

Keysight X-Series Signal Analyzer

Notice: This document contains references to Agilent. Please note that Agilent's Test and Measurement business has become Keysight Technologies. For more information, go to www.keysight.com.

This help file provides documentation for the following X-Series Analyzers:
PXA Signal Analyzer N9030A
MXA Signal Analyzer N9020A
EXA Signal Analyzer N9010A
CXA Signal Analyzer N9000A

N9077A & W9077A
WLAN
Measurement
Application User's &
Programmer's
Reference

Notices

© Keysight Technologies, Inc.
2011-2014

No part of this manual may be reproduced in any form or by any means (including electronic storage and retrieval or translation into a foreign language) without prior agreement and written consent from Keysight Technologies, Inc. as governed by United States and international copyright laws.

Acknowledgments

Adobe Acrobat® and Reader® are U.S. registered trademarks of Adobe Systems Incorporated.

Manual Part Number

N9077-90003

Edition

October 2014
Printed in USA
Keysight Technologies, Inc.
1400 Fountaingrove Parkway
Santa Rosa, CA 95403

Warranty

The material contained in this document is provided “as is,” and is subject to being changed, without notice, in future editions. Further, to the maximum extent permitted by applicable law, Keysight disclaims all warranties, either express or implied, with regard to this manual and any information contained herein, including but not limited to the implied warranties of merchantability and fitness for a particular purpose. Keysight shall not be liable for errors or for incidental or consequential

damages in connection with the furnishing, use, or performance of this document or of any information contained herein. Should Keysight and the user have a separate written agreement with warranty terms covering the material in this document that conflict with these terms, the warranty terms in the separate agreement shall control.

Technology Licenses

The hardware and/or software described in this document are furnished under a license and may be used or copied only in accordance with the terms of such license.

Restricted Rights

Legend

If software is for use in the performance of a U.S. Government prime contract or subcontract, Software is delivered and licensed as “Commercial computer software” as defined in DFAR 252.227-7014 (June 1995), or as a “commercial item” as defined in FAR 2.101(a) or as “Restricted computer software” as defined in FAR 52.227-19 (June 1987) or any equivalent agency regulation or contract clause. Use, duplication or disclosure of Software is subject to Keysight Technologies’ standard commercial license terms, and non-DOD Departments and Agencies of the U.S. Government will receive no greater than Restricted Rights as defined in FAR 52.227-19(c)(1-2) (June 1987). U.S. Government users will

receive no greater than Limited Rights as defined in FAR 52.227-14 (June 1987) or DFAR 252.227-7015 (b)(2) (November 1995), as applicable in any technical data.

Safety Notices

CAUTION

A CAUTION notice denotes a hazard. It calls attention to an operating procedure, practice, or the like that, if not correctly performed or adhered to, could result in damage to the product or loss of important data. Do not proceed beyond a CAUTION notice until the indicated conditions are fully understood and met.

WARNING

A WARNING notice denotes a hazard. It calls attention to an operating procedure, practice, or the like that, if not correctly performed or adhered to, could result in personal injury or death. Do not proceed beyond a WARNING notice until the indicated conditions are fully understood and met.

Table of Contents

N9077A & W9077A WLAN Measurement Application User's & Programmer's Reference	i
Table of Contents	iii
1 About the Analyzer	79
Installing Application Software	80
Viewing a License Key	80
Obtaining and Installing a License Key	80
Updating Measurement Application Software	80
X-Series Options and Accessories	82
Front-Panel Features	83
Display Annotations	84
Rear-Panel Features	85
Window Control Keys	86
Multi-Window	86
Zoom	86
Next Window	87
Full Screen	88
Display Enable (Remote Command Only)	88
Mouse and Keyboard Control	90
Right-Click	90
PC Keyboard	92
Instrument Security & Memory Volatility	95
2 About the WLAN Measurement Application	97
What Does the WLAN Measurement Application Do?	98
3 Programming the Analyzer	99
What Programming Information is Available?	100
List of SCPI Commands	101
STATus Subsystem	142
Detailed Description	144
What Are Status Registers	145
What Are Status Register SCPI Commands	145
How to Use the Status Registers	146
Using a Status Register	147
Using the Service Request (SRQ) Method	148
Generating a Service Request	148
Status Register System	149
The Status Byte Register	150
Standard Event Status Register	152
Operation and Questionable Status Registers	154
Operation Status Register	154
Questionable Status Register	154

STATus Subsystem Command Descriptions	155
Operation Register	155
Operation Condition Query	155
Operation Enable	156
Operation Event Query	156
Operation Negative Transition	156
Operation Positive Transition	157
Preset the Status Byte	157
Questionable Register	158
Questionable Condition	158
Questionable Enable	158
Questionable Event Query	159
Questionable Negative Transition	159
Questionable Positive Transition	159
Questionable Calibration Register	160
Questionable Calibration Condition	160
Questionable Calibration Enable	160
Questionable Calibration Event Query	161
Questionable Calibration Negative Transition	161
Questionable Calibration Positive Transition	162
Questionable Calibration Skipped Register	162
Questionable Calibration Skipped Condition	162
Questionable Calibration Skipped Enable	163
Questionable Calibration Skipped Event Query	163
Questionable Calibration Skipped Negative Transition	164
Questionable Calibration Skipped Positive Transition	164
Questionable Calibration Extended Failure Register	164
Questionable Calibration Extended Failure Condition	165
Questionable Calibration Extended Failure Enable	165
Questionable Calibration Extended Failure Event Query	165
Questionable Calibration Extended Failure Negative Transition	166
Questionable Calibration Extended Failure Positive Transition	166
Questionable Calibration Extended Needed Register	167
Questionable Calibration Extended Needed Condition	167
Questionable Calibration Extended Needed Enable	167
Questionable Calibration Extended Needed Event Query	168
Questionable Calibration Extended Needed Negative Transition	168
Questionable Calibration Extended Needed Positive Transition	169
Questionable Frequency Register	169
Questionable Frequency Condition	169
Questionable Frequency Enable	170
Questionable Frequency Event Query	170
Questionable Frequency Negative Transition	170

Questionable Frequency Positive Transition	171
Questionable Integrity Register	171
Questionable Integrity Condition	171
Questionable Integrity Enable	172
Questionable Integrity Event Query	172
Questionable Integrity Negative Transition	173
Questionable Integrity Positive Transition	173
Questionable Integrity Signal Register	173
Questionable Integrity Signal Condition	174
Questionable Integrity Signal Enable	174
Questionable Integrity Signal Event Query	175
Questionable Integrity Signal Negative Transition	175
Questionable Integrity Signal Positive Transition	175
Questionable Integrity Uncalibrated Register	176
Questionable Integrity Uncalibrated Condition	176
Questionable Integrity Uncalibrated Enable	176
Questionable Integrity Uncalibrated Event Query	177
Questionable Integrity Uncalibrated Negative Transition	177
Questionable Integrity Uncalibrated Positive Transition	178
Questionable Power Register	178
Questionable Power Condition	178
Questionable Power Enable	179
Questionable Power Event Query	179
Questionable Power Negative Transition	180
Questionable Power Positive Transition	180
Questionable Temperature Register	180
Questionable Temperature Condition	181
Questionable Temperature Enable	181
Questionable Temperature Event Query	181
Questionable Temperature Negative Transition	182
Questionable Temperature Positive Transition	182
IEEE 488.2 Common Commands	184
All	184
Clear Status	186
Standard Event Status Enable	187
Standard Event Status Register Query	187
Identification Query	188
Operation Complete	188
Query Instrument Options	189
Recall Instrument State	189
*RST (Remote Command Only)	190
Save Instrument State	190
Service Request Enable	191

Status Byte Query	191
Trigger	192
Self Test Query	192
Wait-to-Continue	192
4 Input/Output Functions	193
Input/Output	194
Input/Output variables - Preset behavior	195
RF Input	196
Input Z Correction	196
RF Coupling	197
External Mixer	198
More Information	199
Ext Mix Setup	201
Mixer Presets	206
Mixer Bias	211
Cable IF Loss	211
I/Q	212
Baseband I/Q (Option BBA)	212
Baseband I/Q Remote Language Compatibility	214
I/Q Path	215
I+jQ	216
I Only	216
Q Only	216
I Setup	217
I Differential Input	217
I Input Z	218
I Skew	218
I Probe	219
Combined Differential/Input Z (Remote Command Only)	221
Q Setup	222
Q Same as I	222
Q Differential Input	222
Q Input Z	223
Q Skew	224
Q Probe	224
Reference Z	226
I/Q Cable Calibrate...	227
I/Q Probe Setup	228
Attenuation	228
Offset	229
Coupling	229
Calibrate	231
Clear Calibration	231

RF Calibrator	231
50 MHz	232
4.8 GHz	233
Off	233
External Gain	233
Ext Preamp	234
More Information	235
MS	235
BTS	236
I Ext Gain	237
Q Ext Gain	238
Restore Input/Output Defaults	238
Data Source	239
Inputs	239
Capture Buffer	240
Current Meas -> Capture Buffer	240
Corrections	241
Select Correction	241
Correction On/Off	242
Properties	242
Select Correction	243
Antenna Unit	243
Frequency Interpolation	245
Description	247
Comment	247
Edit	248
Navigate	249
Frequency	249
Amplitude	249
Insert Point Below	249
Delete Point	250
Scale X Axis	250
Delete Correction	250
Apply Corrections	250
Delete All Corrections	251
Remote Correction Data Set Commands	251
Set (Replace) Data (Remote Command Only)	251
Merge Correction Data (Remote Command Only)	252
Freq Ref In	252
Sense	254
Internal	255
External	255
Ext Ref Freq	255

External Reference Lock BW	256
External Ref Coupling	257
Output Config	258
Trig Out	259
Polarity	259
Off	260
Sweeping (HSWP)	260
Measuring	260
Main Trigger	260
Gate Trigger	261
Gate	261
Source Point Trigger	261
Odd/Even Trace Point	262
Analog Out	262
More Information	262
Auto	263
Off	263
Screen Video	263
Log Video (RF Envelope, Ref=Mixer Level)	264
Linear Video (RF Envelope, Ref=Ref Level)	265
Demod Audio	266
Digital Bus	266
Bus Out On/Off	267
I/Q Cal Out	267
1 kHz Square Wave	268
250 kHz Square Wave	268
Off	268
Aux IF Out	268
Off	269
Second IF	269
Arbitrary IF	270
Fast Log Video	270
I/Q Guided Calibration	271
I/Q Isolation Calibration	271
Next	271
Exit	271
I/Q Isolation Calibration Time (Remote Command Only)	272
I/Q Cable Calibrate...	272
I Port	273
I-bar Port	274
Q Port	275
Q-bar Port	276
I/Q Cable Calibration Time (Remote Command Only)	277

I/Q Probe Calibration	277
I Port	278
I-bar Port	279
Q Port	280
Q-bar Port	281
Show Adapter Screen	282
I/Q Probe Calibration Time (Remote Command Only)	283
Exit Confirmation	283
LISN Control	283
V-network (Remote Command Only)	283
Phase (Remote Command Only)	284
150 kHz Highpass (Remote Command Only)	284
Protective Earth (Remote Command Only)	284
5 Mode Functions	287
Mode	288
More Information	289
Spectrum Analyzer	290
Noise Figure	291
Vector Signal Analyzer (VXA)	291
Analog Demod	291
Phase Noise	292
CMMB	292
Combined WLAN	292
TD-SCDMA with HSPA/8PSK	293
IQ Analyzer (Basic)	293
GSM/EDGE/EDGE Evo	293
Combined Fixed WiMAX	294
W-CDMA with HSPA+	294
DVB-T/H with T2	294
EMI Receiver	294
802.16 OFDM (Fixed WiMAX)	295
WLAN	295
1xEV-DO	295
802.16 OFDMA (WiMAX/WiBro)	296
89601 VSA	296
MSR	297
cdma2000	297
Bluetooth	298
LTE	298
SCPI Language Compatibility	298
iDEN/WiDEN/MOTOTalk	299
ISDB-T	299
Digital Cable TV	299

LTE TDD	299
Remote Language Compatibility	300
DTMB (CTTB)	300
LTE-Advanced FDD	300
LTE-Advanced TDD	301
Application Mode Number Selection (Remote Command Only)	301
Application Mode Catalog Query (Remote Command Only)	303
Application Identification (Remote Commands Only)	303
Current Application Model	304
Current Application Revision	304
Current Application Options	304
Application Identification Catalog (Remote Commands Only)	305
Application Catalog Number of Entries	305
Application Catalog Model Numbers	305
Application Catalog Revision	305
Application Catalog Options	306
Detailed List of Modes	306
1xEV-DO	306
802.16 OFDMA (WiMAX/WiBro)	307
802.16 OFDM (Fixed WiMAX)	307
89601 VSA	307
Analog Demod	308
Bluetooth	308
cdma2000	309
CMMB	309
Combined WLAN	309
Combined Fixed WiMAX	310
Digital Cable TV	310
DTMB (CTTB)	310
DVB-T/H with T2	310
EMI Receiver	311
GSM/EDGE/EDGE Evo	311
iDEN/WiDEN/MOTOTalk	311
IQ Analyzer (Basic)	312
ISDB-T	312
LTE	312
LTE TDD	313
LTE-Advanced FDD	313
LTE-Advanced TDD	313
MSR	314
Noise Figure	314
Phase Noise	315
Real Time Spectrum Analyzer	315

Remote Language Compatibility	315
SCPI Language Compatibility	316
Spectrum Analyzer	316
TD-SCDMA with HSPA/8PSK	316
Vector Signal Analyzer (VXA)	317
W-CDMA with HSPA+	317
WLAN	317
Global Settings	318
Global Center Freq	318
Restore Defaults	319
Mode Setup	320
Radio Std	320
802.11a/b/g	321
802.11a/g	321
802.11b/g	323
802.11g DSSS-OFDM	324
802.11n	326
802.11n 20 MHz	326
802.11n 40 MHz	328
802.11ac	331
802.11ac 20 MHz	331
802.11ac 40 MHz	334
802.11ac 80 MHz	337
802.11ac 80+80 MHz	339
Noise Reduction	342
Noise Floor Extension	342
More Information	343
Restore Mode Defaults	344
Preset Type (Remote Command Only)	345
6 System Functions	347
File	348
File Explorer	348
Page Setup	349
Print	350
Minimize	350
Exit	350
Maximize/Restore Down	351
Maximize	351
Restore Down	351
Print	352
System	353
Show	353
Errors	353

Previous Page	354
Next Page	355
History	355
Verbose SCPI On/Off	355
Refresh	356
Clear Error Queue	356
Status	356
Input Overload Enable (Remote Command Only)	356
System	357
Show System contents (Remote Command Only)	358
Computer System description (Remote Command Only)	358
Hardware	358
LXI	359
Power On	359
Mode and Input/Output Defaults	360
User Preset	360
Last State	361
Power On Application	361
Configure Applications	362
Preloading Applications	363
Access to Configure Applications utility	363
Virtual memory usage	363
Select All	364
Deselect All	364
Move Up	364
Move Down	364
Select/Deselect	364
Save Changes and Exit	365
Exit Without Saving	365
Restore Power On Defaults	365
Configure Applications - Instrument boot-up	366
Configure Applications - Windows desktop	366
Configure Applications - Remote Commands	366
Configuration list (Remote Command Only)	367
Configuration Memory Available (Remote Command Only)	367
Configuration Memory Total (Remote Command Only)	367
Configuration Memory Used (Remote Command Only)	367
Configuration Application Memory (Remote Command Only)	368
Alignments	368
Auto Align	368
Normal	369
Partial	370
Off	370

All but RF	371
Alert	371
Execute Expired Alignments (Remote Command Only)	374
Align Now	375
All	375
All but RF	377
RF	379
External Mixer	380
Show Alignment Statistics	381
Restore Align Defaults	386
Backup or Restore Align Data...	386
Alignment Data Wizard	387
Perform Backup (Remote Command Only)	392
Perform Restore (Remote Command Only)	393
Advanced	393
Characterize Preselector	393
Characterize Reference Clock	395
Characterize Noise Floor	398
Timebase DAC	400
Calibrated	400
User	400
I/O Config	401
GPIB	402
GPIB Address	402
GPIB Controller	402
SCPI LAN	403
SCPI Telnet	404
SCPI Socket	404
SICL Server	404
HiSLIP Server	405
SCPI Socket Control Port (Remote Command Only)	406
Reset Web Password	406
LXI	407
LAN Reset	407
Device Identification (Remote Command Only)	407
System IDN Response	407
Factory	408
User	408
Query USB Connection (Remote Command Only)	409
USB Connection Status (Remote Command Only)	409
USB Packet Count (Remote Command Only)	409
Restore Defaults	410
Restore Input/Output Defaults	410

Restore Power On Defaults	411
Restore Align Defaults	411
Restore Misc Defaults	412
Restore Mode Defaults (All Modes)	413
All	414
Control Panel...	415
Licensing...	416
Security	418
USB	418
Read-Write	418
Read only	418
Diagnostics	419
Show Hardware Statistics	419
SCPI for Show Hardware Statistics (Remote Commands Only)	420
Internet Explorer...	422
System Remote Commands (Remote Commands Only)	422
System Powerdown (Remote Command Only)	422
List installed Options (Remote Command Only)	423
Lock the Front-panel keys (Remote Command Only)	423
List SCPI Commands (Remote Command Only)	424
SCPI Version Query (Remote Command Only)	424
Date (Remote Command Only)	424
Time (Remote Command Only)	424
7 Trigger Functions	427
Trigger	428
Trigger Source Presets	429
RF Trigger Source	432
I/Q Trigger Source	433
More Information	434
Free Run	435
Video (IF Envelope)	436
Trigger Level	436
Trig Slope	437
Trig Delay	438
Line	439
Trig Slope	440
Trig Delay	440
External 1	441
Trigger Level	441
Trig Slope	442
Trig Delay	443
Zero Span Delay Comp On/Off	443
External 2	444

Trigger Level	444
Trig Slope	445
Trig Delay	445
Zero Span Delay Comp On/Off	446
RF Burst	447
Absolute Trigger Level	447
Relative Trigger Level	448
Trigger Slope	449
Trig Delay	450
Periodic Timer (Frame Trigger)	451
Period	452
Offset	453
Reset Offset Display	454
Sync Source	454
Off	455
External 1	455
External 2	456
RF Burst	458
Trig Delay	460
Auto/Holdoff	461
Auto Trig	461
Trig Holdoff	462
8 Channel Power Measurement	463
AMPTD Y Scale	472
Ref Value	472
Attenuation	472
Dual Attenuator Configurations:	473
Single Attenuator Configuration:	474
(Mech) Atten	474
Attenuator Configurations and Auto/Man	476
Enable Elec Atten	476
More Information	477
Mechanical Attenuator Transition Rules	477
When the Electronic Attenuation is enabled from a disabled state:	477
Examples in the dual attenuator configuration:	477
When the Electronic Attenuation is disabled from an enabled state:	478
Using the Electronic Attenuator: Pros and Cons	478
Elec Atten	478
Adjust Atten for Min Clip	479
Pre-Adjust for Min Clip	479
Off	480
Elec Atten Only	480
Mech + Elec Atten	481

(Mech) Atten Step	481
Scale/Div	482
Presel Center	482
Proper Preselector Operation	483
Preselector Adjust	483
μW Path Control	485
μW Path Control Auto	485
Standard Path	485
Low Noise Path Enable	486
More Information	486
μW Preselector Bypass	488
Internal Preamp	489
Off	490
Low Band	490
Full Range	490
Ref Position	491
Auto Scaling	491
Auto Couple	493
More Information	493
Auto/Man Active Function keys	493
Auto/Man 1-of-N keys	493
BW	495
Res BW	495
Video BW	496
Filter Type	498
Cont (Continuous Measurement/Sweep)	499
File	501
FREQ Channel	502
Center Freq	502
Center Frequency Presets	503
RF Center Freq	505
Ext Mix Center Freq	506
I/Q Center Freq	507
CF Step	507
Input/Output	509
Marker	510
Select Marker	510
Marker Type	510
Properties	511
Select Marker	511
Relative To	511
All Markers Off	511
Marker X Axis Value (Remote Command Only)	512

Marker X Axis Position (Remote Command Only)	512
Marker Y Axis Value (Remote Command only)	513
Backward Compatibility SCPI Commands	513
Marker Function	515
Marker To	516
Meas	517
Remote Measurement Functions	517
Measurement Group of Commands	518
Current Measurement Query (Remote Command Only)	520
Limit Test Current Results (Remote Command Only)	520
Data Query (Remote Command Only)	520
Calculate/Compress Trace Data Query (Remote Command Only)	521
Calculate Peaks of Trace Data (Remote Command Only)	526
Hardware-Accelerated Fast Power Measurement (Remote Command Only)	527
Reset Fast Power Measurement (Remote Command Only)	527
Define Fast Power Measurement (Remote Command Only)	528
Define Fast Power Measurement Query (Remote Command Only)	537
Configure Fast Power Measurement (Remote Command Only)	538
Initiate Fast Power Measurement (Remote Command Only)	539
Fetch Fast Power Measurement (Remote Command Only)	539
Execute Fast Power Measurement (Remote Command Only)	539
Binary Read Fast Power Measurement (Remote Command Only)	540
Diagnostic Binary Read Fast Power Measurement (Remote Command Only)	540
Format Data: Numeric Data (Remote Command Only)	541
Format Data: Byte Order (Remote Command Only)	542
Meas Setup	543
Avg/Hold Num	543
Avg Mode	544
Integ BW	545
PhNoise Opt	546
PhNoise Opt Auto	546
PhNoise Opt State	546
IF Gain	547
IF Gain Auto	548
IF Gain State	548
Method	549
Method	550
Filter Alpha	550
Filter BW	551
Limits	552
Power Limit	552
PSD Limit	553
Power Limit Fail (remote command only)	554

PSD Limit Fail (remote command only)	555
PSD Unit	555
Meas Preset	556
Mode	557
Mode Preset	558
How-To Preset	559
Mode Setup	561
Peak Search	562
Print	563
Quick Save	564
Recall	566
State	566
More Information	568
From File...	568
Edit Register Names	570
Register 1 thru Register 16	570
Register 1 thru Register 16	571
Data (Import)	572
Masks	573
Capture Buffer	574
Open...	574
Restart	575
More Information	575
Save	577
State	577
To File . . .	578
Edit Register Names	580
More Information	580
Register 1 thru Register 16	581
Register 1 thru Register 16	581
Data (Export)	582
Meas Results	583
Capture Buffer	583
Save As . . .	583
Screen Image	584
Themes	585
3D Color	585
3D Monochrome	586
Flat Color	586
Flat Monochrome	586
Save As...	586
Mass Storage Catalog (Remote Command Only)	587
Mass Storage Change Directory (Remote Command Only)	587

Mass Storage Copy (Remote Command Only)	588
Mass Storage Device Copy (Remote Command Only)	588
Mass Storage Delete (Remote Command Only)	588
Mass Storage Data (Remote Command Only)	588
Mass Storage Make Directory (Remote Command Only)	589
Mass Storage Move (Remote Command Only)	589
Mass Storage Remove Directory (Remote Command Only)	590
Single (Single Measurement/Sweep)	591
More Information	591
Source	592
Span X Scale	593
Span	593
Full Span	594
Last Span	595
Sweep/Control	596
Sweep Time	596
Sweep Setup	597
Auto Sweep Time Rules	597
Pause	598
Gate	598
Gate On/Off	598
Gate View On/Off	599
Gate View Setup	602
Gate View Sweep Time	603
Gate View Start Time	603
Gate Delay	604
Gate Length	604
Gate Source	605
Line	606
External 1	606
External 2	608
RF Burst	611
Periodic Timer (Frame Trigger)	614
Control Edge/Level	625
Gate Holdoff	625
Gate Delay Compensation	627
More Information	628
Min Fast Position Query (Remote Command Only)	628
Gate Preset (Remote Command Only)	629
Gate Level (Remote Command Only)	629
Gate Polarity (Remote Command Only)	629
Points	630
System	632

Trace/Detector	633
Trace Type	633
Detector	633
Auto	634
Detector Selection	634
Trigger	636
Free Run	636
Video	636
Trigger Level	636
Trig Slope	636
Trig Delay	636
Line	636
Trig Slope	636
Trig Delay	636
External 1	636
Trigger Level	636
Trig Slope	636
Trig Delay	636
Zero Span Delay Comp	636
External 2	637
Trigger Level	637
Trig Slope	637
Trig Delay	637
Zero Span Delay Comp	637
RF Burst	637
Absolute Trigger	637
Relative Trigger	637
Trig Slope	637
Trig Delay	637
Periodic Timer	637
Period	637
Offset	637
Reset Offset Display	637
Sync Source	638
Off	638
External 1	638
External 2	638
RF Burst	638
Trig Delay	638
Auto/Holdoff	638
Auto Trig	638
Trig Holdoff	638
User Preset	639

User Preset	639
User Preset All Modes	640
Save User Preset	641
View/Display	642
View selection by name (MSR and LTE-Advanced FDD/TDD only)	644
Selects the results view. The following SCPI command allows you to select the desired measurement view by enumeration.	644
Selects the results view. The following SCPI command allows you to select the desired measurement view by enumeration.	645
View selection by name (DTMB (CTTB), DVB-T/H only)	645
View selection by name (ISDB-T, CMMB only)	646
Display	646
Annotation	646
Meas Bar On/Off	647
Screen	648
Active Function Values On/Off	648
Title	649
Change Title	649
Clear Title	650
Graticule	651
System Display Settings	651
Annotation Local Settings	651
Themes	652
Backlight	653
Backlight Intensity	653
Bar Graph	654
9 Occupied Bandwidth Measurement	655
AMPTD Y Scale (Amplitude/Y Scale)	658
Ref Value	658
Attenuation	658
Dual Attenuator Configurations:	659
Single Attenuator Configuration:	660
(Mech) Atten	660
Attenuator Configurations and Auto/Man	662
Enable Elec Atten	662
More Information	663
Mechanical Attenuator Transition Rules	663
When the Electronic Attenuation is enabled from a disabled state:	663
Examples in the dual attenuator configuration:	663
When the Electronic Attenuation is disabled from an enabled state:	664
Using the Electronic Attenuator: Pros and Cons	664
Elec Atten	664
Adjust Atten for Min Clip	665

Pre-Adjust for Min Clip	665
Off	666
Elec Atten Only	666
Mech + Elec Atten	667
(Mech) Atten Step	667
Scale/Div	668
Presel Center	668
Proper Preselector Operation	669
Preselector Adjust	669
μ W Path Control	671
μ W Path Control Auto	671
Standard Path	671
Low Noise Path Enable	672
More Information	672
μ W Preselector Bypass	674
Internal Preamp	675
Off	676
Low Band	676
Full Range	676
Ref Position	677
Auto Scaling	677
Auto Couple	679
More Information	679
Auto/Man Active Function keys	679
Auto/Man 1-of-N keys	679
BW	681
Res BW	681
Video BW	682
Filter Type	683
Cont (Continuous Measurement/Sweep)	685
File	687
FREQ Channel	688
Center Freq	688
Center Frequency Presets	689
RF Center Freq	691
Ext Mix Center Freq	692
I/Q Center Freq	693
CF Step	693
Input/Output	695
Marker	696
Select Marker	696
Select Marker	696
Marker Type	696

Properties	697
Select Marker	697
Select Marker	697
Relative To	697
All Markers Off	698
Marker X Axis Value (Remote Command Only)	698
Marker X Axis Position (Remote Command Only)	699
Marker Y Axis Value (Remote Command Only)	699
Backward Compatibility SCPI Commands	700
Marker Function	701
Marker To	702
Meas	703
Remote Measurement Functions	703
Measurement Group of Commands	704
Current Measurement Query (Remote Command Only)	706
Limit Test Current Results (Remote Command Only)	706
Data Query (Remote Command Only)	706
Calculate/Compress Trace Data Query (Remote Command Only)	707
Calculate Peaks of Trace Data (Remote Command Only)	712
Hardware-Accelerated Fast Power Measurement (Remote Command Only)	713
Reset Fast Power Measurement (Remote Command Only)	713
Define Fast Power Measurement (Remote Command Only)	714
Define Fast Power Measurement Query (Remote Command Only)	723
Configure Fast Power Measurement (Remote Command Only)	724
Initiate Fast Power Measurement (Remote Command Only)	725
Fetch Fast Power Measurement (Remote Command Only)	725
Execute Fast Power Measurement (Remote Command Only)	725
Binary Read Fast Power Measurement (Remote Command Only)	726
Diagnostic Binary Read Fast Power Measurement (Remote Command Only)	726
Format Data: Numeric Data (Remote Command Only)	727
Format Data: Byte Order (Remote Command Only)	728
Meas Setup	729
Avg/Hold Num	729
Avg Mode	730
Occ BW % Pwr	730
x dB	731
IF Gain	732
IF Gain Auto	732
IF Gain State	732
Limit (for all modes except MSR and LTE-Advanced FDD/TDD)	733
Meas Preset	734
Max Hold (Remote Command Only)	735
Mode	736

Mode Preset	737
How-To Preset	738
Mode Setup	740
Peak Search	741
Print	742
Quick Save	743
Recall	745
State	745
More Information	747
From File...	747
Edit Register Names	749
Register 1 thru Register 16	749
Register 1 thru Register 16	750
Data (Import)	751
Masks	752
Capture Buffer	753
Open...	753
Restart	754
More Information	754
Save	756
State	756
To File . . .	757
Edit Register Names	759
More Information	759
Register 1 thru Register 16	760
Register 1 thru Register 16	760
Data (Export)	761
Meas Results	762
Capture Buffer	762
Save As . . .	762
Screen Image	763
Themes	764
3D Color	764
3D Monochrome	765
Flat Color	765
Flat Monochrome	765
Save As...	765
Mass Storage Catalog (Remote Command Only)	766
Mass Storage Change Directory (Remote Command Only)	766
Mass Storage Copy (Remote Command Only)	767
Mass Storage Device Copy (Remote Command Only)	767
Mass Storage Delete (Remote Command Only)	767
Mass Storage Data (Remote Command Only)	767

Mass Storage Make Directory (Remote Command Only)	768
Mass Storage Move (Remote Command Only)	768
Mass Storage Remove Directory (Remote Command Only)	769
Single (Single Measurement/Sweep)	770
More Information	770
Source	771
Span X Scale	772
Span	772
Full Span	773
Last Span	773
Sweep/Control	775
Sweep Time	775
Sweep Setup	776
Auto Sweep Time Rules	776
Pause	777
Gate	777
Gate On/Off	777
Gate View On/Off	778
Gate View Setup	781
Gate View Sweep Time	782
Gate View Start Time	782
Gate Delay	783
Gate Length	783
Gate Source	784
Line	785
External 1	785
External 2	787
RF Burst	790
Periodic Timer (Frame Trigger)	793
Control Edge/Level	804
Gate Holdoff	804
Gate Delay Compensation	806
More Information	807
Min Fast Position Query (Remote Command Only)	807
Gate Preset (Remote Command Only)	808
Gate Level (Remote Command Only)	808
Gate Polarity (Remote Command Only)	808
Points	809
System	811
Trace/Detector	812
Trace Type	812
Detector	812
Auto	813

Detector Selection	813
Trigger	815
Free Run	815
Video	815
Trigger Level	815
Trig Slope	815
Trig Delay	815
Line	815
Trig Slope	815
Trig Delay	815
External 1	815
Trigger Level	815
Trig Slope	815
Trig Delay	815
Zero Span Delay Comp	815
External 2	816
Trigger Level	816
Trig Slope	816
Trig Delay	816
Zero Span Delay Comp	816
RF Burst	816
Absolute Trigger	816
Relative Trigger	816
Trig Slope	816
Trig Delay	816
Periodic Timer	816
Period	816
Offset	816
Reset Offset Display	816
Sync Source	817
Off	817
External 1	817
External 2	817
RF Burst	817
Trig Delay	817
Auto/Holdoff	817
Auto Trig	817
Trig Holdoff	817
User Preset	818
User Preset	818
User Preset All Modes	819
Save User Preset	820
View/Display	821

Spectrum View	821
Display	826
Annotation	826
Meas Bar On/Off	828
Screen	828
Active Function Values On/Off	828
Title	829
Change Title	829
Clear Title	830
Graticule	831
System Display Settings	831
Annotation Local Settings	831
Themes	832
Backlight	833
Backlight Intensity	833
10 Power Stat CCDF Measurement	835
AMPTD Y Scale	840
Attenuation	840
Dual Attenuator Configurations:	840
Single Attenuator Configuration:	841
(Mech) Atten	842
Attenuator Configurations and Auto/Man	843
Enable Elec Atten	843
More Information	844
Mechanical Attenuator Transition Rules	844
When the Electronic Attenuation is enabled from a disabled state:	845
Examples in the dual attenuator configuration:	845
When the Electronic Attenuation is disabled from an enabled state:	845
Using the Electronic Attenuator: Pros and Cons	845
Elec Atten	846
Adjust Atten for Min Clip	846
Pre-Adjust for Min Clip	847
Off	848
Elec Atten Only	848
Mech + Elec Atten	848
(Mech) Atten Step	848
Presel Center	849
Proper Preselector Operation	850
Preselector Adjust	850
μ W Path Control	852
μ W Path Control Auto	852
Standard Path	852
Low Noise Path Enable	853

More Information	853
μ W Preselector Bypass	855
Internal Preamp	856
Off	857
Low Band	857
Full Range	857
Y Axis Unit	858
Reference Level Offset	858
Auto Couple	859
More Information	859
Auto/Man Active Function keys	859
Auto/Man 1-of-N keys	859
BW	861
Info BW	861
Cont (Continuous Measurement/Sweep)	863
File	865
FREQ Channel	866
Center Freq	866
Center Frequency Presets	867
RF Center Freq	869
Ext Mix Center Freq	870
I/Q Center Freq	871
CF Step	871
Input/Output	873
Marker	874
Select Marker	874
Marker Type	874
Properties	875
Select Marker	875
Relative To	875
Marker Trace	876
Couple Markers	876
All Markers Off	876
Marker X Axis Value (Remote Command Only)	877
Marker Y Axis Value (Remote Command Only)	877
Marker Function	879
Marker To	880
Meas	881
Remote Measurement Functions	881
Measurement Group of Commands	882
Current Measurement Query (Remote Command Only)	884
Limit Test Current Results (Remote Command Only)	884
Data Query (Remote Command Only)	884

Calculate/Compress Trace Data Query (Remote Command Only)	885
Calculate Peaks of Trace Data (Remote Command Only)	890
Hardware-Accelerated Fast Power Measurement (Remote Command Only)	891
Reset Fast Power Measurement (Remote Command Only)	891
Define Fast Power Measurement (Remote Command Only)	892
Define Fast Power Measurement Query (Remote Command Only)	901
Configure Fast Power Measurement (Remote Command Only)	902
Initiate Fast Power Measurement (Remote Command Only)	903
Fetch Fast Power Measurement (Remote Command Only)	903
Execute Fast Power Measurement (Remote Command Only)	903
Binary Read Fast Power Measurement (Remote Command Only)	904
Diagnostic Binary Read Fast Power Measurement (Remote Command Only)	904
Format Data: Numeric Data (Remote Command Only)	905
Format Data: Byte Order (Remote Command Only)	906
Meas Setup	907
Counts	907
Meas Cycles	907
Meas Interval (Not 1xEVDO)	908
IF Gain	909
IF Gain Auto	909
IF Gain State	910
Meas Preset	910
Mode	912
Mode Preset	913
How-To Preset	914
Mode Setup	916
Peak Search	917
Print	918
Quick Save	919
Recall	921
State	921
More Information	923
From File...	923
Edit Register Names	925
Register 1 thru Register 16	925
Register 1 thru Register 16	926
Data (Import)	927
Masks	928
Capture Buffer	929
Open...	929
Restart	930
More Information	930
Save	932

State	932
To File . . .	933
Edit Register Names	935
More Information	935
Register 1 thru Register 16	936
Register 1 thru Register 16	936
Data (Export)	937
Meas Results	938
Capture Buffer	938
Save As . . .	938
Screen Image	939
Themes	940
3D Color	940
3D Monochrome	941
Flat Color	941
Flat Monochrome	941
Save As...	941
Mass Storage Catalog (Remote Command Only)	942
Mass Storage Change Directory (Remote Command Only)	942
Mass Storage Copy (Remote Command Only)	943
Mass Storage Device Copy (Remote Command Only)	943
Mass Storage Delete (Remote Command Only)	943
Mass Storage Data (Remote Command Only)	943
Mass Storage Make Directory (Remote Command Only)	944
Mass Storage Move (Remote Command Only)	944
Mass Storage Remove Directory (Remote Command Only)	945
Single (Single Measurement/Sweep)	946
More Information	946
Source	947
Span X Scale	948
Scale/Div	948
Sweep/Control	949
Pause/Resume	949
System	950
Trace/Detector	951
Store Ref Trace	951
Ref Trace	951
Gaussian Line	952
Trigger	953
Free Run	953
Video	953
Trigger Level	953
Trig Slope	953

Trig Delay	953
Line	953
Trig Slope	953
Trig Delay	953
External 1	953
Trigger Level	953
Trig Slope	953
Trig Delay	953
Zero Span Delay Comp	953
External 2	954
Trigger Level	954
Trig Slope	954
Trig Delay	954
Zero Span Delay Comp	954
RF Burst	954
Absolute Trigger	954
Relative Trigger	954
Trig Slope	954
Trig Delay	954
Periodic Timer	954
Period	954
Offset	954
Offset Adjust (Remote Command Only)	954
Reset Offset Display	955
Sync Source	955
Off	955
External 1	955
External 2	955
RF Burst	955
Trig Delay	955
Auto/Holdoff	955
Auto Trig	955
Trig Holdoff	956
User Preset	957
User Preset	957
User Preset All Modes	958
Save User Preset	959
View/Display	960
Metrics window	962
Graph window	963
Wave window (TD-SCDMA and LTE TDD only)	963
Display	964
Annotation	964

Meas Bar On/Off	965
Screen	966
Active Function Values On/Off	966
Title	967
Change Title	967
Clear Title	968
Graticule	969
System Display Settings	969
Annotation Local Settings	969
Themes	970
Backlight	971
Backlight Intensity	971
11 Spectrum Emission Mask Measurement	973
AMPTD Y Scale	996
Ref Value	996
Attenuation	996
Dual Attenuator Configurations:	997
Single Attenuator Configuration:	998
(Mech) Atten	998
Attenuator Configurations and Auto/Man	1000
Enable Elec Atten	1000
More Information	1001
Mechanical Attenuator Transition Rules	1001
When the Electronic Attenuation is enabled from a disabled state:	1001
Examples in the dual attenuator configuration:	1001
When the Electronic Attenuation is disabled from an enabled state:	1002
Using the Electronic Attenuator: Pros and Cons	1002
Elec Atten	1002
Adjust Atten for Min Clip	1003
Pre-Adjust for Min Clip	1003
Off	1004
Elec Atten Only	1004
Mech + Elec Atten	1005
(Mech) Atten Step	1005
Scale/Div	1006
Presel Center	1006
Proper Preselector Operation	1007
Preselector Adjust	1007
μ W Path Control	1009
μ W Path Control Auto	1009
Standard Path	1009
Low Noise Path Enable	1010
More Information	1010

μW Preselector Bypass	1012
Internal Preamp	1013
Off	1014
Low Band	1014
Full Range	1014
Ref Position	1015
Auto Scaling	1015
Auto Couple	1017
More Information	1017
Auto/Man Active Function keys	1017
Auto/Man 1-of-N keys	1017
BW	1019
Filter Type	1019
Cont (Continuous Measurement/Sweep)	1020
File	1022
FREQ Channel	1023
Center Freq	1023
Center Frequency Presets	1024
RF Center Freq	1026
Ext Mix Center Freq	1027
I/Q Center Freq	1028
CF Step	1028
Input/Output	1030
Marker	1031
Select Marker	1031
Marker Type	1031
Couple Markers	1032
All Markers Off	1032
Marker X Axis Value (Remote Command Only)	1032
Marker X Axis Position (Remote Command Only)	1033
Marker Y Axis Value (Remote Command Only)	1034
Marker Function	1035
Marker To	1036
Meas	1037
Remote Measurement Functions	1037
Measurement Group of Commands	1038
Current Measurement Query (Remote Command Only)	1040
Limit Test Current Results (Remote Command Only)	1040
Data Query (Remote Command Only)	1040
Calculate/Compress Trace Data Query (Remote Command Only)	1041
Calculate Peaks of Trace Data (Remote Command Only)	1046
Hardware-Accelerated Fast Power Measurement (Remote Command Only)	1047
Reset Fast Power Measurement (Remote Command Only)	1047

Define Fast Power Measurement (Remote Command Only)	1048
Define Fast Power Measurement Query (Remote Command Only)	1057
Configure Fast Power Measurement (Remote Command Only)	1058
Initiate Fast Power Measurement (Remote Command Only)	1059
Fetch Fast Power Measurement (Remote Command Only)	1059
Execute Fast Power Measurement (Remote Command Only)	1059
Binary Read Fast Power Measurement (Remote Command Only)	1060
Diagnostic Binary Read Fast Power Measurement (Remote Command Only)	1060
Format Data: Numeric Data (Remote Command Only)	1061
Format Data: Byte Order (Remote Command Only)	1062
Meas Setup	1063
Avg/Hold Num	1063
Meas Type	1063
Ref Channel	1064
Integ BW	1064
Span	1065
Sweep Time	1067
Res BW	1067
Video BW	1069
VBW/RBW	1070
Power Ref (for the modes except MSR and LTE-Advanced FDD/TDD)	1071
Total Power	1071
PSD	1072
Spectrum Peak	1073
Offset/Limits	1074
Select Offset	1074
Start Freq	1074
Stop Freq	1077
Sweep Time	1079
Offset Side	1080
Res BW	1081
Meas BW	1083
Video BW	1084
VBW/RBW	1085
Limits	1087
Select Offset	1087
Abs Start	1087
Abs Stop	1089
Rel Start	1092
Rel Stop	1094
Fail Mask	1096
Offset Freq Define	1098
80+80 MHz Mask (Only for WLAN)	1100

Method	1101
Filter Alpha	1101
Meas Preset	1102
Mode	1103
Mode Preset	1104
How-To Preset	1105
Mode Setup	1107
Peak Search	1108
Print	1109
Quick Save	1110
Recall	1112
State	1112
More Information	1114
From File...	1114
Edit Register Names	1116
Register 1 thru Register 16	1116
Register 1 thru Register 16	1117
Data (Import)	1118
Masks	1119
Capture Buffer	1120
Open...	1120
Restart	1121
More Information	1121
Save	1123
State	1123
To File . . .	1124
Edit Register Names	1126
More Information	1126
Register 1 thru Register 16	1127
Register 1 thru Register 16	1127
Data (Export)	1128
Meas Results	1129
Capture Buffer	1129
Save As . . .	1129
Screen Image	1130
Themes	1131
3D Color	1131
3D Monochrome	1132
Flat Color	1132
Flat Monochrome	1132
Save As...	1132
Mass Storage Catalog (Remote Command Only)	1133
Mass Storage Change Directory (Remote Command Only)	1133

Mass Storage Copy (Remote Command Only)	1134
Mass Storage Device Copy (Remote Command Only)	1134
Mass Storage Delete (Remote Command Only)	1134
Mass Storage Data (Remote Command Only)	1134
Mass Storage Make Directory (Remote Command Only)	1135
Mass Storage Move (Remote Command Only)	1135
Mass Storage Remove Directory (Remote Command Only)	1136
Single (Single Measurement/Sweep)	1137
More Information	1137
Source	1138
Span X Scale	1139
Ref Value	1139
Scale/Div	1139
Ref Position	1140
Auto Scaling	1140
Sweep/Control	1142
Pause	1142
Gate	1142
Gate On/Off	1142
Gate View On/Off	1143
Gate View Setup	1146
Gate View Sweep Time	1147
Gate View Start Time	1147
Gate Delay	1148
Gate Length	1148
Gate Source	1149
Line	1150
External 1	1150
External 2	1152
RF Burst	1155
Periodic Timer (Frame Trigger)	1158
Control Edge/Level	1169
Gate Holdoff	1169
Gate Delay Compensation	1171
More Information	1172
Min Fast Position Query (Remote Command Only)	1172
Gate Preset (Remote Command Only)	1173
Gate Level (Remote Command Only)	1173
Gate Polarity (Remote Command Only)	1173
System	1175
Trace/Detector	1176
Trace Type	1176
Chan Detector	1176

Chan Detector Auto	1177
Chan Detector Selection	1177
Offset Detector	1178
Offset Detector Auto	1178
Offset Detector Selection	1179
Trigger	1180
Free Run	1180
Video	1180
Trigger Level	1180
Trig Slope	1180
Trig Delay	1180
Line	1180
Trig Slope	1180
Trig Delay	1180
External 1	1180
Trigger Level	1180
Trig Slope	1180
Trig Delay	1180
Zero Span Delay Comp	1180
External 2	1181
Trigger Level	1181
Trig Slope	1181
Trig Delay	1181
Zero Span Delay Comp	1181
RF Burst	1181
Absolute Trigger	1181
Relative Trigger	1181
Trig Slope	1181
Trig Delay	1181
Periodic Timer	1181
Period	1181
Offset	1181
Reset Offset Display	1181
Sync Source	1182
Off	1182
External 1	1182
External 2	1182
RF Burst	1182
Trig Delay	1182
Auto/Holdoff	1182
Auto Trig	1182
Trig Holdoff	1182
User Preset	1183

User Preset	1183
User Preset All Modes	1184
Save User Preset	1185
View/Display	1186
View Selection by Name (Remote Command Only)	1186
Views Selection by Number (Remote Command only)	1187
Display	1187
Annotation	1188
Meas Bar On/Off	1189
Screen	1190
Active Function Values On/Off	1190
Title	1191
Change Title	1191
Clear Title	1192
Graticule	1193
System Display Settings	1193
Annotation Local Settings	1193
Themes	1194
Backlight	1195
Backlight Intensity	1195
Abs Pwr Freq	1196
Abs Peak Pwr & Freq (Total Pwr Ref)	1196
Trace Window	1198
Results Window	1198
Abs Peak Pwr & Freq (PSD Ref)	1198
Trace Window	1200
Results Window	1200
Abs Peak Pwr & Freq (Spectrum Pk Ref)	1200
Trace Window	1202
Results Window	1202
Rel Pwr Freq	1202
Rel Peak Pwr & Freq (Total Pwr Ref)	1202
Trace Window	1203
Results Window	1203
Rel Peak Pwr & Freq (PSD Ref)	1204
Trace Window	1204
Results Window	1205
Rel Peak Pwr & Freq (Spectrum Pk Ref)	1205
Trace Window	1206
Results Window	1206
Integrated Power	1207
Integrated Power (Total Pwr Ref)	1207
Trace Window	1209

Results Window	1209
Integrated Power (PSD Ref)	1210
Trace Window	1212
Results Window	1212
Integrated Power (Spectrum Pk Ref)	1213
Trace Window	1214
Results Window	1214
Limit Lines	1215
12 Spurious Emissions Measurement	1217
AMPTD Y Scale	1220
Ref Value	1220
Attenuation	1220
Dual Attenuator Configurations:	1221
Single Attenuator Configuration:	1222
(Mech) Atten	1222
Attenuator Configurations and Auto/Man	1224
Enable Elec Atten	1224
More Information	1225
Mechanical Attenuator Transition Rules	1225
When the Electronic Attenuation is enabled from a disabled state:	1225
Examples in the dual attenuator configuration:	1225
When the Electronic Attenuation is disabled from an enabled state:	1226
Using the Electronic Attenuator: Pros and Cons	1226
Elec Atten	1226
Adjust Atten for Min Clip	1227
Pre-Adjust for Min Clip	1227
Off	1228
Elec Atten Only	1228
Mech + Elec Atten	1229
(Mech) Atten Step	1229
Scale/Div	1230
Presel Center	1230
Proper Preselector Operation	1231
Preselector Adjust	1232
μ W Path Control	1233
μ W Path Control Auto	1233
Standard Path	1233
Low Noise Path Enable	1234
More Information	1235
μ W Preselector Bypass	1236
Internal Preamp	1237
Off	1238
Low Band	1238

Full Range	1238
Auto Scaling	1239
Auto Couple	1240
More Information	1240
Auto/Man Active Function keys	1240
Auto/Man 1-of-N keys	1240
BW	1242
Cont (Continuous Measurement/Sweep)	1243
File	1245
FREQ Channel	1246
Center Freq	1246
Center Frequency Presets	1247
RF Center Freq	1249
Ext Mix Center Freq	1250
I/Q Center Freq	1251
CF Step	1251
Input/Output	1253
Marker	1254
Select Marker	1254
Marker Type	1254
Properties	1255
Select Marker	1255
Relative To	1255
Couple Markers	1256
All Markers Off	1256
Marker X Axis Value (Remote Command only)	1257
Marker X Axis Position (Remote Command only)	1257
Marker Y Axis Value (Remote Command only)	1258
Marker Function	1259
Marker To	1260
Meas	1261
Remote Measurement Functions	1261
Measurement Group of Commands	1262
Current Measurement Query (Remote Command Only)	1264
Limit Test Current Results (Remote Command Only)	1264
Data Query (Remote Command Only)	1264
Calculate/Compress Trace Data Query (Remote Command Only)	1265
Calculate Peaks of Trace Data (Remote Command Only)	1270
Hardware-Accelerated Fast Power Measurement (Remote Command Only)	1271
Reset Fast Power Measurement (Remote Command Only)	1271
Define Fast Power Measurement (Remote Command Only)	1272
Define Fast Power Measurement Query (Remote Command Only)	1281
Configure Fast Power Measurement (Remote Command Only)	1282

Initiate Fast Power Measurement (Remote Command Only)	1283
Fetch Fast Power Measurement (Remote Command Only)	1283
Execute Fast Power Measurement (Remote Command Only)	1283
Binary Read Fast Power Measurement (Remote Command Only)	1284
Diagnostic Binary Read Fast Power Measurement (Remote Command Only)	1284
Format Data: Numeric Data (Remote Command Only)	1285
Format Data: Byte Order (Remote Command Only)	1286
Meas Setup	1287
Avg/Hold Num	1287
Avg Mode	1287
Range Table	1288
Range	1288
Start Freq	1290
Stop Freq	1291
Res BW	1292
Video BW	1294
Filter Type	1295
Abs Start Limit	1296
Abs Stop Limit	1297
Peak Excursion	1299
Pk Threshold	1299
Attenuation	1300
Detector 1	1301
Detector 2	1302
Sweep Time	1303
Points	1303
IF Gain	1305
IF Gain Auto	1305
IF Gain State	1306
Meas Type	1306
Spur	1307
Spurious Report Mode	1308
Meas Preset	1308
Fast Spurious Meas (Remote Command only)	1309
Mode	1310
Mode Preset	1311
How-To Preset	1312
Mode Setup	1314
Peak Search	1315
Next Peak	1315
Next Pk Right	1315
Next Pk Left	1316
Marker Delta	1316

Pk-Pk Search	1316
Min Search	1316
Print	1318
Quick Save	1319
Recall	1321
State	1321
More Information	1323
From File...	1323
Edit Register Names	1325
Register 1 thru Register 16	1325
Register 1 thru Register 16	1326
Data (Import)	1327
Masks	1328
Capture Buffer	1329
Open...	1329
Restart	1330
More Information	1330
Save	1332
State	1332
To File . . .	1333
Edit Register Names	1335
More Information	1335
Register 1 thru Register 16	1336
Register 1 thru Register 16	1336
Data (Export)	1337
Meas Results	1338
Capture Buffer	1338
Save As . . .	1338
Screen Image	1339
Themes	1340
3D Color	1340
3D Monochrome	1341
Flat Color	1341
Flat Monochrome	1341
Save As...	1341
Mass Storage Catalog (Remote Command Only)	1342
Mass Storage Change Directory (Remote Command Only)	1342
Mass Storage Copy (Remote Command Only)	1343
Mass Storage Device Copy (Remote Command Only)	1343
Mass Storage Delete (Remote Command Only)	1343
Mass Storage Data (Remote Command Only)	1343
Mass Storage Make Directory (Remote Command Only)	1344
Mass Storage Move (Remote Command Only)	1344

Mass Storage Remove Directory (Remote Command Only)	1345
Single (Single Measurement/Sweep)	1346
More Information	1346
Source	1347
Span X Scale	1348
Sweep/Control	1349
Sweep Setup	1349
Auto Sweep Time Rules	1349
Sweep Type	1350
Pause	1350
Gate	1350
Gate On/Off	1351
Gate View On/Off	1352
Gate View Setup	1355
Gate View Sweep Time	1355
Gate View Start Time	1356
Gate Delay	1356
Gate Length	1357
Gate Source	1357
Line	1358
External 1	1359
External 2	1361
RF Burst	1363
Periodic Timer (Frame Trigger)	1366
Control Edge/Level	1377
Gate Holdoff	1378
Gate Delay Compensation	1379
More Information	1380
Min Fast Position Query (Remote Command Only)	1381
Gate Preset (Remote Command Only)	1381
Gate Level (Remote Command Only)	1381
Gate Polarity (Remote Command Only)	1381
System	1383
Trace/Detector	1384
Trigger	1385
Free Run	1385
Video	1385
Trigger Level	1385
Trig Slope	1385
Trig Delay	1385
Line	1385
Trig Slope	1385
Trig Delay	1385

External 1	1385
Trigger Level	1385
Trig Slope	1385
Trig Delay	1385
Zero Span Delay Comp	1385
External 2	1386
Trigger Level	1386
Trig Slope	1386
Trig Delay	1386
Zero Span Delay Comp	1386
RF Burst	1386
Absolute Trigger	1386
Relative Trigger	1386
Trig Slope	1386
Trig Delay	1386
Periodic Timer	1386
Period	1386
Offset	1386
Reset Offset Display	1386
Sync Source	1387
Off	1387
External 1	1387
External 2	1387
RF Burst	1387
Trig Delay	1387
Auto/Holdoff	1387
Auto Trig	1387
Trig Holdoff	1387
User Preset	1388
User Preset	1388
User Preset All Modes	1389
Save User Preset	1390
View/Display	1391
Display	1391
Annotation	1391
Meas Bar On/Off	1392
Screen	1393
Active Function Values On/Off	1393
Title	1394
Change Title	1394
Clear Title	1395
Graticule	1396
System Display Settings	1396

Annotation Local Settings	1396
Themes	1397
Backlight	1398
Backlight Intensity	1398
View Selection	1399
Graph + Metrics	1399
Range Table	1400
All Ranges	1403
Range Table Selection (SCPI only command)	1404
13 Power vs. Time Measurement Overview	1407
AMPTD Y Scale	1410
Ref Value (Burst View)	1410
Attenuation	1410
Dual Attenuator Configurations:	1411
Single Attenuator Configuration:	1411
(Mech) Atten	1412
Attenuator Configurations and Auto/Man	1413
Enable Elec Atten	1414
More Information	1415
Mechanical Attenuator Transition Rules	1415
When the Electronic Attenuation is enabled from a disabled state:	1415
Examples in the dual attenuator configuration:	1415
When the Electronic Attenuation is disabled from an enabled state:	1415
Using the Electronic Attenuator: Pros and Cons	1416
Elec Atten	1416
Adjust Atten for Min Clip	1417
Pre-Adjust for Min Clip	1417
Off	1418
Elec Atten Only	1418
Mech + Elec Atten	1419
(Mech) Atten Step	1419
Scale/Div(Burst View)	1419
Presel Center	1420
Proper Preselector Operation	1421
Preselector Adjust	1421
μ W Path Control	1422
μ W Path Control Auto	1423
Standard Path	1423
Low Noise Path Enable	1423
More Information	1424
μ W Preselector Bypass	1425
Internal Preamp	1426
Off	1427

Low Band	1428
Full Range	1428
Ref Position(Burst View)	1428
Auto Scaling(Burst View)	1429
Attenuation	1429
Auto Couple	1430
More Information	1430
Auto/Man Active Function keys	1430
Auto/Man 1-of-N keys	1430
BW	1432
BW	1432
Filter Type	1433
Cont (Continuous Measurement/Sweep)	1434
File	1436
FREQ Channel	1437
CF Step	1437
Input/Output	1439
Marker	1440
Select Marker	1440
Marker Type	1440
Properties	1441
Select Marker	1441
Relative To	1441
Marker Trace	1442
Couple Marker	1442
All Markers Off	1442
Marker To	1444
Meas	1445
Remote Measurement Functions	1445
Measurement Group of Commands	1446
Current Measurement Query (Remote Command Only)	1448
Limit Test Current Results (Remote Command Only)	1448
Data Query (Remote Command Only)	1448
Calculate/Compress Trace Data Query (Remote Command Only)	1449
Calculate Peaks of Trace Data (Remote Command Only)	1454
Hardware-Accelerated Fast Power Measurement (Remote Command Only)	1455
Reset Fast Power Measurement (Remote Command Only)	1455
Define Fast Power Measurement (Remote Command Only)	1456
Define Fast Power Measurement Query (Remote Command Only)	1465
Configure Fast Power Measurement (Remote Command Only)	1466
Initiate Fast Power Measurement (Remote Command Only)	1467
Fetch Fast Power Measurement (Remote Command Only)	1467
Execute Fast Power Measurement (Remote Command Only)	1467

Binary Read Fast Power Measurement (Remote Command Only)	1468
Diagnostic Binary Read Fast Power Measurement (Remote Command Only)	1468
Format Data: Numeric Data (Remote Command Only)	1469
Format Data: Byte Order (Remote Command Only)	1470
Meas Setup	1471
Avg Number	1471
Avg Mode	1471
Avg Type	1472
Burst Time	1473
Ramp Time Length	1473
Limits	1474
Max Ramp Down Time	1474
Max Ramp Up Time	1474
Fail	1475
Threshold	1475
Ramp Up Start Level	1476
Ramp Up End Level	1476
Ramp Down Start Level	1477
Ramp Down End Level	1477
IF Gain	1478
More Information about IF Gain	1478
IF Gain Auto	1478
IF Gain State	1479
Meas Preset	1479
Mode	1480
Mode Preset	1481
How-To Preset	1482
Mode Setup	1484
Peak Search	1485
Print	1486
Properties	1487
Quick Save	1488
Recall	1490
State	1490
More Information	1492
From File...	1492
Edit Register Names	1494
Register 1 thru Register 16	1494
Register 1 thru Register 16	1495
Data (Import)	1496
Masks	1497
Capture Buffer	1498
Open...	1498

Restart	1499
More Information	1499
Save	1501
State	1501
To File . . .	1502
Edit Register Names	1504
More Information	1504
Register 1 thru Register 16	1505
Register 1 thru Register 16	1505
Data (Export)	1506
Meas Results	1507
Capture Buffer	1507
Save As . . .	1507
Screen Image	1508
Themes	1509
3D Color	1509
3D Monochrome	1510
Flat Color	1510
Flat Monochrome	1510
Save As...	1510
Mass Storage Catalog (Remote Command Only)	1511
Mass Storage Change Directory (Remote Command Only)	1511
Mass Storage Copy (Remote Command Only)	1512
Mass Storage Device Copy (Remote Command Only)	1512
Mass Storage Delete (Remote Command Only)	1512
Mass Storage Data (Remote Command Only)	1512
Mass Storage Make Directory (Remote Command Only)	1513
Mass Storage Move (Remote Command Only)	1513
Mass Storage Remove Directory (Remote Command Only)	1514
Single (Single Measurement/Sweep)	1515
More Information	1515
Source	1516
SPAN X Scale	1517
Ref Value(Burst View)	1517
Scale/Div(Burst View)	1517
Ref Position(Burst View)	1518
Auto Scaling(Burst View)	1518
Sweep/Control	1520
Pause/Resume	1520
Abort (Remote Command Only)	1520
System	1522
Trace/Detector	1523
Max Hold Trace	1523

Min Hold Trace	1523
Trigger	1525
Free Run	1525
Video	1525
Trigger Level	1525
Trig Slope	1525
Trig Delay	1525
External 1	1525
Trigger Level	1525
Trig Slope	1525
Trig Delay	1525
Zero Span Delay Comp	1525
External 2	1525
Trigger Level	1525
Trig Slope	1525
Trig Delay	1526
Zero Span Delay Comp	1526
RF Burst	1526
Absolute Trigger	1526
Relative Trigger	1526
Trig Slope	1526
Trig Delay	1526
Periodic Timer	1526
Period	1526
Offset	1526
Offset Adjust (Remote Command Only)	1526
Reset Offset Display	1526
Sync Source	1526
Off	1526
External 1	1527
External 2	1527
RF Burst	1527
Trig Delay	1527
Auto/Holdoff	1527
Auto Trig	1527
Trig Holdoff	1527
Holdoff Type	1527
User Preset	1528
User Preset	1528
User Preset All Modes	1529
Save User Preset	1530
View/Display	1531
Display	1532

Annotation	1532
Meas Bar On/Off	1533
Screen	1534
Active Function Values On/Off	1534
Title	1535
Change Title	1535
Clear Title	1536
Graticule	1537
System Display Settings	1537
Annotation Local Settings	1537
Themes	1538
Backlight	1539
Backlight Intensity	1539
Burst View	1540
RF Envelope window	1540
Result Metrics window	1541
Burst Line	1541
Rise & Fall View	1541
Ramp Lines	1542
14 Spectral Flatness Measurement	1545
AMPTD Y Scale	1549
Ref Value	1549
Attenuation	1549
Dual Attenuator Configurations:	1550
Single Attenuator Configuration:	1550
(Mech) Atten	1551
Attenuator Configurations and Auto/Man	1552
Enable Elec Atten	1553
More Information	1554
Mechanical Attenuator Transition Rules	1554
When the Electronic Attenuation is enabled from a disabled state:	1554
Examples in the dual attenuator configuration:	1554
When the Electronic Attenuation is disabled from an enabled state:	1554
Using the Electronic Attenuator: Pros and Cons	1555
Elec Atten	1555
Adjust Atten for Min Clip	1556
Pre-Adjust for Min Clip	1556
Off	1557
Elec Atten Only	1557
Mech + Elec Atten	1558
(Mech) Atten Step	1558
Scale/Div	1558
Presel Center	1559

Proper Preselector Operation	1560
Preselector Adjust	1560
μW Path Control	1561
μW Path Control Auto	1562
Standard Path	1562
Low Noise Path Enable	1562
More Information	1563
μW Preselector Bypass	1564
Internal Preamp	1565
Off	1566
Low Band	1567
Full Range	1567
Ref Position	1567
Auto Scaling	1568
Attenuation	1568
Internal Preamp	1568
Auto Couple	1570
More Information	1570
Auto/Man Active Function keys	1570
Auto/Man 1-of-N keys	1570
BW	1572
Info BW	1572
Filter Type	1573
Cont (Continuous Measurement/Sweep)	1574
File	1576
FREQ Channel	1577
Center Freq	1577
Center Frequency Presets	1578
RF Center Freq	1580
Ext Mix Center Freq	1581
I/Q Center Freq	1582
CF Step	1582
Input/Output	1584
Marker	1585
Select Marker	1585
Marker Type	1585
Relative To	1586
Select Marker	1586
Relative To	1586
Marker Trace	1587
Couple Markers	1587
All Markers Off	1587
Marker X Axis Value	1588

Marker X Axis Position (Remote Command only)	1588
Marker Y Axis Value (Remote Command only)	1589
Marker Function	1590
Marker To	1591
Meas	1592
Remote Measurement Functions	1592
Measurement Group of Commands	1593
Current Measurement Query (Remote Command Only)	1595
Limit Test Current Results (Remote Command Only)	1595
Data Query (Remote Command Only)	1595
Calculate/Compress Trace Data Query (Remote Command Only)	1596
Calculate Peaks of Trace Data (Remote Command Only)	1601
Hardware-Accelerated Fast Power Measurement (Remote Command Only)	1602
Reset Fast Power Measurement (Remote Command Only)	1602
Define Fast Power Measurement (Remote Command Only)	1603
Define Fast Power Measurement Query (Remote Command Only)	1612
Configure Fast Power Measurement (Remote Command Only)	1613
Initiate Fast Power Measurement (Remote Command Only)	1614
Fetch Fast Power Measurement (Remote Command Only)	1614
Execute Fast Power Measurement (Remote Command Only)	1614
Binary Read Fast Power Measurement (Remote Command Only)	1615
Diagnostic Binary Read Fast Power Measurement (Remote Command Only)	1615
Format Data: Numeric Data (Remote Command Only)	1616
Format Data: Byte Order (Remote Command Only)	1617
Meas Setup	1618
Avg Number	1618
Avg Mode	1618
Search Length	1619
Limits	1619
Upper Limit Section 1	1620
Lower Limit Section 1	1621
Upper Limit Section 2	1621
Lower Limit Section 2	1622
Advanced	1623
IF Gain	1623
More Information about IF Gain	1623
IF Gain Auto	1623
IF Gain State	1624
Symbol Timing Adjust	1624
Sync Training Sequence	1626
PhNoise Opt	1626
Spectrum	1627
Meas Preset	1627

Mode	1629
Mode Preset	1630
How-To Preset	1631
Mode Setup	1633
Peak Search	1634
Print	1635
Quick Save	1636
Recall	1638
State	1638
More Information	1640
From File...	1640
Edit Register Names	1642
Register 1 thru Register 16	1642
Register 1 thru Register 16	1643
Data (Import)	1644
Masks	1645
Capture Buffer	1646
Open...	1646
Restart	1647
More Information	1647
Save	1649
State	1649
To File . . .	1650
Edit Register Names	1652
More Information	1652
Register 1 thru Register 16	1653
Register 1 thru Register 16	1653
Data (Export)	1654
Meas Results	1655
Capture Buffer	1655
Save As . . .	1655
Screen Image	1656
Themes	1657
3D Color	1657
3D Monochrome	1658
Flat Color	1658
Flat Monochrome	1658
Save As...	1658
Mass Storage Catalog (Remote Command Only)	1659
Mass Storage Change Directory (Remote Command Only)	1659
Mass Storage Copy (Remote Command Only)	1660
Mass Storage Device Copy (Remote Command Only)	1660
Mass Storage Delete (Remote Command Only)	1660

Mass Storage Data (Remote Command Only)	1660
Mass Storage Make Directory (Remote Command Only)	1661
Mass Storage Move (Remote Command Only)	1661
Mass Storage Remove Directory (Remote Command Only)	1662
Single (Single Measurement/Sweep)	1663
More Information	1663
Source	1664
SPAN X Scale	1665
Ref Value	1665
Scale/Div	1665
Ref Position	1666
Auto Scaling	1666
Sweep/Control	1668
Pause/Resume	1668
System	1669
Trace/Detector	1670
Trigger	1671
Free Run	1671
Video	1671
Trigger Level	1671
Trig Slope	1671
Trig Delay	1671
Line	1671
Trig Slope	1671
Trig Delay	1671
External 1	1671
Trigger Level	1671
Trig Slope	1671
Trig Delay	1671
Zero Span Delay Comp	1671
External 2	1672
Trigger Level	1672
Trig Slope	1672
Trig Delay	1672
Zero Span Delay Comp	1672
RF Burst	1672
Absolute Trigger	1672
Relative Trigger	1672
Trig Slope	1672
Trig Delay	1672
Periodic Timer	1672
Period	1672
Offset	1672

Offset Adjust (Remote Command Only)	1672
Reset Offset Display	1673
Sync Source	1673
Off	1673
External 1	1673
External 2	1673
RF Burst	1673
Trig Delay	1673
Auto/Holdoff	1673
Auto Trig	1673
Trig Holdoff	1674
Holdoff Type	1674
User Preset	1675
User Preset	1675
User Preset All Modes	1676
Save User Preset	1677
View/Display	1678
Flatness window	1678
Display	1678
Annotation	1678
Meas Bar On/Off	1679
Screen	1680
Active Function Values On/Off	1680
Title	1681
Change Title	1681
Clear Title	1682
Graticule	1683
System Display Settings	1683
Annotation Local Settings	1683
Themes	1684
Backlight	1685
Backlight Intensity	1685
Limit Line	1686
15 WLAN Modulation Analysis measurement	1687
AMPTD Y Scale	1695
Ref Value	1695
Ref Value (EVM vs. Symbol or EVM vs. Carrier Window)	1695
Ref Value (Mag Error or EVM Window)	1696
Ref Value (Phase Error Window)	1696
Ref Value (Preamble Freq Error vs. Time)	1697
Ref Value (IQ Gain Imbalance vs. Carrier Window)	1697
Ref Value (IQ Quadrature Skew vs. Carrier Window)	1697
Ref Value (EVM vs. Carrier Window)	1698

Attenuation	1698
Dual Attenuator Configurations:	1699
Single Attenuator Configuration:	1700
(Mech) Atten	1700
Attenuator Configurations and Auto/Man	1702
Enable Elec Atten	1702
More Information	1703
Mechanical Attenuator Transition Rules	1703
When the Electronic Attenuation is enabled from a disabled state:	1703
Examples in the dual attenuator configuration:	1703
When the Electronic Attenuation is disabled from an enabled state:	1704
Using the Electronic Attenuator: Pros and Cons	1704
Elec Atten	1704
Adjust Atten for Min Clip	1705
Pre-Adjust for Min Clip	1705
Off	1706
Elec Atten Only	1706
Mech + Elec Atten	1707
(Mech) Atten Step	1707
Scale/Div	1708
Scale/Div (EVM vs. Symbol or EVM vs. Carrier Window)	1708
Scale/Div (Mag Error or EVM Window)	1708
Scale/Div (Phase Error Window)	1709
Scale/Div (Preamble Freq Error vs. Time)	1709
Scale/Div (IQ Gain Imbalance vs. Carrier Window)	1710
Scale/Div (IQ Quadrature Skew vs. Carrier Window)	1710
Scale/Div (EVM vs. Carrier Window)	1710
Presel Center	1711
Proper Preselector Operation	1712
Preselector Adjust	1712
μ W Path Control	1713
μ W Path Control Auto	1714
Standard Path	1714
Low Noise Path Enable	1714
More Information	1715
μ W Preselector Bypass	1716
Internal Preamp	1717
Off	1718
Low Band	1719
Full Range	1719
Ref Position	1719
Ref Position (EVM vs. Symbol or EVM vs. Carrier Window)	1720
Ref Position (Mag Error or EVM Window)	1720

Ref Position (Phase Error Window)	1720
Ref Position (Preamble Freq Error vs. Time)	1721
Ref Position (IQ Gain Imbalance vs. Carrier Window and EVM vs. Carrier window)	1721
Ref Position (IQ Quadrature Skew vs. Carrier Window)	1721
Auto Scaling	1722
Auto Scaling (EVM vs. Symbol or EVM vs. Carrier Window)	1722
Auto Scaling (Mag Error or EVM Window)	1723
Auto Scaling (Phase Error Window)	1723
Auto Scaling (Preamble Freq Error vs. Time)	1723
Auto Scaling (IQ Gain Imbalance vs Carrier Window, IQ Quadrature Skew vs Carrier Window and EVM vs. Carrier Window)	1724
Auto Couple	1725
More Information	1725
Auto/Man Active Function keys	1725
Auto/Man 1-of-N keys	1725
BW	1727
Info BW	1727
Cont (Continuous Measurement/Sweep)	1728
File	1730
FREQ Channel	1731
Center Freq	1731
Center Frequency Presets	1732
RF Center Freq	1734
Ext Mix Center Freq	1735
I/Q Center Freq	1736
CF Step	1736
Input/Output	1738
Marker	1739
Select Marker	1739
Marker Type	1739
Properties	1740
Select Marker	1740
Relative To	1740
Marker Trace	1741
Marker Trace	1741
Couple Markers	1742
All Markers Off	1742
Marker X Axis Value (Remote Command only)	1743
Marker X Axis Position (Remote Command only)	1743
Marker Y Axis Value (Remote Command only)	1744
Backward Compatibility SCPI Commands	1744
Marker Function	1745

Marker To	1746
Meas	1747
Remote Measurement Functions	1747
Measurement Group of Commands	1748
Current Measurement Query (Remote Command Only)	1750
Limit Test Current Results (Remote Command Only)	1750
Data Query (Remote Command Only)	1750
Calculate/Compress Trace Data Query (Remote Command Only)	1751
Calculate Peaks of Trace Data (Remote Command Only)	1756
Hardware-Accelerated Fast Power Measurement (Remote Command Only)	1757
Reset Fast Power Measurement (Remote Command Only)	1757
Define Fast Power Measurement (Remote Command Only)	1758
Define Fast Power Measurement Query (Remote Command Only)	1767
Configure Fast Power Measurement (Remote Command Only)	1768
Initiate Fast Power Measurement (Remote Command Only)	1769
Fetch Fast Power Measurement (Remote Command Only)	1769
Execute Fast Power Measurement (Remote Command Only)	1769
Binary Read Fast Power Measurement (Remote Command Only)	1770
Diagnostic Binary Read Fast Power Measurement (Remote Command Only)	1770
Format Data: Numeric Data (Remote Command Only)	1771
Format Data: Byte Order (Remote Command Only)	1772
Meas Setup	1773
Avg/Burst Number	1773
Avg Mode	1773
Meas Time	1774
Search Length	1774
Meas Interval	1775
Meas Offset	1776
Result Length	1777
Max Result Length	1778
From SIG Symbols	1779
Subcarrier	1780
Subcarrier Number	1780
Optimize EVM	1781
Subcarrier I/Q Estimation	1782
Limits	1782
BPSK-1/2 RMS EVM	1782
QPSK-1/2 RMS EVM	1783
QPSK-3/4 RMS EVM	1783
16QAM-1/2 RMS EVM	1784
16QAM-3/4 RMS EVM	1784
64QAM-2/3 RMS EVM	1785
64QAM-3/4 RMS EVM	1785

64QAM-5/6 RMS EVM	1786
256QAM-3/4 RMS EVM	1786
256QAM-5/6 RMS EVM	1787
Freq Error	1787
Clock Error	1788
Center Freq Leakage	1788
48 Mbits/s RMS EVM	1789
54 Mbits/s RMS EVM	1789
RMS EVM	1790
1000 Chips EVM	1790
RF Carrier Suppression	1791
6 Mbits/s RMS EVM	1791
9 Mbits/s RMS EVM	1792
12 Mbits/s RMS EVM	1792
18 Mbits/s RMS EVM	1792
24 Mbits/s RMS EVM	1793
36 Mbits/s RMS EVM	1793
Advanced	1794
Symbol Timing Adjust	1794
Pilot Tracking	1795
Track Amplitude	1795
Track Phase	1795
Track Timing	1796
Sync Training Sequence	1797
Equalizer Training	1797
I/Q Normalize	1798
I/Q Compensation	1798
IF Gain	1799
More Information about IF Gain	1799
IF Gain Auto	1799
Other	1800
IF Gain Select	1800
Spectrum	1801
PhNoise Opt	1802
PhNoise Opt	1802
Chip Rate	1805
Clock Adjust	1805
Equalizer	1806
Descramble	1807
Track Phase	1807
Meas Preset	1808
Filter	1808
Reference Filter	1808

Table of Contents

Alpha/BT	1809
Measurement Filter	1809
Mode	1810
Mode Preset	1811
How-To Preset	1812
Mode Setup	1814
Peak Search	1815
Next Peak	1815
Next Pk Right	1815
Next Pk Left	1815
Marker Delta	1816
Pk-Pk Search	1816
Min Search	1816
Print	1817
Quick Save	1818
Recall	1820
State	1820
More Information	1822
From File...	1822
Edit Register Names	1824
Register 1 thru Register 16	1824
Register 1 thru Register 16	1825
Data (Import)	1826
Masks	1827
Capture Buffer	1828
Open...	1828
Restart	1829
More Information	1829
Save	1831
State	1831
To File . . .	1832
Edit Register Names	1834
More Information	1834
Register 1 thru Register 16	1835
Register 1 thru Register 16	1835
Data (Export)	1836
Meas Results	1837
Capture Buffer	1837
Save As . . .	1837
Screen Image	1838
Themes	1839
3D Color	1839
3D Monochrome	1840

Flat Color	1840
Flat Monochrome	1840
Save As...	1840
Mass Storage Catalog (Remote Command Only)	1841
Mass Storage Change Directory (Remote Command Only)	1841
Mass Storage Copy (Remote Command Only)	1842
Mass Storage Device Copy (Remote Command Only)	1842
Mass Storage Delete (Remote Command Only)	1842
Mass Storage Data (Remote Command Only)	1842
Mass Storage Make Directory (Remote Command Only)	1843
Mass Storage Move (Remote Command Only)	1843
Mass Storage Remove Directory (Remote Command Only)	1844
Single (Single Measurement/Sweep)	1845
More Information	1845
Source	1846
SPAN X Scale	1847
Sweep/Control	1848
Pause/Resume	1848
System	1849
Trace/Detector	1850
Trigger	1851
Free Run	1851
Video	1851
Trigger Level	1851
Trig Slope	1851
Trig Delay	1851
Line	1851
Trig Slope	1851
Trig Delay	1851
External 1	1851
Trigger Level	1851
Trig Slope	1851
Trig Delay	1851
Zero Span Delay Comp	1851
External 2	1852
Trigger Level	1852
Trig Slope	1852
Trig Delay	1852
Zero Span Delay Comp	1852
RF Burst	1852
Absolute Trigger	1852
Relative Trigger	1852
Trig Slope	1852

Trig Delay	1852
Periodic Timer	1852
Period	1852
Offset	1852
Offset Adjust (Remote Command Only)	1852
Reset Offset Display	1853
Sync Source	1853
Off	1853
External 1	1853
External 2	1853
RF Burst	1853
Trig Delay	1853
Auto/Holdoff	1853
Auto Trig	1853
Trig Holdoff	1854
Holdoff Type	1854
User Preset	1855
User Preset	1855
User Preset All Modes	1856
Save User Preset	1857
View/Display	1858
Understanding Front Panel Results to Use Remote Commands	1858
Front Panel Results	1858
View Selection by Name	1859
View Selection by number (SCPI Only)	1860
Display	1861
Annotation	1861
Meas Bar On/Off	1862
Screen	1863
Active Function Values On/Off	1863
Title	1864
Change Title	1864
Clear Title	1865
Graticule	1866
System Display Settings	1866
Annotation Local Settings	1866
Themes	1867
Backlight	1868
Backlight Intensity	1868
IQ Measured Polar Vector	1869
Numeric Results Window	1870
I/Q Symbol Constellation Window	1870
I/Q Polar Vec/Constln	1873

I/Q Points	1874
I/Q Points Offset	1874
I/Q Rotation	1875
Full Vector	1875
I/Q Error (Quad View)	1876
"Numeric Results Window" on page 1	1877
Mag Error Window	1877
Phase Error Window	1877
EVM Window	1877
Numeric Results Window	1877
OFDM EVM View	1878
EVM vs. Symbol	1878
EVM vs. Carrier	1878
I/Q Measured Polar	1879
Numeric Results Window	1879
I/Q Error	1879
MER/EVM vs. Sub-carrier/Frequency Window	1880
Logical Channel Window	1884
Polar Graph Window	1884
Result Metrics Window	1885
Prev Page	1886
Next Page	1886
Scroll Up	1886
Scroll Down	1886
First Page	1886
Last Page	1887
Result Metrics	1887
Burst Info & HT-Sig Info	1888
Burst Info Content	1889
HT-Sig Content	1891
L-Sig Content	1892
Preamble Freq Error vs. Time	1892
I/Q Impairments	1893
IQ Gain Imbalance vs. Carrier	1894
IQ Quadrature Skew vs. Carrier Window	1894
EVM vs. Carrier	1894
Segment Number	1895
16 WLAN List Sequence Measurement	1897
AMPTD Y Scale	1905
BW	1906
FREQ Channel	1907
Marker	1908
Marker Fctn	1909

Marker To	1910
Meas Setup	1911
General Setting Commands	1911
Trigger Timeout	1911
Abort on Limit Fail	1912
Abort on Error	1912
Input Trigger Setup	1913
RF Burst Trig Slope	1913
Video Trig Slope	1913
External 1 Trig Slope	1914
External 1 Trigger Level	1914
External 2 Trig Slope	1914
External 2 Trigger Level	1915
Use Preselector	1915
Auto Range Setup	1915
Auto Rules	1915
Exclude Mech Atten	1916
Include Mech Atten	1916
Mech Atten	1916
Min Signal To Noise Ratio Margin	1917
Peak Power Margin	1917
Max Mixer Level	1918
Capture Setup	1918
Number of Bursts	1918
Radio Standard	1919
Frequency	1919
Peak Power	1920
Expected Power at DUT Output	1920
Burst Length	1921
Prefix	1921
Transition Time	1922
Input Trigger Type	1922
Input Trigger Level	1923
Input Trigger Delay	1923
TX Power Setup	1924
TX Power	1924
Display Range	1924
Start Burst	1924
Stop Burst	1925
Limits	1925
Limits State	1925
Limits Fail	1926
Transmit Power Limit	1926

Peak Power Spectral Density	1927
TX Output Spectrum Setup	1928
TX Output Spectrum	1928
Display Range	1928
Start Burst	1928
Stop Burst	1929
Offset/Limits	1929
Limits State	1929
Mod Accuracy Setup	1932
Modulation Accuracy	1932
Display Range	1933
Start Burst	1933
Stop Burst	1933
Mod Accuracy /Limits	1934
Limits State	1934
Limits Fail	1934
Freq Error	1935
Symbol Clock Error	1935
Center Freq Leakage	1936
6 Mbits/s RMS EVM	1936
9 Mbits/s RMS EVM	1937
12 Mbits/s RMS EVM	1938
18 Mbits/s RMS EVM	1938
24 Mbits/s RMS EVM	1939
36 Mbits/s RMS EVM	1940
48 Mbits/s RMS EVM	1940
54 Mbits/s RMS EVM	1941
BPSK-1/2 RMS EVM	1941
QPSK-1/2 RMS EVM	1942
QPSK-3/4 RMS EVM	1943
16QAM-1/2 RMS EVM	1943
16QAM-3/4 RMS EVM	1944
64QAM-2/3 RMS EVM	1945
64QAM-3/4 RMS EVM	1945
64QAM-5/6 RMS EVM	1946
256QAM-3/4 RMS EVM	1947
256QAM-5/6 RMS EVM	1947
Chip Clock Error	1948
RF Carrier Suppression	1948
RMS EVM	1949
1000 Chips EVM	1949
Flatness Limits	1949
Meas Interval	1952

Subcarrier	1953
Subcarrier Spacing	1954
Guard Interval	1954
Reference Filter	1955
Alpha/BT	1955
Measurement Filter	1956
Symbol Timing Adjust	1956
Sync Training Sequence	1957
Track Amplitude	1957
Track Phase	1958
Track Timing	1959
Equalizer Training	1959
I/Q Normalize	1960
I/Q Compensation	1961
Spectrum	1961
Chip Rate	1962
Clock Adjust	1962
Equalizer	1963
Descramble	1963
Remote Setup	1964
Programming Acquisitions Via SCPI	1964
Acquisition Setup using SCPI	1964
Validation and Setup dependencies	1965
Peak Search	1966
SPAN X Scale	1967
Trigger	1968
View/Display	1969
Display	1969
Annotation	1969
Meas Bar On/Off	1970
Screen	1971
Active Function Values On/Off	1971
Title	1972
Change Title	1972
Clear Title	1973
Graticule	1974
System Display Settings	1974
Annotation Local Settings	1974
Themes	1975
Backlight	1976
Backlight Intensity	1976
Parameter List view	1977
Value	1977

17 Monitor Spectrum Measurement	1979
AMPTD Y Scale	1982
Ref Value	1982
Attenuation	1982
Dual Attenuator Configurations:	1983
Single Attenuator Configuration:	1983
(Mech) Atten	1984
Attenuator Configurations and Auto/Man	1985
Enable Elec Atten	1986
More Information	1987
Mechanical Attenuator Transition Rules	1987
When the Electronic Attenuation is enabled from a disabled state:	1987
Examples in the dual attenuator configuration:	1987
When the Electronic Attenuation is disabled from an enabled state:	1987
Using the Electronic Attenuator: Pros and Cons	1988
Elec Atten	1988
Adjust Atten for Min Clip	1989
Pre-Adjust for Min Clip	1989
Off	1990
Elec Atten Only	1990
Mech + Elec Atten	1991
(Mech) Atten Step	1991
Scale/Div	1991
Presel Center	1992
Proper Preselector Operation	1993
Preselector Adjust	1993
μ W Path Control	1994
μ W Path Control Auto	1995
Standard Path	1995
Low Noise Path Enable	1995
More Information	1996
μ W Preselector Bypass	1997
Internal Preamp	1998
Off	1999
Low Band	2000
Full Range	2000
Ref Position	2000
Auto Scaling	2001
Auto Couple	2002
More Information	2002
Auto/Man Active Function keys	2002
Auto/Man 1-of-N keys	2002
BW	2004

Table of Contents

Res BW	2004
Video BW	2005
VBW:3dB RBW	2007
Span:3dB RBW	2007
Cont (Continuous Measurement/Sweep)	2009
File	2011
FREQ Channel	2012
Center Freq	2012
Center Frequency Presets	2013
RF Center Freq	2015
Ext Mix Center Freq	2016
I/Q Center Freq	2017
CF Step	2017
Input/Output	2019
Marker	2020
Select Marker	2020
Marker Type	2020
Properties	2021
Select Marker	2021
Relative To	2021
Marker Trace	2021
Couple Markers	2022
All Markers Off	2022
Marker X Axis Value (Remote Command only)	2023
Marker X Axis Position (Remote Command only)	2023
Marker Y Axis Value (Remote Command only)	2024
Marker Function	2025
Select Marker	2025
Marker Function Type	2025
Band Adjust	2025
Band/Interval Span for Frequency Domain	2026
Band/Interval Left for Frequency Domain	2026
Band/Interval Right for Frequency Domain	2027
Marker To	2028
Meas	2029
Remote Measurement Functions	2029
Measurement Group of Commands	2030
Current Measurement Query (Remote Command Only)	2032
Limit Test Current Results (Remote Command Only)	2032
Data Query (Remote Command Only)	2032
Calculate/Compress Trace Data Query (Remote Command Only)	2033
Calculate Peaks of Trace Data (Remote Command Only)	2038
Hardware-Accelerated Fast Power Measurement (Remote Command Only)	2039

Reset Fast Power Measurement (Remote Command Only)	2039
Define Fast Power Measurement (Remote Command Only)	2040
Define Fast Power Measurement Query (Remote Command Only)	2049
Configure Fast Power Measurement (Remote Command Only)	2050
Initiate Fast Power Measurement (Remote Command Only)	2051
Fetch Fast Power Measurement (Remote Command Only)	2051
Execute Fast Power Measurement (Remote Command Only)	2051
Binary Read Fast Power Measurement (Remote Command Only)	2052
Diagnostic Binary Read Fast Power Measurement (Remote Command Only)	2052
Format Data: Numeric Data (Remote Command Only)	2053
Format Data: Byte Order (Remote Command Only)	2054
Meas Setup	2055
Avg/Hold Num	2055
Avg Mode	2055
Meas Preset	2056
Mode	2057
Mode Preset	2058
How-To Preset	2059
Mode Setup	2061
Peak Search	2062
Print	2063
Quick Save	2064
Recall	2066
State	2066
More Information	2068
From File...	2068
Edit Register Names	2070
Register 1 thru Register 16	2070
Register 1 thru Register 16	2071
Data (Import)	2072
Masks	2073
Capture Buffer	2074
Open...	2074
Restart	2075
More Information	2075
Save	2077
State	2077
To File . . .	2078
Edit Register Names	2080
More Information	2080
Register 1 thru Register 16	2081
Register 1 thru Register 16	2081
Data (Export)	2082

Meas Results	2083
Capture Buffer	2083
Save As . . .	2083
Screen Image	2084
Themes	2085
3D Color	2085
3D Monochrome	2086
Flat Color	2086
Flat Monochrome	2086
Save As...	2086
Mass Storage Catalog (Remote Command Only)	2087
Mass Storage Change Directory (Remote Command Only)	2087
Mass Storage Copy (Remote Command Only)	2088
Mass Storage Device Copy (Remote Command Only)	2088
Mass Storage Delete (Remote Command Only)	2088
Mass Storage Data (Remote Command Only)	2088
Mass Storage Make Directory (Remote Command Only)	2089
Mass Storage Move (Remote Command Only)	2089
Mass Storage Remove Directory (Remote Command Only)	2090
Single (Single Measurement/Sweep)	2091
More Information	2091
Source	2092
Span X Scale	2093
Span	2093
IDEN Mode Span Preset for Monitor Spectrum	2094
Full Span	2094
Last Span	2094
Sweep/Control	2096
Sweep Time	2096
Pause	2096
Gate	2097
Gate On/Off	2097
Gate View On/Off	2098
Gate View Setup	2101
Gate View Sweep Time	2102
Gate View Start Time	2102
Gate Delay	2103
Gate Length	2103
Gate Source	2104
Line	2105
External 1	2105
External 2	2107
RF Burst	2110

Periodic Timer (Frame Trigger)	2113
Control Edge/Level	2124
Gate Holdoff	2124
Gate Delay Compensation	2126
More Information	2127
Min Fast Position Query (Remote Command Only)	2127
Gate Preset (Remote Command Only)	2128
Gate Level (Remote Command Only)	2128
Gate Polarity (Remote Command Only)	2128
Points	2129
System	2130
Trace/Detector	2131
Select Trace	2131
Trace Type	2131
Update	2132
Display	2132
Detector	2133
Auto	2134
Clear Trace	2134
Clear All Traces	2134
Trigger	2136
Free Run	2136
Video	2136
Trigger Level	2136
Trig Slope	2136
Trig Delay	2136
Line	2136
Trig Slope	2136
Trig Delay	2136
External 1	2136
Trigger Level	2136
Trig Slope	2136
Trig Delay	2136
Zero Span Delay Comp	2136
External 2	2137
Trigger Level	2137
Trig Slope	2137
Trig Delay	2137
Zero Span Delay Comp	2137
RF Burst	2137
Absolute Trigger	2137
Relative Trigger	2137
Trig Slope	2137

Trig Delay	2137
Periodic Timer	2137
Period	2137
Offset	2137
Reset Offset Display	2137
Sync Source	2138
Off	2138
External 1	2138
External 2	2138
RF Burst	2138
Trig Delay	2138
Auto/Holdoff	2138
Auto Trig	2138
Trig Holdoff	2138
User Preset	2139
User Preset	2139
User Preset All Modes	2140
Save User Preset	2141
View/Display	2142
View for all modes except MSR, 1xEV-DO, LTE-Advanced FDD/TDD	2142
1xEV-DO Mode View	2143
MSR and LTE-Advanced FDD/TDD Mode Views	2143
View Selection by Name (MSR and LTE-Advanced FDD/TDD mode only)	2144
View Selection by Number (MSR and LTE-Advanced FDD/TDD mode only)	2144
Display	2144
Annotation	2145
Meas Bar On/Off	2146
Screen	2146
Active Function Values On/Off	2146
Title	2147
Change Title	2147
Clear Title	2148
Graticule	2149
System Display Settings	2149
Annotation Local Settings	2149
Themes	2150
Backlight	2151
Backlight Intensity	2151
18 Waveform Measurement	2153
AMPTD Y Scale	2157
Ref Value	2157
Scale/Div	2157
Scale/Div (RF Envelope View)	2157

Scale/Div (I/Q Waveform View)	2158
Attenuation	2158
Dual Attenuator Configurations:	2159
Single Attenuator Configuration:	2160
(Mech) Atten	2160
Attenuator Configurations and Auto/Man	2162
Enable Elec Atten	2162
More Information	2163
Mechanical Attenuator Transition Rules	2163
When the Electronic Attenuation is enabled from a disabled state:	2163
Examples in the dual attenuator configuration:	2163
When the Electronic Attenuation is disabled from an enabled state:	2164
Using the Electronic Attenuator: Pros and Cons	2164
Elec Atten	2164
Adjust Atten for Min Clip	2165
Pre-Adjust for Min Clip	2165
Off	2166
Elec Atten Only	2166
Mech + Elec Atten	2167
(Mech) Atten Step	2167
Presel Center	2168
Proper Preselector Operation	2168
Preselector Adjust	2169
μ W Path Control	2170
μ W Path Control Auto	2170
Standard Path	2171
Low Noise Path Enable	2171
More Information	2172
μ W Preselector Bypass	2173
Internal Preamp	2174
Off	2175
Low Band	2176
Full Range	2176
Ref Position	2176
Auto Scaling	2176
Auto Couple	2178
More Information	2178
Auto/Man Active Function keys	2178
Auto/Man 1-of-N keys	2178
BW	2180
Digital IF BW	2180
Filter Type	2181
Filter BW	2182

Filter Alpha	2183
Filter Type Bwcc	2183
Gaussian	2184
Gaussian filters	2184
Flattop	2188
Flattop Filters	2189
Channel Filter Bandwidth Bwcc (Remote Command Only)	2190
Cont (Continuous Measurement/Sweep)	2191
File	2193
FREQ Channel	2194
Center Freq	2194
Center Frequency Presets	2195
RF Center Freq	2197
Ext Mix Center Freq	2198
I/Q Center Freq	2199
CF Step	2199
Input/Output	2201
Marker	2202
Select Marker	2202
Marker Type	2202
Properties	2203
Select Marker	2203
Relative To	2203
Marker Trace	2204
Couple Markers	2204
All Markers Off	2205
Marker X Axis Value (Remote Command Only)	2205
Marker X Axis Position (Remote Command Only)	2206
Marker Y Axis Value (Remote Command Only)	2206
Backward Compatibility SCPI Commands	2207
Marker ->	2208
Marker Function	2209
Select Marker	2209
Marker Function Type	2209
Band Adjust	2210
Band/Interval Span for Time Domain	2210
Band/Interval Left for Time Domain	2211
Band/Interval Right for Time Domain	2211
Meas	2213
Remote Measurement Functions	2213
Measurement Group of Commands	2214
Current Measurement Query (Remote Command Only)	2216
Limit Test Current Results (Remote Command Only)	2216

Data Query (Remote Command Only)	2216
Calculate/Compress Trace Data Query (Remote Command Only)	2217
Calculate Peaks of Trace Data (Remote Command Only)	2222
Hardware-Accelerated Fast Power Measurement (Remote Command Only)	2223
Reset Fast Power Measurement (Remote Command Only)	2223
Define Fast Power Measurement (Remote Command Only)	2224
Define Fast Power Measurement Query (Remote Command Only)	2233
Configure Fast Power Measurement (Remote Command Only)	2234
Initiate Fast Power Measurement (Remote Command Only)	2235
Fetch Fast Power Measurement (Remote Command Only)	2235
Execute Fast Power Measurement (Remote Command Only)	2235
Binary Read Fast Power Measurement (Remote Command Only)	2236
Diagnostic Binary Read Fast Power Measurement (Remote Command Only)	2236
Format Data: Numeric Data (Remote Command Only)	2237
Format Data: Byte Order (Remote Command Only)	2238
Meas Setup	2239
Average/Hold Num	2239
Avg Mode	2239
Avg Type	2240
Time Avg Num	2241
Meas Time	2241
Sample Rate	2242
PhNoise Opt	2242
Auto	2243
Best Close-in P Noise	2244
Best Wide-offset P Noise	2244
Fast Tuning	2245
Advanced	2245
ADC Dither	2245
ADC Dither Auto	2245
ADC Dither	2246
IF Gain	2247
IF Gain Auto	2247
IF Gain State	2247
IF Gain Offset	2248
Meas Preset	2249
HW Averaging	2249
Time Avg Num	2250
Sample Period (Aperture) Setting (Remote Command Only)	2250
Mode	2251
Mode Preset	2252
How-To Preset	2253
Mode Setup	2255

Peak Search	2256
Next Peak	2256
Min Search	2256
Print	2258
Quick Save	2259
Recall	2261
State	2261
More Information	2263
From File...	2263
Edit Register Names	2265
Register 1 thru Register 16	2265
Register 1 thru Register 16	2266
Data (Import)	2267
Masks	2268
Capture Buffer	2269
Open...	2269
Restart	2270
More Information	2270
Save	2272
State	2272
To File . . .	2273
Edit Register Names	2275
More Information	2275
Register 1 thru Register 16	2276
Register 1 thru Register 16	2276
Data (Export)	2277
Meas Results	2278
Capture Buffer	2278
Save As . . .	2278
Screen Image	2279
Themes	2280
3D Color	2280
3D Monochrome	2281
Flat Color	2281
Flat Monochrome	2281
Save As...	2281
Mass Storage Catalog (Remote Command Only)	2282
Mass Storage Change Directory (Remote Command Only)	2282
Mass Storage Copy (Remote Command Only)	2283
Mass Storage Device Copy (Remote Command Only)	2283
Mass Storage Delete (Remote Command Only)	2283
Mass Storage Data (Remote Command Only)	2283
Mass Storage Make Directory (Remote Command Only)	2284

Mass Storage Move (Remote Command Only)	2284
Mass Storage Remove Directory (Remote Command Only)	2285
Single (Single Measurement/Sweep)	2286
More Information	2286
Source	2287
Span X Scale	2288
Ref Value	2288
Scale/Div	2288
Ref Position	2289
Auto Scaling	2289
Sweep/Control	2291
Pause/Resume	2291
Abort (Remote Command Only)	2291
System	2293
Trace/Detector	2294
Trigger	2295
Free Run	2295
Video	2295
Trigger Level	2295
Trig Slope	2295
Trig Delay	2295
Line	2295
Trig Slope	2295
Trig Delay	2295
External 1	2295
Trigger Level	2295
Trig Slope	2295
Trig Delay	2295
Zero Span Delay Comp	2295
External 2	2296
Trigger Level	2296
Trig Slope	2296
Trig Delay	2296
Zero Span Delay Comp	2296
RF Burst	2296
Absolute Trigger	2296
Relative Trigger	2296
Trig Slope	2296
Trig Delay	2296
Periodic Timer	2296
Period	2296
Offset	2296
Offset Adjust (Remote Command Only)	2296

Reset Offset Display	2297
Sync Source	2297
Off	2297
External 1	2297
External 2	2297
RF Burst	2297
Trig Delay	2297
Auto/Holdoff	2297
Auto Trig	2297
Trig Holdoff	2298
Holdoff Type	2298
User Preset	2299
User Preset	2299
User Preset All Modes	2300
Save User Preset	2301
View/Display	2302
View Selection by name (Remote Command Only)	2302
View Selection by number (Remote Command Only)	2302
Display	2303
Annotation	2303
Meas Bar On/Off	2304
Screen	2305
Active Function Values On/Off	2305
Title	2306
Change Title	2306
Clear Title	2307
Graticule	2308
System Display Settings	2308
Annotation Local Settings	2308
Themes	2309
Backlight	2310
Backlight Intensity	2310
RF Envelope	2311
I/Q Waveform	2312

1 About the Analyzer

The X-Series signal analyzer measures and monitors complex RF and microwave signals. Analog baseband analysis is available on MXA. The analyzer integrates traditional spectrum measurements with advanced vector signal analysis to optimize speed, accuracy, and dynamic range. The analyzer has Windows 7[®] built in as an operating system, which expands its usability.

With a broad set of applications and demodulation capabilities, an intuitive user interface, outstanding connectivity and powerful one-button measurements, the analyzer is ideal for both R&D and manufacturing engineers working on cellular, emerging wireless communications, general purpose, aerospace and defense applications.

Installing Application Software

If you want to install a measurement application after your initial hardware purchase, you need only to license it. All of the available applications are loaded in your analyzer at the time of purchase.

Thus, when you purchase a new application, you will receive an entitlement certificate that you can use to obtain a license key for that application. To activate the new measurement application, enter the license key that you obtain into the Signal Analyzer.

For the latest information on Keysight Signal Analyzer measurement applications and upgrade kits, visit the following internet URL.

http://www.agilent.com/find/sa_upgrades

Viewing a License Key

Measurement applications that you purchased with your instrument have been installed and activated at the factory before shipment. The instrument requires a unique License Key for every measurement application purchased. The license key is a hexadecimal string that is specific to your measurement application, instrument model number and serial number. It enables you to install, or reactivate, that particular application.

Press **System, Show, System** to display the measurement applications that are currently licensed in your analyzer.

Go to the following location to view the license keys for the installed measurement applications:

C:\Program Files\Agilent\Licensing

You may want to keep a copy of your license key in a secure location. To do this, you can print out a copy of the display showing the license numbers. If you should lose your license key, call your nearest Keysight Technologies service or sales office for assistance.

Obtaining and Installing a License Key

If you purchase an additional application that requires installation, you will receive an "Entitlement Certificate", which may be redeemed for a license key for one instrument. To obtain your license key, follow the instructions that accompany the certificate.

Installing a license key for the selected application can be done automatically using a USB memory device. To do this, you copy the license file to the USB memory device, at the root level. Follow the instructions that come with your software installation kit.

Installing a license key can also be done manually using the built-in license management application, which may be found via the instrument front panel keys at **System, Licensing. . .**, or on-disk at:

C:\Programming Files\Agilent\Licensing

You can also use these procedures to reinstall a license key that has been accidentally deleted, or lost due to a memory failure.

Updating Measurement Application Software

All the software applications were loaded at the time of original instrument manufacture. It is a good idea to regularly update your software with the latest available version. This helps to ensure that you receive

any improvements and expanded functionality.

Because the software was loaded at the initial purchase, further additional measurement applications may now be available. If the application you are interested in licensing is not available, you will need to do a software update. (To display a list of installed applications, press **System, Show, System.**)

Check the appropriate page of the Keysight web site for the latest available software versions, according to the name of your instrument, as follows:

http://www.agilent.com/find/pxa_software

http://www.agilent.com/find/mxa_software

http://www.agilent.com/find/exa_software

http://www.agilent.com/find/cxa_software

You can load the updated software package into the analyzer from a USB drive, or directly from the internet. An automatic loading program is included with the files.

X-Series Options and Accessories

You can view an online list of available Options and Accessories for your instrument as follows:

1. Browse to one of the following URLs, according to the product name of your analyzer:

www.agilent.com/find/cxa

www.agilent.com/find/exa

www.agilent.com/find/mxa

www.agilent.com/find/pxa

2. The home page for your instrument appears (in some cases, you may see an initial splash screen containing a button named View the Webpage, which you should click to display the home page).
3. Locate the Options tab, as highlighted in the example below, which shows the home page for the MXA.



4. Click the Options tab, to display a list of available options and accessories for your instrument.

Front-Panel Features

The instrument's Front-panel features are fully detailed in the section "Front-Panel Features" (under the chapter "Front and Rear Panel Features") of the document:

[Getting Started Guide](#)

If you are viewing this information as a Help file in the instrument, then you can click on the link above to open the PDF document.

Display Annotations

Display Annotations are fully detailed under the chapter "Front and Rear Panel Features" of the document:

[Getting Started Guide](#)

If you are viewing this information as a Help file in the instrument, then you can click on the link above to open the PDF document.

Rear-Panel Features

The instrument's Rear-panel features are fully detailed in the section "Rear-Panel Features" (under the chapter "Front and Rear Panel Features") of the document:

[Getting Started Guide](#)

If you are viewing this information as a Help file in the instrument, then you can click on the link above to open the PDF document.

Window Control Keys

The instrument provides three front-panel keys for controlling windows. They are Multi Window, Zoom, and Next Window. These are all “immediate action” keys.

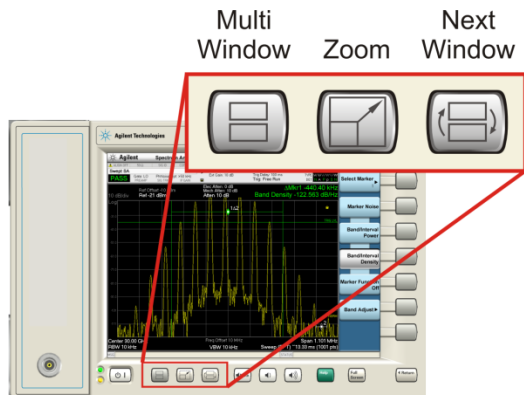

Multi-Window



The Multi Window front-panel key will toggle you back and forth between the Normal View and the last Multi Window View (Zone Span, Trace Zoom or Spectrogram) that you were in, when using the Swept SA measurement of the Spectrum Analyzer Mode. It remembers which View you were in through a Preset. This “previous view” is set to Zone Span on a Restore Mode Defaults.

Key Path	Front-panel key
Initial S/W Revision	Prior to A.02.00

Zoom

Zoom is a toggle function. Pressing this key once increases the size of the selected window. Pressing the key again returns the window to the original size.

When Zoom is on for a window, that window will get the entire primary display area. The zoomed window, since it is the selected window, is outlined in green.

Zoom is local to each Measurement. Each Measurement remembers its Zoom state. The Zoom state of each Measurement is part of the Mode’s state.

NOTE

Data acquisition and processing for the other windows continues while a window is zoomed, as does all SCPI communication with the other windows.

Remote Command	:DISPlay:WINDow:FORMat:ZOOM
----------------	-----------------------------

Remote Command	:DISPlay:WINDow:FORMat:TILE
Example	:DISP:WIND:FORM:ZOOM sets zoomed :DISP:WIND:FORM:TILE sets un-zoomed
Preset	TILE
Initial S/W Revision	Prior to A.02.00

Next Window

Selects the next window of the current view. When the Next Window key is pressed, the next window in the order of precedence becomes selected. If the selected window was zoomed, the next window will also be zoomed.

The window numbers are as follows. Note that these numbers also determine the order of precedence (that is, Next Window goes from 1 to 2, then 2 to 3, etc.):

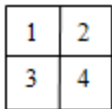

Four window display

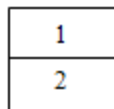

Two window display

RTSA measurements:

Only two windows are available in the Spectrogram view under the Spectrum measurement and up to three windows are available in the Power vs. Time measurement, depending on the view set up.

Remote Command	:DISPlay:WINDow[:SElect] <number> :DISPlay:WINDow[:SElect]?
Example	:DISP:WIND 1
Preset	1
Min	1
Max	If <number> is greater than the number of windows, limit to <number of windows>
Initial S/W Revision	Prior to A.02.00

One and only one window is always selected. The selected window has the focus; this means that all window-specific key presses apply only to that window. You can tell which window is selected by the thick green border around it. If a window is not selected, its boundary is gray.

If a window in a multi-window display is zoomed it is still outlined in green. If there is only one window, the green outline is not used. This allows the user to distinguish between a zoomed window and a display with only one window.

The selected window is local to each Measurement. Each Measurement remembers which window is selected. The selected window for each Measurement is remembered in Mode state.

NOTE

When this key is pressed in Help Mode, it toggles focus between the table of contents window and the topic pane window.

Full Screen

When Full Screen is pressed the measurement window expands horizontally over the entire instrument display. The screen graticule area expands to fill the available display area.

It turns off the display of the softkey labels, however the menus and active functions still work. (Though it would obviously be very hard to navigate without the key labels displayed.) Pressing Full Screen again while Full Screen is in effect cancels Full Screen.

Note that the banner and status lines are unaffected. You can get even more screen area for your data display by turning off the Meas Bar (in the Display menu) which also turns off the settings panel.

Full Screen is a Meas Global function. Therefore it is cancelled by the Preset key.

Key Path	Display
Remote Command	:DISPlay:FSCReen[:STAtE] OFF ON 0 1 :DISPlay:FSCReen[:STAtE]?
Preset	Unaffected by Preset but set to Off by Restore Misc Defaults or shutdown and restart
State Saved	Not saved in instrument state.
Backwards Compatibility SCPI	:DISPlay:MENU[:STAtE] OFF ON 0 1 This emulates ESA full screen functionality, which is the same as the FSCReen command in PSA except that the sense of on/off is reversed (that is, OFF means the menus are OFF, so Fullscreen is ON) and the default is ON (meaning Fullscreen is OFF).
Backwards Compatibility Notes	In ESA/PSA, Full Screen was turned on with a softkey, so pressing any other key turned Full Screen off. In the X-Series, because a hardkey is provided to turn this function on and off, pressing any other key no longer turns off Full Screen
Initial S/W Revision	Prior to A.02.00

Display Enable (Remote Command Only)

Turns the display on/off, including the display drive circuitry. The backlight stays lit so you can tell that the instrument is on. The display enable setting is mode global. The reasons for turning the display off are three:

- To increase speed as much as possible by freeing the instrument from having to update the display
- To reduce emissions from the display, drive circuitry
- For security purposes

If you have turned off the display:

- and you are in local operation, the display can be turned back on by pressing any key or by sending the SYSTem:DEFaults MISC command or the DISPlay:ENABle ON (neither *RST nor SYSTem:PRESet enable the display.)
- and you are in remote operation, the display can be turned back on by pressing the Local or Esc keys or by sending the SYSTem:DEFaults MISC command or the DISPlay:ENABle ON (neither *RST nor SYSTem:PRESet enable the display.)

and you are using either the SYSTem:KLOCK command or GPIB local lockout, then no front-panel key press will turn the display back on. You must turn it back on remotely.

Remote Command	:DISPlay:ENABle OFF ON 0 1 :DISPlay:ENABle?
Example	DISP:ENAB OFF
Couplings	DISP:ENAB OFF turns Backlight OFF and DISP:ENAB ON turns Backlight ON. However, settings of Backlight do not change the state of DISP:ENAB
Preset	On Set by SYST:DEF MISC, but Not affected by *RST or SYSTem:PRESet.
State Saved	Not saved in instrument state.
Backwards Compatibility Notes	SYST:PRES no longer turns on DISPlay:ENABle as it did in legacy analyzers
Initial S/W Revision	Prior to A.02.00

Mouse and Keyboard Control

If you do not have access to the instrument front-panel, there are several ways that a mouse and PC Keyboard can give you access to functions normally accessed using the front-panel keys.

Right-Click

If you plug in a mouse and right-click on the analyzer screen, a menu will appear as below:

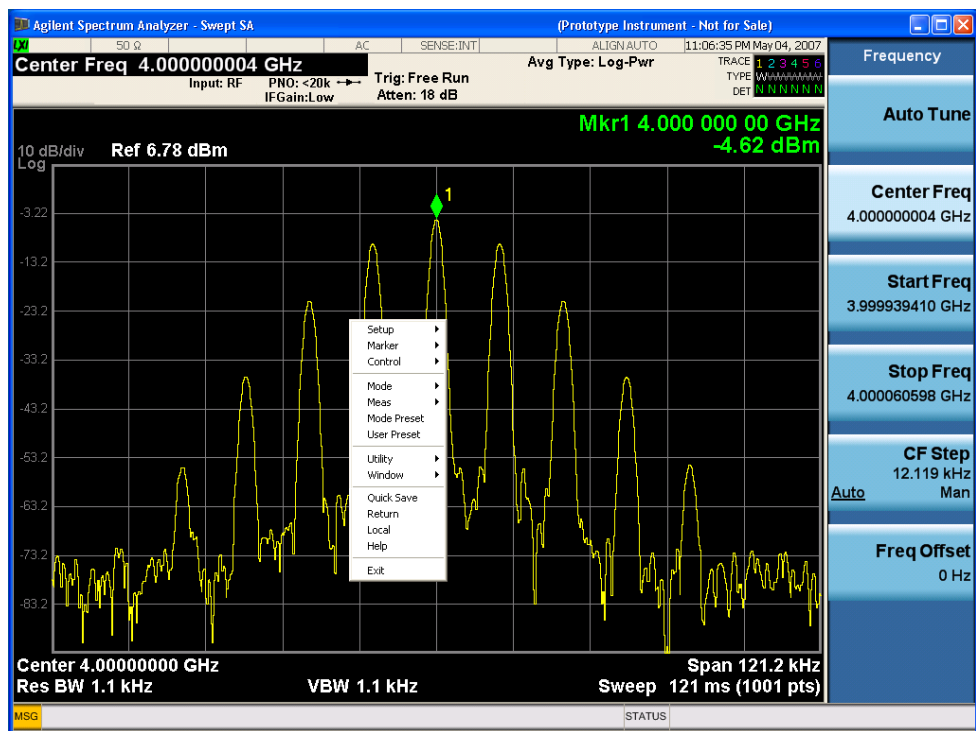

Placing the mouse on one of the rows marked with a right arrow symbol will cause that row to expand, as for example below where the mouse is hovered over the “Utility” row:

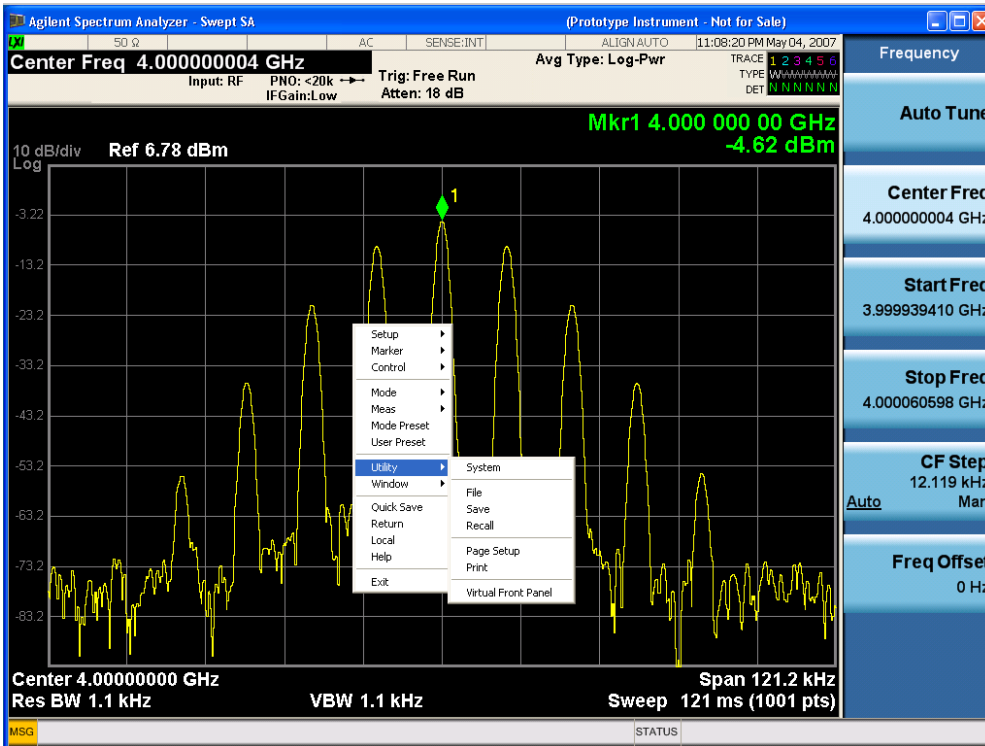

This method can be used to access any of the front-panel keys by using a mouse; as for example if you are accessing the instrument through Remote Desktop.

The array of keys thus available is shown below:

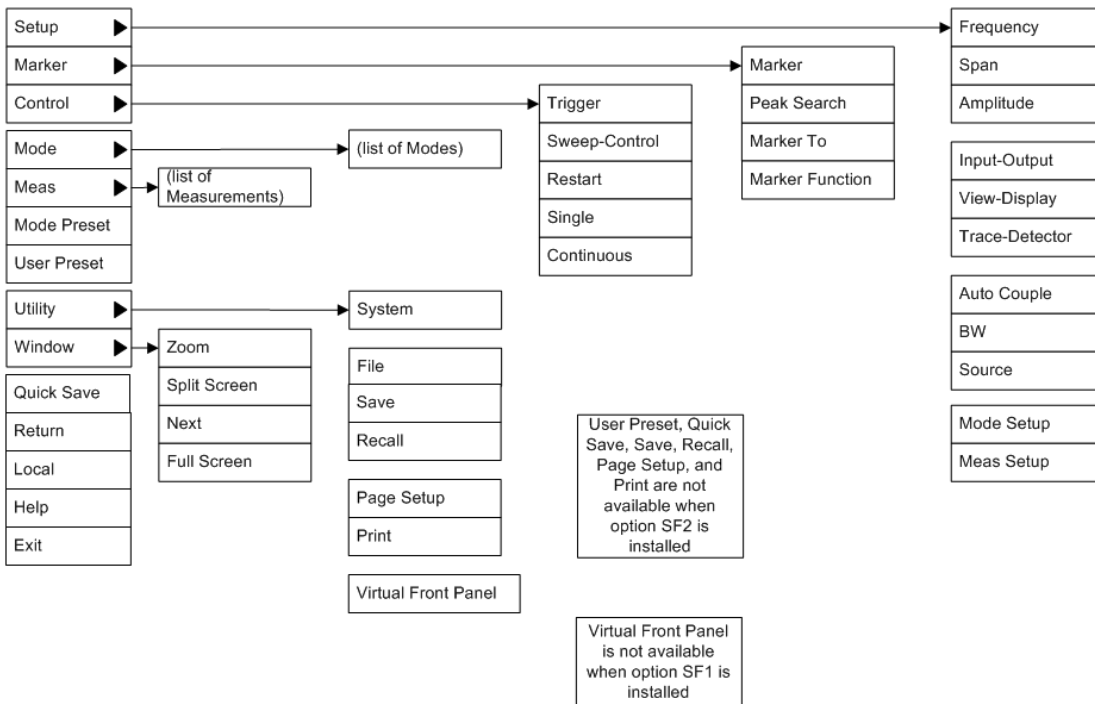

PC Keyboard

If you have a PC keyboard plugged in (or via Remote Desktop), certain key codes on the PC keyboard map to front-panel keys on the GPSA front panel. These key codes are shown below:

Front-panel key	Key code
Frequency	CTRL+SHIFT+F
Span	CTRL+SHIFT+S
Amplitude	CTRL+SHIFT+A
Input/Output	CTRL+SHIFT+O
View/Display	CTRL+SHIFT+V
Trace/Detector	CTRL+ALT+T
Auto Couple	CTRL+SHIFT+C
Bandwidth	CTRL+ALT+B
Source	CTRL+ALT-U
Marker	CTRL+ALT+K
Peak Search	CTRL+ALT+P
Marker To	CTRL+ALT+N
Marker Function	CTRL+ALT+F
System	CTRL+SHIFT+Y
Quick Save	CTRL+Q
Save	CTRL+S
Recall	CTRL+R
Mode Preset	CTRL+M
User Preset	CTRL+U
Print	CTRL+P
File	CTRL+SHIFT+L
Mode	CTRL+SHIFT+M
Measure	CTRL+ALT+M
Mode Setup	CTRL+SHIFT+E
Meas Setup	CTRL+ALT+E
Trigger	CTRL+SHIFT+T
Sweep/Control	CTRL+SHIFT+W
Restart	CTRL+ALT+R
Single	CTRL+ALT+S
Cont	CTRL+ALT+C
Zoom	CTRL+SHIFT+Z
Next Window	CTRL+SHIFT+N
Split Screen	CTRL+L

Front-panel key	Key code
Full Screen	CTRL+SHIFT+B
Return	CTRL+SHIFT+R
Mute	Mute
Inc Audio	Volume Up
Dec Audio	Volume Down
Help	F1
Control	CTRL
Alt	ALT
Enter	Return
Cancel	Esc
Del	Delete
Backspace	Backspace
Select	Space
Up Arrow	Up
Down Arrow	Down
Left Arrow	Left
Right Arrow	Right
Menu key 1	CTRL+SHIFT+F1
Menu key 2	CTRL+SHIFT+F2
Menu key 3	CTRL+SHIFT+F3
Menu key 4	CTRL+SHIFT+F4
Menu key 5	CTRL+SHIFT+F5
Menu key 6	CTRL+SHIFT+F6
Menu key 7	CTRL+SHIFT+F7
Backspace	BACKSPACE
Enter	ENTER
Tab	Tab
1	1
2	2
3	3
4	4
5	5
6	6
7	7
8	8
9	9
0	0

1 About the Analyzer
 Mouse and Keyboard Control

This is a pictorial view of the table:

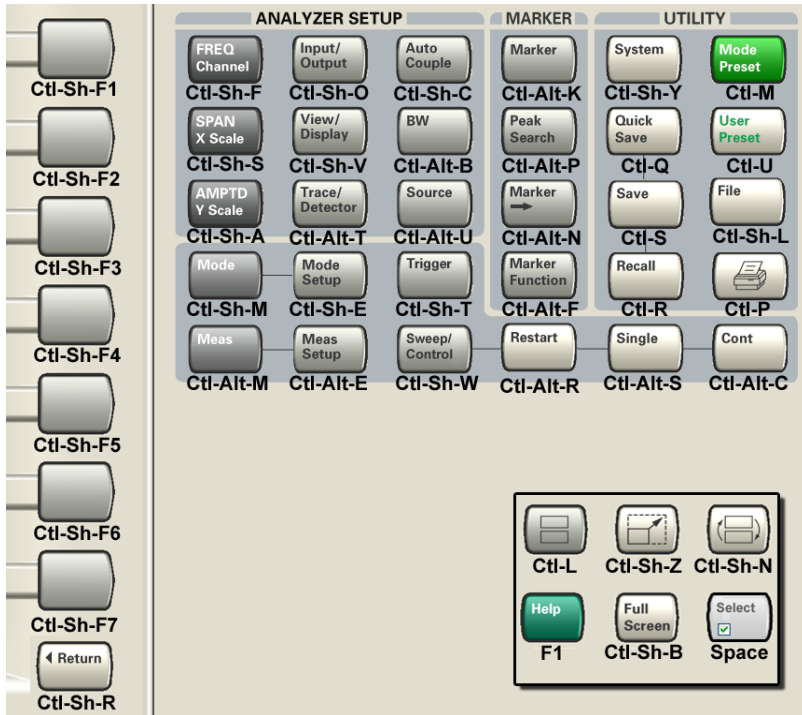

Instrument Security & Memory Volatility

If you are using the instrument in a secure environment, you may need details of how to clear or sanitize its memory, in compliance with published security standards of the United States Department of Defense, or other similar authorities.

For X-Series analyzers, this information is contained in the document "Security Features and Document of Volatility". This document is not included in the Documentation CD, or the instrument's on-disk library, but it may be downloaded from Keysight's web site.

To obtain a copy of the document, click on or browse to the following URL:

<http://www.agilent.com/find/security>

To locate and download the document, select Model Number "N9020A", then click "Submit". Then, follow the on-screen instructions to download the file.

2 About the WLAN Measurement Application

This chapter describes WLAN measurements made by the analyzer.

What Does the WLAN Measurement Application Do?

The Agilent N9077A & W9077A WLAN measurement application can be used to quickly ensure a product development conforms to regulatory requirements, as well as providing RF diagnostic and troubleshooting capability for a WLAN device.

WLAN measurement application provides the following measurements:

- Channel Power
- Occupied Bandwidth
- Power Stat CCDF
- Spectrum Emission Mask
- Spurious Emissions
- Power vs Time
- Spectral Flatness
- Modulation Analysis
- List Sequence
- Monitor Spectrum
- I/Q Waveform

3 Programming the Analyzer

This section provides introductory information about the programming documentation included with your product.

- ["What Programming Information is Available?" on page 100](#)
- ["STATus Subsystem " on page 142](#)
- ["IEEE 488.2 Common Commands" on page 184](#)

What Programming Information is Available?

The X-Series Documentation can be accessed through the Additional Documentation page in the instrument Help system and is included on the Documentation DVD shipped with the instrument. It can also be found online at: http://www.agilent.com/find/mxa_manuals.

The following resources are available to help you create programs for automating your X-Series measurements:

Resource	Description
X-Series Programmer's Guide	Provides general SCPI programming information on the following topics: <ul style="list-style-type: none">• Programming the X-Series Applications• Programming fundamentals• Programming examples Note that SCPI command descriptions for measurement applications are not in this book, but are in the User's and Programmer's Reference.
User's and Programmer's Reference manuals	Describes all front-panel keys and softkeys, including SCPI commands for a measurement application. Note that: <ul style="list-style-type: none">• Each measurement application has its own User's and Programmer's Reference.• The content in this manual is duplicated in the instrument's Help (the Help that you see for a key is identical to what you see in this manual).
Embedded Help in your instrument	Describes all front-panel keys and softkeys, including SCPI commands, for a measurement application. Note that the content that you see in Help when you press a key is identical to what you see in the User's and Programmer's Reference.
X-Series Getting Started Guide	Provides valuable sections related to programming including: <ul style="list-style-type: none">• Licensing New Measurement Application Software - After Initial Purchase• Configuring instrument LAN Hostname, IP Address, and Gateway Address• Using the Windows Remote Desktop to connect to the instrument remotely• Using the Embedded Web Server Telnet connection to communicate SCPI This printed document is shipped with the instrument.
Keysight Application Notes	Printable PDF versions of pertinent application notes.
Keysight VISA User's Guide	Describes the Keysight Virtual Instrument Software Architecture (VISA) library and shows how to use it to develop I/O applications and instrument drivers on Windows PCs.

List of SCPI Commands

```

*CAL?
*CLS
*ESE <integer>
*ESE?
*ESR?
*IDN?
*OPC
*OPC?
*OPT?
*RCL <register#>
*RST
*SAV <register#>
*SRE <integer>
*SRE?
*STB?
*TRG
*TST?
*WAI
ABORT
CALCulate:EVM:SPECTrum?
CALCulate:FLATness:SPECTrum?
CALCulate:WLSequence:EVM:STANdard[1]|2|...7:SPECTrum?
CALCulate:CHPower:LIMit:POWer <ampl>
CALCulate:CHPower:LIMit:POWer?
CALCulate:CHPower:LIMit:POWer:FAIL?
CALCulate:CHPower:LIMit:POWer:STATe OFF | ON | 0 | 1
CALCulate:CHPower:LIMit:POWer:STATe?
CALCulate:CHPower:LIMit:PSDensitY <real>
CALCulate:CHPower:LIMit:PSDensitY?
CALCulate:CHPower:LIMit:PSDensitY:STATe OFF | ON | 0 | 1
CALCulate:CHPower:LIMit:PSDensitY:STATe?
CALCulate:CHPower:LIMit:PSD:FAIL?
CALCulate:CHPower:MARKer:AOFF
CALCulate:CHPower:MARKer[1]|2|...|12:MAXimum
CALCulate:CHPower:MARKer[1]|2|...|12:MODE POSition | DELTA | OFF
CALCulate:CHPower:MARKer[1]|2|...|12:MODE?
CALCulate:CHPower:MARKer[1]|2|...|12:REFerence <integer>
CALCulate:CHPower:MARKer[1]|2|...|12:REFerence?
CALCulate:CHPower:MARKer[1]|2|...|12:STATe OFF | ON | 0 | 1
CALCulate:CHPower:MARKer[1]|2|...|12:STATe?
CALCulate:CHPower:MARKer[1]|2|...|12:X <real>
CALCulate:CHPower:MARKer[1]|2|...|12:X?
CALCulate:CHPower:MARKer[1]|2|...|12:X:POSition <real>
CALCulate:CHPower:MARKer[1]|2|...|12:X:POSition?
CALCulate:CHPower:MARKer[1]|2|...|12:Y?
CALCulate:CLIMits:FAIL?
CALCulate:DATA<n>:COMPRESS? BLOCK | CFIT | MAXimum | MINimum | MEAN |
DMEan | RMS | RMSCubed | SAMPLE | SDEVIation | PPHase[, <soffset>[,
<length>[, <roffset>[, <rlimit>]]]]
CALCulate:DATA[n]?

```

```
CALCulate:DATA[1]|2|...|6:PEAKs? <threshold>, <excursion>[, AMPLitude |  
FREQuency | TIME[, ALL | GTDLine | LTDLine]]  
CALCulate:DATA[1]|2|...|6:PEAKs? <threshold>, <excursion>[, AMPLitude |  
FREQuency | TIME]  
CALCulate:EVM:EQUalizer:TMODe SEQuence | SDATA  
CALCulate:EVM:EQUalizer:TMODe?  
CALCulate:EVM:IQEstimation OFF | ON | 0 | 1  
CALCulate:EVM:IQEstimation?  
CALCulate:EVM:IQNorm OFF | ON | 0 | 1  
CALCulate:EVM:IQNorm?  
CALCulate:EVM:LIMit:CARRier <rel_ampl>  
CALCulate:EVM:LIMit:CARRier?  
CALCulate:EVM:LIMit:CFLeakage <rel_ampl>  
CALCulate:EVM:LIMit:CFLeakage?  
CALCulate:EVM:LIMit:CHIP <percent>  
CALCulate:EVM:LIMit:CHIP?  
CALCulate:EVM:LIMit:CLKerror <real>  
CALCulate:EVM:LIMit:CLKerror ?  
CALCulate:EVM:LIMit:FERRor <real>  
CALCulate:EVM:LIMit:FERRor ?  
CALCulate:EVM:LIMit:IQOffset <rel_ampl>  
CALCulate:EVM:LIMit:RMS <percent>  
CALCulate:EVM:LIMit:RMS?  
CALCulate:EVM:LIMit:RMS:BPSK:R1B2  
CALCulate:EVM:LIMit:RMS:BPSK:R1B2 <rel_ampl>  
CALCulate:EVM:LIMit:RMS:M12 <rel_ampl>  
CALCulate:EVM:LIMit:RMS:M18 <rel_ampl>  
CALCulate:EVM:LIMit:RMS:M24 <rel_ampl>  
CALCulate:EVM:LIMit:RMS:M9 <rel_ampl>  
CALCulate:EVM:LIMit:RMS:M54 <rel_ampl>  
CALCulate:EVM:LIMit:RMS:M6 <rel_ampl>  
CALCulate:EVM:LIMit:RMS:M36 <rel_ampl>  
CALCulate:EVM:LIMit:RMS:M48 <rel_ampl>  
CALCulate:EVM:LIMit:RMS:M48?  
CALCulate:EVM:LIMit:RMS:M6?  
CALCulate:EVM:LIMit:RMS:M24?  
CALCulate:EVM:LIMit:RMS:M54?  
CALCulate:EVM:LIMit:RMS:M12?  
CALCulate:EVM:LIMit:RMS:M18?  
CALCulate:EVM:LIMit:RMS:M36?  
CALCulate:EVM:LIMit:RMS:M9?  
CALCulate:EVM:LIMit:RMS:QA16:R1B2 <rel_ampl>  
CALCulate:EVM:LIMit:RMS:QA256:R3B4  
CALCulate:EVM:LIMit:RMS:QA256:R5B6  
CALCulate:EVM:LIMit:RMS:QA256:R5B6 <rel_ampl>  
CALCulate:EVM:LIMit:RMS:QA64:R5B6  
CALCulate:EVM:LIMit:RMS:QA64:R3B4 <rel_ampl>  
CALCulate:EVM:LIMit:RMS:QA64:R2B3 <rel_ampl>  
CALCulate:EVM:LIMit:RMS:QA64:R5B6 <rel_ampl>  
CALCulate:EVM:LIMit:RMS:QA64:R3B4  
CALCulate:EVM:LIMit:RMS:QA16:R3B4 <rel_ampl>  
CALCulate:EVM:LIMit:RMS:QA16:R1B2  
CALCulate:EVM:LIMit:RMS:QA256:R3B4 <rel_ampl>
```

```

CALCulate:EVM:LIMit:RMS:QA16:R3B4?
CALCulate:EVM:LIMit:RMS:QA64:R2B3?
CALCulate:EVM:LIMit:RMS:QPSK:R1B2
CALCulate:EVM:LIMit:RMS:QPSK:R1B2 <rel_amp>
CALCulate:EVM:LIMit:RMS:QPSK:R3B4
CALCulate:EVM:LIMit:RMS:QPSK:R3B4 <rel_amp>
CALCulate:EVM:MARKer:AOff
CALCulate:EVM:MARKer:COUple[:STATE] ON | OFF | 1 | 0
CALCulate:EVM:MARKer:COUple[:STATE]?
CALCulate:EVM:MARKer[1]|2|...|12:MAXimum
CALCulate:EVM:MARKer[1]|2|...|12:MAXimum:LEFT
CALCulate:EVM:MARKer[1]|2|...|12:MAXimum:NEXT
CALCulate:EVM:MARKer[1]|2|...|12:MAXimum:RIGHT
CALCulate:EVM:MARKer[1]|2|...|12:MINimum
CALCulate:EVM:MARKer[1]|2|...|12:MODE POSITION | DELTA | OFF
CALCulate:EVM:MARKer[1]|2|...|12:MODE?
CALCulate:EVM:MARKer[1]|2|...|12:PTPeak
CALCulate:EVM:MARKer[1]|2|...|12:REfERENCE <integer>
CALCulate:EVM:MARKer[1]|2|...|12:REfERENCE?
CALCulate:EVM:MARKer[1]|2|...|12:STATE OFF | ON | 0 | 1
CALCulate:EVM:MARKer[1]|2|...|12:STATE?
CALCulate:EVM:MARKer[1]|2|...|12:TRACe SYMBol | POLar | EVCarrier |
RECarrier | EVSymbol | RESymbol | PCARrier | RPCarrier | PSYMBOL |
RPSymbol | FLATness | DFLatness | PVT | SPECTrum
CALCulate:EVM:MARKer[1]|2|...|12:TRACe POLar | EVM | MERRor | PERRor |
EVMS | EVMC | PFError | IQGain | IQQuad | IQTime
CALCulate:EVM:MARKer[1]|2|...|12:TRACe?
CALCulate:EVM:MARKer[1]|2|...|12:TRACe?
CALCulate:EVM:MARKer[1]|2|...|12:X <real>
CALCulate:EVM:MARKer[1]|2|...|12:X?
CALCulate:EVM:MARKer[1]|2|...|12:X:POSition <real>
CALCulate:EVM:MARKer[1]|2|...|12:X:POSition?
CALCulate:EVM:MARKer[1]|2|...|12:Y?
CALCulate:EVM:PILot:TRACk:AMPLitude OFF | ON | 0 | 1
CALCulate:EVM:PILot:TRACk:AMPLitude?
CALCulate:EVM:PILot:TRACk:PHASe OFF | ON | 0 | 1
CALCulate:EVM:PILot:TRACk:PHASe?
CALCulate:EVM:PILot:TRACk:TIMing OFF | ON | 0 | 1
CALCulate:EVM:PILot:TRACk:TIMing?
CALCulate:EVM:SEGment SEGM1 | SEGM2
CALCulate:EVM:SEGment?
CALCulate:EVM:SPECTrum INVert | NORMal
CALCulate:EVM:SUBCarrier ALL | PILOt | SINGLE
CALCulate:EVM:SUBCarrier?
CALCulate:EVM:SUBCarrier:COUNT
CALCulate:EVM:SUBCarrier:COUNT <integer>
CALCulate:EVM:TRACk:PHASe OFF | ON | 0 | 1
CALCulate:EVM:TRACk:PHASe?
CALCulate:FLATness:LIMit:LOWer:SECTion1 <rel_amp>
CALCulate:FLATness:LIMit:LOWer:SECTion2 <rel_amp>
CALCulate:FLATness:LIMit:LOWer:SECTion2?
CALCulate:FLATness:LIMit:LOWer:SECTion1?

```

```
CALCulate:FLATness:LIMit:UPPer:SECTIon2 <rel_amp>
CALCulate:FLATness:LIMit:UPPer:SECTIon1 <rel_amp>
CALCulate:FLATness:LIMit:UPPer:SECTIon1?
CALCulate:FLATness:LIMit:UPPer:SECTIon2?
CALCulate:FLATness:MARKer:AOFF
CALCulate:FLATness:MARKer:COUple[:STATe] ON | OFF | 1 | 0
CALCulate:FLATness:MARKer:COUple[:STATe]?
CALCulate:FLATness:MARKer[1]|2|...|12:MAXimum
CALCulate:FLATness:MARKer[1]|2|...|12:MODE POSition | DELTa | OFF
CALCulate:FLATness:MARKer[1]|2|...|12:MODE?
CALCulate:FLATness:MARKer[1]|2|...|12:REFerence <integer>
CALCulate:FLATness:MARKer[1]|2|...|12:REFerence?
CALCulate:FLATness:MARKer[1]|2|...|12:TRACe FLATness | ULIMit | LLIMit
CALCulate:FLATness:MARKer[1]|2|...|12:TRACe?
CALCulate:FLATness:MARKer[1]|2|...|12:X <real>
CALCulate:FLATness:MARKer[1]|2|...|12:X?
CALCulate:FLATness:MARKer[1]|2|...|12:X:POSition <real>
CALCulate:FLATness:MARKer[1]|2|...|12:X:POSition?
CALCulate:FLATness:MARKer[1]|2|...|12:Y?
CALCulate:FLATness:SEGment:LIST:LIMit:LOWer <rel_ampl>, ...
CALCulate:FLATness:SEGment:LIST:LIMit:LOWer <rel_ampl>, ...
CALCulate:FLATness:SEGment:LIST:LIMit:LOWer?
CALCulate:FLATness:SEGment:LIST:LIMit:LOWer?
CALCulate:FLATness:SEGment:LIST:LIMit:UPPer <rel_ampl>, ...
CALCulate:FLATness:SEGment:LIST:LIMit:UPPer <rel_ampl>, ...
CALCulate:FLATness:SEGment:LIST:LIMit:UPPer?
CALCulate:FLATness:SEGment:LIST:LIMit:UPPer?
CALCulate:FLATness:SPECtrum INVert | NORMAl
CALCulate:FPOWER:POWER[1,2,...,999]?
CALCulate:FPOWER:POWER[1,2,...,999]:CONFigure
CALCulate:FPOWER:POWER[1,2,...,999]:DEFine "configurationstring"
CALCulate:FPOWER:POWER[1,2,...,999]:DEFine?
CALCulate:FPOWER:POWER[1,2,...,999]:FETCh?
CALCulate:FPOWER:POWER[1,2,...,999]:INITiate
CALCulate:FPOWER:POWER[1,2,...,999]:READ2?
CALCulate:FPOWER:POWER[1,2,...,999]:READ?
CALCulate:FPOWER:POWER[1,2,...,999]:READ1?
CALCulate:FPOWER:POWER[1,2,...,999]:RESet
CALCulate:MONitor:MARKer:AOFF
CALCulate:MONitor:MARKer:COUple[:STATe] ON | OFF | 1 | 0
CALCulate:MONitor:MARKer:COUple[:STATe]?
CALCulate:MONitor:MARKer[1]|2|...|12:FUNCTion NOISe | BPOWER | BDENsity |
OFF
CALCulate:MONitor:MARKer[1]|2|...|12:FUNCTion?
CALCulate:MONitor:MARKer[1]|2|...|12:FUNCTion:BAND:LEFT <freq>
CALCulate:MONitor:MARKer[1]|2|...|12:FUNCTion:BAND:LEFT?
CALCulate:MONitor:MARKer[1]|2|...|12:FUNCTion:BAND:RIGHT <freq>
CALCulate:MONitor:MARKer[1]|2|...|12:FUNCTion:BAND:RIGHT?
CALCulate:MONitor:MARKer[1]|2|...|12:FUNCTion:BAND:SPAN <freq>
CALCulate:MONitor:MARKer[1]|2|...|12:FUNCTion:BAND:SPAN?
CALCulate:MONitor:MARKer[1]|2|...|12:FUNCTion:RESult?
CALCulate:MONitor:MARKer[1]|2|...|12:MAXimum
CALCulate:MONitor:MARKer[1]|2|...|12:MODE POSition | DELTa | OFF
```



```

CALCulate:MONitor:MARKer[1]|2|...|12:MODE?
CALCulate:MONitor:MARKer[1]|2|...|12:REfERENCE <integer>
CALCulate:MONitor:MARKer[1]|2|...|12:REfERENCE?
CALCulate:MONitor:MARKer[1]|2|...|12:TRACe <integer>
CALCulate:MONitor:MARKer[1]|2|...|12:TRACe?
CALCulate:MONitor:MARKer[1]|2|...|12:X <freq>
CALCulate:MONitor:MARKer[1]|2|...|12:X?
CALCulate:MONitor:MARKer[1]|2|...|12:X:POSition <real>
CALCulate:MONitor:MARKer[1]|2|...|12:X:POSition?
CALCulate:MONitor:MARKer[1]|2|...|12:Y?
CALCulate:NFIgure:MARKer[1]|2|...|4:REfERENCE <int>
CALCulate:NFIgure:MARKer[1]|2|...|4:REfERENCE?
CALCulate:OBWidth:LIMit:FBLimit <freq>
CALCulate:OBWidth:LIMit:FBLimit?
CALCulate:OBWidth:LIMit[:TEST] ON | OFF | 1 | 0
CALCulate:OBWidth:LIMit[:TEST]?
CALCulate:OBWidth:MARKer:AOff
CALCulate:OBWidth:MARKer[1]|2|...|12:MAXimum
CALCulate:OBWidth:MARKer[1]|2|...|12:MODE POSition | DELTa | OFF
CALCulate:OBWidth:MARKer[1]|2|...|12:MODE?
CALCulate:OBWidth:MARKer[1]|2|...|12:REfERENCE <integer>
CALCulate:OBWidth:MARKer[1]|2|...|12:REfERENCE?
CALCulate:OBWidth:MARKer[1]|2|...|12:STATE OFF | ON | 0 | 1
CALCulate:OBWidth:MARKer[1]|2|...|12:STATE?
CALCulate:OBWidth:MARKer[1]|2|...|12:X <freq>
CALCulate:OBWidth:MARKer[1]|2|...|12:X?
CALCulate:OBWidth:MARKer[1]|2|...|12:X:POSition <real>
CALCulate:OBWidth:MARKer[1]|2|...|12:X:POSition?
CALCulate:OBWidth:MARKer[1]|2|...|12:Y?
CALCulate:PStatistic:MARKer:AOff
CALCulate:PStatistic:MARKer[1]|2|...|12:FUNCTion:RESult?
CALCulate:PStatistic:MARKer[1]|2|...|12:MODE POSition | DELTa | OFF
CALCulate:PStatistic:MARKer[1]|2|...|12:MODE?
CALCulate:PStatistic:MARKer[1]|2|...|12:REfERENCE <integer>
CALCulate:PStatistic:MARKer[1]|2|...|12:REfERENCE?
CALCulate:PStatistic:MARKer[1]|2|...|12:TRACe MEASured | GAUSSian |
REfERENCE
CALCulate:PStatistic:MARKer[1]|2|...|12:TRACe?
CALCulate:PStatistic:MARKer[1]|2|...|12:X <rel_ampl>
CALCulate:PStatistic:MARKer[1]|2|...|12:X?
CALCulate:PStatistic:MARKer[1]|2|...|12:Y?
CALCulate:PStatistic:STORE:REfERENCE
CALCulate:PVTime:FAIL UP | DOWN | BOTH
CALCulate:PVTime:FAIL?
CALCulate:PVTime:LIMit:DRTime
CALCulate:PVTime:LIMit:RDTime <time>
CALCulate:PVTime:LIMit:RDTime?
CALCulate:PVTime:LIMit:RUTime <time>
CALCulate:PVTime:LIMit:RUTime?
CALCulate:PVTime:LIMit:URTime
CALCulate:PVTime:MARKer:AOff
CALCulate:PVTime:MARKer:COUple[:STATe] ON | OFF | 1 | 0
CALCulate:PVTime:MARKer:COUple[:STATe]?

```

3 Programming the Analyzer

List of SCPI Commands

```
CALCulate:PVTime:MARKer[1]|2|...|12:MAXimum
CALCulate:PVTime:MARKer[1]|2|...|12:MODE POSITION | DELTA | OFF
CALCulate:PVTime:MARKer[1]|2|...|12:MODE?
CALCulate:PVTime:MARKer[1]|2|...|12:REFERENCE <integer>
CALCulate:PVTime:MARKer[1]|2|...|12:REFERENCE?
CALCulate:PVTime:MARKer[1]|2|...|12:TRACE RFENvelope | MAXHold | MINHold
CALCulate:PVTime:MARKer[1]|2|...|12:TRACE?
CALCulate:SEMask:LLINE:STATE ON | OFF | 1 | 0
CALCulate:SEMask:LLINE:STATE?
CALCulate:SEMask:MARKer:AOFF
CALCulate:SEMask:MARKer:COUPLE[:STATE] ON | OFF | 1 | 0
CALCulate:SEMask:MARKer:COUPLE[:STATE]?
CALCulate:SEMask:MARKer[1]|2|...|12:FUNCTION:RESULT?
CALCulate:SEMask:MARKer[1]|2|...|12:MODE POSITION | OFF
CALCulate:SEMask:MARKer[1]|2|...|12:MODE?
CALCulate:SEMask:MARKer[1]|2|...|12:X <freq>
CALCulate:SEMask:MARKer[1]|2|...|12:X?
CALCulate:SEMask:MARKer[1]|2|...|12:X:POSITION <real>
CALCulate:SEMask:MARKer[1]|2|...|12:X:POSITION?
CALCulate:SEMask:MARKer[1]|2|...|12:Y?
CALCulate:SPURious:MARKer:AOFF
CALCulate:SPURious:MARKer:COUPLE[:STATE] ON | OFF | 1 | 0
CALCulate:SPURious:MARKer:COUPLE[:STATE]?
CALCulate:SPURious:MARKer[1]|2|...|12:MAXimum
CALCulate:SPURious:MARKer[1]|2|...|12:MAXimum:LEFT
CALCulate:SPURious:MARKer[1]|2|...|12:MAXimum:NEXT
CALCulate:SPURious:MARKer[1]|2|...|12:MAXimum:RIGHT
CALCulate:SPURious:MARKer[1]|2|...|12:MINimum
CALCulate:SPURious:MARKer[1]|2|...|12:MODE POSITION | DELTA | OFF
CALCulate:SPURious:MARKer[1]|2|...|12:MODE?
CALCulate:SPURious:MARKer[1]|2|...|12:PTPeak
CALCulate:SPURious:MARKer[1]|2|...|12:REFERENCE <integer>
CALCulate:SPURious:MARKer[1]|2|...|12:REFERENCE?
CALCulate:SPURious:MARKer[1]|2|...|12:X <freq>
CALCulate:SPURious:MARKer[1]|2|...|12:X?
CALCulate:SPURious:MARKer[1]|2|...|12:X:POSITION <integer>
CALCulate:SPURious:MARKer[1]|2|...|12:X:POSITION?
CALCulate:SPURious:MARKer[1]|2|...|12:Y?
CALCulate:SPURious[:RANGE][:LIST]:LIMIT:ABSolute[:UPPer]:DATA[:START]
<ampl>, ...
CALCulate:SPURious[:RANGE][:LIST]:LIMIT:ABSolute[:UPPer]:DATA[:START]?
CALCulate:SPURious[:RANGE][:LIST]:LIMIT:ABSolute[:UPPer]:DATA:STOP <ampl>,
...
CALCulate:SPURious[:RANGE][:LIST]:LIMIT:ABSolute[:UPPer]:DATA:STOP?
CALCulate:SPURious[:RANGE][:LIST]:LIMIT:ABSolute[:UPPer]:DATA:STOP:AUTO
OFF|ON|0|1, ...
CALCulate:SPURious[:RANGE][:LIST]:LIMIT:ABSolute[:UPPer]:DATA:STOP:AUTO?
CALCulate:WAVEform:MARKer:AOFF
CALCulate:WAVEform:MARKer:COUPLE[:STATE] ON | OFF | 1 | 0
CALCulate:WAVEform:MARKer:COUPLE[:STATE]?
CALCulate:WAVEform:MARKer[1]|2|...|12:FUNCTION BPOWER | BDENSITY | OFF
CALCulate:WAVEform:MARKer[1]|2|...|12:FUNCTION?
```

```

CALCulate:WAVeform:MARKer[1]|2|...|12:FUNction:BAND:LEFT <time>
CALCulate:WAVeform:MARKer[1]|2|...|12:FUNction:BAND:LEFT?
CALCulate:WAVeform:MARKer[1]|2|...|12:FUNction:BAND:RIGHT <time>
CALCulate:WAVeform:MARKer[1]|2|...|12:FUNction:BAND:RIGHT?
CALCulate:WAVeform:MARKer[1]|2|...|12:FUNction:BAND:SPAN <time>
CALCulate:WAVeform:MARKer[1]|2|...|12:FUNction:BAND:SPAN?
CALCulate:WAVeform:MARKer[1]|2|...|12:FUNction:RESult?
CALCulate:WAVeform:MARKer[1]|2|...|12:MAXimum
CALCulate:WAVeform:MARKer[1]|2|...|12:MAXimum:NEXT
CALCulate:WAVeform:MARKer[1]|2|...|12:MINimum
CALCulate:WAVeform:MARKer[1]|2|...|12:MODE POSition | DELTA | OFF
CALCulate:WAVeform:MARKer[1]|2|...|12:MODE?
CALCulate:WAVeform:MARKer[1]|2|...|12:REFerence <integer>
CALCulate:WAVeform:MARKer[1]|2|...|12:REFerence?
CALCulate:WAVeform:MARKer[1]|2|...|12:STATE OFF | ON | 0 | 1
CALCulate:WAVeform:MARKer[1]|2|...|12:STATE?
CALCulate:WAVeform:MARKer[1]|2|...|12:TRACe RFENvelope | I | Q | IQ
CALCulate:WAVeform:MARKer[1]|2|...|12:TRACe?
CALCulate:WAVeform:MARKer[1]|2|...|12:X <time>
CALCulate:WAVeform:MARKer[1]|2|...|12:X?
CALCulate:WAVeform:MARKer[1]|2|...|12:X:POSition <real>
CALCulate:WAVeform:MARKer[1]|2|...|12:X:POSition?
CALCulate:WAVeform:MARKer[1]|2|...|4:X:SPAN
CALCulate:WAVeform:MARKer[1]|2|...|12:Y?
CALCulate:WLSequence:EVM:BURSt:START ?
CALCulate:WLSequence:EVM:BURSt:START <Integer>
CALCulate:WLSequence:EVM:BURSt:STOP ?
CALCulate:WLSequence:EVM:BURSt:STOP <Integer>
CALCulate:WLSequence:EVM:LIMit:CHIP <percent>
CALCulate:WLSequence:EVM:LIMit:CHIP?
CALCulate:WLSequence:EVM:LIMit:CSUPpression <rel_ampl>
CALCulate:WLSequence:EVM:LIMit:CSUPpression?
CALCulate:WLSequence:EVM:LIMit:FAIL?
CALCulate:WLSequence:EVM:LIMit:RMS <percent>
CALCulate:WLSequence:EVM:LIMit:RMS?
CALCulate:WLSequence:EVM:LIMit:STANdard[1]|2|...7:CCLKerror <real>
CALCulate:WLSequence:EVM:LIMit:STANdard[1]|2|...7:CCLKerror?
CALCulate:WLSequence:EVM:LIMit:STANdard[1]|2|...7:CFLeakage <rel_ampl>
CALCulate:WLSequence:EVM:LIMit:STANdard[1]|2|...7:CFLeakage?
CALCulate:WLSequence:EVM:LIMit:STANdard[1]|2|...7:FERRor <real>
CALCulate:WLSequence:EVM:LIMit:STANdard[1]|2|...7:FERRor?
CALCulate:WLSequence:EVM:LIMit:STANdard[1]|2|...7:RMS:BPSK:R1B2 <rel_ampl>
CALCulate:WLSequence:EVM:LIMit:STANdard[1]|2|...7:RMS:BPSK:R1B2
CALCulate:WLSequence:EVM:LIMit:STANdard[1]|2|...7:RMS:D9Mbits <rel_ampl>
CALCulate:WLSequence:EVM:LIMit:STANdard[1]|2|...7:RMS:D12Mbits <rel_ampl>
CALCulate:WLSequence:EVM:LIMit:STANdard[1]|2|...7:RMS:D54Mbits <rel_ampl>
CALCulate:WLSequence:EVM:LIMit:STANdard[1]|2|...7:RMS:D6Mbits <rel_ampl>
CALCulate:WLSequence:EVM:LIMit:STANdard[1]|2|...7:RMS:D18Mbits <rel_ampl>
CALCulate:WLSequence:EVM:LIMit:STANdard[1]|2|...7:RMS:D24Mbits <rel_ampl>
CALCulate:WLSequence:EVM:LIMit:STANdard[1]|2|...7:RMS:D48Mbits <rel_ampl>
CALCulate:WLSequence:EVM:LIMit:STANdard[1]|2|...7:RMS:D36Mbits <rel_ampl>
CALCulate:WLSequence:EVM:LIMit:STANdard[1]|2|...7:RMS:D54Mbits?
CALCulate:WLSequence:EVM:LIMit:STANdard[1]|2|...7:RMS:D36Mbits?

```

3 Programming the Analyzer

List of SCPI Commands

```
CALCulate:WLSequence:EVM:LIMit:STANdard[1]|2|...7:RMS:D24Mbits?
CALCulate:WLSequence:EVM:LIMit:STANdard[1]|2|...7:RMS:D18Mbits?
CALCulate:WLSequence:EVM:LIMit:STANdard[1]|2|...7:RMS:D12Mbits?
CALCulate:WLSequence:EVM:LIMit:STANdard[1]|2|...7:RMS:D6Mbits?
CALCulate:WLSequence:EVM:LIMit:STANdard[1]|2|...7:RMS:D48Mbits?
CALCulate:WLSequence:EVM:LIMit:STANdard[1]|2|...7:RMS:D9Mbits?
CALCulate:WLSequence:EVM:LIMit:STANdard[1]|2|...7:RMS:QA64:R2B3 <rel_ampl>
CALCulate:WLSequence:EVM:LIMit:STANdard[1]|2|...7:RMS:QA64:R5B6
CALCulate:WLSequence:EVM:LIMit:STANdard[1]|2|...7:RMS:QA64:R3B4
CALCulate:WLSequence:EVM:LIMit:STANdard[1]|2|...7:RMS:QA16:R1B2 <rel_ampl>
CALCulate:WLSequence:EVM:LIMit:STANdard[1]|2|...7:RMS:QA64:R3B4 <rel_ampl>
CALCulate:WLSequence:EVM:LIMit:STANdard[1]|2|...7:RMS:QA64:R5B6 <rel_ampl>
CALCulate:WLSequence:EVM:LIMit:STANdard[1]|2|...7:RMS:QA256:R5B6 <rel_
ampl>
CALCulate:WLSequence:EVM:LIMit:STANdard[1]|2|...7:RMS:QA256:R3B4 <rel_
ampl>
CALCulate:WLSequence:EVM:LIMit:STANdard[1]|2|...7:RMS:QA256:R3B4
CALCulate:WLSequence:EVM:LIMit:STANdard[1]|2|...7:RMS:QA256:R5B6
CALCulate:WLSequence:EVM:LIMit:STANdard[1]|2|...7:RMS:QA16:R1B2
CALCulate:WLSequence:EVM:LIMit:STANdard[1]|2|...7:RMS:QA16:R3B4 <rel_ampl>
CALCulate:WLSequence:EVM:LIMit:STANdard[1]|2|...7:RMS:QA16:R3B4?
CALCulate:WLSequence:EVM:LIMit:STANdard[1]|2|...7:RMS:QA64:R2B3?
CALCulate:WLSequence:EVM:LIMit:STANdard[1]|2|...7:RMS:QPSK:R1B2 <rel_ampl>
CALCulate:WLSequence:EVM:LIMit:STANdard[1]|2|...7:RMS:QPSK:R1B2
CALCulate:WLSequence:EVM:LIMit:STANdard[1]|2|...7:RMS:QPSK:R3B4 <rel_ampl>
CALCulate:WLSequence:EVM:LIMit:STANdard[1]|2|...7:RMS:QPSK:R3B4
CALCulate:WLSequence:EVM:LIMit:STANdard[1]|2|...7:SCLkError <real>
CALCulate:WLSequence:EVM:LIMit:STANdard[1]|2|...7:SCLkError?
CALCulate:WLSequence:EVM:LIMit:STATe OFF | ON | 0 | 1
CALCulate:WLSequence:EVM:LIMit:STATe?
CALCulate:WLSequence:EVM:STANdard[1]|2|...7:EQualizer:TMODE SEQuence |
SDATa
CALCulate:WLSequence:EVM:STANdard[1]|2|...7:EQualizer:TMODE?
CALCulate:WLSequence:EVM:STANdard[1]|2|...7:IQNorm OFF | ON | 0 | 1
CALCulate:WLSequence:EVM:STANdard[1]|2|...7:IQNorm?
CALCulate:WLSequence:EVM:STANdard[1]|2|...7:PILot:TRACk:AMPLitude OFF | ON
| 0 | 1
CALCulate:WLSequence:EVM:STANdard[1]|2|...7:PILot:TRACk:AMPLitude?
CALCulate:WLSequence:EVM:STANdard[1]|2|...7:PILot:TRACk:PHASe OFF | ON | 0
| 1
CALCulate:WLSequence:EVM:STANdard[1]|2|...7:PILot:TRACk:PHASe?
CALCulate:WLSequence:EVM:STANdard[1]|2|...7:PILot:TRACk:TIMing OFF | ON |
0 | 1
CALCulate:WLSequence:EVM:STANdard[1]|2|...7:PILot:TRACk:TIMing?
CALCulate:WLSequence:EVM:STANdard[1]|2|...7:SPECTrum INVert | NORMal
CALCulate:WLSequence:FLATness:LIMit:STANdard[1]|2|...7:LOWer:SEG2 <rel_
ampl>
CALCulate:WLSequence:FLATness:LIMit:STANdard[1]|2|...7:LOWer:SEG1 <rel_
ampl>
CALCulate:WLSequence:FLATness:LIMit:STANdard[1]|2|...7:LOWer:SEG2?
CALCulate:WLSequence:FLATness:LIMit:STANdard[1]|2|...7:LOWer:SEG1?
```

```

CALCulate:WLSequence:FLATness:LIMit:STANdard[1]|2|...7:UPPer:SEG2 <rel_
amp>
CALCulate:WLSequence:FLATness:LIMit:STANdard[1]|2|...7:UPPer:SEG1 <rel_
amp>
CALCulate:WLSequence:FLATness:LIMit:STANdard[1]|2|...7:UPPer:SEG2?
CALCulate:WLSequence:FLATness:LIMit:STANdard[1]|2|...7:UPPer:SEG1?
CALCulate:WLSequence:TOSpectrum:BURSt:START <Integer>
CALCulate:WLSequence:TOSpectrum:BURSt:START ?
CALCulate:WLSequence:TOSpectrum:BURSt:STOP <Integer>
CALCulate:WLSequence:TOSpectrum:BURSt:STOP ?
CALCulate:WLSequence:TOSpectrum:LIMit:FAIL?
CALCulate:WLSequence:TOSpectrum:LIMit:STANdard[1]|2|...7:DATA <real>, ...
CALCulate:WLSequence:TOSpectrum:LIMit:STANdard[1]|2|...7:DATA?
CALCulate:WLSequence:TOSpectrum:LIMit:STANdard[1]|2|...7::OFFSet[1]
|2|...4:DATA <real>
CALCulate:WLSequence:TOSpectrum:LIMit:STANdard[1]|2|...7::OFFSet[1]
|2|...4:DATA?
CALCulate:WLSequence:TOSpectrum:LIMit:STATe OFF | ON | 0 | 1
CALCulate:WLSequence:TOSpectrum:LIMit:STATe?
CALCulate:WLSequence:TXPower:BURSt:START ?
CALCulate:WLSequence:TXPower:BURSt:START <Integer>
CALCulate:WLSequence:TXPower:BURSt:STOP <Integer>
CALCulate:WLSequence:TXPower:BURSt:STOP ?
CALCulate:WLSequence:TXPower:LIMit:FAIL?
CALCulate:WLSequence:TXPower:LIMit:STANdard[1]|2|...7:PSDensity <real>
CALCulate:WLSequence:TXPower:LIMit:STANdard[1]|2|...7:PSDensity?
CALCulate:WLSequence:TXPower:LIMit:STANdard[1]|2|...7:TPOWer <ampl>
CALCulate:WLSequence:TXPower:LIMit:STANdard[1]|2|...7:TPOWer?
CALCulate:WLSequence:TXPower:LIMit:STATe OFF | ON | 0 | 1
CALCulate:WLSequence:TXPower:LIMit:STATe?
CALibration[:ALL]
CALibration[:ALL]?
CALibration[:ALL]:NPENding
CALibration:AUTO ON | PARTIal | OFF
CALibration:AUTO ALERT
CALibration:AUTO?
CALibration:AUTO:ALERT TEMPerature | DAY | WEEK | NONE
CALibration:AUTO:ALERT?
CALibration:AUTO:MODE ALL | NRF
CALibration:AUTO:MODE?
CALibration:AUTO:TIME:OFF?
CALibration:DATA:BACKUp <filename>
CALibration:DATA:DEFault
CALibration:DATA:REStore <filename>
CALibration:EMIXer
CALibration:EMIXer?
CALibration:EXPIred?
CALibration:FREQuency:REFerence:COARse
CALibration:FREQuency:REFerence:COARse <integer>
CALibration:FREQuency:REFerence:COARse?
CALibration:FREQuency:REFerence:FINE <integer>
CALibration:FREQuency:REFerence:FINE?

```

3 Programming the Analyzer

List of SCPI Commands

```
CALibration:FREQuency:REFeRence:MODE CALibrated | USER
CALibration:FREQuency:REFeRence:MODE?
CALibration:IQ:FLATness:I
CALibration:IQ:FLATness:IBAR
CALibration:IQ:FLATness:I|IBAR|Q|QBAR:TIME?
CALibration:IQ:FLATness:Q
CALibration:IQ:FLATness:QBAR
CALibration:IQ:ISOLation
CALibration:IQ:ISOLation:TIME?
CALibration:IQ:PROBE:I
CALibration:IQ:PROBE:IBar
CALibration:IQ:PROBE:I|IBAR|Q|QBAR:TIME?
CALibration:IQ:PROBE:I|Q:CLEAr
CALibration:IQ:PROBE:Q
CALibration:IQ:PROBE:QBar
CALibration:NFLoor
CALibration:NFLoor?
CALibration:NRF
CALibration:NRF?
CALibration:NRF:NPENding
CALibration:REFeRence:CLOCK?
CALibration:REFeRence:CLOCK:END?
CALibration:REFeRence:CLOCK:INITialize?
CALibration:RF
CALibration:RF?
CALibration:RF:NPENding
CALibration:RFPSelector:SCHeduler:TIME:NEXT?
CALibration:SOURce:STATe OFF | ON | 0 | 1
CALibration:SOURce:STATe?
CALibration:TEMPerature:CURRent?
CALibration:TEMPerature:LALL?
CALibration:TEMPerature:LPReselector?
CALibration:TEMPerature:LRF?
CALibration:TEMPerature:NFLoor?
CALibration:TEMPerature:RFPSelector:LCONducted?
CALibration:TEMPerature:RFPSelector:LRADiated?
CALibration:TIME:ELAPsed:NFLoor?
CALibration:TIME:LALL?
CALibration:TIME:LPReselector?
CALibration:TIME:LRF?
CALibration:TIME:NFLoor?
CALibration:TIME:REFeRence:CLOCK?
CALibration:TIME:RFPSelector:LCONducted?
CALibration:TIME:RFPSelector:LRADiated?
CALibration:YTF
CALibration:YTF?
CALibration:YTF:NPENding
CONF FSC
CONFigure?
CONFigure:CHPower
CONFigure:CHPower
CONFigure:CHPower:NDEFault
CONFigure:EVM
```

```

CONFigure:EVM
CONFigure:EVM:NDEFault
CONFigure:FLATness
CONFigure:FLATness
CONFigure:MONitor
CONFigure:MONitor
CONFigure:MONitor:NDEFault
CONFigure:OBWidth
CONFigure:OBWidth
CONFigure:OBWidth:NDEFault
CONFigure:PStatistic
CONFigure:PStatistic
CONFigure:PStatistic:NDEFault
CONFigure:PVTime
CONFigure:PVTime
CONFigure:PVTime:NDEFault
CONFigure:SEMask
CONFigure:SEMask
CONFigure:SEMask:NDEFault
CONFigure:SPURious
CONFigure:SPURious
CONFigure:SPURious:NDEFault
CONFigure:WAVEform
CONFigure:WAVEform
CONFigure:WAVEform:NDEFault
CONFigure:WLSequence
CONFigure:WLSequence:NDEFault
COUple ALL | NONE
DISPlay:<measurement>:ANNOtation:TITLe:DATA <string>
DISPlay:<measurement>:ANNOtation:TITLe:DATA?
DISPlay:ACTivefunc[:STATE] ON | OFF | 1 | 0
DISPlay:ACTivefunc[:STATE]?
DISPlay:ANNOtation:MBAR[:STATE] OFF | ON | 0 | 1
DISPlay:ANNOtation:MBAR[:STATE]?
DISPlay:ANNOtation:SCREen[:STATE] OFF | ON | 0 | 1
DISPlay:ANNOtation:SCREen[:STATE]?
DISPlay:BACKlight ON | OFF
DISPlay:BACKlight?
DISPlay:BACKlight:INTensity <integer>
DISPlay:BACKlight:INTensity?
DISPlay:CHPower:VIEW:NSElect <integer>
DISPlay:CHPower:VIEW:NSElect?
DISPlay:CHPower:VIEW[:SElect] RFSpectrum | SHOulder
DISPlay:CHPower:VIEW[:SElect] RFSpectrum | SHOulder | MASK
DISPlay:CHPower:VIEW[:SElect] PRESult | CINformation
DISPlay:CHPower:VIEW[:SElect]?
DISPlay:CHPower:VIEW[:SElect]?
DISPlay:CHPower:VIEW[:SElect]?
DISPlay:CHPower:VIEW[1]:WINDow[1]:BGRaph ON | OFF | 1 | 0
DISPlay:CHPower:VIEW[1]:WINDow[1]:BGRaph?
DISPlay:CHPower:VIEW[1]:WINDow[1]:TRACe:Y[:SCALe]:COUple 0 | 1 | OFF | ON
DISPlay:CHPower:VIEW[1]:WINDow[1]:TRACe:Y[:SCALe]:COUple?
DISPlay:CHPower:VIEW[1]:WINDow[1]:TRACe:Y[:SCALe]:PDIVision <rel_amp>

```

```
DISPlay:CHPower:VIEW[1]:WINDow[1]:TRACe:Y[:SCALe]:PDIVision?
DISPlay:CHPower:VIEW[1]:WINDow[1]:TRACe:Y[:SCALe]:RLEVel <real>
DISPlay:CHPower:VIEW[1]:WINDow[1]:TRACe:Y[:SCALe]:RLEVel?
DISPlay:CHPower:VIEW[1]:WINDow[1]:TRACe:Y[:SCALe]:RPOSition TOP | CENTer |
BOTTom
DISPlay:CHPower:VIEW[1]:WINDow[1]:TRACe:Y[:SCALe]:RPOSition?
DISPlay:ENABLE OFF | ON | 0 | 1
DISPlay:ENABLE?
DISPlay:EVM:VIEW:NSElect <integer>
DISPlay:EVM:VIEW:NSElect?
DISPlay:EVM:VIEW[:SElect] POLar | IQERror | OFDM | DBITs | NRESults |
BHTSiginfo | PFERror | IQIMpair
DISPlay:EVM:VIEW[:SElect]?
DISPlay:EVM:VIEW[1]:WINDow[1]:TRACe:FVEctOr[:STATe] 0 | 1 | OFF | ON
DISPlay:EVM:VIEW[1]:WINDow[1]:TRACe:FVEctOr[:STATe]?
DISPlay:EVM:VIEW[1]:WINDow[1]:TRACe:IQOffset <integer>
DISPlay:EVM:VIEW[1]:WINDow[1]:TRACe:IQOffset?
DISPlay:EVM:VIEW[1]:WINDow[1]:TRACe:IQPoints <integer>
DISPlay:EVM:VIEW[1]:WINDow[1]:TRACe:IQPoints?
DISPlay:EVM:VIEW[1]:WINDow[1]:TRACe:POLar VC | VECtOr | CONSTln
DISPlay:EVM:VIEW[1]:WINDow[1]:TRACe:POLar?
DISPlay:EVM:VIEW[1]:WINDow[1]:TRACe:ROTation <real>
DISPlay:EVM:VIEW[1]:WINDow[1]:TRACe:ROTation?
DISPlay:EVM:VIEW[1]:WINDow[1]:TRACe:ROTation:STATe 0 | 1 | OFF | ON
DISPlay:EVM:VIEW[1]:WINDow1:TRACe:ROTation:STATe?
DISPlay:EVM:VIEW2:WINDow[1]|3:TRACe:Y[:SCALe]:COUPle 0 | 1 | OFF | ON
DISPlay:EVM:VIEW3:WINDow[1]|2:TRACe:Y[:SCALe]:COUPle 0 | 1 | OFF | ON
DISPlay:EVM:VIEW7:WINDow[1]:TRACe:Y[:SCALe]:COUPle 0 | 1 | OFF | ON
DISPlay:EVM:VIEW2:WINDow2:TRACe:Y[:SCALe]:COUPle 0 | 1 | OFF | ON
DISPlay:EVM:VIEW8:WINDow[1]|2|3:TRACe:Y[:SCALe]:COUPle 0 | 1 | OFF | ON
DISPlay:EVM:VIEW8:WINDow[1]|2|3:TRACe:Y[:SCALe]:COUPle?
DISPlay:EVM:VIEW7:WINDow[1]:TRACe:Y[:SCALe]:COUPle?
DISPlay:EVM:VIEW2:WINDow[1]|3:TRACe:Y[:SCALe]:COUPle?
DISPlay:EVM:VIEW2:WINDow2:TRACe:Y[:SCALe]:COUPle?
DISPlay:EVM:VIEW3:WINDow[1]|2:TRACe:Y[:SCALe]:COUPle?
DISPlay:EVM:VIEW3:WINDow[1]|2:TRACe:Y[:SCALe]:PDIVision <rel_ampl>
DISPlay:EVM:VIEW8:WINDow2:TRACe:Y[:SCALe]:PDIVision <real>
DISPlay:EVM:VIEW2:WINDow[1]|3:TRACe:Y[:SCALe]:PDIVision <percent>
DISPlay:EVM:VIEW8:WINDow3:TRACe:Y[:SCALe]:PDIVision <rel_ampl>
DISPlay:EVM:VIEW8:WINDow[1]:TRACe:Y[:SCALe]:PDIVision <rel_ampl>
DISPlay:EVM:VIEW2:WINDow2:TRACe:Y[:SCALe]:PDIVision <real>
DISPlay:EVM:VIEW7:WINDow[1]:TRACe:Y[:SCALe]:PDIVision <real>
DISPlay:EVM:VIEW8:WINDow2:TRACe:Y[:SCALe]:PDIVision?
DISPlay:EVM:VIEW8:WINDow3:TRACe:Y[:SCALe]:PDIVision?
DISPlay:EVM:VIEW3:WINDow[1]|2:TRACe:Y[:SCALe]:PDIVision?
DISPlay:EVM:VIEW2:WINDow[1]|3:TRACe:Y[:SCALe]:PDIVision?
DISPlay:EVM:VIEW7:WINDow[1]:TRACe:Y[:SCALe]:PDIVision?
DISPlay:EVM:VIEW8:WINDow[1]:TRACe:Y[:SCALe]:PDIVision?
DISPlay:EVM:VIEW2:WINDow2:TRACe:Y[:SCALe]:PDIVision?
DISPlay:EVM:VIEW8:WINDow[1]:TRACe:Y[:SCALe]:RLEVel <rel_ampl>
DISPlay:EVM:VIEW8:WINDow2:TRACe:Y[:SCALe]:RLEVel <real>
DISPlay:EVM:VIEW3:WINDow[1]|2:TRACe:Y[:SCALe]:RLEVel <rel_ampl>
DISPlay:EVM:VIEW2:WINDow[1]|3:TRACe:Y[:SCALe]:RLEVel <real>
```



```

DISPlay:EVM:VIEW7:WINDow[1]:TRACe:Y[:SCALe]:RLEVel <real>
DISPlay:EVM:VIEW2:WINDow2:TRACe:Y[:SCALe]:RLEVel <real>
DISPlay:EVM:VIEW8:WINDow3:TRACe:Y[:SCALe]:RLEVel <rel_ampl>
DISPlay:EVM:VIEW2:WINDow2:TRACe:Y[:SCALe]:RLEVel?
DISPlay:EVM:VIEW8:WINDow3:TRACe:Y[:SCALe]:RLEVel?
DISPlay:EVM:VIEW2:WINDow[1]|3:TRACe:Y[:SCALe]:RLEVel?
DISPlay:EVM:VIEW8:WINDow[1]:TRACe:Y[:SCALe]:RLEVel?
DISPlay:EVM:VIEW3:WINDow[1]|2:TRACe:Y[:SCALe]:RLEVel?
DISPlay:EVM:VIEW7:WINDow[1]:TRACe:Y[:SCALe]:RLEVel?
DISPlay:EVM:VIEW8:WINDow2:TRACe:Y[:SCALe]:RLEVel?
DISPlay:EVM:VIEW2:WINDow2:TRACe:Y[:SCALe]:RPOStion TOP | CENTer | BOTTom
DISPlay:EVM:VIEW8:WINDow[1]|3:TRACe:Y[:SCALe]:RPOStion TOP | CENTer |
BOTTom
DISPlay:EVM:VIEW7:WINDow[1]:TRACe:Y[:SCALe]:RPOStion TOP | CENTer |
BOTTom
DISPlay:EVM:VIEW2:WINDow[1]|3:TRACe:Y[:SCALe]:RPOStion TOP | CENTer |
BOTTom
DISPlay:EVM:VIEW3:WINDow[1]|2:TRACe:Y[:SCALe]:RPOStion TOP | CENTer |
BOTTom
DISPlay:EVM:VIEW8:WINDow2:TRACe:Y[:SCALe]:RPOStion TOP | CENTer | BOTTom
DISPlay:EVM:VIEW8:WINDow[1]|3:TRACe:Y[:SCALe]:RPOStion?
DISPlay:EVM:VIEW8:WINDow2:TRACe:Y[:SCALe]:RPOStion?
DISPlay:EVM:VIEW7:WINDow[1]:TRACe:Y[:SCALe]:RPOStion?
DISPlay:EVM:VIEW3:WINDow[1]|2:TRACe:Y[:SCALe]:RPOStion?
DISPlay:EVM:VIEW2:WINDow[1]|3:TRACe:Y[:SCALe]:RPOStion?
DISPlay:EVM:VIEW2:WINDow2:TRACe:Y[:SCALe]:RPOStion?
DISPlay:FLATness:LLINe ON | OFF | 1 | 0
DISPlay:FLATness:LLINe?
DISPlay:FLATness:VIEW[1]:WINDow[1]:TRACe:X[:SCALe]:COUPle 0 | 1 | OFF | ON
DISPlay:FLATness:VIEW[1]:WINDow[1]:TRACe:X[:SCALe]:COUPle?
DISPlay:FLATness:VIEW[1]:WINDow[1]:TRACe:X[:SCALe]:PDIVision <real>
DISPlay:FLATness:VIEW[1]:WINDow[1]:TRACe:X[:SCALe]:PDIVision?
DISPlay:FLATness:VIEW[1]:WINDow[1]:TRACe:X[:SCALe]:RLEVel <real>
DISPlay:FLATness:VIEW[1]:WINDow[1]:TRACe:X[:SCALe]:RLEVel?
DISPlay:FLATness:VIEW[1]:WINDow[1]:TRACe:X[:SCALe]:RPOStion LEFT | CENTer
| RIGHT
DISPlay:FLATness:VIEW[1]:WINDow[1]:TRACe:X[:SCALe]:RPOStion?
DISPlay:FLATness:VIEW[1]:WINDow[1]:TRACe:Y[:SCALe]:COUPle 0 | 1 | OFF | ON
DISPlay:FLATness:VIEW[1]:WINDow[1]:TRACe:Y[:SCALe]:COUPle?
DISPlay:FLATness:VIEW[1]:WINDow[1]:TRACe:Y[:SCALe]:PDIVision <rel_ampl>
DISPlay:FLATness:VIEW[1]:WINDow[1]:TRACe:Y[:SCALe]:PDIVision?
DISPlay:FLATness:VIEW[1]:WINDow[1]:TRACe:Y[:SCALe]:RLEVel <rel_ampl>
DISPlay:FLATness:VIEW[1]:WINDow[1]:TRACe:Y[:SCALe]:RLEVel?
DISPlay:FLATness:VIEW[1]:WINDow[1]:TRACe:Y[:SCALe]:RPOStion TOP | CENTer
| BOTTom
DISPlay:FLATness:VIEW[1]:WINDow[1]:TRACe:Y[:SCALe]:RPOStion?
DISPlay:FSCREEN[:STATe] OFF | ON | 0 | 1
DISPlay:FSCREEN[:STATe]?
DISPlay:MENU[:STATe] OFF | ON | 0 | 1
DISPlay:MONitor:VIEW:NSElect <integer>
DISPlay:MONitor:VIEW:NSElect?
DISPlay:MONitor:VIEW[:SElect] RTRace | CINformation

```

```
DISPlay:MONitor:VIEW[:SElect]?
DISPlay:MONitor:VIEW:WINDow:TRACe[1]|2|3:CLEar
DISPlay:MONitor:VIEW:WINDow:TRACe:CLEar:ALL
DISPlay:MONitor:VIEW:WINDow:TRACe[1]|2|3:TYPE
DISPlay:MONitor:VIEW[1]:WINDow[1]:TRACe:Y[:SCALE]:COUPle 0 | 1 | OFF | ON
DISPlay:MONitor:VIEW[1]:WINDow[1]:TRACe:Y[:SCALE]:COUPle?
DISPlay:MONitor:VIEW[1]:WINDow[1]:TRACe:Y[:SCALE]:PDIVision <rel_ampl>
DISPlay:MONitor:VIEW[1]:WINDow[1]:TRACe:Y[:SCALE]:PDIVision?
DISPlay:MONitor:VIEW[1]:WINDow[1]:TRACe:Y[:SCALE]:RLEVel <real>
DISPlay:MONitor:VIEW[1]:WINDow[1]:TRACe:Y[:SCALE]:RLEVel?
DISPlay:MONitor:VIEW[1]:WINDow[1]:TRACe:Y[:SCALE]:RPOStition TOP | CENTer |
BOTTom
DISPlay:MONitor:VIEW[1]:WINDow[1]:TRACe:Y[:SCALE]:RPOStition?
DISPlay:OBWidth:VIEW[1]:WINDow[1]:TRACe:Y[:SCALE]:COUPle 0 | 1 | OFF | ON
DISPlay:OBWidth:VIEW[1]:WINDow[1]:TRACe:Y[:SCALE]:COUPle?
DISPlay:OBWidth:VIEW[1]:WINDow[1]:TRACe:Y[:SCALE]:PDIVision <rel_ampl>
DISPlay:OBWidth:VIEW[1]:WINDow[1]:TRACe:Y[:SCALE]:PDIVision?
DISPlay:OBWidth:VIEW[1]:WINDow[1]:TRACe:Y[:SCALE]:RLEVel <real>
DISPlay:OBWidth:VIEW[1]:WINDow[1]:TRACe:Y[:SCALE]:RLEVel?
DISPlay:OBWidth:VIEW[1]:WINDow[1]:TRACe:Y[:SCALE]:RPOStition TOP | CENTer |
BOTTom
DISPlay:OBWidth:VIEW[1]:WINDow[1]:TRACe:Y[:SCALE]:RPOStition?
DISPlay:PStatistic:GAUSSian[:STATE] OFF | ON | 0 | 1
DISPlay:PStatistic:GAUSSian[:STATE]?
DISPlay:PStatistic:RTRace[:STATE] OFF | ON | 0 | 1
DISPlay:PStatistic:RTRace[:STATE]?
DISPlay:PStatistic:VIEW[1]:WINDow2:TRACe:X[:SCALE]:PDIVision <rel_ampl>
DISPlay:PStatistic:VIEW[1]:WINDow2:TRACe:X[:SCALE]:PDIVision?
DISPlay:PStatistic:XSCale
DISPlay:PVTime:BLINes[:STATE] OFF | ON | 0 | 1
DISPlay:PVTime:BLIN[:STATE]?
DISPlay:PVTime:RAMP[:STATE] OFF | ON | 0 | 1
DISPlay:PVTime:RAMP[:STATE]?
DISPlay:PVTime:VIEW:NSElect <integer>
DISPlay:PVTime:VIEW:NSElect?
DISPlay:PVTime:VIEW[:SElect] ALL | BOTH
DISPlay:PVTime:VIEW[:SElect]?
DISPlay:PVTime:VIEW[1]:WINDow[1]:TRACe:MAXHold[:STATE] ON | OFF | 1 | 0
DISPlay:PVTime:VIEW[1]:WINDow[1]:TRACe:MAXHold[:STATE]?
DISPlay:PVTime:VIEW[1]:WINDow[1]:TRACe:MINHold[:STATE] ON | OFF | 1 | 0
DISPlay:PVTime:VIEW[1]:WINDow[1]:TRACe:MINHold[:STATE]?
DISPlay:PVTime:VIEW[1]:WINDow[1]:TRACe:X[:SCALE]:COUPle 0 | 1 | OFF | ON
DISPlay:PVTime:VIEW[1]:WINDow[1]:TRACe:X[:SCALE]:COUPle?
DISPlay:PVTime:VIEW[1]:WINDow[1]:TRACe:X[:SCALE]:PDIVision <time>
DISPlay:PVTime:VIEW[1]:WINDow[1]:TRACe:X[:SCALE]:PDIVision?
DISPlay:PVTime:VIEW[1]:WINDow[1]:TRACe:X[:SCALE]:RLEVel <time>
DISPlay:PVTime:VIEW[1]:WINDow[1]:TRACe:X[:SCALE]:RLEVel?
DISPlay:PVTime:VIEW[1]:WINDow[1]:TRACe:X[:SCALE]:RPOStition LEFT | CENTer |
RIGHT
DISPlay:PVTime:VIEW[1]:WINDow[1]:TRACe:X[:SCALE]:RPOStition?
DISPlay:PVTime:VIEW[1]:WINDow[1]:TRACe:Y[:SCALE]:COUPle 0 | 1 | OFF | ON
DISPlay:PVTime:VIEW[1]:WINDow[1]:TRACe:Y[:SCALE]:COUPle?
```

```

DISPlay:PVTime:VIEW[1]:WINDow[1]:TRACe:Y[:SCALe]:PDIVision <rel_ampl>
DISPlay:PVTime:VIEW[1]:WINDow[1]:TRACe:Y[:SCALe]:PDIVision?
DISPlay:PVTime:VIEW[1]:WINDow[1]:TRACe:Y[:SCALe]:RLEVel <real>
DISPlay:PVTime:VIEW[1]:WINDow[1]:TRACe:Y[:SCALe]:RLEVel?
DISPlay:PVTime:VIEW[1]:WINDow[1]:TRACe:Y[:SCALe]:RPOStion TOP | CENTer |
BOTTOm
DISPlay:PVTime:VIEW[1]:WINDow[1]:TRACe:Y[:SCALe]:RPOStion?
DISPlay:SEMAsk:VIEW:NSElect <integer>
DISPlay:SEMAsk:VIEW:NSElect?
DISPlay:SEMAsk:VIEW[:SElect] APFReq | RPFReq | IPOWer | CINformation
DISPlay:SEMAsk:VIEW[:SElect]?
DISPlay:SEMAsk:VIEW[1]:WINDow[1]:TRACe:X[:SCALe]:COUPle 0 | 1 | OFF | ON
DISPlay:SEMAsk:VIEW[1]:WINDow[1]:TRACe:X[:SCALe]:COUPle?
DISPlay:SEMAsk:VIEW[1]:WINDow[1]:TRACe:X[:SCALe]:PDIVision ?
DISPlay:SEMAsk:VIEW[1]:WINDow[1]:TRACe:X[:SCALe]:PDIVision <freq>
DISPlay:SEMAsk:VIEW[1]:WINDow[1]:TRACe:X[:SCALe]:RLEVel <freq>
DISPlay:SEMAsk:VIEW[1]:WINDow[1]:TRACe:X[:SCALe]:RLEVel?
DISPlay:SEMAsk:VIEW[1]:WINDow[1]:TRACe:X[:SCALe]:RPOStion LEFT | CENTer |
RIGHT
DISPlay:SEMAsk:VIEW[1]:WINDow[1]:TRACe:X[:SCALe]:RPOStion?
DISPlay:SEMAsk:VIEW[1]:WINDow[1]:TRACe:Y[:SCALe]:COUPle 0 | 1 | ON | OFF
DISPlay:SEMAsk:VIEW[1]:WINDow[1]:TRACe:Y[:SCALe]:COUPle?
DISPlay:SEMAsk:VIEW[1]:WINDow[1]:TRACe:Y[:SCALe]:PDIVision <rel_ampl>
DISPlay:SEMAsk:VIEW[1]:WINDow[1]:TRACe:Y[:SCALe]:PDIVision?
DISPlay:SEMAsk:VIEW[1]:WINDow[1]:TRACe:Y[:SCALe]:RLEVel <real>
DISPlay:SEMAsk:VIEW[1]:WINDow[1]:TRACe:Y[:SCALe]:RLEVel?
DISPlay:SEMAsk:VIEW[1]:WINDow[1]:TRACe:Y[:SCALe]:RPOStion TOP | CENTer |
BOTTOm
DISPlay:SEMAsk:VIEW[1]:WINDow[1]:TRACe:Y[:SCALe]:RPOStion?
DISPlay:SPURious:VIEW:RANGe[:SElect] <integer>
DISPlay:SPURious:VIEW:RANGe[:SElect]?
DISPlay:SPURious:VIEW:RANGe:TABLE <integer>
DISPlay:SPURious:VIEW:RANGe:TABLE?
DISPlay:SPURious:VIEW[:SElect] RESult | RANGe | ALL
DISPlay:SPURious:VIEW[:SElect]?
DISPlay:SPURious:VIEW[1]:WINDow[1]:TRACe:Y[:SCALe]:COUPle 0 | 1 | OFF | ON
DISPlay:SPURious:VIEW[1]:WINDow[1]:TRACe:Y[:SCALe]:COUPle?
DISPlay:SPURious:VIEW[1]:WINDow[1]:TRACe:Y[:SCALe]:PDIVision <rel_ampl>
DISPlay:SPURious:VIEW[1]:WINDow[1]:TRACe:Y[:SCALe]:PDIVision?
DISPlay:SPURious:VIEW[1]:WINDow[1]:TRACe:Y[:SCALe]:RLEVel <real>
DISPlay:SPURious:VIEW[1]:WINDow[1]:TRACe:Y[:SCALe]:RLEVel?
DISPlay:WAVEform:VIEW:NSElect <integer>
DISPlay:WAVEform:VIEW:NSElect?
DISPlay:WAVEform:VIEW[:SElect] RFENvelope | IQ
DISPlay:WAVEform:VIEW[:SElect]?
DISPlay:WAVEform:VIEW[1]|2:WINDow[1]:TRACe:X[:SCALe]:COUPle 0 | 1 | OFF |
ON
DISPlay:WAVEform:VIEW[1]|2:WINDow[1]:TRACe:X[:SCALe]:COUPle?
DISPlay:WAVEform:VIEW[1]|2:WINDow[1]:TRACe:X[:SCALe]:PDIVision <time>
DISPlay:WAVEform:VIEW[1]|2:WINDow[1]:TRACe:X[:SCALe]:PDIVision?
DISPlay:WAVEform:VIEW[1]|2:WINDow[1]:TRACe:X[:SCALe]:RLEVel <time>
DISPlay:WAVEform:VIEW[1]|2:WINDow[1]:TRACe:X[:SCALe]:RLEVel?

```

3 Programming the Analyzer

List of SCPI Commands

```
DISPlay:WAVEform:VIEW[1]|2:WINDow[1]:TRACe:X[:SCALE]:RPOSition LEFT |  
CENTER | RIGHT  
DISPlay:WAVEform:VIEW[1]|2:WINDow[1]:TRACe:X[:SCALE]:RPOSition?  
DISPlay:WAVEform:VIEW[1]|2:WINDow[1]:TRACe:Y[:SCALE]:COUPlE 0 | 1 | OFF |  
ON  
DISPlay:WAVEform:VIEW[1]|2:WINDow[1]:TRACe:Y[:SCALE]:COUPlE?  
DISPlay:WAVEform:VIEW2:WINDow[1]:TRACe:Y[:SCALE]:PDIVision <voltage>  
DISPlay:WAVEform:VIEW[1]:WINDow[1]:TRACe:Y[:SCALE]:PDIVision <rel_ampl>  
DISPlay:WAVEform:VIEW[1]:WINDow[1]:TRACe:Y[:SCALE]:PDIVision?  
DISPlay:WAVEform:VIEW2:WINDow[1]:TRACe:Y[:SCALE]:PDIVision?  
DISPlay:WINDow[1]:ANNOtation[:ALL] OFF | ON | 0 | 1  
DISPlay:WINDow[1]:ANNOtation[:ALL]?  
DISPlay:WINDow:FORMat:TILE  
DISPlay:WINDow:FORMat:ZOOM  
DISPlay:WINDow[:SElect] <number>  
DISPlay:WINDow[:SElect]?  
DISPlay:WINDow[1]:TRACe:GRATICule:GRID[:STATE] OFF | ON | 0 | 1  
DISPlay:WINDow[1]:TRACe:GRATICule:GRID[:STATE]?  
FETCh:CHPower:CHPower?  
FETCh:CHPower:DENSity?  
FETCh:CHPower[n]?  
FETCh:EVM[n]?  
FETCh:FLATness[n]?  
FETCh:MONitor[n]?  
FETCh:OBWidth:FERRor?  
FETCh:OBWidth[n]?  
FETCh:OBWidth:OBWidth?  
FETCh:OBWidth:XDB?  
FETCh:PStatistic[n]?  
FETCh:PVTime[n]?  
FETCh:SEMAsk[n]?  
FETCh:SPURious[n]?  
FETCh:WAVEform[n]?  
FETCh:WLSequence[n]?  
FORMat:BORDER NORMAL | SWAPPED  
FORMat:BORDER?  
FORMat[:TRACe][:DATA] ASCii | INTeger, 32 | REAL, 32 | REAL, 64  
FORMat[:TRACe][:DATA]?  
GLOBal:DEFault  
GLOBal:FREQuency:CENTer[:STATE] 1 | 0 | ON | OFF  
GLOBal:FREQuency:CENTer[:STATE]?  
HCOpy:ABORT  
HCOpy[:IMMediate]  
INITiate:CHPower  
INITiate:CONTinuous OFF | ON | 0 | 1  
INITiate:CONTinuous?  
INITiate:EVM  
INITiate:FLATness  
INITiate[:IMMediate]  
INITiate:MONitor  
INITiate:OBWidth  
INITiate:PAUSE  
INITiate:PStatistic
```

```

INITiate:PVTime
INITiate:REStArt
INITiate:RESume
INITiate:SEMAsk
INITiate:SPURious
INITiate:WAVEform
INITiate:WLSequence
INPut:COUPling AC | DC
INPut:COUPling?
INPut:COUPling:I|Q DC | LFR1 | LFR2
INPut:COUPling:I|Q?
INPut:IMPedance:IQ U50 | B50 | U1M | B1M
INPut:IMPedance:IQ?
INPut:IMPedance:REFErence <integer>
INPut:IMPedance:REFErence?
INPut[1]:IQ:BALEnced[:STATE] OFF | ON | 0 | 1
INPut[1]:IQ:BALEnced[:STATE]?
INPut:IQ[:I]:DIFFErential OFF | ON | 0 | 1
INPut:IQ[:I]:DIFFErential?
INPut[1]:IQ[:I]:IMPedance LOW | HIGH
INPut[1]:IQ[:I]:IMPedance?
INPut:IQ:MIRROred OFF | ON | 0 | 1
INPut:IQ:MIRROred?
INPut:IQ:Q:DIFFErential OFF | ON | 0 | 1
INPut:IQ:Q:DIFFErential?
INPut[1]:IQ:Q:IMPedance LOW | HIGH
INPut[1]:IQ:Q:IMPedance?
INPut[1]:IQ:TYPE IQ | I | Q
INPut[1]:IQ:TYPE?
INPut[1]|2:LISN:FILTER:HPAS[:STATE] ON | OFF
INPut[1]|2:LISN:FILTER:HPAS[:STATE]?
INPut[1]|2:LISN:PEARth GROunded | FLOating
INPut[1]|2:LISN:PEARth?
INPut[1]|2:LISN:PHASE L1 | L2 | L3 | N
INPut[1]|2:LISN:PHASE?
INPut[1]|2:LISN[:TYPE] FOURphase | ESH2Z5 | ENV216 | OFF
INPut[1]|2:LISN[:TYPE]?
INPut:MIXer EXTErnal | INTernal
INPut:MIXer?
INPut:OFFSet:I|Q <voltage>
INPut:OFFSet:I|Q?
INST:NSEL 102
INST:NSEL 105
INSTrument:CATalog?
INSTrument:COUPlE:DEFault
INSTrument:COUPlE:FREQuency:CENTer ALL | NONE
INSTrument:COUPlE:FREQuency:CENTer?
INSTrument:DEFault
INSTrument:NSELEct <integer>
INSTrument:NSELEct?
INSTrument[:SELEct] RECEiver
INSTrument[:SELEct] 'SA' | 'PNOISE' | 'EDGE' | 'GSM' | 'BASIC'
INSTrument[:SELEct] SANalyzer

```

3 Programming the Analyzer

List of SCPI Commands

```
INSTRument[:SElect] GSM
INSTRument[:SElect] SA | RTSA | SEQAN | EMI | BASIC | WCDMA | EDGE GSM |
WIMAXOFDMA | VSA | PNOISE | NFIGure | ADEMOD | BTooth | TDSCDMA | CDMA2K |
CDMA1XEV | LTE | LTETDD | LTEAFDD | LTEATDD | MSR | DVB | DTMB | DCATV |
ISDBT | CMMB | WLAN | CWLAN | CWIMAXOFDM | WIMAXFIXED | IDEN | RLC |
SCPILC | VSA89601
INSTRument[:SElect]?
INST:SEL SCPILC
INST:SEL EMI
INST:SEL LTE
INST:SEL LTETDD
LXI:IDENtify[:STATE] OFF | ON | 0 | 1
LXI:IDENtify[:STATE]?
MEASure:CHPower:CHPower?
MEASure:CHPower:DENSity?
MEASure:CHPower[n]?
MEASure:EVM[n]?
MEASure:FLATness[n]?
MEASure:MONitor[n]?
MEASure:OBWidth:FERRor?
MEASure:OBWidth[n]?
MEASure:OBWidth:OBWidth?
MEASure:OBWidth:XDB?
MEASure:PStatistic[n]?
MEASure:PVTime[n]?
MEASure:SEMask[n]?
MEASure:SPURious[n]?
MEASure:WAVEform[n]?
MEASure:WLSequence[n]?
MMEemory:CATalog? [<directory_name>]
MMEemory:CDIRectory [<directory_name>]
MMEemory:CDIRectory?
MMEemory:COPY <string>, <string>[, <string>, <string>]
MMEemory:COPY:DEvice <source_string>, <dest_string>
MMEemory:DATA <file_name>, <data>
MMEemory:DATA? <file_name>
MMEemory:DELeTe <file_name>[, <directory_name>]
MMEemory:LOAD:MASK <string>
MMEemory:LOAD:STATE <filename>
MMEemory:LOAD:STATE 1, <filename>
MMEemory:MDIRectory <directory_name>
MMEemory:MOVE <string>, <string>[, <string>, <string>]
MMEemory:RDIRectory <directory_name>
MMEemory:REGister:STATE:LABel <regnumber>, "label"
MMEemory:REGister:STATE:LABel? <regnumber>
MMEemory:STORE:SCREen <filename>
MMEemory:STORE:SCREen:THEMe TDColor | TDMonochrome | FCOLor | FMONochrome
MMEemory:STORE:SCREen:THEMe?
MMEemory:STORE:STATE 1, <filename>
MMEemory:STORE:STATE <filename>
OUTPut:ANALog OFF | SVIDeo | LOGVideo | LINVideo | DAUDio
OUTPut:ANALog?
```

```

OUTPut:ANALog:AUTO OFF | ON | 0 | 1
OUTPut:ANALog:AUTO?
OUTPut:AUX SIF | AIF | LOGVideo | OFF
OUTPut:AUX?
OUTPut:AUX:AIF <value>
OUTPut:AUX:AIF?
OUTPut:DBUS[1][:STATe] ON | OFF | 1 | 0
OUTPut:DBUS[1][:STATe]?
OUTPut:IQ:OUTPut IQ1 | IQ250 | OFF
OUTPut:IQ:OUTPut?
READ:CHPower:CHPower?
READ:CHPower:DENSity
READ:CHPower[n]?
READ:EVM[n]?
READ:FLATness[n]?
READ:MONitor[n]?
READ:OBWidth:FERRor?
READ:OBWidth[n]?
READ:OBWidth:OBWidth?
READ:OBWidth:XDB?
READ:PStatistic[n]?
READ:PVTime[n]?
READ:SEMask[n]?
READ:SPURious[n]?
READ:WAVEform[n]?
READ:WLSequence[n]?
[:SENSE]:<measurement>:TRIGger:SOURce
[:SENSE]:<measurement>:TRIGger:SOURce IF
[:SENSE]:ACPR:TRIGger:SOURce
[:SENSE]:CHPower:AVERAge:COUNT <integer>
[:SENSE]:CHPower:AVERAge:COUNT?
[:SENSE]:CHPower:AVERAge[:STATe] ON | OFF | 1 | 0
[:SENSE]:CHPower:AVERAge[:STATe]?
[:SENSE]:CHPower:AVERAge:TCONtrol EXPONential | REPeat
[:SENSE]:CHPower:AVERAge:TCONtrol?
[:SENSE]:CHPower:BANDwidth:INTEgration <bandwidth>
[:SENSE]:CHPower:BANDwidth:INTEgration?
[:SENSE]:CHPower:BANDwidth[:RESolution] <bandwidth>
[:SENSE]:CHPower:BANDwidth[:RESolution]?
[:SENSE]:CHPower:BANDwidth[:RESolution]:AUTO ON | OFF | 1 | 0
[:SENSE]:CHPower:BANDwidth[:RESolution]:AUTO?
[:SENSE]:CHPower:BANDwidth:SHAPE GAUSSian | FLATtop
[:SENSE]:CHPower:BANDwidth:SHAPE?
[:SENSE]:CHPower:BANDwidth:VIDeo <bandwidth>
[:SENSE]:CHPower:BANDwidth:VIDeo?
[:SENSE]:CHPower:BANDwidth:VIDeo:AUTO ON | OFF | 1 | 0
[:SENSE]:CHPower:BANDwidth:VIDeo:AUTO?
[:SENSE]:CHPower:BWIDth[:RESolution]
[:SENSE]:CHPower:BWIDth:SHAPE
[:SENSE]:CHPower:DETEctor:AUTO ON | OFF | 1 | 0
[:SENSE]:CHPower:DETEctor:AUTO?
[:SENSE]:CHPower:DETEctor[:FUNction] NORMal | AVERAge | POSitive | SAMPlE
| NEGative

```

```

[:SENSe]:CHPower:DETECTOR[:FUNCTION]?
[:SENSe]:CHPower:FILTEr[:RRC]:ALPHA <real>
[:SENSe]:CHPower:FILTEr[:RRC]:ALPHA?
[:SENSe]:CHPower:FILTEr[:RRC]:BANDwidth <real>
[:SENSe]:CHPower:FILTEr[:RRC]:BANDwidth?
[:SENSe]:CHPower:FILTEr[:RRC]:BWIDth
[:SENSe]:CHPower:FILTEr[:RRC][:STATE] OFF | ON | 0 | 1
[:SENSe]:CHPower:FILTEr[:RRC][:STATE]?
[:SENSe]:CHPower:FREQUency:SPAN <freq>
[:SENSe]:CHPower:FREQUency:SPAN?
[:SENSe]:CHPower:FREQUency:SPAN:FULL
[:SENSe]:CHPower:FREQUency:SPAN:PREVious
[:SENSe]:CHPower:FREQUency:SYNThesis:AUTO[:STATE] OFF | ON | 0 | 1
[:SENSe]:CHPower:FREQUency:SYNThesis:AUTO[:STATE]?
[:SENSe]:CHPower:FREQUency:SYNThesis[:STATE] 1 | 2 | 3
[:SENSe]:CHPower:FREQUency:SYNThesis[:STATE]?
[:SENSe]:CHPower:IF:GAIN:AUTO[:STATE] ON | OFF | 1 | 0
[:SENSe]:CHPower:IF:GAIN:AUTO[:STATE]?
[:SENSe]:CHPower:IF:GAIN[:STATE] ON | OFF | 1 | 0
[:SENSe]:CHPower:IF:GAIN[:STATE]?
[:SENSe]:CHPower:SWEep:POINts <integer>
[:SENSe]:CHPower:SWEep:POINts?
[:SENSe]:CHPower:SWEep:TIME <time>
[:SENSe]:CHPower:SWEep:TIME?
[:SENSe]:CHPower:SWEep:TIME:AUTO OFF | ON | 0 | 1
[:SENSe]:CHPower:SWEep:TIME:AUTO?
[:SENSe]:CHPower:SWEep:TIME:AUTO:RULEs NORMAL | ACCuracy
[:SENSe]:CHPower:SWEep:TIME:AUTO:RULEs?
[:SENSe]:CORRection:BTS[:RF]:GAIN <rel_ampl>
[:SENSe]:CORRection:BTS[:RF]:GAIN?
[:SENSe]:CORRection:BTS[:RF]:LOSS <rel_ampl>
[:SENSe]:CORRection:BTS[:RF]:LOSS?
[:SENSe]:CORRection:CSET:ALL:DELeTe
[:SENSe]:CORRection:CSET:ALL[:STATE] ON | OFF | 1 | 0
[:SENSe]:CORRection:CSET:ALL[:STATE]?
[:SENSe]:CORRection:CSET[1]:ANTenna[:UNIT] GAUSs | PTESla | UVM | UAM | UA
| NOConversion
[:SENSe]:CORRection:CSET[1]:ANTenna[:UNIT]?
[:SENSe]:CORRection:CSET[1]|2|...|8:COMMeNt "text"
[:SENSe]:CORRection:CSET[1]|2|...|8:COMMeNt?
[:SENSe]:CORRection:CSET[1]|2|...|8:DATA <freq>, <ampl>, ...
[:SENSe]:CORRection:CSET[1]|2|...|8:DATA?
[:SENSe]:CORRection:CSET[1]|2|...|8:DATA:MERGe <freq>, <ampl>, ...
[:SENSe]:CORRection:CSET[1]|2|...|6:DELeTe
[:SENSe]:CORRection:CSET[1]|2|...|8:DESCription "text"
[:SENSe]:CORRection:CSET[1]|2|...|8:DESCription?
[:SENSe]:CORRection:CSET[1]|2|...|8[:STATE] ON | OFF | 1 | 0
[:SENSe]:CORRection:CSET[1]|2|...|8[:STATE]?
[:SENSe]:CORRection:CSET[1]|2|...|8:X:SPACing LINear | LOGarithmic
[:SENSe]:CORRection:CSET[1]|2|...|8:X:SPACing?
[:SENSe]:CORRection:IMPedance[:INPut][:MAGNitude] 50 | 75
[:SENSe]:CORRection:IMPedance[:INPut][:MAGNitude]?
[:SENSe]:CORRection:IQ:I:GAIN <rel_ampl>

```



```

[:SENSe]:CORRection:IQ:I:GAIN?
[:SENSe]:CORRection:IQ:I|Q:ATTenuation <rel_ampl>
[:SENSe]:CORRection:IQ:I|Q:ATTenuation?
[:SENSe]:CORRection:IQ:I|Q:ATTenuation:RATio <real>
[:SENSe]:CORRection:IQ:I|Q:ATTenuation:RATio?
[:SENSe]:CORRection:IQ[:I]:SKEW <seconds>
[:SENSe]:CORRection:IQ[:I]:SKEW?
[:SENSe]:CORRection:IQ:Q:GAIN <rel_ampl>
[:SENSe]:CORRection:IQ:Q:GAIN?
[:SENSe]:CORRection:IQ:Q:SKEW <seconds>
[:SENSe]:CORRection:IQ:Q:SKEW?
[:SENSe]:CORRection:MS[:RF]:GAIN <rel_ampl>
[:SENSe]:CORRection:MS[:RF]:GAIN?
[:SENSe]:CORRection:MS[:RF]:LOSS <rel_ampl>
[:SENSe]:CORRection:MS[:RF]:LOSS?
[:SENSe]:CORRection:NOISe:FLoor ON | OFF | 1 | 0
[:SENSe]:CORRection:NOISe:FLoor?
[:SENSe]:CORRection:OFFSet[:MAGNitude]
[:SENSe]:CORRection:SA[:RF]:GAIN <rel_ampl>
[:SENSe]:CORRection:SA[:RF]:GAIN?
[:SENSe]:DEMod[:WLAN]:AC80:FORMat AUTO | BPSK | QPSK | QAM16 | QAM64 |
QAM256 | SIG
[:SENSe]:DEMod[:WLAN]:AC40:FORMat AUTO | BPSK | QPSK | QAM16 | QAM64 |
QAM256 | SIG
[:SENSe]:DEMod[:WLAN]:AC20:FORMat AUTO | BPSK | QPSK | QAM16 | QAM64 |
QAM256 | SIG
[:SENSe]:DEMod[:WLAN]:AC80:FORMat?
[:SENSe]:DEMod[:WLAN]:AC20:FORMat?
[:SENSe]:DEMod[:WLAN]:AC40:FORMat?
[:SENSe]:DEMod[:WLAN]:AC160:GINterval R1B4 | R1B8 | SIG | OTHer
[:SENSe]:DEMod[:WLAN]:AC20:GINterval R1B4 | R1B8 | SIG | OTHer
[:SENSe]:DEMod[:WLAN]:AC40:GINterval R1B4 | R1B8 | SIG | OTHer
[:SENSe]:DEMod[:WLAN]:AC80:GINterval R1B4 | R1B8 | SIG | OTHer
[:SENSe]:DEMod[:WLAN]:AC40:GINterval?
[:SENSe]:DEMod[:WLAN]:AC80:GINterval?
[:SENSe]:DEMod[:WLAN]:AC160:GINterval?
[:SENSe]:DEMod[:WLAN]:AC20:GINterval?
[:SENSe]:DEMod[:WLAN]:AC80:GINterval:LENGth <real>
[:SENSe]:DEMod[:WLAN]:AC40:GINterval:LENGth <real>
[:SENSe]:DEMod[:WLAN]:AC20:GINterval:LENGth <real>
[:SENSe]:DEMod[:WLAN]:AC40:GINterval:LENGth?
[:SENSe]:DEMod[:WLAN]:AC20:GINterval:LENGth?
[:SENSe]:DEMod[:WLAN]:AC80:GINterval:LENGth?
[:SENSe]:DEMod[:WLAN]:AC20:SUBCarrier:SPACing <freq>
[:SENSe]:DEMod[:WLAN]:AC80:SUBCarrier:SPACing <freq>
[:SENSe]:DEMod[:WLAN]:AC40:SUBCarrier:SPACing <freq>
[:SENSe]:DEMod[:WLAN]:AC80:SUBCarrier:SPACing?
[:SENSe]:DEMod[:WLAN]:AC20:SUBCarrier:SPACing?
[:SENSe]:DEMod[:WLAN]:AC40:SUBCarrier:SPACing?
[:SENSe]:DEMod[:WLAN]:ACT80:FORMat AUTO | BPSK | QPSK | QAM16 | QAM64 |
QAM256 | SIG
[:SENSe]:DEMod[:WLAN]:ACT80:FORMat?

```

3 Programming the Analyzer

List of SCPI Commands

```
[ :SENSe]:DEMod[:WLAN]:ACT80:GINTerval R1B4 | R1B8 | SIG | OTher
[ :SENSe]:DEMod[:WLAN]:ACT80:GINTerval?
[ :SENSe]:DEMod[:WLAN]:ACT80:GINTerval:LENGth <real>
[ :SENSe]:DEMod[:WLAN]:ACT80:GINTerval:LENGth?
[ :SENSe]:DEMod[:WLAN]:ACT80:SUBCarrier:SPACing <freq>
[ :SENSe]:DEMod[:WLAN]:ACT80:SUBCarrier:SPACing?
[ :SENSe]:DEMod[:WLAN]:AG:FORMat AUTO | BPSK | QPSK | QAM16 | QAM64
[ :SENSe]:DEMod[:WLAN]:AG:FORMat?
[ :SENSe]:DEMod[:WLAN]:AG:GINTerval?
[ :SENSe]:DEMod[:WLAN]:AG:GINTerval:LENGth <real>
[ :SENSe]:DEMod[:WLAN]:AG:GINTerval:LENGth?
[ :SENSe]:DEMod[:WLAN]:AG:GINTervalR1B4|R1B8|OTher
[ :SENSe]:DEMod[:WLAN]:AG:SUBCarrier:SPACing <freq>
[ :SENSe]:DEMod[:WLAN]:AG:SUBCarrier:SPACing?
[ :SENSe]:DEMod[:WLAN]:BG:FORMat DSSS1 | DSSS2 | CCK55 | CCK11 | PBCC55 |
PBCC11 | PBCC22 | PBCC33
[ :SENSe]:DEMod[:WLAN]:BG:FORMat?
[ :SENSe]:DEMod[:WLAN]:GDO:FORMat AUTO | BPSK | QPSK | QAM16 | QAM64
[ :SENSe]:DEMod[:WLAN]:GDO:FORMat?
[ :SENSe]:DEMod[:WLAN]:GDO:GINTerval R1B4 | R1B8 | OTher
[ :SENSe]:DEMod[:WLAN]:GDO:GINTerval?
[ :SENSe]:DEMod[:WLAN]:GDO:GINTerval:LENGth <real>
[ :SENSe]:DEMod[:WLAN]:GDO:GINTerval:LENGth?
[ :SENSe]:DEMod[:WLAN]:GDO:SUBCarrier:SPACing <freq>
[ :SENSe]:DEMod[:WLAN]:GDO:SUBCarrier:SPACing?
[ :SENSe]:DEMod[:WLAN]:N20:FORMat AUTO | BPSK | QPSK | QAM16 | QAM64 | SIG
[ :SENSe]:DEMod[:WLAN]:N40:FORMat AUTO | BPSK | QPSK | QAM16 | QAM64 | SIG
[ :SENSe]:DEMod[:WLAN]:N20:FORMat?
[ :SENSe]:DEMod[:WLAN]:N40:FORMat?
[ :SENSe]:DEMod[:WLAN]:N20:GINTerval R1B4 | R1B8 | SIG | OTher
[ :SENSe]:DEMod[:WLAN]:N40:GINTerval R1B4 | R1B8 | SGI | OTher
[ :SENSe]:DEMod[:WLAN]:N40:GINTerval?
[ :SENSe]:DEMod[:WLAN]:N20:GINTerval?
[ :SENSe]:DEMod[:WLAN]:N40:GINTerval:LENGth <real>
[ :SENSe]:DEMod[:WLAN]:N20:GINTerval:LENGth <real>
[ :SENSe]:DEMod[:WLAN]:N40:GINTerval:LENGth?
[ :SENSe]:DEMod[:WLAN]:N20:GINTerval:LENGth?
[ :SENSe]:DEMod[:WLAN]:N20:SUBCarrier:SPACing <freq>
[ :SENSe]:DEMod[:WLAN]:N40:SUBCarrier:SPACing <freq>
[ :SENSe]:DEMod[:WLAN]:N40:SUBCarrier:SPACing?
[ :SENSe]:DEMod[:WLAN]:N20:SUBCarrier:SPACing?
[ :SENSe]:EBWidth:AVERAge:COUNT
[ :SENSe]:EBWidth:FREQuency:SPAN
[ :SENSe]:EBWidth:MAXHold
[ :SENSe]:EBWidth:XDB
[ :SENSe]:EVM:AVERAge:COUNT <integer>
[ :SENSe]:EVM:AVERAge:COUNT?
[ :SENSe]:EVM:AVERAge[:STATE] OFF | ON | 0 | 1
[ :SENSe]:EVM:AVERAge[:STATE]?
[ :SENSe]:EVM:AVERAge:TCONtrol EXPonential | REPeat
[ :SENSe]:EVM:AVERAge:TCONtrol?
[ :SENSe]:EVM:BANDwidth[:RESolution] <bandwidth>
[ :SENSe]:EVM:BANDwidth[:RESolution]?
```

```

[:SENSe]:EVM:CADJust <real>
[:SENSe]:EVM:CADJust?
[:SENSe]:EVM:CHPRate <frequency>
[:SENSe]:EVM:CHPRate?
[:SENSe]:EVM:COMPensate OFF | ON | 0 | 1
[:SENSe]:EVM:COMPensate?
[:SENSe]:EVM:CRATE <frequency>
[:SENSe]:EVM:CRATE?
[:SENSe]:EVM:DESCramble ALL | NONE | PONLy | PHONly
[:SENSe]:EVM:DESCramble?
[:SENSe]:EVM:EQUalizer:LENGth <integer>
[:SENSe]:EVM:EQUalizer:LENGth?
[:SENSe]:EVM:EQUalizer[:STATE] OFF | ON | 0 | 1
[:SENSe]:EVM:EQUalizer[:STATE]?
[:SENSe]:EVM:EQUalizer:TRAIning SEQuence | SDATA
[:SENSe]:EVM:EQUalizer:TRAIning?
[:SENSe]:EVM:FILTer:ALPHA <real>
[:SENSe]:EVM:FILTer:ALPHA?
[:SENSe]:EVM:FILTer:BT <real>
[:SENSe]:EVM:FILTer:BT?
[:SENSe]:EVM:FILTer:MEASurement:TYPE NONE | RRC
[:SENSe]:EVM:FILTer:MEASurement:TYPE?
[:SENSe]:EVM:FILTer:REFerence:TYPE GAUSSian | RECT | RC
[:SENSe]:EVM:FILTer:REFerence:TYPE?
[:SENSe]:EVM:FREQuency:SYNThesis[:STATE] 1 | 2 | 3
[:SENSe]:EVM:FREQuency:SYNThesis[:STATE]?
[:SENSe]:EVM:IFBW
[:SENSe]:EVM:IF:GAIN:AUTO[:STATE] ON | OFF | 1 | 0
[:SENSe]:EVM:IF:GAIN:AUTO[:STATE]?
[:SENSe]:EVM:IF:GAIN:LEVel <rel_ampl>
[:SENSe]:EVM:IF:GAIN:LEVel?
[:SENSe]:EVM:IF:GAIN:SElect LOW | HIGH | OTHer
[:SENSe]:EVM:IF:GAIN:SElect?
[:SENSe]:EVM:IF:GAIN[:STATE] ON | OFF | 1 | 0
[:SENSe]:EVM:IF:GAIN[:STATE]?
[:SENSe]:EVM:IQNorm OFF | ON | 0 | 1
[:SENSe]:EVM:IQNorm?
[:SENSe]:EVM:MIRRorspec OFF | ON | 0 | 1
[:SENSe]:EVM:MIRRorspec?
[:SENSe]:EVM:OPTimize
[:SENSe]:EVM:PREamble ALL | NONE | PONLy | PHONly
[:SENSe]:EVM:PREamble?
[:SENSe]:EVM:STSequence LONG | SHORT
[:SENSe]:EVM:STSequence?
[:SENSe]:EVM:SYMBol:ADJust <percent>
[:SENSe]:EVM:SYMBol:ADJust?
[:SENSe]:EVM:SYNCseq LONG | SHORT
[:SENSe]:EVM:SYNCseq?
[:SENSe]:EVM:TADJust <percent>
[:SENSe]:EVM:TADJust?
[:SENSe]:EVM:TIME:INTerval <integer>
[:SENSe]:EVM:TIME:INTerval?
[:SENSe]:EVM:TIME:OFFSet <integer>

```

3 Programming the Analyzer

List of SCPI Commands

```
[ :SENSe ]:EVM:TIME:OFFSet?
[ :SENSe ]:EVM:TIME:RESMax <integer>
[ :SENSe ]:EVM:TIME:RESMax?
[ :SENSe ]:EVM:TIME:RESult:LENGth <integer>
[ :SENSe ]:EVM:TIME:RESult:LENGth?
[ :SENSe ]:EVM:TIME:RESult:MAX <integer>
[ :SENSe ]:EVM:TIME:RESult:MAX?
[ :SENSe ]:EVM:TIME:RESult:SIG OFF | ON | 0 | 1
[ :SENSe ]:EVM:TIME:RESult:SIG?
[ :SENSe ]:EVM:TIME:RESult[:STATE]:AUTO OFF | ON | 0 | 1
[ :SENSe ]:EVM:TIME:RESult[:STATE]:AUTO?
[ :SENSe ]:EVM:TIME:SEARChlength <real>
[ :SENSe ]:EVM:TIME:SEARChlength
[ :SENSe ]:EVM:TIME:SEARChlength?
[ :SENSe ]:EVM:TIME:SELENgth <time>
[ :SENSe ]:EVM:TIME:SELENgth?
[ :SENSe ]:EVM:TRACk:AMP OFF | ON | 0 | 1
[ :SENSe ]:EVM:TRACk:AMP?
[ :SENSe ]:EVM:TRACk:TIMing
[ :SENSe ]:FEED IQ | IONLY | QONLY
[ :SENSe ]:FEED AREFERENCE
[ :SENSe ]:FEED RF | AIQ | EMIXer
[ :SENSe ]:FEED?
[ :SENSe ]:FEED?
[ :SENSe ]:FEED:AREFERENCE REF50 | REF4800 | OFF
[ :SENSe ]:FEED:AREFERENCE?
[ :SENSe ]:FEED:DATA INPut | STORed
[ :SENSe ]:FEED:DATA?
[ :SENSe ]:FEED:DATA:STORe
[ :SENSe ]:FEED:IQ:TYPE IQ | IONLY | QONLY
[ :SENSe ]:FEED:IQ:TYPE?
[ :SENSe ]:FEED:SOURce INPut | STORed
[ :SENSe ]:FEED:SOURce?
[ :SENSe ]:FEED:SOURce:STORe
[ :SENSe ]:FLATness:AVERage:COUNT <integer>
[ :SENSe ]:FLATness:AVERage:COUNT?
[ :SENSe ]:FLATness:AVERage[:STATE] OFF | ON | 0 | 1
[ :SENSe ]:FLATness:AVERage[:STATE]?
[ :SENSe ]:FLATness:AVERage:TCONtrol EXPonential | REPeat
[ :SENSe ]:FLATness:AVERage:TCONtrol?
[ :SENSe ]:FLATness:BANDwidth[:RESolution] <bandwidth>
[ :SENSe ]:FLATness:BANDwidth[:RESolution]?
[ :SENSe ]:FLATness:BANDwidth:TYPE GAUSSian | FLATtop
[ :SENSe ]:FLATness:BANDwidth:TYPE?
[ :SENSe ]:FLATness:FREQuency:SYNThesis[:STATE] 1 | 2 | 3
[ :SENSe ]:FLATness:FREQuency:SYNThesis[:STATE]?
[ :SENSe ]:FLATness:IFBW
[ :SENSe ]:FLATness:IF:GAIN:AUTO[:STATE] ON | OFF | 1 | 0
[ :SENSe ]:FLATness:IF:GAIN:AUTO[:STATE]?
[ :SENSe ]:FLATness:IF:GAIN[:STATE] ON | OFF | 1 | 0
[ :SENSe ]:FLATness:IF:GAIN[:STATE]?
[ :SENSe ]:FLATness:MIRRorspec OFF | ON | 0 | 1
[ :SENSe ]:FLATness:SELENgth <time>
```

```

[:SENSe]:FLATness:SLENgth?
[:SENSe]:FLATness:STSequence LONG | SHORT
[:SENSe]:FLATness:STSequence?
[:SENSe]:FLATness:SYNCseq
[:SENSe]:FLATness:TADJust <percent>
[:SENSe]:FLATness:TADJust?
[:SENSe]:FLATness:TIMAdj <percent>
[:SENSe]:FLATness:TIME:SEARChlen <time>
[:SENSe]:FREQuency:CENTer <freq>
[:SENSe]:FREQuency:CENTer?
[:SENSe]:FREQuency:CENTer:STEP:AUTO OFF | ON | 0 | 1
[:SENSe]:FREQuency:CENTer:STEP:AUTO?
[:SENSe]:FREQuency:CENTer:STEP[:INCRement] <freq>
[:SENSe]:FREQuency:CENTer:STEP[:INCRement]?
[:SENSe]:FREQuency:EMIXer:CENTer <freq>
[:SENSe]:FREQuency:EMIXer:CENTer?
[:SENSe]:FREQuency:IQ:CENTer <freq>
[:SENSe]:FREQuency:IQ:CENTer?
[:SENSe]:FREQuency:RF:CENTer <freq>
[:SENSe]:FREQuency:RF:CENTer?
[:SENSe]:FREQuency:SYNThesis[:STATE] 1 | 2 | 3
[:SENSe]:FREQuency:SYNThesis[:STATE]?
[:SENSe]:MIXer:BAND A | Q | U | V | W | NA | ND | NE | NF | NG | NJ | NK |
NQ | NU | NV | NW | NY | NEXT | DD | DF | DG | DJ | DK | DQ | DV | DW | DY
| DEXT | MA | ME | MU | MCOAX | USB
[:SENSe]:MIXer:BAND?
[:SENSe]:MIXer:BIAS <real>
[:SENSe]:MIXer:BIAS?
[:SENSe]:MIXer:BIAS:STATE OFF | ON | 0 | 1
[:SENSe]:MIXer:BIAS:STATE?
[:SENSe]:MIXer:CIFLoss <rel_ampl>
[:SENSe]:MIXer:CIFLoss?
[:SENSe]:MONitor:AVERage:COUNT <integer>
[:SENSe]:MONitor:AVERage:COUNT?
[:SENSe]:MONitor:AVERage[:STATE] OFF | ON | 0 | 1
[:SENSe]:MONitor:AVERage[:STATE]?
[:SENSe]:MONitor:AVERage:TCONtrol EXPONential | REPeat
[:SENSe]:MONitor:AVERage:TCONtrol?
[:SENSe]:MONitor:BANDwidth[:RESolution] <freq>
[:SENSe]:MONitor:BANDwidth[:RESolution]?
[:SENSe]:MONitor:BANDwidth[:RESolution]:AUTO OFF | ON | 0 | 1
[:SENSe]:MONitor:BANDwidth[:RESolution]:AUTO?
[:SENSe]:MONitor:BANDwidth:VIDeo <bandwidth>
[:SENSe]:MONitor:BANDwidth:VIDeo?
[:SENSe]:MONitor:BANDwidth:VIDeo:AUTO ON | OFF | 1 | 0
[:SENSe]:MONitor:BANDwidth:VIDeo:AUTO?
[:SENSe]:MONitor:BANDwidth:VIDeo:RATio <real>
[:SENSe]:MONitor:BANDwidth:VIDeo:RATio?
[:SENSe]:MONitor:BANDwidth:VIDeo:RATio:AUTO OFF | ON | 0 | 1
[:SENSe]:MONitor:BANDwidth:VIDeo:RATio:AUTO?
[:SENSe]:MONitor:BWIDth[:RESolution]
[:SENSe]:MONitor:BWIDth:VIDeo
[:SENSe]:MONitor:BWIDth:VIDeo:RATio

```

3 Programming the Analyzer

List of SCPI Commands

```
[ :SENSe]:MONitor:DETEctor:AUTO ON | OFF | 1 | 0
[ :SENSe]:MONitor:DETEctor:AUTO?
[ :SENSe]:MONitor:DETEctor[:FUNction]
[ :SENSe]:MONitor:DETEctor:TRACe AVERAge | NEGAtive | NORMAl | POSitive |
SAMPle
[ :SENSe]:MONitor:DETEctor:TRACe?
[ :SENSe]:MONitor:FREQUency:SPAN <freq>
[ :SENSe]:MONitor:FREQUency:SPAN?
[ :SENSe]:MONitor:FREQUency:SPAN:BANDwidth[:RESolution]:RATio <integer>
[ :SENSe]:MONitor:FREQUency:SPAN:BANDwidth[:RESolution]:RATio?
[ :SENSe]:MONitor:FREQUency:SPAN:BANDwidth[:RESolution]:RATio:AUTO OFF | ON
| 0 | 1
[ :SENSe]:MONitor:FREQUency:SPAN:BANDwidth[:RESolution]:RATio:AUTO?
[ :SENSe]:MONitor:FREQUency:SPAN:BWIDth[:RESolution]:RATio
[ :SENSe]:MONitor:FREQUency:SPAN:FULL
[ :SENSe]:MONitor:FREQUency:SPAN:PREVious
[ :SENSe]:MONitor:SWEEp:POINts <integer>
[ :SENSe]:MONitor:SWEEp:POINts?
[ :SENSe]:MONitor:SWEEp:TIME <time>
[ :SENSe]:MONitor:SWEEp:TIME?
[ :SENSe]:MONitor:SWEEp:TIME:AUTO OFF | ON | 0 | 1
[ :SENSe]:MONitor:SWEEp:TIME:AUTO?
[ :SENSe]:OBWidth:AVERAge:COUNT <integer>
[ :SENSe]:OBWidth:AVERAge:COUNT?
[ :SENSe]:OBWidth:AVERAge[:STATe] ON | OFF | 1 | 0
[ :SENSe]:OBWidth:AVERAge[:STATe]?
[ :SENSe]:OBWidth:AVERAge:TCONtrol EXPonential | REPeat
[ :SENSe]:OBWidth:AVERAge:TCONtrol?
[ :SENSe]:OBWidth:BANDwidth[:RESolution] <bandwidth>
[ :SENSe]:OBWidth:BANDwidth[:RESolution]?
[ :SENSe]:OBWidth:BANDwidth[:RESolution]:AUTO ON | OFF | 1 | 0
[ :SENSe]:OBWidth:BANDwidth[:RESolution]:AUTO?
[ :SENSe]:OBWidth:BANDwidth:SHApe GAUSSian | FLATtop
[ :SENSe]:OBWidth:BANDwidth:SHApe?
[ :SENSe]:OBWidth:BANDwidth:VIDeo <bandwidth>
[ :SENSe]:OBWidth:BANDwidth:VIDeo?
[ :SENSe]:OBWidth:BANDwidth:VIDeo:AUTO ON | OFF | 1 | 0
[ :SENSe]:OBWidth:BANDwidth:VIDeo:AUTO?
[ :SENSe]:OBWidth:BWIDth[:RESolution]
[ :SENSe]:OBWidth:BWIDth:SHApe
[ :SENSe]:OBWidth:BWIDth:VIDeo
[ :SENSe]:OBWidth:DETEctor:AUTO ON | OFF | 1 | 0
[ :SENSe]:OBWidth:DETEctor:AUTO?
[ :SENSe]:OBWidth:DETEctor[:FUNction] NORMAl | AVERAge | POSitive | SAMPle
| NEGAtive
[ :SENSe]:OBWidth:DETEctor[:FUNction]?
[ :SENSe]:OBWidth:FREQUency:SPAN <freq>
[ :SENSe]:OBWidth:FREQUency:SPAN?
[ :SENSe]:OBWidth:FREQUency:SPAN:AUTO ON | OFF | 0 | 1
[ :SENSe]:OBWidth:FREQUency:SPAN:AUTO?
[ :SENSe]:OBWidth:FREQUency:SPAN:FULL
[ :SENSe]:OBWidth:FREQUency:SPAN:PREVious
```

```

[:SENSE]:OBWidth:IF:GAIN:AUTO[:STATE] ON | OFF | 1 | 0
[:SENSE]:OBWidth:IF:GAIN:AUTO[:STATE]?
[:SENSE]:OBWidth:IF:GAIN[:STATE] ON | OFF | 1 | 0
[:SENSE]:OBWidth:IF:GAIN[:STATE]?
[:SENSE]:OBWidth:MAXHold ON | OFF | 1 | 0
[:SENSE]:OBWidth:MAXHold?
[:SENSE]:OBWidth:PERCent <real>
[:SENSE]:OBWidth:PERCent?
[:SENSE]:OBWidth:SWEEP:POINTS <integer>
[:SENSE]:OBWidth:SWEEP:POINTS?
[:SENSE]:OBWidth:SWEEP:TIME <time>
[:SENSE]:OBWidth:SWEEP:TIME?
[:SENSE]:OBWidth:SWEEP:TIME:AUTO OFF | ON | 0 | 1
[:SENSE]:OBWidth:SWEEP:TIME:AUTO?
[:SENSE]:OBWidth:SWEEP:TIME:AUTO:RULES NORMAl | ACCuracy
[:SENSE]:OBWidth:SWEEP:TIME:AUTO:RULES?
[:SENSE]:OBWidth:XDB <rel_ampl>
[:SENSE]:OBWidth:XDB?
[:SENSE]:POWER[:RF]:ATTenuation <rel_ampl>
[:SENSE]:POWER[:RF]:ATTenuation?
[:SENSE]:POWER[:RF]:ATTenuation:AUTO OFF | ON | 0 | 1
[:SENSE]:POWER[:RF]:ATTenuation:AUTO?
[:SENSE]:POWER[:RF]:ATTenuation:STEP[:INCRement] 10 dB | 2 dB
[:SENSE]:POWER[:RF]:ATTenuation:STEP[:INCRement]?
[:SENSE]:POWER[:RF]:EATTenuation <rel_ampl>
[:SENSE]:POWER[:RF]:EATTenuation?
[:SENSE]:POWER[:RF]:EATTenuation:STATE OFF | ON | 0 | 1
[:SENSE]:POWER[:RF]:EATTenuation:STATE?
[:SENSE]:POWER[:RF]:GAIN:BAND LOW | FULL
[:SENSE]:POWER[:RF]:GAIN:BAND?
[:SENSE]:POWER[:RF]:GAIN[:STATE] OFF | ON | 0 | 1
[:SENSE]:POWER[:RF]:GAIN[:STATE]?
[:SENSE]:POWER[:RF]:MMW:PADJust
[:SENSE]:POWER[:RF]:MW:PADJust
[:SENSE]:POWER[:RF]:MW:PATH:AUTO ON | OFF | 1 | 0
[:SENSE]:POWER[:RF]:MW:PATH:AUTO?
[:SENSE]:POWER[:RF]:MW:PRESelector[:STATE] ON | OFF | 0 | 1
[:SENSE]:POWER[:RF]:MW:PRESelector[:STATE]?
[:SENSE]:POWER[:RF]:PADJust <freq>
[:SENSE]:POWER[:RF]:PADJust?
[:SENSE]:POWER[:RF]:PADJust:PRESelector MWAVe | MMWave | EXTernal
[:SENSE]:POWER[:RF]:PADJust:PRESelector?
[:SENSE]:POWER[:RF]:PCENTER
[:SENSE]:POWER[:RF]:RANGE:AUTO ON | OFF | 1 | 0
[:SENSE]:POWER[:RF]:RANGE:AUTO?
[:SENSE]:POWER[:RF]:RANGE:OPTimize IMMEDIATE
[:SENSE]:POWER[:RF]:RANGE:OPTimize:ATTenuation OFF | ELECTrical | COMBined
[:SENSE]:POWER[:RF]:RANGE:OPTimize:ATTenuation?
[:SENSE]:PSTatistic:BANDwidth <freq>
[:SENSE]:PSTatistic:BANDwidth?
[:SENSE]:PSTatistic:BWIDth
[:SENSE]:PSTatistic:COUNTs <integer>
[:SENSE]:PSTatistic:COUNTs?

```

```
[ :SENSe]:PStatIstIc:GAUSsIan[:STATe]
[ :SENSe]:PStatIstIc:IF:GAIN:AUTO[:STATe] ON | OFF | 1 | 0
[ :SENSe]:PStatIstIc:IF:GAIN:AUTO[:STATe]?
[ :SENSe]:PStatIstIc:IF:GAIN[:STATe] ON | OFF | 1 | 0
[ :SENSe]:PStatIstIc:IF:GAIN[:STATe]?
[ :SENSe]:PStatIstIc:RTRace[:STATe]
[ :SENSe]:PStatIstIc:SRTRace
[ :SENSe]:PStatIstIc:SWEep:CYCLes <integer>
[ :SENSe]:PStatIstIc:SWEep:CYCLes?
[ :SENSe]:PStatIstIc:SWEep:TIME <time>
[ :SENSe]:PStatIstIc:SWEep:TIME?
[ :SENSe]:PVTime:AVERAge:COUNT <integer>
[ :SENSe]:PVTime:AVERAge:COUNT?
[ :SENSe]:PVTime:AVERAge[:STATe] OFF | ON | 0 | 1
[ :SENSe]:PVTime:AVERAge[:STATe]?
[ :SENSe]:PVTime:AVERAge:TCONTRol EXPonentIal | REPeat
[ :SENSe]:PVTime:AVERAge:TCONTRol?
[ :SENSe]:PVTime:AVERAge:TYPE LOG | RMS
[ :SENSe]:PVTime:AVERAge:TYPE?
[ :SENSe]:PVTime:BANDwidth <freq>
[ :SENSe]:PVTime:BANDwidth?
[ :SENSe]:PVTime:BANDwidth:TYPE GAUSsIan | FLATtop
[ :SENSe]:PVTime:BANDwidth:TYPE?
[ :SENSe]:PVTime:BURSt
[ :SENSe]:PVTime:BURSt:TIME <time>
[ :SENSe]:PVTime:BURSt:TIME?
[ :SENSe]:PVTime:IF:GAIN:AUTO[:STATe] ON | OFF | 1 | 0
[ :SENSe]:PVTime:IF:GAIN:AUTO[:STATe]?
[ :SENSe]:PVTime:IF:GAIN[:STATe] ON | OFF | 1 | 0
[ :SENSe]:PVTime:IF:GAIN[:STATe]?
[ :SENSe]:PVTime:LIST:FAIL
[ :SENSe]:PVTime:LIST:LEVeL:END
[ :SENSe]:PVTime:LIST:LEVeL:END
[ :SENSe]:PVTime:LIST:LEVeL:START
[ :SENSe]:PVTime:LIST:LEVeL:START
[ :SENSe]:PVTime:RSLength <time>
[ :SENSe]:PVTime:RSLength?
[ :SENSe]:PVTime:RTIME
[ :SENSe]:PVTime:THReshold:DOWN:START <rel_ampl>
[ :SENSe]:PVTime:THReshold:DOWN:START?
[ :SENSe]:PVTime:THReshold:DOWN:STOP <rel_ampl>
[ :SENSe]:PVTime:THReshold:DOWN:STOP?
[ :SENSe]:PVTime:THReshold:UP:START <rel_ampl>
[ :SENSe]:PVTime:THReshold:UP:START?
[ :SENSe]:PVTime:THReshold:UP:STOP <rel_ampl>
[ :SENSe]:PVTime:THReshold:UP:STOP?
[ :SENSe]:RADIo:STANdard[:WLAN] AG | BG | GDO | N20 | N40AC20 | AC40 | AC80
| ACT80 | AC160
[ :SENSe]:RADIo:STANdard[:WLAN]?
[ :SENSe]:ROSCillator:BANDwidth WIDE | NARROW
[ :SENSe]:ROSCillator:BANDwidth?
[ :SENSe]:ROSCillator:COUPLing NORMAl | NACQuISItion
[ :SENSe]:ROSCillator:COUPLing?
```



```

[:SENSE]:ROSCillator:EXTernal:FREQuency <freq>
[:SENSE]:ROSCillator:EXTernal:FREQuency?
[:SENSE]:ROSCillator:SOURce INTernal | EXTernal
[:SENSE]:ROSCillator:SOURce?
[:SENSE]:ROSCillator:SOURce:TYPE INTernal | EXTernal | SENSE | PULSe
[:SENSE]:ROSCillator:SOURce:TYPE?
[:SENSE]:SEMask:AVERage:COUNT <integer>
[:SENSE]:SEMask:AVERage:COUNT?
[:SENSE]:SEMask:AVERage[:STATE] ON | OFF | 1 | 0
[:SENSE]:SEMask:AVERage[:STATE]?
[:SENSE]:SEMask:BANDwidth[1]|2:INTegration <bandwidth>
[:SENSE]:SEMask:BANDwidth[1]|2:INTegration?
[:SENSE]:SEMask:BANDwidth[1]|2[:RESolution] <bandwidth>
[:SENSE]:SEMask:BANDwidth[1]|2[:RESolution]?
[:SENSE]:SEMask:BANDwidth[1]|2[:RESolution]:AUTO OFF | ON | 1 | 0
[:SENSE]:SEMask:BANDwidth[1]|2[:RESolution]:AUTO?
[:SENSE]:SEMask:BANDwidth:SHApe ASENse | GAUSSian | FLATtop
[:SENSE]:SEMask:BANDwidth:SHApe?
[:SENSE]:SEMask:BANDwidth[1]|2:VIDeo <bandwidth>
[:SENSE]:SEMask:BANDwidth[1]|2:VIDeo?
[:SENSE]:SEMask:BANDwidth[1]|2:VIDeo:AUTO OFF | ON | 1 | 0
[:SENSE]:SEMask:BANDwidth[1]|2:VIDeo:AUTO?
[:SENSE]:SEMask:BANDwidth[1]|2:VIDeo:RATio <real>
[:SENSE]:SEMask:BANDwidth[1]|2:VIDeo:RATio
[:SENSE]:SEMask:BANDwidth[1]|2:VIDeo:RATio:AUTO OFF | ON | 1 | 0
[:SENSE]:SEMask:BANDwidth[1]|2:VIDeo:RATio:AUTO?
[:SENSE]:SEMask:BWIDth[1]|2[:RESolution]
[:SENSE]:SEMask:BWIDth[1]|2:VIDeo
[:SENSE]:SEMask:BWIDth[1]|2:VIDeo:RATio
[:SENSE]:SEMask:CARRier:AUTO[:STATE] OFF | ON | 1 | 0
[:SENSE]:SEMask:CARRier:AUTO[:STATE]?
[:SENSE]:SEMask:CARRier:CPSD <real>
[:SENSE]:SEMask:CARRier:CPSD?
[:SENSE]:SEMask:CARRier:PEAK[:POWER] <real>
[:SENSE]:SEMask:CARRier:PEAK[:POWER]?
[:SENSE]:SEMask:CARRier[:POWER] <real>
[:SENSE]:SEMask:CARRier[:POWER]?
[:SENSE]:SEMask:DETector:CARRier:AUTO ON | OFF | 1 | 0
[:SENSE]:SEMask:DETector:CARRier:AUTO?
[:SENSE]:SEMask:DETector:CARRier[:FUNction] AVERage | NEGative | NORMal |
Positive | SAMple
[:SENSE]:SEMask:DETector:CARRier[:FUNction]?
[:SENSE]:SEMask:DETector:OFFSet:AUTO ON | OFF | 1 | 0
[:SENSE]:SEMask:DETector:OFFSet:AUTO?
[:SENSE]:SEMask:DETector:OFFSet[:FUNction] AVERage | NEGative | NORMal |
Positive | SAMple
[:SENSE]:SEMask:DETector:OFFSet[:FUNction]?
[:SENSE]:SEMask:FILTer[:RRC]:ALPHA <real>
[:SENSE]:SEMask:FILTer[:RRC]:ALPHA?
[:SENSE]:SEMask:FILTer[:RRC][:STATE] OFF | ON | 0 | 1
[:SENSE]:SEMask:FILTer[:RRC][:STATE]?
[:SENSE]:SEMask:FREQuency[1]|2:SPAN <freq>
[:SENSE]:SEMask:FREQuency[1]|2:SPAN?

```

3 Programming the Analyzer
List of SCPI Commands

```

[:SENSe]:SEMAsk:OFFSet[1]|2[:LIST:BWIDth:IMULti
[:SENSe]:SEMAsk:OFFSet[1]|2[:LIST:BWIDth[:RESolution]
[:SENSe]:SEMAsk:OFFSet[1]|2[:LIST:BWIDth:VIDeo
[:SENSe]:SEMAsk:OFFSet[1]|2[:LIST:SWEep[:TIME]
[:SENSe]:SEMAsk:OFFSet[1]|2[:OUTer]:LIST:BANDwidth:IMULti <integer>, ...
[:SENSe]:SEMAsk:OFFSet[1]|2[:OUTer]:LIST:BANDwidth:IMULti?
[:SENSe]:SEMAsk:OFFSet[1]|2[:OUTer]:LIST:BANDwidth[:RESolution]
<bandwidth>, ...
[:SENSe]:SEMAsk:OFFSet[1]|2[:OUTer]:LIST:BANDwidth[:RESolution]?
[:SENSe]:SEMAsk:OFFSet[1]|2[:OUTer]:LIST:BANDwidth[:RESolution]:AUTO OFF |
ON | 1 | 0, ...
[:SENSe]:SEMAsk:OFFSet[1]|2[:OUTer]:LIST:BANDwidth[:RESolution]:AUTO?
[:SENSe]:SEMAsk:OFFSet[1]|2[:OUTer]:LIST:BANDwidth:VIDeo <freq>, ...
[:SENSe]:SEMAsk:OFFSet[1]|2[:OUTer]:LIST:BANDwidth:VIDeo?
[:SENSe]:SEMAsk:OFFSet[1]|2[:OUTer]:LIST:BANDwidth:VIDeo:AUTO OFF | ON | 0
| 1, ...
[:SENSe]:SEMAsk:OFFSet[1]|2[:OUTer]:LIST:BANDwidth:VIDeo:AUTO?
[:SENSe]:SEMAsk:OFFSet[1]|2[:OUTer]:LIST:BANDwidth:VIDeo:RATio <real>, ...
[:SENSe]:SEMAsk:OFFSet[1]|2[:OUTer]:LIST:BANDwidth:VIDeo:RATio?
[:SENSe]:SEMAsk:OFFSet[1]|2[:OUTer]:LIST:BANDwidth:VIDeo:RATio:AUTO OFF |
ON | 0 | 1, ...
[:SENSe]:SEMAsk:OFFSet[1]|2[:OUTer]:LIST:BANDwidth:VIDeo:RATio:AUTO?
[:SENSe]:SEMAsk:OFFSet[1]|2[:OUTer]:LIST:FREQuency:START <freq>, ...
[:SENSe]:SEMAsk:OFFSet[1]|2[:OUTer]:LIST:FREQuency:START?
[:SENSe]:SEMAsk:OFFSet[1]|2[:OUTer]:LIST:FREQuency:STOP <freq>, ...
[:SENSe]:SEMAsk:OFFSet[1]|2[:OUTer]:LIST:FREQuency:STOP?
[:SENSe]:SEMAsk:OFFSet[1]|2[:OUTer]:LIST:SIDE BOTH | NEGative | POSitive,
...
[:SENSe]:SEMAsk:OFFSet[1]|2[:OUTer]:LIST:SIDE?
[:SENSe]:SEMAsk:OFFSet[1]|2[:OUTer]:LIST:START:ABSolute <real>, ...
[:SENSe]:SEMAsk:OFFSet[1]|2[:OUTer]:LIST:START:ABSolute?
[:SENSe]:SEMAsk:OFFSet[1]|2[:OUTer]:LIST:START:RCARrier <rel_ampl>, ...
[:SENSe]:SEMAsk:OFFSet[1]|2[:OUTer]:LIST:START:RCARrier?
[:SENSe]:SEMAsk:OFFSet[1]|2[:OUTer]:LIST:STATE ON | OFF | 1 | 0, ...
[:SENSe]:SEMAsk:OFFSet[1]|2[:OUTer]:LIST:STATE?
[:SENSe]:SEMAsk:OFFSet[1]|2[:OUTer]:LIST:STOP:ABSolute <real>, ...
[:SENSe]:SEMAsk:OFFSet[1]|2[:OUTer]:LIST:STOP:ABSolute?
[:SENSe]:SEMAsk:OFFSet[1]|2[:OUTer]:LIST:STOP:ABSolute:COUple ON | OFF | 1
| 0, ...
[:SENSe]:SEMAsk:OFFSet[1]|2[:OUTer]:LIST:STOP:ABSolute:COUple?
[:SENSe]:SEMAsk:OFFSet[1]|2[:OUTer]:LIST:STOP:RCARrier <rel_ampl>, ...
[:SENSe]:SEMAsk:OFFSet[1]|2[:OUTer]:LIST:STOP:RCARrier?
[:SENSe]:SEMAsk:OFFSet[1]|2[:OUTer]:LIST:STOP:RCARrier:COUple ON | OFF | 1
| 0, ...
[:SENSe]:SEMAsk:OFFSet[1]|2[:OUTer]:LIST:STOP:RCARrier:COUple?
[:SENSe]:SEMAsk:OFFSet[1]|2[:OUTer]:LIST:SWEep:TIME <time>, ...
[:SENSe]:SEMAsk:OFFSet[1]|2[:OUTer]:LIST:SWEep:TIME?
[:SENSe]:SEMAsk:OFFSet[1]|2[:OUTer]:LIST:SWEep:TIME:AUTO ON | OFF | 1 | 0,
...
[:SENSe]:SEMAsk:OFFSet[1]|2[:OUTer]:LIST:SWEep:TIME:AUTO?
[:SENSe]:SEMAsk:OFFSet[1]|2[:OUTer]:LIST:TEST ABSolute | AND | OR |
RElative, ...

```

```

[:SENSE]:SEMask:OFFSet[1]|2[:OUTer]:LIST:TEST?
[:SENSE]:SEMask:OFFSet[1]|2:TYPE CTOCenter | CTOEdge | ETOCenter | ETOEdge
[:SENSE]:SEMask:OFFSet[1]|2:TYPE?
[:SENSE]:SEMask:SWEEP[1]|2:TIME <time>
[:SENSE]:SEMask:SWEEP[1]|2:TIME?
[:SENSE]:SEMask:SWEEP[1]|2:TIME:AUTO OFF | 0 | ON | 1
[:SENSE]:SEMask:SWEEP[1]|2:TIME:AUTO?
[:SENSE]:SEMask:T80Mask:AUTO ON | OFF | 1 | 0[:SENSE]:SEMask:T80Mask:AUTO?
[:SENSE]:SEMask:TYPE PSDRef | TPreRef | SPRef
[:SENSE]:SEMask:TYPE?
[:SENSE]:SPURious:AVERage:COUNT <integer>
[:SENSE]:SPURious:AVERage:COUNT?
[:SENSE]:SPURious:AVERage[:STATE] ON | OFF | 1 | 0
[:SENSE]:SPURious:AVERage[:STATE]?
[:SENSE]:SPURious:AVERage:TCONtrol EXPonential | REPEAT
[:SENSE]:SPURious:AVERage:TCONtrol?
[:SENSE]:SPURious:FSMeas ON | OFF | 1 | 0
[:SENSE]:SPURious:FSMeas?
[:SENSE]:SPURious:IF:GAIN:AUTO[:STATE] OFF|ON|0|1, ...
[:SENSE]:SPURious:IF:GAIN:AUTO[:STATE]?
[:SENSE]:SPURious:IF:GAIN[:STATE] OFF|ON|0|1, ...
[:SENSE]:SPURious:IF:GAIN[:STATE]?
[:SENSE]:SPURious:POWer[:RF]:RANGE:AUTO
[:SENSE]:SPURious[:RANGE]:ALL:SWEEP:TYPE:AUTO OFF | ON | 0 | 1
[:SENSE]:SPURious[:RANGE]:ALL:SWEEP:TYPE:AUTO?
[:SENSE]:SPURious[:RANGE][:LIST]:ATTenuation <rel_amp>, ...
[:SENSE]:SPURious[:RANGE][:LIST]:ATTenuation?
[:SENSE]:SPURious[:RANGE][:LIST]:ATTenuation:AUTO OFF|ON|0|1, ...
[:SENSE]:SPURious[:RANGE][:LIST]:ATTenuation:AUTO?
[:SENSE]:SPURious[:RANGE][:LIST]:BANDwidth[:RESolution] <freq>, ...
[:SENSE]:SPURious[:RANGE][:LIST]:BANDwidth[:RESolution]?
[:SENSE]:SPURious[:RANGE][:LIST]:BANDwidth[:RESolution]:AUTO OFF|ON|0|1,
...
[:SENSE]:SPURious[:RANGE][:LIST]:BANDwidth[:RESolution]:AUTO?
[:SENSE]:SPURious[:RANGE][:LIST]:BANDwidth:SHAPE GAUSSian|FLATtop, ...
[:SENSE]:SPURious[:RANGE][:LIST]:BANDwidth:SHAPE?
[:SENSE]:SPURious[:RANGE][:LIST]:BANDwidth:VIDeo <freq>, ...
[:SENSE]:SPURious[:RANGE][:LIST]:BANDwidth:VIDeo?
[:SENSE]:SPURious[:RANGE][:LIST]:BANDwidth:VIDeo:AUTO OFF|ON|0|1, ...
[:SENSE]:SPURious[:RANGE][:LIST]:BANDwidth:VIDeo:AUTO?
[:SENSE]:SPURious[:RANGE][:LIST]:BWIDth[:RESolution]
[:SENSE]:SPURious[:RANGE][:LIST]:BWIDth:SHAPE
[:SENSE]:SPURious[:RANGE][:LIST]:BWIDth:VIDeo
[:SENSE]:SPURious[:RANGE][:LIST]:DETEctor[1][:FUNCTION]
AVERage|NEGative|NORMAL|POSitive|SAMPLE|RMS, ...
[:SENSE]:SPURious[:RANGE][:LIST]:DETEctor2[:FUNCTION]
OFF|AVERage|NEGative|NORMAL|POSitive|SAMPLE|RMS, ...
[:SENSE]:SPURious[:RANGE][:LIST]:DETEctor2[:FUNCTION]?
[:SENSE]:SPURious[:RANGE][:LIST]:DETEctor[1][:FUNCTION]?
[:SENSE]:SPURious[:RANGE][:LIST]:FREQuency:START <freq>, ...
[:SENSE]:SPURious[:RANGE][:LIST]:FREQuency:START?
[:SENSE]:SPURious[:RANGE][:LIST]:FREQuency:STOP <freq>, ...

```

```

[:SENSe]:SPURious[:RANGe][:LIST]:FREQuency:STOP?
[:SENSe]:SPURious[:RANGe][:LIST]:PEAK:EXCursion <rel_ampl>, ...
[:SENSe]:SPURious[:RANGe][:LIST]:PEAK:EXCursion?
[:SENSe]:SPURious[:RANGe][:LIST]:PEAK:THReshold <real>, ...
[:SENSe]:SPURious[:RANGe][:LIST]:PEAK:THReshold?
[:SENSe]:SPURious[:RANGe][:LIST]:STATe ON|OFF|1|0, ...
[:SENSe]:SPURious[:RANGe][:LIST]:STATe?
[:SENSe]:SPURious[:RANGe][:LIST]:SWEep:POINTs <integer>
[:SENSe]:SPURious[:RANGe][:LIST]:SWEep:POINTs?
[:SENSe]:SPURious[:RANGe][:LIST]:SWEep:POINTs:AUTO OFF|ON|0|1, ...
[:SENSe]:SPURious[:RANGe][:LIST]:SWEep:POINTs:AUTO?
[:SENSe]:SPURious[:RANGe][:LIST]:SWEep:TIME <time>, ...
[:SENSe]:SPURious[:RANGe][:LIST]:SWEep:TIME?
[:SENSe]:SPURious[:RANGe][:LIST]:SWEep:TIME:AUTO OFF|ON|0|1, ...
[:SENSe]:SPURious[:RANGe][:LIST]:SWEep:TIME:AUTO?
[:SENSe]:SPURious:REPT:MODE ALL | LIMTest | MMARgin
[:SENSe]:SPURious:REPT:MODE?
[:SENSe]:SPURious:SPUR <integer>
[:SENSe]:SPURious:SPUR?
[:SENSe]:SPURious:SWEep:TIME:AUTO:RULEs NORMAl | ACCuracy
[:SENSe]:SPURious:SWEep:TIME:AUTO:RULEs?
[:SENSe]:SPURious:TYPE EXAMine | FULL
[:SENSe]:SPURious:TYPE?
[:SENSe]:SWEep:EGATE:CONTRol EDGE | LEVel
[:SENSe]:SWEep:EGATE:CONTRol?
[:SENSe]:SWEep:EGATE:DELay <time>
[:SENSe]:SWEep:EGATE:DELay?
[:SENSe]:SWEep:EGATE:DELay:COMPensation:TYPE OFF | SETTled | GDELay
[:SENSe]:SWEep:EGATE:DELay:COMPensation:TYPE?
[:SENSe]:SWEep:EGATE:EXTernal[1]|2:LEVel <voltage>
[:SENSe]:SWEep:EGATE:EXTernal[1]|2:LEVel?
[:SENSe]:SWEep:EGATE:HOLDoff <time>
[:SENSe]:SWEep:EGATE:HOLDoff?
[:SENSe]:SWEep:EGATE:HOLDoff:AUTO OFF | ON | 0 | 1
[:SENSe]:SWEep:EGATE:HOLDoff:AUTO?
[:SENSe]:SWEep:EGATE:LENGth <time>
[:SENSe]:SWEep:EGATE:LENGth?
[:SENSe]:SWEep:EGATE:MINFast?
[:SENSe]:SWEep:EGATE:POLarity NEGative | POSitive
[:SENSe]:SWEep:EGATE:POLarity?
[:SENSe]:SWEep:EGATE:SOURce EXTernal1 | EXTernal2 | LINE | FRAME | RFBurst
[:SENSe]:SWEep:EGATE:SOURce?
[:SENSe]:SWEep:EGATE[:STATe] OFF | ON | 0 | 1
[:SENSe]:SWEep:EGATE[:STATe]?
[:SENSe]:SWEep:EGATE:TIME <time>
[:SENSe]:SWEep:EGATE:TIME?
[:SENSe]:SWEep:EGATE:VIEW ON | OFF | 1 | 0
[:SENSe]:SWEep:EGATE:VIEW?
[:SENSe]:SWEep:EGATE:VIEW:STARt <time>
[:SENSe]:SWEep:EGATE:VIEW:STARt?
[:SENSe]:SWEep:TIME:GATE:LEVel HIGH | LOW
[:SENSe]:SWEep:TIME:GATE:LEVel?
[:SENSe]:WAVEform:ADC:DITHer:AUTO[:STATe] OFF | ON | 0 | 1

```

```

[:SENSe]:WAVeform:ADC:DITHer:AUTO[:STATe]?
[:SENSe]:WAVeform:ADC:DITHer[:STATe] OFF | ON | 0 | 1
[:SENSe]:WAVeform:ADC:DITHer[:STATe]?
[:SENSe]:WAVeform:APERTure?
[:SENSe]:WAVeform:AVERAge:COUNT <integer>
[:SENSe]:WAVeform:AVERAge:COUNT?
[:SENSe]:WAVeform:AVERAge[:STATe] OFF | ON | 0 | 1
[:SENSe]:WAVeform:AVERAge[:STATe]?
[:SENSe]:WAVeform:AVERAge:TACount <integer>
[:SENSe]:WAVeform:AVERAge:TACount?
[:SENSe]:WAVeform:AVERAge:TCONTRol EXPonential | REPEAT
[:SENSe]:WAVeform:AVERAge:TCONTRol?
[:SENSe]:WAVeform:AVERAge:TYPE LOG | MAXimum | MINimum | RMS | SCALar
[:SENSe]:WAVeform:AVERAge:TYPE?
[:SENSe]:WAVeform:BANDwidth|BWIDth[:RESolution]:TYPE
[:SENSe]:WAVeform:BANDwidth[:RESolution]
[:SENSe]:WAVeform:BANDwidth:SHAPE
[:SENSe]:WAVeform:BWIDth[:RESolution]
[:SENSe]:WAVeform:BWIDth:SHAPE
[:SENSe]:WAVeform:DIF:BANDwidth <freq>
[:SENSe]:WAVeform:DIF:BANDwidth?
[:SENSe]:WAVeform:DIF:FILTer:ALPHa <real>
[:SENSe]:WAVeform:DIF:FILTer:ALPHa?
[:SENSe]:WAVeform:DIF:FILTer:BANDwidth <freq>
[:SENSe]:WAVeform:DIF:FILTer:BANDwidth?
[:SENSe]:WAVeform:DIF:FILTer:BANDwidth:AUTO ON | OFF | 1 | 0
[:SENSe]:WAVeform:DIF:FILTer:BANDwidth:AUTO?
[:SENSe]:WAVeform:DIF:FILTer:TYPE GAUSSian | FLATtop
[:SENSe]:WAVeform:DIF:FILTer:TYPE GAUSSian | FLATtop | SNYQuist |
RSNYquist | RCOSine | RRCosine
[:SENSe]:WAVeform:DIF:FILTer:TYPE?
[:SENSe]:WAVeform:DIF:FILTer:TYPE?
[:SENSe]:WAVeform:FREQuency:SYNThesis:AUTO[:STATe] OFF | ON | 0 | 1
[:SENSe]:WAVeform:FREQuency:SYNThesis:AUTO[:STATe]?
[:SENSe]:WAVeform:FREQuency:SYNThesis[:STATe] 1 | 2 | 3
[:SENSe]:WAVeform:FREQuency:SYNThesis[:STATe]?
[:SENSe]:WAVeform:IF:GAIN:AUTO[:STATe] ON | OFF | 1 | 0
[:SENSe]:WAVeform:IF:GAIN:AUTO[:STATe]?
[:SENSe]:WAVeform:IF:GAIN:OFFSet <rel_ampl>
[:SENSe]:WAVeform:IF:GAIN:OFFSet?
[:SENSe]:WAVeform:IF:GAIN[:STATe] AUTOrange | LOW | HIGH
[:SENSe]:WAVeform:IF:GAIN[:STATe]?
[:SENSe]:WAVeform:PDITHer
[:SENSe]:WAVeform:SRATE <freq>
[:SENSe]:WAVeform:SRATE?
[:SENSe]:WAVeform:SWEep:TIME <time>
[:SENSe]:WAVeform:SWEep:TIME?
[:SENSe]:WAVeform:WBIF:ADC:DITHer
[:SENSe]:WAVeform:WBIF:FILTer:ALPHa
[:SENSe]:WAVeform:WBIF:FILTer:BANDwidth <real>
[:SENSe]:WAVeform:WBIF:FILTer:BANDwidth?
[:SENSe]:WAVeform:WBIF:FILTer[:TYPE] GAUSSian | NONE | NYQuist | RNYQuist
| RCOSine | RRCosine

```

```

[:SENSe]:WAVEform:WBIF:FILTer[:TYPE]?
[:SENSe]:WLSequence:ABORt:ERRor[:STATE] ON | OFF | 1 | 0
[:SENSe]:WLSequence:ABORt:ERRor[:STATE]?
[:SENSe]:WLSequence:ABORt:LIMit:FAIL[:STATE] ON | OFF | 1 | 0
[:SENSe]:WLSequence:ABORt:LIMit:FAIL[:STATE]?
[:SENSe]:WLSequence:ACQuire[1]|2|...4..45:SETup AG | BG | GDO | N20 |
N40AC20 | AC40, <real>, <ampl>, <ampl>, <time>, <time>, <time>, IMMEDIATE
| VIDEO | RFBurst | EXT1 | EXT2, <ampl>, <time>
[:SENSe]:WLSequence:ACQuire[1]|2|...4..45:SETup?
[:SENSe]:WLSequence:ASRLevels:ARULes EMAT | IMAT
[:SENSe]:WLSequence:ASRLevels:ARULes?
[:SENSe]:WLSequence:ASRLevels:MSNRratio <rel_ampl>
[:SENSe]:WLSequence:ASRLevels:MSNRratio?
[:SENSe]:WLSequence:ASRLevels:PPMargin <rel_ampl>
[:SENSe]:WLSequence:ASRLevels:PPMargin?
[:SENSe]:WLSequence:CAPTure:BURSt:FREQuency <freq>, <freq>, <freq>, ....
[:SENSe]:WLSequence:CAPTure:BURSt:FREQuency?
[:SENSe]:WLSequence:CAPTure:BURSt:LENGth <time>, <time>, <time>, ....
[:SENSe]:WLSequence:CAPTure:BURSt:LENGth?
[:SENSe]:WLSequence:CAPTure:BURSt:NUMBer <integer>
[:SENSe]:WLSequence:CAPTure:BURSt:NUMBer?
[:SENSe]:WLSequence:CAPTure:BURSt:POWer:EXPeCted <ampl>, <ampl>, <ampl>,
....
[:SENSe]:WLSequence:CAPTure:BURSt:POWer:EXPeCted?
[:SENSe]:WLSequence:CAPTure:BURSt:POWer:PEAK <ampl>, <ampl>, <ampl>, ....
[:SENSe]:WLSequence:CAPTure:BURSt:POWer:PEAK?
[:SENSe]:WLSequence:CAPTure:BURSt:RADio <enum>, <enum>, <enum>, ....
[:SENSe]:WLSequence:CAPTure:BURSt:RADio?
[:SENSe]:WLSequence:CAPTure:BURSt:TIME:PREFix
[:SENSe]:WLSequence:CAPTure:BURSt:TIME:PREFix <time>, <time>, <time>, ....
[:SENSe]:WLSequence:CAPTure:BURSt:TIME:TRANSition
[:SENSe]:WLSequence:CAPTure:BURSt:TIME:TRANSition <time>, <time>, <time>,
....
[:SENSe]:WLSequence:CAPTure:BURSt:TRIGger:DELay
[:SENSe]:WLSequence:CAPTure:BURSt:TRIGger:DELay <time>, <time>, <time>,
....
[:SENSe]:WLSequence:CAPTure:BURSt:TRIGger:LEVel <amp>, <ampl>, <ampl>,
....
[:SENSe]:WLSequence:CAPTure:BURSt:TRIGger:LEVel
[:SENSe]:WLSequence:CAPTure:BURSt:TRIGger:TYPE
[:SENSe]:WLSequence:CAPTure:BURSt:TRIGger:TYPE <enum>, <enum>, <enum>,
....
[:SENSe]:WLSequence:EVM:CADJust <real>
[:SENSe]:WLSequence:EVM:CADJust?
[:SENSe]:WLSequence:EVM:CRATe <frequency>
[:SENSe]:WLSequence:EVM:CRATe?
[:SENSe]:WLSequence:EVM:DESCramble ALL | NONE | PONLy | PHONLy
[:SENSe]:WLSequence:EVM:DESCramble?
[:SENSe]:WLSequence:EVM[:ENABLE] OFF | ON | 0 | 1
[:SENSe]:WLSequence:EVM[:ENABLE]?
[:SENSe]:WLSequence:EVM:EQUalizer:LENGth <integer>
[:SENSe]:WLSequence:EVM:EQUalizer:LENGth?

```

```

[:SENSE]:WLSequence:EVM:EQualizer[:STATE] OFF | ON | 0 | 1
[:SENSE]:WLSequence:EVM:EQualizer[:STATE]?
[:SENSE]:WLSequence:EVM:FILTer:ALPHa <real>
[:SENSE]:WLSequence:EVM:FILTer:ALPHa?
[:SENSE]:WLSequence:EVM:FILTer:MEASurement:TYPE NONE | RRC
[:SENSE]:WLSequence:EVM:FILTer:MEASurement:TYPE?
[:SENSE]:WLSequence:EVM:FILTer:REFerence:TYPE GAUSSian | RECT | RC
[:SENSE]:WLSequence:EVM:FILTer:REFerence:TYPE?
[:SENSE]:WLSequence:EVM:STANdard[1]|2|...7:COMPensate OFF | ON | 0 | 1
[:SENSE]:WLSequence:EVM:STANdard[1]|2|...7:COMPensate?
[:SENSE]:WLSequence:EVM:STANdard[1]|2|...7:GINterval:LENGth <real>
[:SENSE]:WLSequence:EVM:STANdard[1]|2|...7:GINterval:LENGth?
[:SENSE]:WLSequence:EVM:STANdard[1]|2|...7:STSequence LONG | SHORT
[:SENSE]:WLSequence:EVM:STANdard[1]|2|...7:STSequence?
[:SENSE]:WLSequence:EVM:STANdard[1]|2|...7:SUBCarrier:SPACing <freq>
[:SENSE]:WLSequence:EVM:STANdard[1]|2|...7:SUBCarrier:SPACing?
[:SENSE]:WLSequence:EVM:STANdard[1]|2|...7:SYMBOL:ADJust <real>
[:SENSE]:WLSequence:EVM:STANdard[1]|2|...7:SYMBOL:ADJust?
[:SENSE]:WLSequence:EVM:STANdard[1]|2|...7:TIME:INTerval <integer>
[:SENSE]:WLSequence:EVM:STANdard[1]|2|...7:TIME:INTerval?
[:SENSE]:WLSequence:POWER[:RF]:ATTenuation <rel_ampl>
[:SENSE]:WLSequence:POWER[:RF]:ATTenuation?
[:SENSE]:WLSequence:POWER[:RF]:PRESelector:STATE ON | OFF | 1 | 0
[:SENSE]:WLSequence:POWER[:RF]:PRESelector:STATE?
[:SENSE]:WLSequence:TIMEout:TRIGger <time>
[:SENSE]:WLSequence:TIMEout:TRIGger?
[:SENSE]:WLSequence:TIMEout:TRIGger:STATE OFF | ON | 0 | 1
[:SENSE]:WLSequence:TIMEout:TRIGger:STATE?
[:SENSE]:WLSequence:TOSpectrum[:ENABLE] OFF | ON | 0 | 1
[:SENSE]:WLSequence:TOSpectrum[:ENABLE]?
[:SENSE]:WLSequence:TXPower[:ENABLE] OFF | ON | 0 | 1
[:SENSE]:WLSequence:TXPower[:ENABLE]?
SERVICE[:PRODUCTION]:WLSequence:ASRLevels:MMLevel <rel_ampl>
SERVICE[:PRODUCTION]:WLSequence:ASRLevels:MMLevel?
STATUS:OPERation:CONDition?
STATUS:OPERation:ENABLE <integer>
STATUS:OPERation:ENABLE?
STATUS:OPERation[:EVENT]?
STATUS:OPERation:NTRansition <integer>
STATUS:OPERation:NTRansition?
STATUS:OPERation:PTRansition <integer>
STATUS:OPERation:PTRansition?
STATUS:PRESet
STATUS:QUESTionable:CALibration:CONDition?
STATUS:QUESTionable:CALibration:ENABLE <integer>
STATUS:QUESTionable:CALibration:ENABLE?
STATUS:QUESTionable:CALibration[:EVENT]?
STATUS:QUESTionable:CALibration:EXTended:FAILure:CONDition?
STATUS:QUESTionable:CALibration:EXTended:FAILure:ENABLE <integer>
STATUS:QUESTionable:CALibration:EXTended:FAILure:ENABLE?
STATUS:QUESTionable:CALibration:EXTended:FAILure[:EVENT]?
STATUS:QUESTionable:CALibration:EXTended:FAILure:NTRansition <integer>
STATUS:QUESTionable:CALibration:EXTended:FAILure:NTRansition?

```

```
STaTus:QUEStionable:CALibration:EXTended:FAILure:PTRansition <integer>
STaTus:QUEStionable:CALibration:EXTended:FAILure:PTRansition?
STaTus:QUEStionable:CALibration:EXTended:NEEDed:CONDition?
STaTus:QUEStionable:CALibration:EXTended:NEEDed:ENABle <integer>
STaTus:QUEStionable:CALibration:EXTended:NEEDed:ENABle?
STaTus:QUEStionable:CALibration:EXTended:NEEDed[:EVENT]?
STaTus:QUEStionable:CALibration:EXTended:NEEDed:NTRansition <integer>
STaTus:QUEStionable:CALibration:EXTended:NEEDed:NTRansition?
STaTus:QUEStionable:CALibration:EXTended:NEEDed:PTRansition <integer>
STaTus:QUEStionable:CALibration:EXTended:NEEDed:PTRansition?
STaTus:QUEStionable:CALibration:NTRansition <integer>
STaTus:QUEStionable:CALibration:NTRansition?
STaTus:QUEStionable:CALibration:PTRansition <integer>
STaTus:QUEStionable:CALibration:PTRansition?
STaTus:QUEStionable:CALibration:SKIPPed:CONDition?
STaTus:QUEStionable:CALibration:SKIPPed:ENABle <integer>
STaTus:QUEStionable:CALibration:SKIPPed:ENABle?
STaTus:QUEStionable:CALibration:SKIPPed[:EVENT]?
STaTus:QUEStionable:CALibration:SKIPPed:NTRansition <integer>
STaTus:QUEStionable:CALibration:SKIPPed:NTRansition?
STaTus:QUEStionable:CALibration:SKIPPed:PTRansition <integer>
STaTus:QUEStionable:CALibration:SKIPPed:PTRansition?
STaTus:QUEStionable:CONDition?
STaTus:QUEStionable:ENABle <integer>
STaTus:QUEStionable:ENABle?
STaTus:QUEStionable[:EVENT]?
STaTus:QUEStionable:FREQuency:CONDition?
STaTus:QUEStionable:FREQuency:ENABle <integer>
STaTus:QUEStionable:FREQuency:ENABle?
STaTus:QUEStionable:FREQuency[:EVENT]?
STaTus:QUEStionable:FREQuency:NTRansition <integer>
STaTus:QUEStionable:FREQuency:NTRansition?
STaTus:QUEStionable:FREQuency:PTRansition <integer>
STaTus:QUEStionable:FREQuency:PTRansition?
STaTus:QUEStionable:INTEgrity:CONDition?
STaTus:QUEStionable:INTEgrity:ENABle <integer>
STaTus:QUEStionable:INTEgrity:ENABle?
STaTus:QUEStionable:INTEgrity[:EVENT]?
STaTus:QUEStionable:INTEgrity:NTRansition <integer>
STaTus:QUEStionable:INTEgrity:NTRansition?
STaTus:QUEStionable:INTEgrity:PTRansition <integer>
STaTus:QUEStionable:INTEgrity:PTRansition?
STaTus:QUEStionable:INTEgrity:SIGNal:CONDition?
STaTus:QUEStionable:INTEgrity:SIGNal:ENABle <integer>
STaTus:QUEStionable:INTEgrity:SIGNal:ENABle?
STaTus:QUEStionable:INTEgrity:SIGNal[:EVENT]?
STaTus:QUEStionable:INTEgrity:SIGNal:NTRansition <integer>
STaTus:QUEStionable:INTEgrity:SIGNal:NTRansition?
STaTus:QUEStionable:INTEgrity:SIGNal:PTRansition <integer>
STaTus:QUEStionable:INTEgrity:SIGNal:PTRansition?
STaTus:QUEStionable:INTEgrity:UNCalibrated:CONDition?
STaTus:QUEStionable:INTEgrity:UNCalibrated:ENABle
STaTus:QUEStionable:INTEgrity:UNCalibrated:ENABle?
```



```

STATus:QUESTionable:INTEGRity:UNCalibrated[:EVENT]?
STATus:QUESTionable:INTEGRity:UNCalibrated:NTRansition <integer>
STATus:QUESTionable:INTEGRity:UNCalibrated:NTRansition?
STATus:QUESTionable:INTEGRity:UNCalibrated:PTRansition <integer>
STATus:QUESTionable:INTEGRity:UNCalibrated:PTRansition?
STATus:QUESTionable:NTRansition <integer>
STATus:QUESTionable:NTRansition?
STATus:QUESTionable:POWER:CONDition?
STATus:QUESTionable:POWER:ENABle <integer>
STATus:QUESTionable:POWER:ENABle?
STATus:QUESTionable:POWER[:EVENT]?
STATus:QUESTionable:POWER:NTRansition <integer>
STATus:QUESTionable:POWER:NTRansition?
STATus:QUESTionable:POWER:PTRansition <integer>
STATus:QUESTionable:POWER:PTRansition?>
STATus:QUESTionable:PTRansition <integer>
STATus:QUESTionable:PTRansition?
STATus:QUESTionable:TEMPerature:CONDition?
STATus:QUESTionable:TEMPerature:ENABle <integer>
STATus:QUESTionable:TEMPerature:ENABle?
STATus:QUESTionable:TEMPerature[:EVENT]?
STATus:QUESTionable:TEMPerature:NTRansition <integer>
STATus:QUESTionable:TEMPerature:NTRansition?
STATus:QUESTionable:TEMPerature:PTRansition <integer>
STATus:QUESTionable:TEMPerature:PTRansition?
SYSTEM:APPLication:CATalog[:NAME]?
SYSTEM:APPLication:CATalog[:NAME]:COUNT?
SYSTEM:APPLication:CATalog:OPTion? <model>
SYSTEM:APPLication:CATalog:REVision? <model>
SYSTEM:APPLication[:CURRent][:NAME]?
SYSTEM:APPLication[:CURRent]:OPTion?
SYSTEM:APPLication[:CURRent]:REVision?
SYSTEM:COMMunicate:GPIB[1][:SELF]:ADDRes <integer>
SYSTEM:COMMunicate:GPIB[1][:SELF]:ADDRes?
SYSTEM:COMMunicate:GPIB[1][:SELF]:CONTROLLER[:ENABle] ON | OFF | 0 | 1
SYSTEM:COMMunicate:GPIB[1][:SELF]:CONTROLLER[:ENABle]?
SYSTEM:COMMunicate:LAN:SCPI:HISLip:ENABle OFF | ON | 0 | 1
SYSTEM:COMMunicate:LAN:SCPI:HISLip:ENABle?
SYSTEM:COMMunicate:LAN:SCPI:SICL:ENABle OFF | ON | 0 | 1
SYSTEM:COMMunicate:LAN:SCPI:SICL:ENABle?
SYSTEM:COMMunicate:LAN:SCPI:SOCKET:CONTROl?
SYSTEM:COMMunicate:LAN:SCPI:SOCKET:ENABle OFF | ON | 0 | 1
SYSTEM:COMMunicate:LAN:SCPI:SOCKET:ENABle?
SYSTEM:COMMunicate:LAN:SCPI:TELNet:ENABle OFF | ON | 0 | 1
SYSTEM:COMMunicate:LAN:SCPI:TELNet:ENABle?
SYSTEM:COMMunicate:USB:CONNEction?
SYSTEM:COMMunicate:USB:PACKets?
SYSTEM:COMMunicate:USB:STATus?
SYSTEM:CONFIgure[:SYSTEM]?
SYSTEM:CSYSTEM?
SYSTEM:DATE "<year>, <month>, <day>"
SYSTEM:DATE?
SYSTEM:DEFault [ALL] | ALIGn | INPut | MISC | MODes | PON

```

3 Programming the Analyzer

List of SCPI Commands

```
SYSTem:ERRor[:NEXT]?
SYSTem:ERRor:OVERload[:STATE] 0 | 1 | OFF | ON
SYSTem:ERRor:VERBoSe OFF | ON | 0 | 1
SYSTem:ERRor:VERBoSe?
SYSTem:HELP:HEADers?
SYSTem:HID?
SYSTem:KLOCK OFF | ON | 0 | 1
SYSTem:KLOCK?
SYSTem:LKEY <"OptionInfo">, <"LicenseInfo">
SYSTem:LKEY? <"OptionInfo">
SYSTem:LKEY:DELeTe <"OptionInfo">, <"LicenseInfo">
SYSTem:LKEY:LIST?
SYSTem:MRELay:COUNT?
SYSTem:OPTions?
SYSTem:PDOWN [NORMAL | FORCE]
SYSTem:PON:APPLication:LLIST <stringofINSTRument:SElectnames>
SYSTem:PON:APPLication:LLIST?
SYSTem:PON:APPLication:VMEMory[:AVAILable]?
SYSTem:PON:APPLication:VMEMory:TOTAL?
SYSTem:PON:APPLication:VMEMory:USED?
SYSTem:PON:APPLication:VMEMory:USED:NAME? <INSTRument:SElectname>
SYSTem:PON:ETIME?
SYSTem:PON:MODE SA | BASIC | ADEMOD | NFIGURE | PNOISE | CDMA2K | TDSCDMA
| VSA | VSA89601 | WCDMA | WIMAXOFDMA
SYSTem:PON:MODE?
SYSTem:PON:TIME?
SYSTem:PON:TYPE MODE | USER | LAST
SYSTem:PON:TYPE PRESet
SYSTem:PON:TYPE?
SYSTem:PRESet
SYSTem:PRESet:TYPE FACTory | MODE | USER
SYSTem:PRESet:TYPE?
SYSTem:PRESet:USER
SYSTem:PRESet:USER:ALL
SYSTem:PRESet:USER:SAVE
SYSTem:PRINT:THEME TDColor | TDMonochrome | FColor | FMONochrome
SYSTem:PRINT:THEME?
SYSTem:PUP:PROcEss
SYSTem:SECurity:USB:WPRotect[:ENABLE] ON | OFF | 0 | 1
SYSTem:SECurity:USB:WPRotect[:ENABLE]?
SYSTem:SHOW OFF | ERRor | SYSTem | HARDware | LXI | HWStAtistics |
ALIGNment | SOFTware | CAPplication
SYSTem:SHOW?
SYSTem:TEMPerature:HEXTreme?
SYSTem:TEMPerature:LEXTreme?
SYSTem:TIME "<hour>, <minute>, <second>"
SYSTem:TIME?
SYSTem:VERSIon?
TRACe:CHPower:TYPE WRITe | AVERage | MAXHold | MINHold
TRACe:CHPower:TYPE?
TRACe:MONitor:CLear [TRACE1] | TRACE2 | TRACE3
TRACe:MONitor:CLear:ALL
TRACe[1]|2|3:MONitor:DISPlay[:STATE] ON | OFF | 0 | 1
```

```

TRACe[1]|2|3:MONitor:DISPlay[:STATE]?
TRACe[1]|2|3:MONitor:TYPE WRITe | AVERAge | MAXHold | MINHold
TRACe[1]|2|3:MONitor:TYPE?
TRACe[1]|2|3:MONitor:UPDate[:STATE] ON | OFF | 0 | 1
TRACe[1]|2|3:MONitor:UPDate[:STATE]?
TRACe:OBWidth:TYPE WRITe | AVERAge | MAXHold | MINHold
TRACe:OBWidth:TYPE?
TRACe:SEMask:TYPE WRITe | AVERAge | MAXHold | MINHold
TRACe:SEMask:TYPE?
TRIGger:<measurement>[:SEQuence]:IQ:SOURce EXTErnal1 | EXTErnal2 |
IMMediate | IQMag | IDEMod | QDEMod | IINPut | QINPut | AIQMag
TRIGger:<measurement>[:SEQuence]:IQ:SOURce?
TRIGger:<measurement>[:SEQuence]:RF:SOURce EXTErnal1 | EXTErnal2 |
IMMediate | LINE | FRAME | RFBurst | VIDEo | IF | ALARm | LAN | TV
TRIGger:<measurement>[:SEQuence]:RF:SOURce?
TRIGger:<measurement>[:SEQuence]:SOURce EXTErnal1 | EXTErnal2 | IMMediate
| LINE | FRAME | RFBurst | VIDEo | IF | ALARm | LAN | IQMag | IDEMod |
QDEMod | IINPut | QINPut | AIQMag | TV
TRIGger:<measurement>[:SEQuence]:SOURce?
TRIGger[:SEQuence]:ATRigger <time>
TRIGger[:SEQuence]:ATRigger?
TRIGger[:SEQuence]:ATRigger:STATE OFF | ON | 0 | 1
TRIGger[:SEQuence]:ATRigger:STATE?
TRIGger[:SEQuence]:DELay <time>
TRIGger[:SEQuence]:DELay?
TRIGger[:SEQuence]:DELay:STATE OFF | ON | 0 | 1
TRIGger[:SEQuence]:DELay:STATE?
TRIGger[:SEQuence]:EXTErnal:DELay
TRIGger[:SEQuence]:EXTErnal2:DELay <time>
TRIGger[:SEQuence]:EXTErnal1:DELay <time>
TRIGger[:SEQuence]:EXTErnal1:DELay?
TRIGger[:SEQuence]:EXTErnal2:DELay?
TRIGger[:SEQuence]:EXTErnal2:DELay:COMPensation OFF | ON | 0 | 1
TRIGger[:SEQuence]:EXTErnal1:DELay:COMPensation OFF | ON | 0 | 1
TRIGger[:SEQuence]:EXTErnal2:DELay:COMPensation?
TRIGger[:SEQuence]:EXTErnal1:DELay:COMPensation?
TRIGger[:SEQuence]:EXTErnal1:DELay:STATE OFF | ON | 0 | 1
TRIGger[:SEQuence]:EXTErnal2:DELay:STATE OFF | ON | 0 | 1
TRIGger[:SEQuence]:EXTErnal1:DELay:STATE?
TRIGger[:SEQuence]:EXTErnal2:DELay:STATE?
TRIGger[:SEQuence]:EXTErnal2:LEVel
TRIGger[:SEQuence]:EXTErnal1:LEVel <level>
TRIGger[:SEQuence]:EXTErnal:LEVel
TRIGger[:SEQuence]:EXTErnal2:LEVel?
TRIGger[:SEQuence]:EXTErnal1:LEVel?
TRIGger[:SEQuence]:EXTErnal2:SLOPe POSitive | NEGative
TRIGger[:SEQuence]:EXTErnal:SLOPe
TRIGger[:SEQuence]:EXTErnal1:SLOPe POSitive | NEGative
TRIGger[:SEQuence]:EXTErnal2:SLOPe?
TRIGger[:SEQuence]:EXTErnal1:SLOPe?
TRIGger[:SEQuence]:FRAME:ADJust <time>
TRIGger[:SEQuence]:FRAME:DELay <time>

```

3 Programming the Analyzer

List of SCPI Commands

```
TRIGger[:SEquence]:FRAME:DElay?
TRIGger[:SEquence]:FRAME:DElay:STATE OFF | ON | 0 | 1
TRIGger[:SEquence]:FRAME:DElay:STATE?
TRIGger[:SEquence]:FRAME:EXternal1:LEvel
TRIGger[:SEquence]:FRAME:EXternal2:LEvel
TRIGger[:SEquence]:FRAME:EXternal1:SLOpe
TRIGger[:SEquence]:FRAME:EXternal2:SLOpe
TRIGger[:SEquence]:FRAME:OFFSet <time>
TRIGger[:SEquence]:FRAME:OFFSet?
TRIGger[:SEquence]:FRAME:OFFSet:DISplay:RESet
TRIGger[:SEquence]:FRAME:PERiod <time>
TRIGger[:SEquence]:FRAME:PERiod?
TRIGger[:SEquence]:FRAME:RFBurst:LEvel:ABSolute
TRIGger[:SEquence]:FRAME:RFBurst:SLOpe
TRIGger[:SEquence]:FRAME:SYNC EXternal1 | EXternal2 | RFBurst | OFF
TRIGger[:SEquence]:FRAME:SYNC EXternal
TRIGger[:SEquence]:FRAME:SYNC?
TRIGger[:SEquence]:FRAME:SYNC:HOLDOff <time>
TRIGger[:SEquence]:FRAME:SYNC:HOLDOff?
TRIGger[:SEquence]:FRAME:SYNC:HOLDOff:STATE OFF | ON | 0 | 1
TRIGger[:SEquence]:FRAME:SYNC:HOLDOff:STATE?
TRIGger[:SEquence]:HOLDOff <time>
TRIGger[:SEquence]:HOLDOff?
TRIGger[:SEquence]:HOLDOff:STATE OFF | ON | 0 | 1
TRIGger[:SEquence]:HOLDOff:STATE?
TRIGger[:SEquence]:IF:LEvel
TRIGger[:SEquence]:IF:LEvel?
TRIGger[:SEquence]:IF:SLOpe NEGative | POSitive
TRIGger[:SEquence]:IF:SLOpe?
TRIGger[:SEquence]:LINE:DElay <time>
TRIGger[:SEquence]:LINE:DElay?
TRIGger[:SEquence]:LINE:DElay:STATE OFF | ON | 0 | 1
TRIGger[:SEquence]:LINE:DElay:STATE?
TRIGger[:SEquence]:LINE:SLOpe POSitive | NEGative
TRIGger[:SEquence]:LINE:SLOpe?
TRIGger[:SEquence]:OFFSet <time>
TRIGger[:SEquence]:OFFSet?
TRIGger[:SEquence]:OFFSet:STATE OFF | ON | 0 | 1
TRIGger[:SEquence]:OFFSet:STATE?
TRIGger[:SEquence]:RFBurst:DElay <time>
TRIGger[:SEquence]:RFBurst:DElay?
TRIGger[:SEquence]:RFBurst:DElay:STATE OFF | ON | 0 | 1
TRIGger[:SEquence]:RFBurst:DElay:STATE?
TRIGger[:SEquence]:RFBurst:LEvel
TRIGger[:SEquence]:RFBurst:LEvel:ABSolute <ampl>
TRIGger[:SEquence]:RFBurst:LEvel:ABSolute?
TRIGger[:SEquence]:RFBurst:LEvel:RELative <rel_ampl>
TRIGger[:SEquence]:RFBurst:LEvel:RELative?
TRIGger[:SEquence]:RFBurst:LEvel:TYPE ABSolute | RELative
TRIGger[:SEquence]:RFBurst:LEvel:TYPE?
TRIGger[:SEquence]:RFBurst:SLOpe POSitive | NEGative
TRIGger[:SEquence]:RFBurst:SLOpe?
TRIGger[:SEquence]:SLOpe POSitive | NEGative
```

```

TRIGger[:SEquence]:SLOPe?
TRIGger[:SEquence]:SOURCe EXTernal
TRIGger[:SEquence]:VIDeo:DELAy <time>
TRIGger[:SEquence]:VIDeo:DELAy?
TRIGger[:SEquence]:VIDeo:DELAy:STATe OFF | ON | 0 | 1
TRIGger[:SEquence]:VIDeo:DELAy:STATe?
TRIGger[:SEquence]:VIDeo:LEVel <ampl>
TRIGger[:SEquence]:VIDeo:LEVel?
TRIGger[:SEquence]:VIDeo:SLOPe POSitive | NEGative
TRIGger[:SEquence]:VIDeo:SLOPe?
TRIGger|TRIGger1|TRIGger2[:SEquence]:OUTPut HSWP | MEASuring | MAIN | GATE
| GTRigger | OEVEN | SPOint | SSweep | SSETtled | S1Marker | S2Marker |
S3Marker | S4Marker | OFF
TRIGger|TRIGger1|TRIGger2[:SEquence]:OUTPut?
TRIGger|TRIGger1|TRIGger2[:SEquence]:OUTPut:POLarity POSitive | NEGative
TRIGger|TRIGger1|TRIGger2[:SEquence]:OUTPut:POLarity?
TRIGger:WLSequence:EXTernal1:LEVel <level>
TRIGger:WLSequence:EXTernal2:LEVel <level>
TRIGger:WLSequence:EXTernal2:LEVel?
TRIGger:WLSequence:EXTernal1:LEVel?
TRIGger:WLSequence:EXTernal2:SLOPe POSitive | NEGative
TRIGger:WLSequence:EXTernal1:SLOPe POSitive | NEGative
TRIGger:WLSequence:EXTernal2:SLOPe?
TRIGger:WLSequence:EXTernal1:SLOPe?
TRIGger:WLSequence:RFBurst:SLOPe POSitive | NEGative
TRIGger:WLSequencer:RFBurst:SLOPe?
TRIGger:WLSequence:VIDeo:SLOPe POSitive | NEGative
TRIGger:WLSequence:VIDeo:SLOPe?
UNIT:CHPower:POWER:PSD DBMHZ | DBMMHZ
UNIT:CHPower:POWER:PSD?

```

STATus Subsystem

The following diagram provides a graphical overview of the entire X-Series Status Register System.

For readability, the diagram is split into two sections:

- ["X-Series Status Register System \(1\) " on page 143](#)
- ["X-Series Status Register System \(2\) " on page 144](#)

X-Series Status Register System (1)

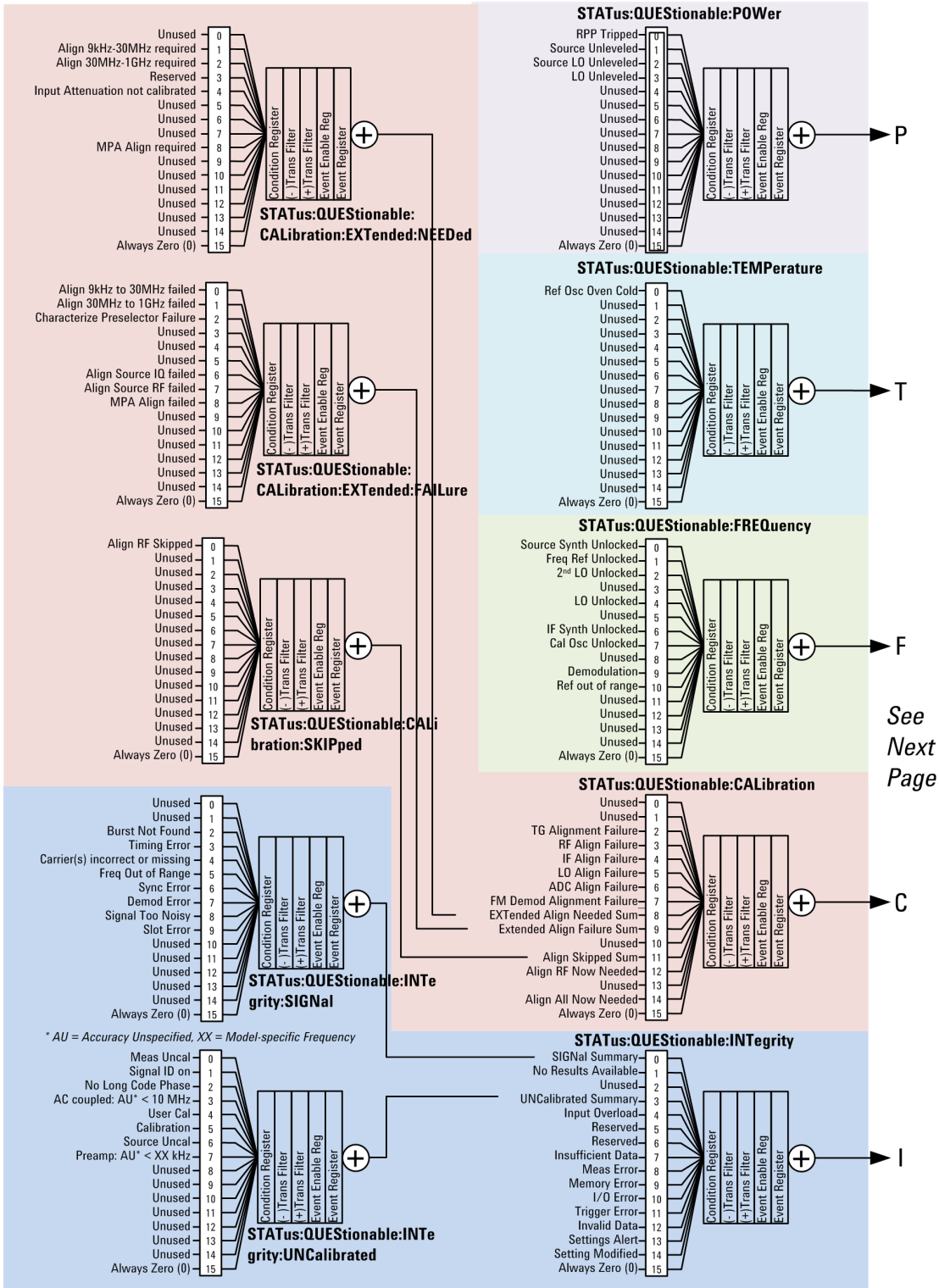

See
Next
Page

X-Series Status Register System (2)

See
 Previous
 Page

P
 T
 F
 C
 I

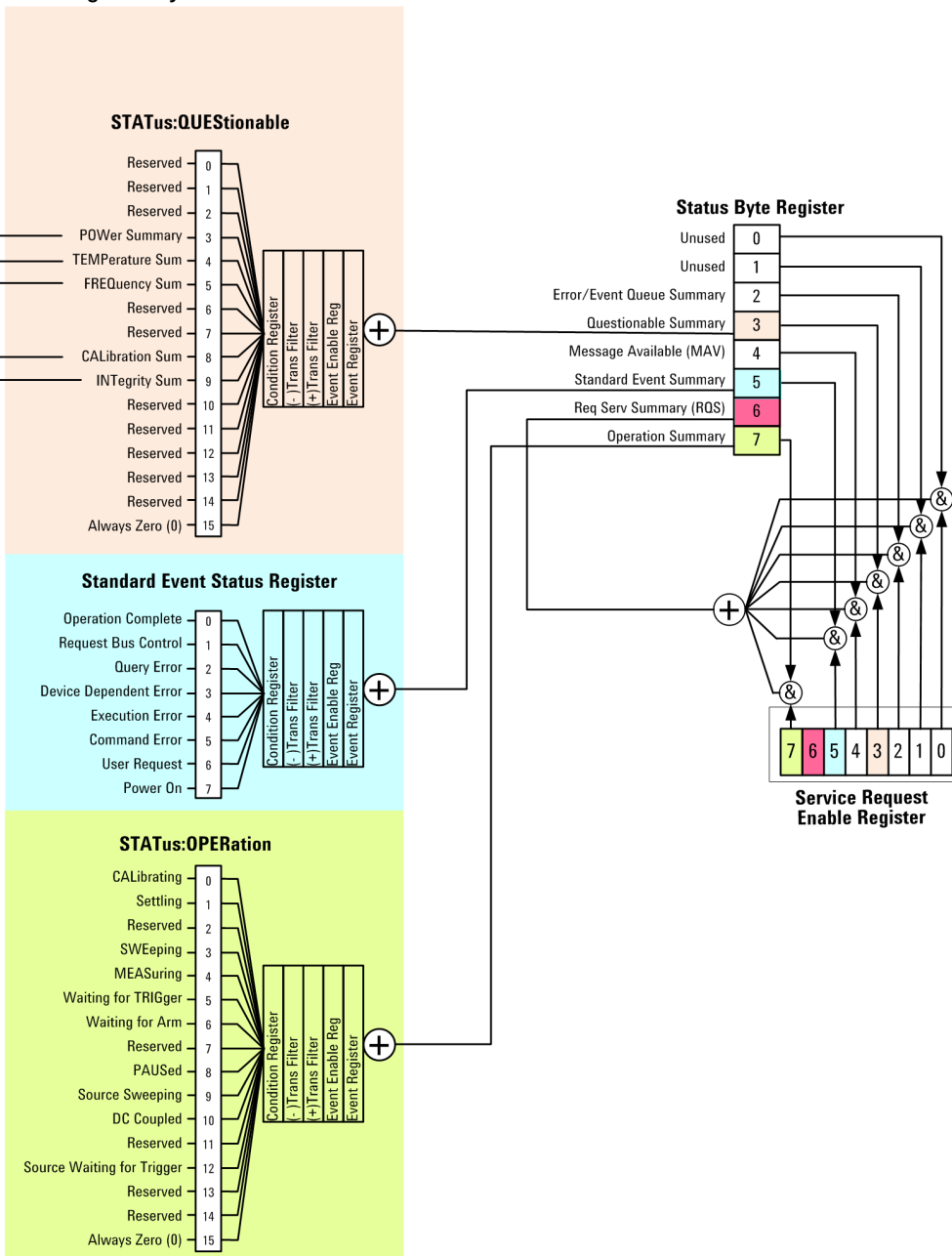

Detailed Description

The STATus subsystem remote commands set and query the status hardware registers. This system of registers monitors various events and conditions in the instrument. Software written to control the instrument may need to monitor some of these events and conditions.

NOTE

All status register commands are sequential. Most commands can be started immediately and will overlap with any existing commands that are already running. This is not true of status commands. All the commands in the spectrum analyzer are assumed to be overlapped unless a command description specifically says that it is sequential.

What Are Status Registers

The status system contains multiple registers that are arranged in a hierarchical order. The lower-level status registers propagate their data to the higher-level registers in the data structures by means of summary bits. The status byte register is at the top of the hierarchy and contains general status information for the instrument's events and conditions. All other individual registers are used to determine the specific events or conditions. For a diagram of the registers and their interconnections, see above.

The operation and questionable status registers are sets of registers that monitor the overall instrument condition. They are accessed with the STATus:OPERation and STATus:QUEStionable commands in the STATus command subsystem. Each register set is made up of five registers:

- Condition Register—It reports the real-time state of the signals monitored by this register set. There is no latching or buffering for a condition register.
- Positive Transition Register—This filter register controls which signals will set a bit in the event register when the signal makes a low to high transition (when the condition bit changes from 0 to 1).
- Negative Transition Register—This filter register controls which signals will set a bit in the event register when the signal makes a high to low transition (when the condition bit changes from 1 to 0).
- Event Register—It latches any signal state changes, in the way specified by the filter registers. Bits in the event register are never cleared by signal state changes. Event registers are cleared when read. They are also cleared by *CLS and by presetting the instrument.
- Event Enable Register—It controls which of the bits, being set in the event register, will be summarized as a single output for the register set. Summary bits are then used by the next higher register.

The STATus:QUEStionable registers report abnormal operating conditions. The status register hierarchy is:

1. The summary outputs from the six STATus:QUEStionable:<keyword> detail registers are inputs to the STATus:QUEStionable register.
2. The summary output from the STATus:QUEStionable register is an input to the Status Byte Register. See the overall system in Figure at the beginning of this section.

The STATus:OPERation register set has no summarized inputs. The inputs to the STATus:OPERation:CONDition register indicate the real time state of the instrument. The STATus:OPERation:EVENT register summary output is an input to the Status Byte Register.

What Are Status Register SCPI Commands

Most monitoring of the instrument conditions is done at the highest level using the IEEE common commands indicated below. Complete command descriptions are available in the IEEE commands section at the beginning of the language reference. Individual status registers can be set and queried using the commands in the STATus subsystem of the language reference.

- *CLS (clear status) clears the status byte by emptying the error queue and clearing all the event registers.
- *ESE, *ESE? (event status enable) sets and queries the bits in the enable register part of the standard event status register.
- *ESR? (event status register) queries and clears the event register part of the standard event status register.

- *OPC, *OPC? (operation complete) sets the standard event status register to monitor the completion of all commands. The query stops any new commands from being processed until the current processing is complete, then returns a '1'.
- *PSC, *PSC? (power-on state clear) sets the power-on state so that it clears the service request enable register and the event status enable register at power on.
- *SRE, *SRE? (service request enable) sets and queries the value of the service request enable register.
- *STB? (status byte) queries the value of the status byte register without erasing its contents.

How to Use the Status Registers

A program often needs to be able to detect and manage error conditions or changes in instrument status. There are two methods you can use to programmatically access the information in status registers:

- The polling method
- The service request (SRQ) method

In the polling method, the instrument has a passive role. It only tells the controller that conditions have changed when the controller asks the right question. In the SRQ method, the instrument takes a more active role. It tells the controller when there has been a condition change without the controller asking. Either method allows you to monitor one or more conditions.

The polling method works well if you do not need to know about changes the moment they occur. The SRQ method should be used if you must know immediately when a condition changes. To detect a change using the polling method, the program must repeatedly read the registers.

Use the SRQ method when:

- you need time-critical notification of changes
- you are monitoring more than one device which supports SRQs
- you need to have the controller do something else while waiting
- you can't afford the performance penalty inherent to polling

Use polling when:

- your programming language/development environment does not support SRQ interrupts
- you want to write a simple, single-purpose program and don't want the added complexity of setting up an SRQ handler
- To monitor a condition:
 - a. Determine which register contains the bit that reports the condition.
 - b. Send the unique SCPI query that reads that register.
 - c. Examine the bit to see if the condition has changed.

You can monitor conditions in different ways.

- Check the current instrument hardware and firmware status.

Do this by querying the condition registers which continuously monitor status. These registers represent the current state of the instrument. Bits in a condition register are updated in real time. When the condition monitored by a particular bit becomes true, the bit is set to 1. When the condition becomes false, the bit is reset to 0.

- Monitor a particular condition (bit).

You can enable a particular bit(s), using the event enable register. The instrument will then monitor that particular condition(s). If the bit becomes true (0 to 1 transition) in the event register, it will stay set until the event register is cleared. Querying the event register allows you to detect that this condition occurred even if the condition no longer exists. The event register can only be cleared by querying it or sending the *CLS command.

- Monitor a particular type of change in a condition (bit).
 - The transition registers are preset to register if the condition goes from 0 to 1 (false to true, or a positive transition).
 - This can be changed so the selected condition is detected if the bit goes from 1 to 0 (true to false, or a negative transition).
 - It can also be set for both types of transitions occurring.
 - Or it can be set for neither transition. If both transition registers are set to 0 for a particular bit position, that bit will not be set in the event register for either type of change.

Using a Status Register

Each bit in a register is represented by a numerical value based on its location. See figure below. This number is sent with the command to enable a particular bit. If you want to enable more than one bit, you would send the sum of all the bits that you want to monitor.

Figure: Status Register Bit Values

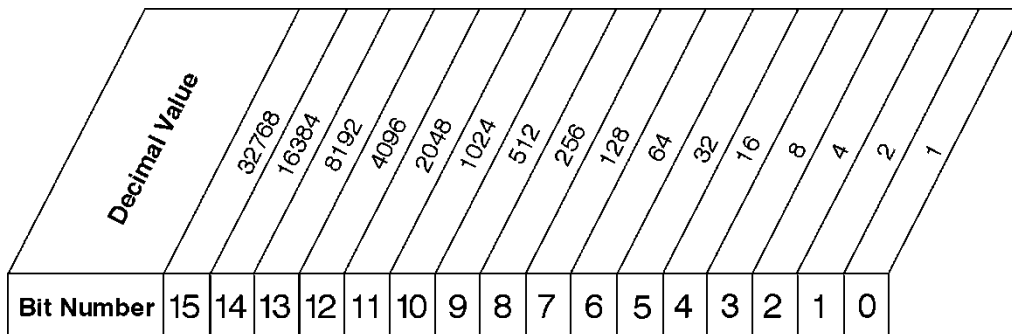

STATUS:OPERation:ENABLE <num>
 STATUS:OPERation:ENABLE?

Standard Operation Event Enable Register

ck730a

Bit 15 is not used to report status.

Example 1:

1. To enable bit 0 and bit 6 of standard event status register, you would send the command *ESE 65 because 1 + 64 = 65.

2. The results of a query are evaluated in a similar way. If the *STB? command returns a decimal value of 140, ($140 = 128 + 8 + 4$) then bit 7 is true, bit 3 is true and bit 2 is true.

Example 2:

1. Suppose you want to know if an Auto-trigger Timeout occurs, but you only cared about that specific condition. So you would want to know what was happening with bit 10 in the Status Questionable Integrity register, and not about any other bits.
2. It's usually a good idea to start by clearing all the status registers with *CLS.
3. Sending the STAT:QUES:INT:ENAB 1024 command lets you monitor only bit 10 events, instead of the default monitoring all the bits in the register. The register default is for positive transition events (0 to 1 transition). That is, when an auto-trigger timeout occurs. If instead, you wanted to know when the Auto-trigger timeout condition is cleared, then you would set the STAT:QUES:INT:PTR 0 and the STAT:QUES:INT:NTR 32767.
4. So now the only output from the Status Questionable Integrity register will come from a bit 10 positive transition. That output goes to the Integrity Sum bit 9 of the Status Questionable register.
5. You can do a similar thing with this register to only look at bit 9 using, STAT:QUES:ENAB 512.
6. The Status Questionable register output goes to the "Status Questionable Summary" bit 3 of the Status Byte Register. The output from this register can be enabled using the *SRE 8 command.
7. Finally, you would use the serial polling functionality available for the particular bus/software that you are using to monitor the Status Byte Register. (You could also use *STB? to poll the Status Byte Register.)

Using the Service Request (SRQ) Method

Your language, bus, and programming environment must be able to support SRQ interrupts. (For example, BASIC used with VXI-11.3 (GPIB over LAN). When you monitor a condition with the SRQ method, you must:

1. Determine which bit monitors the condition.
2. Determine how that bit reports to the request service (RQS) bit of the status byte.
3. Send SCPI commands to enable the bit that monitors the condition and to enable the summary bits that report the condition to the RQS bit.
4. Enable the controller to respond to service requests.

When the condition changes, the instrument sets its RQS bit. The controller is informed of the change as soon as it occurs. As a result, the time the controller would otherwise have used to monitor the condition can be used to perform other tasks. Your program determines how the controller responds to the SRQ.

Generating a Service Request

To use the SRQ method, you must understand how service requests are generated. Bit 6 of the status byte register is the request service (RQS) bit. The *SRE command is used to configure the RQS bit to report changes in instrument status. When such a change occurs, the RQS bit is set. It is cleared when the status byte register is queried using *SRE? (with a serial poll.) It can be queried without erasing the contents with *STB?.

When a register set causes a summary bit in the status byte to change from 0 to 1, the instrument can initiate the service request (SRQ) process. However, the process is only initiated if both of the following conditions are true:

- The corresponding bit of the service request enable register is also set to 1.
- The instrument does not have a service request pending. (A service request is considered to be pending between the time the instrument's SRQ process is initiated and the time the controller reads the status byte register.)

The SRQ process sets the SRQ true. It also sets the status byte's request service (RQS) bit to 1. Both actions are necessary to inform the controller that the instrument requires service. Setting the SRQ line only informs the controller that some device on the bus requires service. Setting the RQS bit allows the controller to determine which instrument requires service.

If your program enables the controller to detect and respond to service requests, it should instruct the controller to perform a serial poll when the SRQ is set true. Each device on the bus returns the contents of its status byte register in response to this poll. The device whose RQS bit is set to 1 is the device that requested service.

When you read the instrument's status byte register with a serial poll, the RQS bit is reset to 0. Other bits in the register are not affected.

If the status register is configured to SRQ on end-of-measurement and the measurement is in continuous mode, then restarting a measurement (INIT command) can cause the measuring bit to pulse low. This causes an SRQ when you have not actually reached the "end-of-measurement" condition. To avoid this:

1. Set INITiate:CONTinuous off.
2. Set/enable the status registers.
3. Restart the measurement (send INIT).

Status Register System

The hardware status registers are combined to form the instrument status system. Specific status bits are assigned to monitor various aspects of the instrument operation and status. See the diagram of the status system above for information about the bit assignments and status register interconnections.

The Status Byte Register

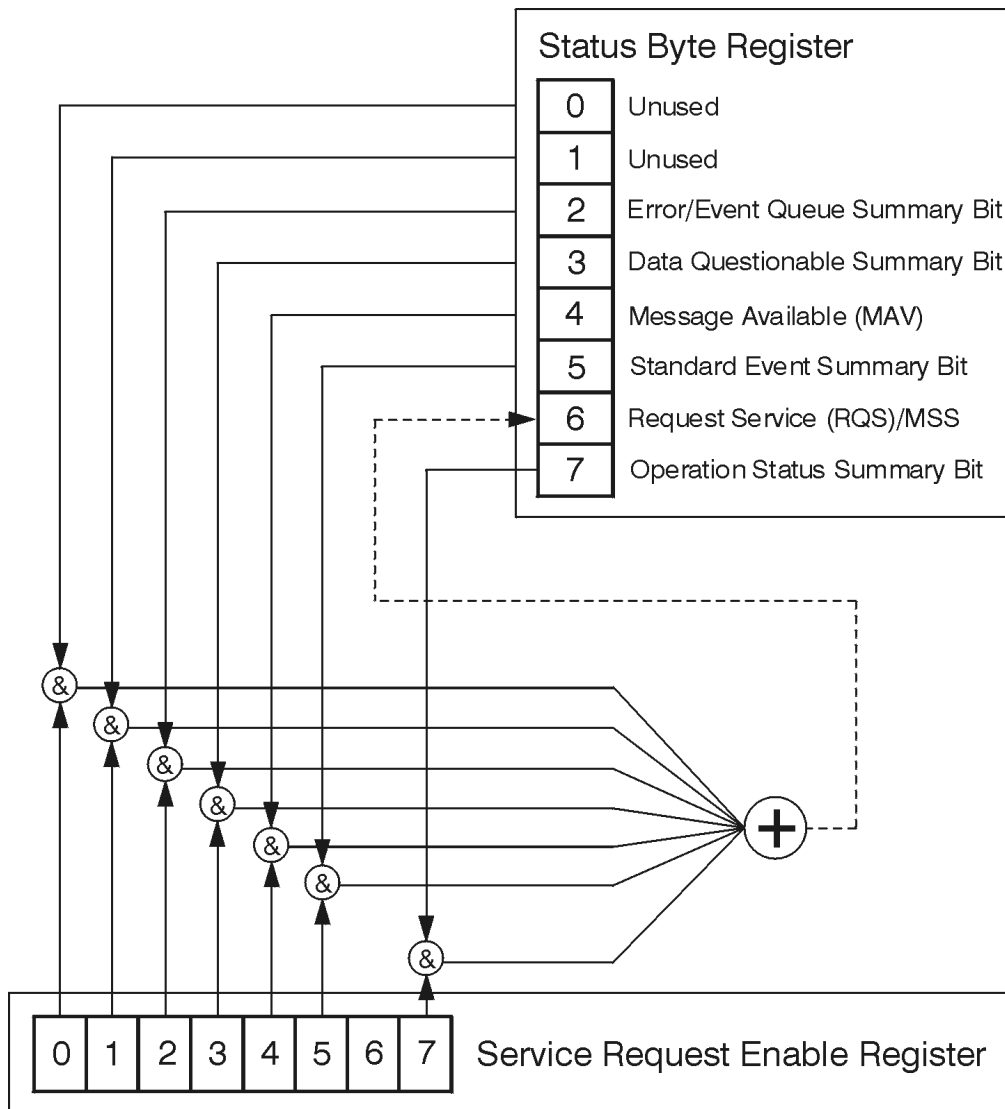

ck776a

The RQS bit is read and reset by a serial poll. The same bit position (MSS) is read, non-destructively by the *STB? command. If you serial poll bit 6 it is read as RQS, but if you send *STB it reads bit 6 as MSS. For more information refer to IEEE 488.2 standards, section 11.

Description									
	Standard Operation Status Summary Bit	Request Service (RQS) Summary Bit	Standard Event Status Summary Bit	Message Available (MAV)	Data Questionable Status Summary Bit	Error/Event Queue Summary Bit	Unused	Unused	
Bit Number	7	6	5	4	3	2	1	0	

*STB?

Status Byte Register

ck725a

Bit	Description
0, 1	These bits are always set to 0.
2	A 1 in this bit position indicates that the SCPI error queue is not empty which means that it contains at least one error message.
3	A 1 in this bit position indicates that the data questionable summary bit has been set. The data questionable event register can then be read to determine the specific condition that caused this bit to be set.
4	A 1 in this bit position indicates that the instrument has data ready in the output queue. There are no lower status groups that provide input to this bit.
5	A 1 in this bit position indicates that the standard event summary bit has been set. The standard event status register can then be read to determine the specific event that caused this bit to be set.
6	A 1 in this bit position indicates that the instrument has at least one reason to report a status change. This bit is also called the master summary status bit (MSS).
7	A 1 in this bit position indicates that the standard operation summary bit has been set. The standard operation event register can then be read to determine the specific condition that caused this bit to be set.

To query the status byte register, send the command *STB?. The response will be the decimal sum of the bits which are set to 1. For example, if bit number 7 and bit number 3 are set to 1, the decimal sum of the 2 bits is 128 plus 8. So the decimal value 136 is returned. The *STB command does not clear the status register.

In addition to the status byte register, the status byte group also contains the service request enable register. This register lets you choose which bits in the status byte register will trigger a service request.

Send the *SRE <integer> command where <integer> is the sum of the decimal values of the bits you want to enable plus the decimal value of bit 6. For example, assume that you want to enable bit 7 so that whenever the standard operation status register summary bit is set to 1 it will trigger a service request. Send the command *SRE 192 (because 192 = 128 + 64). You must always add 64 (the numeric value of RQS

bit 6) to your numeric sum when you enable any bits for a service request. The command *SRE? returns the decimal value of the sum of the bits previously enabled with the *SRE <integer> command.

The service request enable register presets to zeros (0).

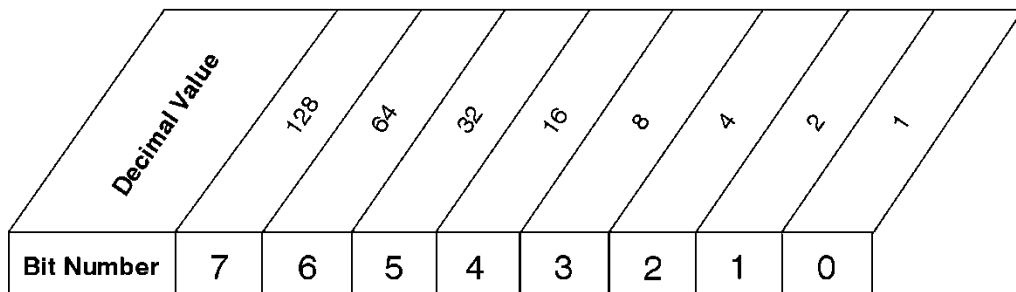

*SRE <num>
 *SRE?

Service Request Enable Register

ck726a

Standard Event Status Register

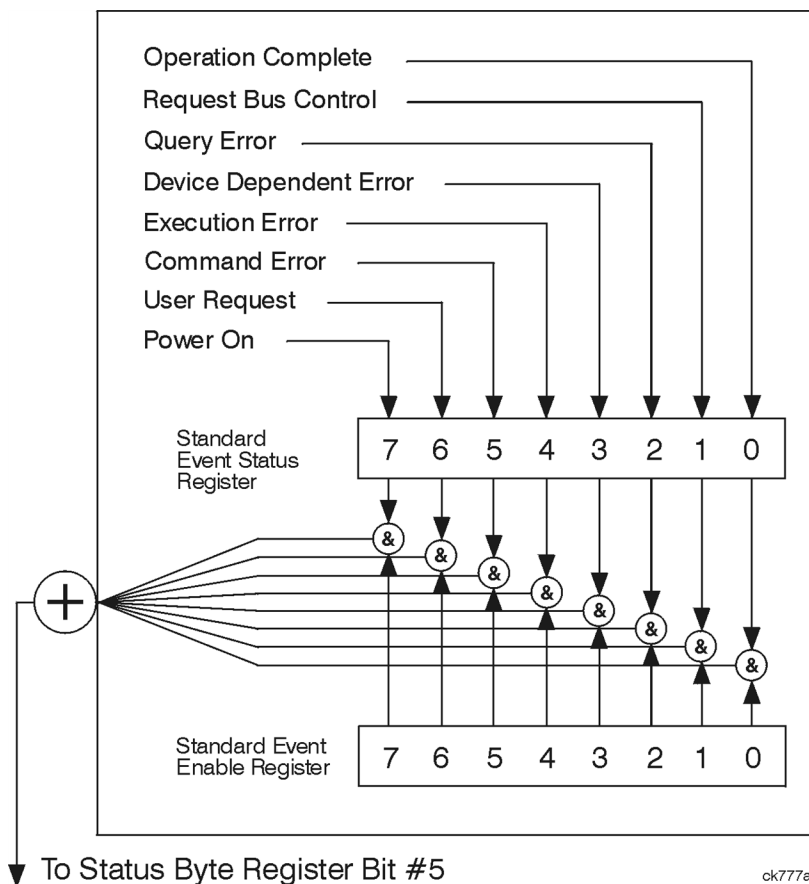

ck777a

The standard event status register contains the following bits:

Description									
	Power On	User Request Key (Local)	Command Error	Execution Error	Device Dependent Error	Query Error	Request Control	Operation Complete	
Bit Number	7	6	5	4	3	2	1	0	

*ESR?

Standard Event Status Register

ck727a

Bit	Description
0	A 1 in this bit position indicates that all pending operations were completed following execution of the *OPC command.
1	This bit is for GPIB handshaking to request control. Currently it is set to 0 because there are no implementations where the spectrum analyzer controls another instrument.
2	A 1 in this bit position indicates that a query error has occurred. Query errors have SCPI error numbers from -499 to -400.
3	A 1 in this bit position indicates that a device dependent error has occurred. Device dependent errors have SCPI error numbers from -399 to -300 and 1 to 32767.
4	A 1 in this bit position indicates that an execution error has occurred. Execution errors have SCPI error numbers from -299 to -200.
5	A 1 in this bit position indicates that a command error has occurred. Command errors have SCPI error numbers from -199 to -100.
6	A 1 in this bit position indicates that the LOCAL key has been pressed. This is true even if the instrument is in local lockout mode.
7	A 1 in this bit position indicates that the instrument has been turned off and then on.

The standard event status register is used to determine the specific event that set bit 5 in the status byte register. To query the standard event status register, send the command *ESR?. The response will be the decimal sum of the bits which are enabled (set to 1). For example, if bit number 7 and bit number 3 are enabled, the decimal sum of the 2 bits is 128 plus 8. So the decimal value 136 is returned.

In addition to the standard event status register, the standard event status group also contains a standard event status enable register. This register lets you choose which bits in the standard event status register will set the summary bit (bit 5 of the status byte register) to 1. Send the *ESE <integer> command where <integer> is the sum of the decimal values of the bits you want to enable. For example, to enable bit 7 and bit 6 so that whenever either of those bits is set to 1, the standard event status summary bit of the status

byte register will be set to 1, send the command *ESE 192 (128 + 64). The command *ESE? returns the decimal value of the sum of the bits previously enabled with the *ESE <integer> command.

The standard event status enable register presets to zeros (0).

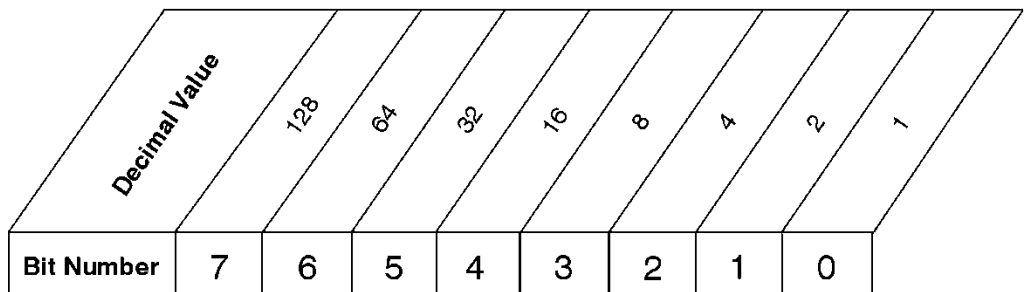

*ESE <num>
 *ESE?

Standard Event Status Enable Register

ck728a

Operation and Questionable Status Registers

The operation and questionable status registers are registers that monitor the overall instrument condition. They are accessed with the STATus:OPERation and STATus:QUEStionable commands in the STATus command subsystem. See the figure at the beginning of this chapter.

Operation Status Register

The operation status register monitors the current instrument measurement state. It checks to see if the instrument is calibrating, sweeping, or waiting for a trigger. For more information see the *OPC? command located in the IEEE Common Commands section.

Bit	Condition	Operation
0	Calibrating	The instrument is busy executing its Align Now process
3	Sweeping	The instrument is busy taking a sweep.
4	Measuring	The instrument is busy making a measurement. Measurements often require multiple sweeps. They are initiated by keys under the MEASURE key or with the MEASure group of commands. The bit is valid for most X-Series Modes.
5	Waiting for trigger	The instrument is waiting for the trigger conditions to be met, then it will trigger a sweep or measurement.

Questionable Status Register

The questionable status register monitors the instrument's condition to see if anything questionable has happened to it. It is looking for anything that might cause an error or a bad measurement like a hardware problem, an out of calibration situation, or a unusual signal. All the bits are summary bits from lower-level event registers.

Bit	Condition	Operation
-----	-----------	-----------

3	Power summary	The instrument hardware has detected a power unlevelled condition.
4	Temperature summary	The instrument is still warming up.
5	Frequency summary	The instrument hardware has detected an unlocked condition or a problem with the external frequency reference.
8	Calibration summary	The instrument has detected a hardware problem while doing the automatic internal alignment process.
9	Integrity summary	The instrument has detected a questionable measurement condition such as: bad timing, bad signal/data, timeout problem, signal overload, or "meas uncal".

STATus Subsystem Command Descriptions

The STATus subsystem controls the SCPI-defined instrument status reporting structures. Each status register has a set of five commands used for querying or masking that particular register.

Numeric values for bit patterns can be entered using decimal or hexadecimal representations. (i.e. 0 to 32767 is equivalent to #H0 to #H7FFF. It is also equal to all ones, 111111111111111) See the SCPI Basics information about using bit patterns for variable parameters.

Operation Register

"Operation Condition Query" on page 155

"Operation Enable" on page 156

"Operation Event Query" on page 156

"Operation Negative Transition" on page 156

"Operation Positive Transition" on page 157

Operation Condition Query

This query returns the decimal value of the sum of the bits in the Status Operation Condition register.

NOTE The data in this register is continuously updated and reflects the current conditions.

Mode	All
Remote Command	:STATus:OPERation:CONDition?
Example	STAT:OPER:COND?
Preset	0
Status Bits/OPC dependencies	Sequential command
Initial S/W Revision	Prior to A.02.00

Operation Enable

This command determines which bits in the Operation Event register, will set the Operation Status Summary bit (bit 7) in the Status Byte Register. The variable <integer> is the sum of the decimal values of the bits you want to enable.

NOTE

The preset condition is to have all bits in this enable register set to 0. To have any Operation Events reported to the Status Byte Register, one or more bits need to be set to 1.

Mode	All
Remote Command	:STATus:OPERation:ENABle <integer> :STATus:OPERation:ENABle?
Example	STAT:OPER:ENAB 1 Sets the register so that Align Now operation will be reported to the Status Byte Register.
Preset	0
Min	0
Max	32767
Status Bits/OPC dependencies	Sequential command
Initial S/W Revision	Prior to A.02.00

Operation Event Query

This query returns the decimal value of the sum of the bits in the Operation Event register.

NOTE

The register requires that the associated PTR or NTR filters be set before a condition register bit can set a bit in the event register. The data in this register is latched until it is queried. Once queried, the register is cleared.

Mode	All
Remote Command	:STATus:OPERation[:EVENT]?
Example	STAT:OPER?
Preset	0
Status Bits/OPC dependencies	Sequential command
Initial S/W Revision	Prior to A.02.00

Operation Negative Transition

This command determines which bits in the Operation Condition register will set the corresponding bit in the Operation Event register when the condition register bit has a negative transition (1 to 0). The variable <integer> is the sum of the decimal values of the bits that you want to enable.

Mode	All
Remote Command	:STATus:OPERation:NTRansition <integer> :STATus:OPERation:NTRansition?
Example	STAT:OPER:NTR 1 Align Now operation complete will be reported to the Status Byte Register.
Preset	0
Min	0
Max	32767
Status Bits/OPC dependencies	Sequential command
Initial S/W Revision	Prior to A.02.00

Operation Positive Transition

This command determines which bits in the Operation Condition register will set the corresponding bit in the Operation Event register when the condition register bit has a positive transition (0 to 1). The variable <integer> is the sum of the decimal values of the bits that you want to enable.

Mode	All
Remote Command	:STATus:OPERation:PTRansition <integer> :STATus:OPERation:PTRansition?
Example	STAT:OPER:PTR 1 Align Now operation beginning will be reported to the Status Byte Register.
Preset	32767
Min	0
Max	32767
Status Bits/OPC dependencies	Sequential command
Initial S/W Revision	Prior to A.02.00

Preset the Status Byte

Sets bits in most of the enable and transition registers to their default state. It presets all the Transition Filters, Enable Registers, and the Error/Event Queue Enable. It has no effect on Event Registers, Error/Event QUEUE, IEEE 488.2 ESE, and SRE Registers as described in IEEE Standard 488.2–1992, IEEE Standard Codes, Formats, Protocols, and Common Commands for Use with ANSI/IEEE Std 488.1–1987. New York, NY, 1992.

Remote Command	:STATus:PRESet
Example	STAT:PREs
Initial S/W Revision	Prior to A.02.00

Questionable Register

"Questionable Condition " on page 158

"Questionable Enable " on page 158

"Questionable Event Query " on page 159

"Questionable Negative Transition " on page 159

"Questionable Positive Transition" on page 159

Questionable Condition

This query returns the decimal value of the sum of the bits in the Questionable Condition register.

NOTE The data in this register is continuously updated and reflects the current conditions.

Mode	All
Remote Command	:STATus:QUEStionable:CONDition?
Example	STAT:QUES:COND?
Preset	0
Status Bits/OPC dependencies	Sequential command
Initial S/W Revision	Prior to A.02.00

Questionable Enable

This command determines which bits in the Questionable Event register will set the Questionable Status Summary bit (bit3) in the Status Byte Register. The variable <integer> is the sum of the decimal values of the bits you want to enable.

NOTE The preset condition is all bits in this enable register set to 0. To have any Questionable Events reported to the Status Byte Register, one or more bits need to be set to 1. The Status Byte Event Register should be queried after each measurement to check the Questionable Status Summary (bit 3). If it is equal to 1, a condition during the test may have made the test results invalid. If it is equal to 0, this indicates that no hardware problem or measurement problem was detected by the analyzer.

Mode	All
Remote Command	:STATus:QUEStionable:ENABle <integer> :STATus:QUEStionable:ENABle?
Example	STAT:OPER:PTR 1 Align Now operation beginning will be reported to the Status Byte Register.
Preset	0
Min	0
Max	32767
Status Bits/OPC dependencies	Sequential command
Initial S/W Revision	Prior to A.02.00

Questionable Event Query

This query returns the decimal value of the sum of the bits in the Questionable Event register.

NOTE

The register requires that the associated PTR or NTR filters be set before a condition register bit can set a bit in the event register. The data in this register is latched until it is queried. Once queried, the register is cleared.

Mode	All
Remote Command	:STATus:QUEStionable[:EVENT]?
Example	STAT:QUES?
Preset	0
Status Bits/OPC dependencies	Sequential command
Initial S/W Revision	Prior to A.02.00

Questionable Negative Transition

This command determines which bits in the Questionable Condition register will set the corresponding bit in the Questionable Event register when the condition register bit has a negative transition (1 to 0). The variable <integer> is the sum of the decimal values of the bits that you want to enable.

Mode	All
Remote Command	:STATus:QUEStionable:NTRansition <integer> :STATus:QUEStionable:NTRansition?
Example	STAT:QUES:NTR 16 Temperature summary 'questionable cleared' will be reported to the Status Byte Register.
Preset	0
Min	0
Max	32767
Status Bits/OPC dependencies	Sequential command
Initial S/W Revision	Prior to A.02.00

Questionable Positive Transition

This command determines which bits in the Questionable Condition register will set the corresponding bit in the Questionable Event register when the condition register bit has a positive transition (0 to 1). The variable <integer> is the sum of the decimal values of the bits that you want to enable.

Mode	All
------	-----

Remote Command	:STATus:QUEStionable:PTRansition <integer> :STATus:QUEStionable:PTRansition?
Example	STAT:QUES:PTR 16 Temperature summary 'questionable asserted' will be reported to the Status Byte Register.
Preset	32767
Min	0
Max	32767
Status Bits/OPC dependencies	Sequential command
Initial S/W Revision	Prior to A.02.00

Questionable Calibration Register

"Questionable Calibration Condition " on page 160

"Questionable Calibration Enable " on page 160

"Questionable Calibration Event Query " on page 161

"Questionable Calibration Negative Transition " on page 161

"Questionable Calibration Positive Transition " on page 162

Questionable Calibration Condition

This query returns the decimal value of the sum of the bits in the Questionable Calibration Condition register.

NOTE

The data in this register is continuously updated and reflects the current conditions.

Mode	All
Remote Command	:STATus:QUEStionable:CALibration:CONDition?
Example	STAT:QUES:CAL:COND?
Preset	0
Status Bits/OPC dependencies	Sequential command
Initial S/W Revision	Prior to A.02.00

Questionable Calibration Enable

This command determines which bits in the Questionable Calibration Condition Register will set bits in the Questionable Calibration Event register, which also sets the Calibration Summary bit (bit 8) in the Questionable Register. The variable <integer> is the sum of the decimal values of the bits you want to enable.

Mode	All
Remote Command	:STATus:QUESTionable:CALibration:ENABle <integer> :STATus:QUESTionable:CALibration:ENABle?
Example	STAT:QUES:CAL:ENAB 16384 Can be used to query if an alignment is needed, if you have turned off the automatic alignment process.
Min	0
Max	32767
Status Bits/OPC dependencies	Sequential command
Initial S/W Revision	Prior to A.02.00

Questionable Calibration Event Query

This query returns the decimal value of the sum of the bits in the Questionable Calibration Event register.

NOTE

The register requires that the associated PTR or NTR filters be set before a condition register bit can set a bit in the event register. The data in this register is latched until it is queried. Once queried, the register is cleared.

Mode	All
Remote Command	:STATus:QUESTionable:CALibration[:EVENT]?
Example	STAT:QUES:CAL?
Preset	0
Status Bits/OPC dependencies	Sequential command
Initial S/W Revision	Prior to A.02.00

Questionable Calibration Negative Transition

This command determines which bits in the Questionable Calibration Condition register will set the corresponding bit in the Questionable Calibration Event register when the condition register bit has a negative transition (1 to 0). The variable <integer> is the sum of the decimal values of the bits that you want to enable.

Mode	All
Remote Command	:STATus:QUESTionable:CALibration:NTRansition <integer> :STATus:QUESTionable:CALibration:NTRansition?
Example	STAT:QUES:CAL:NTR 16384 Alignment is not required.
Preset	0
Min	0

Max	32767
Status Bits/OPC dependencies	Sequential command
Initial S/W Revision	Prior to A.02.00

Questionable Calibration Positive Transition

This command determines which bits in the Questionable Calibration Condition register will set the corresponding bit in the Questionable Calibration Event register when the condition register bit has a positive transition (0 to 1). The variable <integer> is the sum of the decimal values of the bits that you want to enable.

Mode	All
Remote Command	:STATus:QUESTionable:CALibration:PTRansition <integer> :STATus:QUESTionable:CALibration:PTRansition?
Example	STAT:QUES:CAL:PTR 16384 Alignment is required.
Preset	32767
Min	0
Max	32767
Status Bits/OPC dependencies	Sequential command
Initial S/W Revision	Prior to A.02.00

Questionable Calibration Skipped Register

"Questionable Calibration Skipped Condition " on page 162

"Questionable Calibration Skipped Enable " on page 163

"Questionable Calibration Skipped Event Query " on page 163

"Questionable Calibration Skipped Negative Transition " on page 164

"Questionable Calibration Skipped Positive Transition " on page 164

Questionable Calibration Skipped Condition

This query returns the decimal value of the sum of the bits in the Questionable Calibration Skipped Condition register.

NOTE The data in this register is continuously updated and reflects the current conditions.

Mode	All
Remote Command	:STATus:QUESTionable:CALibration:SKIpped:CONDition?

Example	STAT:QUES:CAL:SKIP:COND?
Preset	0
Status Bits/OPC dependencies	Sequential command
Initial S/W Revision	Prior to A.02.00

Questionable Calibration Skipped Enable

This command determines which bits in the Questionable Calibration Skipped Condition Register will set bits in the Questionable Calibration Skipped Event register, which also sets bit 11 of the Questionable Calibration Register. The variable <integer> is the sum of the decimal values of the bits you want to enable.

Mode	All
Remote Command	:STATus:QUESTionable:CALibration:SKIPped:ENABle <integer> :STATus:QUESTionable:CALibration:SKIPped:ENABle?
Example	STAT:QUES:CAL:SKIP:ENAB 1 Can be used to query if an EMI alignment skipped condition is detected
Preset	32767
Min	0
Max	32767
Status Bits/OPC dependencies	Sequential command
Initial S/W Revision	Prior to A.02.00

Questionable Calibration Skipped Event Query

This query returns the decimal value of the sum of the bits in the Questionable Calibration Event register.

NOTE

The register requires that the associated PTR or NTR filters be set before a condition register bit can set a bit in the event register. The data in this register is latched until it is queried. Once queried, the register is cleared.

Mode	All
Remote Command	:STATus:QUESTionable:CALibration:SKIPped[:EVENT]?
Example	STAT:QUES:CAL:SKIP?
Preset	0
Status Bits/OPC dependencies	Sequential command
Initial S/W Revision	Prior to A.02.00

Questionable Calibration Skipped Negative Transition

This command determines which bits in the Questionable Calibration Skipped Condition register will set the corresponding bit in the Questionable Calibration Skipped Event register when the condition register bit has a negative transition (1 to 0). The variable <integer> is the sum of the decimal values of the bits that you want to enable.

Mode	All
Remote Command	:STATus:QUEStionable:CALibration:SKIpped:NTRansition <integer> :STATus:QUEStionable:CALibration:SKIpped:NTRansition?
Example	STAT:QUES:CAL:SKIP:NTR 1 Align RF skipped is not required.
Preset	0
Min	0
Max	32767
Status Bits/OPC dependencies	Sequential command
Initial S/W Revision	Prior to A.02.00

Questionable Calibration Skipped Positive Transition

This command determines which bits in the Questionable Calibration Skipped Condition register will set the corresponding bit in the Questionable Calibration Skipped Event register when the condition register bit has a positive transition (0 to 1). The variable <integer> is the sum of the decimal values of the bits that you want to enable.

Mode	All
Remote Command	:STATus:QUEStionable:CALibration:SKIpped:PTRansition <integer> :STATus:QUEStionable:CALibration:SKIpped:PTRansition?
Example	STAT:QUES:CAL:SKIP:PTR 1 Align RF skipped is required.
Preset	32767
Min	0
Max	32767
Status Bits/OPC dependencies	Sequential command
Initial S/W Revision	Prior to A.02.00

Questionable Calibration Extended Failure Register

"Questionable Calibration Extended Failure Condition " on page 165

"Questionable Calibration Extended Failure Enable " on page 165

"Questionable Calibration Extended Failure Event Query " on page 165

"Questionable Calibration Extended Failure Negative Transition " on page 166

"Questionable Calibration Extended Failure Positive Transition " on page 166

Questionable Calibration Extended Failure Condition

This query returns the decimal value of the sum of the bits in the Questionable Calibration Extended Failure Condition register.

NOTE The data in this register is continuously updated and reflects the current conditions.

Mode	All
Remote Command	:STATus:QUESTionable:CALibration:EXTended:FAILure:CONDition?
Example	STAT:QUES:CAL:EXT:FAIL:COND?
Preset	0
Status Bits/OPC dependencies	Sequential command
Initial S/W Revision	Prior to A.02.00

Questionable Calibration Extended Failure Enable

This command determines which bits in the Questionable Calibration Extended Failure Condition Register will set bits in the Questionable Calibration Extended Failure Event register, which also sets bit 9 of the Questionable Calibration Register. The variable <integer> is the sum of the decimal values of the bits you want to enable.

Mode	All
Remote Command	:STATus:QUESTionable:CALibration:EXTended:FAILure:ENABle <integer> :STATus:QUESTionable:CALibration:EXTended:FAILure:ENABle?
Example	STAT:QUES:CAL:EXT:FAIL:ENAB 1 Can be used to query if an EMI conducted alignment is needed.
Preset	32767
Min	0
Max	32767
Status Bits/OPC dependencies	Sequential command
Initial S/W Revision	Prior to A.02.00

Questionable Calibration Extended Failure Event Query

This query returns the decimal value of the sum of the bits in the Questionable Calibration Extended Failure Event register.

NOTE The register requires that the associated PTR or NTR filters be set before a condition register bit can set a bit in the event register. The data in this register is latched until it is queried. Once queried, the register is cleared.

Mode	All
Remote Command	:STATus:QUESTionable:CALibration:EXTended:FAILure[:EVENT]?
Example	STAT:QUES:CAL:EXT:FAIL?
Preset	0
Status Bits/OPC dependencies	Sequential command
Initial S/W Revision	Prior to A.02.00

Questionable Calibration Extended Failure Negative Transition

This command determines which bits in the Questionable Calibration Extended Failure Condition register will set the corresponding bit in the Questionable Calibration Extended Failure Event register when the condition register bit has a negative transition (1 to 0). The variable <integer> is the sum of the decimal values of the bits that you want to enable.

Mode	All
Remote Command	:STATus:QUESTionable:CALibration:EXTended:FAILure:NTRansition <integer> :STATus:QUESTionable:CALibration:EXTended:FAILure:NTRansition?
Example	STAT:QUES:CAL:EXT:FAIL:NTR 1 EMI conducted align failure is not required.
Preset	0
Min	0
Max	32767
Status Bits/OPC dependencies	Sequential command
Initial S/W Revision	Prior to A.02.00

Questionable Calibration Extended Failure Positive Transition

This command determines which bits in the Questionable Calibration Extended Failure Condition register will set the corresponding bit in the Questionable Calibration Extended Failure Event register when the condition register bit has a positive transition (0 to 1). The variable <integer> is the sum of the decimal values of the bits that you want to enable.

Mode	All
Remote Command	:STATus:QUESTionable:CALibration:EXTended:FAILure:PTRansition <integer> :STATus:QUESTionable:CALibration:EXTended:FAILure:PTRansition?
Example	STAT:QUES:CAL:EXT:FAIL:PTR 1 EMI conducted align failure is required.
Preset	32767
Min	0
Max	32767

Status Bits/OPC dependencies	Sequential command
Initial S/W Revision	Prior to A.02.00

Questionable Calibration Extended Needed Register

"Questionable Calibration Extended Needed Condition " on page 167

"Questionable Calibration Extended Needed Enable " on page 167

"Questionable Calibration Extended Needed Event Query " on page 168

"Questionable Calibration Extended Needed Negative Transition " on page 168

"Questionable Calibration Extended Needed Positive Transition " on page 169

Questionable Calibration Extended Needed Condition

This query returns the decimal value of the sum of the bits in the Questionable Calibration Extended Needed Condition register.

NOTE The data in this register is continuously updated and reflects the current conditions.

Mode	All
Remote Command	:STATus:QUESTionable:CALibration:EXTended:NEEDed:CONDition?
Example	STAT:QUES:CAL:EXT:NEED:COND?
Preset	0
Status Bits/OPC dependencies	Sequential command
Initial S/W Revision	Prior to A.02.00

Questionable Calibration Extended Needed Enable

This command determines which bits in the Questionable Calibration Extended Needed Condition Register will set bits in the Questionable Calibration Extended Needed Event register, which also sets bit 14 of the Questionable Calibration Register. The variable <integer> is the sum of the decimal values of the bits you want to enable.

Mode	All
Remote Command	:STATus:QUESTionable:CALibration:EXTended:NEEDed:ENABle <integer> :STATus:QUESTionable:CALibration:EXTended:NEEDed:ENABle?
Example	STAT:QUES:CAL:EXT:NEED:ENAB 2 Can be used to query if an EMI conducted alignment is needed.
Preset	32767
Min	0

Max	32767
Status Bits/OPC dependencies	Sequential command
Initial S/W Revision	Prior to A.02.00

Questionable Calibration Extended Needed Event Query

This query returns the decimal value of the sum of the bits in the Questionable Calibration Extended Needed Event register.

NOTE

The register requires that the associated PTR or NTR filters be set before a condition register bit can set a bit in the event register. The data in this register is latched until it is queried. Once queried, the register is cleared.

Mode	All
Remote Command	:STATus:QUESTionable:CALibration:EXTended:NEEDed[:EVENT]?
Example	STAT:QUES:CAL:EXT:NEED?
Preset	0
Status Bits/OPC dependencies	Sequential command
Initial S/W Revision	Prior to A.02.00

Questionable Calibration Extended Needed Negative Transition

This command determines which bits in the Questionable Calibration Extended Needed Condition register will set the corresponding bit in the Questionable Calibration Extended Needed Event register when the condition register bit has a negative transition (1 to 0). The variable <integer> is the sum of the decimal values of the bits that you want to enable.

Mode	All
Remote Command	:STATus:QUESTionable:CALibration:EXTended:NEEDed:NTRansition <integer> :STATus:QUESTionable:CALibration:EXTended:NEEDed:NTRansition?
Example	STAT:QUES:CAL:EXT:NEED:NTR 2 Align EMI conducted is not required.
Preset	0
Min	0
Max	32767
Status Bits/OPC dependencies	Sequential command
Initial S/W Revision	Prior to A.02.00

Questionable Calibration Extended Needed Positive Transition

This command determines which bits in the Questionable Calibration Extended Needed Condition register will set the corresponding bit in the Questionable Calibration Extended Needed Event register when the condition register bit has a positive transition (0 to 1). The variable <integer> is the sum of the decimal values of the bits that you want to enable.

Mode	All
Remote Command	:STATus:QUEStionable:CALibration:EXTended:NEEDED:PTRansition <integer> :STATus:QUEStionable:CALibration:EXTended:NEEDED:PTRansition?
Example	STAT:QUES:CAL:EXT:NEED:PTR 2 Align EMI conducted is required.
Preset	32767
Min	0
Max	32767
Status Bits/OPC dependencies	Sequential command
Initial S/W Revision	Prior to A.02.00

Questionable Frequency Register

"Questionable Frequency Condition " on page 169

"Questionable Frequency Enable " on page 170

"Questionable Frequency Event Query " on page 170

"Questionable Frequency Negative Transition " on page 170

"Questionable Frequency Positive Transition " on page 171

Questionable Frequency Condition

This query returns the decimal value of the sum of the bits in the Questionable Frequency Condition register.

NOTE The data in this register is continuously updated and reflects the current conditions.

Mode	All
Remote Command	:STATus:QUEStionable:FREQuency:CONDition?
Example	STAT:QUES:FREQ:COND?
Preset	0
Status Bits/OPC dependencies	Sequential command
Initial S/W Revision	Prior to A.02.00

Questionable Frequency Enable

This command determines which bits in the Questionable Frequency Condition Register will set bits in the Questionable Frequency Event register, which also sets the Frequency Summary bit (bit 5) in the Questionable Register. The variable <integer> is the sum of the decimal values of the bits you want to enable.

Mode	All
Remote Command	:STATus:QUEStionable:FREQuency:ENABle <integer> :STATus:QUEStionable:FREQuency:ENABle?
Example	STAT:QUES:FREQ:ENAB 2 Frequency Reference Unlocked will be reported to the Frequency Summary of the Status Questionable register.
Preset	32767
Min	0
Max	32767
Status Bits/OPC dependencies	Sequential command
Initial S/W Revision	Prior to A.02.00

Questionable Frequency Event Query

This query returns the decimal value of the sum of the bits in the Questionable Frequency Event register.

NOTE

The register requires that the associated PTR or NTR filters be set before a condition register bit can set a bit in the event register. The data in this register is latched until it is queried. Once queried, the register is cleared.

Mode	All
Remote Command	:STATus:QUEStionable:FREQuency[:EVENT]?
Example	STAT:QUES:FREQ?
Preset	0
Status Bits/OPC dependencies	Sequential command
Initial S/W Revision	Prior to A.02.00

Questionable Frequency Negative Transition

This command determines which bits in the Questionable Frequency Condition register will set the corresponding bit in the Questionable Frequency Event register when the condition register bit has a negative transition (1 to 0). The variable <integer> is the sum of the decimal values of the bits that you want to enable.

Mode	All
------	-----

Remote Command	:STATus:QUESTionable:FREQuency:NTRansition <integer> :STATus:QUESTionable:FREQuency:NTRansition?
Example	STAT:QUES:FREQ:NTR 2 Frequency Reference 'regained lock' will be reported to the Frequency Summary of the Status Questionable register.
Preset	0
Min	0
Max	32767
Status Bits/OPC dependencies	Sequential command
Initial S/W Revision	Prior to A.02.00

Questionable Frequency Positive Transition

This command determines which bits in the Questionable Frequency Condition register will set the corresponding bit in the Questionable Frequency Event register when the condition register bit has a positive transition (0 to 1). The variable <integer> is the sum of the decimal values of the bits that you want to enable.

Mode	All
Remote Command	:STATus:QUESTionable:FREQuency:PTRansition <integer> :STATus:QUESTionable:FREQuency:PTRansition?
Example	STAT:QUES:FREQ:PTR 2 Frequency Reference 'became unlocked' will be reported to the Frequency Summary of the Status Questionable register.
Preset	32767
Min	0
Max	32767
Status Bits/OPC dependencies	Sequential command
Initial S/W Revision	Prior to A.02.00

Questionable Integrity Register

"Questionable Integrity Condition " on page 171

"Questionable Integrity Enable " on page 172

"Questionable Integrity Event Query " on page 172

"Questionable Integrity Negative Transition " on page 173

"Questionable Integrity Positive Transition " on page 173

Questionable Integrity Condition

This query returns the decimal value of the sum of the bits in the Questionable Integrity Condition register.

NOTE The data in this register is continuously updated and reflects the current conditions.

Mode	All
Remote Command	:STATus:QUESTionable:INTEgrity:CONDition?
Example	STAT:QUES:INT:COND?
Preset	0
Status Bits/OPC dependencies	Sequential command
Initial S/W Revision	Prior to A.02.00

Questionable Integrity Enable

This command determines which bits in the Questionable Integrity Condition Register will set bits in the Questionable Integrity Event register, which also sets the Integrity Summary bit (bit 9) in the Questionable Register. The variable <integer> is the sum of the decimal values of the bits you want to enable.

Mode	All
Remote Command	:STATus:QUESTionable:INTEgrity:ENABle <integer> :STATus:QUESTionable:INTEgrity:ENABle?
Example	STAT:QUES:INT:ENAB 8 Measurement Uncalibrated Summary will be reported to the Integrity Summary of the Status Questionable register.
Preset	32767
Min	0
Max	32767
Status Bits/OPC dependencies	Sequential command
Initial S/W Revision	Prior to A.02.00

Questionable Integrity Event Query

This query returns the decimal value of the sum of the bits in the Questionable Integrity Event register.

NOTE The register requires that the associated PTR or NTR filters be set before a condition register bit can set a bit in the event register. The data in this register is latched until it is queried. Once queried, the register is cleared.

Mode	All
Remote Command	:STATus:QUESTionable:INTEgrity[:EVENT]?
Example	STAT:QUES:INT?
Preset	0
Status Bits/OPC dependencies	Sequential command
Initial S/W Revision	Prior to A.02.00

Questionable Integrity Negative Transition

This command determines which bits in the Questionable Integrity Condition register will set the corresponding bit in the Questionable Integrity Event register when the condition register bit has a negative transition (1 to 0)

The variable <integer> is the sum of the decimal values of the bits that you want to enable.

Mode	All
Remote Command	:STATus:QUEStionable:INTEgrity:NTRansition <integer> :STATus:QUEStionable:INTEgrity:NTRansition?
Example	STAT:QUES:INT:NTR 8 Measurement 'regained calibration' Summary will be reported to the Integrity Summary of the Status Questionable register.
Preset	0
Min	0
Max	32767
Status Bits/OPC dependencies	Sequential command
Initial S/W Revision	Prior to A.02.00

Questionable Integrity Positive Transition

This command determines which bits in the Questionable Integrity Condition register will set the corresponding bit in the Questionable Integrity Event register when the condition register bit has a positive transition (0 to 1). The variable <integer> is the sum of the decimal values of the bits that you want to enable.

Mode	All
Remote Command	:STATus:QUEStionable:INTEgrity:PTRansition <integer> :STATus:QUEStionable:INTEgrity:PTRansition?
Example	STAT:QUES:INT:PTR 8 Measurement 'became uncalibrated' Summary will be reported to the Integrity Summary of the Status Questionable register.
Preset	32767
Min	0
Max	32767
Status Bits/OPC dependencies	Sequential command
Initial S/W Revision	Prior to A.02.00

Questionable Integrity Signal Register

"Questionable Integrity Signal Condition" on page 174

"Questionable Integrity Signal Enable" on page 174

"Questionable Integrity Signal Event Query" on page 175

"Questionable Integrity Signal Negative Transition" on page 175

"Questionable Integrity Signal Positive Transition" on page 175

Questionable Integrity Signal Condition

This query returns the decimal value of the sum of the bits in the Questionable Integrity Signal Condition register.

NOTE The data in this register is continuously updated and reflects the current conditions.

Mode	All
Remote Command	:STATus:QUESTionable:INTEgrity:SIGNal:CONDition?
Example	STAT:QUES:INT:SIGN:COND?
Preset	0
Status Bits/OPC dependencies	Sequential command
Initial S/W Revision	Prior to A.02.00

Questionable Integrity Signal Enable

This command determines which bits in the Questionable Integrity Signal Condition Register will set bits in the Questionable Integrity Signal Event register, which also sets the Integrity Summary bit (bit 9) in the Questionable Register. The variable <integer> is the sum of the decimal values of the bits you want to enable.

Mode	All
Remote Command	:STATus:QUESTionable:INTEgrity:SIGNal:ENABle <integer> :STATus:QUESTionable:INTEgrity:SIGNal:ENABle?
Example	STAT:QUES:INT:SIGN:ENAB 4 Burst Not Found will be reported to the Integrity Summary of the Status Questionable register.
Preset	32767
Min	0
Max	32767
Status Bits/OPC dependencies	Sequential command
Initial S/W Revision	Prior to A.02.00

Questionable Integrity Signal Event Query

This query returns the decimal value of the sum of the bits in the Questionable Integrity Signal Event register.

NOTE

The register requires that the associated PTR or NTR filters be set before a condition register bit can set a bit in the event register. The data in this register is latched until it is queried. Once queried, the register is cleared.

Mode	All
Remote Command	:STATus:QUESTionable:INTEgrity:SIGNal[:EVENT]?
Example	STAT:QUES:INT:SIGN?
Preset	0
Status Bits/OPC dependencies	Sequential command
Initial S/W Revision	Prior to A.02.00

Questionable Integrity Signal Negative Transition

This command determines which bits in the Questionable Integrity Signal Condition register will set the corresponding bit in the Questionable Integrity Signal Event register when the condition register bit has a negative transition (1 to 0). The variable <integer> is the sum of the decimal values of the bits that you want to enable.

Mode	All
Remote Command	:STATus:QUESTionable:INTEgrity:SIGNal:NTRansition <integer> :STATus:QUESTionable:INTEgrity:SIGNal:NTRansition?
Example	STAT:QUES:INT:SIGN:NTR 4 Burst found will be reported to the Integrity Summary of the Status Questionable register.
Preset	0
Min	0
Max	32767
Status Bits/OPC dependencies	Sequential command
Initial S/W Revision	Prior to A.02.00

Questionable Integrity Signal Positive Transition

This command determines which bits in the Questionable Integrity Signal Condition register will set the corresponding bit in the Questionable Integrity Signal Event register when the condition register bit has a positive transition (0 to 1). The variable <integer> is the sum of the decimal values of the bits that you want to enable.

Mode	All
Remote Command	:STATus:QUEStionable:INTEgrity:SIGNal:PTRansition <integer> :STATus:QUEStionable:INTEgrity:SIGNal:PTRansition?
Example	STAT:QUES:INT:SIGN:PTR 4 Burst not found will be reported to the Integrity Summary of the Status Questionable register.
Preset	32767
Min	0
Max	32767
Status Bits/OPC dependencies	Sequential command
Initial S/W Revision	Prior to A.02.00

Questionable Integrity Uncalibrated Register

"Questionable Integrity Uncalibrated Condition " on page 176

"Questionable Integrity Uncalibrated Enable " on page 176

"Questionable Integrity Uncalibrated Event Query " on page 177

"Questionable Integrity Uncalibrated Negative Transition " on page 177

"Questionable Integrity Uncalibrated Positive Transition " on page 178

Questionable Integrity Uncalibrated Condition

This query returns the decimal value of the sum of the bits in the Questionable Integrity Uncalibrated Condition register.

NOTE

The data in this register is continuously updated and reflects the current conditions.

Mode	All
Remote Command	:STATus:QUEStionable:INTEgrity:UNCalibrated:CONDition?
Example	STAT:QUES:INT:UNC:COND?
Preset	0
Status Bits/OPC dependencies	Sequential command
Initial S/W Revision	Prior to A.02.00

Questionable Integrity Uncalibrated Enable

This command determines which bits in the Questionable Integrity Uncalibrated Condition Register will set bits in the Questionable Integrity Uncalibrated Event register, which also sets the Data Uncalibrated Summary bit (bit 3) in the Questionable Integrity Register. The variable <integer> is the sum of the decimal values of the bits you want to enable.

Mode	All
Remote Command	:STATus:QUEStionable:INTEgrity:UNCalibrated:ENABle :STATus:QUEStionable:INTEgrity:UNCalibrated:ENABle?
Example	STAT:QUES:INT:UNC:ENAB 1 Oversweep (Meas Uncal) will be reported to the Integrity Summary of the Status Questionable register.
Preset	32767
Min	0
Max	32767
Status Bits/OPC dependencies	Sequential command
Initial S/W Revision	Prior to A.02.00

Questionable Integrity Uncalibrated Event Query

This query returns the decimal value of the sum of the bits in the Questionable Integrity Uncalibrated Event register.

NOTE

The register requires that the associated PTR or NTR filters be set before a condition register bit can set a bit in the event register. The data in this register is latched until it is queried. Once queried, the register is cleared.

Mode	All
Remote Command	:STATus:QUEStionable:INTEgrity:UNCalibrated[:EVENT]?
Example	STAT:QUES:INT:UNC?
Preset	0
Status Bits/OPC dependencies	Sequential command
Initial S/W Revision	Prior to A.02.00

Questionable Integrity Uncalibrated Negative Transition

This command determines which bits in the Questionable Integrity Uncalibrated Condition register will set the corresponding bit in the Questionable Integrity Uncalibrated Event register when the condition register bit has a negative transition (1 to 0). The variable <integer> is the sum of the decimal values of the bits that you want to enable.

Mode	All
Remote Command	:STATus:QUEStionable:INTEgrity:UNCalibrated:NTRansition <integer> :STATus:QUEStionable:INTEgrity:UNCalibrated:NTRansition?
Example	STAT:QUES:INT:UNC:NTR 1 Oversweep cleared will be reported to the Integrity Summary of the Status Questionable register.

Preset	0
Min	0
Max	32767
Status Bits/OPC dependencies	Sequential command
Initial S/W Revision	Prior to A.02.00

Questionable Integrity Uncalibrated Positive Transition

This command determines which bits in the Questionable Integrity Uncalibrated Condition register will set the corresponding bit in the Questionable Integrity Uncalibrated Event register when the condition register bit has a positive transition (0 to 1). The variable <integer> is the sum of the decimal values of the bits that you want to enable.

Mode	All
Remote Command	:STATus:QUEStionable:INTEgrity:UNCalibrated:PTRansition <integer> :STATus:QUEStionable:INTEgrity:UNCalibrated:PTRansition?
Example	STAT:QUES:INT:UNC:PTR 1 Oversweep (Meas Uncal) occurred will be reported to the Integrity Summary of the Status Questionable register.
Preset	32767
Min	0
Max	32767
Status Bits/OPC dependencies	Sequential command
Initial S/W Revision	Prior to A.02.00

Questionable Power Register

"Questionable Power Condition " on page 178

"Questionable Power Enable " on page 179

"Questionable Power Event Query " on page 179

"Questionable Power Negative Transition " on page 180

"Questionable Power Positive Transition " on page 180

Questionable Power Condition

This query returns the decimal value of the sum of the bits in the Questionable Power Condition register.

NOTE

The data in this register is continuously updated and reflects the current conditions.

Mode	All
Remote Command	:STATus:QUESTionable:POWer:CONDition?
Example	STAT:QUES:POW:COND?
Preset	0
Status Bits/OPC dependencies	Sequential command
Initial S/W Revision	Prior to A.02.00

Questionable Power Enable

This command determines which bits in the Questionable Power Condition Register will set bits in the Questionable Power Event register, which also sets the Power Summary bit (bit 3) in the Questionable Register. The variable <integer> is the sum of the decimal values of the bits you want to enable.

Mode	All
Remote Command	:STATus:QUESTionable:POWer:ENABle <integer> :STATus:QUESTionable:POWer:ENABle?
Example	STAT:QUES:POW:ENAB 32 50 MHz Input Pwr too High for Cal will be reported to the Power Summary of the Status Questionable register.
Preset	32767
Min	0
Max	32767
Status Bits/OPC dependencies	Sequential command
Initial S/W Revision	Prior to A.02.00

Questionable Power Event Query

This query returns the decimal value of the sum of the bits in the Questionable Power Event register.

NOTE

The register requires that the associated PTR or NTR filters be set before a condition register bit can set a bit in the event register. The data in this register is latched until it is queried. Once queried, the register is cleared.

Mode	All
Remote Command	:STATus:QUESTionable:POWer[:EVENT]?
Example	STAT:QUES:POW?
Preset	0
Status Bits/OPC dependencies	Sequential command
Initial S/W Revision	Prior to A.02.00

Questionable Power Negative Transition

This command determines which bits in the Questionable Power Condition register will set the corresponding bit in the Questionable Power Event register when the condition register bit has a negative transition (1 to 0). The variable <integer> is the sum of the decimal values of the bits that you want to enable.

Mode	All
Remote Command	:STATus:QUESTionable:POWer:NTRansition <integer> :STATus:QUESTionable:POWer:NTRansition?
Example	STAT:QUES:POW:NTR 32 50 MHz Input Power became OK for Cal will be reported to the Power Summary of the Status Questionable register.
Preset	0
Min	0
Max	32767
Status Bits/OPC dependencies	Sequential command
Initial S/W Revision	Prior to A.02.00

Questionable Power Positive Transition

This command determines which bits in the Questionable Power Condition register will set the corresponding bit in the Questionable Power Event register when the condition register bit has a positive transition (0 to 1). The variable <integer> is the sum of the decimal values of the bits that you want to enable.

Mode	All
Remote Command	:STATus:QUESTionable:POWer:PTRansition <integer> :STATus:QUESTionable:POWer:PTRansition?>
Example	STAT:QUES:POW:PTR 32 50 MHz Input Power became too high for Cal will be reported to the Power Summary of the Status Questionable register.
Preset	32767
Min	0
Max	32767
Status Bits/OPC dependencies	Sequential command
Initial S/W Revision	Prior to A.02.00

Questionable Temperature Register

"Questionable Temperature Condition" on page 181

"Questionable Temperature Enable" on page 181

"Questionable Temperature Event Query" on page 181

"Questionable Temperature Negative Transition" on page 182

"Questionable Temperature Positive Transition" on page 182

Questionable Temperature Condition

This query returns the decimal value of the sum of the bits in the Questionable Temperature Condition register.

NOTE

The data in this register is continuously updated and reflects the current conditions.

Mode	All
Remote Command	:STATus:QUEStionable:TEMPerature:CONDition?
Example	STAT:QUES:TEMP:COND?
Preset	0
Status Bits/OPC dependencies	Sequential command
Initial S/W Revision	Prior to A.02.00

Questionable Temperature Enable

This command determines which bits in the Questionable Temperature Condition Register will set bits in the Questionable Temperature Event register, which also sets the Temperature Summary bit (bit 4) in the Questionable Register. The variable <integer> is the sum of the decimal values of the bits you want to enable.

Mode	All
Remote Command	:STATus:QUEStionable:TEMPerature:ENABle <integer> :STATus:QUEStionable:TEMPerature:ENABle?
Example	STAT:QUES:TEMP:ENAB 1 Reference Oscillator Oven Cold will be reported to the Temperature Summary of the Status Questionable register.
Preset	32767
Min	0
Max	32767
Status Bits/OPC dependencies	Sequential command
Initial S/W Revision	Prior to A.02.00

Questionable Temperature Event Query

This query returns the decimal value of the sum of the bits in the Questionable Temperature Event register.

NOTE

The register requires that the associated PTR or NTR filters be set before a condition register bit can set a bit in the event register. The data in this register is latched until it is queried. Once queried, the register is cleared

Mode	All
Remote Command	:STATus:QUEStionable:TEMPerature[:EVENT]?
Example	STAT:QUES:TEMP?
Preset	0
Status Bits/OPC dependencies	Sequential command
Initial S/W Revision	Prior to A.02.00

Questionable Temperature Negative Transition

This command determines which bits in the Questionable Temperature Condition register will set the corresponding bit in the Questionable Temperature Event register when the condition register bit has a negative transition (1 to 0). The variable <integer> is the sum of the decimal values of the bits that you want to enable.

Mode	All
Remote Command	:STATus:QUEStionable:TEMPerature:NTRansition <integer> :STATus:QUEStionable:TEMPerature:NTRansition?
Example	STAT:QUES:TEMP:NTR 1 Reference Oscillator Oven not cold will be reported to the Temperature Summary of the Status Questionable register.
Preset	0
Min	0
Max	32767
Status Bits/OPC dependencies	Sequential command
Initial S/W Revision	Prior to A.02.00

Questionable Temperature Positive Transition

This command determines which bits in the Questionable Temperature Condition register will set the corresponding bit in the Questionable Temperature Event register when the condition register bit has a positive transition (0 to 1). The variable <integer> is the sum of the decimal values of the bits that you want to enable.

Mode	All
Remote Command	:STATus:QUEStionable:TEMPerature:PTRansition <integer> :STATus:QUEStionable:TEMPerature:PTRansition?
Example	STAT:QUES:TEMP:PTR 1 Reference Oscillator Oven became cold will be reported to the

	Temperature Summary of the Status Questionable register.
Preset	32767
Min	0
Max	32767
Status Bits/OPC dependencies	Sequential command
Initial S/W Revision	Prior to A.02.00

IEEE 488.2 Common Commands

The instrument supports the following subset of IEEE 488.2 Common Commands, as defined in Chapter 10 of [IEEE Standard 488.2-1992](#). As indicated in the detailed descriptions, some of these commands correspond directly to instrument front-panel key functionality, while others are available only as remote commands.

Command	Description
*CAL?	Align Now "All " on page 375
*CLS	"Clear Status " on page 186
*ESE	"Standard Event Status Enable " on page 187
*ESE?	
*ESR?	"Standard Event Status Register Query " on page 187
*IDN?	"Identification Query " on page 188
*OPC	"Operation Complete " on page 188
*OPC?	
*OPT?	"Query Instrument Options " on page 189
*RCL	"Recall Instrument State " on page 189
*RST	"*RST (Remote Command Only)" on page 190
*SAV	"Save Instrument State " on page 190
*SRE	"Service Request Enable " on page 191
*SRE?	
*STB?	"Status Byte Query " on page 191
*TRG	"Trigger " on page 192
*TST?	"Self Test Query " on page 192
*WAI	"Wait-to-Continue " on page 192

All

(In MXE the key label is "All (plus RF Presel 20 Hz – 3.6 GHz)")Immediately executes an alignment of all subsystems In MXE, the Align Now All is followed by additionally aligning the RF Preselector section, so in MXE, the key label contains the parenthetical note "(plus RF Presel 20 Hz – 3.6 GHz)". The instrument stops any measurement currently underway, performs the alignment, then restarts the measurement from the beginning (similar to pressing the Restart key).

If an interfering user signal is present at the RF Input, the alignment is performed on all subsystems except the RF. After completion, the Error Condition message "Align skipped: 50 MHz interference" or "Align skipped: 4.8 GHz interference" is generated. In addition the Error Condition message "Align Now, RF required" is generated, and bits 11 and 12 are set in the Status Questionable Calibration register.

The query form of the remote commands (:CALibration[:ALL]? or *CAL?) invokes the alignment of all subsystems and returns a success or failure value. An interfering user signal is not grounds for failure; if the

alignment was able to succeed on all portions but unable to align the RF because of an interfering signal, the resultant will be the success value.

Successful completion of Align Now, All will clear the “Align Now, All required” Error Condition, and clear bit 14 in the Status Questionable Calibration register. It will also begin the elapsed time counter for Last Align Now, All Time, and capture the Last Align Now, All Temperature.

In the MXE, successful completion will also clear the “Align 20 Hz to 30 MHz required” Error Condition, the “Align 30 MHz to 3.6 GHz required” Error Condition, and the “Align 20 Hz to 3.6 GHz required” Error Condition, and clear bits 1 and bit 2 and clear the bit 1 in the Status Questionable Calibration Extended Needed register.

If the Align RF subsystem succeeded in aligning (no interfering signal present), the elapsed time counter begins for Last Align Now, RF Time, and the temperature is captured for the Last Align Now, RF Temperature. In addition the Error Conditions “Align skipped: 50 MHz interference” and “Align skipped: 4.8 GHz interference” are cleared, the Error Condition “Align Now, RF required” is cleared, and bits 11 and 12 are cleared in the Status Questionable Calibration register

Align Now, All can be interrupted by pressing the Cancel (ESC) front-panel key or remotely with Device Clear followed by the :ABORt SCPI command. When this occurs the Error Condition message “Align Now, All required” is generated, and bit 14 is set in the Status Questionable Condition register. This is because new alignment data may be employed for an individual subsystem, but not a cohesive set of data for all subsystems.

In many cases, you might find it more convenient to change alignments to Normal, instead of executing Align Now, All. When the Auto Align process transitions to Normal, the analyzer will immediately start to update only the alignments that have expired, thus efficiently restoring the alignment process.

Key Path	System, Alignments, Align Now
Mode	All
Remote Command	:CALibration[:ALL] :CALibration[:ALL]?
Example	:CAL
Notes	:CALibration[:ALL]? returns 0 if successful :CALibration[:ALL]? returns 1 if failed :CALibration[:ALL]? is the same as *CAL? While Align Now, All is performing the alignment, bit 0 in the Status Operation register is set. Completion, or termination, will clear bit 0 in the Status Operation register. This command is sequential; it must complete before further SCPI commands are processed. Interrupting the alignment from remote is accomplished by invoking Device Clear followed by the :ABORt command. Successful completion will clear bit 14 in the Status Questionable Calibration register. An interfering user signal is not grounds for failure of Align Now, All. However, bits 11 and 12 are set in the Status Questionable Calibration register to indicate Align Now, RF is required. An interfering user supplied signal will result in the instrument requiring an Align Now, RF with the interfering signal removed.
Couplings	Initializes the time for the Last Align Now, All Time. Records the temperature for the Last Align Now, All Temperature.

	If Align RF component succeeded, initializes the time for the Last Align Now, RF Time. If Align RF component succeeded, records the temperature for the Last Align Now, RF Temperature.
Status Bits/OPC dependencies	Bits 11, 12, or 14 may be set in the Status Questionable Calibration register.
Initial S/W Revision	Prior to A.02.00

Mode	All
Remote Command	*CAL?
Example	*CAL?
Notes	*CAL? returns 0 if successful *CAL? returns 1 if failed :CALibration[:ALL]? is the same as *CAL? See additional remarks described with :CALibration[:ALL]? Everything about :CALibration[:ALL]? is synonymous with *CAL? including all conditions, status register bits, and couplings
Initial S/W Revision	Prior to A.02.00

Mode	All
Remote Command	:CALibration[:ALL]:NPENding
Example	CAL:NPEN
Notes	:CALibration[:ALL]:NPENding is the same as :CALibration[:ALL] including all conditions, status register bits, except this scpi command does not BLOCK the scpi session, so the user should use status register bits to query if the calibration is successfully completed or not. Typical usage is: 1) :CALibration:ALL:NPENding (Start a calibration) 2) :STATus:OPERation:CONDition? (Check if the calibration is completed or not, If bit 0 is set, then the system is doing calibration, the user should repeat this scpi query until the bit is cleared) 3):STATus:QUEStionable:CALibration:CONDition? (Check if if there are any errors/failures in previous calibration procedure
Initial S/W Revision	X.14.20

Clear Status

Clears the status byte register. It does this by emptying the error queue and clearing all bits in all of the event registers. The status byte register summarizes the states of the other registers. It is also responsible for generating service requests.

Key Path	No equivalent key. Related key System, Show Errors, Clear Error Queue
----------	---

Remote Command	*CLS
Example	*CLS Clears the error queue and the Status Byte Register.
Notes	For related commands, see the SYSTem:ERRor[:NEXT]? command. See also the STATus:PRESet command and all commands in the STATus subsystem.
Status Bits/OPC dependencies	Resets all bits in all event registers to 0, which resets all the status byte register bits to 0 also.
Backwards Compatibility Notes	In general the status bits used in the X-Series status system will be backwards compatible with ESA and PSA. However, note that all conditions will generate events that go into the event log, and some will also generate status bits.
Initial S/W Revision	Prior to A.02.00

Standard Event Status Enable

Selects the desired bits from the standard event status enable register. This register monitors I/O errors and synchronization conditions such as operation complete, request control, query error, device dependent error, status execution error, command error, and power on. The selected bits are OR'd to become a summary bit (bit 5) in the byte register which can be queried.

The query returns the state of the standard event status enable register.

Key Path	No equivalent key. Related key System, Show Errors, Clear Error Queue
Remote Command	*ESE <integer> *ESE?
Example	*ESE 36 Enables the Standard Event Status Register to monitor query and command errors (bits 2 and 5). *ESE? Returns a 36 indicating that the query and command status bits are enabled.
Notes	For related commands, see the STATus subsystem and SYSTem:ERRor[:NEXT]? commands.
Preset	255
State Saved	Not saved in state.
Min	0
Max	255
Status Bits/OPC dependencies	Event Enable Register of the Standard Event Status Register.
Initial S/W Revision	Prior to A.02.00

Standard Event Status Register Query

Queries and clears the standard event status event register. (This is a destructive read.) The value returned is a hexadecimal number that reflects the current state (0/1) of all the bits in the register.

Remote Command	*ESR?
-----------------------	-------

Example	*ESR? Returns a 1 if there is either a query or command error, otherwise it returns a zero.
Notes	For related commands, see the STATus subsystem commands.
Preset	0
Min	0
Max	255
Status Bits/OPC dependencies	Standard Event Status Register (bits 0 - 7).
Initial S/W Revision	Prior to A.02.00

Identification Query

Returns a string of instrument identification information. The string will contain the model number, serial number, and firmware revision.

The response is organized into four fields separated by commas. The field definitions are as follows:

- Manufacturer
- Model
- Serial number
- Firmware version

Key Path	No equivalent key. See related key System, Show System.
Remote Command	*IDN?
Example	*IDN? Returns instrument identification information, such as: Agilent Technologies, N9020A, US01020004, A.01.02
Initial S/W Revision	Prior to A.02.00
Modified at S/W Revision	x.14.50

Operation Complete

The *OPC command sets bit 0 in the standard event status register (SER) to “1” when pending operations have finished, that is when all overlapped commands are complete. It does not hold off subsequent operations. You can determine when the overlapped commands have completed either by polling the OPC bit in SER, or by setting up the status system such that a service request (SRQ) is asserted when the OPC bit is set.

The *OPC? query returns a “1” after all the current overlapped commands are complete. So it holds off subsequent commands until the “1” is returned, then the program continues. This query can be used to synchronize events of other instruments on the external bus.

Remote Command	*OPC
-----------------------	------

	*OPC?
Example	INIT:CONT 0 Selects single sweeping. INIT:IMM Initiates a sweep. *OPC? Holds off any further commands until the sweep is complete.
Status Bits/OPC dependencies	Not global to all remote ports or front panel. *OPC only considers operation that was initiated on the same port as the *OPC command was issued from. *OPC is an overlapped command, but *OPC? is sequential.
Backwards Compatibility Notes	<ol style="list-style-type: none"> 1. The ESA/PSA/VSA products do not meet all the requirements for the *OPC command specified by IEEE 488.2. This is corrected for X-Series. This will sometimes cause behavior that is not backward compatible, but it will work as customers expect. 2. Commands such as, *OPC/*OPC?/*WAI/*RST used to be global. They considered front panel operation in conjunction with the GPIB functionality. Now they are evaluated on a per channel basis. That is, the various rear panel remote ports and the front panel i/o are all considered separately. Only the functionality initiated on the port where the *OPC was sent, is considered for its operation. 3. *OPC used to hold off until the operation bits were cleared. Now it holds off until all overlapping commands are completed. Also, earlier instruments did not wait for completion of all processes, only the ones identified here (in the STATus:OPERation register): Calibrating: monitored by PSA, ESA, VSA (E4406A) Sweeping: monitored by PSA, ESA, VSA (E4406A) Waiting for Trigger: monitored by PSA, ESA, VSA (E4406A) Measuring: monitored by PSA and ESA (but not in all Modes). Paused: monitored by VSA (E4406A). Printing: monitored by VSA (E4406A). Mass memory busy: monitored by VSA (E4406A).
Initial S/W Revision	Prior to A.02.00

Query Instrument Options

Returns a string of all the installed instrument options. It is a comma separated list with quotes, such as: "503,P03,PFR".

To be IEEE compliant, this command should return an arbitrary ascii variable that would not begin and end with quotes. But the quotes are needed to be backward compatible with previous SA products and software. So, the actual implementation will use arbitrary ascii. But quotes will be sent as the first and last ascii characters that are sent with the comma-separated option list.

Remote Command	*OPT?
Initial S/W Revision	Prior to A.02.00

Recall Instrument State

This command recalls the instrument state from the specified instrument memory register.

- If the state being loaded has a newer firmware revision than the revision of the instrument, no state is recalled and an error is reported
- If the state being loaded has an equal firmware revision than the revision of the instrument, the state will be loaded.
- If the state being loaded has an older firmware revision than the revision of the instrument, the instrument will only load the parts of the state that apply to the older revision.

Remote Command	*RCL <register #>
Example	*RCL 7 Recalls the instrument state that is currently stored in register 7.
Notes	Registers 0 through 6 are accessible from the front panel in menu keys for Recall Registers.
Min	0
Max	127
Status Bits/OPC dependencies	The command is sequential.
Initial S/W Revision	Prior to A.02.00

*RST (Remote Command Only)

*RST is equivalent to :SYST:PRES::INIT:CONT OFF, which is a Mode Preset in the Single measurement state. This remote command is preferred over Mode Preset remote command - :SYST:PRES, as optimal remote programming occurs with the instrument in the single measurement state.

Remote Command	*RST
Example	*RST
Notes	Sequential Clears all pending OPC bits and the Status Byte is set to 0.
Couplings	A *RST will cause the currently running measurement to be aborted and cause the default measurement to be active. *RST gets the mode to a consistent state with all of the default couplings set.
Backwards Compatibility Notes	In legacy analyzers *RST did not set the analyzer to Single, but in the X-Series it does, for compliance with the IEEE 488.2 specification. In the X-Series, *RST does not do a *CLS (clear the status bits and the error queue). In legacy analyzers, *RST used to do the equivalent of SYSTem:PRESet, *CLS and INITiate:CONTInuous OFF. But to be 488.2 compliant, *RST in the X-Series does not do a *CLS.
Initial S/W Revision	Prior to A.02.00

Save Instrument State

This command saves the current instrument state and mode to the specified instrument memory register.

Remote Command	*SAV <register #>
Example	*SAV 9 Saves the instrument state in register 9.
Notes	Registers 0 through 6 are accessible from the front panel in menu keys for Save Registers.
Min	0
Max	127
Status Bits/OPC dependencies	The command is sequential.
Initial S/W Revision	Prior to A.02.00

Service Request Enable

This command enables the desired bits of the service request enable register.

The query returns the value of the register, indicating which bits are currently enabled.

Remote Command	*SRE <integer> *SRE?
Example	*SRE 22 Enables bits 1, 2, and 4 in the service request enable register.
Notes	For related commands, see the STATus subsystem and SYSTem:ERRor[:NEXT]? commands.
Preset	0
Min	0
Max	255
Status Bits/OPC dependencies	Service Request Enable Register (all bits, 0 - 7).
Initial S/W Revision	Prior to A.02.00

Status Byte Query

Returns the value of the status byte register without erasing its contents.

Remote Command	*STB?
Example	*STB? Returns a decimal value for the bits in the status byte register. For example, if a 16 is returned, it indicates that bit 5 is set and one of the conditions monitored in the standard event status register is set.
Notes	See related command *CLS.
Status Bits/OPC dependencies	Status Byte Register (all bits, 0 - 7).
Initial S/W Revision	Prior to A.02.00

Trigger

This command triggers the instrument. Use the :TRIGger[:SEQuence]:SOURce command to select the trigger source.

Key Path	No equivalent key. See related keys Single and Restart.
Remote Command	*TRG
Example	*TRG Triggers the instrument to take a sweep or start a measurement, depending on the current instrument settings.
Notes	See related command :INITiate:IMMediate.
Initial S/W Revision	Prior to A.02.00

Self Test Query

This query performs the internal self-test routines and returns a number indicating the success of the testing. A zero is returned if the test is successful, 1 if it fails.

Remote Command	*TST?
Example	*TST? Runs the self-test routines and returns 0=passed, 1=some part failed.
Initial S/W Revision	Prior to A.02.00

Wait-to-Continue

This command causes the instrument to wait until all overlapped commands are completed before executing any additional commands. There is no query form for the command.

Remote Command	*WAI
Example	INIT:CONT OFF; INIT;*WAI Sets the instrument to single sweep. Starts a sweep and waits for its completion.
Status Bits/OPC dependencies	Not global to all remote ports or front panel. *OPC only considers operation that was initiated on the same port as the *OPC command was issued from.
Initial S/W Revision	Prior to A.02.00

4 Input/Output Functions

Input/Output

The Input/Output features are common across multiple Modes and Measurements. These common features are described in this section. See the Measurement description for information on features that are unique.

The Input/Output key accesses the keys that control the Input/Output parameters of the instrument. In general, these are functions associated with external connections to the analyzer, either to the inputs or the outputs. Since these connections tend to be fairly stable within a given setup, in general, the input/output settings do not change when you Preset the analyzer.

Other functions related to the input/output connections, but which tend to change on a measurement by measurement basis, can be found under the Trigger and AMPTD Y Scale keys. In addition, some of the digital I/O bus configurations can be found under the System key.

NOTE

The functions in the Input/Output menu are "global" (common) to all Modes (applications). But individual Input/Output functions only appear in a Mode if they apply to that Mode. Functions that apply to a Mode but not to all measurements in the Mode may be grayed-out in some measurements.

["Input/Output variables - Preset behavior" on page 195](#)

The Input Port selection is the first menu under the Input/Output key:

Key Path	Front-panel key
Remote Command	<code>[:SENSe] :FEED RF AIQ EMIXer</code> <code>[:SENSe] :FEED?</code>
Example	<code>:FEED RF</code> <code>:FEED?</code>
Couplings	The <code>[:SENSe] :FEED RF</code> command turns the calibrator OFF
Preset	This setting is unaffected by a Preset or power cycle. It survives a Mode Preset and mode changes. It is set to RF on a "Restore Input/Output Defaults" or "Restore System Defaults->All"
State Saved	Saved in instrument state
Backwards Compatibility SCPI	<code>[:SENSe] :FEED AREFERENCE</code> In the PSA the calibrator was one of the inputs and selected using the AREF parameter to the same <code>:FEED</code> command that switched the inputs. In the X-Series it is controlled in a separate menu and overrides the input selection. For code compatibility the <code>[:SENSe] :FEED AREFERENCE</code> command is provided, and is aliased to <code>[:SENSe] :FEED :AREF REF50</code> , which causes the input to be switched to the 50 MHz calibrator. The <code>[:SENSe] :FEED RF</code> command switches the input back to the RF port and turns the calibrator OFF, thus providing full compatibility with the PSA calibrator function. Note that after sending this, the query <code>[:SENSe] :FEED?</code> will NOT return "AREF" but instead the currently selected input.
Backwards Compatibility SCPI	<code>[:SENSe] :FEED IQ IONLy QONLy</code> <code>[:SENSe] :FEED?</code> The parameters <code>IQ IONLy QONLy</code> are supported for backwards compatibility with the E44406A. <code>[:SENSe] :FEED IQ</code> aliases to <code>[:SENSe] :FEED :IQ :TYPE IQ</code> <code>[:SENSe] :FEED IONLy</code> aliases to <code>[:SENSe] :FEED :IQ :TYPE IONLy</code>

	<p>[;SENSe]:FEED QONLy aliases to [;SENSe]:FEED:IQ:TYPE QONLy</p> <p>The query [;SENSe]:FEED? will always returns AIQ whatever the type of legacy parameters IQ IONLy QONLy has been used.</p>
Backwards Compatibility Notes	<p>Most of the settings in the X-Series Input/Output system, including External Gain, Amplitude Corrections settings and data, etc., are shared by all modes and are not changed by a mode switch. Furthermore, most variables in the Input/Output system key are not affected by Mode Preset. Both of these behaviors represent a departure from legacy behavior.</p> <p>In the X-Series. Input/Output settings are reset by using the "Restore Input/Output Defaults" function. They can also be reset to their default values through the System->Restore System Defaults-> In/Out Config key or through the System ->Restore System Defaults -> All key (and corresponding SCPI).</p> <p>While this matches most use cases better, it does create some code compatibility issues. For example, Amplitude Corrections are no longer turned off by a Mode Preset, but instead by using the "Restore Input/Output Defaults" key/SCPI.</p> <p>Although Input/Output settings are not part of each Mode's State, they are saved in the Save State files, so that all of the instrument settings can be recalled with Recall State, as in legacy instruments.</p>
Initial S/W Revision	Prior to A.02.00
Remote Command	<p>:INPut:MIXer EXTernal INTernal</p> <p>:INPut:MIXer?</p>
Example	<p>INP:MIX INT</p> <p>INP:MIX?</p>
Notes	<p>In legacy analyzers you choose between the Internal mixer or an External Mixer. In the X-Series, the External Mixer is one of the choices for the Input and is selected using the FEED command (:SENSe:FEED EXTMIxer).</p> <p>For compatibility, the INPut:MIXer EXTernal INTernal legacy command is mapped as follows:</p> <ol style="list-style-type: none"> 1. When INPut:MIXer EXTernal is received, SENSe:FEED EMIXer is executed. 2. When INPut:MIXer INTernal is received, SENSe:FEED RF is executed. 3. When INPut:MIXer? is received, the response will be INT if any input other than the external mixer is selected and EXT if the external mixer is selected
Preset	INT
Backwards Compatibility Notes	<p>PSA supports the following SCPI Command :</p> <p>:INPut:MIXer:TYPE PRESelected UNPReselect</p> <p>:INPut:MIXer:TYPE?</p> <p>PXA does not support the :INPut:MIXer:TYPE command.</p>
Initial S/W Revision	A.08.01

Input/Output variables - Preset behavior

Virtually all the input/output settings are NOT a part of mode preset. They can be set to their default value

by one of the three ways:

- by using the Restore Input/Output Defaults key on the first page of the input/output menu,
- by using the System->Restore System Defaults->Input/Output Settings or,
- by using the System -> Restore System Defaults->All. Also, they survive a Preset and a Power cycle.

A very few of the Input/Output settings do respond to a Mode Preset; for example, if the Calibrator is on it turns off on a Preset, and if DC coupling is in effect it switches to AC on a Preset. These exceptions are made in the interest of reliability and usability, which overrides the need for absolute consistency. Exceptions are noted in the SCPI table for the excepted functions.

RF Input

Selects the front-panel RF input port to be the analyzer signal input. If RF is already selected, pressing this key accesses the RF input setup functions.

Key Path	Input/Output
Example	[:SENSe]:FEED RF
Couplings	The act of connecting the U7227A USB Preamplifier to one of the analyzer's USB ports will cause the Input to automatically switch to the RF Input. If the RF Calibrator is on, it is turned off. Subsequently disconnecting the USB Preamp from USB does not change the Input selection nor restore the previous selection.
Readback	The RF input port, RF coupling, and current input impedance settings appear on this key as: "XX, YY, ZZ" where XX is RF, RF2, RFIO1, RFIO2, depending on what input is selected (only appears on analyzers with multiple RF inputs) YY is AC or DC ZZ is 50Ω or 75Ω
Initial S/W Revision	Prior to A.02.00
Modified at S/W Revision	A.14.00

Input Z Correction

Sets the input impedance for unit conversions. This affects the results when the y-axis unit is voltage or current units (dBmV, dBμV, dBμA, V, A), but not when it is power units (dBm, W). The impedance you select is for computational purposes only, since the actual impedance is set by internal hardware to 50 ohms. Setting the computational input impedance to 75 ohms is useful when using a 75 ohm to 50 ohm adapter to measure a 75 ohm device on an analyzer with a 50 ohm input impedance.

There are a variety of ways to make 50 to 75 ohm transitions, such as impedance transformers or minimum loss pads. The choice of the solution that is best for your measurement situation requires balancing the amount of loss that you can tolerate with the amount of measurement frequency range that you need. If you are using one of these pads/adaptors with the Input Z Corr function, you might also want to use the Ext Gain key. This function is used to set a correction value to compensate for the gain (loss) through your pad. This correction factor is applied to the displayed measurement values.

Key Path	Input/Output, RF Input
Remote Command	[:SENSe] :CORRection:IMPedance [:INPut] [:MAGNitude] 50 75 [:SENSe] :CORRection:IMPedance [:INPut] [:MAGNitude] ?
Example	CORR:IMP 75 sets the input impedance correction to 75 ohms. CORR:IMP?
Couplings	In the N9000A option C75, when RF Input 2 is selected, the Input Z Correction will automatically change to 75 ohms. You may then change it to whatever is desired. When the main RF Input is selected, the Input Z Correction will automatically change to 50 ohms. You may then change it to whatever is desired.
Preset	This is unaffected by a Preset but is set to 50 ohms on a "Restore Input/Output Defaults" or "Restore System Defaults->All" Some instruments/options may have 75 ohms available.
State Saved	Saved in instrument state
Readback	50 Ω or 75 Ω . Current setting reads back to the RF key.
Initial S/W Revision	Prior to A.02.00

RF Coupling

Specifies alternating current (AC) or direct current (DC) coupling at the analyzer RF input port. Selecting AC coupling switches in a blocking capacitor that blocks any DC voltage present at the analyzer input. This decreases the input frequency range of the analyzer, but prevents damage to the input circuitry of the analyzer if there is a DC voltage present at the RF input.

In AC coupling mode, you can view signals below the corner frequency of the DC block, but below a certain frequency the amplitude accuracy is not specified. The frequency below which specifications do not apply is:

X-Series Model	Lowest Freq for meeting specs when AC coupled	Lowest Freq for meeting specs when DC coupled
N9000A-503/507	100 kHz	n/a
N9000A-C75 Input 2	1 MHz	n/a
N9000A-513/526	10 MHz	9 kHz
N9010A	10 MHz	9 kHz
N9020A	10 MHz	20 Hz
N9030A	10 MHz	3 Hz

Some amplitude specifications apply only when coupling is set to DC. Refer to the appropriate amplitude specifications and characteristics for your analyzer.

When operating in DC coupled mode, ensure protection of the analyzer input circuitry by limiting the DC part of the input level to within 200 mV of 0 Vdc. In AC or DC coupling, limit the input RF power to +30 dBm (1 Watt).

Key Path	Input/Output, RF Input
Remote Command	:INPut:COUPling AC DC :INPut:COUPling?
Example	INP:COUP DC
Dependencies	This key does not appear in models that are always AC coupled. When the SCPI command to set DC coupling is sent to these models, it results in the error "Illegal parameter value; This model is always AC coupled" In these models, the SCPI query INP:COUP? always returns AC. This key does not appear in models that are always DC coupled. When the SCPI command to set AC coupling is sent to these models, it results in the error "Illegal parameter value; This instrument is always DC coupled" In these models, the SCPI query INP:COUP? always returns DC.
Preset	AC on models that support AC coupling On models that are always DC coupled, such as millimeter wave models (frequency ranges 30 GHz and above), the preset is DC.
State Saved	Saved in instrument state.
Initial S/W Revision	Prior to A.02.00
Modified at S/W Revision	A.03.00

External Mixer

This key allows you to choose an External Mixer through which to apply signal input to the analyzer. When chosen, the LO/IF port becomes the input to the analyzer.

External Mixing requires option EXM. The External Mixer key will not appear unless option EXM is installed. The presence of the LO/IF connector alone does not indicate that you have Option EXM licensed. To verify that option EXM is installed, press System, Show, System.

When External Mixer is selected, the Center Freq key controls the setting of the Center Freq in external mixing, which is separate from the settings of Center Freq for the RF Input or BBIQ. Each input retains its unique settings for Center Freq. A unique SCPI command is provided solely for the external mixing Center Freq (see the Center Freq key description), which only affects the External Mixer CF, although sending the generic Center Freq command while External Mixer is selected also controls the External Mixer CF.

See "[More Information](#)" on page 199

Key Path	Input/Output
Example	:FEED EMIX
Notes	Not all measurements support the use of the External Mixer input. When External Mixer is selected in a measurement that does not support it, the "No result; Meas invalid with Ext Mixing" error condition occurs.
Dependencies	Unless option EXM is present, the External Mixer key is blanked, and all SCPI commands associated with menus accessed by this key return an error

	Manual FFT mode is available with external mixing, but not with Signal ID.
Preset	All settings under this key are returned to their default state when Restore Input/Output Defaults is pressed.
State Saved	All settings under this key, and all Frequency settings, are remembered when you go out of External Mixer, so that when External Mixer is chosen again, all the external mixer functions will retain their previous settings, with the exception of Signal ID which is set to OFF (Signal ID is also set to Off unless External Mixer is the selected Input).
Readback Text	The readback text on this key shows the currently selected mixer, in square brackets.
Backwards Compatibility Notes	Unlike PSA, all external mixer settings including Center Frequency are retained when you go in and out of External Mixing. Also, Preset does not take you out of External Mixing (Restore Input/Output Defaults does).
Initial S/W Revision	A.08.01

More Information

X-series analyzers have a combined LO Out/IF In connection, whereas earlier analyzers used separate ports for the LO Out and the IF in. Internal diplexers in the analyzer and the mixer simplify the connection for the user – only a single SMA cable is required.

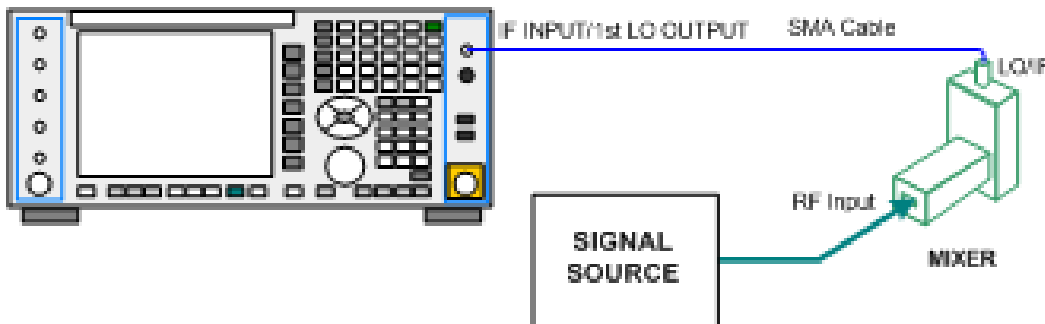

Legacy HP/Agilent and some third party mixers have separate LO In and IF out connections. This requires you to use an external diplexer to connect these mixers. A diplexer can easily be purchased for this purpose (for example, Diplexer Model # DPL.26 or # DPL.313B from OML Inc., Morgan Hill CA)

The connection diagram for such a legacy mixer is:

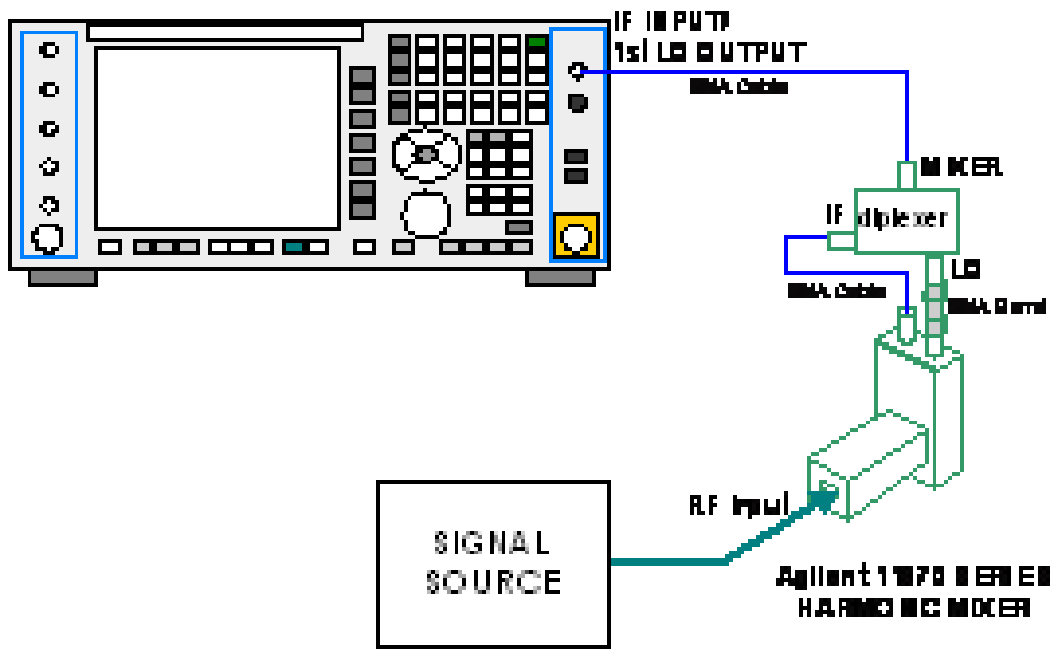

In addition, External Mixing in the X-Series supports the new Agilent M1970 series of Harmonic Mixers, which provide a USB connection for download of calibration data and additional control.

The connection diagram for one of the Agilent USB mixers is:

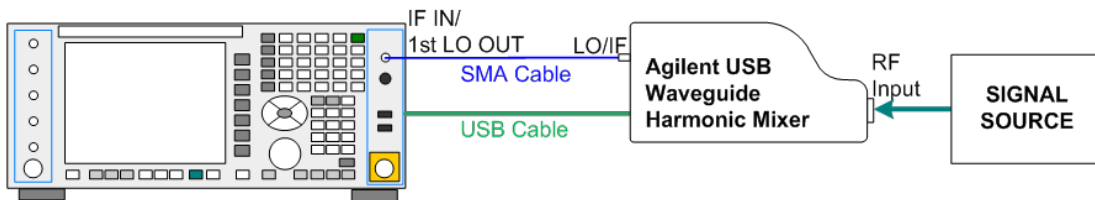

External Mixing is only supported in certain Modes and Measurements in the X-Series, as shown in the table below:

Mode	Measurements	Sig ID (Image Suppress only)
Spectrum Analyzer	Swept SA	Y*
	TOI	Y
	Harmonics	N
	Spurious Emissions	Y
	Channel Power	Y
	Occupied BW	Y
	ACP	Y
	Spectrum Emissions Mask	Y
	CCDF	N

	Burst Power	N
	List Sweep	N
Phase Noise	Monitor Spectrum	Y
	Log Plot	Y
	Spot Frequency	N
	Waveform	N
I/Q Analyzer	Complex Spectrum	N
	Waveform	N
Vector Signal Analyzer	Vector Analysis	N
	Analog Demod	N
	Digital Demod	N

* the Swept SA measurement also supports Image Shift

Ext Mix Setup

This menu lets you select the mixer type, and lets you configure your mixer (if necessary). While in this menu, and any of its submenus, the External Mixer Setup screen appears, showing you the current settings for the selected mixer. These settings may be dependent on which IF path is currently in use, whether a + or – harmonic is currently selected, etc.

To apply any amplitude correction factors needed to correct mixer flatness, you enter values into one of the Correction tables (under Input/Output, Corrections). The correction conversion loss values can be extracted from data supplied with the mixer or from manual measurements you make to determine the conversion loss. Note that the correction applied by the Correction tables is global to the analyzer; therefore you should make sure to turn off the External Mixer corrections when you are not using the External Mixer input.

NOTE

The Agilent USB Mixers automatically give their flatness data to the analyzer, and the correction is applied internally. No correction needs to be entered by the user, and the correction does not appear in the user-accessible Corrections tables. The user is free to enter additional corrections into the Correction tables under Input/Output, Corrections.

Key Path	Input/Output, External Mixer
State Saved	All settings in the Mixer Setup are part of the Input/Output system, and hence are saved whenever State is saved.
Readback Text	The readback line on this key shows the currently selected mixer, in square brackets.
Initial S/W Revision	A.08.01
Modified at S/W Revision	A.08.50

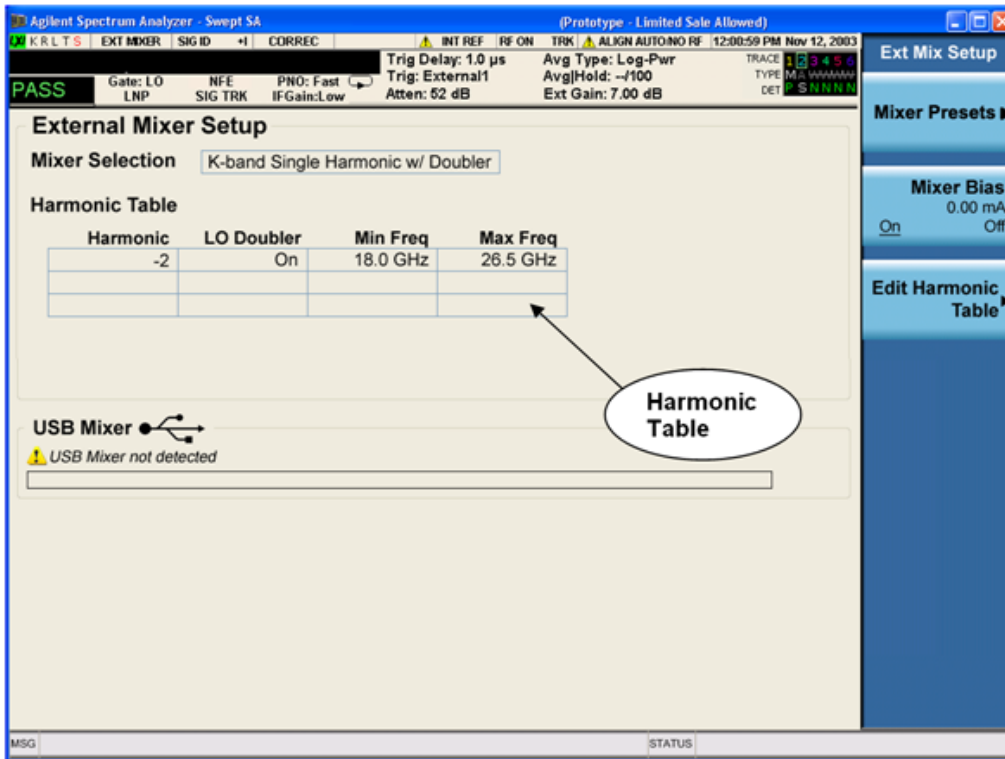

The External Mixer Setup screen looks like this

The current Mixer selection (the current or most recently connected USB Mixer, or the most recent Mixer Preset, or “Custom” if the user has modified the setup) reads out at the top of this screen.

The Harmonic Table currently being used reads out below the Mixer Selection. It shows each range being used for the current mixer. Note that a band may be made up of up to 3 ranges. Each range represents a choice of mixer harmonic and doubler state. When you select a Mixer Preset, it sets the analyzer Start and Stop frequency to the values shown in the Harmonic Table; Start Freq is set to the Min Freq for the bottom range, and Stop Freq is set to the Max Freq for the top range. In many cases you can exceed these nominal values; the absolute maximum and minimum frequency for each preset are shown in the tables that accompany the key descriptions for the Mixer Presets.

NOTE

If the current measurement has a limited Span available to it, and cannot achieve the Span shown in the table (Span=Stop Freq – Start Freq), the analyzer uses the maximum Span the measurement allows, and sets the Center Freq to the midpoint of the Start and Stop Freq values in the Harmonic Table.

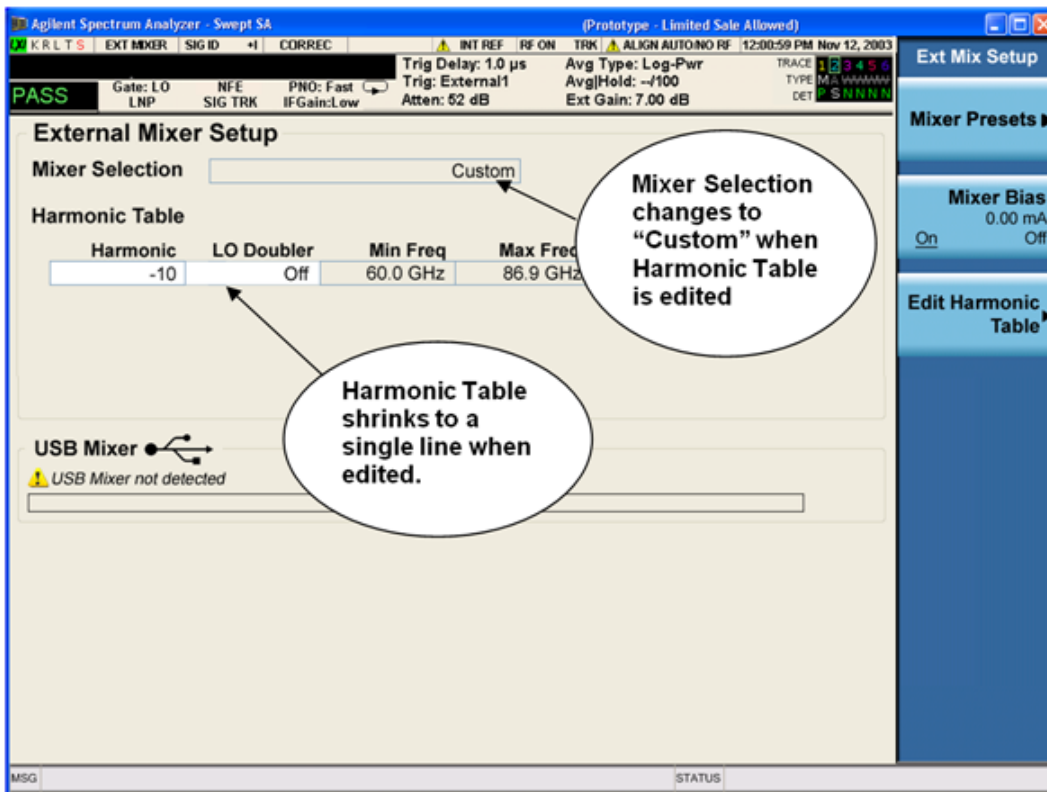

You may customize the Harmonic Table, but when you do this the analyzer goes into “single harmonic” mode. You may enter the harmonic number and whether to use the doubler or not, but now range switching is not supported, so you can only have one harmonic.

When you edit the Harmonic Table, the Mixer Selection changes to “Custom.” To change it back you must go back into the Mixer Presets menu and select a Preset.

When you edit the Harmonic Table, the nominal Min Freq and Max Freq that are available will usually be different than the Preset you were using; and the absolute frequency limits will change as well. This may result in a change to your Start and/or Stop Freq, if the current values fall outside the new range, requiring you to retune your Center Freq to get your signal back in the center.

The analyzer supports the Agilent M1970 Series Harmonic Mixers with USB connection. While in External Mixing, if one of these mixers is plugged in to a USB port, it is automatically detected and displayed in the “USB Mixer” area of the setup screen, including its model number and serial number.

The analyzer assumes that if you plug a mixer into the USB, that is the mixer you want to use. Therefore:

1. If a USB mixer is connected to the USB port, the Mixer Presets menu is grayed out, as none of the presets make sense with a USB Mixer connected. Note that once the analyzer has acquired the USB Mixer, the mixer selection will remain if it is subsequently unplugged from the USB, allowing you to plug it back in with no change to your settings. However, once you unplug it, the Mixer Presets key will stop being grayed out, allowing you to preset to a different mixer.
2. When Restore Input/Output Defaults is performed, if an Agilent USB Mixer is plugged into the analyzer’s USB port, the Mixer Selection remains unchanged.

3. When recalling an instrument state, if an Agilent USB Mixer is plugged into the analyzer's USB port, and the Mixer Selection in the recalled state is for a USB Mixer that does not match the mixer currently plugged in, you will have to unplug your mixer and then plug it back in to get the analyzer to recognize your mixer.

As long as the selection in Ext Mixer Setup shows one of the USB mixers, both the Mixer Bias and Edit Harmonic Table keys will be grayed out.

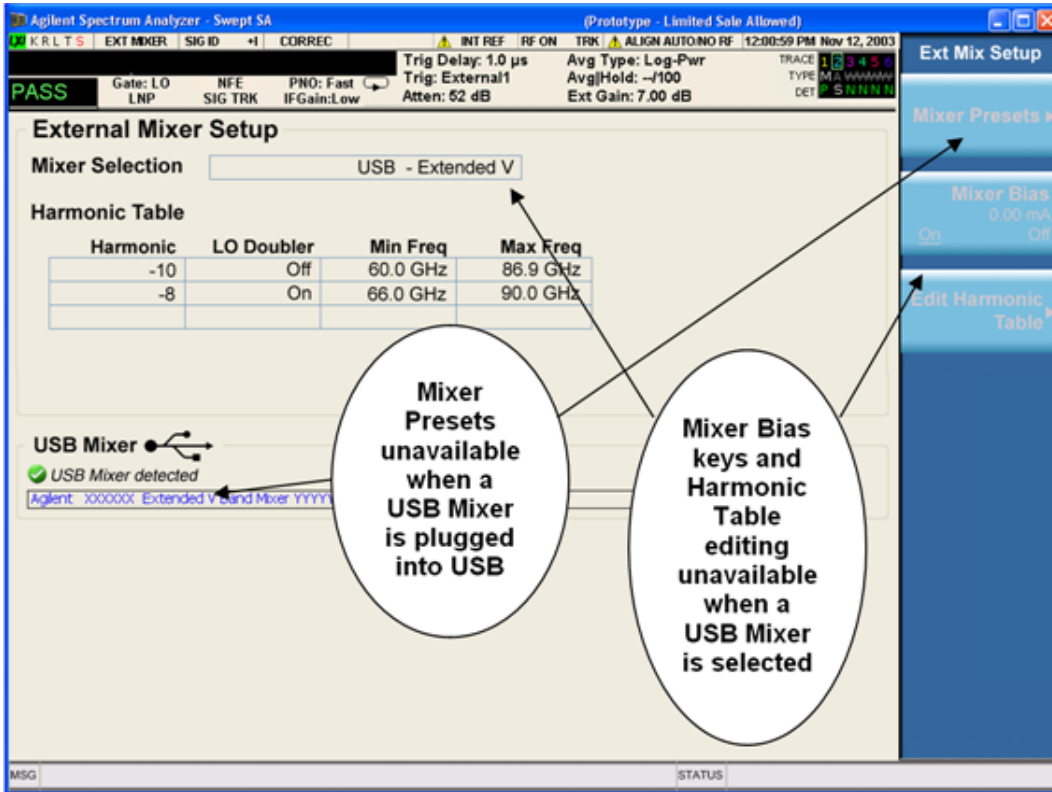

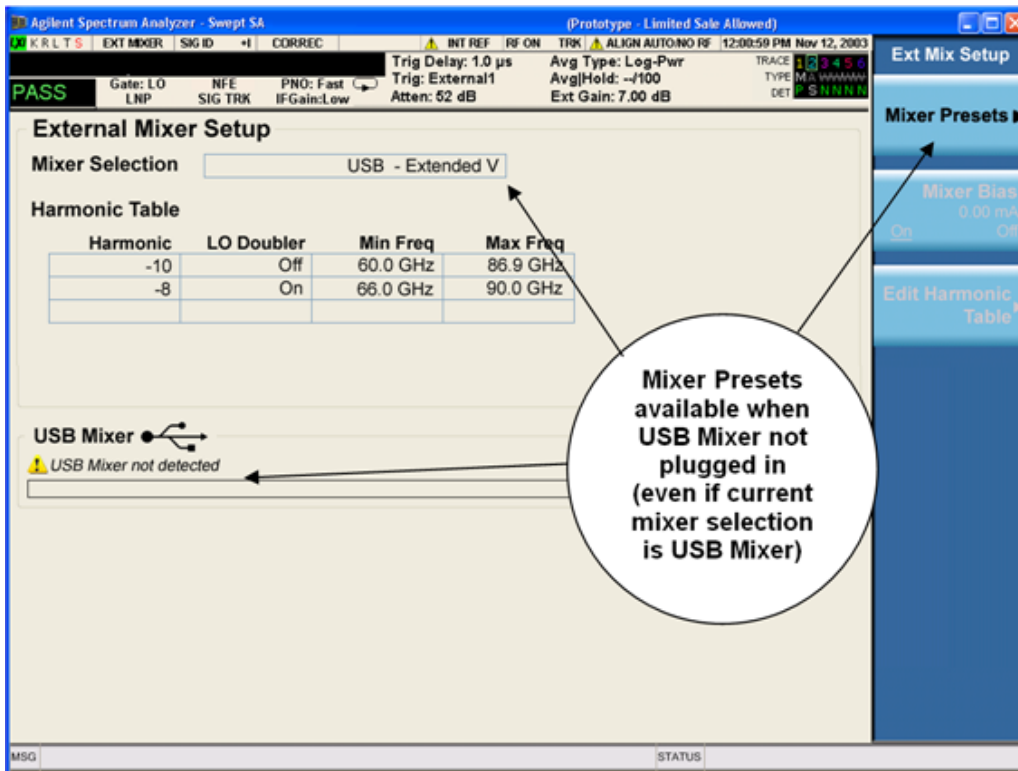

Only one USB Mixer is supported at a time. To switch to a different USB Mixer, disconnect the one that is no longer being used prior to connecting a new one.

The Mixer Selection displayed and softkey readback for the Agilent M1970 series mixers is:

Mixer Model	Mixer Selection display on Setup Screen	Readback on softkeys
Agilent M1970E: Option 001: 60 to 90 GHz Waveguide Harmonic Mixer	USB - M1970E E-Band	USB Mixer E-Band
Agilent M1970V Option 001: 50 to 75 GHz Waveguide Harmonic Mixer	USB - M1970V-001 V-Band	USB Mixer V-Band
Agilent M1970V Option 002: 50 to 80 GHz Waveguide Harmonic Mixer	USB - M1970V-002 Extended V-Band	USB Mixer Extended V
Agilent M1970W: 75 to 110 GHz Waveguide Harmonic Mixer	USB - M1970W W-Band	USB Mixer W-Band

The Agilent USB mixer essentially acts as a “remote front end” and is fully calibrated over the specified frequency range, without requiring any user interaction. This is particularly useful at high mm-wave frequencies, where cable loss is typically quite large, and it is desirable to bring the front end right up to the device under test, rather than bringing the mm-wave signal to the analyzer using a lossy and uncalibrated cable or waveguide connection.

Connecting the mixer to the USB port on the analyzer switches you to External Mixing, aborts the current measurement, and initiates an alignment of the mixer. A popup message, “USB Mixer connected” appears on the display. When a USB mixer and the LO/IF cable are connected the alignment is performed. When the alignment begins, an “Aligning” popup replaces the previous message on the display. When the alignment completes, the current measurement restarts.

Mixer Presets

This menu lets you preset the mixer setup for the particular type of mixer that you are using.

These presets are divided into four groups:

- one for Agilent legacy mixers,
- three for general purpose mixers:
 - o presets that use a single harmonic and no doubling
 - o presets that use a single harmonic but double the LO
 - o presets that use multiple harmonics

Note that the IF/LO port provides a 3.8–14 GHz LO in two bands: 3.8–8.7 (LO fundamental), and 8.6–14 GHz (doubled LO).

In most cases, once you have executed the preset, you will not need to adjust any further settings.

Key Path	Input/Output, External Mixer, Ext Mix Setup
Remote Command	[:SENSe]:MIXer:BAND A Q U V W NA ND NE NF NG NJ NK NQ NU NV NW NY NEXT DD DF DG DJ DK DQ DV DW DY DEXT MA ME MU MCOAX USB [:SENSe]:MIXer:BAND?
Example	:MIX:BAND A :MIX:BAND?
Notes	A Q U V W select Agilent 11970 mixer presets NA ND NE NF NG NJ NK NQ NU NV NW NY NEXT select single harmonic, non-doubled LO presets DD DF DG DJ DK DQ DV DW DY DEXT select single harmonic, doubled LO presets MA ME MU MCOAX select multiple harmonic presets All of these presets are detailed in their respective key descriptions The query form of this command returns the most recent preset, UNLESS the harmonic table has been edited after the preset was executed. If the harmonic table has been edited it returns CUSTOM The command USB will refresh the USB mixer connection and automatically detect the mixer band. The query form of this command returns the following if an Agilent USB Mixer is plugged into the analyzer’s USB port: USB E Agilent E-Band USB Mixer USB V Agilent V-Band USB Mixer USB VEXT Agilent Extended V-Band USB Mixer USB W Agilent W-Band USB Mixer Note that the parameters CUSTOM, USB V, USB VEXT, and USB W are query responses only, and cannot be sent TO the analyzer.

	<p>The following cross-reference matches the mixer band designators used by Agilent to the EIA waveguide designations:</p> <p>EIAAgilentFreq Range</p> <p>WR-28 A26.5 – 40 GHz</p> <p>WR-22 Q33 – 50 GHz</p> <p>WR-19 U40 – 60 GHz</p> <p>WR-15 V50 – 75 GHz</p> <p>WR-12 E60 – 90 GHz</p> <p>WR-10 W75 – 110 GHz</p> <p>WR-8 F90 – 140 GHz</p> <p>WR-6 D110 – 170 GHz</p> <p>WR-5 G140 – 220 GHz</p> <p>WR-3 J220 – 325 GHz</p>
Preset	<p>When Restore Input/Output Defaults is performed, an “A” mixer preset is also issued (11970A band), unless an Agilent USB Mixer is plugged into the analyzer’s USB port, in which case the Mixer Selection remains unchanged.</p> <p>When using Agilent USB Mixers, if a Restore All Defaults (SCPI command SYSTem:DEFault) has been performed, either remove and reinsert the USB cable or press the Refresh USB Mixer Connection softkey.</p>
Backwards Compatibility Notes	<p>The [:SENSe]:MIXer:BAND command was used in PSA and ESA to select the mixer band. In the X-Series, only the legacy parameters A, Q, U, V, and W are honored, and they preset the analyzer to match the corresponding Agilent 11970 legacy mixer. Parameters D, E, F, G, J, K, Y, which were accepted in ESA and PSA, return an error if sent. If you are using a mixer in one of these bands, you should study the tables of presets and choose the appropriate preset to match your application. Also the USER parameter is no longer accepted, as the control model for mixer customization is very different in the X-Series.</p>
Initial S/W Revision	A.08.01
Modified at S/W Revision	A.14.00

Agilent 11970

This menu allows you to preset for one of the models in the HP/Agilent 11970 series.

Because the X-Series has an LO range of 3.8 – 14 GHz, and older analyzers had an LO range of 3.0 – 6.8 GHz, the harmonic numbers used in the X-Series may differ from those used on older analyzers for the same mixers. Additionally, some of the 11970 mixers cannot be operated over their full range with the X-Series without switching harmonics. Consequently, you will find that some of the bands (A-Band, for example) are broken into two ranges for use with the X-Series.

See ["More Information" on page 208](#)

Key Path	Input/Output, External Mixer, Ext Mix Setup, Mixer Presets
Example	MIX:BAND A
Initial S/W Revision	A.08.01

More Information

Below are the 11970A presets. The 11970U and the 11970W use a single harmonic. The other three switch harmonics mid-band. Both harmonic ranges are shown in the table. None of these mixers use LO doubling.

The 11970 K-band mixer and the 11974 preselected mixer series are not supported.

Preset	Readout in setup screen	Readback on softkeys	Range	Harm #	RF start	RF stop	RF center
A-band	Agilent 11970A	Agilent 11970A	1	-6	26.5	30.45	28.475
			2	-8	30.35	40	35.175
Q-band	Agilent 11970Q	Agilent 11970Q	1	-8	33	40.8	36.9
			2	-10	39.8	50	44.9
U-band	Agilent 11970U	Agilent 11970U	..	-10	40	60	50
V-band	Agilent 11970V	Agilent 11970V	1	-12	50	66	58
			2	-14	53	75	64
W-band	Agilent 11970W	Agilent 11970W	..	-18	75	110	92.5

Single Harmonic

These presets choose a setup that uses a single harmonic and no doubling for the LO.

Key Path	Input/Output, External Mixer, Ext Mix Setup, Mixer Presets
Example	MIX:BAND NA
Initial S/W Revision	A.08.01

These are the presets for single harmonic operation with no doubler:

Mixer	Readout in setup screen	Readback on softkeys	Harm #	RF start	RF stop	RF center
K-band	K-band Single Harmonic, no doubler	Sngl harm LOx1 K-band	-4	18	26.5	22.25
A-band	A-band Single Harmonic, no doubler	Sngl harm LOx1 A-band	-6	26.5	40	33.25
D-band	D-band Single Harmonic, no doubler	Sngl harm LOx1 D-band	-20	110	170	140
E-band	E-band Single Harmonic, no doubler	Sngl harm LOx1 E-band	-12	60	90	75
F-band	F-band Single Harmonic, no doubler	Sngl harm LOx1	-18	90	140	115

Mixer	Readout in setup screen	Readback on softkeys	Harm #	RF start	RF stop	RF center
		F-band				
Q-band	Q-band Single Harmonic, no doubler	Sngl harm LOx1 Q-band	-6	33	50	41.5
U-band	U-band Single Harmonic, no doubler	Sngl harm LOx1 U-band	-8	40	60	50
V-band	V-band Single Harmonic, no doubler	Sngl harm LOx1 V-band	-10	50	75	62.5
W-band	W-band Single Harmonic, no doubler	Sngl harm LOx1 W-band	-14	75	110	92.5
G-band	G-band Single Harmonic, no doubler	Sngl harm LOx1 G-band	-26	140	220	180
Y-band	Y-band Single Harmonic, no doubler	Sngl harm LOx1 Y-band	-30	170	260	215
J-band	J-band Single Harmonic, no doubler	Sngl harm LOx1 J-band	-38	220	325	272.5
Extended	Extended Single Harmonic, no doubler	Sngl harm LOx1 Extended	-40	155	345	250

Single Harmonic w/doubler

These presets choose a setup that uses a single harmonic and doubling for the LO.

Key Path	Input/Output, External Mixer, Ext Mix Setup, Mixer Presets
Example	MIX:BAND DW
Initial S/W Revision	A.08.01

These are the presets for single harmonic operation with LO doubling:

Mixer	Readout in setup screen	Readback on softkeys	Harm #	RF start	RF stop	RF center
D-band	D-band Single Harmonic w/doubler	Sngl harm LOx2 K-band	-14	110	170	140
F-band	F-band Single Harmonic w/doubler	Sngl harm LOx2 A-band	-10	90	140	115
G-band	G-band Single Harmonic w/doubler	Sngl harm LOx2 A-band	-16	140	220	180
J-band	J-band Single	Sngl harm LOx2	-24	220	325	272.5

Mixer	Readout in setup screen	Readback on softkeys	Harm #	RF start	RF stop	RF center
	Harmonic w/doubler	A-band				
K-band	K-band Single Harmonic w/doubler	Sngl harm LOx2 A-band	-2	18	26.5	22.25
Q-band	Q-band Single Harmonic w/doubler	Sngl harm LOx2 A-band	-4	33	50	41.5
V-band	V-band Single Harmonic w/doubler	Sngl harm LOx2 A-band	-6	50	75	62.5
W-band	W-band Single Harmonic w/doubler	Sngl harm LOx2 A-band	-8	75	110	92.5
Y-band	Y-band Single Harmonic w/doubler	Sngl harm LOx2 A-band	-20	170	260	215
Extended	Extended Single Harmonic w/doubler	Sngl harm LOx2 A-band	-28	245	390	317.5

Multiple Harmonics

These presets choose a setup that uses multiple harmonics and may or may not use doubling for the LO.

Key Path	Input/Output, External Mixer, Ext Mix Setup, Mixer Presets
Example	MIX:BAND MA
Initial S/W Revision	A.08.01

These are the presets for multiple harmonic operation:

Mixer	Readout in setup screen	Readback on softkeys	Range	Harm #	Dblr?	RF start	RF stop	RF Center
A-band	A-band Multiple Harmonic	Multi harm A-band	1	-4	N	26.5	34.1	30.3
			2	-4	Y	33.1	40	36.55
E-band	E-band Multiple Harmonic	Multi harm E-band	1	-6	Y	60	83	71.5
			2	-8	Y	65	90	77.5
U-band	U-band Multiple Harmonic	Multi harm U-band	1	-6	N	40	51.5	45.75
			2	-6	Y	49.5	60	54.75
Coaxial	Coaxial Multiple Harmonic	Multi harm Coaxial	1	-4	N	26.5	34	30.25
			2	-4	Y	32.5	55	43.75
			3	-6	Y	50	70	60

Mixer Bias

Adjusts an internal bias source for use with external mixers. The bias signal is present on the center conductor of the IF input connector on the front panel. The shunt current range is from –10 mA to 10 mA and it can be set whether Mixer Bias state is On or Off, but it will only be applied if it is On.

The bias remains as set if the user switches to another input (e.g., the RF Input).

Key Path	Input/Output, External Mixer, Ext Mix Setup
Remote Command	[:SENSe]:MIXer:BIAS <real> [:SENSe]:MIXer:BIAS? [:SENSe]:MIXer:BIAS:STATe OFF ON 0 1 [:SENSe]:MIXer:BIAS:STATe?
Example	:MIX:BIAS 0 :MIX:BIAS? MIX:BIAS:STAT 0 MIX:BIAS:STAT?
Preset	This is unaffected by Preset but is set to OFF and 0 on a "Restore Input/Output Defaults"
State Saved	Saved in instrument state
Min	-10 mA
Max	10 mA
Initial S/W Revision	A.08.01

Cable IF Loss

The loss at the IF in the IF/LO cable can be compensated for with this function, by entering the loss in dB for your cable.

The cable loss will depend on the IF frequency. The IF frequency varies depending on which IF path your measurement is using. For best accuracy, characterize your cable's loss for the IF frequency or frequencies you will be using.

IF Frequencies:

10 MHz path: 322.5 MHz

25 MHz path: 322.5 MHz

40 MHz path: 250 MHz

140 MHz path: 300 MHz

Key Path	Input/Output, External Mixer
Key Path	Input/Output, External Mixer, Calibrate Mixer
Remote Command	[:SENSe]:MIXer:CIFLoss <rel_amp1> [:SENSe]:MIXer:CIFLoss?

Example	:MIX:CIFL 0.23 DB :MIX:CIFL?
Preset	0.26 dB
State Saved	Saved in instrument state
Min	-100
Max	100
Initial S/W Revision	A.08.01

I/Q

This feature is not available unless the "[Baseband I/Q \(Option BBA\)](#)" on page 212 is installed.

Selects the front-panel I/Q input ports to be the analyzer signal input. If I/Q is already selected, pressing this key accesses the I/Q setup menu.

Key Path	Input/Output
Mode	BASIC, CDMA2K, EDGE GSM, TDSCDMA, VSA89601, WIMAX OFDMA, LTE, LTE TDD, LTE FDD, LTE ATDD, DCATV, DTMB (CTTB), DVB-T/H with T2, CMMB, ISDBT, WCDMA, VXA, CDMA1XEV
Example	FEED AIQ
Notes	Not all measurements support the use of the I/Q signal input. When I/Q is selected in a measurement that does not support it, the "No Result; Meas invalid with I/Q inputs" error condition message appears. This is error 135
Initial S/W Revision	Prior to A.02.00

Baseband I/Q (Option BBA)

The Baseband I/Q functionality is a hardware option. It is option BBA. If the option is not installed, none of the I/Q functionality is enabled.

The Baseband I/Q has four input ports and one output port. The input ports are I, I-bar, Q, and Q-bar. The I and I-bar together compose the I channel and the Q and Q-bar together compose the Q channel. Each channel has two modes of operation, Single-Ended (also called "unbalanced") and Differential Input (also called "balanced"). When in Single-Ended operation, only the main port (I or Q) is used and the complementary port (I-bar or Q-bar) is ignored. When in Differential Input mode, both main and complementary ports are used.

The input settings (range, attenuation, skew, impedance, external gain) apply to the channels, not the individual ports.

The system supports a variety of 1 M Ω input passive probes as well as the Agilent 113x Series active differential probes using the Infinimax probe interface.

The Agilent 113x Series active probes can be used for both single ended and differential measurements. In either case a single connection is made for each channel (on either the I or Q input). The input is

automatically configured to 50 Ω single ended and the probe power is supplied through the Infinimax interface. The probe can be configured for a variety of input coupling and low frequency rejection modes. In addition, a wide range of offset voltages and probe attenuation accessories are supported at the probe interface. The active probe has the advantage that it does not significantly load the circuit under test, even with unity gain probing.

With passive 1 M Ω probes, the probe will introduce a capacitive load on the circuit, unless higher attenuation is used at the probe interface. Higher attenuation reduces the signal level and degrades the signal-to-noise-ratio of the measurement. Passive probes are available with a variety of attenuation values for a moderate cost. Most Agilent passive probes can be automatically identified by the system, setting the input impedance setting required as well as the nominal attenuation. For single ended measurements a single probe is used for each channel. Other passive probes can be used, with the attenuation and impedance settings configured manually.

For full differential measurements, the system supports probes on each of the four inputs. The attenuation of the probes should be the same for good common mode rejection and channel match.

Both active and passive probes in single ended and differential configurations can be calibrated. This calibration uses the Cal Out BNC connection and a probe connection accessory. The calibration achieves excellent absolute gain flatness in a probed measurement. It matches both the gain and frequency response of the I and Q channels as well as any delay skew, resulting in high accuracy in derived measurements such as Error Vector Magnitude (EVM).

When a probe is connected a status message will be displayed. The message will indicate if calibration data is available or not. Calibration data is saved for each type of probe (including "none") for each port and will be reapplied whenever that type of probe is re-connected to the same port. For probes with EEPROM identification, the calibration data will be stored based on the unique probe identifier and will reapply data for that particular probe if it is available. The data will not follow a probe from one port to another. For probes without EEPROM identification, the instrument cannot distinguish between different probes of the same type and it will use the data from the last calibration for that probe type on that port.

When in differential mode, both the main and complementary probes are expected to be of the same type.

In some situations, the I and Q channels should be configured identically. In other situations it is convenient to control them independently. Some menus have a "Q Same as I" setting that will cause the Q channel configuration to mirror the I channel configuration, avoiding the overhead of double data entry when the channels should be the same.

The output port is for calibrating the I/Q input ports, although it can also be manually controlled.

There are two types of calibrations available: cable calibration and probe calibration. The cable calibration will guide the user through connecting each input port in turn. All ports must be calibrated together. The probe calibration is done for a specific channel (I or Q). If in Single-Ended mode, only the main port is calibrated. When in Differential Input mode, the user is guided through calibrating both main and complementary ports.

The front panel I/Q port LEDs indicate the current state of that port. On (green) indicates it is active, and off (dark) indicates it is not in use. For example, the Cal Out port LED is on if and only if there is signal coming out of that port.

The input is a context and some parameters have separate values for each context. The SCPI for these parameters has an optional "[:RF|IQ]" node. If the specific context is omitted, the command acts on the current input context's value. Here are the parameters that are input context sensitive:

- Center Frequency
- Trigger Source

It is important to distinguish between the I and Q input ports and the displayed I and Q data values. The I and Q input ports feed into a digital receiver that does digital tuning and filtering. The I and Q data seen by the user (either on the display or through SCPI) corresponds to the real ("I") and the imaginary ("Q") output from the digital receiver. When the input path is I+jQ or I Only and the center frequency is 0 Hz the I input ends up in as the real output from the receiver and appears as "I" data. Likewise, when the input path is I+jQ and the center frequency is 0 Hz, the Q input ends up as the imaginary output from the receiver and appears as "Q" data. However, when the input path is Q Only, the Q input is sent to the receiver as Q+j0, so the receiver output has the Q input coming out on the real output, and so in Q Only, the signal from the Q input port appears as the "I" data. Another situation where the I and Q data do not necessarily correspond directly to the I and Q inputs is when the center frequency is non-zero. The digital processing involved in the tuning is a complex operation. This will result in I Only data appearing as both "I" and "Q" data, the same as that signal would appear if seen through the RF input port.

Baseband I/Q Remote Language Compatibility

For the Agilent E4406A VSA Series Transmitter Tester, Option B7C provided baseband I/Q inputs. Code compatibility has been provided to allow many of the commands for option B7C to function properly with the X-Series. The X-Series has hardware differences and additional capabilities (e.g., E4406A does not have independent settings of I & Q nor does it provide for probe calibrations) which make 100% compatibility impossible.

1. The following commands are supported:

:CALibration:IQ:FLATness

:INPut:IMPedance:IQ U50|B50|U1M|B1M

:INPut:IMPedance:REFerence <integer>

2. The [:SENSe]:FEED RF|IQ|IONLy|QONLy|AREFerence|IFALign command supports all parameters except IFALign. The FEED? query will return only RF|AIQ|AREF.

3. The following commands are not supported:

:CALibration:GIQ

:CALibration:IQ:CMR

:INPut:IQ:ALIGn OFF|ON|0|1

The Rohde & Schwarz FSQ-B71 also provides baseband I/Q inputs. A certain amount of code compatibility is provided in the X-Series, however hardware differences make this a somewhat limited set.

Supported:

The "<1|2>" is supported as "[1]".

INPut<1|2>:IQ:BALanced[:STATe] ON | OFF

INPut<1|2>:IQ:TYPE I | Q | IQ

INPut<1|2>:IQ:IMPedance LOW | HIGH

Not Supported:

INPut<1|2>:SElect AIQ | RF

TRACe<1|2>:IQ:DATA:FORMat COMPatible | IQBLock | IQPair>

TRACe<1|2>:IQ:DATA:MEMory? <offset samples>,<# of samples>

TRACe<1|2>:IQ:DATA?

TRACe<1|2>:IQ:SET <filter type>,<rbw>,<sample rate>,<trigger source>,<trigger slope>,<pretrigger samples>,<# of samples>

TRACe<1|2>:IQ:SRATe 10.0kHz to 81.6MHz

TRACe<1|2>:IQ[:STATe] ON|OFF

The Rohde & Schwarz FMU has the following SCPI, which is not supported (these commands start/abort the probe calibration procedure, which is manually interactive from the front panel):

CALibration:ABORT

CALibration:PROBe[:START]

I/Q Path

Selects which I/Q input channels are active. The LED next to each I/Q input port will be on when that port is active.

The analysis bandwidth for each channel is the same as that of the instrument. For example, the base N9020A has a bandwidth of 10 MHz. With I/Q input the I and Q channels would each have an analysis bandwidth of 10 MHz, giving 20 MHz of bandwidth when the I/Q Path is I+jQ. With option B25, the available bandwidth becomes 25 MHz, giving 25 MHz each to I and Q and 50 MHz to I+jQ.

I/Q voltage to power conversion processing is dependent on the I/Q Path selected.

- With I+jQ input we know that the input signal may not be symmetrical about 0 Hz, because it has a complex component. Therefore, above 0 Hz only the positive frequency information is displayed, and below 0 Hz only the negative frequency information is displayed.
- With all other Input Path selections, the input signal has no complex component and therefore is always symmetrical about 0 Hz. In this case, by convention, the power conversion shows the combined voltage for both the positive and negative frequencies. The information displayed below 0 Hz is the mirror of the information displayed above 0 Hz. This results in a power reading 6.02 dB higher (for both) than would be seen with only the positive frequency voltage. Note also that, in this case the real signal may have complex modulation embedded in it, but that must be recovered by further signal processing.

Key Path	Input/Output, I/Q
Remote Command	[:SENSe] :FEED:IQ:TYPE IQ IONLy QONLy [:SENSe] :FEED:IQ:TYPE?
Example	Set the input to be both the I and Q channels, combined as I + j * Q. FEED:IQ:TYPE IQ
Preset	IQ
State Saved	Yes This is unaffected by a Preset but is set to the default value on a "Restore Input/Output Defaults" or

	"Restore System Defaults->All"
Range	I+jQ I Only Q Only
Readback Text	I+jQ I Only Q Only
Initial S/W Revision	Prior to A.02.00

Remote Command	:INPut [1] :IQ:TYPE IQ I Q :INPut [1] :IQ:TYPE?
Notes	For R&S FSQ-B71 compatibility
Preset	IQ
Initial S/W Revision	Prior to A.02.00

I+jQ

Sets the signal input to be both the I and Q channels. The I and Q channel data will be combined as $I + j * Q$.

Key Path	Input/Output, I/Q, I/Q Path
Example	Set the input to be both the I and Q channels, combined as $I + j * Q$. FEED:IQ:TYPE IQ
Initial S/W Revision	Prior to A.02.00

I Only

Sets the signal input to be only the I channel. The Q channel will be ignored. The data collected is still complex. When the center frequency is 0 the imaginary part will always be zero, but for any other center frequency both the real and imaginary parts will be significant.

Key Path	Input/Output, I/Q, I/Q Path
Example	Set the input to be only the I channel. FEED:IQ:TYPE IONL
Initial S/W Revision	Prior to A.02.00

Q Only

Sets the signal input to be only the Q channel. The I channel will be ignored. The Q channel will be sent to the digital receiver block as $Q+j0$. The receiver's output is still complex. When the center frequency is 0 the imaginary part will always be zero, but for any other center frequency both the real and imaginary parts will be significant. Note that since the receiver's real output is displayed as the "I" data, when the center frequency is 0, the Q Only input appears as the "I" data.

Key Path	Input/Output, I/Q, I/Q Path
Example	Set the input to be only the Q channel. FEED:IQ:TYPE QONL
Initial S/W Revision	Prior to A.02.00

I Setup

Access the channel setup parameters for the I channel.

Key Path	Input/Output, I/Q
Initial S/W Revision	Prior to A.02.00

I Differential Input

Selects differential input on or off for the I channel. For differential input (also called balanced input), the analyzer uses both main and complementary ports. When differential input is off (also called single-ended or unbalanced input), the analyzer uses only the main port.

Key Path	Input/Output, I/Q, I Setup
Remote Command	:INPut:IQ[:I]:DIFFerential OFF ON 0 1 :INPut:IQ[:I]:DIFFerential?
Example	Put the I channel in Differential Input mode INP:IQ:DIFF ON
Notes	When I Differential Input = On, the analyzer will check for attenuation mismatches between the I and I-bar ports. If the difference in attenuation values exceeds 0.5 dB a Settings Alert error condition, error 159 will be set. When I Differential Input = On, and IQ Path is I+jQ, the Q Differential input must also be On. Similarly, when I Differential Input = Off, and IQ Path is I+jQ, the Q Differential input must also be Off. If the states of the two inputs do not match, an error condition message is generated, 159;Settings Alert;I/Q mismatch:Differential.
Couplings	Some active probes include built-in differential capability. When one of these probes is sensed, this key is disabled. Since the differential capability is handled in the probe, the Analyzer will use only the main port and the key will show that the Analyzer's Differential Input mode is Off (indicating that the complementary port is not in use). When Q Same as I is On, the value set for I will also be copied to Q.
Preset	Off
State Saved	Yes This is unaffected by a Preset but is set to the default value on a "Restore Input/Output Defaults" or "Restore System Defaults->All"
Range	Off On
Initial S/W Revision	Prior to A.02.00

Remote Command	:INPut [1] :IQ:BAALanced[:STATe] OFF ON 0 1 :INPut [1] :IQ:BAALanced[:STATe] ?
Notes	For R&S FSQ-B71 compatibility, with no independent settings for the I and Q channels. Therefore, it is tied only to the I channel and does not provide an equivalent for the Q channel. For proper operation of the backwards compatibility command Q Same as I should be set to On.
Preset	OFF
Initial S/W Revision	Prior to A.02.00

I Input Z

Selects the input impedance for the I channel. The impedance applies to both the I and I-bar ports.

The input impedance controls the hardware signal path impedance match. It is not used for converting voltage to power. The voltage to power conversion always uses the Reference Z parameter. The Reference Z parameter applies to both I and Q channels.

Key Path	Input/Output, I/Q, I Setup
Remote Command	:INPut [1] :IQ[:I] :IMPedance LOW HIGH :INPut [1] :IQ[:I] :IMPedance?
Example	Set the I channel input impedance to 1 MΩ INP:IQ:IMP HIGH
Notes	LOW = 50 Ω, HIGH = 1 MΩ When IQ Path is I+jQ, the I Input Z setting must be the same as the Q Input Z setting. If the settings of the two inputs do not match, an error condition message is generated, 159;Settings Alert;I/Q mismatch:Input Z.
Couplings	Input impedance is a built-in characteristic of a probe. Therefore, whenever a probe is sensed, this key is disabled and the value is set to match the probe. When no probe is sensed on Q and Q Same as I is On, the value set for I will also be copied to Q.
Preset	LOW
State Saved	Yes This is unaffected by a Preset but is set to the default value on a "Restore Input/Output Defaults" or "Restore System Defaults->All"
Range	50 Ω 1 MΩ
Initial S/W Revision	Prior to A.02.00

I Skew

Sets the skew factor for the I channel. The skew will shift the channel's data in time. Use this to compensate for differences in the electrical lengths of the input paths due to cabling.

Key Path	Input/Output, I/Q, I Setup
Remote Command	[:SENSe]:CORRection:IQ[:I]:SKEW <seconds>

	<code>[:SENSe] :CORRection:IQ[:I]:SKEW?</code>
Example	Delay the data for the I channel by 10 ns. <code>CORR:IQ:SKEW 10 ns</code>
Preset	0
State Saved	Yes This is unaffected by Preset but is set to the default value on a "Restore Input/Output Defaults" or "Restore System Defaults->All"
Range	0 s to 100 ns
Min	0 s
Max	+100 ns
Initial S/W Revision	Prior to A.02.00

I Probe

Access the probe setup parameters for the I channel. See ["I/Q Probe Setup" on page 228](#).

Key Path	Input/Output, I/Q, I Setup
State Saved	No
Readback Text	[<I port probe id>] This is reporting the type of probe sensed on the I port. There is no parameter for overriding what is sensed.
Initial S/W Revision	Prior to A.02.00

Attenuation

The attenuation is part of the calibration data stored with the probe type and is initially the value that was returned by the last calibration. You can modify this value and any changes will be stored with the calibration data and will survive power cycles and presets. When a probe calibration is performed the attenuation value will be overwritten by the calibration.

Key Path	Input/Output, I/Q, I Setup Q Setup, I Probe Q Probe
Remote Command	<code>[:SENSe] :CORRection:IQ:I Q:ATTenuation:RATio <real></code> <code>[:SENSe] :CORRection:IQ:I Q:ATTenuation:RATio?</code>
Example	Set the attenuation for the current I probe to 100.00:1. <code>CORR:IQ:I:ATT:RAT 100</code>
Notes	Each probe type has its own attenuation setting. As probes are changed the attenuation value will reflect the new probe's setting. Changing the attenuation affects only the current probe type's setting and leaves all others unchanged. When the IQ Path is I+jQ, the Q probe attenuation setting must match the I Probe attenuation setting within 1 dB. If this is not the case, an error condition message is generated, 159;Settings Alert;I/Q mismatch:Attenuation.

Preset	Each probe type has its own default. The default for the "Unknown" probe type is 1:1.
State Saved	Saved with probe calibration data. It survives a power cycle and is not affected by a Preset or Restore.
Range	0.001 to 10000
Min	0.001
Max	10000
Initial S/W Revision	Prior to A.02.00

This is an alternate form of the SCPI that allows input as a power instead of a ratio.

Remote Command	<code>[[:SENSE]:CORRection:IQ:I Q:ATTenuation <rel_ampl></code> <code>[[:SENSE]:CORRection:IQ:I Q:ATTenuation?</code>
Example	Set the attenuation for the current I probe type to 100.00:1. CORR:IQ:I:ATT 20 dB
Range	-60 dB to +80 dB
Min	-60 dB
Max	+80 dB
Initial S/W Revision	Prior to A.02.00

Calibrate

Invokes the guided probe calibration. The guided probe calibration is context sensitive and depends on the channel (I or Q) and the Differential Input state. The calibration is only performed on the selected channel. When Differential Input is on, both the probe attached to the main port and the probe attached to the complementary port are calibrated. When Differential Input is off, only the probe attached to the main port is calibrated. See "[I/Q Guided Calibration](#)" on page 271.

Key Path	Input/Output, I/Q, I Setup Q Setup, I Probe Q Probe, Coupling
Readback Text	The last calibration date, or if no calibration exists, "(empty)". Last: <cal date> <cal time> Example: Last: 8/22/2007 1:02:49 PM
Initial S/W Revision	Prior to A.02.00

Clear Calibration

Clears the calibration data for the current port and probe. It does not clear the data for other probe types or other ports. If the sensed probe has EEPROM identification, only the data for that specific probe is

cleared. After this command has completed, the probe calibration state will be the same as if no probe calibration had ever been performed for the specified channel and probe. The probe attenuation will be the default value for that probe type and the Cable Calibration frequency response corrections will be used. This command is dependent on the Differential Input state. When Differential Input is on, both the data for the probe attached to the main port and the data for the probe attached to the complementary port are cleared. When Differential Input is off, only data for the probe attached to the main port is cleared.

Key Path	Input/Output, I/Q, I Setup Q Setup, I Probe Q Probe
Remote Command	:CALibration:IQ:PROBe:I Q:CLEar
Example	Clear the calibration data for the I channel and the current probe (with EEPROM identification) or probe type (without EEPROM identification). :CAL:IQ:PROBe:I:CLE
Initial S/W Revision	Prior to A.02.00

Combined Differential/Input Z (Remote Command Only)

This is Remote Command only (no front panel) and is for backwards compatibility only. It combines the Differential Input and Input Z selections into a single SCPI command.

Remote Command	:INPut:IMPedance:IQ U50 B50 U1M B1M :INPut:IMPedance:IQ?
Example	:INPut:IMPedance:IQ U50 This is equivalent to the following two SCPI commands: :INP:IQ:DIFF OFF :INP:IQ:IMP 50
Notes	Provided for E4406A code compatibility. The enum values translate as follows: U50: Differential Input = Off, Input Z = 50Ω B50: Differential Input = On, Input Z = 50Ω U1M: Differential Input = Off, Input Z = 1 MΩ B1M: Differential Input = On, Input Z = 1 MΩ This command is for backwards compatibility. It combines the Input Z (50Ω or 1 MΩ) parameter with the Differential Input (Off = "Unbalanced", On = "Balanced") parameter into a single enumeration. This backwards compatibility SCPI command was for an instrument without independent settings for the I and Q channels. Therefore, it is tied only to the I channel and does not provide an equivalent for the Q channel. For proper operation of the backwards compatibility command Q Same as I should be set to On. Also, note the subtle difference between this SCPI command and the backwards compatibility command for Input Z. The Input Z SCPI has "IQ" before "IMP" while this command has that order reversed.
Couplings	This command does not have an independent parameter, but instead is tied to the Differential Input and Input Z parameters. The coupling for those parameters apply to this command too.
Preset	U50
Initial S/W Revision	Prior to A.02.00

Q Setup

Access the channel setup parameters for the Q channel.

Key Path	Input/Output, I/Q
Readback Text	When Q Same as I is On the readback is "Q Same as I".
Initial S/W Revision	Prior to A.02.00

Q Same as I

Many, but not all, usages require the I and Q channels have an identical setup. To simplify channel setup, the Q Same as I will cause the Q channel parameters to be mirrored from the I channel. That way you only need to set up one channel (the I channel). The I channel values are copied to the Q channel, so at the time Q Same as I is turned off the I and Q channel setups will be identical. This does not apply to Probe settings or to parameters that are determined by the probe.

Key Path	Input/Output, I/Q, Q Setup
Remote Command	:INPut:IQ:MIRRored OFF ON 0 1 :INPut:IQ:MIRRored?
Example	Turn off the mirroring of parameters from I to Q. INP:IQ:MIRR OFF
Couplings	Only displayed for the Q channel. When Yes, the I channel values for some parameters are mirrored (copied) to the Q channel. However, when a parameter is determined by the type of probe and a probe is sensed, the probe setting is always used and the I channel setting is ignored. The following parameters are mirrored: Differential Input (when not determined by probe) Input Z (when not determined by probe)
Preset	This is unaffected by a Preset but is set to the default value (Q Same as I set to "On") on a "Restore Input/Output Defaults" or "Restore System Defaults->All"
State Saved	Saved in instrument state
Range	On Off
Readback Text	"Q Same as I" when On, otherwise none.
Initial S/W Revision	Prior to A.02.00

Q Differential Input

Selects differential input on or off for the Q channel. For differential input (also called balanced input), the analyzer uses both the Q and Q-bar ports. When differential input is off (also called single-ended or unbalanced input), the analyzer uses only the Q port.

Key Path	Input/Output, I/Q, Q Setup
----------	----------------------------

Remote Command	:INPut:IQ:Q:DIFFerential OFF ON 0 1 :INPut:IQ:Q:DIFFerential?
Example	Put the Q channel in Differential Input mode INP:IQ:Q:DIFF ON
Notes	When Differential Input = On, the analyzer will check for attenuation mismatches between the Q and Q-bar ports. If the difference in attenuation values exceeds 0.5 dB a Settings Alert error condition, error 159 will be set. When Q Differential Input = On, and IQ Path is I+jQ, the I Differential input must also be On. Similarly, when Q Differential Input = Off, and IQ Path is I+jQ, the I Differential input must also be Off. If the states of the two inputs do not match, an error condition message is generated, 159;Settings Alert;I/Q mismatch:Differential.
Couplings	Some active probes include built-in differential capability. When one of these probes is sensed, this key is disabled. Since the differential capability is handled in the probe, the Analyzer will use only the main port and the key will show that the Analyzer's Differential Input mode is Off (indicating that the complementary port not in use). When a differential probe is not sensed and Q Same as I is On, the value set for I will be copied to Q. This key is disabled when Q Same as I is On.
Preset	Off
State Saved	Yes This is unaffected by a Preset but is set to the default value on a "Restore Input/Output Defaults" or "Restore System Defaults->All"
Range	Off On
Initial S/W Revision	Prior to A.02.00

Q Input Z

Selects the input impedance for the Q channel. The impedance applies to both the Q and Q-bar ports.

The input impedance controls the hardware signal path impedance match. It is not used for converting voltage to power. The voltage to power conversion always uses the Reference Z parameter. The Reference Z parameter applies to both I and Q channels.

Key Path	Input/Output, I/Q, Q Setup
Remote Command	:INPut [1] :IQ:Q:IMPedance LOW HIGH :INPut [1] :IQ:Q:IMPedance?
Example	Set the Q channel input impedance to 1 M Ω INP:IQ:Q:IMP HIGH
Notes	LOW = 50 Ω , HIGH = 1 M Ω When IQ Path is I+jQ, the I Input Z setting must be the same as the Q Input Z setting. If the settings of the two inputs do not match, an error condition message is generated, 159;Settings Alert;I/Q mismatch:Input Z.
Couplings	Input impedance is a built-in characteristic of a probe. Therefore, whenever a probe is sensed, this key is disabled and the value is set to match the probe.

	When no probe is sensed and Q Same as I is On, the value set for I will also be copied to Q. This key is disabled when Q Same as I is On.
Preset	LOW
State Saved	Yes This is unaffected by Preset but is set to the default value on a "Restore Input/Output Defaults" or "Restore System Defaults->All"
Range	50 Ω 1 M Ω
Initial S/W Revision	Prior to A.02.00

Q Skew

Sets the skew factor for the Q channel. The skew will shift the channel's data in time. Use this to compensate for differences in the electrical lengths of the input paths due to cabling and probes.

Key Path	Input/Output, I/Q, Q Setup
Remote Command	<code>[:SENSe]:CORRection:IQ:Q:SKEW <seconds></code> <code>[:SENSe]:CORRection:IQ:Q:SKEW?</code>
Example	Delay the data for the Q channel by 10 ns. <code>CORR:IQ:Q:SKEW 10 ns</code>
Preset	0
State Saved	Yes This is unaffected by a Preset but is set to the default value on a "Restore Input/Output Defaults" or "Restore System Defaults->All"
Range	0 s to 100 ns
Min	0 s
Max	+100 ns
Initial S/W Revision	Prior to A.02.00

Q Probe

Accesses the probe setup parameters for the Q channel. See "[I/Q Probe Setup](#)" on page 228.

Key Path	Input/Output, I/Q, Q Setup
State Saved	No
Readback Text	<code>[<Q port probe id>]</code> This is reporting the type of probe sensed on the Q port. There is no parameter for overriding what is sensed.
Initial S/W Revision	Prior to A.02.00

Attenuation

The attenuation is part of the calibration data stored with the probe type and is initially the value that was returned by the last calibration. You can modify this value and any changes will be stored with the calibration data and will survive power cycles and presets. When a probe calibration is performed the attenuation value will be overwritten by the calibration.

Key Path	Input/Output, I/Q, I Setup Q Setup, I Probe Q Probe
Remote Command	[:SENSe] :CORRection:IQ:I Q:ATTenuation:RATio <real> [:SENSe] :CORRection:IQ:I Q:ATTenuation:RATio?
Example	Set the attenuation for the current I probe to 100.00:1. CORR:IQ:I:ATT:RAT 100
Notes	Each probe type has its own attenuation setting. As probes are changed the attenuation value will reflect the new probe's setting. Changing the attenuation affects only the current probe type's setting and leaves all others unchanged. When the IQ Path is I+jQ, the Q probe attenuation setting must match the I Probe attenuation setting within 1 dB. If this is not the case, an error condition message is generated, 159;Settings Alert;I/Q mismatch:Attenuation.
Preset	Each probe type has its own default. The default for the "Unknown" probe type is 1:1.
State Saved	Saved with probe calibration data. It survives a power cycle and is not affected by a Preset or Restore.
Range	0.001 to 10000
Min	0.001
Max	10000
Initial S/W Revision	Prior to A.02.00

This is an alternate form of the SCPI that allows input as a power instead of a ratio.

Remote Command	[:SENSe] :CORRection:IQ:I Q:ATTenuation <rel_ampl> [:SENSe] :CORRection:IQ:I Q:ATTenuation?
Example	Set the attenuation for the current I probe type to 100.00:1. CORR:IQ:I:ATT 20 dB
Range	-60 dB to +80 dB
Min	-60 dB
Max	+80 dB
Initial S/W Revision	Prior to A.02.00

Calibrate

Invokes the guided probe calibration. The guided probe calibration is context sensitive and depends on the channel (I or Q) and the Differential Input state. The calibration is only performed on the selected channel. When Differential Input is on, both the probe attached to the main port and the probe attached to the

complementary port are calibrated. When Differential Input is off, only the probe attached to the main port is calibrated. See "[I/Q Guided Calibration](#)" on page 271.

Key Path	Input/Output, I/Q, I Setup Q Setup, I Probe Q Probe, Coupling
Readback Text	The last calibration date, or if no calibration exists, "(empty)". Last: <cal date> <cal time> Example: Last: 8/22/2007 1:02:49 PM
Initial S/W Revision	Prior to A.02.00

Clear Calibration

Clears the calibration data for the current port and probe. It does not clear the data for other probe types or other ports. If the sensed probe has EEPROM identification, only the data for that specific probe is cleared. After this command has completed, the probe calibration state will be the same as if no probe calibration had ever been performed for the specified channel and probe. The probe attenuation will be the default value for that probe type and the Cable Calibration frequency response corrections will be used. This command is dependent on the Differential Input state. When Differential Input is on, both the data for the probe attached to the main port and the data for the probe attached to the complementary port are cleared. When Differential Input is off, only data for the probe attached to the main port is cleared.

Key Path	Input/Output, I/Q, I Setup Q Setup, I Probe Q Probe
Remote Command	:CALibration:IQ:PROBe:I Q:CLEar
Example	Clear the calibration data for the I channel and the current probe (with EEPROM identification) or probe type (without EEPROM identification). :CAL:IQ:PROBe:I:CLE
Initial S/W Revision	Prior to A.02.00

Reference Z

Sets the value of the impedance to be used in converting voltage to power for the I and Q channels. This does not change the hardware's path impedance (see "[I Input Z](#)" on page 218).

Key Path	Input/Output, I/Q
Remote Command	:INPut:IMPedance:REFerence <integer> :INPut:IMPedance:REFerence?
Example	Set the I/Q reference impedance to 50 Ω INP:IMP:REF 50
Preset	50 Ω
State Saved	Yes

	This is unaffected by a Preset but is set to the default value on a "Restore Input/Output Defaults" or "Restore System Defaults->All"
Range	1 Ω to 1 M Ω
Min	1 Ω
Max	1 M Ω
Initial S/W Revision	Prior to A.02.00

I/Q Cable Calibrate...

The I/Q cable calibration creates correction data for each of the front panel I/Q ports. This calibration data is used whenever no probe specific calibration data is available. It is important that all ports are calibrated using the same short BNC cable so that the data is comparable from port to port.

The guided calibration (front panel only) will show connection diagrams and guide you through the isolation calibration and calibrating each port. The calibration data for each port is stored separately, so as soon as a port is calibrated that data is saved and will be used. If you press "Exit" to exit the calibration process, the data for the ports already completed will still be used. It is recommended that a calibration be completed once started, or if exited, that it be properly done before the next use of the I/Q ports. The "Next" button will perform the calibration for the current port and then proceed to the next step in the calibration procedure. The "Back" button will return to the prior port in the procedure. Both keys and dialog buttons are supplied for ease of use. The dialog buttons are for mouse use and the softkeys for front panel use.

The calibration can also be done via SCPI, but no connection diagrams will be shown. You will have to make the correct connections before issuing each port calibration command. Again, it is recommended that all ports be calibrated at the same time.

The instrument state remains as it was prior to entering the calibration procedure except while a port is actually being calibrated. Once a port is calibrated it returns to the prior state. A port calibration is in process only from the time the "Next" button is pressed until the next screen is shown. For SCPI, this corresponds to the time from issuing the CAL:IQ:FLAT:I|B|Q|QB command until the operation is complete.

For example, if the prior instrument state is Cal Out = Off, Input = I+jQ, and Differential = Off, then up until the time the "Next" button is pressed the I Input and Q Input LEDs are on and the Cal Out, I-bar Input and Q-bar Input LEDs are off. Once the "Next" button is pressed for the I port calibration, only the Cal Out and I Input LEDs will be on and the others will be off. When the screen progresses to the next step ("Next" button again enabled), the prior state is restored and only the I Input and Q Input LEDs are on (Cal Out is off again).

The last calibration date and time for each port will be displayed. Any calibrations that are more than a day older than the most recent calibration will be displayed with the color amber.

Key Path	Input/Output, I/Q
Initial S/W Revision	Prior to A.02.00

I/Q Probe Setup

The set of I/Q probe setup parameters will change based on the type of probe that is sensed. All probe types have the Attenuation parameter, and all probe types can be calibrated. The remaining parameters are only available for some probe types and will not be shown when not available. The probe type is determined by and reported for only for the I and Q ports, never the I-bar or Q-bar ports. The menu title will be "<ch>: <probe id>", where "<ch>" is either "I" or "Q" and "<probe id>" is the type of probe. For example, for the I Probe setup with an Agilent 1130A probe connected to the I port, the title will be "I: 1130A".

Probe calibration data is stored for each probe type for each channel. When no probe is sensed, the probe type "Unknown" is used, and this is also treated like a probe type with its own calibration data. When a probe is changed, the calibration data for that probe type for that port is restored. An advisory message will be displayed showing the new probe type and the calibration status. The calibration data is stored permanently (survives a power cycle) and is not affected by a Preset or any of the Restore commands. When the probe has EEPROM identification (most newer Agilent probes have this), the calibration data is stored by probe serial number and port, so if you have two probes of the same type, the correct calibration data will be used for each. For probes that do not have EEPROM identification, the calibration data is stored by probe type and port and the instrument cannot distinguish between different probes of the same type. In all cases (with or without EEPROM identification), the calibration data is port specific, so it will not follow a specific probe from port to port if the probe is moved.

The "Unknown" probe type is used whenever no probe is sensed. When no calibration data exists for "Unknown" the latest cable calibration data is used (see ["I/Q Guided Calibration " on page 271](#)).

Attenuation

The attenuation is part of the calibration data stored with the probe type and is initially the value that was returned by the last calibration. You can modify this value and any changes will be stored with the calibration data and will survive power cycles and presets. When a probe calibration is performed the attenuation value will be overwritten by the calibration.

Key Path	Input/Output, I/Q, I Setup Q Setup, I Probe Q Probe
Remote Command	[:SENSe] :CORRection:IQ:I Q:ATTenuation:RATio <real> [:SENSe] :CORRection:IQ:I Q:ATTenuation:RATio?
Example	Set the attenuation for the current I probe to 100.00:1. CORR:IQ:I:ATT:RAT 100
Notes	Each probe type has its own attenuation setting. As probes are changed the attenuation value will reflect the new probe's setting. Changing the attenuation affects only the current probe type's setting and leaves all others unchanged. When the IQ Path is I+jQ, the Q probe attenuation setting must match the I Probe attenuation setting within 1 dB. If this is not the case, an error condition message is generated, 159;Settings Alert;I/Q mismatch:Attenuation.
Preset	Each probe type has its own default. The default for the "Unknown" probe type is 1:1.
State Saved	Saved with probe calibration data. It survives a power cycle and is not affected by a Preset or Restore.
Range	0.001 to 10000
Min	0.001
Max	10000
Initial S/W Revision	Prior to A.02.00

This is an alternate form of the SCPI that allows input as a power instead of a ratio.

Remote Command	<code>[:SENSE] :CORREction:IQ:I Q:ATTenuation <rel_ampl></code> <code>[:SENSE] :CORREction:IQ:I Q:ATTenuation?</code>
Example	Set the attenuation for the current I probe type to 100.00:1. <code>CORR:IQ:I:ATT 20 dB</code>
Range	-60 dB to +80 dB
Min	-60 dB
Max	+80 dB
Initial S/W Revision	Prior to A.02.00

Offset

Some active probes have DC offset capability. When one of these probes is connected this control will be visible. The signal is adjusted for the DC offset before entering the analyzer's port. This allows for removal of a DC offset before reaching the analyzer's input port voltage limits. For example, a signal that varies 1 V peak-to-peak with a DC offset equal to the analyzer's max input voltage would exceed the input limits of the analyzer for half its cycle. Removing the DC offset allows the analyzer to correctly process the entire signal.

Key Path	Input/Output, I/Q, I Setup Q Setup, I Probe Q Probe
Remote Command	<code>:INPut:OFFSet:I Q <voltage></code> <code>:INPut:OFFSet:I Q?</code>
Example	Remove a DC offset of -0.5 V from the I channel input. <code>INP:OFFS:I -0.5</code>
Notes	Only some probe types support Offset. For those that do, each probe type has its own Offset setting. As probes are changed the Offset value will reflect the new probe's setting. Changing the Offset affects only the current probe type's setting and leaves all others unchanged.
Preset	0 V
State Saved	Saved with probe calibration data. It survives power cycle and is not affected by Preset or Restore.
Range	-18 V to +18 V
Min	-18 V
Max	+18 V
Initial S/W Revision	Prior to A.02.00

Coupling

Some probe types allow coupling to reject low frequencies. This will filter out the DC component of a signal that is composed of a DC bias plus some AC signal. This control is visible only for probe types that have this capability.

Key Path	Input/Output, I/Q, I Setup Q Setup, I Probe Q Probe
Remote Command	:INPut:COUPling:I Q DC LFR1 LFR2 :INPut:COUPling:I Q?
Example	Set the probe to low frequency rejection below 1.7 Hz. INP:COUP:I LFR1
Notes	Only some probe types support Coupling. For those that do, each probe type has its own Coupling setting. As probes are changed the Coupling value will reflect the new probe's setting. Changing the Coupling affects only the current probe type's setting and leaves all others unchanged.
Preset	DC
State Saved	Saved with probe calibration data. It survives a power cycle and is not affected by a Preset or Restore.
Range	DC AC 1.7 Hz LFR1 AC 0.14 Hz LFR2
Readback Text	DC LFR1 LFR2
Initial S/W Revision	Prior to A.02.00

DC

Turns off low frequency rejection, allowing signals down to DC.

Key Path	Input/Output, I/Q, I Setup Q Setup, I Probe Q Probe, Coupling
Example	Turn off low frequency rejection on the I channel INP:COUP:I DC
Initial S/W Revision	Prior to A.02.00

LFR1

Turns on low frequency rejection, rejecting signal component lower than 1.7 Hz.

Key Path	Input/Output, I/Q, I Setup Q Setup, I Probe Q Probe, Coupling
Example	Turn on low frequency rejection on the I channel for frequencies lower than 1.7 Hz INP:COUP:I LFR1
Initial S/W Revision	Prior to A.02.00

LFR2

Turns on low frequency rejection, rejecting signal component lower than 0.14 Hz.

Key Path	Input/Output, I/Q, I Setup Q Setup, I Probe Q Probe, Coupling
Example	Turn on low frequency rejection on the I channel for frequencies lower than 0.14 Hz INP:COUP:I LFR2
Initial S/W Revision	Prior to A.02.00

Calibrate

Invokes the guided probe calibration. The guided probe calibration is context sensitive and depends on the channel (I or Q) and the Differential Input state. The calibration is only performed on the selected channel. When Differential Input is on, both the probe attached to the main port and the probe attached to the complementary port are calibrated. When Differential Input is off, only the probe attached to the main port is calibrated. See "[I/Q Guided Calibration](#)" on page 271.

Key Path	Input/Output, I/Q, I Setup Q Setup, I Probe Q Probe, Coupling
Readback Text	The last calibration date, or if no calibration exists, "(empty)". Last: <cal date> <cal time> Example: Last: 8/22/2007 1:02:49 PM
Initial S/W Revision	Prior to A.02.00

Clear Calibration

Clears the calibration data for the current port and probe. It does not clear the data for other probe types or other ports. If the sensed probe has EEPROM identification, only the data for that specific probe is cleared. After this command has completed, the probe calibration state will be the same as if no probe calibration had ever been performed for the specified channel and probe. The probe attenuation will be the default value for that probe type and the Cable Calibration frequency response corrections will be used. This command is dependent on the Differential Input state. When Differential Input is on, both the data for the probe attached to the main port and the data for the probe attached to the complementary port are cleared. When Differential Input is off, only data for the probe attached to the main port is cleared.

Key Path	Input/Output, I/Q, I Setup Q Setup, I Probe Q Probe
Remote Command	:CALibration:IQ:PROBe:I Q:CLEar
Example	Clear the calibration data for the I channel and the current probe (with EEPROM identification) or probe type (without EEPROM identification). :CAL:IQ:PROBe:I:CLE
Initial S/W Revision	Prior to A.02.00

RF Calibrator

Lets you choose a calibrator signal to look at or turns the calibrator "off".

Key Path	Input/Output
Remote Command	[:SENSe] :FEED:AREFERENCE REF50 REF4800 OFF [:SENSe] :FEED:AREFERENCE?

Example	FEED:AREF REF50 selects the 50 MHz amplitude reference as the signal input. FEED:AREF REF4800 selects the 4.8 GHz amplitude reference as the signal input FEED:AREF OFF turns the calibrator "off" (switches back to the selected input – RF or I/Q)
Dependencies	Selecting an input (RF or I/Q) turns the Calibrator OFF. This is true whether the input is selected by the keys or with the [:SENSe]:FEED command. The 4.8 GHz internal reference is only available in some models and frequency range options. If the 4.8 GHz reference is not present, the 4.8 GHz softkey will be blanked, and if the REF4800 parameter is sent, the analyzer will generate an error.
Couplings	When one of the calibrator signals is selected, the analyzer routes that signal (an internal amplitude reference) to the analyzer, and changes the main input selection to RF so the calibrator signal can be seen. When you turn the calibrator off it does not switch back to the previously selected input.
Preset	OFF
State Saved	Saved in instrument state
Readback	Off, 50 MHz, 4.8 GHz
Initial S/W Revision	Prior to A.02.00

Remote Command	:CALibration:SOURce:STATe OFF ON 0 1 :CALibration:SOURce:STATe?
Notes	For ESA backwards compatibility. In the ESA the calibrator was a separate output which you connected to the input and switched on with this command. In the X-Series, the ON parameter is aliased to the [:SENSe]:FEED:AREF REF50 command and the OFF parameter is aliased to [:SENSe]:FEED:AREF OFF. When CALibration:SOURce:STATe? is received, 1 will be returned if any of the references is selected and 0 if the Calibrator is "Off"
Preset	OFF
Initial S/W Revision	Prior to A.02.00

50 MHz

Selects the 50 MHz internal reference as the input signal.

Key Path	Input/Output, RF Calibrator
Example	:FEED:AREF REF50
Readback	50 MHz
Initial S/W Revision	Prior to A.02.00

4.8 GHz

Selects the 4.8 GHz internal reference as the input signal.

Key Path	Input/Output, RF Calibrator
Example	:FEED:AREF REF4800
Dependencies	The 4.8 GHz internal reference is only available in some models and frequency range options. If the 4.8 GHz reference is not present, the 4.8 GHz softkey will be blanked, and if the REF4800 parameter is sent, the analyzer will generate an error.
Readback	4.8 GHz
Initial S/W Revision	Prior to A.02.00
Modified at S/W Revision	A.03.00

Off

Switches the input back to the selected input (RF or I/Q)

Key Path	Input/Output, RF Calibrator
Example	:FEED:AREF OFF
Readback	Off
Initial S/W Revision	Prior to A.02.00

External Gain

Compensates for gain or loss in the measurement system outside the spectrum analyzer. The External Gain is subtracted from the amplitude readout (or the loss is added to the amplitude readout). So, the displayed signal level represents the signal level at the output of the device-under-test, which can be the input of an external device that provides gain or loss.

Entering an External Gain value does not affect the Reference Level, therefore the trace position on screen changes, as do all of the values represented by the trace data. Thus, the values of exported trace data, queried trace data, marker amplitudes, trace data used in calculations such as N dB points, trace math, peak threshold, etc., are all affected by External Gain. Changing the External Gain, even on a trace that is not updating, will immediately change all of the above, without new data needing to be taken.

NOTE

Changing the External Gain causes the analyzer to immediately stop the current sweep and prepare to begin a new sweep. The data will not change until the trace data updates because the offset is applied to the data as it is taken. If a trace is exported with a nonzero External Gain, the exported data will contain the trace data with the offset applied.

In the Spectrum Analyzer mode, a Preamp is the common external device providing gain or loss. In a measurement application mode like GSM or W-CDMA, the gain or loss could be from a BTS (Base Transceiver Station) or an MS (Mobile Station). So in the Spectrum Analyzer mode MS and BTS would be

grayed out and the only choice would be Ext Preamp. Similarly in some of the digital communications applications, Ext Preamp will be grayed out and you would have a choice of MS or BTS.

Key Path	Input/Output
Couplings	The Ext Preamp, MS, and BS keys may be grayed out depending on which measurement is currently selected. If any of the grayed out keys are pressed, or the equivalent SCPI command is sent, an advisory message is generated.
Readback	1-of-N selection [variable]
Initial S/W Revision	Prior to A.02.00

Ext Preamp

This function is similar to the reference level offset function. Both affect the displayed signal level. Ref Lvl Offset is a mathematical offset only, no analyzer configuration is affected. Ext Preamp gain is used when determining the auto-coupled value of the Attenuator. The External Gain value and the Maximum Mixer Level settings are both part of the automatic setting equation for the RF attenuation setting. (10 dB of Attenuation is added for every 10 dB of External Gain.)

Note that the Ref Lvl Offset and Maximum Mixer Level are described in the Amplitude section. They are reset by the instrument Preset. The External Preamp Gain is reset by the "Restore Input/Output Defaults" or "Restore System Defaults->All functions. . The External Gain is subtracted from the amplitude readout so that the displayed signal level represents the signal level at the output of the device-under-test, which is the input of the external device that is providing gain or loss.

"More Information" on page 235

Key Path	Input/Output, External Gain
Remote Command	<code>[[:SENSE]:CORRection:SA[:RF]:GAIN <rel_ampl></code> <code>[[:SENSE]:CORRection:SA[:RF]:GAIN?</code>
Example	CORR:SA:GAIN 10 sets the Ext Gain value to 10 dB CORR:SA:GAIN -10 sets the Ext Gain value to -10 dB (that is, an attenuation of 10 dB)
Notes	Does not auto return.
Dependencies	The reference level limits are determined in part by the External Gain/Atten, Max Mixer Level, and RF Atten. This key is grayed out in Modes that do not support External Gain
Preset	This is unaffected by Preset but is set to 0 dB on a "Restore Input/Output Defaults" or "Restore System Defaults->All"
State Saved	Saved in instrument state
Min	-120 dB
Max	120 dB
Readback	Preamp Gain, <Ext Gain value> dB
Backwards Compatibility SCPI	<code>[[:SENSE]:CORRection:OFFSet[:MAGNitude]</code> The legacy "Ext Preamp Gain" key is now called "Ext Gain" and the sub-menu has choices of Ext

	Preamp MS BTS for backwards compatibility.
Initial S/W Revision	Prior to A.02.00
Modified at S/W Revision	A.14.00

More Information

The U7227A USB Preamplifier is an accessory for the X-Series Signal Analyzer that provides gain externally, and whose gain settings are automatically loaded into the analyzer over USB whenever it is connected to one of the analyzer's USB ports.

While the USB Preamplifier is plugged into one of the analyzer's USB ports, the analyzer will consider it to be in the signal path of the RF Input and will apply the calibration data from the USB Preamp to measurements taken at the RF Input (on 2 input boxes, it will be considered to be in the signal path of RF Input 1; it is not supported for RF Input 2).

The USB Preamplifier contains its own cal data. This includes a noise trace suitable for use with NFE, for those models which support NFE. The act of connecting the Preamp to USB will cause the cal data to be downloaded from the preamp. When this happens an informational message is provided saying "Cal data loaded from USB Preamp". The analyzer will then automatically apply the calibration factors loaded from the Preamp in any measurement that supports the USB Preamp.

The External Preamp Gain setting may still be used, even though it is not required for the USB Preamp (since the USB Preamp supplies its own gain data to the analyzer which is applied automatically). Connecting the USB Preamp does not change the External Preamp Gain setting, however unless you have another gain or attenuation element in the signal path, the appropriate setting for External Preamp Gain is 0 dB.

Overload detection and reporting will apply when the USB preamplifier is connected to USB. The USB Preamplifier has its own overload detector which reports overloads to the instrument over USB. This generates an error condition, "Input Overload;USB Preamp."

If, while the USB Preamp is connected to USB, a measurement is selected that does not support the USB preamplifier, the "No result; Meas invalid with Preamp" error condition is generated.

MS

Sets an external gain/attenuation value for MS (Mobile Station) tests.

Key Path	Input/Output, External Gain
Remote Command	<code>[:SENSe] :CORRection:MS[:RF]:GAIN <rel_amp></code> <code>[:SENSe] :CORRection:MS[:RF]:GAIN?</code>
Example	<code>CORR:MS:GAIN 10</code> sets the Ext Gain value to 10 dB <code>CORR:MS:GAIN -10</code> sets the Ext Gain value to -10 dB (that is, a loss of 10 dB.)
Notes	Does not auto return.
Dependencies	The reference level limits are determined in part by the External Gain, Max Mixer Level, RF Atten This key is grayed out in modes that do not support MS.
Preset	This is unaffected by a Preset but is set to 0 dB on a "Restore Input/Output Defaults" or "Restore

	System Defaults->All"
State Saved	Saved in instrument state.
Min	-100 dB
Max	100 dB
Readback	MS, <Ext Gain value> dB
Initial S/W Revision	Prior to A.02.00

Remote Command	<code>[:SENSe] :CORRection:MS[:RF]:LOSS <rel_ampl></code> <code>[:SENSe] :CORRection:MS[:RF]:LOSS?</code>
Example	<code>CORR:MS:LOSS 10</code> sets the Ext Gain value to -10 dB, and subsequently querying <code>:LOSS</code> will give 10 dB <code>CORR:MS:LOSS -10</code> sets the Ext Gain value to 10 dB, and subsequently querying <code>:LOSS</code> will give -10 dB
Notes	A positive value of <rel_ampl> in the above command means a loss and a negative value indicates a gain. Anytime <code>:LOSS</code> is set it sets <code>:GAIN</code> to the negative value of the parameter sent. Anytime <code>:LOSS</code> is queried it gives the negative of <code>:GAIN</code>
Preset	This is unaffected by a Preset but is set to 0 dB on a "Restore Input/Output Defaults" or "Restore System Defaults->All"
Min	100 dB
Max	-100 dB
Initial S/W Revision	Prior to A.02.00

BTS

Sets an external attenuation value for BTS (Base Transceiver Station) tests.

Key Path	Input/Output, External Gain
Remote Command	<code>[:SENSe] :CORRection:BTS[:RF]:GAIN <rel_ampl></code> <code>[:SENSe] :CORRection:BTS[:RF]:GAIN?</code>
Example	<code>CORR:BTS:GAIN 10</code> sets the Ext Gain value to 10 dB <code>CORR:BTS:GAIN -10</code> sets the Ext Gain value to -10 dB (that is, a loss of 10 dB.)
Notes	Does not auto return.
Dependencies	The reference level limits are determined in part by the External Gain, Max Mixer Level, RF Atten This key is grayed out in modes that do not support BTS.
Preset	This is unaffected by a Preset but is set to 0 dB on a "Restore Input/Output Defaults" or "Restore System Defaults->All"

State Saved	Saved in instrument state.
Min	-100 dB
Max	100 dB
Readback	BTS, <Ext Gain value> dB
Initial S/W Revision	Prior to A.02.00

Remote Command	<code>[:SENSe] :CORRection:BTS[:RF]:LOSS <rel_ampl></code> <code>[:SENSe] :CORRection:BTS[:RF]:LOSS?</code>
Example	<code>CORR:BTS:LOSS 10</code> sets the Ext Gain value to -10 dB, and subsequently querying <code>:LOSS</code> will give 10 dB <code>CORR:BTS:LOSS -10</code> sets the Ext Gain value to 10 dB, and subsequently querying <code>:LOSS</code> will give -10 dB
Notes	A positive value of <rel_ampl> in the above command means a loss and a negative value indicates a gain. Anytime <code>:LOSS</code> is set it sets <code>:GAIN</code> to the negative value of the parameter sent. Anytime <code>:LOSS</code> is queried it gives the negative of <code>:GAIN</code>
Preset	This is unaffected by a Preset but is set to 0 dB on a "Restore Input/Output Defaults" or "Restore System Defaults->All"
Min	100 dB
Max	-100 dB
Initial S/W Revision	Prior to A.02.00

I Ext Gain

This function affects the I channel input. However, when Q Gain in I+jQ is set to Same as I Gain, this value is applied to both I and Q channel inputs.

Key Path	Input/Output, External Gain
Remote Command	<code>[:SENSe] :CORRection:IQ:I:GAIN <rel_ampl></code> <code>[:SENSe] :CORRection:IQ:I:GAIN?</code>
Example	Set the I Ext Gain to 10 dB <code>CORR:IQ:I:GAIN 10</code> Set the I Ext Gain to -10 dB (that is, a loss of 10 dB.) <code>CORR:IQ:I:GAIN -10</code>
Dependencies	Not available unless option BBA is installed
Preset	0 dB This is unaffected by a Preset but is set to 0 dB on a "Restore Input/Output Defaults" or "Restore System Defaults->All"

State Saved	Saved in instrument state.
Min	-100 dB
Max	100 dB
Readback Text	I Gain, <I Ext Gain> dB
Initial S/W Revision	Prior to A.02.00

Q Ext Gain

This function affects the Q channel input.

Key Path	Input/Output, External Gain
Remote Command	[:SENSe] :CORRection:IQ:Q:GAIN <rel_ampl> [:SENSe] :CORRection:IQ:Q:GAIN?
Example	Set the Q Ext Gain to 10 dB CORR:IQ:Q:GAIN 10 Set the Q Ext Gain to -10 dB (that is, a loss of 10 dB.) CORR:IQ:Q:GAIN -10
Dependencies	Not available unless option BBA is installed.
Preset	0 dB This is unaffected by a Preset but is set to 0 dB on a "Restore Input/Output Defaults" or "Restore System Defaults->All"
State Saved	Saved in instrument state
Min	-100 dB
Max	100 dB
Readback Text	Q Gain, <I Ext Gain> dB
Initial S/W Revision	Prior to A.02.00

Restore Input/Output Defaults

This selection causes the group of settings and data associated with the Input/Output key to be a reset to their default values. In addition, when a Source is installed, licensed and selected, Restore Input/Output defaults will initiate a Source Preset.

This level of Restore System Defaults does not affect any other system settings or mode settings and does not cause a mode switch. All the features described in this section are reset using this key, including Input Corrections and Data (described in the Corrections section).

Key Path	Input/Output
Example	:SYST:DEF INP presets all the Input/Output variables to their factory default values.

Notes	Refer to the Utility Functions for information about Restore System Defaults and the complete description of the :SYSTem:DEFAult INPut: command.
Initial S/W Revision	Prior to A.02.00

Data Source

Gives you the choice of either using a hardware input signal as the input or raw data stored in a data storage buffer from an earlier acquisition. You can also share raw data across certain measurements that support this feature. The measurements must be capable of storing raw data. There are three choices under this menu. You can select "Inputs" which is the same as selecting one of the inputs from the input port, for example RF, AREF, I/Q, or IFALign. Selecting "Capture Buffer" allows you to use data that has been stored earlier in the same measurement or from a previous measurement using the "Current Meas -> Capture Buffer" feature. Selecting "Recorded Data" allows you to playback long data capture records stored in the record buffer.

Key Path	Input/Output
Remote Command	[:SENSe] :FEED:DATA INPut STORed [:SENSe] :FEED:DATA?
Example	FEED:DATA STOR FEED:DATA?
Notes	INPutS = Inputs STORed = Capture Buffer
Dependencies	Not all inputs are available in all modes. Unavailable keys are grayed out.
Preset	This is unaffected by Preset but is set to INPut on a "Restore Input/Output Defaults" or "Restore System Defaults->All"
State Saved	Saved in instrument state
Readback	Variable
Backwards Compatibility SCPI	[:SENSe] :FEED:SOURce INPut STORed [:SENSe] :FEED:SOURce?
Initial S/W Revision	Prior to A.02.00

Inputs

Sets the measurement to use the input selections (RF, AREF, I/Q)

Key Path	Input/Output, Data Source
Example	FEED:DATA INP causes the measurement to look at the input selection

Notes	Does not auto return.
Readback	Inputs
Initial S/W Revision	Prior to A.02.00

Capture Buffer

Some WCDMA and demod measurements support this feature. This allows sharing of the raw data across certain measurements. If you want to make another measurement on the same signal, you would store that raw data using the "Current Meas -> Capture Buffer" key. Then the data is available for the next measurement to use. You must have raw data stored in the instrument memory before the Capture Buffer choice is available for use.

Key Path	Input/Output, Data Source
Example	FEED:DATA STOR causes stored measurement data to be used with a different measurement that supports this.
Notes	Does not auto return. This key is grayed out when you switch to a measurement that does not support this feature.
Dependencies	If you switch to a measurement that does not support this feature, then the instrument switches to use "Inputs" and grays out this key. If the grayed out key is pressed, it generates a message.
Readback	Stored Data
Initial S/W Revision	Prior to A.02.00

Current Meas -> Capture Buffer

Pressing this key stores the raw data of one measurement in the internal memory of the instrument where it can then be used by a different measurement by pressing "Stored Data". When raw data is stored, then the data source selection switch automatically changes to "Stored Data". Stored raw data cannot be directly accessed by a user. There is no save/recall function to save the raw data in an external media. However if you want to get the stored raw data, you must first perform a measurement using the stored raw data. Now you can access the used raw data, which is the same as stored raw data, using the FETch or READ commands.

Key Path	Input/Output, Data Source
Remote Command	[:SENSe] :FEED:DATA:STORe
Example	FEED:DATA:STOR stores recorded data
Notes	This is command only, there is no query
Dependencies	Grayed out in the SA measurement.
Backwards Compatibility SCPI	[:SENSe] :FEED:SOURce:STORe
Initial S/W Revision	Prior to A.02.00

Corrections

This key accesses the Amplitude Corrections menu.

Amplitude Corrections arrays can be entered, sent over SCPI, or loaded from a file. They allow you to correct the response of the analyzer for various use cases. The X-series supports four separate Corrections arrays, each of which can contain up to 2000 points. They can be turned on and off individually and any or all can be on at the same time.

Trace data is in absolute units and corrections data is in relative units, but we want to be able to display trace data at the same time as corrections data. Therefore we establish a reference line to be used while building or editing a Corrections table. The reference line is halfway up the display and represents 0 dB of correction. It is labeled "0 dB CORREC". It is drawn in blue.

Corrections data is always in dB. Whatever dB value appears in the correction table represents the correction applied to that trace at that frequency. So if a table entry shows 30 dB that means we ADD 30 dB to each trace to correct it before displaying it.

In zero span, where the frequency is always the center frequency of the analyzer, we apply the (interpolated) correction for the center frequency to all points in the trace. In the event where there are two correction amplitudes at the center frequency, we apply the first one in the table.

Note that the corrections are applied as the data is taken; therefore, a trace in View (Update Off) will not be affected by changes made to the corrections table after the trace is put in View.

Key Path	Input/Output, Corrections
Mode	SA, I/Q Analyzer, Phase Noise, VXI, RTSA, EMI Receiver, DVB-T/H, DTMB, DVB-T/H, DTMB, W-CDMA, LTE & LTE-Adv FDD, LTE & LTE-Adv TDD, Sequence Analyzer, BTooth
Dependencies	This key will only appear if you have the proper option installed in your instrument. Amplitude correction may not be available in all modes; if a mode does not support amplitude correction, the Corrections key should be blanked while in that mode. If an application supports corrections but the current measurement does not, then the key should be grayed out in that measurement
Preset	Corrections arrays are reset (deleted) by Restore Input/Output Defaults. They survive shutdown and restarting of the analyzer application, which means they will survive a power cycle.
Initial S/W Revision	A.02.00
Modified at S/W Revision	x.14.50

Select Correction

Specifies the selected correction. The term "selected correction" is used throughout this document to specify which correction will be affected by the functions.

Key Path	Input/Output, Corrections
Mode	SA, I/Q Analyzer, Phase Noise, VXI, RTSA, EMI Receiver, DVB-T/H, DTMB, DVB-T/H, DTMB, W-CDMA, LTE & LTE-Adv FDD, LTE & LTE-Adv TDD, Sequence Analyzer, BTooth

Notes	The selected correction is remembered even when not in the correction menu.
Preset	Set to Correction 1 by Restore Input/Output Defaults
Readback	Correction 1 Correction 2 Correction 3 Correction 4 Correction 5 Correction 6 Correction 7 Correction 8
Initial S/W Revision	A.02.00
Modified at S/W Revision	x.14.50

Correction On/Off

Turning the Selected Correction from the OFF state to the ON state allows the values in it to be applied to the data. This state transition also automatically turns on "Apply Corrections" (sets it to ON), otherwise the correction would not take effect.

A new sweep is initiated if an amplitude correction is switched on or off. Note that changing, sending or loading corrections data does NOT directly initiate a sweep, however in general these operations will turn corrections on, which DOES initiate a sweep.

Key Path	Input/Output, Corrections
Remote Command	<code>[[:SENSe]:CORRection:CSET[1] 2 ... 8[:STATe] ON OFF 1 0</code> <code>[[:SENSe]:CORRection:CSET[1] 2 ... 8[:STATe]?</code>
Example	SENS:CORR:CSET1 ON
Dependencies	Changing this from the OFF state to the ON state automatically turns on "Apply Corrections". Only the first correction array (Correction 1) supports antenna units. When this array is turned on, and it contains an Antenna Unit other than "None", the Y Axis Unit of the analyzer is forced to that Antenna Unit. All other Y Axis Unit choices are grayed out. Note that this means that a correction file with an Antenna Unit can only be loaded into the Corrections 1 register. Consequently only for Correction 1 does the dropdown in the Recall dialog include.ant, and if an attempt is made to load a correction file into any other Correction register which DOES contain an antenna unit, a Mass Storage error is generated. This command will generate an "Option not available" error unless you have the proper option installed in your instrument.
Preset	Not affected by a Preset. Set to OFF by Restore Input/Output Defaults
State Saved	Saved in instrument state.
Backwards Compatibility Notes	Unlike legacy analyzers, Preset does not turn Corrections off (Restore Input/Output Defaults does).
Initial S/W Revision	A.02.00
Modified at S/W Revision	A.14.00

Properties

Accesses a menu that lets you set the properties of the selected correction.

Key Path	Input/Output, Corrections
Initial S/W Revision	A.02.00

Select Correction

Specifies the selected correction. The term "selected correction" is used throughout this document to specify which correction will be affected by the functions.

Key Path	Input/Output, Corrections
Mode	SA, I/Q Analyzer, Phase Noise, VXA, RTSA, EMI Receiver, DVB-T/H, DTMB, DVB-T/H, DTMB, W-CDMA, LTE & LTE-Adv FDD, LTE & LTE-Adv TDD, Sequence Analyzer, BTooth
Notes	The selected correction is remembered even when not in the correction menu.
Preset	Set to Correction 1 by Restore Input/Output Defaults
Readback	Correction 1 Correction 2 Correction 3 Correction 4 Correction 5 Correction 6 Correction 7 Correction 8
Initial S/W Revision	A.02.00
Modified at S/W Revision	x.14.50

Antenna Unit

For devices (like antennas) that make measurements of field strength or flux density, the correction array should contain within its values the appropriate conversion factors such that, when the data on the analyzer is presented in dB μ V, the display is calibrated in the appropriate units. The "Antenna Unit" used for the conversion is contained within the corrections array database. It may be specified or loaded in from an external file or SCPI.

When an array with an Antenna Unit other than "None" is turned on, the Y Axis Unit of the analyzer is forced to that unit. When this array is turned on, and it contains an Antenna Unit other than "None", the Y Axis Unit of the analyzer is forced to that Antenna Unit., and all other Y Axis Unit choices are grayed out.

Antenna Unit does not appear in all Modes that support Corrections. Only the modes listed in the Mode row of the table below support Antenna Units.

Key Path	Input/Output, Corrections, Properties
Mode	SA, I/Q Analyzer, Phase Noise, VXA, RTSA, EMI Receiver, DVB-T/H, DTMB, DVB-T/H, DTMB, W-CDMA, LTE & LTE-Adv FDD, LTE & LTE-Adv TDD, Sequence Analyzer, BTooth
Remote Command	<code>[:SENSe] :CORRection:CSET[1]:ANTenna[:UNIT] GAUSs PTESla UVM UAM UA NOConversion</code> <code>[:SENSe] :CORRection:CSET[1]:ANTenna[:UNIT] ?</code>
Example	CORR:CSET:ANT GAUS
Dependencies	Only the first correction array (Correction 1) supports antenna units. Note that this means that a correction file with an Antenna Unit can only be loaded into the Corrections 1 register. Consequently only for Correction 1 does the dropdown in the Recall dialog

	include.ant, and if an attempt is made to load a correction file into any other Correction register which DOES contain an antenna unit, a Mass Storage error is generated.
Preset	Unaffected by Preset. Set to NOC by Restore Input/Output Defaults
State Saved	Saved in instrument state
Initial S/W Revision	A.02.00
Modified at S/W Revision	x.14.50

None

Selects no antenna unit for this Correction set. Thus no Y Axis unit will be forced.

Key Path	Input/Output, Corrections, Properties, Antenna Unit
Example	:CORR:CSET:ANT NOC
Readback	"None"
Initial S/W Revision	A.02.00

dB μ V/m

Sets the antenna unit to dB μ V/m. If this correction is turned on, and Apply Corrections is on, the Y Axis Unit will then be forced to dB μ V/m and all other Y Axis Unit selections will be grayed out.

Key Path	Input/Output, Corrections, Properties, Antenna Unit
Example	:CORR:CSET:ANT UVM
Readback	"dB μ V/m"
Initial S/W Revision	A.02.00

dB μ A/m

Sets the antenna unit to dB μ A/m. If this correction is turned on, and Apply Corrections is on, the Y Axis Unit will then be forced to dB μ A/m and all other Y Axis Unit selections will be grayed out.

Key Path	Input/Output, Corrections, Properties, Antenna Unit
Example	:CORR:CSET:ANT UVA
Readback	" dB μ A/m"
Initial S/W Revision	A.02.00

dBpT

Sets the antenna unit to dBpT. If this correction is turned on, and Apply Corrections is on, the Y Axis Unit will then be forced to dBpT and all other Y Axis Unit selections will be grayed out.

Key Path	Input/Output, Corrections, Properties, Antenna Unit
Example	:CORR:CSET:ANT PTES
Readback	"dBpT"
Initial S/W Revision	A.02.00

dBG

Sets the antenna unit to dBG. If this correction is turned on, and Apply Corrections is on, the Y Axis Unit will then be forced to dBG and all other Y Axis Unit selections will be grayed out.

Key Path	Input/Output, Corrections, Properties, Antenna Unit
Example	:CORR:CSET:ANT GAUS
Readback	" dBG"
Initial S/W Revision	A.02.00

dB μ A

Sets the antenna unit to dB μ A. If this correction is turned on, and Apply Corrections is on, the Y Axis Unit will then be forced to dB μ A and all other Y Axis Unit selections will be grayed out.

Key Path	Input/Output, Corrections, Properties, Antenna Unit
Example	:CORR:CSET:ANT UA
Readback	" dB μ A"
Initial S/W Revision	A.11.00

Frequency Interpolation

This setting controls how the correction values per-bucket are calculated. We interpolate between frequencies in either the logarithmic or linear scale.

This setting is handled and stored individually per correction set.

See "[Interpolation](#)" on page 246

Key Path	Input/Output, Corrections, Properties
Remote Command	[[:SENSe]:CORRection:CSET[1] 2 ... 8:X:SPACing LINear LOGarithmic [:SENSe]:CORRection:CSET[1] 2 ... 8:X:SPACing?
Example	CORR:CSET:X:SPAC LIN
Preset	Unaffected by a Preset. Set to Linear by Restore Input/Output Defaults.
State Saved	Saved in instrument state.
Initial S/W Revision	A.02.00
Modified at S/W Revision	A.14.00

Interpolation

For each bucket processed by the application, all of the correction factors at the frequency of interest (center frequency of each bucket) are summed and added to the amplitude. All trace operations and post processing treat this post-summation value as the true signal to use.

To effect this correction, the goal, for any particular start and stop frequency, is to build a correction trace, whose number of points matches the current Sweep Points setting of the instrument, which will be used to apply corrections on a bucket by bucket basis to the data traces.

For amplitudes that lie between two user specified frequency points, we interpolate to determine the amplitude value. You may select either linear or logarithmic interpolation between the frequencies.

If we interpolate on a log scale, we assume that the line between the two points is a straight line on the log scale. For example, let's say the two points are (2,4) and (20,1). A straight line between them on a log scale looks like:

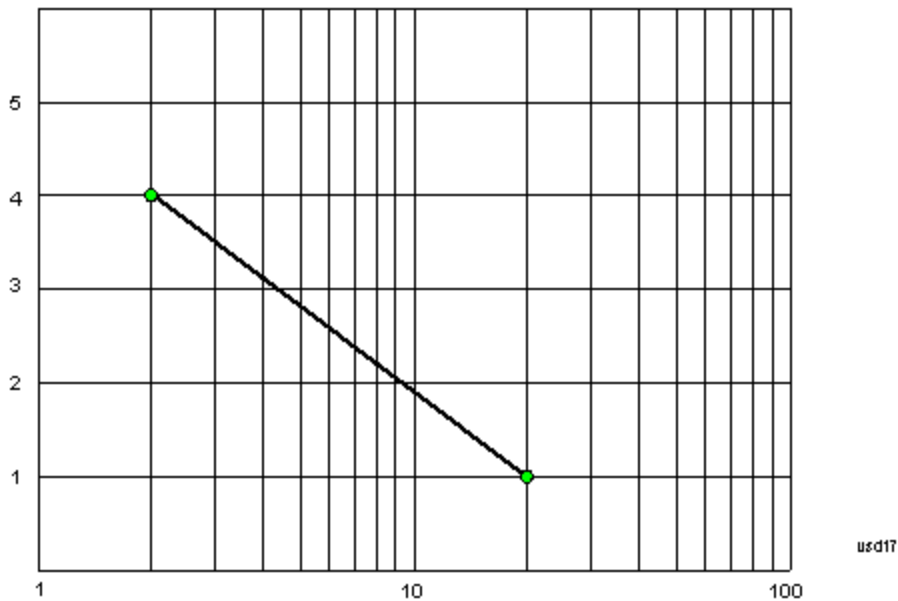

On a linear scale (like that of the spectrum analyzer), this translates to:

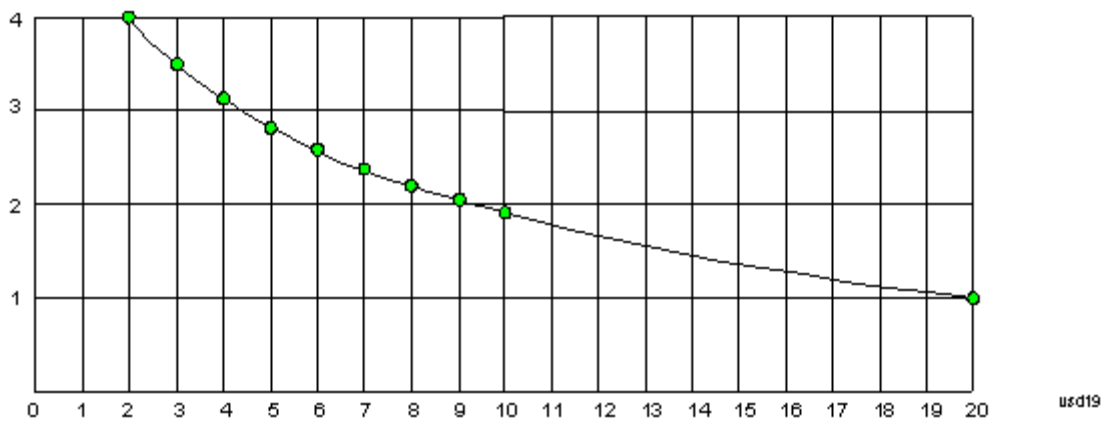

If we interpolate on a linear scale, we assume that the two points are connected by a straight line on the linear scale, as below:

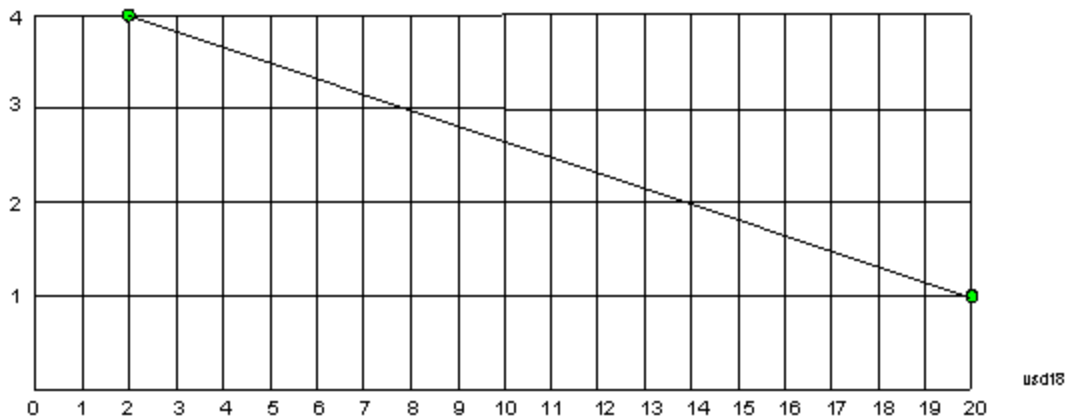

The correction to be used for each bucket is taken from the interpolated correction curve at the center of the bucket.

Description

Sets an ASCII description field which will be stored in an exported file. Can be displayed in the active function area by selecting as the active function, if desired to appear in a screen capture.

Key Path	Input/Output, Corrections, Properties
Remote Command	<code>[[:SENSe]:CORRection:CSET[1] 2 ... 8:DESCription "text"</code> <code>[[:SENSe]:CORRection:CSET[1] 2 ... 8:DESCription?</code>
Example	<code>:CORR:CSET1:DESC "11941A Antenna correction"</code>
Notes	45 chars max; may not fit on display if max chars used
Preset	Unaffected by a Preset. Set to empty by Restore Input/Output Defaults
State Saved	Saved in instrument state.
Initial S/W Revision	A.02.00
Modified at S/W Revision	A.14.00

Comment

Sets an ASCII comment field which will be stored in an exported file. Can be displayed in the active function area by selecting as the active function, if desired to appear in a screen capture.

Key Path	Input/Output, Corrections, Properties
Remote Command	<code>[[:SENSe]:CORRection:CSET[1] 2 ... 8:COMMeNt "text"</code> <code>[[:SENSe]:CORRection:CSET[1] 2 ... 8:COMMeNt?</code>
Example	<code>:CORR:CSET1:COMM "this is a comment"</code>
Notes	60 chars max; may not fit on display if max chars used
Preset	Unaffected by Preset. Set to empty by Restore Input/Output Defaults

State Saved	Saved in instrument state
Initial S/W Revision	A.02.00
Modified at S/W Revision	A.14.00

Edit

Invokes the integrated editing facility for this correction set.

When entering the menu, the editor window turns on, the selected correction is turned On, Apply Corrections is set to On, the amplitude scale is set to Log, and the Amplitude Correction (“Ampcor”) trace is displayed. The actual, interpolated correction trace is shown in green for the selected correction. Note that since the actual interpolated correction is shown, the correction trace may have some curvature to it. This trace represents only the correction currently being edited, rather than the total, accumulated amplitude correction for all amplitude corrections which are currently on, although the total, accumulated correction for all corrections which are turned on is still applied to the data traces.

Because corrections data is always in dB, but the Y-axis of the analyzer is in absolute units, it is necessary to establish a reference line for display of the Corrections data. The reference line is halfway up the display and represents 0 dB of correction. It is labeled “0 dB CORREC”. It is drawn in blue.

Corrections data is always in dB. Whatever dB value appears in the correction table represents the correction to be applied to that trace at that frequency. So if a table entry shows 30 dB that means we ADD 30 dB to each trace to correct it before displaying it. By definition all points are connected. If a gap is desired for corrections data, enter 0 dB.

Note that a well-designed Corrections array should start at 0 dB and end at 0 dB. This is because whatever the high end point is will be extended to the top frequency of the instrument, and whatever the low end point is will be extended down to 0 Hz. So for a Corrections array to have no effect outside its range, you should start and end the array at 0 dB.

NOTE

The table editor will only operate properly if the analyzer is sweeping, because its updates are tied to the sweep system. Thus, you should not try to use the editor in single sweep, and it will be sluggish during compute-intensive operations like narrow-span FFT sweeps.

When exiting the edit menu (by using the Return key or by pressing an instrument front-panel key), the editor window turns off and the Ampcor trace is no longer displayed; however, Apply Corrections remains On, any correction that was on while in the editor remains on, and the amplitude scale returns to its previous setting.

Corrections arrays are not affected by a Preset, because they are in the Input/Output system. They also survive shutdown and restarting of the analyzer application, which means they will survive a power cycle.

When editing a correction, the editor remembers which correction and which element in the correction array you were editing, and returns you to that correction and that element when you return to the editor after leaving it.

Key Path	Input/Output, Corrections
Initial S/W Revision	A.02.00

Navigate

Lets you move through the table to edit the desired point.

Key Path	Input/Output, Corrections, Edit
Notes	There is no value readback on the key
Min	1
Max	2000
Initial S/W Revision	A.02.00

Frequency

Lets you edit the frequency of the current row.

Key Path	Input/Output, Corrections, Edit
Notes	There is no value readback on the key.
Min	0
Max	1 THz
Initial S/W Revision	A.02.00

Amplitude

Lets you edit the Amplitude of the current row.

Key Path	Input/Output, Corrections, Edit
Notes	There is no value readback on the key.
Min	-1000 dB
Max	1000 dB
Initial S/W Revision	A.02.00

Insert Point Below

Inserts a point below the current point. The new point is a copy of the current point and becomes the current point. The new point is not yet entered into the underlying table, and the data in the row is displayed in light gray.

Key Path	Input/Output, Corrections, Edit
Initial S/W Revision	A.02.00

Delete Point

Deletes the currently-selected point, whether or not that point is being edited, and selects the Navigate functionality. The point following the currently-selected point (or the point preceding if there is none) will be selected.

Key Path	Input/Output, Corrections, Edit
Initial S/W Revision	A.02.00

Scale X Axis

Matches the X Axis to the selected Correction, as well as possible. Sets the Start and Stop Frequency to contain the minimum and maximum Frequency of the selected Correction. The range between Start Frequency and Stop Frequency is 12.5% above the range between the minimum and maximum Frequency, so that span exceeds this range by one graticule division on either side. If in zero-span, or there is no data in the Ampcor table, or the frequency range represented by the table is zero, no action is taken. Standard clipping rules apply if the value in the table is outside the allowable range for the X axis.

Key Path	Input/Output, Corrections, Edit
Dependencies	If either the first or last point in the array is outside the frequency range of the current input, an error message is generated: “-221. Settings conflict; Start or Stop Freq out of range for current input settings”
Initial S/W Revision	A.02.00

Delete Correction

Deletes the correction values for this set. When this key is pressed a prompt is placed on the screen that says “Please press Enter or OK key to delete correction. Press ESC or Cancel to close this dialog.” The deletion is only performed if you press OK or Enter.

Key Path	Input/Output, Corrections
Remote Command	[:SENSe] :CORRection:CSET [1] 2 . . . 6 :DELete
Example	CORR:CSET:DEL CORR:CSET1:DEL CORR:CSET4:DEL
Notes	Pressing this key when no corrections are present is accepted without error.
Initial S/W Revision	A.02.00

Apply Corrections

Applies amplitude corrections, which are marked as ON to the measured data. If this is set to OFF, then no amplitude correction sets will be used, regardless of their individual on/off settings. If set to ON, the corrections that are marked as ON (see ["Correction On/Off" on page 242](#)) are used.

Key Path	Input/Output, Corrections
Remote Command	[:SENSe] :CORRection:CSET:ALL[:STATe] ON OFF 1 0 [:SENSe] :CORRection:CSET:ALL[:STATe] ?
Example	SENS:CORR:CSET:ALL OFF This command makes sure that no amplitude corrections are applied, regardless of their individual on/off settings.
Preset	Not affected by Preset. Set to OFF by Restore Input/Output Defaults
State Saved	Saved in instrument state.
Initial S/W Revision	A.02.00

Delete All Corrections

Erases all correction values for all 4 Amplitude Correction sets.

When this key is pressed a prompt is placed on the screen that says "Please press Enter or OK key to delete all corrections. Press ESC or Cancel to close this dialog." The deletion is only performed if you press OK or Enter.

Key Path	Input/Output, Corrections
Remote Command	[:SENSe] :CORRection:CSET:ALL:DELeTe
Example	CORR:CSET:ALL:DEL
Initial S/W Revision	A.02.00

Remote Correction Data Set Commands

This section describes the remote (SCPI) commands used to put values into correction sets. See the correction / table editor section of the Input/Output section for the information on front panel entry of correction data.

["Set \(Replace\) Data \(Remote Command Only\)" on page 251](#)

["Merge Correction Data \(Remote Command Only\)" on page 252](#)

Set (Replace) Data (Remote Command Only)

The command takes an ASCII series of alternating frequency and amplitude points, each value separated by commas.

The values sent in the command will totally replace all existing correction points in the specified set.

An Ampcor array can contain 2000 points maximum.

Remote Command	[:SENSe] :CORRection:CSET[1] 2 ... 8:DATA <freq>, <ampl>, . . . [:SENSe] :CORRection:CSET[1] 2 ... 8:DATA?
Example	CORR:CSET1:DATA 10000000, -1.0, 20000000, 1.0

	This defines two correction points at (10 MHz, -1.0 dB) and (20 MHz, 1.0 dB) for correction set 1.
Preset	Empty after Restore Input/Output Defaults. Survives a shutdown or restart of analyzer application (including a power cycle).
State Saved	Saved in instrument state.
Min	Freq: 0 Hz Amptd: -1000 dBm
Max	Freq: 1 THz Amptd: +1000 dBm
Initial S/W Revision	A.02.00
Modified at S/W Revision	A.14.00

Merge Correction Data (Remote Command Only)

The command takes an ASCII series of alternating frequency and amplitude points, each value separated by commas. The difference between this command and Set Data is that this merges new correction points into an existing set.

Any new point with the same frequency as an existing correction point will replace the existing point's amplitude with that of the new point.

An Ampcor array can contain 2000 total points, maximum.

Remote Command	<code>[[:SENSe]:CORRection:CSET[1] 2 ... 8:DATA:MERGe <freq>, <ampl>, ...</code>
Example	<code>CORR:CSET1:DATA:MERGE 15000000, -5.0, 25000000, 5.0</code> This adds two correction points at (15 MHz, -5.0 dB) and (25 MHz, 5.0 dB) to whatever values already exist in correction set 1.
Preset	Empty after Restore Input/Output Defaults. Survives shutdown/restart of analyzer application (including power cycle)
Min	Freq: 0 Hz Amptd: -1000 dBm
Max	Freq: 1 THz Amptd: +1000 dBm
Initial S/W Revision	A.02.00
Modified at S/W Revision	A.14.00

Freq Ref In

Specifies the frequency reference as being the internal reference at the rear panel input labeled EXT REF IN, a 1 pulse per second signal at the EXT REF IN input,, external reference or sensing the presence of a signal at the EXT REF IN input.

When the frequency reference is set to internal, the internal 10 MHz reference is used even if an external reference is connected.

When the frequency reference is set to external, the instrument will use the external reference. However, if there is no external signal present, or it is not within the proper amplitude range, a condition error message is generated. When the external signal becomes valid, the error is cleared.

When the frequency reference is set to Pulse, the instrument expects a 1 pulse per second signal at the EXT REF IN input. The instrument uses this signal to adjust the frequency of the internal reference.

If Sense is selected, the instrument checks whether a signal is present at the external reference connector. If it senses a signal within 5 ppm of the External Ref Freq (as set on the External Ref Freq softkey), it will automatically switch to the external reference. If it senses a 1 pulse per second signal, it enters Pulse mode, wherein the signal is used to adjust the internal reference. When no signal is present, it automatically switches to the internal reference. No message is generated as the reference switches between pulse, external and internal. The monitoring of the external reference occurs approximately on 1 millisecond intervals, and never occurs in the middle of a measurement acquisition, only at the end of the measurement (end of the request).

If for any reason the instrument's frequency reference is not able to obtain lock, Status bit 1 in the Questionable Frequency register will be true and a condition error message is generated. When lock is regained, Status bit 1 in the Questionable Frequency register will be cleared and the condition error will be cleared.

If an external frequency reference is being used, you must enter the frequency of the external reference if it is not exactly 10 MHz. The External Ref Freq key is provided for this purpose.

Key Path	Input/Output
Remote Command	<code>[:SENSe]:ROSCillator:SOURce:TYPE INTernal EXTernal SENSe PULSe</code> <code>[:SENSe]:ROSCillator:SOURce:TYPE?</code>
Dependencies	The PULSe parameter, and support of the 1 pps signal at the EXT REF IN input, are not available in firmware prior to A.13.00. They are also not available in some model numbers. If not available, the Pulse key will be blank, and sending the PULSe parameter via SCPI will generate an error:
Preset	This is unaffected by a Preset but is set to SENSe on a "Restore Input/Output Defaults" or "Restore System Defaults->All".
State Saved	Saved in instrument state.
Status Bits/OPC dependencies	STATus:QUESTionable:FREQUency bit 1 set if unlocked.
Backwards Compatibility Notes	Freq Ref In was not saved in state in the legacy instruments. It is a part of state in the X-Series.
Initial S/W Revision	Prior to A.02.00
Modified at S/W Revision	A.14.00

Remote Command	<code>[:SENSe]:ROSCillator:SOURce?</code>
Notes	The query <code>[SENSe]:ROSCillator:SOURce?</code> returns the current switch setting. This means: <ol style="list-style-type: none"> 1. If it was set to SENSe but there is no external reference nor 1 pps signal so the instrument is actually using the internal reference, then this query returns INTernal and not SENSe. 2. If it was set to SENSe and there is an external reference present, the query returns EXTernal and not SENSe.

3. If it was set to SENSE and there is a 1 pps signal present, the query returns PULSe and not SENSE.
4. If it was set to EXTERNAL, then the query returns "EXTERNAL"
5. If it was set to INTERNAL, then the query returns "INTERNAL".
6. If it was set to PULSe, then the query returns "PULSe"

Preset	SENSe
Backwards Compatibility Notes	The query [:SENSe]:ROSCillator:SOURce? was a query-only command in ESA which always returned whichever reference the instrument was using. The instrument automatically switched to the ext ref if it was present. In PSA (which had no sensing) the command [:SENSe]:ROSCillator:SOURce set the reference (INT or EXT), so again its query returned the actual routing. Thus the query form of this command is 100% backwards compatible with both instruments.
Initial S/W Revision	Prior to A.02.00

Remote Command	<code>[:SENSe]:ROSCillator:SOURce INTernal EXTernal</code>
Notes	For PSA compatibility the command form is provided and is directly mapped to [:SENSe]:ROSCillator:SOURce:TYPE
Initial S/W Revision	Prior to A.02.00

Sense

If Sense is selected, the instrument checks whether a signal is present at the external reference connector. If it senses a signal within 5 ppm of the External Ref Freq (as set on the External Ref Freq softkey), it will use this signal as an External Reference. If it senses a 1 pulse per second signal, it will use this signal to adjust the internal reference by adjusting the User setting of the Timebase DAC. When no signal is present, it automatically switches to the internal reference.

Key Path	Input/Output, Freq Ref In
Example	:ROSC:SOUR:TYPE SENS
Couplings	If set to SENSE and the analyzer senses a 1 pulse per second signal, it sets the System, Alignments, Timebase DAC setting to "User". This setting survives Preset and Power Cycle but is set to "Calibrated" on a System, Restore Defaults, Align or a System, Restore Defaults, All
Readback	Sense
Initial S/W Revision	Prior to A.02.00
Modified at S/W Revision	A.14.00

Internal

The internal reference is used. A 1 pps signal at the EXT REF IN port, or a signal there between 1 and 50 MHz, will cause a warning triangle to appear in the settings panel next to the word "INTERNAL", but will otherwise be ignored.

Key Path	Input/Output, Freq Ref In
Example	:ROSC:SOUR:TYPE INT
Readback	Internal
Initial S/W Revision	Prior to A.02.00
Modified at S/W Revision	A.14.00

External

The external reference is used.

Key Path	Input/Output, Freq Ref In
Example	:ROSC:SOUR:TYPE EXT
Readback	External
Initial S/W Revision	Prior to A.02.00

Ext Ref Freq

This key tells the analyzer the frequency of the external reference. When the external reference is in use (either because the reference has been switched to External or because the Reference has been switched to Sense and there is a valid external reference present) this information is used by the analyzer to determine the internal settings needed to lock to that particular external reference signal.

For the instrument to stay locked, the value entered must be within 5 ppm of the actual external reference frequency. So it is important to get it close, or you risk an unlock condition.

Note that this value only affects the instrument's ability to lock. It does not affect any calculations or measurement results. See "Freq Offset" in the Frequency section for information on how to offset frequency values.

Key Path	Input/Output, Freq Ref In
Remote Command	[:SENSe] :ROSCillator:EXTernal:FREQuency <freq> [:SENSe] :ROSCillator:EXTernal:FREQuency?
Example	ROSC:EXT:FREQ 20 MHz sets the external reference frequency to 20 MHz, but does not select the external reference. ROSC:SOUR:TYPE EXT selects the external reference.
Dependencies	Still available with Internal or Pulse selected, to allow setup for when External is in use. However, the setting has no effect if the Internal Reference is in use (Freq Ref In set to Internal, Pulse, or SENSE:INT or SENSE:PULSE).

Preset	This is unaffected by a Preset but is set to 10 MHz on a "Restore Input/Output Defaults" or "Restore System Defaults->All"
Min	CXA: 10 MHz EXA: 10 MHz MXA: 1 MHz PXA: 1 MHz N8973B, N8974B, N8975B, or N8976B: 10 MHz
Max	CXA: 10 MHz EXA: 10 MHz EXA with option R13: 20 MHz MXA: 50 MHz PXA: 50 MHz N8973B, N8974B, N8975B, or N8976B: 10 MHz
Default Unit	Hz
Initial S/W Revision	Prior to A.02.00
Modified at S/W Revision	A.14.00

External Reference Lock BW

This control lets you adjust the External Reference phase lock bandwidth. This control is available in some models of the X-Series.

The PXA variable reference loop bandwidth allows an external reference to be used and have the analyzer close-in phase noise improved to match that of the reference. This could result in an improvement of tens of decibels. The choice of "Wide" or "Narrow" affects the phase noise at low offset frequencies, especially 4 to 400 Hz offset. When using an external reference with superior phase noise, we recommend setting the external reference phase-locked-loop bandwidth to wide (60 Hz), to take advantage of that superior performance. When using an external reference with inferior phase noise performance, we recommend setting that bandwidth to narrow (15 Hz). In these relationships, inferior and superior phase noise are with respect to -134 dBc/Hz at 30 Hz offset from a 10 MHz reference. Because most reference sources have phase noise behavior that falls off at a rate of 30 dB/decade, this is usually equivalent to -120 dBc/Hz at 10 Hz offset.

Key Path	Input/Output, Freq Ref In
Scope	Mode Global
Remote Command	[:SENSe] :ROSCillator :BANDwidth WIDE NARROW [:SENSe] :ROSCillator :BANDwidth ?
Example	ROSC :BAND WIDE

Dependencies	Still available with Internal or Pulse selected, to allow setup for when External is in use. However, the setting has no effect if the Internal Reference is in use (Freq Ref In set to Internal, Pulse, or SENSE:INT or SENSE:PULSE). This key only appears in analyzers equipped with the required hardware.
Preset	This is unaffected by a Preset but is set to Narrow on a "Restore Input/Output Defaults" or "Restore System Defaults -> All"
State Saved	Saved in Input/Output state.
Initial S/W Revision	A.04.00
Modified at S/W Revision	A.14.00

External Ref Coupling

Only appears with option ERC installed and licensed.

This function lets you couple the sweep system of the analyzer to the state of the External Reference. If Normal is selected, data acquisition proceeds regardless of the state of the External Reference. When you select Ext Ref Out Of Range Stops Acquisition, the data acquisition (sweep or measurement) stops when either the "521, External ref out of range" or the "503, Frequency Reference unlocked" error message is asserted. Note that this will only take place if the Freq Ref In selection is External.

With the acquisition stopped, the data display will stop updating (even if this occurs in the middle of a sweep or measurement) and no data will be returned to a READ? or MEASure? query; that is, these queries will not complete because the analyzer will not respond to them. Furthermore, no response will be generated to a *WAI? or *OPC? query.

Proper SCPI sequences are shown below, which will always fail to return if the acquisition stops during the requested sweep or measurement. Note that, for predictable operation of this function, it is best to operate the analyzer in single measurement mode (INIT:CONT OFF), because if operating in continuous mode, the analyzer may respond to the above queries even after the acquisition stops, with data left over from the previous acquisition.

```
:INIT:CONT OFF
:INIT:IMM;*OPC?
--
:INIT:CONT OFF
:INIT:IMM;*WAI?
--
:INIT:CONT OFF
:READ?
--
:INIT:CONT OFF
```

:MEASure?

When the acquisition ceases, in addition to the error condition(s) described above, a popup error message will be generated informing you that the acquisition has ceased due to an invalid external reference. This message will stay on the screen while the acquisition is suspended.

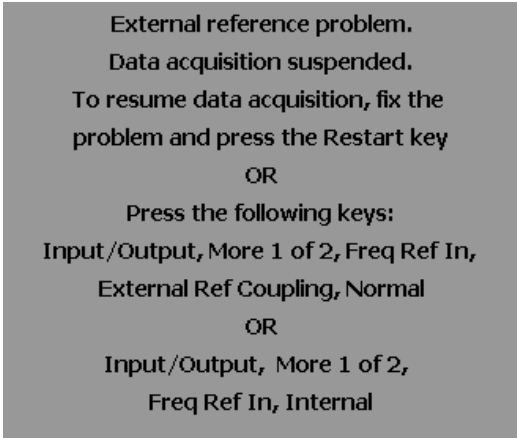

If you press the Restart key this message will be taken off the screen and a new acquisition will be attempted. If the External Reference problem persists the message will re-appear. You can also remove the message by changing back to the Normal setting of Sweep/Ext Ref Coupling, or by pressing Freq Ref In, Internal, or Freq Ref In, Sense, or Restore Input/Output Defaults.

The setting of External Ref Coupling is persistent across power-cycling and is not reset with a Preset. It is reset to the default state (Normal) when Restore Input/Output Defaults is invoked, which will also restart normal data acquisition.

The detection of invalid external reference is under interrupt processing. If the external reference becomes invalid then returns to valid in too short a time, no error condition will be detected or reported and therefore the acquisition will not be stopped.

Key Path	Input/Output, Freq Ref In
Mode	All
Remote Command	[[:SENSE]:ROSCillator:COUpling NORMal NACquisition [:SENSE]:ROSCillator:COUpling?
Preset	This setting is persistent: it survives power-cycling or a Preset and is reset with Restore Input/Output defaults.
State Saved	Not saved in instrument state
Readback	Normal Stop Acq
Initial S/W Revision	A.02.00

Output Config

Accesses keys that configure various output settings, like the frequency reference output, trigger output and analog output.

Key Path	Input/Output
Backwards Compatibility Notes	In ESA there was not a user interface to enable the Video Output (Analog Output), Trigger Output, or Gate Output. In the X-Series each of these physical connectors requires configuration, thus the user interface has been added for X-Series, along with the potential for an output you think is always on to be switched off.
Initial S/W Revision	Prior to A.02.00

Trig Out

Select the type of output signal that will be output from the Trig 1 Out, or Trig 2 Out connectors.

Key Path	Input/Output, Output Config
Remote Command	:TRIGger TRIGger1 TRIGger2[:SEquence]:OUTPut HSWP MEASuring MAIN GATE GTRigger OEVEN SPOint SSWeep SSEtled S1Marker S2Marker S3Marker S4Marker OFF :TRIGger TRIGger1 TRIGger2[:SEquence]:OUTPut?
Example	TRIG:OUTP HSWP TRIG2:OUTP GATE
Dependencies	The second Trigger output (Trig 2 Out) does not appear in all models; in models that do not support it, the Trig 2 Out key is blanked, and sending the SCPI command for this output generates an error, "Hardware missing; Not available for this model number" In models that do not support the Trigger 2 output, this error is returned if trying to set Trig 2 Out and a query of Trig 2 Out returns OFF.
Preset	Trigger 1: Sweeping (HSWP) Trigger 2: Gate This is unaffected by a Preset but is preset to the above values on a "Restore Input/Output Defaults" or "Restore System Defaults->All"
State Saved	Saved in instrument state
Initial S/W Revision	Prior to A.02.00

Polarity

Sets the output to the Trig 1 Out, or Trig 2 Out, connector to trigger on either the positive or negative polarity.

Key Path	Input/Output, Output Config, Trig 1/2 Output
Remote Command	:TRIGger TRIGger1 TRIGger2[:SEquence]:OUTPut:POLarity POSitive NEGative :TRIGger TRIGger1 TRIGger2[:SEquence]:OUTPut:POLarity?
Example	TRIG1:OUTP:POL POS
Preset	This is unaffected by a Preset but is set to POSitive on a "Restore Input/Output Defaults" or "Restore System Defaults->All"

State Saved	Saved in instrument state
Initial S/W Revision	Prior to A.02.00

Off

Selects no signal to be output to the Trig 1 Out, or Trig 2 Out, connector.

Key Path	Input/Output, Output Config, Trig 1/2 Output
Example	TRIG1:OUTP OFF
Readback	Off
Initial S/W Revision	Prior to A.02.00

Sweeping (HSWP)

Selects the Sweeping Trigger signal to be output to the Trig 1 Out, or Trig 2 Out, connector when a measurement is made. This signal has historically been known as "HSWP" (High = Sweeping), and is 5 V TTL level with 50 ohm output impedance.

Key Path	Input/Output, Output Config, Trig 1/2 Output
Example	TRIG1:OUTP HSWP
Readback	Sweeping
Initial S/W Revision	Prior to A.02.00

Measuring

Selects the Measuring trigger signal to be output to the Trig 1 Out, or Trig 2 Out, connector. This signal is true while the Measuring status bit is true.

Key Path	Input/Output, Output Config, Trig 1/2 Output
Example	TRIG1:OUTP MEAS
Readback	Measuring
Initial S/W Revision	Prior to A.02.00

Main Trigger

Selects the current instrument trigger signal to be output to the Trig 1 Out, or Trig 2 Out, connector.

Key Path	Input/Output, Output Config, Trig 1/2 Output
----------	--

Example	TRIG1:OUTP MAIN
Readback	Main Trigger
Initial S/W Revision	Prior to A.02.00

Gate Trigger

Selects the gate trigger signal to be output to the Trig 1 Out, or Trig 2 Out, connector. This is the source of the gate timing, not the actual gate signal.

Key Path	Input/Output, Output Config, Trig 1/2 Output
Example	TRIG1:OUTP GTR
Readback	Gate Trigger
Initial S/W Revision	Prior to A.02.00

Gate

Selects the gate signal to be output to the Trig 1 Out, or Trig 2 Out, connector. The gate signal has been delayed and its length determined by delay and length settings. When the polarity is positive, a high on the Trig 1 Out, or Trig 2 Out, represents the time the gate is configured to pass the signal.

Key Path	Input/Output, Output Config, Trig 1/2 Output
Example	TRIG1:OUTP GATE
Readback	Gate
Initial S/W Revision	Prior to A.02.00

Source Point Trigger

Selects the gate signal to be output to the Trig 1 Out, or Trig 2 Out, connector for use as the Point Trigger when operating an external source in Tracking mode. When Ext Trigger 1 is selected as the Point Trigger under Source, the Source Point Trigger under Trig1 Out automatically gets selected. Similarly, when Ext Trigger 2 is selected as the Point Trigger under Source, the Source Point Trigger key under Trig 2 Out automatically gets selected

Key Path	Input/Output, Output Config, Trig 1/2 Output
Example	TRIG1:OUTP SPO
Readback	Source Point
Initial S/W Revision	Prior to A.02.00

Odd/Even Trace Point

Selects either the odd or even trace points as the signal to be output to the Trig 1 Out, or Trig 2 Out, connector when performing swept spectrum analysis. When the polarity is positive, this output goes high during the time the analyzer is sweeping past the first point (Point 0) and every other following trace point. The opposite is true if the polarity is negative.

Key Path	Input/Output, Output Config, Trig 1/2 Output
Example	TRIG1:OUTP OEV
Readback	Odd/Even
Initial S/W Revision	Prior to A.02.00

Analog Out

This menu lets you control which signal is fed to the “Analog Out” connector on the analyzer rear panel.

See ["More Information" on page 262](#)

Key Path	Input/Output, Output Config
Remote Command	:OUTPut:ANALog OFF SVIDeo LOGVideO LINVideO DAUDio :OUTPut:ANALog?
Example	OUTP:ANAL SVIDeo ! causes the analog output type to be Screen Video
Preset	This is unaffected by Preset but is set to DAUDio on a "Restore Input/Output Defaults" or "Restore System Defaults->All
Preset	OFF
State Saved	Saved in Input/Output State
Readback line	1-of-N selection [variable]
Backwards Compatibility Notes	Prior to A.04.00, OFF was the default functionality except when in the Analog Demod application or with Tune and Listen, in which case it was DAUDio, and there was no selection menu. So for backwards compatibility with earlier X-Series firmware versions, Auto (:OUTP:ANAL:AUTO ON) will duplicate the prior behavior. The DNWB and SANalyzer parameters, which were legal in PSA but perform no function in the X-Series, are accepted without error.
Initial S/W Revision	A.04.00

More Information

The table below gives the range for each output.

Analog Out	Nominal Range exc. (10% overrange)	Scale Factor	Notes
Off	0 V		

Analog Out	Nominal Range exc. (10% overrange)	Scale Factor	Notes
Screen Video	0 – 1 V open circuit	10%/division	8566 compatible
Log Video	0 – 1 V terminated	1/(192.66 dB/V)	dB referenced to mixer level, 1V out for –10 dBm at the mixer.
Linear Video	0 – 1 V terminated	100%/V	Linear referenced to Ref Level, 1 V out for RF envelope at the Ref Level.
Demod Audio	(varies with analyzer setting)		

Auto

Selects the Auto state for the Analog Output menu. In this state, the Analog Output will automatically be set to the most sensible setting for the current mode or measurement.

If you make a selection manually from the Analog Out menu, this selection will remain in force until you change it (or re-select Auto), even if you go to a mode or measurement for which the selected output does not apply.

Key Path	Input/Output, Output Config, Analog Out
Remote Command	OUTPut:ANALog:AUTO OFF ON 0 1 OUTPut:ANALog:AUTO?
Example	OUTP:ANAL:AUTO ON
Preset	ON
State Saved	Saved in Input/Output State
Initial S/W Revision	A.04.00

Off

Turns off the analog output.

Key Path	Input/Output, Output Config, Analog Out
Example	OUTP:ANAL OFF ! causes the analog output to be off
Readback Text	Off
Initial S/W Revision	A.04.00

Screen Video

Selects the analog output to be the screen video signal. In this mode, the pre-detector data is output to the Analog Out connector. The output looks very much like the trace displayed on the analyzer's screen,

and depends on the Log/Lin display Scale, Reference Level, and dB per division, but is not influenced by the selected detector or any digital flatness corrections or trace post-processing (like Trace Averaging).

Note that this mode is similar to the Analog Output of the HP 8566 family and the Video Out (opt 124) capability of the Agilent PSA analyzer (E444x), although there are differences in the behavior.

Key Path	Input/Output, Output Config, Analog Out
Example	OUTP:ANAL SVID
Dependencies	<p>Because the Screen Video output uses one of the two IF processing channels, only one detector is available while Screen Video is selected. All active traces will change to use the same detector as the selected trace when Screen Video is activated.</p> <p>Screen Video output is not available while any EMI Detector is selected (Quasi Peak, RMS Average or EMI Average), because these detectors use both IF processing channels. Consequently, if the user chooses an EMI Detector, there will be no Screen Video output.</p> <p>The output holds at its last value during an alignment and during a marker count. After a sweep:</p> <ul style="list-style-type: none"> • If a new sweep is to follow (as in Continuous sweep mode), the output holds at its last value during the retrace before the next sweep starts. If the analyzer is in zero-span, there is no retrace, as the analyzer remains tuned to the Center Frequency and does not sweep. Therefore, in zero-span, the output simply remains live between display updates. • If no new sweep is to follow (as in Single sweep mode), the output remains live, and continues to show the pre-detector data <p>This function depends on optional capability; the key will be blanked and the command will generate an "Option not available" error unless you have Option YAV or YAS licensed in your instrument.</p>
Couplings	Screen Video output changes while in FFT Sweeps, so for measurements that use exclusively FFT Sweeps, or if the user manually chooses FFT Sweeps, the Screen Video output will look different than it does in swept mode.
Readback Text	Screen Video
Backwards Compatibility Notes	See " Backwards Compatibility: " on page 264, below.
Initial S/W Revision	A.04.00

Backwards Compatibility:

The Screen Video function is intended to be very similar to the 8566 Video Output and the PSA Option 124. However, unlike the PSA, it is not always on; it must be switched on by the Screen Video key. Also, unlike the PSA, there are certain dependencies (detailed above) – for example, the Quasi Peak Detector is unavailable when Screen Video is on.

Furthermore, the PSA Option 124 hardware was unipolar and its large range was padded to be exactly right for use as a Screen Video output. In the X-Series, the hardware is bipolar and has a wider range to accommodate the other output choices. Therefore, the outputs won't match up exactly and users may have to modify their setup when applying the X-Series in a PSA application.

Log Video (RF Envelope, Ref=Mixer Level)

Selects the analog output to be the log of the video signal. In this mode, the pre-detector data is output to the Analog Out connector with a Log scaling. The output is referenced to the current level at the mixer, does not depend on display settings like Reference Level or dB per division, and it is not influenced by the

selected detector or any digital flatness corrections or trace post-processing (like Trace Averaging), but does change with input attenuation.

The output is designed so that full scale (1 V) corresponds to -10 dBm at the mixer. The full range (0–1 V) covers 192.66 dB ; thus, 0 V corresponds to -202.66 dBm at the mixer.

Key Path	Input/Output, Output Config, Analog Out
Example	OUTP:ANAL LOGV
Dependencies	<p>Because the Log Video output uses one of the two IF processing channels, only one detector is available while Screen Video is selected. All active traces will change to use the same detector as the selected trace when Log Video is activated.</p> <p>Log Video output is not available while any EMI Detector is selected (Quasi Peak, RMS Average or EMI Average), because these detectors use both IF processing channels. Consequently, if the user chooses an EMI Detector, there will be no Log Video output.</p> <p>The output holds at its last value during an alignment, during a marker count, and during retrace (after a sweep and before the next sweep starts).</p> <p>This function depends on optional capability. The key will be blanked and the command will generate an “Option not available” error unless you have Option YAV licensed in your instrument.</p>
Couplings	Log Video output changes while in FFT Sweeps, so for measurements that use exclusively FFT Sweeps, or if the user manually chooses FFT Sweeps, the Log Video output will look different than it does in swept mode.
Readback Text	Log Video
Initial S/W Revision	A.04.00

Linear Video (RF Envelope, Ref=Ref Level)

Selects the analog output to be the envelope signal on a linear (voltage) scale. In this mode, the pre-detector data is output to the Analog Out connector with a Linear scaling. The output is based on the current Reference Level, and is not influenced by the selected detector or any digital flatness corrections or trace post-processing (like Trace Averaging).

The scaling is set so that 1 V output occurs with an instantaneous video level equal to the reference level, and 0 V occurs at the bottom of the graticule. This scaling gives you the ability to control the gain without having another setup control for the key. But it requires you to control the look of the display (the reference level) in order to control the analog output.

This mode is ideal for looking at Amplitude Modulated signals, as the linear envelope effectively demodulates the signal.

Key Path	Input/Output, Output Config, Analog Out
Example	OUTP:ANAL LINV
Dependencies	<p>Because the Linear Video output uses one of the two IF processing channels, only one detector is available while Linear Video is selected. All active traces will change to use the same detector as the selected trace when Log Video is activated.</p> <p>Linear Video output is not available while any EMI Detector is selected (Quasi Peak, RMS Average or EMI Average), because these detectors use both IF processing channels. Consequently, if the user chooses an EMI Detector, there will be no Linear Video output.</p>

	The output holds at its last value during an alignment and during a marker count and during retrace (after a sweep and before the next sweep starts). This function depends on optional capability; the key will be blanked and the command will generate an “Option not available” error unless you have Option YAV licensed in your instrument.
Couplings	Linear Video output changes while in FFT Sweeps, so for measurements that use exclusively FFT Sweeps, or if the user manually chooses FFT Sweeps, the Linear Video output will look different than it does in swept mode.
Readback Text	Linear Video
Initial S/W Revision	A.04.00

Demod Audio

Selects the analog output to be the demodulation of the video signal.

When Demod Audio is selected, the demodulated audio signal appears at this output whenever the Analog Demod application is demodulating a signal or when Analog Demod Tune and Listen is operating in the Swept SA measurement.

When Analog Out is in the Auto state, this output is auto-selected when in the Analog Demod mode or when Analog Demod Tune and Listen is operating in the Swept SA measurement.

If any other Analog Output is manually selected when in the Analog Demod mode or when Analog Demod Tune and Listen is operating in the Swept SA measurement, a condition warning message appears.

Key Path	Input/Output, Output Config, Analog Out
Example	OUTP:ANAL DAUD
Dependencies	This key only appears if the Analog Demod application (N9063A), the N6141A or W6141A application, or Option EMC is installed and licensed, otherwise the key will be blanked and the command will generate an “Option not available” error. The output holds at its last value during an alignment and during a marker count. It is not held between sweeps, in order for Tune and Listen to work properly. When Demod Audio is the selected Analog Output: <ul style="list-style-type: none"> • all active traces are forced to use the same detector. • CISPR detectors (QPD, EMI Avg, RMS Avg) are unavailable
Readback Text	Demod Audio
Initial S/W Revision	Prior to A.02.00 (this was the default functionality, and there was no selection)
Modified at S/W Revision	A.04.00

Digital Bus

This menu allows you to configure the LVDS connector located on the rear panel of the instrument. It is a unidirectional link of real time data at a 90 MSa/s rate. The ADC is sampling a 22.5 MHz IF.

The data that appears on this port is raw, uncorrected ADC samples, unless you have option RTL. With option RTL, you get fully corrected I/Q data.

This connector will only be active when the Narrowband IF Path is currently in use.

Key Path	Input/Output, Output Config
Initial S/W Revision	A.04.00

Bus Out On/Off

When Bus Out is on, all acquisitions are streamed to the output port including acquisitions for internal purposes such as Alignment. The internal processing and routing of acquisitions continues as usual and is unaffected by the state of Bus Out.

When Bus Out is off, no signal appears on the LVDS port.

Key Path	Input/Output, Output Config, Digital Bus
Scope	Mode Global
Remote Command	:OUTPut:DBUS[1][:STATe] ON OFF 1 0 :OUTPut:DBUS[1][:STATe]?
Example	OUTP:DBUS ON
Preset	This is unaffected by a Preset but is set to Off on a "Restore Input/Output Defaults" or "Restore System Defaults -> All"
State Saved	Saved in Input/Output State
Initial S/W Revision	Prior to A.02.00
Modified at S/W Revision	A.04.00

I/Q Cal Out

The Baseband I/Q "Cal Out" port can be turned on with either a 1 kHz or a 250 kHz square wave. This can be turned on independent of the input selection. A Preset will reset this to Off.

Key Path	Input/Output, Output Config
Remote Command	:OUTPut:IQ:OUTPut IQ1 IQ250 OFF :OUTPut:IQ:OUTPut?
Example	OUTP:IQ:OUTP IQ1
Couplings	An I/Q Cable Calibration or an I/Q Probe Calibration will change the state of the Cal Out port as needed by the calibration routine. When the calibration is finished the I/Q Cal Out is restored to the pre-calibration state.
Preset	Off
State Saved	Saved in instrument state
Range	1 kHz Square Wave 250 kHz Square Wave Off
Readback Text	1 kHz 250 kHz Off
Initial S/W Revision	Prior to A.02.00

1 kHz Square Wave

Turns on the 1 kHz square wave signal at the Cal Out port. This choice is only available with option BBA.

Key Path	Input/Output, Output Config, I/Q Cal Out
Readback	I/Q 1kHz
Initial S/W Revision	Prior to A.02.00

250 kHz Square Wave

Turns on the 250 kHz square wave signal at the Cal Out port. This choice is only available with option BBA.

Key Path	Input/Output, Output Config, I/Q Cal Out
Readback	I/Q 250kHz
Initial S/W Revision	Prior to A.02.00

Off

Turns off the signal at the Cal Out port. This choice is only available with option BBA.

Key Path	Input/Output, Output Config, I/Q Cal Out
Readback	Off
Initial S/W Revision	Prior to A.02.00

Aux IF Out

This menu controls the signals that appear on the SMA output on the rear panel labeled "AUX IF OUT"

The Aux IF Out functionality is only valid for RF and External Mixer inputs. When using the External Mixing path, the Aux IF Out levels (for all three Options CR3, CRP, and ALV) will be uncalibrated because the factory default Aux IF level was set to accommodate the expected IF levels for the RF path.

Key Path	Input/Output, Output Config
Remote Command	:OUTPut:AUX SIF AIF LOGVideo OFF :OUTPut:AUX?
Dependencies	The softkey does not appear in models that do not support the Aux IF Out.
Preset	This is unaffected by a Preset but is set to OFF on a "Restore Input/Output Defaults" or "Restore System Defaults->All"
State Saved	Saved in Input/Output state
Readback line	1-of-N selection [variable]

Backwards Compatibility Notes	In the PSA, the IF output has functionality equivalent to the "Second IF" function in the X-Series' Aux IF Out menu. In the X-Series, it is necessary to switch the Aux IF Out to "Second IF" to get this functionality, whereas in PSA it is always on, since there are no other choices. Hence a command to switch this function to "Second IF" will have to be added by customers migrating from PSA who use the IF Output in PSA.
Initial S/W Revision	A.04.00

Off

In this mode nothing comes out of the "AUX IF OUT" connector on the rear panel. The connector appears as an open-circuit (that is, it is not terminated in any way).

Key Path	Input/Output, Output Config, Aux IF Out
Example	OUTP:AUX OFF causes the aux output type to be off
Readback Text	Off
Initial S/W Revision	A.04.00

Second IF

In this mode the 2nd IF output is routed to the rear panel connector. The annotation on the key shows the current 2nd IF frequency in use in the analyzer.

The frequency of the 2nd IF depends on the current IF signal path as shown in the table below:

IF Path Selected	Frequency of "Second IF" Output
10 MHz	322.5 MHz
25 MHz	322.5 MHz
40 MHz	250 MHz
140 MHz	300 MHz

The signal quality, such as signal to noise ratio and phase noise, are excellent in this mode.

Key Path	Input/Output, Output Config, Aux IF Out
Example	OUTP:AUX SIF causes the aux output type to be Second IF
Dependencies	Does not appear unless Option CR3 is installed.
Readback Text	Second IF
Initial S/W Revision	A.04.00

Arbitrary IF

In this mode the 2nd IF output is mixed with a local oscillator and mixer to produce an arbitrary IF output between 10 MHz and 75 MHz with 500 kHz resolution. The phase noise in this mode will not be as good as in Second IF mode.

The IF output frequency is adjustable, through an active function which appears on the Arbitrary IF selection key, from 10 MHz to 75 MHz with 500 kHz resolution.

The bandwidth of this IF output varies with band and center frequency, but is about 40 MHz at the -3 dB width. When the output is centered at lower frequencies in its range, signal frequencies at the bottom of the bandwidth will “fold”. For example, with a 40 MHz bandwidth (20 MHz half-bandwidth), and a 15 MHz IF center, a signal -20 MHz relative to the spectrum analyzer center frequency will have a relative response of about -3 dB with a frequency 20 MHz below the 15 MHz IF center. This -5 MHz frequency will fold to become a +5 MHz signal at the IF output. Therefore, lower IF output frequencies are only useful with known band-limited signals.

Key Path	Input/Output, Output Config, Aux IF Out
Example	OUTP:AUX AIF causes the aux output type to be the Arbitrary IF
Dependencies	Does not appear unless Option CRP is installed.
Readback Text	Arbitrary IF
Initial S/W Revision	A.04.00

Key Path	Input/Output, Output Config, Aux IF Out
Scope	Mode Global
Remote Command	:OUTPut:AUX:AIF <value> :OUTPut:AUX:AIF?
Example	:OUTP:AUX:AIF 50 MHZ
Preset	This is unaffected by a Preset but is set to 70 MHz on a "Restore Input/Output Defaults" or "Restore System Defaults->All"
State Saved	Saved in Input/Output State
Min	10 MHz
Max	75 MHz
Default Unit	Hz
Initial S/W Revision	A.04.00

Fast Log Video

In this mode the 2nd IF output is passed through a log amp and the log envelope of the IF signal is sent to the rear panel. The open circuit output level varies by about 25 mV per dB, with a top-of-screen signal producing about 1.6 Volts. The output impedance is nominally 50 ohms.

This mode is intended to meet the same needs as Option E4440A-H7L Fast Rise Time Video Output on the Agilent E4440A PSA Series, allowing you to characterize pulses with fast rise times using standard measurement suites on modern digital scopes.

Key Path	Input/Output, Output Config, Aux IF Out
Example	OUTP:AUX LOGVideo causes the aux output type to be Fast Log Video
Dependencies	Does not appear unless Option ALV is installed. The output is off during an alignment but not during a marker count, and is not blanked during retrace (after a sweep and before the next sweep starts).
Readback Text	Fast Log Video
Initial S/W Revision	A.04.00

I/Q Guided Calibration

Calibrating the Baseband I/Q ports requires several steps and manual connections. The Guided Calibration will interactively step you through the required steps, displaying diagrams to help with the connections. The steps will vary depending on the setup.

In the Guided Calibration windows, the date and time of the last calibration are displayed. If any of the items listed are displayed in yellow, this indicates that the calibration for that item is inconsistent with the latest calibration, and you should complete the entire calibration process before you exit the calibration.

I/Q Isolation Calibration

The I/Q Isolation Calibration must be run before calibrating any port with either the I/Q Cable Calibration or I/Q Probe Calibration. This calibration is performed with nothing connected to any of the front panel I/Q ports. This is the first step in both the I/Q Cable Calibration and the I/Q Probe Calibration.

Next

Perform the I/Q Isolation calibration.

Key Path	Input/Output, I/Q, I/Q Cable Calibration
Remote Command	:CALibration:IQ:ISOLation
Example	CAL:IQ:ISOL
Notes	All front panel I/Q ports must not be connected to anything.
Notes	All cables and probes should be disconnected from the I/Q ports before issuing the SCPI command.
State Saved	No.
Initial S/W Revision	Prior to A.02.00

Exit

Exits the calibration procedure. All ports calibrated before pressing Exit will use the newly acquired calibration data.

Key Path	Input/Output, I/Q, I/Q Cable Calibration
Notes	Using the Exit button will not restore the calibration data to the state prior to entering the guided calibration. Once a port is calibrated the data is stored immediately and the only way to change it is to redo the calibration step. When the calibration may be left in an inconsistent state, a confirmation dialog will be displayed (see "Exit Confirmation" on page 283).
Initial S/W Revision	Prior to A.02.00

I/Q Isolation Calibration Time (Remote Command Only)

Returns the last date and time that the I/Q Isolation Calibration was performed. This is a remote query command only.

Remote Command	:CALibration:IQ:ISOLation:TIME?
Example	:CAL:IQ:ISOL:TIME?
Notes	This returns 6 integer values: year, month, day, hour, minute, second. When no calibration has been performed, all values will be 0.
Initial S/W Revision	A.02.00

I/Q Cable Calibrate...

The I/Q cable calibration creates correction data for each of the front panel I/Q ports. This calibration data is used whenever no probe specific calibration data is available. It is important that all ports are calibrated using the same short BNC cable so that the data is comparable from port to port.

The guided calibration (front panel only) will show connection diagrams and guide you through the isolation calibration and calibrating each port. The calibration data for each port is stored separately, so as soon as a port is calibrated that data is saved and will be used. If you press "Exit" to exit the calibration process, the data for the ports already completed will still be used. It is recommended that a calibration be completed once started, or if exited, that it be properly done before the next use of the I/Q ports. The "Next" button will perform the calibration for the current port and then proceed to the next step in the calibration procedure. The "Back" button will return to the prior port in the procedure. Both keys and dialog buttons are supplied for ease of use. The dialog buttons are for mouse use and the softkeys for front panel use.

The calibration can also be done via SCPI, but no connection diagrams will be shown. You will have to make the correct connections before issuing each port calibration command. Again, it is recommended that all ports be calibrated at the same time.

The instrument state remains as it was prior to entering the calibration procedure except while a port is actually being calibrated. Once a port is calibrated it returns to the prior state. A port calibration is in process only from the time the "Next" button is pressed until the next screen is shown. For SCPI, this corresponds to the time from issuing the CAL:IQ:FLAT:|I|B|Q|QB command until the operation is complete.

For example, if the prior instrument state is Cal Out = Off, Input = I+jQ, and Differential = Off, then up until the time the "Next" button is pressed the I Input and Q Input LEDs are on and the Cal Out, I-bar Input and Q-bar Input LEDs are off. Once the "Next" button is pressed for the I port calibration, only the Cal Out and I

Input LEDs will be on and the others will be off. When the screen progresses to the next step ("Next" button again enabled), the prior state is restored and only the I Input and Q Input LEDs are on (Cal Out is off again).

The last calibration date and time for each port will be displayed. Any calibrations that are more than a day older than the most recent calibration will be displayed with the color amber.

Key Path	Input/Output, I/Q
Initial S/W Revision	Prior to A.02.00

I Port

The I port calibration is performed with the front panel's I port connected via a short BNC cable to the Cal Out port. The guided calibration will show a diagram of the required connections.

Back

Return to the prior step in the calibration procedure.

Key Path	Input/Output, I/Q, Q Setup, Q Probe, Calibrate
Initial S/W Revision	Prior to A.02.00

Next

Perform the I port calibration.

Key Path	Input/Output, I/Q, I/Q Cable Calibrate...
Remote Command	:CALibration:IQ:FLATness:I
Example	CAL:IQ:FLAT:I
Notes	The recommended procedure is to use the same BNC cable to calibrate all I/Q ports. All I/Q ports should be calibrated sequentially during the procedure. The calibration data is saved as soon as the port is calibrated and will survive power cycles. It is not reset by any preset or restore data commands.
Notes	The I port must be connected to the Cal Out port before issuing the SCPI command.
State Saved	No.
Initial S/W Revision	Prior to A.02.00

Exit

Exit the calibration procedure. All ports calibrated before pressing Exit will use the newly acquired calibration data.

Key Path	Input/Output, I/Q, I/Q Cable Calibrate...
Notes	Using the Exit button will not restore the calibration data to the state prior to entering the guided calibration. Once a port is calibrated the data is stored immediately and the only way to change it is

to redo the calibration step.
When the calibration may be left in an inconsistent state, a confirmation dialog will be displayed (see "Exit Confirmation" on page 283).

Initial S/W Revision	Prior to A.02.00
----------------------	------------------

I-bar Port

The I-bar port calibration is performed with the front panel's I-bar port connected via a short BNC cable to the Cal Out port. The guided calibration will show a diagram of the required connections.

Back

Return to the prior step in the calibration procedure.

Key Path	Input/Output, I/Q, I/Q Cable Calibration
Notes	Using the Back button will not restore the calibration data to a prior state. Once a port is calibrated the data is stored immediately and the only way to change it is to redo the calibration step. The Back button allows the user to go back to a prior step to redo that calibration step.
Initial S/W Revision	Prior to A.02.00

Next

Perform the I-bar port calibration.

Key Path	Input/Output, I/Q, I/Q Cable Calibrate...
Remote Command	:CALibration:IQ:FLATness:IBAR
Example	CAL:IQ:FLAT:IBAR
Notes	The recommended procedure is to use the same BNC cable to calibrate all I/Q ports. All I/Q ports should be calibrated sequentially during the procedure. The calibration data is saved as soon as the port is calibrated and will survive power cycles. It is not reset by any preset or restore data commands.
Notes	The I-bar port must be connected to the Cal Out port before issuing the SCPI command.
State Saved	No
Initial S/W Revision	Prior to A.02.00

Exit

Exit the calibration procedure. All ports calibrated before pressing Exit will use the newly acquired calibration data.

Key Path	Input/Output, I/Q, I/Q Cable Calibrate...
Notes	Using the Exit button will not restore the calibration data to the state prior to entering the guided calibration. Once a port is calibrated the data is stored immediately and the only way to change it is

to redo the calibration step.

When the calibration may be left in an inconsistent state, a confirmation dialog will be displayed (see ["Exit Confirmation" on page 283](#)).

Initial S/W Revision	Prior to A.02.00
----------------------	------------------

Q Port

The Q port calibration is performed with the front panel's Q port connected via a short BNC cable to the Cal Out port. The guided calibration will show a diagram of the required connections.

Back

Return to the prior step in the calibration procedure.

Key Path	Input/Output, I/Q, I/Q Cable Calibrate...
Notes	Using the Back button will not restore the calibration data to a prior state. Once a port is calibrated the data is stored immediately and the only way to change it is to redo the calibration step. The Back button allows the user to go back to a prior step to redo that calibration step.
Initial S/W Revision	Prior to A.02.00

Next

Perform the Q port calibration.

Key Path	Input/Output, I/Q, I/Q Cable Calibrate...
Remote Command	:CALibration:IQ:FLATness:Q
Example	CAL:IQ:FLAT:Q
Notes	The recommended procedure is to use the same BNC cable to calibrate all I/Q ports. All I/Q ports should be calibrated sequentially during the procedure. The calibration data is saved as soon as the port is calibrated and will survive power cycles. It is not reset by any preset or restore data commands.
Notes	The Q port must be connected to the Cal Out port before issuing the SCPI command.
State Saved	No
Initial S/W Revision	Prior to A.02.00

Exit

Exit the calibration procedure. All ports calibrated before pressing Exit will use the newly acquired calibration data.

Key Path	Input/Output, I/Q, I/Q Cable Calibrate...
Notes	Using the Exit button will not restore the calibration data to the state prior to entering the guided calibration. Once a port is calibrated the data is stored immediately and the only way to change it is

to redo the calibration step.

When the calibration may be left in an inconsistent state, a confirmation dialog will be displayed (see ["Exit Confirmation" on page 283](#)).

Initial S/W Revision	Prior to A.02.00
----------------------	------------------

Q-bar Port

The Q-bar port calibration is performed with the front panel's Q-bar port connected via a short BNC cable to the Cal Out port. The guided calibration will show a diagram of the required connections.

Back

Return to the prior step in the calibration procedure.

Key Path	Input/Output, I/Q, I/Q Cable Calibrate...
Notes	Using the Back button will not restore the calibration data to a prior state. Once a port is calibrated the data is stored immediately and the only way to change it is to redo the calibration step. The Back button allows the user to go back to a prior step to redo that calibration step.
Initial S/W Revision	Prior to A.02.00

Next

Perform the Q-bar port calibration.

Key Path	Input/Output, I/Q, I/Q Cable Calibrate...
Remote Command	:CALibration:IQ:FLATness:QBAR
Example	CAL:IQ:FLAT:QBAR
Notes	The recommended procedure is to use the same BNC cable to calibrate all I/Q ports. All I/Q ports should be calibrated sequentially during the procedure. The calibration data is saved as soon as the port is calibrated and will survive power cycles. It is not reset by any preset or restore data commands.
Notes	The Q-bar port must be connected to the Cal Out port before issuing the SCPI command.
State Saved	No
Initial S/W Revision	Prior to A.02.00

Exit

Exit the calibration procedure. All ports calibrated before pressing Exit will use the newly acquired calibration data.

Key Path	Input/Output, I/Q, I/Q Cable Calibrate...
Notes	Using the Exit button will not restore the calibration data to the state prior to entering the guided calibration. Once a port is calibrated the data is stored immediately and the only way to change it is

to redo the calibration step.

When the calibration may be left in an inconsistent state, a confirmation dialog will be displayed (see **"Exit Confirmation" on page 283**).

Initial S/W Revision Prior to A.02.00

I/Q Cable Calibration Time (Remote Command Only)

Returns the last date and time that the I/Q Cable Calibration was performed for a specific port. This is a remote query command only.

Remote Command :CALibration:IQ:FLATness:I|IBAR|Q|QBAR:TIME?

Example :CAL:IQ:FLAT:I:TIME?

Notes This returns 6 integer values: year, month, day, hour, minute, second. When no calibration has been performed, all values will be 0.

Initial S/W Revision A.02.00

I/Q Probe Calibration

The I/Q probe calibration creates correction data for one of the front panel I/Q channels. When the probe has EEPROM identification, the data is unique to that specific probe. When the probe does not have EEPROM identification, the data will be used for all probes of the same type. The data is also unique to the channel, so calibration data for the I channel will not be used for the Q channel and vice versa.

The guided calibration (front panel only) will show connection diagrams and guide the user through the I/Q Isolation Calibration and through calibrating each port. The calibration data for each port is stored separately, so as soon as a port is calibrated that data is saved and will be used. If a user presses "Exit" to exit the calibration process, the data for the port already completed will still be used. It is recommended that a calibration be completed once started, or if exited, that it be properly done before the next use of the probe. The "Next" button will perform the calibration for the current port and then proceed to the next step in the calibration procedure. The "Back" button will return to the prior port in the procedure. Both softkeys and dialog buttons are supplied for ease of use. The dialog buttons are for mouse use and the softkeys for front panel use.

The calibration can also be done via SCPI, but no connection diagrams will be shown. The user will have to make the correct connections before issuing each port calibration command. Again, it is recommended that all ports be calibrated at the same time.

For Active probes or when Differential is Off, only the main port is calibrated, otherwise both the main and complementary ports are calibrated.

The instrument state remains as it was prior to entering the calibration procedure except while a port is actually being calibrated. Once a port is calibrated it returns to the prior state. A port calibration is in process only from the time the "Next" button is pressed until the next screen is shown. For SCPI, this corresponds to the time from issuing the CAL:IQ:PROB:I|B|Q|QB command until the operation is complete.

For example, if the prior instrument state is Cal Out = Off, Input = I+jQ, and Differential = Off, then up until the time the "Next" button is pressed the I Input and Q Input LEDs are on and the Cal Out, I-bar Input and

Q-bar Input LEDs are off. Once the "Next" button is pressed for the I port calibration, only the Cal Out and I Input LEDs will be on and the others will be off. When the screen progresses to the next step ("Next" button again enabled), the prior state is restored and only the I Input and Q Input LEDs are on (Cal Out is off again).

The last calibration date and time for each relevant port will be displayed. For passive probes with Differential On, any calibration that is more than a day older than the most recent calibration will be displayed with the color amber.

I Port

The I port calibration is performed with the probe body attached to the front panel's I port and the probe tip connected via an adapter to the Cal Out port. The guided calibration will show a diagram of the required connections.

Show Adapter

Show a connection diagram and instructions for the probe and adapter. See ["Show Adapter Screen" on page 282](#).

Key Path	Input/Output, I/Q, I Setup, I Probe, Calibrate
Notes	Either a passive or an active probe adapter diagram will be shown, depending on the type of probe attached.
Initial S/W Revision	Prior to A.02.00

Back

Return to the prior step in the calibration procedure.

Key Path	Input/Output, I/Q, Q Setup, Q Probe, Calibrate
Initial S/W Revision	Prior to A.02.00

Next

Perform the I port calibration.

Key Path	Input/Output, I/Q, I Setup, I Probe, Calibrate
Remote Command	:CALibration:IQ:PROBE:I
Example	CAL:IQ:PROB:I
Notes	The I port must be connected to the Cal Out port before issuing the SCPI command. The calibration data is saved as soon as the port is calibrated and will survive power cycles. It is not reset by any preset or restore data commands.
State Saved	No
Initial S/W Revision	Prior to A.02.00

Exit

Exit the calibration procedure. All ports calibrated before pressing Exit will use the newly acquired calibration data.

Key Path	Input/Output, I/Q, I Setup, I Probe, Calibrate
Notes	Using the Exit button will not restore the calibration data to the state prior to entering the guided calibration. Once a port is calibrated the data is stored immediately and the only way to change it is to redo the calibration step. When the calibration may be left in an inconsistent state, a confirmation dialog will be displayed (see "Exit Confirmation" on page 283).
Initial S/W Revision	Prior to A.02.00

I-bar Port

The I-bar port calibration is performed with the probe body attached to the front panel's I-bar port and the probe tip connected via an adapter to the Cal Out port. The I-bar probe calibration is only available for passive probes with Differential On. The guided calibration will show a diagram of the required connections.

Show Adapter

Show a connection diagram and instructions for the probe and adapter. See ["Show Adapter Screen" on page 282](#).

Key Path	Input/Output, I/Q, I Setup, I Probe, Calibrate
Notes	Either a passive or an active probe adapter diagram will be shown, depending on the type of probe attached.
Initial S/W Revision	Prior to A.02.00

Back

Return to the prior step in the calibration procedure.

Key Path	Input/Output, I/Q, I Setup, I Probe, Calibrate
Notes	Using the Back button will not restore the calibration data to a prior state. Once a port is calibrated the data is stored immediately and the only way to change it is to redo the calibration step. The Back button allows the user to go back to a prior step to redo that calibration step.
Initial S/W Revision	Prior to A.02.00

Next

Perform the I-bar port calibration.

Key Path	Input/Output, I/Q, I Setup, I Probe, Calibrate
----------	--

Remote Command	:CALibration:IQ:PROBE:IBar
Example	CAL:IQ:PROB:IB
Notes	The I-bar port must be connected to the Cal Out port before issuing the SCPI command. The calibration data is saved as soon as the port is calibrated and will survive power cycles. It is not reset by any preset or restore data commands.
State Saved	No
Initial S/W Revision	Prior to A.02.00

Exit

Exit the calibration procedure. All ports calibrated before pressing Exit will use the newly acquired calibration data.

Key Path	Input/Output, I/Q, I Setup, I Probe, Calibrate
Notes	Using the Exit button will not restore the calibration data to the state prior to entering the guided calibration. Once a port is calibrated the data is stored immediately and the only way to change it is to redo the calibration step. When the calibration may be left in an inconsistent state, a confirmation dialog will be displayed (see "Exit Confirmation" on page 283).
Initial S/W Revision	Prior to A.02.00

Q Port

The Q port calibration is performed with the probe body attached to the front panel's Q port and the probe tip connected via an adapter to the Cal Out port. The guided calibration will show a diagram of the required connections.

Show Adapter

Show a connection diagram and instructions for the probe and adapter. See ["Show Adapter Screen" on page 282](#).

Key Path	Input/Output, I/Q, Q Setup, Q Probe, Calibrate
Notes	Either a passive or an active probe adapter diagram will be shown, depending on the type of probe attached.
Initial S/W Revision	Prior to A.02.00

Back

Return to the prior step in the calibration procedure.

Key Path	Input/Output, I/Q, Q Setup, Q Probe, Calibrate
Initial S/W Revision	Prior to A.02.00

Next

Perform the Q port calibration.

Key Path	Input/Output, I/Q, Q Setup, Q Probe, Calibrate
Remote Command	:CALibration:IQ:PROBe:Q
Example	CAL:IQ:PROB:Q
Notes	The Q port must be connected to the Cal Out port before issuing the SCPI command. The calibration data is saved as soon as the port is calibrated and will survive power cycles. It is not reset by any preset or restore data commands.
State Saved	No
Initial S/W Revision	Prior to A.02.00

Exit

Exit the calibration procedure. All ports calibrated before pressing Exit will use the newly acquired calibration data.

Key Path	Input/Output, I/Q, Q Setup, Q Probe, Calibrate
Notes	Using the Exit button will not restore the calibration data to the state prior to entering the guided calibration. Once a port is calibrated the data is stored immediately and the only way to change it is to redo the calibration step. When the calibration may be left in an inconsistent state, a confirmation dialog will be displayed (see "Exit Confirmation" on page 283).
Initial S/W Revision	Prior to A.02.00

Q-bar Port

The Q-bar port calibration is performed with the probe body attached to the front panel's Q-bar port and the probe tip connected via an adapter to the Cal Out port. The Q-bar probe calibration is only available for passive probes with Differential On. The guided calibration will show a diagram of the required connections.

Show Adapter

Show a connection diagram and instructions for the probe and adapter. See ["Show Adapter Screen" on page 282](#).

Key Path	Input/Output, I/Q, Q Setup, Q Probe, Calibrate
Notes	Either a passive or an active probe adapter diagram will be shown, depending on the type of probe attached.
Initial S/W Revision	Prior to A.02.00

Back

Return to the prior step in the calibration procedure.

Key Path	Input/Output, I/Q, Q Setup, Q Probe, Calibrate
Notes	Using the Back button will not restore the calibration data to a prior state. Once a port is calibrated the data is stored immediately and the only way to change it is to redo the calibration step. The Back button allows the user to go back to a prior step to redo that calibration step.
Initial S/W Revision	Prior to A.02.00

Next

Perform the Q-bar port calibration.

Key Path	Input/Output, I/Q, Q Setup, Q Probe, Calibrate
Remote Command	:CALibration:IQ:PROBE:QBar
Example	CAL:IQ:PROB:QB
Notes	The Q-bar port must be connected to the Cal Out port before issuing the SCPI command. The calibration data is saved as soon as the port is calibrated and will survive power cycles. It is not reset by any preset or restore data commands.
State Saved	No
Initial S/W Revision	Prior to A.02.00

Exit

Exit the calibration procedure. All ports calibrated before pressing Exit will use the newly acquired calibration data.

Key Path	Input/Output, I/Q, Q Setup, Q Probe, Calibrate
Notes	Using the Exit button will not restore the calibration data to the state prior to entering the guided calibration. Once a port is calibrated the data is stored immediately and the only way to change it is to redo the calibration step. When the calibration may be left in an inconsistent state, a confirmation dialog will be displayed (see "Exit Confirmation" on page 283).
Initial S/W Revision	Prior to A.02.00

Show Adapter Screen

When one of the Probe Calibration Show Adapter buttons is pressed, a diagram of the probe with its adapter will be shown. Depending on the type of probe attached, either the Passive Probe Adapter or the Active Probe Adapter diagram will be shown.

I/Q Probe Calibration Time (Remote Command Only)

Return the last date and time that the I/Q Probe Calibration was performed for a specific port. This is a remote query command only.

Remote Command	:CALibration:IQ:PROBe:I IBAR Q QBAR:TIME?
Example	:CAL:IQ:PROB:I:TIME?
Notes	This returns 6 integer values: year, month, day, hour, minute, second. When no calibration has been performed, all values will be 0. The value is specific to both the port and probe, so the value will change as probes are connected or disconnected.
Initial S/W Revision	A.02.00

Exit Confirmation

When Exit is pressed during one of the calibration routines, the calibration may be in an inconsistent state with some of the ports having newly measured calibration data and others with old data. If this is the case, a dialog box will appear to confirm that the user really wants to exit. A "Yes" answer will exit the calibration procedure, leaving potentially inconsistent calibration data in place. A "No" answer will return to the calibration procedure.

LISN Control

Enables you to access LISN related functions. LISN control is only available with option LSN indicating that the LISN IO board is installed. This is a remote query command only.

V-network (Remote Command Only)

Enables you to select the V-network that is controlled via the AUX IO port.

Remote Command	INPut [1] 2:LISN[:TYPE] FOURphase ESH2Z5 ENV216 OFF INPut [1] 2:LISN[:TYPE] ?
Example	:INP:LISN FOUR
Notes	FOURPhase and ESH2-Z5 R&S ESH2-Z5 (four phases and protective earth are controllable) ENV216 R&S ENV216 (two phases and highpass are controllable) OFF Remote control deactivated This query will return :- FOUR when ESH2-Z5 is selected.
Preset	Set to off on a "Restore Input/Output Defaults"
State Saved	Saved in instrument state
Initial S/W Revision	A.14.50

Phase (Remote Command Only)

This command enables you to select the phase of the V-network that is used, which is controlled via the AUX IO port. The permissible selection depends on the selected V-network.

Remote Command	INPut [1] 2:LISN:PHASe L1 L2 L3 N INPut [1] 2:LISN:PHASe?
Example	:INP:LISN:PHAS L1
Couplings	L2, L3 keys are grayed out when ENV216 is selected. If the grayed out key is pressed, an advisory message is generated. If the equivalent SCPI command is sent, this same message is generated as part of a “-224, Illegal parameter value; must apply ESH2Z5 to make this phase available” warning.
Preset	Set to N on a "Restore Input/Output Defaults"
State Saved	Saved in instrument state
Range	Phase N Phase L1 Phase L2 Phase L3 Only one phase can be selected.
Initial S/W Revision	A.14.50

150 kHz Highpass (Remote Command Only)

Controls highpass setting on the V-network.

Remote Command	INPut [1] 2:LISN:FILTer:HPAS[:STATe] ON OFF INPut [1] 2:LISN:FILTer:HPAS[:STATe]?
Example	:INP:LISN:FILT:HPAS ON
Dependencies	Only available for ENV216 V-network . This key is grayed out when a V-network that is not ENV216 is selected. If the grayed out key is pressed, an advisory message is generated. If the equivalent SCPI command is sent, this same message is generated as part of a “-221, Settings conflicts; LISN function not available” warning.
Preset	Set to off on a "Restore Input/Output Defaults"
State Saved	Saved in instrument state
Range	ON OFF
Initial S/W Revision	A.14.50

Protective Earth (Remote Command Only)

Enables you to set the Protective Earth setting that is controlled via the AUX IO port.

Remote Command	INPut [1] 2:LISN:PEARth GROunded FLOating INPut [1] 2:LISN:PEARth?
Example	:INP:LISN:PEAR GRO
Dependencies	Only available for ESH2Z5. This key is grayed out when a v-network other than ESH2Z5 is selected. If the grayed out key is pressed, an advisory message is generated. If the equivalent SCPI command is

	sent, this same message is generated as part of a “-221, Settings conflict; LISN function not available” warning.
Preset	Set to GRO on a "Restore Input/Output Defaults"
State Saved	Saved in instrument state
Range	GRO FLO
Initial S/W Revision	A.14.50

5 Mode Functions

Mode

The Mode key allows you to select the available measurement applications or “Modes”. Modes are a collection of measurement capabilities packaged together to provide an instrument personality that is specific to your measurement needs. Each application software product is ordered separately by Model Number and must be licensed to be available. Once an instrument mode is selected, only the commands that are valid for that mode can be executed.

NOTE

Key operation can be different between modes. The information displayed in Help is about the current mode.

To access Help for a different Mode you must first exit Help (by pressing the Cancel (Esc) key). Then select the desired mode and re-access Help.

For more information on Modes, preloading Modes, and memory requirements for Modes, see ["More Information" on page 289](#)

Key Path	Front-panel key
Remote Command	:INSTrument[:SElect] SA RTSA SEQAN EMI BASIC WCDMA EDGE GSM WIMAXOFDMA VSA PNOISE NFIGure ADEMOD BTooth TDSCDMA CDMA2K CDMA1XEV LTE LTETDD LTEAFDD LTEATDD MSR DVB DTMB DCATV ISDBT CMMB WLAN CWLAN CWIMAXOFDM WIMAXFIXED IDEN RLC SCPI LC VSA89601 :INSTrument[:SElect]?
Example	:INST SA
Notes	The available parameters are dependent upon installed and licensed applications resident in the instrument. Parameters given here are an example, specific parameters are in the individual Application. A list of the valid mode choices is returned with the INST:CAT? Query.
Preset	This is unaffected by a Preset but is set on a “Restore System Defaults->All” to: For N9038A: EMI For N8973B, N8974B, N8975B, or N8976B: NFIG For all other models: SA
State Saved	Saved in instrument state
Backwards Compatibility SCPI	:INSTrument[:SElect] GSM provided for backwards compatibility. Mapped to EDGE GSM.
Backwards Compatibility SCPI	:INSTrument[:SElect] SANalyzer provided for ESU compatibility. When this command is received, the analyzer aliases it to the following: INST:SEL SCPI LC This results in the analyzer being placed in SCPI Language Compatibility Mode, in order to emulate

	the ESU Spectrum Analyzer Mode.
Backwards Compatibility SCPI	:INSTrument[:SElect] RECeiver provided for ESU compatibility. When this command is received, the analyzer aliases it to the following: :INST:SEL EMI :CONF FSC This results in the analyzer being placed in the EMI Receiver Mode, running the Frequency Scan measurement, in order to emulate the ESU Receiver Mode.
Initial S/W Revision	Prior to A.02.00
Modified at S/W Revision	A.13.00

Example	:INST 'SA'
Notes	The query is not a quoted string. It is an enumeration as indicated in the Instrument Select table above. The command must be sequential: i.e. continued parsing of commands cannot proceed until the instrument select is complete and the resultant SCPI trees are available.
Backwards Compatibility SCPI	:INSTrument[:SElect] `SA' 'PNOISE' 'EDGE' 'GSM' 'BASIC'
Initial S/W Revision	Prior to A.02.00

More Information

The Mode name appears on the banner after the word “Agilent” followed by the Measurement Title. For example, for the Spectrum Analyzer mode with the Swept SA measurement running:



It is possible to specify the order in which the Modes appear in the Mode menu, using the Configure Applications utility (System, Power On, Configure Applications). It is also possible, using the same utility, to specify a subset of the available applications to load into memory at startup time, which can significantly decrease the startup time of the analyzer. During runtime, if an application that is not loaded into memory is selected (by either pressing that applications Mode key or sending that applications :INST:SEL command over SCPI), there will be a pause while the Application is loaded. During this pause a message box that says “Loading application, please wait...” is displayed.

Each application (Mode) that runs in the X-Series signal analyzers consumes virtual memory. The various applications consume varying amounts of virtual memory, and as more applications run, the memory consumption increases. Once an application is run, some of its memory remains allocated even when it is not running, and is not released until the analyzer program (xSA.exe) is shut down.

Agilent characterizes each Mode and assigns a memory usage quantity based on a conservative estimate. There is a limited amount of virtual memory available to applications (note that this is virtual memory and is independent of how much physical RAM is in the instrument). The instrument keeps track of how much

memory is being used by all loaded applications – which includes those that preloaded at startup, and all of those that have been run since startup.

When you request a Mode that is not currently loaded, the instrument looks up the memory estimate for that Mode, and adds it to the residual total for all currently loaded Modes. If there is not enough virtual memory to load the Mode, a dialog box and menu will appear that gives you four options:

1. Close and restart the analyzer program without changing your configured preloads. This may free up enough memory to load the requested Mode, depending on your configured preloads
2. Clear out all preloads and close and restart the analyzer program with only the requested application preloaded, and with that application running. This choice is guaranteed to allow you to run the requested application; but you will lose your previously configured preloads. In addition, there may be little or no room for other applications, depending on the size of the requested application.
3. Bring up the Configure Applications utility in order to reconfigure the preloaded apps to make room for the applications you want to run (this will then require restarting the analyzer program with your new configuration). This is the recommended choice because it gives you full flexibility to select exactly what you want.
4. Exit the dialog box without doing anything, which means you will be unable to load the application you requested.

In each case except 4, this will cause the analyzer software to close, and you will lose all unsaved traces and results.

If you attempt to load a mode via SCPI that will exceed memory capacity, the Mode does not load and an error message is returned:

```
-225,"Out of memory;Insufficient resources to load Mode (mode name)"
```

where “mode name” is the SCPI parameter for the Mode in question, for example, SA for Spectrum Analyzer Mode.

Spectrum Analyzer

Selects the Spectrum Analyzer mode for general purpose measurements. There are several measurements available in this mode. General spectrum analysis measurements, in swept and zero span, can be done using the first key in the Meas menu, labeled Swept SA. Other measurements in the Meas Menu are designed to perform specialized measurement tasks, including power and demod measurements.

If you are using the Help feature, this mode must be currently active to access its detailed information. If it is not active, exit the Help feature (Esc key), select the mode, and re-access Help.

Key Path	Mode
Example	INST:SEL SA INST:NSEL 1
Initial S/W Revision	Prior to A.02.00

Noise Figure

The Noise Figure mode provides pre-configured measurements for making general purpose measurements of device noise figure.

If you are using the Help feature, this mode must be currently active to access its detailed information. If it is not active, exit the Help feature (Esc key), select the mode, and re-access Help.

Key Path	Mode
Example	INST:SEL NFIGURE INST:NSEL 219
Initial S/W Revision	Prior to A.02.00

Vector Signal Analyzer (VXA)

The N9064A (formerly 89601X) VXA Vector signal and WLAN modulation analysis application provides solutions for basic vector signal analysis, analog demodulation, and digital demodulation. The digital demodulation portion of N9064A allows you to perform measurements on standard-based formats such as cellular, wireless networking and digital video as well as general purpose flexible modulation analysis for wide range of digital formats, FSK to 1024QAM, with easy-to-use measurements and display tools such as constellation and eye diagram, EVM traces and up to four simultaneous displays. Analog baseband analysis is available using the MXA and PXA with option BBA. Option 3FP WLAN has been discontinued.

N9064A honors existing 89601X licenses with all features and functionalities found on X-Series software versions prior to A.06.00. Specifically:

N9064A-1 is equivalent to 89601X-205

N9064A-2 is equivalent to 89601X-AYA

If you are using the Help feature, this mode must be currently active to access its detailed information. If it is not active, exit the Help feature (Esc key), select the mode, and re-access Help.

Key Path	Mode
Example	INST:SEL VSA INST:NSEL 100
Initial S/W Revision	Prior to A.02.00

Analog Demod

Selects the Analog Demod mode for making measurements of AM, FM and phase modulated signals.

If you are using the Help feature, this mode must be currently active to access its detailed information. If it is not active, exit the Help feature (Esc key), select the mode, and re-access Help.

Key Path	Mode
Example	INST:SEL ADEMOM

	INST:NSEL 234
Initial S/W Revision	Prior to A.02.00

Phase Noise

The Phase Noise mode provides pre-configured measurements for making general purpose measurements of device phase noise.

If you are using the Help feature, this mode must be currently active to access its detailed information. If it is not active, exit the Help feature (Esc key), select the mode, and re-access Help.

Key Path	Mode
Example	INST:SEL PNOISE or INST:NSEL 14
Initial S/W Revision	Prior to A.02.00

CMMB

Selects the CMMB mode for measurements of digital video signals using this format. There are several power and demod measurements available in this mode.

If you are using the Help feature, this mode must be currently active to access its detailed information. If it is not active, exit the Help feature (Esc key), select the mode, and re-access Help.

Key Path	Mode
Example	INST:SEL CMMB INST:NSEL 240
Initial S/W Revision	A.03.00

Combined WLAN

Selects the CWLAN mode for general purpose measurements of signals following this standard. There are several measurements available in this mode.

If you are using the Help feature, this mode must be currently active to access its detailed information. If it is not active, exit the Help feature (Esc key), select the mode, and re-access Help.

Key Path	Mode
Example	INST:SEL CWLAN INST:NSEL 19
Initial S/W Revision	A.02.00

TD-SCDMA with HSPA/8PSK

Selects the TD-SCDMA mode for general purpose measurements of signals following this standard. There are several measurements available in this mode.

If you are using the Help feature, this mode must be currently active to access its detailed information. If it is not active, exit the Help feature (Esc key), select the mode, and re-access Help.

Key Path	Mode
Example	INST:SEL TDSCDMA INST:NSEL 211
Initial S/W Revision	Prior to A.02.00

IQ Analyzer (Basic)

The IQ Analyzer Mode makes general purpose frequency domain and time domain measurements. These measurements often use alternate hardware signal paths when compared with a similar measurement in the Signal Analysis Mode using the Swept SA measurement. These frequency domain and time domain measurements can be used to output I/Q data results when measuring complex modulated digital signals.

If you are using the Help feature, this mode must be currently active to access its detailed information. If it is not active, exit the Help feature (Esc key), select the mode, and re-access Help.

Key Path	Mode
Example	INST:SEL BASIC INST:NSEL 8
Initial S/W Revision	Prior to A.02.00

GSM/EDGE/EDGE Evo

Selects the GSM with EDGE mode for general purpose measurements of signals following this standard. There are several measurements available in this mode.

If you are using the Help feature, this mode must be currently active to access its detailed information. If it is not active, exit the Help feature (Esc key), select the mode, and re-access Help.

Key Path	Mode
Example	INST:SEL EDGEGSM INST:NSEL 13
Initial S/W Revision	Prior to A.02.00
Modified at S/W Revision	A.02.00

Combined Fixed WiMAX

Selects the Combined Fixed WiMAX mode for general purpose measurements of signals following this standard. There are several measurements available in this mode.

If you are using the Help feature, this mode must be currently active to access its detailed information. If it is not active, exit the Help feature (Esc key), select the mode, and re-access Help.

Key Path	Mode
Example	INST:SEL CWIMAXOFDM INST:NSEL 81
Initial S/W Revision	A.02.00

W-CDMA with HSPA+

Selects the W-CDMA with HSPA+ mode for general purpose measurements of signals following this standard. There are several measurements available in this mode.

If you are using the Help feature, this mode must be currently active to access its detailed information. If it is not active, exit the Help feature (Esc key), select the mode, and re-access Help.

Key Path	Mode
Example	INST:SEL WCDMA INST:NSEL 9
Initial S/W Revision	Prior to A.02.00

DVB-T/H with T2

Selects the DVB-T/H mode for measurements of digital video signals using this format. There are several power and demod measurements available in this mode.

If you are using the Help feature, this mode must be currently active to access its detailed information. If it is not active, exit the Help feature (Esc key), select the mode, and re-access Help.

Key Path	Mode
Example	INST:SEL DVB INST:NSEL 235
Initial S/W Revision	A.02.00
Modified at S/W Revision	A.07.00

EMI Receiver

The EMI Receiver Mode makes EMC measurements. Several measurements are provided to aid the user in characterizing EMC performance of their systems, including looking at signals with CISPR-16 compliant

detectors, performing scans for interfering signals, and determining and charting interfering signals over time.

If you are using the Help feature, this mode must be currently active to access its detailed information. If it is not active, exit the Help feature (Esc key), select the mode, and re-access Help.

Key Path	Mode
Example	INST:SEL EMI INST:NSEL 141
Initial S/W Revision	A.07.01

802.16 OFDM (Fixed WiMAX)

Selects the 802.16 OFDM (Fixed WiMAX) mode. This mode allows modulation quality measurements of signals that comply with IEEE 802.16a–2003 and IEEE 802.16–2004 standards, with flexibility to measure nonstandard OFDM formats. Along with the typical digital demodulation measurement results, several additional 802.16 OFDM unique trace data formats and numeric error data results provide enhanced data analysis.

If you are using the Help feature, this mode must be currently active to access its detailed information. If it is not active, exit the Help feature (Esc key), select the mode, and re-access Help.

Key Path	Mode
Example	INST:SEL WIMAXFIXED INST:NSEL 104
Initial S/W Revision	A.02.00

WLAN

Selects the WLAN mode for general purpose measurements of signals following this standard. There are several measurements available in this mode.

If you are using the Help feature, this mode must be currently active to access its detailed information. If it is not active, exit the Help feature (Esc key), select the mode, and re-access Help.

Key Path	Mode
Example	INST:SEL WLAN INST:NSEL 217
Initial S/W Revision	A.09.491

1xEV-DO

Selects the 1xEV-DO mode for general purpose measurements of signals following this standard. There are several measurements available in this mode.

If you are using the Help feature, this mode must be currently active to access its detailed information. If it is not active, exit the Help feature (Esc key), select the mode, and re-access Help.

Key Path	Mode
Example	INST:SEL CDMA1XEV INST:NSEL 15
Initial S/W Revision	Prior to A.02.00

802.16 OFDMA (WiMAX/WiBro)

Selects the OFDMA mode for general purpose measurements of WiMAX signals. There are several measurements available in this mode.

If you are using the Help feature, this mode must be currently active to access its detailed information. If it is not active, exit the Help feature (Esc key), select the mode, and re-access Help.

Key Path	Mode
Example	INST:SEL WIMAXOFDMA INST:NSEL 75
Initial S/W Revision	Prior to A.02.00

89601 VSA

Selecting the 89601 VSA mode will start the 89600 VSA software. The 89600 VSA software is powerful, PC-based software, offering the industry's most sophisticated general purpose and standards specific signal evaluation and troubleshooting tools for R&D engineers. Even for proprietary and non-standard signals in SATCOM or MILCOM applications, you can make signal quality measurements with customized IQ constellation. Reach deeper into signals, gather more data on signal problems, and gain greater insight.

- Over 35 general-purpose analog and digital demodulators ranging from 2FSK to 4096QAM
- Flexible and custom IQ and OFDM signal analysis for single carrier
- Standards specific modulation analysis including:
 - Cellular: GSM/EDGE, cdma2000, W-CDMA, TD-SCDMA, LTE(FDD/TDD),
 - LTE-Advanced and more
 - Wireless networking: 802.11a/b/g, 802.11n, 802.ac, 802.16 WiMAX (fixed/mobile), WiSUN (MR-FSK PHY)
 - RFID
 - Digital satellite video and other satellite signals, radar, LMDS
 - Up to 400K bin FFT, for the highest resolution spectrum analysis

- A full suite of time domain analysis tools, including signal capture and playback, time gating, and CCDF measurements
- 20 simultaneous trace displays and the industry's most complete set of marker functions
- Easy-to-use Microsoft® Windows® graphical user interface

For more information see the Agilent 89600 Series VSA web site at www.agilent.com/find/89600vsa

To learn more about how to use the 89600 VSA running in the X-Series, after the 89600 VSA software is running, open the 89600 VSA Help and open the "About Agilent X-Series Signal Analyzer with 89600 VSA Software" help topic.

Key Path	Mode
Example	INST:SEL VSA89601 INST:NSEL 101
Initial S/W Revision	Prior to A.02.00

MSR

Selects the MSR mode. The MSR mode makes several measurements for Cellular Communication devices that can be configured with multiple radio formats simultaneously following the 3GPP standard of Multi-Standard Radio, including GSM/EDGE, WCDMA/HSPA+ and LTE.

If you are using the Help feature, this mode must be currently active to access its detailed information. If it is not active, exit the Help feature (Esc key), select the mode, and re-access Help.

Key Path	Mode
Example	INST:SEL MSR INST:NSEL 106
Initial S/W Revision	A.09.491

cdma2000

Selects the cdma2000 mode for general purpose measurements of signals following this standard. There are several measurements available in this mode.

If you are using the Help feature, this mode must be currently active to access its detailed information. If it is not active, exit the Help feature (Esc key), select the mode, and re-access Help.

Key Path	Mode
Example	INST:SEL CDMA2K INST:NSEL 10
Initial S/W Revision	Prior to A.02.00

Bluetooth

Selects the Bluetooth mode for Bluetooth specific measurements. There are several measurements available in this mode.

If you are using the Help feature, this mode must be currently active to access its detailed information. If it is not active, exit the Help feature (Esc key), select the mode, and re-access Help.

Key Path	Mode
Example	INST:SEL BT INST:NSEL 228
Initial S/W Revision	A.06.01

LTE

Selects the LTE mode for general purpose measurements of signals following the LTE FDD standard. There are several measurements available in this mode.

If you are using the Help feature, this mode must be currently active to access its detailed information. If it is not active, exit the Help feature (Esc key), select the mode, and re-access Help.

Key Path	Mode
Example	INST:SEL LTE INST:NSEL 102
Initial S/W Revision	Prior to A.02.00

SCPI Language Compatibility

The SCPI Language Compatibility mode provides remote language compatibility for SCPI-based instruments, such as the Rohde and Schwartz FSP and related series of spectrum analyzers.

NOTE After changing into or out of this mode, allow a 1 second delay before sending any subsequent commands.

If you are using the Help feature, this mode must be currently active to access its detailed information. If it is not active, exit the Help feature (Esc key), select the mode, and re-access Help.

Key Path	Mode
Example	INST:SEL SCPI LC Or INST:NSEL 270
Initial S/W Revision	A.06.00

iDEN/WiDEN/MOTOTalk

Selects the iDEN/WiDEN/MOTOTalk mode for general purpose measurements of iDEN and iDEN-related signals. There are several measurements available in this mode.

If you are using the Help feature, this mode must be currently active to access its detailed information. If it is not active, exit the Help feature (Esc key), select the mode, and re-access Help.

Key Path	Mode
Example	INST:SEL IDEN INST:NSEL 103
Initial S/W Revision	A.02.00

ISDB-T

Selects the ISDB-T mode for measurements of digital video signals using this format. There are several power and demod measurements available in this mode.

If you are using the Help feature, this mode must be currently active to access its detailed information. If it is not active, exit the Help feature (Esc key), select the mode, and re-access Help.

Key Path	Mode
Example	INST:SEL ISDBT INST:NSEL 239
Initial S/W Revision	A.03.00

Digital Cable TV

Selects the Digital Cable TV mode for measurements of digital cable television systems. There are several power and demod measurements available in this mode.

If you are using the Help feature, this mode must be currently active to access its detailed information. If it is not active, exit the Help feature (Esc key), select the mode, and re-access Help.

Key Path	Mode
Example	INST:SEL DCATV INST:NSEL 238
Initial S/W Revision	A.07.00

LTE TDD

Selects the LTE TDD mode for general purpose measurements of signals following the LTE TDD standard. There are several measurements available in this mode.

If you are using the Help feature, this mode must be currently active to access its detailed information. If it is not active, exit the Help feature (Esc key), select the mode, and re-access Help.

Key Path	Mode
Example	INST:SEL LTETDD INST:NSEL 105
Initial S/W Revision	A.03.00

Remote Language Compatibility

The Remote Language Compatibility (RLC) mode provides remote command backwards compatibility for the 8560 series of spectrum analyzers, known as legacy spectrum analyzers.

NOTE After changing into or out of this mode, allow a 1 second delay before sending any subsequent commands.

If you are using the Help feature, this mode must be currently active to access its detailed information. If it is not active, exit the Help feature (Esc key), select the mode, and re-access Help.

Key Path	Mode
Example	INST:SEL RLC Or INST:NSEL 266
Initial S/W Revision	Prior to A.02.00

DTMB (CTTB)

Selects the DTMB (CTTB) mode for measurements of digital video signals using this format. There are several power and demod measurements available in this mode.

If you are using the Help feature, this mode must be currently active to access its detailed information. If it is not active, exit the Help feature (Esc key), select the mode, and re-access Help.

Key Path	Mode
Example	INST:SEL DTMB INST:NSEL 236
Initial S/W Revision	A.02.00

LTE-Advanced FDD

As LTE-Advanced FDD and LTE modes are converged into one single application, the single softkey under Mode menu is designed to select the covered mode. The display mode of the LTE and LTE-Advanced FDD are distinguished by the licenses.

If you are using the Help feature, this mode must be currently active to access its detailed information. If it is not active, exit the Help feature (Esc key), select the mode, and re-access Help.

Key Path	Mode
Example	INST:SEL LTEAFDD INST:NSEL 107
Notes	When the N9080A/80B-1FP exists, the display mode name is LTE. When the N9080A/80B-1FP and N9080B-2FP all exist, the display mode name is LTE FDD & LTE-A FDD.
Backwards Compatibility SCPI	INST:SEL LTE INST:NSEL 102
Initial S/W Revision	A.14.00
Modified at S/W Revision	A.14.50

LTE-Advanced TDD

As LTE-Advanced TDD and LTE TDD modes are converged into one single application, the single softkey under Mode menu is designed to select the converged mode. The display mode of the LTE TDD and LTE-Advanced TDD are distinguished by the licenses.

If you are using the Help feature, this mode must be currently active to access its detailed information. If it is not active, exit the Help feature (Esc key), select the mode, and re-access Help.

Key Path	Mode
Example	INST:SEL LTEATDD INST:NSEL 108
Notes	When the N9082A/82B-1FP exists, the display mode name is LTE TDD. When the N9082A/82B-1FP and N9082B-2FP all exist, the display mode name is LTE TDD & LTE-A TDD.
Backwards Compatibility SCPI	INST:SEL LTETDD INST:NSEL 105
Initial S/W Revision	A.14.00
Modified at S/W Revision	A.14.50

Application Mode Number Selection (Remote Command Only)

Select the measurement mode by its mode number. The actual available choices depend upon which applications are installed in your instrument. The modes appear in this table in the same order they appear in the Mode menu (if the order is not changed by the Configure Applications utility found in the System, Power On menu). See "[Detailed List of Modes](#)" on page 306 for Mode details.

The Mode Number is the parameter for use with the :INSTrument:NSElect command. The Mode Parameter is the parameter for use with the :INSTrument[:SElect] command.

Mode	Mode Number	Mode Parameter
Spectrum Analyzer	1	SA
Real Time Spectrum Analyzer	107	RTSA
Sequence Analyzer	400	SEQAN
EMI Receiver	141	EMI
I/Q Analyzer (Basic)	8	BASIC
WCDMA with HSPA+	9	WCDMA
GSM/EDGE/EDGE Evo	13	EDGE GSM
802.16 OFDMA (WiMAX/WiBro)	75	WIMAX OFDMA
Vector Signal Analyzer (VXA)	100	VSA
Phase Noise	14	PNOISE
Noise Figure	219	NFIGure
Analog Demod	234	ADEM0D
Bluetooth	228	BT00th
TD-SCDMA with HSPA/8PSK	211	TDSCDMA
cdma2000	10	CDMA2K
1xEV-DO	15	CDMA1XEV
LTE	102	LTE
LTE TDD	105	LTETDD
LTE-Advanced FDD	107	LTEAFDD
LTE-Advanced TDD	108	LTEATDD
MSR	106	MSR
DVB-T/H with T2	235	DVB
DTMB (CTTB)	236	DTMB
Digital Cable TV	238	DCATV
ISDB-T	239	ISDBT
CMMB	240	CMMB
WLAN	217	WLAN
Combined WLAN	19	CWLAN
Combined Fixed WiMAX	81	CWIMAXOFDM
802.16 OFDM (Fixed WiMAX)	104	WIMAXFIXED
iDEN/WiDEN/MotoTalk	103	IDEN
Remote Language Compatibility	266	RLC
SCPI Language Compatibility	270	SCPILC
89601 VSA	101	VSA89601

Remote Command	:INSTRument:NSElect <integer> :INSTRument:NSElect?
Example	:INST:NSEL 1
Notes	SA mode is 1 The command must be sequential: i.e. continued parsing of commands cannot proceed until the instrument select is complete and the resultant SCPI trees are available.
Preset	Not affected by Preset. Set to default mode (1 for SA mode) following Restore System Defaults.
State Saved	Saved in instrument state
Initial S/W Revision	Prior to A.02.00

Application Mode Catalog Query (Remote Command Only)

Returns a string containing a comma separated list of names of all the installed and licensed measurement modes (applications). These names can only be used with the :INSTRument[:SElect] command.

Remote Command	:INSTRument:CATalog?
Example	:INST:CAT?
Notes	Query returns a quoted string of the installed and licensed modes separated with a comma. Example: "SA,PNOISE,WCDMA"
Backwards Compatibility Notes	VSA (E4406A) :INSTRument:CATalog? returned a list of installed INSTRument:SELECT items as a comma separated list of string values: "BASIC","GSM","EDGE GSM","CDMA","NADC","PDC","WCDMA","CDMA2K","CDMA1XEV","IDEN","WIDEN","WLAN","SERVICE" X-Series uses the ESA/PSA compatible query of a string contain comma separated values: "SA,PNOISE,NFIGURE,BASIC,CDMA,CDMA2K,WCDMA,CDMA1XEV,EDGE GSM,GSM,NADC,PDC,TDSCDMA,DMODULATION,WLAN"
Initial S/W Revision	Prior to A.02.00

Application Identification (Remote Commands Only)

Each entry in the Mode Menu will have a Model Number and associated information: Version, and Options.

This information is displayed in the Show System screen. The corresponding SCPI remote commands are defined here.

"Current Application Model " on page 304

"Current Application Revision" on page 304

"Current Application Options" on page 304

Current Application Model

Returns a string that is the Model Number of the currently selected application (mode).

Remote Command	:SYSTem:APPLication[:CURRent][:NAME]?
Example	:SYST:APPL?
Notes	Query returns a quoted string that is the Model Number of the currently selected application (Mode). Example: "N9060A" String length is 6 characters.
Preset	Not affected by Preset
State Saved	Not saved in state, the value will be the selected application when a Save is done.
Initial S/W Revision	Prior to A.02.00

Current Application Revision

Returns a string that is the Revision of the currently selected application (mode).

Remote Command	:SYSTem:APPLication[:CURRent]:REVision?
Example	:SYST:APPL:REV?
Notes	Query returns a quoted string that is the Revision of the currently selected application (Mode). Example: "1.0.0.0" String length is a maximum of 23 characters. (each numeral can be an integer + 3 decimal points)
Preset	Not affected by a Preset
State Saved	Not saved in state, the value will be the selected application when a Save is done.
Initial S/W Revision	Prior to A.02.00

Current Application Options

Returns a string that is the Options list of the currently selected application (Mode).

Remote Command	:SYSTem:APPLication[:CURRent]:OPTion?
Example	:SYST:APPL:OPT?
Notes	Query returns a quoted string that is the Option list of the currently selected application (Mode). The format is the name as the *OPT? or SYSTem:OPTion command: a comma separated list of option identifiers. Example: "1FP,2FP" String length is a maximum of 255 characters.
Preset	Not affected by a Preset
State Saved	Not saved in state per se, the value will be the selected application when a Save is invoked.
Initial S/W Revision	Prior to A.02.00

Application Identification Catalog (Remote Commands Only)

A catalog of the installed and licensed applications (Modes) can be queried for their identification.

"Application Catalog Number of Entries" on page 305

"Application Catalog Model Numbers" on page 305

"Application Catalog Revision" on page 305

"Application Catalog Options" on page 306

Application Catalog Number of Entries

Returns the number of installed and licensed applications (Modes).

Remote Command	:SYSTem:APPLication:CATalog[:NAME]:COUNT?
Example	:SYST:APPL:CAT:COUN?
Preset	Not affected by Preset
State Saved	Not saved in instrument state.
Initial S/W Revision	Prior to A.02.00

Application Catalog Model Numbers

Returns a list of Model Numbers for the installed and licensed applications (Modes).

Remote Command	:SYSTem:APPLication:CATalog[:NAME]?
Example	:SYST:APPL:CAT?
Notes	Returned value is a quoted string of a comma separated list of Model Numbers. Example, if SAMS and Phase Noise are installed and licensed: "N9060A,N9068A" String length is COUNT * 7 - 1. (7 = Model Number length + 1 for comma. -1 = no comma for the 1st entry.)
Preset	Not affected by a Preset
State Saved	Not saved in instrument state.
Initial S/W Revision	Prior to A.02.00

Application Catalog Revision

Returns the Revision of the provided Model Number.

Remote Command	:SYSTem:APPLication:CATalog:REVision? <model>
Example	:SYST:APPL:CAT:REV? 'N9060A'
Notes	Returned value is a quoted string of revision for the provided Model Number. The revision will be a

	null-string ("") if the provided Model Number is not installed and licensed. Example, if SAMS is installed and licensed: "1.0.0.0"
Preset	Not affected by a Preset.
State Saved	Not saved in instrument state.
Initial S/W Revision	Prior to A.02.00

Application Catalog Options

Returns a list of Options for the provided Model Number

Remote Command	:SYSTem:APPLication:CATalog:OPTion? <model>
Example	:SYST:APPL:CAT:OPT? 'N9060A'
Notes	Returned value is a quoted string of a comma separated list of Options, in the same format as *OPT? or :SYSTem:OPTion?. If the provided Model Number is not installed and licensed a null-string ("") will be returned. Example, if SAMS is installed and licensed: "2FP" String length is a maximum of 255 characters.
Preset	Not affected by a Preset
State Saved	Not saved in instrument state.
Initial S/W Revision	Prior to A.02.00

Detailed List of Modes

This section contains an alphabetical list of Modes available in the X-Series, along with a brief description of each Mode.

Note that with the exception of the 89601 VSA, only licensed applications appear in the Mode menu. The 89601 will always appear, because it's licensing is handled differently.

1xEV-DO

Selects the 1xEV-DO mode for general purpose measurements of signals following this standard. There are several measurements available in this mode.

If you are using the Help feature, this mode must be currently active to access its detailed information. If it is not active, exit the Help feature (Esc key), select the mode, and re-access Help.

Key Path	Mode
Example	INST:SEL CDMA1XEV INST:NSEL 15
Initial S/W Revision	Prior to A.02.00

802.16 OFDMA (WiMAX/WiBro)

Selects the OFDMA mode for general purpose measurements of WiMAX signals. There are several measurements available in this mode.

If you are using the Help feature, this mode must be currently active to access its detailed information. If it is not active, exit the Help feature (Esc key), select the mode, and re-access Help.

Key Path	Mode
Example	INST:SEL WIMAXOFDMA INST:NSEL 75
Initial S/W Revision	Prior to A.02.00

802.16 OFDM (Fixed WiMAX)

Selects the 802.16 OFDM (Fixed WiMAX) mode. This mode allows modulation quality measurements of signals that comply with IEEE 802.16a–2003 and IEEE 802.16–2004 standards, with flexibility to measure nonstandard OFDM formats. Along with the typical digital demodulation measurement results, several additional 802.16 OFDM unique trace data formats and numeric error data results provide enhanced data analysis.

If you are using the Help feature, this mode must be currently active to access its detailed information. If it is not active, exit the Help feature (Esc key), select the mode, and re-access Help.

Key Path	Mode
Example	INST:SEL WIMAXFIXED INST:NSEL 104
Initial S/W Revision	A.02.00

89601 VSA

Selecting the 89601 VSA mode will start the 89600 VSA software. The 89600 VSA software is powerful, PC-based software, offering the industry's most sophisticated general purpose and standards specific signal evaluation and troubleshooting tools for R&D engineers. Even for proprietary and non-standard signals in SATCOM or MILCOM applications, you can make signal quality measurements with customized IQ constellation. Reach deeper into signals, gather more data on signal problems, and gain greater insight.

- Over 35 general-purpose analog and digital demodulators ranging from 2FSK to 4096QAM
- Flexible and custom IQ and OFDM signal analysis for single carrier
- Standards specific modulation analysis including:
 - Cellular: GSM/EDGE, cdma2000, W-CDMA, TD-SCDMA, LTE(FDD/TDD),
 - LTE-Advanced and more

- Wireless networking: 802.11a/b/g, 802.11n, 802.ac, 802.16 WiMAX (fixed/mobile), WiSUN (MR-FSK PHY)
- RFID
- Digital satellite video and other satellite signals, radar, LMDS
- Up to 400K bin FFT, for the highest resolution spectrum analysis
- A full suite of time domain analysis tools, including signal capture and playback, time gating, and CCDF measurements
- 20 simultaneous trace displays and the industry's most complete set of marker functions
- Easy-to-use Microsoft ® Windows ® graphical user interface

For more information see the Agilent 89600 Series VSA web site at www.agilent.com/find/89600vsa

To learn more about how to use the 89600 VSA running in the X-Series, after the 89600 VSA software is running, open the 89600 VSA Help and open the "About Agilent X-Series Signal Analyzer with 89600 VSA Software" help topic.

Key Path	Mode
Example	INST:SEL VSA89601 INST:NSEL 101
Initial S/W Revision	Prior to A.02.00

Analog Demod

Selects the Analog Demod mode for making measurements of AM, FM and phase modulated signals.

If you are using the Help feature, this mode must be currently active to access its detailed information. If it is not active, exit the Help feature (Esc key), select the mode, and re-access Help.

Key Path	Mode
Example	INST:SEL ADEMOM INST:NSEL 234
Initial S/W Revision	Prior to A.02.00

Bluetooth

Selects the Bluetooth mode for Bluetooth specific measurements. There are several measurements available in this mode.

If you are using the Help feature, this mode must be currently active to access its detailed information. If it is not active, exit the Help feature (Esc key), select the mode, and re-access Help.

Key Path	Mode
Example	INST:SEL BT

	INST:NSEL 228
Initial S/W Revision	A.06.01

cdma2000

Selects the cdma2000 mode for general purpose measurements of signals following this standard. There are several measurements available in this mode.

If you are using the Help feature, this mode must be currently active to access its detailed information. If it is not active, exit the Help feature (Esc key), select the mode, and re-access Help.

Key Path	Mode
Example	INST:SEL CDMA2K INST:NSEL 10
Initial S/W Revision	Prior to A.02.00

CMMB

Selects the CMMB mode for measurements of digital video signals using this format. There are several power and demod measurements available in this mode.

If you are using the Help feature, this mode must be currently active to access its detailed information. If it is not active, exit the Help feature (Esc key), select the mode, and re-access Help.

Key Path	Mode
Example	INST:SEL CMMB INST:NSEL 240
Initial S/W Revision	A.03.00

Combined WLAN

Selects the CWLAN mode for general purpose measurements of signals following this standard. There are several measurements available in this mode.

If you are using the Help feature, this mode must be currently active to access its detailed information. If it is not active, exit the Help feature (Esc key), select the mode, and re-access Help.

Key Path	Mode
Example	INST:SEL CWLAN INST:NSEL 19
Initial S/W Revision	A.02.00

Combined Fixed WiMAX

Selects the Combined Fixed WiMAX mode for general purpose measurements of signals following this standard. There are several measurements available in this mode.

If you are using the Help feature, this mode must be currently active to access its detailed information. If it is not active, exit the Help feature (Esc key), select the mode, and re-access Help.

Key Path	Mode
Example	INST:SEL CWIMAXOFDM INST:NSEL 81
Initial S/W Revision	A.02.00

Digital Cable TV

Selects the Digital Cable TV mode for measurements of digital cable television systems. There are several power and demod measurements available in this mode.

If you are using the Help feature, this mode must be currently active to access its detailed information. If it is not active, exit the Help feature (Esc key), select the mode, and re-access Help.

Key Path	Mode
Example	INST:SEL DCATV INST:NSEL 238
Initial S/W Revision	A.07.00

DTMB (CTTB)

Selects the DTMB (CTTB) mode for measurements of digital video signals using this format. There are several power and demod measurements available in this mode.

If you are using the Help feature, this mode must be currently active to access its detailed information. If it is not active, exit the Help feature (Esc key), select the mode, and re-access Help.

Key Path	Mode
Example	INST:SEL DTMB INST:NSEL 236
Initial S/W Revision	A.02.00

DVB-T/H with T2

Selects the DVB-T/H mode for measurements of digital video signals using this format. There are several power and demod measurements available in this mode.

If you are using the Help feature, this mode must be currently active to access its detailed information. If it is not active, exit the Help feature (Esc key), select the mode, and re-access Help.

Key Path	Mode
Example	INST:SEL DVB INST:NSEL 235
Initial S/W Revision	A.02.00
Modified at S/W Revision	A.07.00

EMI Receiver

The EMI Receiver Mode makes EMC measurements. Several measurements are provided to aid the user in characterizing EMC performance of their systems, including looking at signals with CISPR-16 compliant detectors, performing scans for interfering signals, and determining and charting interfering signals over time.

If you are using the Help feature, this mode must be currently active to access its detailed information. If it is not active, exit the Help feature (Esc key), select the mode, and re-access Help.

Key Path	Mode
Example	INST:SEL EMI INST:NSEL 141
Initial S/W Revision	A.07.01

GSM/EDGE/EDGE Evo

Selects the GSM with EDGE mode for general purpose measurements of signals following this standard. There are several measurements available in this mode.

If you are using the Help feature, this mode must be currently active to access its detailed information. If it is not active, exit the Help feature (Esc key), select the mode, and re-access Help.

Key Path	Mode
Example	INST:SEL EDGEGSM INST:NSEL 13
Initial S/W Revision	Prior to A.02.00
Modified at S/W Revision	A.02.00

iDEN/WiDEN/MOTOTalk

Selects the iDEN/WiDEN/MOTOTalk mode for general purpose measurements of iDEN and iDEN-related signals. There are several measurements available in this mode.

If you are using the Help feature, this mode must be currently active to access its detailed information. If it is not active, exit the Help feature (Esc key), select the mode, and re-access Help.

Key Path	Mode
Example	INST:SEL IDEN INST:NSEL 103
Initial S/W Revision	A.02.00

IQ Analyzer (Basic)

The IQ Analyzer Mode makes general purpose frequency domain and time domain measurements. These measurements often use alternate hardware signal paths when compared with a similar measurement in the Signal Analysis Mode using the Swept SA measurement. These frequency domain and time domain measurements can be used to output I/Q data results when measuring complex modulated digital signals.

If you are using the Help feature, this mode must be currently active to access its detailed information. If it is not active, exit the Help feature (Esc key), select the mode, and re-access Help.

Key Path	Mode
Example	INST:SEL BASIC INST:NSEL 8
Initial S/W Revision	Prior to A.02.00

ISDB-T

Selects the ISDB-T mode for measurements of digital video signals using this format. There are several power and demod measurements available in this mode.

If you are using the Help feature, this mode must be currently active to access its detailed information. If it is not active, exit the Help feature (Esc key), select the mode, and re-access Help.

Key Path	Mode
Example	INST:SEL ISDBT INST:NSEL 239
Initial S/W Revision	A.03.00

LTE

Selects the LTE mode for general purpose measurements of signals following the LTE FDD standard. There are several measurements available in this mode.

If you are using the Help feature, this mode must be currently active to access its detailed information. If it is not active, exit the Help feature (Esc key), select the mode, and re-access Help.

Key Path	Mode
Example	INST:SEL LTE INST:NSEL 102
Initial S/W Revision	Prior to A.02.00

LTE TDD

Selects the LTE TDD mode for general purpose measurements of signals following the LTE TDD standard. There are several measurements available in this mode.

If you are using the Help feature, this mode must be currently active to access its detailed information. If it is not active, exit the Help feature (Esc key), select the mode, and re-access Help.

Key Path	Mode
Example	INST:SEL LTETDD INST:NSEL 105
Initial S/W Revision	A.03.00

LTE-Advanced FDD

As LTE-Advanced FDD and LTE modes are converged into one single application, the single softkey under Mode menu is designed to select the covered mode. The display mode of the LTE and LTE-Advanced FDD are distinguished by the licenses.

If you are using the Help feature, this mode must be currently active to access its detailed information. If it is not active, exit the Help feature (Esc key), select the mode, and re-access Help.

Key Path	Mode
Example	INST:SEL LTEAFDD INST:NSEL 107
Notes	When the N9080A/80B-1FP exists, the display mode name is LTE. When the N9080A/80B-1FP and N9080B-2FP all exist, the display mode name is LTE FDD & LTE-A FDD.
Backwards Compatibility SCPI	INST:SEL LTE INST:NSEL 102
Initial S/W Revision	A.14.00
Modified at S/W Revision	A.14.50

LTE-Advanced TDD

As LTE-Advanced TDD and LTE TDD modes are converged into one single application, the single softkey under Mode menu is designed to select the covered mode. The display mode of the LTE TDD and LTE-

Advanced TDD are distinguished by the licenses.

If you are using the Help feature, this mode must be currently active to access its detailed information. If it is not active, exit the Help feature (Esc key), select the mode, and re-access Help.

Key Path	Mode
Example	INST:SEL LTEATDD INST:NSEL 108
Notes	When the N9082A/82B-1FP exists, the display mode name is LTE TDD. When the N9082A/82B-1FP and N9082B-2FP all exist, the display mode name is LTE TDD & LTE-A TDD.
Backwards Compatibility SCPI	INST:SEL LTETDD INST:NSEL 105
Initial S/W Revision	A.14.00
Modified at S/W Revision	A.14.50

MSR

Selects the MSR mode. The MSR mode makes several measurements for Cellular Communication devices that can be configured with multiple radio formats simultaneously following the 3GPP standard of Multi-Standard Radio, including GSM/EDGE, WCDMA/HSPA+ and LTE.

If you are using the Help feature, this mode must be currently active to access its detailed information. If it is not active, exit the Help feature (Esc key), select the mode, and re-access Help.

Key Path	Mode
Example	INST:SEL MSR INST:NSEL 106
Initial S/W Revision	A.09.491

Noise Figure

The Noise Figure mode provides pre-configured measurements for making general purpose measurements of device noise figure.

If you are using the Help feature, this mode must be currently active to access its detailed information. If it is not active, exit the Help feature (Esc key), select the mode, and re-access Help.

Key Path	Mode
Example	INST:SEL NFIGURE INST:NSEL 219
Initial S/W Revision	Prior to A.02.00

Phase Noise

The Phase Noise mode provides pre-configured measurements for making general purpose measurements of device phase noise.

If you are using the Help feature, this mode must be currently active to access its detailed information. If it is not active, exit the Help feature (Esc key), select the mode, and re-access Help.

Key Path	Mode
Example	INST:SEL PNOISE or INST:NSEL 14
Initial S/W Revision	Prior to A.02.00

Real Time Spectrum Analyzer

The Real Time Spectrum Analyzer (RTSA) mode provides real-time signal analysis, very high probability-of-intercept for intermittent signals with appropriate triggers.

If you are using the Help feature, this mode must be currently active to access its detailed information. If it is not active, exit the Help feature (Esc key), select the mode, and re-access Help.

Key Path	Mode
Example	INST:SEL RTSA or INST:NSEL 107
Initial S/W Revision	A.13.00

Remote Language Compatibility

The Remote Language Compatibility (RLC) mode provides remote command backwards compatibility for the 8560 series of spectrum analyzers, known as legacy spectrum analyzers.

NOTE After changing into or out of this mode, allow a 1 second delay before sending any subsequent commands.

If you are using the Help feature, this mode must be currently active to access its detailed information. If it is not active, exit the Help feature (Esc key), select the mode, and re-access Help.

Key Path	Mode
Example	INST:SEL RLC Or INST:NSEL 266
Initial S/W Revision	Prior to A.02.00

SCPI Language Compatibility

The SCPI Language Compatibility mode provides remote language compatibility for SCPI-based instruments, such as the Rohde and Schwartz FSP and related series of spectrum analyzers.

NOTE After changing into or out of this mode, allow a 1 second delay before sending any subsequent commands.

If you are using the Help feature, this mode must be currently active to access its detailed information. If it is not active, exit the Help feature (Esc key), select the mode, and re-access Help.

Key Path	Mode
Example	INST:SEL SCPILC Or INST:NSEL 270
Initial S/W Revision	A.06.00

Spectrum Analyzer

Selects the Spectrum Analyzer mode for general purpose measurements. There are several measurements available in this mode. General spectrum analysis measurements, in swept and zero span, can be done using the first key in the Meas menu, labeled Swept SA. Other measurements in the Meas Menu are designed to perform specialized measurement tasks, including power and demod measurements.

If you are using the Help feature, this mode must be currently active to access its detailed information. If it is not active, exit the Help feature (Esc key), select the mode, and re-access Help.

Key Path	Mode
Example	INST:SEL SA INST:NSEL 1
Initial S/W Revision	Prior to A.02.00

TD-SCDMA with HSPA/8PSK

Selects the TD-SCDMA mode for general purpose measurements of signals following this standard. There are several measurements available in this mode.

If you are using the Help feature, this mode must be currently active to access its detailed information. If it is not active, exit the Help feature (Esc key), select the mode, and re-access Help.

Key Path	Mode
Example	INST:SEL TDSCDMA INST:NSEL 211
Initial S/W Revision	Prior to A.02.00

Vector Signal Analyzer (VXA)

The N9064A (formerly 89601X) VXA Vector signal and WLAN modulation analysis application provides solutions for basic vector signal analysis, analog demodulation, and digital demodulation. The digital demodulation portion of N9064A allows you to perform measurements on standard-based formats such as cellular, wireless networking and digital video as well as general purpose flexible modulation analysis for wide range of digital formats, FSK to 1024QAM, with easy-to-use measurements and display tools such as constellation and eye diagram, EVM traces and up to four simultaneous displays. Analog baseband analysis is available using the MXA and PXA with option BBA. Option 3FP WLAN has been discontinued.

N9064A honors existing 89601X licenses with all features and functionalities found on X-Series software versions prior to A.06.00. Specifically:

N9064A-1 is equivalent to 89601X-205

N9064A-2 is equivalent to 89601X-AYA

If you are using the Help feature, this mode must be currently active to access its detailed information. If it is not active, exit the Help feature (Esc key), select the mode, and re-access Help.

Key Path	Mode
Example	INST:SEL VSA INST:NSEL 100
Initial S/W Revision	Prior to A.02.00

W-CDMA with HSPA+

Selects the W-CDMA with HSPA+ mode for general purpose measurements of signals following this standard. There are several measurements available in this mode.

If you are using the Help feature, this mode must be currently active to access its detailed information. If it is not active, exit the Help feature (Esc key), select the mode, and re-access Help.

Key Path	Mode
Example	INST:SEL WCDMA INST:NSEL 9
Initial S/W Revision	Prior to A.02.00

WLAN

Selects the WLAN mode for general purpose measurements of signals following this standard. There are several measurements available in this mode.

If you are using the Help feature, this mode must be currently active to access its detailed information. If it is not active, exit the Help feature (Esc key), select the mode, and re-access Help.

Key Path	Mode
----------	------

Example	INST:SEL WLAN INST:NSEL 217
Initial S/W Revision	A.09.491

Global Settings

Opens a menu that allows you to switch certain Meas Global parameters to a Mode Global state. These switches apply to all Modes that support global settings. No matter what Mode you are in when you set the “Global Center Frequency” switch to on, it applies to all Modes that support Global Settings.

Key Path	Mode Setup
Initial S/W Revision	Prior to A.02.00

Global Center Freq

The software maintains a Mode Global value called “Global Center Freq”.

When the Global Center Freq key is switched to On in any mode, the current mode’s center frequency is copied into the Global Center Frequency, and from then on all modes that support global settings use the Global Center Frequency. So you can switch between any of these modes and the Center Freq will remain unchanged.

Adjusting the Center Freq of any mode which supports Global Settings, while Global Center Freq is On, will modify the Global Center Frequency.

When Global Center Freq is turned Off, the Center Freq of the current mode is unchanged, but now the Center Freq of each mode is once again independent.

When Mode Preset is pressed while Global Center Freq is On, the Global Center Freq is preset to the preset Center Freq of the current mode.

This function is reset to Off when the Restore Defaults key is pressed in the Global Settings menu, or when System, Restore Defaults, All Modes is pressed.

Key Path	Mode Setup, Global Settings
Scope	Mode Global
Remote Command	:INSTrument:COUPle:FREQuency:CENTer ALL NONE :INSTrument:COUPle:FREQuency:CENTer?
Example	INST:COUP:FREQ:CENt ALL INST:COUP:FREQ:CENt?
Preset	Set to Off on Global Settings, Restore Defaults and System, Restore Defaults, All Modes
Range	On Off
Initial S/W Revision	Prior to A.02.00

Remote Command	:GLOBal:FREQuency:CENTer[:STATe] 1 0 ON OFF :GLOBal:FREQuency:CENTer[:STATe]?
Preset	Off
Initial S/W Revision	Prior to A.02.00

Restore Defaults

This key resets all of the functions in the Global Settings menu to Off. This also occurs when System, Restore Defaults, All Modes is pressed.

Key Path	Mode Setup, Global Settings
Remote Command	:INSTrument:COUPle:DEFault
Example	INST:COUP:DEF
Backwards Compatibility SCPI	:GLOBal:DEFault
Initial S/W Revision	Prior to A.02.00

Mode Setup

This key accesses a menu to allow you to select mode parameters. These settings apply to all measurements in the current mode.

Key Path	Front-panel key
Initial S/W Revision	A.10.01

Radio Std

Accesses the Radio Std menu. In this menu, 3 group of WLAN standards can be selected, the first is 802.11a/g/b which includes 802.11a/g,802.11b/g,802.11g DSSS-OFDM, the second is 802.11n which includes 802.11n 20MHz and 802.11n 40MHz, the third one is 802.11ac which includes 802.11ac 20MHz, 802.11ac 40MHz, 802.11ac 80MHz, 802.11ac 80+80MHz and 802.11ac 160MHz. Below each separate standard, the parameters related to demodulation can be set, such as modulation format, Guard Interval, and so forth.

Key Path	Mode Setup
Mode	WLAN
Scope	Meas Global
Remote Command	[:SENSe]:RADio:STANdard[:WLAN] AG BG GDO N20 N40 AC20 AC40 AC80 ACT80 AC160 [:SENSe]:RADio:STANdard[:WLAN] ?
Example	RAD:STAN AG RAD:STAN?
Notes	<p>1)If only N9077A-2FP/TP is installed, 802.11a/b/g key and its following radio standard keys will be available, other keys will be blanked. And SCPI command only support AG BG GDO.</p> <p>2)If N9077A-2FP/TP + N9077A-3FP/TP are installed, 802.11a/b/g , 802.11n and their following keys will be available. And SCPI command only support AG BG GDO N20 N40.</p> <p>3)If N9077A-2FP/TP + N9077A-3FP/TP + N9077A-4FP are installed, all the keys in radio standard menu will be available. All the parameters are supported by SCPI.</p> <p>If the SCPI command is sent with unsupported parameters, an error is generated, -221.1900, "Settings conflict;option not installed"</p> <p>For IQ measurements (CCDF,Power vs Time,Spectral Flatness or IQ Waveform or Modulation Accuracy), they are also limited by infoBW license. when any radio standard is selected in a IQ measurement which maximum BW could not meet this radio standard request, the "Invalid result;Wider BW required" message occurs, and the measurement should return invalid data.</p> <p>Enum "ACT80" means "AC Two 80MHz" (802.11ac 80+80 MHz)</p>
Preset	AG
State Saved	Saved in instrument state.
Range	802.11a/g (OFDM) 802.11b/g (DSSS/CCK/PBCC) 802.11g (DSSS-OFDM) 802.11n (20 MHz) 802.11n (40 MHz) 802.11ac (20 MHz) 802.11ac (40 MHz) 802.11ac (80 MHz) 802.11ac (80 + 80MHz) 802.11ac (160MHz)
Initial S/W Revision	A.10.01

802.11a/b/g

This key accesses a menu to allow you to select 802.11a/g(OFDM),802.11b/g(DSSS/CCK/PBCC),802.11g (DSSS-OFDM).

Key Path	Mode Setup, Radio std
Initial S/W Revision	A.10.01

802.11a/g

When 802.11a/g key is not selected, pressing this key selects the 802.11a/g standard as WLAN standard. When 802.11a/g key is already selected, pressing this key accesses the demodulation setup for 802.11a/g standard.

Key Path	Mode Setup, Radio std, 802.11a/b/g
Mode	WLAN
Example	:RAD:STAN AG
State Saved	Saved in instrument state.
Initial S/W Revision	A.10.01

Modulation Format

Accessing the modulation format key allows you to specify the modulation format of input signal. You can select Auto Detect to automatically detect the modulation format or specify modulation format for your testing.

Key Path	Mode Setup, Radio std, 802.11a/b/g, 802.11a/g
Mode	WLAN
Remote Command	[:SENSE] :DEMod [:WLAN] :AG:FORMat AUTO BPSK QPSK QAM16 QAM64 [:SENSE] :DEMod [:WLAN] :AG:FORMat?
Example	DEM:AG:FORM:AG AUTO DEM:AG:FORM:AG?
Preset	AUTO
State Saved	Saved in instrument state.
Range	Auto Detect BPSK QPSK 16QAM 64QAM
Initial S/W Revision	A.10.01

Subcarrier Spacing

This parameter specifies the subcarrier frequency spacing of the input signal. This parameter must match the actual subcarrier frequency spacing of the input signal, otherwise demodulation will fail. The default

312.5 kHz matches the 802.11a/g/n standards.

Key Path	Mode Setup, Radio std, 802.11a/b/g, 802.11a/g
Mode	WLAN
Remote Command	[:SENSE] :DEMod [:WLAN] :AG:SUBCarrier:SPACing <freq> [:SENSE] :DEMod [:WLAN] :AG:SUBCarrier:SPACing?
Example	DEM:AG:SUBC:SPAC 312.5 kHz DEM:AG:SUBC:SPAC?
Preset	312.5 kHz
State Saved	Saved in instrument state.
Min	1Hz
Max	1.25MHz
Initial S/W Revision	A.10.01

Guard Interval

This specifies the guard interval (also called cyclic extension) length for each symbol time, as a fraction of the FFT length. The value must match the guard interval length actually used in the input signal in order for demodulation to work properly. The value should be between zero and one, and values outside that range are clipped to be within the range. The value is rounded to the nearest 1/128th. The 802.11a/g standards require that the guard interval always is 1/4 of the FFT length. The 802.11n standard allows values of either 1/4 or you can select from HT-SIG.

Key Path	Mode Setup, Radio std, 802.11a/b/g, 802.11a/g
Mode	WLAN
Remote Command	[:SENSE] :DEMod [:WLAN] :AG:GINTervalR1B4 R1B8 OTHER [:SENSE] :DEMod [:WLAN] :AG:GINTerval?
Example	DEM:AG:GINT R1B4 DEM:AG:GINT?
Notes	.
Preset	1/4
State Saved	Saved in instrument state.
Range	1/4 1/8 Other
Initial S/W Revision	A.10.01

Other

This specifies the guard interval (also called cyclic extension) length for each symbol time, when Guard Interval is set to Other, this value will be used as Guard Interval

Key Path	Mode Setup, Radio std, 802.11a/b/g, 802.11a/g, Guard Interval
----------	---

Mode	WLAN
Remote Command	[:SENSe] :DEMod [:WLAN] :AG:GINTerval:LENGth <real> [:SENSe] :DEMod [:WLAN] :AG:GINTerval:LENGth?
Example	DEM:AG:GINT:LENG 0.25 DEM:AG:GINT:LENG?
Preset	0.25
State Saved	Saved in instrument state.
Min	0.0078125
Max	1
Initial S/W Revision	A.10.01

802.11b/g

When 802.11b/g key is not selected, pressing this key selects the 802.11b/g standard as WLAN standard. When 802.11b/g key is already selected, pressing this key accesses the demodulation setup for 802.11b/g.

Key Path	Mode Setup, Radio std, 802.11a/b/g
Mode	WLAN
Example	:RAD:STAN BG
State Saved	Saved in instrument state.
Initial S/W Revision	A.10.01

Modulation Format

Accessing the modulation format key allows you to specify the modulation format of input signal. You can select Auto Detect to automatically detect the modulation format or specify modulation format for your testing.

Key Path	Mode Setup, Radio std, 802.11a/b/g, 802.11b/g
Mode	WLAN
Remote Command	[:SENSe] :DEMod [:WLAN] :BG:FORMat DSSS1 DSSS2 CCK55 CCK11 PBCC55 PBCC11 PBCC22 PBCC33 [:SENSe] :DEMod [:WLAN] :BG:FORMat?
Example	DEM:BG:FORM AUTO DEM:BG:FORM?
Preset	AUTO
State Saved	Saved in instrument state.
Range	DSSS 1.0Mbps DSSS 2.0Mbps CCK 5.5Mbps CCK 11.0Mbps PBCC 5.5Mbps PBCC 11.0Mbps PBCC 22.0Mbps PBCC 33.0Mbps
Initial S/W Revision	A.10.01

802.11g DSSS-OFDM

When 802.11g DSSS-OFMD key is not selected, pressing this key selects the 802.11g DSSS-OFDM standard as WLAN standard. When 802.11g DSSS-OFDM key is already selected, pressing this key accesses the demodulation setup for 802.11g DSSS-OFDM standard.

Key Path	Mode Setup, Radio std, 802.11a/b/g
Mode	WLAN
Example	:RAD:STAN GDO
State Saved	Saved in instrument state.
Initial S/W Revision	A.10.01

Modulation Format

Accessing the modulation format key allows you to specify the modulation format of input signal. You can select Auto Detect to automatically detect the modulation format or specify modulation format for your testing.

Key Path	Mode Setup, Radio std, 802.11a/b/g, 802.11g DSSS-OFDM
Mode	WLAN
Remote Command	[:SENSe] :DEMod [:WLAN] :GDO:FORMat AUTO BPSK QPSK QAM16 QAM64 [:SENSe] :DEMod [:WLAN] :GDO:FORMat?
Example	DEM:GDO:FORM AUTO DEM:GDO:FORM?
Preset	AUTO
State Saved	Saved in instrument state.
Range	Auto Detect BPSK QPSK 16QAM 64QAM
Initial S/W Revision	A.10.01

Subcarrier Spacing

This parameter specifies the subcarrier frequency spacing of the input signal. This parameter must match the actual subcarrier frequency spacing of the input signal, otherwise demodulation will fail. The default 312.5 kHz matches the 802.11a/g/n standards.

Key Path	Mode Setup, Radio std, 802.11a/b/g, 802.11g DSSS-OFDM
Mode	WLAN
Remote Command	[:SENSe] :DEMod [:WLAN] :GDO:SUBCarrier:SPACing <freq> [:SENSe] :DEMod [:WLAN] :GDO:SUBCarrier:SPACing?
Example	DEM:GDO:SUBC:SPAC 312.5 kHz DEM:GDO:SUBC:SPAC?

Preset	312.5 kHz
State Saved	Saved in instrument state.
Min	1Hz
Max	1.25 MHz
Initial S/W Revision	A.10.01

Guard Interval

This specifies the guard interval (also called cyclic extension) length for each symbol time, as a fraction of the FFT length. The value must match the guard interval length actually used in the input signal in order for demodulation to work properly. The value should be between zero and one, and values outside that range are clipped to be within the range. The value is rounded to the nearest 1/128th. The 802.11a/g standards require that the guard interval always is 1/4 of the FFT length. The 802.11n standard allows values of either 1/4 or you can select from HT-SIG.

Key Path	Mode Setup, Radio std, 802.11a/b/g, 802.11g DSSS-OFDM
Mode	WLAN
Remote Command	<code>[:SENSe] :DEMod [:WLAN] :GDO:GINTerval R1B4 R1B8 OTHer</code> <code>[:SENSe] :DEMod [:WLAN] :GDO:GINTerval?</code>
Example	DEM:GDO:GINT R1 B4 DEM:GDO:GINT?
Notes	.
Preset	1/4
State Saved	Saved in instrument state.
Range	1/4 1/8 Other
Initial S/W Revision	A.10.01

Other

This specifies the guard interval (also called cyclic extension) length for each symbol time, when Guard Interval is set to Other, this value will be used as Guard Interval

Key Path	Mode Setup, Radio std, 802.11a/b/g, 802.11g DSSS-OFDM, Guard Interval
Mode	WLAN
Remote Command	<code>[:SENSe] :DEMod [:WLAN] :GDO:GINTerval:LENGth <real></code> <code>[:SENSe] :DEMod [:WLAN] :GDO:GINTerval:LENGth?</code>
Example	DEM:GDO:GINT:LENG 0.25 DEM:GDO:GINT:LENG?
Preset	0.25
State Saved	Saved in instrument state.

Min	0.0078125
Max	1
Initial S/W Revision	A.10.01

802.11n

This key accesses a menu to allow you to select 802.11n (20M),802.11n(40M).

Key Path	Mode Setup, Radio std
Notes	For E/M/PXA platform: If N9077A-2FP/TP + N9077A-3FP/TP are installed, this key will be available. If only N9077A-2FP/TP is installed,this key will be blanked For CXA platform: If W9077A-2FP + W9077A-3FP are installed,this key will be available. If only W9077A-2FP is installed, this key will be blanked
Initial S/W Revision	A.10.01

802.11n 20 MHz

When 802.11n 20 MHz key is not selected, pressing this key selects the 802.11n 20 MHz standard as WLAN standard. When 802.11n 20 MHz key is already selected, pressing this key accesses the demodulation setup for 802.11n 20 MHz standard.

Key Path	Mode Setup, Radio std, 802.11n
Mode	WLAN
Example	:RAD:STAN N20
Notes	For E/M/PXA platform: If N9077A-2FP/TP + N9077A-3FP/TP are installed, this key will be available. If only N9077A-2FP/TP is installed,this key will be blanked and :RAD:STAN N20 will return -221, " Settings conflict; Option not available". For CXA platform: If W9077A-2FP + W9077A-3FP are installed,this key will be available. If only W9077A-2FP is installed, this key will be blanked and :RAD:STAN N20 will return -221, " Settings conflict; Option not available".
State Saved	Saved in instrument state.
Initial S/W Revision	A.10.01

Modulation Format

Accessing the modulation format key allows you to specify the modulation format of input signal. You can select Auto Detect to automatically detect the modulation format or specify modulation format for your

testing.

Key Path	Mode Setup, Radio std, 802.11n, 802.11n 20 MHz
Mode	WLAN
Remote Command	[:SENSe] :DEMod [:WLAN] :N20 :FORMat AUTO BPSK QPSK QAM16 QAM64 SIG [:SENSe] :DEMod [:WLAN] :N20 :FORMat ?
Example	DEM:N20:FORM AUTO DEM:N20:FORM?
Preset	Auto Detect
State Saved	Saved in instrument state.
Range	Auto Detect BPSK QPSK 16QAM 64QAM From SIG Syms
Initial S/W Revision	A.10.01

Subcarrier Spacing

This parameter specifies the subcarrier frequency spacing of the input signal. This parameter must match the actual subcarrier frequency spacing of the input signal, otherwise demodulation will fail. The default 312.5 kHz matches the 802.11a/g/n standards.

Key Path	Mode Setup, Radio std, 802.11n, 802.11n 20 MHz
Mode	WLAN
Remote Command	[:SENSe] :DEMod [:WLAN] :N20 :SUBCarrier :SPACing <freq> [:SENSe] :DEMod [:WLAN] :N20 :SUBCarrier :SPACing ?
Example	DEM:N20:SUBC:SPAC 312.5 kHz DEM:N20:SUBC:SPAC?
Preset	312.5 kHz
State Saved	Saved in instrument state.
Min	1Hz
Max	1.25 MHz
Initial S/W Revision	A.10.01

Guard Interval

This specifies the guard interval (also called cyclic extension) length for each symbol time, as a fraction of the FFT length. The value must match the guard interval length actually used in the input signal in order for demodulation to work properly. The value should be between zero and one, and values outside that range are clipped to be within the range. The value is rounded to the nearest 1/128th. The 802.11a/g standards require that the guard interval always is 1/4 of the FFT length. The 802.11n standard allows values of either 1/4 or you can select from HT-SIG.

Key Path	Mode Setup, Radio std, 802.11n, 802.11n 20 MHz
Mode	WLAN
Remote Command	[:SENSe] :DEMod [:WLAN] :N20:GINTerval R1B4 R1B8 SIG Other [:SENSe] :DEMod [:WLAN] :N20:GINTerval?
Example	DEM:N20:GINT R1B4 DEM:N20:GINT?
Preset	1/4
State Saved	Saved in instrument state.
Range	1/4 1/8 From SIG Syms Other
Initial S/W Revision	A.10.01

Other

This specifies the guard interval (also called cyclic extension) length for each symbol time, when Guard Interval is set to Other, this value will be used as Guard Interval

Key Path	Mode Setup, Radio std, 802.11n, 802.11n 20 MHz, Guard Interval
Mode	WLAN
Remote Command	[:SENSe] :DEMod [:WLAN] :N20:GINTerval:LENGth <real> [:SENSe] :DEMod [:WLAN] :N20:GINTerval:LENGth?
Example	DEM:N20:GINT:LENG 0.25 DEM:N20:GINT:LENG?
Preset	0.25
State Saved	Saved in instrument state.
Min	0.0078125
Max	1
Initial S/W Revision	A.10.01

802.11n 40 MHz

When 802.11n 40 MHz key is not selected, pressing this key selects the 802.11n 40 MHz standard as WLAN standard. When 802.11n 40 MHz key is already selected, pressing this key accesses the demodulation setup for 802.11n 40 MHz standard.

Key Path	Mode Setup, Radio std, 802.11n
Mode	WLAN
Example	:RAD:STAN N40
Notes	For E/M/PXA platform: 1)if only N9077A–2FP/TP is installed, this key will be blanked.

RAD:STAN N40 will return -221," Settings conflict; Option not available".

2)If N9077A-2FP/TP + N9077A-3FP/TP are installed, this key will be available.

(a)If maxium infoBW is less than 40 MHz and If current measurement is one of CCDF,Power vs Time,Spectral Flatness or IQ Waveform or Modulation Accuracy, then 802.11n(40MHz) key under radio standard is pressed, error message "Invalid results;Wider BW required" will be shown in message area of this measurement.

(b)If maxium infoBW is less than 40 MHz and If current radio standard is 802.11n(40M) and the current measurement is one of Monitor Spectrum, Channel Power,Occupied BW, Specturm Emission Mask or Spurious Emission, then switching current measurement to one of CCDF,Power vs Time,Spectral Flatness or IQ Waveform or Modulation Accuracy, error message "Invalid results;Wider BW required" will be shown in message area of switched measurement.

For CXA platform:

1)If W9077A-2FP is installed, this key will be blanked.

RAD:STAN N40 will return -221," Settings conflict; Option not available".

2)If W9077A-2FP + W9077A-3FP are installed, this key will be available.

a)If current measurement is one of CCDF,Power vs Time,Spectral Flatness or IQ Waveform or Modulation Accuracy, then 802.11n(40MHz) key under radio standard is pressed, error message "Invalid results;Wider BW required" will be shown in message area of this measurement.

b)If current radio standard is 802.11n(40M) and the current measurement is one of Monitor Spectrum, Channel Power,Occupied BW, Specturm Emission Mask or Spurious Emission, then switching current measurement to one of CCDF,Power vs Time,Spectral Flatness or IQ Waveform or Modulation Accuracy, error message "Invalid results;Wider BW required" will be shown in message area of switched measurement.

State Saved	Saved in instrument state.
Initial S/W Revision	A.10.01

Modulation Format

Accessing the modulation format key allows you to specify the modulation format of input signal. You can select Auto Detect to automatically detect the modulation format or specify modulation format for your testing.

Key Path	Mode Setup, Radio std, 802.11n, 802.11n 40 MHz
Mode	WLAN
Remote Command	[:SENSe] :DEMod [:WLAN] :N40 :FORMat AUTO BPSK QPSK QAM16 QAM64 SIG [:SENSe] :DEMod [:WLAN] :N40 :FORMat ?
Example	DEM:N40:FORM AUTO DEM:N40:FORM?
Preset	Auto Detect
State Saved	Saved in instrument state.
Range	Auto Detect BPSK QPSK 16QAM 64QAM From SIG Syms
Initial S/W Revision	A.10.01

Subcarrier Spacing

This parameter specifies the subcarrier frequency spacing of the input signal. This parameter must match the actual subcarrier frequency spacing of the input signal, otherwise demodulation will fail. The default 312.5 kHz matches the 802.11a/g/n standards.

Key Path	Mode Setup, Radio std, 802.11n, 802.11n 40 MHz
Mode	WLAN
Remote Command	[:SENSe] :DEMod [:WLAN] :N40 :SUBCarrier :SPACing <freq> [:SENSe] :DEMod [:WLAN] :N40 :SUBCarrier :SPACing?
Example	DEM:N40:SUBC:SPAC 312.5 kHz DEM:N40:SUBC:SPAC?
Preset	312.5 kHz
State Saved	Saved in instrument state.
Min	1Hz
Max	1.25 MHz
Initial S/W Revision	A.10.01

Guard Interval

This specifies the guard interval (also called cyclic extension) length for each symbol time, as a fraction of the FFT length. The value must match the guard interval length actually used in the input signal in order for demodulation to work properly. The value should be between zero and one, and values outside that range are clipped to be within the range. The value is rounded to the nearest 1/128th. The 802.11a/g standards require that the guard interval always is 1/4 of the FFT length. The 802.11n standard allows values of either 1/4 or you can select from HT-SIG.

Key Path	Mode Setup, Radio std, 802.11n, 802.11n 40 MHz
Mode	WLAN
Remote Command	[:SENSe] :DEMod [:WLAN] :N40 :GINTerval R1B4 R1B8 SGI Other [:SENSe] :DEMod [:WLAN] :N40 :GINTerval?
Example	DEM:N40:GINT R1B4 DEM:N40:GINT?
Notes	.
Preset	1/4
State Saved	Saved in instrument state.
Range	1/4 1/8 From SIG Syms Other
Initial S/W Revision	A.10.01

Other

This specifies the guard interval (also called cyclic extension) length for each symbol time, when Guard Interval is set to Other, this value will be used as Guard Interval

Key Path	Mode Setup, 802.11n 40 MHz, Guard Interval
Mode	WLAN
Remote Command	[:SENSE] :DEMod [:WLAN] :N40:GINTErval:LENGth <real> [:SENSE] :DEMod [:WLAN] :N40:GINTErval:LENGth?
Example	DEM:N40:GINT:LENG 0.25 DEM:N40:GINT:LENG?
Preset	0.25
State Saved	Saved in instrument state.
Min	0.0078125
Max	1
Initial S/W Revision	A.10.01

802.11ac

This key accesses a menu to allow you to select 802.11ac (20MHz), 802.11ac (40MHz), 802.11ac (80MHz), 802.11ac (80+80MHz) and 802.11ac (160MHz)

Key Path	Mode Setup, Radio std
Notes	If N9077A-2FP/TP + N9077A-3FP/TP + N9077A-4FP/TP are installed, this key will be available. Otherwise this key will be blank
Initial S/W Revision	A.11.01

802.11ac 20 MHz

When 802.11ac 20 MHz key is not selected, pressing this key selects the 802.11ac 20 MHz standard as WLAN standard. When 802.11ac 20 MHz key is already selected, pressing this key accesses the demodulation setup for 802.11ac20 MHz standard.

Key Path	Mode Setup, Radio std, 802.11ac
Mode	WLAN
Example	:RAD:STAN AC20
Notes	If N9077A-2FP/TP + N9077A-3FP/TP + N9077A-4FP/TP are installed, this key will be available. Otherwise this key will be blanked and :RAD:STAN AC20 will return -221, "Settings conflict; Option not available".
State Saved	Saved in instrument state.
Initial S/W Revision	A.11.01

Modulation Format

Accessing the modulation format key allows you to specify the modulation format of input signal. You can select Auto Detect to automatically detect the modulation format or specify modulation format for your testing.

Key Path	Mode Setup, Radio std, 802.11 ac, 802.11 ac 20 MHz
Mode	WLAN
Remote Command	[:SENSe] :DEMod [:WLAN] :AC20:FORMat AUTO BPSK QPSK QAM16 QAM64 QAM256 SIG [:SENSe] :DEMod [:WLAN] :AC20:FORMat?
Example	DEM:AC20:FORM AUTO DEM:AC20:FORM?
Preset	Auto Detect
State Saved	Saved in instrument state.
Range	Auto Detect BPSK QPSK 16QAM 64QAM 256QAM From SIG Syms
Initial S/W Revision	A.11.01

Subcarrier Spacing

This parameter specifies the subcarrier frequency spacing of the input signal. This parameter must match the actual subcarrier frequency spacing of the input signal, otherwise demodulation will fail. The default 312.5 kHz matches the 802.11 a/g/n/ac standards.

Key Path	Mode Setup, Radio std, 802.11 ac, 802.11 ac 20 MHz
Mode	WLAN
Remote Command	[:SENSe] :DEMod [:WLAN] :AC20:SUBCarrier:SPACing <freq> [:SENSe] :DEMod [:WLAN] :AC20:SUBCarrier:SPACing?
Example	DEM:AC20:SUBC:SPAC 312.5 kHz DEM:AC20:SUBC:SPAC?
Preset	312.5 kHz
State Saved	Saved in instrument state.
Min	1Hz
Max	1.25 MHz
Initial S/W Revision	A.11.01

Guard Interval

This specifies the guard interval (also called cyclic extension) length for each symbol time, as a fraction of the FFT length. The value must match the guard interval length actually used in the input signal in order for demodulation to work properly. The value should be between zero and one, and values outside that range are clipped to be within the range. The value is rounded to the nearest 1/128th. The 802.11 a/g standards

require that the guard interval always is 1/4 of the FFT length. The 802.11ac standard allows values of either 1/4 or you can select from HT-SIG.

Key Path	Mode Setup, Radio std, 802.11n, 802.11n 20 MHz
Mode	WLAN
Remote Command	<code>[:SENSe] :DEMod [:WLAN] :AC20:GINTerval R1B4 R1B8 SIG OTHer</code> <code>[:SENSe] :DEMod [:WLAN] :AC20:GINTerval?</code>
Example	DEM:AC20:GINT R1B4 DEM:AC20:GINT?
Notes	.
Preset	1/4
State Saved	Saved in instrument state.
Range	1/4 1/8 From SIG Syms Other
Initial S/W Revision	A.11.01

Guard Interval

This specifies the guard interval (also called cyclic extension) length for each symbol time, as a fraction of the FFT length. The value must match the guard interval length actually used in the input signal in order for demodulation to work properly. The value should be between zero and one, and values outside that range are clipped to be within the range. The value is rounded to the nearest 1/128th. The 802.11a/g standards require that the guard interval always is 1/4 of the FFT length. The 802.11ac standard allows values of either 1/4 or you can select from HT-SIG.

Key Path	Mode Setup, Radio std, 802.11ac, 802.11ac 160 MHz
Mode	WLAN
Remote Command	<code>[:SENSe] :DEMod [:WLAN] :AC160:GINTerval R1B4 R1B8 SIG OTHer</code> <code>[:SENSe] :DEMod [:WLAN] :AC160:GINTerval?</code>
Example	DEM:AC160:GINT R1B4 DEM:AC160:GINT?
Notes	.
Preset	1/4
State Saved	Saved in instrument state.
Range	1/4 1/8 From SIG Syms Other
Initial S/W Revision	A.11.01

Other

This specifies the guard interval (also called cyclic extension) length for each symbol time, when Guard Interval is set to Other, this value will be used as Guard Interval

Key Path	Mode Setup, Radio std, 802.11ac, 802.11ac20 MHz, Guard Interval
Mode	WLAN
Remote Command	[:SENSe] :DEMod [:WLAN] :AC20:GINTerval:LENGth <real> [:SENSe] :DEMod [:WLAN] :AC20:GINTerval:LENGth?
Example	DEM:AC20:GINT:LENG 0.25 DEM:AC20:GINT:LENG?
Preset	0.25
State Saved	Saved in instrument state.
Min	0.0078125
Max	1
Initial S/W Revision	A.11.01

802.11ac 40 MHz

When 802.11ac 40 MHz key is not selected, pressing this key selects the 802.11ac 40 MHz standard as WLAN standard. When 802.11ac 40 MHz key is already selected, pressing this key accesses the demodulation setup for 802.11ac 40 MHz standard.

Key Path	Mode Setup, Radio std, 802.11ac
Mode	WLAN
Example	:RAD:STAN AC40
Notes	If N9077A-4FP/TP is not available installed, this key will be blanked. RAD:STAN AC40 will return -221, "Settings conflict; Option not available".
State Saved	Saved in instrument state.
Initial S/W Revision	A.11.01

Modulation Format

Accessing the modulation format key allows you to specify the modulation format of input signal. You can select Auto Detect to automatically detect the modulation format or specify modulation format for your testing.

Key Path	Mode Setup, Radio std, 802.11ac, 802.11ac 40 MHz
Mode	WLAN
Remote Command	[:SENSe] :DEMod [:WLAN] :AC40:FORMat AUTO BPSK QPSK QAM16 QAM64 QAM256 SIG [:SENSe] :DEMod [:WLAN] :AC40:FORMat?
Example	DEM:AC40:FORM AUTO DEM:AC40:FORM?

Preset	Auto Detect
State Saved	Saved in instrument state.
Range	Auto Detect BPSK QPSK 16QAM 64QAM 256QAM From SIG Syms
Initial S/W Revision	A.11.01

Subcarrier Spacing

This parameter specifies the subcarrier frequency spacing of the input signal. This parameter must match the actual subcarrier frequency spacing of the input signal, otherwise demodulation will fail. The default 312.5 kHz matches the 802.11a/g/n/ac standards.

Key Path	Mode Setup, Radio std, 802.11ac, 802.11ac 40 MHz
Mode	WLAN
Remote Command	[:SENSe] :DEMod [:WLAN] :AC40 :SUBCarrier :SPACing <freq> [:SENSe] :DEMod [:WLAN] :AC40 :SUBCarrier :SPACing?
Example	DEM:AC40:SUBC:SPAC 312.5 kHz DEM:AC40:SUBC:SPAC?
Preset	312.5 kHz
State Saved	Saved in instrument state.
Min	1Hz
Max	1.25 MHz
Initial S/W Revision	A.11.01

Guard Interval

This specifies the guard interval (also called cyclic extension) length for each symbol time, as a fraction of the FFT length. The value must match the guard interval length actually used in the input signal in order for demodulation to work properly. The value should be between zero and one, and values outside that range are clipped to be within the range. The value is rounded to the nearest 1/128th. The 802.11a/g standards require that the guard interval always is 1/4 of the FFT length. The 802.11ac standard allows values of either 1/4 or you can select from HT-SIG.

Key Path	Mode Setup, Radio std, 802.11ac, 802.11ac 40 MHz
Mode	WLAN
Remote Command	[:SENSe] :DEMod [:WLAN] :AC40 :GINTerval R1B4 R1B8 SIG OTHER [:SENSe] :DEMod [:WLAN] :AC40 :GINTerval?
Example	DEM:AC40:GINT R1B4 DEM:AC40:GINT?
Notes	.
Preset	1/4

State Saved	Saved in instrument state.
Range	1/4 1/8 From SIG Syms Other
Initial S/W Revision	A.11.01

Guard Interval

This specifies the guard interval (also called cyclic extension) length for each symbol time, as a fraction of the FFT length. The value must match the guard interval length actually used in the input signal in order for demodulation to work properly. The value should be between zero and one, and values outside that range are clipped to be within the range. The value is rounded to the nearest 1/128th. The 802.11a/g standards require that the guard interval always is 1/4 of the FFT length. The 802.11ac standard allows values of either 1/4 or you can select from HT-SIG.

Key Path	Mode Setup, Radio std, 802.11ac, 802.11ac 160 MHz
Mode	WLAN
Remote Command	[:SENSe] :DEMod [:WLAN] :AC160 :GINTerval R1B4 R1B8 SIG Other [:SENSe] :DEMod [:WLAN] :AC160 :GINTerval ?
Example	DEM:AC160:GINT R1B4 DEM:AC160:GINT?
Notes	.
Preset	1/4
State Saved	Saved in instrument state.
Range	1/4 1/8 From SIG Syms Other
Initial S/W Revision	A.11.01

Other

This specifies the guard interval (also called cyclic extension) length for each symbol time, when Guard Interval is set to Other, this value will be used as Guard Interval

Key Path	Mode Setup, 802.11ac 40 MHz, Guard Interval
Mode	WLAN
Remote Command	[:SENSe] :DEMod [:WLAN] :AC40 :GINTerval :LENGth <real> [:SENSe] :DEMod [:WLAN] :AC40 :GINTerval :LENGth ?
Example	DEM:AC40:GINT:LENG 0.25 DEM:AC40:GINT:LENG?
Preset	0.25
State Saved	Saved in instrument state.
Min	0.0078125
Max	1
Initial S/W Revision	A.11.01

802.11ac 80 MHz

When 802.11ac 80 MHz key is not selected, pressing this key selects the 802.11ac 80 MHz standard as WLAN standard. When 802.11ac 80 MHz key is already selected, pressing this key accesses the demodulation setup for 802.11ac 80 MHz standard.

Key Path	Mode Setup, Radio std, 802.11ac
Mode	WLAN
Example	:RAD:STAN AC80
Notes	If N9077A-4FP is not available this key will be blanked. RAD:STAN AC80 will return -221, "Settings conflict; Option not available".
State Saved	Saved in instrument state.
Initial S/W Revision	A.11.01

Modulation Format

Accessing the modulation format key allows you to specify the modulation format of input signal. You can select Auto Detect to automatically detect the modulation format or specify modulation format for your testing.

Key Path	Mode Setup, Radio std, 802.11ac, 802.11ac 80 MHz
Mode	WLAN
Remote Command	[:SENSe] :DEMod [:WLAN] :AC80 :FORMat AUTO BPSK QPSK QAM16 QAM64 QAM256 SIG [:SENSe] :DEMod [:WLAN] :AC80 :FORMat ?
Example	DEM:AC80:FORM AUTO DEM:AC80:FORM ?
Preset	Auto Detect
State Saved	Saved in instrument state.
Range	Auto Detect BPSK QPSK 16QAM 64QAM 256QAM From SIG Syms
Initial S/W Revision	A.11.01

Subcarrier Spacing

This parameter specifies the subcarrier frequency spacing of the input signal. This parameter must match the actual subcarrier frequency spacing of the input signal, otherwise demodulation will fail. The default 312.5 kHz matches the 802.11a/g/n/ac standards.

Key Path	Mode Setup, Radio std, 802.11ac, 802.11ac 80 MHz
Mode	WLAN

Remote Command	<code>[:SENSe] :DEMod [:WLAN] :AC80 :SUBCarrier :SPACing <freq></code> <code>[:SENSe] :DEMod [:WLAN] :AC80 :SUBCarrier :SPACing?</code>
Example	DEM:AC80:SUBC:SPAC 312.5 kHz DEM:AC80:SUBC:SPAC?
Preset	312.5 kHz
State Saved	Saved in instrument state.
Min	1Hz
Max	1.25 MHz
Initial S/W Revision	A.11.01

Guard Interval

This specifies the guard interval (also called cyclic extension) length for each symbol time, as a fraction of the FFT length. The value must match the guard interval length actually used in the input signal in order for demodulation to work properly. The value should be between zero and one, and values outside that range are clipped to be within the range. The value is rounded to the nearest 1/128th. The 802.11a/g standards require that the guard interval always is 1/4 of the FFT length. The 802.11ac standard allows values of either 1/4 or you can select from HT-SIG.

Key Path	Mode Setup, Radio std, 802.11 ac, 802.11 ac 80 MHz
Mode	WLAN
Remote Command	<code>[:SENSe] :DEMod [:WLAN] :AC80 :GINTerval R1B4 R1B8 SIG OTHER</code> <code>[:SENSe] :DEMod [:WLAN] :AC80 :GINTerval?</code>
Example	DEM:AC80:GINT R1B4 DEM:AC80:GINT?
Notes	.
Preset	1/4
State Saved	Saved in instrument state.
Range	1/4 1/8 From SIG Syms Other
Initial S/W Revision	A.11.01

Guard Interval

This specifies the guard interval (also called cyclic extension) length for each symbol time, as a fraction of the FFT length. The value must match the guard interval length actually used in the input signal in order for demodulation to work properly. The value should be between zero and one, and values outside that range are clipped to be within the range. The value is rounded to the nearest 1/128th. The 802.11a/g standards require that the guard interval always is 1/4 of the FFT length. The 802.11ac standard allows values of either 1/4 or you can select from HT-SIG.

Key Path	Mode Setup, Radio std, 802.11ac, 802.11ac 160 MHz
Mode	WLAN
Remote Command	[:SENSe] :DEMod [:WLAN] :AC160:GINTerval R1B4 R1B8 SIG OTHer [:SENSe] :DEMod [:WLAN] :AC160:GINTerval?
Example	DEM:AC160:GINT R1B4 DEM:AC160:GINT?
Notes	.
Preset	1/4
State Saved	Saved in instrument state.
Range	1/4 1/8 From SIG Syms Other
Initial S/W Revision	A.11.01

Other

This specifies the guard interval (also called cyclic extension) length for each symbol time, when Guard Interval is set to Other, this value will be used as Guard Interval

Key Path	Mode Setup, 802.11ac 80 MHz, Guard Interval
Mode	WLAN
Remote Command	[:SENSe] :DEMod [:WLAN] :AC80:GINTerval:LENGth <real> [:SENSe] :DEMod [:WLAN] :AC80:GINTerval:LENGth?
Example	DEM:AC80:GINT:LENG 0.25 DEM:AC80:GINT:LENG?
Preset	0.25
State Saved	Saved in instrument state.
Min	0.0078125
Max	1
Initial S/W Revision	A.11.01

802.11ac 80+80 MHz

When 802.11ac 80+80 MHz key is not selected, pressing this key selects the 802.11ac 80+80 MHz standard as WLAN standard. When 802.11ac 80+80 MHz key is already selected, pressing this key accesses the demodulation setup for 802.11ac 80+80 MHz standard.

Key Path	Mode Setup, Radio std, 802.11ac
Mode	WLAN
Example	:RAD:STAN ACT80
Notes	If N9077A-4FP is not available this key will be blanked.

RAD:STAN ACT80 will return -221," Settings conflict; Option not available".

State Saved	Saved in instrument state.
Initial S/W Revision	A.11.01

Modulation Format

Accessing the modulation format key allows you to specify the modulation format of input signal. You can select Auto Detect to automatically detect the modulation format or specify modulation format for your testing.

Key Path	Mode Setup, Radio std, 802.11ac, 802.11ac 80 +80 MHz
Mode	WLAN
Remote Command	[:SENSe] :DEMod [:WLAN] :ACT80:FORMat AUTO BPSK QPSK QAM16 QAM64 QAM256 SIG [:SENSe] :DEMod [:WLAN] :ACT80:FORMat?
Example	DEM:ACT80:FORM AUTO DEM:ACT80:FORM?
Preset	Auto Detect
State Saved	Saved in instrument state.
Range	Auto Detect BPSK QPSK 16QAM 64QAM 256QAM From SIG Syms
Initial S/W Revision	A.11.01

Subcarrier Spacing

This parameter specifies the subcarrier frequency spacing of the input signal. This parameter must match the actual subcarrier frequency spacing of the input signal, otherwise demodulation will fail. The default 312.5 kHz matches the 802.11a/g/n/ac standards.

Key Path	Mode Setup, Radio std, 802.11ac, 802.11ac 80 +80 MHz
Mode	WLAN
Remote Command	[:SENSe] :DEMod [:WLAN] :ACT80:SUBCarrier:SPACing <freq> [:SENSe] :DEMod [:WLAN] :ACT80:SUBCarrier:SPACing?
Example	DEM:ACT80:SUBC:SPAC 312.5 kHz DEM:ACT80:SUBC:SPAC?
Preset	312.5 kHz
State Saved	Saved in instrument state.
Min	1Hz
Max	1.25 MHz
Initial S/W Revision	A.11.01

Guard Interval

This specifies the guard interval (also called cyclic extension) length for each symbol time, as a fraction of the FFT length. The value must match the guard interval length actually used in the input signal in order for demodulation to work properly. The value should be between zero and one, and values outside that range are clipped to be within the range. The value is rounded to the nearest 1/128th. The 802.11a/g standards require that the guard interval always is 1/4 of the FFT length. The 802.11ac standard allows values of either 1/4 or you can select from HT-SIG.

Key Path	Mode Setup, Radio std, 802.11ac, 802.11ac 80 + 80 MHz
Mode	WLAN
Remote Command	[:SENSe] :DEMod [:WLAN] :ACT80:GINTerval R1B4 R1B8 SIG Other [:SENSe] :DEMod [:WLAN] :ACT80:GINTerval?
Example	DEM:ACT80:GINT R1B4 DEM:ACT80:GINT?
Notes	.
Preset	1/4
State Saved	Saved in instrument state.
Range	1/4 1/8 From SIG Syms Other
Initial S/W Revision	A.11.01

Guard Interval

This specifies the guard interval (also called cyclic extension) length for each symbol time, as a fraction of the FFT length. The value must match the guard interval length actually used in the input signal in order for demodulation to work properly. The value should be between zero and one, and values outside that range are clipped to be within the range. The value is rounded to the nearest 1/128th. The 802.11a/g standards require that the guard interval always is 1/4 of the FFT length. The 802.11ac standard allows values of either 1/4 or you can select from HT-SIG.

Key Path	Mode Setup, Radio std, 802.11ac, 802.11ac 160 MHz
Mode	WLAN
Remote Command	[:SENSe] :DEMod [:WLAN] :AC160:GINTerval R1B4 R1B8 SIG Other [:SENSe] :DEMod [:WLAN] :AC160:GINTerval?
Example	DEM:AC160:GINT R1B4 DEM:AC160:GINT?
Notes	.
Preset	1/4
State Saved	Saved in instrument state.
Range	1/4 1/8 From SIG Syms Other
Initial S/W Revision	A.11.01

Other

This specifies the guard interval (also called cyclic extension) length for each symbol time, when Guard Interval is set to Other, this value will be used as Guard Interval

Key Path	Mode Setup, 802.11ac 80 + 80 MHz, Guard Interval
Mode	WLAN
Remote Command	[:SENSe] :DEMod [:WLAN] :ACT80 :GINTerval :LENGth <real> [:SENSe] :DEMod [:WLAN] :ACT80 :GINTerval :LENGth?
Example	DEM:ACT80:GINT:LENG 0.25 DEM:ACT80:GINT:LENG?
Preset	0.25
State Saved	Saved in instrument state.
Min	0.0078125
Max	1
Initial S/W Revision	A.11.01

Noise Reduction

Noise Reduction accesses a menu for configuring the noise compensation of the instrument. This menu only appears in models that support Noise Reduction.

Key Path	Mode Setup
Initial S/W Revision	A.04.00

Noise Floor Extension

Turns on the Noise Floor Extension function. When this function is On, the expected noise power of the analyzer (derived from a factory calibration) is subtracted from the trace data. This will usually reduce the apparent noise level by about 10 dB in low band, and 8 dB in high band (>~3.6 GHz).

Noise Floor Extension works with any RBW, VBW, detector, any setting of Average Type, any amount of trace averaging, and any signal type. It is ineffective when the trace is not smoothed (smoothing processes include narrow VBWs, trace averaging, and long sweep times with the detector set to Average or Peak). It works best with extreme amounts of smoothing, and with the average detector, with the Average Type set to Power.

NOTE

Noise Floor Extensions has no effect unless the RF Input is selected, therefore it does nothing when External Mixing is selected.

In those cases where the cancellation is ineffective, it nonetheless has no undesirable side-effects. There is no significant speed impact to having Noise Floor Extension on.

The best accuracy is achieved when substantial smoothing occurs in each point before trace averaging. Thus, when using the average detector, results are better with long sweep times and fewer trace averages. When using the sample detector, the VBW filter should be set narrow with less trace averaging, instead of a wide VBW filter with more trace averaging.

See "[More Information](#)" on page 343

Key Path	Mode Setup, Noise Reduction
Scope	Meas Global
Remote Command	<code>[:SENSe] :CORRection:NOISe:FLOor ON OFF 1 0</code> <code>[:SENSe] :CORRection:NOISe:FLOor?</code>
Example	CORR:NOIS:FLO ON
Dependencies	This key only appears in instruments with the NFE or NF2 license installed. In all others, the key does not appear, however the SCPI command will be accepted without error (but will have no effect).
Couplings	When NFE is enabled in any mode manually, a prompt will be displayed reminding you to perform the Characterize Noise Floor operation if it is needed. If NFE is enabled through SCPI and a Characterize Noise Floor operation is needed, an error will be entered in the system error queue.
Preset	Unaffected by Mode Preset. Turned off by Restore Mode Defaults.
State Saved	No
Initial S/W Revision	A.04.00

More Information

The analyzer is characterized in the factory (or during a field calibration) with a model of the noise, referred to the input mixer, versus frequency in each band and path combination. Bands are 0 (low band) and 1 through 4 (high band) in a 26.5 GHz instrument, for example. Paths include normal paths, preamp paths, the electronic attenuator, etc.

In most band/path combinations, the noise can be well characterized based on just two parameters and the analyzer frequency response before compensation for frequency-dependent losses.

After the noise density at the input mixer is estimated, the effects of the input attenuator, RBW, detector, etc. are computed to get the estimated input-port-referred noise level.

In the simplest case, the measured power (signal plus analyzer noise) in each display point (bucket) is compensated by subtracting the estimated noise power, leaving just the signal power. This is the operation when the detector is Average and the Average Type is set to Power.

In other cases, operation is often not quite as good but still highly effective. With peak detection, the noise floor is estimated based on the RBW and the duration of the bucket using the same equations used in the noise marker function. The voltage of the noise is subtracted from the voltage of the observed signal-plus-noise measurement to compute the estimated signal voltage. The peak detector is one example of processing that varies with detector to give good estimates of the signal level without the analyzer noise.

For best operation, the average detector and the power scale are recommended, as already stated. Peak detection for pulsed-RF can still give excellent effectiveness. FFT analysis does not work well, and does not do NFE well, with pulsed-RF signals, so this combination is not recommended. Negative peak detection is not very useful, either. Sample detection works well, but is never better than the average detector

because it doesn't smooth as well. The Normal detector is a combination of peak and negative peak behaviors, and works about as well as these.

For best operation, extreme smoothing is desirable, as already stated. Using narrow VBWs works well, but using very long bucket durations and the average detector works best. Reducing the number of trace points will make the buckets longer.

For best operation, the power scale (Average Type = Power) is optimum. When making CW measurements in the presence of noise without NFE, averaging on the decibel scale has the advantage of reducing the effect of noise. When using NFE, the NFE does an even better job than using the log scale ever could. Using NFE with the log scale is not synergistic, though; NFE with the power scale works a little better than NFE with log averaging type.

The results from NFE with internal preamp can often be lower than the theoretical noise in a signal source at room temperature, a noise density of -174 dBm/Hz. This is expected and useful behavior, because NFE is designed to report the amount of input signal that is in excess of the thermal noise, not the amount that includes the thermal noise. This can be a useful behavior because thermal noise often interferes with what you want to measure, instead of being part of what you want to measure. Note that NFE is not adequately accurate to always be able to read below kTB.

On instruments with the NF2 license installed, the calibrated Noise Floor used by Noise Floor Extensions should be refreshed periodically. Agilent recommends that the Characterize Noise Floor operation be performed after the first 500 hours of operation, and once every calendar year. The key to perform this is located in the System, Alignments, Advanced menu. If you have not done this yourself at the recommended interval, then when you turn on Noise Floor Extensions, the analyzer will prompt you to do so with a dialog that says:

"This action will take several minutes to perform. Please disconnect all cables from the RF input and press Enter to proceed. Press ESC to cancel, or Postpone to postpone for a week."

If you Cancel, you will be prompted again the next time you turn NFE on. If you postpone, you will be prompted again after a week passes and you then turn NFE on.

Restore Mode Defaults

Resets the state for the currently active mode by resetting the mode persistent settings to their factory default values, clearing mode data and by performing a Mode Preset. This function will never cause a mode switch. This function performs a full preset for the currently active mode; whereas, Mode Preset performs a partial preset. Restore Mode Defaults does not affect any system settings. System settings are reset by the Restore System Defaults function. This function does reset mode data; as well as settings.

Key Path	Mode Setup
Remote Command	:INSTrument:DEFault
Example	:INST:DEF
Notes	Clears all pending OPC bits. The Status Byte is set to 0. A message comes up saying: "If you are sure, press key again".
Couplings	A Restore Mode Defaults will cause the currently running measurement to be aborted and causes the default measurement to be active. It gets the mode to a consistent state with all of the default couplings set.
Initial S/W Revision	Prior to A.02.00

Preset Type (Remote Command Only)

As stated in the Backward Compatibility section, to be compatible with ESA/PSA the PRESet:TYPE command will be implemented as a no-op.

Mode	All
Remote Command	:SYSTem:PRESet:TYPE FACTory MODE USER :SYSTem:PRESet:TYPE?
Example	:SYST:PRES:TYPE FACT
Notes	This command is supported for backward compatibility only. It is a no-op which does not change the behavior of any preset operation.
Preset	This is unaffected by Preset but is set to Mode on a "Restore System Defaults->All"
State Saved	No
Initial S/W Revision	Prior to A.02.00

6 System Functions

File

Opens a menu that enables you to access various standard and custom Windows functions. Press any other front-panel key to exit

Key Path	Front-panel key
Initial S/W Revision	Prior to A.02.00

File Explorer

Opens the standard Windows File Explorer. The File Explorer opens in the My Documents directory for the current user.

The File Explorer is a separate Windows application, so to return to the analyzer once you are in the File Explorer, you may either:

Exit the File Explorer by clicking on the red X in the upper right corner, with a mouse

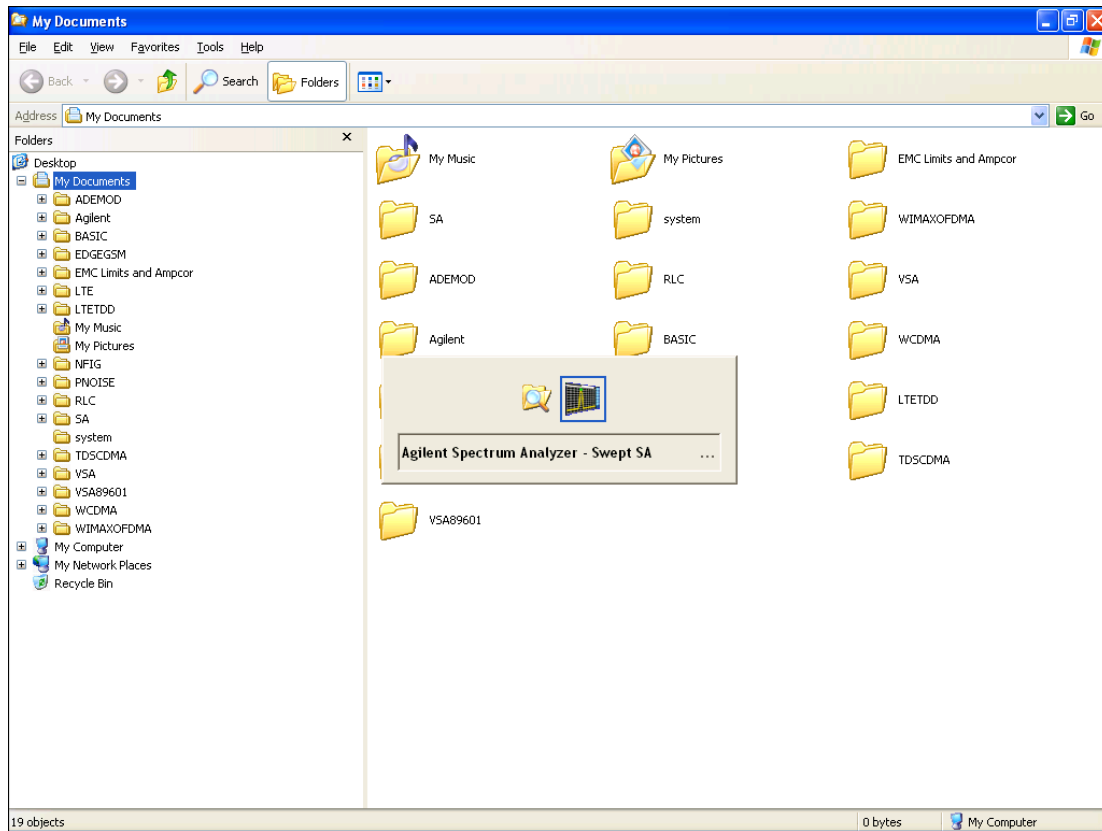

Or use Alt-Tab: press and hold the Alt key and press and release the Tab key until the Analyzer logo is showing in the window in the center of the screen, as shown above, then release the Alt key.

The ability to access File Explorer is not available if Option SF1 is installed.

Key Path	File
Initial S/W Revision	Prior to A.02.00

Page Setup

The Page Setup key brings up a Windows Page Setup dialog that allows you to control aspects of the pages sent to the printer when the PRINT hardkey is pressed.

Key Path	File
Initial S/W Revision	Prior to A.02.00

Paper size, the printer paper source, the page orientation and the margins are all settable. Just like any standard Windows dialog, you may navigate the dialog using the front-panel keys, or a mouse. There are no SCPI commands for controlling these parameters.

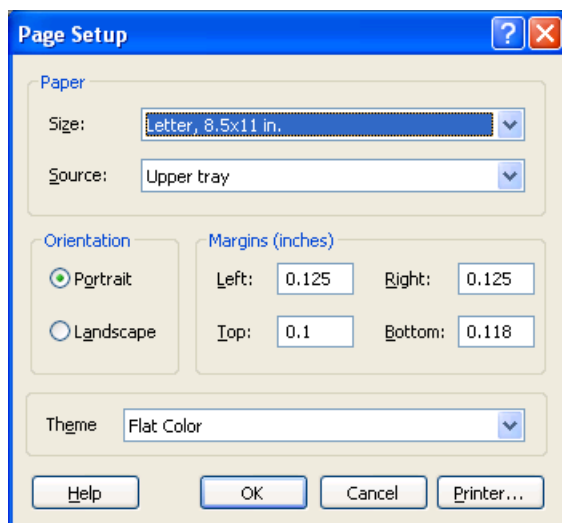

Also contained in this dialog is a drop-down control that lets you select the Theme to use when printing. For more on Themes, see information under View/Display, Display, System Display Settings, Theme. The Theme control has a corresponding SCPI command.

Parameter Name	Print Themes
Parameter Type	Enum
Mode	All
Remote Command	:SYSTem:PRINt:THEME TDCoLor TDMonochrome FCOLor FMONochrome :SYSTem:PRINt:THEME?
Example	:SYST:PRIN:THEM FCOL
Setup	:SYSTem:DEFault MISC
Preset	FCOL; not part of Preset, but is reset by Restore Misc Defaults or Restore System Defaults All and

	survives subsequent running of the modes.
State Saved	No
Initial S/W Revision	Prior to A.02.00

Print

This front-panel key is equivalent to performing a File, Print, OK. It immediately performs the currently configured Print to the Default printer.

The :HCOPY command is equivalent to pressing the PRINT key. The HCOpy:ABORt command can be used to abort a print which is already in progress. Sending HCOpy:ABORt will cause the analyzer to stop sending data to the printer, although the printer may continue or even complete the print, depending on how much data was sent to the printer before the user sent the ABORt command.

Key Path	Front-panel key
Remote Command	:HCOPY[:IMMEDIATE]
Initial S/W Revision	Prior to A.02.00

Key Path	SCPI command only
Remote Command	:HCOPY:ABORt
Initial S/W Revision	Prior to A.02.00

Minimize

The Minimize key causes the analyzer display to disappear down into the task bar, allowing you to see the Windows Desktop. You can use Alt-Tab (press and hold the Alt  key and press and release the Tab key) to restore the analyzer display.

Key Path	File
Mode	All
Notes	No equivalent remote command for this key.
State Saved	No
Initial S/W Revision	A.05.01

Exit

This key, when pressed, will exit the Instrument Application. A dialog box is used to confirm that you intended to exit the application:

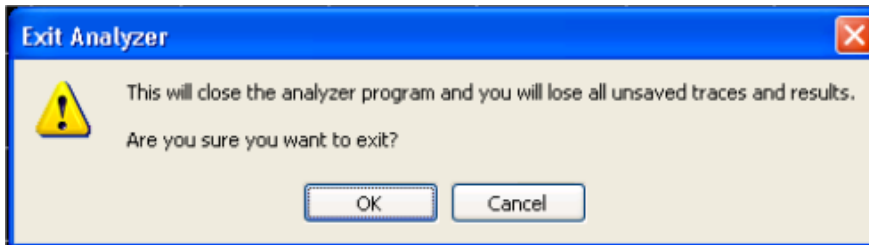

Key Path	File
Mode	All
Notes	The Instrument Application will close. No further SCPI commands can be sent. Use with caution!
Initial S/W Revision	Prior to A.02.00

Maximize/Restore Down

These keys allow the Instrument Application to be maximized and then restored to its prior state. Only one of the two keys is visible at a time. When not already maximized the Maximize Application key is visible, and when maximized, the Restore Down Application key is visible and replaces the Maximize Application key.

Maximize

This key allows you to Maximize the Instrument Application, which causes the analyzer display to fill the screen. Once the application is maximized, this key is replaced by the Restore Down key.

Key Path	File
Mode	All
Notes	No equivalent remote command for this key.
State Saved	No
Initial S/W Revision	A.05.01

Restore Down

This key allows you to Restore Down the Instrument Application and reverses the action taken by Maximize. This key is only visible when the application has been maximized, and after the Restore Down action has been completed this key is replaced by the Maximize key.

Key Path	File
Mode	All
Notes	No equivalent remote command for this key.
State Saved	No
Initial S/W Revision	A.05.01

Print

This front-panel key is equivalent to performing a File, Print, OK. It immediately performs the currently configured Print to the Default printer.

The :HCOPY command is equivalent to pressing the PRINT key. The HCOPY:ABORT command can be used to abort a print which is already in progress. Sending HCOPY:ABORT will cause the analyzer to stop sending data to the printer, although the printer may continue or even complete the print, depending on how much data was sent to the printer before the user sent the ABORT command.

Key Path	Front-panel key
Remote Command	:HCOPY[:IMMEDIATE]
Initial S/W Revision	Prior to A.02.00

Key Path	SCPI command only
Remote Command	:HCOPY:ABORT
Initial S/W Revision	Prior to A.02.00

System

Opens a menu of keys that access various configuration menus and dialogs.

Key Path	Front-panel key
Notes	No remote command for this key specifically.
Initial S/W Revision	Prior to A.02.00

Show

Accesses a menu of choices that enable you to select the information window you want to view.

Key Path	System
Mode	All
Remote Command	:SYSTem:SHOW OFF ERRor SYSTem HARDware LXI HWSTatistics ALIGNment SOFTware CAPPllication :SYSTem:SHOW?
Example	:SYST:SHOW SYST
Notes	This command displays (or exits) the various System information screens.
Preset	OFF
State Saved	No
Range	OFF ERRor SYSTem HARDware LXI HWSTatistics ALIGNment SOFTware CAPPllication
Initial S/W Revision	Prior to A.02.00

Errors

There are two modes for the Errors selection, History and Status.

The list of errors displayed in the Errors screen does not automatically refresh. You must press the Refresh key or leave the screen and return to it to refresh it.

History brings up a screen displaying the event log in chronological order, with the newest event at the top. The history queue can hold up to 100 messages (if a message has a repeat count greater than 1 it only counts once against this number of 100). Note that this count bears no relation to the size of the SCPI queue. If the queue extends onto a second page, a scroll bar appears to allow scrolling with a mouse. Time is displayed to the second.

Status brings up a screen summarizing the status conditions currently in effect. Note that the time is displayed to the second.

The fields on the Errors display are:

Type (unlabeled) - Displays the icon identifying the event or condition as an error or warning.

ID - Displays the error number.

Message - Displays the message text.

Repeat (RPT) - This field shows the number of consecutive instances of the event, uninterrupted by other events. If an event occurs 5 times with no other intervening event, the value of repeat will be 5.

If the value of Repeat is 1 the field does not display. If the value of Repeat is >1, the time and date shown are those of the most recent occurrence. If the value of repeat reaches 999,999 it stops there.

Time - Shows the most recent time (including the date) at which the event occurred.

Key Path	System, Show
Mode	All
Remote Command	:SYSTem:ERRor[:NEXT]?
Example	:SYST:ERR?
Notes	The return string has the format: “<Error Number>,<Error>” Where <Error Number> and <Error> are those shown on the Show Errors screen
Backwards Compatibility Notes	In some legacy analyzers, the Repeat field shows the number of times the message has repeated since the last time the error queue was cleared. In the X-Series, the Repeat field shows the number of times the error has repeated since the last intervening error. So the count may very well be different than in the past even for identical signal conditions Unlike previous analyzers, in the X-Series all errors are reported through the Message or Status lines and are logged to the event queue. They never appear as text in the graticule area (as they sometimes do in previous analyzers) and they are never displayed in the settings panel at the top of the screen (as they sometimes do, by changing color, in previous analyzers). As a consequence of the above, the user can only see one status condition (the most recently generated) without looking at the queue. In the past, at least in the Spectrum Analyzer, multiple status conditions might display on the right side of the graticule. In general, there is no backwards compatibility specified or guaranteed between the error numbers in the X-Series and those of earlier products. Error, event, and status processing code in customers' software will probably need to be rewritten to work with X-Series. In the legacy analyzers, some conditions report as errors and others simply turn on status bits. Conditions that report as errors often report over and over as long as the condition exists. In the X-series, all conditions report as start and stop events. Consequently, software that repeatedly queries for a condition error until it stops reporting will have to be rewritten for the X-series.
Initial S/W Revision	Prior to A.02.00

Previous Page

See ["Next Page" on page 355.](#)

Key Path	System, Show, Errors
Initial S/W Revision	Prior to A.02.00

Next Page

Next Page and Previous Page menu keys move you between pages of the log, if it fills more than one page. These keys are grayed out in some cases:

- If on the last page of the log, the Next Page key is grayed-out
- If on the first page of the log, the Previous Page key is grayed-out.
- If there is only one page, both keys are grayed out.

Key Path	System, Show, Errors
Initial S/W Revision	Prior to A.02.00

History

The History and Status keys select the Errors view. The Status key has a second line that shows a number in [square brackets]. This is the number of currently open status items.

Key Path	System, Show, Errors
Initial S/W Revision	Prior to A.02.00

Verbose SCPI On/Off

When you turn Verbose SCPI on, additional information is returned when you send the :SYSTem:ERRor? query. The additional information consists of the characters that stimulated the error. This can aid you in debugging your test programs by indicating where in the parsing of a SCPI command the instrument encountered an invalid command or query.

Specifically, with Verbose SCPI on, the SYSTem:ERRor? query is expanded to show the SCPI data received, with the indicator <Err> at the point in the stream that the error occurred.

Verbose SCPI has no effect on the Show Errors screen or front panel Message Line; it only changes the response to the :SYST:ERR? query.

See the example below, where the invalid command "SENS:BOGUS" is sent:

Normal response to :SYST:ERR (using the Telnet window):

```
SCPI> SENS:BOGUS
```

```
SCPI> SYST:ERR?
```

```
-113,"Undefined header"
```

Now after turning on Verbose SCPI:

```
SCPI> SYST:BOGUS
```

```
SCPI> SYST:ERR?
```

```
-113,"Undefined header;SYST:BOGUS<Err>"
```

Key Path	System, Show, Errors
Mode	All
Remote Command	:SYSTem:ERRor:VERBose OFF ON 0 1 :SYSTem:ERRor:VERBose?
Example	:SYST:ERR:VERB ON
Preset	This is unaffected by Preset but is set to OFF on a "Restore System Defaults->Misc"
State Saved	No
Range	On Off
Initial S/W Revision	Prior to A.02.00

Refresh

When pressed, refreshes the Show Errors display.

Key Path	System, Show, Errors
Initial S/W Revision	Prior to A.02.00

Clear Error Queue

This clears all errors in all error queues.

Note the following:

- Clear Error Queue does not affect the current status conditions.
- Mode Preset does not clear the error queue.
- Restore System Defaults will clear all error queues.
- *CLS only clears the queue if it is sent remotely and *RST does not affect any error queue.
- Switching modes does not affect any error queues.

Key Path	System, Show, Errors
Initial S/W Revision	Prior to A.02.00

Status

See "[History](#)" on page 355.

Input Overload Enable (Remote Command Only)

Input Overload errors are reported using the Input Overload status bit (bit 12 in the Measurement Integrity status register). Input Overloads (for example, ADC Overload errors) can come and go with great frequency, generating many error events (for example, for signals just on the verge of overload), and so are

not put into the SCPI error queue by default. Normally the status bit is the only way for detecting these errors remotely.

It is possible to enable Input Overload reporting to the SCPI queue, by issuing the :SYSTEM:ERROR:OVERload ON command. To return to the default state, issue the :SYSTEM:ERROR:OVERload OFF command. In either case, Input Overloads always set the status bit.

NOTE For versions of firmware before A.10.01, the Input Overload was only a Warning and so was never available in the SCPI queue, although it did set the status bit. For A.10.01 and later, the Input Overload is an error and can be enabled to the SCPI queue using this command.

Key Path	SCPI only
Remote Command	:SYSTEM:ERROR:OVERload[:STATe] 0 1 OFF ON
Example	:SYST:ERR:OVER 1 Enable overload errors
Preset	Set to OFF by Restore Misc Defaults (no Overload errors go to SCPI)
State Saved	Saved in instrument state.
Initial S/W Revision	A.10.01

System

The System screen is formatted into three groupings: product descriptive information, options tied to the hardware, and software products:

```

<Product Name> <Product Description>
Product Number: N9020A
Serial Number: US46220924
Firmware Revision: A.01.01
Computer Name: <hostname>
Host ID: N9020A,US44220924

N9020A-503      Frequency Range to 3.6 GHz
N9020A-PFR     Precision Frequency Reference
N9020A-P03     Preamp 3.6 GHz

N9060A-2FP     Spectrum Analysis Measurement Suite  1.0.0.0
N9073A-1FP     WCDMA 1.0.0.0
N9073A-2FP     WCDMA with HSDPA 1.0.0.0
  
```

The Previous Page is grayed-out if the first page of information is presently displayed. The Next Page menu key is grayed-out if the last page is information is presently displayed.

Key Path	System, Show
----------	--------------

Mode	All
Example	SYST:SHOW SYST
Backwards Compatibility Notes	The hardware statistics that are displayed in the PSA Show System screen have been moved to a dedicated Show Hardware Statistics screen in the Service Menu.
Initial S/W Revision	Prior to A.02.00

Show System contents (Remote Command Only)

A remote command is available to obtain the contents of the Show System screen (the entire contents, not just the currently displayed page).

Remote Command	:SYSTem:CONFigure [:SYSTem] ?
Example	:SYST:CONF?
Notes	The output is an IEEE Block format of the Show System contents. Each line is separated with a new-line character.
Initial S/W Revision	Prior to A.02.00

Computer System description (Remote Command Only)

A remote command is available to obtain the Computer System description. The Computer System is the operating system and patch level as reported by operating system.

Remote Command	:SYSTem:CSYSem?
Example	:SYST:CSYS?
Notes	The return value is the Computer System name and service pack level.
Initial S/W Revision	Prior to A.12.00

Hardware

The show hardware screen is used to view details of the installed hardware. This information can be used to determine versions of hardware assemblies and field programmable devices, in the advent of future upgrades or potential repair needs.

The screen is formatted into two groupings: product descriptive information and hardware information. The hardware information is listed in a table format:

Hardware Information							
MXA Signal Analyzer Product Number: N9020A Serial Number: US46220107 Firmware Revision: A.01.14							
Assembly Name	Part #	Serial #	Matl Rev	Rev	OF Rev	Hw Id	Misc
Analog IF	E441060104	78060200131	003	0	C	15	
YIG Tuned Filter	50877305	11061500550	005	0	A	11	
Digital IF	E441060105	78060100559	003	0	F	14	
Front End Controller	E441060101	78060100147	004	2	A	8	
Low Band Switch	E441060170	78060800346	005	1	A	10	
LO Synthesizer	E441060102	78060100226	003	3	G	2	
Reference	E441060108	78060300420	004	1	C	16	
Front End	E441060154	13062800820	010	2	B	9	

The Previous Page is grayed-out if the first page of information is presently displayed. The Next Page menu key is grayed-out if the last page is information is presently displayed.

Key Path	System, Show
Mode	All
Example	SYST:SHOW HARD
Initial S/W Revision	Prior to A.02.00

LXI

This key shows you the product number, serial number, firmware revision, computer name, IP address, Host ID, LXI Class, LXI Version, MAC Address, and the Auto-MDIX Capability.

Key Path	System, Show
Initial S/W Revision	Prior to A.02.00

Power On

Enables you to select how the instrument should power on. The options are: Mode and Input/Output Defaults, User Preset and Last State.

Key Path	System
Mode	All
Remote Command	:SYSTem:PON:TYPE MODE USER LAST :SYSTem:PON:TYPE?
Example	:SYST:PON:TYPE MODE
Preset	This is unaffected by a Preset but is set to Mode on a “Restore System Defaults->All”
State Saved	No
Backwards Compatibility SCPI	:SYSTem:PON:TYPE PRESet the “PRESet” parameter is supported for backward compatibility only and behaves the same as MODE.
Backwards Compatibility Notes	The Preset Type key in legacy analyzers has been removed, and the Power On toggle key has been replaced by this 1-of-N key in the System menu.
Initial S/W Revision	Prior to A.02.00

Mode and Input/Output Defaults

When the analyzer is powered on in Mode and Input/Output Defaults, it performs a Restore Mode Defaults to all modes in the instrument and also performs a Restore Input/Output Defaults.

Persistent parameters (such as Amplitude Correction tables or Limit tables) are not affected at power on, even though they are normally cleared by Restore Input/Output Defaults and/or Restore Mode Defaults.

Key Path	System, Power On
Mode	All
Example	SYST:PON:TYPE MODE
Readback Text	Defaults
Initial S/W Revision	Prior to A.02.00

User Preset

Sets Power On to User Preset. When the analyzer is powered on in User Preset, it will User Preset each mode and switch to the power-on mode. Power On User Preset will not affect any settings beyond what a normal User Preset affects.

NOTE

An instrument could never power up for the first time in User Preset.

Key Path	System, Power On
Mode	All
Example	SYST:PON:TYPE USER
Readback Text	User Preset

Backwards Compatibility Notes	Power On User Preset will cause the instrument to power up in the power-on mode, not the last mode the instrument was in prior to shut down. Also, Power On User Preset will User Preset all modes. This does not exactly match legacy behavior.
Initial S/W Revision	Prior to A.02.00

Last State

Sets Power On to **Last**. When the analyzer is powered on, it will put all modes in the last state they were in prior to when the analyzer was put into Power Standby and it will wake up in the mode it was last in prior to powering off the instrument. The saving of the active mode prior to shutdown happens behind the scenes when a controlled shutdown is requested by using the front panel power Standby key or by using the remote command SYSTem:PDOWn. The non-active modes are saved as they are deactivated and recalled by Power On Last State.

NOTE

An instrument can never power up for the first time in Last.

If line power to the analyzer is interrupted, for example by pulling the line cord plug or by switching off power to a test rack, Power On Last State may not work properly. For proper operation, Power On Last State depends on you shutting down the instrument using the Standby key or the SYSTem:PDOWn SCPI command. This will ensure the last state of each mode is saved and can be recalled during a power up.

Key Path	System, Power On
Mode	All
Example	SYST:PON:TYPE LAST
Notes	Power on Last State only works if you have done a controlled shutdown prior to powering on in Last. If a controlled shutdown is not done when in Power On Last State, the instrument will power up in the last active mode, but it may not power up in the active mode's last state. If an invalid mode state is detected, a Mode Preset will occur. To control the shutdown under remote control use the :SYSTem:PDOWn command.
Readback Text	Last State
Backwards Compatibility Notes	It is no longer possible to power-up the analyzer in the last mode the analyzer was running with that mode in the preset state. (ESA/PSA SYST:PRESET:TYPE MODE with SYST:PON:PRESET) You can power-on the analyzer in the last mode the instrument was running in its last state (SYST:PON:TYPE LAST), or you can specify the mode to power-up in its preset state (SYST:PON:MODE <mode>).
Initial S/W Revision	Prior to A.02.00

Power On Application

Accesses a menu that lists the available Modes and lets you select which Mode is to be the power-on application.

This application is used for Power On Type "Mode and Input/Output Defaults" and Restore System Defaults All.

Key Path	System, Power On
Mode	All
Remote Command	:SYSTem:PON:MODE SA BASIC ADEMOM NFIGURE PNOISE CDMA2K TDSCDMA VSA VSA89601 WCDMA WIMAXOFDMA :SYSTem:PON:MODE?
Example	SYST:PON:MODE SA
Notes	The list of possible modes (and remote parameters) to choose from is dependent on which modes are installed in the instrument.
Preset	This is unaffected by a Preset but is set on a "Restore System Defaults->All" to: For N9038A: EMI For all other models: SA
State Saved	No
Initial S/W Revision	Prior to A.02.00

Configure Applications

The Configure Applications utility can be used to:

- select applications for preload
- determine how many applications can fit in memory at one time
- specify the order of the Modes in the Mode menu.

This utility consists of a window with instructions, a set of "Select Application" checkboxes, a "fuel bar" style memory gauge, and keys that help you set up your configuration.

For more information, see the following topics:

["Preloading Applications" on page 363](#)

["Access to Configure Applications utility" on page 363](#)

["Virtual memory usage" on page 363](#)

Key Path	System, Power On
Example	:SYST:SHOW CAPP Displays the Config Applications screen
Initial S/W Revision	A.02.00

Preloading Applications

During runtime, if a Mode that is not preloaded is selected using the Mode menu or sending SCPI commands, there will be a pause while the Application is loaded. During this pause a message that says “Loading application, please wait ...” is displayed. Once loaded, the application stays loaded, so the next time you select it during a session, there is no delay.

Preloading enables you to “preload” at startup, to eliminate the runtime delay. Preloading an application will cause it to be loaded into the analyzer’s memory when the analyzer program starts up. If you do this, the delay will increase the time it takes to start up the analyzer program, but this may be preferable to having to wait the first time you select an application. Note that, once an application is loaded into memory, it cannot be unloaded without exiting and restarting the analyzer program.

Note that there are more applications available for the X-Series than can fit into Windows Virtual Memory. By allowing you to choose which licensed applications to load at startup, the Configure Applications utility allows you to make optimal use of your memory.

Access to Configure Applications utility

A version of the utility runs the first time you power up the analyzer after purchasing it from Keysight. The utility automatically configures preloads so that as many licensed applications as possible are preloaded while keeping the total estimated virtual memory usage below the limit. This auto-configuration only takes place at the very first run, and after analyzer software upgrades.

You may, at any time, manually call up the Configure Applications utility by pressing System, Power On, Configure Applications, to find a configuration that works best for you, and then restart the analyzer program.

The utility may also be called if, during operation of the analyzer, you attempt to load more applications than can fit in memory at once.

Virtual memory usage

There are more applications available for the X-Series than can fit into memory at any one time, so the Configure Applications utility includes a memory tracker that serves two purposes:

1. It will not let you preload more applications than will fit into memory at once.
2. You can determine how many of your favorite applications can reside in memory at one time.

The utility provides a graphical representation of the amount of memory (note that the memory in question here is Virtual memory and is a limitation imposed by the operating system, not by the amount of physical memory you have in your analyzer). You select applications to preload by checking the boxes on the left. Checked applications preload at startup. The colored fuel bar indicates the total memory required when all the checked applications are loaded (either preloaded or selected during runtime).

Here is what the fuel bar colors mean:

RED: the applications you have selected cannot all fit into the analyzer’s memory. You must deselect applications until the fuel bar turns yellow.

YELLOW: the applications you have selected can all fit into the analyzer’s memory, but there is less than 10% of the memory left, probably not enough to load any other applications, either via preload or by selecting a Mode while the analyzer is running..

GREEN: The indicator is green when <90% of the memory limit is consumed. This means the applications you have selected can all fit into the analyzer's memory with room to spare. You will likely be able to load one or more other applications without running out of memory.

Select All

Marks all applications in the selection list. This allows you to enable all applications licensed on the instrument for pre-loading, or is a convenience for selecting all applications in one operation and then letting you deselect individual applications.

Key Path	System, Power On, Configure Applications
Initial S/W Revision	A.02.00

Deselect All

Clears the marks from all applications in the selection list, except the Power On application. The Power On application cannot be eliminated from the pre-load list.

Key Path	System, Power On, Configure Applications
Initial S/W Revision	A.02.00

Move Up

The application list is the order that applications appear in the Mode Menu. This key enables you to shift the selected application up in the list, thus moving the selected application earlier in the Mode Menu.

Key Path	System, Power On, Configure Applications
Initial S/W Revision	A.02.00

Move Down

The application list is the order that applications appear in the Mode Menu. This key enables you to shift the selected application down in the list, thus moving the selected application later in the Mode Menu.

Key Path	System, Power On, Configure Applications
Initial S/W Revision	A.02.00

Select/Deselect

Toggles the currently highlighted application in the list.

Key Path	System, Power On, Configure Applications
Initial S/W Revision	A.02.00

Save Changes and Exit

Applies the configuration of the applications list. The marked applications will be pre-loaded in memory the next time the instrument application is started, and the order of the applications in the list will be the order of the applications in the Mode Menu.

After saving your changes, the analyzer asks you if you would like it to restart so that your changes can take effect (see dialog box, below). If you choose not to restart, the changes will not take effect until the next time you shut down and restart the analyzer.

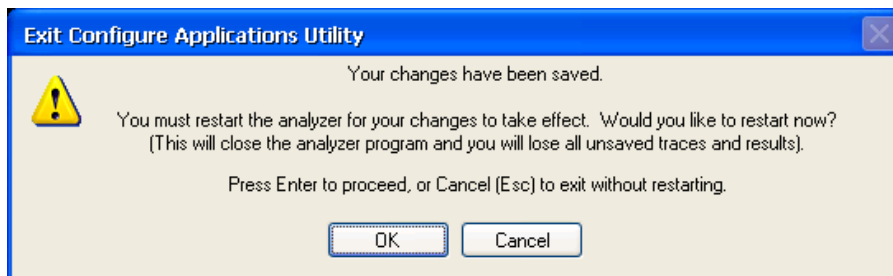

Key Path	System, Power On, Configure Applications
Remote Command	:SYSTem:PUP:PROcess
Example	:SYST:PUP:PROC This is the SCPI command for restarting the analyzer. You must Wait after this command for the instrument application to restart
Notes	The softkey will be grayed-out when the virtual memory of the selected applications exceeds 100% of the limit.
Notes	You cannot use *WAI or *OPC? to synchronize operation after a restart. This command stops and restarts the instrument application, thus the SCPI operation is terminated and restarted. A remote program must use fixed wait time to resume sending commands to the instrument. The wait time will be dependent upon which applications are pre-loaded.
Initial S/W Revision	A.02.00
Modified at S/W Revision	A.04.00

Exit Without Saving

Pressing this key will exit the Configure Applications utility without saving your changes.

Key Path	System, Power On, Configure Applications
Initial S/W Revision	A.02.00
Modified at S/W Revision	A.04.00

Restore Power On Defaults

This selection causes the Power On Type and Power On Application settings to be a reset to their default values. This level of Restore System Defaults does not affect any other system settings, mode settings and

does not cause a mode switch. The Power On key, under the Restore System Defaults menu, causes the same action.

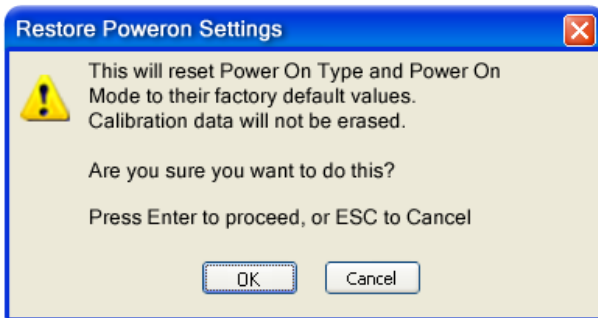

If you press any key other than OK or Enter, it is construed as a Cancel, because the only path that will actually cause the reset to be executed is through OK or Enter.

Key Path	System, Power On
Example	:SYST:DEF PON
Initial S/W Revision	Prior to A.02.00

Configure Applications - Instrument boot-up

At start-up of the analyzer program a dialog box similar to the one under the System, Power On, Configure Applications key will be displayed allowing you to choose which licensed applications are to be loaded. This dialog will only be displayed if the memory required to pre-load all of the licensed applications exceeds the Virtual Memory available.

Configure Applications - Windows desktop

The Configure Applications Utility may be run from the Windows Desktop. The utility is launched by double-



clicking the icon on the desktop, which brings-up a dialog box similar to the one under the System, Power On, Configure Applications key, allowing you to choose which licensed applications are to be loaded when the analyzer program starts up. This dialog box has mouse buttons on it that do the job the softkeys normally do in the System, Power On, Configure Applications menu.

Configure Applications - Remote Commands

The following topics provide details on using remote commands to configure the list of applications you want to load into the instrument memory or query the Virtual Memory utilization for your applications.

- "Configuration list (Remote Command Only)" on page 367
- "Configuration Memory Available (Remote Command Only)" on page 367
- "Configuration Memory Total (Remote Command Only)" on page 367
- "Configuration Memory Used (Remote Command Only)" on page 367

- "Configuration Application Memory (Remote Command Only)" on page 368

Configuration list (Remote Command Only)

This remote command is used to set or query the list of applications to be loaded in-memory.

Remote Command	:SYSTem:PON:APPLication:LLISt <string of INSTRument:SElect names> :SYSTem:PON:APPLication:LLISt?
Example	:SYST:PON:APPL:LLIS "SA,BASIC,WCDMA"
Notes	<string of INSTRument:SElect names> are from the enums of the :INSTRument:SElect command. The order of the <INSTRument:SElect names> is the order that the applications are loaded into memory, and the order that they appear in the Mode Menu. Error message -225 "Out of Memory" is reported when more applications are listed than can reside in Virtual Memory. When this occurs, the existing applications load list is unchanged.
Preset	Not affected by Preset
State Saved	Not saved in instrument state
Initial S/W Revision	A.02.00

Configuration Memory Available (Remote Command Only)

This remote command is used to query the amount of Virtual Memory remaining.

Remote Command	:SYSTem:PON:APPLication:VMEMory[:AVAIlable]?
Example	:SYST:PON:APPL:VMEM?
Preset	Not affected by Preset
Initial S/W Revision	A.02.00

Configuration Memory Total (Remote Command Only)

This remote command is used to query the limit of Virtual Memory allowed for applications.

Remote Command	:SYSTem:PON:APPLication:VMEMory:TOTal?
Example	:SYST:PON:APPL:VMEM:TOT?
Preset	Not affected by Preset
Initial S/W Revision	A.02.00

Configuration Memory Used (Remote Command Only)

This remote command is a query of the amount of Virtual Memory used by all measurement applications.

Remote Command	:SYSTem:PON:APPLication:VMEMory:USED?
Example	:SYST:PON:APPL:VMEM:USED?

Preset	Not affected by Preset
Initial S/W Revision	A.02.00

Configuration Application Memory (Remote Command Only)

This remote command is used to query the amount of Virtual Memory a particular application consumes.

Remote Command	:SYSTem:PON:APPLication:VMEMory:USED:NAME? <INSTrument:SElect name>
Example	:SYST:PON:APPL:VMEM:USED:NAME? CDMA2K
Notes	<INSTrument:SElect name> is from the enums of the :INSTrument:SElect command Value returned will be 0 (zero) if the name provided is invalid.
Preset	Not affected by Preset
Initial S/W Revision	Prior to A.02.00

Alignments

The Alignments Menu controls and displays the automatic alignment of the instrument, and provides the ability to restore the default alignment values.

The current setting of the alignment system is displayed in the system Settings Panel along the top of the display, including a warning icon for conditions that may cause specifications to be impacted.



Key Path	System
Initial S/W Revision	Prior to A.02.00

Auto Align

Configures the method for which the automatic background alignment is run.

Automatic background alignments are run periodically between measurement acquisitions. The instrument's software determines when alignments are to be performed to maintain warranted operation. The recommended setting for Auto Align is Normal.

An Auto Align execution cannot be aborted with the Cancel (ESC) key. To interrupt an Auto Align execution, select Auto Align Off.

Key Path	System, Alignments
Mode	All
Remote Command	:CALibration:AUTO ON PARTial OFF :CALibration:AUTO?
Example	:CAL:AUTO ON

Notes	While Auto Align is executing, bit 0 of Status Operation register is set.
Couplings	Auto Align is set to Off if Restore Align Data is invoked.
Preset	This is unaffected by Preset but is set to ON upon a “Restore System Defaults->Align”.
State Saved	No
Status Bits/OPC dependencies	When Auto Align is executing, bit 0 in the Status Operational register is set.
Backwards Compatibility SCPI	:CALibration:AUTO ALERT Parameter ALERT is for backward compatibility only and is mapped to PARTIAL
Backwards Compatibility Notes	<ol style="list-style-type: none"> 1. ESA SCPI for Auto Align is :CALibration:AUTO <Boolean>. The command for X-Series is an enumeration. Thus the parameters of “0” and “1” are not possible in X-Series. 2. Similarly, the ESA SCPI for :CALibration:AUTO? returned the Boolean value 1 or 0, in X-Series it is an Enumeration (string). Thus, queries by customer applications into numeric variables will result in an error 3. In PSA Auto Align OFF was not completely off, it is equivalent to PARTIAL in X-Series. In X-Series, OFF will be fully OFF. This means users of PSA SCPI who choose OFF may see degraded performance and should migrate their software to use PARTIAL.
Initial S/W Revision	Prior to A.02.00

Normal

Auto Align, Normal turns on the automatic alignment of all measurement systems. The Auto Align, Normal selection maintains the instrument in warranted operation across varying temperature and over time.

If the condition “Align Now, All required” is set, transition to Auto Align, Normal will perform the required alignments and clear the “Align Now, All required” condition and then continue with further alignments as required to maintain the instrument adequately aligned for warranted operation.

When Auto Align, Normal is selected the Auto Align Off time is set to zero.

When Auto Align, Normal is selected the Settings Panel indicates ALIGN AUTO.

Key Path	System, Alignments, Auto Align
Mode	All
Example	:CAL:AUTO ON
Notes	<p>Alignment processing as a result of the transition to Normal will be executed sequentially. Thus, *OPC? or *WAI following CAL:AUTO ON will return when the alignment processing is complete.</p> <p>The presence of an external signal may interfere with the RF portion of the alignment. If so, the Error Condition message “Align skipped: 50 MHz interference” or “Align skipped: 4.8 GHz interference” is reported, and bit 11 is set in the Status Questionable Calibration register. After the interfering signal is removed, subsequent alignment of the RF will clear the condition, and clear bit 11 in the Status Questionable Calibration register.</p>
Readback Text	Normal
Status Bits/OPC dependencies	An interfering user signal may prevent automatic alignment of the RF subsystem. If this occurs, the Error Condition message “Align skipped: 50 MHz interference” or “Align skipped: 4.8 GHz

interference” is reported, the Status Questionable Calibration bit 11 is set, and the alignment proceeds. When a subsequent alignment of the RF subsystem succeeds, either by the next cycle of automatic alignment or from an Align Now, RF, the Error Condition and Status Questionable Calibration bit 11 are cleared.

Initial S/W Revision	Prior to A.02.00
----------------------	------------------

Partial

Auto Align, Partial disables the full automatic alignment and the maintenance of warranted operation for the benefit of improved measurement throughput. Accuracy is retained for the Resolution Bandwidth filters and the IF Passband, which is critical to FFT accuracy, demodulation, and many measurement applications. With Auto Align set to Partial, you are now responsible for maintaining warranted operation by updating the alignments when they expire. The Auto Align, Alert mechanism will notify you when alignments have expired. One solution to expired alignments is to perform the Align All, Now operation. Another is to return the Auto Align selection to Normal.

Auto Align, Partial is recommended for measurements where the throughput is so important that a few percent of improvement is more valued than an increase in the accuracy errors of a few tenths of a decibel. One good application of Auto Align, Partial would be an automated environment where the alignments can be called during overhead time when the device-under-test is exchanged.

When Auto Align, Partial is selected the elapsed time counter begins for Auto Align Off time.

When Auto Align, Partial is selected the Settings Panel indicates ALIGN PARTIAL with a warning icon. The warning icon is to inform the operator that they are responsible for maintaining the warranted operation of the instrument

Key Path	System, Alignments, Auto Align
Mode	All
Example	:CAL:AUTO PART
Notes	Auto Align Partial begins the elapsed time counter for Auto Align Off time.
Readback Text	Partial
Initial S/W Revision	Prior to A.02.00

Off

Auto Align, Off disables automatic alignment and the maintenance of warranted operation, for the benefit of maximum measurement throughput. With Auto Align set to Off, you are now responsible for maintaining warranted operation by updating the alignments when they expire. The Auto Align, Alert mechanism will notify you when alignments have expired. One solution to expired alignments is to perform the Align All, Now operation. Another is to return the Auto Align selection to Normal.

The Auto Align, Off setting is rarely the best choice, because Partial gives almost the same improvement in throughput while maintaining the warranted performance for a much longer time. The choice is intended for unusual circumstances such as the measurement of radar pulses where you might like the revisit time to be as consistent as possible.

When Auto Align, Off is selected the Auto Align Off time is initialized and the elapsed time counter begins.

When Auto Align, Off is selected the Settings Panel indicates ALIGN OFF with a warning icon. The warning icon is to inform the operator that they are responsible for maintaining the warranted operation of the instrument:

Key Path	System, Alignments, Auto Align
Mode	All
Example	:CAL:AUTO OFF
Notes	Auto Align Off begins the elapsed time counter for Auto Align Off time.
Couplings	Auto Align is set to Off if Restore Align Data is invoked.
Readback Text	Off
Initial S/W Revision	Prior to A.02.00

All but RF

Auto Align, All but RF, configures automatic alignment to include or exclude the RF subsystem. (Eliminating the automatic alignment of the RF subsystem prevents the input impedance from changing. The normal input impedance of 50 ohms can change to an open circuit when alignments are being used. Some devices under test do not behave acceptably under such circumstances, for example by showing instability.) When Auto Align, All but RF ON is selected, the operator is responsible for performing an Align Now, RF when RF-related alignments expire. The Auto Align, Alert mechanism will notify the operator to perform an Align Now, All when the combination of time and temperature variation is exceeded.

When Auto Align, All but RF ON is selected the Settings Panel indicates ALIGN AUTO/NO RF with a warning icon (warning icon is intended to inform the operator they are responsible for the maintaining the RF alignment of the instrument):

Key Path	System, Alignments, Auto Align
Mode	All
Remote Command	:CALibration:AUTO:MODE ALL NRF :CALibration:AUTO:MODE?
Example	:CAL:AUTO:MODE NRF
Preset	This is unaffected by Preset but is set to ALL on a "Restore System Defaults->Align".
State Saved	No
Readback Text	RF or NRF
Initial S/W Revision	Prior to A.02.00

Alert

The instrument will signal an Alert when conditions exist such that you will need to perform a full alignment (for example, Align Now, All). The Alert can be configured in one of four settings; Time & Temperature, 24 hours, 7 days, or None. A confirmation is required when a selection other than Time & Temperature is chosen. This prevents accidental deactivation of alerts.

With Auto Align set to Normal, the configuration of Alert is not relevant because the instrument's software maintains the instrument in warranted operation.

Key Path	System, Alignments, Auto Align
Mode	All
Remote Command	:CALibration:AUTO:ALERt TTEMperature DAY WEEK NONE :CALibration:AUTO:ALERt?
Example	:CAL:AUTO:ALER TTEM
Notes	The alert that alignment is needed is the setting of bit 14 in the Status Questionable Calibration register.
Preset	This is unaffected by Preset but is set to TTEMperature on a "Restore System Defaults->Align".
State Saved	No
Status Bits/OPC dependencies	The alert is the Error Condition message "Align Now, All required" and bit 14 is set in the Status Questionable Calibration register.
Initial S/W Revision	Prior to A.02.00

Time & Temperature

With Auto Align Alert set to Time & Temperature the instrument will signal an alert when alignments expire due to the combination of the passage of time and changes in temperature. The alert is the Error Condition message "Align Now, All required". If this choice for Alert is selected, the absence of an alert means that the analyzer alignment is sufficiently up-to-date to maintain warranted accuracy.

Key Path	System, Alignments, Auto Align, Alert
Mode	All
Example	:CAL:AUTO:ALER TTEM
Readback Text	Time & Temp
Status Bits/OPC dependencies	Bit 14 is set in the Status Questionable Calibration register.
Initial S/W Revision	Prior to A.02.00

24 hours

With Auto Align Alert set to 24 Hours the instrument will signal an alert after a time span of 24 hours since the last successful full alignment (for example, Align Now, All or completion of a full Auto Align). You may choose this selection in an environment where the temperature is stable on a daily basis at a small risk of accuracy errors in excess of the warranted specifications. The alert is the Error Condition message "Align Now, All required".

For front-panel operation, confirmation is required to transition into this setting of Alert. The confirmation dialog is:

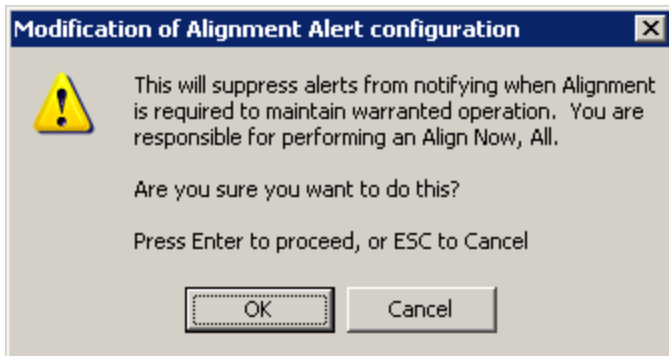

No confirmation is required when Alert is configured through a remote command.

Key Path	System, Alignments, Auto Align, Alert
Mode	All
Example	:CAL:AUTO:ALER DAY
Readback Text	24 hours
Status Bits/OPC dependencies	Bit 14 is set in the Status Questionable Calibration register.
Initial S/W Revision	Prior to A.02.00

7 days

With Auto Align Alert is set to 7 days the instrument will signal an alert after a time span of 168 hours since the last successful full alignment (for example, Align Now, All or completion of a full Auto Align). You may choose this selection in an environment where the temperature is stable on a weekly basis, at a modest risk of accuracy degradations in excess of warranted performance. The alert is the Error Condition message “Align Now, All required”.

For front panel operation, confirmation is required for the customer to transition into this setting of Alert. The confirmation dialog is:

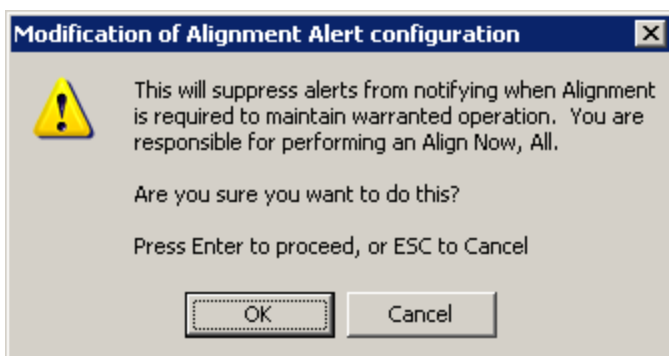

No confirmation is required when Alert is configured through a remote command.

Key Path	System, Alignments, Auto Align, Alert
Mode	All
Example	:CAL:AUTO:ALER WEEK
Readback Text	7 days
Status Bits/OPC dependencies	Bit 14 is set in the Status Questionable Calibration register.
Initial S/W Revision	Prior to A.02.00

None

With Auto Align Alert set to None the instrument will not signal an alert. This is provided for rare occasions where you are making a long measurement which cannot tolerate Auto Align interruptions, and must have the ability to capture a screen image at the end of the measurement without an alert posted to the display. Keysight does not recommend using this selection in any other circumstances, because of the risk of accuracy performance drifting well beyond expected levels without the operator being informed.

For front panel operation, confirmation is required to transition into this setting of Alert. The confirmation dialog is:

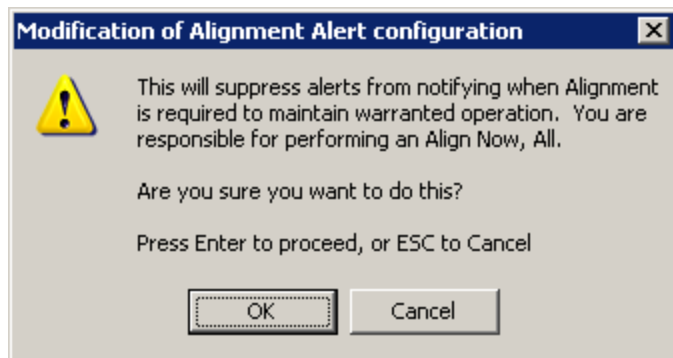

No confirmation is required when Alert is configured through a remote command.

Key Path	System, Alignments, Auto Align, Alert
Mode	All
Example	:CAL:AUTO:ALER NONE
Initial S/W Revision	Prior to A.02.00

Execute Expired Alignments (Remote Command Only)

Alignments can be expired in the situation where Auto Align is in the state of Partial or Off. This feature runs the alignments that have expired. This is different than performing an Align All, Now operation. Align All, Now performs an alignment of all subsystems regardless of whether they are needed or not, with Execute Expired Alignments, only the individual subsystems that have become due are aligned.

Mode	All
Remote Command	:CALibration:EXPIred?
Example	:CAL:EXP?
Notes	:CALibration:EXPIred? returns 0 if successful :CALibration:EXPIred? returns 1 if failed
Initial S/W Revision	Prior to A.02.00

Align Now

Accesses alignment processes that are immediate action operations. They perform complete operations and run until they are complete.

Key Path	System, Alignments
Initial S/W Revision	Prior to A.02.00

All

(In MXE the key label is “All (plus RF Presel 20 Hz – 3.6 GHz)”)Immediately executes an alignment of all subsystems In MXE, the Align Now All is followed by additionally aligning the RF Preselector section, so in MXE, the key label contains the parenthetical note “(plus RF Presel 20 Hz – 3.6 GHz)”. The instrument stops any measurement currently underway, performs the alignment, then restarts the measurement from the beginning (similar to pressing the Restart key).

If an interfering user signal is present at the RF Input, the alignment is performed on all subsystems except the RF. After completion, the Error Condition message “Align skipped: 50 MHz interference” or “Align skipped: 4.8 GHz interference” is generated. In addition the Error Condition message “Align Now, RF required” is generated, and bits 11 and 12 are set in the Status Questionable Calibration register.

The query form of the remote commands (:CALibration[:ALL]? or *CAL?) invokes the alignment of all subsystems and returns a success or failure value. An interfering user signal is not grounds for failure; if the alignment was able to succeed on all portions but unable to align the RF because of an interfering signal, the resultant will be the success value.

Successful completion of Align Now, All will clear the “Align Now, All required” Error Condition, and clear bit 14 in the Status Questionable Calibration register. It will also begin the elapsed time counter for Last Align Now, All Time, and capture the Last Align Now, All Temperature.

In the MXE, successful completion will also clear the “Align 20 Hz to 30 MHz required” Error Condition, the “Align 30 MHz to 3.6 GHz required” Error Condition, and the “Align 20 Hz to 3.6 GHz required” Error Condition, and clear bits 1 and bit 2 and clear the bit 1 in the Status Questionable Calibration Extended Needed register.

If the Align RF subsystem succeeded in aligning (no interfering signal present), the elapsed time counter begins for Last Align Now, RF Time, and the temperature is captured for the Last Align Now, RF Temperature. In addition the Error Conditions “Align skipped: 50 MHz interference” and “Align skipped: 4.8

GHz interference” are cleared, the Error Condition “Align Now, RF required” is cleared, and bits 11 and 12 are cleared in the Status Questionable Calibration register

Align Now, All can be interrupted by pressing the Cancel (ESC) front-panel key or remotely with Device Clear followed by the :ABORt SCPI command. When this occurs the Error Condition message “Align Now, All required” is generated, and bit 14 is set in the Status Questionable Condition register. This is because new alignment data may be employed for an individual subsystem, but not a cohesive set of data for all subsystems.

In many cases, you might find it more convenient to change alignments to Normal, instead of executing Align Now, All. When the Auto Align process transitions to Normal, the analyzer will immediately start to update only the alignments that have expired, thus efficiently restoring the alignment process.

Key Path	System, Alignments, Align Now
Mode	All
Remote Command	:CALibration[:ALL] :CALibration[:ALL]?
Example	:CAL
Notes	:CALibration[:ALL]? returns 0 if successful :CALibration[:ALL]? returns 1 if failed :CALibration[:ALL]? is the same as *CAL? While Align Now, All is performing the alignment, bit 0 in the Status Operation register is set. Completion, or termination, will clear bit 0 in the Status Operation register. This command is sequential; it must complete before further SCPI commands are processed. Interrupting the alignment from remote is accomplished by invoking Device Clear followed by the :ABORt command. Successful completion will clear bit 14 in the Status Questionable Calibration register. An interfering user signal is not grounds for failure of Align Now, All. However, bits 11 and 12 are set in the Status Questionable Calibration register to indicate Align Now, RF is required. An interfering user supplied signal will result in the instrument requiring an Align Now, RF with the interfering signal removed.
Couplings	Initializes the time for the Last Align Now, All Time. Records the temperature for the Last Align Now, All Temperature. If Align RF component succeeded, initializes the time for the Last Align Now, RF Time. If Align RF component succeeded, records the temperature for the Last Align Now, RF Temperature.
Status Bits/OPC dependencies	Bits 11, 12, or 14 may be set in the Status Questionable Calibration register.
Initial S/W Revision	Prior to A.02.00

Mode	All
Remote Command	*CAL?
Example	*CAL?
Notes	*CAL? returns 0 if successful

	<p>*CAL? returns 1 if failed</p> <p>:CALibration[:ALL]? is the same as *CAL?</p> <p>See additional remarks described with :CALibration[:ALL]?</p> <p>Everything about :CALibration[:ALL]? is synonymous with *CAL? including all conditions, status register bits, and couplings</p>
Initial S/W Revision	Prior to A.02.00
Mode	All
Remote Command	:CALibration[:ALL]:NPENDING
Example	CAL:NPEN
Notes	<p>:CALibration[:ALL]:NPENDING is the same as :CALibration[:ALL] including all conditions, status register bits, except this scpi command does not BLOCK the scpi session, so the user should use status register bits to query if the calibration is successfully completed or not.</p> <p>Typical usage is:</p> <ol style="list-style-type: none"> 1) :CALibration:ALL:NPENDING (Start a calibration) 2) :STATUS:OPERation:CONDition? (Check if the calibration is completed or not, If bit 0 is set, then the system is doing calibration, the user should repeat this scpi query until the bit is cleared) 3):STATUS:QUESTionable:CALibration:CONDition? (Check if there are any errors/failures in previous calibration procedure
Initial S/W Revision	X.14.20

All but RF

(In MXE the key label is “All but RF (not including RF Presel)”)

Immediately executes an alignment of all subsystems except the RF subsystem . The instrument will stop any measurement currently underway, perform the alignment, and then restart the measurement from the beginning (similar to pressing the Restart key). This can be used to align portions of the instrument that are not impacted by an interfering user input signal.

This operation might be chosen instead of All if you do not want the device under test to experience a large change in input impedance, such as a temporary open circuit at the analyzer input.

The query form of the remote commands (:CALibration:NRF?) will invoke the alignment and return a success or failure value.

Successful completion of Align Now, All but RF will clear the “Align Now, All required” Error Condition, and clear bit 14 in the Status Questionable Calibration register. If “Align Now, All required” was in effect prior to executing the All but RF, the Error Condition message “Align Now, RF required” is generated and bit 12 in the Status Questionable Calibration register is set. It will also begin the elapsed time counter for Last Align Now, All Time, and capture the Last Align Now, All Temperature.

Align Now, All but RF can be interrupted by pressing the Cancel (ESC) front-panel key or remotely with Device Clear followed by the :ABORt SCPI command. When this occurs the Error Condition message “Align Now, All required” is generated, and bit 14 is set in the Status Questionable Condition register. This is

because new alignment data may be used for an individual subsystem, but not a full new set of data for all subsystems.

In models with the RF Preselector, such as the N9038A, the “All but RF” alignment will execute an alignment of all subsystems except the RF subsystem of the Spectrum Analyzer, as well as the system gain of the RF Preselector.

Key Path	System, Alignments, Align Now
Mode	All
Remote Command	:CALibration:NRF :CALibration:NRF?
Example	:CAL:NRF
Notes	:CALibration:NRF? returns 0 if successful :CALibration:NRF? returns 1 if failed While Align Now, All but RF is performing the alignment, bit 0 in the Status Operation register is set. Completion, or termination, will clear bit 0 in the Status Operation register. This command is sequential; it must complete before further SCPI commands are processed. Interrupting the alignment from remote is accomplished by invoking Device Clear followed by the :ABORt command. Successful completion will clear bit 14 in the Status Questionable Calibration register and set bit 12 if invoked with “Align Now, All required”.
Couplings	Initializes the time for the Last Align Now, All Time. Records the temperature for the Last Align Now, All Temperature.
Status Bits/OPC dependencies	Bits 12 or 14 may be set in the Status Questionable Calibration register.
Initial S/W Revision	Prior to A.02.00

Mode	All
Remote Command	:CALibration:NRF:NPENding
Example	CAL:NRF:NPEN
Notes	:CALibration:NRF:NPENding is the same as :CALibration:NRF including all conditions, status register bits, except that this scpi command does not BLOCK the scpi session, so the user should use status register bits to query if the calibration is successfully completed or not. Typical usage is: 1):CALibration:NRF:NPENding (start theAll but RF calibration) 2):STATus:OPERation:CONDition? (If bit 0 is set, then the system is doing calibration, the user should do re-query until this bit is cleared) 3):STATus:QUEStionable:CALibration:CONDition? (to check if there are any errors/failures in previous calibration procedure)
Initial S/W Revision	X.14.20

RF

(In MXE the key label is “RF Only”)

Immediately executes an alignment of the RF subsystem . The instrument stops any measurement currently underway, performs the alignment, then restarts the measurement from the beginning (similar to pressing the Restart key).

This operation might be desirable if the alignments had been set to not include RF alignments, or if previous RF alignments could not complete because of interference which has since been removed.

If an interfering user signal is present at the RF Input, the alignment will terminate and generate the Error Condition message “Align skipped: 50 MHz interference” or “Align skipped: 4.8 GHz interference”, and Error Condition “Align Now, RF required”. In addition, bits 11 and 12 will be set in the Status Questionable Calibration register.

The query form of the remote commands (:CALibration:RF?) will invoke the alignment of the RF subsystem and return a success or failure value. An interfering user signal is grounds for failure.

Successful completion of Align Now, RF will begin the elapsed time counter for Last Align Now, RF Time, and capture the Last Align Now, RF Temperature.

Align Now, RF can be interrupted by pressing the Cancel (ESC) front-panel key or remotely with Device Clear followed by the :ABORt SCPI command. When this occurs, the Error Condition message “Align Now, RF required” is generated, and bit 12 is set in the Status Questionable Condition register. None of the new alignment data is used.

In models with the RF Preselector, such as the N9038A, the RF alignment will execute an alignment of the RF subsystem of the Spectrum Analyzer, as well as the RF subsystem on RF Preselector path.

Key Path	System, Alignments, Align Now
Mode	All
Remote Command	:CALibration:RF :CALibration:RF?
Example	:CAL:RF
Notes	:CALibration:RF? returns 0 if successful :CALibration:RF? returns 1 if failed (including interfering user signal) While Align Now, RF is performing the alignment, bit 0 in the Status Operation register is set. Completion, or termination, will clear bit 0 in the Status Operation register. This command is sequential; it must complete before further SCPI commands are processed. Interrupting the alignment from remote is accomplished by invoking Device Clear followed by the :ABORt command. Successful completion clears the Error Conditions “Align skipped: 50 MHz interference” and “Align skipped: 4800 MHz interference” and the Error Conditions “Align RF failed” and “Align Now, RF required”, and clears bits 3, 11, and 12 in the Status Questionable Calibration register. A failure encountered during alignment will generate the Error Condition message “Align RF failed” and set bit 3 in the Status Questionable Calibration register. An interfering user signal will result in bits 11 and 12 to be set in the Status Questionable Calibration register to indicate Align Now, RF is required. An interfering user supplied signal will result in the instrument requiring an Align Now, RF with the

	interfering signal removed.
Couplings	Initializes the time for the Last Align Now, RF Time. Records the temperature for the Last Align Now, RF Temperature.
Status Bits/OPC dependencies	Bits 11, 12, or 14 may be set in the Status Questionable Calibration register.
Initial S/W Revision	Prior to A.02.00
Mode	All
Remote Command	:CALibration:RF:NPENding
Example	CAL:RF:NPEN
Notes	:CALibration:RF:NPENding is the same as :CALibration:RF including all conditions, status register bits, except that this scpi command does not BLOCK the scpi session, so the user should use status register bits to query if the calibration is successfully completed or not. Typical usage is: 1):CALibration:RF:NPENding (Start a RF calibration) 2):STATus:OPERation:CONDition? (If bit 0 is set, then the system is doing calibration, the user should do re-query until this bit is cleared) 3):STATus:QUEStionable:CALibration:CONDition? (to check if there are any errors/failures in previous calibration procedure)
Initial S/W Revision	X.14.20

External Mixer

Immediately executes an alignment of the External Mixer that is plugged into the USB port. The instrument stops any measurement currently underway, performs the alignment, then restarts the measurement from the beginning (similar to pressing the Restart key). As this alignment calibrates the LO power to the mixer, this is considered an LO alignment; and failure is classified as an LO alignment failure.

The query form of the remote commands (:CALibration:EMIXer?) will invoke the alignment of the External Mixer and return a success or failure value.

Key Path	System, Alignments, Align Now
Mode	All
Remote Command	:CALibration:EMIXer :CALibration:EMIXer?
Example	:CAL:EMIX
Notes	:CAL:EMIX? returns 0 if successful :CAL:EMIX? returns 1 if failed While Align Now, Ext Mix is performing the alignment, bit 0 in the Status Operation register is set. Completion, or termination, will clear bit 0 in the Status Operation register.

	<p>This command is sequential; it must complete before further SCPI commands are processed. Interrupting the alignment from remote is accomplished by invoking Device Clear followed by the :ABORt command.</p> <p>A failure encountered during alignment will generate the Error Condition message “Align LO failed” and set bit 5 in the Status Questionable Calibration register. Successful completion will clear the “Align LO failed” message and bit 5 in the Status Questionable Calibration register.</p>
Dependencies	This key does not appear unless option EXM is present and is grayed-out unless a USB mixer is plugged in to the USB.
Status Bits/OPC dependencies	Bit3 may be set in the Status Questionable Calibration Extended Failure register.
Initial S/W Revision	A.08.00

Show Alignment Statistics

Shows alignment information you can use to ensure that the instrument is operating in a specific manner. The Show Alignment Statistics screen is where you can view time and temperature information.

Values which are displayed are only updated when the Show Alignment Statistics screen is invoked, they are not updated while the Show Alignment Statistics screen is being displayed. The remote commands that access this information obtain current values.

An example of the Show Alignment Statistics screen would be similar to:

Std Header	Product Number: N9020A Serial Number: US46340924 Firmware Revision: A.01.01	
Instrument Info	Time since start-up: 300 hrs Current Temperature: +28 degC	
Auto Align Info	Time while Auto Align off: 90 min	
Std Align Now	Time since last Align Now All: 12.5 hrs Temperature since last Align Now All: -1.3 degC Time since last Align Now RF: 5 min Temperature since last Align Now RF: +0.1 degC	Times & Temperature delta. Shown as "---" if none since start-up.
If TG Option (Not Zorro1)	Time since last Align TG: 2.5 hrs Temperature since last Align TG: +0.2 degC	
Opts 508,513 526	Last Characterize Preselector: Jun 1, 2006 15:00:00 Last Characterize Preselector Temperature: +32.1 degC	Time & Temperature 'stamp'

A successful Align Now, RF will set the Last Align RF temperature to the current temperature, and reset the Last Align RF time. A successful Align Now, All or Align Now, All but RF will set the Last Align Now All temperature to the current temperature, and reset the Last Align Now All time. A successful Align Now, All will also reset the Last Align RF items if the RF portion of the Align Now succeeded.

Key Path	System, Alignments
Mode	All
Notes	The values displayed on the screen are only updated upon entry to the screen and not updated while the screen is being displayed.
Initial S/W Revision	Prior to A.02.00

Key Path	Visual annotation in the Show Alignment Statistics screen
Mode	All
Remote Command	:SYSTem:PON:TIME?
Example	:SYST:PON:TIME?
Notes	Value is the time since the most recent start-up in seconds.
State Saved	No
Initial S/W Revision	Prior to A.02.00

Key Path	Visual annotation in the Show Alignment Statistics screen
Mode	All
Remote Command	:CALibration:TEMPerature:CURREnt?
Example	:CAL:TEMP:CURR?
Notes	Value is in degrees Centigrade. Value is invalid if using default alignment data (Align Now, All required)
State Saved	No
Initial S/W Revision	Prior to A.02.00

Key Path	Visual annotation in the Show Alignment Statistics screen
Mode	All
Remote Command	:CALibration:TIME:LALL?
Example	:CAL:TIME:LALL?
Notes	Value is the elapsed time, in seconds, since the last successful Align Now, All or Align Now, All but RF was executed.
State Saved	No
Initial S/W Revision	Prior to A.02.00

Key Path	Visual annotation in the Show Alignment Statistics screen
----------	---

Mode	All
Remote Command	:CALibration:TEMPerature:LALL?
Example	:CAL:TEMP:LALL?
Notes	Value is in degrees Centigrade at which the last successful Align Now, All or Align Now, All but RF was executed.
State Saved	No
Initial S/W Revision	Prior to A.02.00

Key Path	Visual annotation in the Show Alignment Statistics screen
Mode	All
Remote Command	:CALibration:TIME:LRF?
Example	:CAL:TIME:LRF?
Notes	Value is the elapsed time, in seconds, since the last successful Align Now, RF was executed, either individually or as a component of Align Now, All.
State Saved	No
Initial S/W Revision	Prior to A.02.00

Key Path	Visual annotation in the Show Alignment Statistics screen
Mode	All
Remote Command	:CALibration:TEMPerature:LRF?
Example	:CAL:TEMP:LRF?
Notes	Value is in degrees Centigrade at which the last successful Align Now, RF was executed, either individually or as a component of Align Now, All.
State Saved	No
Initial S/W Revision	Prior to A.02.00

Key Path	Visual annotation in the Show Alignment Statistics screen
Mode	All
Remote Command	:CALibration:TIME:LPreselector?
Example	:CAL:TIME:LPR?
Notes	Value is the date and time the last successful Characterize Preselector was executed. The date is separated from the time by a space character. Returns "" if no Characterize Preselector has ever been performed on the instrument.
Dependencies	In models that do not include preselectors, this command is not enabled and any attempt to set or query will yield an error.
State Saved	No
Initial S/W Revision	Prior to A.02.00

Key Path	Visual annotation in the Show Alignment Statistics screen
Mode	All
Remote Command	:CALibration:TEMPerature:LPreselector?
Example	:CAL:TEMP:LPR?
Notes	Value is in degrees Centigrade at which the last successful Characterize Preselector was executed.
Dependencies	In models that do not include preselectors, this command is not enabled and any attempt to set or query will yield an error.
State Saved	No
Initial S/W Revision	Prior to A.02.00

Key Path	Visual annotation in the Show Alignment Statistics screen
Mode	All
Remote Command	:CALibration:AUTO:TIME:OFF?
Example	:CAL:AUTO:TIME:OFF?
Notes	Value is the elapsed time, in seconds, since Auto Align has been set to Off or Off with Alert. The value is 0 if Auto Align is ALL or NORF.
State Saved	No
Initial S/W Revision	Prior to A.02.00

Key Path	Visual annotation in the Show Alignment Statistics screen
Mode	All
Remote Command	:CALibration:TIME:RFPSelector:LCONducted?
Example	:CAL:TIME:RFPS:LCON?
Notes	Values are the date and time the last successful Align Now, 20 Hz – 30 MHz was executed. The date is separated from the time by a semi-colon character.
State Saved	No

Key Path	Visual annotation in the Show Alignment Statistics screen
Mode	All
Remote Command	:CALibration:TEMPerature:RFPSelector:LCONducted?
Example	:CAL:TEMP:RFPS:LCON?
Notes	Value is in degrees Centigrade at which the last successful Align Now, 20 Hz – 30 MHz was executed.
State Saved	No

Key Path	Visual annotation in the Show Alignment Statistics screen
Mode	All
Remote Command	:CALibration:TIME:RFPSector:LRADiated?
Example	:CAL:TIME:RFPS:LRAD?
Notes	Value is the date and time the last successful Align Now, 30 MHz – 3.6 GHz was executed. The date is separated from the time by a semi-colon character.
State Saved	No

Key Path	Visual annotation in the Show Alignment Statistics screen
Mode	All
Remote Command	:CALibration:TEMPerature:RFPSector:LRADiated?
Example	:CAL:TEMP:RFPS:LRAD?
Notes	Value is in degrees Centigrade at which the last successful Align Now, 30 MHz – 3.6 GHz was executed.
State Saved	No

Key Path	Visual annotation in the Show Alignment Statistics screen
Mode	All
Remote Command	:CALibration:RFPSector:SCHeuler:TIME:NEXT? This query returns data using the following format “YYYY/MM/DD; HH:MM:SS”
Example	:CAL:RFPS:SCH:TIME:NEXT?
Notes	The next run time will be updated based on the start date/time and recurrence set by the users. “date” is representation of the date the task will run in the form of “YYYY/MM/DD” where: –YYYY is the four digit representation of year. (for example, 2009) –MM is the two digit representation of month. (for example, 01 to 12) –DD is the two digit representation of the day. (for example, 01 to 28, 29, 30 or 31 depending on the month and year) “time” is a representation of the time of day the task will run in the form of “HH:MM:SS” where: –HH is the two digit representation of the hour in 24 hour format –MM is the two digit representation of minute –SS is the two digit representation of seconds For model N9038A only.
State Saved	No

Restore Align Defaults

Initializes the alignment user interface settings, not alignment data, to the factory default values. Align Now, All must be executed if the value of the Timebase DAC results in a change.

For front panel operation, you are prompted to confirm action before setting the alignment parameters to factory defaults:

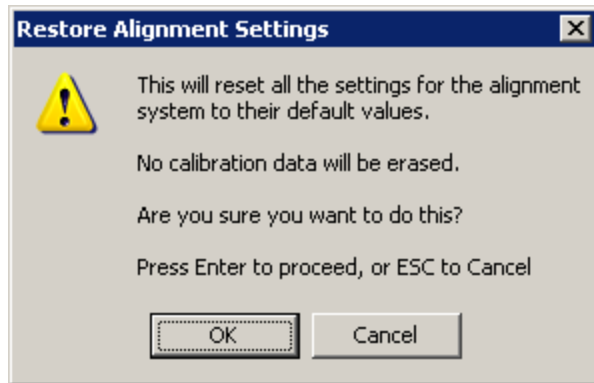

The parameters affected are:

Parameter	Setting
Timebase DAC	Calibrated
Timebase DAC setting	Calibrated value
Auto Align State	Normal (if the instrument is not operating with default alignment data, Off otherwise)
Auto Align All but RF	Off
Auto Align Alert	Time & Temperature

Key Path	System, Alignments
Mode	All
Example	:SYST:DEF ALIG
Notes	Alignment processing that results as the transition to Auto Alignment Normal will be executed sequentially; thus *OPC? or *WAI will wait until the alignment processing is complete.
Initial S/W Revision	Prior to A.02.00

Backup or Restore Align Data...

Opens the utility for backing-up or restoring the alignment data.

Alignment data for the instrument resides on the hard drive in a database. Keysight uses high quality hard drives; however it is highly recommended the alignment data be backed-up to storage outside of the instrument. Additionally, for customers who use multiple CPU Assemblies or multiple disk drives, the

alignment that pertains to the instrument must be transferred to the resident hard drive after a CPU or hard drive is replaced. This utility facilitates backing-up and restoring the alignment data.

NOTE

This utility allows the operator to navigate to any location of the Windows file system. It is intended that the operator use a USB memory device or Mapped Network Drive to back up the alignment data to storage outside of the instrument.

Key Path	System, Alignments
Initial S/W Revision	A.02.00

Key Path	System, Alignments
Mode	All
Remote Command	:CALibration:DATA:DEFault
Example	:CAL:DATA:DEF
Couplings	Sets Auto Align to Off. Sets bit 14 in the Status Questionable Calibration register. The Error Condition message "Align Now, All required" is generated.
Initial S/W Revision	Prior to A.02.00

Alignment Data Wizard

The Backup or Restore Alignment Data wizard guides you through the operation of backing-up or restoring the alignment data.

The following dialogue boxes operates without a mouse or external keyboard when you use the default file names.

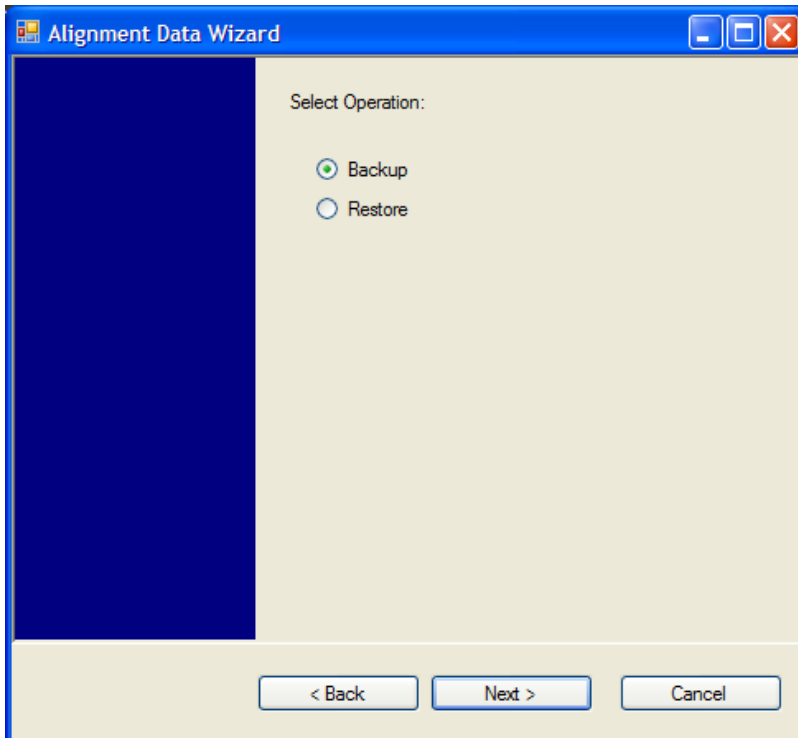
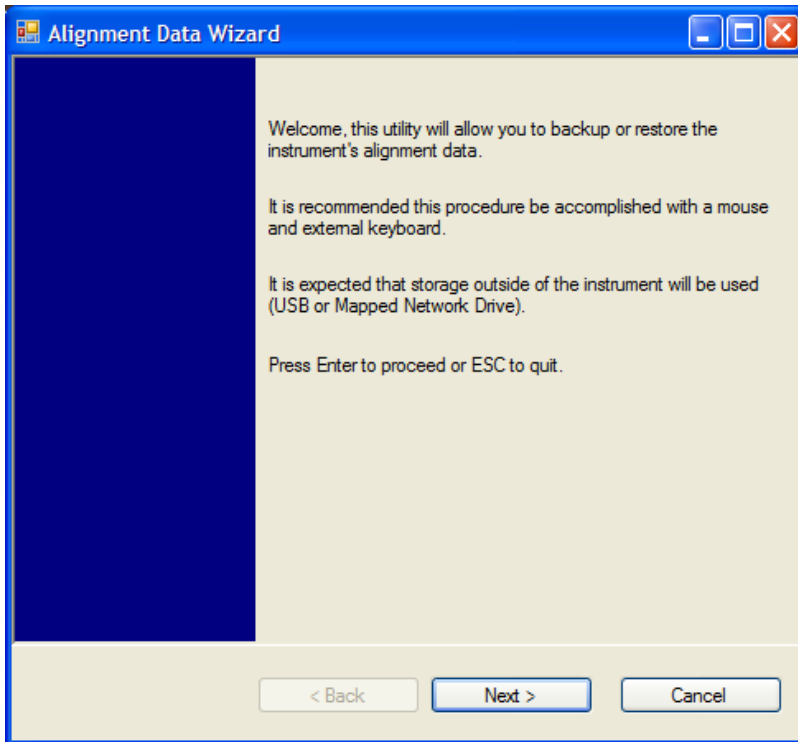

The backup screen indicates the approximate amount of space required to contain the backup file.

The default file name will be AlignDataBackup_<model number>_<serial number>_<date in YYYYMMDDHHMMSS>.bak.

The default backup location will be first drive identified as an external drive (USB or LAN) if such is available; if not, the internal D: partition will be selected.

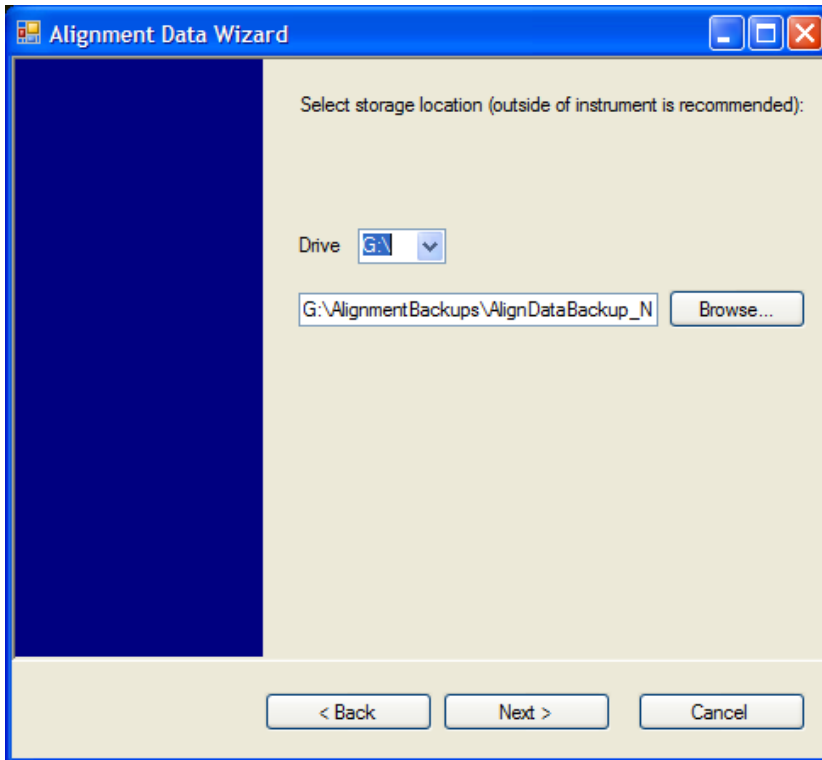

Changing the drive letter will also modify the path displayed in the box below. When this step is first loaded, the drive drop-down menu is populated with connected drives, which provide the user with write access. If there are many unreachable network drives connected to the instrument, this step can take a few seconds. If a USB drive is present, it will be selected by default. The path defaults to the AlignmentBackups folder, and a filename is automatically created in the form of AlignDataBackup_<model>_<serial number>_<date><time>. When the "Next >" button is pressed, you will be prompted to create a new folder if the chosen path does not yet exist.

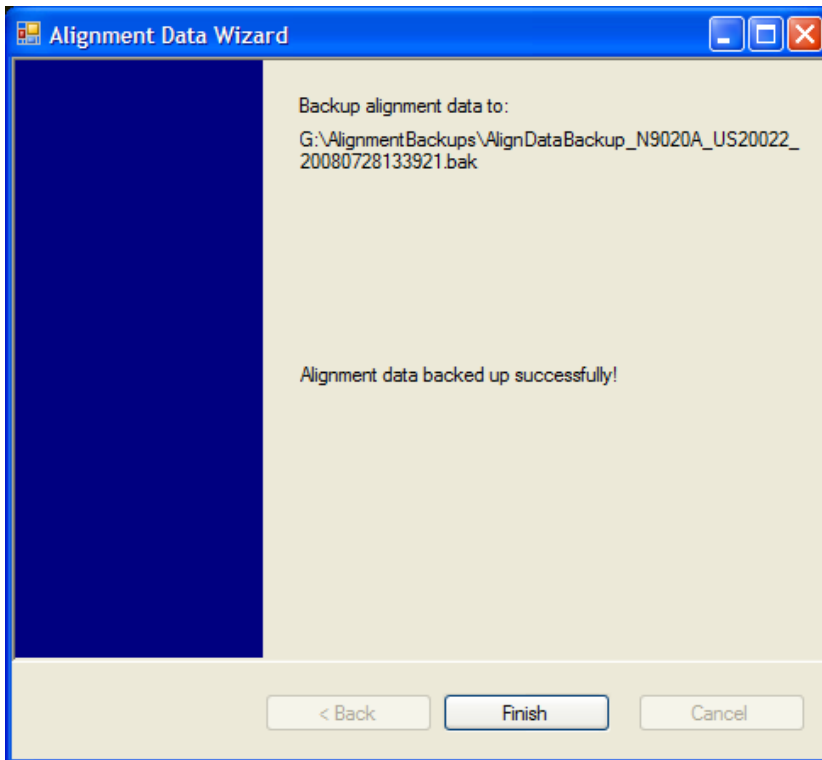
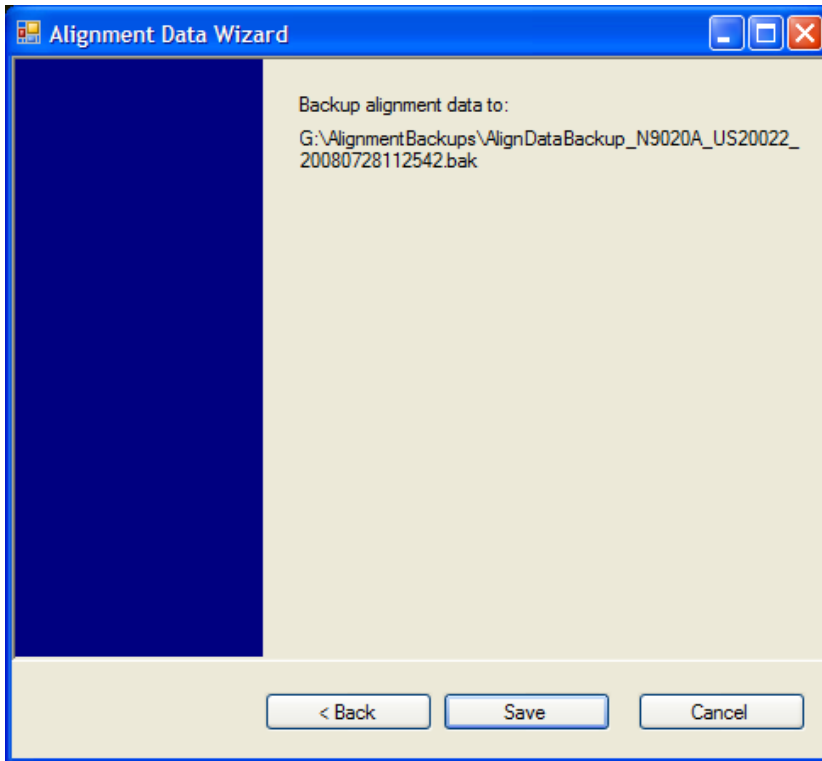

The restore operation checks the validity of the restore file using the database's built-in file validation. If the restore file is corrupt, the existing alignment data will remain in use.

If the serial number information in the backup file being restored is different from that of the instrument, the following message appears (the serial number shown are examples):

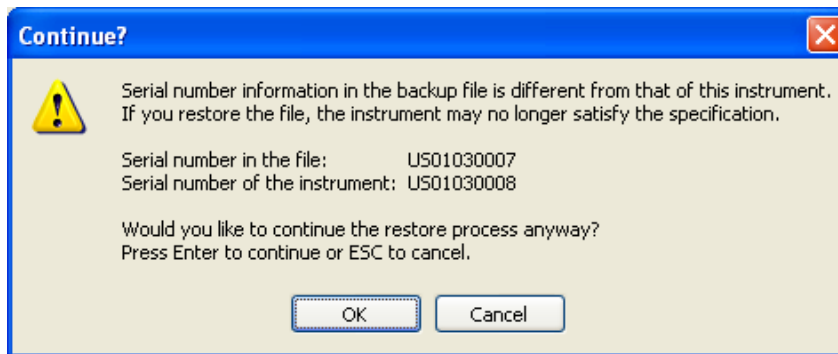

The default restore location will be first drive identified as an external drive (USB or LAN) if such is available; if not, the internal D: partition will be selected. The default restore file will be the most recent file that matches the default backup file name format: AlignDataBackup_<model number>_<serial number>_<date>.bak

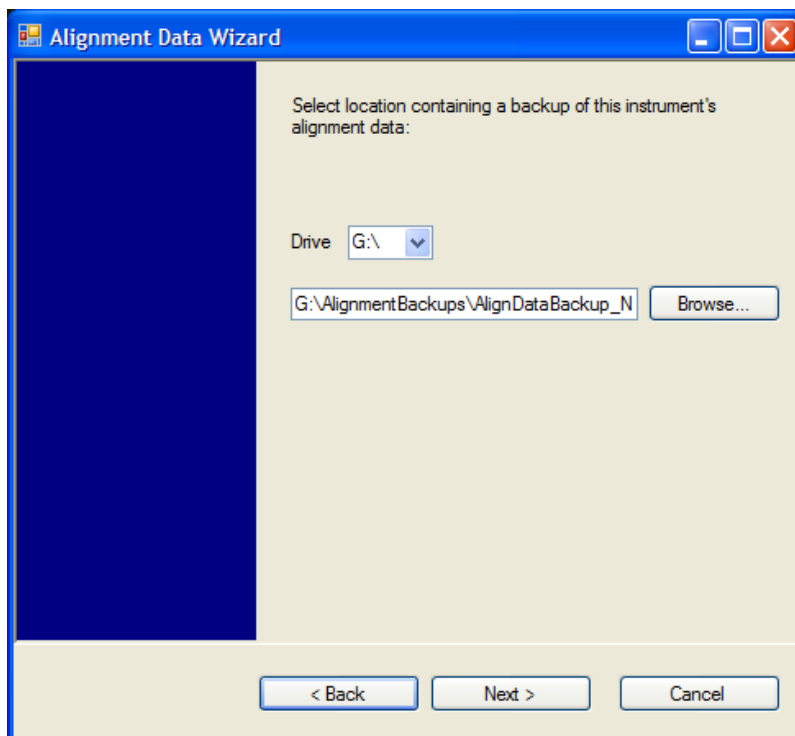

Changing the drive letter also modifies the path displayed in the box below. When this step is first loaded, the drive drop-down menu is populated with connected drives, which provide you with read access. The path defaults to the AlignBackups folder. The most recent *.bak file in the folder will also be selected by default.

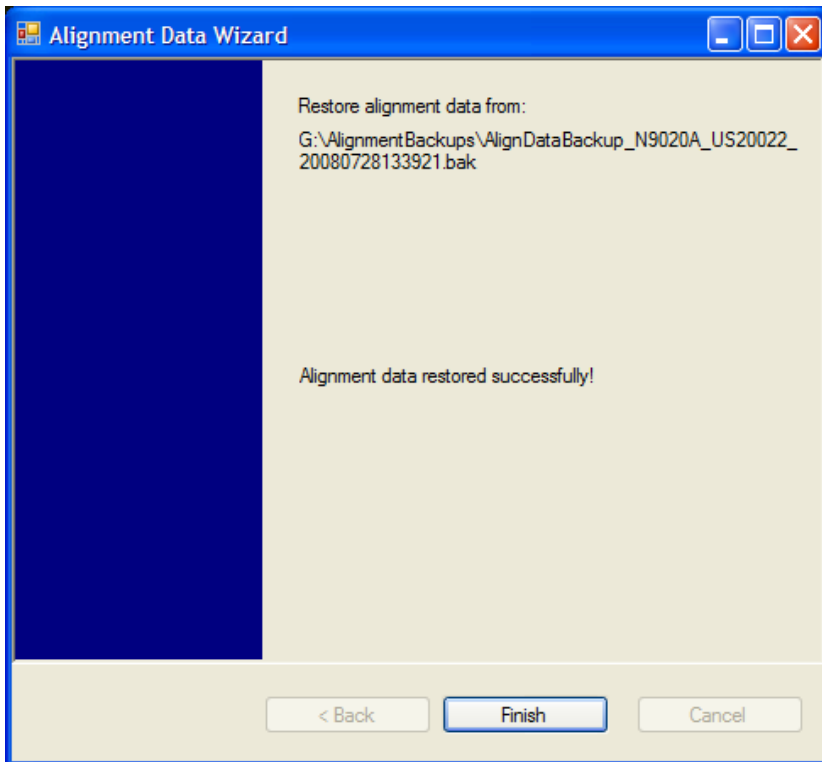
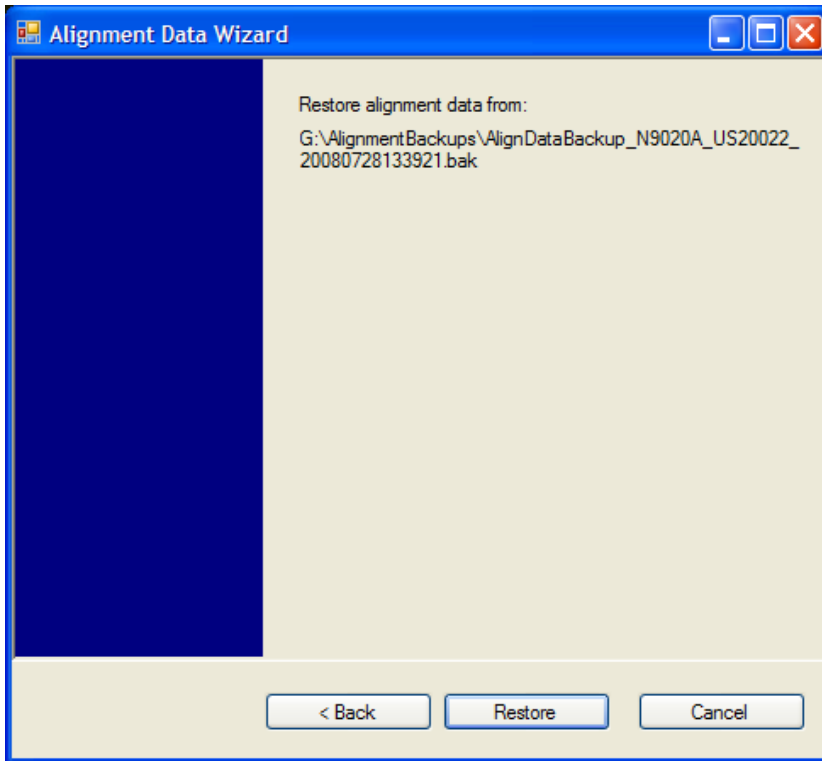

Perform Backup (Remote Command Only)

Invokes an alignment data backup operation to the provided Folder.

NOTE

It is recommended that the Folder provided is outside of the instrument (USB or Mapped Network Drive).

Remote Command	:CALibration:DATA:BACKup <filename>
Example	:CAL:DATA:BACK "F:\AlignDataBackup_N9020A_US00000001_2008140100.bak"
Initial S/W Revision	A.02.00

Perform Restore (Remote Command Only)

Invokes an alignment data restore operation from the provided filename.

Remote Command	:CALibration:DATA:RESTore <filename>
Example	:CAL:DATA:REST "F:\ AlignDataBackup_N9020A_US00000001_2008140100.bak "
Initial S/W Revision	A.02.00

Advanced

Accesses alignment processes that are immediate action operations that perform operations that run until complete. Advanced alignments are performed on an irregular basis, or require additional operator interaction

Key Path	System, Alignments
Initial S/W Revision	Prior to A.02.00

Characterize Preselector

The Preselector tuning curve drifts over temperature and time. Recognize that the Amplitude, Presel Center function adjusts the preselector for accurate amplitude measurements at an individual frequency. Characterize Preselector improves the amplitude accuracy by ensuring the Preselector is approximately centered at all frequencies without the use of the Amplitude, Presel Center function. Characterize Preselector can be useful in situations where absolute amplitude accuracy is not of utmost importance, and the throughput savings or convenience of not performing a Presel Center is desired. Presel Center is required prior to any measurement for best (and warranted) amplitude accuracy.

Keysight recommends that the Characterize Preselector operation be performed yearly as part of any calibration, but performing this operation every three months can be worthwhile.

Characterize Preselector immediately executes a characterization of the Preselector, which is a YIG-tuned filter (YTF). The instrument stops any measurement currently underway, performs the characterization, then restarts the measurement from the beginning (similar to pressing the Restart key).

The query form of the remote commands (:CALibration:YTF?) will invoke the alignment of the YTF subsystem and return a success or failure value.

A failure encountered during alignment will generate the Error Condition message "Characterize Preselector failure" and set bit 3 in the STATus:QUEStionable:CALibration:EXTended:FAILure status register. Successful completion of Characterize Preselector will clear this Condition. It will also begin the

elapsed time counter for Last Characterize Preselector Time, and capture the Last Characterize Preselector Temperature.

The last Characterize Preselector Time and Temperature survives across the power cycle as this operation is performed infrequently.

NOTE

The Characterize Preselector function can be interrupted by pressing the Cancel (ESC) front-panel key or remotely with Device Clear followed by the :ABORt SCPI command. None of the new characterization data is then used. However, since the old characterization data is purged at the beginning of the characterization, you now have an uncharacterized preselector. You should re-execute this function and allow it to finish before making any further preselected measurements.

Key Path	System, Alignments, Advanced
Mode	All
Remote Command	:CALibration:YTF :CALibration:YTF?
Example	:CAL:YTF
Notes	:CALibration:YTF? returns 0 if successful :CALibration:YTF? returns 1 if failed (including interfering user signal) While Advanced, Characterize Preselector is performing the alignment, bit 0 in the Status Operation register is set. Completion, or termination, will clear bit 0 in the Status Operation register. This command is sequential; it must complete before further SCPI commands are processed. Interrupting the alignment from remote is accomplished by invoking Device Clear followed by the :ABORt command. Successful completion will clear bit 9 in the Status Questionable Calibration register. A failure encountered during alignment will generate the Error Condition message “Characterize Preselector failed” and set bit 9 in the Status Questionable Calibration register. For Options that support frequencies > 3.6 GHz only.
Dependencies	This key does not appear in models that do not contain preselectors. In these models the SCPI command is accepted without error but no action is taken.
Couplings	Initializes the time for the Last Characterize Preselector Time. Records the temperature for the Last Characterize Preselector Temperature.
Initial S/W Revision	Prior to A.02.00

Mode	All
Remote Command	:CALibration:YTF:NPENding
Example	CAL:YTF:NPEN
Notes	:CALibration:YTF:NPENding is the same as :CALibration:YTF including all conditions, status register bits, except that this scpi command does not BLOCK the scpi session, so the user should use status register bits to query if the calibration is successfully completed or not. Typical usage is: 1) :CALibration:YTF:NPENding (Start a YTF calibration)

- 2) :STATus:OPERation:CONDition? (Check if the calibration is completed or not, If bit 0 is set, then the system is doing calibration, the user should repeat this scpi query until the bit is cleared)
- 3):STATus:QUESTionable:CALibration:EXTended:FAILure:CONDition? (Check if bit 2 is set or not. If this bit is set, that means there are some errors in previous internal source calibration)

Initial S/W Revision	X.14.20
----------------------	---------

Characterize Reference Clock

Characterizing the reference clock is calibrating the Reference Input Phase with the External Reference Output. This feature is only available when either option DP2 or B40 is present. It requires connecting the 10 MHz OUT to the EXT REF IN port with a BNC cable before running the characterization.

See "[Front panel guided calibration sequence](#)" on page 396

Key Path	System, Alignments, Advanced
Mode	All
Remote Command	:CALibration:REFerence:CLOCk?
Example	:CAL:REF:CLOC:INIT? //connect cable :CAL:REF:CLOC? //disconnect cable :CAL:REF:CLOC:END?
Notes	:CALibration:REFerence:CLOCk? returns 0 if successful :CALibration:REFerence:CLOCk? returns 1 if failed
Dependencies	Option DP2 or B40
Couplings	Initializes the time for the Last Characterize Reference Clock Time. Records the temperature for the Last Characterize Reference Clock Temperature. Expected to be run after :CAL:REF:CLOC:INIT, and before :CAL:REF:CLOC:END.
Initial S/W Revision	A.13.00

Parameter Name	Characterize Reference Clock Initialization
Mode	All
Remote Command	:CALibration:REFerence:CLOCk:INITialize?
Example	:CAL:REF:CLOC:INIT?
Notes	:CALibration:REFerence:CLOCk:INIT? returns 0 if successful :CALibration:REFerence:CLOCk:INIT? returns 1 if failed
Dependencies	Option DP2 or B40
Couplings	Expected to be run before sending the :CAL:REF:CLOC? command. This will stop the current measurement when it has completed (does not abort the current data acquisition), and it will prepare the instrument for the expected cabling.

Force Restart	Yes
Initial S/W Revision	A.12.00

Parameter Name	Characterize Reference Clock End
Mode	All
Remote Command	:CALibration:REFeRence:CLOCK:END?
Example	:CAL:REF:CLOC:END?
Notes	:CALibration:REFeRence:CLOCK:END? returns 0 if successful :CALibration:REFeRence:CLOCK:END? returns 1 if failed
Dependencies	Option DP2 or B40
Couplings	Expected to be run after sending the :CAL:REF:CLOC? command, and after removing the cable used in that Characterize Reference Clock step. This will resume any queued measurements, and it concludes the reference clock characterization.
Force Restart	Yes
Initial S/W Revision	A.12.00

Parameter Name	Last Characterize Reference Clock
Key Path	Visual annotation in the Show Alignment Statistics screen
Parameter Type	String
Mode	All
Remote Command	:CALibration:TIME:REFeRence:CLOCK?
Example	:CAL:TIME:REFeRence:CLOCK?
Notes	Value is the date and time the last successful Characterize Reference Clock was executed. The date is separated from the time by a space character. Returns "" if Characterize Reference Clock has never been performed on the instrument.
Dependencies	Option DP2 or B40
State Saved	No
Initial S/W Revision	A.12.00

Front panel guided calibration sequence

When selecting “Characterize Reference Clock” through the front panel, the following form will be shown.

Step 1 of the guided calibration sequence:

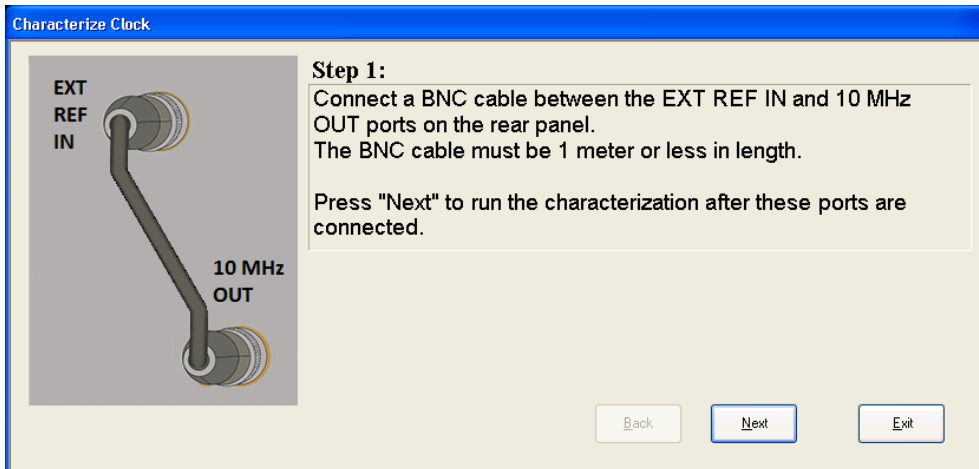

Step 2 of the guided calibration sequence:

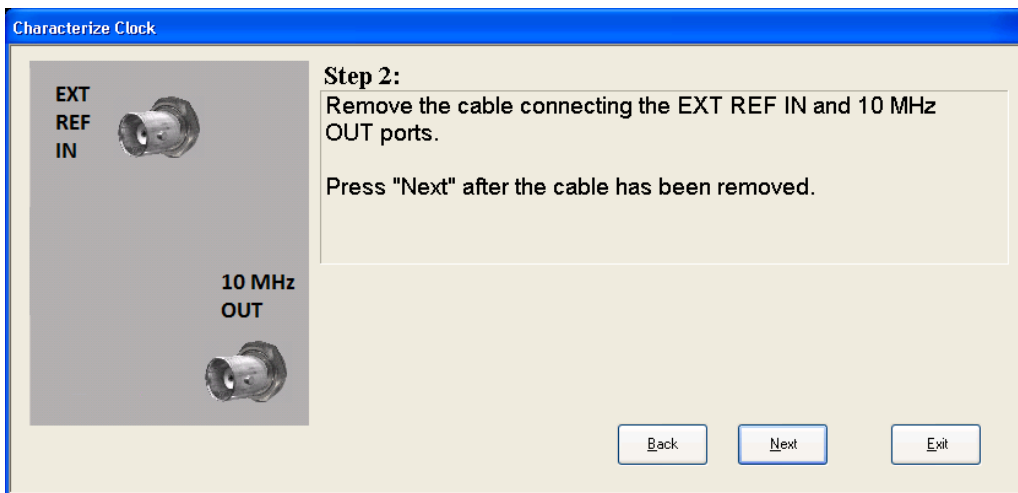

Step 3 of the guided calibration sequence:

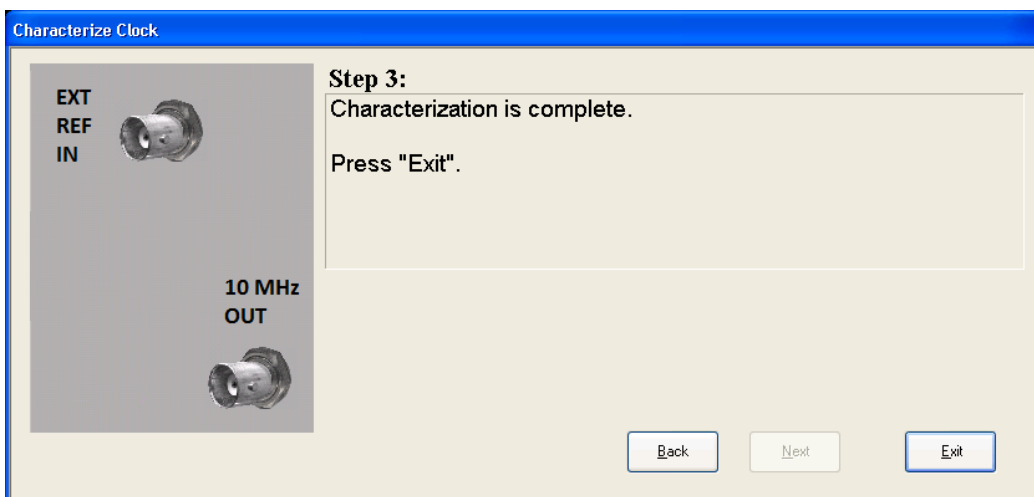

Characterize Noise Floor

On instruments with the NF2 license installed, the calibrated Noise Floor used by Noise Floor Extensions should be refreshed periodically. To do this, press the Characterize Noise Floor key. When you press this key, the instrument stops any measurement currently underway, and a dialog appears with an OK and Cancel button which says:

“This action will take several minutes to perform. Please disconnect all cables from the RF input and press Enter to proceed. Press ESC to cancel.”

When you press Enter or OK, the characterization proceeds. After the characterization, the analyzer restarts the measurement from the beginning (similar to pressing the Restart key). The characterization takes many minutes to run.

The noise floor model used by NFE includes an estimation of the temperature behavior of the noise floor, but this is only an estimation. The noise floor changes little with the age of the components. However, even small changes in the estimated level of the noise floor can make large changes in the effective noise floor, because the effective noise floor is the error in the estimation of the noise floor. Keysight recommends that the Characterize Noise Floor operation be performed when the analyzer is operating at an ambient temperature that is significantly different than the ambient temperature at which this alignment was last run. In addition, Keysight recommends that the Characterize Noise Floor operation be performed after the first 500 hours of operation, and once every calendar year.

The noise floor model from the last operation of Characterize Noise Floor survives across the power cycle.

NOTE

The Characterize Noise Floor function can be interrupted by pressing the Cancel (ESC) front-panel key or remotely with Device Clear followed by the :ABORt SCPI command. None of the new characterization data is then used. However, since the old characterization data is purged at the beginning of the characterization, you now have an uncharacterized noise floor. You should re-execute this function and allow it to finish before making any further measurements with NFE. Until you do, the analyzer will display a “Characterize Noise Floor required” message and set bit 12 in the Status Questionable Calibration register (STATus:QUESTionable:CALibration:EXTended:NEEDED).

Key Path	System, Alignments, Advanced
Mode	All
Remote Command	:CALibration:NFLoor :CALibration:NFLoor?
Example	:CAL:NFL
Notes	:CALibration:NFLoor? returns 0 if successful :CALibration:NFLoor? returns 1 if failed (including interfering user signal) While Characterize Noise Floor is performing the alignment, bit ? in the Status Operation register is set. Completion, or termination, will clear bit ? in the Status Operation register. This command is sequential; it must complete before further SCPI commands are processed. Interrupting the alignment from remote is accomplished by invoking Device Clear followed by the :ABORt command. A failure encountered during characterization will generate the Error Condition message “Characterize Noise Floor failed” message and set bit ? in the Status Questionable Calibration register. Successful completion will clear bit ? in the Status Questionable Calibration register.
Dependencies	This key does not appear in models that do not contain NFE. In these models the SCPI command is

	accepted without error but no action is taken.
Couplings	Successful completion of Characterize Noise Floor will begin the elapsed time counter or the Last Characterize Noise Floor Time.
Initial S/W Revision	A.14.00

Key Path	Visual annotation in the Show Alignment Statistics screen
Mode	All
Remote Command	:CALibration:TIME:NFLoor?
Example	:CAL:TIME:NFL?
Notes	Value is the date and time the last successful Characterize Noise Floor was executed. The date is separated from the time by a space character. Returns "" if no Characterize Noise Floor has ever been performed on the instrument.
Dependencies	In models that do not include NFE, this command is not enabled and any attempt to set or query will yield an error.
State Saved	No
Initial S/W Revision	A.14.00

Key Path	Visual annotation in the Show Alignment Statistics screen
Mode	All
Remote Command	:CALibration:TEMPerature:NFLoor?
Example	:CAL:TEMP:NFL?
Notes	Value is the temperature of the last successful Characterize Noise Floor was executed. Returns "" if no Characterize Noise Floor has ever been performed on the instrument.
Dependencies	In models that do not include NFE, this command is not enabled and any attempt to set or query will yield an error.
State Saved	No
Initial S/W Revision	A.14.00

Key Path	Visual annotation in the Show Alignment Statistics screen
Mode	All
Remote Command	:CALibration:TIME:ELAPsed:NFLoor?
Example	:CAL:TIME:ELAP:NFL?
Notes	Value is the elapsed time the instrument was powered-on since the last successful Characterize Noise Floor was executed. Returns "" if no Characterize Noise Floor has ever been performed on the instrument.
Dependencies	In models that do not include NFE, this command is not enabled and any attempt to set or query will yield an error.

State Saved	No
Initial S/W Revision	A.14.00

Timebase DAC

Allows control of the internal 10 MHz reference oscillator timebase. This may be used to adjust for minor frequency alignment between the signal and the internal frequency reference. This adjustment has no effect if the instrument is operating with an External Frequency Reference.

If the value of the Timebase DAC changes (by switching to Calibrated from User with User set to a different value, or in User with a new value entered) an alignment may be necessary. The alignment system will take appropriate action; which will either invoke an alignment or cause an Alert.

Key Path	System, Alignments
Mode	All
Remote Command	:CALibration:FREQuency:REFerence:MODE CALibrated USER :CALibration:FREQuency:REFerence:MODE?
Example	:CAL:FREQ:REF:MODE CAL
Notes	If the value of the timebase is changed the alignment system automatically performs an alignment or alerts that an alignment is due. If the value of the timebase is changed the alignment system automatically performs an alignment or alerts that an alignment is due.
Preset	This is unaffected by Preset but is set to CALibrated on a "Restore System Defaults->Align".
State Saved	No
Initial S/W Revision	Prior to A.02.00

Calibrated

Sets the Timebase DAC to the value established during factory or field calibration. The value displayed on the menu key is the calibrated value.

Key Path	System, Alignments, Timebase DAC
Mode	All
Example	:CAL:FREQ:REF:MODE CAL
Readback Text	[xxx] < where xxx is the calibrated value
Initial S/W Revision	Prior to A.02.00

User

Allows setting the Timebase DAC to a value other than the value established during the factory or field calibration. The value displayed on the menu key is the calibrated value.

Key Path	System, Alignments, Timebase DAC
Mode	All
Example	:CAL:FREQ:REF:MODE USER
Readback Text	xxx < where xxx is the Timebase DAC setting
Initial S/W Revision	Prior to A.02.00

Key Path	System, Alignments, Timebase DAC
Mode	All
Remote Command	:CALibration:FREQuency:REFerence:FINE <integer> :CALibration:FREQuency:REFerence:FINE?
Example	:CAL:FREQ:REF:FINE 8191
Notes	If the value of the timebase is changed the alignment system automatically performs an alignment or alerts that an alignment is due.
Couplings	Setting :CAL:FREQ:REF:FINE sets :CAL:FREQ:REF:MODE USER
Preset	This is unaffected by Preset but is set to the factory setting on a "Restore System Defaults->Align".
State Saved	No
Min	0
Max	16383
Backwards Compatibility SCPI	:CALibration:FREQuency:REFerence:COARse ESA hardware contained two DAC controls for the Timebase. In X-Series the command :CALibration:FREQuency:REFerence:FINE is the method for adjusting the timebase. The :COARse command is provided as an alias to :FINE.
Initial S/W Revision	Prior to A.02.00

Remote Command	:CALibration:FREQuency:REFerence:COARse <integer> :CALibration:FREQuency:REFerence:COARse?
Example	:CAL:FREQ:REF:COAR 8191
Notes	This is an alias for CAL:FREQ:REF:FINE any change to COARse is reflected in FINE and vice-versa. See CAL:FREQ:REF:FINE for description of functionality.
Couplings	Setting :CAL:FREQ:REF:COAR sets :CAL:FREQ:REF:MODE USER
Initial S/W Revision	Prior to A.02.00

I/O Config

Activates a menu for identifying and changing the I/O configuration for remote control.

Key Path	System
Initial S/W Revision	Prior to A.02.00

GPIB

Activates a menu for configuring the GPIB I/O port.

Key Path	System, I/O Config
Initial S/W Revision	A.02.00

GPIB Address

Select the GPIB remote address.

Key Path	System, I/O Config, GPIB
Mode	All
Remote Command	:SYSTem:COMMunicate:GPIB[1][:SELF]:ADDRess <integer> :SYSTem:COMMunicate:GPIB[1][:SELF]:ADDRess?
Example	:SYST:COMM:GPIB:ADDR 17
Notes	Changing the Address on the GPIB port requires all further communication to use the new address.
Preset	This is unaffected by Preset but is set to 18 on a "Restore System Defaults->Misc"
State Saved	No
Range	0 to 30
Min	0
Max	30
Initial S/W Revision	Prior to A.02.00

GPIB Controller

Sets the GPIB port into controller or device mode. In the normal state, GPIB controller is disabled, which allows the analyzer to be controlled by a remote computer. When GPIB Controller is enabled, the instrument can run software applications that use the instrument's computer as a GPIB controller; controlling devices connected to the instrument's GPIB port.

NOTE

When GPIB Controller is enabled, the analyzer application itself cannot be controlled over GPIB. In this case it can easily be controlled via LAN or USB. The GPIB port cannot be a controller and device at the same time. Only one controller can be active on the GPIB bus at any given time. If the analyzer is the controller, an external PC cannot be a controller.

To control the instrument from the software that is performing GPIB controller operation, you can use an internal TCP/IP connection to the analyzer application. Use the address TCPIP0:localhost:inst0:INSTR to send SCPI commands to the analyzer application.

Key Path	System, I/O Config, GPIB
----------	--------------------------

Mode	All
Scope	Mode Global
Remote Command	:SYSTem:COMMunicate:GPIB[1][:SELF]:CONTroller[:ENABle] ON OFF 0 1 :SYSTem:COMMunicate:GPIB[1][:SELF]:CONTroller[:ENABle]?
Example	:SYST:COMM:GPIB:CONT ON Will set GPIB port to Controller
Notes	When the instrument becomes the Controller bit 0 in the Standard Event Status Register is set (and when the instrument relinquishes Controller capability bit 0 is cleared in the Standard Event Status Register).
Preset	This is unaffected by Preset but is set to OFF on a “Restore System Defaults->Misc”
State Saved	No
Range	Disabled Enabled
Initial S/W Revision	A.02.00

Disabled

Disables the GPIB Controller capability, this is the default (or normal) setting.

Key Path	System, I/O Config, GPIB, GPIB Controller
Example	:SYST:COMM:GPIB:CONT OFF Will set GPIB port to Device
Initial S/W Revision	A.02.00

Enabled

Enables the GPIB Controller capability.

Key Path	System, I/O Config, GPIB, GPIB Controller
Example	:SYST:COMM:GPIB:CONT ON Will set GPIB port to Controller
Initial S/W Revision	A.02.00

SCPI LAN

Activates a menu for identifying and changing the SCPI over a LAN configuration. There are a number of different ways to send SCPI remote commands to the instrument over LAN. It can be a problem to have multiple users simultaneously accessing the instrument over the LAN. These keys limit that somewhat by disabling the telnet, socket, and/or SICL capability.

Key Path	System, I/O Config
Initial S/W Revision	Prior to A.02.00

SCPI Telnet

Turns the SCPI LAN telnet capability On or Off allowing you to limit SCPI access over LAN through telnet.

Key Path	System, I/O Config, SCPI LAN
Mode	All
Remote Command	:SYSTem:COMMunicate:LAN:SCPI:TELNet:ENABle OFF ON 0 1 :SYSTem:COMMunicate:LAN:SCPI:TELNet:ENABle?
Example	:SYST:COMM:LAN:SCPI:TELN:ENAB OFF
Preset	This is unaffected by Preset but is set to ON with a “Restore System Defaults->Misc”
State Saved	No
Range	On Off
Initial S/W Revision	Prior to A.02.00

SCPI Socket

Turns the capability of establishing Socket LAN sessions On or Off. This allows you to limit SCPI access over LAN through socket sessions.

Key Path	System, I/O Config, SCPI LAN
Mode	All
Remote Command	:SYSTem:COMMunicate:LAN:SCPI:SOCKet:ENABle OFF ON 0 1 :SYSTem:COMMunicate:LAN:SCPI:SOCKet:ENABle?
Example	:SYST:COMM:LAN:SCPI:SOCK:ENAB OFF
Preset	This is unaffected by a Preset but is set to ON with a “Restore System Defaults->Misc”
State Saved	No
Range	On Off
Initial S/W Revision	Prior to A.02.00

SICL Server

Turns the SICL server capability On or Off, enabling you to limit SCPI access over LAN through the SICL server. (SICL IEEE 488.2 protocol.)

Parameter	Description	Setting
Maximum Connections	The maximum number of connections that can be accessed simultaneously	5
Instrument Name	The name (same as the remote SICL address) of your analyzer	inst0
Instrument Logical Unit	The unique integer assigned to your analyzer when using SICL LAN	8
Emulated GPIB Name	The name (same as the remote SICL address) of the device used	gpib7

	when communicating with your analyzer	
Emulated GPIB Logical Unit	The unique integer assigned to your device when it is being controlled using SICL LAN	8
Emulated GPIB Address	The emulated GPIB address assigned to your transmitter tester when it is a SICL server (the same as your GPIB address)	18

Key Path	System, I/O Config, SCPI LAN
Mode	All
Remote Command	:SYSTem:COMMunicate:LAN:SCPI:SICL:ENABle OFF ON 0 1 :SYSTem:COMMunicate:LAN:SCPI:SICL:ENABle?
Example	:SYST:COMM:LAN:SCPI:SICL:ENAB OFF
Preset	This is unaffected by Preset, but is set to ON with a “Restore System Defaults->Misc”
State Saved	No
Range	On Off
Initial S/W Revision	Prior to A.02.00

HiSLIP Server

Turns the HiSLIP server capability On or Off, enabling you to limit SCPI access over LAN through the HiSLIP server.

HiSLIP stands for High Speed LAN Instrument Protocol and is part of the IVI-6.1 specification.

Here is an example of a VISA connection string used to connect to the HiSLIP Server on an X-Series Spectrum Analyzer:

```
TCPIP0::a-n9030a-93016::hislip0::INSTR
```

In the example above, hislip0 is the HiSLIP device name that VISA users must include in their HiSLIP VISA Address strings. Your HiSLIP device name may be different depending on your VISA settings.

Key Path	System, I/O Config, SCPI LAN
Mode	All
Remote Command	:SYSTem:COMMunicate:LAN:SCPI:HISLip:ENABle OFF ON 0 1 :SYSTem:COMMunicate:LAN:SCPI:HISLip:ENABle?
Example	:SYST:COMM:LAN:SCPI:HISL:ENAB OFF
Preset	This is unaffected by Preset, but is set to ON with a “Restore System Defaults->Misc”
State Saved	No
Range	On Off
Initial S/W Revision	A.11.00

SCPI Socket Control Port (Remote Command Only)

Returns the TCP/IP port number of the control socket associated with the SCPI socket session. This query enables you to obtain the unique port number to open when a device clear is to be sent to the instrument. Every time a connection is made to the SCPI socket, the instrument creates a peer control socket. The port number for this socket is random. The user must use this command to obtain the port number of the control socket. To force a device clear on this socket, open the port and send the string "DCL" to the instrument.

If this SCPI command is sent to a non SCPI Socket interface, then 0 is returned.

Mode	All
Remote Command	:SYSTem:COMMunicate:LAN:SCPI:SOCKet:CONTrol?
Example	:SYST:COMM:LAN:SCPI:SOCK:CONT?
Preset	This is unaffected by Preset or "Restore System Defaults->Misc".
State Saved	No
Range	0 to 65534
Min	0
Max	65534
Initial S/W Revision	Prior to A.02.00

Reset Web Password

The embedded web server contains certain capability which are password protected; modifying the LAN configuration of the instrument, and access to web pages that can change the settings of the instrument. The default password from the factory is 'agilent' (without the quotes). The control provided here is the means to set the web password as the user desires, or to reset the password to the factory default.

Selecting Reset web password brings up a control for resetting the password as the user desires, or to the factory default. A keyboard is required to change the password from the factory default of 'agilent' or to set a new password that contains alphabetic characters. The control is:

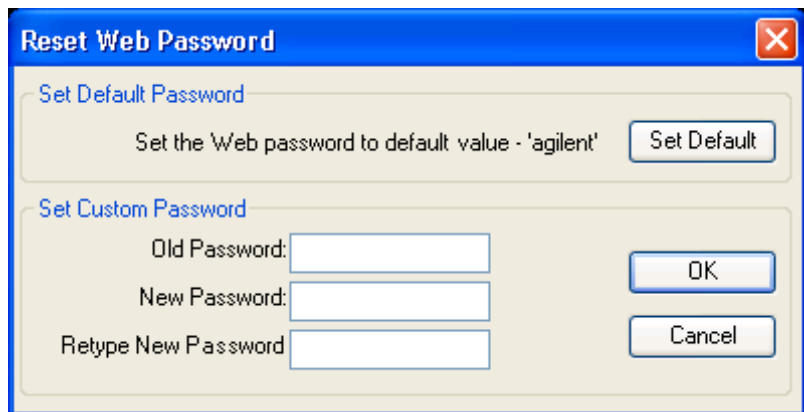

If this control is entered without an external keyboard or mouse connected, you can cancel the control by pressing the Cancel (ESC) front-panel key.

Key Path	System, I/O Config
Mode	All
Initial S/W Revision	Prior to A.02.00

LXI

Opens a menu that allows you to access the various LXI configuration properties.

Key Path	System, I/O Config
Initial S/W Revision	Prior to A.02.00

LAN Reset

Resets the LAN connection.

Key Path	System, I/O Config, LXI
Initial S/W Revision	Prior to A.02.00

Device Identification (Remote Command Only)

Enabling the LXI device identification will place the LXI Status Indicator to the 'Identify' state. Disabling the LXI device identification will place the LXI Status Indicator to the 'No Fault' state. The LXI Status indicator is in the upper left region of the instrument's graphical user interface (.

Mode	All
Remote Command	:LXI:IDENtify[:STATe] OFF ON 0 1 :LXI:IDENtify[:STATe]?
Example	:LXI:IDEN ON
Preset	Not part of Preset, but reset to OFF on Restore System Defaults All
State Saved	No
Range	On Off
Initial S/W Revision	A.12.50

System IDN Response

This key allows you to specify a response to the *IDN? query, or to return the analyzer to the Factory response if you have changed it.

To choose the factory-set response, press the Factory key.

To specify your own response, press the User key, and enter your desired response.

If your test software is expecting the response to indicate Agilent Technologies as the Manufacturer, you can conveniently configure the response by pressing the Agilent key.

Key Path	System, I/O Config
Mode	All
Remote Command	
Notes	<ul style="list-style-type: none"> • This affects the response given in all Modes of the Analyzer, unless the current Mode has also specified a custom response, in which case the current Mode's custom IDN response takes precedence over the System's, but only while that Mode is the current Mode.. • It survives shutdown and restart of the software and therefore survives a power cycle
Preset	This is unaffected by Preset but is set to Factory on a "Restore System Defaults->Misc"
State Saved	No
Initial S/W Revision	A.06.00
Modified at S/W Revision	x.14.50

Factory

This key selects the factory setting, for example:

"Agilent Technologies,N9020A,MY00012345,A.05.01"

where the fields are manufacturer, model number, serial number, firmware revision.

Key Path	System, I/O Config, IDN Response
Example	:SYST:IDN:CONF FACT
Initial S/W Revision	A.06.0

User

This key allows you to specify your own response to the *IDN? query. You may enter your desired response with the Alpha Editor or a plugin PC keyboard.

When you press this key, the active function becomes the current User string with the cursor at the end. This makes it easy to edit the existing string.

If you enter a null string (for example, by clearing the User String while editing and then pressing Done) the analyzer automatically reverts to the Factory setting.

Key Path	System, I/O Config, IDN Response
Example	:SYST:IDN:CONF USER
Initial S/W Revision	A.06.00

Query USB Connection (Remote Command Only)

Enables you to determine the speed of the USB connection.

Mode	All
Remote Command	:SYSTem:COMMunicate:USB:CONNectioN?
Example	:SYST:COMM:USB:CONN?
Notes	NONE – Indicates no USB connection has been made. LSPeed – Indicates a USB low speed connection (1.5 Mbps). This is reserved for future use, the T+M488 protocol is not supported on low speed connections. HSPeed – Indicates that a USB high speed connection (480 Mbps) has been negotiated. FSPeed – Indicates that a USB full speed connection (12 Mbps) has been negotiated.
State Saved	No
Range	NONE LSPeed HSPeed FSPeed
Initial S/W Revision	Prior to A.02.00

USB Connection Status (Remote Command Only)

Enables you to determine the current status of the USB connection.

Mode	All
Remote Command	:SYSTem:COMMunicate:USB:STATus?
Example	:SYST:COMM:USB:STAT?
Notes	SUSPended – Indicates that the USB bus is currently in its suspended state. The bus is in the suspended state when: <ul style="list-style-type: none"> • The bus is not connected to any controller • The controller is currently powered off • The controller has explicitly placed the USB device into the suspended state. When in the suspended state, no USB activity, including start of frame packets are received. ACTive – Indicates that the USB device is in the active state. When the device is in the active state, it is receiving periodic start of frames but it isn't necessarily receiving or transmitting data.
State Saved	No
Range	SUSPended ACTive
Initial S/W Revision	Prior to A.02.00

USB Packet Count (Remote Command Only)

Enables you to determine the number of packets received and transmitted on the USB bus.

Mode	All
------	-----

Remote Command	:SYSTem:COMMunicate:USB:PACKets?
Example	:SYST:COMM:USB:PACK?
Notes	Two integers are returned. The first is the number of packets received since application invocation, the second is the number of packets transmitted since application invocation. If no packets have been received or transmitted the response is 0,0. The packet count is initialized to 0,0 when the instrument application is started.
State Saved	No
Initial S/W Revision	Prior to A.02.00

Restore Defaults

Provides incremental initialization of the system setting groups along with supporting a comprehensive reset of the entire instrument back to a factory default state. The menu selections are the groups of system settings and when one is selected, that particular group of system settings is reset back to their default values.

Key Path	System
Mode	All
Remote Command	:SYSTem:DEFault [ALL] ALIGn INPut MISC MODes PON
Example	SYST:DEF
State Saved	No
Initial S/W Revision	Prior to A.02.00

Restore Input/Output Defaults

Causes the group of settings and data associated with Input/Output front-panel key to be a reset to their default values. This level of Restore System Defaults does not affect any other system settings, mode settings and does not cause a mode switch. .

Confirmation is required to restore the Input/Output setting. The confirmation dialog is:

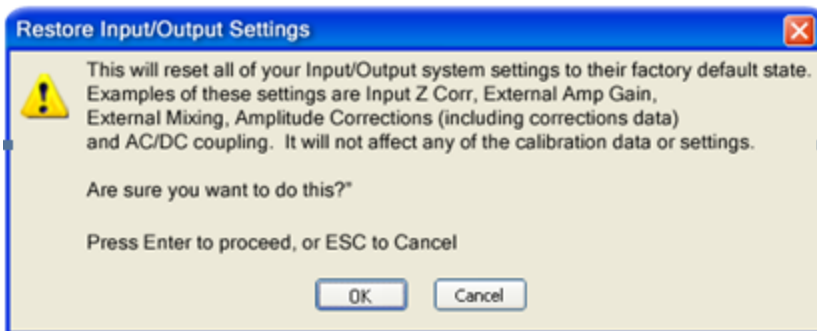

Key Path	System, Restore System Defaults
-----------------	---------------------------------

Example	:SYST:DEF INP
Initial S/W Revision	Prior to A.02.00

Restore Power On Defaults

This selection causes the Power On settings to be a reset to their default value. This level of Restore System Defaults does not affect any other system settings, mode settings and does not cause a mode switch. The Power On settings and their default values are Power On Type reset to Mode and Input/Output Defaults and Power On Application reset to whatever the factory set as its default value.

Confirmation is required to restore the factory default values. The confirmation dialog is:

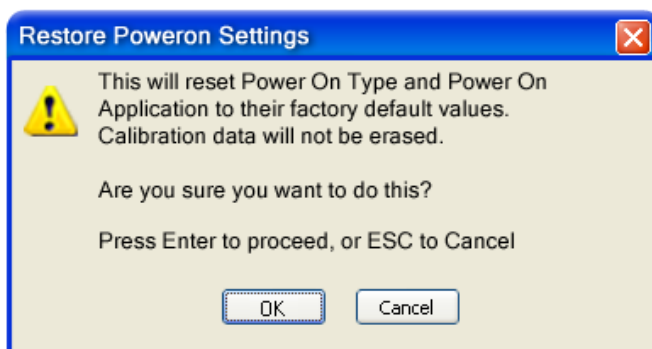

Key Path	System, Restore System Defaults
Example	:SYST:DEF PON
Initial S/W Revision	Prior to A.02.00

Restore Align Defaults

This selection causes the Alignment system settings to be a reset to their default values. This does not affect any Alignment data stored in the system. This level of Restore System Defaults does not affect any other system settings, mode settings and does not cause a mode switch.

After performing this function, it may impact the auto-alignment time of the instrument until a new alignment baseline has been established.

Confirmation is required to restore the factory default values. The confirmation dialog is:

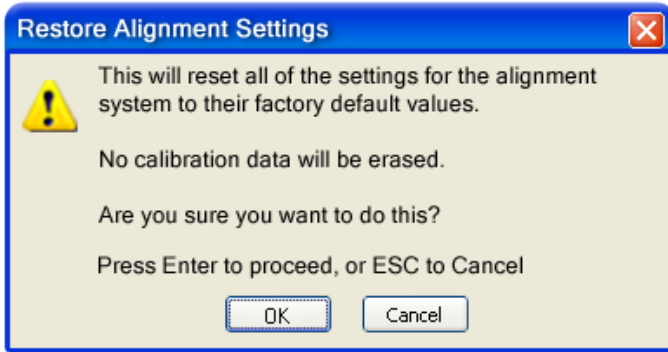

Key Path	System, Restore System Defaults
Example	:SYST:DEF ALIG
Initial S/W Revision	Prior to A.02.00

Restore Misc Defaults

This selection causes miscellaneous system settings to be reset to their default values. With this reset, you lose the GPIB address and it is reset to 18, so this should be used with caution. This level of Restore System Defaults does not affect any other system settings, mode settings and does not cause a mode switch. This miscellaneous group contains the rest of the settings that have not been part of the other Restore System Defaults groups. The following table is a complete list of settings associated with this group:

Miscellaneous Setting	Default Value
Verbose SCPI	Off
The SYST:PRES:TYPE	MODE
Auto File Name Number	000
Save Type	State
State Save To	Register 1
Screen Save To	SCREEN000.png
DISP:ENABLE	ON
Full Screen	Off
SCPI Telnet	ON
SCPI Socket	ON
SICL Server	ON
Softkey Language	English
System Annotation	ON
Display Theme	TDCOLOR
System IDN Response	Factory result of *IDN?

Miscellaneous Setting	Default Value
System IDN Response selection	Factory
Display Intensity	100
Display Backlight	ON
GPIB Address	18

Confirmation is required to restore the factory default values. The confirmation dialog is:

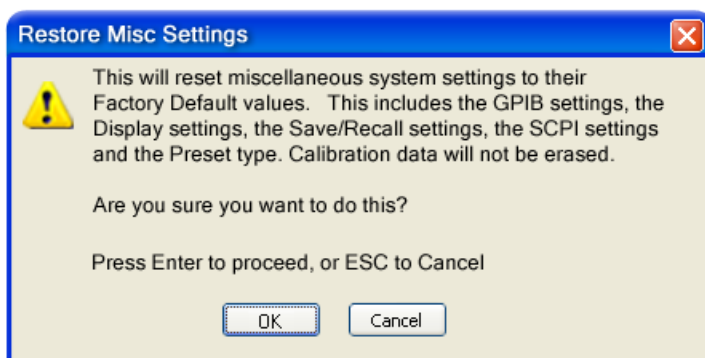

Key Path	System, Restore System Defaults
Example	:SYST:DEF MISC
Initial S/W Revision	Prior to A.02.00
Modified at S/W Revision	x.14.50

Restore Mode Defaults (All Modes)

This selection resets all of the modes in the instrument back to their default state just as a Restore Mode Defaults does and it switches the instrument to the power-on mode and causes the default measurement for the power-on mode to be active. This level of Restore System Defaults does not affect any system settings, but it does affect the state of all modes and does cause a mode switch unless the instrument was already in the power-on mode.

Confirmation is required to restore the factory default values. The confirmation dialog is:

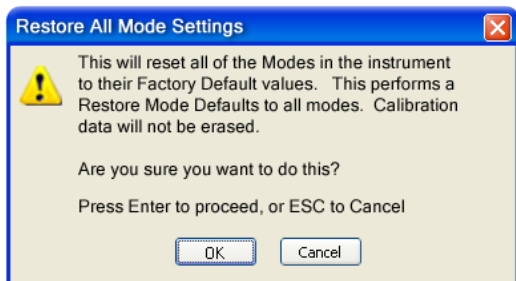

Key Path	System, Restore System Defaults
Example	:SYST:DEF MOD
Couplings	An All Mode will cause the currently running measurement to be aborted, mode switch to the power-on mode and activate the default measurement for the power-on mode.. It gets the mode to a consistent state with all of the default couplings set.
Initial S/W Revision	Prior to A.02.00

All

This performs a comprehensive reset of ALL analyzer settings to their factory default values. It resets all of the system setting groups, causes a Restore Mode Defaults for all modes in the instrument, and switches back to the power-on mode. It does not affect the User Preset file or any user saved files.

Confirmation is required to restore the factory default values. The confirmation dialog is:

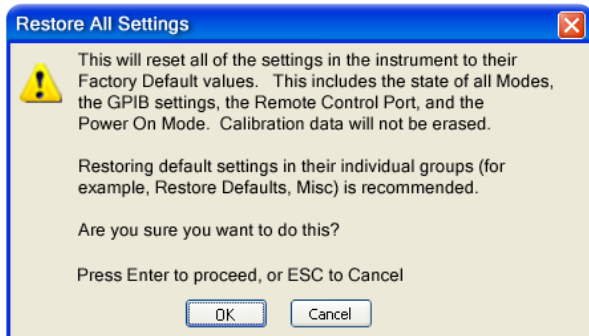

NOTE

If you are using an Keysight USB External Mixer, then you will need to perform a Refresh USB Mixer Connection after Restoring All Defaults.

Key Path	System, Restore System Defaults
Example	:SYST:DEF ALL
Notes	If using Keysight USB External Mixer, perform a Refresh USB Mixer Connection (SCPI command :MIX:BAND USB) following a Restore All Defaults.
Couplings	An All will cause the currently running measurement to be aborted and get all modes to a consistent state, so it is unnecessary to couple any settings.
Initial S/W Revision	Prior to A.02.00
Modified at S/W Revision	A.14.00

Control Panel...

Opens the Windows Control Panel. The Control Panel is used to configure certain elements of Windows that are not configured through the hardkey/softkey System menus.

NOTE This feature is not available if option SF1 is installed.

The Control Panel is a separate Windows application, so to return to the analyzer once you are in the Control Panel, you may either:

Exit the Control Panel by clicking on the red X in the upper right hand corner, with a mouse

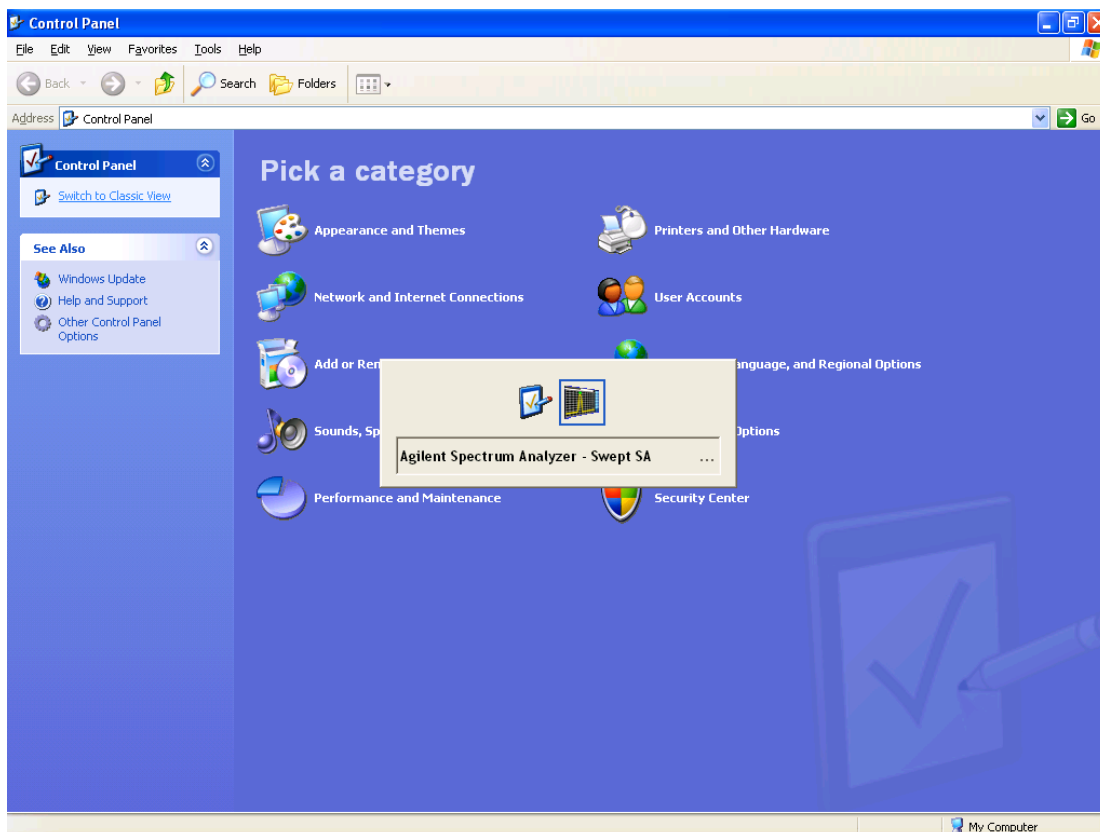

Or use Alt-Tab: press and hold the Alt key and press and release the Tab key until the Analyzer logo is showing in the window in the center of the screen, as above, then release the Alt key.

Key Path	System
Notes	No remote command for this key.
Initial S/W Revision	Prior to A.02.00

Licensing...

Opens the license explorer.

NOTE This feature is not available if option SF1 is installed.

For Help on this key, select Help in the menu bar at the top of the license explorer window.

Key Path	System
Notes	No equivalent remote command for this key.
Backwards Compatibility Notes	In ESA the SCPI command for displaying the Show Licenses screen is: :SYSTem:CONFigure:LKEY:STATe OFF ON 0 1:SYSTem:CONFigure:LKEY:STATe? There are no equivalent SCPI commands in the X-Series for displaying the License Explorer.
Initial S/W Revision	Prior to A.02.00

Remote Command	:SYSTem:LKEY <"OptionInfo">, <"LicenseInfo">
Example	SYST:LKEY "N9073A-1FP", "027253AD27F83CDA5673A9BA5F427FDA5E4F25AEB1017638211AC9F60D9C639FE539735909C551DE0A91"
Notes	The <"OptionInfo"> contains the feature and the version. You must specify the feature but can omit the version. If you omit the version, the system regards it as the latest one, since the system knows which version is supported for each feature. The <"LicenseInfo"> contains the signature, the expiration date, and serial number for transport if transportable. You must specify the signature, but you can omit the other information. If you omit the expiration date, the system regards it as permanent. If you omit the serial number, the system regards it as non-transportable. As a result, this supports reverse compatibility.
Initial S/W Revision	Prior to A.02.00

Remote Command	:SYSTem:LKEY:DElete <"OptionInfo">,<"LicenseInfo">
Example	SYST:LKEY:DEL 'N9073A-1FP', "027253AD27F83CDA5673A9BA5F427FDA5E4F25AEB1017638211AC9F60D9C639FE539735909C551DE0A91"
Notes	The <"OptionInfo"> contains the feature and the version. You must specify the feature but can omit the version. If you omit the version, the system regards it as the latest one, if more than one version is installed. The <"LicenseInfo"> contains the signature, the expiration date, and whether or not be transportable. You must specify the signature, but you can omit the other information. If you omit the expiration date, the system regards it as permanent. If you omit the transportability, the system regards it as non-transportable. As a result, this supports reverse compatibility.
Initial S/W Revision	Prior to A.02.00

Remote Command	:SYSTem:LKEY:LIST?
Notes	<p>Return Value:</p> <p>An <arbitrary block data> of all the installed instrument licenses.</p> <p>The format of each license is as follows.</p> <p><Feature>,<Version>,<Signature>,<Expiration Date>,<Serial Number for Transport></p> <p>Return Value Example:</p> <p>#3136</p> <p>N9073A-1FP,1.000,B043920A51CA</p> <p>N9060A-2FP,1.000,4D1D1164BE64</p> <p>N9020A-508,1.000,389BC042F920</p> <p>N9073A-1F1,1.000,5D71E9BA814C,13-aug-2005</p> <p><arbitrary block data> is:</p> <p>#NMMM<data></p> <p>Where:</p> <p>N is the number of digits that describes the number of MMM characters. For example if the data was 55 bytes, N would be 2.</p> <p>MMM would be the ASCII representation of the number of bytes. In the previous example, N would be 55.</p> <p><data> ASCII contents of the data</p>
Initial S/W Revision	Prior to A.02.00
Remote Command	:SYSTem:LKEY? <"OptionInfo">
Example	SYST:LKEY? "N9073A-1FP"
Notes	<p>The <"OptionInfo"> contains the feature and the version. You must specify the feature but can omit the version. If you omit the version, the system regards it as the latest one.</p> <p>Return Value:</p> <p><"LicenseInfo"> if the license is valid, null otherwise.</p> <p><"LicenseInfo"> contains the signature, the expiration date, and serial number if transportable.</p> <p>Return Value Example:</p> <p>"B043920A51CA"</p>
Initial S/W Revision	Prior to A.02.00
Remote Command	:SYSTem:HID?
Notes	Return value is the host ID as a string
Initial S/W Revision	Prior to A.02.00

Security

Accesses capabilities for operating the instrument in a security controlled environment.

Key Path	System
Initial S/W Revision	A.04.00

USB

The Windows operating system can be configured to disable write access to the USB ports for users who are in a secure environment where transferring data from the instrument is prohibited. This user interface is a convenient way for the customer to disable write access to USB.

Key Path	System, Security
Mode	All
Scope	Mode Global
Remote Command	:SYSTem:SECurity:USB:WPRotect[:ENABLE] ON OFF 0 1 :SYSTem:SECurity:USB:WPRotect[:ENABLE]?
Example	:SYST:SEC:USB:WPR ON Will set USB ports to Read-only
Notes	When the USB ports are in Read-only mode then no data can be stored to USB, including the internal USB memory used for a back-up location for the calibration data.
Dependencies	This key is grayed-out unless the current user has administrator privileges.
Preset	This is unaffected by Preset or any Restore System Defaults. An Agilent Recovery will set the USB to write protect OFF
State Saved	No
Range	Read-Write Read only
Initial S/W Revision	A.04.00

Read-Write

Selection for allowing full read-write access to the USB ports.

Key Path	System, Security, USB
Example	:SYST:SEC:USB:WPR OFF Will set USB ports to Read-Write
Initial S/W Revision	A.04.00

Read only

Selection for disabling write access to the USB ports.

Key Path	System, Security, USB	
Example	:SYST:SEC:USB:WPR ON	Will set USB ports to Read only
Initial S/W Revision	A.04.00	

Diagnostics

The Diagnostics key in the System menu gives you access to basic diagnostic capabilities of the instrument.

Key Path	System
Initial S/W Revision	Prior to A.02.00

Show Hardware Statistics

Provides a display of various hardware statistics. The statistics include the following:

- Mechanical relay cycles
- High and Low temperature extremes
- Elapsed time that the instrument has been powered-on (odometer)

The display should appear listing the statistics, product number, serial number, and firmware revision.

Hardware Statistical Information
 Agilent MXA Signal Analyzer
 Product Number: N9020A
 Serial Number: US00061145
 Instrument S/W Revision: A.12.00
 Revision Date: 7/11/2012 12:11:10 PM

Component Name	Value	
MechAtten #1 Count Total	457304	
Calibrator Switch Cycles	105953	
AC/DC Switch Cycles	114240	
2 dB #1 Mechanical Atten Cycles	112655	
2 dB #2 Mechanical Atten Cycles	124456	
MechAtten #2 Count Total	472265	
6 dB Mechanical Atten Cycles	115302	
10 dB Mechanical Atten Cycles	93602	
20 dB Mechanical Atten Cycles	144781	
30 dB Mechanical Atten Cycles	118580	
Low Noise Path Switch	45668	Only shown if LNP installed
Preselector Bypass Cycles	31133	Only shown if MPB installed
High temperature operating extreme	45.75	
Low temperature operating extreme	-23.9375	
Elapsed Time (On-Time)(hours)	134164	

The CXA models in which the AC/DC Switch field is called Fixed Atten and that omit the mechanical attenuation fields are the N9000A–503/507 models.

Modular HWs only have time and temperature information in Show Hardware Statistics.

The data will be updated only when the Show Hardware Statistics menu key is pressed, it will not be updated while the screen is displayed.

The tabular data should be directly printable.

Key Path	System, Diagnostics
Mode	All
Notes	The values displayed on the screen are only updated upon entry to the screen and not updated while the screen is being displayed.
Initial S/W Revision	Prior to A.02.00

SCPI for Show Hardware Statistics (Remote Commands Only)

Each of the hardware statistic items can be queried via SCPI.

- "Query the Mechanical Relay Cycle Count" on page 421
- "Query the Operating Temperature Extremes" on page 421
- "Query the Elapsed Time since 1st power on" on page 422

Query the Mechanical Relay Cycle Count

Return the count of mechanical relay cycles.

For N9038A model, there are additional 2 Mechanical Relays which are <N9038A Input2>, <N9038A Bypass>.

Remote Command	:SYSTem:MRELay:COUNT?
Example	:SYST:MREL:COUN?
Notes	<p>Query Only</p> <p>The return value is a comma separated list of the individual counts for each mechanical relay.</p> <p>The position of the relays in the list is: “<Cal Signal>,<AC/DC>,<2dB #1 Atten>,<2dB #2 Atten>,<6dB Atten>,<10dB Atten>,<20dB Atten>,<30dB Atten>,<Fixed Atten>,<Low Noise Path Switch>,<Presel Bypass>,<N9038A Input2>,<N9038A Bypass>”</p> <p>Items in the list not pertaining to your particular hardware configuration will return as -999 for those items.</p>
Initial S/W Revision	Prior to A.02.00
Modified at S/W Revision	A.08.00

Query the Operating Temperature Extremes

Returns the low operating temperature extreme value. The value survives a power-cycle and is the temperature extreme encountered since the value was reset by the factory or service center.

Mode	All
Remote Command	:SYSTem:TEMPerature:LEXTreme?
Example	:SYST:TEMP:LEXT?
Notes	Value is in degrees Celsius at which the lowest operating temperature has been recorded since 1st power-up.
State Saved	No
Initial S/W Revision	Prior to A.02.00

Mode	All
Remote Command	:SYSTem:TEMPerature:HEXTreme?
Example	:SYST:TEMP:HEXT?
Notes	Value is in degrees Celsius at which the highest operating temperature has been recorded since 1st power-up.
State Saved	No
Initial S/W Revision	Prior to A.02.00

Query the Elapsed Time since 1st power on

Returns the elapsed on-time in minutes since 1st power-on.

Remote Command	:SYSTem:PON:ETIMe?
Example	:SYST:PON:ETIM?
Notes	Query Only
Initial S/W Revision	Prior to A.02.00

Internet Explorer...

This key launches Microsoft Internet Explorer. A mouse and external keyboard are highly desired for using Internet Explorer. When Internet Explorer is running, close Internet Explorer to return focus to the Instrument Application (or use Alt-Tab).

NOTE This feature is not available if option SF1 is installed.

Key Path	System
Mode	All
Notes	No equivalent remote command for this key.
Initial S/W Revision	A.05.01

System Remote Commands (Remote Commands Only)

The commands in this section have no front-panel key equivalent.

- "System Powerdown (Remote Command Only)" on page 422
- "List installed Options (Remote Command Only)" on page 423
- "Lock the Front-panel keys (Remote Command Only)" on page 423
- "List SCPI Commands (Remote Command Only)" on page 424
- "SCPI Version Query (Remote Command Only)" on page 424
- "Date (Remote Command Only)" on page 424
- "Time (Remote Command Only)" on page 424

Initial S/W Revision	Prior to A.02.00
-----------------------------	------------------

System Powerdown (Remote Command Only)

Remote Command	SYSTem:PDOWn [NORMal FORCe]
Notes	Shuts down the instrument in the normal way (NORMAL) or forced way (FORCE). In case there is

another application with modified data pending for saving, the application prompts the user. The system waits until the user responds in the normal mode. It will go off after 20 seconds of wait in the force mode and all data will be lost.

List installed Options (Remote Command Only)

Lists the installed options that pertain to the instrument (signal analyzer). .

Mode	All
Remote Command	:SYSTem:OPTions?
Example	:SYST:OPT?
Notes	The return string is a comma separated list of the installed options. For example: "503,P03,PFR" :SYSTem:OPTions? and *OPT? are the same.
State Saved	No
Initial S/W Revision	Prior to A.02.00

Lock the Front-panel keys (Remote Command Only)

Disables the instrument keyboard to prevent local input when the instrument is controlled remotely. Annunciation showing a "K" for "Klock" (keyboard lock) alerts the local user that the keyboard is locked. Klock is similar to the GPIB Local Lockout function; namely that no front-panel keys are active with the exception of the Power Standby key. (The instrument is allowed to be turned-off if Klock is ON.) The Klock command is used in remote control situations where Local Lockout cannot be used.

Although primary intent of Klock is to lock-out the front panel, it will lock-out externally connected keyboards through USB. Klock has no effect on externally connected pointing devices (mice).

The front panel 'Local' key (Cancel/Esc) has no effect if Klock is ON.

Mode	All
Remote Command	:SYSTem:KLOCK OFF ON 0 1 :SYSTem:KLOCK?
Example	:SYST:KLOC ON
Notes	Keyboard lock remains in effect until turned-off or the instrument is power-cycled
Preset	Initialized to OFF at startup, unaffected by Preset
State Saved	No
Initial S/W Revision	Prior to A.02.00

List SCPI Commands (Remote Command Only)

Outputs a list of the valid SCPI commands for the currently selected Mode.

Remote Command	:SYSTem:HELP:HEADers?
Example	:SYST:HELP:HEAD?
Notes	The output is an IEEE Block format with each command separated with the New-Line character (hex 0x0A)
Initial S/W Revision	Prior to A.02.00

SCPI Version Query (Remote Command Only)

Returns the SCPI version number with which the instrument complies. The SCPI industry standard changes regularly. This command indicates the version used when the instrument SCPI commands were defined.

Remote Command	:SYSTem:VERSion?
Example	:SYST:VERS?
Initial S/W Revision	Prior to A.02.00

Date (Remote Command Only)

The recommended access to the Date, Time, and Time zone of the instrument is through the Windows native control (Control Panel or accessing the Task Bar). You may also access this information remotely, as shown in this command and Time (below).

Sets or queries the date in the instrument.

Mode	All
Remote Command	:SYSTem:DATE "<year>,<month>,<day>" :SYSTem:DATE?
Example	:SYST:DATE "2006,05,26"
Notes	<year> is the four digit representation of year. (for example, 2006) <month> is the two digit representation of year. (for example. 01 to 12) <day> is the two digit representation of day. (for example, 01 to 28, 29, 30, or 31) depending on the month and year Unless the current account has Power User or Administrator privileges, an error will be generated by this command and no action will be taken.
Initial S/W Revision	Prior to A.02.00

Time (Remote Command Only)

Sets or queries the time in the instrument.

Mode	All
Remote Command	:SYSTem:TIME "<hour>, <minute>, <second>" :SYSTem:TIME?
Example	:SYST:TIME "13,05,26"
Notes	<hour> is the two digit representation of the hour in 24 hour format <minute> is the two digit representation of minute <second> is the two digit representation of second Unless the current account has Power User or Administrator privileges, an error will be generated by this command and no action will be taken.
Initial S/W Revision	Prior to A.02.00

7 Trigger Functions

Trigger

Accesses a menu of keys to control the selection of the trigger source and the setup of each of the trigger sources. The analyzer is designed to allow triggering from a number of different sources, for example, Free Run, Video, External, RF Burst, and so forth.

The TRIG:SOURCe command (below) will specify the trigger source for the currently selected input (RF or I/Q). If you change inputs, the new input remembers the trigger source it was last programmed to for the current measurement, and uses that trigger source. You can directly set the trigger source for each input using the TRIGger:RF:SOURce and TRIGger:IQ:SOURce commands (later in this section). When in External Mixing, the analyzer uses the RF trigger source.

Note the inclusion of the <measurement> parameter in the command below. Because each measurement remembers its own Trigger Source, the command must be qualified with the measurement name. Note that for the Swept SA measurement this is not the case; for backwards compatibility, no <measurement> parameter is used when setting the Trigger Source for the Swept SA measurement.

See ["Trigger Source Presets" on page 429](#)

See ["RF Trigger Source" on page 432](#)

See ["I/Q Trigger Source" on page 433](#)

See ["More Information" on page 434](#)

Key Path	Front-panel key
Remote Command	<pre>:TRIGger:<measurement>[:SEquence]:SOURce EXTernal1 EXTernal2 IMMediate LINE FRAMe RFBurst VIDeo IF ALARm LAN IQMag IDEMod QDEMod IINPut QINPut AIQMag TV :TRIGger:<measurement>[:SEquence]:SOURce?</pre> <p>where <measurement> is the measurement for which you wish to set the Source (blank for the Swept SA measurement)</p>
Example	<pre>TRIG:ACP:SOUR EXT1</pre> <p>Selects the external 1 trigger input for the ACP measurement and the selected input</p> <pre>TRIG:SOUR VID</pre> <p>Selects video triggering for the Swept SA (SANalyzer) measurement in the Spectrum Analyzer mode. For SAN, do not use the <measurement> keyword. Only send this form in the Spectrum Analyzer mode or you will get an Undefined Header error</p>
Notes	<p>Not all measurements have all the trigger sources available to them. Check the trigger source documentation for your specific measurement to see what sources are available.</p> <p>Not all trigger sources are available for each input. See the "RF Trigger Source" on page 432 and "I/Q Trigger Source" on page 433 commands for detailed information on which trigger sources are available for each input.</p> <p>Other trigger-related commands are found in the INITiate and ABORt SCPI command subsystems.</p> <p>*OPC should be used after requesting data. This will hold off any subsequent changes to the selected trigger source, until after the sweep is completed and the data is returned.</p> <p>Available ranges and presets can vary from mode to mode.</p>
Dependencies	<p>In some models, there is no second External input. In these models, the External 2 key is blanked and</p>

	the EXternal2 parameter will generate a "Hardware missing; Not available for this model number" message.
Preset	See table below
Status Bits/OPC dependencies	The Status Operation Register bit 5 "Waiting for Trigger" is set at the same time as the Sweeping or Measuring bit is set. It is cleared when the trigger actually occurs (that is, after the trigger event occurs and all the applicable trigger criteria have been met). A corresponding pop-up message ("Waiting for trigger") is generated if no trigger signal appears after approximately 2 sec. This message goes away when a trigger signal appears.
Backwards Compatibility SCPI	:TRIGger[:SEquence]:SOURCe EXTernal For backward compatibility, the parameter EXTernal is mapped to EXTernal1
Backwards Compatibility SCPI	[:SENSe]:<measurement>:TRIGger:SOURce This backwards compatibility alias command is provided for ESA/PSA compatibility This backwards compatibility command does not apply to the Swept SA measurement, for that just use :TRIGger:SOURCe This backwards compatibility command does not apply to the monitor spectrum, log plot and spot frequency measurements
Backwards Compatibility SCPI	[:SENSe]:<measurement>:TRIGger:SOURce IF In earlier instruments, the parameter IF was used by apps for the video trigger, so using the IF parameter selects VIDeo triggering. Sending IF in the command causes VID to be returned to a query.
Backwards Compatibility SCPI	[:SENSe]:ACPR:TRIGger:SOURce This backwards Compatibility SCPI command is provided to support the same functionality as [:SENSe]:ACPr:TRIGger:SOURce (PSA W-CDMA, PSA cdma2000 and PSA 1xEVDO) due to the fact that the ACPr node conflicts with the ACPower node.
Initial S/W Revision	Prior to A.02.00
Modified at S/W Revision	A.03.00

Trigger Source Presets

Here are the Trigger Source Presets for the various measurements:

Meas	Mode	Preset for RF	Preset for IQ	Notes
Swept SA	SA	IMM	IQ not supported	
CHP	SA, WCDMA, C2K, WIMAX OFDMA, 1xEVDO, DVB-T/H, DTMB, LTE, LTETDD, CMMB, ISDB-T, Digital Cable TV, MSR	IMM	IQ not supported	
OBW	SA, WCDMA, C2K, WIMAX OFDMA,	1xEVDO: EXT1 others: IMM	IQ not supported	For 1xEVDO mode, the trigger source is coupled with the gate state, as well as the gate

	TD-SCDMA, 1xEVDO, LTE, LTETDD, CMMB, ISDB-T, MSR			source. When the trigger source changes to RFBurst, External1 or External2, the gate state is set to on, and the gate source is set identically with the trigger source. When the trigger source changes to IMMEDIATE, VIDEO, LINE, FRAME or IF, the gate state is set to off.
CCDF	SA, WCDMA, C2K, WIMAX OFDMA, TD-SCDMA, 1xEV-DO, DVB-T/H, DTMB, LTE, LTETDD, CMMB, ISDB-T, Digital Cable TV, MSR	WIMAX OFDMA: RFBurst LTETDD: BTS: External 1 MS: Periodic Timer TD-SCDMA and 1xEV-DO: BTS: External 1 MS: RFBurst SA, WCDMA, C2K, LTE, CMMB, ISDB-T, DVB-T/H, DTMB, Digital Cable TV, MSR: IMMEDIATE	TD-SCDMA and 1xEV-DO: BTS: External 1 MS: IQMag LTETDD: BTS: External 1 MS: Periodic Timer Others: IMM	For TD-SCDMA: Trigger source is coupled with radio device. When radio device changes to BTS, trigger source will be changed to EXTERNAL1. When radio device changes to MS, trigger source will be set as RFBurst for RF or IQ Mag for BBIQ. When TriggerSource is RFBurst or IQ Mag, Measure Interval is grayed out.
ACP	SA, WCDMA, C2K, WIMAX OFDMA, TD-SCDMA, 1xEVDO, DVB-T/H, DTMB, LTE, LTETDD, CMMB, ISDB-T, Digital Cable TV, MSR	IMM	IQ not supported	
Tx Power	SA, GSM, TD-SCDMA	SA, GSM: RFBurst TD-SCDMA: EXTERNAL	IMM	TD-SCDMA doesn't support the Line and Periodic Timer parameters. When the mode is TD-SCDMA, if the Radio Device is switched to BTS, the value will be changed to External 1 and if the Radio device is switched to MS, the value will be changed to RFBurst
SPUR	SA, WCDMA, C2K, WIMAX OFDMA, TD-SCDMA, 1xEV-DO, DVB-T/H, LTE, LTETDD, MSR	IMM	IQ not supported	
SEM	SA, WCDMA, C2K, WIMAX OFDMA, TD-SCDMA, 1xEVDO, DVB-	1xEVDO(BTS): EXTERNAL1 All others: IMMEDIATE	IQ not supported	

	T/H, DTMB, LTE, LTETDD, CMMB, ISDB-T, Digital Cable TV, MSR			
CDP	WCDMA	IMM	IMM	
RHO	WCDMA	IMM	IMM	
PCON	WCDMA	IMM	IMM	
QPSK	WCDMA, C2K, 1xEVDO	All except CDMA1xEVDO: IMMediate CDMA1xEVDO: EXT1	IMM	
MON	All except SA and BASIC	IMM	IQ not supported	
WAV		LTETDD: BTS: External 1 MS: Periodic Timer GSM/EDGE: RFBurst All others: IMMediate	LTETDD: BTS: External 1 MS: Periodic Timer GSM/EDGE: IQMag All others: IMMMediate	
PVT	WIMAXOFDMA	RFB	IMM	
EVM	WIMAXOFDMA, DVB-T/H, DTMB, LTE, LTETDD, CMMB, ISDB-T, Digital Cable TV	All but CMMB: IMM CMMB: Periodic Timer	All but CMMB: IMM CMMB: External 1	LTE, LTETDD supports Free Run, Video and External 1 only.
SPEC	BASIC	IMM	IMM	
LOG Plot	PN	IMM	IQ not supported	
Spot Freq	PN	IMM	IQ not supported	
GMSK PVT	EDGE/GSM	RFB	IMM	
GMSK PFER	EDGE/GSM	RFB	IQMag	
GMSK ORFS	EDGE/GSM	RF Burst	IQ not supported	
EDGE PVT	EDGE/GSM	RFB	IMM	

EDGE EVM	EDGE/GSM	RFB	IQMag
EDGE ORFS	EDGE/GSM	Periodic Timer	IQ not supported
Combined WCDMA	WCDMA	IMM	IQ not supported
Combined GSM	EDGE/GSM	RFB	IQ not supported
List Power Step	WCDMA, EDGE/GSM	IMM	IQ not supported
Transmit On/Off Power	LTETDD	LTETDD: BTS: External 1 MS: Periodic Timer	LTETDD: BTS: External 1 MS: Periodic Timer
Transmit Analysis	BLUETOOTH	RFB	IQ not supported
Adjacent Channel Power	BLUETOOTH	IMM	IQ not supported
LE In-band Emissions	BLUETOOTH	IMM	IQ not supported
EDR In-band Spurious Emissions	BLUETOOTH	Periodic Timer	IQ not supported
Conformance EVM	LTE, LTETDD, MSR	IMM	IMM

RF Trigger Source

The RF Trigger Source command selects the trigger to be used for the specified measurement when RF is the selected input. The RF trigger source can be queried and changed even while another input is selected, but it is inactive until RF becomes the selected input.

Note the inclusion of the <measurement> parameter in the command below. Because each measurement remembers its own Trigger Source, the command must be qualified with the measurement name. Note that for the Swept SA measurement this is not the case; for backwards compatibility, no <measurement> parameter is used when setting the Trigger Source for the Swept SA measurement.

Remote Command	:TRIGger:<measurement>[:SEquence]:RF:SOURce EXTernal1 EXTernal2 IMMEDIATE LINE FRAME RFBurst VIDEO IF ALARm LAN TV :TRIGger:<measurement>[:SEquence]:RF:SOURce?
-----------------------	--

Example	TRIG:ACP:RF:SOUR EXT1 Selects the external 1 trigger input for the ACP measurement and the RF input
----------------	--

	<p>TRIG:RF:SOUR VID</p> <p>Selects video triggering for the SANalyzer measurement and the RF input. For SAN, do not use the <measurement> keyword.</p>
Notes	<p>Not all measurements have all the trigger sources available to them. Check the trigger source documentation for your specific measurement to see what sources are available.</p> <p>Not all trigger sources are available for each input. For the RF Trigger Source, the following trigger sources are available:</p> <ul style="list-style-type: none"> –IMMediate - free run triggering –VIDeo - triggers on the video signal level –LINE - triggers on the power line signal –EXTernal1 (or EXTernal) - triggers on an externally connected trigger source marked “Trigger 1 In” on the rear panel –EXTernal2 - triggers on an externally connected trigger source marked “Trigger 2 In” on the front panel. In some models, there is no second External input. In these models, the External 2 key is blanked and the EXTernal2 parameter will generate a “Hardware missing; Not available for this model number” message –RFBurst - triggers on the bursted frame –FRAMe - triggers on the periodic timer –IF (video) - same as video, for backwards compatibility only <p>*OPC should be used after requesting data. This will hold off any subsequent changes to the selected trigger source, until after the sweep is completed and the data is returned.</p> <p>Available ranges, and presets can vary from mode to mode.</p>
Status Bits/OPC dependencies	<p>The Status Operation Register bit 5 "Waiting for Trigger" is set at the same time as the Sweeping or Measuring bit is set. It is cleared when the trigger actually occurs (that is, after the trigger event occurs and all the applicable trigger criteria have been met). A corresponding pop-up message ("Waiting for trigger") is generated if no trigger signal appears after approximately 2 sec. This message goes away when a trigger signal appears.</p>
Initial S/W Revision	Prior to A.02.00

I/Q Trigger Source

This command selects the trigger to be used for the specified measurement when I/Q (which requires option BBA) is the selected input. The I/Q trigger source can be queried and changed even while another input is selected, but it is inactive until I/Q becomes the selected input.

Remote Command	<pre>:TRIGger:<measurement>[:SEquence]:IQ:SOURce EXTernal1 EXTernal2 IMMediate IQMag IDEMod QDEMod IINPut QINPut AIQMag :TRIGger:<measurement>[:SEquence]:IQ:SOURce?</pre>
Example	<p>TRIG:WAVeform:SOUR IQM</p> <p>Selects I/Q magnitude triggering for the IQ Waveform measurement and the I/Q input</p>
Notes	<p>Not all measurements have all the trigger sources available to them. Check the trigger source documentation for your specific measurement to see what sources are available.</p> <p>Not all trigger sources are available for each input. For the I/Q Trigger Source, the following trigger sources are available:</p>

	<ul style="list-style-type: none"> –IMMediate - free run triggering –EXTernal1 (or EXTernal) - triggers on an externally connected trigger source on the rear panel –EXTernal2 - triggers on an externally connected trigger source on the front panel –IQMag - triggers on the magnitude of the I/Q signal –IDEMod - triggers on the I/Q signal's demodulated I voltage –QDEMod - triggers on the I/Q signal's demodulated Q voltage –IINPut - triggers on the I channel's ADC voltage –QINPut - triggers on the Q channel's ADC voltage –AIQMag - triggers on the magnitude of the auxiliary receiver channel I/Q signal <p>*OPC should be used after requesting data. This will hold off any subsequent changes to the selected trigger source, until after the sweep is completed and the data is returned.</p> <p>Available ranges, and from mode to mode presets can vary</p>
Status Bits/OPC dependencies	The Status Operation Register bit 5 "Waiting for Trigger" is set at the same time as the Sweeping or Measuring bit is set. It is cleared when the trigger actually occurs (that is, after the trigger event occurs and all the applicable trigger criteria have been met). A corresponding pop-up message ("Waiting for trigger") is generated if no trigger signal appears after approximately 2 sec. This message goes away when a trigger signal appears.
Initial S/W Revision	Prior to A.02.00

More Information

The trigger menus let you select the trigger source and trigger settings for a sweep or measurement. In triggered operation (basically, any trigger source other than Free Run), the analyzer will begin a sweep or measurement only with the selected trigger conditions are met, generally when your trigger source signal meets the specified trigger level and polarity requirements. (In FFT measurements, the trigger controls when the data acquisition begins for FFT conversion.)

For each of the trigger sources, you may define a set of operational parameters or settings which will be applied when that source is selected as the current trigger source. Examples of these settings are Trigger Level, Trigger Delay, and Trigger Slope. You may apply different settings for each source; so, for example, you could have a Trigger Level of 1v for External 1 trigger and –10 dBm for Video trigger.

Once you have established the settings for a given trigger source, they generally will remain unchanged for that trigger source as you go from measurement to measurement within a Mode (although the settings do change as you go from Mode to Mode). Furthermore, the trigger settings within a Mode are the same for the **Trigger** menu, the **Gate Source** menu, and the **Sync Source** menu that is part of the **Periodic Timer Trigger Setup** menu. That is, if **Ext1** trigger level is set to 1v in the **Trigger** menu, it will appear as 1v in both the **Gate Source** and the **Sync Source** menus. For these reasons the trigger settings commands are not qualified with the measurement name, the way the trigger source commands are.

The settings setup menu can be accessed by pressing the key for the current trigger source a second time. For example, one press of Video selects the Video trigger as the source. The Video key becomes highlighted and the hollow arrow on the key turns black. Now a second press of the key takes you into the Video Trigger Setup menu.

Trigger Setup Parameters:

The following examples show trigger setup parameters using an external trigger source.

Example 1 illustrates the trigger conditions with negative slope and no trigger occurs during trigger Holdoff time.

Example 2 illustrates the trigger conditions with positive slope, trigger delay, and auto trigger time.

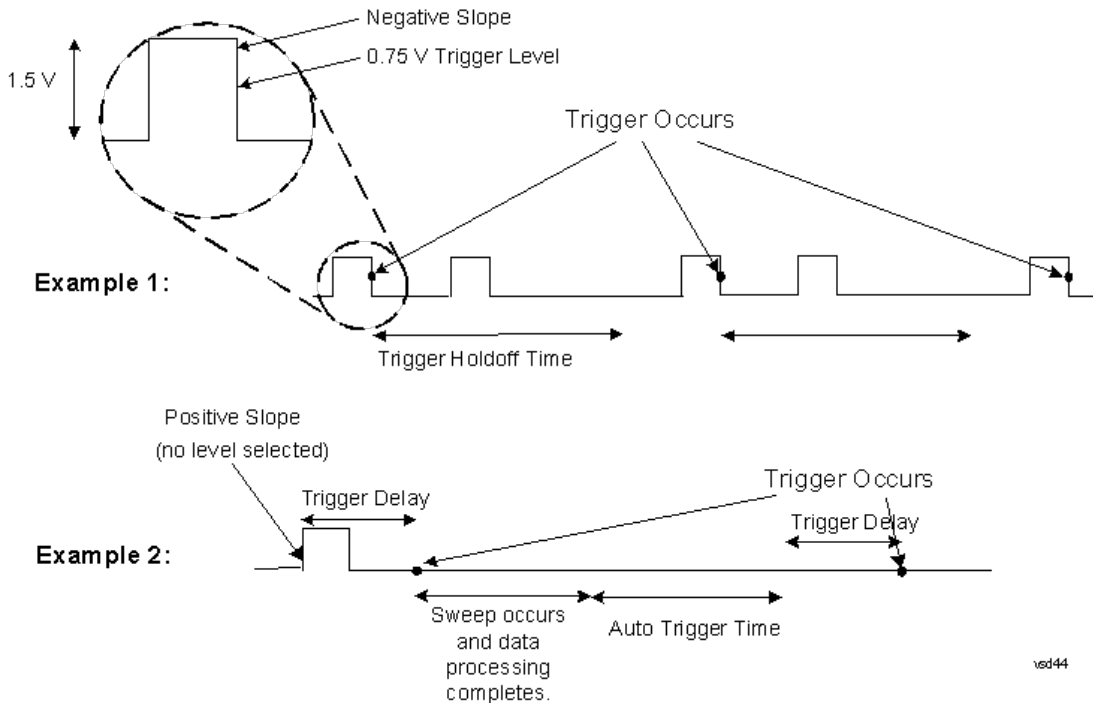

Free Run

Pressing this key, when it is not selected, selects free-run triggering. Free run triggering occurs immediately after the sweep/measurement is initiated.

Key Path	Trigger
Example	TRIG:SOUR IMM Swept SA measurement TRIG:<meas>:SOUR IMM Measurements other than Swept SA
State Saved	Saved in instrument state
Status Bits/OPC dependencies	The Status Operation Register bit 5 "Waiting for Trigger" is set at the same time as the Sweeping or Measuring bit is set. It is cleared when the trigger actually occurs (that is, after the trigger event occurs and all the applicable trigger criteria have been met). A corresponding pop-up message ("Waiting for trigger") is generated if no trigger signal appears after approximately 2 sec. This message goes away when a trigger signal appears.
Initial S/W Revision	Prior to A.02.00

Video (IF Envelope)

Pressing this key, when it is not selected, selects the video signal as the trigger. The Video trigger condition is met when the video signal (the filtered and detected version of the input signal, including both RBW and VBW filtering) crosses the video trigger level.

NOTE When the detector selected for all active traces is the average detector, the video signal for triggering does not include any VBW filtering.

The video trigger level is shown as a labeled line on the display. The line is displayed as long as video is the selected trigger source.

Pressing this key, when it is already selected, accesses the video trigger setup functions.

Key Path	Trigger
Example	TRIG:SOUR VID Swept SA measurement TRIG:<meas>:SOUR VID Measurements other than Swept SA
Notes	Log Plot and Spot Frequency measurements do not support Video Trigger
Dependencies	Video trigger is allowed in average detector mode.
State Saved	Saved in instrument state
Status Bits/OPC dependencies	The Status Operation Register bit 5 "Waiting for Trigger" is set at the same time as the Sweeping or Measuring bit is set. It is cleared when the trigger actually occurs (that is, after the trigger event occurs and all the applicable trigger criteria have been met). A corresponding pop-up message ("Waiting for trigger") is generated if no trigger signal appears after approximately 2 sec. This message goes away when a trigger signal appears.
Backwards Compatibility Notes	In the past, the Average detector was not available when Video triggering was on, and consequently, functions that set the detector to average (such as Marker Noise or Band/Intvl Power) were not available when the video trigger was on. Similarly, Video triggering was not available when the detector was Average. In the X-Series, these restrictions are removed.
Initial S/W Revision	Prior to A.02.00

Trigger Level

Sets a level for the video signal trigger. When the video signal crosses this level, with the chosen slope, the trigger occurs. This level is displayed with a horizontal line only if **Video** is the selected trigger source.

Key Path	Trigger, Video
Remote Command	:TRIGger[:SEquence]:VIDeo:LEVel <ampl> :TRIGger[:SEquence]:VIDeo:LEVel?
Example	TRIG:VID:LEV -40 dBm
Notes	When sweep type = FFT, the video trigger uses the amplitude envelope in a bandwidth wider than the FFT width as a trigger source. This might often be useful, but does not have the same relationship between the displayed trace and the trigger level as in swept triggering. Amplitude Corrections are not taken into account by the Video Trig Level. For example, if you have

given yourself effective gain with an amplitude correction factor, the Video Trigger will not fire until you have dropped the trigger line that far below the displayed signal level, rather than simply dropping it down to the displayed signal level.

Note that other corrections, specifically External Gain and Ref Level Offset, modify the actual trace data as it is taken and therefore ARE taken into account by Trig Level.

Couplings	This same level is used for the Video trigger source in the Trigger menu and for the Video selection in the Gate Source menu.
Preset	Set the Video Trigger Level -25 dBm on Preset. When the Video Trigger Level becomes the active function, if the value is off screen, set it to either the top or bottom of screen, depending on which direction off screen it was.
State Saved	Saved in instrument state
Min	-170 dBm
Max	+30 dBm
Default Unit	Depends on the current selected Y axis unit
Backwards Compatibility SCPI	:TRIGger[:SEquence]:IF:LEVel :TRIGger[:SEquence]:IF:LEVel?
Backwards Compatibility Notes	This alias is provided for backward compatibility with VSA/PSA comms apps.
Initial S/W Revision	Prior to A.02.00

Trig Slope

Controls the trigger polarity. It is set positive to trigger on a rising edge and negative to trigger on a falling edge.

Key Path	Trigger, Video
Remote Command	:TRIGger[:SEquence]:VIDeo:SLOPe POSitive NEGative :TRIGger[:SEquence]:VIDeo:SLOPe?
Example	TRIG:VID:SLOP NEG
Preset	POSitive
State Saved	Saved in instrument state
Backwards Compatibility SCPI	:TRIGger[:SEquence]:IF:SLOPe NEGative POSitive :TRIGger[:SEquence]:IF:SLOPe? For backward compatibility with VSA/PSA comms apps
Backwards Compatibility Notes	The legacy :TRIGger[:SEquence]:SLOPe command affects the slopes for the VID, LINE, EXT1, EXT2, and RFB triggers.
Initial S/W Revision	Prior to A.02.00

Remote Command	:TRIGger[:SEquence]:SLOPe POSitive NEGative :TRIGger[:SEquence]:SLOPe?
Example	TRIG:SLOP NEG
Preset	POSitive
State Saved	Saved in instrument state
Backwards Compatibility Notes	In ESA/PSA, the Trigger Slope was global to all triggers. In the X-Series, the slope can be set individually for each Trigger Source. For backward compatibility, the global SLOPe command updates all instances of trigger slope (VID, LINE, EXT1, EXT2, TV, RFB). The query returns the trigger slope setting of the currently selected trigger source.
Initial S/W Revision	Prior to A.02.00

Trig Delay

Controls a time delay during that the analyzer will wait to begin a sweep after meeting the trigger criteria. You can use negative delay to pre-trigger the instrument in the time domain or FFT, but not in swept spans.

Key Path	Trigger, Video
Remote Command	:TRIGger[:SEquence]:VIDeo:DELaY <time> :TRIGger[:SEquence]:VIDeo:DELaY? :TRIGger[:SEquence]:VIDeo:DELaY:STATe OFF ON 0 1 :TRIGger[:SEquence]:VIDeo:DELaY:STATe?
Example	TRIG:VID:DEL:STAT ON TRIG:VID:DEL 100 ms
Notes	Video trigger delay may be set to negative values, in time domain, FFT and even swept. It makes intuitive sense in time domain and works well in FFT mode where the bandwidth of the filter before the video trigger is about 1.25 span. In swept spans, negative settings of Trig Delay are treated as a zero setting within the internal hardware and the advisory message "Neg. Trig Delay unavailable in Swept Mode, zero delay used." is generated when such a delay is set.
Preset	Off, 1 us
State Saved	Saved in instrument state
Min	-150 ms
Max	+500 ms
Default Unit	s
Backwards Compatibility Notes	! For backward compatibility with VSA/PSA comms apps :TRIGger[:SEquence]:IF:DELaY :TRIGger[:SEquence]:DELaY The legacy :TRIGger[:SEquence]:DELaY command affects the delay for the VID, LINE, EXT1, EXT2, and RFB triggers.
Initial S/W Revision	Prior to A.02.00

Remote Command	:TRIGger[:SEquence]:DELay <time> :TRIGger[:SEquence]:DELay? :TRIGger[:SEquence]:DELay:STATE OFF ON 0 1 :TRIGger[:SEquence]:DELay:STATE?
Example	TRIG:DEL 1 ms
Preset	1 us
State Saved	Saved in instrument state
Backwards Compatibility Notes	In ESA/PSA, the Trigger Delay was global to all triggers. In the X-Series, the delay can be set individually for each Trigger Source. For backward compatibility, the global DELay command updates all instances of trigger slope (VID, LINE, EXT1, EXT2) except TV and RFBurst. The query returns the trigger delay setting of the currently selected trigger source.
Initial S/W Revision	Prior to A.02.00

Remote Command	:TRIGger[:SEquence]:OFFSet <time> :TRIGger[:SEquence]:OFFSet? :TRIGger[:SEquence]:OFFSet:STATE OFF ON 0 1 :TRIGger[:SEquence]:OFFSet:STATE?
Example	TRIG:OFFS ON TRIG:OFFS -100 ms
Notes	These are ESA commands for trigger offset that allowed you to use a positive or negative delay when in zero span and in a Res BW \geq 1 kHz. For ESA compatibility, X-series analyzers keep track of this offset and adds it to the Trigger Delay for VIDEo, LINE, EXTernal1 or EXTernal2 whenever the value is sent to the hardware, if in Zero Span and RBW \geq 1 kHz.
Preset	Off, 0 s
State Saved	Saved in instrument state
Min	-11 s
Max	+11 s
Initial S/W Revision	Prior to A.02.00

Line

Pressing this key, when it is not selected, selects the line signal as the trigger. A new sweep/measurement will start synchronized with the next cycle of the line voltage. Pressing this key, when it is already selected, access the line trigger setup menu.

Key Path	Trigger
Example	TRIG:SOUR LINE Swept SA measurement TRIG:<meas>:SOUR LINE Measurements other than Swept SA
Dependencies	Line trigger is not available when operating from a "dc power source", for example, when the

	instrument is powered from batteries.
State Saved	Saved in instrument state
Status Bits/OPC dependencies	The Status Operation Register bit 5 "Waiting for Trigger" is set at the same time as the Sweeping or Measuring bit is set. It is cleared when the trigger actually occurs (that is, after the trigger event occurs and all the applicable trigger criteria have been met). A corresponding pop-up message ("Waiting for trigger") is generated if no trigger signal appears after approximately 2 sec. This message goes away when a trigger signal appears.
Initial S/W Revision	Prior to A.02.00

Trig Slope

Controls the trigger polarity. It is set positive to trigger on a rising edge and negative to trigger on a falling edge.

Key Path	Trigger, Line
Remote Command	:TRIGger[:SEquence]:LINE:SLOPe POSitive NEGative :TRIGger[:SEquence]:LINE:SLOPe?
Example	TRIG:LINE:SLOP NEG
Preset	POSitive
State Saved	Saved in instrument state
Backwards Compatibility Notes	The legacy :TRIGger[:SEquence]:SLOPe command affects the slopes for the VID, LINE, EXT1, EXT2, and RFB triggers.
Initial S/W Revision	Prior to A.02.00

Trig Delay

Controls a time delay during which the analyzer will wait to begin a sweep after meeting the trigger criteria. You can use negative delay to pre-trigger the instrument in time domain or FFT, but not in swept spans.

Key Path	Trigger, Line
Remote Command	:TRIGger[:SEquence]:LINE:DELay <time> :TRIGger[:SEquence]:LINE:DELay? :TRIGger[:SEquence]:LINE:DELay:STATe OFF ON 0 1 :TRIGger[:SEquence]:LINE:DELay:STATe?
Example	TRIG:LINE:DEL:STAT ON TRIG:LINE:DEL 100 ms
Notes	Video trigger delay may be set to negative values, in time domain, FFT and even swept. It makes intuitive sense in time domain and works well in FFT mode where the bandwidth of the filter before the video trigger is about 1.25 span. In swept spans, negative settings of Trig Delay are treated as a

	zero setting within the internal hardware and the advisory message "Neg. Trig Delay unavailable in Swept Mode, zero delay used." is generated when such a delay is set.
Preset	Off, 1.000 us
State Saved	Saved in instrument state
Min	-150 ms
Max	500 ms
Default Unit	S
Backwards Compatibility Notes	The legacy :TRIGger[:SEQuence]:DELay command affects the delay for the VID, LINE, EXT1, EXT2, and RFB triggers. The legacy :TRIGger[:SEQuence]:OFFSet command is supported for the VIDeo, LINE, EXT1, and EXT2 triggers.
Initial S/W Revision	Prior to A.02.00

External 1

Pressing this key, when it is not selected, selects an external input signal as the trigger. A new sweep/measurement will start when the external trigger condition is met using the external 1 input connector on the rear panel.

Pressing this key, when it is already selected, accesses the external 1 trigger setup menu.

Key Path	Trigger
Example	TRIG:SOUR EXT1 Swept SA measurement TRIG:<meas>:SOUR EXT1 Measurements other than Swept SA
Dependencies	Grayed out if in use by Point Trigger in the Source Setup menu. Forced to Free Run if already selected and Point Trigger is set to External 1.
State Saved	Saved in instrument state
Status Bits/OPC dependencies	The Status Operation Register bit 5 "Waiting for Trigger" is set at the same time as the Sweeping or Measuring bit is set. It is cleared when the trigger actually occurs (that is, after the trigger event occurs and all the applicable trigger criteria have been met). A corresponding pop-up message ("Waiting for trigger") is generated if no trigger signal appears after approximately 2 sec. This message goes away when a trigger signal appears.
Initial S/W Revision	Prior to A.02.00

Trigger Level

Sets the value where the external 1 trigger input will trigger a new sweep/measurement.

Key Path	Trigger, External 1
Remote Command	:TRIGger[:SEQuence]:EXTernal1:LEVel <level>

	:TRIGger[:SEquence]:EXTernal1:LEVel?
Example	TRIG:EXT1:LEV 0.4 V
Couplings	This same level is used for the Ext1 trigger source in the Trigger menu, for the Ext1 selection in the Periodic Timer sync source (in the Trigger menu and in the Gate Source menu), and also for the Ext1 selection in the Gate Source menu.
Preset	1.2 V
State Saved	Saved in instrument state
Min	-5 V
Max	5 V
Default Unit	V
Backwards Compatibility SCPI	:TRIGger[:SEquence]:EXTernal:LEVel
Backwards Compatibility SCPI	For backward compatibility, the parameter EXTernal is mapped to EXTernal1
Backwards Compatibility SCPI	:TRIGger[:SEquence]:FRAMe:EXTernal1:LEVel
Initial S/W Revision	Prior to A.02.00

Trig Slope

Controls the trigger polarity. It is set positive to trigger on a rising edge and negative to trigger on a falling edge.

Key Path	Trigger, External 1
Remote Command	:TRIGger[:SEquence]:EXTernal1:SLOPe POSitive NEGative :TRIGger[:SEquence]:EXTernal1:SLOPe?
Example	TRIG:EXT1:SLOP NEG
Couplings	This same slope is used in the Ext1 selection for the trigger source in the Trigger menu and for the period timer sync source (in the Trigger menu and in the Gate Source menu).
Preset	POSitive
State Saved	Saved in instrument state
Backwards Compatibility SCPI	:TRIGger[:SEquence]:EXTernal:SLOPe
Backwards Compatibility SCPI	For backward compatibility, the parameter EXTernal is mapped to EXTernal1
Backwards Compatibility SCPI	:TRIGger[:SEquence]:FRAMe:EXTernal1:SLOPe
Backwards Compatibility Notes	The legacy :TRIGger[:SEquence]:SLOPe command affects the slopes for the VID, LINE, EXT1, EXT2, and RFB triggers.
Initial S/W Revision	Prior to A.02.00

Trig Delay

Controls a time delay during which the analyzer will wait to begin a sweep after meeting the trigger criteria. You can use negative delay to pre-trigger the instrument in time domain or FFT, but not in swept spans.

Key Path	Trigger, External 1
Remote Command	:TRIGger[:SEQuence]:EXTernal1:DELAy <time> :TRIGger[:SEQuence]:EXTernal1:DELAy? :TRIGger[:SEQuence]:EXTernal1:DELAy:STATe OFF ON 0 1 :TRIGger[:SEQuence]:EXTernal1:DELAy:STATe?
Example	TRIG:EXT1:DEL:STAT ON TRIG:EXT1:DEL 100 ms
Notes	Video trigger delay may be set to negative values, in time domain, FFT and even swept. It makes intuitive sense in time domain and works well in FFT mode where the bandwidth of the filter before the video trigger is about 1.25 span. In swept spans, negative settings of Trig Delay are treated as a zero setting within the internal hardware and the advisory message "Neg. Trig Delay unavailable in Swept Mode, zero delay used." is generated when such a delay is set.
Preset	Off, 1.000 us
State Saved	Saved in instrument state
Min	-150 ms
Max	+500 ms
Default Unit	s
Backwards Compatibility SCPI	:TRIGger[:SEQuence]:EXTernal:DELAy For backward compatibility, the parameter EXTernal is mapped to EXTernal1
Backwards Compatibility Notes	The legacy :TRIGger[:SEQuence]:DELAy command affects the delay for the VID, LINE, EXT1, EXT2, and RFB triggers. The legacy :TRIGger[:SEQuence]:OFFSet command is supported for the VIDeO, LINE, EXT1, and EXT2 triggers.
Initial S/W Revision	Prior to A.02.00

Zero Span Delay Comp On/Off

In zero span, there is a natural delay in the signal path, which comes from the RBW filter. This is usually desirable, as it allows you to trigger on events and also see those events, because the signal is delayed from the trigger event. However, in some cases it is desirable to eliminate this delay, so that trigger events line up exactly with the zero time point in zero span. You can use the Zero Span Delay Comp On/Off feature to enable or disable zero span delay compensation.

Key Path	Trigger, External 1
Remote Command	:TRIGger[:SEQuence]:EXTernal1:DELAy:COMPensation OFF ON 0 1 :TRIGger[:SEQuence]:EXTernal1:DELAy:COMPensation?
Example	TRIG:EXT1:DEL:COMP ON

Dependencies	No effect except in zero-span, but not locked out in nonzero spans. Blanked in modes that do not support zero-span measurements. If the SCPI command is sent when the key is blanked, an error is returned: -221, "Settings conflict; Feature not supported for this measurement" In analyzers shipping N9060A, this feature requires N9060A-7FP.
Preset	OFF
State Saved	Saved in instrument state
Initial S/W Revision	A.11.00

External 2

Pressing this key, when it is not selected, selects an external input signal as the trigger. A new sweep/measurement will start when the external trigger condition is met using the external 2 input connector. The external trigger 2 input connector is on the rear panel.

Pressing this key, when it is already selected, accesses the external 2 trigger setup menu.

Key Path	Trigger
Example	TRIG:SOUR EXT2 Swept SA measurement TRIG:<meas>:SOUR EXT2 Measurements other than Swept SA
Dependencies	In some models, there is no second External input. In these models, the External 2 key is blanked and the EXTernal2 parameter will generate a "Hardware missing; Not available for this model number" message. Grayed out if in use by Point Trigger in the Source Setup menu. Forced to Free Run if already selected and Point Trigger is set to External 2.
State Saved	Saved in instrument state
Status Bits/OPC dependencies	The Status Operation Register bit 5 "Waiting for Trigger" is set at the same time as the Sweeping or Measuring bit is set. It is cleared when the trigger actually occurs (that is, after the trigger event occurs and all the applicable trigger criteria have been met). A corresponding pop-up message ("Waiting for trigger") is generated if no trigger signal appears after approximately 2 sec. This message goes away when a trigger signal appears.
Initial S/W Revision	Prior to A.02.00
Modified at S/W Revision	A.03.00

Trigger Level

Sets the value where the external 2 trigger input will trigger a new sweep/measurement.

Key Path	Trigger, External 2
Remote Command	:TRIGger[:SEquence]:EXTernal2:LEVel :TRIGger[:SEquence]:EXTernal2:LEVel?

Example	TRIG:EXT2:LEV 1.1 V
Couplings	This same level is used for the Ext2 trigger source in the Trigger menu, for the Ext2 selection in the Periodic Timer sync source (in the Trigger menu and in the Gate Source menu), and also for the Ext2 selection in the Gate Source menu.
Preset	1.2 V
State Saved	Saved in instrument state
Min	-5 V
Max	5 V
Default Unit	V
Backwards Compatibility SCPI	:TRIGger[:SEquence]:FRAMe:EXTernal2:LEVel
Initial S/W Revision	Prior to A.02.00

Trig Slope

Controls the trigger polarity. It is set positive to trigger on a rising edge and negative to trigger on a falling edge.

Key Path	Trigger, External 2
Remote Command	:TRIGger[:SEquence]:EXTernal2:SLOPe POSitive NEGative :TRIGger[:SEquence]:EXTernal2:SLOPe?
Example	TRIG:EXT2:SLOP NEG
Couplings	This same slope is used in the Ext2 selection for the trigger source in the Trigger menu and for the period timer sync source (in the Trigger menu and in the Gate Source menu).
Preset	POSitive
State Saved	Saved in instrument state
Backwards Compatibility SCPI	:TRIGger[:SEquence]:FRAMe:EXTernal2:SLOPe
Backwards Compatibility Notes	The legacy :TRIGger[:SEquence]:SLOPe command affects the slopes for the VID, LINE, EXT1, EXT2, and RFB triggers.
Initial S/W Revision	Prior to A.02.00

Trig Delay

Controls a time delay during which the analyzer will wait to begin a sweep after meeting the trigger criteria. You can use negative delay to pre-trigger the instrument in time domain or FFT, but not in swept spans.

Key Path	Trigger, External 2
Remote Command	:TRIGger[:SEquence]:EXTernal2:DELay <time>

	:TRIGger[:SEquence]:EXternal2:DElay?
	:TRIGger[:SEquence]:EXternal2:DElay:STATe OFF ON 0 1
	:TRIGger[:SEquence]:EXternal2:DElay:STATe?
Example	TRIG:EXT2:DEL:STAT ON TRIG:EXT2:DEL 100 ms
Notes	Video trigger delay may be set to negative values, in time domain, FFT and even swept. It makes intuitive sense in time domain and works well in FFT mode where the bandwidth of the filter before the video trigger is about 1.25 span. In swept spans, negative settings of Trig Delay are treated as a zero setting within the internal hardware and the advisory message "Neg. Trig Delay unavailable in Swept Mode, zero delay used." is generated when such a delay is set.
Preset	Off, 1.000 us
State Saved	Saved in instrument state
Min	-150 ms
Max	500 ms
Default Unit	s
Backwards Compatibility Notes	The legacy :TRIGger[:SEquence]:DElay command affects the delay for the VID, LINE, EXT1, EXT2, and RFB triggers. The legacy :TRIGger[:SEquence]:OFFSet command is supported for the VIDEO, LINE, EXT1, and EXT2 triggers.
Initial S/W Revision	Prior to A.02.00

Zero Span Delay Comp On/Off

In zero span, there is a natural delay in the signal path, which comes from the RBW filter. This is usually desirable, as it allows you to trigger on events and also see those events, because the signal is delayed from the trigger event. However, in some cases it is desirable to eliminate this delay, so that trigger events line up exactly with the zero time point in zero span. You can use the Zero Span Delay Comp On/Off feature to enable or disable zero span delay compensation.

Key Path	Trigger, External 2
Remote Command	:TRIGger[:SEquence]:EXternal2:DElay:COMPensation OFF ON 0 1 :TRIGger[:SEquence]:EXternal2:DElay:COMPensation?
Example	TRIG:EXT2:DEL:COMP ON
Dependencies	No effect except in zero-span, but not locked out in nonzero spans. Blanked in modes that do not support zero-span measurements. If the SCPI command is sent when the key is blanked, an error is returned: -221, "Settings conflict; Feature not supported for this measurement" In analyzers shipping N9060A, this feature requires N9060A-7FP.
Preset	OFF
State Saved	Saved in instrument state
Initial S/W Revision	A.11.00

RF Burst

Pressing this key, when it is not selected, selects the RF Burst as the trigger. A new sweep/measurement will start when an RF burst envelope signal is identified from the signal at the RF Input connector. Pressing this key, when it is already selected, accesses the RF Burst trigger setup menu.

In some models, a variety of burst trigger circuitry is available, resulting in various available burst trigger bandwidths. The analyzer automatically chooses the appropriate trigger path based on the hardware configuration and other settings of the analyzer.

Key Path	Trigger
Example	TRIG:SOUR RFB Swept SA measurement TRIG:<meas>:SOUR RFB Measurements other than Swept SA
State Saved	Saved in instrument state
Status Bits/OPC dependencies	The Status Operation Register bit 5 "Waiting for Trigger" is set at the same time as the Sweeping or Measuring bit is set. It is cleared when the trigger actually occurs (that is, after the trigger event occurs and all the applicable trigger criteria have been met). A corresponding pop-up message ("Waiting for trigger") is generated if no trigger signal appears after approximately 2 sec. This message goes away when a trigger signal appears.
Backwards Compatibility Notes	The legacy command: :TRIGger[:SEQuence]:RFBurst:FSElectivity[:STATe] OFF ON 0 1 is not supported in the X-Series, as the hardware to do Frequency Selective burst triggers does not exist in X-Series.
Initial S/W Revision	Prior to A.02.00
Modified at S/W Revision	A.04.00

Absolute Trigger Level

Sets the absolute trigger level for the RF burst envelope.

When using the External Mixing path, the Absolute Trigger Level is uncalibrated because the factory default was set to accommodate the expected IF levels for the RF path.

Key Path	Trigger, RF Burst
Scope	Meas Global
Remote Command	:TRIGger[:SEQuence]:RFBurst:LEVel:ABSolute <ampl> :TRIGger[:SEQuence]:RFBurst:LEVel:ABSolute?
Example	TRIG:RFB:LEV:ABS 10 dBm sets the trigger level of the RF burst envelope signal to the absolute level of 10 dBm
Notes	Sending this command does not switch the setting from relative to absolute; to switch it you need to send the :TRIGger[:SEQuence]:RFBurst:LEVel:TYPE command, below. Amplitude Corrections are not taken into account by the Absolute Trigger Level. For example, if you

	<p>have given yourself effective gain with an amplitude correction factor, the Absolute Trigger will not fire until you have set the trigger level that far below the displayed signal level, rather than simply to the displayed signal level. This is only true for Amplitude Corrections, not External Gain or Ref Level Offset functions.</p> <p>If mode is Bluetooth, the default value is -50 dBm.</p>
Couplings	This same level is used for the RF Burst trigger source in the Trigger menu, for the RF Burst selection in the Periodic Timer sync source (in the Trigger menu and in the Gate Source menu), and also for the RF Burst selection in the Gate Source menu
Preset	-20 dBm
State Saved	Saved in instrument state
Min	-200 dBm
Max	100 dBm
Default Unit	depends on the current selected Y-Axis unit
Backwards Compatibility SCPI	:TRIGger[:SEquence]:FRAME:RFBurst:LEVel:ABSolute
Initial S/W Revision	Prior to A.02.00
Modified at S/W Revision	A.04.00

Key Path	Trigger, RF Burst
Remote Command	:TRIGger[:SEquence]:RFBurst:LEVel:TYPE ABSolute RELative :TRIGger[:SEquence]:RFBurst:LEVel:TYPE?
Example	TRIG:RFB:LEV:TYPE REL sets the trigger level type of the RF burst trigger to Relative.
Preset	ABSolute
State Saved	Saved in instrument state
Initial S/W Revision	Prior to A.02.00
Modified at S/W Revision	A.04.00

Relative Trigger Level

Sets the relative trigger level for the RF burst envelope.

In some models, the relative burst trigger function is implemented in hardware. In other models, without the advanced triggering hardware required, the relative burst trigger function is implemented in software in some measurements, and is unavailable in other measurements.

When implemented in software, the relative RF Burst trigger function is implemented as follows:

1. The measurement starts with the absolute RF Burst trigger setting. If it cannot get a trigger with that level, auto trigger fires and the acquisition starts anyway. After the acquisition, the measurement searches for the peak in the acquired waveform and saves it.

2. Now, in the next cycle of the measurement, the measurement determines a new absolute RF Burst level based on the peak value from the first measurement and the Relative RF Burst Trigger Level (always 0 or negative dB) set by the user. The following formula is used:
 3. absolute RF Burst level = peak level of the previous acquisition + relative RF Burst level
 4. If the new absolute RF Burst level differs from the previous by more than 0.5 dB, the new level is sent to the hardware; otherwise it is not updated (to avoid slowing down the acquisition)
- Steps 2 and 3 repeat for subsequent measurements.

Key Path	Trigger, RF Burst
Scope	Meas Global
Remote Command	:TRIGger[:SEquence]:RFBurst:LEVel:RELative <rel_ampl> :TRIGger[:SEquence]:RFBurst:LEVel:RELative?
Example	TRIG:RFB:LEV:REL -10 dB sets the trigger level of the RF burst envelope signal to the relative level of -10 dB
Notes	Sending this command does not switch the setting from absolute to relative; to switch it you need to send the :TRIGger[:SEquence]:RFBurst:LEVel:TYPE command, above. The relative trigger level is not available in some measurements. In those measurements the RELative parameter, and the :TRIGger[:SEquence]:RFBurst:LEVel:TYPE command (above), will generate an error if sent.
Dependencies	This key is grayed out and Absolute Trigger Level selected if the required hardware is not present in your analyzer and the current measurement does not support Relative triggering.
Preset	-6 dB GSM: -25 dB
State Saved	Saved in instrument state
Min	-45 dB
Max	0 dB
Default Unit	dB or dBc
Backwards Compatibility SCPI	:TRIGger[:SEquence]:RFBurst:LEVel This legacy command is aliased to :TRIGger[:SEquence]:RFBurst:LEVel:RELative because the PSA had ONLY relative burst triggering
Initial S/W Revision	Prior to A.02.00
Modified at S/W Revision	A.04.00

Trigger Slope

It is set positive to trigger on a rising edge and negative to trigger on a falling edge.

Key Path	Trigger, RF Burst
Remote Command	:TRIGger[:SEquence]:RFBurst:SLOPe POSitive NEGative :TRIGger[:SEquence]:RFBurst:SLOPe?

Example	TRIG:RFB:SLOP NEG
Couplings	This same slope is used in the RF Burst selection for the trigger source in the Trigger menu and for the period timer sync source (in the Trigger menu and in the Gate Source menu).
Preset	POSitive
State Saved	Saved in instrument state
Backwards Compatibility SCPI	:TRIGger[:SEQuence]:FRAMe:RFBurst:SLOPe
Backwards Compatibility Notes	The legacy :TRIGger[:SEQuence]:SLOPe command affects the slopes for the VID, LINE, EXT1, EXT2, and RFB triggers.
Initial S/W Revision	Prior to A.02.00

Trig Delay

Controls a time delay during which the analyzer will wait to begin a sweep after meeting the trigger criteria. You can use negative delay to pre-trigger the instrument in time domain or FFT, but not in swept spans.

Key Path	Trigger, RF Burst
Remote Command	:TRIGger[:SEQuence]:RFBurst:DELaY <time> :TRIGger[:SEQuence]:RFBurst:DELaY? :TRIGger[:SEQuence]:RFBurst:DELaY:STATe OFF ON 0 1 :TRIGger[:SEQuence]:RFBurst:DELaY:STATe?
Example	TRIG:RFB:DEL:STAT ON TRIG:RFB:DEL 100 ms
Notes	Video trigger delay may be set to negative values, in time domain, FFT and even swept. It makes intuitive sense in time domain and works well in FFT mode where the bandwidth of the filter before the video trigger is about 1.25 span. In swept spans, negative settings of Trig Delay are treated as a zero setting within the internal hardware and the advisory message "Neg. Trig Delay unavailable in Swept Mode, zero delay used." is generated when such a delay is set.
Preset	Off, 1.000 us
State Saved	Saved in instrument state
Min	-150 ms
Max	500 ms
Default Unit	s
Backwards Compatibility Notes	The legacy :TRIGger[:SEQuence]:DELaY command affects the delay for the VID, LINE, EXT1, EXT2, and RFB triggers.
Initial S/W Revision	Prior to A.02.00

Periodic Timer (Frame Trigger)

Pressing this key, when it is not selected, selects the internal periodic timer signal as the trigger. Triggering occurrences are set by the **Period** parameter, which is modified by the **Sync Source** and **Offset**. Pressing this key, when it is already selected, accesses the periodic timer trigger setup functions.

If you do not have a sync source selected (it is Off), then the internal timer will not be synchronized with any external timing events.

Key Path	Trigger
Example	TRIG:SOUR FRAM Swept SA measurement
	TRIG:<meas>:SOUR FRAM Measurements other than Swept SA
State Saved	Saved in instrument state
Readback	[Sync: <value of Sync Source>], for example, [Sync: External 1]
Status Bits/OPC dependencies	The Status Operation Register bit 5 "Waiting for Trigger" is set at the same time as the Sweeping or Measuring bit is set. It is cleared when the trigger actually occurs (that is, after the trigger event occurs and all the applicable trigger criteria have been met). A corresponding pop-up message ("Waiting for trigger") is generated if no trigger signal appears after approximately 2 sec. This message goes away when a trigger signal appears.
Initial S/W Revision	Prior to A.02.00

Periodic Timer Triggering:

This feature selects the internal periodic timer signal as the trigger. Trigger occurrences are set by the **Periodic Timer** parameter, which is modified by the **Sync Source** and **Offset**.

The figure below shows the action of the periodic timer trigger. Before reviewing the figure, we'll explain some uses for the periodic trigger.

A common application is measuring periodic burst RF signals for which a trigger signal is not easily available. For example, we might be measuring a TDMA radio which bursts every 20 ms. Let's assume that the 20 ms period is very consistent. Let's also assume that we do not have an external trigger source available that is synchronized with the period, and that the signal-to-noise ratio of the signal is not high enough to provide a clean RF burst trigger at all of the analysis frequencies. For example, we might want to measure spurious transmissions at an offset from the carrier that is larger than the bandwidth of the RF burst trigger. In this application, we can set the Periodic Timer to a 20.00 ms period and adjust the offset from that timer to position our trigger just where we want it. If we find that the 20.00 ms is not exactly right, we can adjust the period slightly to minimize the drift between the period timer and the signal to be measured.

A second way to use this feature would be to use **Sync Source** temporarily, instead of **Offset**. In this case, we might tune to the signal in a narrow span and use the RF Burst trigger to synchronize the periodic timer. Then we would turn the sync source off so that it would not miss-trigger. Miss-triggering can occur when we are tuned so far away from the RF burst trigger that it is no longer reliable.

A third example would be to synchronize to a signal that has a reference time element of much longer period than the period of interest. In some CDMA applications, it is useful to look at signals with a short periodicity, by synchronizing that periodicity to the "even-second clock" edge that happens every two

seconds. Thus, we could connect the even-second clock trigger to Ext1 and use then Ext1 as the sync source for the periodic timer.

The figure below illustrates this third example. The top trace represents the even-second clock. It causes the periodic timer to synchronize with the leading edge shown. The analyzer trigger occurs at a time delayed by the accumulated offset from the period trigger event. The periodic timer continues to run, and triggers continue to occur, with a periodicity determined by the analyzer time base. The timer output (labeled "late event") will drift away from its ideal time due to imperfect matching between the time base of the signal being measured and the time base of the analyzer, and also because of imperfect setting of the period parameter. But the synchronization is restored on the next even-second clock event. ("Accumulated offset" is described in the in the **Offset** function section.)

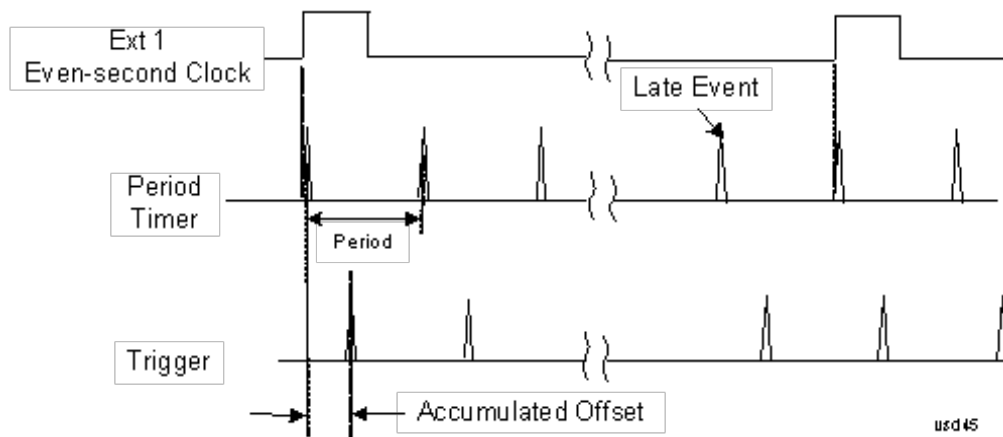

Period

Sets the period of the internal periodic timer clock. For digital communications signals, this is usually set to the frame period of your current input signal. In the case that sync source is not set to OFF, and the external sync source rate is changed for some reason, the periodic timer is synchronized at the every external synchronization pulse by resetting the internal state of the timer circuit.

Key Path	Trigger, Periodic Timer
Remote Command	:TRIGger[:SEquence]:FRAMe:PERiod <time> :TRIGger[:SEquence]:FRAMe:PERiod?
Example	TRIG:FRAM:PER 100 ms
Dependencies	The invalid data indicator turns on when the period is changed, until the next sweep/measurement completes.
Couplings	The same period is used in the Gate Source selection of the period timer.
Preset	20 ms GSM: 4.615383
State Saved	Saved in instrument state
Min	100.000 ns
Max	559.0000 ms
Default Unit	S
Initial S/W Revision	Prior to A.02.00

Offset

Adjusts the accumulated offset between the periodic timer events and the trigger event. Adjusting the accumulated offset is different than setting an offset, and requires explanation.

The periodic timer is usually not synchronized with any external events, so the timing of its output events has no absolute meaning. Since the timing relative to external events (RF signals) is important, you need to be able to adjust (offset) it. However, you have no direct way to see when the periodic timer events occur. All that you can see is the trigger timing. When you want to adjust the trigger timing, you will be changing the internal offset between the periodic timer events and the trigger event. Because the absolute value of that internal offset is unknown, we will just call that the accumulated offset. Whenever the Offset parameter is changed, you are changing that accumulated offset. You can reset the displayed offset using Reset Offset Display. Changing the display does not change the value of the accumulated offset, and you can still make additional changes to accumulated offset.

To avoid ambiguity, we define that an increase in the "offset" parameter, either from the knob or the SCPI adjust command, serves to delay the timing of the trigger event.

Key Path	Trigger, Periodic Timer
Remote Command	:TRIGger[:SEquence]:FRAMe:OFFSet <time> :TRIGger[:SEquence]:FRAMe:OFFSet?
Example	TRIG:FRAM:OFFS 1.2 ms
Notes	<p>The front panel interface (for example, the knob), and this command, adjust the accumulated offset, which is shown on the active function display. However, the actual amount sent to the hardware each time the offset is updated is the delta value, that is, the current accumulated offset value minus the previous accumulated offset value. Note that the accumulated offset value is essentially arbitrary; it represents the accumulated offset from the last time the offset was zeroed (with the Reset Offset Display key).</p> <p>Note that this command does not change the period of the trigger waveform. Note also that Offset is used only when the sync source is set to OFF, otherwise delay is used, see section "Trig Delay" on page 460.</p> <p>An increase in the "offset" parameter, either from the knob or the SCPI adjust command, serves to delay the timing of the trigger event.</p>
Notes	<p>When the SCPI command is sent the value shown on the key (and the Active Function, if this happens to be the active function) is updated with the new value. However, the actual amount sent to the hardware is the delta value, that is, the current accumulated offset value minus the previous accumulated offset value.</p> <p>The SCPI query simply returns the value currently showing on the key.</p>
Dependencies	The invalid data indicator turns on when the offset is changed, until the next sweep/measurement completes.
Couplings	The same offset is used in the Gate Source selection of the period timer.
Preset	0 s
State Saved	Saved in instrument state
Min	-10.000 s
Max	10.000 s

Default Unit	S
Initial S/W Revision	Prior to A.02.00

Reset Offset Display

Resets the value of the periodic trigger offset display setting to 0.0 seconds. The current displayed trigger location may include an offset value defined with the Offset key. Pressing this key redefines the currently displayed trigger location as the new trigger point that is 0.0 s offset. The Offset key can then be used to add offset relative to this new timing.

Key Path	Trigger, Periodic Timer
Remote Command	:TRIGger[:SEquence]:FRAMe:OFFSet:DISPlay:RESet
Example	TRIG:FRAM:OFFS:DISP:RES
Initial S/W Revision	Prior to A.02.00

Sync Source

Selects a signal source for you to synchronize your periodic timer trigger to, otherwise you are triggering at some arbitrary location in the frame. Synchronization reduces the precision requirements on the setting of the period.

For convenience you may adjust the level and slope of the selected sync source in a conditional branch setup menu accessed from the Sync Source menu. Note that these settings match those in the **Trigger** and **Gate Source** menus; that is, each trigger source has only one value of level and slope, regardless of which menu it is accessed from.

Key Path	Trigger, Periodic Timer
Remote Command	:TRIGger[:SEquence]:FRAMe:SYNC EXTernal1 EXTernal2 RFBurst OFF :TRIGger[:SEquence]:FRAMe:SYNC?
Example	TRIG:FRAM:SYNC EXT2
Dependencies	In some models, there is no second External input. In these models, the External 2 key is blanked and the EXTernal2 parameter will generate a "Hardware missing; Not available for this model number" message.
Preset	Off GSM/EDGE, MSR,LTE,LTETDD: RFBurst
State Saved	Saved in instrument state
Readback	The current setting is read back to this key and it is also Readback to the previous Periodic Timer trigger key.
Backwards Compatibility SCPI	:TRIGger[:SEquence]:FRAMe:SYNC EXTernal For backward compatibility, the parameter EXTernal is mapped to EXTernal1
Initial S/W Revision	Prior to A.02.00
Modified at S/W Revision	A.03.00, A.14.00

Off

Turns off the sync source for your periodic trigger. With the sync source off, the timing will drift unless the signal source frequency is locked to the analyzer frequency reference.

Key Path	Trigger, Periodic Timer, Sync Source
Example	TRIG:FRAM:SYNC OFF
Readback	Off
Initial S/W Revision	Prior to A.02.00

External 1

Pressing this key, when it is not selected, selects an external input signal as the trigger. A new sweep/measurement will start when the external trigger condition is met using the external 1 input connector on the rear panel.

Pressing this key, when it is already selected, accesses the external 1 trigger setup menu.

Key Path	Trigger
Example	TRIG:SOUR EXT1 Swept SA measurement TRIG:<meas>:SOUR EXT1 Measurements other than Swept SA
Dependencies	Grayed out if in use by Point Trigger in the Source Setup menu. Forced to Free Run if already selected and Point Trigger is set to External 1.
State Saved	Saved in instrument state
Status Bits/OPC dependencies	The Status Operation Register bit 5 "Waiting for Trigger" is set at the same time as the Sweeping or Measuring bit is set. It is cleared when the trigger actually occurs (that is, after the trigger event occurs and all the applicable trigger criteria have been met). A corresponding pop-up message ("Waiting for trigger") is generated if no trigger signal appears after approximately 2 sec. This message goes away when a trigger signal appears.
Initial S/W Revision	Prior to A.02.00

Trigger Level

Sets the value where the external 1 trigger input will trigger a new sweep/measurement.

Key Path	Trigger, External 1
Remote Command	:TRIGger[:SEquence]:EXTernal1:LEVel <level> :TRIGger[:SEquence]:EXTernal1:LEVel?
Example	TRIG:EXT1:LEV 0.4 V
Couplings	This same level is used for the Ext1 trigger source in the Trigger menu, for the Ext1 selection in the Periodic Timer sync source (in the Trigger menu and in the Gate Source menu), and also for the Ext1

	selection in the Gate Source menu.
Preset	1.2 V
State Saved	Saved in instrument state
Min	-5 V
Max	5 V
Default Unit	V
Backwards Compatibility SCPI	:TRIGger[:SEquence]:EXTernal:LEVel
Backwards Compatibility SCPI	For backward compatibility, the parameter EXTernal is mapped to EXTernal1
Backwards Compatibility SCPI	:TRIGger[:SEquence]:FRAMe:EXTernal1:LEVel
Initial S/W Revision	Prior to A.02.00

Trig Slope

Controls the trigger polarity. It is set positive to trigger on a rising edge and negative to trigger on a falling edge.

Key Path	Trigger, External 1
Remote Command	:TRIGger[:SEquence]:EXTernal1:SLOPe POSitive NEGative :TRIGger[:SEquence]:EXTernal1:SLOPe?
Example	TRIG:EXT1:SLOP NEG
Couplings	This same slope is used in the Ext1 selection for the trigger source in the Trigger menu and for the period timer sync source (in the Trigger menu and in the Gate Source menu).
Preset	POSitive
State Saved	Saved in instrument state
Backwards Compatibility SCPI	:TRIGger[:SEquence]:EXTernal:SLOPe
Backwards Compatibility SCPI	For backward compatibility, the parameter EXTernal is mapped to EXTernal1
Backwards Compatibility SCPI	:TRIGger[:SEquence]:FRAMe:EXTernal1:SLOPe
Backwards Compatibility Notes	The legacy :TRIGger[:SEquence]:SLOPe command affects the slopes for the VID, LINE, EXT1, EXT2, and RFB triggers.
Initial S/W Revision	Prior to A.02.00

External 2

Pressing this key, when it is not selected, selects an external input signal as the trigger. A new sweep/measurement will start when the external trigger condition is met using the external 2 input connector. The external trigger 2 input connector is on the rear panel.

Pressing this key, when it is already selected, accesses the external 2 trigger setup menu.

Key Path	Trigger
Example	TRIG:SOUR EXT2 Swept SA measurement TRIG:<meas>:SOUR EXT2 Measurements other than Swept SA
Dependencies	In some models, there is no second External input. In these models, the External 2 key is blanked and the EXTernal2 parameter will generate a "Hardware missing; Not available for this model number" message. Grayed out if in use by Point Trigger in the Source Setup menu. Forced to Free Run if already selected and Point Trigger is set to External 2.
State Saved	Saved in instrument state
Status Bits/OPC dependencies	The Status Operation Register bit 5 "Waiting for Trigger" is set at the same time as the Sweeping or Measuring bit is set. It is cleared when the trigger actually occurs (that is, after the trigger event occurs and all the applicable trigger criteria have been met). A corresponding pop-up message ("Waiting for trigger") is generated if no trigger signal appears after approximately 2 sec. This message goes away when a trigger signal appears.
Initial S/W Revision	Prior to A.02.00
Modified at S/W Revision	A.03.00

Trigger Level

Sets the value where the external 2 trigger input will trigger a new sweep/measurement.

Key Path	Trigger, External 2
Remote Command	:TRIGger[:SEquence]:EXTernal2:LEVel :TRIGger[:SEquence]:EXTernal2:LEVel?
Example	TRIG:EXT2:LEV 1.1 V
Couplings	This same level is used for the Ext2 trigger source in the Trigger menu, for the Ext2 selection in the Periodic Timer sync source (in the Trigger menu and in the Gate Source menu), and also for the Ext2 selection in the Gate Source menu.
Preset	1.2 V
State Saved	Saved in instrument state
Min	-5 V
Max	5 V
Default Unit	V
Backwards Compatibility SCPI	:TRIGger[:SEquence]:FRAMe:EXTernal2:LEVel
Initial S/W Revision	Prior to A.02.00

Trig Slope

Controls the trigger polarity. It is set positive to trigger on a rising edge and negative to trigger on a falling edge.

Key Path	Trigger, External 2
Remote Command	:TRIGger[:SEquence]:EXTErnal2:SLOPe POSitive NEGative :TRIGger[:SEquence]:EXTErnal2:SLOPe?
Example	TRIG:EXT2:SLOP NEG
Couplings	This same slope is used in the Ext2 selection for the trigger source in the Trigger menu and for the period timer sync source (in the Trigger menu and in the Gate Source menu).
Preset	POSitive
State Saved	Saved in instrument state
Backwards Compatibility SCPI	:TRIGger[:SEquence]:FRAMe:EXTErnal2:SLOPe
Backwards Compatibility Notes	The legacy :TRIGger[:SEquence]:SLOPe command affects the slopes for the VID, LINE, EXT1, EXT2, and RFB triggers.
Initial S/W Revision	Prior to A.02.00

RF Burst

Pressing this key, when it is not selected, selects the RF Burst as the trigger. A new sweep/measurement will start when an RF burst envelope signal is identified from the signal at the RF Input connector. Pressing this key, when it is already selected, accesses the RF Burst trigger setup menu.

In some models, a variety of burst trigger circuitry is available, resulting in various available burst trigger bandwidths. The analyzer automatically chooses the appropriate trigger path based on the hardware configuration and other settings of the analyzer.

Key Path	Trigger
Example	TRIG:SOUR RFB Swept SA measurement TRIG:< meas>:SOUR RFB Measurements other than Swept SA
State Saved	Saved in instrument state
Status Bits/OPC dependencies	The Status Operation Register bit 5 "Waiting for Trigger" is set at the same time as the Sweeping or Measuring bit is set. It is cleared when the trigger actually occurs (that is, after the trigger event occurs and all the applicable trigger criteria have been met). A corresponding pop-up message ("Waiting for trigger") is generated if no trigger signal appears after approximately 2 sec. This message goes away when a trigger signal appears.
Backwards Compatibility Notes	The legacy command: :TRIGger[:SEquence]:RFBurst:FSElectivity[:STATe] OFF ON 0 1 is not supported in the X-Series, as the hardware to do Frequency Selective burst triggers does not exist in X-Series.
Initial S/W Revision	Prior to A.02.00
Modified at S/W Revision	A.04.00

Absolute Trigger Level

Sets the absolute trigger level for the RF burst envelope.

When using the External Mixing path, the Absolute Trigger Level is uncalibrated because the factory default was set to accommodate the expected IF levels for the RF path.

Key Path	Trigger, RF Burst
Scope	Meas Global
Remote Command	<code>:TRIGger[:SEquence]:RFBurst:LEVel:ABSolute <ampl></code> <code>:TRIGger[:SEquence]:RFBurst:LEVel:ABSolute?</code>
Example	TRIG:RFB:LEV:ABS 10 dBm sets the trigger level of the RF burst envelope signal to the absolute level of 10 dBm
Notes	<p>Sending this command does not switch the setting from relative to absolute; to switch it you need to send the <code>:TRIGger[:SEquence]:RFBurst:LEVel:TYPE</code> command, below.</p> <p>Amplitude Corrections are not taken into account by the Absolute Trigger Level. For example, if you have given yourself effective gain with an amplitude correction factor, the Absolute Trigger will not fire until you have set the trigger level that far below the displayed signal level, rather than simply to the displayed signal level. This is only true for Amplitude Corrections, not External Gain or Ref Level Offset functions.</p> <p>If mode is Bluetooth, the default value is -50 dBm.</p>
Couplings	This same level is used for the RF Burst trigger source in the Trigger menu, for the RF Burst selection in the Periodic Timer sync source (in the Trigger menu and in the Gate Source menu), and also for the RF Burst selection in the Gate Source menu
Preset	-20 dBm
State Saved	Saved in instrument state
Min	-200 dBm
Max	100 dBm
Default Unit	depends on the current selected Y-Axis unit
Backwards Compatibility SCPI	<code>:TRIGger[:SEquence]:FRAMe:RFBurst:LEVel:ABSolute</code>
Initial S/W Revision	Prior to A.02.00
Modified at S/W Revision	A.04.00

Key Path	Trigger, RF Burst
Remote Command	<code>:TRIGger[:SEquence]:RFBurst:LEVel:TYPE ABSolute RELative</code> <code>:TRIGger[:SEquence]:RFBurst:LEVel:TYPE?</code>
Example	TRIG:RFB:LEV:TYPE REL sets the trigger level type of the RF burst trigger to Relative.
Preset	ABSolute

State Saved	Saved in instrument state
Initial S/W Revision	Prior to A.02.00
Modified at S/W Revision	A.04.00

Trigger Slope

It is set positive to trigger on a rising edge and negative to trigger on a falling edge.

Key Path	Trigger, RF Burst
Remote Command	:TRIGger[:SEquence]:RFBurst:SLOPe POSitive NEGative :TRIGger[:SEquence]:RFBurst:SLOPe?
Example	TRIG:RFB:SLOP NEG
Couplings	This same slope is used in the RF Burst selection for the trigger source in the Trigger menu and for the period timer sync source (in the Trigger menu and in the Gate Source menu).
Preset	POSitive
State Saved	Saved in instrument state
Backwards Compatibility SCPI	:TRIGger[:SEquence]:FRAME:RFBurst:SLOPe
Backwards Compatibility Notes	The legacy :TRIGger[:SEquence]:SLOPe command affects the slopes for the VID, LINE, EXT1, EXT2, and RFB triggers.
Initial S/W Revision	Prior to A.02.00

Trig Delay

This setting delays the measurement timing relative to the Periodic Timer.

Key Path	Trigger, Periodic Timer
Remote Command	:TRIGger[:SEquence]:FRAME:DELAy <time> :TRIGger[:SEquence]:FRAME:DELAy? :TRIGger[:SEquence]:FRAME:DELAy:STATE OFF ON 0 1 :TRIGger[:SEquence]:FRAME:DELAy:STATE?
Notes	Note that delay is used when the sync source is not set to OFF. If the sync source is set to OFF, offset is used.
Preset	Off, 1.000 us
State Saved	Saved in instrument state
Min	-150 ms
Max	+500 ms
Default Unit	s
Initial S/W Revision	Prior to A.02.00

Auto/Holdoff

Opens up a menu that lets you adjust Auto Trigger and Trigger Holdoff parameters

Key Path	Trigger
Readback line	Displays a summary of the Auto Trig and Holdoff settings, in square brackets First line: Auto Off or Auto On Second Line: "Hld" followed by: <ul style="list-style-type: none"> • If Holdoff is Off, readback Off • If Holdoff On and Type = Normal, readback value • If Holdoff On and Type = Above, readback value followed by AL • If Holdoff On and Type = Below, readback value followed by BL • If Holdoff Type selection is not supported by the current measurement, Holdoff Type is always Normal
Initial S/W Revision	A.02.00

Auto Trig

Sets the time that the analyzer will wait for the trigger conditions to be met. If they are not met after that much time, then the analyzer is triggered anyway.

Key Path	Trigger, Auto/Holdoff
Remote Command	<pre>:TRIGger[:SEQuence]:ATRigger <time></pre> <pre>:TRIGger[:SEQuence]:ATRigger?</pre> <pre>:TRIGger[:SEQuence]:ATRigger:STATe OFF ON 0 1</pre> <pre>:TRIGger[:SEQuence]:ATRigger:STATe?</pre>
Example	<pre>TRIG:ATR:STAT ON</pre> <pre>TRIG:ATR 100 ms</pre>
Notes	The "time that the analyzer will wait" starts when the analyzer is ready for a trigger, which may be hundreds of ms after the data acquisition for a sweep is done. The "time" ends when the trigger condition is satisfied, not when the delay ends.
Preset	Off, 100 ms
State Saved	Saved in instrument state
Min	1 ms
Max	100 s
Default Unit	s
Initial S/W Revision	Prior to A.02.00

Trig Holdoff

Sets the holdoff time between triggers. When the trigger condition is satisfied, the trigger occurs, the delay begins, and the holdoff time begins. New trigger conditions will be ignored until the holdoff time expires. For a free-running trigger, the holdoff value is the minimum time between triggers.

Key Path	Trigger, Auto/Holdoff
Remote Command	:TRIGger[:SEquence]:HOLDoff <time> :TRIGger[:SEquence]:HOLDoff? :TRIGger[:SEquence]:HOLDoff:STATe OFF ON 0 1 :TRIGger[:SEquence]:HOLDoff:STATe?
Example	TRIG:HOLD:STAT ON TRIG:HOLD 100 ms
Dependencies	Unavailable if the selected Input is BBIQ. If this is the case, the key is grayed out if it is pressed the informational message "Feature not supported for this Input" is displayed. If the SCPI command is sent, the error "Settings conflict; Feature not supported for this Input" is generated.
Preset	Off, 100 ms
State Saved	Saved in instrument state
Min	0 s
Max	0.5 s
Default Unit	s
Initial S/W Revision	Prior to A.02.00

8 Channel Power Measurement

The Channel Power measurement is used to find the total power present in a specified bandwidth. The power spectral density (the power in the signal normalized to 1 Hz) is also reported (In WLAN mode or WLAN radio standard in SA mode, the peak power spectral density for 1 MHz is reported). For measurement results and views, see ["View/Display" on page 642](#).

This topic contains the following sections:

["Measurement Commands for Channel Power" on page 464](#)

["Remote CommandResults for Channel Power Measurement" on page 465](#)

Measurement Commands for Channel Power

These commands are used to measure the total rms power in a specified integration bandwidth.

Use `:INSTrument:SElect` to set the mode.

```
:CONFigure:CHPower
:CONFigure:CHPower:NDEFault
:INITiate:CHPower
:FETCh:CHPower[n]?
:MEASure:CHPower[n]?
:READ:CHPower[n]?
:FETCh:CHPower:CHPower?
:MEASure:CHPower:CHPower?
:READ:CHPower:CHPower?
:FETCh:CHPower:DENSity?
:MEASure:CHPower:DENSity?
:READ:CHPower:DENSity
```

For more measurement related commands, see the SENSE subsystem, and the section "[Remote Measurement Functions](#)" on page 2213.

Remote CommandResults for Channel Power Measurement

For DVB-T/H and DTMB (CTTB) mode, see ["DVB-T/H and DTMB \(CTTB\) Mode Remote Command Results" on page 466](#).

For ISDB-T and CMMB mode, see ["ISDB-T and CMMB mode Remote Command Results" on page 468](#).

For MSR, see ["Remote Command Results for WLAN Channel Power Measurement" on page 471](#)

For LTE-Advanced FDD/TDD, see ["LTE-Advanced FDD/TDD Mode Remote Command Results " on page 470](#)

For WLAN, see ["MSR Mode Remote Command Results" on page 469](#)

Command	Return Value
FETCh:CHPower[n]?	Refer to the table below.
MEASure:CHPower[n]?	
READ:CHPower[n]?	
FETCh:CHPower:CHPower?	Returns the Channel Power (dBm) (BW compatibility functionality)
MEASure:CHPower:CHPower?	
READ:CHPower:CHPower?	
FETCh:CHPower:DENSity?	Returns the Power Spectral Density (dBm/Hz) (BW compatibility functionality)
MEASure:CHPower:DENSity?	
READ:CHPower:DENSity?	

n	Results Returned
n=1 (or not specified)	Returns scalar results: <ol style="list-style-type: none"> 1. Channel Power is a floating point number representing the total channel power in the specified integration bandwidth. 2. PSD (Power Spectral Density) is the power in the specified unit bandwidth. The unit bandwidth is selected by the PSD Unit parameter in either dBm/Hz or dBm/MHz.
2	Returns floating point numbers that are the captured trace data of the power (in dBm/resolution BW) of the signal. The frequency span of the captured trace data is specified by the Span key.

DVB-T/H and DTMB (CTTB) Mode Remote Command Results

The following commands are available only for DVB-T/H and DTMB (CTTB) mode.

Condition	n	Results Returned
	n=1 (or not specified)	Returns scalar results: 1. Channel Power is a floating point number representing the total channel power in the specified integration bandwidth. 2. PSD (Power Spectral Density) is the power in the specified unit bandwidth. The unit bandwidth is selected by the PSD Unit parameter in either dBm/Hz or dBm/MHz.
	2	Returns floating point numbers that are the captured trace data of the power (in dBm/resolution BW) of the signal. The frequency span of the captured trace data is specified by the Span key.
Mode = DVB-T/H or Mode = DTMB (CTTB)	3	Returns 7 comma-separated scalar results, in the following order. 1. The shoulder attenuation result (dB) 2. Lower shoulder attenuation result (dB) 3. Upper shoulder attenuation result (dB) 4. Lower Offset - MAX shoulder point power (dBm) 5. Lower Offset - MAX shoulder point frequency (MHz) 6. Upper Offset - MAX shoulder point power (dBm) 7. Upper Offset - MAX shoulder point frequency (MHz) If the results are not available, -999.0 is returned. For example, if current view is RF spectrum or spectrum mask, -999.0 is returned.
Mode = DVB-T/H or Mode = DTMB (CTTB)	4	Returns floating point numbers that are the captured trace data of the power (in dBm/resolution BW) of the signal in the left graph of the shoulder attenuation view. If the results are not available, -999.0 is returned. For example, if current view is RF spectrum or spectrum mask, -999.0 is returned.
Mode = DVB-T/H or Mode = DTMB (CTTB)	5	Returns floating point numbers that are the captured trace data of the power (in dBm/resolution BW) of the signal in the right graph of the shoulder attenuation view. If the results are not available, -999.0 is returned. For example, if current view is RF spectrum or spectrum mask, -999.0 is returned.
Mode = DVB-T/H or Mode = DTMB (CTTB)	6	Returns floating point numbers that are the captured trace data of the power (in dBm/resolution BW) of the mask in the spectrum mask view. If the results are not available, -999.0 is returned. For example, if current view is RF spectrum or shoulder attenuation, -999.0 is returned.
Mode = DVB-T/H or Mode = DTMB (CTTB)	7	Returns the failed point information in the following order: 1. the 1st failed point frequency (MHz) 2. the 1st failed point absolute power (dBm) 3. the 1st failed point relative power (dB) 4. the 2nd failed point frequency (MHz) 5. the 2nd failed point absolute power (dBm)

6. the 2nd failed point relative power (dB)

...

$3*N-2$. the ($3*N-2$)th failed point frequency (MHz)

$3*N-1$. the ($3*N-1$)th failed point absolute power (dBm)

$3*N$. the ($3*N$)th failed point relative power (dB)

If the number of failed points is less than 20, it will show all of them (frequency, power and relative power), $N < 20$;

If the number of failed points is great than 20, the first ten failed points and the last ten failed points will be show, $N = 20$.

If the results are not available, -999.0 is returned.

For example, if current view is RF spectrum or shoulder attenuation, -999.0 is returned.

ISDB-T and CMMB mode Remote Command Results

The following commands are available only for ISDB-T and CMMB mode.

Condition	n	Results Returned
	n=1 (or not specified)	Returns scalar results: 1. Channel Power is a floating point number representing the total channel power in the specified integration bandwidth. 2. PSD (Power Spectral Density) is the power in the specified unit bandwidth. The unit bandwidth is selected by the PSD Unit parameter in either dBm/Hz or dBm/MHz.
	2	Returns floating point numbers that are the captured trace data of the power (in dBm/resolution BW) of the signal. The frequency span of the captured trace data is specified by the Span key.
Mode = ISDB-T or Mode = CMMB	3	Returns 7 comma-separated scalar results, in the following order. 1. The shoulder attenuation result (dB) 2. Lower shoulder attenuation result (dB) 3. Upper shoulder attenuation result (dB) 4. Lower Offset - MAX shoulder point power (dBm) 5. Lower Offset - MAX shoulder point frequency (MHz) 6. Upper Offset - MAX shoulder point power (dBm) 7. Upper Offset - MAX shoulder point frequency (MHz) If the results are not available, -999.0 is returned. For example, if current view is RF spectrum or spectrum mask, -999.0 is returned.
Mode = ISDB-T or Mode = CMMB	4	Returns floating point numbers that are the captured trace data of the power (in dBm/resolution BW) of the signal in the left window of the shoulder attenuation view. If the results are not available, -999.0 is returned. For example, if current view is RF spectrum or spectrum mask, -999.0 is returned.
Mode = ISDB-T or Mode = CMMB	5	Returns floating point numbers that are the captured trace data of the power (in dBm/resolution BW) of the signal in the right window of the shoulder attenuation view. If the results are not available, -999.0 is returned. For example, if current view is RF spectrum or spectrum mask, -999.0 is returned.

MSR Mode Remote Command Results

The following commands are available only for MSR mode.

Condition	n	Results Returned
	n=1 (or not specified)	Returns scalar results: 1. Channel Power is a floating point number representing the total channel power in the specified integration bandwidth. 2. PSD (Power Spectral Density) is the power in the specified unit bandwidth. The unit bandwidth is selected by the PSD Unit parameter in either dBm/Hz or dBm/MHz.
	2	Returns floating point numbers that are the captured trace data of the power (in dBm/resolution BW) of the signal. The frequency span of the captured trace data is specified by the Span key.
Mode = MSR	3	Returns [Carriers] comma-separated scalar results, in the following order. 1. Total Power of Carrier 1 (dBm) 2. Total Power of Carrier 2 (dBm) ... [Carriers]. Total Power of Carrier [Carriers] (dBm) If the result is not available, NaN (9.91E+37) is returned. Number of returned values might be changed in future releases.
Mode = MSR	4	Returns comma-separated scalar results, in the following order. 1. Total Power of LTE FDD carriers (dBm) 2. Total Power of W-CDMA carriers (dBm) 3. Total Power of GSM/EDGE carriers (dBm) 4. Total Power of cdma2000 carriers (dBm) 5. Total Power of 1xEV-DO carriers (dBm) ... The number of results is incremented by one when a new format is supported. If the result is not available, NaN (9.91E+37) is returned. Number of returned values will be changed in future releases if the number of supported radio format is increased.

LTE-Advanced FDD/TDD Mode Remote Command Results

The following commands are available only for LTE-Advanced FDD/TDD mode.

Condition	n	Results Returned
	n=1 (or not specified)	Returns scalar results: 1. Channel Power is a floating point number representing the total channel power in the specified integration bandwidth. 2. PSD (Power Spectral Density) is the power in the specified unit bandwidth. The unit bandwidth is selected by the PSD Unit parameter in either dBm/Hz or dBm/MHz.
	2	Returns floating point numbers that are the captured trace data of the power (in dBm/resolution BW) of the signal. The frequency span of the captured trace data is specified by the Span key.
Mode = LTEATDD/ LTEAFDD	3	Returns comma-separated scalar results, in the following order. 1. Total Power of Component Carrier 0 (dBm) 2. Total Power of Component Carrier 1 (dBm) 3. Total Power of Component Carrier 2 (dBm) 4. Total Power of Component Carrier 3 (dBm) 5. Total Power of Component Carrier 4 (dBm) If the result is not available, NaN (9.91E+37) is returned.
Mode = LTEATDD/ LTEAFDD	4	Returns comma-separated scalar results, in the following order. The unit bandwidth is selected by the PSD Unit parameter in either dBm/Hz or dBm/MHz. 1. Total Power Spectral Density of Component Carrier 0 (PSD Unit) 2. Total Power Spectral Density of Component Carrier 1 (PSD Unit) 3. Total Power Spectral Density of Component Carrier 2 (PSD Unit) 4. Total Power Spectral Density of Component Carrier 3 (PSD Unit) 5. Total Power Spectral Density of Component Carrier 4 (PSD Unit) If the result is not available, NaN (9.91E+37) is returned.

Remote Command Results for WLAN Channel Power Measurement

n	Results Returned
n=1 (or not specified)	<p>Returns scalar results:</p> <p>When the radio standard is NOT WLAN 802.11ac 80 + 80 MHz:</p> <ol style="list-style-type: none"> 1. Channel Power is a floating point number representing the total channel power in the specified integration bandwidth. 2. PSD (Power Spectral Density) is the power in the specified unit bandwidth. The unit bandwidth is selected by the PSD Unit parameter in either dBm/Hz or dBm/MHz. <p>When the radio standard is WLAN 802.11ac 80 + 80 MHz:</p> <ol style="list-style-type: none"> 1. Channel Power of the carrier of which the center frequency is indicated by Freq Segment 1 is a floating point number representing the total channel power of the first segment in the specified integration bandwidth. 2. PSD (Power Spectral Density) of the carrier of which the center frequency is indicated by Freq Segment 1 is the power in the specified unit bandwidth of the first segment. The unit bandwidth is selected by the PSD Unit parameter in either dBm/Hz or dBm/MHz. 3. Channel Power of the carrier of which the center frequency is indicated by Freq Segment 2 is a floating point number representing the total channel power of the second segment in the specified integration bandwidth. 4. PSD (Power Spectral Density) of the carrier of which the center frequency is indicated by Freq Segment 2 is the power in the specified unit bandwidth of the second segment. The unit bandwidth is selected by the PSD Unit parameter in either dBm/Hz or dBm/MHz.
2	Returns floating point numbers that are the captured trace data of the power (in dBm/resolution BW) of the signal. The frequency span of the captured trace data is specified by the Span key.

Key Path	Meas
Mode	SA, WCDMA, C2K, WIMAX OFDMA, 1xEVDO, DVB-T/H, DTMB (CTTB), ISDB-T, CMMB, LTE, LTETDD, Digital Cable TV, WLAN, MSR, LTEAFDD, LTEATDD
Initial S/W Revision	Prior to A.02.00
Modified at S/W Revision	A.03.00

AMPTD Y Scale

Accesses a menu of functions that enable you to set the vertical scale parameters. The parameter values are measurement independent, except all Attenuation values and the Internal Preamp selection, which are the same across all measurements.

Key Path	Front-panel key
Initial S/W Revision	Prior to A.02.00

Ref Value

Sets the value for the absolute power reference. However, since the Auto Scaling is defaulted to On, this value is automatically determined by the measurement result. When you set a value manually, Auto Scaling automatically changes to Off.

Key Path	AMPTD Y Scale
Mode	SA, WCDMA, C2K, WIMAX OFDMA, 1xEVDO, DVB-T/H, DTMB (CTTB), ISDB-T, CMMB, LTE, LTETDD, Digital Cable TV, WLAN, MSR, LTEAFDD, LTEATDD
Remote Command	:DISPlay:CHPower:VIEW[1]:WINDow[1]:TRACe:Y[:SCALe]:RLEVel <real> :DISPlay:CHPower:VIEW[1]:WINDow[1]:TRACe:Y[:SCALe]:RLEVel?
Example	DISP:CHP:VIEW:WIND:TRAC:Y:RLEV 10 dBm DISP:CHP:VIEW:WIND:TRAC:Y:RLEV?
Notes	You must be in the Spectrum Analysis mode, W-CDMA mode, cdma2000 mode, DVB-T/H mode, DTMB (CTTB) mode, ISDB-T mode, CMMB mode, Digital Cable TV mode, LTD mode, LTE TDD mode, WLAN mode, 1xEVDO mode, MSR, LTE-Advanced FDD/TDD mode or WIMAX OFDMA mode to use this command. Use :INSTrument:SElect to set the mode.
Couplings	When the Auto Scaling is On, this value is automatically determined by the measurement result. When you set a value manually, Auto Scaling automatically changes to Off.
Preset	10.00 dBm
State Saved	Saved in instrument state.
Min	-250.00 dBm
Max	250.00 dBm
Initial S/W Revision	Prior to A.02.00
Modified at S/W Revision	A.02.00, A.03.00

Attenuation

This menu controls the attenuator functions and interactions between the attenuation system components.

There are two attenuator configurations in the X-Series. One is a dual attenuator configuration consisting of a mechanical attenuator and an optional electronic attenuator. The other configuration uses a single

attenuator with combined mechanical and electronic sections that controls all the attenuation functions. Different models in the X-Series come with different configurations.

See ["Dual Attenuator Configurations:" on page 473](#)

See ["Single Attenuator Configuration:" on page 474](#)

Most Attenuation settings are the same for all measurements – they do not change as you change measurements. Settings like these are called “Meas Global” and are unaffected by Meas Preset.

Key Path	AMPTD Y Scale
Scope	Meas Global
Dependencies	In measurements that support the I/Q inputs, this key is unavailable when I/Q is the selected input, and is replaced by the Range key in that case.
Readback Line	Contains a summary in [] brackets of the current total attenuation. See the descriptions of the , " (Mech) Atten " on page 2160, and " Enable Elec Atten " on page 2162 keys for more detail on the contributors to the total attenuation. Note that when "Pre-Adjust for Min Clip" is on, this value can change at the start of every measurement.
Initial S/W Revision	Prior to A.02.00
Modified at S/W Revision	A.03.00

Dual Attenuator Configurations:

Configuration 1: Mechanical attenuator + optional electronic attenuator

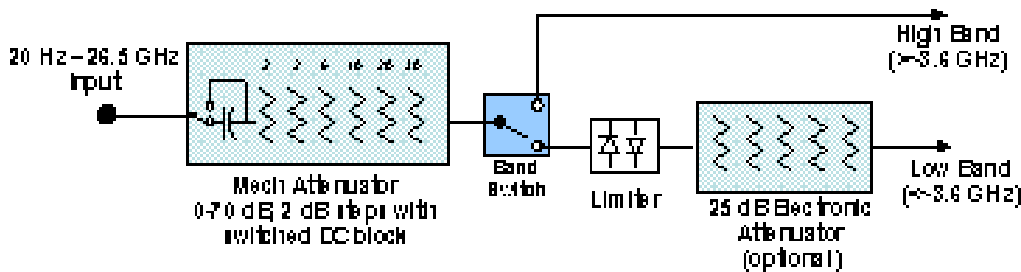

Configuration 2: Mechanical attenuator, no optional electronic attenuator

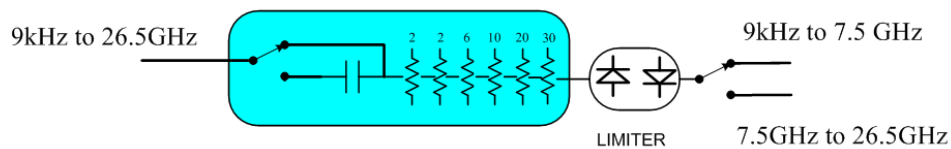

(note that Configuration 2 is not strictly speaking a dual-section attenuator, since there is no electronic section available. However, it behaves exactly like Configuration 1 without the Electronic Attenuator option EA3, therefore for the sake of this document it is grouped into the “Dual Attenuator” configuration)

Single Attenuator Configuration:

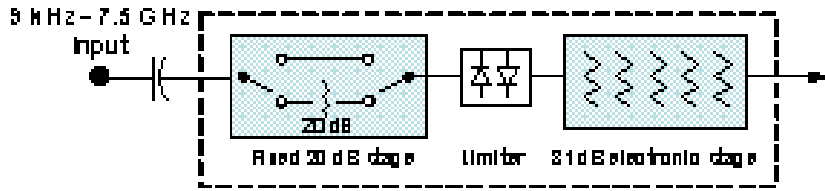

You can tell which attenuator configuration you have by pressing the Attenuation key, which (in most Modes) opens the Attenuation menu. If the first key in the Attenuation menu says Mech Atten you have the dual attenuator configuration. If the first key says Atten you have the single attenuator configuration.

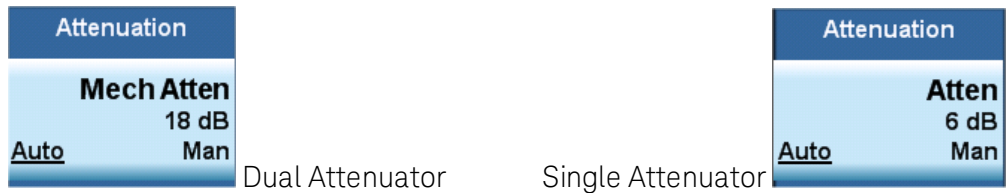

In the single attenuator configuration, you control the attenuation with a single control, as the fixed stage has only two states. In the dual attenuator configuration, both stages have significant range so you are given separate control of the mechanical and electronic attenuator stages.

When you have the dual attenuator configuration, you may still have only a single attenuator, because unless option EA3 (the Electronic Attenuator option) is available, and you purchase it, you will have only the mechanical attenuator.

(Mech) Atten

This key is labeled Mech Atten in dual attenuator models and Atten in single attenuator models. In the dual attenuator configuration, this key only affects the mechanical attenuator.

This key lets you modify the attenuation applied to the RF input signal path. This value is normally auto coupled to the Ref Level, the Internal Preamp Gain, any External Gain that is entered, and the Max Mixer Level, as described in the table below.

See ["Attenuator Configurations and Auto/Man" on page 476](#)

Key Path	AMPTD Y Scale, Attenuation
Remote Command	<pre>[:SENSe]:POWeR[:RF]:ATTenuation <rel_ampl> [:SENSe]:POWeR[:RF]:ATTenuation? [:SENSe]:POWeR[:RF]:ATTenuation:AUTO OFF ON 0 1 [:SENSe]:POWeR[:RF]:ATTenuation:AUTO?</pre>
Example	<p>POW:ATT 20</p> <p>Dual attenuator configuration: sets the mechanical attenuator to 20 dB</p> <p>Single attenuator mode: sets the main attenuation to 20 dB (see below for definition of “main” attenuation).</p> <p>If the attenuator was in Auto, it sets it to Manual.</p>
Dependencies	Some measurements do not support the Auto setting of (Mech) Atten. In these measurements, the

Auto/Man selection is not available, and the Auto/Man line on the key disappears.

In dual attenuator configurations, when the electronic attenuator is enabled, the mechanical attenuator has no auto setting and the Auto/Man line on the key disappears. The state of Auto/Man is remembered and restored when the electronic attenuator is once again disabled. This is described in more detail in the "[Enable Elec Atten](#)" on page 2162 key description.

See "[Attenuator Configurations and Auto/Man](#)" on page 476 for more information on the Auto/Man functionality of Attenuation.

Couplings

When (Mech) Atten is in Auto, it uses the following algorithm to determine a value:

If the USB Preamp is connected to USB, use 0 dB.

Otherwise, $Atten = ReferenceLevel + PreAmpGain + ExternalGain - RefLevelOffset - MaxMixerLevel + IF\ Gain$.

Limit this value to be between 6 dB and the Max value. No value below 6 dB can ever be chosen by Auto.

The resulting value is rounded up to the largest value possible given the attenuation step setting. That is, 50.01 dB would change to 60 dB (for a 10 dB attenuation step).

The "IF Gain" term in the equation above is either 0 dB or +10 dB, depending on the settings of FFT IF Gain, Swept IF Gain, max Ref Level and the Auto/Man setting of Mech Atten.

In External Mixing and BBIQ, where the Attenuator is not in the signal path, the Attenuator setting changes as described above when (Mech) Atten is in Auto, but no changes are made to the actual attenuator hardware setting until the input is changed back to the RF Input.

Preset

The preset for Mech Attenuation is "Auto."

The Auto value of attenuation is:

CXA, EXA, MXA and PXA: 10 dB

State Saved

Saved in instrument state

Min

0 dB

The attenuation set by this key cannot be decreased below 6 dB with the knob or step keys. To get to a value below 6 dB it has to be directly entered from the keypad or via SCPI. This protects from adjusting the attenuation to a dangerously small value which can put the instrument at risk of damage to input circuitry. However, if the current mechanical attenuation is below 6 dB it can be increased with the knob and step keys, but not decreased.

Max

CXA N9000A-503/507: 50 dB

CXA N9000A-513/526: 70dB

EXA: 60 dB

MXA and PXA: 70 dB

In the single attenuator configuration, the total of ATT and EATT cannot exceed 50 dB, so if the EATT is set to 24 dB first, the main attenuation cannot be greater than 26 dB and will be reduced accordingly; if the main attenuator is set to 40 dB first, EATT cannot be greater than 10 dB.

Initial S/W Revision

Prior to A.02.00

Modified at S/W Revision

A.03.00

Attenuator Configurations and Auto/Man

As described in the Attenuation key description, there are two distinct attenuator configurations available in the X-Series, the single attenuator and dual attenuator configurations. In dual attenuator configurations, we have the mechanical attenuation and the electronic attenuation, and the current total attenuation is the sum of the electronic + mechanical attenuation. In single attenuator configurations, we refer to the attenuation set using the (Mech) Atten key (or POW:ATT SCPI) as the “main” attenuation; and the attenuation that is set by the SCPI command POW:EATT as the “soft” attenuation (the POW:EATT command is honored even in the single attenuator configuration, for compatibility purposes). Then the current total attenuation is the sum of the main + soft attenuation. See the Elec Atten key description for more on “soft” attenuation.

In the dual attenuator configuration, when the electronic attenuator is enabled, there is no Auto/Man functionality for the mechanical attenuator, and the third line of the key label (the Auto/Man line) disappears:



Enable Elec Atten

Enables the Electronic Attenuator.

The electronic attenuator offers finer steps than the mechanical attenuator, has no acoustical noise, is faster, and is less subject to wear. These advantages primarily aid in remote operation and are negligible for front panel use. See ["Using the Electronic Attenuator: Pros and Cons" on page 478](#) for a detailed discussion of the pros and cons of using the electronic attenuator.

For the single attenuator configuration, for SCPI backwards compatibility, the “soft” attenuation feature replaces the dual attenuator configuration’s electronic attenuator. All the same couplings and limitations apply. See ["Attenuator Configurations and Auto/Man" on page 2162](#)

See ["More Information" on page 477](#)

Key Path	AMPTD Y Scale, Attenuation
Remote Command	[:SENSe] :POWer [:RF] :EATTenuation :STATe OFF ON 0 1 [:SENSe] :POWer [:RF] :EATTenuation :STATe ?
Example	POW:EATT:STAT ON
Dependencies	This key only appears in Dual Attenuator models with an Electronic Attenuator installed. It does not appear in models with the Single Attenuator configuration, as in the single attenuator configuration there is no “electronic attenuator” there is only a single integrated attenuator (which has both a mechanical and electronic stage). However, in the single attenuator configuration, EATT SCPI commands are accepted for compatibility with other X-series instruments and set a “soft” attenuation as described in "Attenuator Configurations and Auto/Man" on page 2162 . The electronic attenuator (and the “soft” attenuation function provided in single attenuator configurations) is unavailable above 3.6 GHz. Therefore, if the Stop Frequency of the analyzer is > 3.6 GHz then the Enable Elec Atten key will be OFF and grayed out.

	<p>If the Internal Preamp is on, meaning it is set to Low Band or Full, the electronic attenuator (and the “soft” attenuation function provided in single attenuator configurations) is unavailable. In this case the Enable Elec Atten key will be OFF and grayed out.</p> <p>If either of the above is true, if the SCPI command is sent, an error indicating that the electronic attenuator is unavailable will be sent.</p> <p>If the electronic/soft Attenuator is enabled, then the Stop Freq of the analyzer is limited to 3.6 GHz and the Internal Preamp is unavailable.</p> <p>The SCPI-only “soft” electronic attenuation for the single-attenuator configuration is not available in all measurements; in particular, it is not available in the Swept SA measurement.</p>
Couplings	Enabling and disabling the Electronic Attenuator affects the setting of the Mechanical Attenuator (in dual attenuator configurations). This is described in more detail below this table.
Preset	OFF for Swept SA measurement; ON for all other measurements that support the electronic attenuator
State Saved	Saved in instrument state
Initial S/W Revision	Prior to A.02.00
Modified at S/W Revision	A.03.00

More Information

Mechanical Attenuator Transition Rules

When the Electronic Attenuator is enabled, the Mechanical Attenuator transitions to a state that has no Auto function. Below are the rules for transitioning the Mechanical Attenuator. NOTE that the information below ONLY applies to the dual attenuator configurations, and ONLY when the Electronic Attenuator is installed:

When the Electronic Attenuation is enabled from a disabled state:

- The Mechanical Attenuator is initialized to 10 dB (this is its optimal performance setting). You can then set it as desired with SCPI, numeric keypad, step keys, or knob, and it behaves as it normally would in manual mode
- The Auto/Man state of (Mech) Atten is saved
- The Auto/Man line on the (Mech) Atten key disappears and the auto rules are disabled
- The Electronic Attenuator is set to 10 dB less than the previous value of the Mechanical Attenuator, within the limitation that it must stay within the range of 0 to 24 dB of attenuation.

Examples in the dual attenuator configuration:

- Mech Atten at 20 dB. Elec Atten enabled, Mech Atten set to 10 dB, and Elec Atten set to 10 dB. New total attenuation equals the value before Elec Atten enabled.
- Mech Atten at 0 dB. Elec Atten enabled, Mech Atten set to 10 dB, and Elec Atten set to 0 dB. New total attenuation does not equal the value before Elec Atten enabled.
- Mech Atten at 40 dB. Elec Atten enabled, Mech Atten set to 10 dB, and Elec Atten set to 24 dB. New total attenuation does not equal the value before Elec Atten enabled.

When the Electronic Attenuation is disabled from an enabled state:

- The Elec Atten key is grayed out
- The Auto/Man state of (Mech) Atten is restored
- If now in Auto, (Mech) Atten recouples
- If now in Man, (Mech) Atten is set to the value of total attenuation that existed before the Elec Atten was disabled. The resulting value is rounded up to the smallest value possible given the (Mech) Atten Step setting - (That is, 57 dB changes to 58 dB when (Mech) Atten Step is 2 dB.)

Using the Electronic Attenuator: Pros and Cons

The electronic attenuator offers finer steps than the mechanical attenuator, has no acoustical noise, is faster, and is less subject to wear.

The “finer steps” advantage of the electronic attenuator is beneficial in optimizing the alignment of the analyzer dynamic range to the signal power in the front panel as well as remote use. Thus, you can achieve improved relative signal measurement accuracy. Compared to a mechanical attenuator with 2 dB steps, the 1 dB resolution of the electronic attenuator only gives better resolution when the odd-decibel steps are used. Those odd-decibel steps are less accurately calibrated than the even-decibel steps, so one tradeoff for this superior relative accuracy is reduced absolute amplitude accuracy.

Another disadvantage of the electronic attenuator is that the spectrum analyzer loses its “Auto” setting, making operation less convenient.

Also, the relationship between the dynamic range specifications (TOI, SHI, compression and noise) and instrument performance are less well-known with the electrical attenuator. With the mechanical attenuator, TOI, SHI and compression threshold levels increase dB-for-dB with increasing attenuation, and the noise floor does as well. With the electronic attenuator, there is an excess attenuation of about 1 to 3 dB between 0 and 3.6 GHz, making the effective TOI, SHI, and so forth, less well known. Excess attenuation is the actual attenuation relative to stated attenuation. Excess attenuation is accounted for in the analyzer calibration

Elec Atten

Controls the Electronic Attenuator in dual attenuator configurations. This key does not appear in single attenuator configurations, as the control of both the mechanical and electronic stages of the single attenuator is integrated into the single Atten key.

Key Path	AMPTD Y Scale, Attenuation
Remote Command	[:SENSe] :POWer [:RF] :EATTenuation <rel_amp> [:SENSe] :POWer [:RF] :EATTenuation?
Notes	Electronic Attenuation’s specification is defined only when Mechanical Attenuation is 6 dB.
Dependencies	This key only appears in Dual Attenuator models with an Electronic Attenuator installed. It does not appear in models with the Single Attenuator configuration, as in the single attenuator configuration there is no “electronic attenuator” there is only a single integrated attenuator (which has both a mechanical and electronic stage). However, in the single attenuator configuration, EATT SCPI commands are accepted for compatibility with other X-series instruments and set a “soft” attenuation as described in "Attenuator Configurations and Auto/Man" on page 2162 . The “soft” attenuation is treated as an addition to the “main” attenuation value set by the Atten softkey or the

	POW:ATT SCPI command and affects the total attenuation displayed on the Attenuation key and the Meas Bar. When Enable Elec Atten is off or grayed out, the Elec Atten key is grayed out.
Preset	0 dB
State Saved	Saved in instrument state
Min	0 dB
Max	Dual attenuator configuration: 24 dB Single attenuator configuration: the total of ATT and EATT cannot exceed 50 dB, so if the EATT is set to 24 dB first, the main attenuation cannot be greater than 26 dB and will be reduced accordingly; if the main attenuator is set to 40 dB first, EATT cannot be greater than 10 dB
Initial S/W Revision	Prior to A.02.00
Modified at S/W Revision	A.03.00

Adjust Atten for Min Clip

Sets the combination of mechanical and electronic attenuation and gain based on the current measured signal level so that clipping will be at a minimum.

This is an "immediate action" function, that is, it executes once, when the key is pressed.

This key is grayed out in measurements that do not support this functionality. The spectrum analyzer measurement, Swept SA, does not support this functionality.

Key Path	AMPTD Y Scale, Attenuation
Remote Command	<code>[:SENSe] :POWer [:RF] :RANGe:OPTimize IMMEDIATE</code>
Initial S/W Revision	Prior to A.02.00
Modified at S/W Revision	A.03.00

Pre-Adjust for Min Clip

If this function is on, it does the adjustment described under "[Adjust Atten for Min Clip](#)" on page 2165 each time a measurement restarts. Therefore, in Continuous measurement mode, it only executes before the first measurement.

In dual attenuator models, you can set Elec+Mech Atten, in which case both attenuators participate in the autoranging, or Elec Atten Only, in which case the mechanical attenuator does not participate in the autoranging. This latter case results in less wear on the mechanical attenuator and is usually faster.

This key is grayed out in measurements that do not support this functionality. The spectrum analyzer measurement, Swept SA, does not support this functionality.

Key Path	AMPTD Y Scale, Attenuation
Remote Command	<code>[:SENSe] :POWer [:RF] :RANGe:OPTimize:ATTenuation OFF ELECTRical COMBined</code>

	<code>[:SENSe] :POWer [:RF] :RANGe:OPTimize:ATTenuation?</code>
Notes	The SCPI parameter ELECtrical sets this function to On in single attenuator models. The SCPI parameter COMBined is mapped to ELECtrical in single attenuator models; if you send COMBined, it sets the function to On and returns ELEC to a query.
Dependencies	This key only appears in Dual Attenuator models with an Electronic Attenuator installed. In instruments with Dual Attenuator model, when Enable Elec Atten is off or grayed out, the Pre-Adjust for Min Clip key is grayed out.
Preset	OFF for Swept SA measurement; ON for all other measurements that support Pre-Adjust for Min Clip
State Saved	Saved in instrument state
Range	Dual attenuator models: Off Elec Atten Only Mech + Elec Atten Single attenuator models: Off On
Initial S/W Revision	Prior to A.02.00
Modified at S/W Revision	A.03.00

Remote Command	<code>[:SENSe] :POWer [:RF] :RANGe:AUTO ON OFF 1 0</code> <code>[:SENSe] :POWer [:RF] :RANGe:AUTO?</code>
Notes	ON aliases to "Elec Atten Only" (:POW:RANG:OPT:ATT ELEC) OFF aliases to "Off" (:POW:RANG:OPT:ATT OFF) The query :POW:RANG:AUTO? returns true if :POW:RANG:OPT:ATT is not "Off"
Initial S/W Revision	Prior to A.02.00

Off

Turns Pre-Adjust for Min Clip off. This is the default setting.

This key is grayed out in measurements that do not support this functionality. The spectrum analyzer measurement, Swept SA, does not support this functionality.

Key Path	AMPTD Y Scale, Attenuation, Pre-Adjust for Min Clip
Example	:POW:RANGe:OPT:ATT OFF
Initial S/W Revision	Prior to A.02.00

Elec Atten Only

Selects only the electric attenuator to participate in auto ranging. This offers less wear on the mechanical attenuator and is usually faster.

This key is grayed out in measurements that do not support this functionality. The spectrum analyzer measurement, Swept SA, does not support this functionality.

Key Path	AMPTD Y Scale, Attenuation, Pre-Adjust for Min Clip
Example	:POW:RANGe:OPT:ATT ELEC
Initial S/W Revision	Prior to A.02.00

Mech + Elec Atten

In dual attenuator models, this selects both attenuators participate in the autoranging.

This key is grayed out in measurements that do not support this functionality. The spectrum analyzer measurement, Swept SA, does not support this functionality.

Key Path	AMPTD Y Scale, Attenuation, Pre-Adjust for Min Clip
Example	:POW:RANGe:OPT:ATT COMB
Initial S/W Revision	Prior to A.02.00

(Mech) Atten Step

This controls the step size used when making adjustments to the input attenuation.

This key is labeled Mech Atten Step in dual attenuator models and Atten Step in single attenuator models. In the dual attenuator configuration, this key only affects the step size of the mechanical attenuator.

Key Path	AMPTD Y Scale, Attenuation
Remote Command	[:SENSe] :POWer [:RF] :ATTenuation :STEP [:INCRement] 10 dB 2 dB [:SENSe] :POWer [:RF] :ATTenuation :STEP [:INCRement] ?
Example	POW:ATT:STEP 2
Notes	Note this feature works like a 1-N choice from the front panel, but it takes a specific value (in dB) when used remotely. The only valid values are 2 and 10.
Dependencies	Blanked in CXA and EXA if option FSA (2 dB steps) is not present. If blanked, attempts to set it via SCPI will yield an error.
Couplings	When the attenuation step size changes, the current mechanical attenuation value is adjusted (if necessary) to be quantized to the new step size. That is, if step is set to 10 dB, mech atten is increased if necessary so it is a multiple of 10 dB
Preset	PXA and MXA: 2 dB EXA and CXA: 10 dB (2 dB with option FSA)
State Saved	Saved in instrument state
Initial S/W Revision	Prior to A.02.00
Modified at S/W Revision	A.03.00

Scale/Div

Sets the units per division of the vertical scale in the logarithmic display. However, since the Auto Scaling is defaulted to On, this value is automatically determined by the measurement result. When you set a value manually, Auto Scaling automatically changes to Off.

Key Path	AMPTD Y Scale
Mode	SA, WCDMA, C2K, WIMAX OFDMA, 1xEVDO, DVB-T/H, DTMB (CTTB), ISDB-T, CMMB, LTE, LTETDD, Digital Cable TV, WLAN, MSR, LTEAFDD, LTEATDD
Remote Command	:DISPlay:CHPower:VIEW[1]:WINDow[1]:TRACe:Y[:SCALe]:PDIVision <rel_amp1> :DISPlay:CHPower:VIEW[1]:WINDow[1]:TRACe:Y[:SCALe]:PDIVision?
Example	DISP:CHP:VIEW:WIND:TRAC:Y:PDIV 2 DISP:CHP:VIEW:WIND:TRAC:Y:PDIV?
Notes	You must be in the Spectrum Analysis mode, W-CDMA mode, cdma2000 mode, DVB-T/H mode, DTMB (CTTB) mode, ISDB-T mode, CMMB mode, Digital Cable TV mode, LTE mode, LTE TDD mode, WLAN mode, 1xEVDO mode, MSR, LTE-Advanced FDD/TDD mode or WIMAX OFDMA mode to use this command. Use :INSTrument:SElect to set the mode.
Couplings	When the Auto Scaling is On, this value is automatically determined by the measurement result. When you set a value manually, Auto Scaling automatically changes to Off.
Preset	10.00 dB
State Saved	Saved in instrument state.
Min	0.10 dB
Max	20.00 dB
Initial S/W Revision	Prior to A.02.00
Modified at S/W Revision	A.02.00, A.03.00

Presel Center

When this key is pressed, the centering of the preselector filter is adjusted to optimize the amplitude accuracy at the frequency of the selected marker. If the selected marker is not on when Presel Center is pressed, the analyzer will turn on the selected marker, perform a peak search, and then perform centering on the marker's center frequency. If the selected marker is already on and between the start and stop frequencies of the analyzer, the analyzer performs the preselector calibration on that marker's frequency. If the selected marker is already on, but outside the frequency range between Start Freq and Stop Freq, the analyzer will first perform a peak search, and then perform centering on the marker's center frequency.

The value displayed on the Presel Adjust key will change to reflect the new preselector tuning (see Presel Adjust).

A number of considerations should be observed to ensure proper operation. See ["Proper Preselector Operation" on page 483](#).

Key Path	AMPTD Y Scale
Remote Command	[:SENSE]:POWer[:RF]:PCENTER

Example	POW:PCEN
Notes	Note that the rules outlined above under the key description apply for the remote command as well as the key. The result of the command is dependent on marker position, and so forth. Any message shown by the key press is also shown in response to the remote command.
Dependencies	<ul style="list-style-type: none"> • Grayed out if the microwave preselector is off.) • If the selected marker's frequency is below Band 1, advisory message 0.5001 is generated and no action is taken. • Grayed out if entirely in Band 0. • Blank in models that do not include a preselector, such as option 503. If the SCPI is sent in these instruments, it is accepted without error, and the query always returns 0. • Grayed out in the Spectrogram View.
Couplings	<p>The active marker position determines where the centering will be attempted.</p> <p>If the analyzer is in a measurement such as averaging when centering is initiated, the act of centering the preselector will restart averaging but the first average trace will not be taken until the centering is completed.</p>
Status Bits/OPC dependencies	<p>When centering the preselector, *OPC will not return true until the process is complete and a subsequent measurement has completed, nor will results be returned to a READ or MEASURE command.</p> <p>The Measuring bit should remain set while this command is operating and should not go false until the subsequent sweep/measurement has completed.</p>
Initial S/W Revision	Prior to A.02.00
Modified at S/W Revision	A.03.00

Proper Preselector Operation

A number of considerations should be observed to ensure proper operation:

1. If the selected marker is off, the analyzer will turn on a marker, perform a peak search, and adjust the preselector using the selected marker's frequency. It uses the "highest peak" peak search method unqualified by threshold or excursion, so that there is no chance of a 'no peak found' error. It continues with that peak, even if it is the peak of just noise. Therefore, for this operation to work properly, there should be a signal on screen in a preselected range for the peak search to find.
2. If the selected marker is already on, the analyzer will attempt the centering at that marker's frequency. There is no preselector for signals below about 3.6 GHz, therefore if the marker is on a signal below 3.6 GHz, no centering will be attempted and an advisory message generated
3. In some models, the preselector can be bypassed. If it is bypassed, no centering will be attempted in that range and a message will be generated.

Preselector Adjust

Allows you to manually adjust the preselector filter frequency to optimize its response to the signal of interest. This function is only available when "[Presel Center](#)" on page 2168 is available.

For general purpose signal analysis, using Presel Center is recommended. Centering the filter minimizes the impact of long-term preselector drift. Presel Adjust can be used instead to manually optimize the preselector. One application of manual optimization would be to peak the preselector response, which both optimizes the signal-to-noise ratio and minimizes amplitude variations due to small (short-term) preselector drifting.

Key Path	AMPTD Y Scale
Scope	Meas Global
Remote Command	<code>[:SENSe] :POWer [:RF] :PADJust <freq></code> <code>[:SENSe] :POWer [:RF] :PADJust?</code>
Example	POW:PADJ 100KHz POW:PADJ?
Notes	The value on the key reads out to 0.1 MHz resolution.
Dependencies	<ul style="list-style-type: none"> • Grayed out if microwave preselector is off.) • Grayed out if entirely in Band 0. • Blank in models that do not include a preselector, such as option 503. If the SCPI is sent in these instruments, it is accepted without error, and the query always returns 0. • Grayed out in the Spectrogram View.
Preset	0 MHz
State Saved	The Presel Adjust value set by Presel Center, or by manually adjusting Presel Adjust, is not saved in instrument state, and does not survive a Preset or power cycle.
Min	-500 MHz
Max	500 MHz
Default Unit	Hz
Backwards Compatibility SCPI	<code>[:SENSe] :POWer [:RF] :MW :PADJust</code> <code>[:SENSe] :POWer [:RF] :MMW :PADJust</code> PSA had multiple preselectors, but the X-Series has only one. These commands simply alias to <code>[:SENSe] :POWer [:RF] :PADJust</code>
Initial S/W Revision	Prior to A.02.00
Modified at S/W Revision	A.03.00

Remote Command	<code>[:SENSe] :POWer [:RF] :PADJust :PRESelector MWAVE MMWave EXTERNAL</code> <code>[:SENSe] :POWer [:RF] :PADJust :PRESelector?</code>
Notes	PSA had multiple preselectors, and you could select which preselector to adjust. Since the X-Series has only one mm/uW preselector, the preselector selection softkey is no longer available. However, to provide backward compatibility, we accept the legacy remote commands. The command form has no effect, the query always returns MWAVE
Initial S/W Revision	Prior to A.02.00

μW Path Control

Sets the μW Path Control function to Auto, standard path, μW Preselector Bypass (Option MPB) and Low Noise Path(Option LNP).

Key Path	AMPTD/Y Scale
Initial S/W Revision	A.14.50

μW Path Control Auto

Activates the auto rules for μW Path Control. When Auto is active, the μW Path Control is set to Preselector Bypass in modulation analysis and spectral flatness measurement; it is set to standard path in other measurements.

Key Path	AMPTD/Y Scale
Remote Command	[:SENSe] :POWer [:RF] :MW:PATH:AUTO ON OFF 1 0 [:SENSe] :POWer [:RF] :MW:PATH:AUTO?
Example	POW:MW:PATH:AUTO ON POW:MW:PATH:AUTO?
Couplings	When Auto is active, the μW Path Control is set to μW Preselector Bypass in IQ measurements (IQ waveform, CCDF, PVT, EVM, Spetrum flatness and WLS); it is set to standard path in other measurements.
Preset	ON
Range	Off On
Initial S/W Revision	A.14.50

Standard Path

This path gives the best remote-control throughput, minimizes acoustic noise from switching and minimizes the risk of wear in the hardware switches, particularly in remote test scenarios where both low band and high band setups will follow in rapid succession.

In this path, the bypass of the low band/high band switch and microwave preamp is never activated, which can cause some noise degradation but preserves the life of the bypass switch.

Key Path	AMPTD Y Scale, μW Path Control
Example	:POW:MW:PATH STD
Readback Text	Standard Path
Initial S/W Revision	A.04.00

Low Noise Path Enable

You may choose Low Noise Path Enable, which gives a lower noise floor under some circumstances, particularly when operating in the 21–26.5 GHz region. With the Low Noise Path enabled, the low band/high band switch and microwave preamp are bypassed whenever all of the following are true:

- The analyzer is not in the Low Band, meaning:
- the start frequency is above 3.5 GHz and
- the stop frequency is above 3.6 GHz.
- the internal preamp is not installed or (if installed) is set to Off or Low Band

Note that this means that, when any part of a sweep is done in Low Band, the Low Noise Path is not used, whether or not the Low Noise Path Enable is selected in the user interface. Also, if the preamp is turned on, the Low Noise Path is not used, whether or not the Low Noise Path Enable is selected in the user interface. The only time the Low Noise Path is used is when Low Noise Path Enable is selected, the sweep is completely in High Band (> 3.6 GHz) and no preamp is in use.

See "[More Information](#)" on page 486

Key Path	AMPTD Y Scale, μ W Path Control
Measurement	Swept SA
Example	:POW:MW:PATH LNP
Notes	<p>For measurements that use IQ acquisition, the low noise path is used when the Center Frequency is in High Band (> 3.6 GHz) and no preamp is in use.</p> <p>In other words, the rules above are modified to use only the center frequency to qualify which path to switch in.</p> <p>This is not the case for FFT's in the Swept SA measurement; they use the same rules as swept measurements.</p>
Dependencies	<p>Key is blanked if current mode does not support it.</p> <p>Key is grayed out if mode supports it but current measurement does not support it.</p> <p>Unless Option LNP is present and licensed, key is blank and if SCPI command sent, error -241, "Hardware missing; Option not installed" is generated.</p>
Readback Text	Low Noise Path Enable
Initial S/W Revision	A.04.00

More Information

The user should understand that the Low Noise Path, while giving improved DANL, has the disadvantage of decreased TOI performance and decreased gain compression performance relative to the standard path.

The user should also understand that the bypass switch is a mechanical switch and has finite life, so if the Low Noise Path is enabled, it is possible to cause frequent cycling of this switch by frequently changing analyzer settings such that the above conditions hold true only some of the time. A user making tests of this nature should consider opting for the Standard Path, which will never throw the bypass switch, at the expense of some degraded noise performance.

The low noise path is useful for situations where the signal level is so low that the analyzer performance is dominated by noise even with 0 dB attenuation, but still high enough that the preamp option would have excessive third-order intermodulation or compression. The preamp, if purchased and used, gives better noise floor than does the “Low Noise Path.” However, its compression threshold and third-order intercept are much poorer than that of the non-preamp path. There are some applications, typically for signals around -30 dBm, for which the third-order dynamic range of the standard path is good enough, but the noise floor is not low enough even with 0 dB input attenuation. When the third-order dynamic range of the preamp path is too little and the noise floor of the standard path is too high, the Low Noise Path can provide the best dynamic range

The graph below illustrates the concept. It shows, in red, the performance of an analyzer at different attenuation settings, both with the preamp on and off, in a measurement that is affected by both analyzer noise and analyzer TOI. The green shows the best available dynamic range, offset by 0.5 dB for clarity. The blue shows how the best available dynamic range improves for moderate signal levels with the low noise path switched in. In this illustration, the preamp improves the noise floor by 15 dB while degrading the third-order intercept by 30 dB, and the low noise path reduces loss by 8 dB. The attenuator step size is 2 dB.

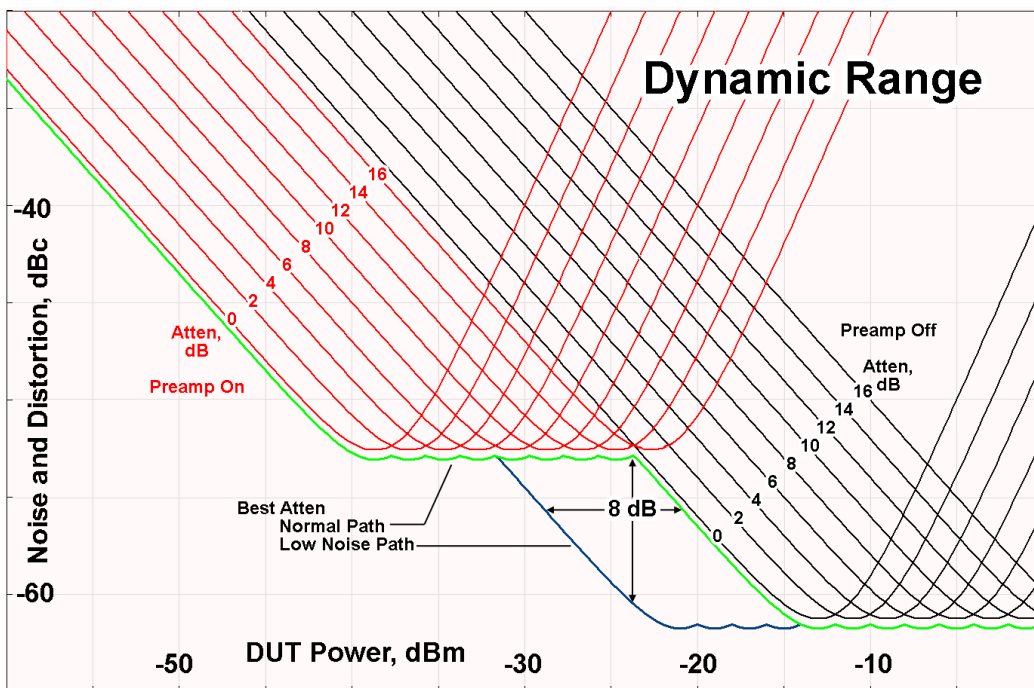

There are other times where selecting the low noise path improves performance, too. Compression-limited measurements such as finding the nulls in a pulsed-RF spectrum can profit from the low noise path in a way similar to the TOI-limited measurement illustrated. Accuracy can be improved when the low noise path allows the optimum attenuation to increase from a small amount like 0, 2 or 4 dB to a larger amount, giving better return loss at the analyzer input. Harmonic measurements, such as second and third harmonic levels, are much improved using the low noise path because of the superiority of that path for harmonic (though not intermodulation) distortion performance.

μW Preselector Bypass

This key toggles the preselector bypass switch for band 1 and higher. When the microwave preselector is on, the signal path is preselected. When the microwave preselector is off, the signal path is not preselected. The preselected path is the normal path for the analyzer.

The preselector is a tunable bandpass filter which prevents signals away from the frequency of interest from combining in the mixer to generate in-band spurious signals (images). The consequences of using a preselector filter are its limited bandwidth, the amplitude and phase ripple in its passband, and any amplitude and phase instability due to center frequency drift.

Option MPB or pre-selector bypass provides an unpreselected input mixer path for certain X-Series signal analyzers with frequency ranges above 3.6 GHz. This signal path allows a wider bandwidth and less amplitude variability, which is an advantage when doing modulation analysis and broadband signal analysis. The disadvantage is that, without the preselector, image signals will be displayed. Another disadvantage of bypassing the preselector is increased LO emission levels at the front panel input port.

Image responses are separated from the real signal by twice the 1st IF. For IF Paths of 10 MHz and 25 MHz, the 1st IF is 322.5 MHz, so the image response and the real signal will be separated by 645 MHz. The 1st IF will be different for other IF Path settings. When viewing a real signal and its corresponding image response in internal mixing, the image response will be to the left of the real signal.

Also, the image response and the real signal typically have the same amplitude and exhibit the same shape factor.

However, if Option FS1, Fast Sweep Capability, is enabled, the image response in the Swept SA measurement will appear lower in amplitude and have a much wider shape factor compared to the real signal.

Key Path	AMPTD Y Scale, μW Path Control
Example	:POW:MW:PATH MPB
Dependencies	Key is blanked if current mode does not support it. Key is grayed out if mode supports it but current measurement does not support it. Key is blank unless Option MPB is present and licensed. If SCPI command sent when MPB not present, error -241, "Hardware missing; Option not installed" is generated.
Readback Text	μW Preselector Bypass
Initial S/W Revision	A.04.00

Remote Command	<code>[:SENSe] :POWer [:RF] :MW:PRESelector [:STATe] ON OFF 0 1</code> <code>[:SENSe] :POWer [:RF] :MW:PRESelector [:STATe] ?</code>
Example	:POW:MW:PRES OFF Bypasses the microwave preselector
Notes	The ON parameter sets the STD path (:POW:MW:PATH STD) The OFF parameter sets path MPB (:POW:MW:PATH MPB)
Preset	ON

Internal Preamp

Accesses a menu of keys that control the internal preamps. Turning on the preamp gives a better noise figure, but a poorer TOI to noise floor dynamic range. You can optimize this setting for your particular measurement.

The instrument takes the preamp gain into account as it sweeps. If you sweep outside of the range of the preamp the instrument will also account for that. The displayed result will always reflect the correct gain.

For some measurements, when the preamp is on and any part of the displayed frequency range is below the lowest frequency for which the preamp has specifications, a warning condition message appears in the status line. For example, for a preamp with a 9 kHz lowest specified frequency: "Preamp: Accy unspec'd below 9 kHz".

Key Path	AMPTD Y Scale
Scope	Meas Global
Remote Command	[:SENSe] :POWer [:RF] :GAIN [:STATE] OFF ON 0 1 [:SENSe] :POWer [:RF] :GAIN [:STATE] ?
Dependencies	Preamp is not available on all hardware platforms. If the preamp is not present or is unlicensed, the key is not shown. The preamp is not available when the electronic/soft attenuator is enabled.
Couplings	The act of connecting the U7227A USB Preamplifier to one of the analyzer's USB ports will cause the Internal Preamp to be switched on. When this happens an informational message will be generated: "Internal Preamp turned on for optimal operation with USB Preamp." Note that if the Internal Preamp was already on, there will be no change to the setting, but if it was Off it will be switched On, to Full Range. Note that this same action occurs when the SA mode is selected while the USB Preamp is connected to one of the analyzer's USB ports, if it is the first time that the SA mode has run since powerup, or if the last time the SA mode was running the USB Preamp was NOT connected. Subsequently disconnecting the USB Preamp from USB does not change the Internal Preamp setting nor restore the previous setting.
Preset	OFF
State Saved	Saved in instrument state
Initial S/W Revision	Prior to A.02.00
Modified at S/W Revision	A.14.00

Key Path	AMPTD Y Scale, Internal Preamp
Scope	Meas Global
Remote Command	[:SENSe] :POWer [:RF] :GAIN :BAND LOW FULL [:SENSe] :POWer [:RF] :GAIN :BAND ?
Dependencies	Preamp is not available on all hardware platforms. If the preamp is not present or is unlicensed, the key is not shown. If a POW:GAIN:BAND FULL command is sent when a low band preamp is available, the preamp band

	parameter is to LOW instead of FULL, and an "Option not installed" message is generated.
Preset	LOW
State Saved	Saved in instrument state
Initial S/W Revision	Prior to A.02.00

Off

Turns the internal preamp off

Key Path	AMPTD Y Scale, Internal Preamp
Example	:POW:GAIN OFF
Readback	Off
Initial S/W Revision	Prior to A.02.00

Low Band

Sets the internal preamp to use only the low band.

The frequency range of the installed (optional) low-band preamp is displayed in square brackets on the Low Band key label.

Key Path	AMPTD Y Scale, Internal Preamp
Example	:POW:GAIN ON :POW:GAIN:BAND LOW
Readback	Low Band
Initial S/W Revision	Prior to A.02.00

Full Range

Sets the internal preamp to use its full range. The low band (0–3.6 GHz or 0–3GHz, depending on the model) is supplied by the low band preamp and the frequencies above low band are supplied by the high band preamp.

The frequency range of the installed (optional) preamp is displayed in square brackets on the Full Range key label. If the high band option is not installed the Full Range key does not appear.

Key Path	AMPTD Y Scale, Internal Preamp
Example	:POW:GAIN ON :POW:GAIN:BAND FULL
Readback	Full Range
Initial S/W Revision	Prior to A.02.00

Ref Position

Positions the reference level at the top, center, or bottom of the Y Scale display. Changing the reference position does not change the reference level value.

Key Path	AMPTD Y Scale
Mode	SA, WCDMA, C2K, WIMAX OFDMA, 1xEVDO, DVB-T/H, DTMB (CTTB), ISDB-T, CMMB, LTE, LTETDD, Digital Cable TV, WLAN, MSR, LTEAFDD, LTEATDD
Remote Command	:DISPlay:CHPower:VIEW[1]:WINDow[1]:TRACe:Y[:SCALe]:RPOSition TOP CENTER BOTTom :DISPlay:CHPower:VIEW[1]:WINDow[1]:TRACe:Y[:SCALe]:RPOSition?
Example	DISP:CHP:VIEW:WIND:TRAC:Y:RPOS CENT DISP:CHP:VIEW:WIND:TRAC:Y:RPOS?
Notes	You must be in the Spectrum Analysis mode, W-CDMA mode, cdma2000 mode, DVB-T/H mode, DTMB (CTTB) mode, ISDB-T mode, CMMB mode, Digital Cable TV mode, LTE mode, LTE TDD mode, WLAN mode, 1xEVDO mode, MSR, LTE-Advanced FDD/TDD mode or WIMAX OFDMA mode to use this command. Use :INSTrument:SElect to set the mode.
Preset	TOP
State Saved	Saved in instrument state.
Range	Top Ctr Bot
Initial S/W Revision	Prior to A.02.00
Modified at S/W Revision	A.02.00, A.03.00

Auto Scaling

Toggles the Auto Scaling function between On and Off.

Key Path	AMPTD Y Scale
Mode	SA, WCDMA, C2K, WIMAX OFDMA, 1xEVDO, DVB-T/H, DTMB (CTTB), ISDB-T, CMMB, LTE, LTETDD, Digital Cable TV, WLAN, MSR, LTEAFDD, LTEATDD
Remote Command	:DISPlay:CHPower:VIEW[1]:WINDow[1]:TRACe:Y[:SCALe]:COUPle 0 1 OFF ON :DISPlay:CHPower:VIEW[1]:WINDow[1]:TRACe:Y[:SCALe]:COUPle?
Example	DISP:CHP:VIEW:WIND:TRAC:Y:COUP OFF DISP:CHP:VIEW:WIND:TRAC:Y:COUP?
Couplings	When Auto Scaling is On, and the Restart front-panel key is pressed, this function automatically sets the scale per division to 10 dB and determines the reference values based on the measurement results. When you set a value to either Scale/Div or Ref Value manually, Auto Scaling automatically changes to Off.
Preset	1
State Saved	Saved in instrument state.

8 Channel Power Measurement
AMPTD Y Scale

Range	On Off
Initial S/W Revision	Prior to A.02.00
Modified at S/W Revision	A.02.00, A.03.00

Auto Couple

The Auto Couple feature provides a quick and convenient way to automatically couple multiple instrument settings. This helps ensure accurate measurements and optimum dynamic range. When the Auto Couple feature is activated, either from the front panel or remotely, all parameters of the current measurement that have an Auto/Manual mode are set to Auto mode and all measurement settings dependent on (or coupled to) the Auto/Man parameters are automatically adjusted for optimal performance.

However, the Auto Couple key actions are confined to the current measurement only. It does not affect other measurements in the mode, and it does not affect markers, marker functions, or trace or display attributes.

See "[More Information](#)" on page 493

Key Path	Front-panel key
Remote Command	:COUPle ALL NONE
Example	:COUP ALL
Notes	:COUPle ALL puts all Auto/Man parameters in Auto mode (equivalent to pressing the Auto Couple key). :COUPLE NONE puts all Auto/Man parameters in manual mode. It decouples all the coupled instrument parameters and is not recommended for making measurements.
Initial S/W Revision	Prior to A.02.00

More Information

There are two types of functions that have Auto/Manual modes.

Auto/Man Active Function keys

An Auto/Man toggle key controls the binary state associated with an instrument parameter by toggling between Auto (where the parameter is automatically coupled to the other parameters it is dependent upon) and Man (where the parameter is controlled independent of the other parameters), as well as making the parameter the active function. The current mode is indicated on the softkey with either Auto or Man underlined as illustrated below.



Auto/Man 1-of-N keys

An Auto/Man 1-of-N key allows you to manually pick from a list of parameter values, or place the function in Auto, in which case the value is automatically selected (and indicated) as shown below. If in Auto, Auto is underlined on the calling key. If in manual operation, manual is indicated on the calling key. But the calling key does not actually toggle the function, it simply opens the menu.

8 Channel Power Measurement
Auto Couple

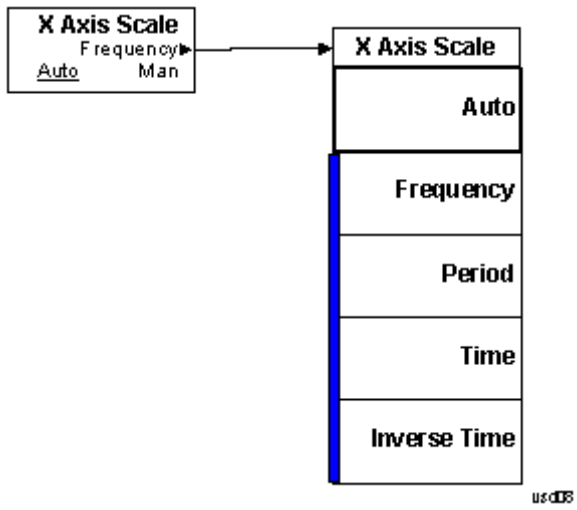

BW

Accesses a menu of functions that enable you to specify and control the video and resolution bandwidths. You can also select the type of filter for the measurement and set the filter bandwidth.

Key Path	Front-panel key
Initial S/W Revision	Prior to A.02.00

Res BW

Sets the value of the resolution bandwidth (RBW). If an unavailable bandwidth is entered with the numeric keypad, the closest available bandwidth is selected.

LTE-Advanced FDD/TDD Auto RBW:

Bandwidth	RBW (KHz)
1.4MHz	20
3MHz	43
5MHz	68
10MHz	150
15MHz	220
20MHz	270

the resolution bandwidth is predefined based on the corresponding bandwidth of the single LTE carrier, which is listed above. When ResBW mode is Auto, the narrowest RBW over the active carriers is selected for Multi-carriers.

Key Path	BW
Mode	SA, WCDMA, C2K, WIMAX OFDMA, 1xEVDO, DVB-T/H, DTMB (CTTB), ISDB-T, CMMB, LTE, LTE-TDD, Digital Cable TV, WLAN, MSR, LTEAFDD, LTEATDD
Remote Command	<pre>[:SENSe]:CHPower:BANDwidth[:RESolution] <bandwidth> [:SENSe]:CHPower:BANDwidth[:RESolution]? [:SENSe]:CHPower:BANDwidth[:RESolution]:AUTO ON OFF 1 0 [:SENSe]:CHPower:BANDwidth[:RESolution]:AUTO?</pre>
Example	<pre>CHP:BAND 5 MHz CHP:BAND? CHP:BAND:AUTO ON CHP:BAND:AUTO?</pre>
Notes	You must be in the Spectrum Analysis mode, W-CDMA mode, cdma2000 mode, DVB-T/H mode, DTMB (CTTB) mode, ISDB-T mode, CMMB mode, Digital Cable TV mode, LTE mode, LTE TDD mode, WLAN mode, 1xEVDO mode, MSR, LTE-Advanced FDD/TDD mode or WIMAX OFDMA mode to use this command. Use :INSTRument:SElect to set the mode.

Couplings	<p>Sweep time is coupled to the RBW. As the RBW changes, the sweep time (if set to Auto) is changed to maintain amplitude calibration.</p> <p>Video bandwidth (VBW) is coupled to the RBW. As the resolution bandwidth changes, the video bandwidth (if set to Auto) changes to maintain the ratio of VBW/RBW (10:1).</p> <p>When the Res BW is set to Auto, the resolution bandwidth is auto-coupled to the span. The ratio of Span/RBW is approximately 106:1 when auto coupled. When Res BW is set to Man, and the bandwidths are entered manually, these bandwidths are used regardless of other analyzer settings.</p>
Preset	<p>SA: Auto</p> <p>WCDMA: 240 kHz</p> <p>C2K: 24 kHz</p> <p>WIMAX OFDMA: 100kHz</p> <p>1xEVDO: 30kHz</p> <p>DVB-T/H: 3.9kHz</p> <p>DTMB (CTTB): 3.9kHz</p> <p>ISDB-T: 30kHz</p> <p>CMMB: 3.9kHz</p> <p>LTE: Auto</p> <p>LTETDD: Auto</p> <p>Digital Cable TV: 3.9kHz</p> <p>WLAN: 100 kHz</p> <p>MSR: 100kHz</p> <p>LTEAFDD/LTEATDD: Auto</p> <p>WCDMA, C2K, 1xEVDO , WIMAX OFDMA, DVB-T/H, DTMB (CTTB), ISDB-T, CMMB, Digital Cable TV, WLAN, MSR, LTEAFDD, LTEATDD: OFF</p> <p>SA, LTE, LTETDD: ON</p>
State Saved	Saved in instrument state.
Min	1 Hz
Max	8 MHz
Backwards Compatibility SCPI	<code>[:SENSe] :CHPower:BWIDth [:RESolution]</code>
Initial S/W Revision	Prior to A.02.00
Modified at S/W Revision	A.02.00, A.03.00

Video BW

Changes the analyzer post-detection filter (VBW).

Key Path	BW
Mode	SA, WCDMA, C2K, WIMAX OFDMA, 1xEVDO, DVB-T/H, DTMB (CTTB), ISDB-T, CMMB, LTE, LTETDD, Digital Cable TV, WLAN, MSR, LTEAFDD, LTEATDD
Remote Command	<code>[:SENSe] :CHPower:BWIDth:VIDeo <bandwidth></code>

	<pre>[:SENSe] :CHPower :BANDwidth :VIDeo?</pre> <pre>[:SENSe] :CHPower :BANDwidth :VIDeo :AUTO ON OFF 1 0</pre> <pre>[:SENSe] :CHPower :BANDwidth :VIDeo :AUTO?</pre>
Example	<pre>CHP:BAND:VID 2.4 MHz</pre> <pre>CHP:BAND:VID?</pre> <pre>CHP:BAND:VID:AUTO OFF</pre> <pre>CHP:BAND:VID:AUTO?</pre>
Notes	You must be in the Spectrum Analysis mode, W-CDMA mode, cdma2000 mode, DVB-T/H mode, DTMB (CTTB) mode, ISDB-T mode, CMMB mode, Digital Cable TV mode, LTE mode, LTE TDD mode, WLAN mode, 1xEVDO mode, MSR,LTE-Advanced FDD/TDD mode or WIMAX OFDMA mode to use this command. Use :INSTrument:SElect to set the mode.
Dependencies	See Couplings
Couplings	<p>Video bandwidth (VBW) is coupled to the RBW. As the resolution bandwidth changes, the video bandwidth (if set to Auto) changes to maintain the ratio set by VBW/RBW.</p> <p>Sweep Time is coupled to the Video Bandwidth (VBW). As the VBW is changed, the sweep time (when set to Auto) is changed to maintain amplitude calibration. This occurs because of common hardware between the two circuits, even though the Video BW filter is not actually “in-circuit” when the detector is set to Average. Because the purpose of the average detector and the VBW filter are the same, either can be used to reduce the variance of the result.</p> <p>Although the VBW filter is not “in-circuit” when using the average detector, the Video BW key can have an effect on (Auto) sweep time, and is not disabled. In this case, reducing the VBW setting increases the sweep time, which increases the averaging time, producing a lower-variance trace.</p> <p>When using the average detector with either Sweep Time set to Man, or in zero span, the VBW setting has no effect and is disabled (grayed out).</p> <p>When the video bandwidth is AUTO coupled, the video bandwidth value is set to: Resolution Bandwidth * Video Bandwidth to Resolution Bandwidth Ratio</p>
Preset	<pre>SA: Auto</pre> <pre>WCDMA: 2.4MHz</pre> <pre>C2K: 240 kHz</pre> <pre>WIMAX OFDMA: Auto</pre> <pre>1xEVDO: 300 kHz</pre> <pre>DVB-T/H: 39kHz</pre> <pre>DTMB (CTTB): 39kHz</pre> <pre>ISDB-T: 300kHz</pre> <pre>CMMB: 39kHz</pre> <pre>LTE, MSR: Auto</pre> <pre>LTETDD: Auto</pre> <pre>LTEAFDD,LTEATDD:Auto</pre> <pre>Digital Cable TV: 39kHz</pre> <pre>WLAN: Auto</pre> <pre>ON</pre>

State Saved	Saved in instrument state.
Min	1 Hz
Max	50 MHz
Initial S/W Revision	Prior to A.02.00
Modified at S/W Revision	A.02.00, A.03.00

Filter Type

Selects the type of bandwidth filter that is used. The choices are Gaussian or Flat top.

Key Path	BW
Mode	SA, WCDMA, C2K, WIMAX OFDMA, 1xEVDO, DVB-T/H, DTMB (CTTB), ISDB-T, CMMB, LTE, LTETDD, Digital Cable TV, WLAN, MSR, LTEAFDD, LTEATDD
Remote Command	[:SENSe] :CHPower :BANDwidth :SHAPE GAUSSian FLATtop [:SENSe] :CHPower :BANDwidth :SHAPE?
Example	CHP:BAND:SHAP GAUS CHP:BAND:SHAP?
Preset	GAUSSian
State Saved	Saved in instrument state.
Range	Gaussian Flattop
Backwards Compatibility SCPI	[:SENSe] :CHPower :BWIDth :SHAPE
Initial S/W Revision	Prior to A.02.00
Modified at S/W Revision	A.02.00, A.03.00

Cont (Continuous Measurement/Sweep)

Sets the analyzer for Continuous measurement operation. The single/continuous state is Meas Global so the setting will affect all measurements. If you are Paused, pressing Cont does a Resume.

Key Path	Front-panel key
Remote Command	:INITiate:CONTinuous OFF ON 0 1 :INITiate:CONTinuous?
Example	:INIT:CONT 0 puts analyzer in Single measurement operation. :INIT:CONT 1 puts analyzer in Continuous measurement operation
Preset	ON (Note that SYST:PRESet sets INIT:CONT to ON but *RST sets INIT:CONT to OFF)
State Saved	Saved in instrument state
Backwards Compatibility Notes	For Spectrum Analysis mode in ESA and PSA, there is no Cont hardkey, instead there is a Sweep Single/Cont key. In these analyzers, switching the Sweep Single/Cont key from Single to Cont restarts averages (displayed average count reset to 1), but does not restart Max Hold and Min Hold. The X-Series has Single and Cont keys in place of the SweepSingleCont key. In the X-Series, if in single measurement, the Cont key (and INIT:CONT ON) switches to continuous measurement, but never restarts a measurement and never resets a sweep.
Initial S/W Revision	Prior to A.02.00

In Swept SA Measurement (Spectrum Analysis Mode):

The analyzer takes repetitive sweeps, averages, measurements, etc., when in Continuous mode. When the average count reaches the Average/Hold Number the count stops incrementing, but the analyzer keeps sweeping. See the Trace/Detector section for the averaging formula used both before and after the Average/Hold Number is reached. The trigger condition must be met prior to each sweep. The type of trace processing for multiple sweeps, is set under the Trace/Detector key, with choices of Trace Average, Max Hold, or Min Hold.

In Other Measurements/Modes:

With Avg/Hold Num (in the Meas Setup menu) set to Off or set to On with a value of 1, a sweep is taken after the trigger condition is met; and the analyzer continues to take new sweeps after the current sweep has completed and the trigger condition is again met. However, with Avg/Hold Num set to On with a value >1, multiple sweeps (data acquisitions) are taken for the measurement. The trigger condition must be met prior to each sweep. The sweep is not stopped when the average count k equals the number N set for Avg/Hold Num is reached, but the number k stops incrementing. A measurement average usually applies to all traces, marker results, and numeric results. But sometimes it only applies to the numeric results.

If the analyzer is in Single measurement, pressing the Cont key does not change k and does not cause the sweep to be reset; the only action is to put the analyzer into Continuous measurement operation.

If it is already in continuous sweep:

the INIT:CONT 1 command has no effect

8 Channel Power Measurement Cont (Continuous Measurement/Sweep)

the INIT:CONT 0 command will place the analyzer in Single Sweep but will have no effect on the current sequence until $k = N$, at which point the current sequence will stop and the instrument will go to the idle state.

File

See "File" on page 348

FREQ Channel

Accesses a menu of keys that allow you to control the Frequency and Channel parameters of the instrument.

Some features in the Frequency menu are the same for all measurements – they do not change as you change measurements. Settings like these are called “Meas Global” and are unaffected by Meas Preset. For example, the Center Freq setting is the same for all measurements - it does not change as you change measurements.

Key Path	Front-panel key
Initial S/W Revision	Prior to A.02.00

Center Freq

Sets the frequency that corresponds to the horizontal center of the graticule (when frequency Scale Type is set to linear). While adjusting the Center Frequency the Span is held constant, which means that both Start Frequency and Stop Frequency will change.

Pressing Center Freq also sets the frequency entry mode to Center/Span. In Center/Span mode, the center frequency and span values are displayed below the graticule, and the default active function in the Frequency menu is Center Freq.

The center frequency setting is the same for all measurements within a mode, that is, it is Meas Global. Some modes are also able to share a Mode Global center frequency value. If this is the case, the Mode will have a Global Settings key in its Mode Setup menu.

The Center Freq function sets (and queries) the Center Frequency for the currently selected input. If your analyzer has multiple inputs, and you select another input, the Center Freq changes to the value for that input. SCPI commands are available to directly set the Center Freq for a specific input.

Center Freq is remembered as you go from input to input. Thus you can set a Center Freq of 10 GHz with the RF Input selected, change to BBIQ and set a Center Freq of 20 MHz, then switch to External Mixing and set a Center Freq of 60 GHz, and when you go back to the RF Input the Center Freq will go back to 10 GHz; back to BBIQ and it is 20 MHz; back to External Mixing and it is 60 GHz.

See ["RF Center Freq" on page 505](#)

See [Ext Mix Center Freq](#)

See ["I/Q Center Freq" on page 507](#)

See ["Center Frequency Presets" on page 503](#)

Key Path	FREQ Channel
Scope	Meas Global
Remote Command	<code>[:SENSe] :FREQuency:CENTer <freq></code> <code>[:SENSe] :FREQuency:CENTer?</code>

Example	FREQ:CENT 50 MHz FREQ:CENT UP changes the center frequency to 150 MHz if you use FREQ:CENT:STEP 100 MHz to set the center frequency step size to 100 MHz FREQ:CENT?
Notes	This command sets either the RF or I/Q Center Frequency depending on the selected input. For RF input it is equivalent to FREQ:RF:CENT For I/Q input it is equivalent to FREQ:IQ:CENT Preset and Max values are dependent on Hardware Options (5xx) If no terminator (e.g. MHz) is sent the terminator Hz is used. If a terminator with unit other than Frequency is used, an invalid suffix error message is generated.
Dependencies	The Center Frequency can be limited by Start or Stop Freq limits, if the Span is so large that Start or Stop reach their limit.
Couplings	When operating in “swept span”, any value of the Center Frequency or Span that is within the frequency range of the analyzer is allowed when the value is being set through the front panel numeric key pad or the SCPI command. The other parameter is forced to a different value if needed, to keep the Start and the Stop Frequencies within the analyzer’s frequency range
Preset	Depends on instrument maximum frequency, mode, measurement, and selected input. See "Center Frequency Presets" on page 503 and "RF Center Freq" on page 505 and Ext Mix Center Freq and "I/Q Center Freq" on page 507 .
State Saved	Saved in instrument state
Min	Depends on instrument maximum frequency, mode, measurement, and selected input.. See "Center Frequency Presets" on page 503 and "RF Center Freq" on page 505 and "I/Q Center Freq" on page 507 .
Max	Depends on instrument maximum frequency, mode, measurement, and selected input.. See "Center Frequency Presets" on page 503 and "RF Center Freq" on page 505 and "I/Q Center Freq" on page 507 .
Default Unit	Hz
Status Bits/OPC	Non-overlapped
Dependencies	
Initial S/W Revision	Prior to A.02.00

Center Frequency Presets

The following table provides the Center Frequency Presets for the Spectrum Analyzer mode, and the Max Freq, for the various frequency options:

Freq Option	CF after Mode Preset	Stop Freq after Mode Preset	Max Freq (can't tune)

8 Channel Power Measurement
FREQ Channel

			above)
503 (all but N9000A)	1.805 GHz	3.6 GHz	3.7 GHz
503 (N9000A)	1.505 GHz	3.0 GHz	3.08 GHz
507 (all but N9000A)	3.505 GHz	7.0 GHz	7.1 GHz
507 (N9000A)	3.755 GHz	7.5 GHz	7.58 GHz
508 (all but N9038A)	1.805 GHz	3.6 GHz	8.5 GHz
508 (N9038A)	4.205 GHz	8.4 GHz	8.5 GHz
513	6.805 GHz	13.6 GHz	13.8 GHz
526 (all but N9000A and N9038A)	13.255 GHz	26.5 GHz	27.0 GHz
526 (N9000A)	13.255 GHz	26.5 GHz	26.55 GHz
526 (N9038A)	1.805 GHz	3.6 GHz	27.0 GHz
532	16.005 GHz	32.0 GHz	32.5 GHz
543	21.505 GHz	43.0 GHz	TBD
544	22.005 GHz	44.0 GHz	44.5 GHz
550	25.005 GHz	50.0 GHz	51 GHz

Input 2:

Model	CF after Mode Preset	Stop Freq after Mode Preset	Max Freq (can't tune above)
N9000A opt C75	0.7505GHz	1.5 GHz	1.58 GHz
N9038A	505 MHz	1 GHz	1.000025 GHz

Tracking Generator Frequency Limits (N9000A only):

Tracking Generator Option	Min Freq (clips to this freq when turn TG on and	If above this Freq, Stop Freq clipped to this Freq when	Max Freq (can't tune above) while TG

	can't tune below while TG on)	TG turned on	on
T03	9 kHz	3.0 GHz	3.08 GHz
T06	9 kHz	6.0 GHz	6.05 GHz

The following table shows the Center Frequency Presets for modes other than Spectrum Analyzer:

Mode	CF Preset for RF
WCDMA	1 GHz
WIMAXOFDMA,	1 GHz
BASIC	1 GHz
ADEMOD	1 GHz
VSA	1 GHz
TDSCDMA	1 GHz
PNOISE	1 GHz
LTE	1 GHz
LTETDD	1 GHz
MSR	1 GHz
GSM	935.2 MHz
NFIGURE	1.505 GHz

RF Center Freq

SCPI command for specifying the RF Center Frequency. This command will set the Center Frequency to be used when the RF input is selected, even if the RF input is not the input that is selected at the time the command is sent. Note that the Center Freq function in the Frequency menu on the front panel always applies to the currently selected input.

Scope	Meas Global
Remote Command	<code>[:SENSe] :FREQuency:RF:CENTer <freq></code> <code>[:SENSe] :FREQuency:RF:CENTer?</code>
Example	FREQ:RF:CENT 30 MHz
Notes	This command is the same in all modes, but the parameter is Measurement Global. So the value is independent in each mode and common across all the measurements in the mode.
Dependencies	If the electronic/soft attenuator is enabled, any attempt to set Center Frequency such that the Stop Frequency would be >3.6 GHz fails and results in an advisory message. If the equivalent SCPI command is sent, this same message is generated as part of a “-221, Settings conflict” warning. If Source Mode is set to Tracking, and the Max or Min Center Freq is therefore limited by the limits of the source, a warning message is generated, “Data out of range;clipped to source max/min” if these limits are exceeded. Note that for an external source, these limits can be affected by the settings of

	Source Numerator, Source Denominator and Power Sweep.
Preset	See table above
State Saved	Saved in instrument state.
Min	-79.999995 MHz, unless Source Mode is set to Tracking, in which case it is limited by the minimum frequency of the Source
Max	See table above. Basically instrument maximum frequency – 5 Hz. Note that, if the Source Mode is set to Tracking, the effective instrument maximum frequency may be limited by the source maximum frequency. If the knob or step keys are being used, also depends on the value of the other three interdependent parameters Span, Start Frequency and Stop Frequency
Initial S/W Revision	Prior to A.02.00
Modified at S/W Revision	A.03.00

Ext Mix Center Freq

SCPI command for specifying the External Mixer Center Frequency. This command will set the Center Frequency to be used when the External Mixer is selected, even if the External Mixer input is not the input which is selected at the time the command is sent. Note that the Center Freq function in the Frequency menu on the front panel always applies to the currently selected input.

Scope	Meas Global
Remote Command	<code>[:SENSe] :FREQuency:EMIXer:CENTer <freq></code> <code>[:SENSe] :FREQuency:EMIXer:CENTer?</code>
Example	<code>:FREQ:EMIX:CENT 60 GHz</code> <code>:FREQ:EMIX:CENT?</code>
Notes	This command is the same in all modes, but the parameter is Measurement Global. So the value is independent in each mode and common across all the measurements in the mode.
Couplings	When returning to External Mixing after having been switched to one of the other inputs (e.g., RF), you will come back into the settings that you had when you left External Mixing. So you will come back to the band you were in with the Center Frequency that you had. However, Span is not an input-dependent parameter, therefore you will bring the span over from the other input. Therefore, the analyzer comes back with the span from the previous input, limited as necessary by the current mixer setup.
Preset	When a Mode Preset is performed while in External Mixing, the Start frequency of the current Mode is set to the nominal Min Freq of the lowest harmonic range in the Harmonic Table for the current mixer setup. Similarly, the Stop frequency of the current Mode is set to the nominal Max Freq of the highest harmonic range in the Harmonic Table. The Center Freq thus presets to the point arithmetically equidistant from these two frequencies. If the current measurement has a limited Span available to it, and cannot achieve the Span shown in the table (Span=Stop Freq – Start Freq), the analyzer uses the maximum Span the measurement allows, and still sets the Center Freq to the midpoint of the Start and Stop Freq values in the Harmonic Table.

	When Restore Input/Output Defaults is performed, the mixer presets to the 11970A, whose Start and Stop frequencies are 26.5 and 40 GHz respectively. The center of these two frequencies is 33.25 GHz. Therefore, after a Restore Input/Output Defaults, if you go into External Mixing and do a Mode Preset while in the Spectrum Analyzer Mode, the resulting Center Freq is 33.25 GHz.
State Saved	Saved in instrument state.
Min	The minimum frequency in the currently selected mixer band + 5 Hz
Max	The maximum frequency in the currently selected mixer band – 5 Hz If the knob or step keys are being used, also depends on the value of the other three interdependent parameters Span, Start Frequency and Stop Frequency
Initial S/W Revision	A.08.01

I/Q Center Freq

SCPI command for specifying the I/Q Center Frequency. This command will set the Center Frequency to be used when the I/Q input is selected, even if the I/Q input is not the input which is selected at the time the command is sent. Note that the Center Freq function in the Frequency menu on the front panel always applies to the currently selected input.

Scope	Meas Global
Remote Command	<code>[:SENSe] :FREQuency:IQ:CENTer <freq></code> <code>[:SENSe] :FREQuency:IQ:CENTer?</code>
Example	FREQ:IQ:CENT: 30 MHz
Notes	This command is the same in all modes, but the parameter is Measurement Global. So the value is independent in each mode and common across all the measurements in the mode.
Preset	0 Hz
State Saved	Saved in instrument state.
Min	-40.049995 MHz
Max	40.049995 MHz
Initial S/W Revision	Prior to A.02.00

CF Step

Changes the step size for the center frequency and start and stop frequency functions. Once a step size has been selected and the center frequency function is active, the step keys (and the UP|DOWN parameters for Center Frequency from remote commands) change the center frequency by the step-size value. The step size function is useful for finding harmonics and sidebands beyond the current frequency span of the analyzer.

Note that the start and stop frequencies also step by the CF Step value.

Key Path	FREQ Channel
Remote Command	[:SENSe]:FREQuency:CENTer:STEP[:INCRement] <freq> [:SENSe]:FREQuency:CENTer:STEP[:INCRement]? [:SENSe]:FREQuency:CENTer:STEP:AUTO OFF ON 0 1 [:SENSe]:FREQuency:CENTer:STEP:AUTO?
Example	FREQ:CENT:STEP:AUTO ON FREQ:CENT:STEP 500 MHz FREQ:CENT UP increases the current center frequency value by 500 MHz FREQ:CENT:STEP? FREQ:CENT:STEP:AUTO?
Notes	Preset and Max values are depending on Hardware Options (503, 507, 508, 513, 526)
Notes	Preset and Max values are dependent on Hardware Options (5xx)
Dependencies	Freq Offset is not available in External Mixing. In this case the Freq Offset key is grayed out and shows a value of zero. It will once again be available, and show the previously set value, when you return to the RF Input.
Dependencies	Span, RBW, Center frequency If the electronic/soft attenuator is enabled, any attempt to change the value of the center frequency >3.6 GHz by pressing the Up-arrow key, fails and results in an advisory message. If the equivalent SCPI command is sent, this same message is generated as part of a “-221, Settings conflict” warning.
Couplings	When auto-coupled in a non-zero span, the center frequency step size is set to 10% of the span. When auto-coupled in zero span, the center frequency step size is set to the equivalent -3 dB RBW value.
Preset	Auto ADEMOD: 1 MHz ON
State Saved	Saved in instrument state
Min	– (the maximum frequency of the instrument). That is, 27 GHz max freq instrument has a CF step range of +/- 27 GHz. Note that this is the maximum frequency given the current settings of the instrument, so in External Mixing, for example, it is the maximum frequency of the current mixer band.
Max	The maximum frequency of the instrument. That is, 27 GHz max freq instrument has a CF step range of +/- 27 GHz. Note that this is the maximum frequency given the current settings of the instrument, so in External Mixing, for example, it is the maximum frequency of the current mixer band.
Default Unit	Hz
Status Bits/OPC dependencies	non-overlapped
Initial S/W Revision	Prior to A.02.00
Modified at S/W Revision	A.03.00

Input/Output

See "Input/Output" on page 194

Marker

Accesses a menu that enables you to select, set up and control the markers for the current measurement.

Key Path	Front-panel key
Initial S/W Revision	Prior to A.02.00

Select Marker

Displays 12 markers available for selection.

Key Path	Marker
Initial S/W Revision	Prior to A.02.00

Marker Type

Sets the marker control mode to Normal, Delta, Fixed or Off. All interactions and dependencies detailed under the key description are enforced when the remote command is sent. If the selected marker is Off, pressing Marker sets it to Normal and places it at the center of the screen on the trace determined by the Marker Trace rules. At the same time, Marker X Axis Value appears on the Active Function area.

The default active function is the active function for the currently selected marker control mode. If the current control mode is Off, there is no active function and the active function is turned off.

Key Path	Marker
Mode	SA, WCDMA, C2K, WIMAX OFDMA, 1xEVDO, DVB-T/H, DTMB (CTTB), ISDB-T, CMMB, LTE, LTETDD, Digital Cable TV, WLAN, MSR, LTEAFDD, LTEATDD
Remote Command	:CALCulate:CHPower:MARKer[1] 2 ... 12:MODE POSITION DELTA OFF :CALCulate:CHPower:MARKer[1] 2 ... 12:MODE?
Example	CALC:CHP:MARK3:MODE POS CALC:CHP:MARK3:MODE?
Notes	If the selected marker is Off, pressing Marker sets it to Normal and places it at the center of the screen on the trace determined by the Marker Trace rules. At the same time, Marker X Axis Value appears on the Active Function area. Default Active Function: the active function for the selected marker's current control mode. If the current control mode is Off, there is no active function and the active function is turned off. Active Function Display: the marker X axis value entered in the active function area displays the marker value to its full entered precision.
Preset	OFF
State Saved	Saved in instrument state.
Range	Normal Delta Off
Initial S/W Revision	Prior to A.02.00
Modified at S/W Revision	A.02.00, A.03.00

Properties

Accesses the marker properties menu.

Key Path	Marker
Initial S/W Revision	Prior to A.02.00

Select Marker

Displays 12 markers available for selection.

Key Path	Marker
Initial S/W Revision	Prior to A.02.00

Relative To

Sets the reference marker to which the selected marker is relative.

Key Path	Marker, Properties
Mode	SA, WCDMA, C2K, WIMAX OFDMA, 1xEVDO, DVB-T/H, DTMB (CTTB), ISDB-T, CMMB, LTE, LTETDD, Digital Cable TV, WLAN, MSR, LTEAFDD, LTEATDD
Remote Command	:CALCulate:CHPower:MARKer[1] 2 ... 12:REFerence <integer> :CALCulate:CHPower:MARKer[1] 2 ... 12:REFerence?
Example	CALC:CHP:MARK:REF 5 CALC:CHP:MARK:REF?
Notes	A marker cannot be relative to itself so that choice is grayed out, and if sent from SCPI generates error -221: "Settings conflict; marker cannot be relative to itself." When queried, a single value is returned (the specified marker numbers relative marker). You must be in the Spectrum Analysis or WCDMA mode to use this command. Use :INSTrument:SElect to set the mode.
Preset	2 3 4 5 6 7 8 9 10 11 12 1
State Saved	Saved in instrument state.
Min	1
Max	12
Initial S/W Revision	Prior to A.02.00
Modified at S/W Revision	A.02.00, A.03.00

All Markers Off

Turns off all markers.

Key Path	Marker
Mode	SA, WCDMA, C2K, WIMAX OFDMA, 1xEVDO, DVB-T/H, DTMB (CTTB), ISDB-T, CMMB, LTE, LTETDD, Digital Cable TV, WLAN, MSR, LTEAFDD, LTEATDD
Remote Command	:CALCulate:CHPower:MARKer:AOff
Example	CALC:CHP:MARK:AOff
Initial S/W Revision	Prior to A.02.00
Modified at S/W Revision	A.02.00, A.03.00

Marker X Axis Value (Remote Command Only)

Sets the marker X Axis value in the current marker X Axis Scale unit. It has no effect if the control mode is Off, but is the SCPI equivalent of entering an X value if the control mode is Normal, Delta, or Fixed.

Mode	SA, WCDMA, CDMA2K, WIMAXOFDMA, CDMA1XEV, DVB, DTMB, ISDBT, CMMB, LTE, LTETDD, DCATV, WLAN, MSR, LTEAFDD, LTEATDD
Remote Command	:CALCulate:CHPower:MARKer[1] 2 ... 12:X <real> :CALCulate:CHPower:MARKer[1] 2 ... 12:X?
Example	CALC:CHP:MARK3:X 0 CALC:CHP:MARK3:X?
Notes	The query returns the marker's absolute X Axis value if the control mode is Normal, or the offset from the marker's reference marker if the control mode is Delta. The query is returned in the fundamental units for the current marker X Axis scale: Hz for Frequency.
Preset	After a preset, all markers are turned OFF, so Marker X Axis Value query returns a not a number (NAN).
State Saved	Saved in instrument state.
Min	-9.9E+37
Max	9.9E+37
Initial S/W Revision	Prior to A.02.00
Modified at S/W Revision	A.02.00, A.03.00

Marker X Axis Position (Remote Command Only)

Sets the marker X Axis Scale position in trace points. This setting has no effect if the control mode is Off, but is the SCPI equivalent of entering a value if the control mode is Normal or Delta . The entered value is immediately translated into the current X Axis Scale units for setting the value of the marker.

Mode	SA, WCDMA, CDMA2K, WIMAXOFDMA, CDMA1XEV, DVB, DTMB, ISDBT, CMMB, LTE, LTETDD, DCATV, WLAN, MSR, LTEAFDD, LTEATDD
Remote Command	:CALCulate:CHPower:MARKer[1] 2 ... 12:X:POStion <real> :CALCulate:CHPower:MARKer[1] 2 ... 12:X:POStion?
Example	CALC:CHP:MARK10:X:POS 0

	CALC:CHP:MARK10:X:POS?
Notes	The query returns the marker's absolute X Axis value in trace points if the control mode is Normal, or the offset from the marker's reference marker in trace points if the control mode is Delta.
Preset	After a preset, all markers are turned OFF, so Marker X Axis Value query returns a not a number (NAN).
State Saved	Saved in instrument state.
Min	-9.9E+37
Max	9.9E+37
Initial S/W Revision	Prior to A.02.00
Modified at S/W Revision	A.02.00, A.03.00

Marker Y Axis Value (Remote Command only)

Returns the marker Y Axis value in the current marker Y Axis unit.

Mode	SA, WCDMA, CDMA2K, WIMAXOFDMA, CDMA1XEV, DVB, DTMB, ISDBT, CMMB, LTE, LTETDD, DCATV, WLAN, MSR, LTEAFDD, LTEATDD
Remote Command	:CALCulate:CHPower:MARKer[1] 2 ... 12:Y?
Example	CALC:CHP:MARK11:Y?
Preset	Result dependent on Markers setup and signal source.
State Saved	Saved in instrument state.
Initial S/W Revision	Prior to A.02.00
Modified at S/W Revision	A.02.00, A.03.00

Backward Compatibility SCPI Commands

Sets or queries the state of a marker. Setting a marker which is OFF to state ON or 1 puts it in Normal mode and places it at the center of the screen.

Mode	SA, WCDMA, CDMA2K, WIMAXOFDMA, CDMA1XEV, DVB, DTMB, ISDBT, CMMB, LTE, LTETDD, DCATV, WLAN, MSR, LTEAFDD, LTEATDD
Remote Command	:CALCulate:CHPower:MARKer[1] 2 ... 12:STATe OFF ON 0 1 :CALCulate:CHPower:MARKer[1] 2 ... 12:STATe?
Example	CALC:CHP:MARK3:STAT ON CALC:CHP:MARK3:STAT?
Preset	OFF
State Saved	Saved in instrument state.
Range	On Off
Initial S/W Revision	Prior to A.02.00
Modified at S/W Revision	A.02.00, A.03.00

Marker Function

There are no 'Marker Functions' supported in Channel Power, so this front-panel key displays a blank menu when pressed.

Key Path	Front-panel key
Initial S/W Revision	Prior to A.02.00

Marker To

There is no 'Marker To' functionality supported in Channel Power measurement, so this front-panel key displays a blank key menu when pressed.

Key Path	Front-panel key
Initial S/W Revision	Prior to A.02.00

Meas

The information in this section is common to all measurements. For key and remote command information for a specific measurement, refer to the section that describes the measurement of interest.

Measurements available under the Meas key are specific to the current Mode.

When viewing Help for measurements, note the following:

NOTE

Operation for some keys differs between measurements. The information displayed in Help pertains to the current measurement. To see how a key operates in a different measurement, exit Help (press the Cancel Esc key), select the measurement, then reenter Help (press the Help key) and press that key.

Key Path	Front-panel key
Initial S/W Revision	Prior to A.02.00

Remote Measurement Functions

This section contains the following topics:

"Measurement Group of Commands" on page 2214

"Current Measurement Query (Remote Command Only)" on page 2216

"Limit Test Current Results (Remote Command Only)" on page 2216

"Data Query (Remote Command Only)" on page 2216

"Calculate/Compress Trace Data Query (Remote Command Only)" on page 2217

"Calculate Peaks of Trace Data (Remote Command Only)" on page 2222

"Hardware-Accelerated Fast Power Measurement (Remote Command Only)" on page 2223

"Format Data: Numeric Data (Remote Command Only)" on page 2237

"Format Data: Byte Order (Remote Command Only)" on page 2238

Initial S/W Revision	Prior to A.02.00
----------------------	------------------

Measurement Group of Commands

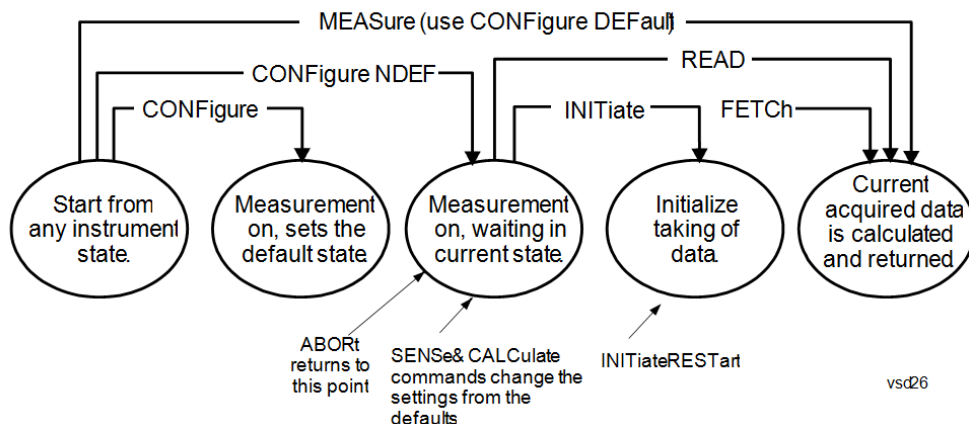

Measure Commands:

:MEASure:<measurement>[n]?

This is a fast single-command way to make a measurement using the factory default instrument settings. These are the settings and units that conform to the Mode Setup settings (e.g. radio standard) that you have currently selected.

- Stops the current measurement (if any) and sets up the instrument for the specified measurement using the factory defaults
- Initiates the data acquisition for the measurement
- Blocks other SCPI communication, waiting until the measurement is complete before returning results.
- If the function does averaging, it is turned on and the number of averages is set to 10.
- After the data is valid it returns the scalar results, or the trace data, for the specified measurement. The type of data returned may be defined by an [n] value that is sent with the command.
- The scalar measurement results will be returned if the optional [n] value is not included, or is set to 1. If the [n] value is set to a value other than 1, the selected trace data results will be returned. See each command for details of what types of scalar results or trace data results are available.
- ASCII is the default format for the data output. (Older versions of Spectrum Analysis and Phase Noise mode measurements only use ASCII.) The binary data formats should be used for handling large blocks of data since they are smaller and faster than the ASCII format. Refer to the FORMat:DATA command for more information.

If you need to change some of the measurement parameters from the factory default settings you can set up the measurement with the CONFigure command. Use the commands in the SENSE:<measurement> and CALCulate:<measurement> subsystems to change the settings. Then you can use the READ? command to initiate the measurement and query the results.

If you need to repeatedly make a given measurement with settings other than the factory defaults, you can use the commands in the SENSE:<measurement> and CALCulate:<measurement> subsystems to set up the measurement. Then use the READ? command to initiate the measurement and query results.

Measurement settings persist if you initiate a different measurement and then return to a previous one. Use READ:<measurement>? if you want to use those persistent settings. If you want to go back to the default settings, use MEASure:<measurement>?.

Configure Commands:

:CONFigure:<measurement>

This command stops the current measurement (if any) and sets up the instrument for the specified measurement using

the factory default instrument settings. It does not initiate the taking of measurement data unless INIT:CONTinuous is ON. If you change any measurement settings after using the CONFigure command, the READ command can be used to initiate a measurement without changing the settings back to their defaults.

In the Swept SA measurement in Spectrum Analyzer mode the CONFigure command also turns the averaging function on and sets the number of averages to 10 for all measurements.

:CONFigure: <measurement>: NDEFault stops the current measurement and changes to the specified measurement. It does not change the settings to the defaults. It does not initiate the taking of measurement data unless INIT:CONTinuous is ON.

The CONFigure? query returns the current measurement name.

The CONFigure:CATalog? query returns a quoted string of all licensed measurement names in the current mode. For example, "SAN, CHP, OBW, ACP, PST, TXP, SPUR, SEM, LIST".

Fetch Commands:

:FETCh:<measurement>[n]?

This command puts selected data from the most recent measurement into the output buffer. Use FETCh if you have already made a good measurement and you want to return several types of data (different [n] values, for example, both scalars and trace data) from a single measurement. FETCh saves you the time of re-making the measurement. You can only FETCh results from the measurement that is currently active, it will not change to a different measurement. An error message is reported if a measurement other than the current one is specified.

If you need to get new measurement data, use the READ command, which is equivalent to an INITiate followed by a FETCh.

The scalar measurement results will be returned if the optional [n] value is not included, or is set to 1. If the [n] value is set to a value other than 1, the selected trace data results will be returned. See each command for details of what types of scalar results or trace data results are available. The binary data formats should be used for handling large blocks of data since they are smaller and transfer faster than the ASCII format. (FORMat:DATA)

FETCh may be used to return results other than those specified with the original READ or MEASure command that you sent.

INITiate Commands:

:INITiate:<measurement>

This command is not available for measurements in all the instrument modes:

- Initiates a trigger cycle for the specified measurement, but does not output any data. You must then use the FETCh<meas> command to return data. If a measurement other than the current one is specified, the instrument will switch to that measurement and then initiate it.
 - For example, suppose you have previously initiated the ACP measurement, but now you are running the channel power measurement. If you send INIT:ACP? it will change from channel power to ACP and will initiate an ACP measurement.
 - Does not change any of the measurement settings. For example, if you have previously started the ACP measurement and you send INIT:ACP? it will initiate a new ACP measurement using the same instrument settings as the last time ACP was run.
 - If your selected measurement is currently active (in the idle state) it triggers the measurement, assuming the trigger conditions are met. Then it completes one trigger cycle. Depending upon the measurement and the number of averages, there may be multiple data acquisitions, with multiple trigger events, for one full trigger cycle. It also holds off additional commands on GPIB until the acquisition is complete.
-

READ Commands:

:READ:<measurement>[n]?

- Does not preset the measurement to the factory default settings. For example, if you have previously initiated the ACP
-

measurement and you send READ:ACP? it will initiate a new measurement using the same instrument settings.

- Initiates the measurement and puts valid data into the output buffer. If a measurement other than the current one is specified, the instrument will switch to that measurement before it initiates the measurement and returns results.
 - For example, suppose you have previously initiated the ACP measurement, but now you are running the channel power measurement. Then you send READ:ACP? It will change from channel power back to ACP and, using the previous ACP settings, will initiate the measurement and return results.
 - Blocks other SCPI communication, waiting until the measurement is complete before returning the results
 - If the optional [n] value is not included, or is set to 1, the scalar measurement results will be returned. If the [n] value is set to a value other than 1, the selected trace data results will be returned. See each command for details of what types of scalar results or trace data results are available. The binary data formats should be used when handling large blocks of data since they are smaller and faster than the ASCII format. (FORMat:DATA)
-

Initial S/W Revision	Prior to A.02.00
----------------------	------------------

Current Measurement Query (Remote Command Only)

This command returns the name of the measurement that is currently running.

Remote Command	:CONFigure?
-----------------------	-------------

Example	CONF?
----------------	-------

Initial S/W Revision	Prior to A.02.00
----------------------	------------------

Limit Test Current Results (Remote Command Only)

Queries the status of the current measurement limit testing. It returns a 0 if the measured results pass when compared with the current limits. It returns a 1 if the measured results fail any limit tests.

Remote Command	:CALCulate:CLIMits:FAIL?
-----------------------	--------------------------

Example	CALC:CLIM:FAIL? queries the current measurement to see if it fails the defined limits. Returns a 0 or 1: 0 it passes, 1 it fails.
----------------	--

Initial S/W Revision	Prior to A.02.00
----------------------	------------------

Data Query (Remote Command Only)

Returns the designated measurement data for the currently selected measurement and subopcode.

n = any valid subopcode for the current measurement. See the measurement command results table for your current measurement, for information about what data is returned for the subopcodes.

This command uses the data setting specified by the FORMat:BORDER and FORMat:DATA commands and can return real or ASCII data. (See the format command descriptions under Input/Output in the Analyzer Setup section.)

Remote Command	:CALCulate:DATA[n]?
Notes	The return trace depends on the measurement. In CALCulate:<meas>:DATA[n], n is any valid subopcode for the current measurement. It returns the same data as the FETCH:<measurement>? query where <measurement> is the current measurement.
Initial S/W Revision	Prior to A.02.00

Calculate/Compress Trace Data Query (Remote Command Only)

Returns compressed data for the currently selected measurement and sub-opcode [n].

n = any valid sub-opcode for that measurement. See the MEASure:<measurement>? command description of your specific measurement for information on the data that can be returned.

The data is returned in the current Y Axis Unit of the analyzer. The command is used with a sub-opcode <n> (default=1) to specify the trace. With trace queries, it is best if the analyzer is not sweeping during the query. Therefore, it is generally advisable to be in Single Sweep, or Update=Off.

This command is used to compress or decimate a long trace to extract and return only the desired data. A typical example would be to acquire N frames of GSM data and return the mean power of the first burst in each frame. The command can also be used to identify the best curve fit for the data.

Remote Command	:CALCulate:DATA<n>:COMPRESS? BLOCK CFIT MAXimum MINimum MEAN DMEan RMS RMSCubed SAMPLE SDEVIation PPHase [,<soffset> [,<length>[,<roffset>[,<rlimit>]]]]
Example	To query the mean power of a set of GSM bursts: Supply a signal that is a set of GSM bursts. Select the IQ Waveform measurement (in IQ Analyzer Mode). Set the sweep time to acquire at least one burst. Set the triggers such that acquisition happens at a known position relative to a burst. Then query the mean burst levels using, CALC:DATA2:COMP? MEAN, 24e-6, 526e-6 (These parameter values correspond to GSM signals, where 526e-6 is the length of the burst in the slot and you just want 1 burst.)
Notes	The command supports 5 parameters. Note that the last 4 (<soffset>, <length>, <roffset>, <rlimit>) are optional. But these optional parameters must be entered in the specified order. For example, if you want to specify <length>, then you must also specify <soffset>. See details below for a definition of each of these parameters. This command uses the data in the format specified by FORMat:DATA, returning either binary or ASCII data.
Initial S/W Revision	Prior to A.02.00

- BLOCK or block data - returns all the data points from the region of the trace data that you specify. For example, it could be used to return the data points of an input signal over several timeslots, excluding the portions of the trace data that you do not want. (This is x,y pairs for trace data and I,Q pairs for complex data.)

- CFIT or curve fit - applies curve fitting routines to the data. <soffset> and <length> are required to define the data that you want. <roffset> is an optional parameter for the desired order of the curve equation. The query will return the following values: the x-offset (in seconds) and the curve coefficients ((order + 1) values).

MIN, MAX, MEAN, DME, RMS, RMSC, SAMP, SDEV and PPH return one data value for each specified region (or <length>) of trace data, for as many regions as possible until you run out of trace data (using <roffset> to specify regions). Or they return the number of regions you specify (using <rlimit>) ignoring any data beyond that.

- MINimum - returns the minimum data point (y value) for the specified region(s) of trace data. For I/Q trace data, the minimum magnitude of the I/Q pairs is returned.
- MAXimum - returns the maximum data point (y value) for the specified region(s) of trace data. For I/Q trace data, the maximum magnitude of the I/Q pairs is returned.
- MEAN - returns a single value that is the arithmetic mean of the data point values (in dB/ dBm) for the specified region(s) of trace data. For I/Q trace data, the mean of the magnitudes of the I/Q pairs is returned. See the following equations.

NOTE If the original trace data is in dB, this function returns the arithmetic mean of those log values, not log of the mean power which is a more useful value. The mean of the log is the better measurement technique when measuring CW signals in the presence of noise. The mean of the power, expressed in dB, is useful in power measurements such as Channel Power. To achieve the mean of the power, use the RMS option.

Equation 1

Mean Value of Data Points for Specified Region(s)

$$\text{MEAN} = \frac{1}{n} \sum_{X_i \in \text{region}(s)} X_i$$

where X_i is a data point value, and n is the number of data points in the specified region(s).

Equation 2

Mean Value of I/Q Data Pairs for Specified Region(s)

$$\text{MEAN} = \frac{1}{n} \sum_{X_i \in \text{region}(s)} |X_i|$$

where $|X_i|$ is the magnitude of an I/Q pair, and n is the number of I/Q pairs in the specified region(s).

- DMEan - returns a single value that is the mean power (in dB/ dBm) of the data point values for the specified region(s) of trace data. See the following equation:

Equation 3

DMEan Value of Data Points for Specified Region(s)

$$\text{DME} = 10 \times \log_{10} \left(\frac{1}{n} \sum_{X_i \in \text{region}(s)} 10^{\frac{X_i}{10}} \right)$$

- RMS - returns a single value that is the average power on a root-mean-squared voltage scale (arithmetic rms) of the data point values for the specified region(s) of trace data. See the following equation.

NOTE For I/Q trace data, the rms of the magnitudes of the I/Q pairs is returned. See the following equation. This function is very useful for I/Q trace data. However, if the original trace data is in dB, this function returns the rms of the log values which is not usually needed.

Equation 4

RMS Value of Data Points for Specified Region(s)

$$\text{RMS} = \sqrt{\frac{1}{n} \sum_{X_i \in \text{region}(s)} X_i^2}$$

where X_i is a data point value, and n is the number of data points in the specified region(s).

Equation 5

RMS Value of I/Q Data Pairs for Specified Region(s)

$$\text{RMS} = \sqrt{\frac{1}{n} \sum_{X_i \in \text{region}(s)} X_i X_i^*}$$

where X_i is the complex value representation of an I/Q pair, X_i^* its conjugate complex number, and n is the number of I/Q pairs in the specified region(s).

Once you have the rms value for a region of trace data (linear or I/Q), you may want to calculate the mean power. You must convert this rms value (peak volts) to power in dBm:

$$10 \times \log[10 \times (\text{rms value})^2]$$

- SAMPLe - returns the first data value (x,y pair) for the specified region(s) of trace data. For I/Q trace data, the first I/Q pair is returned.
- SDEViation - returns a single value that is the arithmetic standard deviation for the data point values for the specified region(s) of trace data. See the following equation.
- For I/Q trace data, the standard deviation of the magnitudes of the I/Q pairs is returned. See the following equation.

Equation 6

Standard Deviation of Data Point Values for Specified Region(s)

$$\text{SDEV} = \sqrt{\frac{1}{n} \sum_{X_i \in \text{region}(s)} (X_i - \bar{X})^2}$$

where X_i is a data point value, \bar{X} is the arithmetic mean of the data point values for the specified region (s), and n is the number of data points in the specified region(s).

$$\text{SDEV} = \sqrt{\frac{1}{n} \sum_{X_i \in \text{region}(s)} (|X_i| - \bar{X})^2}$$

where $|X_i|$ is the magnitude of an I/Q pair, \bar{X} is the mean of the magnitudes for the specified region(s), and n is the number of data points in the specified region(s).

- PPHase - returns the x,y pairs of both rms power (dBm) and arithmetic mean phase (radian) for every specified region and frequency offset (Hz). The number of pairs is defined by the specified number of regions. This parameter can be used for I/Q vector ($n=0$) in Waveform (time domain) measurement and all parameters are specified by data point in PPHase.

The rms power of the specified region may be expressed as:

$$\text{Power} = 10 \times \log [10 \times (\text{RMS I/Q value})] + 10.$$

The RMS I/Q value (peak volts) is:

$$\sqrt{\frac{1}{n} \sum_{X_i \in \text{region}} X_i X_i^*}$$

where X_i is the complex value representation of an I/Q pair, X_i^* its conjugate complex number, and n is the number of I/Q pairs in the specified region.

The arithmetic mean phase of the specified region may be expressed as:

$$\frac{1}{n} \sum_{Y_i \in \text{region}} Y_i$$

where Y_i is the unwrapped phase of I/Q pair with applying frequency correction and n is the number of I/Q pairs in the specified region.

The frequency correction is made by the frequency offset calculated by the arithmetic mean of every specified region's frequency offset. Each frequency offset is calculated by the least square method against the unwrapped phase of I/Q pair.

Sample Trace Data - Constant Envelope

(See below for explanation of variables.)

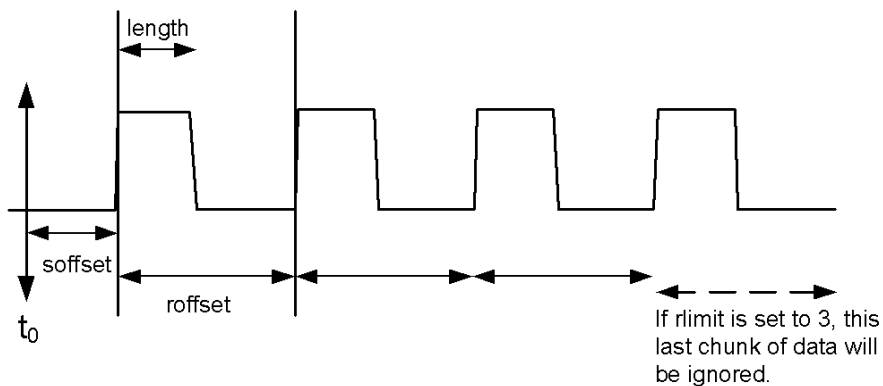

Sample Trace Data - Not Constant Envelope

(See below for explanation of variables.)



<soffset> - start offset is an optional real number. (It is in seconds for time-domain traces, and is a dimensionless index 0 to Npoints - 1, for frequency-domain traces). It specifies the amount of data at the beginning of the trace that will be ignored before the decimation process starts. It is the time or frequency change from the start of the trace to the point where you want to start using the data. The default value is zero.

<length> - is an optional real number. (It is in seconds for time-domain traces, and is a dimensionless index 0 to Npoints - 1, for frequency-domain traces). It defines how much data will be compressed into one value. This parameter has a default value equal to the current trace length.

<roffset> - repeat offset is an optional real number. (It is in seconds for time-domain traces, and is a dimensionless index 0 to Npoints - 1, for frequency-domain traces). It defines the beginning of the next field of trace elements to be compressed. This is relative to the beginning of the previous field. This parameter has a default value equal to the <length> variable. Note that this parameter is used for a completely different purpose when curve fitting (see CFIT above).

<rlimit> - repeat limit is an optional integer. It specifies the number of data items that you want returned. It will ignore any additional items beyond that number. You can use the Start offset and the Repeat limit to pick out exactly what part of the data you want to use. The default value is all the data.

Calculate Peaks of Trace Data (Remote Command Only)

Returns a list of all the peaks for the currently selected measurement and sub-opcode [n]. The peaks must meet the requirements of the peak threshold and excursion values.

n = any valid sub-opcode for the current measurement. See the MEASure:<measurement> command description of your specific measurement for information on the data that can be returned.

The command can only be used with specific sub-opcodes with measurement results that are trace data. Both real and complex traces can be searched, but complex traces are converted to magnitude in dBm. In many measurements the sub-opcode n=0, is the raw trace data which cannot be searched for peaks. And Sub-opcode n=1, is often calculated results values which also cannot be searched for peaks.

This command uses the data setting specified by the FORMat:BORDER and FORMat:DATA commands and can return real or ASCII data. If the format is set to INT,32, it returns REAL,32 data.

The command has four types of parameters:

- Threshold (in dBm)
- Excursion (in dB)
- Sorting order (amplitude, frequency, time)
- Optional in some measurements: Display line use (all, > display line, < display line)

Remote Command	<p>For Swept SA measurement:</p> <pre>:CALCulate:DATA[1] 2 ... 6:PEAKs? <threshold>,<excursion>[,AMPLitude FREQuency TIME[,ALL GTDLLine LTDLine]]</pre> <p>For most other measurements:</p> <pre>:CALCulate:DATA[1] 2 ... 6:PEAKs? <threshold>,<excursion>[,AMPLitude FREQuency TIME]</pre>
-----------------------	---

Example	<p>Example for Swept SA measurement in Spectrum Analyzer Mode:</p> <p>CALC:DATA4:PEAK? -40, 10, FREQ, GTDL This will identify the peaks of trace 4 that are above -40 dBm, with excursions of at least 10 dB. The peaks are returned in order of increasing frequency, starting with the lowest frequency. Only the peaks that are above the display line are returned.</p> <p>Query Results 1:</p> <p>With FORMat:DATA REAL, 32 selected, it returns a list of floating-point numbers. The first value in the list is the number of peak points that are in the following list. A peak point consists of two values: a peak amplitude followed by its corresponding frequency (or time).</p> <p>If no peaks are found the peak list will consist of only the number of peaks, (0).</p>
----------------	---

Notes	<p><n> - is the trace that will be used</p> <p><threshold> - is the level below which trace data peaks are ignored. Note that the threshold value is required and is always used as a peak criterion. To effectively disable the threshold criterion for this command, provide a substantially low threshold value such as -200 dBm. Also note that the threshold value used in this command is independent of and has no effect on the threshold value stored under the Peak Criteria menu.</p> <p><excursion> - is the minimum amplitude variation (rise and fall) required for a signal to be identified as peak. Note that the excursion value is required and is always used as a peak criterion. To effectively disable the excursion criterion for this command, provide the minimum value of 0.0 dB. Also note that the excursion value used in this command is independent of and has no effect on the</p>
--------------	---

excursion value stored under the Peak Criteria menu.

Values must be provided for threshold and excursion. The sorting and display line parameters are optional (defaults are AMPLitude and ALL).

Note that there is always a Y-axis value for the display line, regardless of whether the display line state is on or off. It is the current Y-axis value of the display line which is used by this command to determine whether a peak should be reported

Sorting order:

AMPLitude - lists the peaks in order of descending amplitude, with the highest peak first (default if optional parameter not sent)

FREQUency - lists the peaks in order of occurrence, left to right across the x-axis.

TIME - lists the peaks in order of occurrence, left to right across the x-axis.

Peaks vs. Display Line:

ALL - lists all of the peaks found (default if optional parameter not sent).

GTDLine (greater than display line) - lists all of the peaks found above the display line.

LTDLine (less than display line) - lists all of the peaks found below the display line.

Initial S/W Revision	Prior to A.02.00
----------------------	------------------

Hardware-Accelerated Fast Power Measurement (Remote Command Only)

The Fast Power option (FP2) enables very fast channel power measurements for instruments with the prerequisite hardware (DP2 and/or B40). It accomplishes this by performing real-time overlapped FFTs at the hardware layer, using software for basic post-processing before returning the result to the user. The upshot of this approach is improved throughput for user applications that require many sequential power measurements.

The analysis bandwidth of FP2 is limited by the licenses in the instrument, but its maximum overall analysis bandwidth per acquisition is 40 MHz.

FP2 is remote-only, which means the instrument does not switch to any particular mode or measurement. FP2 commands can be sent while another application is in use on the front panel.

Each Fast Power measurement can be predefined using an array index, and up to 1,000 measurements can be stored. In the following documentation, instances of [1,2,...,999] can be substituted with a particular measurement index, e.g. CALC:FPOW:POW1?, CALC:FPOW:POW2?, CALC:FPOW:POW134?. In this way, power measurements can be defined one time in a batch, and then executed multiple times without having to redefine them, similar to “list mode” on other measurements.

In addition to basic channel power measurements, there are a number of other measurement “functions” for each channel, including peak power, peak frequency, and power spectral density. See the Function parameter for more information.

Reset Fast Power Measurement (Remote Command Only)

Resets the measurement configuration to the defaults.

Mode	All
Remote Command	:CALCulate:FPOWer:POWer[1,2,...,999]:RESet
Example	:CALC:FPOW:POW1:RES

Notes	Option FP2 is required.
Initial S/W Revision	A.14.00

Define Fast Power Measurement (Remote Command Only)

Fast Power acquisitions are configured using the DEFine command. This command accepts a comma-delimited string of configuration parameters and their appropriate values, which are all specified in the subsection below.

Mode	All
Remote Command	:CALCulate:FPOWer:POWer[1,2,...,999]:DEFine "configuration string"
Example	:CALC:FPOW:POW1:DEF "CenterFrequency=2e9, AcquisitionTime=0.005"
Notes	See below for a list of measurement variables that can be defined in the configuration string.
Initial S/W Revision	A.14.00

Acquisition Time

Value	Time (s)
Range	0 s to 1 s
Preset	0.001 s
Example	CALC:FPOW:POW1:DEF "AcquisitionTime=0.002"
Notes	The acquisition time parameter sets the time in which the entire spectrum is measured. An increase in the acquisition time yields an improvement in measurement repeatability.
Initial S/W Revision	A.14.00

Center Frequency

Value	Frequency (Hz)
Range	0 Hz to maximum instrument frequency
Preset	1 GHz
Example	CALC:FPOW:POW1:DEF "CenterFrequency=2e9"
Notes	The center frequency parameter sets the frequency in which the measurement is centered around. The OffsetFrequency parameter is calculated relative to the center frequency.
Initial S/W Revision	A.14.00

DC Coupled

Value	Boolean
Range	True (DC Coupled) or False (AC Coupled)
Preset	False
Example	CALC:FPOW:POW1:DEF "DCCoupled=True"
Notes	The DC coupled parameter allows the user to specify whether the DC blocking capacitor is utilized. Set parameter to true when measuring frequencies below 10 MHz.
Initial S/W Revision	A.14.00

DetectorType

Example	CALC:FPOW:POW1:DEF "DetectorType=Peak"
Notes	Option FP2 is required. The detector type parameter allows the user to choose whether a RMS average or peak value is used during the measurement.
Preset	RmsAverage
Range	RmsAverage, Peak
Initial S/W Revision	A.14.00

Do Noise Correction

Value	Boolean
Range	True (enable noise correction) or False (disable noise correction)
Preset	False
Example	CALC:FPOW:POW1:DEF "DoNoiseCorrection=True"
Notes	When noise correction is enabled, the linear noise power contributed by the analyzer is subtracted from all measurements. This effectively lowers the noise floor of the analyzer. When noise correction is enabled, the first measurement for a given set of input parameters will take extra time. This is because the analyzer takes an extra acquisition with the RF input disconnected from the analyzer's front end to measure the noise of just the analyzer. The measured noise floor is stored in a cache so the noise acquisition will occur only once for the same state settings. In other words, if noise correction was turned on and the analyzer made an acquisition at frequency A, then frequency B, and back again to frequency A, the hidden initial noise floor acquisition would only occur for the first acquisition at frequency A and the cached noise floor would be used the second time frequency A was measured.
Initial S/W Revision	A.14.00

Do Spur Suppression

Value	Boolean
Range	True (enable spur suppression) or False (disable spur suppression)
Preset	False
Example	CALC:FPOW:POW1:DEF "DoSpurSuppression=True"
Notes	<p>When measuring very low level signals, or when large out-of-band inputs are input into the analyzer, sometimes unwanted spurs and residuals can appear in the measured spectrum. Spur suppression is a method to help minimize the levels of these internally generated spurs and residuals.</p> <p>When spur suppression is enabled, the analyzer will automatically take two acquisitions using two different internal analog LO frequencies. The FFT spectrums from both acquisitions are combined by taking the minimum power between both traces on a per FFT bin basis. External signals will have the same amplitude for both traces and therefore will return the expected amplitudes. However, low level spurs and residuals generated internally to the analyzer tend to move to different FFT bins depending on the internal analog LO frequency used, and therefore tend to be suppressed using this spur suppression method.</p> <p>Because two acquisitions, rather than a single acquisition, are made when spur suppression is enabled, the measurement time will always be slower when spur suppression is enabled.</p>
Initial S/W Revision	A.14.00

Electronic Attenuator Bypass

Value	Boolean
Range	True (bypass electronic attenuator) or False (use electronic attenuator)
Preset	True
Example	CALC:FPOW:POW1:DEF "ElecAttBypass =False"
Notes	The electronic attenuation bypass parameter allows the user to either utilize or bypass the electronic attenuator. The electronic attenuator is only available for frequencies up to 3.6 GHz. Set parameter to true when using frequencies above 3.6 GHz and set the parameter to false when using the preamp.
Initial S/W Revision	A.14.00

Electronic Attenuation

Value	dB
Range	0 - 24 dB (1 dB steps)
Preset	0 dB
Example	CALC:FPOW:POW1:DEF "ElecAttenuation=10"
Notes	<p>Option EA3 is required.</p> <p>The electronic attenuation value parameter sets the amount of electrical attenuation from 0 to 24 dB (1 dB steps).</p>

Set "ElecAttBypass=False" to make sure the electronic attenuator path is enabled.

Initial S/W Revision	A.14.00
-------------------------	---------

IF Gain

Value	dB
Range	-6 - 16 dB (1 dB steps)
Preset	0 dB
Example	CALC:FPOW:POW1:DEF "IFGain=10"
Notes	The IF gain parameter allows the user to specify the gain at the IF stage anywhere from -6 to 16 dB (1 dB steps). This is an advanced feature, and for most cases this should remain at its default value of 0 dB.
Initial S/W Revision	A.14.00

IF Type

Example	CALC:FPOW:POW1:DEF "IFType=B25M"
Notes	The IF type parameter allows the user to select between different IF paths. For example, if the signal is less than 25 MHz wide, then the user can select the B25M path to take advantage of additional filtering on this analog IF path.
Preset	B40M
Range	B10M, B25M, B40M
Initial S/W Revision	A.14.00

Include Power Spectrum

Value	Boolean
Range	True (return both channel power and full power spectrum) or False (returns only channel power)
Preset	False
Example	CALC:FPOW:POW1:DEF "IncludePowerSpectrum=True"
Notes	The power spectrum parameter allows the user to read data on the entire spectrum for diagnostic purposes. It is not recommended for production use. See CALC:FPOW:POW[n]:READ2? for details on the binary format of the response.
Initial S/W Revision	A.14.00

Mechanical Attenuation

Value	dB
Range	0 – 70 dB (2 dB steps)
Preset	0 dB
Example	CALC:FPOW:POW1:DEF "MechAttenuation=10"
Notes	The mechanical attenuation value parameter sets the amount of mechanical attenuation anywhere from 0 to 70 dB (2 dB steps).
Initial S/W Revision	A.14.00

Preamp Mode

Example	CALC:FPOW:POW1:DEF "PreAmpMode=Low"
Notes	The license for the appropriate preamp is required. The preamp mode parameter specifies whether the preamps are being utilized. Low allows any preamps up to 3.6 GHz, and Full allows all licensed preamps. Set "ElecAttBypass=True" in order to utilize any preamps.
Preset	Off
Range	Off, Low, Full
Initial S/W Revision	A.14.00

Resolution Bandwidth Mode

Example	CALC:FPOW:POW1:DEF "PreAmpMode=Low"
Notes	The resolution bandwidth mode parameter allows the user to choose whether the RBW filter is automatically or manually set. The BestSpeed value minimizes measurement time, while the Narrowest value minimizes RBW size (minimum of two FFT bins per RBW). To manually specify an RBW, set this parameter to Explicit, and set the ResolutionBW parameter to the desired value.
Preset	BestSpeed
Range	BestSpeed, Narrowest, Explicit
Initial S/W Revision	A.14.00

Resolution Bandwidth

Value	Hz
Preset	0 Hz

Example	CALC:FPOW:POW1:DEF "ResolutionBW=25e3"
Notes	The resolution bandwidth parameter sets the 3-dB bandwidth of the RBW filter. The ResolutionBWMode parameter must be set to Explicit in order to manually set the RBW.
Initial S/W Revision	A.14.00

Trigger Delay

Value	Seconds
Range	0 – 1 s
Preset	0 s
Example	CALC:FPOW:POW1:DEF "TriggerDelay=0.025"
Notes	The trigger delay parameter sets the time after an external trigger is detected until the measurement is performed.
Initial S/W Revision	A.14.00

Trigger Level

Value	Volts
Range	-5 to 5 V
Preset	1.2 V
Example	CALC:FPOW:POW1:DEF "TriggerLevel=2"
Notes	The trigger level parameter sets the voltage value at which an external trigger is detected.
Initial S/W Revision	A.14.00

Trigger Slope

Example	CALC:FPOW:POW1:DEF "TriggerSlope=Negative"
Notes	The trigger slope parameter indicates the direction of the edge trigger voltage for detection.
Preset	Positive
Range	Positive, Negative
Initial S/W Revision	A.14.00

Trigger Source

Example	CALC:FPOW:POW1:DEF "TriggerSource=Ext1 "
Notes	The trigger source parameter allows the user to choose between measurement's triggering freely or controlled by an external input. Ext1 and Ext2 correspond to Trigger 1 In and Trigger 2 In, respectively.
Preset	Free
Range	Free, Ext1, Ext2
Initial S/W Revision	A.14.00

Trigger Timeout

Value	Seconds
Range	0 - 1 s
Preset	1 s
Example	CALC:FPOW:POW1:DEF "TriggerTimeout=0.1"
Notes	The trigger timeout parameter sets the time in which the analyzer will wait for a trigger before automatically performing the measurement.
Initial S/W Revision	A.14.00

Signal Input

Example	CALC:FPOW:POW1:DEF "SignalInput=Fp50MHzCW"
Notes	The signal input parameter allows the user to select between using the main RF input or the internal analyzer reference CW signal of 50 MHz.
Preset	FpMainRf
Range	FpMainRf, Fp50MHzCW
Initial S/W Revision	A.14.00

Use Preselector

Value	Boolean
Range	True (use preselector above 3.6 GHz), or False (preselector bypassed)
Preset	False
Example	CALC:FPOW:POW1:DEF "UsePreSelector=True"
Notes	The preselector parameter allows the user to either utilize or bypass the front end tunable filter at frequencies above 3.6 GHz. For frequencies below 3.6 GHz, the preselector is automatically

bypassed, so you do not need to set this parameter to False in those cases.

Initial S/W Revision A.14.00

Channel Bandwidth Array

Value	Hz
Range	0 to 40 MHz
Preset	[1 e6]
Example	CALC:FPOW:POW1:DEF "Bandwidth=[3.84e6, 5e6, 3.84e6]"
Notes	The bandwidth parameter array defines the bandwidth of each channel that will be measured. All array parameters should have the same number of elements. Alternatively, if all the elements are the same value, a single number with no square brackets can be used to define the parameter.
Initial S/W Revision	A.14.00

Channel Filter Type Array

Example	CALC:FPOW:POW1:DEF "FilterType=[RRC, IBW, RRC]"
Notes	The filter type parameter allows the user to choose between an integration bandwidth (IBW) filter or a root-raised-cosine (RRC) filter. The integration bandwidth filter weighs all frequencies within the bandwidth equally. The root-raised-cosine filter has an associated shape parameter, defined by the FilterAlpha parameter. All array parameters should have the same number of elements. Alternatively, if all the elements are the same value, a single value with no square brackets can be used to define the parameter.
Preset	[IBW]
Range	IBW, RRC
Initial S/W Revision	A.14.00

Channel Filter Alpha Array

Example	CALC:FPOW:POW1:DEF "FilterAlpha=[0.5, 0.0, 0.5]"
Notes	The filter alpha parameter allows the user to adjust the alpha value associated with the root-raised-cosine (RRC) filter type. Set FilterType to RRC in order to utilize this parameter. All array parameters should have the same number of elements. Alternatively, if all the elements are the same value, a single number with no square brackets can be used to define the parameter.
Preset	[0.22]
Range	0.0 - 1.0
Initial S/W Revision	A.14.00

Channel Measurement Function Array

Example	CALC:FPOW:POW1:DEF "Function=[BandPower, PeakPower, BandPower]"
Notes	<p>This parameter array defines what measurement is being made for each individually-specified channel:</p> <p>BandPower: Total power within the specified bandwidth of the channel (dBm)</p> <p>BandDensity: Total power density within the specified bandwidth of the channel (dBm/Hz)</p> <p>PeakPower: The peak power value within the specified bandwidth of the channel (dBm)</p> <p>PeakFrequency: The frequency which corresponds to the peak power value within the specified bandwidth of the channel. This frequency is relative to the center frequency (Hz)</p> <p>XdBBandwidth: The half power (-3.01 dB) bandwidth of the highest amplitude signal that resides within the channel (Hz), dB is configurable using XdBBandwidth parameter</p> <p>OccupiedBandwidth: The bandwidth at which 99% of the total power resides within the channel (Hz), percentage configurable using OccupiedBandwidthPercent parameter</p> <p>All array parameters should have the same number of elements. Alternatively, if all the elements are the same value, a single value with no square brackets can be used to define the parameter.</p>
Preset	[BandPower]
Range	BandPower, BandDensity, PeakPower, PeakFrequency, XdBBandwidth, OccupiedBandwidth
Initial S/W Revision	A.14.00

Channel Offset Frequency Array

Value	Hz
Range	0 to 20 MHz
Preset	[0]
Example	CALC:FPOW:POW1:DEF "OffsetFrequency=[-5e6, 0, 5e6]"
Notes	<p>The offset frequency parameter array defines the difference between the center frequency to the center frequency of each channel.</p> <p>All array parameters should have the same number of elements.</p>
Initial S/W Revision	A.14.00

Channel Occupied Bandwidth Percent Array

Example	CALC:FPOW:POW1:DEF "OccupiedBandwidthPercent =[0.95, 0.95, 0.95]"
Notes	<p>This parameter only applies for channels whose Function is set to OccupiedBandwidth. The occupied bandwidth percent parameter specifies the percent of total power in these channels. The valid range for this parameter is 0.0 to 1.0, where 1.0 represents 100%. The default for this parameter is 0.99, which will return the bandwidth that contains 99% of the total channel power.</p>

Preset	[0.99]
Range	0 - 1.0
Initial S/W Revision	A.14.00

Channel x-dB Bandwidth Array

Value	dB
Range	-200 to 0 dB
Preset	[-3.01]
Example	CALC:FPOW:POW1:DEF " XdBBandwidth =[-6.02, -3.01, -1.0]"
Notes	This parameter only applies for channels whose Function is set to XdBBandwidth. The X dB bandwidth parameter is used to specify the power relative to the peak channel power over which the bandwidth is calculated. The parameter value must be a negative number.
Initial S/W Revision	A.14.00

Define Fast Power Measurement Query (Remote Command Only)

The DEFine? command is used to retrieve a list of all defined parameters in an ASCII string format

M o d e	All
R e m o t e	:CALCulate:FPOWER:POWer [1,2,...,999]:DEFine?
C o m m a n d	
E x a m	:CALC:FPOW:POW1:DEF?

```

p
l
e
N This command query is used to retrieve a list of all defined parameters in an ASCII format.
o The following is an example of the returned results:
t "DCCoupled=False,ElecAttBypass=True,ElecAttenuation=0,IFGain=0,MechAttenuation=0,PreAmpMode=Off,PreSelectorOffset
e =0,UsePreSelector=False,ExternalReferenceFrequency=10000000,FrequencyReferenceSource=AutoExternalFrequencyRefer
s ence,IFType=B40M,LOMode=SLW,SignalInput=FpMainRf,AcquisitionTime=0.001,CenterFrequency=1000000000,Resolution
BW=0,ResolutionBWMode=BestSpeed,DetectorType=RmsAverage,Bandwidth=[1000000],OffsetFrequency=[0],Function=
[BandPower],FilterType=[IBW],FilterAlpha=[0.22],OccupiedBandwidthPercent=[0.99],XdBBandwidth=[-
3.01],DoNoiseCorrection=False,DoSpurSuppression=False,MeasurementMethod=HardwareFFT,IncludePowerSpectrum=False,
e,TriggerDelay=0,TriggerLevel=1.2,TriggerSlope=Positive,TriggerSource=Free,TriggerTimeout=1"
I A.14.00
n
i
t
i
a
l
S
/
W
R
e
v
i
s
i
o
n

```

Configure Fast Power Measurement (Remote Command Only)

The configure command begins hardware setup and returns immediately, with no acquisition made. This can be used in parallel with other hardware operations to effectively hide the hardware setup time.

Mode	All
Remote Command	:CALCulate:FPOWER:POWER[1,2,...,999]:CONFigure
Example	:CALC:FPOW:POW1:CONF
Notes	Option FP2 is required.
Initial S/W Revision	A.14.00

Initiate Fast Power Measurement (Remote Command Only)

The INITiate command begins an acquisition and returns immediately. The results of the measurement can be retrieved using FETCh.

Mode	All
Remote Command	:CALCulate:FPOWER:POWER[1,2,...,999]:INITiate
Example	:CALC:FPOW:POW1:INIT
Notes	Option FP2 is required.
Initial S/W Revision	A.14.00

Fetch Fast Power Measurement (Remote Command Only)

The FETCh command query is used to retrieve the results of an acquisition initiated by the INIT command. The returned results are in ASCII string format. The string begins and ends with quotation marks.

Mode	All
Remote Command	:CALCulate:FPOWER:POWER[1,2,...,999]:FETCh?
Example	:CALC:FPOW:POW1:FETC?
Notes	Option FP2 is required. Returns m comma-separated ASCII values, where m corresponds to the number of bandwidths defined. 1. Declared function return in the 1st specified channel 2. Declared function return in the 2nd specified channel ... m. Declared function return in the last specified channel The INIT and FETC? command sequence performs the same functionality of a single CALC:FPOW:POW[n]? query. Units of the returned values are dependent on the Function parameter for each channel.
Initial S/W Revision	A.14.00

Execute Fast Power Measurement (Remote Command Only)

This command query is used as shorthand for an INIT command immediately followed by a FETC? command. The returned results are in ASCII string format. The string begins and ends with quotation marks.

Mode	All
Remote Command	:CALCulate:FPOWER:POWER[1,2,...,999]?
Example	:CALC:FPOW:POW1?
Notes	Option FP2 is required. See notes for Fast Power Fetch for return format.
Initial S/W Revision	A.14.00

Binary Read Fast Power Measurement (Remote Command Only)

This command query is used as shorthand for an INIT command immediately followed by a FETC? command. The returned results are in a binary format.

Mode	All
Remote Command	:CALCulate:FPOWER:POWER[1,2,...,999]:READ? :CALCulate:FPOWER:POWER[1,2,...,999]:READ1?
Example	:CALC:FPOW:POW1:READ? :CALC:FPOW:POW1:READ1?
Notes	Option FP2 is required. Returns m 4 byte floating point binary values (Little-Endian), where m corresponds to the number of bandwidths defined.
Initial S/W Revision	A.14.00

Diagnostic Binary Read Fast Power Measurement (Remote Command Only)

This command query is used as shorthand for an INIT command immediately followed by a FETC? command. The returned results are in a binary format. This command is used primarily for diagnostic purposes to test for ADC overloads and to visibly inspect the spectrum.

Mode	All
Remote Command	:CALCulate:FPOWER:POWER[1,2,...,999]:READ2?
Example	:CALC:FPOW:POW1:READ2?
Notes	Option FP2 is required. Note: Spectrum data is only returned if the IncludePowerSpectrum parameter is set to True. If IncludePowerSpectrum is False, the number of spectrum points will be zero (0). Units of the returned values are dependent on the Function parameter per channel (e.g. dBm for BandPower, Hz for PeakFrequency). Returns binary data (Little-Endian) that contains information on m amount of channels, along with ADC over range and full spectrum data. The following is the binary format of the response. Bandwidth Return Value 1. Number of channels specified, m [4 byte int] 2. Declared function result for the 1st specified channel [4 byte float] 3. Declared function result for the 2nd specified channel [4 byte float] ... (m + 1). Declared function result for the last (mth) specified channel [4 byte float] ADC Over Range 1. ADC over-range occurred (1: true, 0: false) [2 byte short]

	<p>Spectrum Data</p> <ol style="list-style-type: none"> 1. Number of points in the spectrum data, k [4 byte int] 2. Start frequency of spectrum data (Hz) [8 byte double] 3. Step frequency of spectrum data (Hz) [8 byte double] 4. FFT bin at 1st point (dBm) [4 byte float] 5. FFT bin at 2nd point (dBm) [4 byte float] <p>...</p> <p>(k + 3). FFT bin at last (kth) point (dBm) [4 byte float]</p>
Initial S/W Revision	A.14.00

Format Data: Numeric Data (Remote Command Only)

This command specifies the format of the trace data input and output. It specifies the formats used for trace data during data transfer across any remote port. It affects only the data format for setting and querying trace data for the :TRACe[:DATA], TRACe[:DATA]?, :CALCulate:DATA[n]? and FETCh:SANalyzer[n]? commands and queries.

Remote Command	<pre>:FORMat[:TRACe][:DATA] ASCii INTeger,32 REAL,32 REAL,64 :FORMat[:TRACe][:DATA]?</pre>
Notes	<p>The query response is:</p> <pre>ASCii: ASC,8 REAL,32: REAL,32 REAL,64: REAL,64 INTeger,32: INT,32</pre> <p>When the numeric data format is REAL or ASCii, data is output in the current Y Axis unit. When the data format is INTeger, data is output in units of m dBm (.001 dBm).</p> <p>The INT,32 format returns binary 32-bit integer values in internal units (m dBm), in a definite length block.</p>
Dependencies	<p>Sending a data format spec with an invalid number (for example, INT,48) generates no error. The analyzer simply uses the default (8 for ASCii, 32 for INTeger, 32 for REAL).</p> <p>Sending data to the analyzer which does not conform to the current FORMat specified, results in an error. Sending ASCII data when a definite block is expected generates message -161 "Invalid Block Data" and sending a definite block when ASCII data is expected generates message -121 "Invalid Character in Number".</p>
Preset	ASCii
Backwards Compatibility Notes	Note that the INT,32 format is only applicable to the command, TRACe:DATA. This preserves backwards compatibility for the Swept SA measurement. For all other commands/queries which honor FORMat:DATA, if INT,32 is sent the analyzer will behave as though it were set to REAL,32.
Initial S/W Revision	Prior to A.02.00

The specs for each output type follow:

AScii - Amplitude values are in ASCII, in the current Y Axis Unit, one ASCII character per digit, values separated by commas, each value in the form:

SX.YYYYYEsZZ

Where:

S = sign (+ or -)

X = one digit to left of decimal point

Y = 5 digits to right of decimal point

E = E, exponent header

s = sign of exponent (+ or -)

ZZ = two digit exponent

REAL,32 - Binary 32-bit real values in the current Y Axis Unit, in a definite length block.

REAL,64 - Binary 64-bit real values in the current Y Axis Unit, in a definite length block.

Format Data: Byte Order (Remote Command Only)

This command selects the binary data byte order for data transfer and other queries. It controls whether binary data is transferred in normal or swapped mode. This command affects only the byte order for setting and querying trace data for the :TRACe[:DATA], TRACe[:DATA]? , :CALCulate:DATA[n]? and FETCh:SANalyzer[n]? commands and queries.

By definition any command that says it uses FORMat:DATA uses any format supported by FORMat:DATA.

The NORMal order is a byte sequence that begins with the most significant byte (MSB) first, and ends with the least significant byte (LSB) last in the sequence: 1|2|3|4. SWAPped order is when the byte sequence begins with the LSB first, and ends with the MSB last in the sequence: 4|3|2|1.

Remote Command	:FORMat:BORDER NORMAL SWAPped :FORMat:BORDER?
Preset	NORMal
Initial S/W Revision	Prior to A.02.00

Meas Setup

Displays the setup menu for the currently selected measurement. The parameters included in this menu are as follows.

- Averaging
- IF Gain
- Channel Power Span
- Integrated Bandwidth
- Filter Bandwidth
- Root Raised Cosine (RRC) Filter

Key Path	Front-panel key
Initial S/W Revision	Prior to A.02.00

Avg/Hold Num

Specifies the number of measurement averages used to calculate the measurement result. The average is displayed at the end of each sweep. After the specified number of average counts, the averaging mode (terminal control) setting determines the averaging action.

Key Path	Meas Setup
Mode	SA, WCDMA, C2K, WIMAX OFDMA, 1xEVDO, DVB-T/H, DTMB (CTTB), ISDB-T, CMMB, LTE, LTETDD, Digital Cable TV, WLAN, MSR, LTEAFDD, LTEATDD
Remote Command	[:SENSe]:CHPower:AVERage:COUNT <integer> [:SENSe]:CHPower:AVERage:COUNT? [:SENSe]:CHPower:AVERage[:STATe] ON OFF 1 0 [:SENSe]:CHPower:AVERage[:STATe]?
Example	CHP:AVER:COUN 15 CHP:AVER:COUN? CHP:AVER ON CHP:AVER?
Notes	You must be in the Spectrum Analysis mode, W-CDMA mode, cdma2000 mode, DVB-T/H mode, DTMB (CTTB) mode, ISDB-T mode, CMMB mode, Digital Cable TV mode, LTE mode, LTE TDD mode 1xEVDO mode or WIMAX OFDMA mode to use this command. Use :INSTRument:SElect to set the mode.
Preset	SA: 10 WCDMA: 200 WIMAX OFDMA, LTE, LTETDD, MSR: 200 CDMA2K: 20 1xEVDO: 20

	DVB-T/H: 20 DTMB (CTTB): 20 ISDB-T: 10 CMMB: 10 Digital Cable TV: 10 WLAN: 10 LTEAFDD, LTEATDD:200 ON
State Saved	Saved in instrument state.
Min	1
Max	10000
Initial S/W Revision	Prior to A.02.00
Modified at S/W Revision	A.02.00, A.03.00

Avg Mode

Allows you to select the type of termination control used for the averaging function. This determines the averaging action after the specified number of data acquisitions (average count) is reached.

When set to Exponential (Exp) the measurement averaging continues using the specified number of averages to compute each exponentially-weighted averaged value. The average is displayed at the end of each sweep.

When set to Repeat, the measurement resets the average counter each time the specified number of averages is reached.

Key Path	Meas Setup
Mode	SA, WCDMA, C2K, WIMAX OFDMA, 1xEVDO, DVB-T/H, DTMB (CTTB), ISDB-T, CMMB, LTE, LTEATDD, Digital Cable TV, WLAN, MSR, LTEAFDD, LTEATDD
Remote Command	[:SENSe] :CHPower:AVERage:TCONtrol EXPonential REPeat [:SENSe] :CHPower:AVERage:TCONtrol?
Example	CHP:AVER:TCON EXP CHP:AVER:TCON?
Notes	You must be in the Spectrum Analysis mode, W-CDMA mode, cdma2000 mode, DVB-T/H mode, DTMB (CTTB) mode, ISDB-T mode, CMMB mode, Digital Cable TV mode, LTE mode, LTE TDD mode, WLAN mode, 1xEVDO mode or WIMAX OFDMA mode to use this command. Use :INSTrument:SElect to set the mode.
Preset	EXP
State Saved	Saved in instrument state.
Range	Exp Repeat
Initial S/W Revision	Prior to A.02.00
Modified at S/W Revision	A.02.00, A.03.00

Integ BW

Specifies the range of integration used in calculating the power in the channel. The integration bandwidth (IBW) is displayed on the trace as two markers connected by an arrow.

Key Path	Meas Setup
Mode	SA, WCDMA, C2K, WIMAX OFDMA, 1xEVDO, DVB-T/H, DTMB (CTTB), ISDB-T, CMMB, LTE, LTETDD, Digital Cable TV, WLAN
Remote Command	<code>[:SENSe] :CHPower:BANDwidth:INTEgration <bandwidth></code> <code>[:SENSe] :CHPower:BANDwidth:INTEgration?</code>
Example	CHP:BAND:INT 10MHz CHP:BAND:INT?
Notes	You must be in the Spectrum Analysis mode, W-CDMA mode, cdma2000 mode, DVB-T/H mode, DTMB (CTTB) mode, ISDB-T mode, CMMB mode, Digital Cable TV mode, LTE mode, LTE TDD mode, WLAN mode, 1xEVDO mode or WIMAX OFDMA mode to use this command. Use <code>:INSTrument:SElect</code> to set the mode.
Dependencies	For MSR/LTE-Advanced FDD/TDD mode, this key is blank.
Couplings	The minimum value of the span is coupled with the integration bandwidth.
Preset	SA: 2 MHz WCDMA: 5 MHz C2K: 1.23 MHz WIMAX OFDMA: 10 MHz 1xEVDO: 1.23 MHz DVB-T/H: 7.61MHz DTMB (CTTB): 8MHz ISDB-T: 5.6MHz CMMB: 8MHz LTE: 5 MHz LTETDD: 5 MHz Digital Cable TV: 8MHz WLAN: if Radio Std is 802.11a/g(OFDM/DSSS-OFDM): 20 MHz if Radio Std is 802.11b: 25 MHz if Radio Std is 802.11n(20MHz): 20 MHz if Radio Std is 802.11n(40MHz): 40 MHz if Radio Std is 802.11ac (20 MHz): 20 MHz if Radio Std is 802.11ac (40 MHz): 40 MHz if Radio Std is 802.11ac (80 MHz): 80 MHz if Radio Std is 802.11ac (160 MHz): 160 MHz if Radio Std is 802.11ac (80 MHz + 80 MHz): 80 MHz

State Saved	Saved in instrument state.
Min	100 Hz
Max	Hardware Maximum Span
Initial S/W Revision	Prior to A.02.00
Modified at S/W Revision	A.02.00, A.03.00

PhNoise Opt

Selects the LO (local oscillator) phase noise behavior for various operating conditions. Refer to "[PhNoise Opt](#)" on page 1802

in the Swept SA measurement for details.

Key Path	Meas Setup
Initial S/W Revision	A.04.20

PhNoise Opt Auto

Selects the LO (local oscillator) phase noise behavior to optimize dynamic range and speed for various instrument operating conditions. Refer to PhNoise Opt Auto State in the Swept SA measurement for details.

Key Path	Meas Setup
Remote Command	<code>[:SENSe] :CHPower:FREQuency:SYNTHeSis:AUTO [:STATe] OFF ON 0 1</code> <code>[:SENSe] :CHPower:FREQuency:SYNTHeSis:AUTO [:STATe] ?</code>
Example	CHP:FREQ:SYNT:AUTO 1 CHP:FREQ:SYNT:AUTO?
Preset	OFF
State Saved	Saved in instrument state.
Range	Auto Man
Readback Text	"Auto" is underlined when Auto is selected, otherwise Man is underlined.
Initial S/W Revision	A.04.20

PhNoise Opt State

Selects the LO (local oscillator) phase noise behavior for various operating conditions. Refer to "[PhNoise Opt](#)" on page 1802 in the Swept SA measurement for details.

Key Path	Meas Setup
----------	------------

Remote Command	<code>[:SENSe] :CHPower:FREQuency:SYNTHeSis [:STATe] 1 2 3</code> <code>[:SENSe] :CHPower:FREQuency:SYNTHeSis [:STATe] ?</code>
Example	CHP:FREQ:SYNT 1 CHP:FREQ:SYNT?
Notes	Parameter key: 1. optimizes phase noise for close-in from the carrier. 2. optimizes phase noise for wide-offset from the carrier. 3. optimizes LO for tuning speed.
Couplings	Best Close-in Φ Noise The frequency below which the phase noise is optimized is model dependent: PXA with option EP1: [offset <140 kHz] Models with option EP2: [offset <70 kHz] CXA with option EP4: [offset <90 kHz] CXA without option EP4: n/a All other models: [offset <20 kHz] Best Wide-offset Φ Noise The frequency below which the phase noise is optimized is model dependent: PXA with option EP1: [offset >160 kHz] Models with option EP2: [offset >100 kHz] CXA with option EP4: [offset >130 kHz] CXA without option EP4: n/a All other models: [offset >30 kHz] Fast Tuning The Fast Tuning details are model dependent: CXA without option EP4: n/a PXA with option EP1: [single loop] Models with option EP2: [medium loop bandwidth] All other models: [same as Close-in]
Preset	3
State Saved	Saved in instrument state.
Range	Best Close-in Φ Noise [offset < 140 kHz] Best Wide-offset Φ Noise [offset > 160 kHz] Fast Tuning [same as Close-in] [] is model dependent. See Couplings for details.
Initial S/W Revision	A.04.20

IF Gain

Sets the IF Gain function to Auto, Low Gain or High Gain. These settings affect sensitivity and IF overloads.

Key Path	Meas Setup
-----------------	------------

Dependencies	The IF Gain keys (FFT IF Gain and Swept IF Gain) have no effect when the U7227A USB Preamplifier is connected. This is not annotated or reflected on any softkey; there are no keys grayed out nor any SCPI locked out. The analyzer simply behaves as though both FFT IF Gain and Swept IF Gain are set to Low regardless of the setting on the keys.
Initial S/W Revision	Prior to A.02.00

IF Gain Auto

Activates the auto rules for IF Gain. When Auto is active, the IF Gain is set to High Gain under any of the following conditions:

- The input attenuator is set to 0 dB
- The preamp is turned On and the frequency range is under 3.6 GHz

For other settings, Auto sets the IF Gain to Low Gain.

Key Path	Meas Setup, IF Gain
Remote Command	[:SENSe] :CHPower:IF:GAIN:AUTO [:STATe] ON OFF 1 0 [:SENSe] :CHPower:IF:GAIN:AUTO [:STATe] ?
Example	CHP:IF:GAIN:AUTO ON CHP:IF:GAIN:AUTO?
Couplings	When the auto attenuation exists (for example, with an electrical attenuator), IF Gain State differs depending on the condition. Auto sets IF Gain to High Gain under any of the following conditions: The input attenuator is set to 0 dB, or the preamp is turned on and the frequency range is under 3.6 GHz. For other conditions, Auto sets IF Gain to Low Gain.
Preset	OFF
State Saved	Saved in instrument state.
Range	Off On
Initial S/W Revision	Prior to A.02.00

IF Gain State

Selects the range of the IF Gain.

Key Path	Meas Setup, IF Gain
Remote Command	[:SENSe] :CHPower:IF:GAIN [:STATe] ON OFF 1 0 [:SENSe] :CHPower:IF:GAIN [:STATe] ?
Example	CHP:IF:GAIN ONCHP:IF:GAIN?
Notes	ON = high gain OFF = low gain

Couplings	When the auto attenuation exists (for example, with an electrical attenuator), IF Gain State differs depending on the condition. Auto sets IF Gain to High Gain under any of the following conditions: The input attenuator is set to 0 dB, or the preamp is turned on and the frequency range is under 3.6 GHz. For other conditions, Auto sets IF Gain to Low Gain.
Preset	OFF
State Saved	Saved in instrument state.
Range	Low Gain High Gain
Initial S/W Revision	Prior to A.02.00

Method

Turns the Root Raised Cosine (RRC) filter On or Off. The α value (roll off) for the filter is set to the value of the Filter Alpha parameter, and the RRC filter bandwidth is set to the Filter BW parameter.

Key Path	Meas Setup
Mode	SA, WCDMA, WIMAX OFDMA, DVB-T/H, DTMB (CTTB), ISDB-T, CMMB, LTE, LTETDD, Digital Cable TV, WLAN
Remote Command	[:SENSe] :CHPower :FILTer [:RRC] [:STATe] OFF ON 0 1 [:SENSe] :CHPower :FILTer [:RRC] [:STATe] ?
Example	CHP:FILT OFF CHP:FILT?
Notes	This parameter is normally used when TETRA is selected as the Radio Std. You must be in the Spectrum Analysis mode, DVB-T/H mode, DTMB (CTTB) mode, ISDB-T mode, CMMB mode, LTE mode, LTE TDD mode, WLAN mode, WIMAX OFDMA mode or W-CDMA mode to use this command. Use :INSTrument:SElect to set the mode.
Dependencies	For CDMA2K mode, this key is blank. For 1xEVDO mode, this key is blank. For MSR mode, this key is blank. For LTE-Advanced FDD/TDD mode, this key is blank. For WLAN 802.11 ac (80 + 80 MHz), RRC Weighted is not supported .
Preset	OFF
State Saved	Saved in instrument state.
Range	Integ BW RRC Weighted
Initial S/W Revision	Prior to A.02.00
Modified at S/W Revision	A.02.00, A.03.00, A.10.00

Method

Turns the Root Raised Cosine (RRC) filter On or Off. The α value (roll off) for the filter is set to the value of the Filter Alpha parameter, and the RRC filter bandwidth is set to the Filter BW parameter.

Key Path	Meas Setup
Mode	SA, WCDMA,WIMAX OFDMA, DVB-T/H, DTMB (CTTB), ISDB-T, CMMB, LTE, LTETDD, Digital Cable TV, WLAN
Remote Command	<code>[:SENSe] :CHPower:FILTer [:RRC] [:STATe] OFF ON 0 1</code> <code>[:SENSe] :CHPower:FILTer [:RRC] [:STATe] ?</code>
Example	CHP:FILT OFF CHP:FILT?
Notes	This parameter is normally used when TETRA is selected as the Radio Std. You must be in the Spectrum Analysis mode, DVB-T/H mode, DTMB (CTTB) mode, ISDB-T mode, CMMB mode, LTE mode, LTE TDD mode, WLAN mode,WIMAX OFDMA mode or W-CDMA mode to use this command. Use :INSTRument:SElect to set the mode.
Dependencies	For CDMA2K mode, this key is blank. For 1xEVDO mode, this key is blank. For MSR mode, this key is blank. For LTE-Advanced FDD/TDD mode, this key is blank. For WLAN 802.11 ac (80 + 80 MHz), RRC Weighted is not supported .
Preset	OFF
State Saved	Saved in instrument state.
Range	Integ BW RRC Weighted
Initial S/W Revision	Prior to A.02.00
Modified at S/W Revision	A.02.00, A.03.00, A.10.00

Filter Alpha

Inputs the alpha value for the Root Raised Cosine (RRC) filter.

Key Path	Meas Setup, Method
Mode	SA, WCDMA,WIMAX OFDMA, DVB-T/H, DTMB (CTTB), ISDB-T, CMMB, LTE, LTETDD, Digital Cable TV, WLAN
Remote Command	<code>[:SENSe] :CHPower:FILTer [:RRC] :ALPHa <real></code> <code>[:SENSe] :CHPower:FILTer [:RRC] :ALPHa ?</code>
Example	CHP:FILT:ALPH 0.5 CHP:FILT:ALPH?
Notes	This parameter is normally used when TETRA is selected as the Radio Std. You must be in the Spectrum Analysis mode, DVB-T/H mode, DTMB (CTTB) mode, ISDB-T mode, CMMB mode, LTE mode, LTE TDD mode, WLAN mode,WIMAX OFDMA mode or W-CDMA mode to use this command. Use :INSTRument:SElect to set the mode.

Dependencies	For CDMA2K mode, this key is blank. For 1xEVDO mode, this key is blank. For MSR mode, this key is blank. For LTE-Advanced FDD/TDD mode, this key is blank
Preset	SA, WCDMA, , WIMXA OFMDA, DVB-T/H, ISDB-T, CMMB, LTE, LTETDD, WLAN: 0.22 DTMB (CTTB): 0.05 Digital Cable TV: 0.15
State Saved	Saved in instrument state.
Min	0.01
Max	1.00
Initial S/W Revision	Prior to A.02.00
Modified at S/W Revision	A.02.00, A.03.00, A.10.00

Filter BW

Inputs the Root Raised Cosine (RRC) filter bandwidth. Normally, the filter bandwidth is the same as the symbol rate of the signal.

Key Path	Meas Setup, Method, RRC Weighted
Mode	SA, WCDMA, WIMAX OFDMA, DVB-T/H, DTMB (CTTB), ISDB-T, CMMB, LTE, LTETDD, Digital Cable TV, WLAN
Remote Command	<code>[:SENSe]:CHPower:FILTer[:RRC]:BANDwidth <real></code> <code>[:SENSe]:CHPower:FILTer[:RRC]:BANDwidth?</code>
Example	CHP:FILT:BAND 10MHz CHP:FILT:BAND?
Notes	This parameter is normally used when TETRA is selected as the Radio Std. You must be in the Spectrum Analysis mode, DVB-T/H mode, DTMB (CTTB) mode, ISDB-T mode, CMMB mode, LTE mode, LTE TDD mode, WLAN mode, WIMAX OFMDA mode or W-CDMA mode to use this command. Use :INSTrument:SElect to set the mode.
Dependencies	For CDMA2K mode, this key is blank. For 1xEVDO mode, this key is blank. For MSR mode, this key is blank. For LTE-Advanced FDD/TDD, this key is blank.
Preset	SA, LTE, LTETDD: 3.84MHz WCDMA: 3.84MHz WIMAX OFDMA: 10MHz DVB-T/H: 8MHz DTMB (CTTB): 7.56MHz ISDB-T: 5.6MHz CMMB: 7.512MHz

	Digital Cable TV: 6.9MHz WLAN: if Radio Std is 802.11a/g(OFDM/DSSS-OFDM): 16.6 MHz if Radio Std is 802.11b: 22 MHz if Radio Std is 802.11n(20MHz): 17.8 MHz if Radio Std is 802.11n(40MHz): 36.6 MHz
State Saved	Saved in instrument state.
Min	100 Hz
Max	100 MHz
Backwards Compatibility SCPI	[:SENSe] :CHPower:FILTer [:RRC] :BWIDth
Initial S/W Revision	Prior to A.02.00
Modified at S/W Revision	A.02.00, A.03.00, A.10.00

Limits

Accesses the Limits menu that allows you to set up the test limit for channel power or power spectral density.

When DVB-T/H mode or DTMB (CTTB) mode is selected or DVB-T radio standard is selected in SA mode, this functionality is disabled and input signal will be compared against pre-defined spectrum mask, instead. See 1.3.2 Limit Line Mask for DVB-T for more details.

In DVB-T/H, DTMB (CTTB), ISDB-T, CMMB mode, this key is blank. If DVB-T is selected as current Radio Std in SA Mode, this key is grayed out.

In MSR, LTE-Advanced FDD/TDD mode, this feature is not supported and the key is blank because the power of each carrier may be different.

Key Path	Meas Setup
Initial S/W Revision	A.10.00

Power Limit

If Power Limit is on, Power Limit is used as threshold which can judge whether the real measured channel power can be passed or not. If real measured channel power exceeds Power Limit, channel power test fails, otherwise, it passes. If Power Limit is off, channel power test is always passed.

Key Path	Meas Setup, Limits
Mode	SA, WCDMA, C2K, WIMAX OFDMA, 1xEVDO, LTE, LTETDD, Digital Cable TV, WLAN
Remote Command	:CALCulate:CHPower:LIMit:POWer <ampl> :CALCulate:CHPower:LIMit:POWer? :CALCulate:CHPower:LIMit:POWer:STATe OFF ON 0 1

	:CALCulate:CHPower:LIMit:POWer:STATe?
Example	CALC:CHP:LIM:POW 16.00 CALC:CHP:LIM:POW? CALC:CHP:LIM:POW:STAT ON CALC:CHP:LIM:POW:STAT?
Notes	This parameter and PSD Limit can determine Pass/Fail criteria. If ((power limit = On) and (PSD limit= Off)) Pass if (power test passes) Fail if (power test fails) If ((power limit = On) and (PSD limit= On)) Pass if (both power test and PSD test pass) Fail if (either of power test or PSD test fails) If ((power limit = Off) and (PSD limit= On)) Pass if (PSD test passes) Fail if (PSD test fails) If ((power limit = Off) and (PSD limit= Off)) Always Pass For MSR mode, this key is blank. For LTE-Advanced FDD/TDD mode, this key is blank. For WLAN 802.11ac (80 MHz + 80 MHz), the power test and the PSD test are performed to both carriers. Which means the power (or PSD) readouts of both carriers should be compared with the power (or PSD) limit individually, and the test passes only when both values are lower than the limit.
Preset	16.00 SA, WCDMA, C2K, WIMAX OFDMA, 1xEVDO, DVB-T/H, DTMB (CTTB), LTE, LTETDD, Digital Cable TV: OFF WLAN: ON
State Saved	Saved in instrument state.
Min	-200.0
Max	200.0
Initial S/W Revision	A.10.00

PSD Limit

If PSD (power spectral density) Limit is ON, PSD Limit is used as threshold which can judge whether the real measured PSD can be passed or not. If real measured PSD exceeds PSD Limit, PSD test fails, otherwise, it passes. If PSD is off, PSD test is always passed.

Key Path	Meas Setup, Limits
Mode	SA, WCDMA, C2K, WIMAX OFDMA, 1xEVDO, LTE, LTETDD, Digital Cable TV, WLAN
Remote Command	:CALCulate:CHPower:LIMit:PSDensity <real> :CALCulate:CHPower:LIMit:PSDensity?

	:CALCulate:CHPower:LIMit:PSDensity:STATE OFF ON 0 1 :CALCulate:CHPower:LIMit:PSDensity:STATE?
Example	CALC:CHP:LIM:PSD 4.00 CALC:CHP:LIM:PSD? CALC:CHP:LIM:POW:STAT ON CALC:CHP:LIM:POW:STAT?
Notes	This parameter and Power Limit can determine Pass/Fail criteria. If ((power limit = On) and (PSD limit= Off)) Pass if (power test passes) Fail if (power test fails) If ((power limit = On) and (PSD limit= On)) Pass if (both power test and PSD test pass) Fail if (either of power test or PSD test fails) If ((power limit = Off) and (PSD limit= On)) Pass if (PSD test passes) Fail if (PSD test fails) If ((power limit = Off) and (PSD limit= Off)) Always Pass For MSR mode, this key is blank. For LTE-Advanced FDD/TDD mode, this key is blank. For WLAN 802.11ac (80 MHz + 80 MHz), the power test and the PSD test are performed to both carriers. Which means the PSD (or power) readouts of both carriers should be compared with the PSD (or power) limit individually, and the test passes only when both values are lower than the limit.
Couplings	The value is automatically converted when PSD Unit is changed.
Preset	4.00 SA, WCDMA, C2K, WIMAX OFDMA, 1Xevdo, LTE, LTETDD, Digital Cable TV: OFF WLAN: ON
State Saved	Saved in instrument state.
Min	-200.0
Max	200.0
Initial S/W Revision	A.10.00

Power Limit Fail (remote command only)

The command is query only and used to query if power test passes or fails. When DVB-T/H mode or DTMB (CTTB) mode is selected or DVB-T radio standard is selected in SA mode, this query SCPI command does not make any sense.

Remote Command	:CALCulate:CHPower:LIMit:POWer:FAIL?
-----------------------	--------------------------------------

Example	CALC:CHP:LIM:POW:FAIL?
Notes	This command is query only. When Power Limit is off, the returned value is always 0 (pass). When Power Limit is on, the returned value is 0(pass) while power test passes and 1 (fail) while power test fails. In MSR, LTE-Advanced FDD/TDD mode, this feature is not supported.
Initial S/W Revision	A.10.00

PSD Limit Fail (remote command only)

The command is query only and used to query if PSD test passes or fails. When DVB-T/H mode or DTMB (CTTB) mode is selected or DVB-T radio standard is selected in SA mode, this query SCPI command does not make any sense.

Remote Command	:CALCulate:CHPower:LIMit:PSD:FAIL?
Example	CALC:CHP:LIM:PSD:FAIL?
Notes	This command is query only. When PSD Limit is off, the returned value is always 0 (pass). When PSD Limit is on, the returned value is 0(pass) while PSD test passes and 1 (fail) while PSD test fails.
Initial S/W Revision	A.10.00

PSD Unit

Sets the unit bandwidth for Power Spectral Density. The available units are dBm/Hz and dBm/MHz.

Key Path	Meas Setup
Mode	SA, WCDMA, WIMAX OFDMA, 1xEVDO, DVB-T/H, DTMB (CTTB), LTE, LTE-TDD, Digital Cable TV, WLAN, MSR, LTE-AFDD, LTE-TDD
Remote Command	:UNIT:CHPower:POWer:PSD DBMHZ DBMMHZ :UNIT:CHPower:POWer:PSD?
Example	UNIT:CHP:POW:PSD DBMMHZ UNIT:CHP:POW:PSD?
Couplings	When the PSD unit is changed, the PSD result of the "MEAS READ FETCH:CHP1?" is also changed by the PSD unit basis (in either dBm/Hz or dBm/MHz).
Preset	DBMHZ WLAN: DBMMHZ
State Saved	Saved in instrument state.
Range	dBm/Hz dBm/MHz
Initial S/W Revision	Prior to A.02.00
Modified at S/W Revision	A.02.00, A.03.00

Meas Preset

Restores all the measurement parameters to their default values.

Key Path	Meas Setup
Mode	SA, WCDMA, C2K, WIMAX OFDMA, 1xEVDO, DVB-T/H, DTMB (CTTB), ISDB-T, CMMB, LTE, LTETDD, Digital Cable TV, WLAN, MSR, LTEAFDD, LTEATDD
Remote Command	:CONFigure:CHPower
Example	CONF:CHP
Initial S/W Revision	Prior to A.02.00
Modified at S/W Revision	A.02.00, A.03.00

Mode

See "Mode" on page 288

Mode Preset

Returns the active mode to a known state.

Mode Preset does the following for the currently active mode:

- Aborts the currently running measurement.
- Brings up the default menu for the mode, with no active function.
- Sets measurement Global settings to their preset values for the active mode only.
- Activates the default measurement.
- Brings up the default menu for the mode.
- Clears the input and output buffers.
- Sets Status Byte to 0.

Mode Preset does not:

- Cause a mode switch
- Affect mode persistent settings
- Affect system settings
- See "[How-To Preset](#)" on page 559 for more information.

Key Path	Front-panel key
Remote Command	:SYSTem:PRESet
Example	:SYST:PRES
Notes	*RST is preferred over :SYST:PRES for remote operation. *RST does a Mode Preset, as done by the :SYST:PRES command, and it sets the measurement mode to Single measurement rather than Continuous for optimal remote control throughput. Clears all pending OPC bits. The Status Byte is set to 0.
Couplings	A Mode Preset aborts the currently running measurement, activates the default measurement, and gets the mode to a consistent state with all of the default couplings set.
Backwards Compatibility Notes	In the X-Series, the legacy "Factory Preset" has been replaced with Mode Preset, which only presets the currently active mode, not the entire instrument. In the X-Series, the way to preset the entire instrument is by using System, Restore System Defaults All, which behaves essentially the same way as restore System Defaults does on ESA and PSA. There is also no "Preset Type" as there is on the PSA. There is a green Mode Preset front-panel key that does a Mode Preset and a white-with-green-letters User Preset front-panel key that does a User Preset. The old PRESet:TYPE command is ignored (without generating an error), and SYST:PRES without a parameter does a Mode Preset, which should cover most backward code compatibility issues. The settings and correction data under the Input/Output front-panel key (examples: Input Z Corr, Ext Amp Gain, etc.) are no longer part of any Mode, so they will not be preset by a Mode Preset. They are preset using Restore Input/Output Defaults, Restore System Defaults All. Note that because User Preset does a Recall State, and all of these settings are saved in State, they ARE recalled when using

	User Preset.
Initial S/W Revision	Prior to A.02.00

How-To Preset

The table below shows all possible presets, their corresponding SCPI commands and front-panel access (key paths). Instrument settings depend on the current measurement context. Some settings are local to the current measurement, some are global (common) across all the measurements in the current mode, and some are global to all the available modes. In a similar way, restoring the settings to their preset state can be done within the different contexts.

Auto Couple - is a measurement local key. It sets all Auto/Man parameter couplings in the measurement to Auto. Any Auto/Man selection that is local to other measurements in the mode will not be affected.

Meas Preset - is a measurement local key. Meas Preset resets all the variables local to the current measurement except the persistent ones.

Mode Preset - resets all the current mode's measurement local and measurement global variables except the persistent ones.

Restore Mode Defaults - resets ALL the Mode variables (and all the Meas global and Meas local variables), including the persistent ones.

Type Of Preset	SCPI Command	Front Panel Access
Auto Couple	:COUPlE ALL	Auto Couple front-panel key
Meas Preset	:CONFIgure:<Measurement>	Meas Setup Menu
Mode Preset	:SYSTem:PRESet	Mode Preset (green key)
Restore Mode Defaults	:INSTrument:DEFault	Mode Setup Menu
Restore All Mode Defaults	:SYSTem:DEFault MODEs	System Menu; Restore System Default Menu
*RST	*RST	not possible (Mode Preset with Single)
Restore Input/Output Defaults	:SYSTem:DEFault INPut	System Menu; Restore System Default Menu
Restore Power On Defaults	:SYSTem:DEFault PON	System Menu; Restore System Default Menu
Restore Alignment Defaults	:SYSTem:DEFault ALIGn	System Menu; Restore System Default Menu
Restore Miscellaneous Defaults	:SYSTem:DEFault MISC	System Menu; Restore System Default Menu
Restore All System Defaults	:SYSTem:DEFault [ALL] :SYSTem:PRESet:PERSistent	System Menu; Restore System Default Menu
User Preset	:SYSTem:PRESet:USER	User Preset Menu
User Preset All Modes	:SYSTem:PRESet:USER:ALL	User Preset Menu

8 Channel Power Measurement
Mode Preset

Power On Mode Preset	:SYSTem:PON:TYPE MODE	System Menu
Power On User Preset	:SYSTem:PON:TYPE USER	System Menu
Power On Last State	:SYSTem:PON:TYPE LAST	System Menu

Mode Setup

See "[Mode Setup](#)" on page 320

Peak Search

Places the selected marker on the trace point with the maximum y-axis value. Pressing Peak Search with the selected marker Off causes the selected marker to be set to Normal, then a peak search is immediately performed.

Key Path	Front panel key
Mode	SA, WCDMA, C2K, WIMAX OFDMA, 1xEVDO, DVB-T/H, DTMB (CTTB), ISDB-T, CMMB, LTE, LTETDD, Digital Cable TV, WLAN, MSR, LTEAFDD, LTEATDD
Remote Command	:CALCulate:CHPower:MARKer[1] 2 ... 12:MAXimum
Example	CALC:CHP:MARK2:MAX
Initial S/W Revision	Prior to A.02.00
Modified at S/W Revision	A.02.00, A.03.00

Print

See "Print" on page 352

Quick Save

The Quick Save front-panel key repeats the most recent save that was performed from the Save menu, with the following exceptions:

- Register saves are not remembered as Saves for the purpose of the Quick Save function
- If the current measurement does not support the last non-register save that was performed, an informational message is generated, “File type not supported for this measurement”

Quick Save repeats the last type of qualified save (that is, a save qualified by the above criteria) in the last save directory by creating a unique filename using the Auto File Naming algorithm described below.

If Quick Save is pressed after startup and before any qualified Save has been performed, the Quick Save function performs a Screen Image save using the current settings for Screen Image saves (current theme, current directory), which then becomes the “last save” for the purpose of subsequent Quick Saves.

The Auto File Naming feature automatically generates a file name for use when saving a file. The filename consists of a prefix and suffix separated by a dot, as is standard for the Windows® file system. A default prefix exists for each of the available file types:

Type	Default Prefix	Menu
State	State_	(Save/Recall)
Trace + State	State_	(Save/Recall)
Screen	Screen_	(Save/Recall)
Amplitude Corrections	Ampcor_	(Import/Export)
Traces	Trace_	(Import/Export)
Limit Lines	LLine_	(Import/Export)
Measurement Result	MeasR_	(Import/Export)
Capture Buffer	CapBuf_	(Import/Export)

A four digit number is appended to the prefix to create a unique file name. The numbering sequence starts at 0000 within each Mode for each file type and updates incrementally to 9999, then wraps to 0000 again. It remembers where it was through a Mode Preset and when leaving and returning to the Mode. It is reset by Restore Misc Defaults and Restore System Defaults and subsequent running of the instrument application. So, for example, the first auto file name generated for State files is State_0000.state. The next is State_0001, and so forth.

One of the key features of Auto File Name is that we guarantee that the Auto File Name will never conflict with an existing file. The algorithm looks for the next available number. If it gets to 9999, then it looks for holes. If it find no holes, that is no more numbers are available, it gives an error.

For example, if when we get to State_0010.state there is already a State_0010.state file in the current directory, it advances the counter to State_0011.state to ensure that no conflict will exist (and then it verifies that State_0011.state also does not exist in the current directory and advances again if it does, and so forth).

If you enter a file name for a given file type, then the prefix becomes the filename you entered instead of the default prefix, followed by an underscore. The last four letters (the suffix) are the 4-digit number.

For example, if you save a measurement results file as “fred.csv”, then the next auto file name chosen for a measurement results save will be fred_0000.csv.

NOTE

Although 0000 is used in the example above, the number that is used is actually the current number in the Meas Results sequence, that is, the number that would have been used if you had not entered your own file name.

NOTE

If the filename you entered ends with _dddd, where d=any number, making it look just like an auto file name, then the next auto file name picks up where you left off with the suffix being dddd + 1.

Key Path	Front-panel key
Notes	No remote command for this key specifically.
Initial S/W Revision	Prior to A.02.00

Recall

The Recall menu lets you choose what you want to recall, and where you want to recall it from. Among the types of files you can recall are **States and Traces**. In addition, an Import (Data) option lets you recall a number of data types stored in CSV files (as used by Excel and other spreadsheet programs).

The default paths for Recall are data type dependent and are the same as for the Save key.

Key Path	Front-panel key
Notes	<p>No remote command for this key specifically, but the :MMEM:LOAD command is available for specific file types. An example is :MMEM:LOAD:STATe <filename>.</p> <p>If you try to recall a State file for a mode that is not licensed or not available in the instrument, an error message will occur and the state will not change.</p>
Backwards Compatibility Notes	<p>In legacy analyzers, it was possible to load a state without affecting the trace data, limit lines or correction data. Similarly (since User Preset is actually loading a state), it was possible to do a User Preset without affecting the trace data, limit lines or correction data.</p> <p>In the X-Series, “state” always includes all of this data; so whenever state is loaded, all of the traces, limit lines and corrections are affected. Although this differs from previous behavior, it is desirable behavior, and should not cause adverse issues for users.</p>
Backwards Compatibility Notes	<p>Recall for the X-Series supports backward compatibility in the sense that you can recall a state file from any X-Series model number and any version of X-Series software. This is only possible if part of the recalling process goes through a limiting step after recalling the mode settings, at least for settings that may vary with version number, model number, option and license differences. If you try to recall a state file onto an instrument with less capability than what was available on the instrument during the save, the recall will ignore the state it doesn't support and it will limit the recalled setting to what it allows.</p> <p>Example: if the saved state includes preamp ON, but the recalling instrument does not have a preamp; the preamp is limited to OFF. Conversely, if you save a state without a preamp, the preamp is OFF in the state file. When this saved file is recalled on an instrument with a licensed preamp, the preamp is changed to OFF. Another example is if the saved state has center frequency set to 20 GHz, but the instrument recalling the saved state is a different model and only supports 13.5 GHz. In this case, the center frequency is limited along with any other frequency based settings. Since the center frequency can't be preserved in this case, the recall limiting tries to at least preserve span to keep the measurement setup as intact as possible.</p> <p>It may be appropriate to issue a warning if the state is limited on the recall; warnings do not go out to SCPI so this would only affect the manual user.</p> <p>Note that there is no state file compatibility outside of the X-Series. For example, you cannot recall a state file from ESA or PSA.</p>
Initial S/W Revision	Prior to A.02.00

State

The Recall State menu lets you choose a register or file from which to recall the state.

The content of a state file includes all of the settings and data required to return the analyzer as closely as possible to the Mode it was in, with the exact settings that were in place, when the save occurred. The Mode settings in each state file include the settings that are affected by Mode Preset, as well as the

additional settings affected by Restore Mode Defaults; all of the Mode’s settings. In addition, all of the settings of the Input/Output system are included, even though they are outside of the Mode’s state, because they are needed to restore the complete setup. Persistent System settings (for example, GPIB address) are not affected by either a Mode Preset or Restore Mode Defaults, nor are they included in a saved State file.

Since each state file is only for one Mode, the settings for other Modes are unaffected when it is loaded. Recall State will cause a mode switch if the state being recalled is not from the current active mode.

After the recall completes, the message "File <filename> recalled" or “Recalled State Register <register number>” is displayed.

For rapid recalls, the State menu lists 16 registers that you can choose from to recall. Pressing a Register key initiates the recall. You can also select a file from which to recall.

The default path for all State Files is:

My Documents\<<mode name>\state

where <mode name> is the parameter used to select the mode with the INST:SEL command (for example, SA for the Spectrum Analyzer).

See "[More Information](#)" on page 568.

Key Path	Recall
Mode	All
Remote Command	:MMEMory:LOAD:STATe <filename>
Example	:MMEM:LOAD:STAT "myState.state" This recalls the file myState.state on the default path
Example	MMEM:LOAD:STAT "MyStateFile.state" This loads the state file data (on the default file directory path) into the instrument state.
Notes	<p>When you pick a file to recall, the analyzer first verifies that the file is recallable in the current instrument by checking the software version and model number of the instrument. If everything matches, a full recall proceeds by aborting the currently running measurement, clearing any pending operations, and then loading the State from the saved state file. You can open state files from any mode, so recalling a State file switches to the mode that was active when the save occurred. After switching to the mode of the saved state file, mode settings and data (if any for the mode) are loaded with values from the saved file. The saved measurement of the mode becomes the newly active measurement and the data relevant to the measurement (if there is any) is recalled.</p> <ul style="list-style-type: none"> • If there is a mismatch between file version or model number or instrument version or model number, the recall function tries to recall as much as possible and returns a warning message. It may limit settings that differ based on model number, licensing or version number. <p>After recalling the state, the Recall State function does the following:</p> <ul style="list-style-type: none"> • Makes the saved measurement for the mode the active measurement. • Clears the input and output buffers. • Status Byte is set to 0. • Executes a *CLS <p>If the file specified is empty an error is generated. If the specified file does not exist, another error is generated. If there is a mismatch between the file and the proper file type, an error is generated. If</p>

	there is a mismatch between file version or model number or instrument version or model number, a warning is displayed. Then it returns to the State menu and File Open dialog goes away. After the Recall, the analyzer exits the Recall menu and returns to the previous menu.
Backwards Compatibility SCPI	:MMEMory:LOAD:STATe 1,<filename> For backwards compatibility, the above syntax is supported. The "1" is simply ignored.
Initial S/W Revision	Prior to A.02.00

More Information

In measurements that support saving Traces, for example, Swept SA, the Trace data is saved along with the State in the State file. When recalling the State, the Trace data is recalled as well. Traces are recalled exactly as they were stored, including the writing mode and update and display modes. If a Trace was updating and visible when the State was saved, it will come back updating and visible, and its data will be rewritten right away. When you use State to save and recall traces, any trace whose data must be preserved should be placed in View or Blank mode before saving.

The following table describes the Trace Save and Recall possibilities:

You want to recall state and one trace's data, leaving other traces unaffected.	Save Trace+State from 1 trace. Make sure that no other traces are updating (they should all be in View or Blank mode) when the save is performed.	On Recall, specify the trace you want to load the one trace's data into. This trace will load in View. All other traces' data will be unaffected, although their trace mode will be as it was when the state save was performed.
You want to recall all traces	Save Trace+State from ALL traces.	On Recall, all traces will come back in View (or Blank if they were in Blank or Background when saved)
You want all traces to load exactly as they were when saved.	Save State	On recall, all traces' mode and data will be exactly as they were when saved. Any traces that were updating will have their data immediately overwritten.

From File...

When you press "From File", the analyzer brings up a Windows dialog and a menu entitled "File Open." This menu allows you to navigate to the various fields in the Windows dialog without using a keyboard or mouse. The Tab and Arrow keys can also be used for dialog navigation.

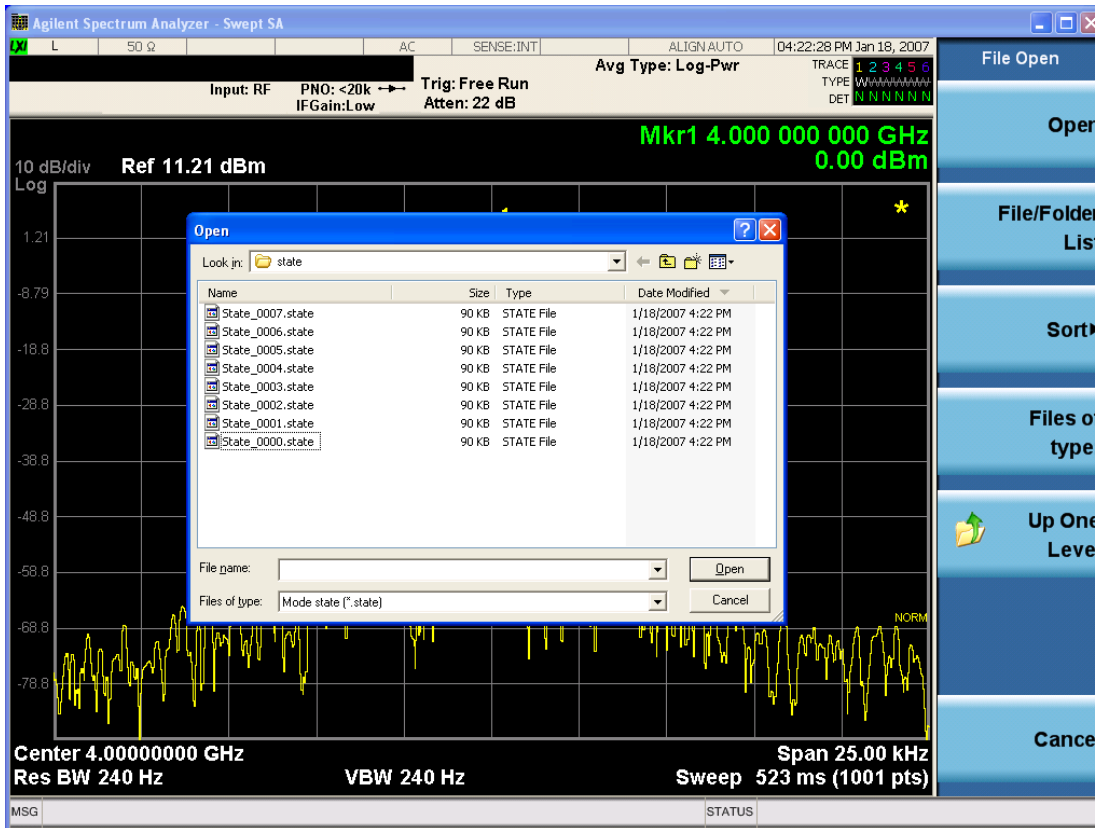

Listed below are the functions of the various fields in the dialog, and the corresponding softkeys:

Open

Performs the recall of the specified file. While the recall is being performed, the floppy icon appears briefly in the Meas bar.

File/Folder List

Enables you to navigate to the center of the dialog that contains the list of files and folders. Once here you can get information about the file and use the tab keys to navigate to the other fields in the dialog, such as Look In.

Look In

The Look In field shows the path from which the file will be recalled and allows you to change the path using the up and down arrow keys to navigate to other paths; the Enter key to open a directory; and the Backspace key to go back one directory. The **Look In field** first uses the last path from the Save As dialog **Save In:** path for that same file type. There is no softkey for directly navigating to the Look In field, but you can use the left tab to get here from the File/Folder List.

User specified paths are remembered when you leave and return to a Mode and are reset back to the default using Restore Mode Defaults.

Sort

Accesses a menu that enables you to sort the files within the File Open dialog. Only one sorting type can be selected at a time and the sorting happens immediately. The sorting types are By Date, By Name, By extension, and By Size.

Files of Type

This field shows the file suffix for the type of file you have selected to recall. For example, if you navigated here while recalling State, "Mode state (*.state)" is in the field. If you navigated here while recalling Trace, ""Mode state (*.trace)" is in the field. If you navigated here while importing a trace data file, "Trace Data (*.csv)" is in the field. For some file types, there is more than one choice in the dropdown menu, which you can select by using the up and down arrow keys and Enter.

Up One Level

This key corresponds to the icon of a folder with the up arrow that is in the tool bar of the dialog. When pressed, it causes the file and folder list to navigate up one level in the directory structure. The Backspace key does the same thing.

Cancel

This key corresponds to the Cancel selection in the dialog. It causes the current **Open** request to be cancelled. The ESC key does the same thing.

Key Path	Recall, State
Notes	Brings up the Open dialog for recalling a State Save Type
Initial S/W Revision	Prior to A.02.00

Edit Register Names

You may enter a custom name on any of the Register keys, to help you remember what you are using that state to save. To do this, press the Edit Register Names key, choose the register whose name you wish to edit, and then enter the desired label using the Alpha Editor or an external PC keyboard.

The maximum number of characters that can be added is 30. In most cases, 30 characters will fit on two lines of the key.

For more information and the SCPI command, see Edit Register Names under the Save, State function.

Key Path	Recall, State
Mode	All
Dependencies	N9060A-7FP or N9060B-2FP license required to edit the register names. When the feature is not licensed, sending the SCPI command generates an error, -221, "Settings conflict;Option not available"
Initial S/W Revision	A.11.00

Register 1 thru Register 16

Selecting any one of these register keys causes the State of the mode from the specified Register to be recalled. Each of the register keys annotates whether it is empty or at what date and time it was last

modified. In addition, you can use the Edit Register Names key under Save, State to enter custom names for each register.

Registers are shared by all modes, so recalling from any one of the registers will cause a mode switch to the mode that was active when the save to the Register occurred.

Although these 16 registers are the only registers available from the front panel, there are 128 state registers available in the instrument. Registers 17–128 are only available from the SCPI interface, using the *RCL command.

After the recall completes, the message "Register <register number> recalled" appears in the message bar. If you are in the Spectrum Analyzer Mode, and you are recalling a register that was saved in the Spectrum Analyzer Mode, then after the recall, you will still be in the Recall Register menu. If the Recall causes you to switch modes, then after the Recall, you will be in the Frequency menu.

If a requested register is empty an error is generated.

Key Path	Recall, State
Example	*RCL 1
Range	1–16 from front panel, 1–128 from SCPI
Readback	Date and time with seconds resolution are displayed on the key OR A custom name of up to 30 characters entered using the Save, State, Edit Register Names key OR “(empty)” if no prior save operation has been performed to this register.
Initial S/W Revision	Prior to A.02.00
Modified at S/W Revision	Prior to A.11.00

Register 1 thru Register 16

Selecting any one of these register keys causes the State of the mode from the specified Register to be recalled. Each of the register keys annotates whether it is empty or at what date and time it was last modified. In addition, you can use the Edit Register Names key under Save, State to enter custom names for each register.

Registers are shared by all modes, so recalling from any one of the registers will cause a mode switch to the mode that was active when the save to the Register occurred.

Although these 16 registers are the only registers available from the front panel, there are 128 state registers available in the instrument. Registers 17–128 are only available from the SCPI interface, using the *RCL command.

After the recall completes, the message "Register <register number> recalled" appears in the message bar. If you are in the Spectrum Analyzer Mode, and you are recalling a register that was saved in the Spectrum Analyzer Mode, then after the recall, you will still be in the Recall Register menu. If the Recall causes you to switch modes, then after the Recall, you will be in the Frequency menu.

If a requested register is empty an error is generated.

Key Path	Recall, State
Example	*RCL 1
Range	1-16 from front panel, 1-128 from SCPI
Readback	Date and time with seconds resolution are displayed on the key OR A custom name of up to 30 characters entered using the Save, State,Edit Register Names key OR “(empty)” if no prior save operation has been performed to this register.
Initial S/W Revision	Prior to A.02.00
Modified at S/W Revision	Prior to A.11.00

Data (Import)

Importing a data file loads data that was previously saved from the current measurement or from other measurements and/or modes that produce compatible data files. The Import Menu only contains Data Types that are supported by the current measurement.

Since the commonly exported data files are in .csv format, the data can be edited by the user prior to importing. This allows you to export a data file, manipulate the data in Excel (the most common PC Application for manipulating .csv files) and then import it.

Importing Data loads measurement data from the specified file into the specified or default destination, depending on the data type selected. Selecting an Import Data menu key will not actually cause the importing to occur, since the analyzer still needs to know from where to get the data. Pressing the Open key in this menu brings up the Open dialog and Open menu that provides you with the options from where to recall the data. Once a filename has been selected or entered in the Open menu, the recall occurs as soon as the Open button is pressed.

Key Path	Recall
Mode	All
Notes	The menu is built from whatever data types are available for the mode. Some keys will be missing completely, so the key locations in the sub-menu will vary. No SCPI command directly controls the Data Type that this key controls. The Data Type is included in the MMEM:LOAD commands.
Dependencies	If a file type is not used by a certain measurement, it is grayed out for that measurement. The key for a file type will not show at all if there are no measurements in the Mode that support it.
Preset	Is not affected by Preset or shutdown, but is reset during Restore Mode Defaults
Readback	The data type that is currently selected
Initial S/W Revision	Prior to A.02.00

Masks

This key enables you to recall a preset mask file from the list. It is only available in SEM measurement under the Data menu: Limit Mask. Limit Mask enables setting a preset limit mask for 802.11p 5MHz and 10MHz system.

You cannot change or create the preset mask file since it is a binary file. This key is valid for the Spectrum Emission Mask measurement.

File location: "My Documents\WLAN\data.masks"

Note that "**My Documents**" is an alias to a directory and its location depends on which user is logged in. At XSA start up, all of the limit mask files in the current user's "My Documents\WLAN\data.masks" directory are overwritten.

File type: Binary

Filename:

11p_5MHz_A.mask

11p_5MHz_B.mask

11p_5MHz_C.mask

11p_5MHz_D.mask

11p_10MHz_A.mask

11p_10MHz_B.mask

11p_10MHz_C.mask

11p_10MHz_D.mask

File extension: .mask

Selecting OPEN under the Import Data menu, opens the above directory enabling you to select a mask file.

Example:

File Location: My Documents/WLAN/data/masks

File Name: 11p_5MHz_A.mask

Key Path	Recall, Data
Mode	WLAN
Remote Command	MMEMoRY:LOAD:MASK <string>
Example	MMEM:LOAD:MASK "11p_5MHz_A.mask"
Initial S/W Revision	A.11.00

Capture Buffer

Capture buffer functionality is only available when measurement is Mod Accuracy and radio standard is not 802.11ac 80+80MHz. The captured data is raw data which is not processed.

Key Path	Recall, Data
Mode	WLAN
Example	MMEM:LOAD:CAPT "MyCaptureData.bin" This loads the file of capture data (on the default file directory path) into the instrument.
Dependencies	Capture buffer data is only available when measurement is Mod Accuracy and radio standard is not 802.11ac 80+80MHz. In other situation, this key is grayed out.
Initial S/W Revision	A.11.00

Open...

When you press "Open", the analyzer brings up a Windows dialog and a menu entitled "File Open." This menu allows you to navigate to the various fields in the Windows dialog without using a keyboard or mouse. The Tab and Arrow keys can also be used for dialog navigation.

See "[From File...](#)" on page 2263 in Recall, State, for a full description of this dialog and menu.

Key Path	Recall, Data
Notes	The key location is mode-dependent and will vary. Brings up Open dialog for recalling a <mode specific> Save Type
Initial S/W Revision	Prior to A.02.00

Restart

The Restart function restarts the current sweep, or measurement, or set of averaged/held sweeps or measurements. If you are Paused, pressing Restart does a Resume.

The Restart function is accessed in several ways:

- Pressing the Restart key
- Sending the remote command INIT:IMMEDIATE
- Sending the remote command INIT:RESTART

See "[More Information](#)" on page 575

Key Path	Front-panel key
Remote Command	:INITiate[:IMMEDIATE] :INITiate:RESTART
Example	:INIT:IMM :INIT:REST
Notes	:INITiate:RESTART and :INITiate:IMMEDIATE perform exactly the same function.
Couplings	Resets average/hold count k. For the first sweep overwrites all active (update=on) traces with new current data. For application modes, it resets other parameters as required by the measurement.
Status Bits/OPC dependencies	This is an Overlapped command. The STATUS:OPERation register bits 0 through 8 are cleared. The STATUS:QUESTIONable register bit 9 (INTEgrity sum) is cleared. The SWEEPING bit is set. The MEASURING bit is set.
Backwards Compatibility Notes	For Spectrum Analysis mode in ESA and PSA, the Restart hardkey and the INITiate:RESTART command restart trace averages (displayed average count reset to 1) for a trace in Clear Write, but did not restart Max Hold and Min Hold. In the X-Series, the Restart hardkey and the INITiate:RESTART command restart not only Trace Average, but MaxHold and MinHold traces as well. For wireless comms modes in ESA and PSA, the Restart hardkey and the INITiate:RESTART command restart every measurement, which includes all traces and numeric results. There is no change to this operation.
Initial S/W Revision	Prior to A.02.00

More Information

The **Restart** function first aborts the current sweep/measurement as quickly as possible. It then resets the sweep and trigger systems, sets up the measurement and initiates a new data measurement sequence with a new data acquisition (sweep) taken once the trigger condition is met.

If the analyzer is in the process of aligning when **Restart** is executed, the alignment finishes before the restart function is performed.

Even when set for Single operation, multiple sweeps may be taken when Restart is pressed (for example, when averaging/holding is on). Thus when we say that **Restart** "restarts a measurement," we may mean:

- It restarts the current sweep
- It restarts the current measurement
- It restarts the current set of sweeps if any trace is in Trace Average, Max Hold or Min Hold
- It restarts the current set of measurements if Averaging, or Max Hold, or Min Hold is on for the measurement
- depending on the current settings.

With **Average/Hold Number** (in **Meas Setup** menu) set to 1, or Averaging off, or no trace in Trace Average or Hold, a single sweep is equivalent to a single measurement. A single sweep is taken after the trigger condition is met; and the analyzer stops sweeping once that sweep has completed. However, with **Average/Hold Number** >1 and at least one trace set to **Trace Average, Max Hold, or Min Hold (SA Measurement)** or **Averaging on (most other measurements)**, multiple sweeps/data acquisitions are taken for a single measurement. The trigger condition must be met prior to each sweep. The sweep is stopped when the average count k equals the number N set for **Average/Hold Number**. A measurement average usually applies to all traces, marker results, and numeric results; but sometimes it only applies to the numeric results.

Once the full set of sweeps has been taken, the analyzer will go to idle state. To take one more sweep without resetting the average count, increment the average count by 1, by pressing the step up key while **Average/Hold Number** is the active function, or sending the remote command `CALC:AVER:TCON UP`.

Save

The Save menu lets you choose what you want to save and where you want to save it. Among the types of files you can save are **States**, **Traces**, and **Screen Images**. In addition, an Export (Data) option lets you save a number of data types as CSV files for easy import into Excel and other spreadsheet programs.

Key Path	Front-panel key
Mode	All
Notes	No remote command for this key specifically, but the :MMEM:STORe command is available for specific file types. An example is :MMEM:STOR:STATe <filename>.
Initial S/W Revision	Prior to A.02.00

State

The Save State menu lets you choose a register or file for saving the state.

The content of a state file includes all of the settings and data required to return the analyzer as closely as possible to the Mode it was in, with the exact settings which were in place, when the save occurred. The Mode settings in each state file include the settings that are affected by Mode Preset, as well as the additional settings affected by Restore Mode Defaults; all of the Mode's settings. In addition, all of the settings of the Input/Output system are included, even though they are outside of the Mode's state, because they are needed to restore the complete setup. Persistent System settings (for example, Verbose SCPI) are not affected by either Mode Preset or Restore Mode Defaults, nor are they included in a saved State file.

After the save completes, the message "File <filename> saved" or "State Register <register number> saved" is displayed.

For rapid saving, the State menu lists 16 registers to save to. Pressing a Register key initiates the save. You can also select a file to save to.

The default path for all State Files is:

My Documents\<>mode name>\state

where <mode name> is the parameter used to select the mode with the INST:SEL command (for example, SA for the Spectrum Analyzer).

Key Path	Save
Mode	All
Remote Command	:MMEMory:STORe:STATe <filename>
Example	MMEM:STOR:STATe "MyStateFile.state" This stores the current instrument state data in the file MyStateFile.state in the default directory.
Notes	Both single and double quotes are supported for any filename parameter over remote. After saving to a register, that register's menu key is updated with the date the time, unless a custom label has been entered for that key. After saving to a register, you remain in the Save State menu, so that you can see the Register key

update. After saving to a file, the analyzer automatically returns to the previous menu and any Save As dialog goes away.

Backwards Compatibility SCPI :MMEMory:STORe:STATe 1,<filename>

For backwards compatibility, the above syntax is supported. The "1" is simply ignored. The command is sequential.

Initial S/W Revision Prior to A.02.00

To File . . .

When you press “To File”, the analyzer brings up a Windows dialog and a menu entitled “Save As.” This menu allows you to navigate to the various fields in the Windows dialog without using a keyboard or mouse. The Tab and Arrow keys can also be used for dialog navigation.

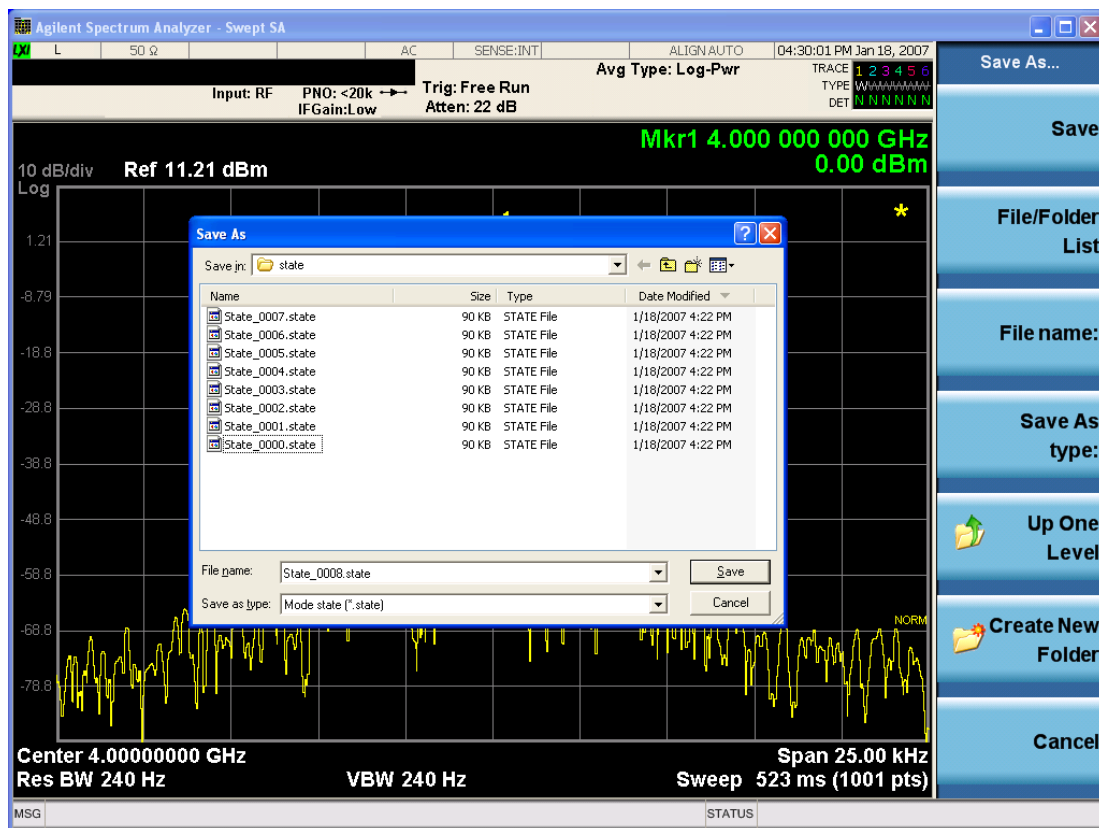

The Listed below

are the functions of the various fields in the dialog, and the corresponding softkeys:

Save

Performs the save to the specified file of the selected type. If the file already exists, a dialog will appear that allows you to replace the existing file by selecting OK, or you can Cancel the request. If you select OK, the file will be overwritten. Using the C: drive is strongly discouraged, since it runs the risk of being overwritten during an instrument software upgrade.

While the save is being performed, the floppy icon appears briefly in the Meas bar.

File/Folder List

Enables you to navigate to the center of the dialog that contains the list of files and folders. Once here you can get information about the file and use the tab keys to navigate to the other fields in the dialog, such as Save In.

Save In

The Save In field shows the path to which the file will be saved and allows you to change the path using the up and down arrow keys to navigate to other paths; the Enter key to open a directory; and the Backspace key to go back one directory. The **Save In field** defaults to the default path for this type of file and remembers the last path you used to save this type of file. There is no softkey for directly navigating to the Save In field but you can use left tab to get here from the File/Folder List.

User specified paths are remembered when you leave and return to a Mode and are reset back to the default using Restore Mode Defaults.

File Name

The File Name field is initially loaded with an automatically generated filename specific to the appropriate Save Type. The automatically generated filename is guaranteed not to conflict with any filename currently in the directory. You may replace or modify this filename using the File Name key. See the ["Quick Save " on page 2259](#) documentation for more on the automatic file naming algorithm.

When you press the File Name key the analyzer displays the Alpha Editor. Use the knob to choose the letter to add and the front-panel Enter key to add the letter to the file name. The BK character moves you back and the FW character moves you forward in the filename. The Select key on the front panel generates a space character. When you are done entering the filename press the Done softkey. This returns back to the **File Open** dialog and menu, but does not cause the save to occur.

Save As Type

This field shows the file suffix for the type of file you have selected to save. For example, if you navigated here while saving State, "Mode state (*.state)" is in the field. If you navigated here from saving Trace, ""Mode state (*.trace)" is in the field. If you navigated here while exporting a trace data file, "Trace Data (*.csv)" is in the field. For some file types, there is more than one choice in the dropdown, which you can select by using the up and down arrow keys and Enter.

Up One Level

This key corresponds to the icon of a folder with the up arrow that is in the tool bar of the dialog. When pressed, it causes the file and folder list to navigate up one level in the directory structure. The Backspace key does the same thing.

Create New Folder

This key corresponds to the icon of a folder with the "*" that is in the tool bar of the dialog. When pressed, a new folder is created in the current directory with the name **New Folder** and you can enter a new folder name using the Alpha Editor.

Cancel

This key corresponds to the Cancel selection in the dialog. It causes the current **Save As** request to be cancelled. The ESC key does the same thing.

Key Path	Save, State
Mode	All
Notes	Brings up Save As dialog for saving a State Save Type
Initial S/W Revision	Prior to A.02.00

Edit Register Names

You may enter a custom name on any of the Register keys, to help you remember what you are using that state to save. To do this, press the Edit Register Names key, choose the register whose name you wish to edit, and then enter the desired label using the Alpha Editor or an external PC keyboard.

The maximum number of characters that can be added is 30. In most cases, 30 characters will fit on two lines of the key.

See ["More Information" on page 580](#)

Key Path	Save, State
Mode	All
Remote Command	:MMEMory:REGister:STATe:LABel <reg number>,"label" :MMEMory:REGister:STATe:LABel? <reg number>
Example	:MMEM:REG:STAT:LAB 1,"my label"
Notes	<reg number> is an integer from 1 to 16. If the SCPI specifies an invalid register number an error message is generated, -222,"Data out of range;Invalid register label number" "label" is a string from 0 to 30 characters in length. If a label exceeds 30 characters, an error message is generated, -150,"String data error;Label clipped to 30 characters" "label" of length 0 erases the custom label and restores the default (time and date) label. E.g.: :MMEM:REG:STAT:LAB 1,""
Dependencies	N9060A-7FP or N9060B-2FP license required to edit the register names. When the feature is not licensed, sending this command generates an error, -221,"Settings conflict;Option not available"
Preset	The names are unaffected by Preset or power cycle but are set to the default label (time and date) on a "Restore System Defaults->Misc"
Initial S/W Revision	A.11.00

More Information

When you edit one of the register names, the time and date field will be replaced by the custom name.

If you delete all the characters in the custom name, it restores the default (time and date).

The register names are stored within the state files, but they are not part of the instrument state; that is, once you have edited a register name, loading a new state will not change that register name. Another consequence of this is that the names will be persistent through a power cycle. Also, if a named state file is transferred to another analyzer, it will bring its custom name along with it.

If you try to edit the name of an empty register, the analyzer will first save the state to have a file to put the name in. If you load a named state file into an analyzer with older firmware it will ignore the metadata.

The *SAV and *RCL commands will not be affected by the custom register names, nor will the MMEM commands.

Register 1 thru Register 16

Selecting any one of these register menu keys causes the State of the currently active mode to be saved to the specified Register. The registers are provided for rapid saving and recalling, since you do not need to specify a filename or navigate to a file. Each of the register menu keys annotates whether it is empty or at what date and time it was last modified. In addition, you can use the Edit Register Names key to enter custom names for each register.

Although these 16 registers are the only registers available from the front panel, there are 128 state registers available in the instrument. Registers 17–128 are only available from the SCPI interface, using the *SAV command.

There is one set of 128 state registers in the instrument, not one set for each Mode. When a state is saved, the Mode it was saved from is saved with it; then when it is recalled, the instrument switches to that Mode.

After the save completes, the corresponding register menu key annotation is updated with the date and time and the message "Register <register number> saved" is displayed.

Key Path	Save, State
Mode	All
Example	*SAV 1
Range	1–16 from front panel, 1–128 from SCPI
Readback	Date and time with seconds resolution are displayed on the key OR A custom name of up to 30 characters entered using the Edit Register Names key OR “(empty)” if no prior save operation has been performed to this register.
Initial S/W Revision	Prior to A.02.00
Modified at S/W Revision	A.11.00

Register 1 thru Register 16

Selecting any one of these register menu keys causes the State of the currently active mode to be saved to the specified Register. The registers are provided for rapid saving and recalling, since you do not need to specify a filename or navigate to a file. Each of the register menu keys annotates whether it is empty or at what date and time it was last modified. In addition, you can use the Edit Register Names key to enter custom names for each register.

Although these 16 registers are the only registers available from the front panel, there are 128 state registers available in the instrument. Registers 17–128 are only available from the SCPI interface, using the *SAV command.

There is one set of 128 state registers in the instrument, not one set for each Mode. When a state is saved, the Mode it was saved from is saved with it; then when it is recalled, the instrument switches to that Mode.

After the save completes, the corresponding register menu key annotation is updated with the date and time and the message "Register <register number> saved" is displayed.

Key Path	Save, State
Mode	All
Example	*SAV 1
Range	1-16 from front panel, 1-128 from SCPI
Readback	Date and time with seconds resolution are displayed on the key OR A custom name of up to 30 characters entered using the Edit Register Names key OR “(empty)” if no prior save operation has been performed to this register.
Initial S/W Revision	Prior to A.02.00
Modified at S/W Revision	A.11.00

Data (Export)

Exporting a data file stores data from the current measurement to mass storage files. The Export Menu only contains data types that are supported by the current measurement.

Since the commonly exported data files are in .csv format, the data can be edited by you prior to importing. This allows you to export a data file, manipulate the data in Excel (the most common PC Application for manipulating .csv files) and then import it.

Selecting an Export Data menu key will not actually cause the exporting to occur, since the analyzer still needs to know where you wish to save the data. Pressing the Save As key in this menu brings up the Save As dialog and Save As menu that allows you to specify the destination file and directory. Once a filename has been selected or entered in the Open menu, the export will occur as soon as the Save key is pressed.

Key Path	Save
Mode	All
Notes	The menu is built from whatever data types are available for the mode. So the key locations in the sub menu will vary. No SCPI command directly controls the Data Type that this key controls. The Data Type is included in the MMEM:STORe commands.
Dependencies	If a file type is not used by a certain measurement, that type is grayed out for that measurement. The key for a file type will not show at all if there are no measurements in the Mode that support it.
Preset	Is not affected by a Preset or shutdown, but is reset during Restore Mode Defaults
Readback	The data type that is currently selected
Initial S/W Revision	Prior to A.02.00

Meas Results

Key Path	Save, Data
Mode	WLAN
Example	MMEM:STOR:RES "MyResultsFile.csv" This stores the measurement results data in the file MyResultsFile.xml in the default directory.
Initial S/W Revision	A.11.00

Capture Buffer

Capture buffer functionality is only available when measurement is Mod Accuracy and radio standard is not 802.11ac 80+80MHz. The captured data is raw data which is not processed.

Key Path	Save, Data
Mode	WLAN
Example	MMEM:STOR:CAPT "MyCaptureData.bin" This stores the capture data in the file MyCaptureData.bin in the default directory.
Dependencies	Capture buffer data is only available when measurement is Mod Accuracy and radio standard is not 802.11ac 80+80MHz. In other measurements, this key is grayed out.
Initial S/W Revision	A.11.00

Save As . . .

When you press "Save As", the analyzer brings up a Windows dialog and a menu entitled "**Save As.**" This menu allows you to navigate to the various fields in the Windows dialog without using a keyboard or mouse. The Tab and Arrow keys can also be used for dialog navigation.

See "[To File . . .](#)" on page 2273 in Save, State for a full description of this dialog and menu.

The default path for saving files is:

For all of the Trace Data Files:

My Documents\`<mode name>`\data\traces

For all of the Limit Data Files:

My Documents\`<mode name>`\data\limits

For all of the Measurement Results Data Files:

My Documents\`<mode name>`\data\`<measurement name>`\results

For all of the Capture Buffer Data Files:

My Documents\`<mode name>`\data\captureBuffer

Key Path	Save, Data
Mode	All
Notes	The key location is mode-dependent and will vary. Brings up the Save As dialog for saving a <mode specific> Save Type. The save is performed immediately and does not wait until the measurement is complete.
Initial S/W Revision	Prior to A.02.00

Screen Image

Pressing Screen Image accesses a menu of functions that enable you to specify a format and location for the saved screen image. It brings up a menu that allows you to specify the color scheme of the Screen Image (Themes) or navigate to the Save As dialog to perform the actual save.

Screen Image files contain an exact representation of the analyzer display. They cannot be loaded back onto the analyzer, but they can be loaded into your PC for use in many popular applications.

The image to be saved is actually captured when the Save front panel key is pressed, and kept in temporary storage to be used if you ask for a Screen Image save. When the Screen Image key is pressed, a "thumbnail" of the captured image is displayed, as shown below:

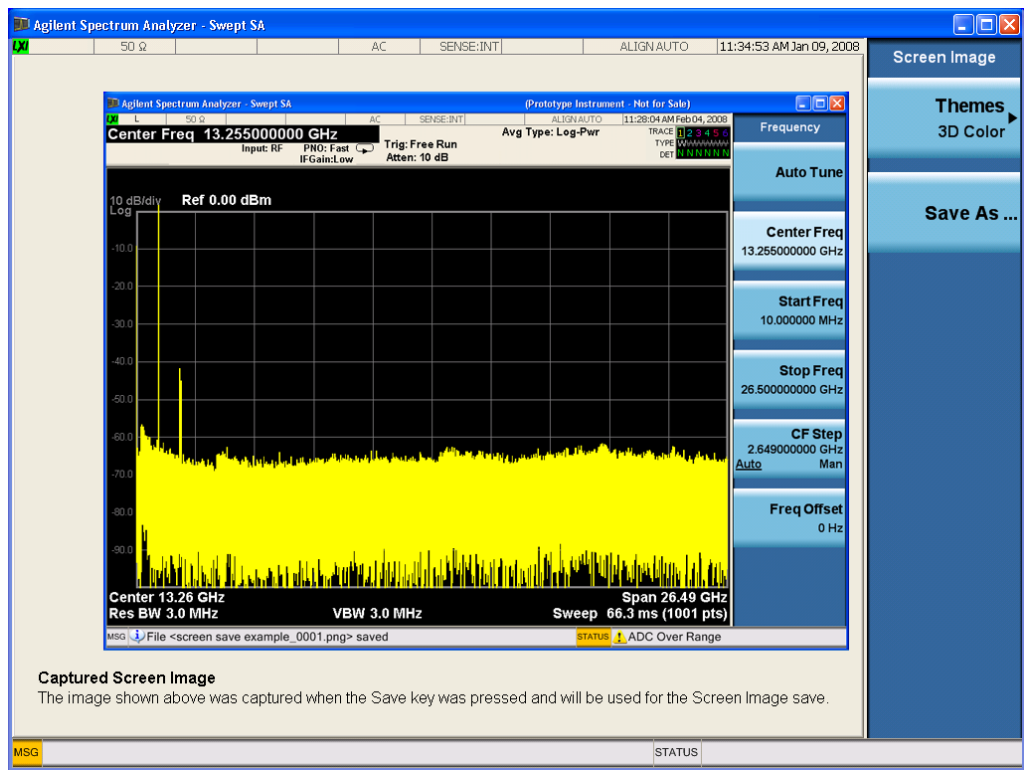

When you continue on into the Save As menu and complete the Screen Image save, the image depicted in the thumbnail is the one that gets saved, showing the menus that were on the screen before going into the Save menus. The save is performed immediately and does not wait until the measurement is complete.

After you have completed the save, the Quick Save front-panel key lets you quickly repeat the last save performed, using an auto-named file, with the current screen data.

NOTE For versions previous to A.01.55, if you initiate a screen image save by navigating through the Save menus, the image that is saved will contain the Save menu softkeys, not the menus and the active function that were on the screen when you first pressed the Save front panel key.

Key Path	Save
Mode	All
Remote Command	:MMEMory:STORe:SCReem <filename>
Example	:MMEM:STOR:SCR "myScreen.png" This stores the current screen image in the file MyScreenFile.png in the default directory.
Initial S/W Revision	Prior to A.02.00

Themes

Accesses a menu of functions that enable you to choose the theme to be used when saving the screen image.

The **Themes** option is the same as the **Themes** option under the **Display** and **Page Setup** dialogs. It allows you to choose between themes to be used when saving the screen image.

Key Path	Save, Screen Image
Remote Command	:MMEMory:STORe:SCReem:THEMe TDColor TDMonochrome FCOLOR FMONochrome :MMEMory:STORe:SCReem:THEMe?
Example	:MMEM:STOR:SCR:THEM TDM
Preset	3D Color; Is not part of Preset, but is reset by Restore Misc Defaults or Restore System Defaults All and survives subsequent running of the modes.
Readback	3D Color 3D Mono Flat Color Flat Mono
Backwards Compatibility Notes	In ESA and PSA we offer the choice of "Reverse Bitmap" or "Reverse Metafile" when saving screen images. This is much like the "Flat Color" theme available in X-Series. Also, if you selected Reverse Bitmap AND a black & white screen image, that would be much like "Flat Monochrome". In other words, each of the X-Series themes has a similar screen image type in ESA/PSA. But they are not identical.
Initial S/W Revision	Prior to A.02.00

3D Color

Selects a standard color theme with each object filled, shaded and colored as designed.

Key Path	Save, Screen Image, Themes
Example	MMEM:STOR:SCR:THEM TDC

Readback	3D Color
Initial S/W Revision	Prior to A.02.00

3D Monochrome

Selects a format that is like 3D color but shades of gray are used instead of colors.

Key Path	Save, Screen Image, Themes
Example	MMEM:STOR:SCR:THEM TDM
Readback	3D Mono
Initial S/W Revision	Prior to A.02.00

Flat Color

Selects a format that is best when the screen is to be printed on an ink printer.

Key Path	Save, Screen Image, Themes
Example	MMEM:STOR:SCR:THEM FCOL
Readback	Flat Color
Initial S/W Revision	Prior to A.02.00

Flat Monochrome

Selects a format that is like Flat Color. But only black is used (no colors, not even gray), and no fill.

Key Path	Save, Screen Image, Themes
Example	MMEM:STOR:SCR:THEM FMON
Readback	Flat Mono
Initial S/W Revision	Prior to A.02.00

Save As...

When you press "Save As", the analyzer brings up a Windows dialog and a menu entitled "**Save As.**" This menu allows you to navigate to the various fields in the Windows dialog without using a keyboard or mouse. The Tab and Arrow keys can also be used for dialog navigation.

See "[To File . . .](#)" on page 2273 in Save, State for a full description of this dialog and menu.

The default path for Screen Images is

My Documents\`<mode name>`\screen.

where <mode name> is the parameter used to select the mode with the INST:SEL command (for example, SA for the Spectrum Analyzer).

Key Path	Save, Screen Image
Notes	Brings up Save As dialog for saving a Screen Image Save Type
Initial S/W Revision	Prior to A.02.00

Mass Storage Catalog (Remote Command Only)

Key path	SCPI Only
Remote Command	:MMEMory:CATalog? [<directory_name>]
Notes	<p>The string must be a valid logical path.</p> <p>Queries disk usage information (drive capacity, free space available) and obtains a list of files and directories in a specified directory in the following format: <numeric_value>,<numeric_value>,{<file_entry>}</p> <p>It returns two numeric parameters and as many strings as there are files and directories. The first parameter indicates the total amount of storage currently used in bytes. The second parameter indicates the total amount of storage available, also in bytes. The <file_entry> is a string. Each <file_entry> indicates the name, type, and size of one file in the directory list: <file_name>,<file_type>,<file_size></p> <p>As the windows file system has an extension that indicates file type, <file_type> is always empty. <file_size> provides the size of the file in bytes. For directories, <file_entry> is surrounded by square brackets and both <file_type> and <file_size> are empty</p>
Initial S/W Revision	Prior to A.02.00

Mass Storage Change Directory (Remote Command Only)

Key path	SCPI Only
Remote Command	:MMEMory:CDIRectory [<directory_name>] :MMEMory:CDIRectory?
Notes	<p>The string must be a valid logical path.</p> <p>Changes the default directory for a mass memory file system. The <directory_name> parameter is a string. If no parameter is specified, the directory is set to the *RST value.</p> <p>At *RST, this value is set to the default user data storage area, that is defined as System.Environment.SpecialFolder.Personal.</p> <p>Query returns full path of the default directory.</p>
Initial S/W Revision	Prior to A.02.00

Mass Storage Copy (Remote Command Only)

Key path	SCPI Only
Remote Command	:MMEMory:COpy <string>,<string>[,<string>,<string>]
Notes	<p>The string must be a valid logical path.</p> <p>Copies an existing file to a new file or an existing directory to a new directory.</p> <p>Two forms of parameters are allowed. The first form has two parameters. In this form, the first parameter specifies the source, and the second parameter specifies the destination.</p> <p>The second form has four parameters. In this form, the first and third parameters specify the source. The second and fourth parameters specify the directories. The first pair of parameters specifies the source. The second pair specifies the destination. An error is generated if the source doesn't exist or the destination file already exists.</p> <p>This command will generate an "access denied" error if the destination is a restricted folder (e.g., C:\Windows) and the current user does not have Power User or Administrator privileges.</p>

Mass Storage Device Copy (Remote Command Only)

This command transfers data to/from a file and a peripheral device.

Key path	SCPI Only
Remote Command	:MMEMory:COpy:DEvice <source_string>,<dest_string>
Notes	<p>The strings must be a valid logical path or a valid device keyword. If the dest_string is a device keyword, the data is copied from the source file to the device. If the source_string is a device keyword, the data is copied to the source file from the device.</p> <p>Valid device keywords are:</p> <p>SNS (smart noise source)</p> <p>An error is generated if the file or device is not found.</p>

Mass Storage Delete (Remote Command Only)

Key path	SCPI Only
Remote Command	:MMEMory:DElete <file_name>[,<directory_name>]
Notes	<p>The string must be a valid logical path.</p> <p>Removes a file from the specified directory. The <file_name> parameter specifies the file name to be removed. This command will generate an "access denied" error if the file is in a restricted folder (e.g., C:\Windows) and the current user does not have Power User or Administrator privileges.</p>
Initial S/W Revision	Prior to A.02.00

Mass Storage Data (Remote Command Only)

Creates a file containing the specified data OR queries the data from an existing file.

Key path	SCPI Only
Remote Command	:MMEMory:DATA <file_name>, <data> :MMEMory:DATA? <file_name>
Notes	The string must be a valid logical path. The command form is MMEMory:DATA <file_name>,<data>. It loads <data> into the file <file_name>. <data> is in 488.2 block format. <file_name> is string data. The query form is MMEMory:DATA? <file_name> with the response being the associated <data> in block format.
Initial S/W Revision	Prior to A.02.00

Mass Storage Make Directory (Remote Command Only)

Key path	SCPI Only
Remote Command	:MMEMory:MDIRectory <directory_name>
Notes	The string must be a valid logical path. Creates a new directory. The <directory_name> parameter specifies the name to be created. This command will generate an “access denied” error if the new directory would be in a restricted folder (e.g., C:\Windows) and the current user does not have Power User or Administrator privileges.
Initial S/W Revision	Prior to A.02.00

Mass Storage Move (Remote Command Only)

Key path	SCPI Only
Remote Command	:MMEMory:MOVE <string>,<string>[,<string>,<string>]
Notes	The string must be a valid logical path. Moves an existing file to a new file or an existing directory to a new directory. Two forms of parameters are allowed. The first form has two parameters. In this form, the first parameter specifies the source, and the second parameter specifies the destination. The second form has four parameters. In this form, the first and third parameters specify the source. The second and fourth parameters specify the directories. The first pair of parameters specifies the source. The second pair specifies the destination. An error is generated if the source doesn't exist or the destination file already exists. This command will generate an “access denied” error if the destination is a restricted folder (e.g., C:\Windows) and the current user does not have Power User or Administrator privileges.
Initial S/W Revision	Prior to A.02.00

Mass Storage Remove Directory (Remote Command Only)

Key path	SCPI Only
Remote Command	<code>:MMEMory:RDIRectory <directory_name></code>
Notes	<p>The string must be a valid logical path.</p> <p>Removes a directory. The <directory_name> parameter specifies the directory name to be removed. All files and directories under the specified directory shall also be removed.</p> <p>This command will generate an “access denied” error if the folder is a restricted folder (e.g., C:\Windows) or is in a restricted folder and the current user does not have Power User or Administrator privileges.</p>
Initial S/W Revision	Prior to A.02.00

Single (Single Measurement/Sweep)

Sets the analyzer for Single measurement operation. The single/continuous state is Meas Global, so the setting will affect all the measurements. If you are Paused, pressing Single does a Resume.

See "[More Information](#)" on page 591

Key Path	Front-panel key
Example	:INIT:CONT OFF
Notes	See Cont key description.
Backwards Compatibility Notes	<p>For Spectrum Analysis mode in ESA and PSA, the Single hardkey and the INITiate:IMM switched from continuous measurement to single measurement and restarted sweeps and averages (displayed average count reset to 1), but did not restart Max Hold and Min Hold. In the X-Series, the Single hardkey and the INITiate:IMM command initiate a sweep/ measurement/ average sequence/hold sequence including MaxHold and MinHold.</p> <p>For Spectrum Analysis mode in ESA and PSA, the Single hardkey restarted the sweep regardless of whether or not you were in an active sweep or sweep sequence. In the X-Series, Restart does this but Single only restarts the sweep or sweep sequence if you are in the idle state.</p> <p>INIT[:IMM] in ESA & PSA Spectrum Analysis Mode does an implied ABORT. In some other PSA Modes, INIT[:IMM] is ignored if not in the idle state. . The X-Series follows the ESA/PSA SA Mode model, which may cause some Modes to have compatibility problems.</p>
Initial S/W Revision	Prior to A.02.00

More Information

See "[Restart](#)" on page 2270 for details on the INIT:IMMEDIATE (Restart) function.

If you are already in single sweep, the INIT:CONT OFF command has no effect.

If you are already in Single Sweep, then pressing the Single key in the middle of a sweep does not restart the sweep or sequence. Similarly, pressing the Single key does not restart the sweep or sequence if the sweep is not in the idle state (for example, if you are taking a very slow sweep, or the analyzer is waiting for a trigger). Instead, it results in a message. "Already in Single, press Restart to initiate a new sweep or sequence". Even though pressing the Single key in the middle of a sweep does not restart the sweep, sending INIT:IMMEDIATE does reset it.

To take one more sweep without resetting the average count, increment the average count by 1, by pressing the step up key while **Average/Hold Number** is the active function, or sending the remote command CALC:AVER:TCON UP.

Source

There is no Source control functionality for this measurement. When this key is pressed, the screen either displays a blank menu, or the previously-selected menu remains unchanged.

Key Path	Front-panel key
----------	-----------------

Span X Scale

Accesses a menu of functions that enable you set the horizontal scale parameters.

Key Path	Front-panel key
Initial S/W Revision	Prior to A.02.00

Span

Changes the frequency range symmetrically about the center frequency.

The default (and minimum) Span is calculated using the number of carriers and the carrier width where;

$$\text{Span} = (\text{Upper Carrier Freq} + (\text{max offset IBW} * (1 + \alpha)) / 2) - (\text{Lower Carrier Freq} - (\text{max offset IBW} * (1 + \alpha)) / 2)$$

The span is increased by a factor of 1 + Filter Alpha if the RRC Filter is on.

Key Path	Span X Scale
Mode	SA, WCDMA, C2K, WIMAX OFDMA, 1xEVDO, DVB-T/H, DTMB (CTTB), ISDB-T, CMMB, LTE, LTETDD, Digital Cable TV, WLAN
Remote Command	[:SENSe] :CHPower:FREQuency:SPAN <freq> [:SENSe] :CHPower:FREQuency:SPAN?
Example	CHP:FREQ:SPAN 10 MHz CHP:FREQ:SPAN?
Notes	You must be in the Spectrum Analysis mode, W-CDMA mode, cdma2000 mode, DVB-T/H mode, DTMB (CTTB) mode, ISDB-T mode, CMMB mode, Digital Cable TV mode, LTE mode, LTE TDD mode, WLAN mode, 1xEVDO mode or WIMAX OFDMA mode to use this command. Use :INSTrument:SElect to set the mode.
Dependencies	For MSR mode, this key is blank. For LTE-Advanced FDD/TDD mode, this key is blank. For WLAN 802.11ac (80 MHz + 80 MHz), the key is not enabled and its value is coupled with the spacing between the center frequencies of the two carriers. Span = Center Frequency 1 - Center Frequency 2 + Integ BW + 40 MHz Margin. When the calculated span is over 1 GHz, it's still coupled to its maximum value, which is 1 GHz.
Couplings	When Res BW is set to Auto, the resolution bandwidth is auto-coupled to span. The ratio of span /RBW is approximately 106:1. When the Res BW is set to Man, bandwidths are entered by the user, and these bandwidths are used regardless of other analyzer settings. Since Span is coupled to Integ BW in the factory default condition, if you change the integration bandwidth setting, the span setting changes by a proportional amount until a limit value is reached. However, the span can be individually set. The minimum value of the span is coupled with the integration bandwidth.
Preset	SA: 3 MHz WCDMA: 7.5 MHz

	<p>C2K: 1.845 MHz WIMAX OFDMA: 20 MHz 1xEVDO: 2.0MHz DVB-T/H: 10MHz DTMB (CTTB): 10MHz ISDB-T: 10MHz CMMB: 10MHz LTE: 7.5 MHz LTETDD: 7.5 MHz Digital Cable TV: 10MHz WLAN: if Radio Std is 802.11a/g(OFDM/DSSS-OFDM): 30 MHz if Radio Std is 802.11b: 37.5MHz if Radio Std is 802.11n(20MHz): 30 MHz if Radio Std is 802.11n(40MHz): 60 MHz if Radio Std is 802.11ac (20 MHz): 30 MHz if Radio Std is 802.11ac (40 MHz): 60 MHz if Radio Std is 802.11ac (80 MHz): 120 MHz if Radio Std is 802.11ac (160 MHz): 240 MHz if Radio Std is 802.11ac (80 MHz + 80 MHz): 360 MHz</p>
State Saved	Saved in instrument state.
Min	100 Hz
Max	Hardware Maximum Span
Initial S/W Revision	Prior to A.02.00
Modified at S/W Revision	A.02.00, A.03.00

Full Span

Changes the span to show the full frequency range of the spectrum analyzer.

Key Path	Span X Scale
Mode	SA, WCDMA, C2K, WIMAX OFDMA, 1xEVDO, DVB-T/H, DTMB (CTTB), ISDB-T, CMMB, LTE, LTETDD, Digital Cable TV, WLAN
Remote Command	[:SENSE] :CHPower:FREQuency:SPAN:FULL
Example	CHP:FREQ:SPAN:FULL
Notes	You must be in the Spectrum Analysis mode, W-CDMA mode, cdma2000 mode, DVB-T/H mode, DTMB (CTTB) mode, ISDB-T mode, CMMB mode, Digital Cable TV mode, LTE mode, LTE TDD mode, WLAN mode, 1xEVDO mode or WIMAX OFDMA mode to use this command. Use :INSTrument:SElect to set the mode.

Dependencies	For MSR mode, this key is blank. For LTE-Advanced FDD/TDD mode, this key is blank.
Couplings	Selecting full span changes the measurement span value.
Initial S/W Revision	Prior to A.02.00
Modified at S/W Revision	A.02.00, A.03.00

Last Span

Changes the span to the previous span setting. If no previous span value exists, then the span remains unchanged.

Key Path	Span X Scale
Mode	SA, WCDMA, C2K, WIMAX OFDMA, 1xEVDO, DVB-T/H, DTMB (CTTB), ISDB-T, CMMB, LTE, LTETDD, Digital Cable TV, WLAN
Remote Command	[:SENSe] :CHPower :FREQuency :SPAN :PREvious
Example	CHP:FREQ:SPAN:PREV
Notes	You must be in the Spectrum Analysis mode, W-CDMA mode, cdma2000 mode, DVB-T/H mode, DTMB (CTTB) mode, ISDB-T mode, CMMB mode, Digital Cable TV mode, LTE mode, LTE TDD mode, WLAN mode, 1xEVDO mode or WIMAX OFDMA mode to use this command. Use :INSTrument:SElect to set the mode.
Dependencies	For MSR mode, this key is blank. For LTE-Advanced FDD/TDD mode, this key is blank.
Couplings	Selecting last span changes the measurement span value.
Initial S/W Revision	Prior to A.02.00
Modified at S/W Revision	A.02.00, A.03.00

Sweep/Control

Accesses a menu of functions that enable you to set up and control the sweep time and source for the current measurement. See "[Sweep/Control](#)" on page 2291 for more information.

Key Path	Front-panel key
Initial S/W Revision	Prior to A.02.00

Sweep Time

Selects the length of time that the spectrum analyzer sweeps the displayed frequency span. Additional overhead time, which impacts the sweep rate, is not calculated as part of the sweep time. In fact:

$$\text{sweep rate} = \text{span} / \text{sweep time}$$

$$\text{update rate} = 1 / (\text{sweep time} + \text{overhead})$$

$$\text{sweep cycle time} = \text{sweep time} + \text{overhead}$$

Sweep time is coupled to RBW and VBW, and is impacted by the number of sweep points, so changing those parameters may change the sweep time.

Key Path	Sweep/Control
Mode	SA, WCDMA, C2K, WIMAX OFDMA, 1xEVDO, DVB-T/H, DTMB (CTTB), ISDB-T, CMMB, LTE, LTETDD, Digital Cable TV, WLAN, MSR, LTEAFDD, LTEATDD
Remote Command	[:SENSe]:CHPower:SWEep:TIME <time> [:SENSe]:CHPower:SWEep:TIME? [:SENSe]:CHPower:SWEep:TIME:AUTO OFF ON 0 1 [:SENSe]:CHPower:SWEep:TIME:AUTO?
Example	CHP:SWE:TIME 25ms CHP:SWE:TIME? CHP:SWE:TIME:AUTO OFF CHP:SWE:TIME:AUTO?
Preset	SA, WIMAX OFDMA: Automatically Calculated WCDMA: 1.0 ms CDMA2K: 9.4ms 1xEVDO: 2.66ms DVB-T/H: Automatically Calculated DTMB (CTTB): Automatically Calculated ISDB-T: Automatically Calculated CMMB: Automatically Calculated LTE, MSR: Automatically Calculated LTETDD: Automatically Calculated Digital Cable TV: Automatically Calculated

	WLAN: Automatically Calculated LTEAFDD,LTEATDD:Automatically Calculated
State Saved	Saved in instrument state.
Min	1 ms
Max	4000 s
Initial S/W Revision	Prior to A.02.00
Modified at S/W Revision	A.02.00, A.03.00

Sweep Setup

Accesses a menu that enables you to set the sweep state for the current measurement.

Key Path	Sweep/Control
Initial S/W Revision	Prior to A.02.00

Auto Sweep Time Rules

Switches the analyzer between normal and accuracy sweep states.

Setting Auto Sweep Time to Accy results in slower sweep times, usually about three times as long, but yields better amplitude accuracy for CW signals. The instrument amplitude accuracy specifications only apply when Auto Sweep Time is set to Accy.

Additional amplitude errors which occur when Auto Sweep Time is set to Norm are usually well under 0.1 dB, though this is not guaranteed. Because of the faster sweep times and still low errors, Norm is the preferred setting of Auto Sweep Time. Auto Sweep Time is set to Norm on a Preset or Auto Couple. This means that in the Preset or Auto Coupled state, instrument amplitude accuracy specifications do not apply.

Key Path	Sweep/Control, Sweep Setup
Mode	SA, WCDMA, C2K, WIMAX OFDMA, 1xEVDO, DVB-T/H, DTMB (CTTB), ISDB-T, CMMB, LTE, LTE-TDD, Digital Cable TV, WLAN, MSR, LTEAFDD, LTEATDD
Remote Command	[:SENSe] :CHPower:SWEep:TIME:AUTO:RULEs NORMal ACCuracy [:SENSe] :CHPower:SWEep:TIME:AUTO:RULEs?
Example	CHP:SWE:TIME:AUTO:RUL NORM CHP:SWE:TIME:AUTO:RUL?
Notes	In Zero Span, this key is irrelevant and inaccessible (because the whole Sweep Setup menu is grayed out in Zero Span), however its settings can be changed remotely with no error indication. Set to Norm when Auto Couple is pressed or sent remotely

Preset	NORMal
State Saved	Saved in instrument state.
Range	Norm Accy
Initial S/W Revision	Prior to A.02.00
Modified at S/W Revision	A.02.00, A.03.00

Pause

Pauses a measurement after the current data acquisition is complete. When Paused, the label on the key changes to Resume. Pressing the Resume key resumes the measurement at the point it was at when paused. See ["Pause/Resume" on page 2291](#) for more details.

Key Path	Sweep/Control
Initial S/W Revision	Prior to A.02.00

Gate

Accesses a menu that enables you to control the gating function. The Gate functionality is used to view signals best viewed by qualifying them with other events.

Gate setup parameters are the same for all measurements – they do not change as you change measurements. Settings like these are called “Meas Global” and are unaffected by Meas Preset.

Note that Sweep Time autocoupling rules and annotation are changed by Gate being on.

Key Path	Sweep/Control
Scope	Meas Global
Readback	The state and method of Gate, as [Off, LO] or [On, Video]. Note that for measurements that only support gated LO, the method is nonetheless read back, but always as LO.
Initial S/W Revision	Prior to A.02.00

Gate On/Off

Turns the gate function on and off.

When the Gate Function is on, the selected Gate Method is used along with the gate settings and the signal at the gate source to control the sweep and video system with the gate signal. Not all measurements allow every type of Gate Methods.

When Gate is on, the annunciation in the measurement bar reflects that it is on and what method is used, as seen in the following "Gate: LO" annunciator graphic.

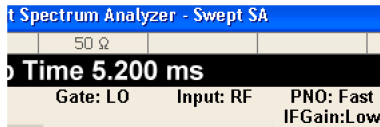

Key Path	Sweep/Control, Gate
Remote Command	[:SENSe] :SWEep:EGATe [:STATe] OFF ON 0 1 [:SENSe] :SWEep:EGATe [:STATe] ?
Example	SWE:EGAT ON SWE:EGAT?
Dependencies	<p>The function is unavailable (grayed out) and Off when:</p> <ul style="list-style-type: none"> • Gate Method is LO or Video and FFT Sweep Type is manually selected. • Gate Method is FFT and Swept Sweep Type is manually selected. • Marker Count is ON. <p>The following are unavailable whenever Gate is on:</p> <ul style="list-style-type: none"> • FFT under Sweep Type when Method=LO or Video or Swept under Sweep Type when Method=FFT • Marker Count <p>While Gate is on, the Auto Rules for Sweep Type are modified so that the choice agrees with the Gate Method: i.e., FFT for Method = FFT and Swept for Method = LO or Video.</p> <p>The Gate softkey and all SCPI under the [:SENSe]:SWEep:EGATe SCPI node are grayed out when Source Mode is Tracking with an external source. This is because the Gate circuitry is used to sync the external source. If the Tracking Source is turned on, the Gate is turned off.</p> <p>When in the ACP measurement:</p> <ul style="list-style-type: none"> • When Meas Method is RBW or FAST, this function is unavailable and the key is grayed out. • Whenever Gate is on, Meas Method, RBW or FAST is unavailable and keys for those are grayed out. • When Gate is on, Offset Res BW and Offset Video BW are ignored (if you set these values) and the measurement works as if all Offset Res BW and all Offset Video BW are coupled with the Res BW and the Video BW under the BW menu. When Gate is on, the Offset BW key in the Offset/Limit menu is grayed out.
Preset	Off LTETDD: On
State Saved	Saved in instrument state
Range	On Off
Backwards Compatibility SCPI	[:SENSe] :SWEep:TIME:GATE[:STATe] ESA compatibility
Backwards Compatibility Notes	In ESA, Trig Delay (On) and Gate (On) could not be active at the same time.. This dependency does not exist in PSA or in the X-Series.
Initial S/W Revision	Prior to A.02.00

Gate View On/Off

Turning on Gate View in the Swept SA measurement provides a single-window gate view display..

Turning on Gate View in other measurements shows the split-screen Gate View. In these measurements, when the Gate View is on, the regular view of the current measurement traces and results are reduced vertically to about 70% of the regular height. The Zero Span window, showing the positions of the Gate, is shown between the Measurement Bar and the reduced measurement window. By reducing the height of the measurement window, some of the annotation on the Data Display may not fit and is not shown.

Key Path	Sweep/Control, Gate
Remote Command	[:SENSe] :SWEep:EGATe:VIEW ON OFF 1 0 [:SENSe] :SWEep:EGATe:VIEW?
Example	SWE:EGAT:VIEW ON turns on the gate view.
Dependencies	In the Swept SA measurement: In Gate View, the regular Sweep Time key is grayed out . When pressed, the grayed out key puts up the informational message "Use Gate View Sweep Time in the Gate menu." In the other measurements: When you turn Gate View on, the lower window takes on the current state of the instrument. Upon leaving Gate View, the instrument takes on the state of the lower window. When you turn Gate View on, the upper window Sweep Time is set to the gate view sweep time.
Couplings	These couplings apply to the Swept SA measurement: <ul style="list-style-type: none"> • When Gate View is turned on, the instrument is set to Zero Span. • Gate View automatically turns off whenever a Span other than Zero is selected. • Gate View automatically turns off if you press the Last Span key while in Gate View, and the instrument returns to the Span it was in before entering Gate View (even if that is Zero Span). • When Gate View is turned on, the sweep time used is the gate view sweep time. This is set according to the rules in section "Gate View Setup" on page 2101 • When Gate View is turned off, Sweep Time is set to the normal Swept SA measurement sweep time. • If Gate View is on and Gate is off, then turning on Gate turns off Gate View.
Preset	OFF
State Saved	Saved in instrument state
Range	On Off
Initial S/W Revision	Prior to A.02.00

A sample of the Gate View screen in the Swept SA measurement is shown in the following graphic :

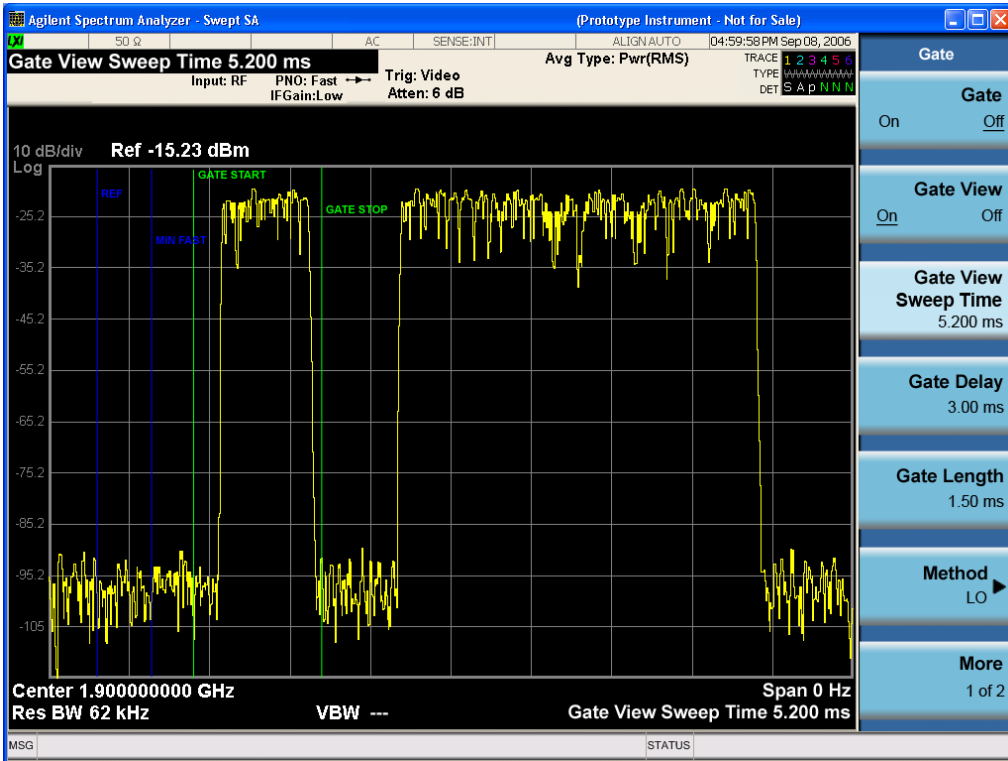

A sample of the Gate View screen in other measurements is shown in the following graphic. This example is for the ACP measurement:

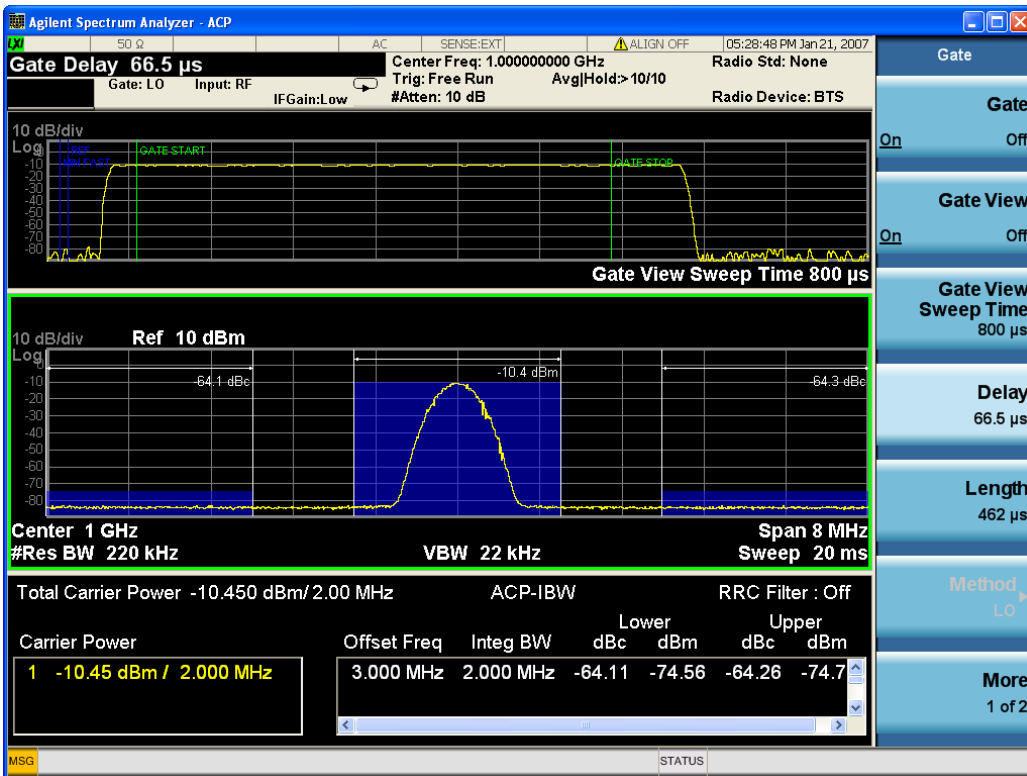

Turning Gate View off returns the analyzer to the Normal measurement view.

In the Swept SA, the normal measurement view is the single-window Swept SA view. When returning to this view, the Swept SA measurement returns to the Span it was in before entering **Gate View** (even if that is Zero Span).

The **Gate View** window is triggered from the Gate Source, with zero trigger delay. Also, when updating the **Gate View** window, the Gate itself must not operate. So it is internally shut off while the gate view window is being updated. For the Swept SA measurement, this means that the Gate is internally shut off whenever the gate view window is displayed. The measurement bar and softkeys continue to show the Trigger source for the main sweep window and give no indication that the Gate is shut off or that the Gate View window is triggered from the Gate Source.

When in **Gate View**, vertical lines are displayed in the Gate View window as follows:

- Green lines are displayed at the gate edges as follows: in Edge Gate, a line is shown for Delay and one for the end of the Gate period, defined by Length. In Level Gate a line is shown only for Delay. You can adjust the position of the green lines by adjusting the gate length and the gate delay. These lines update in the Gate View window as the active function changes, even if the window is not being updated. In Gated LO and Gated Video, these lines are positioned relative to the delay reference line (not relative to 0 time). In Gated FFT, their location is relative to the left edge of the screen.
- A blue line is displayed showing the delay reference, that is, the reference point for the Gate Delay within the Zero Span window. The blue line represents where (in time) the effective location of the gate start would be if the gate were programmed to zero delay.
-
- The second blue line is labeled "MIN FAST" as shown in the figure above because it represents the minimum Gate Delay for fast Gated LO operation. This line is only displayed in Gated LO. You cannot scroll (knob) or decrement (down key) the Gate Delay to less than that represented by the position of this line, it can only be set below this position manually, although once there it can be moved freely with the knob while below the line.
- A yellow line in the Gated Video case only, is displayed at Blength, where Blength is the display point (bucket) length for the swept trace, which is given by the sweep time for that trace divided by number of Points - 1. So it is referenced to 0 time, not to the delay reference. This line is labeled NEXT PT (it is not shown in the figure above because the figure above is for Gated LO).
- The yellow line represents the edge of a display point (bucket). Normally in Gated Video, the bucket length must be selected so that it exceeds the off time of the burst. There is another way to use the analyzer in Gated Video measurements, and that is to set the bucket width much shorter than the off time of the burst. Then use the Max Hold trace function to fill in "missing" buckets more slowly. This allows you to see some of the patterns of the Gated Video results earlier, though seeing a completely filled-in spectrum later.

Gate View Setup

Accesses a menu that enables you to setup parameters relevant to the Gate View

Key Path	Sweep/Control, Gate
Scope	Meas Global
Initial S/W Revision	A.10.00

Gate View Sweep Time

Controls the sweep time in the Gate View window. To provide an optimal view of the gate signal, the analyzer initializes Gate View Sweep Time based on the current settings of Gate Delay and Gate Length.

Key Path	Sweep/Control, Gate, Gate View Setup
Remote Command	[:SENSe] :SWEep:EGATe:TIME <time> [:SENSe] :SWEep:EGATe:TIME?
Example	SWE:EGAT:TIME 500 ms
Dependencies	Gate View Sweep Time is initialized: <ul style="list-style-type: none"> • On Preset (after initializing delay and length). • Every time the Gate Method is set/changed. <p>Additionally, in the Swept SA measurement, whenever you do a Preset, or leave Gate View, the analyzer remembers the Gate Delay and Gate Length settings. Then, when returning to Gate View, if the current Gate Delay and/or Gate Length do not match the remembered values Gate View Sweep Time is re-initialized.</p> <ol style="list-style-type: none"> 1. Compute the location of the "gate stop" line, which you know is at time $t = t_{min} + \text{GateDelay} + \text{GateLength}$.
Preset	519.3 μ s WiMAX OFDMA: 5 ms GSM/EDGE: 1 ms
State Saved	Saved in instrument state
Max	6000 s
Initial S/W Revision	Prior to A.02.00

Gate View Start Time

Controls the time at the left edge of the Gate View.

Key Path	Sweep/Control, Gate, Gate View Setup
Remote Command	[:SENSe] :SWEep:EGATe:VIEW:STARt <time> [:SENSe] :SWEep:EGATe:VIEW:STARt?
Example	SWE:EGAT:VIEW:STAR 10ms
Notes	Units of time are required or no units; otherwise an invalid suffix error message will be generated. See error -131.
Preset	0 ms
State Saved	Saved in instrument state
Min	0
Max	500 ms
Initial S/W Revision	A.10.00

Gate Delay

Controls the length of time from the time the gate condition goes True until the gate is turned on.

Key Path	Sweep/Control, Gate
Remote Command	[:SENSe] :SWEep:EGATe:DELay <time> [:SENSe] :SWEep:EGATe:DELay?
Example	SWE:EGAT:DELay 500ms SWE:EGAT:DELay?
Notes	Units of time are required or no units; otherwise an invalid suffix error message will be generated.
Preset	57.7 us WiMAX OFDMA: 71 us GSM/EDGE: 600 us WLAN: 500 us
State Saved	Saved in instrument state
Min	0.0 us
Max	100 s
Backwards Compatibility SCPI	[:SENSe] :SWEep:TIME:GATE:DELay ESA compatibility
Initial S/W Revision	Prior to A.02.00

Gate Length

Controls the length of time that the gate is on after it opens.

Key Path	Sweep/Control, Gate
Remote Command	[:SENSe] :SWEep:EGATe:LENGth <time> [:SENSe] :SWEep:EGATe:LENGth?
Example	SWE:EGAT:LENG 1 SWE:EGAT:LENG?
Notes	Units of time are required or no units; otherwise an invalid suffix error message will be generated.
Dependencies	<p>Grayed out when Gate Method is set to FFT in which case the label changes to that shown below.</p>  <p>The key is also grayed out if Gate Control = Level.</p>
Preset	461.6 us

	WiMAX OFDMA: 50 us GSM/EDGE: 200 us WLAN: 1.54 ms
State Saved	Saved in instrument state
Min	100 ns
Max	5 s
Backwards Compatibility SCPI	[:SENSe]:SWEep:TIME:GATE:LENGth ESA compatibility
Initial S/W Revision	Prior to A.02.00

Gate Source

The menus under the Gate Source key are the same as those under the Trigger key, with the exception that neither Free Run nor Video are available as Gate Source selections. However, a different SCPI command is used to select the Gate Source (see table below) because you may independently set the Gate Source and the Trigger Source.

Any changes to the settings in the setup menus under each Gate Source selection key (for example: Trigger Level, Trigger Delay, etc.) also affect the corresponding settings under the Trigger menu keys. The SCPI commands used for these are the same for Trigger and Gate, since there is only one setting which affects both Gate and Trigger. Example: to set the Trigger Level for External 1 you use the command :TRIG:EXT1:LEV regardless of whether you are using External 1 as a Trigger Source or a Gate Source.

Key Path	Sweep/Control, Gate
Remote Command	[:SENSe]:SWEep:EGATe:SOURce EXTernal1 EXTernal2 LINE FRAME RFBurst [:SENSe]:SWEep:EGATe:SOURce?
Dependencies	In some models, there is no second External input. In these models, the External 2 key is blanked and the EXTernal2 parameter will generate a "Hardware missing; Not available for this model number" error.
Preset	EXTernal 1 GSM/EDGE, MSR: FRAME LTETDD: EXTernal 1 When Direction is Downlink, FRAME when Direction is Uplink.
Backwards Compatibility Notes	In ESA, there is a single Gate input port. In PSA, the Gate Source may be taken from one of two specified input ports. In the X-Series, any Trigger Source can be a Gate Source.
Initial S/W Revision	Prior to A.02.00
Modified at S/W Revision	A.03.00, A.14.00

Line

Pressing this key, when it is not selected, selects the line signal as the trigger. A new sweep/measurement will start synchronized with the next cycle of the line voltage. Pressing this key, when it is already selected, access the line trigger setup menu.

Key Path	Trigger
Example	TRIG:SOUR LINE Swept SA measurement TRIG:<meas>:SOUR LINE Measurements other than Swept SA
Dependencies	Line trigger is not available when operating from a "dc power source", for example, when the instrument is powered from batteries.
State Saved	Saved in instrument state
Status Bits/OPC dependencies	The Status Operation Register bit 5 "Waiting for Trigger" is set at the same time as the Sweeping or Measuring bit is set. It is cleared when the trigger actually occurs (that is, after the trigger event occurs and all the applicable trigger criteria have been met). A corresponding pop-up message ("Waiting for trigger") is generated if no trigger signal appears after approximately 2 sec. This message goes away when a trigger signal appears.
Initial S/W Revision	Prior to A.02.00

Trig Slope

Controls the trigger polarity. It is set positive to trigger on a rising edge and negative to trigger on a falling edge.

Key Path	Trigger, Line
Remote Command	:TRIGger[:SEquence]:LINE:SLOPe POSitive NEGative :TRIGger[:SEquence]:LINE:SLOPe?
Example	TRIG:LINE:SLOP NEG
Preset	POSitive
State Saved	Saved in instrument state
Backwards Compatibility Notes	The legacy :TRIGger[:SEquence]:SLOPe command affects the slopes for the VID, LINE, EXT1, EXT2, and RFB triggers.
Initial S/W Revision	Prior to A.02.00

External 1

Pressing this key, when it is not selected, selects an external input signal as the trigger. A new sweep/measurement will start when the external trigger condition is met using the external 1 input connector on the rear panel.

Pressing this key, when it is already selected, accesses the external 1 trigger setup menu.

Key Path	Trigger
Example	TRIG:SOUR EXT1 Swept SA measurement TRIG:<meas>:SOUR EXT1 Measurements other than Swept SA
Dependencies	Grayed out if in use by Point Trigger in the Source Setup menu. Forced to Free Run if already selected and Point Trigger is set to External 1.
State Saved	Saved in instrument state
Status Bits/OPC dependencies	The Status Operation Register bit 5 "Waiting for Trigger" is set at the same time as the Sweeping or Measuring bit is set. It is cleared when the trigger actually occurs (that is, after the trigger event occurs and all the applicable trigger criteria have been met). A corresponding pop-up message ("Waiting for trigger") is generated if no trigger signal appears after approximately 2 sec. This message goes away when a trigger signal appears.
Initial S/W Revision	Prior to A.02.00

Trigger Level

Sets the value where the external 1 trigger input will trigger a new sweep/measurement.

Key Path	Trigger, External 1
Remote Command	:TRIGger[:SEquence]:EXTernal1:LEVel <level> :TRIGger[:SEquence]:EXTernal1:LEVel?
Example	TRIG:EXT1:LEV 0.4 V
Couplings	This same level is used for the Ext1 trigger source in the Trigger menu, for the Ext1 selection in the Periodic Timer sync source (in the Trigger menu and in the Gate Source menu), and also for the Ext1 selection in the Gate Source menu.
Preset	1.2 V
State Saved	Saved in instrument state
Min	-5 V
Max	5 V
Default Unit	V
Backwards Compatibility SCPI	:TRIGger[:SEquence]:EXTernal:LEVel For backward compatibility, the parameter EXTernal is mapped to EXTernal1
Backwards Compatibility SCPI	:TRIGger[:SEquence]:FRAME:EXTernal1:LEVel
Initial S/W Revision	Prior to A.02.00

Trig Slope

Controls the trigger polarity. It is set positive to trigger on a rising edge and negative to trigger on a falling edge.

Key Path	Trigger, External 1
Remote Command	:TRIGger[:SEquence]:EXTernal1:SLOPe POSitive NEGative :TRIGger[:SEquence]:EXTernal1:SLOPe?
Example	TRIG:EXT1:SLOP NEG
Couplings	This same slope is used in the Ext1 selection for the trigger source in the Trigger menu and for the period timer sync source (in the Trigger menu and in the Gate Source menu).
Preset	POSitive
State Saved	Saved in instrument state
Backwards Compatibility SCPI	:TRIGger[:SEquence]:EXTernal:SLOPe For backward compatibility, the parameter EXTernal is mapped to EXTernal1
Backwards Compatibility SCPI	:TRIGger[:SEquence]:FRAMe:EXTernal1:SLOPe
Backwards Compatibility Notes	The legacy :TRIGger[:SEquence]:SLOPe command affects the slopes for the VID, LINE, EXT1, EXT2, and RFB triggers.
Initial S/W Revision	Prior to A.02.00

Zero Span Delay Comp On/Off

In zero span, there is a natural delay in the signal path, which comes from the RBW filter. This is usually desirable, as it allows you to trigger on events and also see those events, because the signal is delayed from the trigger event. However, in some cases it is desirable to eliminate this delay, so that trigger events line up exactly with the zero time point in zero span. You can use the Zero Span Delay Comp On/Off feature to enable or disable zero span delay compensation.

Key Path	Trigger, External 1
Remote Command	:TRIGger[:SEquence]:EXTernal1:DELAy:COMPensation OFF ON 0 1 :TRIGger[:SEquence]:EXTernal1:DELAy:COMPensation?
Example	TRIG:EXT1:DEL:COMP ON
Dependencies	No effect except in zero-span, but not locked out in nonzero spans. Blanked in modes that do not support zero-span measurements. If the SCPI command is sent when the key is blanked, an error is returned: -221, "Settings conflict; Feature not supported for this measurement" In analyzers shipping N9060A, this feature requires N9060A-7FP.
Preset	OFF
State Saved	Saved in instrument state
Initial S/W Revision	A.11.00

External 2

Pressing this key, when it is not selected, selects an external input signal as the trigger. A new sweep/measurement will start when the external trigger condition is met using the external 2 input

connector. The external trigger 2 input connector is on the rear panel.

Pressing this key, when it is already selected, accesses the external 2 trigger setup menu.

Key Path	Trigger
Example	TRIG:SOUR EXT2 Swept SA measurement TRIG:<meas>:SOUR EXT2 Measurements other than Swept SA
Dependencies	In some models, there is no second External input. In these models, the External 2 key is blanked and the EXTernal2 parameter will generate a "Hardware missing; Not available for this model number" message. Grayed out if in use by Point Trigger in the Source Setup menu. Forced to Free Run if already selected and Point Trigger is set to External 2.
State Saved	Saved in instrument state
Status Bits/OPC dependencies	The Status Operation Register bit 5 "Waiting for Trigger" is set at the same time as the Sweeping or Measuring bit is set. It is cleared when the trigger actually occurs (that is, after the trigger event occurs and all the applicable trigger criteria have been met). A corresponding pop-up message ("Waiting for trigger") is generated if no trigger signal appears after approximately 2 sec. This message goes away when a trigger signal appears.
Initial S/W Revision	Prior to A.02.00
Modified at S/W Revision	A.03.00

Trigger Level

Sets the value where the external 2 trigger input will trigger a new sweep/measurement.

Key Path	Trigger, External 2
Remote Command	:TRIGger[:SEquence]:EXTernal2:LEVel :TRIGger[:SEquence]:EXTernal2:LEVel?
Example	TRIG:EXT2:LEV 1.1 V
Couplings	This same level is used for the Ext2 trigger source in the Trigger menu, for the Ext2 selection in the Periodic Timer sync source (in the Trigger menu and in the Gate Source menu), and also for the Ext2 selection in the Gate Source menu.
Preset	1.2 V
State Saved	Saved in instrument state
Min	-5 V
Max	5 V
Default Unit	V
Backwards Compatibility SCPI	:TRIGger[:SEquence]:FRAMe:EXTernal2:LEVel
Initial S/W Revision	Prior to A.02.00

Trig Slope

Controls the trigger polarity. It is set positive to trigger on a rising edge and negative to trigger on a falling edge.

Key Path	Trigger, External 2
Remote Command	:TRIGger[:SEquence]:EXternal2:SLOPe POSitive NEGative :TRIGger[:SEquence]:EXternal2:SLOPe?
Example	TRIG:EXT2:SLOP NEG
Couplings	This same slope is used in the Ext2 selection for the trigger source in the Trigger menu and for the period timer sync source (in the Trigger menu and in the Gate Source menu).
Preset	POSitive
State Saved	Saved in instrument state
Backwards Compatibility SCPI	:TRIGger[:SEquence]:FRAMe:EXternal2:SLOPe
Backwards Compatibility Notes	The legacy :TRIGger[:SEquence]:SLOPe command affects the slopes for the VID, LINE, EXT1, EXT2, and RFB triggers.
Initial S/W Revision	Prior to A.02.00

Zero Span Delay Comp On/Off

In zero span, there is a natural delay in the signal path, which comes from the RBW filter. This is usually desirable, as it allows you to trigger on events and also see those events, because the signal is delayed from the trigger event. However, in some cases it is desirable to eliminate this delay, so that trigger events line up exactly with the zero time point in zero span. You can use the Zero Span Delay Comp On/Off feature to enable or disable zero span delay compensation.

Key Path	Trigger, External 2
Remote Command	:TRIGger[:SEquence]:EXternal2:DELAy:COMPensation OFF ON 0 1 :TRIGger[:SEquence]:EXternal2:DELAy:COMPensation?
Example	TRIG:EXT2:DEL:COMP ON
Dependencies	No effect except in zero-span, but not locked out in nonzero spans. Blanked in modes that do not support zero-span measurements. If the SCPI command is sent when the key is blanked, an error is returned: -221, "Settings conflict; Feature not supported for this measurement" In analyzers shipping N9060A, this feature requires N9060A-7FP.
Preset	OFF
State Saved	Saved in instrument state
Initial S/W Revision	A.11.00

RF Burst

Pressing this key, when it is not selected, selects the RF Burst as the trigger. A new sweep/measurement will start when an RF burst envelope signal is identified from the signal at the RF Input connector. Pressing this key, when it is already selected, accesses the RF Burst trigger setup menu.

In some models, a variety of burst trigger circuitry is available, resulting in various available burst trigger bandwidths. The analyzer automatically chooses the appropriate trigger path based on the hardware configuration and other settings of the analyzer.

Key Path	Trigger
Example	TRIG:SOUR RFB Swept SA measurement TRIG:<meas>:SOUR RFB Measurements other than Swept SA
State Saved	Saved in instrument state
Status Bits/OPC dependencies	The Status Operation Register bit 5 "Waiting for Trigger" is set at the same time as the Sweeping or Measuring bit is set. It is cleared when the trigger actually occurs (that is, after the trigger event occurs and all the applicable trigger criteria have been met). A corresponding pop-up message ("Waiting for trigger") is generated if no trigger signal appears after approximately 2 sec. This message goes away when a trigger signal appears.
Backwards Compatibility Notes	The legacy command: :TRIGger[:SEQuence]:RFBurst:FSElectivity[:STATe] OFF ON 0 1 is not supported in the X-Series, as the hardware to do Frequency Selective burst triggers does not exist in X-Series.
Initial S/W Revision	Prior to A.02.00
Modified at S/W Revision	A.04.00

Absolute Trigger Level

Sets the absolute trigger level for the RF burst envelope.

When using the External Mixing path, the Absolute Trigger Level is uncalibrated because the factory default was set to accommodate the expected IF levels for the RF path.

Key Path	Trigger, RF Burst
Scope	Meas Global
Remote Command	:TRIGger[:SEQuence]:RFBurst:LEVel:ABSolute <amp1> :TRIGger[:SEQuence]:RFBurst:LEVel:ABSolute?
Example	TRIG:RFB:LEV:ABS 10 dBm sets the trigger level of the RF burst envelope signal to the absolute level of 10 dBm
Notes	Sending this command does not switch the setting from relative to absolute; to switch it you need to send the :TRIGger[:SEQuence]:RFBurst:LEVel:TYPE command, below. Amplitude Corrections are not taken into account by the Absolute Trigger Level. For example, if you have given yourself effective gain with an amplitude correction factor, the Absolute Trigger will not fire until you have set the trigger level that far below the displayed signal level, rather than simply to

	the displayed signal level. This is only true for Amplitude Corrections, not External Gain or Ref Level Offset functions. If mode is Bluetooth, the default value is -50 dBm.
Couplings	This same level is used for the RF Burst trigger source in the Trigger menu, for the RF Burst selection in the Periodic Timer sync source (in the Trigger menu and in the Gate Source menu), and also for the RF Burst selection in the Gate Source menu
Preset	-20 dBm
State Saved	Saved in instrument state
Min	-200 dBm
Max	100 dBm
Default Unit	depends on the current selected Y-Axis unit
Backwards Compatibility SCPI	:TRIGger[:SEquence]:FRAME:RFBurst:LEVel:ABSolute
Initial S/W Revision	Prior to A.02.00
Modified at S/W Revision	A.04.00

Key Path	Trigger, RF Burst
Remote Command	:TRIGger[:SEquence]:RFBurst:LEVel:TYPE ABSolute RELative :TRIGger[:SEquence]:RFBurst:LEVel:TYPE?
Example	TRIG:RFB:LEV:TYPE REL sets the trigger level type of the RF burst trigger to Relative.
Preset	ABSolute
State Saved	Saved in instrument state
Initial S/W Revision	Prior to A.02.00
Modified at S/W Revision	A.04.00

Relative Trigger Level

Sets the relative trigger level for the RF burst envelope.

In some models, the relative burst trigger function is implemented in hardware. In other models, without the advanced triggering hardware required, the relative burst trigger function is implemented in software in some measurements, and is unavailable in other measurements.

When implemented in software, the relative RF Burst trigger function is implemented as follows:

1. The measurement starts with the absolute RF Burst trigger setting. If it cannot get a trigger with that level, auto trigger fires and the acquisition starts anyway. After the acquisition, the measurement searches for the peak in the acquired waveform and saves it.

2. Now, in the next cycle of the measurement, the measurement determines a new absolute RF Burst level based on the peak value from the first measurement and the Relative RF Burst Trigger Level (always 0 or negative dB) set by the user. The following formula is used:
 3. absolute RF Burst level = peak level of the previous acquisition + relative RF Burst level
 4. If the new absolute RF Burst level differs from the previous by more than 0.5 dB, the new level is sent to the hardware; otherwise it is not updated (to avoid slowing down the acquisition)
- Steps 2 and 3 repeat for subsequent measurements.

Key Path	Trigger, RF Burst
Scope	Meas Global
Remote Command	:TRIGger[:SEquence]:RFBurst:LEVel:RELative <rel_ampl> :TRIGger[:SEquence]:RFBurst:LEVel:RELative?
Example	TRIG:RFB:LEV:REL -10 dB sets the trigger level of the RF burst envelope signal to the relative level of -10 dB
Notes	Sending this command does not switch the setting from absolute to relative; to switch it you need to send the :TRIGger[:SEquence]:RFBurst:LEVel:TYPE command, above. The relative trigger level is not available in some measurements. In those measurements the RELative parameter, and the :TRIGger[:SEquence]:RFBurst:LEVel:TYPE command (above), will generate an error if sent.
Dependencies	This key is grayed out and Absolute Trigger Level selected if the required hardware is not present in your analyzer and the current measurement does not support Relative triggering.
Preset	-6 dB GSM: -25 dB
State Saved	Saved in instrument state
Min	-45 dB
Max	0 dB
Default Unit	dB or dBc
Backwards Compatibility SCPI	:TRIGger[:SEquence]:RFBurst:LEVel This legacy command is aliased to :TRIGger[:SEquence]:RFBurst:LEVel:RELative because the PSA had ONLY relative burst triggering
Initial S/W Revision	Prior to A.02.00
Modified at S/W Revision	A.04.00

Trigger Slope

It is set positive to trigger on a rising edge and negative to trigger on a falling edge.

Key Path	Trigger, RF Burst
Remote Command	:TRIGger[:SEquence]:RFBurst:SLOPe Positive NEGative :TRIGger[:SEquence]:RFBurst:SLOPe?

Example	TRIG:RFB:SLOP NEG
Couplings	This same slope is used in the RF Burst selection for the trigger source in the Trigger menu and for the period timer sync source (in the Trigger menu and in the Gate Source menu).
Preset	POSitive
State Saved	Saved in instrument state
Backwards Compatibility SCPI	:TRIGger[:SEQuence]:FRAMe:RFBurst:SLOPe
Backwards Compatibility Notes	The legacy :TRIGger[:SEQuence]:SLOPe command affects the slopes for the VID, LINE, EXT1, EXT2, and RFB triggers.
Initial S/W Revision	Prior to A.02.00

Periodic Timer (Frame Trigger)

Pressing this key, when it is not selected, selects the internal periodic timer signal as the trigger. Triggering occurrences are set by the **Period** parameter, which is modified by the **Sync Source** and **Offset**. Pressing this key, when it is already selected, accesses the periodic timer trigger setup functions.

If you do not have a sync source selected (it is Off), then the internal timer will not be synchronized with any external timing events.

Key Path	Trigger
Example	TRIG:SOUR FRAM Swept SA measurement TRIG:<meas>:SOUR FRAM Measurements other than Swept SA
State Saved	Saved in instrument state
Readback	[Sync: <value of Sync Source>], for example, [Sync: External 1]
Status Bits/OPC dependencies	The Status Operation Register bit 5 "Waiting for Trigger" is set at the same time as the Sweeping or Measuring bit is set. It is cleared when the trigger actually occurs (that is, after the trigger event occurs and all the applicable trigger criteria have been met). A corresponding pop-up message ("Waiting for trigger") is generated if no trigger signal appears after approximately 2 sec. This message goes away when a trigger signal appears.
Initial S/W Revision	Prior to A.02.00

Periodic Timer Triggering:

This feature selects the internal periodic timer signal as the trigger. Trigger occurrences are set by the **Periodic Timer** parameter, which is modified by the **Sync Source** and **Offset**.

The figure below shows the action of the periodic timer trigger. Before reviewing the figure, we'll explain some uses for the periodic trigger.

A common application is measuring periodic burst RF signals for which a trigger signal is not easily available. For example, we might be measuring a TDMA radio which bursts every 20 ms. Let's assume that the 20 ms period is very consistent. Let's also assume that we do not have an external trigger source

available that is synchronized with the period, and that the signal-to-noise ratio of the signal is not high enough to provide a clean RF burst trigger at all of the analysis frequencies. For example, we might want to measure spurious transmissions at an offset from the carrier that is larger than the bandwidth of the RF burst trigger. In this application, we can set the Periodic Timer to a 20.00 ms period and adjust the offset from that timer to position our trigger just where we want it. If we find that the 20.00 ms is not exactly right, we can adjust the period slightly to minimize the drift between the period timer and the signal to be measured.

A second way to use this feature would be to use **Sync Source** temporarily, instead of **Offset**. In this case, we might tune to the signal in a narrow span and use the RF Burst trigger to synchronize the periodic timer. Then we would turn the sync source off so that it would not miss-trigger. Miss-triggering can occur when we are tuned so far away from the RF burst trigger that it is no longer reliable.

A third example would be to synchronize to a signal that has a reference time element of much longer period than the period of interest. In some CDMA applications, it is useful to look at signals with a short periodicity, by synchronizing that periodicity to the "even-second clock" edge that happens every two seconds. Thus, we could connect the even-second clock trigger to Ext1 and use then Ext1 as the sync source for the periodic timer.

The figure below illustrates this third example. The top trace represents the even-second clock. It causes the periodic timer to synchronize with the leading edge shown. The analyzer trigger occurs at a time delayed by the accumulated offset from the period trigger event. The periodic timer continues to run, and triggers continue to occur, with a periodicity determined by the analyzer time base. The timer output (labeled "late event") will drift away from its ideal time due to imperfect matching between the time base of the signal being measured and the time base of the analyzer, and also because of imperfect setting of the period parameter. But the synchronization is restored on the next even-second clock event. ("Accumulated offset" is described in the in the **Offset** function section.)

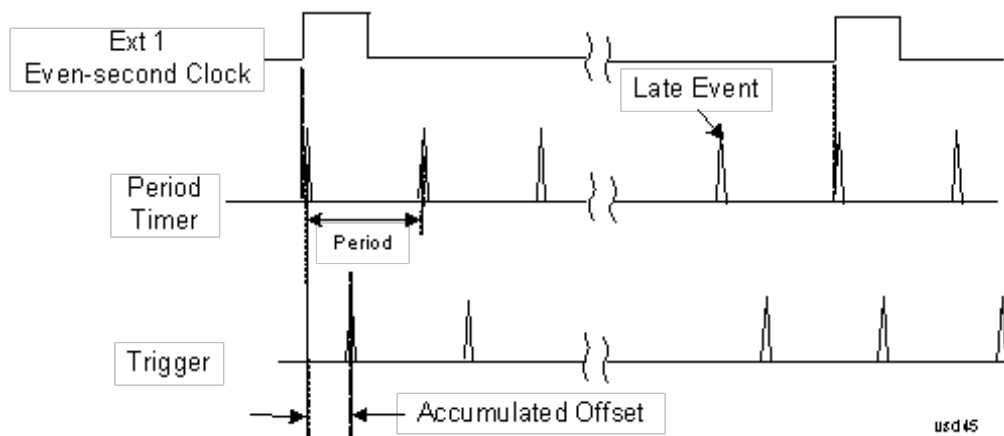

Period

Sets the period of the internal periodic timer clock. For digital communications signals, this is usually set to the frame period of your current input signal. In the case that sync source is not set to OFF, and the external sync source rate is changed for some reason, the periodic timer is synchronized at the every external synchronization pulse by resetting the internal state of the timer circuit.

Key Path	Trigger, Periodic Timer
Remote Command	:TRIGger[:SEquence]:FRAMe:PERIOD <time>

	:TRIGger[:SEquence]:FRAMe:PERiod?
Example	TRIG:FRAM:PER 100 ms
Dependencies	The invalid data indicator turns on when the period is changed, until the next sweep/measurement completes.
Couplings	The same period is used in the Gate Source selection of the period timer.
Preset	20 ms GSM: 4.615383
State Saved	Saved in instrument state
Min	100.000 ns
Max	559.0000 ms
Default Unit	S
Initial S/W Revision	Prior to A.02.00

Offset

Adjusts the accumulated offset between the periodic timer events and the trigger event. Adjusting the accumulated offset is different than setting an offset, and requires explanation.

The periodic timer is usually not synchronized with any external events, so the timing of its output events has no absolute meaning. Since the timing relative to external events (RF signals) is important, you need to be able to adjust (offset) it. However, you have no direct way to see when the periodic timer events occur. All that you can see is the trigger timing. When you want to adjust the trigger timing, you will be changing the internal offset between the periodic timer events and the trigger event. Because the absolute value of that internal offset is unknown, we will just call that the accumulated offset. Whenever the Offset parameter is changed, you are changing that accumulated offset. You can reset the displayed offset using Reset Offset Display. Changing the display does not change the value of the accumulated offset, and you can still make additional changes to accumulated offset.

To avoid ambiguity, we define that an increase in the "offset" parameter, either from the knob or the SCPI adjust command, serves to delay the timing of the trigger event.

Key Path	Trigger, Periodic Timer
Remote Command	:TRIGger[:SEquence]:FRAMe:OFFSet <time> :TRIGger[:SEquence]:FRAMe:OFFSet?
Example	TRIG:FRAM:OFFS 1.2 ms
Notes	The front panel interface (for example, the knob), and this command, adjust the accumulated offset, which is shown on the active function display. However, the actual amount sent to the hardware each time the offset is updated is the delta value, that is, the current accumulated offset value minus the previous accumulated offset value. Note that the accumulated offset value is essentially arbitrary; it represents the accumulated offset from the last time the offset was zeroed (with the Reset Offset Display key). Note that this command does not change the period of the trigger waveform. Note also that Offset is used only when the sync source is set to OFF, otherwise delay is used, see section "Trig Delay" on page 460.

	An increase in the "offset" parameter, either from the knob or the SCPI adjust command, serves to delay the timing of the trigger event.
Notes	When the SCPI command is sent the value shown on the key (and the Active Function, if this happens to be the active function) is updated with the new value. However, the actual amount sent to the hardware is the delta value, that is, the current accumulated offset value minus the previous accumulated offset value. The SCPI query simply returns the value currently showing on the key.
Dependencies	The invalid data indicator turns on when the offset is changed, until the next sweep/measurement completes.
Couplings	The same offset is used in the Gate Source selection of the period timer.
Preset	0 s
State Saved	Saved in instrument state
Min	-10.000 s
Max	10.000 s
Default Unit	S
Initial S/W Revision	Prior to A.02.00

Offset Adjust (Remote Command Only)

This remote command does not work at all like the related front panel keys. This command lets you advance the phase of the frame trigger by the amount you specify.

It does not change the period of the trigger waveform. If the command is sent multiple times, it advances the phase of the frame trigger an additional amount each time it is sent. Negative numbers are permitted.

Remote Command	:TRIGger[:SEquence]:FRAMe:ADJust <time>
Example	TRIG:FRAM:ADJ 1.2 ms
Notes	Note also that Offset is used only when the sync source is set to OFF, otherwise delay is used, see section " Trig Delay " on page 460 An increase in the "offset" parameter, either from the knob or the SCPI adjust command, serves to delay the timing of the trigger event.
Notes	The front panel interface (for example, the knob) and the :TRIG:FRAM:OFFS command adjust the accumulated offset, which is shown on the active function display. However, the actual amount sent to the hardware is the delta value, that is, the current offset value minus the previous offset value. When the SCPI command is sent the value shown on the key (and the Active Function, if this happens to be the active function) is updated by increasing it (or decreasing it if the value sent is negative) by the amount specified in the SCPI command. This is a "command only" SCPI command, with no query.
Dependencies	The invalid data indicator turns on when the offset is changed, until the next sweep/measurement completes.
Couplings	The same offset is used in the Gate Source selection of the period timer.
Preset	0 s

State Saved	Saved in instrument state
Min	-10.000 s
Max	10.000 s
Default Unit	S
Initial S/W Revision	Prior to A.02.00

Reset Offset Display

Resets the value of the periodic trigger offset display setting to 0.0 seconds. The current displayed trigger location may include an offset value defined with the Offset key. Pressing this key redefines the currently displayed trigger location as the new trigger point that is 0.0 s offset. The Offset key can then be used to add offset relative to this new timing.

Key Path	Trigger, Periodic Timer
Remote Command	:TRIGger[:SEquence]:FRAMe:OFFSet:DISPlay:RESet
Example	TRIG:FRAM:OFFS:DISP:RES
Initial S/W Revision	Prior to A.02.00

Sync Source

Selects a signal source for you to synchronize your periodic timer trigger to, otherwise you are triggering at some arbitrary location in the frame. Synchronization reduces the precision requirements on the setting of the period.

For convenience you may adjust the level and slope of the selected sync source in a conditional branch setup menu accessed from the Sync Source menu. Note that these settings match those in the **Trigger** and **Gate Source** menus; that is, each trigger source has only one value of level and slope, regardless of which menu it is accessed from.

Key Path	Trigger, Periodic Timer
Remote Command	:TRIGger[:SEquence]:FRAMe:SYNC EXTernal1 EXTernal2 RFBurst OFF :TRIGger[:SEquence]:FRAMe:SYNC?
Example	TRIG:FRAM:SYNC EXT2
Dependencies	In some models, there is no second External input. In these models, the External 2 key is blanked and the EXTernal2 parameter will generate a "Hardware missing; Not available for this model number" message.
Preset	Off GSM/EDGE, MSR,LTE,LTETDD: RFBurst
State Saved	Saved in instrument state
Readback	The current setting is read back to this key and it is also Readback to the previous Periodic Timer trigger key.

Backwards Compatibility SCPI	:TRIGger[:SEquence]:FRAMe:SYNC EXTernal
Initial S/W Revision	Prior to A.02.00
Modified at S/W Revision	A.03.00, A.14.00

Off

Turns off the sync source for your periodic trigger. With the sync source off, the timing will drift unless the signal source frequency is locked to the analyzer frequency reference.

Key Path	Trigger, Periodic Timer, Sync Source
Example	TRIG:FRAM:SYNC OFF
Readback	Off
Initial S/W Revision	Prior to A.02.00

External 1

Pressing this key, when it is not selected, selects an external input signal as the trigger. A new sweep/measurement will start when the external trigger condition is met using the external 1 input connector on the rear panel.

Pressing this key, when it is already selected, accesses the external 1 trigger setup menu.

Key Path	Trigger
Example	TRIG:SOUR EXT1 Swept SA measurement TRIG:<meas>:SOUR EXT1 Measurements other than Swept SA
Dependencies	Grayed out if in use by Point Trigger in the Source Setup menu. Forced to Free Run if already selected and Point Trigger is set to External 1.
State Saved	Saved in instrument state
Status Bits/OPC dependencies	The Status Operation Register bit 5 "Waiting for Trigger" is set at the same time as the Sweeping or Measuring bit is set. It is cleared when the trigger actually occurs (that is, after the trigger event occurs and all the applicable trigger criteria have been met). A corresponding pop-up message ("Waiting for trigger") is generated if no trigger signal appears after approximately 2 sec. This message goes away when a trigger signal appears.
Initial S/W Revision	Prior to A.02.00

Trigger Level

Sets the value where the external 1 trigger input will trigger a new sweep/measurement.

Key Path	Trigger, External 1
Remote Command	:TRIGger[:SEquence]:EXTernal1:LEVel <level> :TRIGger[:SEquence]:EXTernal1:LEVel?
Example	TRIG:EXT1:LEV 0.4 V
Couplings	This same level is used for the Ext1 trigger source in the Trigger menu, for the Ext1 selection in the Periodic Timer sync source (in the Trigger menu and in the Gate Source menu), and also for the Ext1 selection in the Gate Source menu.
Preset	1.2 V
State Saved	Saved in instrument state
Min	-5 V
Max	5 V
Default Unit	V
Backwards Compatibility SCPI	:TRIGger[:SEquence]:EXTernal:LEVel For backward compatibility, the parameter EXTernal is mapped to EXTernal1
Backwards Compatibility SCPI	:TRIGger[:SEquence]:FRAMe:EXTernal1:LEVel
Initial S/W Revision	Prior to A.02.00

Trig Slope

Controls the trigger polarity. It is set positive to trigger on a rising edge and negative to trigger on a falling edge.

Key Path	Trigger, External 1
Remote Command	:TRIGger[:SEquence]:EXTernal1:SLOPe POSitive NEGative :TRIGger[:SEquence]:EXTernal1:SLOPe?
Example	TRIG:EXT1:SLOP NEG
Couplings	This same slope is used in the Ext1 selection for the trigger source in the Trigger menu and for the period timer sync source (in the Trigger menu and in the Gate Source menu).
Preset	POSitive
State Saved	Saved in instrument state
Backwards Compatibility SCPI	:TRIGger[:SEquence]:EXTernal:SLOPe For backward compatibility, the parameter EXTernal is mapped to EXTernal1
Backwards Compatibility SCPI	:TRIGger[:SEquence]:FRAMe:EXTernal1:SLOPe
Backwards Compatibility Notes	The legacy :TRIGger[:SEquence]:SLOPe command affects the slopes for the VID, LINE, EXT1, EXT2, and RFB triggers.
Initial S/W Revision	Prior to A.02.00

External 2

Pressing this key, when it is not selected, selects an external input signal as the trigger. A new sweep/measurement will start when the external trigger condition is met using the external 2 input connector. The external trigger 2 input connector is on the rear panel.

Pressing this key, when it is already selected, accesses the external 2 trigger setup menu.

Key Path	Trigger
Example	TRIG:SOUR EXT2 Swept SA measurement TRIG:<meas>:SOUR EXT2 Measurements other than Swept SA
Dependencies	In some models, there is no second External input. In these models, the External 2 key is blanked and the EXTernal2 parameter will generate a "Hardware missing; Not available for this model number" message. Grayed out if in use by Point Trigger in the Source Setup menu. Forced to Free Run if already selected and Point Trigger is set to External 2.
State Saved	Saved in instrument state
Status Bits/OPC dependencies	The Status Operation Register bit 5 "Waiting for Trigger" is set at the same time as the Sweeping or Measuring bit is set. It is cleared when the trigger actually occurs (that is, after the trigger event occurs and all the applicable trigger criteria have been met). A corresponding pop-up message ("Waiting for trigger") is generated if no trigger signal appears after approximately 2 sec. This message goes away when a trigger signal appears.
Initial S/W Revision	Prior to A.02.00
Modified at S/W Revision	A.03.00

Trigger Level

Sets the value where the external 2 trigger input will trigger a new sweep/measurement.

Key Path	Trigger, External 2
Remote Command	:TRIGger[:SEquence]:EXTernal2:LEVel :TRIGger[:SEquence]:EXTernal2:LEVel?
Example	TRIG:EXT2:LEV 1.1 V
Couplings	This same level is used for the Ext2 trigger source in the Trigger menu, for the Ext2 selection in the Periodic Timer sync source (in the Trigger menu and in the Gate Source menu), and also for the Ext2 selection in the Gate Source menu.
Preset	1.2 V
State Saved	Saved in instrument state
Min	-5 V
Max	5 V
Default Unit	V
Backwards Compatibility SCPI	:TRIGger[:SEquence]:FRAMe:EXTernal2:LEVel
Initial S/W Revision	Prior to A.02.00

Trig Slope

Controls the trigger polarity. It is set positive to trigger on a rising edge and negative to trigger on a falling edge.

Key Path	Trigger, External 2
Remote Command	:TRIGger[:SEQuence]:EXTernal2:SLOPe POSitive NEGative :TRIGger[:SEQuence]:EXTernal2:SLOPe?
Example	TRIG:EXT2:SLOP NEG
Couplings	This same slope is used in the Ext2 selection for the trigger source in the Trigger menu and for the period timer sync source (in the Trigger menu and in the Gate Source menu).
Preset	POSitive
State Saved	Saved in instrument state
Backwards Compatibility SCPI	:TRIGger[:SEQuence]:FRAMe:EXTernal2:SLOPe
Backwards Compatibility Notes	The legacy :TRIGger[:SEQuence]:SLOPe command affects the slopes for the VID, LINE, EXT1, EXT2, and RFB triggers.
Initial S/W Revision	Prior to A.02.00

RF Burst

Pressing this key, when it is not selected, selects the RF Burst as the trigger. A new sweep/measurement will start when an RF burst envelope signal is identified from the signal at the RF Input connector. Pressing this key, when it is already selected, accesses the RF Burst trigger setup menu.

In some models, a variety of burst trigger circuitry is available, resulting in various available burst trigger bandwidths. The analyzer automatically chooses the appropriate trigger path based on the hardware configuration and other settings of the analyzer.

Key Path	Trigger
Example	TRIG:SOUR RFB Swept SA measurement TRIG:< meas>:SOUR RFB Measurements other than Swept SA
State Saved	Saved in instrument state
Status Bits/OPC dependencies	The Status Operation Register bit 5 "Waiting for Trigger" is set at the same time as the Sweeping or Measuring bit is set. It is cleared when the trigger actually occurs (that is, after the trigger event occurs and all the applicable trigger criteria have been met). A corresponding pop-up message ("Waiting for trigger") is generated if no trigger signal appears after approximately 2 sec. This message goes away when a trigger signal appears.
Backwards Compatibility Notes	The legacy command: :TRIGger[:SEQuence]:RFBurst:FSElectivity[:STATe] OFF ON 0 1 is not supported in the X-Series, as the hardware to do Frequency Selective burst triggers does not exist in X-Series.

Initial S/W Revision	Prior to A.02.00
Modified at S/W Revision	A.04.00

Absolute Trigger Level

Sets the absolute trigger level for the RF burst envelope.

When using the External Mixing path, the Absolute Trigger Level is uncalibrated because the factory default was set to accommodate the expected IF levels for the RF path.

Key Path	Trigger, RF Burst
Scope	Meas Global
Remote Command	:TRIGger[:SEquence]:RFBurst:LEVel:ABSolute <ampl> :TRIGger[:SEquence]:RFBurst:LEVel:ABSolute?
Example	TRIG:RFB:LEV:ABS 10 dBm sets the trigger level of the RF burst envelope signal to the absolute level of 10 dBm
Notes	Sending this command does not switch the setting from relative to absolute; to switch it you need to send the :TRIGger[:SEquence]:RFBurst:LEVel:TYPE command, below. Amplitude Corrections are not taken into account by the Absolute Trigger Level. For example, if you have given yourself effective gain with an amplitude correction factor, the Absolute Trigger will not fire until you have set the trigger level that far below the displayed signal level, rather than simply to the displayed signal level. This is only true for Amplitude Corrections, not External Gain or Ref Level Offset functions. If mode is Bluetooth, the default value is -50 dBm.
Couplings	This same level is used for the RF Burst trigger source in the Trigger menu, for the RF Burst selection in the Periodic Timer sync source (in the Trigger menu and in the Gate Source menu), and also for the RF Burst selection in the Gate Source menu
Preset	-20 dBm
State Saved	Saved in instrument state
Min	-200 dBm
Max	100 dBm
Default Unit	depends on the current selected Y-Axis unit
Backwards Compatibility SCPI	:TRIGger[:SEquence]:FRAME:RFBurst:LEVel:ABSolute
Initial S/W Revision	Prior to A.02.00
Modified at S/W Revision	A.04.00

Key Path	Trigger, RF Burst
Remote Command	:TRIGger[:SEquence]:RFBurst:LEVel:TYPE ABSolute RELative :TRIGger[:SEquence]:RFBurst:LEVel:TYPE?

Example	TRIG:RFB:LEV:TYPE REL sets the trigger level type of the RF burst trigger to Relative.
Preset	ABSolute
State Saved	Saved in instrument state
Initial S/W Revision	Prior to A.02.00
Modified at S/W Revision	A.04.00

Trigger Slope

It is set positive to trigger on a rising edge and negative to trigger on a falling edge.

Key Path	Trigger, RF Burst
Remote Command	:TRIGger[:SEquence]:RFBurst:SLOPe POSitive NEGative :TRIGger[:SEquence]:RFBurst:SLOPe?
Example	TRIG:RFB:SLOP NEG
Couplings	This same slope is used in the RF Burst selection for the trigger source in the Trigger menu and for the period timer sync source (in the Trigger menu and in the Gate Source menu).
Preset	POSitive
State Saved	Saved in instrument state
Backwards Compatibility SCPI	:TRIGger[:SEquence]:FRAME:RFBurst:SLOPe
Backwards Compatibility Notes	The legacy :TRIGger[:SEquence]:SLOPe command affects the slopes for the VID, LINE, EXT1, EXT2, and RFB triggers.
Initial S/W Revision	Prior to A.02.00

Sync Holdoff

Sync Holdoff specifies the duration that the sync source signal must be kept false before the transition to true to be recognized as the sync timing. The periodic timer phase is aligned when the sync source signal becomes true, after the Holdoff time is satisfied.

A holdoff of 2 ms will work with most WiMAX signals, but there may be cases where the burst off duration is less than 1 ms and this value will need to be changed.

Key Path	Trigger, Periodic Timer
Remote Command	:TRIGger[:SEquence]:FRAME:SYNC:HOLDoff <time> :TRIGger[:SEquence]:FRAME:SYNC:HOLDoff? :TRIGger[:SEquence]:FRAME:SYNC:HOLDoff:STATE OFF ON 0 1 :TRIGger[:SEquence]:FRAME:SYNC:HOLDoff:STATE?
Preset	On, 1.000 ms

State Saved	Saved in instrument state
Min	0 ms
Max	+500 ms
Default Unit	s
Initial S/W Revision	Prior to A.02.00

Control Edge/Level

Sets the method of controlling the gating function from the gating signal.

Edge

In Edge triggering, the gate opens (after the Delay) on the selected edge (for example, positive) of the gate signal and closes on the alternate edge (for example, negative).

Level

In Level triggering, the gate opens (after the Delay) when the gate signal has achieved a certain level and stays open as long as that level is maintained.

Key Path	Sweep/Control, Gate
Remote Command	[:SENSe] :SWEep:EGATe:CONTRol EDGE LEVe1 [:SENSe] :SWEep:EGATe:CONTRol?
Example	SWE:EGAT:CONT EDGE
Dependencies	If the Gate Method is FFT the Control key is grayed out and Edge is selected. If the Gate Source is TV, Frame or Line, the Control key is grayed out and Edge is selected.
Preset	EDGE
State Saved	Saved in instrument state
Backwards Compatibility SCPI	[:SENSe] :SWEep:TIME:GATE:TYPE ESA Compatibility
Initial S/W Revision	Prior to A.02.00

Gate Holdoff

Lets you increase or decrease the wait time after a gate event ends before the analyzer will respond to the next gate signal.

After any Gate event finishes, the analyzer must wait for the sweep system to settle before it can respond to another Gate signal. The analyzer calculates a "wait time," taking into account a number of factors, including RBW and Phase Noise Optimization settings. The goal is to achieve the same accuracy when gated as in ungated operation. The figure below illustrates this concept:

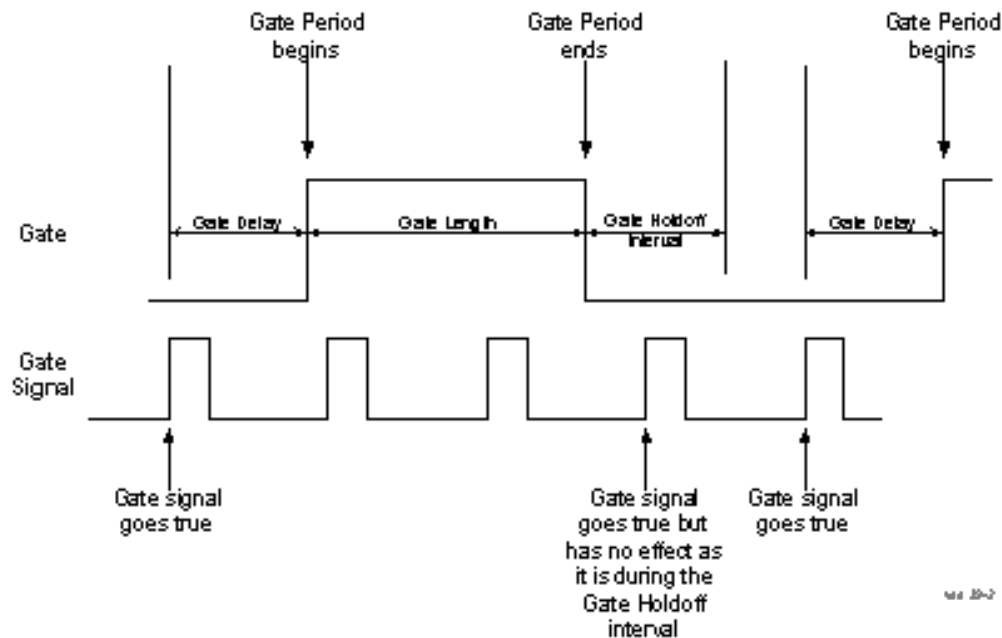

When Gate Holdoff is in Auto, the wait time calculated by the analyzer is used. When Gate Time is in Manual, the user may adjust the wait time, usually decreasing it in order to achieve greater speed, but at the risk of decreasing accuracy.

When the Method key is set to Video or FFT, the Gate Holdoff function has no effect.

In measurements that do not support Auto, the value shown when Auto is selected is “---” and the manually set holdoff is returned to a query.

Key Path	Sweep/Control, Gate
Remote Command	<pre>[:SENSe] :SWEep:EGATe:HOLDoff <time> [:SENSe] :SWEep:EGATe:HOLDoff? [:SENSe] :SWEep:EGATe:HOLDoff:AUTO OFF ON 0 1 [:SENSe] :SWEep:EGATe:HOLDoff:AUTO?</pre>
Example	<pre>SWE:EGAT:HOLD 0.0002 SWE:EGAT:HOLD? SWE:EGAT:HOLD:AUTO ON SWE:EGAT:HOLD:AUTO?</pre>
Couplings	<p>When Gate Holdoff is Auto, the Gate Holdoff key shows the value calculated by the analyzer for the wait time.</p> <p>Pressing the Gate Holdoff key while it is in Auto and not selected, causes the key to become selected and allows the user to adjust the value. If the value is adjusted, the setting changes to Man.</p> <p>Pressing the Gate Holdoff key, while it is in Auto and selected, does not change the value of Gate Holdoff, but causes the setting to change to Man. Now the user can adjust the value.</p> <p>Pressing the key while it is in Man and selected, cause the value to change back to Auto.</p> <p>Pressing the key while it is in Man and not selected, causes the key to become selected and allows the user to adjust the value.</p>

	When Method is set to Video or FFT, the Gate Holdoff function has no effect.
Preset	Auto Auto/On
State Saved	Saved in instrument state
Min	1 μ sec
Max	1 sec
Initial S/W Revision	Prior to A.02.00

Gate Delay Compensation

This function allows you to select an RBW-dependent value by which to adjust the gate delay, to compensate for changes in the delay caused by RBW effects.

You can select between uncompensated operation and two types of compensation, Delay Until RBW Settled and Compensate for RBW Group Delay.

See "[More Information](#)" on page 628

Key Path	Sweep/Control, Gate
Scope	Meas Global
Remote Command	[:SENSe] :SWEep:EGATe:DELaY:COMPensation:TYPE OFF SETTled GDELaY [:SENSe] :SWEep:EGATe:DELaY:COMPensation:TYPE?
Example	SWE:EGAT:DEL:COMP:TYPE SETT SWE:EGAT:DEL:COMP:TYPE?
Notes	Although this function is Meas Global, there are some measurements that do not support this function. In those measurements the operation will be Uncompensated. Going into one of those measurements will not change the Meas Global selection; it will simply display the grayed-out menu key with "Uncompensated" showing as the selection. This is a non-forceful grayout, so the SCPI command is still accepted. If Gate Delay Compensation is not supported at all within a particular mode, the key is not displayed, and if the SCPI command is sent while in a measurement within that mode, an "Undefined Header" message is generated. Measurements that do not support this function include: Swept SA
Preset	TD-SCDMA mode: Compensate for RBW Group Delay All other modes: Delay Until RBW Settled
State Saved	Saved in instrument state
Range	Uncompensated Delay Until RBW Settled Compensate for RBW Group Delay
Readback text	Uncompensated Settled Group Delay
Initial S/W Revision	Prior to A.02.00
Modified at S/W Revision	A.11.0

More Information

Selecting Uncompensated means that the actual gate delay is as you sets it.

Selecting Delay Until RBW Settled causes the gate delay to be increased above the user setting by an amount equal to $3.06/\text{RBW}$. This compensated delay causes the GATE START and GATE STOP lines on the display to move by the compensation amount, and the actual hardware gate delay to be increased by the same amount. All the other gate lines (for example, MIN FAST) are unaffected. If the RBW subsequently changes, the compensation is readjusted for the new RBW. The value shown on the Gate Delay key does NOT change.

Delay Until RBW Settled allows excellent measurements of gated signals, by allowing the IF to settle following any transient that affects the burst. Excellent measurements also require that the analysis region not extend into the region affected by the falling edge of the burst. Thus, excellent measurements can only be made over a width that declines with narrowing RBWs, which is achieved by decreasing the gate length below the user setting by an amount equal to $2.53/\text{RBW}$. Therefore, for general purpose compensation, you will still want to change the gate length with changes in RBW even if the gate delay is compensated. The compensated Gate Length is limited by the analyzer so that it will never go below 10% of the value shown on the Gate Length key, as otherwise the sweep times could get very long. Anytime the Gate Length and RBW values combine in such a way that this limiting takes place, a warning is displayed. For measurements which contain multiple sweeps with different RBW like SEM and SPUR, the smallest RBW is used for this limiting.

Selecting Compensate for RBW Group Delay causes the gate delay to be increased above the user setting by an amount equal to $1.81/\text{RBW}$. This compensated delay causes the GATE START, GATE STOP lines on the display to move by the compensation amount, and the actual hardware gate delay to be increased by the same amount. All the other gate lines (for example, MIN FAST) are unaffected. If the RBW subsequently changes, the compensation is readjusted for the new RBW. The value shown on the Gate Delay key does NOT change. Compensate for RBW Group Delay also includes gate length compensation; the gate length itself is adjusted as necessary to attempt to compensate for delay effects imposed by the RBW.

Compensate for RBW Group Delay is similar to Delay Until RBW Settled, but compensates for the group delay of the RBW filter, rather than the filter settling time. As the RBW gets narrow, this can allow the settling tail of the RBW to affect the beginning part of the gated measurement, and allow the beginning of the RBW settling transient to affect the end of the gated measurement. These two effects are symmetric because the RBW response is symmetric. Because the gate length is not automatically compensated, some users might find this compensation to be more intuitive than compensation for RBW settling.

Min Fast Position Query (Remote Command Only)

This command queries the position of the MIN FAST line, relative to the delay reference (REF) line. See section ["Gate View On/Off" on page 2098](#). If this query is sent while not in gate view, the MinFast calculation is performed based on the current values of the appropriate parameters and the result is returned. Knowing this value lets you set an optimal gate delay value for the current measurement setup.

Remote Command	<code>[:SENSe] :SWEep:EGATe:MINFast?</code>
Example	<code>SWE:EGAT:MIN?</code>
Initial S/W Revision	Prior to A.02.00

Gate Preset (Remote Command Only)

Presets the time-gated spectrum analysis capability.

This command sets gate parameter values to the ESA preset values, as follows:

Gate trigger type = edge

Gate polarity = positive

Gate delay = 1 us

Gate length = 1 us

Remote Command	<code>[[:SENSe]:SWEep:TIME:GATE:PRESet</code> ESA Compatibility
Initial S/W Revision	Prior to A.02.00

Gate Level (Remote Command Only)

Sets the gate input transition point level for the external TRIGGER inputs on the front and rear panel. This is a legacy command for PSA compatibility. It is simply an alias to the equivalent trigger level command.

Remote Command	<code>[[:SENSe]:SWEep:EGATE:EXTernal[1] 2:LEVel <voltage></code> <code>[[:SENSe]:SWEep:EGATE:EXTernal[1] 2:LEVel?</code>
Notes	This command is simply an alias to <code>:TRIGger[:SEQUence]:EXTernal[1] 2:LEVel</code> For details refer
Initial S/W Revision	Prior to A.02.00

Gate Polarity (Remote Command Only)

Sets the polarity for the gate signal. This setup is now done using the gate trigger's slope setting.

When Positive (Pos) is selected, a positive-going edge (Edge) or a high voltage (Level) will satisfy the gate condition, after the delay set with the Gate Delay key. When Negative (Neg) is selected, a negative-going edge (Edge) or a low voltage (Level) will satisfy the gate condition after the delay.

Remote Command	<code>[[:SENSe]:SWEep:EGATE:POLarity</code> NEGative POSitive <code>[[:SENSe]:SWEep:EGATE:POLarity?</code>
Example	<code>SWE:EGAT:POL NEG</code> <code>SWE:EGAT:POL?</code>
Preset	POSitive
State Saved	Saved in instrument state
Backwards Compatibility SCPI	<code>[[:SENSe]:SWEep:TIME:GATE:POLarity</code> ESA compatibility
Initial S/W Revision	Prior to A.02.00

Remote Command	<code>[:SENSe] :SWEep:TIME:GATE:LEVel HIGH LOW</code> <code>[:SENSe] :SWEep:TIME:GATE:LEVel?</code> ESA compatibility
Preset	HIGH
Initial S/W Revision	Prior to A.02.00

Points

Sets the number of points per sweep. The resolution of setting the sweep time depends on the number of points selected. If Preset is selected, the number of points per sweep defaults to 1001. The current value of points is displayed parenthetically, next to the sweep time in the lower-right corner of the display.

Changing the number of points has several effects on the analyzer. Since markers are read at the point location, the marker reading may change. All trace data is cleared.

Key Path	Sweep/Control
Mode	SA, WCDMA, C2K, WIMAX OFDMA, 1xEVDO, DVB-T/H, DTMB (CTTB), ISDB-T, CMMB, LTE, LTETDD, Digital Cable TV, WLAN, MSR, LTEAFDD, LTEATDD
Remote Command	<code>[:SENSe] :CHPower:SWEep:POINts <integer></code> <code>[:SENSe] :CHPower:SWEep:POINts?</code>
Example	CHP:SWE:POIN 501 CHP:SWE:POIN?
Notes	Whenever the number of sweep points changes: All trace data is erased Any traces with Update Off also go to Display Off (like going from View to Blank in the older analyzers) Sweep time is re-quantized Any limit lines that are on are updated If averaging/hold is on, averaging/hold starts over
Couplings	Whenever the number of sweep points changes, the sweep time is re-quantized.
Preset	DVB-T/H: 2001 DTMB (CTTB): 2001 Other: 1001 ISDB-T: 2001 CMMB: 2001 1xEVDO: 512 Digital Cable TV: 2001
State Saved	Saved in instrument state.
Min	101

Max	20001
Initial S/W Revision	Prior to A.02.00
Modified at S/W Revision	A.02.00, A.03.00

System

See ["System" on page 353](#)

Trace/Detector

Accesses a menu of functions that enable you to control the detectors for the current measurement.

Key Path	Front-panel key
Initial S/W Revision	Prior to A.02.00

Trace Type

Allows you to select the type of trace you want to use for the current measurement. The first page of this menu contains a 1-of-N selection of the trace type (Clear Write, Average, Max Hold, Min Hold) for the selected trace.

Key Path	Trace/Detector
Mode	SA, WCDMA, C2K, WIMAX OFDMA, 1xEVDO, DVB-T/H, DTMB (CTTB), ISDB-T, CMMB, LTE, LTETDD, Digital Cable TV, WLAN, MSR, LTEAFDD, LTEATDD
Remote Command	:TRACe:CHPower:TYPE WRITe AVERAge MAXHold MINHold :TRACe:CHPower:TYPE?
Example	TRAC:CHP:TYPE WRIT TRAC:CHP:TYPE?
Notes	WRITe = Clear Write AVERAge = Average MAXHold = Maximum Hold MINHold = Minimum Hold
Couplings	When Detector setting is "Auto" ([:SENSe]:CHPower:DETECTOR:AUTO?), Detector ([:SENSe]:CHPower:DETECTOR[:FUNction]?) switches aligning with the switch of this parameter: "NORMal" with WRITe (Clear Write), "AVERAge" with AVERAge, "POSitive (peak)" with MAXHold, and "NEGative (peak)" with MINHold.
Preset	AVERAge
State Saved	Saved in instrument state.
Range	ClearWrite Average MaxHold MinHold
Initial S/W Revision	Prior to A.02.00
Modified at S/W Revision	A.02.00, A.03.00

Detector

Accesses a menu of functions that enable you to control the detectors for the current measurement. The following choices are available:

- Auto– the detector selected depends on marker functions, trace functions, average type, and the trace averaging function.

- Normal—the detector determines the peak of the CW-like signals, and it yields alternating maximums and minimums of noise-like signals. This is also referred to as Rosenfell detection.
- Average—the detector determines the average of the signal within the sweep points. The averaging method depends upon the Average Type selection (voltage, power or log scales).
- Peak—the detector determines the maximum of the signal within the sweep points.
- Sample—the detector indicates the instantaneous level of the signal at the center of the sweep points represented by each display point.
- Negative Peak—the detector determines the minimum of the signal within the sweep points.

Key Path	Detector
Initial S/W Revision	Prior to A.02.00

Auto

Sets the detector for the currently selected trace to Auto.

Key Path	Trace/Detector
Mode	SA, WCDMA, C2K, WIMAX OFDMA, 1xEVDO, DVB-T/H, DTMB (CTTB), ISDB-T, CMMB, LTE, LTETDD, Digital Cable TV, WLAN, MSR, LTEAFDD, LTEATDD
Remote Command	[[:SENSe]:CHPower:DETECTOR:AUTO ON OFF 1 0 [:SENSe]:CHPower:DETECTOR:AUTO?
Example	CHP:DET:AUTO ON CHP:DET:AUTO?
Couplings	When Detector setting is “Auto” ([[:SENSe]:CHPower:DETECTOR:AUTO?]), Detector ([[:SENSe]:CHPower:DETECTOR:FUNCTION?]) switches aligning with the switch of this parameter: “NORMal” with Clear Write, “AVERage” with AVERage, “POSitive (peak)” with MAXHold, and “NEGative (peak)” with MINHold.
Preset	Others: ON DVB-T/H, DTMB (CTTB), ISDB-T, CMMB, Digital Cable TV: OFF
State Saved	Saved in instrument state.
Initial S/W Revision	Prior to A.02.00
Modified at S/W Revision	A.02.00, A.03.00

Detector Selection

Selects a detector to be used by the analyzer for the current measurement.

Key Path	Trace/Detector
Mode	SA, WCDMA, C2K, WIMAX OFDMA, 1xEVDO, DVB-T/H, DTMB (CTTB), ISDB-T, CMMB, LTE, LTETDD, Digital Cable TV, WLAN, MSR, LTEAFDD, LTEATDD

Remote Command	[:SENSe]:CHPower:DETEctor[:FUNction] NORMal AVERAge POSitive SAMPle NEGative [:SENSe]:CHPower:DETEctor[:FUNction]?
Example	CHP:DET NORM CHP:DET?
Notes	<p>When you manually select a detector (instead of selecting Auto), that detector is used regardless of other analyzer settings.</p> <p>The Normal detector determines the peak of CW-like signals, and it yields alternating maximums and minimums of noise-like signals. This method of detection is also referred to as Rosenfell detection.</p> <p>The Average detector determines the average of the signal within the sweep points. The averaging method is Power Average (RMS).</p> <p>The Peak detector determines the maximum of the signal within the sweep points.</p> <p>The Sample detector indicates the instantaneous level of the signal at the center of the sweep points represented by each display point.</p> <p>The Negative Peak detector determines the minimum of the signal within the sweep points.</p>
Couplings	When Detector setting is "Auto" ([:SENSe]:CHPower:DETEctor:AUTO?), Detector ([:SENSe]:CHPower:DETEctor[:FUNction]?) switches aligning with the switch of this parameter: "NORMal" with Clear Write, "AVERAge" with AVERAge, "POSitive (peak)" with MAXHold, and "NEGative (peak)" with MINHold.
Preset	AVERAge
State Saved	Saved in instrument state.
Range	Normal Average Peak Sample Negative Peak
Initial S/W Revision	Prior to A.02.00
Modified at S/W Revision	A.02.00, A.03.00

Trigger

See ["Trigger" on page 428](#)

Free Run

See ["Free Run " on page 435](#)

Video

See ["Video \(IF Envelope\) " on page 436](#)

Trigger Level

See ["Trigger Level " on page 436](#)

Trig Slope

See ["Trig Slope " on page 437](#)

Trig Delay

See ["Trig Delay " on page 438](#)

Line

See ["Line " on page 2105](#)

Trig Slope

See ["Trig Slope " on page 2105](#)

Trig Delay

See ["Trig Delay " on page 440](#)

External 1

See ["External 1 " on page 2118](#)

Trigger Level

See ["Trigger Level " on page 2118](#)

Trig Slope

See ["Trig Slope " on page 2119](#)

Trig Delay

See ["Trig Delay " on page 443](#)

Zero Span Delay Comp

See ["Zero Span Delay Comp On/Off" on page 2107](#)

External 2

See ["External 2 "](#) on page 2120

Trigger Level

See ["Trigger Level "](#) on page 2120

Trig Slope

See ["Trig Slope "](#) on page 2121

Trig Delay

See ["Trig Delay "](#) on page 445

Zero Span Delay Comp

See ["Zero Span Delay Comp On/Off"](#) on page 2109

RF Burst

See ["RF Burst "](#) on page 2121

Absolute Trigger

See ["Absolute Trigger Level"](#) on page 2122

Relative Trigger

See ["Relative Trigger Level"](#) on page 2111

Trig Slope

See ["Trigger Slope "](#) on page 2123

Trig Delay

See ["Trig Delay "](#) on page 450

Periodic Timer

See ["Periodic Timer \(Frame Trigger\) "](#) on page 2113

Period

See ["Period "](#) on page 2114

Offset

See ["Offset "](#) on page 2115

Reset Offset Display

See ["Reset Offset Display "](#) on page 2117

Sync Source

See ["Sync Source "](#) on page 2117

Off

See ["Off "](#) on page 2118

External 1

See ["External 1 "](#) on page 2118

Trigger Level

See ["Trigger Level "](#) on page 2118

Trig Slope

See ["Trig Slope "](#) on page 2119

External 2

See ["External 2 "](#) on page 2120

Trigger Level

See ["Trigger Level "](#) on page 2120

Trig Slope

See ["Trig Slope "](#) on page 2121

RF Burst

See ["RF Burst "](#) on page 2121

Absolute Trigger

See ["Absolute Trigger Level"](#) on page 2122

Trig Slope

See ["Trigger Slope "](#) on page 2123

Trig Delay

See ["Trig Delay"](#) on page 460

Auto/Holdoff

See ["Auto/Holdoff "](#) on page 461

Auto Trig

See ["Auto Trig "](#) on page 461

Trig Holdoff

See ["Trig Holdoff "](#) on page 462

User Preset

Accesses a menu that gives you the following three choices:

- User Preset – recalls a state previously saved using the Save User Preset function.
- User Preset All Modes – presets all of the modes in the analyzer
- Save User Preset– saves the current state for the current mode

Key Path	Front-panel key
Backwards Compatibility Notes	<p>User Preset is actually loading a state, and in legacy analyzers, it was possible to load a state without affecting the trace data, limit lines or correction data. Similarly it was possible to do a User Preset without affecting the trace data, limit lines or correction data.</p> <p>In the X-Series, “state” always includes all of this data; so whenever state is loaded, or User Preset is executed, all of the traces, limit lines and corrections are affected. Although this differs from previous behavior, it is desirable behavior, and should not cause adverse issues for users.</p> <p>On ESA and PSA, User Preset affected the entire instrument’s state. In the X-Series, User Preset only recalls the state for the active mode. There is a User Preset file for each mode. User Preset can never cause a mode switch as it can in legacy analyzers. If you want to recall all modes to their user preset file state, you will need to do a User Preset after mode switching into each mode.</p> <p>User Preset recalls mode state which can now include data like traces; whereas on ESA and PSA, User Preset did not affect data.</p>
Initial S/W Revision	Prior to A.02.00

User Preset

User Preset sets the state of the currently active mode back to the state that was previously saved for this mode using the Save User Preset menu key or the SCPI command, SYST:PRES:USER:SAV. It not only recalls the Mode Preset settings, but it also recalls all of the mode persistent settings, and the Input/Output system setting that existed at the time Save User Preset was executed.

If a Save User Preset has not been done at any time, User Preset recalls the default user preset file for the currently active mode. The default user preset files are created if, at power-on, a mode detects there is no user preset file. There will never be a scenario when there is no user preset file to restore. For each mode, the default user preset state is the same state that would be saved if a Save User Preset is performed in each mode right after doing a Restore Mode Default and after a Restore Input/Output Defaults.

The User Preset function does the following:

- Aborts the currently running measurement.
- Sets the mode State to the values defined by Save User Preset.
- Makes the saved measurement for the currently running mode the active measurement.
- Brings up the saved menu for the power-on mode.
- Clears the input and output buffers.
- Sets the Status Byte to 0.

Key Path	User Preset
Remote Command	:SYSTem:PRESet:USER
Example	:SYST:PRES:USER:SAVE:SYST:PRES:USER
Notes	:SYST:PRES:USER:SAVE is used to save the current state as the user preset state. Clears all pending OPC bits. The Status Byte is set to 0. Pressing the User Preset front-panel key while already in the User Preset menu will cause the User Preset to get executed
Couplings	A user preset will cause the currently running measurement to be aborted and cause the saved measurement to be active. Recalling a User Preset file has the same issues that recalling a Save State file has. Some settings may need to be limited and therefore re-coupled, since the capabilities of the mode may have changes when the User Preset file was last saved.
Initial S/W Revision	Prior to A.02.00

User Preset All Modes

Recalls all of the User Preset files for each mode, switches to the power-on mode, and activates the saved measurement from the power-on mode User Preset file.

NOTE

When the instrument is secured, all of the user preset files are converted back to their default user preset files.

The User Preset function does the following:

- Aborts the currently running measurement.
- Switches the Mode to the power-on mode.
- Restores the User Preset files for each mode.
- Makes the saved measurement for the power-on mode the active measurement.
- Brings up the saved menu for the power-on mode.
- Clears the input and output buffers.
- Sets the Status Byte to 0.

Key Path	User Preset
Remote Command	:SYSTem:PRESet:USER:ALL
Example	:SYST:PRES:USER:SAVE:SYST:PRES:USER:ALL
Notes	Clears all pending OPC bits. The Status Byte is set to 0. :SYST:PRES:USER:SAVE is used to save the current state as the user preset state.
Couplings	A user preset will cause the currently running measurement to be aborted, cause a mode switch to the power-on mode, and cause the saved measurement to be active in the power-on mode. Recalling a User Preset file has the same issues that recalling a Save State file has. Some settings may need to be limited and therefore re-coupled, since the capabilities of the mode may have changes when the User Preset file was last saved.
Initial S/W Revision	Prior to A.02.00

Save User Preset

Saves the currently active mode and its State. You can recall this User Preset file by pressing the User Preset menu key or sending the SYST:PRES:USER remote command. This same state is also saved by the Save State function.

Key Path	User Preset
Remote Command	:SYSTem:PRESet:USER:SAVE
Example	:SYST:PRES:USER:SAVE
Notes	:SYST:PRES:SAVE creates the same file as if the user requested a *SAV or a MMEM:STOR:STAT, except User Preset Save does not allow the user to specify the filename or the location of the file.
Initial S/W Revision	Prior to A.02.00

View/Display

Accesses a menu of functions that enable you to control the instrument display as well as turn the bar graph On and Off.

If current mode is NOT DVB-T/H, DTMB (CTTB), ISDB-T, MSR, LTE-Advanced FDD/TDD or CMMB mode, the front panel views only contain one view: Spectrum View. The results of the measurement can be displayed as a single spectrum trace view or displayed with a Bar Graph trace on the spectrum trace.

Spectrum View with Bar Graph off

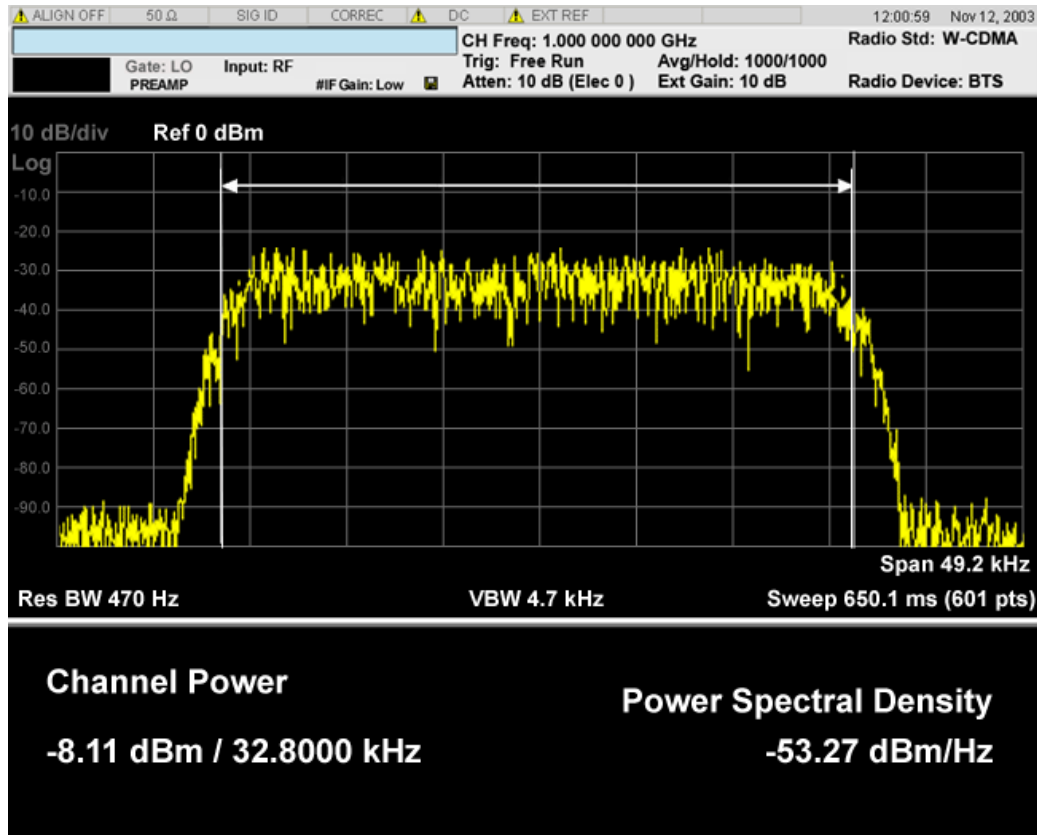

Spectrum View with Bar Graph on

This View is the same as the 'Spectrum' view, but has a blue bar between the markers that indicates the measured output power level. The bar graph is activated when the "Bar Graph" Soft Key is set to ON under the View/Display menu. The actual measured output power level is displayed on the display at the bottom of the bar.

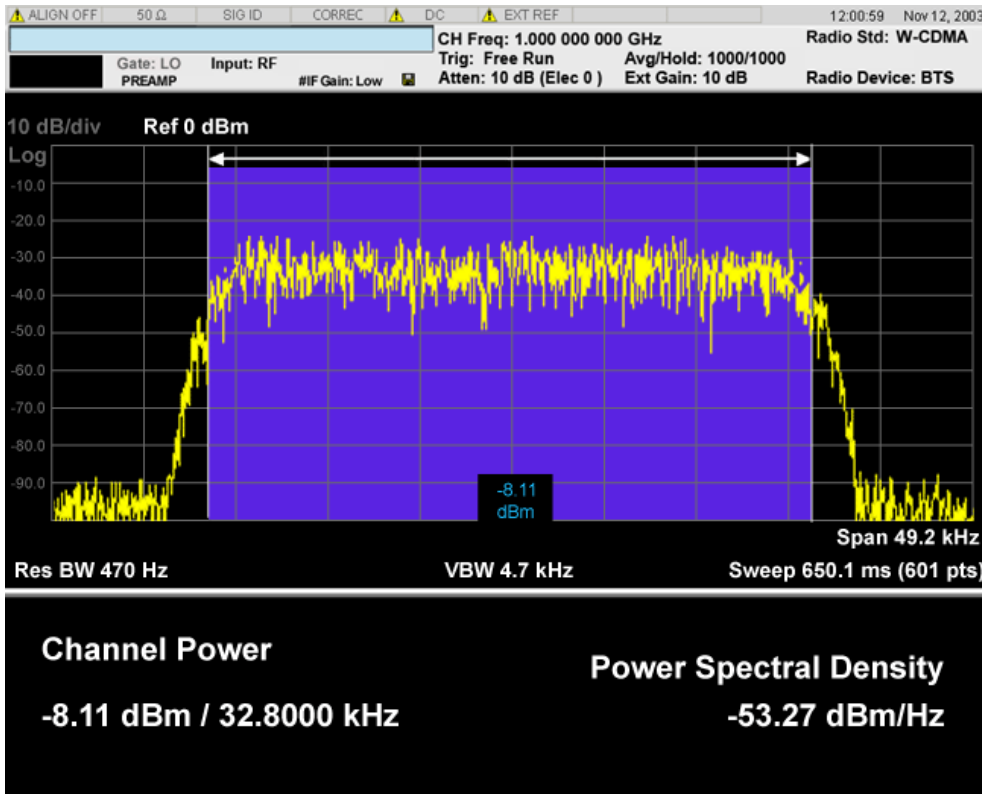

If current mode is MSR and LTE-Advanced FDD/TDD, there are two views, Power Results and Carrier Info. Power Results view is almost the same as the common CHP view.

If the current mode is WLAN and the format is WLAN 802.11ac 80+80 MHz, the spectrum view is changed a little so that the results of both carrier segments can be displayed.

Spectrum View with Bar Graph off for WLAN 802.11ac (80 + 80 MHz):

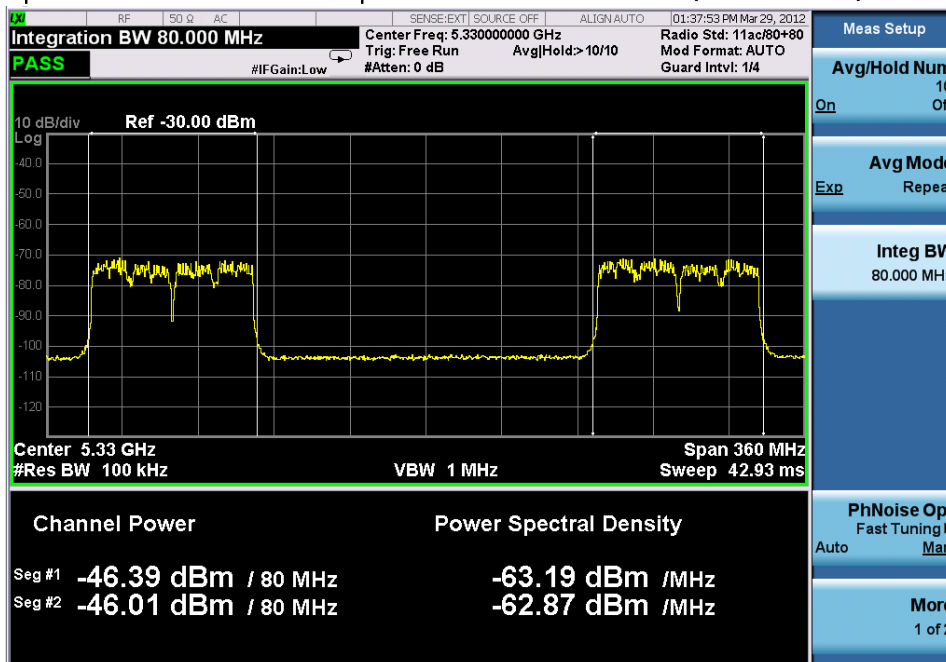

Spectrum View with Bar Graph on for WLAN 802.11ac (80 + 80 MHz):

8 Channel Power Measurement
View/Display

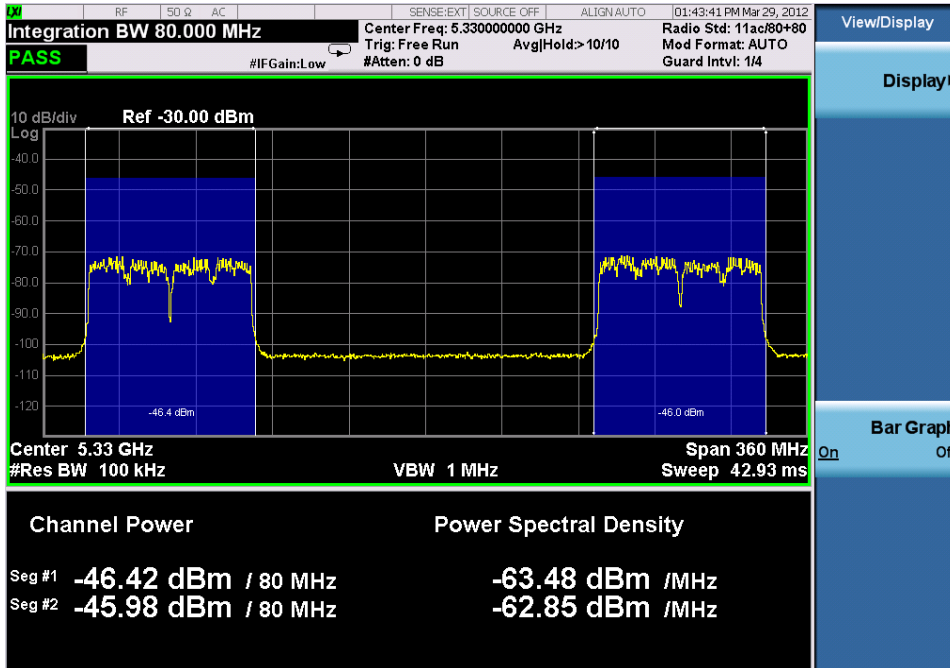

Power Results:

The spectrum trace and power bars are displayed in the upper window. Total carrier power, total PSD and total format carrier power are displayed in the lower window. Total format carrier power is total power of carriers of the same Radio Format. If there is no carrier of the corresponding format, it is not displayed. Thus items in the total format power table changes depending on the carrier configuration. Since the metrics window of MSR and LTE-Advanced FDD/TDD is a bit denser than the common CHP, vertical positions of total power and power spectral density goes up a little bit.

Carrier Info:

The lower window of Power Results view is replaced by the carrier info table in this view. Carrier center frequency can be displayed in either offset or absolute frequency depending on Carrier Freq. The table can be scrolled by Carrier Result on Meas Setup menu or by Select Carrier on Config Carriers menu. The highlighted row changes as either Carrier Result or Select Carrier is changed. The highlighted row and these keys are not coupled.

View selection by name (MSR and LTE-Advanced FDD/TDD only)

Selects the results view. The following SCPI command allows you to select the desired measurement view by enumeration.

Key Path	No equivalent front-panel key
Mode	MSR, LTEAFDD, LTEATDD
Remote Command	:DISPlay:CHPower:VIEW[:SElect] PRESult CINformation :DISPlay:CHPower:VIEW[:SElect]?
Example	:DISP:CHP:VIEW PRES :DISP:CHP:VIEW?

Preset	PRESult
State Saved	Saved in instrument state
Range	Power Results Carrier Info
Initial S/W Revision	A.10.00

Selects the results view. The following SCPI command allows you to select the desired measurement view by enumeration.

Key Path	No equivalent front-panel key
Mode	MSR, LTEAFDD, LTEATDD
Remote Command	:DISPlay:CHPower:VIEW:NSElect <integer> :DISPlay:CHPower:VIEW:NSElect?
Example	DISP:CHP:VIEW:NSEL 1 DISP:CHP:VIEW:NSEL?
Preset	1
State Saved	Saved in instrument state
Min	1
Max	2
Initial S/W Revision	A.10.00

View selection by name (DTMB (CTTB), DVB-T/H only)

Selects the results view. The following SCPI command allows you to select the desired measurement view by enumeration.

Key Path	No equivalent front-panel key
Mode	DVB-T/H, DTMB (CTTB)
Remote Command	:DISPlay:CHPower:VIEW[:SElect] RFSpectrum SHOulder MASK :DISPlay:CHPower:VIEW[:SElect]?
Example	DISP:CHP:VIEW RFSP DISP:CHP:VIEW?
Preset	RFSpectrum
State Saved	Saved in instrument state.
Range	RF Spectrum Shoulder Attenuation Spectrum Mask
Initial S/W Revision	A.02.00

View selection by name (ISDB-T, CMMB only)

Selects the results view. The following SCPI command allows you to select the desired measurement view by enumeration.

Key Path	No equivalent front-panel key
Mode	ISDB-T, CMMB
Remote Command	:DISPlay:CHPower:VIEW[:SElect] RFSPectrum SHOUlder :DISPlay:CHPower:VIEW[:SElect]?
Example	DISP:CHP:VIEW RFSP DISP:CHP:VIEW?
Preset	RFSPectrum
State Saved	Saved in instrument state.
Range	RF Spectrum Shoulder Attenuation
Initial S/W Revision	A.03.00

Key Path	Front-panel key
Initial S/W Revision	Prior to A.02.00

Display

The Display menu is common to most measurements, and is used for configuring items on the display. Some Display menu settings apply to all the measurements in a mode, and some only to the current measurement. Those under the System Display Settings key apply to all measurements in all modes.

Key Path	Display
Key Path	View/Display
Initial S/W Revision	Prior to A.02.00

Annotation

Turns on and off various parts of the display annotation. The annotation is divided up into four categories:

1. Meas Bar: This is the measurement bar at the top of the screen. It does not include the settings panel or the Active Function. Turning off the Meas Bar turns off the settings panel and the Active Function. When the Meas Bar is off, the graticule area expands to fill the area formerly occupied by the Meas Bar.
2. Screen Annotation: this is the annotation and annunciation around the graticule, including any annotation on lines (such as the display line, the threshold line, etc.) This does NOT include the marker number or the N dB result. When off, the graticule expands to fill the entire graticule area.
3. Trace annotation: these are the labels on the traces, showing their detector (or their math mode).

4. Active Function annotation: this is the active function display in the meas bar, and all of the active function values displayed on softkeys.

See the figure below. Each type of annotation can be turned on and off individually.

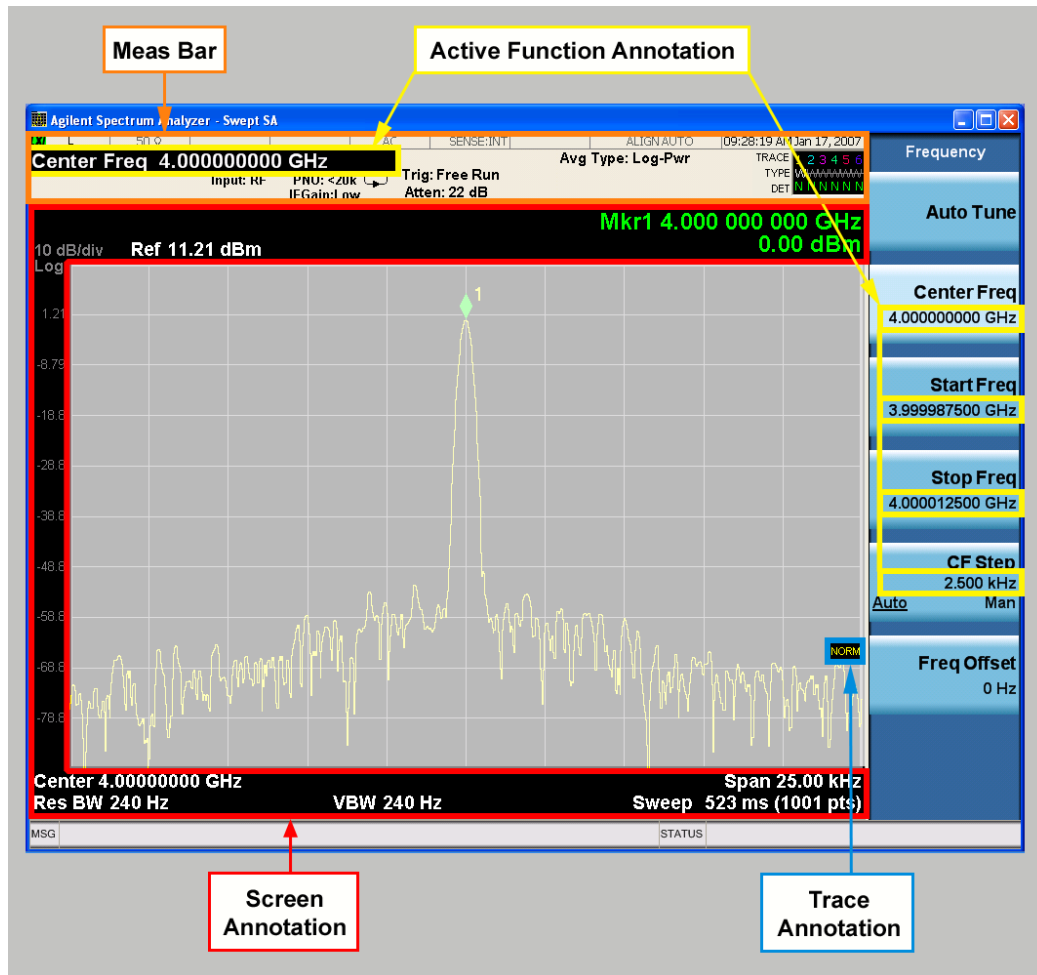

Key Path	View/Display, Display
Initial S/W Revision	Prior to A.02.00

Meas Bar On/Off

This function turns the Measurement Bar on and off, including the settings panel. When off, the graticule area expands to fill the area formerly occupied by the Measurement Bar.

Key Path	View/Display, Display, Annotation
Remote Command	:DISPlay:ANNotation:MBAR[:STATe] OFF ON 0 1 :DISPlay:ANNotation:MBAR[:STATe]?
Example	DISP:ANN:MBAR OFF

Dependencies	Grayed out and forced to OFF when System Display Settings, Annotation is set to Off.
Preset	On This should remain Off through a Preset when System DisplaySettings, Annotation is set to Off.
State Saved	Saved in instrument state.
Initial S/W Revision	Prior to A.02.00

Screen

This controls the display of the annunciation and annotation around the graticule, including any annotation on lines (such as the display line, the threshold line, etc.) and the y-axis annotation. This does NOT include marker annotation (or the N dB result). When off, the graticule expands to fill the entire graticule area, leaving only the 1.5% gap above the graticule as described in the Trace/Detector chapter.

Key Path	View/Display, Display, Annotation
Remote Command	:DISPlay:ANNotation:SCReen[:STATe] OFF ON 0 1 :DISPlay:ANNotation:SCReen[:STATe]?
Example	DISP:ANN:SCR OFF
Dependencies	Grayed-out and forced to OFF when System Display Settings, Annotation is set to Off.
Preset	On This should remain Off through a Preset when System DisplaySettings, Annotation is set to Off
State Saved	Saved in instrument state.
Initial S/W Revision	Prior to A.02.00

Active Function Values On/Off

Turns on and off the active function display in the Meas Bar, and all of the active function values displayed on the softkeys.

Note that all of the softkeys that have active functions have these numeric values blanked when this function is on. This is a security feature..



Key Path	View/Display, Display, Annotation
Remote Command	:DISPlay:ACTivefunc[:STATE] ON OFF 1 0 :DISPlay:ACTivefunc[:STATE]?
Example	DISP:ACT OFF
Dependencies	Grayed out and forced to OFF when System Display Settings, Annotation is set to Off.
Preset	On This should remain Off through a Preset when System DisplaySettings, Annotation is set to Off
State Saved	Saved in instrument state.
Initial S/W Revision	Prior to A.02.00

Title

Displays menu keys that enable you to change or clear a title on your display.

Key Path	View/Display, Display
Initial S/W Revision	Prior to A.02.00

Change Title

Writes a title into the "measurement name" field in the banner, for example, "Swept SA".

Press Change Title to enter a new title through the alpha editor. Press Enter or Return to complete the entry. Press ESC to cancel the entry and preserve your existing title.

The display title will replace the measurement name. It remains for this measurement until you press Change Title again, or you recall a state, or a Preset is performed. A title can also be cleared by pressing Title, Clear Title.

NOTE

Notice the inclusion of the <measurement> parameter in the command below. Because each measurement remembers the Display Title, the command must be qualified with the measurement name. For the Swept SA measurement this is not the case; no <measurement> parameter is used when changing the Display Title for the Swept SA measurement.

Key Path	View/Display, Display, Title
Mode	All
Remote Command	:DISPlay:<measurement>:ANNotation:TITLe:DATA <string> :DISPlay:<measurement>:ANNotation:TITLe:DATA?
Example	DISP:ANN:TITL:DATA "This Is My Title" This example is for the Swept SA measurement in the Spectrum Analyzer mode. The SANalyzer <measurement> name is not used. DISP:ACP:ANN:TITL:DATA "This Is My Title" This example is for Measurements other than Swept SA. Both set the title to: This Is My Title
Notes	Pressing this key cancels any active function. When a title is edited the previous title remains intact (it is not cleared) and the cursor goes at the end so that characters can be added or BKSP can be used to go back over previous characters.
Preset	No title (measurement name instead)
State Saved	Saved in instrument state.
Initial S/W Revision	Prior to A.02.00

Clear Title

Clears a title from the front-panel display. Once cleared, the title cannot be retrieved. After the title is cleared, the current Measurement Name replaces it in the title bar.

Key Path	View/Display, Display, Title
Example	The following commands clear the title and restore the measurement's original title: DISP:ANN:TITL:DATA "" This example is for the Swept SA measurement in the Spectrum Analyzer mode. The SANalyzer <measurement> name is not used. DISP:ACP:ANN:TITL:DATA "" This example is for ACP; in measurements other than Swept SA the measurement name is required.
Notes	Uses the :DISPlay:<measurement>:ANNotation:TITLe:DATA <string> command with an empty string (in the Swept SA, the <measurement> is omitted).
Preset	Performed on Preset.
Initial S/W Revision	Prior to A.02.00

Graticule

Pressing Graticule turns the display graticule On or Off. It also turns the graticule y-axis annotation on and off.

Key Path	View/Display, Display
Remote Command	:DISPlay:WINDow[1]:TRACe:GRATicule:GRID[:STATe] OFF ON 0 1 :DISPlay:WINDow[1]:TRACe:GRATicule:GRID[:STATe]?
Example	DISP:WIND:TRAC:GRAT:GRID OFF
Notes	The graticule is the set of horizontal and vertical lines that make up the grid/divisions for the x-axis and y-axis.
Preset	On
State Saved	Saved in instrument state
Initial S/W Revision	Prior to A.02.00

System Display Settings

These settings are "Mode Global" – they affect all modes and measurements and are reset only by Restore Misc Defaults or Restore System Defaults under System.

Key Path	View/Display, Display
Initial S/W Revision	Prior to A.02.00

Annotation Local Settings

This is a Mode Global override of the meas local annotation settings. When it is All Off, it forces ScreenAnnotation, Meas Bar, Trace, and Active Function Values settings to be OFF for all measurements in all modes. This provides the security based "annotation off" function of previous analyzers; hence it uses the legacy SCPI command.

When it is All Off, the Screen, Meas Bar, Trace, and Active Function Values keys under the Display, Annotation menu are grayed out and forced to Off. When Local Settings is selected, you are able to set the local annotation settings on a measurement by measurement basis.

Key Path	View/Display, Display, System Display Settings
Remote Command	:DISPlay:WINDow[1]:ANNOtation[:ALL] OFF ON 0 1 :DISPlay:WINDow[1]:ANNOtation[:ALL]?
Example	:DISP:WIND:ANN OFF
Preset	On (Set by Restore Misc Defaults)
State Saved	Not saved in instrument state.
Backwards Compatibility Notes	The WINDow parameter and optional subopcode is included for backwards compatibility but ignored – all windows are equally affected.
Initial S/W Revision	Prior to A.02.00

Themes

Accesses a menu of functions that enable you to choose the theme to be used when saving the screen image.

The **Themes** option is the same as the **Themes** option under the **Display** and **Page Setup** dialogs. It allows you to choose between themes to be used when saving the screen image.

Key Path	Save, Screen Image
Remote Command	:MMEMory:STORe:SCReen:THEMe TDColor TDMonochrome FCOLor FMONochrome :MMEMory:STORe:SCReen:THEMe?
Example	:MMEM:STOR:SCR:THEM TDM
Preset	3D Color; Is not part of Preset, but is reset by Restore Misc Defaults or Restore System Defaults All and survives subsequent running of the modes.
Readback	3D Color 3D Mono Flat Color Flat Mono
Backwards Compatibility Notes	In ESA and PSA we offer the choice of "Reverse Bitmap" or "Reverse Metafile" when saving screen images. This is much like the "Flat Color" theme available in X-Series. Also, if you selected Reverse Bitmap AND a black & white screen image, that would be much like "Flat Monochrome". In other words, each of the X-Series themes has a similar screen image type in ESA/PSA. But they are not identical.
Initial S/W Revision	Prior to A.02.00

3D Color

Selects a standard color theme with each object filled, shaded and colored as designed.

Key Path	Save, Screen Image, Themes
Example	MMEM:STOR:SCR:THEM TDC
Readback	3D Color
Initial S/W Revision	Prior to A.02.00

3D Monochrome

Selects a format that is like 3D color but shades of gray are used instead of colors.

Key Path	Save, Screen Image, Themes
Example	MMEM:STOR:SCR:THEM TDM
Readback	3D Mono
Initial S/W Revision	Prior to A.02.00

Flat Color

Selects a format that is best when the screen is to be printed on an ink printer.

Key Path	Save, Screen Image, Themes
Example	MMEM:STOR:SCR:THEM FCOL
Readback	Flat Color
Initial S/W Revision	Prior to A.02.00

Flat Monochrome

Selects a format that is like Flat Color. But only black is used (no colors, not even gray), and no fill.

Key Path	Save, Screen Image, Themes
Example	MMEM:STOR:SCR:THEM FMON
Readback	Flat Mono
Initial S/W Revision	Prior to A.02.00

Backlight

Accesses the display backlight on/off keys. This setting may interact with settings under the Windows "Power" menu.

When the backlight is off, pressing ESC, TAB, SPACE, ENTER, UP, DOWN, LEFT, RIGHT, DEL, BKSP, CTRL, or ALT turns the backlight on without affecting the application. Pressing any other key will turn backlight on and could potentially perform the action as well.

Key Path	View/Display, Display, System Display Settings
Remote Command	:DISPlay:BACKlight ON OFF :DISPlay:BACKlight?
Preset	ON (Set by Restore Misc Defaults)
Initial S/W Revision	Prior to A.02.00

Backlight Intensity

An active function used to set the backlight intensity. It goes from 0 to 100 where 100 is full on and 0 is off. This value is independent of the values set under the Backlight on/off key.

Key Path	View/Display, Display, System Display Settings
Remote Command	:DISPlay:BACKlight:INTensity <integer> :DISPlay:BACKlight:INTensity?
Example	DISP:BACK:INT 50

Preset	100 (Set by Restore Misc Defaults)
Min	0
Max	100
Initial S/W Revision	Prior to A.02.00

Bar Graph

Turns the Bar Graph On and Off.

Key Path	DVB-T/H, DTMB (CTTB), ISDB-T, CMMB: View/Display, RF SpectrumOthers: View/Display
Mode	SA, WCDMA, C2K, WIMAX OFDMA, 1xEVDO, DVB-T/H, DTMB (CTTB), ISDB-T, CMMB, LTE, LTETDD, Digital Cable TV, WLAN, MSR, LTEAFDD, LTEATDD
Remote Command	:DISPlay:CHPower:VIEW[1]:WINDow[1]:BGRaph ON OFF 1 0 :DISPlay:CHPower:VIEW[1]:WINDow[1]:BGRaph?
Example	DISP:CHP:VIEW:WIND:BGR ON DISP:CHP:VIEW:WIND:BGR?
Notes	You must be in the Spectrum Analysis mode, W-CDMA mode, cdma2000 mode, DVB-T/H mode, DTMB (CTTB) mode, ISDB-T mode, CMMB mode, Digital Cable TV mode, LTE mode, LTE TDD mode, WLAN mode, 1xEVDO mode, MSR, LTE-Advanced FDD/TDD mode or WIMAX OFDMA mode to use this command. Use :INSTrument:SElect to set the mode.
Preset	OFF
State Saved	Saved in instrument state.
Range	On Off
Initial S/W Revision	Prior to A.02.00
Modified at S/W Revision	A.02.00, A.03.00

9 Occupied Bandwidth Measurement

The Occupied Bandwidth measurement computes and displays the bandwidth occupied by a given percentage of the total mean power of a signal. For measurement results and views, see ["View/Display" on page 821](#).

This topic contains the following sections:

["Remote Commands for Occupied Bandwidth" on page 656](#)

["Remote Command Results for Occupied Bandwidth Measurement" on page 657](#)

Remote Commands for Occupied Bandwidth

The following commands and queries can be used to retrieve the measurement results:

```
:CONFigure:OBWidth  
:CONFigure:OBWidth:NDEFault  
:INITiate:OBWidth  
:FETCh:OBWidth[n]?  
:MEASure:OBWidth[n]?  
:READ:OBWidth[n]?  
:FETCh:OBWidth:OBWidth?  
:MEASure:OBWidth:OBWidth?  
:READ:OBWidth:OBWidth?  
:FETCh:OBWidth:FERRor?  
:MEASure:OBWidth:FERRor?  
:READ:OBWidth:FERRor?  
:FETCh:OBWidth:XDB?  
:MEASure:OBWidth:XDB?  
:READ:OBWidth:XDB?
```

See also the section, "[Remote Measurement Functions](#)" on page 2213.

Remote Command Results for Occupied Bandwidth Measurement

The following table describes the results returned by the FETCh:OBWidth[n]?, MEASure:OBWidth[n]?, and READ:OBWidth[n]? queries listed above, according to the index value n.

n	Results Returned
n=1 (or not specified)	Returns 7 scalar results, in the following order: 1. Occupied bandwidth - Hz 2. Total Power - dBm (Total Power will be obsolete in TD-SCDMA mode, this place will be replaced by NaN) 3. Span - Hz 4. Spectrum Trace Points - points 5. Res BW - Hz 6. Transmit Frequency Error Hz 7. x DB Bandwidth - Hz
2	Returns the frequency-domain spectrum trace (data array) for the entire frequency range being measured.
n = 3 (Mode = MSR, LTEAFDD, LTEATDD)	1. Number of active carriers Returns number of active carriers within Span in Auto detected mode, otherwise the command is out of scope

Key Path	Meas
Initial S/W Revision	Prior to A.02.00

AMPTD Y Scale (Amplitude/Y Scale)

Activates the Reference Value function and displays the Amplitude menu keys. These functions control how data on the vertical (Y) axis is displayed and control instrument settings that affect the vertical axis

See AMPTD Y Scale for more information.

Key Path	Front-panel key
Initial S/W Revision	Prior to A.02.00

Ref Value

Sets the absolute power reference value. However, since the Auto Scaling is defaulted to On, this value is automatically determined by the measurement result. When you set a value manually, Auto Scaling automatically changes to Off.

Key Path	AMPTD Y Scale
Mode	SA, WCDMA, C2K, WIMAX OFDMA, TD-SCDMA, 1xEVDO, ISDB-T, CMMB, LTE, LTETDD, BLUETOOTH, WLAN, MSR, LTEAFDD, LTEATDD
Remote Command	:DISPlay:OBWidth:VIEW[1]:WINDow[1]:TRACe:Y[:SCALe]:RLEVel <real> :DISPlay:OBWidth:VIEW[1]:WINDow[1]:TRACe:Y[:SCALe]:RLEVel?
Example	DISP:OBW:VIEW:WIND:TRAC:Y:RLEV 125 DISP:OBW:VIEW:WIND:TRAC:Y:RLEV?
Notes	You must be in the Spectrum Analysis mode, W-CDMA mode, cdma2000 mode, TD-SCDMA mode, ISDB-T mode, CMMB mode, BLUETOOTH mode, LTE mode, LTE TDD mode, WLAN mode, 1xEVDO mode, MSR, LTE-Advanced FDD/TDD or WIMAX OFDMA mode to use this command. Use:INSTrument:SElect to set the mode.
Couplings	When the Auto Scaling is On, this value is automatically determined by the measurement result. When you set a value manually, Auto Scaling automatically changes to Off.
Preset	10.00 dBm
State Saved	Saved in instrument state.
Min	-250.00 dBm
Max	250.00 dBm
Initial S/W Revision	Prior to A.02.00
Modified at S/W Revision	A.03.00

Attenuation

This menu controls the attenuator functions and interactions between the attenuation system components.

There are two attenuator configurations in the X-Series. One is a dual attenuator configuration consisting of a mechanical attenuator and an optional electronic attenuator. The other configuration uses a single

attenuator with combined mechanical and electronic sections that controls all the attenuation functions. Different models in the X-Series come with different configurations.

See ["Dual Attenuator Configurations:" on page 659](#)

See ["Single Attenuator Configuration:" on page 660](#)

Most Attenuation settings are the same for all measurements – they do not change as you change measurements. Settings like these are called “Meas Global” and are unaffected by Meas Preset.

Key Path	AMPTD Y Scale
Scope	Meas Global
Dependencies	In measurements that support the I/Q inputs, this key is unavailable when I/Q is the selected input, and is replaced by the Range key in that case.
Readback Line	Contains a summary in [] brackets of the current total attenuation. See the descriptions of the , " (Mech) Atten " on page 2160, and " Enable Elec Atten " on page 2162 keys for more detail on the contributors to the total attenuation. Note that when "Pre-Adjust for Min Clip" is on, this value can change at the start of every measurement.
Initial S/W Revision	Prior to A.02.00
Modified at S/W Revision	A.03.00

Dual Attenuator Configurations:

Configuration 1: Mechanical attenuator + optional electronic attenuator

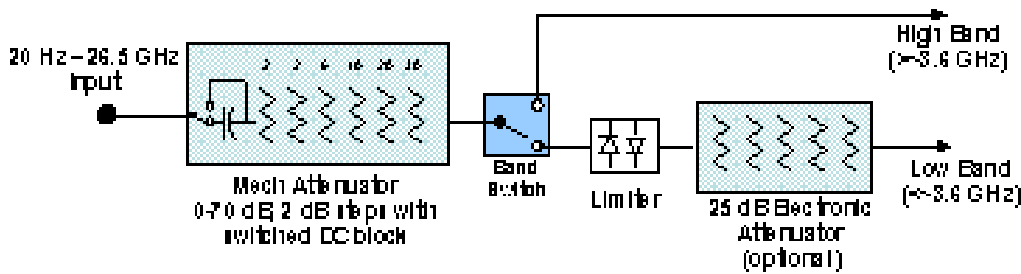

Configuration 2: Mechanical attenuator, no optional electronic attenuator

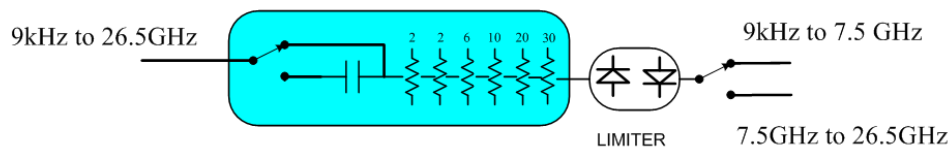

(note that Configuration 2 is not strictly speaking a dual-section attenuator, since there is no electronic section available. However, it behaves exactly like Configuration 1 without the Electronic Attenuator option EA3, therefore for the sake of this document it is grouped into the “Dual Attenuator” configuration)

Single Attenuator Configuration:

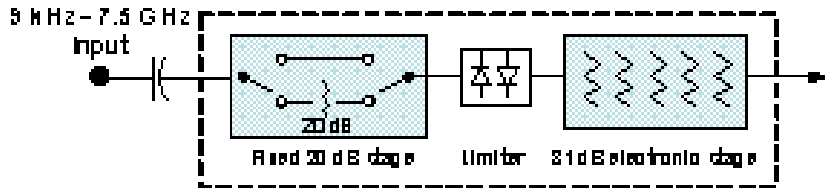

You can tell which attenuator configuration you have by pressing the Attenuation key, which (in most Modes) opens the Attenuation menu. If the first key in the Attenuation menu says Mech Atten you have the dual attenuator configuration. If the first key says Atten you have the single attenuator configuration.

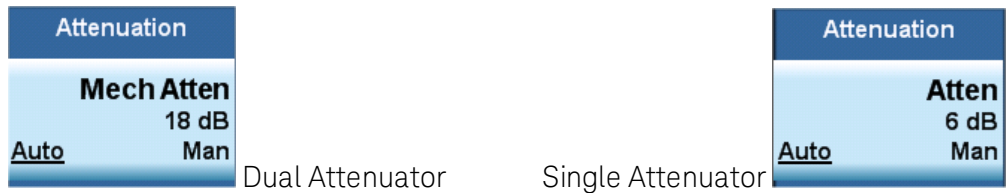

In the single attenuator configuration, you control the attenuation with a single control, as the fixed stage has only two states. In the dual attenuator configuration, both stages have significant range so you are given separate control of the mechanical and electronic attenuator stages.

When you have the dual attenuator configuration, you may still have only a single attenuator, because unless option EA3 (the Electronic Attenuator option) is available, and you purchase it, you will have only the mechanical attenuator.

(Mech) Atten

This key is labeled Mech Atten in dual attenuator models and Atten in single attenuator models. In the dual attenuator configuration, this key only affects the mechanical attenuator.

This key lets you modify the attenuation applied to the RF input signal path. This value is normally auto coupled to the Ref Level, the Internal Preamp Gain, any External Gain that is entered, and the Max Mixer Level, as described in the table below.

See ["Attenuator Configurations and Auto/Man" on page 662](#)

Key Path	AMPTD Y Scale, Attenuation
Remote Command	<pre>[:SENSe]:POWeR[:RF]:ATTenuation <rel_ampl> [:SENSe]:POWeR[:RF]:ATTenuation? [:SENSe]:POWeR[:RF]:ATTenuation:AUTO OFF ON 0 1 [:SENSe]:POWeR[:RF]:ATTenuation:AUTO?</pre>
Example	<p>POW:ATT 20</p> <p>Dual attenuator configuration: sets the mechanical attenuator to 20 dB</p> <p>Single attenuator mode: sets the main attenuation to 20 dB (see below for definition of “main” attenuation).</p> <p>If the attenuator was in Auto, it sets it to Manual.</p>
Dependencies	Some measurements do not support the Auto setting of (Mech) Atten. In these measurements, the

Auto/Man selection is not available, and the Auto/Man line on the key disappears.

In dual attenuator configurations, when the electronic attenuator is enabled, the mechanical attenuator has no auto setting and the Auto/Man line on the key disappears. The state of Auto/Man is remembered and restored when the electronic attenuator is once again disabled. This is described in more detail in the ["Enable Elec Atten" on page 2162](#) key description.

See ["Attenuator Configurations and Auto/Man" on page 662](#) for more information on the Auto/Man functionality of Attenuation.

Couplings

When (Mech) Atten is in Auto, it uses the following algorithm to determine a value:
 If the USB Preamp is connected to USB, use 0 dB.
 Otherwise, $Atten = ReferenceLevel + PreAmpGain + ExternalGain - RefLevelOffset - MaxMixerLevel + IF\ Gain$.
 Limit this value to be between 6 dB and the Max value. No value below 6 dB can ever be chosen by Auto.
 The resulting value is rounded up to the largest value possible given the attenuation step setting. That is, 50.01 dB would change to 60 dB (for a 10 dB attenuation step).
 The "IF Gain" term in the equation above is either 0 dB or +10 dB, depending on the settings of FFT IF Gain, Swept IF Gain, max Ref Level and the Auto/Man setting of Mech Atten.
 In External Mixing and BBIQ, where the Attenuator is not in the signal path, the Attenuator setting changes as described above when (Mech) Atten is in Auto, but no changes are made to the actual attenuator hardware setting until the input is changed back to the RF Input.

Preset The preset for Mech Attenuation is "Auto."
 The Auto value of attenuation is:
 CXA, EXA, MXA and PXA: 10 dB

State Saved Saved in instrument state

Min 0 dB
 The attenuation set by this key cannot be decreased below 6 dB with the knob or step keys. To get to a value below 6 dB it has to be directly entered from the keypad or via SCPI. This protects from adjusting the attenuation to a dangerously small value which can put the instrument at risk of damage to input circuitry. However, if the current mechanical attenuation is below 6 dB it can be increased with the knob and step keys, but not decreased.

Max CXA N9000A-503/507: 50 dB
 CXA N9000A-513/526: 70dB
 EXA: 60 dB
 MXA and PXA: 70 dB
 In the single attenuator configuration, the total of ATT and EATT cannot exceed 50 dB, so if the EATT is set to 24 dB first, the main attenuation cannot be greater than 26 dB and will be reduced accordingly; if the main attenuator is set to 40 dB first, EATT cannot be greater than 10 dB.

Initial S/W Revision Prior to A.02.00

Modified at S/W Revision A.03.00

Attenuator Configurations and Auto/Man

As described in the Attenuation key description, there are two distinct attenuator configurations available in the X-Series, the single attenuator and dual attenuator configurations. In dual attenuator configurations, we have the mechanical attenuation and the electronic attenuation, and the current total attenuation is the sum of the electronic + mechanical attenuation. In single attenuator configurations, we refer to the attenuation set using the (Mech) Atten key (or POW:ATT SCPI) as the “main” attenuation; and the attenuation that is set by the SCPI command POW:EATT as the “soft” attenuation (the POW:EATT command is honored even in the single attenuator configuration, for compatibility purposes). Then the current total attenuation is the sum of the main + soft attenuation. See the Elec Atten key description for more on “soft” attenuation.

In the dual attenuator configuration, when the electronic attenuator is enabled, there is no Auto/Man functionality for the mechanical attenuator, and the third line of the key label (the Auto/Man line) disappears:

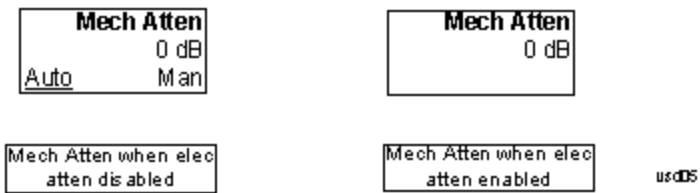

Enable Elec Atten

Enables the Electronic Attenuator.

The electronic attenuator offers finer steps than the mechanical attenuator, has no acoustical noise, is faster, and is less subject to wear. These advantages primarily aid in remote operation and are negligible for front panel use. See ["Using the Electronic Attenuator: Pros and Cons" on page 664](#) for a detailed discussion of the pros and cons of using the electronic attenuator.

For the single attenuator configuration, for SCPI backwards compatibility, the “soft” attenuation feature replaces the dual attenuator configuration’s electronic attenuator. All the same couplings and limitations apply. See ["Attenuator Configurations and Auto/Man" on page 2162](#)

See ["More Information" on page 663](#)

Key Path	AMPTD Y Scale, Attenuation
Remote Command	[:SENSe] :POWer [:RF] :EATTenuation :STATe OFF ON 0 1 [:SENSe] :POWer [:RF] :EATTenuation :STATe ?
Example	POW:EATT:STAT ON
Dependencies	This key only appears in Dual Attenuator models with an Electronic Attenuator installed. It does not appear in models with the Single Attenuator configuration, as in the single attenuator configuration there is no “electronic attenuator” there is only a single integrated attenuator (which has both a mechanical and electronic stage). However, in the single attenuator configuration, EATT SCPI commands are accepted for compatibility with other X-series instruments and set a “soft” attenuation as described in "Attenuator Configurations and Auto/Man" on page 2162 . The electronic attenuator (and the “soft” attenuation function provided in single attenuator configurations) is unavailable above 3.6 GHz. Therefore, if the Stop Frequency of the analyzer is > 3.6 GHz then the Enable Elec Atten key will be OFF and grayed out.

	<p>If the Internal Preamp is on, meaning it is set to Low Band or Full, the electronic attenuator (and the “soft” attenuation function provided in single attenuator configurations) is unavailable. In this case the Enable Elec Atten key will be OFF and grayed out.</p> <p>If either of the above is true, if the SCPI command is sent, an error indicating that the electronic attenuator is unavailable will be sent.</p> <p>If the electronic/soft Attenuator is enabled, then the Stop Freq of the analyzer is limited to 3.6 GHz and the Internal Preamp is unavailable.</p> <p>The SCPI-only “soft” electronic attenuation for the single-attenuator configuration is not available in all measurements; in particular, it is not available in the Swept SA measurement.</p>
Couplings	Enabling and disabling the Electronic Attenuator affects the setting of the Mechanical Attenuator (in dual attenuator configurations). This is described in more detail below this table.
Preset	OFF for Swept SA measurement; ON for all other measurements that support the electronic attenuator
State Saved	Saved in instrument state
Initial S/W Revision	Prior to A.02.00
Modified at S/W Revision	A.03.00

More Information

Mechanical Attenuator Transition Rules

When the Electronic Attenuator is enabled, the Mechanical Attenuator transitions to a state that has no Auto function. Below are the rules for transitioning the Mechanical Attenuator. NOTE that the information below ONLY applies to the dual attenuator configurations, and ONLY when the Electronic Attenuator is installed:

When the Electronic Attenuation is enabled from a disabled state:

- The Mechanical Attenuator is initialized to 10 dB (this is its optimal performance setting). You can then set it as desired with SCPI, numeric keypad, step keys, or knob, and it behaves as it normally would in manual mode
- The Auto/Man state of (Mech) Atten is saved
- The Auto/Man line on the (Mech) Atten key disappears and the auto rules are disabled
- The Electronic Attenuator is set to 10 dB less than the previous value of the Mechanical Attenuator, within the limitation that it must stay within the range of 0 to 24 dB of attenuation.

Examples in the dual attenuator configuration:

- Mech Atten at 20 dB. Elec Atten enabled, Mech Atten set to 10 dB, and Elec Atten set to 10 dB. New total attenuation equals the value before Elec Atten enabled.
- Mech Atten at 0 dB. Elec Atten enabled, Mech Atten set to 10 dB, and Elec Atten set to 0 dB. New total attenuation does not equal the value before Elec Atten enabled.
- Mech Atten at 40 dB. Elec Atten enabled, Mech Atten set to 10 dB, and Elec Atten set to 24 dB. New total attenuation does not equal the value before Elec Atten enabled.

When the Electronic Attenuation is disabled from an enabled state:

- The Elec Atten key is grayed out
- The Auto/Man state of (Mech) Atten is restored
- If now in Auto, (Mech) Atten recouples
- If now in Man, (Mech) Atten is set to the value of total attenuation that existed before the Elec Atten was disabled. The resulting value is rounded up to the smallest value possible given the (Mech) Atten Step setting - (That is, 57 dB changes to 58 dB when (Mech) Atten Step is 2 dB.)

Using the Electronic Attenuator: Pros and Cons

The electronic attenuator offers finer steps than the mechanical attenuator, has no acoustical noise, is faster, and is less subject to wear.

The “finer steps” advantage of the electronic attenuator is beneficial in optimizing the alignment of the analyzer dynamic range to the signal power in the front panel as well as remote use. Thus, you can achieve improved relative signal measurement accuracy. Compared to a mechanical attenuator with 2 dB steps, the 1 dB resolution of the electronic attenuator only gives better resolution when the odd-decibel steps are used. Those odd-decibel steps are less accurately calibrated than the even-decibel steps, so one tradeoff for this superior relative accuracy is reduced absolute amplitude accuracy.

Another disadvantage of the electronic attenuator is that the spectrum analyzer loses its “Auto” setting, making operation less convenient.

Also, the relationship between the dynamic range specifications (TOI, SHI, compression and noise) and instrument performance are less well-known with the electrical attenuator. With the mechanical attenuator, TOI, SHI and compression threshold levels increase dB-for-dB with increasing attenuation, and the noise floor does as well. With the electronic attenuator, there is an excess attenuation of about 1 to 3 dB between 0 and 3.6 GHz, making the effective TOI, SHI, and so forth, less well known. Excess attenuation is the actual attenuation relative to stated attenuation. Excess attenuation is accounted for in the analyzer calibration

Elec Atten

Controls the Electronic Attenuator in dual attenuator configurations. This key does not appear in single attenuator configurations, as the control of both the mechanical and electronic stages of the single attenuator is integrated into the single Atten key.

Key Path	AMPTD Y Scale, Attenuation
Remote Command	<code>[:SENSe] :POWer [:RF] :EATTenuation <rel_ampl></code> <code>[:SENSe] :POWer [:RF] :EATTenuation?</code>
Notes	Electronic Attenuation's specification is defined only when Mechanical Attenuation is 6 dB.
Dependencies	This key only appears in Dual Attenuator models with an Electronic Attenuator installed. It does not appear in models with the Single Attenuator configuration, as in the single attenuator configuration there is no “electronic attenuator” there is only a single integrated attenuator (which has both a mechanical and electronic stage). However, in the single attenuator configuration, EATT SCPI commands are accepted for compatibility with other X-series instruments and set a “soft” attenuation as described in "Attenuator Configurations and Auto/Man" on page 2162 . The “soft” attenuation is treated as an addition to the “main” attenuation value set by the Atten softkey or the

	POW:ATT SCPI command and affects the total attenuation displayed on the Attenuation key and the Meas Bar. When Enable Elec Atten is off or grayed out, the Elec Atten key is grayed out.
Preset	0 dB
State Saved	Saved in instrument state
Min	0 dB
Max	Dual attenuator configuration: 24 dB Single attenuator configuration: the total of ATT and EATT cannot exceed 50 dB, so if the EATT is set to 24 dB first, the main attenuation cannot be greater than 26 dB and will be reduced accordingly; if the main attenuator is set to 40 dB first, EATT cannot be greater than 10 dB
Initial S/W Revision	Prior to A.02.00
Modified at S/W Revision	A.03.00

Adjust Atten for Min Clip

Sets the combination of mechanical and electronic attenuation and gain based on the current measured signal level so that clipping will be at a minimum.

This is an "immediate action" function, that is, it executes once, when the key is pressed.

This key is grayed out in measurements that do not support this functionality. The spectrum analyzer measurement, Swept SA, does not support this functionality.

Key Path	AMPTD Y Scale, Attenuation
Remote Command	<code>[:SENSe] :POWer [:RF] :RANGe:OPTimize IMMEDIATE</code>
Initial S/W Revision	Prior to A.02.00
Modified at S/W Revision	A.03.00

Pre-Adjust for Min Clip

If this function is on, it does the adjustment described under "[Adjust Atten for Min Clip](#)" on page 2165 each time a measurement restarts. Therefore, in Continuous measurement mode, it only executes before the first measurement.

In dual attenuator models, you can set Elec+Mech Atten, in which case both attenuators participate in the autoranging, or Elec Atten Only, in which case the mechanical attenuator does not participate in the autoranging. This latter case results in less wear on the mechanical attenuator and is usually faster.

This key is grayed out in measurements that do not support this functionality. The spectrum analyzer measurement, Swept SA, does not support this functionality.

Key Path	AMPTD Y Scale, Attenuation
Remote Command	<code>[:SENSe] :POWer [:RF] :RANGe:OPTimize:ATTenuation OFF ELECTRical COMBined</code>

	<code>[:SENSe] :POWer [:RF] :RANGe:OPTimize:ATTenuation?</code>
Notes	The SCPI parameter ELECtrical sets this function to On in single attenuator models. The SCPI parameter COMBined is mapped to ELECtrical in single attenuator models; if you send COMBined, it sets the function to On and returns ELEC to a query.
Dependencies	This key only appears in Dual Attenuator models with an Electronic Attenuator installed. In instruments with Dual Attenuator model, when Enable Elec Atten is off or grayed out, the Pre-Adjust for Min Clip key is grayed out.
Preset	OFF for Swept SA measurement; ON for all other measurements that support Pre-Adjust for Min Clip
State Saved	Saved in instrument state
Range	Dual attenuator models: Off Elec Atten Only Mech + Elec Atten Single attenuator models: Off On
Initial S/W Revision	Prior to A.02.00
Modified at S/W Revision	A.03.00

Remote Command	<code>[:SENSe] :POWer [:RF] :RANGe:AUTO ON OFF 1 0</code> <code>[:SENSe] :POWer [:RF] :RANGe:AUTO?</code>
Notes	ON aliases to "Elec Atten Only" (:POW:RANG:OPT:ATT ELEC) OFF aliases to "Off" (:POW:RANG:OPT:ATT OFF) The query :POW:RANG:AUTO? returns true if :POW:RANG:OPT:ATT is not "Off"
Initial S/W Revision	Prior to A.02.00

Off

Turns Pre-Adjust for Min Clip off. This is the default setting.

This key is grayed out in measurements that do not support this functionality. The spectrum analyzer measurement, Swept SA, does not support this functionality.

Key Path	AMPTD Y Scale, Attenuation, Pre-Adjust for Min Clip
Example	:POW:RANGe:OPT:ATT OFF
Initial S/W Revision	Prior to A.02.00

Elec Atten Only

Selects only the electric attenuator to participate in auto ranging. This offers less wear on the mechanical attenuator and is usually faster.

This key is grayed out in measurements that do not support this functionality. The spectrum analyzer measurement, Swept SA, does not support this functionality.

Key Path	AMPTD Y Scale, Attenuation, Pre-Adjust for Min Clip
Example	:POW:RANGe:OPT:ATT ELEC
Initial S/W Revision	Prior to A.02.00

Mech + Elec Atten

In dual attenuator models, this selects both attenuators participate in the autoranging.

This key is grayed out in measurements that do not support this functionality. The spectrum analyzer measurement, Swept SA, does not support this functionality.

Key Path	AMPTD Y Scale, Attenuation, Pre-Adjust for Min Clip
Example	:POW:RANGe:OPT:ATT COMB
Initial S/W Revision	Prior to A.02.00

(Mech) Atten Step

This controls the step size used when making adjustments to the input attenuation.

This key is labeled Mech Atten Step in dual attenuator models and Atten Step in single attenuator models. In the dual attenuator configuration, this key only affects the step size of the mechanical attenuator.

Key Path	AMPTD Y Scale, Attenuation
Remote Command	[:SENSe] :POWer [:RF] :ATTenuation :STEP [:INCRement] 10 dB 2 dB [:SENSe] :POWer [:RF] :ATTenuation :STEP [:INCRement] ?
Example	POW:ATT:STEP 2
Notes	Note this feature works like a 1-N choice from the front panel, but it takes a specific value (in dB) when used remotely. The only valid values are 2 and 10.
Dependencies	Blanked in CXA and EXA if option FSA (2 dB steps) is not present. If blanked, attempts to set it via SCPI will yield an error.
Couplings	When the attenuation step size changes, the current mechanical attenuation value is adjusted (if necessary) to be quantized to the new step size. That is, if step is set to 10 dB, mech atten is increased if necessary so it is a multiple of 10 dB
Preset	PXA and MXA: 2 dB EXA and CXA: 10 dB (2 dB with option FSA)
State Saved	Saved in instrument state
Initial S/W Revision	Prior to A.02.00
Modified at S/W Revision	A.03.00

Scale/Div

Sets the logarithmic units per vertical graticule division on the display. When the Auto Scaling is On, the Scale/Div is automatically determined by the measurement result. When you set a value manually, Auto Scaling is automatically toggled to Off.

Key Path	AMPTD Y Scale
Mode	SA, WCDMA, C2K, WIMAX OFDMA, TD-SCDMA, 1xEVDO, ISDB-T, CMMB, LTE, LTETDD, BLUETOOTH, WLAN, MSR, LTEAFDD, LTEATDD
Remote Command	:DISPlay:OBWidth:VIEW[1]:WINDow[1]:TRACe:Y[:SCALe]:PDIVision <rel_amp1> :DISPlay:OBWidth:VIEW[1]:WINDow[1]:TRACe:Y[:SCALe]:PDIVision?
Example	DISP:OBW:VIEW:WIND:TRAC:Y:PDIV 5 DISP:OBW:VIEW:WIND:TRAC:Y:PDIV?
Notes	You must be in the Spectrum Analysis mode, W-CDMA mode, cdma2000 mode, TD-SCDMA mode, ISDB-T mode, CMMB mode, LTE mode, LTE TDD mode, BLUETOOTH mode, WLAN mode, 1xEVDO mode, MSR, LTE-Advanced FDD/TDD or WIMAX OFDMA mode to use this command. Use :INSTrument:SElect to set the mode.
Couplings	When the Auto Scaling is On, this value is automatically determined by the measurement result. When you set a value manually, Auto Scaling automatically changes to Off.
Preset	10.00 dB
State Saved	Saved in instrument state.
Min	0.10 dB
Max	20.00 dB
Initial S/W Revision	Prior to A.02.00
Modified at S/W Revision	A.03.00

Presel Center

When this key is pressed, the centering of the preselector filter is adjusted to optimize the amplitude accuracy at the frequency of the selected marker. If the selected marker is not on when Presel Center is pressed, the analyzer will turn on the selected marker, perform a peak search, and then perform centering on the marker's center frequency. If the selected marker is already on and between the start and stop frequencies of the analyzer, the analyzer performs the preselector calibration on that marker's frequency. If the selected marker is already on, but outside the frequency range between Start Freq and Stop Freq, the analyzer will first perform a peak search, and then perform centering on the marker's center frequency.

The value displayed on the Presel Adjust key will change to reflect the new preselector tuning (see Presel Adjust).

A number of considerations should be observed to ensure proper operation. See ["Proper Preselector Operation" on page 669](#).

Key Path	AMPTD Y Scale
Remote Command	[:SENSE]:POWer[:RF]:PCENTER

Example	POW:PCEN
Notes	Note that the rules outlined above under the key description apply for the remote command as well as the key. The result of the command is dependent on marker position, and so forth. Any message shown by the key press is also shown in response to the remote command.
Dependencies	<ul style="list-style-type: none"> • Grayed out if the microwave preselector is off.) • If the selected marker's frequency is below Band 1, advisory message 0.5001 is generated and no action is taken. • Grayed out if entirely in Band 0. • Blank in models that do not include a preselector, such as option 503. If the SCPI is sent in these instruments, it is accepted without error, and the query always returns 0. • Grayed out in the Spectrogram View.
Couplings	<p>The active marker position determines where the centering will be attempted.</p> <p>If the analyzer is in a measurement such as averaging when centering is initiated, the act of centering the preselector will restart averaging but the first average trace will not be taken until the centering is completed.</p>
Status Bits/OPC dependencies	<p>When centering the preselector, *OPC will not return true until the process is complete and a subsequent measurement has completed, nor will results be returned to a READ or MEASure command.</p> <p>The Measuring bit should remain set while this command is operating and should not go false until the subsequent sweep/measurement has completed.</p>
Initial S/W Revision	Prior to A.02.00
Modified at S/W Revision	A.03.00

Proper Preselector Operation

A number of considerations should be observed to ensure proper operation:

1. If the selected marker is off, the analyzer will turn on a marker, perform a peak search, and adjust the preselector using the selected marker's frequency. It uses the "highest peak" peak search method unqualified by threshold or excursion, so that there is no chance of a 'no peak found' error. It continues with that peak, even if it is the peak of just noise. Therefore, for this operation to work properly, there should be a signal on screen in a preselected range for the peak search to find.
2. If the selected marker is already on, the analyzer will attempt the centering at that marker's frequency. There is no preselector for signals below about 3.6 GHz, therefore if the marker is on a signal below 3.6 GHz, no centering will be attempted and an advisory message generated
3. In some models, the preselector can be bypassed. If it is bypassed, no centering will be attempted in that range and a message will be generated.

Preselector Adjust

Allows you to manually adjust the preselector filter frequency to optimize its response to the signal of interest. This function is only available when "[Presel Center](#)" on page 2168 is available.

For general purpose signal analysis, using Presel Center is recommended. Centering the filter minimizes the impact of long-term preselector drift. Presel Adjust can be used instead to manually optimize the preselector. One application of manual optimization would be to peak the preselector response, which both optimizes the signal-to-noise ratio and minimizes amplitude variations due to small (short-term) preselector drifting.

Key Path	AMPTD Y Scale
Scope	Meas Global
Remote Command	<code>[:SENSe] :POWer [:RF] :PADJust <freq></code> <code>[:SENSe] :POWer [:RF] :PADJust?</code>
Example	POW:PADJ 100KHz POW:PADJ?
Notes	The value on the key reads out to 0.1 MHz resolution.
Dependencies	<ul style="list-style-type: none"> • Grayed out if microwave preselector is off.) • Grayed out if entirely in Band 0. • Blank in models that do not include a preselector, such as option 503. If the SCPI is sent in these instruments, it is accepted without error, and the query always returns 0. • Grayed out in the Spectrogram View.
Preset	0 MHz
State Saved	The Presel Adjust value set by Presel Center, or by manually adjusting Presel Adjust, is not saved in instrument state, and does not survive a Preset or power cycle.
Min	-500 MHz
Max	500 MHz
Default Unit	Hz
Backwards Compatibility SCPI	<code>[:SENSe] :POWer [:RF] :MW :PADJust</code> <code>[:SENSe] :POWer [:RF] :MMW :PADJust</code> PSA had multiple preselectors, but the X-Series has only one. These commands simply alias to <code>[:SENSe] :POWer [:RF] :PADJust</code>
Initial S/W Revision	Prior to A.02.00
Modified at S/W Revision	A.03.00

Remote Command	<code>[:SENSe] :POWer [:RF] :PADJust :PRESelector MWAVE MMWave EXTERNAL</code> <code>[:SENSe] :POWer [:RF] :PADJust :PRESelector?</code>
Notes	PSA had multiple preselectors, and you could select which preselector to adjust. Since the X-Series has only one mm/uW preselector, the preselector selection softkey is no longer available. However, to provide backward compatibility, we accept the legacy remote commands. The command form has no effect, the query always returns MWAVE
Initial S/W Revision	Prior to A.02.00

μW Path Control

Sets the μW Path Control function to Auto, standard path, μW Preselector Bypass (Option MPB) and Low Noise Path(Option LNP).

Key Path	AMPTD/Y Scale
Initial S/W Revision	A.14.50

μW Path Control Auto

Activates the auto rules for μW Path Control. When Auto is active, the μW Path Control is set to Preselector Bypass in modulation analysis and spectral flatness measurement; it is set to standard path in other measurements.

Key Path	AMPTD/Y Scale
Remote Command	[:SENSe] :POWer [:RF] :MW:PATH:AUTO ON OFF 1 0 [:SENSe] :POWer [:RF] :MW:PATH:AUTO?
Example	POW:MW:PATH:AUTO ON POW:MW:PATH:AUTO?
Couplings	When Auto is active, the μW Path Control is set to μW Preselector Bypass in IQ measurements (IQ waveform, CCDF, PVT, EVM, Spetrum flatness and WLS); it is set to standard path in other measurements.
Preset	ON
Range	Off On
Initial S/W Revision	A.14.50

Standard Path

This path gives the best remote-control throughput, minimizes acoustic noise from switching and minimizes the risk of wear in the hardware switches, particularly in remote test scenarios where both low band and high band setups will follow in rapid succession.

In this path, the bypass of the low band/high band switch and microwave preamp is never activated, which can cause some noise degradation but preserves the life of the bypass switch.

Key Path	AMPTD Y Scale, μW Path Control
Example	:POW:MW:PATH STD
Readback Text	Standard Path
Initial S/W Revision	A.04.00

Low Noise Path Enable

You may choose Low Noise Path Enable, which gives a lower noise floor under some circumstances, particularly when operating in the 21–26.5 GHz region. With the Low Noise Path enabled, the low band/high band switch and microwave preamp are bypassed whenever all of the following are true:

- The analyzer is not in the Low Band, meaning:
- the start frequency is above 3.5 GHz and
- the stop frequency is above 3.6 GHz.
- the internal preamp is not installed or (if installed) is set to Off or Low Band

Note that this means that, when any part of a sweep is done in Low Band, the Low Noise Path is not used, whether or not the Low Noise Path Enable is selected in the user interface. Also, if the preamp is turned on, the Low Noise Path is not used, whether or not the Low Noise Path Enable is selected in the user interface. The only time the Low Noise Path is used is when Low Noise Path Enable is selected, the sweep is completely in High Band (> 3.6 GHz) and no preamp is in use.

See "[More Information](#)" on page 672

Key Path	AMPTD Y Scale, μ W Path Control
Measurement	Swept SA
Example	:POW:MW:PATH LNP
Notes	<p>For measurements that use IQ acquisition, the low noise path is used when the Center Frequency is in High Band (> 3.6 GHz) and no preamp is in use.</p> <p>In other words, the rules above are modified to use only the center frequency to qualify which path to switch in.</p> <p>This is not the case for FFT's in the Swept SA measurement; they use the same rules as swept measurements.</p>
Dependencies	<p>Key is blanked if current mode does not support it.</p> <p>Key is grayed out if mode supports it but current measurement does not support it.</p> <p>Unless Option LNP is present and licensed, key is blank and if SCPI command sent, error -241, "Hardware missing; Option not installed" is generated.</p>
Readback Text	Low Noise Path Enable
Initial S/W Revision	A.04.00

More Information

The user should understand that the Low Noise Path, while giving improved DANL, has the disadvantage of decreased TOI performance and decreased gain compression performance relative to the standard path.

The user should also understand that the bypass switch is a mechanical switch and has finite life, so if the Low Noise Path is enabled, it is possible to cause frequent cycling of this switch by frequently changing analyzer settings such that the above conditions hold true only some of the time. A user making tests of this nature should consider opting for the Standard Path, which will never throw the bypass switch, at the expense of some degraded noise performance.

The low noise path is useful for situations where the signal level is so low that the analyzer performance is dominated by noise even with 0 dB attenuation, but still high enough that the preamp option would have excessive third-order intermodulation or compression. The preamp, if purchased and used, gives better noise floor than does the “Low Noise Path.” However, its compression threshold and third-order intercept are much poorer than that of the non-preamp path. There are some applications, typically for signals around -30 dBm, for which the third-order dynamic range of the standard path is good enough, but the noise floor is not low enough even with 0 dB input attenuation. When the third-order dynamic range of the preamp path is too little and the noise floor of the standard path is too high, the Low Noise Path can provide the best dynamic range

The graph below illustrates the concept. It shows, in red, the performance of an analyzer at different attenuation settings, both with the preamp on and off, in a measurement that is affected by both analyzer noise and analyzer TOI. The green shows the best available dynamic range, offset by 0.5 dB for clarity. The blue shows how the best available dynamic range improves for moderate signal levels with the low noise path switched in. In this illustration, the preamp improves the noise floor by 15 dB while degrading the third-order intercept by 30 dB, and the low noise path reduces loss by 8 dB. The attenuator step size is 2 dB.

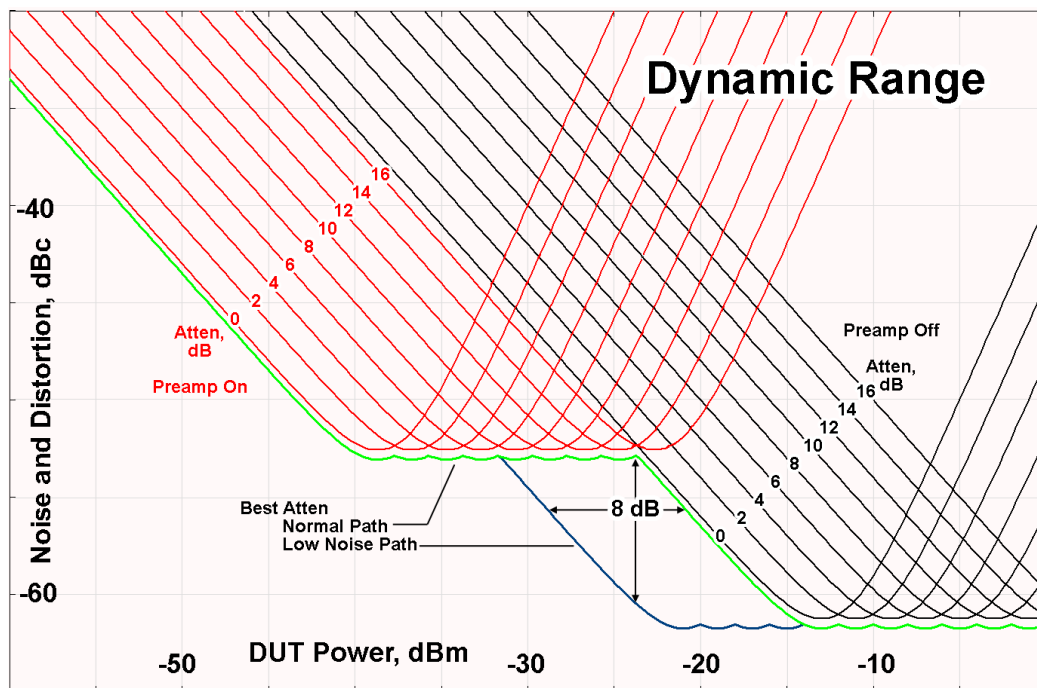

There are other times where selecting the low noise path improves performance, too. Compression-limited measurements such as finding the nulls in a pulsed-RF spectrum can profit from the low noise path in a way similar to the TOI-limited measurement illustrated. Accuracy can be improved when the low noise path allows the optimum attenuation to increase from a small amount like 0, 2 or 4 dB to a larger amount, giving better return loss at the analyzer input. Harmonic measurements, such as second and third harmonic levels, are much improved using the low noise path because of the superiority of that path for harmonic (though not intermodulation) distortion performance.

μW Preselector Bypass

This key toggles the preselector bypass switch for band 1 and higher. When the microwave preselector is on, the signal path is preselected. When the microwave preselector is off, the signal path is not preselected. The preselected path is the normal path for the analyzer.

The preselector is a tunable bandpass filter which prevents signals away from the frequency of interest from combining in the mixer to generate in-band spurious signals (images). The consequences of using a preselector filter are its limited bandwidth, the amplitude and phase ripple in its passband, and any amplitude and phase instability due to center frequency drift.

Option MPB or pre-selector bypass provides an unpreselected input mixer path for certain X-Series signal analyzers with frequency ranges above 3.6 GHz. This signal path allows a wider bandwidth and less amplitude variability, which is an advantage when doing modulation analysis and broadband signal analysis. The disadvantage is that, without the preselector, image signals will be displayed. Another disadvantage of bypassing the preselector is increased LO emission levels at the front panel input port.

Image responses are separated from the real signal by twice the 1st IF. For IF Paths of 10 MHz and 25 MHz, the 1st IF is 322.5 MHz, so the image response and the real signal will be separated by 645 MHz. The 1st IF will be different for other IF Path settings. When viewing a real signal and its corresponding image response in internal mixing, the image response will be to the left of the real signal.

Also, the image response and the real signal typically have the same amplitude and exhibit the same shape factor.

However, if Option FS1, Fast Sweep Capability, is enabled, the image response in the Swept SA measurement will appear lower in amplitude and have a much wider shape factor compared to the real signal.

Key Path	AMPTD Y Scale, μW Path Control
Example	:POW:MW:PATH MPB
Dependencies	Key is blanked if current mode does not support it. Key is grayed out if mode supports it but current measurement does not support it. Key is blank unless Option MPB is present and licensed. If SCPI command sent when MPB not present, error -241, "Hardware missing; Option not installed" is generated.
Readback Text	μW Preselector Bypass
Initial S/W Revision	A.04.00

Remote Command	[:SENSe] :POWer [:RF] :MW:PRESelector [:STATe] ON OFF 0 1 [:SENSe] :POWer [:RF] :MW:PRESelector [:STATe] ?
Example	:POW:MW:PRES OFF Bypasses the microwave preselector
Notes	The ON parameter sets the STD path (:POW:MW:PATH STD) The OFF parameter sets path MPB (:POW:MW:PATH MPB)
Preset	ON

Internal Preamp

Accesses a menu of keys that control the internal preamps. Turning on the preamp gives a better noise figure, but a poorer TOI to noise floor dynamic range. You can optimize this setting for your particular measurement.

The instrument takes the preamp gain into account as it sweeps. If you sweep outside of the range of the preamp the instrument will also account for that. The displayed result will always reflect the correct gain.

For some measurements, when the preamp is on and any part of the displayed frequency range is below the lowest frequency for which the preamp has specifications, a warning condition message appears in the status line. For example, for a preamp with a 9 kHz lowest specified frequency: "Preamp: Accy unspec'd below 9 kHz".

Key Path	AMPTD Y Scale
Scope	Meas Global
Remote Command	[:SENSe] :POWeR [:RF] :GAIN [:STATe] OFF ON 0 1 [:SENSe] :POWeR [:RF] :GAIN [:STATe] ?
Dependencies	Preamp is not available on all hardware platforms. If the preamp is not present or is unlicensed, the key is not shown. The preamp is not available when the electronic/soft attenuator is enabled.
Couplings	The act of connecting the U7227A USB Preamplifier to one of the analyzer's USB ports will cause the Internal Preamp to be switched on. When this happens an informational message will be generated: "Internal Preamp turned on for optimal operation with USB Preamp." Note that if the Internal Preamp was already on, there will be no change to the setting, but if it was Off it will be switched On, to Full Range. Note that this same action occurs when the SA mode is selected while the USB Preamp is connected to one of the analyzer's USB ports, if it is the first time that the SA mode has run since powerup, or if the last time the SA mode was running the USB Preamp was NOT connected. Subsequently disconnecting the USB Preamp from USB does not change the Internal Preamp setting nor restore the previous setting.
Preset	OFF
State Saved	Saved in instrument state
Initial S/W Revision	Prior to A.02.00
Modified at S/W Revision	A.14.00

Key Path	AMPTD Y Scale, Internal Preamp
Scope	Meas Global
Remote Command	[:SENSe] :POWeR [:RF] :GAIN :BAND LOW FULL [:SENSe] :POWeR [:RF] :GAIN :BAND?
Dependencies	Preamp is not available on all hardware platforms. If the preamp is not present or is unlicensed, the key is not shown. If a POW:GAIN:BAND FULL command is sent when a low band preamp is available, the preamp band

	parameter is to LOW instead of FULL, and an "Option not installed" message is generated.
Preset	LOW
State Saved	Saved in instrument state
Initial S/W Revision	Prior to A.02.00

Off

Turns the internal preamp off

Key Path	AMPTD Y Scale, Internal Preamp
Example	:POW:GAIN OFF
Readback	Off
Initial S/W Revision	Prior to A.02.00

Low Band

Sets the internal preamp to use only the low band.

The frequency range of the installed (optional) low-band preamp is displayed in square brackets on the Low Band key label.

Key Path	AMPTD Y Scale, Internal Preamp
Example	:POW:GAIN ON :POW:GAIN:BAND LOW
Readback	Low Band
Initial S/W Revision	Prior to A.02.00

Full Range

Sets the internal preamp to use its full range. The low band (0–3.6 GHz or 0–3GHz, depending on the model) is supplied by the low band preamp and the frequencies above low band are supplied by the high band preamp.

The frequency range of the installed (optional) preamp is displayed in square brackets on the Full Range key label. If the high band option is not installed the Full Range key does not appear.

Key Path	AMPTD Y Scale, Internal Preamp
Example	:POW:GAIN ON :POW:GAIN:BAND FULL
Readback	Full Range
Initial S/W Revision	Prior to A.02.00

Ref Position

Positions the reference level at the top, center or bottom of the Y Scale display. Changing the reference position does not change the reference level value.

Key Path	AMPTD Y Scale
Mode	SA, WCDMA, C2K, WIMAX OFDMA, TD-SCDMA, 1xEVDO, ISDB-T, CMMB, LTE, LTETDD, BLUETOOTH, WLAN, MSR, LTEAFDD, LTEATDD
Remote Command	:DISPlay:OBWidth:VIEW[1]:WINDow[1]:TRACe:Y[:SCALe]:RPOSition TOP CENTER BOTTom :DISPlay:OBWidth:VIEW[1]:WINDow[1]:TRACe:Y[:SCALe]:RPOSition?
Example	DISP:OBW:VIEW:WIND:TRAC:Y:RPOS BOTT DISP:OBW:VIEW:WIND:TRAC:Y:RPOS?
Notes	You must be in the Spectrum Analysis mode, W-CDMA mode, cdma2000 mode, TD-SCDMA mode, ISDB-T mode, CMMB mode, LTE mode, LTE TDD mode, BLUETOOTH mode, WLAN mode, 1xEVDO mode, MSR, LTE-Advanced FDD/TDD or WIMAX OFDMA mode to use this command. Use:INSTRument:SElect to set the mode.
Preset	TOP
State Saved	Saved in instrument state.
Range	Top Ctr Bot
Initial S/W Revision	Prior to A.02.00
Modified at S/W Revision	A.03.00

Auto Scaling

Allows you to toggle the Auto Scaling function between On and Off.

Key Path	AMPTD Y Scale
Mode	SA, WCDMA, C2K, WIMAX OFDMA, TD-SCDMA, 1xEVDO, ISDB-T, CMMB, LTE, LTETDD, BLUETOOTH, WLAN, MSR, LTEAFDD, LTEATDD
Remote Command	:DISPlay:OBWidth:VIEW[1]:WINDow[1]:TRACe:Y[:SCALe]:COUPle 0 1 OFF ON :DISPlay:OBWidth:VIEW[1]:WINDow[1]:TRACe:Y[:SCALe]:COUPle?
Example	DISP:OBW:VIEW:WIND:TRAC:Y:COUP ON DISP:OBW:VIEW:WIND:TRAC:Y:COUP?
Couplings	When Auto Scaling is On, upon pressing the Restart front-panel key, this function automatically sets the scale per division to 10 dB and determines reference values based on the measurement results. When you set a value to either Scale/Div or Ref Value manually, Auto Scaling automatically changes to Off.
Preset	1
State Saved	Saved in instrument state.

9 Occupied Bandwidth Measurement
AMPTD Y Scale (Amplitude/Y Scale)

Range	On Off
Initial S/W Revision	Prior to A.02.00
Modified at S/W Revision	A.03.00

Auto Couple

The Auto Couple feature provides a quick and convenient way to automatically couple multiple instrument settings. This helps ensure accurate measurements and optimum dynamic range. When the Auto Couple feature is activated, either from the front panel or remotely, all parameters of the current measurement that have an Auto/Manual mode are set to Auto mode and all measurement settings dependent on (or coupled to) the Auto/Man parameters are automatically adjusted for optimal performance.

However, the Auto Couple key actions are confined to the current measurement only. It does not affect other measurements in the mode, and it does not affect markers, marker functions, or trace or display attributes.

See "[More Information](#)" on page 679

Key Path	Front-panel key
Remote Command	:COUPle ALL NONE
Example	:COUP ALL
Notes	:COUPle ALL puts all Auto/Man parameters in Auto mode (equivalent to pressing the Auto Couple key). :COUPLE NONE puts all Auto/Man parameters in manual mode. It decouples all the coupled instrument parameters and is not recommended for making measurements.
Initial S/W Revision	Prior to A.02.00

More Information

There are two types of functions that have Auto/Manual modes.

Auto/Man Active Function keys

An Auto/Man toggle key controls the binary state associated with an instrument parameter by toggling between Auto (where the parameter is automatically coupled to the other parameters it is dependent upon) and Man (where the parameter is controlled independent of the other parameters), as well as making the parameter the active function. The current mode is indicated on the softkey with either Auto or Man underlined as illustrated below.



Auto/Man 1-of-N keys

An Auto/Man 1-of-N key allows you to manually pick from a list of parameter values, or place the function in Auto, in which case the value is automatically selected (and indicated) as shown below. If in Auto, Auto is underlined on the calling key. If in manual operation, manual is indicated on the calling key. But the calling key does not actually toggle the function, it simply opens the menu.

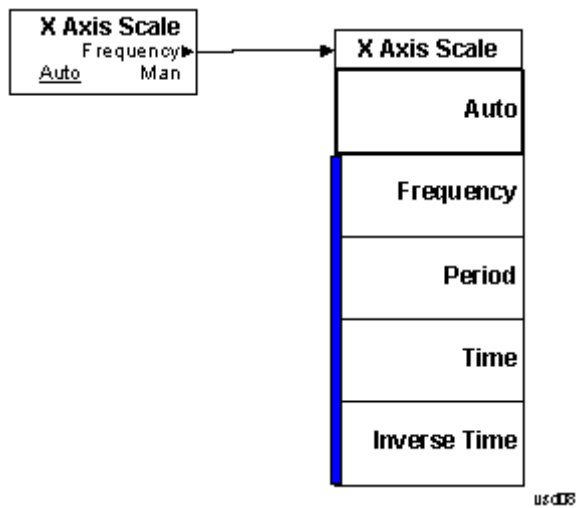

BW

Accesses a menu of functions that enable you to specify and control the video and resolution bandwidths. You can also select the type of filter for the measurement.

Key Path	Front-panel key
Initial S/W Revision	Prior to A.02.00

Res BW

Sets the resolution bandwidth for the current measurement. If an unavailable bandwidth is entered with the numeric keypad, the closest available bandwidth is selected.

Key Path	BW
Mode	SA, WCDMA, C2K, WIMAX OFDMA, TD-SCDMA, 1xEVDO, ISDB-T, CMMB, LTE, LTETDD, BLUETOOTH, WLAN, MSR, LTEAFDD, LTEATDD
Remote Command	<pre>[:SENSe]:OBWidth:BANDwidth[:RESolution] <bandwidth> [:SENSe]:OBWidth:BANDwidth[:RESolution]? [:SENSe]:OBWidth:BANDwidth[:RESolution]:AUTO ON OFF 1 0 [:SENSe]:OBWidth:BANDwidth[:RESolution]:AUTO?</pre>
Example	<pre>OBW:BAND 250000 OBW:BAND? OBW:BAND:AUTO OFF OBW:BAND:AUTO?</pre>
Notes	You must be in the Spectrum Analysis mode, W-CDMA mode, cdma2000 mode, TD-SCDMA mode, ISDB-T mode, CMMB mode, LTE mode, LTE TDD mode, BLUETOOTH mode, WLAN mode, 1xEVDO mode, MSR, LTE-Advanced FDD/TDD or WIMAX OFDMA mode to use this command. Use:INSTRument:SElect to set the mode.
Couplings	<p>Sweep time is coupled to RBW. As the RBW changes, the sweep time (if set to Auto) is changed to maintain amplitude calibration.</p> <p>Video bandwidth (VBW) is coupled to RBW. As the resolution bandwidth changes, the video bandwidth (if set to Auto) changes to maintain the ratio of VBW/RBW (10:1).</p> <p>When Res BW is set to Auto, the resolution bandwidth is auto-coupled to span. The ratio of Span/RBW is approximately 106:1 when auto coupled. When Res BW is set to Man, bandwidths are entered manually, and these bandwidths are used regardless of other analyzer settings.</p>
Preset	<pre>SA: Auto WCDMA: 30 kHz CDMA2K: 12 kHz WIMAX OFDMA: 100 kHz TD-SCDMA: 30 kHz 1xEVDO: 30 kHz ISDB-T: 10 kHz</pre>

	CMMB: 3 kHz LTE: 30 kHz LTETDD: 30 kHz BLUETOOTH:10 kHz WLAN: 100kHz MSR: 30 kHz, LTEAFDD, LTEATDD: 30 kHz SA: ON WCDMA, C2K, TD-SCDMA, WIMAX OFDMA, 1xEVDO , ISDB-T, CMMB, LTE, LTETDD, WLAN, MSR, LTEAFDD, LTEATDD: OFF
State Saved	Saved in instrument state.
Min	1 Hz
Max	8 MHz
Backwards Compatibility SCPI	[:SENSe] :OBWidth:BWIDth[:RESolution]
Initial S/W Revision	Prior to A.02.00
Modified at S/W Revision	A.03.00

Video BW

Changes the analyzer post-detection filter.

Key Path	BW
Mode	SA, WCDMA, C2K, WIMAX OFDMA, TD-SCDMA, 1xEVDO, ISDB-T, CMMB, LTE, LTETDD, BLUETOOTH, WLAN, MSR, LTEAFDD, LTEATDD
Remote Command	<pre>[:SENSe] :OBWidth:BAWdwidth:VIDeo <bandwidth> [:SENSe] :OBWidth:BAWdwidth:VIDeo? [:SENSe] :OBWidth:BAWdwidth:VIDeo:AUTO ON OFF 1 0 [:SENSe] :OBWidth:BAWdwidth:VIDeo:AUTO?</pre>
Example	<pre>OBW:BAWd:VID 5 MHz OBW:BAWd:VID? OBW:BAWd:VID:AUTO ON OBW:BAWd:VID:AUTO?</pre>
Notes	You must be in the Spectrum Analysis mode, W-CDMA mode, cdma2000 mode, TD-SCDMA mode, ISDB-T mode, CMMB mode, LTE mode, LTE TDD mode, BLUETOOTH mode, WLAN mode, 1xEVDO mode, MSR, LTE-Advanced FDD/TDD or WIMAX OFDMA mode to use this command. Use:INSTrument:SElect to set the mode.
Dependencies	When using the average detector with either Sweep Time set to Man, or in zero span, the VBW setting has no effect and is disabled (grayed out).
Couplings	Video bandwidth (VBW) is coupled to RBW. As the resolution bandwidth changes, the video bandwidth (if set to Auto) changes to maintain the ratio set by VBW/RBW.

Sweep Time is coupled to Video Bandwidth (VBW). As the VBW is changed, the sweep time (when set to Auto) is changed to maintain amplitude calibration. This occurs because of common hardware between the two circuits, even though the Video BW filter is not actually “in-circuit” when the detector is set to Average. Because the purpose of the average detector and the VBW filter are the same, either can be used to reduce the variance of the result.

Although the VBW filter is not “in-circuit” when using the average detector, the Video BW key can have an effect on (Auto) sweep time, and is not disabled. In this case, reducing the VBW setting increases the sweep time, which increases the averaging time, producing a lower-variance trace.

When the video bandwidth is AUTO coupled, the video bandwidth value is set to:

Resolution Bandwidth * Video Bandwidth to Resolution Bandwidth Ratio

Preset	SA, LTE, LTETDD, WLAN, MSR, LTEAFDD, LTEATDD: Auto WCDMA: 300 kHz CDMA2K:120 kHz WIMAX OFDMA: 1 MHz TD-SCDMA: 300 kHz 1xEVDO: 300 kHz ISDB-T: 300 Hz CMMB: 3 kHz BLUETOOTH: 30 kHz ON ISDB-T, CMMB: OFF
State Saved	Saved in instrument state.
Min	1 Hz
Max	50 MHz
Backwards Compatibility SCPI	[:SENSe] :OBWidth :BWIDth :VIDeo
Initial S/W Revision	Prior to A.02.00
Modified at S/W Revision	A.03.00

Filter Type

Allows you to select the type of filter to be used for the current measurement. Besides the Gaussian filter shape, there are certain special filter types, such as Flat Top, that are desirable under certain conditions.

Key Path	BW
Mode	SA, WCDMA, C2K, WIMAX OFDMA, TD-SCDMA, 1xEVDO, ISDB-T, CMMB, LTE, LTETDD, BLUETOOTH, WLAN, MSR, LTEAFDD, LTEATDD
Remote Command	[:SENSe] :OBWidth :BANDwidth :SHAPE GAUSSian FLATtop [:SENSe] :OBWidth :BANDwidth :SHAPE?
Example	OBW:BAND:SHAP GAUS

9 Occupied Bandwidth Measurement
BW

	OBW:BAND:SHAP?
Preset	GAUSSian
State Saved	Saved in instrument state.
Range	Gaussian Flattop
Backwards Compatibility SCPI	[:SENSe] :OBWidth:BWIDth:SHAPE
Initial S/W Revision	Prior to A.02.00
Modified at S/W Revision	A.03.00

Cont (Continuous Measurement/Sweep)

Sets the analyzer for Continuous measurement operation. The single/continuous state is Meas Global so the setting will affect all measurements. If you are Paused, pressing Cont does a Resume.

Key Path	Front-panel key
Remote Command	:INITiate:CONTinuous OFF ON 0 1 :INITiate:CONTinuous?
Example	:INIT:CONT 0 puts analyzer in Single measurement operation. :INIT:CONT 1 puts analyzer in Continuous measurement operation
Preset	ON (Note that SYST:PRESet sets INIT:CONT to ON but *RST sets INIT:CONT to OFF)
State Saved	Saved in instrument state
Backwards Compatibility Notes	For Spectrum Analysis mode in ESA and PSA, there is no Cont hardkey, instead there is a Sweep Single/Cont key. In these analyzers, switching the Sweep Single/Cont key from Single to Cont restarts averages (displayed average count reset to 1), but does not restart Max Hold and Min Hold. The X-Series has Single and Cont keys in place of the SweepSingleCont key. In the X-Series, if in single measurement, the Cont key (and INIT:CONT ON) switches to continuous measurement, but never restarts a measurement and never resets a sweep.
Initial S/W Revision	Prior to A.02.00

In Swept SA Measurement (Spectrum Analysis Mode):

The analyzer takes repetitive sweeps, averages, measurements, etc., when in Continuous mode. When the average count reaches the Average/Hold Number the count stops incrementing, but the analyzer keeps sweeping. See the Trace/Detector section for the averaging formula used both before and after the Average/Hold Number is reached. The trigger condition must be met prior to each sweep. The type of trace processing for multiple sweeps, is set under the Trace/Detector key, with choices of Trace Average, Max Hold, or Min Hold.

In Other Measurements/Modes:

With Avg/Hold Num (in the Meas Setup menu) set to Off or set to On with a value of 1, a sweep is taken after the trigger condition is met; and the analyzer continues to take new sweeps after the current sweep has completed and the trigger condition is again met. However, with Avg/Hold Num set to On with a value >1, multiple sweeps (data acquisitions) are taken for the measurement. The trigger condition must be met prior to each sweep. The sweep is not stopped when the average count k equals the number N set for Avg/Hold Num is reached, but the number k stops incrementing. A measurement average usually applies to all traces, marker results, and numeric results. But sometimes it only applies to the numeric results.

If the analyzer is in Single measurement, pressing the Cont key does not change k and does not cause the sweep to be reset; the only action is to put the analyzer into Continuous measurement operation.

If it is already in continuous sweep:

the INIT:CONT 1 command has no effect

9 Occupied Bandwidth Measurement
Cont (Continuous Measurement/Sweep)

the INIT:CONT 0 command will place the analyzer in Single Sweep but will have no effect on the current sequence until $k = N$, at which point the current sequence will stop and the instrument will go to the idle state.

File

See "File" on page 348

FREQ Channel

Accesses a menu of keys that allow you to control the Frequency and Channel parameters of the instrument.

Some features in the Frequency menu are the same for all measurements – they do not change as you change measurements. Settings like these are called “Meas Global” and are unaffected by Meas Preset. For example, the Center Freq setting is the same for all measurements - it does not change as you change measurements.

Key Path	Front-panel key
Initial S/W Revision	Prior to A.02.00

Center Freq

Sets the frequency that corresponds to the horizontal center of the graticule (when frequency Scale Type is set to linear). While adjusting the Center Frequency the Span is held constant, which means that both Start Frequency and Stop Frequency will change.

Pressing Center Freq also sets the frequency entry mode to Center/Span. In Center/Span mode, the center frequency and span values are displayed below the graticule, and the default active function in the Frequency menu is Center Freq.

The center frequency setting is the same for all measurements within a mode, that is, it is Meas Global. Some modes are also able to share a Mode Global center frequency value. If this is the case, the Mode will have a Global Settings key in its Mode Setup menu.

The Center Freq function sets (and queries) the Center Frequency for the currently selected input. If your analyzer has multiple inputs, and you select another input, the Center Freq changes to the value for that input. SCPI commands are available to directly set the Center Freq for a specific input.

Center Freq is remembered as you go from input to input. Thus you can set a Center Freq of 10 GHz with the RF Input selected, change to BBIQ and set a Center Freq of 20 MHz, then switch to External Mixing and set a Center Freq of 60 GHz, and when you go back to the RF Input the Center Freq will go back to 10 GHz; back to BBIQ and it is 20 MHz; back to External Mixing and it is 60 GHz.

See ["RF Center Freq" on page 691](#)

See [Ext Mix Center Freq](#)

See ["I/Q Center Freq" on page 693](#)

See ["Center Frequency Presets" on page 689](#)

Key Path	FREQ Channel
Scope	Meas Global
Remote Command	<code>[:SENSe] :FREQuency:CENTer <freq></code> <code>[:SENSe] :FREQuency:CENTer?</code>

Example	FREQ:CENT 50 MHz FREQ:CENT UP changes the center frequency to 150 MHz if you use FREQ:CENT:STEP 100 MHz to set the center frequency step size to 100 MHz FREQ:CENT?
Notes	This command sets either the RF or I/Q Center Frequency depending on the selected input. For RF input it is equivalent to FREQ:RF:CENT For I/Q input it is equivalent to FREQ:IQ:CENT Preset and Max values are dependent on Hardware Options (5xx) If no terminator (e.g. MHz) is sent the terminator Hz is used. If a terminator with unit other than Frequency is used, an invalid suffix error message is generated.
Dependencies	The Center Frequency can be limited by Start or Stop Freq limits, if the Span is so large that Start or Stop reach their limit.
Couplings	When operating in “swept span”, any value of the Center Frequency or Span that is within the frequency range of the analyzer is allowed when the value is being set through the front panel numeric key pad or the SCPI command. The other parameter is forced to a different value if needed, to keep the Start and the Stop Frequencies within the analyzer’s frequency range
Preset	Depends on instrument maximum frequency, mode, measurement, and selected input. See "Center Frequency Presets" on page 689 and "RF Center Freq" on page 691 and Ext Mix Center Freq and "I/Q Center Freq" on page 693 .
State Saved	Saved in instrument state
Min	Depends on instrument maximum frequency, mode, measurement, and selected input.. See "Center Frequency Presets" on page 689 and "RF Center Freq" on page 691 and "I/Q Center Freq" on page 693 .
Max	Depends on instrument maximum frequency, mode, measurement, and selected input.. See "Center Frequency Presets" on page 689 and "RF Center Freq" on page 691 and "I/Q Center Freq" on page 693 .
Default Unit	Hz
Status Bits/OPC	Non-overlapped
Dependencies	
Initial S/W Revision	Prior to A.02.00

Center Frequency Presets

The following table provides the Center Frequency Presets for the Spectrum Analyzer mode, and the Max Freq, for the various frequency options:

Freq Option	CF after Mode Preset	Stop Freq after Mode Preset	Max Freq (can't tune)

9 Occupied Bandwidth Measurement
 FREQ Channel

			above)
503 (all but N9000A)	1.805 GHz	3.6 GHz	3.7 GHz
503 (N9000A)	1.505 GHz	3.0 GHz	3.08 GHz
507 (all but N9000A)	3.505 GHz	7.0 GHz	7.1 GHz
507 (N9000A)	3.755 GHz	7.5 GHz	7.58 GHz
508 (all but N9038A)	1.805 GHz	3.6 GHz	8.5 GHz
508 (N9038A)	4.205 GHz	8.4 GHz	8.5 GHz
513	6.805 GHz	13.6 GHz	13.8 GHz
526 (all but N9000A and N9038A)	13.255 GHz	26.5 GHz	27.0 GHz
526 (N9000A)	13.255 GHz	26.5 GHz	26.55 GHz
526 (N9038A)	1.805 GHz	3.6 GHz	27.0 GHz
532	16.005 GHz	32.0 GHz	32.5 GHz
543	21.505 GHz	43.0 GHz	TBD
544	22.005 GHz	44.0 GHz	44.5 GHz
550	25.005 GHz	50.0 GHz	51 GHz

Input 2:

Model	CF after Mode Preset	Stop Freq after Mode Preset	Max Freq (can't tune above)
N9000A opt C75	0.7505GHz	1.5 GHz	1.58 GHz
N9038A	505 MHz	1 GHz	1.000025 GHz

Tracking Generator Frequency Limits (N9000A only):

Tracking Generator Option	Min Freq (clips to this freq when turn TG on and	If above this Freq, Stop Freq clipped to this Freq when	Max Freq (can't tune above) while TG

	can't tune below while TG on)	TG turned on	on
T03	9 kHz	3.0 GHz	3.08 GHz
T06	9 kHz	6.0 GHz	6.05 GHz

The following table shows the Center Frequency Presets for modes other than Spectrum Analyzer:

Mode	CF Preset for RF
WCDMA	1 GHz
WIMAXOFDMA,	1 GHz
BASIC	1 GHz
ADEMOD	1 GHz
VSA	1 GHz
TDSCDMA	1 GHz
PNOISE	1 GHz
LTE	1 GHz
LTETDD	1 GHz
MSR	1 GHz
GSM	935.2 MHz
NFIGURE	1.505 GHz

RF Center Freq

SCPI command for specifying the RF Center Frequency. This command will set the Center Frequency to be used when the RF input is selected, even if the RF input is not the input that is selected at the time the command is sent. Note that the Center Freq function in the Frequency menu on the front panel always applies to the currently selected input.

Scope	Meas Global
Remote Command	<code>[:SENSe] :FREQuency:RF:CENTer <freq></code> <code>[:SENSe] :FREQuency:RF:CENTer?</code>
Example	FREQ:RF:CENT 30 MHz
Notes	This command is the same in all modes, but the parameter is Measurement Global. So the value is independent in each mode and common across all the measurements in the mode.
Dependencies	If the electronic/soft attenuator is enabled, any attempt to set Center Frequency such that the Stop Frequency would be >3.6 GHz fails and results in an advisory message. If the equivalent SCPI command is sent, this same message is generated as part of a “-221, Settings conflict” warning. If Source Mode is set to Tracking, and the Max or Min Center Freq is therefore limited by the limits of the source, a warning message is generated, “Data out of range;clipped to source max/min” if these limits are exceeded. Note that for an external source, these limits can be affected by the settings of

	Source Numerator, Source Denominator and Power Sweep.
Preset	See table above
State Saved	Saved in instrument state.
Min	-79.999995 MHz, unless Source Mode is set to Tracking, in which case it is limited by the minimum frequency of the Source
Max	See table above. Basically instrument maximum frequency - 5 Hz. Note that, if the Source Mode is set to Tracking, the effective instrument maximum frequency may be limited by the source maximum frequency. If the knob or step keys are being used, also depends on the value of the other three interdependent parameters Span, Start Frequency and Stop Frequency
Initial S/W Revision	Prior to A.02.00
Modified at S/W Revision	A.03.00

Ext Mix Center Freq

SCPI command for specifying the External Mixer Center Frequency. This command will set the Center Frequency to be used when the External Mixer is selected, even if the External Mixer input is not the input which is selected at the time the command is sent. Note that the Center Freq function in the Frequency menu on the front panel always applies to the currently selected input.

Scope	Meas Global
Remote Command	<code>[:SENSe] :FREQuency:EMIXer:CENTer <freq></code> <code>[:SENSe] :FREQuency:EMIXer:CENTer?</code>
Example	<code>:FREQ:EMIX:CENT 60 GHz</code> <code>:FREQ:EMIX:CENT?</code>
Notes	This command is the same in all modes, but the parameter is Measurement Global. So the value is independent in each mode and common across all the measurements in the mode.
Couplings	When returning to External Mixing after having been switched to one of the other inputs (e.g., RF), you will come back into the settings that you had when you left External Mixing. So you will come back to the band you were in with the Center Frequency that you had. However, Span is not an input-dependent parameter, therefore you will bring the span over from the other input. Therefore, the analyzer comes back with the span from the previous input, limited as necessary by the current mixer setup.
Preset	When a Mode Preset is performed while in External Mixing, the Start frequency of the current Mode is set to the nominal Min Freq of the lowest harmonic range in the Harmonic Table for the current mixer setup. Similarly, the Stop frequency of the current Mode is set to the nominal Max Freq of the highest harmonic range in the Harmonic Table. The Center Freq thus presets to the point arithmetically equidistant from these two frequencies. If the current measurement has a limited Span available to it, and cannot achieve the Span shown in the table (Span=Stop Freq - Start Freq), the analyzer uses the maximum Span the measurement allows, and still sets the Center Freq to the midpoint of the Start and Stop Freq values in the Harmonic Table.

	When Restore Input/Output Defaults is performed, the mixer presets to the 11970A, whose Start and Stop frequencies are 26.5 and 40 GHz respectively. The center of these two frequencies is 33.25 GHz. Therefore, after a Restore Input/Output Defaults, if you go into External Mixing and do a Mode Preset while in the Spectrum Analyzer Mode, the resulting Center Freq is 33.25 GHz.
State Saved	Saved in instrument state.
Min	The minimum frequency in the currently selected mixer band + 5 Hz
Max	The maximum frequency in the currently selected mixer band – 5 Hz If the knob or step keys are being used, also depends on the value of the other three interdependent parameters Span, Start Frequency and Stop Frequency
Initial S/W Revision	A.08.01

I/Q Center Freq

SCPI command for specifying the I/Q Center Frequency. This command will set the Center Frequency to be used when the I/Q input is selected, even if the I/Q input is not the input which is selected at the time the command is sent. Note that the Center Freq function in the Frequency menu on the front panel always applies to the currently selected input.

Scope	Meas Global
Remote Command	[:SENSe] :FREQuency:IQ:CENTer <freq> [:SENSe] :FREQuency:IQ:CENTer?
Example	FREQ:IQ:CENT: 30 MHz
Notes	This command is the same in all modes, but the parameter is Measurement Global. So the value is independent in each mode and common across all the measurements in the mode.
Preset	0 Hz
State Saved	Saved in instrument state.
Min	-40.049995 MHz
Max	40.049995 MHz
Initial S/W Revision	Prior to A.02.00

CF Step

Changes the step size for the center frequency and start and stop frequency functions. Once a step size has been selected and the center frequency function is active, the step keys (and the UP|DOWN parameters for Center Frequency from remote commands) change the center frequency by the step-size value. The step size function is useful for finding harmonics and sidebands beyond the current frequency span of the analyzer.

Note that the start and stop frequencies also step by the CF Step value.

Key Path	FREQ Channel
Remote Command	<pre>[:SENSe] :FREQuency:CENTer:STEP[:INCRement] <freq> [:SENSe] :FREQuency:CENTer:STEP[:INCRement]? [:SENSe] :FREQuency:CENTer:STEP:AUTO OFF ON 0 1 [:SENSe] :FREQuency:CENTer:STEP:AUTO?</pre>
Example	<pre>FREQ:CENT:STEP:AUTO ON FREQ:CENT:STEP 500 MHz FREQ:CENT UP increases the current center frequency value by 500 MHz FREQ:CENT:STEP? FREQ:CENT:STEP:AUTO?</pre>
Notes	Preset and Max values are depending on Hardware Options (503, 507, 508, 513, 526)
Notes	Preset and Max values are dependent on Hardware Options (5xx)
Dependencies	Freq Offset is not available in External Mixing. In this case the Freq Offset key is grayed out and shows a value of zero. It will once again be available, and show the previously set value, when you return to the RF Input.
Dependencies	Span, RBW, Center frequency If the electronic/soft attenuator is enabled, any attempt to change the value of the center frequency >3.6 GHz by pressing the Up-arrow key, fails and results in an advisory message. If the equivalent SCPI command is sent, this same message is generated as part of a “-221, Settings conflict” warning.
Couplings	When auto-coupled in a non-zero span, the center frequency step size is set to 10% of the span. When auto-coupled in zero span, the center frequency step size is set to the equivalent -3 dB RBW value.
Preset	Auto ADEM0D: 1 MHz ON
State Saved	Saved in instrument state
Min	– (the maximum frequency of the instrument). That is, 27 GHz max freq instrument has a CF step range of +/- 27 GHz. Note that this is the maximum frequency given the current settings of the instrument, so in External Mixing, for example, it is the maximum frequency of the current mixer band.
Max	The maximum frequency of the instrument. That is, 27 GHz max freq instrument has a CF step range of +/- 27 GHz. Note that this is the maximum frequency given the current settings of the instrument, so in External Mixing, for example, it is the maximum frequency of the current mixer band.
Default Unit	Hz
Status Bits/OPC dependencies	non-overlapped
Initial S/W Revision	Prior to A.02.00
Modified at S/W Revision	A.03.00

Input/Output

See "Input/Output" on page 194

Marker

Accesses a menu that enables you to select, set up and control the markers for the current measurement.

Key Path	Front-panel key
Initial S/W Revision	Prior to A.02.00

Select Marker

Displays the menu keys that enable you to select, set up and control the markers for the current measurement

Key Path	Marker
Initial S/W Revision	Prior to A.02.00

Select Marker

Displays 12 markers available for selection.

Key Path	Marker, Properties
Initial S/W Revision	Prior to A.02.00

Marker Type

Sets the marker control mode to Normal, Delta or Off, If the selected marker is Off, pressing Marker sets it to Normal and places a single marker at the center of the display. At the same time, Marker X Axis Value appears on the Active Function area.

Key Path	Marker
Mode	SA, WCDMA, C2K, WIMAX OFDMA, TD-SCDMA, 1xEVDO, ISDB-T, CMMB, LTE, LTETDD, BLUETOOTH, WLAN, MSR, LTEAFDD, LTEATDD
Remote Command	:CALCulate:OBWidth:MARKer[1] 2 ... 12:MODE POSition DELTa OFF :CALCulate:OBWidth:MARKer[1] 2 ... 12:MODE?
Example	CALC:OBW:MARK:MODE POS CALC:OBW:MARK:MODE?
Notes	If the selected marker is Off, pressing Marker sets it to Normal and places it at the center of the screen on the trace determined by the Marker Trace rules. At the same time, Marker X Axis Value appears on the Active Function area. Default Active Function: the active function for the selected marker's current control mode. If the current control mode is Off, there is no active function and the active function is turned off. Active Function Display: the marker X axis value entered in the active function area displays the marker value to its full entered precision.

Preset	OFF
State Saved	Saved in instrument state.
Range	Normal Delta Off
Initial S/W Revision	Prior to A.02.00
Modified at S/W Revision	A.03.00

Properties

Accesses the marker properties menu.

Key Path	Marker
Initial S/W Revision	Prior to A.02.00

Select Marker

Displays the menu keys that enable you to select, set up and control the markers for the current measurement

Key Path	Marker
Initial S/W Revision	Prior to A.02.00

Select Marker

Displays 12 markers available for selection.

Key Path	Marker, Properties
Initial S/W Revision	Prior to A.02.00

Relative To

Selects the desired marker. The selected marker will be relative to its reference marker.

Key Path	Marker, Properties
Mode	SA, WCDMA, C2K, WIMAX OFDMA, TD-SCDMA, 1xEVDO, ISDB-T, CMMB, LTE, LTETDD, BLUETOOTH, WLAN, MSR, LTEAFDD, LTEATDD
Remote Command	:CALCulate:OBWidth:MARKer[1] 2 ... 12:REFerence <integer> :CALCulate:OBWidth:MARKer[1] 2 ... 12:REFerence?
Example	CALC:OBW:MARK:REF 2

	CALC:OBW:MARK:REF?
Notes	A marker cannot be relative to itself so that choice is grayed out, and if sent from SCPI generates error -221: "Settings conflict; marker cannot be relative to itself." When queried a single value is returned (the specified marker numbers relative marker). You must be in the Spectrum Analysis mode, WCDMA mode, TD-SCDMA mode, 1xEVDO mode, WIMAX OFDMA mode ISDB-T mode, WLAN mode, CMMB mode, LTE mode, LTETDD mode or BLUETOOTH mode to use this command. Use:INSTrument:SElect to set the mode.
Preset	2 3 4 5 6 7 8 9 10 11 12 1
State Saved	Saved in instrument state.
Min	1
Max	12
Readback	Current selected relative to marker number.
Initial S/W Revision	Prior to A.02.00
Modified at S/W Revision	A.03.00

All Markers Off

Turns off all markers.

Key Path	Marker
Mode	SA, WCDMA, C2K, WIMAX OFDMA, TD-SCDMA, 1xEVDO, ISDB-T, CMMB, LTE, LTETDD, BLUETOOTH, WLAN, MSR, LTEAFDD, LTEATDD
Remote Command	:CALCulate:OBWidth:MARKer:AOff
Example	CALC:OBW:MARK:AOff
Initial S/W Revision	Prior to A.02.00
Modified at S/W Revision	A.03.00

Marker X Axis Value (Remote Command Only)

Sets the marker X Axis value in the current marker X Axis Scale unit. It has no effect if the control mode is Off.

Key Path	SCPI only
Mode	SA, WCDMA, C2K, WIMAX OFDMA, TD-SCDMA, 1xEVDO, ISDB-T, CMMB, LTE, LTETDD, BLUETOOTH, WLAN, MSR, LTEAFDD, LTEATDD
Remote Command	:CALCulate:OBWidth:MARKer[1] 2 ... 12:X <freq> :CALCulate:OBWidth:MARKer[1] 2 ... 12:X?
Example	CALC:OBW:MARK3:X 0 CALC:OBW:MARK3:X?
Notes	The query returns the marker's absolute X Axis value if the control mode is Normal, or the offset from

	the marker's reference marker if the control mode is Delta. The query is returned in the fundamental units for the current marker X Axis scale: Hz for Frequency.
Preset	After a preset, all markers are turned OFF, so Marker X Axis Value query returns a not a number (NAN).
State Saved	No
Min	-9.9E+37
Max	9.9E+37
Initial S/W Revision	Prior to A.02.00
Modified at S/W Revision	A.03.00

Marker X Axis Position (Remote Command Only)

Sets the marker X position in trace points. It has no effect if the control mode is Off.

Key Path	SCPI only
Mode	SA, WCDMA, C2K, WIMAX OFDMA, TD-SCDMA, 1xEVDO, ISDB-T, CMMB, LTE, LTETDD, BLUETOOTH, WLAN, MSR, LTEAFDD, LTEATDD
Remote Command	:CALCulate:OBWidth:MARKer[1] 2 ... 12:X:POSition <real> :CALCulate:OBWidth:MARKer[1] 2 ... 12:X:POSition?
Example	CALC:OBW:MARK10:X:POS 0 CALC:OBW:MARK10:X:POS?
Notes	The query returns the marker's absolute X Axis value in trace points if the control mode is Normal, or the offset from the marker's reference marker in trace points if the control mode is Delta.
Preset	After a preset, all markers are turned OFF, so Marker X Axis Value query returns a not a number (NAN).
State Saved	No
Min	-9.9E+37
Max	9.9E+37
Initial S/W Revision	Prior to A.02.00
Modified at S/W Revision	A.03.00

Marker Y Axis Value (Remote Command Only)

Returns the marker Y Axis value in the current marker Y Axis unit.

Key Path	SCPI only
Mode	SA, WCDMA, C2K, WIMAX OFDMA, TD-SCDMA, 1xEVDO, ISDB-T, CMMB, LTE, LTETDD, BLUETOOTH, WLAN, MSR, LTEAFDD, LTEATDD
Remote Command	:CALCulate:OBWidth:MARKer[1] 2 ... 12:Y?

Example	CALC:OBW:MARK11:Y?
Preset	Result dependent on Markers setup and signal source.
State Saved	No
Min	-9.9E+37
Max	9.9E+37
Initial S/W Revision	Prior to A.02.00
Modified at S/W Revision	A.03.00

Backward Compatibility SCPI Commands

Sets or queries the state of a marker. Setting a marker which is OFF to state ON or 1 puts it in Normal mode and places it at the center of the screen.

Key Path	SCPI only
Mode	SA, WCDMA, C2K, WIMAX OFDMA, TD-SCDMA, 1xEVDO, ISDB-T, CMMB, LTE, LTETDD, BLUETOOTH, WLAN, MSR, LTEAFDD, LTEATDD
Remote Command	:CALCulate:OBWidth:MARKer[1] 2 ... 12:STATe OFF ON 0 1 :CALCulate:OBWidth:MARKer[1] 2 ... 12:STATe?
Example	CALC:OBW:MARK3:STAT ON CALC:OBW:MARK3:STAT?
Preset	OFF
State Saved	Saved in instrument state.
Initial S/W Revision	Prior to A.02.00
Modified at S/W Revision	A.03.00

Marker Function

There are no 'Marker Functions' supported in this measurement. When pressed, this key displays a blank menu.

Key Path	Front panel key
Initial S/W Revision	Prior to A.02.00

Marker To

There is no 'Marker To' functionality supported in this measurement. When pressed, this key displays a blank menu.

Key Path	Front panel key
Initial S/W Revision	Prior to A.02.00

Meas

The information in this section is common to all measurements. For key and remote command information for a specific measurement, refer to the section that describes the measurement of interest.

Measurements available under the Meas key are specific to the current Mode.

When viewing Help for measurements, note the following:

NOTE

Operation for some keys differs between measurements. The information displayed in Help pertains to the current measurement. To see how a key operates in a different measurement, exit Help (press the Cancel Esc key), select the measurement, then reenter Help (press the Help key) and press that key.

Key Path	Front-panel key
Initial S/W Revision	Prior to A.02.00

Remote Measurement Functions

This section contains the following topics:

["Measurement Group of Commands" on page 2214](#)

["Current Measurement Query \(Remote Command Only\)" on page 2216](#)

["Limit Test Current Results \(Remote Command Only\)" on page 2216](#)

["Data Query \(Remote Command Only\)" on page 2216](#)

["Calculate/Compress Trace Data Query \(Remote Command Only\)" on page 2217](#)

["Calculate Peaks of Trace Data \(Remote Command Only\)" on page 2222](#)

["Hardware-Accelerated Fast Power Measurement \(Remote Command Only\)" on page 2223](#)

["Format Data: Numeric Data \(Remote Command Only\)" on page 2237](#)

["Format Data: Byte Order \(Remote Command Only\)" on page 2238](#)

Initial S/W Revision	Prior to A.02.00
----------------------	------------------

Measurement Group of Commands

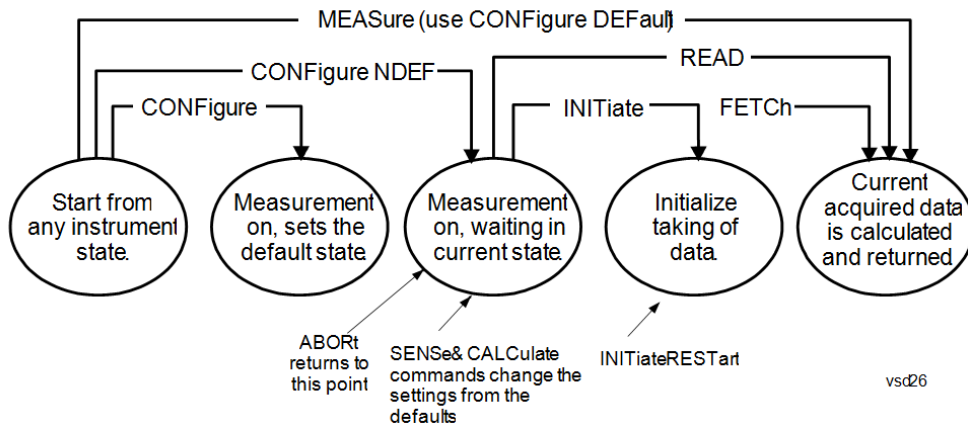

Measure Commands:

:MEASure:<measurement>[n]?

This is a fast single-command way to make a measurement using the factory default instrument settings. These are the settings and units that conform to the Mode Setup settings (e.g. radio standard) that you have currently selected.

- Stops the current measurement (if any) and sets up the instrument for the specified measurement using the factory defaults
- Initiates the data acquisition for the measurement
- Blocks other SCPI communication, waiting until the measurement is complete before returning results.
- If the function does averaging, it is turned on and the number of averages is set to 10.
- After the data is valid it returns the scalar results, or the trace data, for the specified measurement. The type of data returned may be defined by an [n] value that is sent with the command.
- The scalar measurement results will be returned if the optional [n] value is not included, or is set to 1. If the [n] value is set to a value other than 1, the selected trace data results will be returned. See each command for details of what types of scalar results or trace data results are available.
- ASCII is the default format for the data output. (Older versions of Spectrum Analysis and Phase Noise mode measurements only use ASCII.) The binary data formats should be used for handling large blocks of data since they are smaller and faster than the ASCII format. Refer to the FORMat:DATA command for more information.

If you need to change some of the measurement parameters from the factory default settings you can set up the measurement with the CONFigure command. Use the commands in the SENSe:<measurement> and CALCulate:<measurement> subsystems to change the settings. Then you can use the READ? command to initiate the measurement and query the results.

If you need to repeatedly make a given measurement with settings other than the factory defaults, you can use the commands in the SENSe:<measurement> and CALCulate:<measurement> subsystems to set up the measurement. Then use the READ? command to initiate the measurement and query results.

Measurement settings persist if you initiate a different measurement and then return to a previous one. Use READ:<measurement>? if you want to use those persistent settings. If you want to go back to the default settings, use MEASure:<measurement>?.

Configure Commands:

:CONFigure:<measurement>

This command stops the current measurement (if any) and sets up the instrument for the specified measurement using

the factory default instrument settings. It does not initiate the taking of measurement data unless INIT:CONTInuous is ON. If you change any measurement settings after using the CONFigure command, the READ command can be used to initiate a measurement without changing the settings back to their defaults.

In the Swept SA measurement in Spectrum Analyzer mode the CONFigure command also turns the averaging function on and sets the number of averages to 10 for all measurements.

:CONFigure: <measurement>: NDEFault stops the current measurement and changes to the specified measurement. It does not change the settings to the defaults. It does not initiate the taking of measurement data unless INIT:CONTInuous is ON.

The CONFigure? query returns the current measurement name.

The CONFigure:CATalog? query returns a quoted string of all licensed measurement names in the current mode. For example, "SAN, CHP, OBW, ACP, PST, TXP, SPUR, SEM, LIST".

Fetch Commands:

:FETCh:<measurement>[n]?

This command puts selected data from the most recent measurement into the output buffer. Use FETCh if you have already made a good measurement and you want to return several types of data (different [n] values, for example, both scalars and trace data) from a single measurement. FETCh saves you the time of re-making the measurement. You can only FETCh results from the measurement that is currently active, it will not change to a different measurement. An error message is reported if a measurement other than the current one is specified.

If you need to get new measurement data, use the READ command, which is equivalent to an INITiate followed by a FETCh.

The scalar measurement results will be returned if the optional [n] value is not included, or is set to 1. If the [n] value is set to a value other than 1, the selected trace data results will be returned. See each command for details of what types of scalar results or trace data results are available. The binary data formats should be used for handling large blocks of data since they are smaller and transfer faster than the ASCII format. (FORMat:DATA)

FETCh may be used to return results other than those specified with the original READ or MEASure command that you sent.

INITiate Commands:

:INITiate:<measurement>

This command is not available for measurements in all the instrument modes:

- Initiates a trigger cycle for the specified measurement, but does not output any data. You must then use the FETCh<meas> command to return data. If a measurement other than the current one is specified, the instrument will switch to that measurement and then initiate it.
 - For example, suppose you have previously initiated the ACP measurement, but now you are running the channel power measurement. If you send INIT:ACP? it will change from channel power to ACP and will initiate an ACP measurement.
 - Does not change any of the measurement settings. For example, if you have previously started the ACP measurement and you send INIT:ACP? it will initiate a new ACP measurement using the same instrument settings as the last time ACP was run.
 - If your selected measurement is currently active (in the idle state) it triggers the measurement, assuming the trigger conditions are met. Then it completes one trigger cycle. Depending upon the measurement and the number of averages, there may be multiple data acquisitions, with multiple trigger events, for one full trigger cycle. It also holds off additional commands on GPIB until the acquisition is complete.
-

READ Commands:

:READ:<measurement>[n]?

- Does not preset the measurement to the factory default settings. For example, if you have previously initiated the ACP
-

measurement and you send READ:ACP? it will initiate a new measurement using the same instrument settings.

- Initiates the measurement and puts valid data into the output buffer. If a measurement other than the current one is specified, the instrument will switch to that measurement before it initiates the measurement and returns results.
 - For example, suppose you have previously initiated the ACP measurement, but now you are running the channel power measurement. Then you send READ:ACP? It will change from channel power back to ACP and, using the previous ACP settings, will initiate the measurement and return results.
 - Blocks other SCPI communication, waiting until the measurement is complete before returning the results
 - If the optional [n] value is not included, or is set to 1, the scalar measurement results will be returned. If the [n] value is set to a value other than 1, the selected trace data results will be returned. See each command for details of what types of scalar results or trace data results are available. The binary data formats should be used when handling large blocks of data since they are smaller and faster than the ASCII format. (FORMat:DATA)
-

Initial S/W Revision	Prior to A.02.00
----------------------	------------------

Current Measurement Query (Remote Command Only)

This command returns the name of the measurement that is currently running.

Remote Command	:CONFigure?
-----------------------	-------------

Example	CONF?
----------------	-------

Initial S/W Revision	Prior to A.02.00
----------------------	------------------

Limit Test Current Results (Remote Command Only)

Queries the status of the current measurement limit testing. It returns a 0 if the measured results pass when compared with the current limits. It returns a 1 if the measured results fail any limit tests.

Remote Command	:CALCulate:CLIMits:FAIL?
-----------------------	--------------------------

Example	CALC:CLIM:FAIL? queries the current measurement to see if it fails the defined limits. Returns a 0 or 1: 0 it passes, 1 it fails.
----------------	--

Initial S/W Revision	Prior to A.02.00
----------------------	------------------

Data Query (Remote Command Only)

Returns the designated measurement data for the currently selected measurement and subopcode.

n = any valid subopcode for the current measurement. See the measurement command results table for your current measurement, for information about what data is returned for the subopcodes.

This command uses the data setting specified by the FORMat:BORDER and FORMat:DATA commands and can return real or ASCII data. (See the format command descriptions under Input/Output in the Analyzer Setup section.)

Remote Command	:CALCulate:DATA[n]?
Notes	The return trace depends on the measurement. In CALCulate:<meas>:DATA[n], n is any valid subopcode for the current measurement. It returns the same data as the FETCH:<measurement>? query where <measurement> is the current measurement.
Initial S/W Revision	Prior to A.02.00

Calculate/Compress Trace Data Query (Remote Command Only)

Returns compressed data for the currently selected measurement and sub-opcode [n].

n = any valid sub-opcode for that measurement. See the MEASure:<measurement>? command description of your specific measurement for information on the data that can be returned.

The data is returned in the current Y Axis Unit of the analyzer. The command is used with a sub-opcode <n> (default=1) to specify the trace. With trace queries, it is best if the analyzer is not sweeping during the query. Therefore, it is generally advisable to be in Single Sweep, or Update=Off.

This command is used to compress or decimate a long trace to extract and return only the desired data. A typical example would be to acquire N frames of GSM data and return the mean power of the first burst in each frame. The command can also be used to identify the best curve fit for the data.

Remote Command	:CALCulate:DATA<n>:COMPRESS? BLOCK CFIT MAXimum MINimum MEAN DMEan RMS RMSCubed SAMPLE SDEVIation PPHase [,<soffset> [,<length>[,<roffset>[,<rlimit>]]]]
Example	To query the mean power of a set of GSM bursts: Supply a signal that is a set of GSM bursts. Select the IQ Waveform measurement (in IQ Analyzer Mode). Set the sweep time to acquire at least one burst. Set the triggers such that acquisition happens at a known position relative to a burst. Then query the mean burst levels using, CALC:DATA2:COMP? MEAN, 24e-6, 526e-6 (These parameter values correspond to GSM signals, where 526e-6 is the length of the burst in the slot and you just want 1 burst.)
Notes	The command supports 5 parameters. Note that the last 4 (<soffset>, <length>, <roffset>, <rlimit>) are optional. But these optional parameters must be entered in the specified order. For example, if you want to specify <length>, then you must also specify <soffset>. See details below for a definition of each of these parameters. This command uses the data in the format specified by FORMat:DATA, returning either binary or ASCII data.
Initial S/W Revision	Prior to A.02.00

- BLOCK or block data - returns all the data points from the region of the trace data that you specify. For example, it could be used to return the data points of an input signal over several timeslots, excluding the portions of the trace data that you do not want. (This is x,y pairs for trace data and I,Q pairs for complex data.)

- CFIT or curve fit - applies curve fitting routines to the data. <soffset> and <length> are required to define the data that you want. <roffset> is an optional parameter for the desired order of the curve equation. The query will return the following values: the x-offset (in seconds) and the curve coefficients ((order + 1) values).

MIN, MAX, MEAN, DME, RMS, RMSC, SAMP, SDEV and PPH return one data value for each specified region (or <length>) of trace data, for as many regions as possible until you run out of trace data (using <roffset> to specify regions). Or they return the number of regions you specify (using <rlimit>) ignoring any data beyond that.

- MINimum - returns the minimum data point (y value) for the specified region(s) of trace data. For I/Q trace data, the minimum magnitude of the I/Q pairs is returned.
- MAXimum - returns the maximum data point (y value) for the specified region(s) of trace data. For I/Q trace data, the maximum magnitude of the I/Q pairs is returned.
- MEAN - returns a single value that is the arithmetic mean of the data point values (in dB/ dBm) for the specified region(s) of trace data. For I/Q trace data, the mean of the magnitudes of the I/Q pairs is returned. See the following equations.

•

NOTE If the original trace data is in dB, this function returns the arithmetic mean of those log values, not log of the mean power which is a more useful value. The mean of the log is the better measurement technique when measuring CW signals in the presence of noise. The mean of the power, expressed in dB, is useful in power measurements such as Channel Power. To achieve the mean of the power, use the RMS option.

Equation 1

Mean Value of Data Points for Specified Region(s)

$$\text{MEAN} = \frac{1}{n} \sum_{X_i \in \text{region}(s)} X_i$$

where X_i is a data point value, and n is the number of data points in the specified region(s).

Equation 2

Mean Value of I/Q Data Pairs for Specified Region(s)

$$\text{MEAN} = \frac{1}{n} \sum_{X_i \in \text{region}(s)} |X_i|$$

where $|X_i|$ is the magnitude of an I/Q pair, and n is the number of I/Q pairs in the specified region(s).

- DMEan - returns a single value that is the mean power (in dB/ dBm) of the data point values for the specified region(s) of trace data. See the following equation:

Equation 3

DMEan Value of Data Points for Specified Region(s)

$$\text{DME} = 10 \times \log_{10} \left(\frac{1}{n} \sum_{X_i \in \text{region}(s)} 10^{\frac{X_i}{10}} \right)$$

- RMS - returns a single value that is the average power on a root-mean-squared voltage scale (arithmetic rms) of the data point values for the specified region(s) of trace data. See the following equation.

NOTE

For I/Q trace data, the rms of the magnitudes of the I/Q pairs is returned. See the following equation. This function is very useful for I/Q trace data. However, if the original trace data is in dB, this function returns the rms of the log values which is not usually needed.

Equation 4

RMS Value of Data Points for Specified Region(s)

$$\text{RMS} = \sqrt{\frac{1}{n} \sum_{X_i \in \text{region}(s)} X_i^2}$$

where X_i is a data point value, and n is the number of data points in the specified region(s).

Equation 5

RMS Value of I/Q Data Pairs for Specified Region(s)

$$\text{RMS} = \sqrt{\frac{1}{n} \sum_{X_i \in \text{region}(s)} X_i X_i^*}$$

where X_i is the complex value representation of an I/Q pair, X_i^* its conjugate complex number, and n is the number of I/Q pairs in the specified region(s).

Once you have the rms value for a region of trace data (linear or I/Q), you may want to calculate the mean power. You must convert this rms value (peak volts) to power in dBm:

$$10 \times \log[10 \times (\text{rms value})^2]$$

- SAMPLe - returns the first data value (x,y pair) for the specified region(s) of trace data. For I/Q trace data, the first I/Q pair is returned.
- SDEViation - returns a single value that is the arithmetic standard deviation for the data point values for the specified region(s) of trace data. See the following equation.
- For I/Q trace data, the standard deviation of the magnitudes of the I/Q pairs is returned. See the following equation.

Equation 6

Standard Deviation of Data Point Values for Specified Region(s)

$$\text{SDEV} = \sqrt{\frac{1}{n} \sum_{X_i \in \text{region}(s)} (X_i - \bar{X})^2}$$

where X_i is a data point value, \bar{X} is the arithmetic mean of the data point values for the specified region (s), and n is the number of data points in the specified region(s).

$$\text{SDEV} = \sqrt{\frac{1}{n} \sum_{X_i \in \text{region}(s)} (|X_i| - \bar{X})^2}$$

where $|X_i|$ is the magnitude of an I/Q pair, \bar{X} is the mean of the magnitudes for the specified region(s), and n is the number of data points in the specified region(s).

- PPHase - returns the x,y pairs of both rms power (dBm) and arithmetic mean phase (radian) for every specified region and frequency offset (Hz). The number of pairs is defined by the specified number of regions. This parameter can be used for I/Q vector ($n=0$) in Waveform (time domain) measurement and all parameters are specified by data point in PPHase.

The rms power of the specified region may be expressed as:

$$\text{Power} = 10 \times \log [10 \times (\text{RMS I/Q value})] + 10.$$

The RMS I/Q value (peak volts) is:

$$\sqrt{\frac{1}{n} \sum_{X_i \in \text{region}} X_i X_i^*}$$

where X_i is the complex value representation of an I/Q pair, X_i^* its conjugate complex number, and n is the number of I/Q pairs in the specified region.

The arithmetic mean phase of the specified region may be expressed as:

$$\frac{1}{n} \sum_{Y_i \in \text{region}} Y_i$$

where Y_i is the unwrapped phase of I/Q pair with applying frequency correction and n is the number of I/Q pairs in the specified region.

The frequency correction is made by the frequency offset calculated by the arithmetic mean of every specified region's frequency offset. Each frequency offset is calculated by the least square method against the unwrapped phase of I/Q pair.

Sample Trace Data - Constant Envelope

(See below for explanation of variables.)

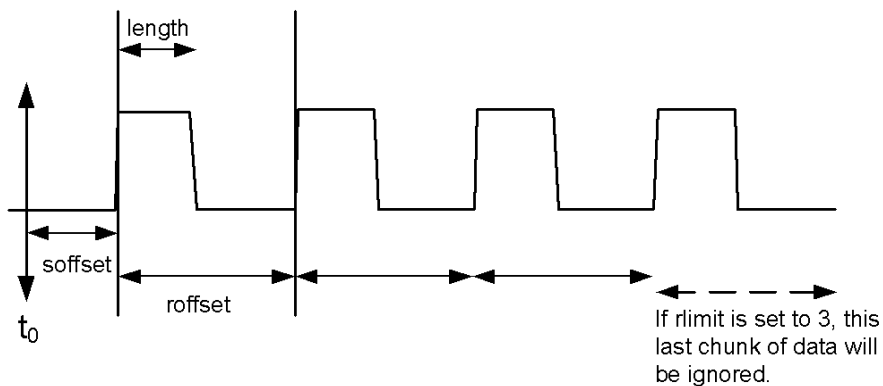

Sample Trace Data - Not Constant Envelope

(See below for explanation of variables.)

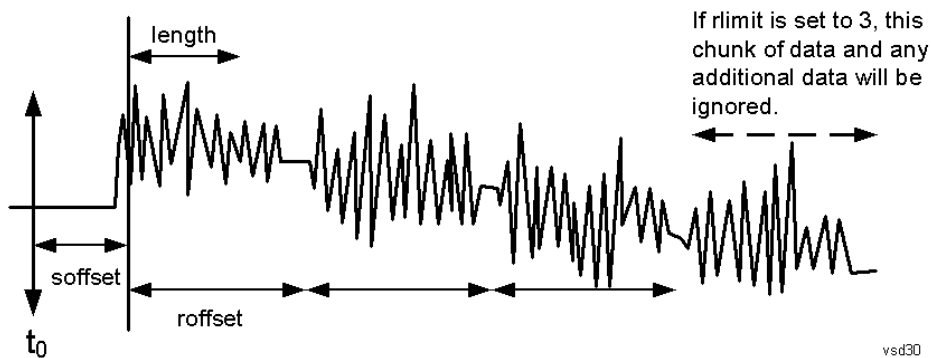

$\langle \text{soffset} \rangle$ - start offset is an optional real number. (It is in seconds for time-domain traces, and is a dimensionless index 0 to $N_{\text{points}} - 1$, for frequency-domain traces). It specifies the amount of data at the beginning of the trace that will be ignored before the decimation process starts. It is the time or frequency change from the start of the trace to the point where you want to start using the data. The default value is zero.

$\langle \text{length} \rangle$ - is an optional real number. (It is in seconds for time-domain traces, and is a dimensionless index 0 to $N_{\text{points}} - 1$, for frequency-domain traces). It defines how much data will be compressed into one value. This parameter has a default value equal to the current trace length.

$\langle \text{roffset} \rangle$ - repeat offset is an optional real number. (It is in seconds for time-domain traces, and is a dimensionless index 0 to $N_{\text{points}} - 1$, for frequency-domain traces). It defines the beginning of the next field of trace elements to be compressed. This is relative to the beginning of the previous field. This parameter has a default value equal to the $\langle \text{length} \rangle$ variable. Note that this parameter is used for a completely different purpose when curve fitting (see CFIT above).

$\langle \text{rlimit} \rangle$ - repeat limit is an optional integer. It specifies the number of data items that you want returned. It will ignore any additional items beyond that number. You can use the Start offset and the Repeat limit to pick out exactly what part of the data you want to use. The default value is all the data.

Calculate Peaks of Trace Data (Remote Command Only)

Returns a list of all the peaks for the currently selected measurement and sub-opcode [n]. The peaks must meet the requirements of the peak threshold and excursion values.

n = any valid sub-opcode for the current measurement. See the MEASure:<measurement> command description of your specific measurement for information on the data that can be returned.

The command can only be used with specific sub-opcodes with measurement results that are trace data. Both real and complex traces can be searched, but complex traces are converted to magnitude in dBm. In many measurements the sub-opcode n=0, is the raw trace data which cannot be searched for peaks. And Sub-opcode n=1, is often calculated results values which also cannot be searched for peaks.

This command uses the data setting specified by the FORMat:BORDER and FORMat:DATA commands and can return real or ASCII data. If the format is set to INT,32, it returns REAL,32 data.

The command has four types of parameters:

- Threshold (in dBm)
- Excursion (in dB)
- Sorting order (amplitude, frequency, time)
- Optional in some measurements: Display line use (all, > display line, < display line)

Remote Command	<p>For Swept SA measurement:</p> <pre>:CALCulate:DATA[1] 2 ... 6:PEAKs? <threshold>,<excursion>[,AMPLitude FREQuency TIME[,ALL GTDLine LTDLine]]</pre> <p>For most other measurements:</p> <pre>:CALCulate:DATA[1] 2 ... 6:PEAKs? <threshold>,<excursion>[,AMPLitude FREQuency TIME]</pre>
-----------------------	--

Example	<p>Example for Swept SA measurement in Spectrum Analyzer Mode:</p> <p>CALC:DATA4:PEAK? -40, 10, FREQ, GTDL This will identify the peaks of trace 4 that are above -40 dBm, with excursions of at least 10 dB. The peaks are returned in order of increasing frequency, starting with the lowest frequency. Only the peaks that are above the display line are returned.</p> <p>Query Results 1:</p> <p>With FORMat:DATA REAL, 32 selected, it returns a list of floating-point numbers. The first value in the list is the number of peak points that are in the following list. A peak point consists of two values: a peak amplitude followed by its corresponding frequency (or time).</p> <p>If no peaks are found the peak list will consist of only the number of peaks, (0).</p>
----------------	---

Notes	<p><n> - is the trace that will be used</p> <p><threshold> - is the level below which trace data peaks are ignored. Note that the threshold value is required and is always used as a peak criterion. To effectively disable the threshold criterion for this command, provide a substantially low threshold value such as -200 dBm. Also note that the threshold value used in this command is independent of and has no effect on the threshold value stored under the Peak Criteria menu.</p> <p><excursion> - is the minimum amplitude variation (rise and fall) required for a signal to be identified as peak. Note that the excursion value is required and is always used as a peak criterion. To effectively disable the excursion criterion for this command, provide the minimum value of 0.0 dB. Also note that the excursion value used in this command is independent of and has no effect on the</p>
--------------	---

excursion value stored under the Peak Criteria menu.

Values must be provided for threshold and excursion. The sorting and display line parameters are optional (defaults are AMPLitude and ALL).

Note that there is always a Y-axis value for the display line, regardless of whether the display line state is on or off. It is the current Y-axis value of the display line which is used by this command to determine whether a peak should be reported

Sorting order:

AMPLitude - lists the peaks in order of descending amplitude, with the highest peak first (default if optional parameter not sent)

FREQUENCY - lists the peaks in order of occurrence, left to right across the x-axis.

TIME - lists the peaks in order of occurrence, left to right across the x-axis.

Peaks vs. Display Line:

ALL - lists all of the peaks found (default if optional parameter not sent).

GTDLine (greater than display line) - lists all of the peaks found above the display line.

LTDLine (less than display line) - lists all of the peaks found below the display line.

Initial S/W Revision	Prior to A.02.00
----------------------	------------------

Hardware-Accelerated Fast Power Measurement (Remote Command Only)

The Fast Power option (FP2) enables very fast channel power measurements for instruments with the prerequisite hardware (DP2 and/or B40). It accomplishes this by performing real-time overlapped FFTs at the hardware layer, using software for basic post-processing before returning the result to the user. The upshot of this approach is improved throughput for user applications that require many sequential power measurements.

The analysis bandwidth of FP2 is limited by the licenses in the instrument, but its maximum overall analysis bandwidth per acquisition is 40 MHz.

FP2 is remote-only, which means the instrument does not switch to any particular mode or measurement. FP2 commands can be sent while another application is in use on the front panel.

Each Fast Power measurement can be predefined using an array index, and up to 1,000 measurements can be stored. In the following documentation, instances of [1,2,...,999] can be substituted with a particular measurement index, e.g. CALC:FPOW:POW1?, CALC:FPOW:POW2?, CALC:FPOW:POW134?. In this way, power measurements can be defined one time in a batch, and then executed multiple times without having to redefine them, similar to “list mode” on other measurements.

In addition to basic channel power measurements, there are a number of other measurement “functions” for each channel, including peak power, peak frequency, and power spectral density. See the Function parameter for more information.

Reset Fast Power Measurement (Remote Command Only)

Resets the measurement configuration to the defaults.

Mode	All
Remote Command	:CALCulate:FPOWer:POWer[1,2,...,999]:RESet
Example	:CALC:FPOW:POW1:RES

Notes	Option FP2 is required.
Initial S/W Revision	A.14.00

Define Fast Power Measurement (Remote Command Only)

Fast Power acquisitions are configured using the DEFine command. This command accepts a comma-delimited string of configuration parameters and their appropriate values, which are all specified in the subsection below.

Mode	All
Remote Command	:CALCulate:FPOWER:POWer[1,2,...,999]:DEFine "configuration string"
Example	:CALC:FPOW:POW1:DEF "CenterFrequency=2e9, AcquisitionTime=0.005"
Notes	See below for a list of measurement variables that can be defined in the configuration string.
Initial S/W Revision	A.14.00

Acquisition Time

Value	Time (s)
Range	0 s to 1 s
Preset	0.001 s
Example	CALC:FPOW:POW1:DEF "AcquisitionTime=0.002"
Notes	The acquisition time parameter sets the time in which the entire spectrum is measured. An increase in the acquisition time yields an improvement in measurement repeatability.
Initial S/W Revision	A.14.00

Center Frequency

Value	Frequency (Hz)
Range	0 Hz to maximum instrument frequency
Preset	1 GHz
Example	CALC:FPOW:POW1:DEF "CenterFrequency=2e9"
Notes	The center frequency parameter sets the frequency in which the measurement is centered around. The OffsetFrequency parameter is calculated relative to the center frequency.
Initial S/W Revision	A.14.00

DC Coupled

Value	Boolean
Range	True (DC Coupled) or False (AC Coupled)
Preset	False
Example	CALC:FPOW:POW1:DEF "DCCoupled=True"
Notes	The DC coupled parameter allows the user to specify whether the DC blocking capacitor is utilized. Set parameter to true when measuring frequencies below 10 MHz.
Initial S/W Revision	A.14.00

DetectorType

Example	CALC:FPOW:POW1:DEF "DetectorType=Peak"
Notes	Option FP2 is required. The detector type parameter allows the user to choose whether a RMS average or peak value is used during the measurement.
Preset	RmsAverage
Range	RmsAverage, Peak
Initial S/W Revision	A.14.00

Do Noise Correction

Value	Boolean
Range	True (enable noise correction) or False (disable noise correction)
Preset	False
Example	CALC:FPOW:POW1:DEF "DoNoiseCorrection=True"
Notes	When noise correction is enabled, the linear noise power contributed by the analyzer is subtracted from all measurements. This effectively lowers the noise floor of the analyzer. When noise correction is enabled, the first measurement for a given set of input parameters will take extra time. This is because the analyzer takes an extra acquisition with the RF input disconnected from the analyzer's front end to measure the noise of just the analyzer. The measured noise floor is stored in a cache so the noise acquisition will occur only once for the same state settings. In other words, if noise correction was turned on and the analyzer made an acquisition at frequency A, then frequency B, and back again to frequency A, the hidden initial noise floor acquisition would only occur for the first acquisition at frequency A and the cached noise floor would be used the second time frequency A was measured.
Initial S/W Revision	A.14.00

Do Spur Suppression

Value	Boolean
Range	True (enable spur suppression) or False (disable spur suppression)
Preset	False
Example	CALC:FPOW:POW1:DEF "DoSpurSuppression=True"
Notes	<p>When measuring very low level signals, or when large out-of-band inputs are input into the analyzer, sometimes unwanted spurs and residuals can appear in the measured spectrum. Spur suppression is a method to help minimize the levels of these internally generated spurs and residuals.</p> <p>When spur suppression is enabled, the analyzer will automatically take two acquisitions using two different internal analog LO frequencies. The FFT spectrums from both acquisitions are combined by taking the minimum power between both traces on a per FFT bin basis. External signals will have the same amplitude for both traces and therefore will return the expected amplitudes. However, low level spurs and residuals generated internally to the analyzer tend to move to different FFT bins depending on the internal analog LO frequency used, and therefore tend to be suppressed using this spur suppression method.</p> <p>Because two acquisitions, rather than a single acquisition, are made when spur suppression is enabled, the measurement time will always be slower when spur suppression is enabled.</p>
Initial S/W Revision	A.14.00

Electronic Attenuator Bypass

Value	Boolean
Range	True (bypass electronic attenuator) or False (use electronic attenuator)
Preset	True
Example	CALC:FPOW:POW1:DEF "ElecAttBypass =False"
Notes	The electronic attenuation bypass parameter allows the user to either utilize or bypass the electronic attenuator. The electronic attenuator is only available for frequencies up to 3.6 GHz. Set parameter to true when using frequencies above 3.6 GHz and set the parameter to false when using the preamp.
Initial S/W Revision	A.14.00

Electronic Attenuation

Value	dB
Range	0 - 24 dB (1 dB steps)
Preset	0 dB
Example	CALC:FPOW:POW1:DEF "ElecAttenuation=10"
Notes	<p>Option EA3 is required.</p> <p>The electronic attenuation value parameter sets the amount of electrical attenuation from 0 to 24 dB (1 dB steps).</p>

Set "ElecAttBypass=False" to make sure the electronic attenuator path is enabled.

Initial S/W Revision	A.14.00
-------------------------	---------

IF Gain

Value	dB
Range	-6 - 16 dB (1 dB steps)
Preset	0 dB
Example	CALC:FPOW:POW1:DEF "IFGain=10"
Notes	The IF gain parameter allows the user to specify the gain at the IF stage anywhere from -6 to 16 dB (1 dB steps). This is an advanced feature, and for most cases this should remain at its default value of 0 dB.
Initial S/W Revision	A.14.00

IF Type

Example	CALC:FPOW:POW1:DEF "IFType=B25M"
Notes	The IF type parameter allows the user to select between different IF paths. For example, if the signal is less than 25 MHz wide, then the user can select the B25M path to take advantage of additional filtering on this analog IF path.
Preset	B40M
Range	B10M, B25M, B40M
Initial S/W Revision	A.14.00

Include Power Spectrum

Value	Boolean
Range	True (return both channel power and full power spectrum) or False (returns only channel power)
Preset	False
Example	CALC:FPOW:POW1:DEF "IncludePowerSpectrum=True"
Notes	The power spectrum parameter allows the user to read data on the entire spectrum for diagnostic purposes. It is not recommended for production use. See CALC:FPOW:POW[n]:READ2? for details on the binary format of the response.
Initial S/W Revision	A.14.00

Mechanical Attenuation

Value	dB
Range	0 – 70 dB (2 dB steps)
Preset	0 dB
Example	CALC:FPOW:POW1:DEF "MechAttenuation=10"
Notes	The mechanical attenuation value parameter sets the amount of mechanical attenuation anywhere from 0 to 70 dB (2 dB steps).
Initial S/W Revision	A.14.00

Preamp Mode

Example	CALC:FPOW:POW1:DEF "PreAmpMode=Low"
Notes	The license for the appropriate preamp is required. The preamp mode parameter specifies whether the preamps are being utilized. Low allows any preamps up to 3.6 GHz, and Full allows all licensed preamps. Set "ElecAttBypass=True" in order to utilize any preamps.
Preset	Off
Range	Off, Low, Full
Initial S/W Revision	A.14.00

Resolution Bandwidth Mode

Example	CALC:FPOW:POW1:DEF "PreAmpMode=Low"
Notes	The resolution bandwidth mode parameter allows the user to choose whether the RBW filter is automatically or manually set. The BestSpeed value minimizes measurement time, while the Narrowest value minimizes RBW size (minimum of two FFT bins per RBW). To manually specify an RBW, set this parameter to Explicit, and set the ResolutionBW parameter to the desired value.
Preset	BestSpeed
Range	BestSpeed, Narrowest, Explicit
Initial S/W Revision	A.14.00

Resolution Bandwidth

Value	Hz
Preset	0 Hz

Example	CALC:FPOW:POW1:DEF "ResolutionBW=25e3"
Notes	The resolution bandwidth parameter sets the 3-dB bandwidth of the RBW filter. The ResolutionBWMode parameter must be set to Explicit in order to manually set the RBW.
Initial S/W Revision	A.14.00

Trigger Delay

Value	Seconds
Range	0 – 1 s
Preset	0 s
Example	CALC:FPOW:POW1:DEF "TriggerDelay=0.025"
Notes	The trigger delay parameter sets the time after an external trigger is detected until the measurement is performed.
Initial S/W Revision	A.14.00

Trigger Level

Value	Volts
Range	-5 to 5 V
Preset	1.2 V
Example	CALC:FPOW:POW1:DEF "TriggerLevel=2"
Notes	The trigger level parameter sets the voltage value at which an external trigger is detected.
Initial S/W Revision	A.14.00

Trigger Slope

Example	CALC:FPOW:POW1:DEF "TriggerSlope=Negative"
Notes	The trigger slope parameter indicates the direction of the edge trigger voltage for detection.
Preset	Positive
Range	Positive, Negative
Initial S/W Revision	A.14.00

Trigger Source

Example	CALC:FPOW:POW1:DEF "TriggerSource=Ext1 "
Notes	The trigger source parameter allows the user to choose between measurement's triggering freely or controlled by an external input. Ext1 and Ext2 correspond to Trigger 1 In and Trigger 2 In, respectively.
Preset	Free
Range	Free, Ext1, Ext2
Initial S/W Revision	A.14.00

Trigger Timeout

Value	Seconds
Range	0 - 1 s
Preset	1 s
Example	CALC:FPOW:POW1:DEF "TriggerTimeout=0.1"
Notes	The trigger timeout parameter sets the time in which the analyzer will wait for a trigger before automatically performing the measurement.
Initial S/W Revision	A.14.00

Signal Input

Example	CALC:FPOW:POW1:DEF "SignalInput=Fp50MHzCW"
Notes	The signal input parameter allows the user to select between using the main RF input or the internal analyzer reference CW signal of 50 MHz.
Preset	FpMainRf
Range	FpMainRf, Fp50MHzCW
Initial S/W Revision	A.14.00

Use Preselector

Value	Boolean
Range	True (use preselector above 3.6 GHz), or False (preselector bypassed)
Preset	False
Example	CALC:FPOW:POW1:DEF "UsePreSelector=True"
Notes	The preselector parameter allows the user to either utilize or bypass the front end tunable filter at frequencies above 3.6 GHz. For frequencies below 3.6 GHz, the preselector is automatically

bypassed, so you do not need to set this parameter to False in those cases.

Initial S/W Revision	A.14.00
----------------------	---------

Channel Bandwidth Array

Value	Hz
Range	0 to 40 MHz
Preset	[1 e6]
Example	CALC:FPOW:POW1:DEF "Bandwidth=[3.84e6, 5e6, 3.84e6]"
Notes	The bandwidth parameter array defines the bandwidth of each channel that will be measured. All array parameters should have the same number of elements. Alternatively, if all the elements are the same value, a single number with no square brackets can be used to define the parameter.
Initial S/W Revision	A.14.00

Channel Filter Type Array

Example	CALC:FPOW:POW1:DEF "FilterType=[RRC, IBW, RRC]"
Notes	The filter type parameter allows the user to choose between an integration bandwidth (IBW) filter or a root-raised-cosine (RRC) filter. The integration bandwidth filter weighs all frequencies within the bandwidth equally. The root-raised-cosine filter has an associated shape parameter, defined by the FilterAlpha parameter. All array parameters should have the same number of elements. Alternatively, if all the elements are the same value, a single value with no square brackets can be used to define the parameter.
Preset	[IBW]
Range	IBW, RRC
Initial S/W Revision	A.14.00

Channel Filter Alpha Array

Example	CALC:FPOW:POW1:DEF "FilterAlpha=[0.5, 0.0, 0.5]"
Notes	The filter alpha parameter allows the user to adjust the alpha value associated with the root-raised-cosine (RRC) filter type. Set FilterType to RRC in order to utilize this parameter. All array parameters should have the same number of elements. Alternatively, if all the elements are the same value, a single number with no square brackets can be used to define the parameter.
Preset	[0.22]
Range	0.0 – 1.0
Initial S/W Revision	A.14.00

Channel Measurement Function Array

Example	CALC:FPOW:POW1:DEF "Function=[BandPower, PeakPower, BandPower]"
Notes	<p>This parameter array defines what measurement is being made for each individually-specified channel:</p> <p>BandPower: Total power within the specified bandwidth of the channel (dBm)</p> <p>BandDensity: Total power density within the specified bandwidth of the channel (dBm/Hz)</p> <p>PeakPower: The peak power value within the specified bandwidth of the channel (dBm)</p> <p>PeakFrequency: The frequency which corresponds to the peak power value within the specified bandwidth of the channel. This frequency is relative to the center frequency (Hz)</p> <p>XdBBandwidth: The half power (-3.01 dB) bandwidth of the highest amplitude signal that resides within the channel (Hz), dB is configurable using XdBBandwidth parameter</p> <p>OccupiedBandwidth: The bandwidth at which 99% of the total power resides within the channel (Hz), percentage configurable using OccupiedBandwidthPercent parameter</p> <p>All array parameters should have the same number of elements. Alternatively, if all the elements are the same value, a single value with no square brackets can be used to define the parameter.</p>
Preset	[BandPower]
Range	BandPower, BandDensity, PeakPower, PeakFrequency, XdBBandwidth, OccupiedBandwidth
Initial S/W Revision	A.14.00

Channel Offset Frequency Array

Value	Hz
Range	0 to 20 MHz
Preset	[0]
Example	CALC:FPOW:POW1:DEF "OffsetFrequency=[-5e6, 0, 5e6]"
Notes	<p>The offset frequency parameter array defines the difference between the center frequency to the center frequency of each channel.</p> <p>All array parameters should have the same number of elements.</p>
Initial S/W Revision	A.14.00

Channel Occupied Bandwidth Percent Array

Example	CALC:FPOW:POW1:DEF "OccupiedBandwidthPercent =[0.95, 0.95, 0.95]"
Notes	<p>This parameter only applies for channels whose Function is set to OccupiedBandwidth. The occupied bandwidth percent parameter specifies the percent of total power in these channels. The valid range for this parameter is 0.0 to 1.0, where 1.0 represents 100%. The default for this parameter is 0.99, which will return the bandwidth that contains 99% of the total channel power.</p>

Preset	[0.99]
Range	0 – 1.0
Initial S/W Revision	A.14.00

Channel x-dB Bandwidth Array

Value	dB
Range	-200 to 0 dB
Preset	[-3.01]
Example	CALC:FPOW:POW1:DEF " XdBBandwidth =[-6.02, -3.01, -1.0]"
Notes	This parameter only applies for channels whose Function is set to XdBBandwidth. The X dB bandwidth parameter is used to specify the power relative to the peak channel power over which the bandwidth is calculated. The parameter value must be a negative number.
Initial S/W Revision	A.14.00

Define Fast Power Measurement Query (Remote Command Only)

The DEFine? command is used to retrieve a list of all defined parameters in an ASCII string format

M o d e	All
R e m o t e	:CALCulate:FPOWER:POWer [1,2,...,999]:DEFine?
C o m m a n d	
E x a m p l e	:CALC:FPOW:POW1:DEF?

```

p
l
e
N This command query is used to retrieve a list of all defined parameters in an ASCII format.
o The following is an example of the returned results:
t "DCCoupled=False,ElecAttBypass=True,ElecAttenuation=0,IFGain=0,MechAttenuation=0,PreAmpMode=Off,PreSelectorOffset
e =0,UsePreSelector=False,ExternalReferenceFrequency=10000000,FrequencyReferenceSource=AutoExternalFrequencyRefer
s ence,IFType=B40M,LOMode=SLW,SignalInput=FpMainRf,AcquisitionTime=0.001,CenterFrequency=1000000000,Resolution
BW=0,ResolutionBWMode=BestSpeed,DetectorType=RmsAverage,Bandwidth=[1000000],OffsetFrequency=[0],Function=
[BandPower],FilterType=[IBW],FilterAlpha=[0.22],OccupiedBandwidthPercent=[0.99],XdBBandwidth=[-
3.01],DoNoiseCorrection=False,DoSpurSuppression=False,MeasurementMethod=HardwareFFT,IncludePowerSpectrum=False,
e,TriggerDelay=0,TriggerLevel=1.2,TriggerSlope=Positive,TriggerSource=Free,TriggerTimeout=1 "
I A.14.00
n
i
t
i
a
l
S
/
W
R
e
v
i
s
i
o
n

```

Configure Fast Power Measurement (Remote Command Only)

The configure command begins hardware setup and returns immediately, with no acquisition made. This can be used in parallel with other hardware operations to effectively hide the hardware setup time.

Mode	All
Remote Command	:CALCulate:FPOWer:POWer[1,2,...,999]:CONFigure
Example	:CALC:FPOW:POW1:CONF
Notes	Option FP2 is required.
Initial S/W Revision	A.14.00

Initiate Fast Power Measurement (Remote Command Only)

The INITiate command begins an acquisition and returns immediately. The results of the measurement can be retrieved using FETCh.

Mode	All
Remote Command	:CALCulate:FPOWer:POWer [1, 2, ..., 999] :INITiate
Example	:CALC:FPOW:POW1:INIT
Notes	Option FP2 is required.
Initial S/W Revision	A.14.00

Fetch Fast Power Measurement (Remote Command Only)

The FETCh command query is used to retrieve the results of an acquisition initiated by the INIT command. The returned results are in ASCII string format. The string begins and ends with quotation marks.

Mode	All
Remote Command	:CALCulate:FPOWer:POWer [1, 2, ..., 999] :FETCh?
Example	:CALC:FPOW:POW1:FETC?
Notes	Option FP2 is required. Returns m comma-separated ASCII values, where m corresponds to the number of bandwidths defined. 1. Declared function return in the 1st specified channel 2. Declared function return in the 2nd specified channel ... m. Declared function return in the last specified channel The INIT and FETC? command sequence performs the same functionality of a single CALC:FPOW:POW[n]? query. Units of the returned values are dependent on the Function parameter for each channel.
Initial S/W Revision	A.14.00

Execute Fast Power Measurement (Remote Command Only)

This command query is used as shorthand for an INIT command immediately followed by a FETC? command. The returned results are in ASCII string format. The string begins and ends with quotation marks.

Mode	All
Remote Command	:CALCulate:FPOWer:POWer [1, 2, ..., 999] ?
Example	:CALC:FPOW:POW1?
Notes	Option FP2 is required. See notes for Fast Power Fetch for return format.
Initial S/W Revision	A.14.00

Binary Read Fast Power Measurement (Remote Command Only)

This command query is used as shorthand for an INIT command immediately followed by a FETC? command. The returned results are in a binary format.

Mode	All
Remote Command	:CALCulate:FPOWER:POWER[1,2,...,999]:READ? :CALCulate:FPOWER:POWER[1,2,...,999]:READ1?
Example	:CALC:FPOW:POW1:READ? :CALC:FPOW:POW1:READ1?
Notes	Option FP2 is required. Returns m 4 byte floating point binary values (Little-Endian), where m corresponds to the number of bandwidths defined.
Initial S/W Revision	A.14.00

Diagnostic Binary Read Fast Power Measurement (Remote Command Only)

This command query is used as shorthand for an INIT command immediately followed by a FETC? command. The returned results are in a binary format. This command is used primarily for diagnostic purposes to test for ADC overloads and to visibly inspect the spectrum.

Mode	All
Remote Command	:CALCulate:FPOWER:POWER[1,2,...,999]:READ2?
Example	:CALC:FPOW:POW1:READ2?
Notes	Option FP2 is required. Note: Spectrum data is only returned if the IncludePowerSpectrum parameter is set to True. If IncludePowerSpectrum is False, the number of spectrum points will be zero (0). Units of the returned values are dependent on the Function parameter per channel (e.g. dBm for BandPower, Hz for PeakFrequency). Returns binary data (Little-Endian) that contains information on m amount of channels, along with ADC over range and full spectrum data. The following is the binary format of the response. Bandwidth Return Value 1. Number of channels specified, m [4 byte int] 2. Declared function result for the 1st specified channel [4 byte float] 3. Declared function result for the 2nd specified channel [4 byte float] ... (m + 1). Declared function result for the last (mth) specified channel [4 byte float] ADC Over Range 1. ADC over-range occurred (1: true, 0: false) [2 byte short]

	<p>Spectrum Data</p> <ol style="list-style-type: none"> 1. Number of points in the spectrum data, k [4 byte int] 2. Start frequency of spectrum data (Hz) [8 byte double] 3. Step frequency of spectrum data (Hz) [8 byte double] 4. FFT bin at 1st point (dBm) [4 byte float] 5. FFT bin at 2nd point (dBm) [4 byte float] <p>...</p> <p>(k + 3). FFT bin at last (kth) point (dBm) [4 byte float]</p>
Initial S/W Revision	A.14.00

Format Data: Numeric Data (Remote Command Only)

This command specifies the format of the trace data input and output. It specifies the formats used for trace data during data transfer across any remote port. It affects only the data format for setting and querying trace data for the :TRACe[:DATA], TRACe[:DATA]?, :CALCulate:DATA[n]? and FETCh:SANalyzer[n]? commands and queries.

Remote Command	<pre>:FORMat[:TRACe][:DATA] ASCii INTeger,32 REAL,32 REAL,64 :FORMat[:TRACe][:DATA]?</pre>
Notes	<p>The query response is:</p> <pre>ASCii: ASC,8 REAL,32: REAL,32 REAL,64: REAL,64 INTeger,32: INT,32</pre> <p>When the numeric data format is REAL or ASCii, data is output in the current Y Axis unit. When the data format is INTeger, data is output in units of m dBm (.001 dBm).</p> <p>The INT,32 format returns binary 32-bit integer values in internal units (m dBm), in a definite length block.</p>
Dependencies	<p>Sending a data format spec with an invalid number (for example, INT,48) generates no error. The analyzer simply uses the default (8 for ASCii, 32 for INTeger, 32 for REAL).</p> <p>Sending data to the analyzer which does not conform to the current FORMat specified, results in an error. Sending ASCII data when a definite block is expected generates message -161 "Invalid Block Data" and sending a definite block when ASCII data is expected generates message -121 "Invalid Character in Number".</p>
Preset	ASCii
Backwards Compatibility Notes	Note that the INT,32 format is only applicable to the command, TRACe:DATA. This preserves backwards compatibility for the Swept SA measurement. For all other commands/queries which honor FORMat:DATA, if INT,32 is sent the analyzer will behave as though it were set to REAL,32.
Initial S/W Revision	Prior to A.02.00

The specs for each output type follow:

AScii - Amplitude values are in ASCII, in the current Y Axis Unit, one ASCII character per digit, values separated by commas, each value in the form:

SX.YYYYYEsZZ

Where:

S = sign (+ or -)

X = one digit to left of decimal point

Y = 5 digits to right of decimal point

E = E, exponent header

s = sign of exponent (+ or -)

ZZ = two digit exponent

REAL,32 - Binary 32-bit real values in the current Y Axis Unit, in a definite length block.

REAL,64 - Binary 64-bit real values in the current Y Axis Unit, in a definite length block.

Format Data: Byte Order (Remote Command Only)

This command selects the binary data byte order for data transfer and other queries. It controls whether binary data is transferred in normal or swapped mode. This command affects only the byte order for setting and querying trace data for the :TRACe[:DATA], TRACe[:DATA]? , :CALCulate:DATA[n]? and FETCh:SANalyzer[n]? commands and queries.

By definition any command that says it uses FORMat:DATA uses any format supported by FORMat:DATA.

The NORMal order is a byte sequence that begins with the most significant byte (MSB) first, and ends with the least significant byte (LSB) last in the sequence: 1|2|3|4. SWAPped order is when the byte sequence begins with the LSB first, and ends with the MSB last in the sequence: 4|3|2|1.

Remote Command	:FORMat:BORDER NORMal SWAPped :FORMat:BORDER?
Preset	NORMal
Initial S/W Revision	Prior to A.02.00

Meas Setup

Displays the setup menu for the current measurement. The measurement setup parameters include the number of measurement averages used to calculate the measurement result and the averaging mode. The setup menu also includes the option to reset the measurement settings to their factory defaults.

Key Path	Front-panel key
Initial S/W Revision	Prior to A.02.00

Avg/Hold Num

Specifies the number of measurement averages used when calculating the measurement result. The average is displayed at the end of each sweep.

Initiates an averaging routine that averages the sweep points in a number of successive sweeps, resulting in trace smoothing.

After the specified number of average counts, the average mode (termination control) setting determines the average action.

Key Path	Meas Setup
Mode	SA, WCDMA, C2K, WIMAX OFDMA, TD-SCDMA, 1xEVDO, ISDB-T, CMMB, LTE, LTETDD, BLUETOOTH, WLAN, MSR, LTEAFDD, LTEATDD
Remote Command	[:SENSe]:OBWidth:AVERage:COUNT <integer> [:SENSe]:OBWidth:AVERage:COUNT? [:SENSe]:OBWidth:AVERage[:STATe] ON OFF 1 0 [:SENSe]:OBWidth:AVERage[:STATe]?
Example	OBW:AVER:COUN 1500 OBW:AVER:COUN? OBW:AVER ON OBW:AVER?
Notes	You must be in the Spectrum Analysis mode, W-CDMA mode, cdma2000 mode, TD-SCDMA mode, ISDB-T mode, CMMB mode, LTE mode, LTE TDD mode, BLUETOOTH mode, WLAN mode, 1xEVDO mode, MSR, LTE-Advanced FDD/TDD or WIMAX OFDMA mode to use this command. Use:INSTRument:SELEct to set the mode.
Couplings	None Averaging state is coupled to Max Hold. If Max Hold is changed from Off to On, Averaging state is automatically set to On.
Preset	10 ON
State Saved	Saved in instrument state.
Min	1
Max	10000

Backwards Compatibility SCPI	<code>[:SENSe] :EBWidth :AVERage :COUNt</code>
Initial S/W Revision	Prior to A.02.00
Modified at S/W Revision	A.03.00

Avg Mode

Enables you to set the averaging mode.

- When set to Exponential (Exp) the measurement averaging continues using the specified number of averages to compute each averaged value. The average is displayed at the end of each sweep.
- When set to Repeat, the measurement resets the average counter each time the specified number of averages is reached.

Key Path	Meas Setup
Mode	SA, WCDMA, C2K, WIMAX OFDMA, TD-SCDMA , 1xEVDO, ISDB-T, CMMB, LTE, LTETDD, BLUETOOTH, WLAN, MSR, LTEAFDD, LTEATDD
Remote Command	<code>[:SENSe] :OBWidth :AVERage :TCONtrol EXPonential REPeat</code> <code>[:SENSe] :OBWidth :AVERage :TCONtrol ?</code>
Example	OBW:AVER:TCON REP OBW:AVER:TCON?
Notes	You must be in the Spectrum Analysis mode, W-CDMA mode, cdma2000 mode, TD-SCDMA mode, ISDB-T mode, CMMB mode, LTE mode, LTE TDD mode, BLUETOOTH mode, WLAN mode, 1xEVDO mode, MSR, LTE-Advanced FDD/TDD or WIMAX OFDMA mode to use this command. Use:INSTrument:SElect to set the mode.
Preset	EXP
State Saved	Saved in instrument state.
Range	Exp Repeat
Initial S/W Revision	Prior to A.02.00
Modified at S/W Revision	A.03.00

Occ BW % Pwr

Assigns the percentage of the total power that is measured within the Occupied Bandwidth for the current measurement. The resulting Occupied Bandwidth limits are displayed by markers placed on the frequencies of the specified percentage.

Key Path	Meas Setup
Mode	SA, WCDMA, C2K, WIMAX OFDMA, TD-SCDMA, 1xEVDO, ISDB-T, CMMB, LTE, LTETDD, BLUETOOTH, WLAN, MSR, LTEAFDD, LTEATDD
Remote Command	<code>[:SENSe] :OBWidth :PERCent <real></code>

	<code>[:SENSe] :OBWidth :PERCent ?</code>
Example	OBW:PERC 75 OBW:PERC?
Notes	You must be in the Spectrum Analysis mode, W-CDMA mode, cdma2000 mode, TD-SCDMA mode, ISDB-T mode, CMMB mode, LTE mode, LTE TDD mode, BLUETOOTH mode, WLAN mode, 1xEVDO mode, MSR, LTE-Advanced FDD/TDD or WIMAX OFDMA mode to use this command. Use:INSTRument:SElect to set the mode. If Mode is BLUETOOTH, the key will be grayed out.
Preset	99.00
State Saved	Saved in instrument state.
Min	10
Max	99.99
Initial S/W Revision	Prior to A.02.00
Modified at S/W Revision	A.03.00

x dB

Sets the x dB value used for the "x dB bandwidth" result that measures the bandwidth between two points on the signal which is x dB down from the highest signal point within the OBW Span.

Key Path	Meas Setup
Mode	SA, WCDMA, C2K, WIMAX OFDMA, TD-SCDMA, 1xEVDO, ISDB-T, CMMB, LTE, LTE TDD, BLUETOOTH, WLAN, MSR, LTEAFDD, LTEATDD
Remote Command	<code>[:SENSe] :OBWidth :XDB <rel_ampl></code> <code>[:SENSe] :OBWidth :XDB ?</code>
Example	OBW:XDB -20 OBW:XDB?
Notes	You must be in the Spectrum Analysis mode, W-CDMA mode, cdma2000 mode, TD-SCDMA mode, ISDB-T mode, CMMB mode, LTE mode, LTE TDD mode, BLUETOOTH mode, WLAN mode, 1xEVDO mode, MSR, LTE-Advanced FDD/TDD or WIMAX OFDMA mode to use this command. Use:INSTRument:SElect to set the mode.
Preset	-26.0 dB BLUETOOTH: -20.0 dB.
State Saved	Saved in instrument state.
Min	-100.0 dB
Max	-0.1 dB
Backwards Compatibility SCPI	<code>[:SENSe] :EBWidth :XDB</code>
Initial S/W Revision	Prior to A.02.00
Modified at S/W Revision	A.03.00

IF Gain

The IF Gain key can be used to set the IF Gain function to Auto, Low Gain or High Gain. These settings affect sensitivity and IF overloads.

This only applies to the RF input. It does not apply to baseband I/Q input.

Key Path	Meas Setup, IF Gain
Dependencies	The IF Gain keys (FFT IF Gain and Swept IF Gain) have no effect when the U7227A USB Preamplifier is connected. This is not annotated or reflected on any softkey; there are no keys grayed out nor any SCPI locked out. The analyzer simply behaves as though both FFT IF Gain and Swept IF Gain are set to Low regardless of the setting on the keys.
Initial S/W Revision	Prior to A.02.00

IF Gain Auto

Activates the Auto Rules for IF Gain. When Auto is active, the IF Gain is set to High Gain under and of the following conditions:

- the input attenuator is set to 0 dB
- the preamp is turned On and the frequency range is under 3.6 GHz

For other settings, Auto sets the IF Gain to Low Gain.

Key Path	Meas Setup, IF Gain
Mode	SA, WCDMA, C2K, WIMAX OFDMA, TD-SCDMA, 1xEVDO, ISDB-T, CMMB, LTE, LTETDD, BLUETOOTH, WLAN, MSR, LTEAFDD, LTEATDD
Remote Command	[:SENSe] :OBWidth :IF :GAIN :AUTO [:STATe] ON OFF 1 0 [:SENSe] :OBWidth :IF :GAIN :AUTO [:STATe] ?
Example	OBW:IF:GAIN:AUTO OFF OBW:IF:GAIN:AUTO?
Couplings	When the auto attenuation exists (for example, with electrical attenuator), the IF Gain setting is changed as following rule. Auto sets IF Gain to High Gain under any of the following conditions: the input attenuator is set to 0 dB, or the preamp is turned on and the frequency range is less than 3.6 GHz. For other settings, Auto sets IF Gain to Low Gain.
Preset	OFF
State Saved	Saved in instrument state.
Range	Off On
Initial S/W Revision	Prior to A.02.00
Modified at S/W Revision	A.03.00

IF Gain State

Selects the range of the IF Gain.

Key Path	Meas Setup, IF Gain
Mode	SA, WCDMA, C2K, WIMAX OFDMA, TD-SCDMA, 1xEVDO, ISDB-T, CMMB, LTE, LTETDD, BLUETOOTH, WLAN, MSR, LTEAFDD, LTEATDD
Remote Command	<code>[:SENSe]:OBWidth:IF:GAIN[:STATe] ON OFF 1 0</code> <code>[:SENSe]:OBWidth:IF:GAIN[:STATe]?</code>
Example	OBW:IF:GAIN ON OBW:IF:GAIN?
Notes	Where ON = high gain OFF = low gain
Couplings	When the auto attenuation exists (for example, with electrical attenuator), the IF Gain setting is changed as following rule. Auto sets IF Gain to High Gain under any of the following conditions: the input attenuator is set to 0 dB, or the preamp is turned on and the frequency range is less than 3.6 GHz. For other settings, Auto sets IF Gain to Low Gain.
Preset	OFF
State Saved	Saved in instrument state.
Range	Low Gain High Gain
Initial S/W Revision	Prior to A.02.00
Modified at S/W Revision	A.03.00

Limit (for all modes except MSR and LTE-Advanced FDD/TDD)

Enables you to turn on or off limit checking at the specified frequency. For results that fail the limit test, a red FAIL appears in the measure bar.

Key Path	Meas Setup
Mode	SA, WCDMA, C2K, WIMAX OFDMA, TD-SCDMA, 1xEVDO, ISDB-T, CMMB, LTE, LTETDD, BLUETOOTH, WLAN
Remote Command	<code>:CALCulate:OBWidth:LIMit:FBLimit <freq></code> <code>:CALCulate:OBWidth:LIMit:FBLimit?</code> <code>:CALCulate:OBWidth:LIMit[:TEST] ON OFF 1 0</code> <code>:CALCulate:OBWidth:LIMit[:TEST]?</code>
Example	CALC:OBW:LIM:FBL 50 kHz CALC:OBW:LIM:FBL? CALC:OBW:LIM OFF CALC:OBW:LIM?
Notes	You must be in the Spectrum Analysis mode, W-CDMA mode, cdma2000 mode, TD-SCDMA mode, ISDB-T mode, CMMB mode, LTE mode, LTE TDD mode, BLUETOOTH mode, WLAN mode, 1xEVDO mode or WIMAX OFDMA mode to use this command. Use:INSTrument:SElect to set the mode.

Preset	SA, WCDMA: 5 MHz C2K: 1.48 MHz WIMAX OFDMA: 10 MHz TD-SCDMA: 1.6 MHz 1xEVDO: 1.48 MHz ISDB-T: 5.7 MHz CMMB: 7.512 MHz LTE, LTETDD: 5 MHz BLUETOOTH: 1 MHz WLAN: If Radio Std is 802.11a/g(OFDM/DSSS-OFDM): 20MHz If Radio Std is 802.11b: 25 MHz If Radio Std is 802.11n(20MHz): 20 MHz If Radio Std is 802.11n(40MHz): 40 MHz If Radio Std is 802.11ac(20MHz): 20 MHz If Radio Std is 802.11ac(40MHz): 40 MHz If Radio Std is 802.11ac(80MHz): 80 MHz If Radio Std is 802.11ac(160MHz): 160 MHz SA: OFF WCDMA, WIMAX OFDMA, TD-SCDMA, 1xEVDO, ISDB-T, CMMB, LTE, LTETDD: ON
State Saved	Saved in instrument state.
Min	1 kHz
Max	Depends on instrument maximum frequency.
Initial S/W Revision	Prior to A.02.00
Modified at S/W Revision	A.03.00

Meas Preset

Restores all measurement parameters to their default values.

Key Path	Meas Setup
Mode	SA, WCDMA, C2K, WIMAX OFDMA, TD-SCDMA, 1xEVDO, ISDB-T, CMMB, LTE, LTETDD, BLUETOOTH, WLAN, MSR, LTEAFDD, LTEATDD
Remote Command	:CONFigure:OBWidth
Example	CONF:OBW
Initial S/W Revision	Prior to A.02.00
Modified at S/W Revision	A.03.00

Max Hold (Remote Command Only)

When On, Max Hold displays and holds the maximum responses of the current measurement. Turn Max Hold to Off to disable the maximum hold feature.

Key Path	SCPI Only
Mode	SA, WCDMA, C2K, WIMAX OFDMA, TD-SCDMA, 1xEVDO, ISDB-T, CMMB, LTE, LTETDD, BLUETOOTH, WLAN, MSR, LTEAFDD, LTEATDD
Remote Command	<code>[:SENSe] :OBwidth:MAXHold ON OFF 1 0</code> <code>[:SENSe] :OBwidth:MAXHold?</code>
Example	OBW:MAXH ON OBW:MAXH?
Notes	You must be in the Spectrum Analysis mode, W-CDMA mode, cdma2000 mode, TD-SCDMA mode, ISDB-T mode, CMMB mode, LTE mode, LTE TDD mode, BLUETOOTH mode, WLAN mode, 1xEVDO mode, MSR, LTE-Advanced FDD/TDD or WIMAX OFDMA mode to use this command. Use:INSTrument:SElect to set the mode.
Couplings	Max Hold is coupled to Average/Hold state. The Max Hold function is activated only if Average state is On. If Max Hold is changed to On when Average state is Off, Average state is automatically set to On.
Preset	OFF
State Saved	Saved in instrument state.
Range	On Off
Backwards Compatibility SCPI	<code>[:SENSe] :EBwidth:MAXHold</code>
Initial S/W Revision	Prior to A.02.00
Modified at S/W Revision	A.03.00

9 Occupied Bandwidth Measurement
Mode

Mode

See "[Mode](#)" on page 288

Mode Preset

Returns the active mode to a known state.

Mode Preset does the following for the currently active mode:

- Aborts the currently running measurement.
- Brings up the default menu for the mode, with no active function.
- Sets measurement Global settings to their preset values for the active mode only.
- Activates the default measurement.
- Brings up the default menu for the mode.
- Clears the input and output buffers.
- Sets Status Byte to 0.

Mode Preset does not:

- Cause a mode switch
- Affect mode persistent settings
- Affect system settings
- See "[How-To Preset](#)" on page 738 for more information.

Key Path	Front-panel key
Remote Command	:SYSTem:PRESet
Example	:SYST:PRES
Notes	*RST is preferred over :SYST:PRES for remote operation. *RST does a Mode Preset, as done by the :SYST:PRES command, and it sets the measurement mode to Single measurement rather than Continuous for optimal remote control throughput. Clears all pending OPC bits. The Status Byte is set to 0.
Couplings	A Mode Preset aborts the currently running measurement, activates the default measurement, and gets the mode to a consistent state with all of the default couplings set.
Backwards Compatibility Notes	In the X-Series, the legacy "Factory Preset" has been replaced with Mode Preset, which only presets the currently active mode, not the entire instrument. In the X-Series, the way to preset the entire instrument is by using System, Restore System Defaults All, which behaves essentially the same way as restore System Defaults does on ESA and PSA. There is also no "Preset Type" as there is on the PSA. There is a green Mode Preset front-panel key that does a Mode Preset and a white-with-green-letters User Preset front-panel key that does a User Preset. The old PRESet:TYPE command is ignored (without generating an error), and SYST:PRES without a parameter does a Mode Preset, which should cover most backward code compatibility issues. The settings and correction data under the Input/Output front-panel key (examples: Input Z Corr, Ext Amp Gain, etc.) are no longer part of any Mode, so they will not be preset by a Mode Preset. They are preset using Restore Input/Output Defaults, Restore System Defaults All. Note that because User Preset does a Recall State, and all of these settings are saved in State, they ARE recalled when using

	User Preset.
Initial S/W Revision	Prior to A.02.00

How-To Preset

The table below shows all possible presets, their corresponding SCPI commands and front-panel access (key paths). Instrument settings depend on the current measurement context. Some settings are local to the current measurement, some are global (common) across all the measurements in the current mode, and some are global to all the available modes. In a similar way, restoring the settings to their preset state can be done within the different contexts.

Auto Couple - is a measurement local key. It sets all Auto/Man parameter couplings in the measurement to Auto. Any Auto/Man selection that is local to other measurements in the mode will not be affected.

Meas Preset - is a measurement local key. Meas Preset resets all the variables local to the current measurement except the persistent ones.

Mode Preset - resets all the current mode's measurement local and measurement global variables except the persistent ones.

Restore Mode Defaults - resets ALL the Mode variables (and all the Meas global and Meas local variables), including the persistent ones.

Type Of Preset	SCPI Command	Front Panel Access
Auto Couple	:COUPle ALL	Auto Couple front-panel key
Meas Preset	:CONFigure:<Measurement>	Meas Setup Menu
Mode Preset	:SYSTem:PRESet	Mode Preset (green key)
Restore Mode Defaults	:INSTrument:DEFault	Mode Setup Menu
Restore All Mode Defaults	:SYSTem:DEFault MODes	System Menu; Restore System Default Menu
*RST	*RST	not possible (Mode Preset with Single)
Restore Input/Output Defaults	:SYSTem:DEFault INPUt	System Menu; Restore System Default Menu
Restore Power On Defaults	:SYSTem:DEFault PON	System Menu; Restore System Default Menu
Restore Alignment Defaults	:SYSTem:DEFault ALIGN	System Menu; Restore System Default Menu
Restore Miscellaneous Defaults	:SYSTem:DEFault MISC	System Menu; Restore System Default Menu
Restore All System Defaults	:SYSTem:DEFault [ALL] :SYSTem:PRESet:PERsistent	System Menu; Restore System Default Menu
User Preset	:SYSTem:PRESet:USER	User Preset Menu
User Preset All Modes	:SYSTem:PRESet:USER:ALL	User Preset Menu

Power On Mode Preset	:SYSTem:PON:TYPE MODE	System Menu
Power On User Preset	:SYSTem:PON:TYPE USER	System Menu
Power On Last State	:SYSTem:PON:TYPE LAST	System Menu

Mode Setup

See "[Mode Setup](#)" on page 320

Peak Search

Places the selected marker on the trace point with the maximum y-axis value for that marker's trace. Pressing Peak Search with the selected marker off causes the selected marker to be set to Normal, then a peak search is immediately performed.

Key Path	Front panel key
Mode	SA, WCDMA, C2K, WIMAX OFDMA, TD-SCDMA, 1xEVDO, ISDB-T, CMMB, LTE, LTETDD, BLUETOOTH, WLAN, MSR, LTEAFDD, LTEATDD
Remote Command	:CALCulate:OBWidth:MARKer[1] 2 ... 12:MAXimum
Example	CALC:OBW:MARK2:MAX
Initial S/W Revision	Prior to A.02.00
Modified at S/W Revision	A.03.00

9 Occupied Bandwidth Measurement
Print

Print

See ["Print" on page 352](#)

Quick Save

The Quick Save front-panel key repeats the most recent save that was performed from the Save menu, with the following exceptions:

- Register saves are not remembered as Saves for the purpose of the Quick Save function
- If the current measurement does not support the last non-register save that was performed, an informational message is generated, “File type not supported for this measurement”

Quick Save repeats the last type of qualified save (that is, a save qualified by the above criteria) in the last save directory by creating a unique filename using the Auto File Naming algorithm described below.

If Quick Save is pressed after startup and before any qualified Save has been performed, the Quick Save function performs a Screen Image save using the current settings for Screen Image saves (current theme, current directory), which then becomes the “last save” for the purpose of subsequent Quick Saves.

The Auto File Naming feature automatically generates a file name for use when saving a file. The filename consists of a prefix and suffix separated by a dot, as is standard for the Windows® file system. A default prefix exists for each of the available file types:

Type	Default Prefix	Menu
State	State_	(Save/Recall)
Trace + State	State_	(Save/Recall)
Screen	Screen_	(Save/Recall)
Amplitude Corrections	Ampcor_	(Import/Export)
Traces	Trace_	(Import/Export)
Limit Lines	LLine_	(Import/Export)
Measurement Result	MeasR_	(Import/Export)
Capture Buffer	CapBuf_	(Import/Export)

A four digit number is appended to the prefix to create a unique file name. The numbering sequence starts at 0000 within each Mode for each file type and updates incrementally to 9999, then wraps to 0000 again. It remembers where it was through a Mode Preset and when leaving and returning to the Mode. It is reset by Restore Misc Defaults and Restore System Defaults and subsequent running of the instrument application. So, for example, the first auto file name generated for State files is State_0000.state. The next is State_0001, and so forth.

One of the key features of Auto File Name is that we guarantee that the Auto File Name will never conflict with an existing file. The algorithm looks for the next available number. If it gets to 9999, then it looks for holes. If it find no holes, that is no more numbers are available, it gives an error.

For example, if when we get to State_0010.state there is already a State_0010.state file in the current directory, it advances the counter to State_0011.state to ensure that no conflict will exist (and then it verifies that State_0011.state also does not exist in the current directory and advances again if it does, and so forth).

If you enter a file name for a given file type, then the prefix becomes the filename you entered instead of the default prefix, followed by an underscore. The last four letters (the suffix) are the 4-digit number.

For example, if you save a measurement results file as “fred.csv”, then the next auto file name chosen for a measurement results save will be fred_0000.csv.

NOTE

Although 0000 is used in the example above, the number that is used is actually the current number in the Meas Results sequence, that is, the number that would have been used if you had not entered your own file name.

NOTE

If the filename you entered ends with _dddd, where d=any number, making it look just like an auto file name, then the next auto file name picks up where you left off with the suffix being dddd + 1.

Key Path	Front-panel key
Notes	No remote command for this key specifically.
Initial S/W Revision	Prior to A.02.00

Recall

The Recall menu lets you choose what you want to recall, and where you want to recall it from. Among the types of files you can recall are **States and Traces**. In addition, an Import (Data) option lets you recall a number of data types stored in CSV files (as used by Excel and other spreadsheet programs).

The default paths for Recall are data type dependent and are the same as for the Save key.

Key Path	Front-panel key
Notes	<p>No remote command for this key specifically, but the :MMEM:LOAD command is available for specific file types. An example is :MMEM:LOAD:STATE <filename>.</p> <p>If you try to recall a State file for a mode that is not licensed or not available in the instrument, an error message will occur and the state will not change.</p>
Backwards Compatibility Notes	<p>In legacy analyzers, it was possible to load a state without affecting the trace data, limit lines or correction data. Similarly (since User Preset is actually loading a state), it was possible to do a User Preset without affecting the trace data, limit lines or correction data.</p> <p>In the X-Series, “state” always includes all of this data; so whenever state is loaded, all of the traces, limit lines and corrections are affected. Although this differs from previous behavior, it is desirable behavior, and should not cause adverse issues for users.</p>
Backwards Compatibility Notes	<p>Recall for the X-Series supports backward compatibility in the sense that you can recall a state file from any X-Series model number and any version of X-Series software. This is only possible if part of the recalling process goes through a limiting step after recalling the mode settings, at least for settings that may vary with version number, model number, option and license differences. If you try to recall a state file onto an instrument with less capability than what was available on the instrument during the save, the recall will ignore the state it doesn't support and it will limit the recalled setting to what it allows.</p> <p>Example: if the saved state includes preamp ON, but the recalling instrument does not have a preamp; the preamp is limited to OFF. Conversely, if you save a state without a preamp, the preamp is OFF in the state file. When this saved file is recalled on an instrument with a licensed preamp, the preamp is changed to OFF. Another example is if the saved state has center frequency set to 20 GHz, but the instrument recalling the saved state is a different model and only supports 13.5 GHz. In this case, the center frequency is limited along with any other frequency based settings. Since the center frequency can't be preserved in this case, the recall limiting tries to at least preserve span to keep the measurement setup as intact as possible.</p> <p>It may be appropriate to issue a warning if the state is limited on the recall; warnings do not go out to SCPI so this would only affect the manual user.</p> <p>Note that there is no state file compatibility outside of the X-Series. For example, you cannot recall a state file from ESA or PSA.</p>
Initial S/W Revision	Prior to A.02.00

State

The Recall State menu lets you choose a register or file from which to recall the state.

The content of a state file includes all of the settings and data required to return the analyzer as closely as possible to the Mode it was in, with the exact settings that were in place, when the save occurred. The Mode settings in each state file include the settings that are affected by Mode Preset, as well as the

additional settings affected by Restore Mode Defaults; all of the Mode’s settings. In addition, all of the settings of the Input/Output system are included, even though they are outside of the Mode’s state, because they are needed to restore the complete setup. Persistent System settings (for example, GPIB address) are not affected by either a Mode Preset or Restore Mode Defaults, nor are they included in a saved State file.

Since each state file is only for one Mode, the settings for other Modes are unaffected when it is loaded. Recall State will cause a mode switch if the state being recalled is not from the current active mode.

After the recall completes, the message "File <filename> recalled" or “Recalled State Register <register number>” is displayed.

For rapid recalls, the State menu lists 16 registers that you can choose from to recall. Pressing a Register key initiates the recall. You can also select a file from which to recall.

The default path for all State Files is:

My Documents\<mode name>\state

where <mode name> is the parameter used to select the mode with the INST:SEL command (for example, SA for the Spectrum Analyzer).

See ["More Information" on page 747](#).

Key Path	Recall
Mode	All
Remote Command	:MMEMory:LOAD:STATe <filename>
Example	:MMEM:LOAD:STAT "myState.state" This recalls the file myState.state on the default path
Example	MMEM:LOAD:STAT "MyStateFile.state" This loads the state file data (on the default file directory path) into the instrument state.
Notes	<p>When you pick a file to recall, the analyzer first verifies that the file is recallable in the current instrument by checking the software version and model number of the instrument. If everything matches, a full recall proceeds by aborting the currently running measurement, clearing any pending operations, and then loading the State from the saved state file. You can open state files from any mode, so recalling a State file switches to the mode that was active when the save occurred. After switching to the mode of the saved state file, mode settings and data (if any for the mode) are loaded with values from the saved file. The saved measurement of the mode becomes the newly active measurement and the data relevant to the measurement (if there is any) is recalled.</p> <ul style="list-style-type: none"> • If there is a mismatch between file version or model number or instrument version or model number, the recall function tries to recall as much as possible and returns a warning message. It may limit settings that differ based on model number, licensing or version number. <p>After recalling the state, the Recall State function does the following:</p> <ul style="list-style-type: none"> • Makes the saved measurement for the mode the active measurement. • Clears the input and output buffers. • Status Byte is set to 0. • Executes a *CLS <p>If the file specified is empty an error is generated. If the specified file does not exist, another error is generated. If there is a mismatch between the file and the proper file type, an error is generated. If</p>

	there is a mismatch between file version or model number or instrument version or model number, a warning is displayed. Then it returns to the State menu and File Open dialog goes away. After the Recall, the analyzer exits the Recall menu and returns to the previous menu.
Backwards Compatibility SCPI	:MMEMory:LOAD:STATe 1,<filename> For backwards compatibility, the above syntax is supported. The "1" is simply ignored.
Initial S/W Revision	Prior to A.02.00

More Information

In measurements that support saving Traces, for example, Swept SA, the Trace data is saved along with the State in the State file. When recalling the State, the Trace data is recalled as well. Traces are recalled exactly as they were stored, including the writing mode and update and display modes. If a Trace was updating and visible when the State was saved, it will come back updating and visible, and its data will be rewritten right away. When you use State to save and recall traces, any trace whose data must be preserved should be placed in View or Blank mode before saving.

The following table describes the Trace Save and Recall possibilities:

You want to recall state and one trace's data, leaving other traces unaffected.	Save Trace+State from 1 trace. Make sure that no other traces are updating (they should all be in View or Blank mode) when the save is performed.	On Recall, specify the trace you want to load the one trace's data into. This trace will load in View. All other traces' data will be unaffected, although their trace mode will be as it was when the state save was performed.
You want to recall all traces	Save Trace+State from ALL traces.	On Recall, all traces will come back in View (or Blank if they were in Blank or Background when saved)
You want all traces to load exactly as they were when saved.	Save State	On recall, all traces' mode and data will be exactly as they were when saved. Any traces that were updating will have their data immediately overwritten.

From File...

When you press "From File", the analyzer brings up a Windows dialog and a menu entitled "File Open." This menu allows you to navigate to the various fields in the Windows dialog without using a keyboard or mouse. The Tab and Arrow keys can also be used for dialog navigation.

9 Occupied Bandwidth Measurement Recall

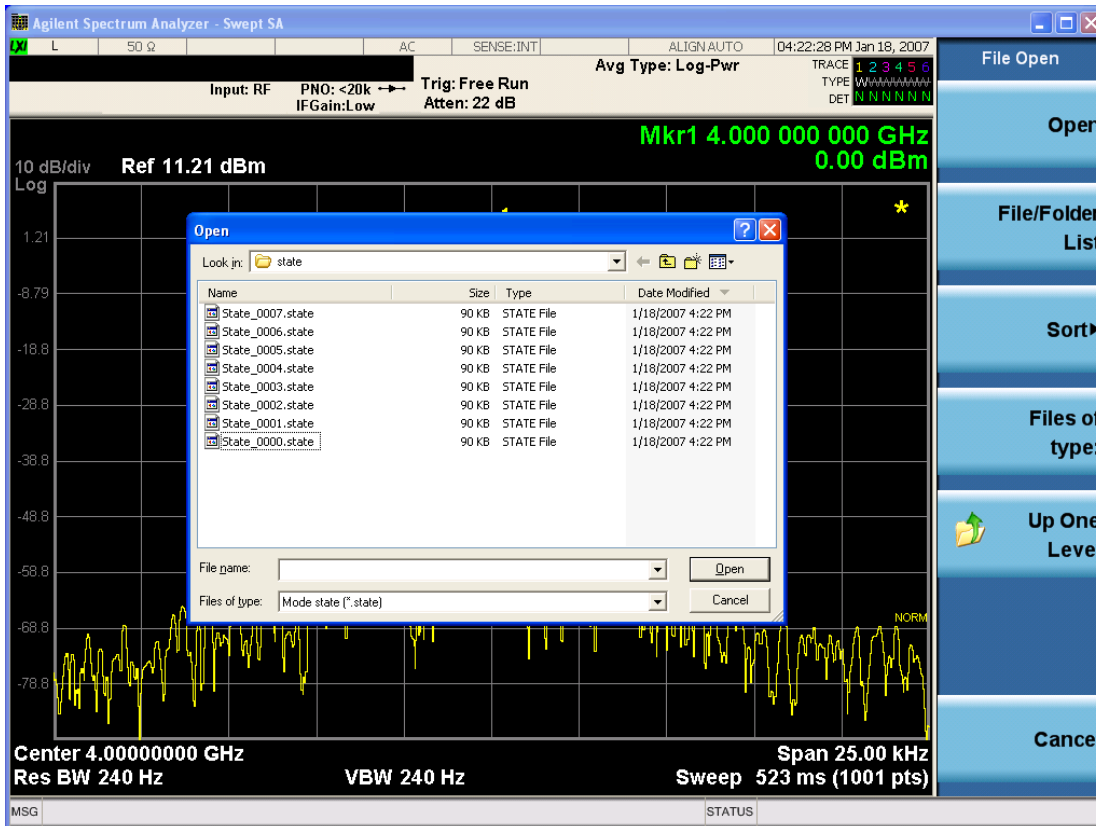

Listed below are the functions of the various fields in the dialog, and the corresponding softkeys:

Open

Performs the recall of the specified file. While the recall is being performed, the floppy icon appears briefly in the Meas bar.

File/Folder List

Enables you to navigate to the center of the dialog that contains the list of files and folders. Once here you can get information about the file and use the tab keys to navigate to the other fields in the dialog, such as Look In.

Look In

The Look In field shows the path from which the file will be recalled and allows you to change the path using the up and down arrow keys to navigate to other paths; the Enter key to open a directory; and the Backspace key to go back one directory. The **Look In field** first uses the last path from the Save As dialog **Save In:** path for that same file type. There is no softkey for directly navigating to the Look In field, but you can use the left tab to get here from the File/Folder List.

User specified paths are remembered when you leave and return to a Mode and are reset back to the default using Restore Mode Defaults.

Sort

Accesses a menu that enables you to sort the files within the File Open dialog. Only one sorting type can be selected at a time and the sorting happens immediately. The sorting types are By Date, By Name, By extension, and By Size.

Files of Type

This field shows the file suffix for the type of file you have selected to recall. For example, if you navigated here while recalling State, "Mode state (*.state)" is in the field. If you navigated here while recalling Trace, ""Mode state (*.trace)" is in the field. If you navigated here while importing a trace data file, "Trace Data (*.csv)" is in the field. For some file types, there is more than one choice in the dropdown menu, which you can select by using the up and down arrow keys and Enter.

Up One Level

This key corresponds to the icon of a folder with the up arrow that is in the tool bar of the dialog. When pressed, it causes the file and folder list to navigate up one level in the directory structure. The Backspace key does the same thing.

Cancel

This key corresponds to the Cancel selection in the dialog. It causes the current **Open** request to be cancelled. The ESC key does the same thing.

Key Path	Recall, State
Notes	Brings up the Open dialog for recalling a State Save Type
Initial S/W Revision	Prior to A.02.00

Edit Register Names

You may enter a custom name on any of the Register keys, to help you remember what you are using that state to save. To do this, press the Edit Register Names key, choose the register whose name you wish to edit, and then enter the desired label using the Alpha Editor or an external PC keyboard.

The maximum number of characters that can be added is 30. In most cases, 30 characters will fit on two lines of the key.

For more information and the SCPI command, see Edit Register Names under the Save, State function.

Key Path	Recall, State
Mode	All
Dependencies	N9060A-7FP or N9060B-2FP license required to edit the register names. When the feature is not licensed, sending the SCPI command generates an error, -221, "Settings conflict;Option not available"
Initial S/W Revision	A.11.00

Register 1 thru Register 16

Selecting any one of these register keys causes the State of the mode from the specified Register to be recalled. Each of the register keys annotates whether it is empty or at what date and time it was last

modified. In addition, you can use the Edit Register Names key under Save, State to enter custom names for each register.

Registers are shared by all modes, so recalling from any one of the registers will cause a mode switch to the mode that was active when the save to the Register occurred.

Although these 16 registers are the only registers available from the front panel, there are 128 state registers available in the instrument. Registers 17–128 are only available from the SCPI interface, using the *RCL command.

After the recall completes, the message "Register <register number> recalled" appears in the message bar. If you are in the Spectrum Analyzer Mode, and you are recalling a register that was saved in the Spectrum Analyzer Mode, then after the recall, you will still be in the Recall Register menu. If the Recall causes you to switch modes, then after the Recall, you will be in the Frequency menu.

If a requested register is empty an error is generated.

Key Path	Recall, State
Example	*RCL 1
Range	1–16 from front panel, 1–128 from SCPI
Readback	Date and time with seconds resolution are displayed on the key OR A custom name of up to 30 characters entered using the Save, State, Edit Register Names key OR “(empty)” if no prior save operation has been performed to this register.
Initial S/W Revision	Prior to A.02.00
Modified at S/W Revision	Prior to A.11.00

Register 1 thru Register 16

Selecting any one of these register keys causes the State of the mode from the specified Register to be recalled. Each of the register keys annotates whether it is empty or at what date and time it was last modified. In addition, you can use the Edit Register Names key under Save, State to enter custom names for each register.

Registers are shared by all modes, so recalling from any one of the registers will cause a mode switch to the mode that was active when the save to the Register occurred.

Although these 16 registers are the only registers available from the front panel, there are 128 state registers available in the instrument. Registers 17–128 are only available from the SCPI interface, using the *RCL command.

After the recall completes, the message "Register <register number> recalled" appears in the message bar. If you are in the Spectrum Analyzer Mode, and you are recalling a register that was saved in the Spectrum Analyzer Mode, then after the recall, you will still be in the Recall Register menu. If the Recall causes you to switch modes, then after the Recall, you will be in the Frequency menu.

If a requested register is empty an error is generated.

Key Path	Recall, State
Example	*RCL 1
Range	1-16 from front panel, 1-128 from SCPI
Readback	Date and time with seconds resolution are displayed on the key OR A custom name of up to 30 characters entered using the Save, State,Edit Register Names key OR “(empty)” if no prior save operation has been performed to this register.
Initial S/W Revision	Prior to A.02.00
Modified at S/W Revision	Prior to A.11.00

Data (Import)

Importing a data file loads data that was previously saved from the current measurement or from other measurements and/or modes that produce compatible data files. The Import Menu only contains Data Types that are supported by the current measurement.

Since the commonly exported data files are in .csv format, the data can be edited by the user prior to importing. This allows you to export a data file, manipulate the data in Excel (the most common PC Application for manipulating .csv files) and then import it.

Importing Data loads measurement data from the specified file into the specified or default destination, depending on the data type selected. Selecting an Import Data menu key will not actually cause the importing to occur, since the analyzer still needs to know from where to get the data. Pressing the Open key in this menu brings up the Open dialog and Open menu that provides you with the options from where to recall the data. Once a filename has been selected or entered in the Open menu, the recall occurs as soon as the Open button is pressed.

Key Path	Recall
Mode	All
Notes	The menu is built from whatever data types are available for the mode. Some keys will be missing completely, so the key locations in the sub-menu will vary. No SCPI command directly controls the Data Type that this key controls. The Data Type is included in the MMEM:LOAD commands.
Dependencies	If a file type is not used by a certain measurement, it is grayed out for that measurement. The key for a file type will not show at all if there are no measurements in the Mode that support it.
Preset	Is not affected by Preset or shutdown, but is reset during Restore Mode Defaults
Readback	The data type that is currently selected
Initial S/W Revision	Prior to A.02.00

Masks

This key enables you to recall a preset mask file from the list. It is only available in SEM measurement under the Data menu: Limit Mask. Limit Mask enables setting a preset limit mask for 802.11p 5MHz and 10MHz system.

You cannot change or create the preset mask file since it is a binary file. This key is valid for the Spectrum Emission Mask measurement.

File location: "My Documents\WLAN\data.masks"

Note that "**My Documents**" is an alias to a directory and its location depends on which user is logged in. At XSA start up, all of the limit mask files in the current user's "My Documents\WLAN\data.masks" directory are overwritten.

File type: Binary

Filename:

11p_5MHz_A.mask

11p_5MHz_B.mask

11p_5MHz_C.mask

11p_5MHz_D.mask

11p_10MHz_A.mask

11p_10MHz_B.mask

11p_10MHz_C.mask

11p_10MHz_D.mask

File extension: .mask

Selecting OPEN under the Import Data menu, opens the above directory enabling you to select a mask file.

Example:

File Location: My Documents/WLAN/data/masks

File Name: 11p_5MHz_A.mask

Key Path	Recall, Data
Mode	WLAN
Remote Command	MME ^M ory:LOAD:MASK <string>
Example	MME:LOAD:MASK "11p_5MHz_A.mask"
Initial S/W Revision	A.11.00

Capture Buffer

Capture buffer functionality is only available when measurement is Mod Accuracy and radio standard is not 802.11ac 80+80MHz. The captured data is raw data which is not processed.

Key Path	Recall, Data
Mode	WLAN
Example	MMEM:LOAD:CAPT "MyCaptureData.bin" This loads the file of capture data (on the default file directory path) into the instrument.
Dependencies	Capture buffer data is only available when measurement is Mod Accuracy and radio standard is not 802.11ac 80+80MHz. In other situation, this key is grayed out.
Initial S/W Revision	A.11.00

Open...

When you press "Open", the analyzer brings up a Windows dialog and a menu entitled "File Open." This menu allows you to navigate to the various fields in the Windows dialog without using a keyboard or mouse. The Tab and Arrow keys can also be used for dialog navigation.

See "[From File...](#)" on page 2263 in Recall, State, for a full description of this dialog and menu.

Key Path	Recall, Data
Notes	The key location is mode-dependent and will vary. Brings up Open dialog for recalling a <mode specific> Save Type
Initial S/W Revision	Prior to A.02.00

Restart

The Restart function restarts the current sweep, or measurement, or set of averaged/held sweeps or measurements. If you are Paused, pressing Restart does a Resume.

The Restart function is accessed in several ways:

- Pressing the Restart key
- Sending the remote command INIT:IMMEDIATE
- Sending the remote command INIT:RESTART

See "[More Information](#)" on page 754

Key Path	Front-panel key
Remote Command	:INITiate[:IMMEDIATE] :INITiate:RESTART
Example	:INIT:IMM :INIT:REST
Notes	:INITiate:RESTART and :INITiate:IMMEDIATE perform exactly the same function.
Couplings	Resets average/hold count k. For the first sweep overwrites all active (update=on) traces with new current data. For application modes, it resets other parameters as required by the measurement.
Status Bits/OPC dependencies	This is an Overlapped command. The STATus:OPERation register bits 0 through 8 are cleared. The STATus:QUESTionable register bit 9 (INTegrity sum) is cleared. The SWEEPING bit is set. The MEASURING bit is set.
Backwards Compatibility Notes	For Spectrum Analysis mode in ESA and PSA, the Restart hardkey and the INITiate:RESTART command restart trace averages (displayed average count reset to 1) for a trace in Clear Write, but did not restart Max Hold and Min Hold. In the X-Series, the Restart hardkey and the INITiate:RESTART command restart not only Trace Average, but MaxHold and MinHold traces as well. For wireless comms modes in ESA and PSA, the Restart hardkey and the INITiate:RESTART command restart every measurement, which includes all traces and numeric results. There is no change to this operation.
Initial S/W Revision	Prior to A.02.00

More Information

The **Restart** function first aborts the current sweep/measurement as quickly as possible. It then resets the sweep and trigger systems, sets up the measurement and initiates a new data measurement sequence with a new data acquisition (sweep) taken once the trigger condition is met.

If the analyzer is in the process of aligning when **Restart** is executed, the alignment finishes before the restart function is performed.

Even when set for Single operation, multiple sweeps may be taken when Restart is pressed (for example, when averaging/holding is on). Thus when we say that **Restart** "restarts a measurement," we may mean:

- It restarts the current sweep
- It restarts the current measurement
- It restarts the current set of sweeps if any trace is in Trace Average, Max Hold or Min Hold
- It restarts the current set of measurements if Averaging, or Max Hold, or Min Hold is on for the measurement
- depending on the current settings.

With **Average/Hold Number** (in **Meas Setup** menu) set to 1, or Averaging off, or no trace in Trace Average or Hold, a single sweep is equivalent to a single measurement. A single sweep is taken after the trigger condition is met; and the analyzer stops sweeping once that sweep has completed. However, with **Average/Hold Number** >1 and at least one trace set to **Trace Average, Max Hold, or Min Hold (SA Measurement)** or **Averaging on (most other measurements)**, multiple sweeps/data acquisitions are taken for a single measurement. The trigger condition must be met prior to each sweep. The sweep is stopped when the average count k equals the number N set for **Average/Hold Number**. A measurement average usually applies to all traces, marker results, and numeric results; but sometimes it only applies to the numeric results.

Once the full set of sweeps has been taken, the analyzer will go to idle state. To take one more sweep without resetting the average count, increment the average count by 1, by pressing the step up key while **Average/Hold Number** is the active function, or sending the remote command `CALC:AVER:TCON UP`.

Save

The Save menu lets you choose what you want to save and where you want to save it. Among the types of files you can save are **States**, **Traces**, and **Screen Images**. In addition, an Export (Data) option lets you save a number of data types as CSV files for easy import into Excel and other spreadsheet programs.

Key Path	Front-panel key
Mode	All
Notes	No remote command for this key specifically, but the :MMEM:STORe command is available for specific file types. An example is :MMEM:STOR:STATe <filename>.
Initial S/W Revision	Prior to A.02.00

State

The Save State menu lets you choose a register or file for saving the state.

The content of a state file includes all of the settings and data required to return the analyzer as closely as possible to the Mode it was in, with the exact settings which were in place, when the save occurred. The Mode settings in each state file include the settings that are affected by Mode Preset, as well as the additional settings affected by Restore Mode Defaults; all of the Mode's settings. In addition, all of the settings of the Input/Output system are included, even though they are outside of the Mode's state, because they are needed to restore the complete setup. Persistent System settings (for example, Verbose SCPI) are not affected by either Mode Preset or Restore Mode Defaults, nor are they included in a saved State file.

After the save completes, the message "File <filename> saved" or "State Register <register number> saved" is displayed.

For rapid saving, the State menu lists 16 registers to save to. Pressing a Register key initiates the save. You can also select a file to save to.

The default path for all State Files is:

My Documents\<<mode name>\state

where <mode name> is the parameter used to select the mode with the INST:SEL command (for example, SA for the Spectrum Analyzer).

Key Path	Save
Mode	All
Remote Command	:MMEMory:STORe:STATe <filename>
Example	MMEM:STOR:STATe "MyStateFile.state" This stores the current instrument state data in the file MyStateFile.state in the default directory.
Notes	Both single and double quotes are supported for any filename parameter over remote. After saving to a register, that register's menu key is updated with the date the time, unless a custom label has been entered for that key. After saving to a register, you remain in the Save State menu, so that you can see the Register key

update. After saving to a file, the analyzer automatically returns to the previous menu and any Save As dialog goes away.

Backwards Compatibility SCPI	:MMEMoRY:STORe:STATe 1,<filename>
Initial S/W Revision	Prior to A.02.00

To File . . .

When you press “To File”, the analyzer brings up a Windows dialog and a menu entitled “**Save As.**” This menu allows you to navigate to the various fields in the Windows dialog without using a keyboard or mouse. The Tab and Arrow keys can also be used for dialog navigation.

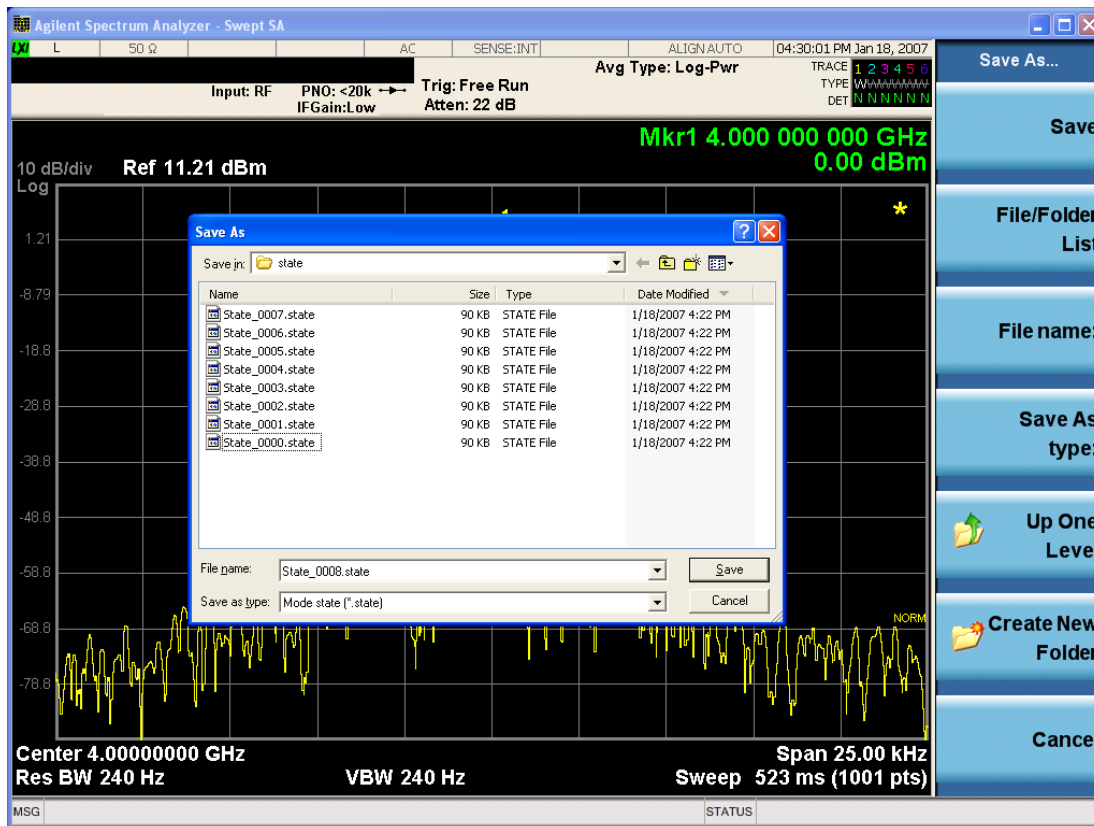

The Listed below

are the functions of the various fields in the dialog, and the corresponding softkeys:

Save

Performs the save to the specified file of the selected type. If the file already exists, a dialog will appear that allows you to replace the existing file by selecting OK, or you can Cancel the request. If you select OK, the file will be overwritten. Using the C: drive is strongly discouraged, since it runs the risk of being overwritten during an instrument software upgrade.

While the save is being performed, the floppy icon appears briefly in the Meas bar.

File/Folder List

Enables you to navigate to the center of the dialog that contains the list of files and folders. Once here you can get information about the file and use the tab keys to navigate to the other fields in the dialog, such as Save In.

Save In

The Save In field shows the path to which the file will be saved and allows you to change the path using the up and down arrow keys to navigate to other paths; the Enter key to open a directory; and the Backspace key to go back one directory. The **Save In field** defaults to the default path for this type of file and remembers the last path you used to save this type of file. There is no softkey for directly navigating to the Save In field but you can use left tab to get here from the File/Folder List.

User specified paths are remembered when you leave and return to a Mode and are reset back to the default using Restore Mode Defaults.

File Name

The File Name field is initially loaded with an automatically generated filename specific to the appropriate Save Type. The automatically generated filename is guaranteed not to conflict with any filename currently in the directory. You may replace or modify this filename using the File Name key. See the ["Quick Save " on page 2259](#) documentation for more on the automatic file naming algorithm.

When you press the File Name key the analyzer displays the Alpha Editor. Use the knob to choose the letter to add and the front-panel Enter key to add the letter to the file name. The BK character moves you back and the FW character moves you forward in the filename. The Select key on the front panel generates a space character. When you are done entering the filename press the Done softkey. This returns back to the **File Open** dialog and menu, but does not cause the save to occur.

Save As Type

This field shows the file suffix for the type of file you have selected to save. For example, if you navigated here while saving State, "Mode state (*.state)" is in the field. If you navigated here from saving Trace, ""Mode state (*.trace)" is in the field. If you navigated here while exporting a trace data file, "Trace Data (*.csv)" is in the field. For some file types, there is more than one choice in the dropdown, which you can select by using the up and down arrow keys and Enter.

Up One Level

This key corresponds to the icon of a folder with the up arrow that is in the tool bar of the dialog. When pressed, it causes the file and folder list to navigate up one level in the directory structure. The Backspace key does the same thing.

Create New Folder

This key corresponds to the icon of a folder with the "*" that is in the tool bar of the dialog. When pressed, a new folder is created in the current directory with the name **New Folder** and you can enter a new folder name using the Alpha Editor.

Cancel

This key corresponds to the Cancel selection in the dialog. It causes the current **Save As** request to be cancelled. The ESC key does the same thing.

Key Path	Save, State
Mode	All
Notes	Brings up Save As dialog for saving a State Save Type
Initial S/W Revision	Prior to A.02.00

Edit Register Names

You may enter a custom name on any of the Register keys, to help you remember what you are using that state to save. To do this, press the Edit Register Names key, choose the register whose name you wish to edit, and then enter the desired label using the Alpha Editor or an external PC keyboard.

The maximum number of characters that can be added is 30. In most cases, 30 characters will fit on two lines of the key.

See ["More Information" on page 759](#)

Key Path	Save, State
Mode	All
Remote Command	:MMEMory:REGister:STATe:LABel <reg number>,"label" :MMEMory:REGister:STATe:LABel? <reg number>
Example	:MMEM:REG:STAT:LAB 1,"my label"
Notes	<reg number> is an integer from 1 to 16. If the SCPI specifies an invalid register number an error message is generated, -222,"Data out of range;Invalid register label number" "label" is a string from 0 to 30 characters in length. If a label exceeds 30 characters, an error message is generated, -150,"String data error;Label clipped to 30 characters" "label" of length 0 erases the custom label and restores the default (time and date) label. E.g.: :MMEM:REG:STAT:LAB 1,""
Dependencies	N9060A-7FP or N9060B-2FP license required to edit the register names. When the feature is not licensed, sending this command generates an error, -221,"Settings conflict;Option not available"
Preset	The names are unaffected by Preset or power cycle but are set to the default label (time and date) on a "Restore System Defaults->Misc"
Initial S/W Revision	A.11.00

More Information

When you edit one of the register names, the time and date field will be replaced by the custom name.

If you delete all the characters in the custom name, it restores the default (time and date).

The register names are stored within the state files, but they are not part of the instrument state; that is, once you have edited a register name, loading a new state will not change that register name. Another consequence of this is that the names will be persistent through a power cycle. Also, if a named state file is transferred to another analyzer, it will bring its custom name along with it.

If you try to edit the name of an empty register, the analyzer will first save the state to have a file to put the name in. If you load a named state file into an analyzer with older firmware it will ignore the metadata.

The *SAV and *RCL commands will not be affected by the custom register names, nor will the MMEM commands.

Register 1 thru Register 16

Selecting any one of these register menu keys causes the State of the currently active mode to be saved to the specified Register. The registers are provided for rapid saving and recalling, since you do not need to specify a filename or navigate to a file. Each of the register menu keys annotates whether it is empty or at what date and time it was last modified. In addition, you can use the Edit Register Names key to enter custom names for each register.

Although these 16 registers are the only registers available from the front panel, there are 128 state registers available in the instrument. Registers 17–128 are only available from the SCPI interface, using the *SAV command.

There is one set of 128 state registers in the instrument, not one set for each Mode. When a state is saved, the Mode it was saved from is saved with it; then when it is recalled, the instrument switches to that Mode.

After the save completes, the corresponding register menu key annotation is updated with the date and time and the message "Register <register number> saved" is displayed.

Key Path	Save, State
Mode	All
Example	*SAV 1
Range	1–16 from front panel, 1–128 from SCPI
Readback	Date and time with seconds resolution are displayed on the key OR A custom name of up to 30 characters entered using the Edit Register Names key OR “(empty)” if no prior save operation has been performed to this register.
Initial S/W Revision	Prior to A.02.00
Modified at S/W Revision	A.11.00

Register 1 thru Register 16

Selecting any one of these register menu keys causes the State of the currently active mode to be saved to the specified Register. The registers are provided for rapid saving and recalling, since you do not need to specify a filename or navigate to a file. Each of the register menu keys annotates whether it is empty or at what date and time it was last modified. In addition, you can use the Edit Register Names key to enter custom names for each register.

Although these 16 registers are the only registers available from the front panel, there are 128 state registers available in the instrument. Registers 17–128 are only available from the SCPI interface, using the *SAV command.

There is one set of 128 state registers in the instrument, not one set for each Mode. When a state is saved, the Mode it was saved from is saved with it; then when it is recalled, the instrument switches to that Mode.

After the save completes, the corresponding register menu key annotation is updated with the date and time and the message "Register <register number> saved" is displayed.

Key Path	Save, State
Mode	All
Example	*SAV 1
Range	1–16 from front panel, 1–128 from SCPI
Readback	Date and time with seconds resolution are displayed on the key OR A custom name of up to 30 characters entered using the Edit Register Names key OR “(empty)” if no prior save operation has been performed to this register.
Initial S/W Revision	Prior to A.02.00
Modified at S/W Revision	A.11.00

Data (Export)

Exporting a data file stores data from the current measurement to mass storage files. The Export Menu only contains data types that are supported by the current measurement.

Since the commonly exported data files are in .csv format, the data can be edited by you prior to importing. This allows you to export a data file, manipulate the data in Excel (the most common PC Application for manipulating .csv files) and then import it.

Selecting an Export Data menu key will not actually cause the exporting to occur, since the analyzer still needs to know where you wish to save the data. Pressing the Save As key in this menu brings up the Save As dialog and Save As menu that allows you to specify the destination file and directory. Once a filename has been selected or entered in the Open menu, the export will occur as soon as the Save key is pressed.

Key Path	Save
Mode	All
Notes	The menu is built from whatever data types are available for the mode. So the key locations in the sub menu will vary. No SCPI command directly controls the Data Type that this key controls. The Data Type is included in the MMEM:STORe commands.
Dependencies	If a file type is not used by a certain measurement, that type is grayed out for that measurement. The key for a file type will not show at all if there are no measurements in the Mode that support it.
Preset	Is not affected by a Preset or shutdown, but is reset during Restore Mode Defaults
Readback	The data type that is currently selected
Initial S/W Revision	Prior to A.02.00

Meas Results

Key Path	Save, Data
Mode	WLAN
Example	MMEM:STOR:RES "MyResultsFile.csv" This stores the measurement results data in the file MyResultsFile.xml in the default directory.
Initial S/W Revision	A.11.00

Capture Buffer

Capture buffer functionality is only available when measurement is Mod Accuracy and radio standard is not 802.11ac 80+80MHz. The captured data is raw data which is not processed.

Key Path	Save, Data
Mode	WLAN
Example	MMEM:STOR:CAPT "MyCaptureData.bin" This stores the capture data in the file MyCaptureData.bin in the default directory.
Dependencies	Capture buffer data is only available when measurement is Mod Accuracy and radio standard is not 802.11ac 80+80MHz. In other measurements, this key is grayed out.
Initial S/W Revision	A.11.00

Save As . . .

When you press "Save As", the analyzer brings up a Windows dialog and a menu entitled "**Save As.**" This menu allows you to navigate to the various fields in the Windows dialog without using a keyboard or mouse. The Tab and Arrow keys can also be used for dialog navigation.

See "[To File . . .](#)" on page 2273 in Save, State for a full description of this dialog and menu.

The default path for saving files is:

For all of the Trace Data Files:

My Documents\`<mode name>`\data\traces

For all of the Limit Data Files:

My Documents\`<mode name>`\data\limits

For all of the Measurement Results Data Files:

My Documents\`<mode name>`\data\`<measurement name>`\results

For all of the Capture Buffer Data Files:

My Documents\`<mode name>`\data\captureBuffer

Key Path	Save, Data
Mode	All
Notes	The key location is mode-dependent and will vary. Brings up the Save As dialog for saving a <mode specific> Save Type. The save is performed immediately and does not wait until the measurement is complete.
Initial S/W Revision	Prior to A.02.00

Screen Image

Pressing Screen Image accesses a menu of functions that enable you to specify a format and location for the saved screen image. It brings up a menu that allows you to specify the color scheme of the Screen Image (Themes) or navigate to the Save As dialog to perform the actual save.

Screen Image files contain an exact representation of the analyzer display. They cannot be loaded back onto the analyzer, but they can be loaded into your PC for use in many popular applications.

The image to be saved is actually captured when the Save front panel key is pressed, and kept in temporary storage to be used if you ask for a Screen Image save. When the Screen Image key is pressed, a "thumbnail" of the captured image is displayed, as shown below:

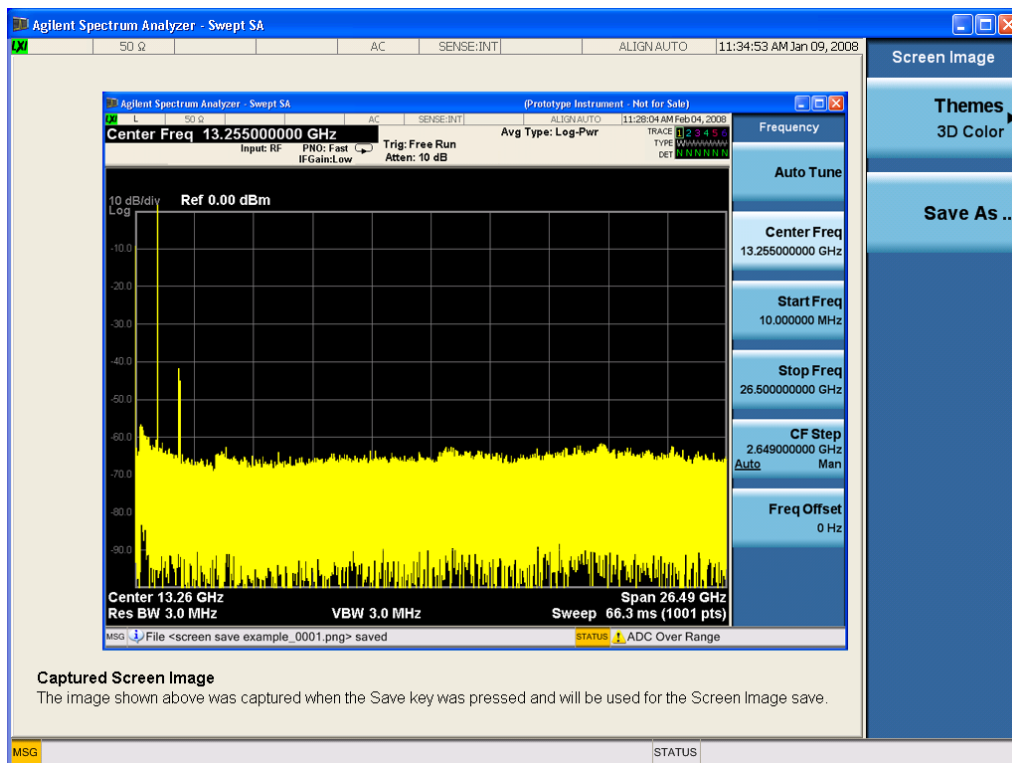

When you continue on into the Save As menu and complete the Screen Image save, the image depicted in the thumbnail is the one that gets saved, showing the menus that were on the screen before going into the Save menus. The save is performed immediately and does not wait until the measurement is complete.

After you have completed the save, the Quick Save front-panel key lets you quickly repeat the last save performed, using an auto-named file, with the current screen data.

NOTE

For versions previous to A.01.55, if you initiate a screen image save by navigating through the Save menus, the image that is saved will contain the Save menu softkeys, not the menus and the active function that were on the screen when you first pressed the Save front panel key.

Key Path	Save
Mode	All
Remote Command	:MMEMory:STORe:SCReem <filename>
Example	:MMEM:STOR:SCR "myScreen.png" This stores the current screen image in the file MyScreenFile.png in the default directory.
Initial S/W Revision	Prior to A.02.00

Themes

Accesses a menu of functions that enable you to choose the theme to be used when saving the screen image.

The **Themes** option is the same as the **Themes** option under the **Display** and **Page Setup** dialogs. It allows you to choose between themes to be used when saving the screen image.

Key Path	Save, Screen Image
Remote Command	:MMEMory:STORe:SCReem:THEMe TDColor TDMonochrome FCOLor FMONochrome :MMEMory:STORe:SCReem:THEMe?
Example	:MMEM:STOR:SCR:THEM TDM
Preset	3D Color; Is not part of Preset, but is reset by Restore Misc Defaults or Restore System Defaults All and survives subsequent running of the modes.
Readback	3D Color 3D Mono Flat Color Flat Mono
Backwards Compatibility Notes	In ESA and PSA we offer the choice of "Reverse Bitmap" or "Reverse Metafile" when saving screen images. This is much like the "Flat Color" theme available in X-Series. Also, if you selected Reverse Bitmap AND a black & white screen image, that would be much like "Flat Monochrome". In other words, each of the X-Series themes has a similar screen image type in ESA/PSA. But they are not identical.
Initial S/W Revision	Prior to A.02.00

3D Color

Selects a standard color theme with each object filled, shaded and colored as designed.

Key Path	Save, Screen Image, Themes
Example	MMEM:STOR:SCR:THEM TDC

Readback	3D Color
Initial S/W Revision	Prior to A.02.00

3D Monochrome

Selects a format that is like 3D color but shades of gray are used instead of colors.

Key Path	Save, Screen Image, Themes
Example	MMEM:STOR:SCR:THEM TDM
Readback	3D Mono
Initial S/W Revision	Prior to A.02.00

Flat Color

Selects a format that is best when the screen is to be printed on an ink printer.

Key Path	Save, Screen Image, Themes
Example	MMEM:STOR:SCR:THEM FCOL
Readback	Flat Color
Initial S/W Revision	Prior to A.02.00

Flat Monochrome

Selects a format that is like Flat Color. But only black is used (no colors, not even gray), and no fill.

Key Path	Save, Screen Image, Themes
Example	MMEM:STOR:SCR:THEM FMON
Readback	Flat Mono
Initial S/W Revision	Prior to A.02.00

Save As...

When you press "Save As", the analyzer brings up a Windows dialog and a menu entitled "**Save As.**" This menu allows you to navigate to the various fields in the Windows dialog without using a keyboard or mouse. The Tab and Arrow keys can also be used for dialog navigation.

See "[To File . . .](#)" on page 2273 in Save, State for a full description of this dialog and menu.

The default path for Screen Images is

My Documents\`<mode name>`\screen.

where <mode name> is the parameter used to select the mode with the INST:SEL command (for example, SA for the Spectrum Analyzer).

Key Path	Save, Screen Image
Notes	Brings up Save As dialog for saving a Screen Image Save Type
Initial S/W Revision	Prior to A.02.00

Mass Storage Catalog (Remote Command Only)

Key path	SCPI Only
Remote Command	:MMEMory:CATalog? [<directory_name>]
Notes	<p>The string must be a valid logical path.</p> <p>Queries disk usage information (drive capacity, free space available) and obtains a list of files and directories in a specified directory in the following format:</p> <p><numeric_value>,<numeric_value>,{<file_entry>}</p> <p>It returns two numeric parameters and as many strings as there are files and directories. The first parameter indicates the total amount of storage currently used in bytes. The second parameter indicates the total amount of storage available, also in bytes. The <file_entry> is a string. Each <file_entry> indicates the name, type, and size of one file in the directory list:</p> <p><file_name>,<file_type>,<file_size></p> <p>As the windows file system has an extension that indicates file type, <file_type> is always empty. <file_size> provides the size of the file in bytes. For directories, <file_entry> is surrounded by square brackets and both <file_type> and <file_size> are empty</p>
Initial S/W Revision	Prior to A.02.00

Mass Storage Change Directory (Remote Command Only)

Key path	SCPI Only
Remote Command	:MMEMory:CDIRectory [<directory_name>] :MMEMory:CDIRectory?
Notes	<p>The string must be a valid logical path.</p> <p>Changes the default directory for a mass memory file system. The <directory_name> parameter is a string. If no parameter is specified, the directory is set to the *RST value.</p> <p>At *RST, this value is set to the default user data storage area, that is defined as System.Environment.SpecialFolder.Personal.</p> <p>Query returns full path of the default directory.</p>
Initial S/W Revision	Prior to A.02.00

Mass Storage Copy (Remote Command Only)

Key path	SCPI Only
Remote Command	:MMEMory:COpy <string>,<string>[,<string>,<string>]
Notes	<p>The string must be a valid logical path.</p> <p>Copies an existing file to a new file or an existing directory to a new directory.</p> <p>Two forms of parameters are allowed. The first form has two parameters. In this form, the first parameter specifies the source, and the second parameter specifies the destination.</p> <p>The second form has four parameters. In this form, the first and third parameters specify the source. The second and fourth parameters specify the directories. The first pair of parameters specifies the source. The second pair specifies the destination. An error is generated if the source doesn't exist or the destination file already exists.</p> <p>This command will generate an "access denied" error if the destination is a restricted folder (e.g., C:\Windows) and the current user does not have Power User or Administrator privileges.</p>

Mass Storage Device Copy (Remote Command Only)

This command transfers data to/from a file and a peripheral device.

Key path	SCPI Only
Remote Command	:MMEMory:COpy:DEvice <source_string>,<dest_string>
Notes	<p>The strings must be a valid logical path or a valid device keyword. If the dest_string is a device keyword, the data is copied from the source file to the device. If the source_string is a device keyword, the data is copied to the source file from the device.</p> <p>Valid device keywords are:</p> <p>SNS (smart noise source)</p> <p>An error is generated if the file or device is not found.</p>

Mass Storage Delete (Remote Command Only)

Key path	SCPI Only
Remote Command	:MMEMory:DElete <file_name>[,<directory_name>]
Notes	<p>The string must be a valid logical path.</p> <p>Removes a file from the specified directory. The <file_name> parameter specifies the file name to be removed. This command will generate an "access denied" error if the file is in a restricted folder (e.g., C:\Windows) and the current user does not have Power User or Administrator privileges.</p>
Initial S/W Revision	Prior to A.02.00

Mass Storage Data (Remote Command Only)

Creates a file containing the specified data OR queries the data from an existing file.

Key path	SCPI Only
Remote Command	:MMEMory:DATA <file_name>, <data> :MMEMory:DATA? <file_name>
Notes	The string must be a valid logical path. The command form is MMEMory:DATA <file_name>,<data>. It loads <data> into the file <file_name>. <data> is in 488.2 block format. <file_name> is string data. The query form is MMEMory:DATA? <file_name> with the response being the associated <data> in block format.
Initial S/W Revision	Prior to A.02.00

Mass Storage Make Directory (Remote Command Only)

Key path	SCPI Only
Remote Command	:MMEMory:MDIRectory <directory_name>
Notes	The string must be a valid logical path. Creates a new directory. The <directory_name> parameter specifies the name to be created. This command will generate an “access denied” error if the new directory would be in a restricted folder (e.g., C:\Windows) and the current user does not have Power User or Administrator privileges.
Initial S/W Revision	Prior to A.02.00

Mass Storage Move (Remote Command Only)

Key path	SCPI Only
Remote Command	:MMEMory:MOVE <string>,<string>[,<string>,<string>]
Notes	The string must be a valid logical path. Moves an existing file to a new file or an existing directory to a new directory. Two forms of parameters are allowed. The first form has two parameters. In this form, the first parameter specifies the source, and the second parameter specifies the destination. The second form has four parameters. In this form, the first and third parameters specify the source. The second and fourth parameters specify the directories. The first pair of parameters specifies the source. The second pair specifies the destination. An error is generated if the source doesn't exist or the destination file already exists. This command will generate an “access denied” error if the destination is a restricted folder (e.g., C:\Windows) and the current user does not have Power User or Administrator privileges.
Initial S/W Revision	Prior to A.02.00

Mass Storage Remove Directory (Remote Command Only)

Key path	SCPI Only
Remote Command	<code>:MMEMory:RDIrectory <directory_name></code>
Notes	<p>The string must be a valid logical path.</p> <p>Removes a directory. The <directory_name> parameter specifies the directory name to be removed. All files and directories under the specified directory shall also be removed.</p> <p>This command will generate an “access denied” error if the folder is a restricted folder (e.g., C:\Windows) or is in a restricted folder and the current user does not have Power User or Administrator privileges.</p>
Initial S/W Revision	Prior to A.02.00

Single (Single Measurement/Sweep)

Sets the analyzer for Single measurement operation. The single/continuous state is Meas Global, so the setting will affect all the measurements. If you are Paused, pressing Single does a Resume.

See "[More Information](#)" on page 770

Key Path	Front-panel key
Example	:INIT:CONT OFF
Notes	See Cont key description.
Backwards Compatibility Notes	<p>For Spectrum Analysis mode in ESA and PSA, the Single hardkey and the INITiate:IMM switched from continuous measurement to single measurement and restarted sweeps and averages (displayed average count reset to 1), but did not restart Max Hold and Min Hold. In the X-Series, the Single hardkey and the INITiate:IMM command initiate a sweep/ measurement/ average sequence/hold sequence including MaxHold and MinHold.</p> <p>For Spectrum Analysis mode in ESA and PSA, the Single hardkey restarted the sweep regardless of whether or not you were in an active sweep or sweep sequence. In the X-Series, Restart does this but Single only restarts the sweep or sweep sequence if you are in the idle state.</p> <p>INIT[:IMM] in ESA & PSA Spectrum Analysis Mode does an implied ABORT. In some other PSA Modes, INIT[:IMM] is ignored if not in the idle state. . The X-Series follows the ESA/PSA SA Mode model, which may cause some Modes to have compatibility problems.</p>
Initial S/W Revision	Prior to A.02.00

More Information

See "[Restart](#)" on page 2270 for details on the INIT:IMMEDIATE (Restart) function.

If you are already in single sweep, the INIT:CONT OFF command has no effect.

If you are already in Single Sweep, then pressing the Single key in the middle of a sweep does not restart the sweep or sequence. Similarly, pressing the Single key does not restart the sweep or sequence if the sweep is not in the idle state (for example, if you are taking a very slow sweep, or the analyzer is waiting for a trigger). Instead, it results in a message. "Already in Single, press Restart to initiate a new sweep or sequence". Even though pressing the Single key in the middle of a sweep does not restart the sweep, sending INIT:IMMEDIATE does reset it.

To take one more sweep without resetting the average count, increment the average count by 1, by pressing the step up key while **Average/Hold Number** is the active function, or sending the remote command CALC:AVER:TCON UP.

Source

There is no Source control functionality for this measurement. When this key is pressed, the screen either displays a blank menu, or the previously-selected menu remains unchanged.

Key Path	Front-panel key
----------	-----------------

Span X Scale

Activates the Span function and displays the menu of span functions. The parameter values are measurement independent.

Key Path	Front-panel key
Initial S/W Revision	Prior to A.02.00

Span

Set the frequency of the occupied bandwidth span for the current measurement.

Key Path	Span X Scale
Mode	SA, WCDMA, C2K, WIMAX OFDMA, TD-SCDMA, 1xEVDO, ISDB-T, CMMB, LTE, LTETDD, BLUETOOTH, WLAN, MSR, LTEAFDD, LTEATDD
Remote Command	[:SENSe] :OBWidth:FREQuency:SPAN <freq> [:SENSe] :OBWidth:FREQuency:SPAN? [:SENSe] :OBWidth:FREQuency:SPAN:AUTO ON OFF 0 1 [:SENSe] :OBWidth:FREQuency:SPAN:AUTO?
Example	OBW:FREQ:SPAN 2.4 MHz OBW:FREQ:SPAN? OBW:FREQ:SPAN:AUTO 0 OBW:FREQ:SPAN:AUTO?
Notes	Span Auto Detector ([:SENSe] :OBWidth:FREQuency:SPAN:AUTO) is only available in MSR and LTE-Advanced FDD/TDD mode. The BAF SCPI is MSR and LTE-Advanced FDD/TDD only.
Couplings	When changing the Occupied Bandwidth Span, the Resolution Bandwidth and Video Bandwidth are set to AUTO to prevent the span from clipping. This is only available in MSR and LTE-Advanced FDD/TDD mode.
Preset	SA: 3 MHz WCDMA: 10 MHz WIMAX OFDMA: 20 MHz CDMA2K: 2 MHz TD-SCDMA: 4.8 MHz 1xEVDO: 3.75 MHz ISDB-T: 20 MHz CMMB: 8 MHz LTE, LTETDD, LTEAFDD, LTEATDD: 10 MHz BLUETOOTH:2 MHz WLAN: If Radio Std is 802.11a/g 802.11n(20MHz) 802.11ac(20MHz): 25 MHz If Radio Std is 802.11b: 30MHz

	If Radio Std is 802.11n(40MHz), 802.11ac (40MHz): 50 MHz If Radio Std is 802.11ac(80MHz): 100MHz If Radio Std is 802.11ac(160MHz): 200MHz MSR: 20MHz ON
State Saved	Saved in instrument state.
Min	100 Hz
Max	Hardware Maximum Span
Backwards Compatibility SCPI	[:SENSe] :EBWidth :FREQuency :SPAN
Initial S/W Revision	Prior to A.02.00
Modified at S/W Revision	A.03.00, A.10.00, A.14.00

Full Span

Changes the Occupied Bandwidth Span to show the full frequency range of the analyzer. When using external mixing, it changes the displayed frequency span to the frequency range specified for the selected external mixing band.

Key Path	Span X Scale
Mode	SA, WCDMA, C2K, WIMAX OFDMA, ISDB-T, CMMB, LTE, LTETDD, BLUETOOTH, WLAN, LTEAFDD, LTEATDD
Remote Command	[:SENSe] :OBWidth :FREQuency :SPAN :FULL
Example	OBW:FREQ:SPAN:FULL
Notes	You must be in the Spectrum Analysis mode, W-CDMA mode, ISDB-T mode, CMMB mode, LTE mode, LTE TDD mode, BLUETOOTH mode, WLAN mode, cdma2000 mode, MSR or WIMAX OFDMA mode to use this command. Use:INSTrument:SElect to set the mode.
Dependencies	For MSR and LTE-Advanced FDD/TDD mode, this key is blank. In order to keep backwards compatible with the legacy LTE FDD/TDD, the scpi command is supported in LTE & LTE-A converged application.
Couplings	Selecting full span changes the measurement span value.
Initial S/W Revision	Prior to A.02.00
Modified at S/W Revision	A.03.00

Last Span

Changes the measurement frequency span to previous measurement span setting. If there is no existing previous span value then the span remains unchanged.

Key Path	Span X Scale
----------	--------------

Mode	SA, WCDMA, C2K, WIMAX OFDMA, ISDB-T, CMMB, LTE, LTETDD, BLUETOOTH, WLAN, MSR, LTEAFDD, LTEATDD
Remote Command	[:SENSe] :OBWidth:FREQuency:SPAN:PREvious
Example	OBW:FREQ:SPAN:PREV
Notes	You must be in the Spectrum Analysis mode, W-CDMA mode, ISDB-T mode, CMMB mode, LTE mode, LTE TDD mode, BLUETOOTH mode, WLAN mode, cdma2000 mode, MSR, LTE-Advanced FDD/TDD or WIMAX OFDMA mode to use this command. Use:INSTrument:SElect to set the mode.
Couplings	Selecting last span changes the measurement span value.
Initial S/W Revision	Prior to A.02.00
Modified at S/W Revision	A.03.00

Sweep/Control

Displays a menu of functions that enable you to set up and control the sweep time and source for the current measurement.

For details about this key, see ["Sweep/Control" on page 2291](#).

Key Path	Front-panel key
Initial S/W Revision	Prior to A.02.00

Sweep Time

Selects the length of time in which the spectrum analyzer sweeps the displayed frequency span. Additional overhead time, which impacts the sweep rate, is not calculated as part of the sweep time. In fact:

- sweep rate = span/sweep time
- update rate = 1/(sweep time + overhead)
- sweep cycle time = sweep time + overhead

Sweep time is coupled to RBW and VBW, and is impacted by the number of sweep points, so changing those parameters may change the sweep time.

This function is not available when the selected input is I/Q.

Key Path	Sweep/Control
Mode	SA, WCDMA, C2K, WIMAX OFDMA, TD-SCDMA, 1xEVDO, ISDB-T, CMMB, LTE, LTETDD, BLUETOOTH, WLAN, MSR, LTEAFDD, LTEATDD
Remote Command	[:SENSe]:OBWidth:SWEep:TIME <time> [:SENSe]:OBWidth:SWEep:TIME? [:SENSe]:OBWidth:SWEep:TIME:AUTO OFF ON 0 1 [:SENSe]:OBWidth:SWEep:TIME:AUTO?
Example	OBW:SWE:TIME 50 ms OBW:SWE:TIME? OBW:SWE:TIME:AUTO ON OBW:SWE:TIME:AUTO?
Couplings	When you manually change the Time, this state automatically goes to 'Man'.
Preset	SA, WIMAX OFDMA, C2K, TD-SCDMA, 1xEVDO, ISDB-T, CMMB, LTE, LTETDD, BLUETOOTH, WLAN, MSR, LTEAFDD, LTEATDD: Automatically Calculated WCDMA: 32.6 ms SA, WIMAX OFDMA, C2K, TD-SCDMA, 1xEVDO, ISDB-T, CMMB, LTE, LTETDD, WLAN, MSR, LTEAFDD, LTEATDD: ON WCDMA: OFF
State Saved	Saved in instrument state.

Min	1 ms
Max	4000 s
Initial S/W Revision	Prior to A.02.00
Modified at S/W Revision	A.03.00

Sweep Setup

Accesses the sweep setup settings for the current measurement.

Key Path	Sweep/Control
Initial S/W Revision	Prior to A.02.00

Auto Sweep Time Rules

Switches the analyzer between normal and accuracy sweep states.

Setting Auto Sweep Time to Accy results in slower sweep times, usually about three times as long, but better amplitude accuracy for CW signals. The instrument amplitude accuracy specifications only apply when Auto Sweep Time is set to Accy.

Additional amplitude errors which occur when Auto Sweep Time is set to Norm are usually well under 0.1 dB, though this is not guaranteed. Because of the faster sweep times and still low errors, Norm is the preferred setting of Auto Sweep Time. Auto Sweep Time is set to Norm on a Preset or Auto Couple. This means that in the Preset or Auto Coupled state, instrument amplitude accuracy specifications do not apply.

Key Path	Sweep/Control, Sweep Setup
Mode	SA, WCDMA, C2K, WIMAX OFDMA, TD-SCDMA, 1xEVDO, ISDB-T, CMMB, LTE, LTETDD, BLUETOOTH, WLAN, MSR, LTEAFDD, LTEATDD
Remote Command	[:SENSe] :OBWidth :SWEep :TIME :AUTO :RULes NORMal ACCuracy [:SENSe] :OBWidth :SWEep :TIME :AUTO :RULes ?
Example	OBW:SWE:TIME:AUTO:RUL NORM OBW:SWE:TIME:AUTO:RUL ?
Notes	Set to Norm when Auto Couple is pressed or sent remotely.
Preset	NORMal
State Saved	Saved in instrument state.
Range	Norm Accy
Initial S/W Revision	Prior to A.02.00
Modified at S/W Revision	A.03.00

Pause

Pauses the measurement after the current data acquisition is complete.

When Paused, the label on the key changes to Resume. Pressing Resume resumes the measurement at the point where it had been paused.

See "[Pause/Resume](#)" on page 2291 for more information.

Key Path	Sweep/Control
Initial S/W Revision	Prior to A.02.00

Gate

Accesses a menu that enables you to control the gating function. The Gate functionality is used to view signals best viewed by qualifying them with other events.

Gate setup parameters are the same for all measurements – they do not change as you change measurements. Settings like these are called “Meas Global” and are unaffected by Meas Preset.

Note that Sweep Time autocoupling rules and annotation are changed by Gate being on.

Key Path	Sweep/Control
Scope	Meas Global
Readback	The state and method of Gate, as [Off, LO] or [On, Video]. Note that for measurements that only support gated LO, the method is nonetheless read back, but always as LO.
Initial S/W Revision	Prior to A.02.00

Gate On/Off

Turns the gate function on and off.

When the Gate Function is on, the selected Gate Method is used along with the gate settings and the signal at the gate source to control the sweep and video system with the gate signal. Not all measurements allow every type of Gate Methods.

When Gate is on, the annunciation in the measurement bar reflects that it is on and what method is used, as seen in the following "Gate: LO" annunciator graphic.

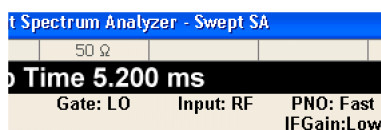

Key Path	Sweep/Control, Gate
Remote Command	[:SENSe] :SWEep:EGATe [:STATe] OFF ON 0 1

	<code>[:SENSe] :SWEep:EGATe [:STATe] ?</code>
Example	SWE:EGAT ON SWE:EGAT?
Dependencies	<p>The function is unavailable (grayed out) and Off when:</p> <ul style="list-style-type: none"> • Gate Method is LO or Video and FFT Sweep Type is manually selected. • Gate Method is FFT and Swept Sweep Type is manually selected. • Marker Count is ON. <p>The following are unavailable whenever Gate is on:</p> <ul style="list-style-type: none"> • FFT under Sweep Type when Method=LO or Video or Swept under Sweep Type when Method=FFT • Marker Count <p>While Gate is on, the Auto Rules for Sweep Type are modified so that the choice agrees with the Gate Method: i.e., FFT for Method = FFT and Swept for Method = LO or Video.</p> <p>The Gate softkey and all SCPI under the <code>[:SENSe] :SWEep:EGATe</code> SCPI node are grayed out when Source Mode is Tracking with an external source. This is because the Gate circuitry is used to sync the external source. If the Tracking Source is turned on, the Gate is turned off.</p> <p>When in the ACP measurement:</p> <ul style="list-style-type: none"> • When Meas Method is RBW or FAST, this function is unavailable and the key is grayed out. • Whenever Gate is on, Meas Method, RBW or FAST is unavailable and keys for those are grayed out. • When Gate is on, Offset Res BW and Offset Video BW are ignored (if you set these values) and the measurement works as if all Offset Res BW and all Offset Video BW are coupled with the Res BW and the Video BW under the BW menu. When Gate is on, the Offset BW key in the Offset/Limit menu is grayed out.
Preset	Off LTETDD: On
State Saved	Saved in instrument state
Range	On Off
Backwards Compatibility SCPI	<code>[:SENSe] :SWEep:TIME:GATE [:STATe]</code> ESA compatibility
Backwards Compatibility Notes	In ESA, Trig Delay (On) and Gate (On) could not be active at the same time.. This dependency does not exist in PSA or in the X-Series.
Initial S/W Revision	Prior to A.02.00

Gate View On/Off

Turning on Gate View in the Swept SA measurement provides a single-window gate view display..

Turning on Gate View in other measurements shows the split-screen Gate View. In these measurements, when the Gate View is on, the regular view of the current measurement traces and results are reduced vertically to about 70% of the regular height. The Zero Span window, showing the positions of the Gate, is shown between the Measurement Bar and the reduced measurement window. By reducing the height of the measurement window, some of the annotation on the Data Display may not fit and is not shown.

Key Path	Sweep/Control, Gate
Remote Command	[:SENSe] :SWEep:EGATe:VIEW ON OFF 1 0 [:SENSe] :SWEep:EGATe:VIEW?
Example	SWE:EGAT:VIEW ON turns on the gate view.
Dependencies	In the Swept SA measurement: In Gate View, the regular Sweep Time key is grayed out . When pressed, the grayed out key puts up the informational message "Use Gate View Sweep Time in the Gate menu." In the other measurements: When you turn Gate View on, the lower window takes on the current state of the instrument. Upon leaving Gate View, the instrument takes on the state of the lower window. When you turn Gate View on, the upper window Sweep Time is set to the gate view sweep time.
Couplings	These couplings apply to the Swept SA measurement: <ul style="list-style-type: none"> • When Gate View is turned on, the instrument is set to Zero Span. • Gate View automatically turns off whenever a Span other than Zero is selected. • Gate View automatically turns off if you press the Last Span key while in Gate View, and the instrument returns to the Span it was in before entering Gate View (even if that is Zero Span). • When Gate View is turned on, the sweep time used is the gate view sweep time. This is set according to the rules in section "Gate View Setup" on page 2101 • When Gate View is turned off, Sweep Time is set to the normal Swept SA measurement sweep time. • If Gate View is on and Gate is off, then turning on Gate turns off Gate View.
Preset	OFF
State Saved	Saved in instrument state
Range	On Off
Initial S/W Revision	Prior to A.02.00

A sample of the Gate View screen in the Swept SA measurement is shown in the following graphic :

9 Occupied Bandwidth Measurement Sweep/Control

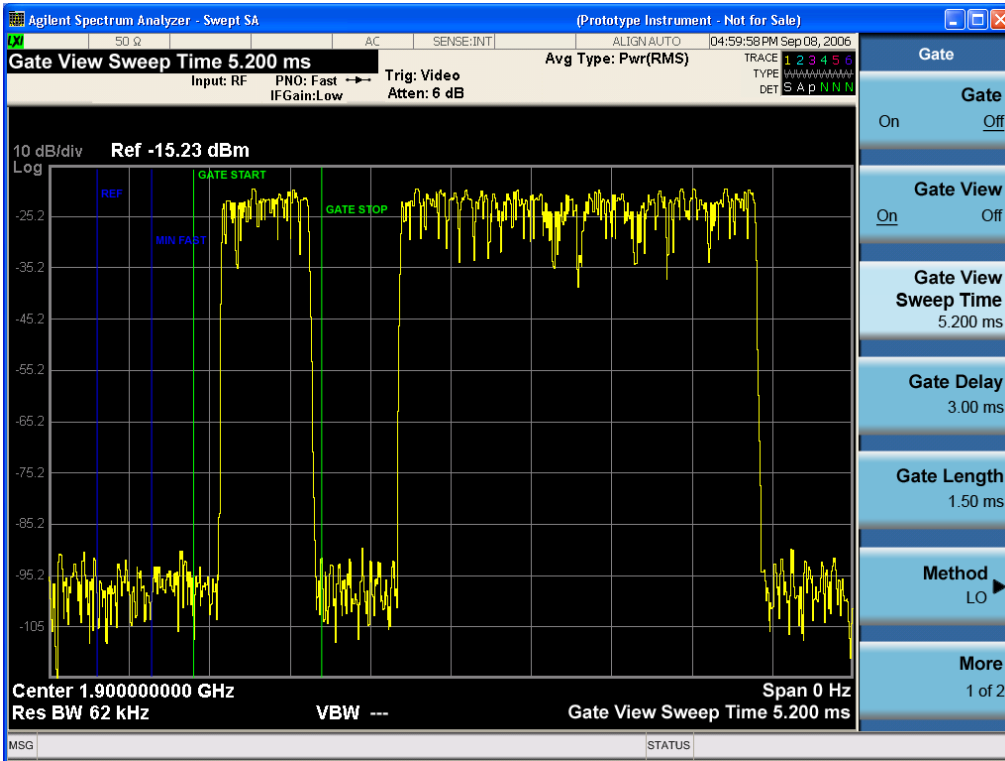

A sample of the Gate View screen in other measurements is shown in the following graphic. This example is for the ACP measurement:

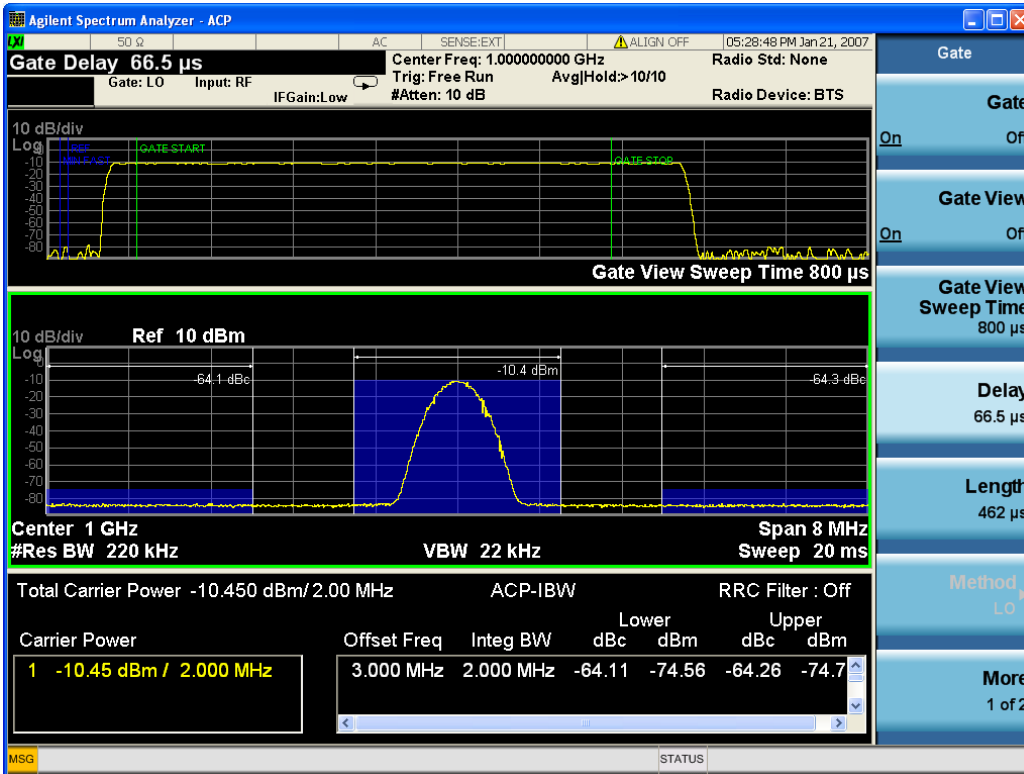

Turning Gate View off returns the analyzer to the Normal measurement view.

In the Swept SA, the normal measurement view is the single-window Swept SA view. When returning to this view, the Swept SA measurement returns to the Span it was in before entering **Gate View** (even if that is Zero Span).

The **Gate View** window is triggered from the Gate Source, with zero trigger delay. Also, when updating the **Gate View** window, the Gate itself must not operate. So it is internally shut off while the gate view window is being updated. For the Swept SA measurement, this means that the Gate is internally shut off whenever the gate view window is displayed. The measurement bar and softkeys continue to show the Trigger source for the main sweep window and give no indication that the Gate is shut off or that the Gate View window is triggered from the Gate Source.

When in **Gate View**, vertical lines are displayed in the Gate View window as follows:

- Green lines are displayed at the gate edges as follows: in Edge Gate, a line is shown for Delay and one for the end of the Gate period, defined by Length. In Level Gate a line is shown only for Delay. You can adjust the position of the green lines by adjusting the gate length and the gate delay. These lines update in the Gate View window as the active function changes, even if the window is not being updated. In Gated LO and Gated Video, these lines are positioned relative to the delay reference line (not relative to 0 time). In Gated FFT, their location is relative to the left edge of the screen.
- A blue line is displayed showing the delay reference, that is, the reference point for the Gate Delay within the Zero Span window. The blue line represents where (in time) the effective location of the gate start would be if the gate were programmed to zero delay.
-
- The second blue line is labeled "MIN FAST" as shown in the figure above because it represents the minimum Gate Delay for fast Gated LO operation. This line is only displayed in Gated LO. You cannot scroll (knob) or decrement (down key) the Gate Delay to less than that represented by the position of this line, it can only be set below this position manually, although once there it can be moved freely with the knob while below the line.
- A yellow line in the Gated Video case only, is displayed at Blength, where Blength is the display point (bucket) length for the swept trace, which is given by the sweep time for that trace divided by number of Points – 1. So it is referenced to 0 time, not to the delay reference. This line is labeled NEXT PT (it is not shown in the figure above because the figure above is for Gated LO).
- The yellow line represents the edge of a display point (bucket). Normally in Gated Video, the bucket length must be selected so that it exceeds the off time of the burst. There is another way to use the analyzer in Gated Video measurements, and that is to set the bucket width much shorter than the off time of the burst. Then use the Max Hold trace function to fill in "missing" buckets more slowly. This allows you to see some of the patterns of the Gated Video results earlier, though seeing a completely filled-in spectrum later.

Gate View Setup

Accesses a menu that enables you to setup parameters relevant to the Gate View

Key Path	Sweep/Control, Gate
Scope	Meas Global
Initial S/W Revision	A.10.00

Gate View Sweep Time

Controls the sweep time in the Gate View window. To provide an optimal view of the gate signal, the analyzer initializes Gate View Sweep Time based on the current settings of Gate Delay and Gate Length.

Key Path	Sweep/Control, Gate, Gate View Setup
Remote Command	[:SENSe] :SWEep:EGATe:TIME <time> [:SENSe] :SWEep:EGATe:TIME?
Example	SWE:EGAT:TIME 500 ms
Dependencies	Gate View Sweep Time is initialized: <ul style="list-style-type: none"> • On Preset (after initializing delay and length). • Every time the Gate Method is set/changed. <p>Additionally, in the Swept SA measurement, whenever you do a Preset, or leave Gate View, the analyzer remembers the Gate Delay and Gate Length settings. Then, when returning to Gate View, if the current Gate Delay and/or Gate Length do not match the remembered values Gate View Sweep Time is re-initialized.</p> <ol style="list-style-type: none"> 1. Compute the location of the "gate stop" line, which you know is at time $t = t_{min} + \text{GateDelay} + \text{GateLength}$.
Preset	519.3 μ s WiMAX OFDMA: 5 ms GSM/EDGE: 1 ms
State Saved	Saved in instrument state
Max	6000 s
Initial S/W Revision	Prior to A.02.00

Gate View Start Time

Controls the time at the left edge of the Gate View.

Key Path	Sweep/Control, Gate, Gate View Setup
Remote Command	[:SENSe] :SWEep:EGATe:VIEW:START <time> [:SENSe] :SWEep:EGATe:VIEW:START?
Example	SWE:EGAT:VIEW:STAR 10ms
Notes	Units of time are required or no units; otherwise an invalid suffix error message will be generated. See error -131.
Preset	0 ms
State Saved	Saved in instrument state
Min	0
Max	500 ms
Initial S/W Revision	A.10.00

Gate Delay

Controls the length of time from the time the gate condition goes True until the gate is turned on.

Key Path	Sweep/Control, Gate
Remote Command	[:SENSe] :SWEep:EGATe:DELay <time> [:SENSe] :SWEep:EGATe:DELay?
Example	SWE:EGAT:DELay 500ms SWE:EGAT:DELay?
Notes	Units of time are required or no units; otherwise an invalid suffix error message will be generated.
Preset	57.7 us WiMAX OFDMA: 71 us GSM/EDGE: 600 us WLAN: 500 us
State Saved	Saved in instrument state
Min	0.0 us
Max	100 s
Backwards Compatibility SCPI	[:SENSe] :SWEep:TIME:GATE:DELay ESA compatibility
Initial S/W Revision	Prior to A.02.00

Gate Length

Controls the length of time that the gate is on after it opens.

Key Path	Sweep/Control, Gate
Remote Command	[:SENSe] :SWEep:EGATe:LENGth <time> [:SENSe] :SWEep:EGATe:LENGth?
Example	SWE:EGAT:LENG 1 SWE:EGAT:LENG?
Notes	Units of time are required or no units; otherwise an invalid suffix error message will be generated.
Dependencies	<p>Grayed out when Gate Method is set to FFT in which case the label changes to that shown below.</p>  <p>The key is also grayed out if Gate Control = Level.</p>
Preset	461.6 us

	WiMAX OFDMA: 50 us GSM/EDGE: 200 us WLAN: 1.54 ms
State Saved	Saved in instrument state
Min	100 ns
Max	5 s
Backwards Compatibility SCPI	[:SENSe] :SWEep:TIME:GATE:LENGth ESA compatibility
Initial S/W Revision	Prior to A.02.00

Gate Source

The menus under the Gate Source key are the same as those under the Trigger key, with the exception that neither Free Run nor Video are available as Gate Source selections. However, a different SCPI command is used to select the Gate Source (see table below) because you may independently set the Gate Source and the Trigger Source.

Any changes to the settings in the setup menus under each Gate Source selection key (for example: Trigger Level, Trigger Delay, etc.) also affect the corresponding settings under the Trigger menu keys. The SCPI commands used for these are the same for Trigger and Gate, since there is only one setting which affects both Gate and Trigger. Example: to set the Trigger Level for External 1 you use the command :TRIG:EXT1:LEV regardless of whether you are using External 1 as a Trigger Source or a Gate Source.

Key Path	Sweep/Control, Gate
Remote Command	<pre>[:SENSe] :SWEep:EGATE:SOURce EXTernal1 EXTernal2 LINE FRAME RFBurst [:SENSe] :SWEep:EGATE:SOURce?</pre>
Dependencies	In some models, there is no second External input. In these models, the External 2 key is blanked and the EXTernal2 parameter will generate a "Hardware missing; Not available for this model number" error.
Preset	EXTernal 1 GSM/EDGE, MSR: FRAME LTETDD: EXTernal 1When Direction is Downlink, FRAME when Direction is Uplink.
Backwards Compatibility Notes	In ESA, there is a single Gate input port. In PSA, the Gate Source may be taken from one of two specified input ports. In the X-Series, any Trigger Source can be a Gate Source.
Initial S/W Revision	Prior to A.02.00
Modified at S/W Revision	A.03.00, A.14.00

Line

Pressing this key, when it is not selected, selects the line signal as the trigger. A new sweep/measurement will start synchronized with the next cycle of the line voltage. Pressing this key, when it is already selected, access the line trigger setup menu.

Key Path	Trigger
Example	TRIG:SOUR LINE Swept SA measurement TRIG:<meas>:SOUR LINE Measurements other than Swept SA
Dependencies	Line trigger is not available when operating from a "dc power source", for example, when the instrument is powered from batteries.
State Saved	Saved in instrument state
Status Bits/OPC dependencies	The Status Operation Register bit 5 "Waiting for Trigger" is set at the same time as the Sweeping or Measuring bit is set. It is cleared when the trigger actually occurs (that is, after the trigger event occurs and all the applicable trigger criteria have been met). A corresponding pop-up message ("Waiting for trigger") is generated if no trigger signal appears after approximately 2 sec. This message goes away when a trigger signal appears.
Initial S/W Revision	Prior to A.02.00

Trig Slope

Controls the trigger polarity. It is set positive to trigger on a rising edge and negative to trigger on a falling edge.

Key Path	Trigger, Line
Remote Command	:TRIGger[:SEQuence]:LINE:SLOPe POSitive NEGative :TRIGger[:SEQuence]:LINE:SLOPe?
Example	TRIG:LINE:SLOP NEG
Preset	POSitive
State Saved	Saved in instrument state
Backwards Compatibility Notes	The legacy :TRIGger[:SEQuence]:SLOPe command affects the slopes for the VID, LINE, EXT1, EXT2, and RFB triggers.
Initial S/W Revision	Prior to A.02.00

External 1

Pressing this key, when it is not selected, selects an external input signal as the trigger. A new sweep/measurement will start when the external trigger condition is met using the external 1 input connector on the rear panel.

Pressing this key, when it is already selected, accesses the external 1 trigger setup menu.

Key Path	Trigger
Example	TRIG:SOUR EXT1 Swept SA measurement TRIG:<meas>:SOUR EXT1 Measurements other than Swept SA
Dependencies	Grayed out if in use by Point Trigger in the Source Setup menu. Forced to Free Run if already selected and Point Trigger is set to External 1.
State Saved	Saved in instrument state
Status Bits/OPC dependencies	The Status Operation Register bit 5 "Waiting for Trigger" is set at the same time as the Sweeping or Measuring bit is set. It is cleared when the trigger actually occurs (that is, after the trigger event occurs and all the applicable trigger criteria have been met). A corresponding pop-up message ("Waiting for trigger") is generated if no trigger signal appears after approximately 2 sec. This message goes away when a trigger signal appears.
Initial S/W Revision	Prior to A.02.00

Trigger Level

Sets the value where the external 1 trigger input will trigger a new sweep/measurement.

Key Path	Trigger, External 1
Remote Command	:TRIGger[:SEquence]:EXTernal1:LEVel <level> :TRIGger[:SEquence]:EXTernal1:LEVel?
Example	TRIG:EXT1:LEV 0.4 V
Couplings	This same level is used for the Ext1 trigger source in the Trigger menu, for the Ext1 selection in the Periodic Timer sync source (in the Trigger menu and in the Gate Source menu), and also for the Ext1 selection in the Gate Source menu.
Preset	1.2 V
State Saved	Saved in instrument state
Min	-5 V
Max	5 V
Default Unit	V
Backwards Compatibility SCPI	:TRIGger[:SEquence]:EXTernal:LEVel For backward compatibility, the parameter EXTernal is mapped to EXTernal1
Backwards Compatibility SCPI	:TRIGger[:SEquence]:FRAME:EXTernal1:LEVel
Initial S/W Revision	Prior to A.02.00

Trig Slope

Controls the trigger polarity. It is set positive to trigger on a rising edge and negative to trigger on a falling edge.

Key Path	Trigger, External 1
Remote Command	:TRIGger[:SEquence]:EXTernal1:SLOPe POSitive NEGative :TRIGger[:SEquence]:EXTernal1:SLOPe?
Example	TRIG:EXT1:SLOP NEG
Couplings	This same slope is used in the Ext1 selection for the trigger source in the Trigger menu and for the period timer sync source (in the Trigger menu and in the Gate Source menu).
Preset	POSitive
State Saved	Saved in instrument state
Backwards Compatibility SCPI	:TRIGger[:SEquence]:EXTernal:SLOPe For backward compatibility, the parameter EXTernal is mapped to EXTernal1
Backwards Compatibility SCPI	:TRIGger[:SEquence]:FRAMe:EXTernal1:SLOPe
Backwards Compatibility Notes	The legacy :TRIGger[:SEquence]:SLOPe command affects the slopes for the VID, LINE, EXT1, EXT2, and RFB triggers.
Initial S/W Revision	Prior to A.02.00

Zero Span Delay Comp On/Off

In zero span, there is a natural delay in the signal path, which comes from the RBW filter. This is usually desirable, as it allows you to trigger on events and also see those events, because the signal is delayed from the trigger event. However, in some cases it is desirable to eliminate this delay, so that trigger events line up exactly with the zero time point in zero span. You can use the Zero Span Delay Comp On/Off feature to enable or disable zero span delay compensation.

Key Path	Trigger, External 1
Remote Command	:TRIGger[:SEquence]:EXTernal1:DELAy:COMPensation OFF ON 0 1 :TRIGger[:SEquence]:EXTernal1:DELAy:COMPensation?
Example	TRIG:EXT1:DEL:COMP ON
Dependencies	No effect except in zero-span, but not locked out in nonzero spans. Blanked in modes that do not support zero-span measurements. If the SCPI command is sent when the key is blanked, an error is returned: -221, "Settings conflict; Feature not supported for this measurement" In analyzers shipping N9060A, this feature requires N9060A-7FP.
Preset	OFF
State Saved	Saved in instrument state
Initial S/W Revision	A.11.00

External 2

Pressing this key, when it is not selected, selects an external input signal as the trigger. A new sweep/measurement will start when the external trigger condition is met using the external 2 input

connector. The external trigger 2 input connector is on the rear panel.

Pressing this key, when it is already selected, accesses the external 2 trigger setup menu.

Key Path	Trigger
Example	TRIG:SOUR EXT2 Swept SA measurement TRIG:<meas>:SOUR EXT2 Measurements other than Swept SA
Dependencies	In some models, there is no second External input. In these models, the External 2 key is blanked and the EXTernal2 parameter will generate a "Hardware missing; Not available for this model number" message. Grayed out if in use by Point Trigger in the Source Setup menu. Forced to Free Run if already selected and Point Trigger is set to External 2.
State Saved	Saved in instrument state
Status Bits/OPC dependencies	The Status Operation Register bit 5 "Waiting for Trigger" is set at the same time as the Sweeping or Measuring bit is set. It is cleared when the trigger actually occurs (that is, after the trigger event occurs and all the applicable trigger criteria have been met). A corresponding pop-up message ("Waiting for trigger") is generated if no trigger signal appears after approximately 2 sec. This message goes away when a trigger signal appears.
Initial S/W Revision	Prior to A.02.00
Modified at S/W Revision	A.03.00

Trigger Level

Sets the value where the external 2 trigger input will trigger a new sweep/measurement.

Key Path	Trigger, External 2
Remote Command	:TRIGger[:SEquence]:EXTernal2:LEVel :TRIGger[:SEquence]:EXTernal2:LEVel?
Example	TRIG:EXT2:LEV 1.1 V
Couplings	This same level is used for the Ext2 trigger source in the Trigger menu, for the Ext2 selection in the Periodic Timer sync source (in the Trigger menu and in the Gate Source menu), and also for the Ext2 selection in the Gate Source menu.
Preset	1.2 V
State Saved	Saved in instrument state
Min	-5 V
Max	5 V
Default Unit	V
Backwards Compatibility SCPI	:TRIGger[:SEquence]:FRAMe:EXTernal2:LEVel
Initial S/W Revision	Prior to A.02.00

Trig Slope

Controls the trigger polarity. It is set positive to trigger on a rising edge and negative to trigger on a falling edge.

Key Path	Trigger, External 2
Remote Command	:TRIGger[:SEquence]:EXTernal2:SLOPe POSitive NEGative :TRIGger[:SEquence]:EXTernal2:SLOPe?
Example	TRIG:EXT2:SLOP NEG
Couplings	This same slope is used in the Ext2 selection for the trigger source in the Trigger menu and for the period timer sync source (in the Trigger menu and in the Gate Source menu).
Preset	POSitive
State Saved	Saved in instrument state
Backwards Compatibility SCPI	:TRIGger[:SEquence]:FRAMe:EXTernal2:SLOPe
Backwards Compatibility Notes	The legacy :TRIGger[:SEquence]:SLOPe command affects the slopes for the VID, LINE, EXT1, EXT2, and RFB triggers.
Initial S/W Revision	Prior to A.02.00

Zero Span Delay Comp On/Off

In zero span, there is a natural delay in the signal path, which comes from the RBW filter. This is usually desirable, as it allows you to trigger on events and also see those events, because the signal is delayed from the trigger event. However, in some cases it is desirable to eliminate this delay, so that trigger events line up exactly with the zero time point in zero span. You can use the Zero Span Delay Comp On/Off feature to enable or disable zero span delay compensation.

Key Path	Trigger, External 2
Remote Command	:TRIGger[:SEquence]:EXTernal2:DELAy:COMPensation OFF ON 0 1 :TRIGger[:SEquence]:EXTernal2:DELAy:COMPensation?
Example	TRIG:EXT2:DEL:COMP ON
Dependencies	No effect except in zero-span, but not locked out in nonzero spans. Blanked in modes that do not support zero-span measurements. If the SCPI command is sent when the key is blanked, an error is returned: -221, "Settings conflict; Feature not supported for this measurement" In analyzers shipping N9060A, this feature requires N9060A-7FP.
Preset	OFF
State Saved	Saved in instrument state
Initial S/W Revision	A.11.00

RF Burst

Pressing this key, when it is not selected, selects the RF Burst as the trigger. A new sweep/measurement will start when an RF burst envelope signal is identified from the signal at the RF Input connector. Pressing this key, when it is already selected, accesses the RF Burst trigger setup menu.

In some models, a variety of burst trigger circuitry is available, resulting in various available burst trigger bandwidths. The analyzer automatically chooses the appropriate trigger path based on the hardware configuration and other settings of the analyzer.

Key Path	Trigger
Example	TRIG:SOUR RFB Swept SA measurement TRIG:< meas>:SOUR RFB Measurements other than Swept SA
State Saved	Saved in instrument state
Status Bits/OPC dependencies	The Status Operation Register bit 5 "Waiting for Trigger" is set at the same time as the Sweeping or Measuring bit is set. It is cleared when the trigger actually occurs (that is, after the trigger event occurs and all the applicable trigger criteria have been met). A corresponding pop-up message ("Waiting for trigger") is generated if no trigger signal appears after approximately 2 sec. This message goes away when a trigger signal appears.
Backwards Compatibility Notes	The legacy command: :TRIGger[:SEQuence]:RFBurst:FSElectivity[:STATe] OFF ON 0 1 is not supported in the X-Series, as the hardware to do Frequency Selective burst triggers does not exist in X-Series.
Initial S/W Revision	Prior to A.02.00
Modified at S/W Revision	A.04.00

Absolute Trigger Level

Sets the absolute trigger level for the RF burst envelope.

When using the External Mixing path, the Absolute Trigger Level is uncalibrated because the factory default was set to accommodate the expected IF levels for the RF path.

Key Path	Trigger, RF Burst
Scope	Meas Global
Remote Command	:TRIGger[:SEQuence]:RFBurst:LEVel:ABSolute <ampl> :TRIGger[:SEQuence]:RFBurst:LEVel:ABSolute?
Example	TRIG:RFB:LEV:ABS 10 dBm sets the trigger level of the RF burst envelope signal to the absolute level of 10 dBm
Notes	Sending this command does not switch the setting from relative to absolute; to switch it you need to send the :TRIGger[:SEQuence]:RFBurst:LEVel:TYPE command, below. Amplitude Corrections are not taken into account by the Absolute Trigger Level. For example, if you have given yourself effective gain with an amplitude correction factor, the Absolute Trigger will not fire until you have set the trigger level that far below the displayed signal level, rather than simply to

	the displayed signal level. This is only true for Amplitude Corrections, not External Gain or Ref Level Offset functions. If mode is Bluetooth, the default value is -50 dBm.
Couplings	This same level is used for the RF Burst trigger source in the Trigger menu, for the RF Burst selection in the Periodic Timer sync source (in the Trigger menu and in the Gate Source menu), and also for the RF Burst selection in the Gate Source menu
Preset	-20 dBm
State Saved	Saved in instrument state
Min	-200 dBm
Max	100 dBm
Default Unit	depends on the current selected Y-Axis unit
Backwards Compatibility SCPI	:TRIGger[:SEquence]:FRAMe:RFBurst:LEVel:ABSolute
Initial S/W Revision	Prior to A.02.00
Modified at S/W Revision	A.04.00

Key Path	Trigger, RF Burst
Remote Command	:TRIGger[:SEquence]:RFBurst:LEVel:TYPE ABSolute RELative :TRIGger[:SEquence]:RFBurst:LEVel:TYPE?
Example	TRIG:RFB:LEV:TYPE REL sets the trigger level type of the RF burst trigger to Relative.
Preset	ABSolute
State Saved	Saved in instrument state
Initial S/W Revision	Prior to A.02.00
Modified at S/W Revision	A.04.00

Relative Trigger Level

Sets the relative trigger level for the RF burst envelope.

In some models, the relative burst trigger function is implemented in hardware. In other models, without the advanced triggering hardware required, the relative burst trigger function is implemented in software in some measurements, and is unavailable in other measurements.

When implemented in software, the relative RF Burst trigger function is implemented as follows:

1. The measurement starts with the absolute RF Burst trigger setting. If it cannot get a trigger with that level, auto trigger fires and the acquisition starts anyway. After the acquisition, the measurement searches for the peak in the acquired waveform and saves it.

2. Now, in the next cycle of the measurement, the measurement determines a new absolute RF Burst level based on the peak value from the first measurement and the Relative RF Burst Trigger Level (always 0 or negative dB) set by the user. The following formula is used:
 3. absolute RF Burst level = peak level of the previous acquisition + relative RF Burst level
 4. If the new absolute RF Burst level differs from the previous by more than 0.5 dB, the new level is sent to the hardware; otherwise it is not updated (to avoid slowing down the acquisition)
- Steps 2 and 3 repeat for subsequent measurements.

Key Path	Trigger, RF Burst
Scope	Meas Global
Remote Command	:TRIGger[:SEquence]:RFBurst:LEVel:RELative <rel_ampl> :TRIGger[:SEquence]:RFBurst:LEVel:RELative?
Example	TRIG:RFB:LEV:REL -10 dB sets the trigger level of the RF burst envelope signal to the relative level of -10 dB
Notes	Sending this command does not switch the setting from absolute to relative; to switch it you need to send the :TRIGger[:SEquence]:RFBurst:LEVel:TYPE command, above. The relative trigger level is not available in some measurements. In those measurements the RELative parameter, and the :TRIGger[:SEquence]:RFBurst:LEVel:TYPE command (above), will generate an error if sent.
Dependencies	This key is grayed out and Absolute Trigger Level selected if the required hardware is not present in your analyzer and the current measurement does not support Relative triggering.
Preset	-6 dB GSM: -25 dB
State Saved	Saved in instrument state
Min	-45 dB
Max	0 dB
Default Unit	dB or dBc
Backwards Compatibility SCPI	:TRIGger[:SEquence]:RFBurst:LEVel This legacy command is aliased to :TRIGger[:SEquence]:RFBurst:LEVel:RELative because the PSA had ONLY relative burst triggering
Initial S/W Revision	Prior to A.02.00
Modified at S/W Revision	A.04.00

Trigger Slope

It is set positive to trigger on a rising edge and negative to trigger on a falling edge.

Key Path	Trigger, RF Burst
Remote Command	:TRIGger[:SEquence]:RFBurst:SLOPe POSitive NEGative :TRIGger[:SEquence]:RFBurst:SLOPe?

Example	TRIG:RFB:SLOP NEG
Couplings	This same slope is used in the RF Burst selection for the trigger source in the Trigger menu and for the period timer sync source (in the Trigger menu and in the Gate Source menu).
Preset	POSitive
State Saved	Saved in instrument state
Backwards Compatibility SCPI	:TRIGger[:SEQuence]:FRAMe:RFBurst:SLOPe
Backwards Compatibility Notes	The legacy :TRIGger[:SEQuence]:SLOPe command affects the slopes for the VID, LINE, EXT1, EXT2, and RFB triggers.
Initial S/W Revision	Prior to A.02.00

Periodic Timer (Frame Trigger)

Pressing this key, when it is not selected, selects the internal periodic timer signal as the trigger. Triggering occurrences are set by the **Period** parameter, which is modified by the **Sync Source** and **Offset**. Pressing this key, when it is already selected, accesses the periodic timer trigger setup functions.

If you do not have a sync source selected (it is Off), then the internal timer will not be synchronized with any external timing events.

Key Path	Trigger
Example	TRIG:SOUR FRAM Swept SA measurement TRIG:<meas>:SOUR FRAM Measurements other than Swept SA
State Saved	Saved in instrument state
Readback	[Sync: <value of Sync Source>], for example, [Sync: External 1]
Status Bits/OPC dependencies	The Status Operation Register bit 5 "Waiting for Trigger" is set at the same time as the Sweeping or Measuring bit is set. It is cleared when the trigger actually occurs (that is, after the trigger event occurs and all the applicable trigger criteria have been met). A corresponding pop-up message ("Waiting for trigger") is generated if no trigger signal appears after approximately 2 sec. This message goes away when a trigger signal appears.
Initial S/W Revision	Prior to A.02.00

Periodic Timer Triggering:

This feature selects the internal periodic timer signal as the trigger. Trigger occurrences are set by the **Periodic Timer** parameter, which is modified by the **Sync Source** and **Offset**.

The figure below shows the action of the periodic timer trigger. Before reviewing the figure, we'll explain some uses for the periodic trigger.

A common application is measuring periodic burst RF signals for which a trigger signal is not easily available. For example, we might be measuring a TDMA radio which bursts every 20 ms. Let's assume that the 20 ms period is very consistent. Let's also assume that we do not have an external trigger source

available that is synchronized with the period, and that the signal-to-noise ratio of the signal is not high enough to provide a clean RF burst trigger at all of the analysis frequencies. For example, we might want to measure spurious transmissions at an offset from the carrier that is larger than the bandwidth of the RF burst trigger. In this application, we can set the Periodic Timer to a 20.00 ms period and adjust the offset from that timer to position our trigger just where we want it. If we find that the 20.00 ms is not exactly right, we can adjust the period slightly to minimize the drift between the period timer and the signal to be measured.

A second way to use this feature would be to use **Sync Source** temporarily, instead of **Offset**. In this case, we might tune to the signal in a narrow span and use the RF Burst trigger to synchronize the periodic timer. Then we would turn the sync source off so that it would not miss-trigger. Miss-triggering can occur when we are tuned so far away from the RF burst trigger that it is no longer reliable.

A third example would be to synchronize to a signal that has a reference time element of much longer period than the period of interest. In some CDMA applications, it is useful to look at signals with a short periodicity, by synchronizing that periodicity to the "even-second clock" edge that happens every two seconds. Thus, we could connect the even-second clock trigger to Ext1 and use then Ext1 as the sync source for the periodic timer.

The figure below illustrates this third example. The top trace represents the even-second clock. It causes the periodic timer to synchronize with the leading edge shown. The analyzer trigger occurs at a time delayed by the accumulated offset from the period trigger event. The periodic timer continues to run, and triggers continue to occur, with a periodicity determined by the analyzer time base. The timer output (labeled "late event") will drift away from its ideal time due to imperfect matching between the time base of the signal being measured and the time base of the analyzer, and also because of imperfect setting of the period parameter. But the synchronization is restored on the next even-second clock event. ("Accumulated offset" is described in the in the **Offset** function section.)

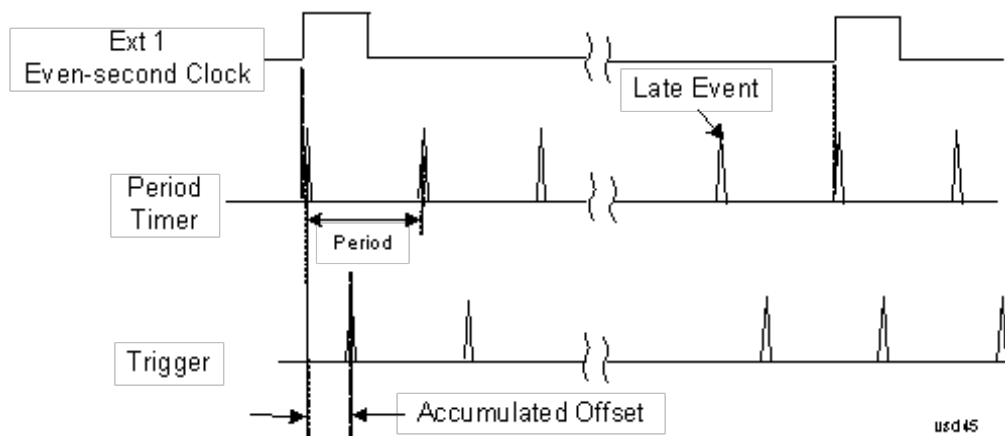

Period

Sets the period of the internal periodic timer clock. For digital communications signals, this is usually set to the frame period of your current input signal. In the case that sync source is not set to OFF, and the external sync source rate is changed for some reason, the periodic timer is synchronized at the every external synchronization pulse by resetting the internal state of the timer circuit.

Key Path	Trigger, Periodic Timer
Remote Command	:TRIGger[:SEquence]:FRAME:PERiod <time>

	:TRIGger[:SEquence]:FRAMe:PERiod?
Example	TRIG:FRAM:PER 100 ms
Dependencies	The invalid data indicator turns on when the period is changed, until the next sweep/measurement completes.
Couplings	The same period is used in the Gate Source selection of the period timer.
Preset	20 ms GSM: 4.615383
State Saved	Saved in instrument state
Min	100.000 ns
Max	559.0000 ms
Default Unit	S
Initial S/W Revision	Prior to A.02.00

Offset

Adjusts the accumulated offset between the periodic timer events and the trigger event. Adjusting the accumulated offset is different than setting an offset, and requires explanation.

The periodic timer is usually not synchronized with any external events, so the timing of its output events has no absolute meaning. Since the timing relative to external events (RF signals) is important, you need to be able to adjust (offset) it. However, you have no direct way to see when the periodic timer events occur. All that you can see is the trigger timing. When you want to adjust the trigger timing, you will be changing the internal offset between the periodic timer events and the trigger event. Because the absolute value of that internal offset is unknown, we will just call that the accumulated offset. Whenever the Offset parameter is changed, you are changing that accumulated offset. You can reset the displayed offset using Reset Offset Display. Changing the display does not change the value of the accumulated offset, and you can still make additional changes to accumulated offset.

To avoid ambiguity, we define that an increase in the "offset" parameter, either from the knob or the SCPI adjust command, serves to delay the timing of the trigger event.

Key Path	Trigger, Periodic Timer
Remote Command	:TRIGger[:SEquence]:FRAMe:OFFSet <time> :TRIGger[:SEquence]:FRAMe:OFFSet?
Example	TRIG:FRAM:OFFS 1.2 ms
Notes	The front panel interface (for example, the knob), and this command, adjust the accumulated offset, which is shown on the active function display. However, the actual amount sent to the hardware each time the offset is updated is the delta value, that is, the current accumulated offset value minus the previous accumulated offset value. Note that the accumulated offset value is essentially arbitrary; it represents the accumulated offset from the last time the offset was zeroed (with the Reset Offset Display key). Note that this command does not change the period of the trigger waveform. Note also that Offset is used only when the sync source is set to OFF, otherwise delay is used, see section "Trig Delay" on page 460.

	An increase in the "offset" parameter, either from the knob or the SCPI adjust command, serves to delay the timing of the trigger event.
Notes	When the SCPI command is sent the value shown on the key (and the Active Function, if this happens to be the active function) is updated with the new value. However, the actual amount sent to the hardware is the delta value, that is, the current accumulated offset value minus the previous accumulated offset value. The SCPI query simply returns the value currently showing on the key.
Dependencies	The invalid data indicator turns on when the offset is changed, until the next sweep/measurement completes.
Couplings	The same offset is used in the Gate Source selection of the period timer.
Preset	0 s
State Saved	Saved in instrument state
Min	-10.000 s
Max	10.000 s
Default Unit	S
Initial S/W Revision	Prior to A.02.00

Offset Adjust (Remote Command Only)

This remote command does not work at all like the related front panel keys. This command lets you advance the phase of the frame trigger by the amount you specify.

It does not change the period of the trigger waveform. If the command is sent multiple times, it advances the phase of the frame trigger an additional amount each time it is sent. Negative numbers are permitted.

Remote Command	:TRIGger[:SEquence]:FRAMe:ADJust <time>
Example	TRIG:FRAM:ADJ 1.2 ms
Notes	Note also that Offset is used only when the sync source is set to OFF, otherwise delay is used, see section "Trig Delay" on page 460 An increase in the "offset" parameter, either from the knob or the SCPI adjust command, serves to delay the timing of the trigger event.
Notes	The front panel interface (for example, the knob) and the :TRIG:FRAM:OFFS command adjust the accumulated offset, which is shown on the active function display. However, the actual amount sent to the hardware is the delta value, that is, the current offset value minus the previous offset value. When the SCPI command is sent the value shown on the key (and the Active Function, if this happens to be the active function) is updated by increasing it (or decreasing it if the value sent is negative) by the amount specified in the SCPI command. This is a "command only" SCPI command, with no query.
Dependencies	The invalid data indicator turns on when the offset is changed, until the next sweep/measurement completes.
Couplings	The same offset is used in the Gate Source selection of the period timer.
Preset	0 s

State Saved	Saved in instrument state
Min	-10.000 s
Max	10.000 s
Default Unit	S
Initial S/W Revision	Prior to A.02.00

Reset Offset Display

Resets the value of the periodic trigger offset display setting to 0.0 seconds. The current displayed trigger location may include an offset value defined with the Offset key. Pressing this key redefines the currently displayed trigger location as the new trigger point that is 0.0 s offset. The Offset key can then be used to add offset relative to this new timing.

Key Path	Trigger, Periodic Timer
Remote Command	:TRIGger[:SEquence]:FRAMe:OFFSet:DISPlay:RESet
Example	TRIG:FRAM:OFFS:DISP:RES
Initial S/W Revision	Prior to A.02.00

Sync Source

Selects a signal source for you to synchronize your periodic timer trigger to, otherwise you are triggering at some arbitrary location in the frame. Synchronization reduces the precision requirements on the setting of the period.

For convenience you may adjust the level and slope of the selected sync source in a conditional branch setup menu accessed from the Sync Source menu. Note that these settings match those in the **Trigger** and **Gate Source** menus; that is, each trigger source has only one value of level and slope, regardless of which menu it is accessed from.

Key Path	Trigger, Periodic Timer
Remote Command	:TRIGger[:SEquence]:FRAMe:SYNC EXTernal1 EXTernal2 RFBurst OFF :TRIGger[:SEquence]:FRAMe:SYNC?
Example	TRIG:FRAM:SYNC EXT2
Dependencies	In some models, there is no second External input. In these models, the External 2 key is blanked and the EXTernal2 parameter will generate a "Hardware missing; Not available for this model number" message.
Preset	Off GSM/EDGE, MSR,LTE,LTETDD: RFBurst
State Saved	Saved in instrument state
Readback	The current setting is read back to this key and it is also Readback to the previous Periodic Timer trigger key.

Backwards Compatibility SCPI	:TRIGger[:SEquence]:FRAMe:SYNC EXTernal
Initial S/W Revision	Prior to A.02.00
Modified at S/W Revision	A.03.00, A.14.00

Off

Turns off the sync source for your periodic trigger. With the sync source off, the timing will drift unless the signal source frequency is locked to the analyzer frequency reference.

Key Path	Trigger, Periodic Timer, Sync Source
Example	TRIG:FRAM:SYNC OFF
Readback	Off
Initial S/W Revision	Prior to A.02.00

External 1

Pressing this key, when it is not selected, selects an external input signal as the trigger. A new sweep/measurement will start when the external trigger condition is met using the external 1 input connector on the rear panel.

Pressing this key, when it is already selected, accesses the external 1 trigger setup menu.

Key Path	Trigger
Example	TRIG:SOUR EXT1 Swept SA measurement TRIG:<meas>:SOUR EXT1 Measurements other than Swept SA
Dependencies	Grayed out if in use by Point Trigger in the Source Setup menu. Forced to Free Run if already selected and Point Trigger is set to External 1.
State Saved	Saved in instrument state
Status Bits/OPC dependencies	The Status Operation Register bit 5 "Waiting for Trigger" is set at the same time as the Sweeping or Measuring bit is set. It is cleared when the trigger actually occurs (that is, after the trigger event occurs and all the applicable trigger criteria have been met). A corresponding pop-up message ("Waiting for trigger") is generated if no trigger signal appears after approximately 2 sec. This message goes away when a trigger signal appears.
Initial S/W Revision	Prior to A.02.00

Trigger Level

Sets the value where the external 1 trigger input will trigger a new sweep/measurement.

Key Path	Trigger, External 1
Remote Command	:TRIGger[:SEquence]:EXTernal1:LEVel <level> :TRIGger[:SEquence]:EXTernal1:LEVel?
Example	TRIG:EXT1:LEV 0.4 V
Couplings	This same level is used for the Ext1 trigger source in the Trigger menu, for the Ext1 selection in the Periodic Timer sync source (in the Trigger menu and in the Gate Source menu), and also for the Ext1 selection in the Gate Source menu.
Preset	1.2 V
State Saved	Saved in instrument state
Min	-5 V
Max	5 V
Default Unit	V
Backwards Compatibility SCPI	:TRIGger[:SEquence]:EXTernal:LEVel For backward compatibility, the parameter EXTernal is mapped to EXTernal1
Backwards Compatibility SCPI	:TRIGger[:SEquence]:FRAMe:EXTernal1:LEVel
Initial S/W Revision	Prior to A.02.00

Trig Slope

Controls the trigger polarity. It is set positive to trigger on a rising edge and negative to trigger on a falling edge.

Key Path	Trigger, External 1
Remote Command	:TRIGger[:SEquence]:EXTernal1:SLOPe POSitive NEGative :TRIGger[:SEquence]:EXTernal1:SLOPe?
Example	TRIG:EXT1:SLOP NEG
Couplings	This same slope is used in the Ext1 selection for the trigger source in the Trigger menu and for the period timer sync source (in the Trigger menu and in the Gate Source menu).
Preset	POSitive
State Saved	Saved in instrument state
Backwards Compatibility SCPI	:TRIGger[:SEquence]:EXTernal:SLOPe For backward compatibility, the parameter EXTernal is mapped to EXTernal1
Backwards Compatibility SCPI	:TRIGger[:SEquence]:FRAMe:EXTernal1:SLOPe
Backwards Compatibility Notes	The legacy :TRIGger[:SEquence]:SLOPe command affects the slopes for the VID, LINE, EXT1, EXT2, and RFB triggers.
Initial S/W Revision	Prior to A.02.00

External 2

Pressing this key, when it is not selected, selects an external input signal as the trigger. A new sweep/measurement will start when the external trigger condition is met using the external 2 input connector. The external trigger 2 input connector is on the rear panel.

Pressing this key, when it is already selected, accesses the external 2 trigger setup menu.

Key Path	Trigger
Example	TRIG:SOUR EXT2 Swept SA measurement TRIG:<meas>:SOUR EXT2 Measurements other than Swept SA
Dependencies	In some models, there is no second External input. In these models, the External 2 key is blanked and the EXTERNAL2 parameter will generate a "Hardware missing; Not available for this model number" message. Grayed out if in use by Point Trigger in the Source Setup menu. Forced to Free Run if already selected and Point Trigger is set to External 2.
State Saved	Saved in instrument state
Status Bits/OPC dependencies	The Status Operation Register bit 5 "Waiting for Trigger" is set at the same time as the Sweeping or Measuring bit is set. It is cleared when the trigger actually occurs (that is, after the trigger event occurs and all the applicable trigger criteria have been met). A corresponding pop-up message ("Waiting for trigger") is generated if no trigger signal appears after approximately 2 sec. This message goes away when a trigger signal appears.
Initial S/W Revision	Prior to A.02.00
Modified at S/W Revision	A.03.00

Trigger Level

Sets the value where the external 2 trigger input will trigger a new sweep/measurement.

Key Path	Trigger, External 2
Remote Command	:TRIGger[:SEquence]:EXTernal2:LEVel :TRIGger[:SEquence]:EXTernal2:LEVel?
Example	TRIG:EXT2:LEV 1.1 V
Couplings	This same level is used for the Ext2 trigger source in the Trigger menu, for the Ext2 selection in the Periodic Timer sync source (in the Trigger menu and in the Gate Source menu), and also for the Ext2 selection in the Gate Source menu.
Preset	1.2 V
State Saved	Saved in instrument state
Min	-5 V
Max	5 V
Default Unit	V
Backwards Compatibility SCPI	:TRIGger[:SEquence]:FRAMe:EXTernal2:LEVel
Initial S/W Revision	Prior to A.02.00

Trig Slope

Controls the trigger polarity. It is set positive to trigger on a rising edge and negative to trigger on a falling edge.

Key Path	Trigger, External 2
Remote Command	:TRIGger[:SEquence]:EXTernal2:SLOPe POSitive NEGative :TRIGger[:SEquence]:EXTernal2:SLOPe?
Example	TRIG:EXT2:SLOP NEG
Couplings	This same slope is used in the Ext2 selection for the trigger source in the Trigger menu and for the period timer sync source (in the Trigger menu and in the Gate Source menu).
Preset	POSitive
State Saved	Saved in instrument state
Backwards Compatibility SCPI	:TRIGger[:SEquence]:FRAMe:EXTernal2:SLOPe
Backwards Compatibility Notes	The legacy :TRIGger[:SEquence]:SLOPe command affects the slopes for the VID, LINE, EXT1, EXT2, and RFB triggers.
Initial S/W Revision	Prior to A.02.00

RF Burst

Pressing this key, when it is not selected, selects the RF Burst as the trigger. A new sweep/measurement will start when an RF burst envelope signal is identified from the signal at the RF Input connector. Pressing this key, when it is already selected, accesses the RF Burst trigger setup menu.

In some models, a variety of burst trigger circuitry is available, resulting in various available burst trigger bandwidths. The analyzer automatically chooses the appropriate trigger path based on the hardware configuration and other settings of the analyzer.

Key Path	Trigger
Example	TRIG:SOUR RFB Swept SA measurement TRIG:<meas>:SOUR RFB Measurements other than Swept SA
State Saved	Saved in instrument state
Status Bits/OPC dependencies	The Status Operation Register bit 5 "Waiting for Trigger" is set at the same time as the Sweeping or Measuring bit is set. It is cleared when the trigger actually occurs (that is, after the trigger event occurs and all the applicable trigger criteria have been met). A corresponding pop-up message ("Waiting for trigger") is generated if no trigger signal appears after approximately 2 sec. This message goes away when a trigger signal appears.
Backwards Compatibility Notes	The legacy command: :TRIGger[:SEquence]:RFBurst:FSElectivity[:STATe] OFF ON 0 1 is not supported in the X-Series, as the hardware to do Frequency Selective burst triggers does not exist in X-Series.

Initial S/W Revision	Prior to A.02.00
Modified at S/W Revision	A.04.00

Absolute Trigger Level

Sets the absolute trigger level for the RF burst envelope.

When using the External Mixing path, the Absolute Trigger Level is uncalibrated because the factory default was set to accommodate the expected IF levels for the RF path.

Key Path	Trigger, RF Burst
Scope	Meas Global
Remote Command	:TRIGger[:SEquence]:RFBurst:LEVel:ABSolute <ampl> :TRIGger[:SEquence]:RFBurst:LEVel:ABSolute?
Example	TRIG:RFB:LEV:ABS 10 dBm sets the trigger level of the RF burst envelope signal to the absolute level of 10 dBm
Notes	Sending this command does not switch the setting from relative to absolute; to switch it you need to send the :TRIGger[:SEquence]:RFBurst:LEVel:TYPE command, below. Amplitude Corrections are not taken into account by the Absolute Trigger Level. For example, if you have given yourself effective gain with an amplitude correction factor, the Absolute Trigger will not fire until you have set the trigger level that far below the displayed signal level, rather than simply to the displayed signal level. This is only true for Amplitude Corrections, not External Gain or Ref Level Offset functions. If mode is Bluetooth, the default value is -50 dBm.
Couplings	This same level is used for the RF Burst trigger source in the Trigger menu, for the RF Burst selection in the Periodic Timer sync source (in the Trigger menu and in the Gate Source menu), and also for the RF Burst selection in the Gate Source menu
Preset	-20 dBm
State Saved	Saved in instrument state
Min	-200 dBm
Max	100 dBm
Default Unit	depends on the current selected Y-Axis unit
Backwards Compatibility SCPI	:TRIGger[:SEquence]:FRAME:RFBurst:LEVel:ABSolute
Initial S/W Revision	Prior to A.02.00
Modified at S/W Revision	A.04.00

Key Path	Trigger, RF Burst
Remote Command	:TRIGger[:SEquence]:RFBurst:LEVel:TYPE ABSolute RELative :TRIGger[:SEquence]:RFBurst:LEVel:TYPE?

Example	TRIG:RFB:LEV:TYPE REL sets the trigger level type of the RF burst trigger to Relative.
Preset	ABSolute
State Saved	Saved in instrument state
Initial S/W Revision	Prior to A.02.00
Modified at S/W Revision	A.04.00

Trigger Slope

It is set positive to trigger on a rising edge and negative to trigger on a falling edge.

Key Path	Trigger, RF Burst
Remote Command	:TRIGger[:SEquence]:RFBurst:SLOPe POSitive NEGative :TRIGger[:SEquence]:RFBurst:SLOPe?
Example	TRIG:RFB:SLOP NEG
Couplings	This same slope is used in the RF Burst selection for the trigger source in the Trigger menu and for the period timer sync source (in the Trigger menu and in the Gate Source menu).
Preset	POSitive
State Saved	Saved in instrument state
Backwards Compatibility SCPI	:TRIGger[:SEquence]:FRAME:RFBurst:SLOPe
Backwards Compatibility Notes	The legacy :TRIGger[:SEquence]:SLOPe command affects the slopes for the VID, LINE, EXT1, EXT2, and RFB triggers.
Initial S/W Revision	Prior to A.02.00

Sync Holdoff

Sync Holdoff specifies the duration that the sync source signal must be kept false before the transition to true to be recognized as the sync timing. The periodic timer phase is aligned when the sync source signal becomes true, after the Holdoff time is satisfied.

A holdoff of 2 ms will work with most WiMAX signals, but there may be cases where the burst off duration is less than 1 ms and this value will need to be changed.

Key Path	Trigger, Periodic Timer
Remote Command	:TRIGger[:SEquence]:FRAME:SYNC:HOLDoff <time> :TRIGger[:SEquence]:FRAME:SYNC:HOLDoff? :TRIGger[:SEquence]:FRAME:SYNC:HOLDoff:STATe OFF ON 0 1 :TRIGger[:SEquence]:FRAME:SYNC:HOLDoff:STATe?
Preset	On, 1.000 ms

State Saved	Saved in instrument state
Min	0 ms
Max	+500 ms
Default Unit	s
Initial S/W Revision	Prior to A.02.00

Control Edge/Level

Sets the method of controlling the gating function from the gating signal.

Edge

In Edge triggering, the gate opens (after the Delay) on the selected edge (for example, positive) of the gate signal and closes on the alternate edge (for example, negative).

Level

In Level triggering, the gate opens (after the Delay) when the gate signal has achieved a certain level and stays open as long as that level is maintained.

Key Path	Sweep/Control, Gate
Remote Command	[:SENSe] :SWEep:EGATe:CONTRol EDGE LEVeL [:SENSe] :SWEep:EGATe:CONTRol?
Example	SWE:EGAT:CONT EDGE
Dependencies	If the Gate Method is FFT the Control key is grayed out and Edge is selected. If the Gate Source is TV, Frame or Line, the Control key is grayed out and Edge is selected.
Preset	EDGE
State Saved	Saved in instrument state
Backwards Compatibility SCPI	[:SENSe] :SWEep:TIME:GATE:TYPE ESA Compatibility
Initial S/W Revision	Prior to A.02.00

Gate Holdoff

Lets you increase or decrease the wait time after a gate event ends before the analyzer will respond to the next gate signal.

After any Gate event finishes, the analyzer must wait for the sweep system to settle before it can respond to another Gate signal. The analyzer calculates a "wait time," taking into account a number of factors, including RBW and Phase Noise Optimization settings. The goal is to achieve the same accuracy when gated as in ungated operation. The figure below illustrates this concept:

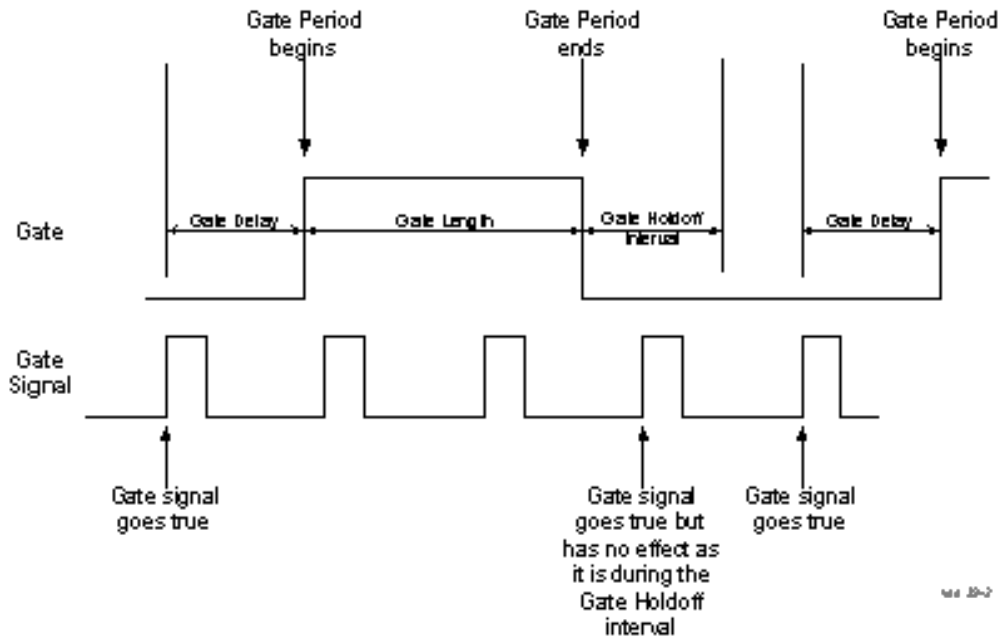

When Gate Holdoff is in Auto, the wait time calculated by the analyzer is used. When Gate Time is in Manual, the user may adjust the wait time, usually decreasing it in order to achieve greater speed, but at the risk of decreasing accuracy.

When the Method key is set to Video or FFT, the Gate Holdoff function has no effect.

In measurements that do not support Auto, the value shown when Auto is selected is “---” and the manually set holdoff is returned to a query.

Key Path	Sweep/Control, Gate
Remote Command	<pre>[:SENSe] :SWEep:EGATe:HOLDoff <time> [:SENSe] :SWEep:EGATe:HOLDoff? [:SENSe] :SWEep:EGATe:HOLDoff:AUTO OFF ON 0 1 [:SENSe] :SWEep:EGATe:HOLDoff:AUTO?</pre>
Example	<pre>SWE:EGAT:HOLD 0.0002 SWE:EGAT:HOLD? SWE:EGAT:HOLD:AUTO ON SWE:EGAT:HOLD:AUTO?</pre>
Couplings	<p>When Gate Holdoff is Auto, the Gate Holdoff key shows the value calculated by the analyzer for the wait time.</p> <p>Pressing the Gate Holdoff key while it is in Auto and not selected, causes the key to become selected and allows the user to adjust the value. If the value is adjusted, the setting changes to Man.</p> <p>Pressing the Gate Holdoff key, while it is in Auto and selected, does not change the value of Gate Holdoff, but causes the setting to change to Man. Now the user can adjust the value.</p> <p>Pressing the key while it is in Man and selected, cause the value to change back to Auto.</p> <p>Pressing the key while it is in Man and not selected, causes the key to become selected and allows the user to adjust the value.</p>

	When Method is set to Video or FFT, the Gate Holdoff function has no effect.
Preset	Auto Auto/On
State Saved	Saved in instrument state
Min	1 µsec
Max	1 sec
Initial S/W Revision	Prior to A.02.00

Gate Delay Compensation

This function allows you to select an RBW-dependent value by which to adjust the gate delay, to compensate for changes in the delay caused by RBW effects.

You can select between uncompensated operation and two types of compensation, Delay Until RBW Settled and Compensate for RBW Group Delay.

See "[More Information](#)" on page 807

Key Path	Sweep/Control, Gate
Scope	Meas Global
Remote Command	[:SENSe] :SWEep:EGATe:DElAy:COMPensation:TYPE OFF SETTled GDElAy [:SENSe] :SWEep:EGATe:DElAy:COMPensation:TYPE?
Example	SWE:EGAT:DEL:COMP:TYPE SETT SWE:EGAT:DEL:COMP:TYPE?
Notes	Although this function is Meas Global, there are some measurements that do not support this function. In those measurements the operation will be Uncompensated. Going into one of those measurements will not change the Meas Global selection; it will simply display the grayed-out menu key with “Uncompensated” showing as the selection. This is a non-forceful grayout, so the SCPI command is still accepted. If Gate Delay Compensation is not supported at all within a particular mode, the key is not displayed, and if the SCPI command is sent while in a measurement within that mode, an “Undefined Header” message is generated. Measurements that do not support this function include: Swept SA
Preset	TD-SCDMA mode: Compensate for RBW Group Delay All other modes: Delay Until RBW Settled
State Saved	Saved in instrument state
Range	Uncompensated Delay Until RBW Settled Compensate for RBW Group Delay
Readback text	Uncompensated Settled Group Delay
Initial S/W Revision	Prior to A.02.00
Modified at S/W Revision	A.11.0

More Information

Selecting Uncompensated means that the actual gate delay is as you sets it.

Selecting Delay Until RBW Settled causes the gate delay to be increased above the user setting by an amount equal to $3.06/\text{RBW}$. This compensated delay causes the GATE START and GATE STOP lines on the display to move by the compensation amount, and the actual hardware gate delay to be increased by the same amount. All the other gate lines (for example, MIN FAST) are unaffected. If the RBW subsequently changes, the compensation is readjusted for the new RBW. The value shown on the Gate Delay key does NOT change.

Delay Until RBW Settled allows excellent measurements of gated signals, by allowing the IF to settle following any transient that affects the burst. Excellent measurements also require that the analysis region not extend into the region affected by the falling edge of the burst. Thus, excellent measurements can only be made over a width that declines with narrowing RBWs, which is achieved by decreasing the gate length below the user setting by an amount equal to $2.53/\text{RBW}$. Therefore, for general purpose compensation, you will still want to change the gate length with changes in RBW even if the gate delay is compensated. The compensated Gate Length is limited by the analyzer so that it will never go below 10% of the value shown on the Gate Length key, as otherwise the sweep times could get very long. Anytime the Gate Length and RBW values combine in such a way that this limiting takes place, a warning is displayed. For measurements which contain multiple sweeps with different RBW like SEM and SPUR, the smallest RBW is used for this limiting.

Selecting Compensate for RBW Group Delay causes the gate delay to be increased above the user setting by an amount equal to $1.81/\text{RBW}$. This compensated delay causes the GATE START, GATE STOP lines on the display to move by the compensation amount, and the actual hardware gate delay to be increased by the same amount. All the other gate lines (for example, MIN FAST) are unaffected. If the RBW subsequently changes, the compensation is readjusted for the new RBW. The value shown on the Gate Delay key does NOT change. Compensate for RBW Group Delay also includes gate length compensation; the gate length itself is adjusted as necessary to attempt to compensate for delay effects imposed by the RBW.

Compensate for RBW Group Delay is similar to Delay Until RBW Settled, but compensates for the group delay of the RBW filter, rather than the filter settling time. As the RBW gets narrow, this can allow the settling tail of the RBW to affect the beginning part of the gated measurement, and allow the beginning of the RBW settling transient to affect the end of the gated measurement. These two effects are symmetric because the RBW response is symmetric. Because the gate length is not automatically compensated, some users might find this compensation to be more intuitive than compensation for RBW settling.

Min Fast Position Query (Remote Command Only)

This command queries the position of the MIN FAST line, relative to the delay reference (REF) line. See section "[Gate View On/Off](#)" on page 2098. If this query is sent while not in gate view, the MinFast calculation is performed based on the current values of the appropriate parameters and the result is returned. Knowing this value lets you set an optimal gate delay value for the current measurement setup.

Remote Command	[:SENSe] :SWEep:EGATe:MINFast?
Example	SWE:EGAT:MIN?
Initial S/W Revision	Prior to A.02.00

Gate Preset (Remote Command Only)

Presets the time-gated spectrum analysis capability.

This command sets gate parameter values to the ESA preset values, as follows:

Gate trigger type = edge

Gate polarity = positive

Gate delay = 1 us

Gate length = 1 us

Remote Command	<code>[[:SENSe]:SWEep:TIME:GATE:PRESet</code> ESA Compatibility
Initial S/W Revision	Prior to A.02.00

Gate Level (Remote Command Only)

Sets the gate input transition point level for the external TRIGGER inputs on the front and rear panel. This is a legacy command for PSA compatibility. It is simply an alias to the equivalent trigger level command.

Remote Command	<code>[[:SENSe]:SWEep:EGATE:EXTernal[1] 2:LEVel <voltage></code> <code>[[:SENSe]:SWEep:EGATE:EXTernal[1] 2:LEVel?</code>
Notes	This command is simply an alias to <code>:TRIGger[:SEQUence]:EXTernal[1] 2:LEVel</code> For details refer
Initial S/W Revision	Prior to A.02.00

Gate Polarity (Remote Command Only)

Sets the polarity for the gate signal. This setup is now done using the gate trigger's slope setting.

When Positive (Pos) is selected, a positive-going edge (Edge) or a high voltage (Level) will satisfy the gate condition, after the delay set with the Gate Delay key. When Negative (Neg) is selected, a negative-going edge (Edge) or a low voltage (Level) will satisfy the gate condition after the delay.

Remote Command	<code>[[:SENSe]:SWEep:EGATE:POLarity</code> NEGative POSitive <code>[[:SENSe]:SWEep:EGATE:POLarity?</code>
Example	<code>SWE:EGAT:POL</code> NEG <code>SWE:EGAT:POL?</code>
Preset	POSitive
State Saved	Saved in instrument state
Backwards Compatibility SCPI	<code>[[:SENSe]:SWEep:TIME:GATE:POLarity</code> ESA compatibility
Initial S/W Revision	Prior to A.02.00

Remote Command	<code>[:SENSe] :SWEep:TIME:GATE:LEVel HIGH LOW</code> <code>[:SENSe] :SWEep:TIME:GATE:LEVel?</code> ESA compatibility
Preset	HIGH
Initial S/W Revision	Prior to A.02.00

Points

Sets the number of points per sweep. The resolution of setting the sweep time depends on the number of points selected. The current value of points is displayed parenthetically, next to the sweep time in the lower-right corner of the display.

Key Path	Sweep/Control
Mode	SA, WCDMA, C2K, WIMAX OFDMA, TD-SCDMA, 1xEVDO, ISDB-T, CMMB, LTE, LTETDD, BLUETOOTH, WLAN, MSR, LTEAFDD, LTEATDD
Remote Command	<code>[:SENSe] :OBWidth:SWEep:POINts <integer></code> <code>[:SENSe] :OBWidth:SWEep:POINts?</code>
Example	OBW:SWE:POIN 1500 OBW:SWE:POIN?
Notes	This function is not available when signal identification is set to On (external mixing). Affected by: log sweep Grayed out in measurements that don't support swept Blanked in modes that do not support swept. Whenever the number of sweep points change: - All trace data is erased - Any traces with Update Off also go to Display Off (like going from View to Blank in the older analyzers) - Sweep time is re-quantized - Any limit lines that are on are updated - If averaging/hold is on, averaging/hold starts over
Couplings	Whenever the number of sweep points change, the sweep time is re-quantized.
Preset	LTE, LTETDD, MSR, LTEAFDD, LTEATDD: 2001 Other: 1001
State Saved	Saved in instrument state.
Min	101
Max	20001
Initial S/W Revision	Prior to A.02.00
Modified at S/W Revision	A.03.00

System

See "System" on page 353

Trace/Detector

Accesses a menu of functions that enable you to control the detectors for the current measurement.

Key Path	Front-panel key
Initial S/W Revision	Prior to A.02.00

Trace Type

Allows you to select the type of trace you want to use for the current measurement.

The first page of this menu contains a 1-of-N selection of the trace type (Clear Write, Average, Max Hold, Min Hold) for the selected trace.

Key Path	Trace/Detector
Mode	SA, WCDMA, C2K, WIMAX OFDMA, TD-SCDMA, 1xEVDO, ISDB-T, CMMB, LTE, LTETDD, BLUETOOTH, WLAN, MSR, LTEAFDD, LTEATDD
Remote Command	:TRACe:OBWidth:TYPE WRITe AVERAge MAXHold MINHold :TRACe:OBWidth:TYPE?
Example	TRAC:OBW:TYPE MINH TRAC:OBW:TYPE?
Notes	WRITe = Clear Write AVERAge = Average MAXHold = Maximum Hold MINHold = Minimum Hold
Couplings	When Detector setting is "Auto" (:SENSe]:OBWidth:DETEctor:AUTO?), Detector (:SENSe]:OBWidth:DETEctor[:FUNCTioN]?) switches aligning with the switch of this parameter: "NORMal" with WRITe (Clear Write), "AVERAge" with AVERAge, "POSitive (peak)" with MAXHold, and "NEGative (peak)" with MINHold.
Preset	AVERAge BLUETOOTH: MAX HOLD.
State Saved	Saved in instrument state.
Range	WRITe AVERAge MAXHold MINHold
Initial S/W Revision	Prior to A.02.00
Modified at S/W Revision	A.03.00

Detector

Accesses a menu of functions that enables you to control the detectors for the current measurement. The following choices are available:

- **Auto**– the detector selected depends on marker functions, trace functions, average type, and the trace averaging function.

- **Normal**–the detector determines the peak of the CW-like signals, and it yields alternating maximums and minimums of noise-like signals. This is also referred to as Rosenfell detection.
- **Average**–the detector determines the average of the signal within the sweep points. The averaging method depends upon the Average Type selection (voltage, power or log scales).
- **Peak (Positive)**–the detector determines the maximum of the signal within the sweep points.
- **Sample**–the detector indicates the instantaneous level of the signal at the center of the sweep points represented by each display point.
- **Negative Peak**–the detector determines the minimum of the signal within the sweep points.

Key Path	Detector
Initial S/W Revision	Prior to A.02.00

Auto

When the detector choice is Auto, the analyzer selects the detector. The selected detector depends on marker functions, trace functions, and trace averaging functions for the current measurement.

Key Path	Trace/Detector
Remote Command	<code>[[:SENSe]:OBWidth:DETECTOR:AUTO ON OFF 1 0</code> <code>[[:SENSe]:OBWidth:DETECTOR:AUTO?</code>
Example	OBW:DET:AUTO ON OBW:DET:AUTO?
Couplings	When Detector setting is “Auto” (<code>[[:SENSe]:OBWidth:DETECTOR:AUTO?</code>), Detector (<code>[[:SENSe]:OBWidth:DETECTOR[:FUNCTION]?</code>) switches aligning with the switch of this parameter: “NORMal” with Clear Write, “AVERage” with AVERage, “POSitive (peak)” with MAXHold, and “NEGative (peak)” with MINHold.
Preset	ON ISDB-T: OFF
State Saved	Saved in instrument state.
Initial S/W Revision	Prior to A.02.00
Modified at S/W Revision	A.03.00

Detector Selection

Allows you to select a specific detector for the current measurement. When the detector choice is Auto, the analyzer selects the detector. The selected detector depends on marker functions, trace functions, and trace averaging functions for the current measurement.

Key Path	Trace/Detector
Mode	SA, WCDMA, C2K, WIMAX OFDMA, TD-SCDMA, 1xEVDO, ISDB-T, CMMB, LTE, LTE4DD, BLUETOOTH, WLAN, MSR, LTEAFDD, LTEATDD

Remote Command	<code>[[:SENSe]:OBWidth:DETEctor[:FUNction] NORMal AVERage POSitive SAMPlE NEGative [:SENSe]:OBWidth:DETEctor[:FUNction]?</code>
Example	<code>OBW:DET NORM OBW:DET?</code>
Notes	<p>When you manually select a detector (instead of selecting Auto), that detector is used regardless of other analyzer settings.</p> <p>The detector choices are:</p> <p>The Normal detector determines the peak of CW-like signals, and it yields alternating maximums and minimums of noise-like signals. This is also referred to as Rosenfell detection.</p> <p>The Average detector determines the average of the signal within the sweep points. The averaging method is Power Average (RMS).</p> <p>The Peak detector determines the maximum of the signal within the sweep points.</p> <p>The Sample detector indicates the instantaneous level of the signal at the center of the sweep points represented by each display point.</p> <p>The Negative Peak detector determines the minimum of the signal within the sweep points.</p>
Couplings	When Detector setting is "Auto" (<code>[[:SENSe]:OBWidth:DETEctor:AUTO?</code>), Detector (<code>[[:SENSe]:OBWidth:DETEctor[:FUNction]?</code>) switches aligning with the switch of this parameter: "NORMal" with Clear Write, "AVERage" with AVERage, "POSitive (peak)" with MAXHold, and "NEGative (peak)" with MINHold.
Preset	AVERage ISDB-T: Peak BLUETOOTH: Peak
State Saved	Saved in instrument state.
Range	Normal Average Peak Sample Negative Peak
Initial S/W Revision	Prior to A.02.00
Modified at S/W Revision	A.03.00

Trigger

See ["Trigger" on page 428](#)

Free Run

See ["Free Run " on page 435](#)

Video

See ["Video \(IF Envelope\) " on page 436](#)

Trigger Level

See ["Trigger Level " on page 436](#)

Trig Slope

See ["Trig Slope " on page 437](#)

Trig Delay

See ["Trig Delay " on page 438](#)

Line

See ["Line " on page 2105](#)

Trig Slope

See ["Trig Slope " on page 2105](#)

Trig Delay

See ["Trig Delay " on page 440](#)

External 1

See ["External 1 " on page 2118](#)

Trigger Level

See ["Trigger Level " on page 2118](#)

Trig Slope

See ["Trig Slope " on page 2119](#)

Trig Delay

See ["Trig Delay " on page 443](#)

Zero Span Delay Comp

See ["Zero Span Delay Comp On/Off" on page 2107](#)

External 2

See "[External 2](#) " on page 2120

Trigger Level

See "[Trigger Level](#) " on page 2120

Trig Slope

See "[Trig Slope](#) " on page 2121

Trig Delay

See "[Trig Delay](#) " on page 445

Zero Span Delay Comp

See "[Zero Span Delay Comp On/Off](#)" on page 2109

RF Burst

See "[RF Burst](#) " on page 2121

Absolute Trigger

See "[Absolute Trigger Level](#)" on page 2122

Relative Trigger

See "[Relative Trigger Level](#)" on page 2111

Trig Slope

See "[Trigger Slope](#) " on page 2123

Trig Delay

See "[Trig Delay](#) " on page 450

Periodic Timer

See "[Periodic Timer \(Frame Trigger\)](#) " on page 2113

Period

See "[Period](#) " on page 2114

Offset

See "[Offset](#) " on page 2115

Reset Offset Display

See "[Reset Offset Display](#) " on page 2117

Sync Source

See ["Sync Source "](#) on page 2117

Off

See ["Off "](#) on page 2118

External 1

See ["External 1 "](#) on page 2118

Trigger Level

See ["Trigger Level "](#) on page 2118

Trig Slope

See ["Trig Slope "](#) on page 2119

External 2

See ["External 2 "](#) on page 2120

Trigger Level

See ["Trigger Level "](#) on page 2120

Trig Slope

See ["Trig Slope "](#) on page 2121

RF Burst

See ["RF Burst "](#) on page 2121

Absolute Trigger

See ["Absolute Trigger Level"](#) on page 2122

Trig Slope

See ["Trigger Slope "](#) on page 2123

Trig Delay

See ["Trig Delay"](#) on page 460

Auto/Holdoff

See ["Auto/Holdoff "](#) on page 461

Auto Trig

See ["Auto Trig "](#) on page 461

Trig Holdoff

See ["Trig Holdoff "](#) on page 462

User Preset

Accesses a menu that gives you the following three choices:

- User Preset – recalls a state previously saved using the Save User Preset function.
- User Preset All Modes – presets all of the modes in the analyzer
- Save User Preset– saves the current state for the current mode

Key Path	Front-panel key
Backwards Compatibility Notes	<p>User Preset is actually loading a state, and in legacy analyzers, it was possible to load a state without affecting the trace data, limit lines or correction data. Similarly it was possible to do a User Preset without affecting the trace data, limit lines or correction data.</p> <p>In the X-Series, “state” always includes all of this data; so whenever state is loaded, or User Preset is executed, all of the traces, limit lines and corrections are affected. Although this differs from previous behavior, it is desirable behavior, and should not cause adverse issues for users.</p> <p>On ESA and PSA, User Preset affected the entire instrument’s state. In the X-Series, User Preset only recalls the state for the active mode. There is a User Preset file for each mode. User Preset can never cause a mode switch as it can in legacy analyzers. If you want to recall all modes to their user preset file state, you will need to do a User Preset after mode switching into each mode.</p> <p>User Preset recalls mode state which can now include data like traces; whereas on ESA and PSA, User Preset did not affect data.</p>
Initial S/W Revision	Prior to A.02.00

User Preset

User Preset sets the state of the currently active mode back to the state that was previously saved for this mode using the Save User Preset menu key or the SCPI command, SYST:PRES:USER:SAV. It not only recalls the Mode Preset settings, but it also recalls all of the mode persistent settings, and the Input/Output system setting that existed at the time Save User Preset was executed.

If a Save User Preset has not been done at any time, User Preset recalls the default user preset file for the currently active mode. The default user preset files are created if, at power-on, a mode detects there is no user preset file. There will never be a scenario when there is no user preset file to restore. For each mode, the default user preset state is the same state that would be saved if a Save User Preset is performed in each mode right after doing a Restore Mode Default and after a Restore Input/Output Defaults.

The User Preset function does the following:

- Aborts the currently running measurement.
- Sets the mode State to the values defined by Save User Preset.
- Makes the saved measurement for the currently running mode the active measurement.
- Brings up the saved menu for the power-on mode.
- Clears the input and output buffers.
- Sets the Status Byte to 0.

Key Path	User Preset
Remote Command	:SYSTem:PRESet:USER
Example	:SYST:PRES:USER:SAVE:SYST:PRES:USER
Notes	:SYST:PRES:USER:SAVE is used to save the current state as the user preset state. Clears all pending OPC bits. The Status Byte is set to 0. Pressing the User Preset front-panel key while already in the User Preset menu will cause the User Preset to get executed
Couplings	A user preset will cause the currently running measurement to be aborted and cause the saved measurement to be active. Recalling a User Preset file has the same issues that recalling a Save State file has. Some settings may need to be limited and therefore re-coupled, since the capabilities of the mode may have changes when the User Preset file was last saved.
Initial S/W Revision	Prior to A.02.00

User Preset All Modes

Recalls all of the User Preset files for each mode, switches to the power-on mode, and activates the saved measurement from the power-on mode User Preset file.

NOTE

When the instrument is secured, all of the user preset files are converted back to their default user preset files.

The User Preset function does the following:

- Aborts the currently running measurement.
- Switches the Mode to the power-on mode.
- Restores the User Preset files for each mode.
- Makes the saved measurement for the power-on mode the active measurement.
- Brings up the saved menu for the power-on mode.
- Clears the input and output buffers.
- Sets the Status Byte to 0.

Key Path	User Preset
Remote Command	:SYSTem:PRESet:USER:ALL
Example	:SYST:PRES:USER:SAVE:SYST:PRES:USER:ALL
Notes	Clears all pending OPC bits. The Status Byte is set to 0. :SYST:PRES:USER:SAVE is used to save the current state as the user preset state.
Couplings	A user preset will cause the currently running measurement to be aborted, cause a mode switch to the power-on mode, and cause the saved measurement to be active in the power-on mode. Recalling a User Preset file has the same issues that recalling a Save State file has. Some settings may need to be limited and therefore re-coupled, since the capabilities of the mode may have changes when the User Preset file was last saved.
Initial S/W Revision	Prior to A.02.00

Save User Preset

Saves the currently active mode and its State. You can recall this User Preset file by pressing the User Preset menu key or sending the SYST:PRES:USER remote command. This same state is also saved by the Save State function.

Key Path	User Preset
Remote Command	:SYSTem:PRESet:USER:SAVE
Example	:SYST:PRES:USER:SAVE
Notes	:SYST:PRES:SAVE creates the same file as if the user requested a *SAV or a MMEM:STOR:STAT, except User Preset Save does not allow the user to specify the filename or the location of the file.
Initial S/W Revision	Prior to A.02.00

View/Display

Accesses a menu of functions that enable you to set the view and display parameters for the current measurement.

There is a single results view available for this measurement. For more details, and samples of screen content for each supported mode, see "[Spectrum View](#)" on page 821 below.

The following result descriptions are available:

Occupied Bandwidth

The occupied bandwidth result is $f_2 - f_1$, where f_1 and f_2 are calculated.

Total Power

The total power is the power integrated in the specified span setting.

Transmit Freq Error

The transmit freq error (transmit frequency error) result is calculated as the difference between $(f_2+f_1)/2$ and the tuned center frequency of the signal, where f_1 and f_2 are calculated.

x dB Bandwidth

The x dB result is a bandwidth measured between two points on the signal which are a certain number of dBs down from the highest signal point within the OBW Span. For example, If the 'x dB' parameter is set to -26 dB, and the 'Occupied BW Span' is set to 10 MHz, then the maximum signal power level is first determined from the 10 MHz wide trace sweep. Next, the two furthest frequencies below (x_{db_f1}) and above (x_{db_f2}) the frequency of the maximum level occurrence are found where the signal level is 26 dB below the peak level. This calculation also uses linear interpolation to find the lower and upper carrier boundary point within the width of a sweep point (the span divided by the number of sweep points).

The x dB bandwidth is calculated to be $x_{db_f2} - x_{db_f1}$.

Spectrum View

For SA, WCDMA, C2K, 1xEVDO, WIMAX OFDMA, WLAN modes:

9 Occupied Bandwidth Measurement
View/Display

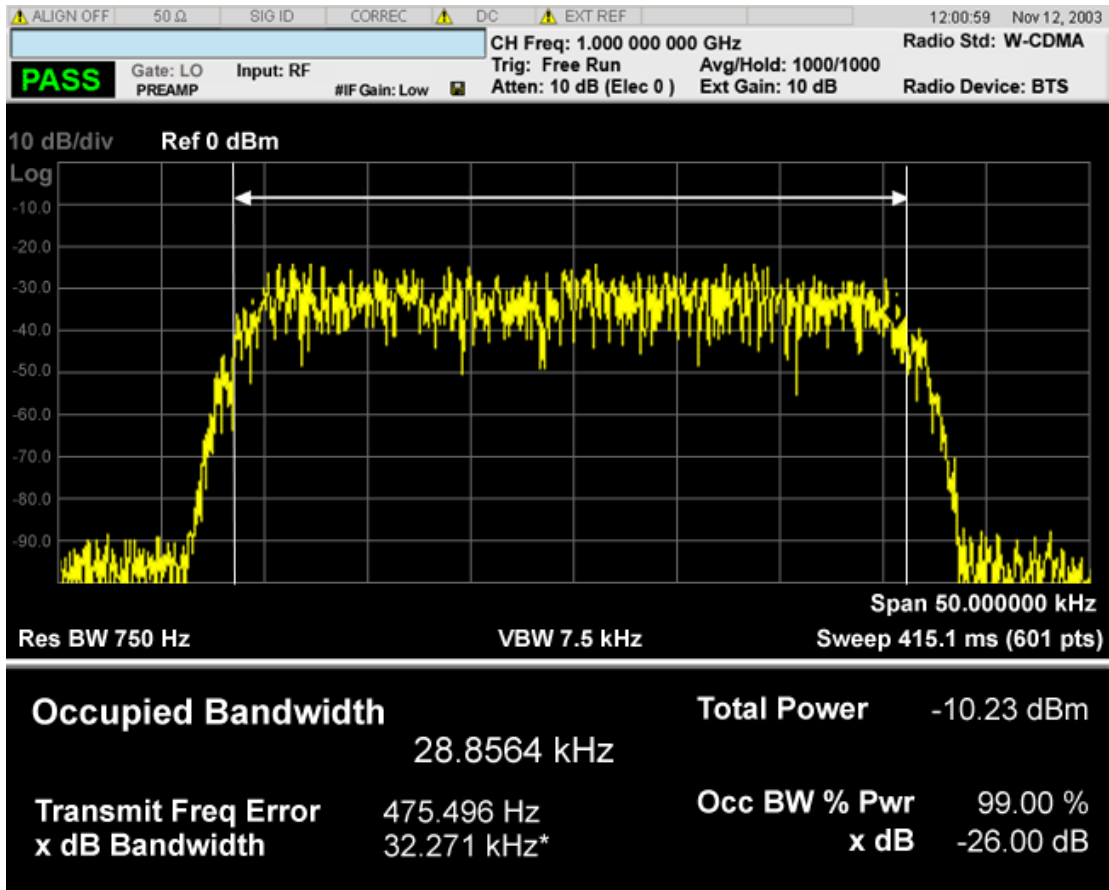

For TD-SCDMA mode only:

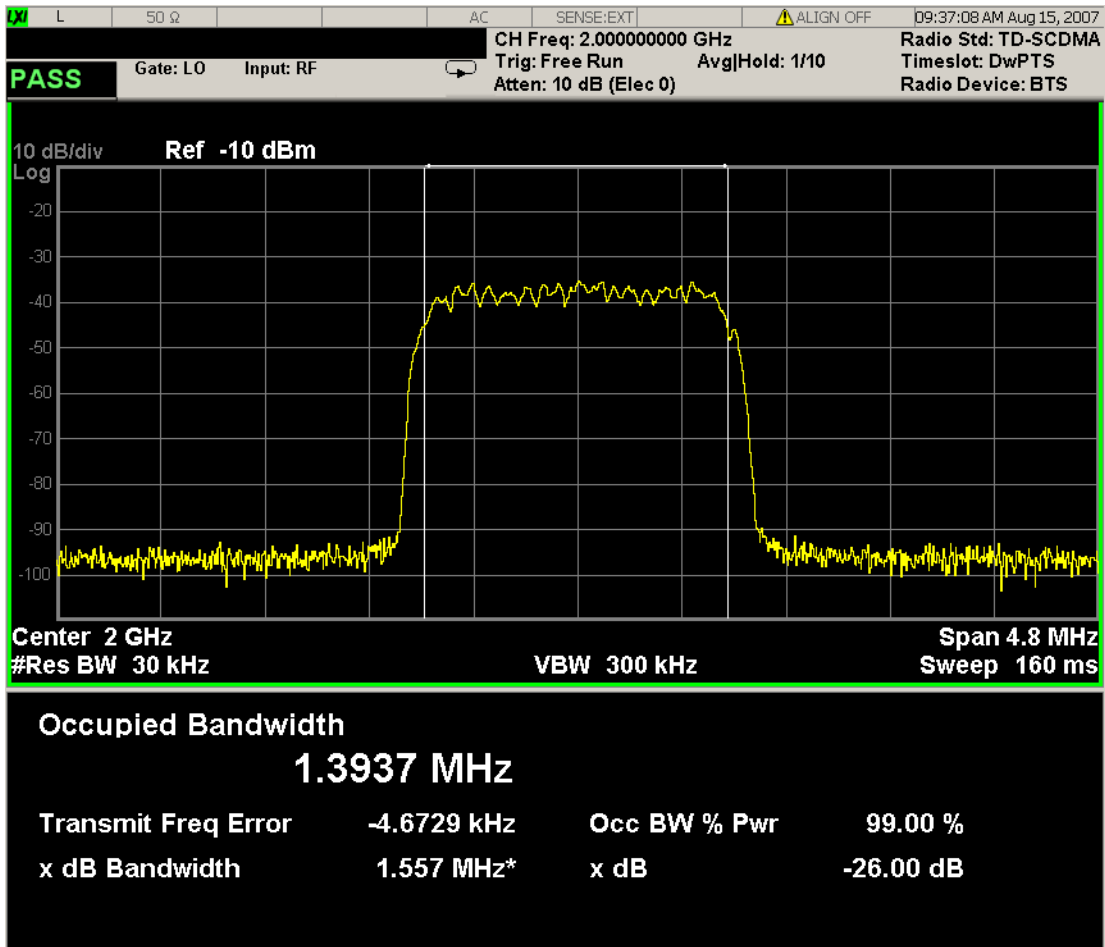

For Bluetooth mode only:

9 Occupied Bandwidth Measurement
View/Display

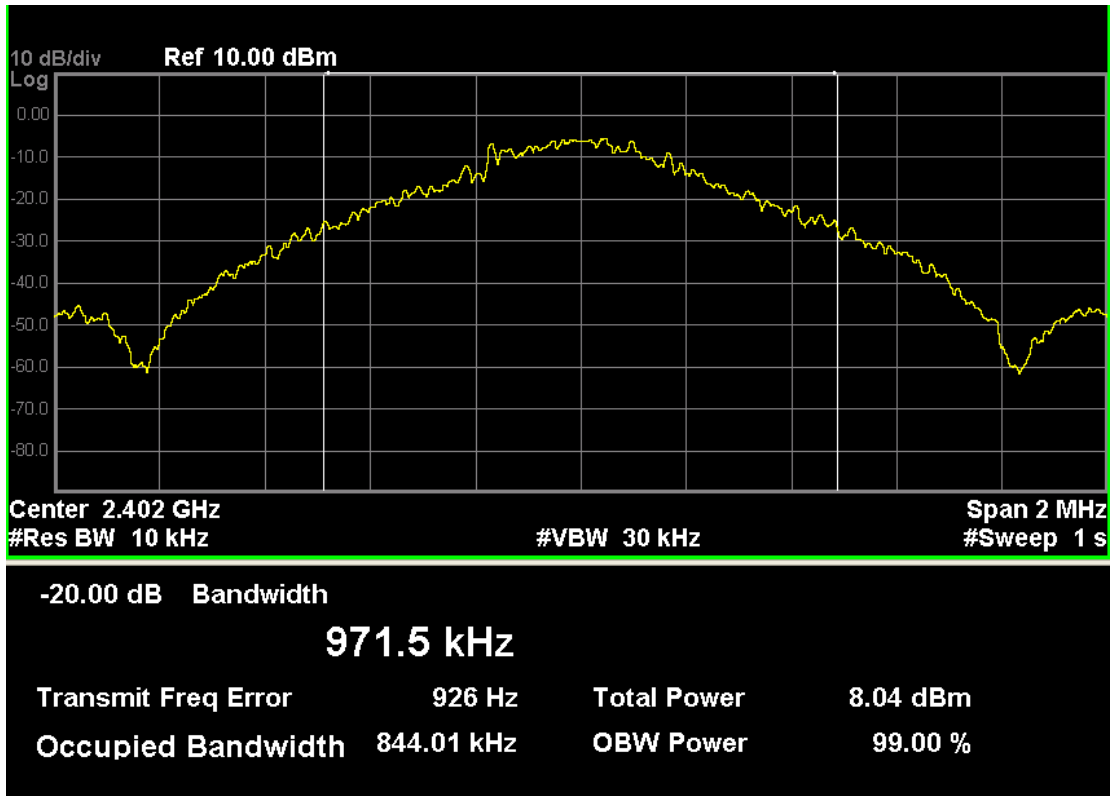

For MSR mode only:

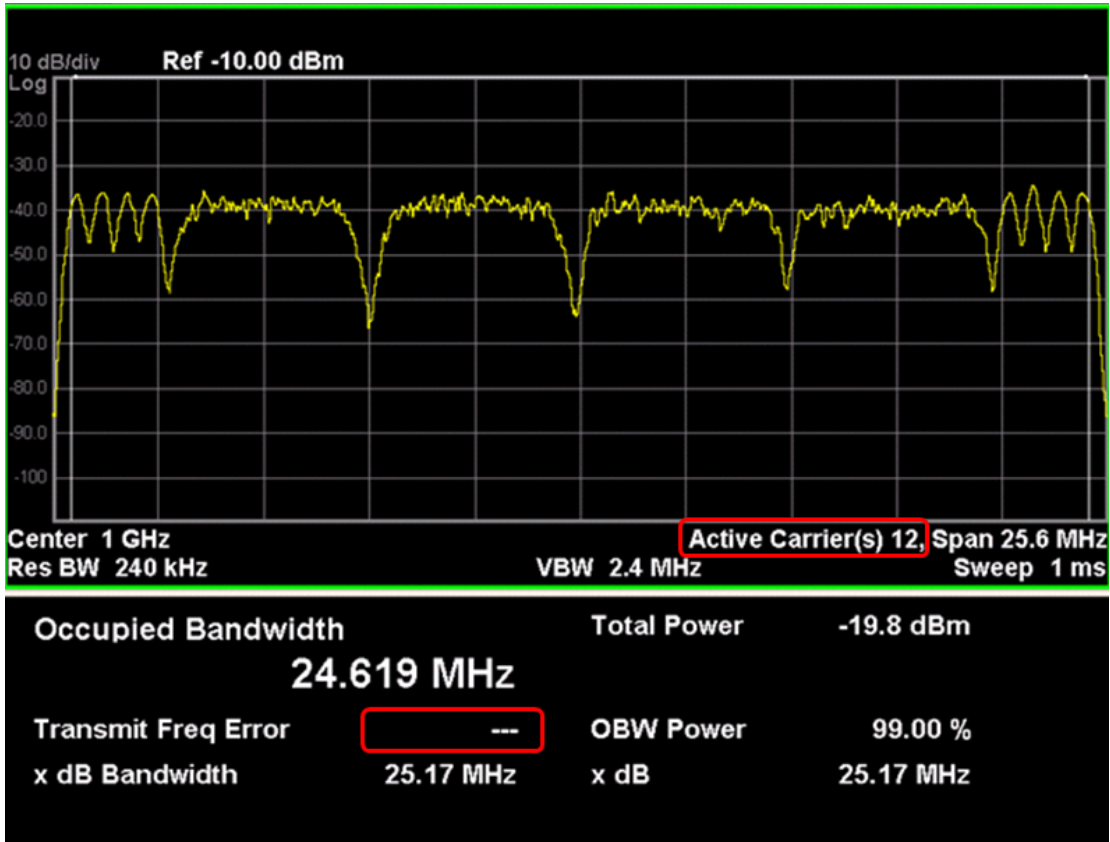

The number of active carriers is displayed. Since span is determined from detected carriers in auto mode, it is necessary to show how many carriers are identified as active., as highlighted above.

When there is one active carrier, Transmit Freq Error is displayed. Otherwise, “---” is displayed, as shown above.

For LTE-Advanced FDD/TDD mode only:

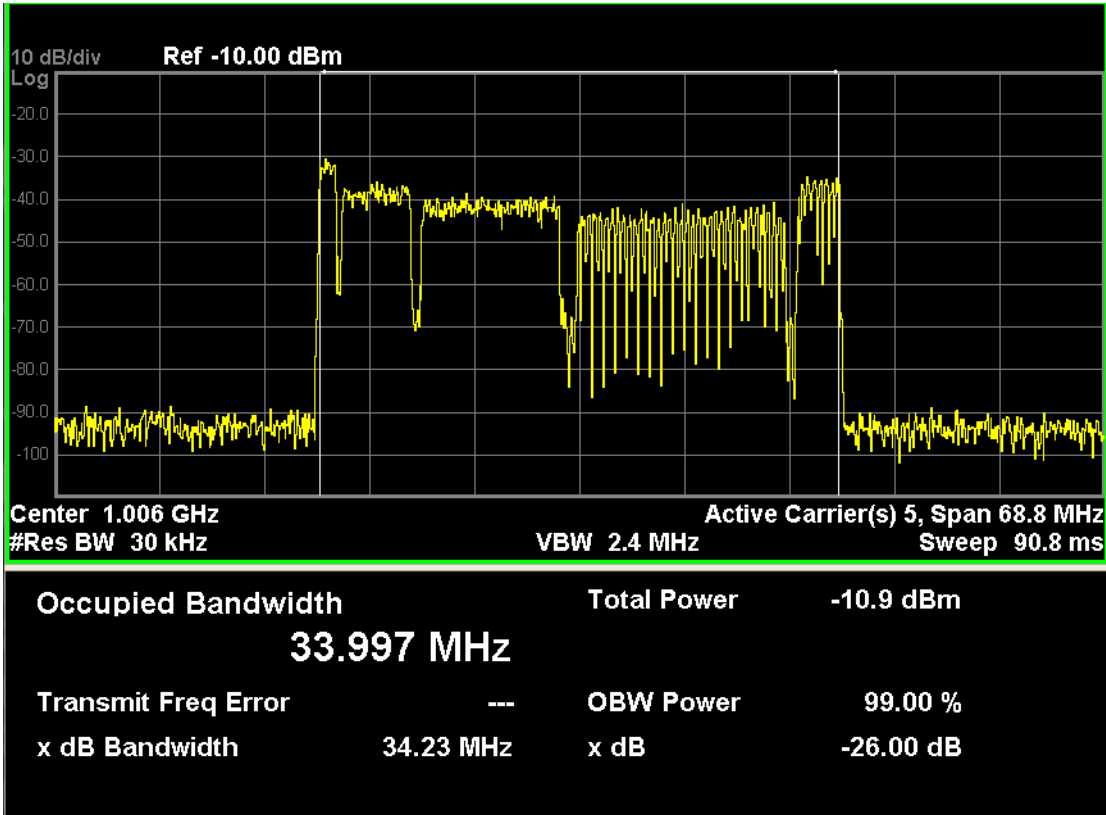

The number of active carriers is displayed to show how many carriers are identified as active in auto detected mode of span, otherwise “-” is displayed to indicate that it is out of scope.

When there is one active carrier, Transmit Freq Error is displayed. Otherwise, “---” is displayed.

Key Path	Front-panel key
Initial S/W Revision	Prior to A.02.00

Display

The Display menu is common to most measurements, and is used for configuring items on the display. Some Display menu settings apply to all the measurements in a mode, and some only to the current measurement. Those under the System Display Settings key apply to all measurements in all modes.

Key Path	Display
Key Path	View/Display
Initial S/W Revision	Prior to A.02.00

Annotation

Turns on and off various parts of the display annotation. The annotation is divided up into four categories:

1. Meas Bar: This is the measurement bar at the top of the screen. It does not include the settings panel or the Active Function. Turning off the Meas Bar turns off the settings panel and the Active Function. When the Meas Bar is off, the graticule area expands to fill the area formerly occupied by the Meas Bar.
2. Screen Annotation: this is the annotation and annunciation around the graticule, including any annotation on lines (such as the display line, the threshold line, etc.) This does NOT include the marker number or the N dB result. When off, the graticule expands to fill the entire graticule area.
3. Trace annotation: these are the labels on the traces, showing their detector (or their math mode).
4. Active Function annotation: this is the active function display in the meas bar, and all of the active function values displayed on softkeys.

See the figure below. Each type of annotation can be turned on and off individually.

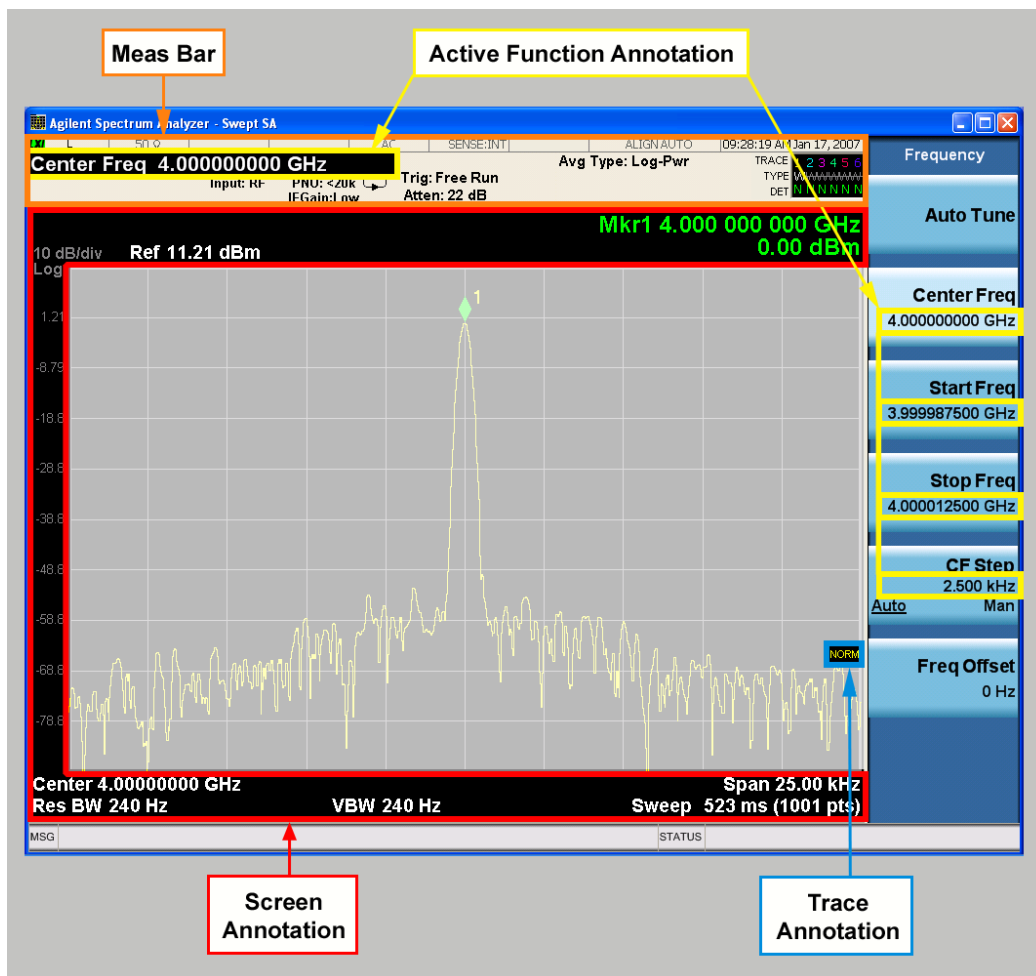

Key Path	View/Display, Display
Initial S/W Revision	Prior to A.02.00

Meas Bar On/Off

This function turns the Measurement Bar on and off, including the settings panel. When off, the graticule area expands to fill the area formerly occupied by the Measurement Bar.

Key Path	View/Display, Display, Annotation
Remote Command	:DISPlay:ANNotation:MBAR[:STATe] OFF ON 0 1 :DISPlay:ANNotation:MBAR[:STATe]?
Example	DISP:ANN:MBAR OFF
Dependencies	Grayed out and forced to OFF when System Display Settings, Annotation is set to Off.
Preset	On This should remain Off through a Preset when System DisplaySettings, Annotation is set to Off.
State Saved	Saved in instrument state.
Initial S/W Revision	Prior to A.02.00

Screen

This controls the display of the annunciation and annotation around the graticule, including any annotation on lines (such as the display line, the threshold line, etc.) and the y-axis annotation. This does NOT include marker annotation (or the N dB result). When off, the graticule expands to fill the entire graticule area, leaving only the 1.5% gap above the graticule as described in the Trace/Detector chapter.

Key Path	View/Display, Display, Annotation
Remote Command	:DISPlay:ANNotation:SCReen[:STATe] OFF ON 0 1 :DISPlay:ANNotation:SCReen[:STATe]?
Example	DISP:ANN:SCR OFF
Dependencies	Grayed-out and forced to OFF when System Display Settings, Annotation is set to Off.
Preset	On This should remain Off through a Preset when System DisplaySettings, Annotation is set to Off
State Saved	Saved in instrument state.
Initial S/W Revision	Prior to A.02.00

Active Function Values On/Off

Turns on and off the active function display in the Meas Bar, and all of the active function values displayed on the softkeys.

Note that all of the softkeys that have active functions have these numeric values blanked when this function is on. This is a security feature..

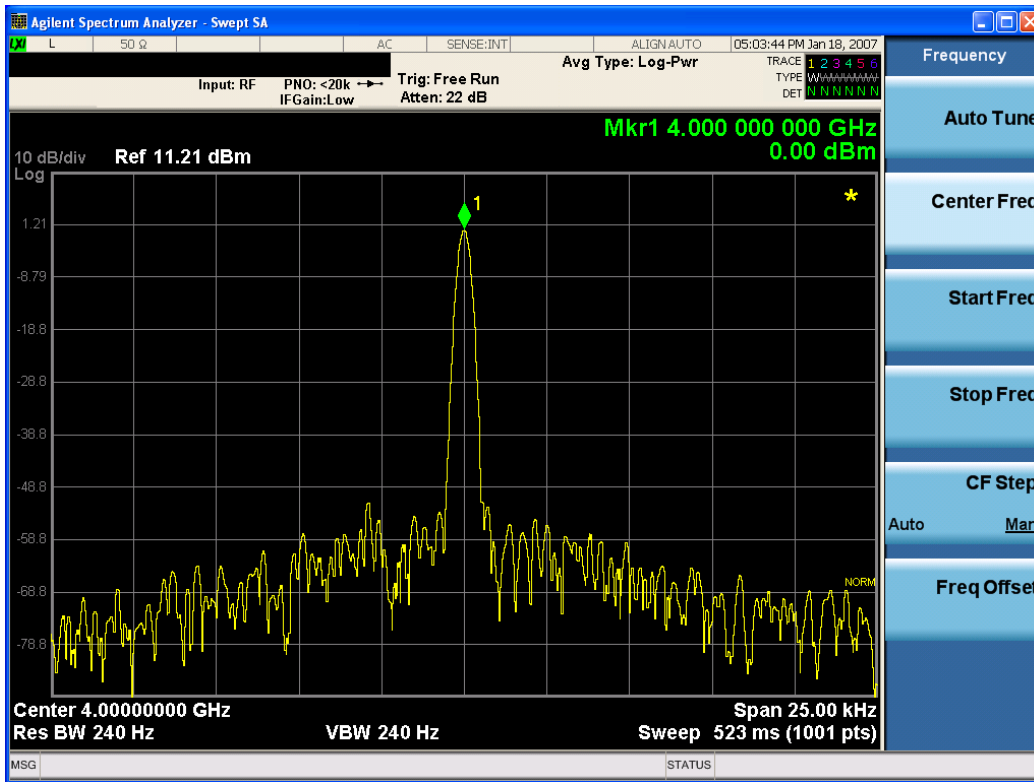

Key Path	View/Display, Display, Annotation
Remote Command	:DISPlay:ACTivefunc[:STATE] ON OFF 1 0 :DISPlay:ACTivefunc[:STATE]?
Example	DISP:ACT OFF
Dependencies	Grayed out and forced to OFF when System Display Settings, Annotation is set to Off.
Preset	On This should remain Off through a Preset when System DisplaySettings, Annotation is set to Off
State Saved	Saved in instrument state.
Initial S/W Revision	Prior to A.02.00

Title

Displays menu keys that enable you to change or clear a title on your display.

Key Path	View/Display, Display
Initial S/W Revision	Prior to A.02.00

Change Title

Writes a title into the "measurement name" field in the banner, for example, "Swept SA".

Press Change Title to enter a new title through the alpha editor. Press Enter or Return to complete the entry. Press ESC to cancel the entry and preserve your existing title.

The display title will replace the measurement name. It remains for this measurement until you press Change Title again, or you recall a state, or a Preset is performed. A title can also be cleared by pressing Title, Clear Title.

NOTE

Notice the inclusion of the <measurement> parameter in the command below. Because each measurement remembers the Display Title, the command must be qualified with the measurement name. For the Swept SA measurement this is not the case; no <measurement> parameter is used when changing the Display Title for the Swept SA measurement.

Key Path	View/Display, Display, Title
Mode	All
Remote Command	:DISPlay:<measurement>:ANNotation:TITLe:DATA <string> :DISPlay:<measurement>:ANNotation:TITLe:DATA?
Example	DISP:ANN:TITL:DATA "This Is My Title" This example is for the Swept SA measurement in the Spectrum Analyzer mode. The SANalyzer <measurement> name is not used. DISP:ACP:ANN:TITL:DATA "This Is My Title" This example is for Measurements other than Swept SA. Both set the title to: This Is My Title
Notes	Pressing this key cancels any active function. When a title is edited the previous title remains intact (it is not cleared) and the cursor goes at the end so that characters can be added or BKSP can be used to go back over previous characters.
Preset	No title (measurement name instead)
State Saved	Saved in instrument state.
Initial S/W Revision	Prior to A.02.00

Clear Title

Clears a title from the front-panel display. Once cleared, the title cannot be retrieved. After the title is cleared, the current Measurement Name replaces it in the title bar.

Key Path	View/Display, Display, Title
Example	The following commands clear the title and restore the measurement's original title: DISP:ANN:TITL:DATA "" This example is for the Swept SA measurement in the Spectrum Analyzer mode. The SANalyzer <measurement> name is not used. DISP:ACP:ANN:TITL:DATA "" This example is for ACP; in measurements other than Swept SA the measurement name is required.
Notes	Uses the :DISPlay:<measurement>:ANNotation:TITLe:DATA <string> command with an empty string (in the Swept SA, the <measurement> is omitted).
Preset	Performed on Preset.
Initial S/W Revision	Prior to A.02.00

Graticule

Pressing Graticule turns the display graticule On or Off. It also turns the graticule y-axis annotation on and off.

Key Path	View/Display, Display
Remote Command	:DISPlay:WINDow[1]:TRACe:GRATicule:GRID[:STATe] OFF ON 0 1 :DISPlay:WINDow[1]:TRACe:GRATicule:GRID[:STATe]?
Example	DISP:WIND:TRAC:GRAT:GRID OFF
Notes	The graticule is the set of horizontal and vertical lines that make up the grid/divisions for the x-axis and y-axis.
Preset	On
State Saved	Saved in instrument state
Initial S/W Revision	Prior to A.02.00

System Display Settings

These settings are "Mode Global" – they affect all modes and measurements and are reset only by Restore Misc Defaults or Restore System Defaults under System.

Key Path	View/Display, Display
Initial S/W Revision	Prior to A.02.00

Annotation Local Settings

This is a Mode Global override of the meas local annotation settings. When it is All Off, it forces ScreenAnnotation, Meas Bar, Trace, and Active Function Values settings to be OFF for all measurements in all modes. This provides the security based "annotation off" function of previous analyzers; hence it uses the legacy SCPI command.

When it is All Off, the Screen, Meas Bar, Trace, and Active Function Values keys under the Display, Annotation menu are grayed out and forced to Off. When Local Settings is selected, you are able to set the local annotation settings on a measurement by measurement basis.

Key Path	View/Display, Display, System Display Settings
Remote Command	:DISPlay:WINDow[1]:ANNOtation[:ALL] OFF ON 0 1 :DISPlay:WINDow[1]:ANNOtation[:ALL]?
Example	:DISP:WIND:ANN OFF
Preset	On (Set by Restore Misc Defaults)
State Saved	Not saved in instrument state.
Backwards Compatibility Notes	The WINDow parameter and optional subopcode is included for backwards compatibility but ignored – all windows are equally affected.
Initial S/W Revision	Prior to A.02.00

Themes

Accesses a menu of functions that enable you to choose the theme to be used when saving the screen image.

The **Themes** option is the same as the **Themes** option under the **Display** and **Page Setup** dialogs. It allows you to choose between themes to be used when saving the screen image.

Key Path	Save, Screen Image
Remote Command	:MMEMory:STORe:SCReen:THEMe TDColor TDMonochrome FCOLor FMONochrome :MMEMory:STORe:SCReen:THEMe?
Example	:MMEM:STOR:SCR:THEM TDM
Preset	3D Color; Is not part of Preset, but is reset by Restore Misc Defaults or Restore System Defaults All and survives subsequent running of the modes.
Readback	3D Color 3D Mono Flat Color Flat Mono
Backwards Compatibility Notes	In ESA and PSA we offer the choice of "Reverse Bitmap" or "Reverse Metafile" when saving screen images. This is much like the "Flat Color" theme available in X-Series. Also, if you selected Reverse Bitmap AND a black & white screen image, that would be much like "Flat Monochrome". In other words, each of the X-Series themes has a similar screen image type in ESA/PSA. But they are not identical.
Initial S/W Revision	Prior to A.02.00

3D Color

Selects a standard color theme with each object filled, shaded and colored as designed.

Key Path	Save, Screen Image, Themes
Example	MMEM:STOR:SCR:THEM TDC
Readback	3D Color
Initial S/W Revision	Prior to A.02.00

3D Monochrome

Selects a format that is like 3D color but shades of gray are used instead of colors.

Key Path	Save, Screen Image, Themes
Example	MMEM:STOR:SCR:THEM TDM
Readback	3D Mono
Initial S/W Revision	Prior to A.02.00

Flat Color

Selects a format that is best when the screen is to be printed on an ink printer.

Key Path	Save, Screen Image, Themes
Example	MMEM:STOR:SCR:THEM FCOL
Readback	Flat Color
Initial S/W Revision	Prior to A.02.00

Flat Monochrome

Selects a format that is like Flat Color. But only black is used (no colors, not even gray), and no fill.

Key Path	Save, Screen Image, Themes
Example	MMEM:STOR:SCR:THEM FMON
Readback	Flat Mono
Initial S/W Revision	Prior to A.02.00

Backlight

Accesses the display backlight on/off keys. This setting may interact with settings under the Windows "Power" menu.

When the backlight is off, pressing ESC, TAB, SPACE, ENTER, UP, DOWN, LEFT, RIGHT, DEL, BKSP, CTRL, or ALT turns the backlight on without affecting the application. Pressing any other key will turn backlight on and could potentially perform the action as well.

Key Path	View/Display, Display, System Display Settings
Remote Command	:DISPlay:BACKlight ON OFF :DISPlay:BACKlight?
Preset	ON (Set by Restore Misc Defaults)
Initial S/W Revision	Prior to A.02.00

Backlight Intensity

An active function used to set the backlight intensity. It goes from 0 to 100 where 100 is full on and 0 is off. This value is independent of the values set under the Backlight on/off key.

Key Path	View/Display, Display, System Display Settings
Remote Command	:DISPlay:BACKlight:INTensity <integer> :DISPlay:BACKlight:INTensity?
Example	DISP:BACK:INT 50

9 Occupied Bandwidth Measurement
View/Display

Preset	100 (Set by Restore Misc Defaults)
Min	0
Max	100
Initial S/W Revision	Prior to A.02.00

10 Power Stat CCDF Measurement

Many of the digitally modulated signals now look noise-like in the time and frequency domain. This means that statistical measurements of the signals can be a useful characterization. The Power Complementary Cumulative Distribution Function (CCDF) curves characterize the higher level power statistics of a digitally modulated signal. The curves can be useful in determining design parameters for digital communications systems.

For more details, see ["Power Stat CCDF Measurement Description" on page 839](#).

For measurement results and views, see ["View/Display" on page 960](#).

This topic contains the following sections:

["Measurement Commands for Power Stat CCDF" on page 836](#)

["Remote Command Results for Power Stat CCDF" on page 837](#)

["Power Stat CCDF Measurement Description" on page 839](#)

Measurement Commands for Power Stat CCDF

The following commands and queries can be used to retrieve the measurement results:

`:CONFigure:PSStatistic`

`:CONFigure:PSStatistic:NDEFault`

`:INITiate:PSStatistic`

`:FETCh:PSStatistic[n]?`

`:READ:PSStatistic[n]?`

`:MEASure:PSStatistic[n]?`

For more measurement related commands, see the SENSE subsystem, and the section "[Remote Measurement Functions](#)" on page 2213.

Remote Command Results for Power Stat CCDF

The following table describes the results returned by the FETCh, MEASure, and READ queries listed above, according to the index value n.

n	Results Returned
0	Returns unprocessed I/Q trace data, as a series of trace point values, in volts. The I values are listed first in each pair, using the 0 through even-indexed values. The Q values are the odd-indexed values,
not specified or 1	Returns 10 scalar results: <ol style="list-style-type: none"> 1. Average input power (in dBm) 2. Probability at the average input power level (in %) 3. Power level that has 10% of the power 4. Power level that has 1% of the power 5. Power level that has 0.1% of the power 6. Power level that has 0.01% of the power 7. Power level that has 0.001% of the power 8. Power level that has 0.0001% of the power 9. Peak power (in dB) 10.Count
2	Returns a series of 5001 floating point numbers (in percent) that represent the current measured power stat trace. This is the probability at particular power levels (average power), in the following order: <ol style="list-style-type: none"> 1. Probability at 0.0 dB power 2. Probability at 0.01 dB power 3. Probability at 0.02 dB power ... 5000. Probability at 49.9 dB power 5001. Probability at 50.0 dB power
3	Returns a series of 5001 floating point numbers (in percent) that represent the Gaussian trace. This is the probability at particular power levels (average power), in the following order: <ol style="list-style-type: none"> 1. Probability at 0.0 dB power 2. Probability at 0.01 dB power 3. Probability at 0.02 dB power ... 5000. Probability at 49.9 dB power 5001. Probability at 50.0 dB power
4	Returns a series of 5001 floating point numbers (in percent) that represent the user-definable reference trace. This is the probability at particular power levels (average power), in the following order: <ol style="list-style-type: none"> 1. Probability at 0.0 dB power 2. Probability at 0.01 dB power 3. Probability at 0.02 dB power ... 5000. Probability at 49.9 dB power 5001. Probability at 50.0 dB power

Power Stat CCDF Measurement Description

The power statistics CCDF measurement can be affected by many factors. For example, modulation filtering, modulation format, combining the multiple signals at different frequencies, number of active codes, and correlation between symbols on different codes with spread spectrum systems will all affect measurement results. These factors are all related to modulation and signal parameters. External factors such as signal compression and expansion by nonlinear components, group delay distortion from filtering, and power control within the observation interval also affect the measurement.

The power measured in power statistics CCDF curves is actually instantaneous envelope power defined by the equation:

$$P = (I^2 + Q^2) / Z_0$$

where I & Q are the quadrature voltage components of the waveform, and Z_0 is the characteristic impedance.

A CCDF curve is defined by how much time the waveform spends at or above a given power level. The percent of time the signal spends at or above the level defines the probability for that particular power level. For capturing a lower probability down to 0.0001%, this measurement is made in the single mode by pressing Single. To make the power statistics CCDF measurement, the instrument uses digital signal processing (DSP) to sample the input signal in the channel bandwidth. The Gaussian distribution line as the band-limited Gaussian noise CCDF reference line, the user-definable reference trace, and the currently measured trace can be displayed on a semi-log graph. If the currently measured trace is above the user reference trace, it means that the higher peak power levels against the average power are included in the input signal.

Key Path	Meas
Initial S/W Revision	Prior to A.02.00

AMPTD Y Scale

Accesses a menu of functions that enable you to set the vertical scale parameters. The parameter values are measurement independent except all Attenuation values, and the Internal Preamp selection, which are the same across all measurements.

Key Path	Front-panel key
Initial S/W Revision	Prior to A.02.00

Attenuation

This menu controls the attenuator functions and interactions between the attenuation system components.

There are two attenuator configurations in the X-Series. One is a dual attenuator configuration consisting of a mechanical attenuator and an optional electronic attenuator. The other configuration uses a single attenuator with combined mechanical and electronic sections that controls all the attenuation functions. Different models in the X-Series come with different configurations.

See ["Dual Attenuator Configurations:" on page 840](#)

See ["Single Attenuator Configuration:" on page 841](#)

Most Attenuation settings are the same for all measurements – they do not change as you change measurements. Settings like these are called “Meas Global” and are unaffected by Meas Preset.

Key Path	AMPTD Y Scale
Scope	Meas Global
Dependencies	In measurements that support the I/Q inputs, this key is unavailable when I/Q is the selected input, and is replaced by the Range key in that case.
Readback Line	Contains a summary in [] brackets of the current total attenuation. See the descriptions of the , " (Mech) Atten " on page 2160, and " Enable Elec Atten " on page 2162 keys for more detail on the contributors to the total attenuation. Note that when "Pre-Adjust for Min Clip" is on, this value can change at the start of every measurement.
Initial S/W Revision	Prior to A.02.00
Modified at S/W Revision	A.03.00

Dual Attenuator Configurations:

Configuration 1: Mechanical attenuator + optional electronic attenuator

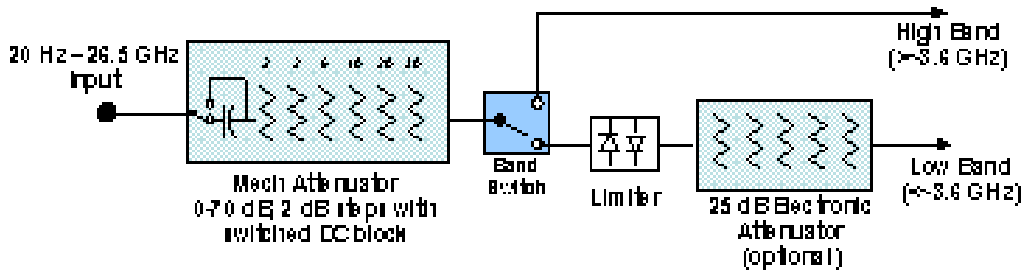

Configuration 2: Mechanical attenuator, no optional electronic attenuator

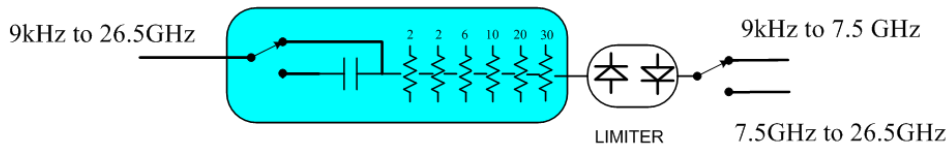

(note that Configuration 2 is not strictly speaking a dual-section attenuator, since there is no electronic section available. However, it behaves exactly like Configuration 1 without the Electronic Attenuator option EA3, therefore for the sake of this document it is grouped into the “Dual Attenuator” configuration)

Single Attenuator Configuration:

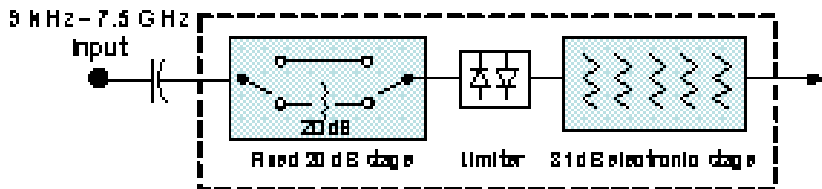

You can tell which attenuator configuration you have by pressing the Attenuation key, which (in most Modes) opens the Attenuation menu. If the first key in the Attenuation menu says Mech Atten you have the dual attenuator configuration. If the first key says Atten you have the single attenuator configuration.

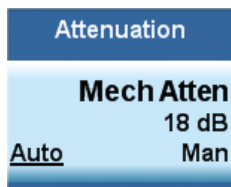

Dual Attenuator

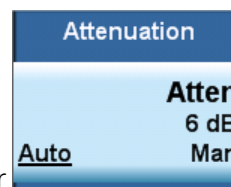

Single Attenuator

In the single attenuator configuration, you control the attenuation with a single control, as the fixed stage has only two states. In the dual attenuator configuration, both stages have significant range so you are given separate control of the mechanical and electronic attenuator stages.

When you have the dual attenuator configuration, you may still have only a single attenuator, because unless option EA3 (the Electronic Attenuator option) is available, and you purchase it, you will have only the mechanical attenuator.

(Mech) Atten

This key is labeled Mech Atten in dual attenuator models and Atten in single attenuator models. In the dual attenuator configuration, this key only affects the mechanical attenuator.

This key lets you modify the attenuation applied to the RF input signal path. This value is normally auto coupled to the Ref Level, the Internal Preamp Gain, any External Gain that is entered, and the Max Mixer Level, as described in the table below.

See "[Attenuator Configurations and Auto/Man](#)" on page 843

Key Path	AMPTD Y Scale, Attenuation
Remote Command	<pre>[:SENSE] :POWER [:RF] :ATTenuation <rel_amp1> [:SENSE] :POWER [:RF] :ATTenuation? [:SENSE] :POWER [:RF] :ATTenuation:AUTO OFF ON 0 1 [:SENSE] :POWER [:RF] :ATTenuation:AUTO?</pre>
Example	<p>POW:ATT 20</p> <p>Dual attenuator configuration: sets the mechanical attenuator to 20 dB</p> <p>Single attenuator mode: sets the main attenuation to 20 dB (see below for definition of “main” attenuation).</p> <p>If the attenuator was in Auto, it sets it to Manual.</p>
Dependencies	<p>Some measurements do not support the Auto setting of (Mech) Atten. In these measurements, the Auto/Man selection is not available, and the Auto/Man line on the key disappears.</p> <p>In dual attenuator configurations, when the electronic attenuator is enabled, the mechanical attenuator has no auto setting and the Auto/Man line on the key disappears. The state of Auto/Man is remembered and restored when the electronic attenuator is once again disabled. This is described in more detail in the "Enable Elec Atten" on page 2162 key description.</p> <p>See "Attenuator Configurations and Auto/Man" on page 843 for more information on the Auto/Man functionality of Attenuation.</p>
Couplings	<p>When (Mech) Atten is in Auto, it uses the following algorithm to determine a value:</p> <p>If the USB Preamp is connected to USB, use 0 dB.</p> <p>Otherwise, $Atten = ReferenceLevel + PreAmpGain + ExternalGain - RefLevelOffset - MaxMixerLevel + IF\ Gain$.</p> <p>Limit this value to be between 6 dB and the Max value. No value below 6 dB can ever be chosen by Auto.</p> <p>The resulting value is rounded up to the largest value possible given the attenuation step setting. That is, 50.01 dB would change to 60 dB (for a 10 dB attenuation step).</p> <p>The “IF Gain” term in the equation above is either 0 dB or +10 dB, depending on the settings of FFT IF Gain, Swept IF Gain, max Ref Level and the Auto/Man setting of Mech Atten.</p> <p>In External Mixing and BBIQ, where the Attenuator is not in the signal path, the Attenuator setting changes as described above when (Mech) Atten is in Auto, but no changes are made to the actual attenuator hardware setting until the input is changed back to the RF Input.</p>
Preset	<p>The preset for Mech Attenuation is “Auto.”</p> <p>The Auto value of attenuation is:</p> <p>CXA, EXA, MXA and PXA: 10 dB</p>

State Saved	Saved in instrument state
Min	0 dB The attenuation set by this key cannot be decreased below 6 dB with the knob or step keys. To get to a value below 6 dB it has to be directly entered from the keypad or via SCPI. This protects from adjusting the attenuation to a dangerously small value which can put the instrument at risk of damage to input circuitry. However, if the current mechanical attenuation is below 6 dB it can be increased with the knob and step keys, but not decreased.
Max	CXA N9000A-503/507: 50 dB CXA N9000A-513/526: 70dB EXA: 60 dB MXA and PXA: 70 dB In the single attenuator configuration, the total of ATT and EATT cannot exceed 50 dB, so if the EATT is set to 24 dB first, the main attenuation cannot be greater than 26 dB and will be reduced accordingly; if the main attenuator is set to 40 dB first, EATT cannot be greater than 10 dB.
Initial S/W Revision	Prior to A.02.00
Modified at S/W Revision	A.03.00

Attenuator Configurations and Auto/Man

As described in the Attenuation key description, there are two distinct attenuator configurations available in the X-Series, the single attenuator and dual attenuator configurations. In dual attenuator configurations, we have the mechanical attenuation and the electronic attenuation, and the current total attenuation is the sum of the electronic + mechanical attenuation. In single attenuator configurations, we refer to the attenuation set using the (Mech) Atten key (or POW:ATT SCPI) as the “main” attenuation; and the attenuation that is set by the SCPI command POW:EATT as the “soft” attenuation (the POW:EATT command is honored even in the single attenuator configuration, for compatibility purposes). Then the current total attenuation is the sum of the main + soft attenuation. See the Elec Atten key description for more on “soft” attenuation.

In the dual attenuator configuration, when the electronic attenuator is enabled, there is no Auto/Man functionality for the mechanical attenuator, and the third line of the key label (the Auto/Man line) disappears:

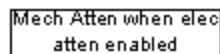
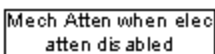
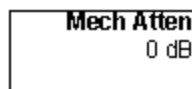
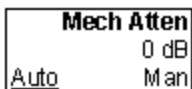

usdB

Enable Elec Atten

Enables the Electronic Attenuator.

The electronic attenuator offers finer steps than the mechanical attenuator, has no acoustical noise, is faster, and is less subject to wear. These advantages primarily aid in remote operation and are negligible

for front panel use. See ["Using the Electronic Attenuator: Pros and Cons" on page 845](#) for a detailed discussion of the pros and cons of using the electronic attenuator.

For the single attenuator configuration, for SCPI backwards compatibility, the “soft” attenuation feature replaces the dual attenuator configuration’s electronic attenuator. All the same couplings and limitations apply. See ["Attenuator Configurations and Auto/Man" on page 2162](#)

See ["More Information" on page 844](#)

Key Path	AMPTD Y Scale, Attenuation
Remote Command	[:SENSe] :POWer [:RF] :EATTenuation :STATe OFF ON 0 1 [:SENSe] :POWer [:RF] :EATTenuation :STATe ?
Example	POW:EATT:STAT ON
Dependencies	<p>This key only appears in Dual Attenuator models with an Electronic Attenuator installed. It does not appear in models with the Single Attenuator configuration, as in the single attenuator configuration there is no “electronic attenuator” there is only a single integrated attenuator (which has both a mechanical and electronic stage). However, in the single attenuator configuration, EATT SCPI commands are accepted for compatibility with other X-series instruments and set a “soft” attenuation as described in "Attenuator Configurations and Auto/Man" on page 2162.</p> <p>The electronic attenuator (and the “soft” attenuation function provided in single attenuator configurations) is unavailable above 3.6 GHz. Therefore, if the Stop Frequency of the analyzer is > 3.6 GHz then the Enable Elec Atten key will be OFF and grayed out.</p> <p>If the Internal Preamp is on, meaning it is set to Low Band or Full, the electronic attenuator (and the “soft” attenuation function provided in single attenuator configurations) is unavailable. In this case the Enable Elec Atten key will be OFF and grayed out.</p> <p>If either of the above is true, if the SCPI command is sent, an error indicating that the electronic attenuator is unavailable will be sent.</p> <p>If the electronic/soft Attenuator is enabled, then the Stop Freq of the analyzer is limited to 3.6 GHz and the Internal Preamp is unavailable.</p> <p>The SCPI-only “soft” electronic attenuation for the single-attenuator configuration is not available in all measurements; in particular, it is not available in the Swept SA measurement.</p>
Couplings	Enabling and disabling the Electronic Attenuator affects the setting of the Mechanical Attenuator (in dual attenuator configurations). This is described in more detail below this table.
Preset	OFF for Swept SA measurement; ON for all other measurements that support the electronic attenuator
State Saved	Saved in instrument state
Initial S/W Revision	Prior to A.02.00
Modified at S/W Revision	A.03.00

More Information

Mechanical Attenuator Transition Rules

When the Electronic Attenuator is enabled, the Mechanical Attenuator transitions to a state that has no Auto function. Below are the rules for transitioning the Mechanical Attenuator. NOTE that the information

below ONLY applies to the dual attenuator configurations, and ONLY when the Electronic Attenuator is installed:

When the Electronic Attenuation is enabled from a disabled state:

- The Mechanical Attenuator is initialized to 10 dB (this is its optimal performance setting). You can then set it as desired with SCPI, numeric keypad, step keys, or knob, and it behaves as it normally would in manual mode
- The Auto/Man state of (Mech) Atten is saved
- The Auto/Man line on the (Mech) Atten key disappears and the auto rules are disabled
- The Electronic Attenuator is set to 10 dB less than the previous value of the Mechanical Attenuator, within the limitation that it must stay within the range of 0 to 24 dB of attenuation.

Examples in the dual attenuator configuration:

- Mech Atten at 20 dB. Elec Atten enabled, Mech Atten set to 10 dB, and Elec Atten set to 10 dB. New total attenuation equals the value before Elec Atten enabled.
- Mech Atten at 0 dB. Elec Atten enabled, Mech Atten set to 10 dB, and Elec Atten set to 0 dB. New total attenuation does not equal the value before Elec Atten enabled.
- Mech Atten at 40 dB. Elec Atten enabled, Mech Atten set to 10 dB, and Elec Atten set to 24 dB. New total attenuation does not equal the value before Elec Atten enabled.

When the Electronic Attenuation is disabled from an enabled state:

- The Elec Atten key is grayed out
- The Auto/Man state of (Mech) Atten is restored
- If now in Auto, (Mech) Atten recouples
- If now in Man, (Mech) Atten is set to the value of total attenuation that existed before the Elec Atten was disabled. The resulting value is rounded up to the smallest value possible given the (Mech) Atten Step setting - (That is, 57 dB changes to 58 dB when (Mech) Atten Step is 2 dB.)

Using the Electronic Attenuator: Pros and Cons

The electronic attenuator offers finer steps than the mechanical attenuator, has no acoustical noise, is faster, and is less subject to wear.

The “finer steps” advantage of the electronic attenuator is beneficial in optimizing the alignment of the analyzer dynamic range to the signal power in the front panel as well as remote use. Thus, you can achieve improved relative signal measurement accuracy. Compared to a mechanical attenuator with 2 dB steps, the 1 dB resolution of the electronic attenuator only gives better resolution when the odd-decibel steps are used. Those odd-decibel steps are less accurately calibrated than the even-decibel steps, so one tradeoff for this superior relative accuracy is reduced absolute amplitude accuracy.

Another disadvantage of the electronic attenuator is that the spectrum analyzer loses its “Auto” setting, making operation less convenient.

Also, the relationship between the dynamic range specifications (TOI, SHI, compression and noise) and instrument performance are less well-known with the electrical attenuator. With the mechanical

attenuator, TOI, SHI and compression threshold levels increase dB-for-dB with increasing attenuation, and the noise floor does as well. With the electronic attenuator, there is an excess attenuation of about 1 to 3 dB between 0 and 3.6 GHz, making the effective TOI, SHI, and so forth, less well known. Excess attenuation is the actual attenuation relative to stated attenuation. Excess attenuation is accounted for in the analyzer calibration

Elec Atten

Controls the Electronic Attenuator in dual attenuator configurations. This key does not appear in single attenuator configurations, as the control of both the mechanical and electronic stages of the single attenuator is integrated into the single Atten key.

Key Path	AMPTD Y Scale, Attenuation
Remote Command	[:SENSe] :POWer [:RF] :EATTenuation <rel_ampl> [:SENSe] :POWer [:RF] :EATTenuation?
Notes	Electronic Attenuation's specification is defined only when Mechanical Attenuation is 6 dB.
Dependencies	This key only appears in Dual Attenuator models with an Electronic Attenuator installed. It does not appear in models with the Single Attenuator configuration, as in the single attenuator configuration there is no "electronic attenuator" there is only a single integrated attenuator (which has both a mechanical and electronic stage). However, in the single attenuator configuration, EATT SCPI commands are accepted for compatibility with other X-series instruments and set a "soft" attenuation as described in "Attenuator Configurations and Auto/Man" on page 2162 . The "soft" attenuation is treated as an addition to the "main" attenuation value set by the Atten softkey or the POW:ATT SCPI command and affects the total attenuation displayed on the Attenuation key and the Meas Bar. When Enable Elec Atten is off or grayed out, the Elec Atten key is grayed out.
Preset	0 dB
State Saved	Saved in instrument state
Min	0 dB
Max	Dual attenuator configuration: 24 dB Single attenuator configuration: the total of ATT and EATT cannot exceed 50 dB, so if the EATT is set to 24 dB first, the main attenuation cannot be greater than 26 dB and will be reduced accordingly; if the main attenuator is set to 40 dB first, EATT cannot be greater than 10 dB
Initial S/W Revision	Prior to A.02.00
Modified at S/W Revision	A.03.00

Adjust Atten for Min Clip

Sets the combination of mechanical and electronic attenuation and gain based on the current measured signal level so that clipping will be at a minimum.

This is an "immediate action" function, that is, it executes once, when the key is pressed.

This key is grayed out in measurements that do not support this functionality. The spectrum analyzer measurement, Swept SA, does not support this functionality.

Key Path	AMPTD Y Scale, Attenuation
Remote Command	[:SENSe] :POWer [:RF] :RANGe:OPTimize IMMEDIATE
Initial S/W Revision	Prior to A.02.00
Modified at S/W Revision	A.03.00

Pre-Adjust for Min Clip

If this function is on, it does the adjustment described under "[Adjust Atten for Min Clip](#)" on page 2165 each time a measurement restarts. Therefore, in Continuous measurement mode, it only executes before the first measurement.

In dual attenuator models, you can set Elec+Mech Atten, in which case both attenuators participate in the autoranging, or Elec Atten Only, in which case the mechanical attenuator does not participate in the autoranging. This latter case results in less wear on the mechanical attenuator and is usually faster.

This key is grayed out in measurements that do not support this functionality. The spectrum analyzer measurement, Swept SA, does not support this functionality.

Key Path	AMPTD Y Scale, Attenuation
Remote Command	[:SENSe] :POWer [:RF] :RANGe:OPTimize:ATTenuation OFF ELECTrical COMBined [:SENSe] :POWer [:RF] :RANGe:OPTimize:ATTenuation?
Notes	The SCPI parameter ELECTrical sets this function to On in single attenuator models. The SCPI parameter COMBined is mapped to ELECTrical in single attenuator models; if you send COMBined, it sets the function to On and returns ELEC to a query.
Dependencies	This key only appears in Dual Attenuator models with an Electronic Attenuator installed. In instruments with Dual Attenuator model, when Enable Elec Atten is off or grayed out, the Pre-Adjust for Min Clip key is grayed out.
Preset	OFF for Swept SA measurement; ON for all other measurements that support Pre-Adjust for Min Clip
State Saved	Saved in instrument state
Range	Dual attenuator models: Off Elec Atten Only Mech + Elec Atten Single attenuator models: Off On
Initial S/W Revision	Prior to A.02.00
Modified at S/W Revision	A.03.00

Remote Command	[:SENSe] :POWer [:RF] :RANGe:AUTO ON OFF 1 0 [:SENSe] :POWer [:RF] :RANGe:AUTO?
Notes	ON aliases to "Elec Atten Only" (:POW:RANG:OPT:ATT ELEC)

	OFF aliases to "Off" (:POW:RANG:OPT:ATT OFF) The query :POW:RANG:AUTO? returns true if :POW:RANG:OPT:ATT is not "Off"
Initial S/W Revision	Prior to A.02.00

Off

Turns Pre-Adjust for Min Clip off. This is the default setting.

This key is grayed out in measurements that do not support this functionality. The spectrum analyzer measurement, Swept SA, does not support this functionality.

Key Path	AMPTD Y Scale, Attenuation, Pre-Adjust for Min Clip
Example	:POW:RANGe:OPT:ATT OFF
Initial S/W Revision	Prior to A.02.00

Elec Atten Only

Selects only the electric attenuator to participate in auto ranging. This offers less wear on the mechanical attenuator and is usually faster.

This key is grayed out in measurements that do not support this functionality. The spectrum analyzer measurement, Swept SA, does not support this functionality.

Key Path	AMPTD Y Scale, Attenuation, Pre-Adjust for Min Clip
Example	:POW:RANGe:OPT:ATT ELEC
Initial S/W Revision	Prior to A.02.00

Mech + Elec Atten

In dual attenuator models, this selects both attenuators participate in the autoranging.

This key is grayed out in measurements that do not support this functionality. The spectrum analyzer measurement, Swept SA, does not support this functionality.

Key Path	AMPTD Y Scale, Attenuation, Pre-Adjust for Min Clip
Example	:POW:RANGe:OPT:ATT COMB
Initial S/W Revision	Prior to A.02.00

(Mech) Atten Step

This controls the step size used when making adjustments to the input attenuation.

This key is labeled Mech Atten Step in dual attenuator models and Atten Step in single attenuator models. In the dual attenuator configuration, this key only affects the step size of the mechanical attenuator.

Key Path	AMPTD Y Scale, Attenuation
Remote Command	[:SENSe] :POWer [:RF] :ATTenuation:STEP [:INCRement] 10 dB 2 dB [:SENSe] :POWer [:RF] :ATTenuation:STEP [:INCRement] ?
Example	POW:ATT:STEP 2
Notes	Note this feature works like a 1-N choice from the front panel, but it takes a specific value (in dB) when used remotely. The only valid values are 2 and 10.
Dependencies	Blanked in CXA and EXA if option FSA (2 dB steps) is not present. If blanked, attempts to set it via SCPI will yield an error.
Couplings	When the attenuation step size changes, the current mechanical attenuation value is adjusted (if necessary) to be quantized to the new step size. That is, if step is set to 10 dB, mech atten is increased if necessary so it is a multiple of 10 dB
Preset	PXA and MXA: 2 dB EXA and CXA: 10 dB (2 dB with option FSA)
State Saved	Saved in instrument state
Initial S/W Revision	Prior to A.02.00
Modified at S/W Revision	A.03.00

Presel Center

When this key is pressed, the centering of the preselector filter is adjusted to optimize the amplitude accuracy at the frequency of the selected marker. If the selected marker is not on when Presel Center is pressed, the analyzer will turn on the selected marker, perform a peak search, and then perform centering on the marker's center frequency. If the selected marker is already on and between the start and stop frequencies of the analyzer, the analyzer performs the preselector calibration on that marker's frequency. If the selected marker is already on, but outside the frequency range between Start Freq and Stop Freq, the analyzer will first perform a peak search, and then perform centering on the marker's center frequency.

The value displayed on the Presel Adjust key will change to reflect the new preselector tuning (see Presel Adjust).

A number of considerations should be observed to ensure proper operation. See ["Proper Preselector Operation" on page 850](#).

Key Path	AMPTD Y Scale
Remote Command	[:SENSe] :POWer [:RF] :PCENter
Example	POW:PCEN
Notes	Note that the rules outlined above under the key description apply for the remote command as well as the key. The result of the command is dependent on marker position, and so forth. Any message shown by the key press is also shown in response to the remote command.
Dependencies	• Grayed out if the microwave preselector is off.)

	<ul style="list-style-type: none">• If the selected marker's frequency is below Band 1, advisory message 0.5001 is generated and no action is taken.• Grayed out if entirely in Band 0.• Blank in models that do not include a preselector, such as option 503. If the SCPI is sent in these instruments, it is accepted without error, and the query always returns 0.• Grayed out in the Spectrogram View.
Couplings	<p>The active marker position determines where the centering will be attempted.</p> <p>If the analyzer is in a measurement such as averaging when centering is initiated, the act of centering the preselector will restart averaging but the first average trace will not be taken until the centering is completed.</p>
Status Bits/OPC dependencies	<p>When centering the preselector, *OPC will not return true until the process is complete and a subsequent measurement has completed, nor will results be returned to a READ or MEASure command.</p> <p>The Measuring bit should remain set while this command is operating and should not go false until the subsequent sweep/measurement has completed.</p>
Initial S/W Revision	Prior to A.02.00
Modified at S/W Revision	A.03.00

Proper Preselector Operation

A number of considerations should be observed to ensure proper operation:

1. If the selected marker is off, the analyzer will turn on a marker, perform a peak search, and adjust the preselector using the selected marker's frequency. It uses the "highest peak" peak search method unqualified by threshold or excursion, so that there is no chance of a 'no peak found' error. It continues with that peak, even if it is the peak of just noise. Therefore, for this operation to work properly, there should be a signal on screen in a preselected range for the peak search to find.
2. If the selected marker is already on, the analyzer will attempt the centering at that marker's frequency. There is no preselector for signals below about 3.6 GHz, therefore if the marker is on a signal below 3.6 GHz, no centering will be attempted and an advisory message generated
3. In some models, the preselector can be bypassed. If it is bypassed, no centering will be attempted in that range and a message will be generated.

Preselector Adjust

Allows you to manually adjust the preselector filter frequency to optimize its response to the signal of interest. This function is only available when "Presel Center" on page 2168 is available.

For general purpose signal analysis, using Presel Center is recommended. Centering the filter minimizes the impact of long-term preselector drift. Presel Adjust can be used instead to manually optimize the preselector. One application of manual optimization would be to peak the preselector response, which both optimizes the signal-to-noise ratio and minimizes amplitude variations due to small (short-term) preselector drifting.

Key Path	AMPTD Y Scale
Scope	Meas Global
Remote Command	<code>[:SENSe] :POWer [:RF] :PADJust <freq></code> <code>[:SENSe] :POWer [:RF] :PADJust?</code>
Example	POW:PADJ 100KHz POW:PADJ?
Notes	The value on the key reads out to 0.1 MHz resolution.
Dependencies	<ul style="list-style-type: none"> • Grayed out if microwave preselector is off.) • Grayed out if entirely in Band 0. • Blank in models that do not include a preselector, such as option 503. If the SCPI is sent in these instruments, it is accepted without error, and the query always returns 0. • Grayed out in the Spectrogram View.
Preset	0 MHz
State Saved	The Presel Adjust value set by Presel Center, or by manually adjusting Presel Adjust, is not saved in instrument state, and does not survive a Preset or power cycle.
Min	-500 MHz
Max	500 MHz
Default Unit	Hz
Backwards Compatibility SCPI	<code>[:SENSe] :POWer [:RF] :MW :PADJust</code> <code>[:SENSe] :POWer [:RF] :MMW :PADJust</code> PSA had multiple preselectors, but the X-Series has only one. These commands simply alias to <code>[:SENSe] :POWer [:RF] :PADJust</code>
Initial S/W Revision	Prior to A.02.00
Modified at S/W Revision	A.03.00
Remote Command	<code>[:SENSe] :POWer [:RF] :PADJust :PRESelector MWAVE MMWave EXTernal</code> <code>[:SENSe] :POWer [:RF] :PADJust :PRESelector?</code>
Notes	PSA had multiple preselectors, and you could select which preselector to adjust. Since the X-Series has only one mm/uW preselector, the preselector selection softkey is no longer available. However, to provide backward compatibility, we accept the legacy remote commands. The command form has no effect, the query always returns MWAVE
Initial S/W Revision	Prior to A.02.00

μW Path Control

Sets the μW Path Control function to Auto, standard path, μW Preselector Bypass (Option MPB) and Low Noise Path (Option LNP).

Key Path	AMPTD/Y Scale
Initial S/W Revision	A.14.50

μW Path Control Auto

Activates the auto rules for μW Path Control. When Auto is active, the μW Path Control is set to Preselector Bypass in modulation analysis and spectral flatness measurement; it is set to standard path in other measurements.

Key Path	AMPTD/Y Scale
Remote Command	<code>[:SENSe] :POWer [:RF] :MW:PATH:AUTO ON OFF 1 0</code> <code>[:SENSe] :POWer [:RF] :MW:PATH:AUTO?</code>
Example	<code>POW:MW:PATH:AUTO ON</code> <code>POW:MW:PATH:AUTO?</code>
Couplings	When Auto is active, the μW Path Control is set to μW Preselector Bypass in IQ measurements (IQ waveform, CCDF, PVT, EVM, Spetrum flatness and WLS); it is set to standard path in other measurements.
Preset	ON
Range	Off On
Initial S/W Revision	A.14.50

Standard Path

This path gives the best remote-control throughput, minimizes acoustic noise from switching and minimizes the risk of wear in the hardware switches, particularly in remote test scenarios where both low band and high band setups will follow in rapid succession.

In this path, the bypass of the low band/high band switch and microwave preamp is never activated, which can cause some noise degradation but preserves the life of the bypass switch.

Key Path	AMPTD Y Scale, μW Path Control
Example	<code>:POW:MW:PATH STD</code>
Readback Text	Standard Path
Initial S/W Revision	A.04.00

Low Noise Path Enable

You may choose Low Noise Path Enable, which gives a lower noise floor under some circumstances, particularly when operating in the 21–26.5 GHz region. With the Low Noise Path enabled, the low band/high band switch and microwave preamp are bypassed whenever all of the following are true:

- The analyzer is not in the Low Band, meaning:
- the start frequency is above 3.5 GHz and
- the stop frequency is above 3.6 GHz.
- the internal preamp is not installed or (if installed) is set to Off or Low Band

Note that this means that, when any part of a sweep is done in Low Band, the Low Noise Path is not used, whether or not the Low Noise Path Enable is selected in the user interface. Also, if the preamp is turned on, the Low Noise Path is not used, whether or not the Low Noise Path Enable is selected in the user interface. The only time the Low Noise Path is used is when Low Noise Path Enable is selected, the sweep is completely in High Band (> 3.6 GHz) and no preamp is in use.

See "[More Information](#)" on page 853

Key Path	AMPTD Y Scale, μ W Path Control
Measurement	Swept SA
Example	:POW:MW:PATH LNP
Notes	For measurements that use IQ acquisition, the low noise path is used when the Center Frequency is in High Band (> 3.6 GHz) and no preamp is in use. In other words, the rules above are modified to use only the center frequency to qualify which path to switch in. This is not the case for FFT's in the Swept SA measurement; they use the same rules as swept measurements.
Dependencies	Key is blanked if current mode does not support it. Key is grayed out if mode supports it but current measurement does not support it. Unless Option LNP is present and licensed, key is blank and if SCPI command sent, error -241, "Hardware missing; Option not installed" is generated.
Readback Text	Low Noise Path Enable
Initial S/W Revision	A.04.00

More Information

The user should understand that the Low Noise Path, while giving improved DANL, has the disadvantage of decreased TOI performance and decreased gain compression performance relative to the standard path.

The user should also understand that the bypass switch is a mechanical switch and has finite life, so if the Low Noise Path is enabled, it is possible to cause frequent cycling of this switch by frequently changing analyzer settings such that the above conditions hold true only some of the time. A user making tests of this nature should consider opting for the Standard Path, which will never throw the bypass switch, at the expense of some degraded noise performance.

The low noise path is useful for situations where the signal level is so low that the analyzer performance is dominated by noise even with 0 dB attenuation, but still high enough that the preamp option would have excessive third-order intermodulation or compression. The preamp, if purchased and used, gives better noise floor than does the “Low Noise Path.” However, its compression threshold and third-order intercept are much poorer than that of the non-preamp path. There are some applications, typically for signals around -30 dBm, for which the third-order dynamic range of the standard path is good enough, but the noise floor is not low enough even with 0 dB input attenuation. When the third-order dynamic range of the preamp path is too little and the noise floor of the standard path is too high, the Low Noise Path can provide the best dynamic range

The graph below illustrates the concept. It shows, in red, the performance of an analyzer at different attenuation settings, both with the preamp on and off, in a measurement that is affected by both analyzer noise and analyzer TOI. The green shows the best available dynamic range, offset by 0.5 dB for clarity. The blue shows how the best available dynamic range improves for moderate signal levels with the low noise path switched in. In this illustration, the preamp improves the noise floor by 15 dB while degrading the third-order intercept by 30 dB, and the low noise path reduces loss by 8 dB. The attenuator step size is 2 dB.

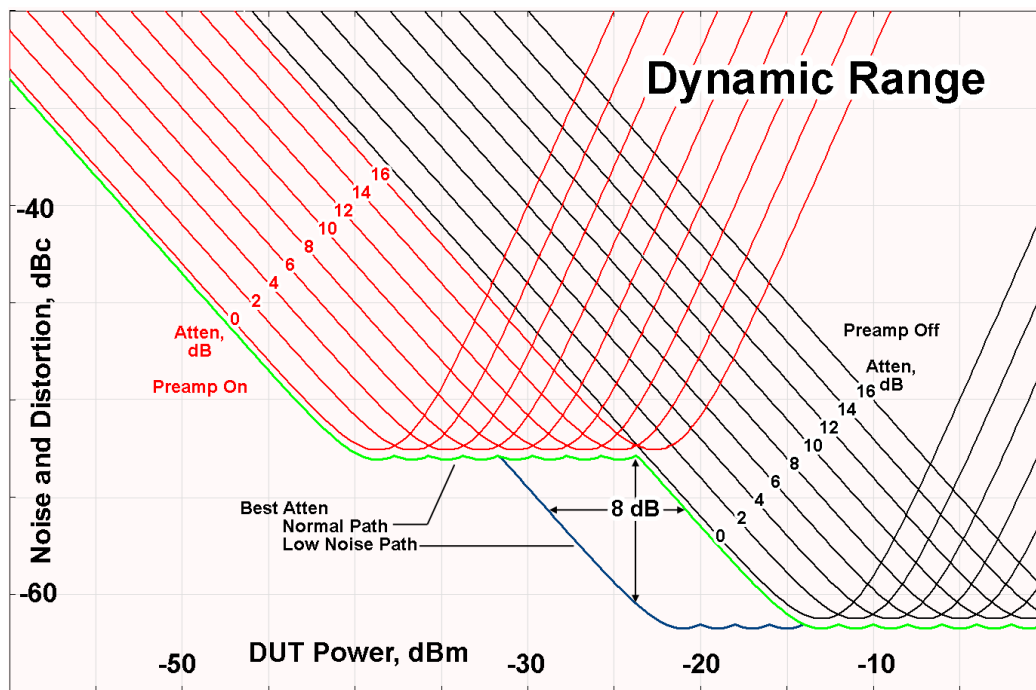

There are other times where selecting the low noise path improves performance, too. Compression-limited measurements such as finding the nulls in a pulsed-RF spectrum can profit from the low noise path in a way similar to the TOI-limited measurement illustrated. Accuracy can be improved when the low noise path allows the optimum attenuation to increase from a small amount like 0, 2 or 4 dB to a larger amount, giving better return loss at the analyzer input. Harmonic measurements, such as second and third harmonic levels, are much improved using the low noise path because of the superiority of that path for harmonic (though not intermodulation) distortion performance.

μW Preselector Bypass

This key toggles the preselector bypass switch for band 1 and higher. When the microwave preselect is on, the signal path is preselected. When the microwave preselector is off, the signal path is not preselected. The preselected path is the normal path for the analyzer.

The preselector is a tunable bandpass filter which prevents signals away from the frequency of interest from combining in the mixer to generate in-band spurious signals (images). The consequences of using a preselector filter are its limited bandwidth, the amplitude and phase ripple in its passband, and any amplitude and phase instability due to center frequency drift.

Option MPB or pre-selector bypass provides an unpreselected input mixer path for certain X-Series signal analyzers with frequency ranges above 3.6 GHz. This signal path allows a wider bandwidth and less amplitude variability, which is an advantage when doing modulation analysis and broadband signal analysis. The disadvantage is that, without the preselector, image signals will be displayed. Another disadvantage of bypassing the preselector is increased LO emission levels at the front panel input port.

Image responses are separated from the real signal by twice the 1st IF. For IF Paths of 10 MHz and 25 MHz, the 1st IF is 322.5 MHz, so the image response and the real signal will be separated by 645 MHz. The 1st IF will be different for other IF Path settings. When viewing a real signal and its corresponding image response in internal mixing, the image response will be to the left of the real signal.

Also, the image response and the real signal typically have the same amplitude and exhibit the same shape factor.

However, if Option FS1, Fast Sweep Capability, is enabled, the image response in the Swept SA measurement will appear lower in amplitude and have a much wider shape factor compared to the real signal.

Key Path	AMPTD Y Scale, μW Path Control
Example	:POW:MW:PATH MPB
Dependencies	Key is blanked if current mode does not support it. Key is grayed out if mode supports it but current measurement does not support it. Key is blank unless Option MPB is present and licensed. If SCPI command sent when MPB not present, error -241, "Hardware missing; Option not installed" is generated.
Readback Text	μW Preselector Bypass
Initial S/W Revision	A.04.00

Remote Command	[:SENSe] :POWer [:RF] :MW:PRESelector [:STATe] ON OFF 0 1 [:SENSe] :POWer [:RF] :MW:PRESelector [:STATe] ?
Example	:POW:MW:PRES OFF Bypasses the microwave preselector
Notes	The ON parameter sets the STD path (:POW:MW:PATH STD) The OFF parameter sets path MPB (:POW:MW:PATH MPB)
Preset	ON

Internal Preamp

Accesses a menu of keys that control the internal preamps. Turning on the preamp gives a better noise figure, but a poorer TOI to noise floor dynamic range. You can optimize this setting for your particular measurement.

The instrument takes the preamp gain into account as it sweeps. If you sweep outside of the range of the preamp the instrument will also account for that. The displayed result will always reflect the correct gain.

For some measurements, when the preamp is on and any part of the displayed frequency range is below the lowest frequency for which the preamp has specifications, a warning condition message appears in the status line. For example, for a preamp with a 9 kHz lowest specified frequency: "Preamp: Accy unspec'd below 9 kHz".

Key Path	AMPTD Y Scale
Scope	Meas Global
Remote Command	[:SENSe] :POWer [:RF] :GAIN [:STATe] OFF ON 0 1 [:SENSe] :POWer [:RF] :GAIN [:STATe] ?
Dependencies	Preamp is not available on all hardware platforms. If the preamp is not present or is unlicensed, the key is not shown. The preamp is not available when the electronic/soft attenuator is enabled.
Couplings	The act of connecting the U7227A USB Preamplifier to one of the analyzer's USB ports will cause the Internal Preamp to be switched on. When this happens an informational message will be generated: "Internal Preamp turned on for optimal operation with USB Preamp." Note that if the Internal Preamp was already on, there will be no change to the setting, but if it was Off it will be switched On, to Full Range. Note that this same action occurs when the SA mode is selected while the USB Preamp is connected to one of the analyzer's USB ports, if it is the first time that the SA mode has run since powerup, or if the last time the SA mode was running the USB Preamp was NOT connected. Subsequently disconnecting the USB Preamp from USB does not change the Internal Preamp setting nor restore the previous setting.
Preset	OFF
State Saved	Saved in instrument state
Initial S/W Revision	Prior to A.02.00
Modified at S/W Revision	A.14.00

Key Path	AMPTD Y Scale, Internal Preamp
Scope	Meas Global
Remote Command	[:SENSe] :POWer [:RF] :GAIN :BAND LOW FULL [:SENSe] :POWer [:RF] :GAIN :BAND ?
Dependencies	Preamp is not available on all hardware platforms. If the preamp is not present or is unlicensed, the key is not shown. If a POW:GAIN:BAND FULL command is sent when a low band preamp is available, the preamp band

	parameter is to LOW instead of FULL, and an "Option not installed" message is generated.
Preset	LOW
State Saved	Saved in instrument state
Initial S/W Revision	Prior to A.02.00

Off

Turns the internal preamp off

Key Path	AMPTD Y Scale, Internal Preamp
Example	:POW:GAIN OFF
Readback	Off
Initial S/W Revision	Prior to A.02.00

Low Band

Sets the internal preamp to use only the low band.

The frequency range of the installed (optional) low-band preamp is displayed in square brackets on the Low Band key label.

Key Path	AMPTD Y Scale, Internal Preamp
Example	:POW:GAIN ON :POW:GAIN:BAND LOW
Readback	Low Band
Initial S/W Revision	Prior to A.02.00

Full Range

Sets the internal preamp to use its full range. The low band (0–3.6 GHz or 0–3GHz, depending on the model) is supplied by the low band preamp and the frequencies above low band are supplied by the high band preamp.

The frequency range of the installed (optional) preamp is displayed in square brackets on the Full Range key label. If the high band option is not installed the Full Range key does not appear.

Key Path	AMPTD Y Scale, Internal Preamp
Example	:POW:GAIN ON :POW:GAIN:BAND FULL
Readback	Full Range
Initial S/W Revision	Prior to A.02.00

Y Axis Unit

Allows you to change the vertical (Y) axis amplitude unit.

See Y Axis Unit under AMPTD Y Scale for more information.

Key Path	AMPTD Y Scale
Initial S/W Revision	A.04.00

Reference Level Offset

Adds an offset value to the displayed reference level. The reference level is the absolute amplitude represented by the top graticule line on the display.

See Reference Level Offset under AMPTD Y Scale for more information.

Key Path	AMPTD Y Scale
Initial S/W Revision	A.04.00

Auto Couple

The Auto Couple feature provides a quick and convenient way to automatically couple multiple instrument settings. This helps ensure accurate measurements and optimum dynamic range. When the Auto Couple feature is activated, either from the front panel or remotely, all parameters of the current measurement that have an Auto/Manual mode are set to Auto mode and all measurement settings dependent on (or coupled to) the Auto/Man parameters are automatically adjusted for optimal performance.

However, the Auto Couple key actions are confined to the current measurement only. It does not affect other measurements in the mode, and it does not affect markers, marker functions, or trace or display attributes.

See "[More Information](#)" on page 859

Key Path	Front-panel key
Remote Command	:COUPle ALL NONE
Example	:COUP ALL
Notes	:COUPle ALL puts all Auto/Man parameters in Auto mode (equivalent to pressing the Auto Couple key). :COUPLE NONE puts all Auto/Man parameters in manual mode. It decouples all the coupled instrument parameters and is not recommended for making measurements.
Initial S/W Revision	Prior to A.02.00

More Information

There are two types of functions that have Auto/Manual modes.

Auto/Man Active Function keys

An Auto/Man toggle key controls the binary state associated with an instrument parameter by toggling between Auto (where the parameter is automatically coupled to the other parameters it is dependent upon) and Man (where the parameter is controlled independent of the other parameters), as well as making the parameter the active function. The current mode is indicated on the softkey with either Auto or Man underlined as illustrated below.



Auto/Man 1-of-N keys

An Auto/Man 1-of-N key allows you to manually pick from a list of parameter values, or place the function in Auto, in which case the value is automatically selected (and indicated) as shown below. If in Auto, Auto is underlined on the calling key. If in manual operation, manual is indicated on the calling key. But the calling key does not actually toggle the function, it simply opens the menu.

10 Power Stat CCDF Measurement
Auto Couple

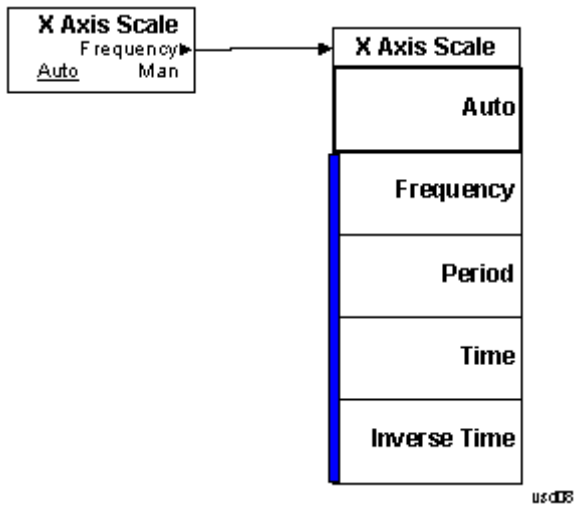

BW

Opens the BW menu, which contains keys to control the information bandwidth functions of the instrument.

Key Path	Front-panel key
Initial S/W Revision	Prior to A.02.00

Info BW

Allows you to enter a frequency value to set the channel bandwidth that will be used for data acquisition.

Key Path	BW
Mode	SA, WCDMA, C2K, WIMAXOFDMA, TD-SCDMA, 1xEV-DO, DVB-T/H, DTMB (CTTB), ISDB-T, CMMB, LTE, LTETDD, Digital Cable TV, WLAN, MSR, LTEATDD, LTEAFDD
Remote Command	<code>[:SENSe] :PStatistic :BANDwidth <freq></code> <code>[:SENSe] :PStatistic :BANDwidth?</code>
Example	PST:BAND 8 MHz PST:BAND?
Couplings	WIMAX OFDMA: The default value depends on the Radio Standard selection..
Preset	SA, WCDM: 5 MHz C2K:1.5 MHz 1xEV-DO:1.3 MHz WiMAX OFDMA: Hardware Dependent No Option = 10 MHz WB (25 MHz or wider) = 25 MHz TD-SCDMA: 1.3 MHz DVB-T/H, DTMB (CTTB): 8 MHz ISDB-T: 6 MHz CMMB: 8 MHz LTE, LTETDD, LTEATDD, LTEAFDD: 6 MHz Digital Cable TV: 8MHz WLAN: Hardware Dependent No option = 10 MHz Option B25 = 25 MHz Option B40: if Radio Std is 802.11a/b/g/n(20MHz) = 25 MHz if Radio Std is 802.11n(40MHz) = 40 MHz if Radio Std is 802.11ac(20MHz) = 25 MHz if Radio Std is 802.11ac(40MHz) = 40 MHz Option B1X: if Radio Std is 802.11ac(80MHz) = 80 MHz

	Option B1Y: if Radio Std is 802.11ac(160MHz) = 160 MHz MSR: same as max value
State Saved	Saved in instrument state.
Min	10.0 kHz
Max	Hardware Dependent: RF Input: No Option = 10 MHz WB (25MHz or wider) = Hardware Option Limit I/Q Input (for I+jQ): No Option = 20 MHz Option B25 = 50 MHz
Backwards Compatibility SCPI	[:SENSe] :PStatistic:BWIDth
Initial S/W Revision	Prior to A.02.00
Modified at S/W Revision	A.02.00, A.03.00, A.06.00

Cont (Continuous Measurement/Sweep)

Sets the analyzer for Continuous measurement operation. The single/continuous state is Meas Global so the setting will affect all measurements. If you are Paused, pressing Cont does a Resume.

Key Path	Front-panel key
Remote Command	:INITiate:CONTinuous OFF ON 0 1 :INITiate:CONTinuous?
Example	:INIT:CONT 0 puts analyzer in Single measurement operation. :INIT:CONT 1 puts analyzer in Continuous measurement operation
Preset	ON (Note that SYST:PRESet sets INIT:CONT to ON but *RST sets INIT:CONT to OFF)
State Saved	Saved in instrument state
Backwards Compatibility Notes	For Spectrum Analysis mode in ESA and PSA, there is no Cont hardkey, instead there is a Sweep Single/Cont key. In these analyzers, switching the Sweep Single/Cont key from Single to Cont restarts averages (displayed average count reset to 1), but does not restart Max Hold and Min Hold. The X-Series has Single and Cont keys in place of the SweepSingleCont key. In the X-Series, if in single measurement, the Cont key (and INIT:CONT ON) switches to continuous measurement, but never restarts a measurement and never resets a sweep.
Initial S/W Revision	Prior to A.02.00

In Swept SA Measurement (Spectrum Analysis Mode):

The analyzer takes repetitive sweeps, averages, measurements, etc., when in Continuous mode. When the average count reaches the Average/Hold Number the count stops incrementing, but the analyzer keeps sweeping. See the Trace/Detector section for the averaging formula used both before and after the Average/Hold Number is reached. The trigger condition must be met prior to each sweep. The type of trace processing for multiple sweeps, is set under the Trace/Detector key, with choices of Trace Average, Max Hold, or Min Hold.

In Other Measurements/Modes:

With Avg/Hold Num (in the Meas Setup menu) set to Off or set to On with a value of 1, a sweep is taken after the trigger condition is met; and the analyzer continues to take new sweeps after the current sweep has completed and the trigger condition is again met. However, with Avg/Hold Num set to On with a value >1, multiple sweeps (data acquisitions) are taken for the measurement. The trigger condition must be met prior to each sweep. The sweep is not stopped when the average count k equals the number N set for Avg/Hold Num is reached, but the number k stops incrementing. A measurement average usually applies to all traces, marker results, and numeric results. But sometimes it only applies to the numeric results.

If the analyzer is in Single measurement, pressing the Cont key does not change k and does not cause the sweep to be reset; the only action is to put the analyzer into Continuous measurement operation.

If it is already in continuous sweep:

the INIT:CONT 1 command has no effect

10 Power Stat CCDF Measurement
Cont (Continuous Measurement/Sweep)

the INIT:CONT 0 command will place the analyzer in Single Sweep but will have no effect on the current sequence until $k = N$, at which point the current sequence will stop and the instrument will go to the idle state.

File

See "File" on page 348

FREQ Channel

Accesses a menu of keys that allow you to control the Frequency and Channel parameters of the instrument.

Some features in the Frequency menu are the same for all measurements – they do not change as you change measurements. Settings like these are called “Meas Global” and are unaffected by Meas Preset. For example, the Center Freq setting is the same for all measurements - it does not change as you change measurements.

Key Path	Front-panel key
Initial S/W Revision	Prior to A.02.00

Center Freq

Sets the frequency that corresponds to the horizontal center of the graticule (when frequency Scale Type is set to linear). While adjusting the Center Frequency the Span is held constant, which means that both Start Frequency and Stop Frequency will change.

Pressing Center Freq also sets the frequency entry mode to Center/Span. In Center/Span mode, the center frequency and span values are displayed below the graticule, and the default active function in the Frequency menu is Center Freq.

The center frequency setting is the same for all measurements within a mode, that is, it is Meas Global. Some modes are also able to share a Mode Global center frequency value. If this is the case, the Mode will have a Global Settings key in its Mode Setup menu.

The Center Freq function sets (and queries) the Center Frequency for the currently selected input. If your analyzer has multiple inputs, and you select another input, the Center Freq changes to the value for that input. SCPI commands are available to directly set the Center Freq for a specific input.

Center Freq is remembered as you go from input to input. Thus you can set a Center Freq of 10 GHz with the RF Input selected, change to BBIQ and set a Center Freq of 20 MHz, then switch to External Mixing and set a Center Freq of 60 GHz, and when you go back to the RF Input the Center Freq will go back to 10 GHz; back to BBIQ and it is 20 MHz; back to External Mixing and it is 60 GHz.

See ["RF Center Freq" on page 869](#)

See [Ext Mix Center Freq](#)

See ["I/Q Center Freq" on page 871](#)

See ["Center Frequency Presets" on page 867](#)

Key Path	FREQ Channel
Scope	Meas Global
Remote Command	<code>[:SENSe] :FREQuency:CENTer <freq></code> <code>[:SENSe] :FREQuency:CENTer?</code>

Example	FREQ:CENT 50 MHz FREQ:CENT UP changes the center frequency to 150 MHz if you use FREQ:CENT:STEP 100 MHz to set the center frequency step size to 100 MHz FREQ:CENT?
Notes	This command sets either the RF or I/Q Center Frequency depending on the selected input. For RF input it is equivalent to FREQ:RF:CENT For I/Q input it is equivalent to FREQ:IQ:CENT Preset and Max values are dependent on Hardware Options (5xx) If no terminator (e.g. MHz) is sent the terminator Hz is used. If a terminator with unit other than Frequency is used, an invalid suffix error message is generated.
Dependencies	The Center Frequency can be limited by Start or Stop Freq limits, if the Span is so large that Start or Stop reach their limit.
Couplings	When operating in "swept span", any value of the Center Frequency or Span that is within the frequency range of the analyzer is allowed when the value is being set through the front panel numeric key pad or the SCPI command. The other parameter is forced to a different value if needed, to keep the Start and the Stop Frequencies within the analyzer's frequency range
Preset	Depends on instrument maximum frequency, mode, measurement, and selected input. See "Center Frequency Presets" on page 867 and "RF Center Freq" on page 869 and Ext Mix Center Freq and "I/Q Center Freq" on page 871 .
State Saved	Saved in instrument state
Min	Depends on instrument maximum frequency, mode, measurement, and selected input.. See "Center Frequency Presets" on page 867 and "RF Center Freq" on page 869 and "I/Q Center Freq" on page 871 .
Max	Depends on instrument maximum frequency, mode, measurement, and selected input.. See "Center Frequency Presets" on page 867 and "RF Center Freq" on page 869 and "I/Q Center Freq" on page 871 .
Default Unit	Hz
Status Bits/OPC	Non-overlapped
Dependencies	
Initial S/W Revision	Prior to A.02.00

Center Frequency Presets

The following table provides the Center Frequency Presets for the Spectrum Analyzer mode, and the Max Freq, for the various frequency options:

Freq Option	CF after Mode Preset	Stop Freq after Mode Preset	Max Freq (can't tune)

10 Power Stat CCDF Measurement
 FREQ Channel

			above)
503 (all but N9000A)	1.805 GHz	3.6 GHz	3.7 GHz
503 (N9000A)	1.505 GHz	3.0 GHz	3.08 GHz
507 (all but N9000A)	3.505 GHz	7.0 GHz	7.1 GHz
507 (N9000A)	3.755 GHz	7.5 GHz	7.58 GHz
508 (all but N9038A)	1.805 GHz	3.6 GHz	8.5 GHz
508 (N9038A)	4.205 GHz	8.4 GHz	8.5 GHz
513	6.805 GHz	13.6 GHz	13.8 GHz
526 (all but N9000A and N9038A)	13.255 GHz	26.5 GHz	27.0 GHz
526 (N9000A)	13.255 GHz	26.5 GHz	26.55 GHz
526 (N9038A)	1.805 GHz	3.6 GHz	27.0 GHz
532	16.005 GHz	32.0 GHz	32.5 GHz
543	21.505 GHz	43.0 GHz	TBD
544	22.005 GHz	44.0 GHz	44.5 GHz
550	25.005 GHz	50.0 GHz	51 GHz

Input 2:

Model	CF after Mode Preset	Stop Freq after Mode Preset	Max Freq (can't tune above)
N9000A opt C75	0.7505GHz	1.5 GHz	1.58 GHz
N9038A	505 MHz	1 GHz	1.000025 GHz

Tracking Generator Frequency Limits (N9000A only):

Tracking Generator Option	Min Freq (clips to this freq when turn TG on and	If above this Freq, Stop Freq clipped to this Freq when	Max Freq (can't tune above) while TG

	can't tune below while TG on)	TG turned on	on
T03	9 kHz	3.0 GHz	3.08 GHz
T06	9 kHz	6.0 GHz	6.05 GHz

The following table shows the Center Frequency Presets for modes other than Spectrum Analyzer:

Mode	CF Preset for RF
WCDMA	1 GHz
WIMAXOFDMA,	1 GHz
BASIC	1 GHz
ADEMOD	1 GHz
VSA	1 GHz
TDSCDMA	1 GHz
PNOISE	1 GHz
LTE	1 GHz
LTETDD	1 GHz
MSR	1 GHz
GSM	935.2 MHz
NFIGURE	1.505 GHz

RF Center Freq

SCPI command for specifying the RF Center Frequency. This command will set the Center Frequency to be used when the RF input is selected, even if the RF input is not the input that is selected at the time the command is sent. Note that the Center Freq function in the Frequency menu on the front panel always applies to the currently selected input.

Scope	Meas Global
Remote Command	<code>[:SENSe] :FREQuency:RF:CENTer <freq></code> <code>[:SENSe] :FREQuency:RF:CENTer?</code>
Example	FREQ:RF:CENT 30 MHz
Notes	This command is the same in all modes, but the parameter is Measurement Global. So the value is independent in each mode and common across all the measurements in the mode.
Dependencies	If the electronic/soft attenuator is enabled, any attempt to set Center Frequency such that the Stop Frequency would be >3.6 GHz fails and results in an advisory message. If the equivalent SCPI command is sent, this same message is generated as part of a “-221, Settings conflict” warning. If Source Mode is set to Tracking, and the Max or Min Center Freq is therefore limited by the limits of the source, a warning message is generated, “Data out of range;clipped to source max/min” if these limits are exceeded. Note that for an external source, these limits can be affected by the settings of

	Source Numerator, Source Denominator and Power Sweep.
Preset	See table above
State Saved	Saved in instrument state.
Min	-79.999995 MHz, unless Source Mode is set to Tracking, in which case it is limited by the minimum frequency of the Source
Max	See table above. Basically instrument maximum frequency - 5 Hz. Note that, if the Source Mode is set to Tracking, the effective instrument maximum frequency may be limited by the source maximum frequency. If the knob or step keys are being used, also depends on the value of the other three interdependent parameters Span, Start Frequency and Stop Frequency
Initial S/W Revision	Prior to A.02.00
Modified at S/W Revision	A.03.00

Ext Mix Center Freq

SCPI command for specifying the External Mixer Center Frequency. This command will set the Center Frequency to be used when the External Mixer is selected, even if the External Mixer input is not the input which is selected at the time the command is sent. Note that the Center Freq function in the Frequency menu on the front panel always applies to the currently selected input.

Scope	Meas Global
Remote Command	<code>[:SENSe] :FREQuency:EMIXer:CENTer <freq></code> <code>[:SENSe] :FREQuency:EMIXer:CENTer?</code>
Example	<code>:FREQ:EMIX:CENT 60 GHz</code> <code>:FREQ:EMIX:CENT?</code>
Notes	This command is the same in all modes, but the parameter is Measurement Global. So the value is independent in each mode and common across all the measurements in the mode.
Couplings	When returning to External Mixing after having been switched to one of the other inputs (e.g., RF), you will come back into the settings that you had when you left External Mixing. So you will come back to the band you were in with the Center Frequency that you had. However, Span is not an input-dependent parameter, therefore you will bring the span over from the other input. Therefore, the analyzer comes back with the span from the previous input, limited as necessary by the current mixer setup.
Preset	When a Mode Preset is performed while in External Mixing, the Start frequency of the current Mode is set to the nominal Min Freq of the lowest harmonic range in the Harmonic Table for the current mixer setup. Similarly, the Stop frequency of the current Mode is set to the nominal Max Freq of the highest harmonic range in the Harmonic Table. The Center Freq thus presets to the point arithmetically equidistant from these two frequencies. If the current measurement has a limited Span available to it, and cannot achieve the Span shown in the table (Span=Stop Freq - Start Freq), the analyzer uses the maximum Span the measurement allows, and still sets the Center Freq to the midpoint of the Start and Stop Freq values in the Harmonic Table.

	When Restore Input/Output Defaults is performed, the mixer presets to the 11970A, whose Start and Stop frequencies are 26.5 and 40 GHz respectively. The center of these two frequencies is 33.25 GHz. Therefore, after a Restore Input/Output Defaults, if you go into External Mixing and do a Mode Preset while in the Spectrum Analyzer Mode, the resulting Center Freq is 33.25 GHz.
State Saved	Saved in instrument state.
Min	The minimum frequency in the currently selected mixer band + 5 Hz
Max	The maximum frequency in the currently selected mixer band – 5 Hz If the knob or step keys are being used, also depends on the value of the other three interdependent parameters Span, Start Frequency and Stop Frequency
Initial S/W Revision	A.08.01

I/Q Center Freq

SCPI command for specifying the I/Q Center Frequency. This command will set the Center Frequency to be used when the I/Q input is selected, even if the I/Q input is not the input which is selected at the time the command is sent. Note that the Center Freq function in the Frequency menu on the front panel always applies to the currently selected input.

Scope	Meas Global
Remote Command	[:SENSe] :FREQuency:IQ:CENTer <freq> [:SENSe] :FREQuency:IQ:CENTer?
Example	FREQ:IQ:CENT: 30 MHz
Notes	This command is the same in all modes, but the parameter is Measurement Global. So the value is independent in each mode and common across all the measurements in the mode.
Preset	0 Hz
State Saved	Saved in instrument state.
Min	-40.049995 MHz
Max	40.049995 MHz
Initial S/W Revision	Prior to A.02.00

CF Step

Changes the step size for the center frequency and start and stop frequency functions. Once a step size has been selected and the center frequency function is active, the step keys (and the UP|DOWN parameters for Center Frequency from remote commands) change the center frequency by the step-size value. The step size function is useful for finding harmonics and sidebands beyond the current frequency span of the analyzer.

Note that the start and stop frequencies also step by the CF Step value.

Key Path	FREQ Channel
Remote Command	<pre>[:SENSe] :FREQuency:CENTer:STEP[:INCRement] <freq> [:SENSe] :FREQuency:CENTer:STEP[:INCRement]? [:SENSe] :FREQuency:CENTer:STEP:AUTO OFF ON 0 1 [:SENSe] :FREQuency:CENTer:STEP:AUTO?</pre>
Example	<pre>FREQ:CENt:STEP:AUTO ON FREQ:CENt:STEP 500 MHz FREQ:CENt UP increases the current center frequency value by 500 MHz FREQ:CENt:STEP? FREQ:CENt:STEP:AUTO?</pre>
Notes	Preset and Max values are depending on Hardware Options (503, 507, 508, 513, 526)
Notes	Preset and Max values are dependent on Hardware Options (5xx)
Dependencies	Freq Offset is not available in External Mixing. In this case the Freq Offset key is grayed out and shows a value of zero. It will once again be available, and show the previously set value, when you return to the RF Input.
Dependencies	Span, RBW, Center frequency If the electronic/soft attenuator is enabled, any attempt to change the value of the center frequency >3.6 GHz by pressing the Up-arrow key, fails and results in an advisory message. If the equivalent SCPI command is sent, this same message is generated as part of a “-221, Settings conflict” warning.
Couplings	When auto-coupled in a non-zero span, the center frequency step size is set to 10% of the span. When auto-coupled in zero span, the center frequency step size is set to the equivalent -3 dB RBW value.
Preset	Auto ADEM0D: 1 MHz ON
State Saved	Saved in instrument state
Min	– (the maximum frequency of the instrument). That is, 27 GHz max freq instrument has a CF step range of +/- 27 GHz. Note that this is the maximum frequency given the current settings of the instrument, so in External Mixing, for example, it is the maximum frequency of the current mixer band.
Max	The maximum frequency of the instrument. That is, 27 GHz max freq instrument has a CF step range of +/- 27 GHz. Note that this is the maximum frequency given the current settings of the instrument, so in External Mixing, for example, it is the maximum frequency of the current mixer band.
Default Unit	Hz
Status Bits/OPC dependencies	non-overlapped
Initial S/W Revision	Prior to A.02.00
Modified at S/W Revision	A.03.00

Input/Output

See "Input/Output" on page 194

Marker

Accesses a menu that enables you to select, set up and control the markers for the current measurement.

Key Path	Front-panel key
Initial S/W Revision	Prior to A.02.00

Select Marker

Accesses a menu that allows you to select one of 12 markers for control and function

Key Path	Marker
Initial S/W Revision	Prior to A.02.00

Marker Type

Sets the marker control mode to Normal, Delta, Fixed or Off.

If the selected marker is Off, pressing Marker sets it to Normal and places it at the center of the screen on the trace determined by the Marker Trace rules. At the same time, Marker X Axis Value appears on the Active Function area.

The Active function for the selected marker's current control mode is the default active function. If the current control mode is Off, there is no active function and the active function is turned off. The active function display is the marker X axis value entered in the active function area, which displays the marker value to its full entered precision.

All interactions and dependencies detailed under the key description are enforced when the remote command is sent.

Key Path	Marker
Mode	SA, WCDMA, C2K, WiMAX OFDMA, TD-SCDMA, 1xEV-DO, DVB-T/H, DTMB (CTTB), ISDB-T, CMMB, LTE, LTETDD, Digital Cable TV, WLAN, MSR, LTEATDD, LTEAFDD
Remote Command	:CALCulate:PStatistic:MARKer[1] 2 ... 12:MODE POSition DELTa OFF :CALCulate:PStatistic:MARKer[1] 2 ... 12:MODE?
Example	CALC:PST:MARK:MODE POS CALC:PST:MARK:MODE?
Notes	If the selected marker is Off, pressing Marker sets it to Normal and places it at the center of the screen on the trace determined by the Marker Trace rules. At the same time, Marker X Axis Value appears on the Active Function area. Default Active Function: the active function for the selected marker's current control mode. If the current control mode is Off, there is no active function and the active function is turned off. Active Function Display: the marker X axis value entered in the active function area displays the marker value to its full entered precision.

Preset	OFF
State Saved	Saved in instrument state.
Range	Normal Delta Off
Initial S/W Revision	Prior to A.02.00
Modified at S/W Revision	A.02.00, A.03.00

Properties

Accesses the marker properties menu.

Key Path	Marker
Initial S/W Revision	Prior to A.02.00

Select Marker

Accesses a menu that allows you to select one of 12 markers for control and function

Key Path	Marker
Initial S/W Revision	Prior to A.02.00

Relative To

Sets the reference marker that the selected marker will be relative to.

Key Path	Marker, Properties
Mode	SA, WCDMA, C2K, WIMAXOFDMA, TD-SCDMA, 1xEV-DO, DVB-T/H, DTMB (CTTB), ISDB-T, CMMB, LTE, LTE-TDD, Digital Cable TV, WLAN, MSR, LTE-TDD, LTE-FDD
Remote Command	:CALCulate:PStatistic:MARKer[1] 2 ... 12:REference <integer> :CALCulate:PStatistic:MARKer[1] 2 ... 12:REference?
Example	CALC:PST:MARK:REF 3 CALC:PST:MARK:REF?
Notes	A marker cannot be relative to itself so that choice is grayed out, and if sent from SCPI generates error -221: "Settings conflict; marker cannot be relative to itself." When queried a single value will be returned (the specified marker numbers relative marker).
Preset	2 3 4 5 6 7 8 9 10 11 12 1
State Saved	Saved in instrument state.
Min	1
Max	12
Initial S/W Revision	Prior to A.02.00
Modified at S/W Revision	A.02.00, A.03.00

Marker Trace

Assigns the specified marker to the designated trace. The trace choices are:

- Measured
- Gaussian
- Reference

Key Path	Marker
Mode	SA, WCDMA, C2K, WIMAXOFDMA, TD-SCDMA, 1xEV-DO, DVB-T/H, DTMB (CTTB), ISDB-T, CMMB, LTE, LTETDD, Digital Cable TV, WLAN, MSR, LTEATDD, LTEAFDD
Remote Command	:CALCulate:PStatistic:MARKer[1] 2 ... 12:TRACe MEASured GAUSSian REFerence :CALCulate:PStatistic:MARKer[1] 2 ... 12:TRACe?
Example	CALC:PST:MARK3:TRAC MEAS CALC:PST:MARK:TRACE?
Preset	MEASured
State Saved	Saved in instrument state.
Range	Measured Gaussian Reference
Initial S/W Revision	Prior to A.02.00
Modified at S/W Revision	A.02.00, A.03.00

Couple Markers

When this function is on, moving any marker causes an equal X axis movement of every other marker that is not off. By “equal X axis movement” we mean that we preserve the difference between each marker’s X axis value (in the fundamental x-axis units of the trace that marker is on) and the X axis value of the marker being moved (in the same fundamental x-axis units).

Key Path	Marker
Initial S/W Revision	Prior to A.02.00

All Markers Off

Turns off all markers.

Key Path	Marker, More
Mode	SA, WCDMA, C2K, WIMAXOFDMA, TD-SCDMA, 1xEV-DO, DVB-T/H, DTMB (CTTB), ISDB-T, CMMB, LTE, LTETDD, Digital Cable TV, WLAN, MSR, LTEATDD, LTEAFDD
Remote Command	:CALCulate:PStatistic:MARKer:AOFF

Example	CALC:PST:MARK:AOFF
Initial S/W Revision	Prior to A.02.00
Modified at S/W Revision	A.02.00, A.03.00

Marker X Axis Value (Remote Command Only)

Sets the marker X Axis value in the current marker X Axis Scale unit. This function has no effect if the control mode is Off, but is the remote command equivalent of entering an X value if the control mode is Normal or Delta.

Mode	SA, WCDMA, C2K, WIMAXOFDMA, TD-SCDMA, 1xEV-DO, DVB-T/H, DTMB (CTTB), ISDB-T, CMMB, LTE, LTEFDD, Digital Cable TV, WLAN, MSR, LTEATDD, LTEAFDD
Remote Command	:CALCulate:PStatistic:MARKer[1] 2 ... 12:X <rel_amp1> :CALCulate:PStatistic:MARKer[1] 2 ... 12:X?
Example	CALC:PST:MARK3:X 0 CALC:PST:MARK3:X?
Notes	If no suffix is sent, it will use the fundamental units for the current marker X Axis Scale. If a suffix is sent that does not match the current marker X Axis Scale unit, an error "Invalid suffix" will be generated. If the specified marker is Fixed and a Marker Function is on, error -221 "Settings conflict; cannot adjust Fixed marker while Marker Function is on" is generated. The query returns the marker's absolute X Axis value if the control mode is Normal, or the offset from the marker's reference marker if the control mode is Delta. The query is returned in the fundamental units for the current marker X Axis scale: Hz for Frequency and Inverse Time, seconds for Period and Time. If the marker is Off the response is not a number.
Preset	After a preset, all Markers are turned OFF, so Marker X Axis Value query will return a not a number (NAN).
State Saved	No
Min	-9.9E+37
Max	9.9E+37
Initial S/W Revision	Prior to A.02.00
Modified at S/W Revision	A.02.00, A.03.00

Marker Y Axis Value (Remote Command Only)

Queries the marker Y Axis value in the current marker Y Axis unit.

Mode	SA, WCDMA, C2K, WIMAXOFDMA, TD-SCDMA, 1xEV-DO, DVB-T/H, DTMB (CTTB), ISDB-T, CMMB, LTE, LTEFDD, Digital Cable TV, WLAN, MSR, LTEATDD, LTEAFDD
Remote Command	:CALCulate:PStatistic:MARKer[1] 2 ... 12:Y?
Example	CALC:PST:MARK11:Y?
Notes	The query returns the marker Y-axis result, if the control mode is Normal, or Delta. If the marker is

	Off the response is not a number.
Preset	0
State Saved	No
Backwards Compatibility SCPI	:CALCulate:PStAtistic:MARKer[1] 2 ... 12:FUNCTion:RESult?
Initial S/W Revision	Prior to A.02.00
Modified at S/W Revision	A.02.00, A.03.00

Marker Function

There are no 'Marker Functions' supported in Power Stat CCDF measurement. The front-panel key displays a blank menu when pressed.

Key Path	Front-panel key
Initial S/W Revision	Prior to A.02.00

Marker To

There is no 'Marker To' functionality supported in Power Stat CCDF measurement. The front-panel key displays a blank menu when pressed.

Key Path	Front-panel key
Initial S/W Revision	Prior to A.02.00

Meas

The information in this section is common to all measurements. For key and remote command information for a specific measurement, refer to the section that describes the measurement of interest.

Measurements available under the Meas key are specific to the current Mode.

When viewing Help for measurements, note the following:

NOTE

Operation for some keys differs between measurements. The information displayed in Help pertains to the current measurement. To see how a key operates in a different measurement, exit Help (press the Cancel Esc key), select the measurement, then reenter Help (press the Help key) and press that key.

Key Path	Front-panel key
Initial S/W Revision	Prior to A.02.00

Remote Measurement Functions

This section contains the following topics:

["Measurement Group of Commands" on page 2214](#)

["Current Measurement Query \(Remote Command Only\)" on page 2216](#)

["Limit Test Current Results \(Remote Command Only\)" on page 2216](#)

["Data Query \(Remote Command Only\)" on page 2216](#)

["Calculate/Compress Trace Data Query \(Remote Command Only\)" on page 2217](#)

["Calculate Peaks of Trace Data \(Remote Command Only\)" on page 2222](#)

["Hardware-Accelerated Fast Power Measurement \(Remote Command Only\)" on page 2223](#)

["Format Data: Numeric Data \(Remote Command Only\)" on page 2237](#)

["Format Data: Byte Order \(Remote Command Only\)" on page 2238](#)

Initial S/W Revision	Prior to A.02.00
----------------------	------------------

Measurement Group of Commands

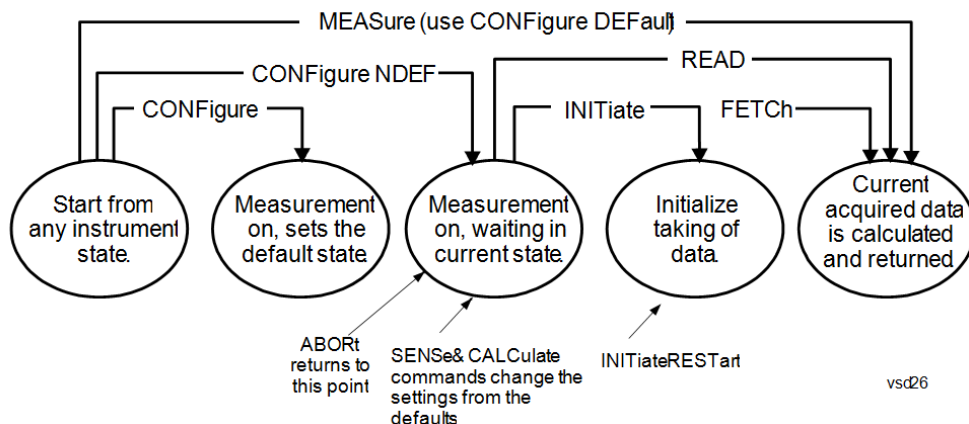

Measure Commands:

:MEASure:<measurement>[n]?

This is a fast single-command way to make a measurement using the factory default instrument settings. These are the settings and units that conform to the Mode Setup settings (e.g. radio standard) that you have currently selected.

- Stops the current measurement (if any) and sets up the instrument for the specified measurement using the factory defaults
- Initiates the data acquisition for the measurement
- Blocks other SCPI communication, waiting until the measurement is complete before returning results.
- If the function does averaging, it is turned on and the number of averages is set to 10.
- After the data is valid it returns the scalar results, or the trace data, for the specified measurement. The type of data returned may be defined by an [n] value that is sent with the command.
- The scalar measurement results will be returned if the optional [n] value is not included, or is set to 1. If the [n] value is set to a value other than 1, the selected trace data results will be returned. See each command for details of what types of scalar results or trace data results are available.
- ASCII is the default format for the data output. (Older versions of Spectrum Analysis and Phase Noise mode measurements only use ASCII.) The binary data formats should be used for handling large blocks of data since they are smaller and faster than the ASCII format. Refer to the FORMat:DATA command for more information.

If you need to change some of the measurement parameters from the factory default settings you can set up the measurement with the CONFIgure command. Use the commands in the SENSe:<measurement> and CALCulate:<measurement> subsystems to change the settings. Then you can use the READ? command to initiate the measurement and query the results.

If you need to repeatedly make a given measurement with settings other than the factory defaults, you can use the commands in the SENSe:<measurement> and CALCulate:<measurement> subsystems to set up the measurement. Then use the READ? command to initiate the measurement and query results.

Measurement settings persist if you initiate a different measurement and then return to a previous one. Use READ:<measurement>? if you want to use those persistent settings. If you want to go back to the default settings, use MEASure:<measurement>?.

Configure Commands:

:CONFIgure:<measurement>

This command stops the current measurement (if any) and sets up the instrument for the specified measurement using

the factory default instrument settings. It does not initiate the taking of measurement data unless INIT:CONTInuous is ON. If you change any measurement settings after using the CONFigure command, the READ command can be used to initiate a measurement without changing the settings back to their defaults.

In the Swept SA measurement in Spectrum Analyzer mode the CONFigure command also turns the averaging function on and sets the number of averages to 10 for all measurements.

:CONFigure: <measurement>: NDEFault stops the current measurement and changes to the specified measurement. It does not change the settings to the defaults. It does not initiate the taking of measurement data unless INIT:CONTInuous is ON.

The CONFigure? query returns the current measurement name.

The CONFigure:CATalog? query returns a quoted string of all licensed measurement names in the current mode. For example, "SAN, CHP, OBW, ACP, PST, TXP, SPUR, SEM, LIST".

Fetch Commands:

:FETCh:<measurement>[n]?

This command puts selected data from the most recent measurement into the output buffer. Use FETCh if you have already made a good measurement and you want to return several types of data (different [n] values, for example, both scalars and trace data) from a single measurement. FETCh saves you the time of re-making the measurement. You can only FETCh results from the measurement that is currently active, it will not change to a different measurement. An error message is reported if a measurement other than the current one is specified.

If you need to get new measurement data, use the READ command, which is equivalent to an INITiate followed by a FETCh.

The scalar measurement results will be returned if the optional [n] value is not included, or is set to 1. If the [n] value is set to a value other than 1, the selected trace data results will be returned. See each command for details of what types of scalar results or trace data results are available. The binary data formats should be used for handling large blocks of data since they are smaller and transfer faster than the ASCII format. (FORMat:DATA)

FETCh may be used to return results other than those specified with the original READ or MEASure command that you sent.

INITiate Commands:

:INITiate:<measurement>

This command is not available for measurements in all the instrument modes:

- Initiates a trigger cycle for the specified measurement, but does not output any data. You must then use the FETCh<meas> command to return data. If a measurement other than the current one is specified, the instrument will switch to that measurement and then initiate it.
- For example, suppose you have previously initiated the ACP measurement, but now you are running the channel power measurement. If you send INIT:ACP? it will change from channel power to ACP and will initiate an ACP measurement.
- Does not change any of the measurement settings. For example, if you have previously started the ACP measurement and you send INIT:ACP? it will initiate a new ACP measurement using the same instrument settings as the last time ACP was run.
- If your selected measurement is currently active (in the idle state) it triggers the measurement, assuming the trigger conditions are met. Then it completes one trigger cycle. Depending upon the measurement and the number of averages, there may be multiple data acquisitions, with multiple trigger events, for one full trigger cycle. It also holds off additional commands on GPIB until the acquisition is complete.

READ Commands:

:READ:<measurement>[n]?

- Does not preset the measurement to the factory default settings. For example, if you have previously initiated the ACP
-

measurement and you send READ:ACP? it will initiate a new measurement using the same instrument settings.

- Initiates the measurement and puts valid data into the output buffer. If a measurement other than the current one is specified, the instrument will switch to that measurement before it initiates the measurement and returns results.
 - For example, suppose you have previously initiated the ACP measurement, but now you are running the channel power measurement. Then you send READ:ACP? It will change from channel power back to ACP and, using the previous ACP settings, will initiate the measurement and return results.
 - Blocks other SCPI communication, waiting until the measurement is complete before returning the results
 - If the optional [n] value is not included, or is set to 1, the scalar measurement results will be returned. If the [n] value is set to a value other than 1, the selected trace data results will be returned. See each command for details of what types of scalar results or trace data results are available. The binary data formats should be used when handling large blocks of data since they are smaller and faster than the ASCII format. (FORMat:DATA)
-

Initial S/W Revision	Prior to A.02.00
----------------------	------------------

Current Measurement Query (Remote Command Only)

This command returns the name of the measurement that is currently running.

Remote Command	:CONFigure?
-----------------------	-------------

Example	CONF?
----------------	-------

Initial S/W Revision	Prior to A.02.00
----------------------	------------------

Limit Test Current Results (Remote Command Only)

Queries the status of the current measurement limit testing. It returns a 0 if the measured results pass when compared with the current limits. It returns a 1 if the measured results fail any limit tests.

Remote Command	:CALCulate:CLIMits:FAIL?
-----------------------	--------------------------

Example	CALC:CLIM:FAIL? queries the current measurement to see if it fails the defined limits. Returns a 0 or 1: 0 it passes, 1 it fails.
----------------	--

Initial S/W Revision	Prior to A.02.00
----------------------	------------------

Data Query (Remote Command Only)

Returns the designated measurement data for the currently selected measurement and subopcode.

n = any valid subopcode for the current measurement. See the measurement command results table for your current measurement, for information about what data is returned for the subopcodes.

This command uses the data setting specified by the FORMat:BORDER and FORMat:DATA commands and can return real or ASCII data. (See the format command descriptions under Input/Output in the Analyzer Setup section.)

Remote Command	:CALCulate:DATA[n]?
Notes	The return trace depends on the measurement. In CALCulate:<meas>:DATA[n], n is any valid subopcode for the current measurement. It returns the same data as the FETCH:<measurement>? query where <measurement> is the current measurement.
Initial S/W Revision	Prior to A.02.00

Calculate/Compress Trace Data Query (Remote Command Only)

Returns compressed data for the currently selected measurement and sub-opcode [n].

n = any valid sub-opcode for that measurement. See the MEASure:<measurement>? command description of your specific measurement for information on the data that can be returned.

The data is returned in the current Y Axis Unit of the analyzer. The command is used with a sub-opcode <n> (default=1) to specify the trace. With trace queries, it is best if the analyzer is not sweeping during the query. Therefore, it is generally advisable to be in Single Sweep, or Update=Off.

This command is used to compress or decimate a long trace to extract and return only the desired data. A typical example would be to acquire N frames of GSM data and return the mean power of the first burst in each frame. The command can also be used to identify the best curve fit for the data.

Remote Command	:CALCulate:DATA<n>:COMPRESS? BLOCK CFIT MAXimum MINimum MEAN DMEan RMS RMSCubed SAMPLE SDEVIation PPHase [,<soffset> [,<length>[,<roffset>[,<rlimit>]]]]
Example	To query the mean power of a set of GSM bursts: Supply a signal that is a set of GSM bursts. Select the IQ Waveform measurement (in IQ Analyzer Mode). Set the sweep time to acquire at least one burst. Set the triggers such that acquisition happens at a known position relative to a burst. Then query the mean burst levels using, CALC:DATA2:COMP? MEAN, 24e-6, 526e-6 (These parameter values correspond to GSM signals, where 526e-6 is the length of the burst in the slot and you just want 1 burst.)
Notes	The command supports 5 parameters. Note that the last 4 (<soffset>, <length>, <roffset>, <rlimit>) are optional. But these optional parameters must be entered in the specified order. For example, if you want to specify <length>, then you must also specify <soffset>. See details below for a definition of each of these parameters. This command uses the data in the format specified by FORMat:DATA, returning either binary or ASCII data.
Initial S/W Revision	Prior to A.02.00

- BLOCK or block data - returns all the data points from the region of the trace data that you specify. For example, it could be used to return the data points of an input signal over several timeslots, excluding the portions of the trace data that you do not want. (This is x,y pairs for trace data and I,Q pairs for complex data.)

- CFIT or curve fit - applies curve fitting routines to the data. <soffset> and <length> are required to define the data that you want. <roffset> is an optional parameter for the desired order of the curve equation. The query will return the following values: the x-offset (in seconds) and the curve coefficients ((order + 1) values).

MIN, MAX, MEAN, DME, RMS, RMSC, SAMP, SDEV and PPH return one data value for each specified region (or <length>) of trace data, for as many regions as possible until you run out of trace data (using <roffset> to specify regions). Or they return the number of regions you specify (using <rlimit>) ignoring any data beyond that.

- MINimum - returns the minimum data point (y value) for the specified region(s) of trace data. For I/Q trace data, the minimum magnitude of the I/Q pairs is returned.
- MAXimum - returns the maximum data point (y value) for the specified region(s) of trace data. For I/Q trace data, the maximum magnitude of the I/Q pairs is returned.
- MEAN - returns a single value that is the arithmetic mean of the data point values (in dB/ dBm) for the specified region(s) of trace data. For I/Q trace data, the mean of the magnitudes of the I/Q pairs is returned. See the following equations.

NOTE If the original trace data is in dB, this function returns the arithmetic mean of those log values, not log of the mean power which is a more useful value. The mean of the log is the better measurement technique when measuring CW signals in the presence of noise. The mean of the power, expressed in dB, is useful in power measurements such as Channel Power. To achieve the mean of the power, use the RMS option.

Equation 1

Mean Value of Data Points for Specified Region(s)

$$MEAN = \frac{1}{n} \sum_{X_i \in \text{region}(s)} X_i$$

where X_i is a data point value, and n is the number of data points in the specified region(s).

Equation 2

Mean Value of I/Q Data Pairs for Specified Region(s)

$$MEAN = \frac{1}{n} \sum_{X_i \in \text{region}(s)} |X_i|$$

where $|X_i|$ is the magnitude of an I/Q pair, and n is the number of I/Q pairs in the specified region(s).

- DMEan - returns a single value that is the mean power (in dB/ dBm) of the data point values for the specified region(s) of trace data. See the following equation:

Equation 3

DMEan Value of Data Points for Specified Region(s)

$$\text{DME} = 10 \times \log_{10} \left(\frac{1}{n} \sum_{X_i \in \text{region}(s)} 10^{\frac{X_i}{10}} \right)$$

- RMS - returns a single value that is the average power on a root-mean-squared voltage scale (arithmetic rms) of the data point values for the specified region(s) of trace data. See the following equation.

NOTE For I/Q trace data, the rms of the magnitudes of the I/Q pairs is returned. See the following equation. This function is very useful for I/Q trace data. However, if the original trace data is in dB, this function returns the rms of the log values which is not usually needed.

Equation 4

RMS Value of Data Points for Specified Region(s)

$$\text{RMS} = \sqrt{\frac{1}{n} \sum_{X_i \in \text{region}(s)} X_i^2}$$

where X_i is a data point value, and n is the number of data points in the specified region(s).

Equation 5

RMS Value of I/Q Data Pairs for Specified Region(s)

$$\text{RMS} = \sqrt{\frac{1}{n} \sum_{X_i \in \text{region}(s)} X_i X_i^*}$$

where X_i is the complex value representation of an I/Q pair, X_i^* its conjugate complex number, and n is the number of I/Q pairs in the specified region(s).

Once you have the rms value for a region of trace data (linear or I/Q), you may want to calculate the mean power. You must convert this rms value (peak volts) to power in dBm:

$$10 \times \log[10 \times (\text{rms value})^2]$$

- SAMPLe - returns the first data value (x,y pair) for the specified region(s) of trace data. For I/Q trace data, the first I/Q pair is returned.
- SDEVIation - returns a single value that is the arithmetic standard deviation for the data point values for the specified region(s) of trace data. See the following equation.
- For I/Q trace data, the standard deviation of the magnitudes of the I/Q pairs is returned. See the following equation.

Equation 6

Standard Deviation of Data Point Values for Specified Region(s)

$$\text{SDEV} = \sqrt{\frac{1}{n} \sum_{X_i \in \text{region}(s)} (X_i - \bar{X})^2}$$

where X_i is a data point value, \bar{X} is the arithmetic mean of the data point values for the specified region (s), and n is the number of data points in the specified region(s).

$$\text{SDEV} = \sqrt{\frac{1}{n} \sum_{X_i \in \text{region}(s)} (|X_i| - \bar{X})^2}$$

where $|X_i|$ is the magnitude of an I/Q pair, \bar{X} is the mean of the magnitudes for the specified region(s), and n is the number of data points in the specified region(s).

- PPHase - returns the x,y pairs of both rms power (dBm) and arithmetic mean phase (radian) for every specified region and frequency offset (Hz). The number of pairs is defined by the specified number of regions. This parameter can be used for I/Q vector ($n=0$) in Waveform (time domain) measurement and all parameters are specified by data point in PPHase.

The rms power of the specified region may be expressed as:

$$\text{Power} = 10 \times \log [10 \times (\text{RMS I/Q value})] + 10.$$

The RMS I/Q value (peak volts) is:

$$\sqrt{\frac{1}{n} \sum_{X_i \in \text{region}} X_i X_i^*}$$

where X_i is the complex value representation of an I/Q pair, X_i^* its conjugate complex number, and n is the number of I/Q pairs in the specified region.

The arithmetic mean phase of the specified region may be expressed as:

$$\frac{1}{n} \sum_{Y_i \in \text{region}} Y_i$$

where Y_i is the unwrapped phase of I/Q pair with applying frequency correction and n is the number of I/Q pairs in the specified region.

The frequency correction is made by the frequency offset calculated by the arithmetic mean of every specified region's frequency offset. Each frequency offset is calculated by the least square method against the unwrapped phase of I/Q pair.

Sample Trace Data - Constant Envelope

(See below for explanation of variables.)

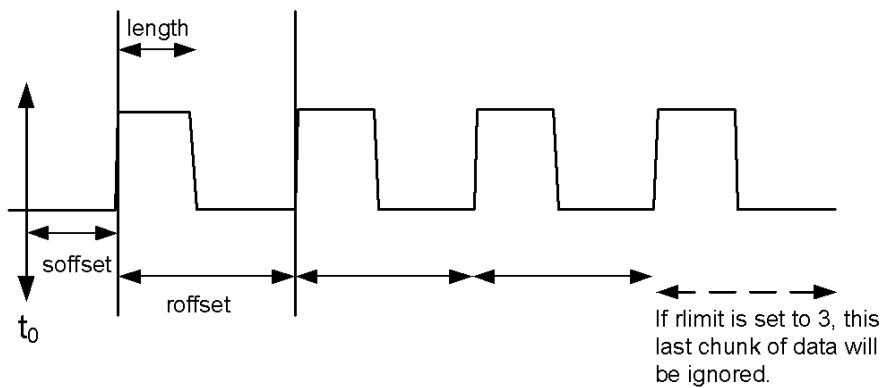

Sample Trace Data - Not Constant Envelope

(See below for explanation of variables.)

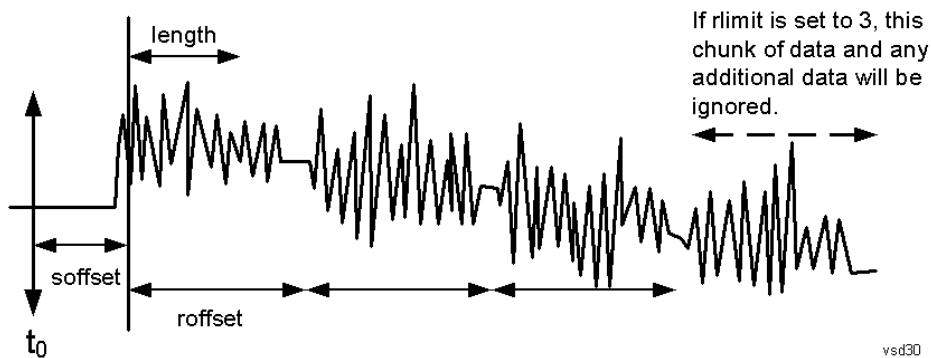

<soffset> - start offset is an optional real number. (It is in seconds for time-domain traces, and is a dimensionless index 0 to Npoints - 1, for frequency-domain traces). It specifies the amount of data at the beginning of the trace that will be ignored before the decimation process starts. It is the time or frequency change from the start of the trace to the point where you want to start using the data. The default value is zero.

<length> - is an optional real number. (It is in seconds for time-domain traces, and is a dimensionless index 0 to Npoints - 1, for frequency-domain traces). It defines how much data will be compressed into one value. This parameter has a default value equal to the current trace length.

<roffset> - repeat offset is an optional real number. (It is in seconds for time-domain traces, and is a dimensionless index 0 to Npoints - 1, for frequency-domain traces). It defines the beginning of the next field of trace elements to be compressed. This is relative to the beginning of the previous field. This parameter has a default value equal to the <length> variable. Note that this parameter is used for a completely different purpose when curve fitting (see CFIT above).

<rlimit> - repeat limit is an optional integer. It specifies the number of data items that you want returned. It will ignore any additional items beyond that number. You can use the Start offset and the Repeat limit to pick out exactly what part of the data you want to use. The default value is all the data.

Calculate Peaks of Trace Data (Remote Command Only)

Returns a list of all the peaks for the currently selected measurement and sub-opcode [n]. The peaks must meet the requirements of the peak threshold and excursion values.

n = any valid sub-opcode for the current measurement. See the MEASure:<measurement> command description of your specific measurement for information on the data that can be returned.

The command can only be used with specific sub-opcodes with measurement results that are trace data. Both real and complex traces can be searched, but complex traces are converted to magnitude in dBm. In many measurements the sub-opcode n=0, is the raw trace data which cannot be searched for peaks. And Sub-opcode n=1, is often calculated results values which also cannot be searched for peaks.

This command uses the data setting specified by the FORMat:BORDER and FORMat:DATA commands and can return real or ASCII data. If the format is set to INT,32, it returns REAL,32 data.

The command has four types of parameters:

- Threshold (in dBm)
- Excursion (in dB)
- Sorting order (amplitude, frequency, time)
- Optional in some measurements: Display line use (all, > display line, < display line)

Remote Command	<p>For Swept SA measurement:</p> <pre>:CALCulate:DATA[1] 2 ... 6:PEAKs? <threshold>,<excursion>[,AMPLitude FREQuency TIME[,ALL GTDLine LTDLine]]</pre> <p>For most other measurements:</p> <pre>:CALCulate:DATA[1] 2 ... 6:PEAKs? <threshold>,<excursion>[,AMPLitude FREQuency TIME]</pre>
-----------------------	--

Example	<p>Example for Swept SA measurement in Spectrum Analyzer Mode:</p> <p>CALC:DATA4:PEAK? -40, 10, FREQ, GTDL This will identify the peaks of trace 4 that are above -40 dBm, with excursions of at least 10 dB. The peaks are returned in order of increasing frequency, starting with the lowest frequency. Only the peaks that are above the display line are returned.</p> <p>Query Results 1:</p> <p>With FORMat:DATA REAL, 32 selected, it returns a list of floating-point numbers. The first value in the list is the number of peak points that are in the following list. A peak point consists of two values: a peak amplitude followed by its corresponding frequency (or time).</p> <p>If no peaks are found the peak list will consist of only the number of peaks, (0).</p>
----------------	---

Notes	<p><n> - is the trace that will be used</p> <p><threshold> - is the level below which trace data peaks are ignored. Note that the threshold value is required and is always used as a peak criterion. To effectively disable the threshold criterion for this command, provide a substantially low threshold value such as -200 dBm. Also note that the threshold value used in this command is independent of and has no effect on the threshold value stored under the Peak Criteria menu.</p> <p><excursion> - is the minimum amplitude variation (rise and fall) required for a signal to be identified as peak. Note that the excursion value is required and is always used as a peak criterion. To effectively disable the excursion criterion for this command, provide the minimum value of 0.0 dB. Also note that the excursion value used in this command is independent of and has no effect on the</p>
--------------	---

excursion value stored under the Peak Criteria menu.

Values must be provided for threshold and excursion. The sorting and display line parameters are optional (defaults are AMPLitude and ALL).

Note that there is always a Y-axis value for the display line, regardless of whether the display line state is on or off. It is the current Y-axis value of the display line which is used by this command to determine whether a peak should be reported

Sorting order:

AMPLitude - lists the peaks in order of descending amplitude, with the highest peak first (default if optional parameter not sent)

FREQUency - lists the peaks in order of occurrence, left to right across the x-axis.

TIME - lists the peaks in order of occurrence, left to right across the x-axis.

Peaks vs. Display Line:

ALL - lists all of the peaks found (default if optional parameter not sent).

GTDLine (greater than display line) - lists all of the peaks found above the display line.

LTDLine (less than display line) - lists all of the peaks found below the display line.

Initial S/W Revision	Prior to A.02.00
----------------------	------------------

Hardware-Accelerated Fast Power Measurement (Remote Command Only)

The Fast Power option (FP2) enables very fast channel power measurements for instruments with the prerequisite hardware (DP2 and/or B40). It accomplishes this by performing real-time overlapped FFTs at the hardware layer, using software for basic post-processing before returning the result to the user. The upshot of this approach is improved throughput for user applications that require many sequential power measurements.

The analysis bandwidth of FP2 is limited by the licenses in the instrument, but its maximum overall analysis bandwidth per acquisition is 40 MHz.

FP2 is remote-only, which means the instrument does not switch to any particular mode or measurement. FP2 commands can be sent while another application is in use on the front panel.

Each Fast Power measurement can be predefined using an array index, and up to 1,000 measurements can be stored. In the following documentation, instances of [1,2,...,999] can be substituted with a particular measurement index, e.g. CALC:FPOW:POW1?, CALC:FPOW:POW2?, CALC:FPOW:POW134?. In this way, power measurements can be defined one time in a batch, and then executed multiple times without having to redefine them, similar to “list mode” on other measurements.

In addition to basic channel power measurements, there are a number of other measurement “functions” for each channel, including peak power, peak frequency, and power spectral density. See the Function parameter for more information.

Reset Fast Power Measurement (Remote Command Only)

Resets the measurement configuration to the defaults.

Mode	All
Remote Command	:CALCulate:FPOWer:POWer[1,2,...,999]:RESet
Example	:CALC:FPOW:POW1:RES

Notes	Option FP2 is required.
Initial S/W Revision	A.14.00

Define Fast Power Measurement (Remote Command Only)

Fast Power acquisitions are configured using the DEFine command. This command accepts a comma-delimited string of configuration parameters and their appropriate values, which are all specified in the subsection below.

Mode	All
Remote Command	:CALCulate:FPOWER:POWer[1,2,...,999]:DEFine "configuration string"
Example	:CALC:FPOW:POW1:DEF "CenterFrequency=2e9, AcquisitionTime=0.005"
Notes	See below for a list of measurement variables that can be defined in the configuration string.
Initial S/W Revision	A.14.00

Acquisition Time

Value	Time (s)
Range	0 s to 1 s
Preset	0.001 s
Example	CALC:FPOW:POW1:DEF "AcquisitionTime=0.002"
Notes	The acquisition time parameter sets the time in which the entire spectrum is measured. An increase in the acquisition time yields an improvement in measurement repeatability.
Initial S/W Revision	A.14.00

Center Frequency

Value	Frequency (Hz)
Range	0 Hz to maximum instrument frequency
Preset	1 GHz
Example	CALC:FPOW:POW1:DEF "CenterFrequency=2e9"
Notes	The center frequency parameter sets the frequency in which the measurement is centered around. The OffsetFrequency parameter is calculated relative to the center frequency.
Initial S/W Revision	A.14.00

DC Coupled

Value	Boolean
Range	True (DC Coupled) or False (AC Coupled)
Preset	False
Example	CALC:FPOW:POW1:DEF "DCCoupled=True"
Notes	The DC coupled parameter allows the user to specify whether the DC blocking capacitor is utilized. Set parameter to true when measuring frequencies below 10 MHz.
Initial S/W Revision	A.14.00

DetectorType

Example	CALC:FPOW:POW1:DEF "DetectorType=Peak"
Notes	Option FP2 is required. The detector type parameter allows the user to choose whether a RMS average or peak value is used during the measurement.
Preset	RmsAverage
Range	RmsAverage, Peak
Initial S/W Revision	A.14.00

Do Noise Correction

Value	Boolean
Range	True (enable noise correction) or False (disable noise correction)
Preset	False
Example	CALC:FPOW:POW1:DEF "DoNoiseCorrection=True"
Notes	When noise correction is enabled, the linear noise power contributed by the analyzer is subtracted from all measurements. This effectively lowers the noise floor of the analyzer. When noise correction is enabled, the first measurement for a given set of input parameters will take extra time. This is because the analyzer takes an extra acquisition with the RF input disconnected from the analyzer's front end to measure the noise of just the analyzer. The measured noise floor is stored in a cache so the noise acquisition will occur only once for the same state settings. In other words, if noise correction was turned on and the analyzer made an acquisition at frequency A, then frequency B, and back again to frequency A, the hidden initial noise floor acquisition would only occur for the first acquisition at frequency A and the cached noise floor would be used the second time frequency A was measured.
Initial S/W Revision	A.14.00

Do Spur Suppression

Value	Boolean
Range	True (enable spur suppression) or False (disable spur suppression)
Preset	False
Example	CALC:FPOW:POW1:DEF "DoSpurSuppression=True"
Notes	<p>When measuring very low level signals, or when large out-of-band inputs are input into the analyzer, sometimes unwanted spurs and residuals can appear in the measured spectrum. Spur suppression is a method to help minimize the levels of these internally generated spurs and residuals.</p> <p>When spur suppression is enabled, the analyzer will automatically take two acquisitions using two different internal analog LO frequencies. The FFT spectrums from both acquisitions are combined by taking the minimum power between both traces on a per FFT bin basis. External signals will have the same amplitude for both traces and therefore will return the expected amplitudes. However, low level spurs and residuals generated internally to the analyzer tend to move to different FFT bins depending on the internal analog LO frequency used, and therefore tend to be suppressed using this spur suppression method.</p> <p>Because two acquisitions, rather than a single acquisition, are made when spur suppression is enabled, the measurement time will always be slower when spur suppression is enabled.</p>
Initial S/W Revision	A.14.00

Electronic Attenuator Bypass

Value	Boolean
Range	True (bypass electronic attenuator) or False (use electronic attenuator)
Preset	True
Example	CALC:FPOW:POW1:DEF "ElecAttBypass =False"
Notes	The electronic attenuation bypass parameter allows the user to either utilize or bypass the electronic attenuator. The electronic attenuator is only available for frequencies up to 3.6 GHz. Set parameter to true when using frequencies above 3.6 GHz and set the parameter to false when using the preamp.
Initial S/W Revision	A.14.00

Electronic Attenuation

Value	dB
Range	0 - 24 dB (1 dB steps)
Preset	0 dB
Example	CALC:FPOW:POW1:DEF "ElecAttenuation=10"
Notes	<p>Option EA3 is required.</p> <p>The electronic attenuation value parameter sets the amount of electrical attenuation from 0 to 24 dB (1 dB steps).</p>

Set "ElecAttBypass=False" to make sure the electronic attenuator path is enabled.

Initial S/W Revision	A.14.00
-------------------------	---------

IF Gain

Value	dB
Range	-6 - 16 dB (1 dB steps)
Preset	0 dB
Example	CALC:FPOW:POW1:DEF "IFGain=10"
Notes	The IF gain parameter allows the user to specify the gain at the IF stage anywhere from -6 to 16 dB (1 dB steps). This is an advanced feature, and for most cases this should remain at its default value of 0 dB.
Initial S/W Revision	A.14.00

IF Type

Example	CALC:FPOW:POW1:DEF "IFType=B25M"
Notes	The IF type parameter allows the user to select between different IF paths. For example, if the signal is less than 25 MHz wide, then the user can select the B25M path to take advantage of additional filtering on this analog IF path.
Preset	B40M
Range	B10M, B25M, B40M
Initial S/W Revision	A.14.00

Include Power Spectrum

Value	Boolean
Range	True (return both channel power and full power spectrum) or False (returns only channel power)
Preset	False
Example	CALC:FPOW:POW1:DEF "IncludePowerSpectrum=True"
Notes	The power spectrum parameter allows the user to read data on the entire spectrum for diagnostic purposes. It is not recommended for production use. See CALC:FPOW:POW[n]:READ2? for details on the binary format of the response.
Initial S/W Revision	A.14.00

Mechanical Attenuation

Value	dB
Range	0 – 70 dB (2 dB steps)
Preset	0 dB
Example	CALC:FPOW:POW1:DEF "MechAttenuation=10"
Notes	The mechanical attenuation value parameter sets the amount of mechanical attenuation anywhere from 0 to 70 dB (2 dB steps).
Initial S/W Revision	A.14.00

Preamp Mode

Example	CALC:FPOW:POW1:DEF "PreAmpMode=Low"
Notes	The license for the appropriate preamp is required. The preamp mode parameter specifies whether the preamps are being utilized. Low allows any preamps up to 3.6 GHz, and Full allows all licensed preamps. Set "ElecAttBypass=True" in order to utilize any preamps.
Preset	Off
Range	Off, Low, Full
Initial S/W Revision	A.14.00

Resolution Bandwidth Mode

Example	CALC:FPOW:POW1:DEF "PreAmpMode=Low"
Notes	The resolution bandwidth mode parameter allows the user to choose whether the RBW filter is automatically or manually set. The BestSpeed value minimizes measurement time, while the Narrowest value minimizes RBW size (minimum of two FFT bins per RBW). To manually specify an RBW, set this parameter to Explicit, and set the ResolutionBW parameter to the desired value.
Preset	BestSpeed
Range	BestSpeed, Narrowest, Explicit
Initial S/W Revision	A.14.00

Resolution Bandwidth

Value	Hz
Preset	0 Hz

Example	CALC:FPOW:POW1:DEF "ResolutionBW=25e3"
Notes	The resolution bandwidth parameter sets the 3-dB bandwidth of the RBW filter. The ResolutionBWMode parameter must be set to Explicit in order to manually set the RBW.
Initial S/W Revision	A.14.00

Trigger Delay

Value	Seconds
Range	0 – 1 s
Preset	0 s
Example	CALC:FPOW:POW1:DEF "TriggerDelay=0.025"
Notes	The trigger delay parameter sets the time after an external trigger is detected until the measurement is performed.
Initial S/W Revision	A.14.00

Trigger Level

Value	Volts
Range	-5 to 5 V
Preset	1.2 V
Example	CALC:FPOW:POW1:DEF "TriggerLevel=2"
Notes	The trigger level parameter sets the voltage value at which an external trigger is detected.
Initial S/W Revision	A.14.00

Trigger Slope

Example	CALC:FPOW:POW1:DEF "TriggerSlope=Negative"
Notes	The trigger slope parameter indicates the direction of the edge trigger voltage for detection.
Preset	Positive
Range	Positive, Negative
Initial S/W Revision	A.14.00

Trigger Source

Example	CALC:FPOW:POW1:DEF "TriggerSource=Ext1 "
Notes	The trigger source parameter allows the user to choose between measurement's triggering freely or controlled by an external input. Ext1 and Ext2 correspond to Trigger 1 In and Trigger 2 In, respectively.
Preset	Free
Range	Free, Ext1, Ext2
Initial S/W Revision	A.14.00

Trigger Timeout

Value	Seconds
Range	0 - 1 s
Preset	1 s
Example	CALC:FPOW:POW1:DEF "TriggerTimeout=0.1"
Notes	The trigger timeout parameter sets the time in which the analyzer will wait for a trigger before automatically performing the measurement.
Initial S/W Revision	A.14.00

Signal Input

Example	CALC:FPOW:POW1:DEF "SignalInput=Fp50MHzCW"
Notes	The signal input parameter allows the user to select between using the main RF input or the internal analyzer reference CW signal of 50 MHz.
Preset	FpMainRf
Range	FpMainRf, Fp50MHzCW
Initial S/W Revision	A.14.00

Use Preselector

Value	Boolean
Range	True (use preselector above 3.6 GHz), or False (preselector bypassed)
Preset	False
Example	CALC:FPOW:POW1:DEF "UsePreSelector=True"
Notes	The preselector parameter allows the user to either utilize or bypass the front end tunable filter at frequencies above 3.6 GHz. For frequencies below 3.6 GHz, the preselector is automatically

bypassed, so you do not need to set this parameter to False in those cases.

Initial S/W Revision	A.14.00
----------------------	---------

Channel Bandwidth Array

Value	Hz
Range	0 to 40 MHz
Preset	[1 e6]
Example	CALC:FPOW:POW1:DEF "Bandwidth=[3.84e6, 5e6, 3.84e6]"
Notes	The bandwidth parameter array defines the bandwidth of each channel that will be measured. All array parameters should have the same number of elements. Alternatively, if all the elements are the same value, a single number with no square brackets can be used to define the parameter.
Initial S/W Revision	A.14.00

Channel Filter Type Array

Example	CALC:FPOW:POW1:DEF "FilterType=[RRC, IBW, RRC]"
Notes	The filter type parameter allows the user to choose between an integration bandwidth (IBW) filter or a root-raised-cosine (RRC) filter. The integration bandwidth filter weighs all frequencies within the bandwidth equally. The root-raised-cosine filter has an associated shape parameter, defined by the FilterAlpha parameter. All array parameters should have the same number of elements. Alternatively, if all the elements are the same value, a single value with no square brackets can be used to define the parameter.
Preset	[IBW]
Range	IBW, RRC
Initial S/W Revision	A.14.00

Channel Filter Alpha Array

Example	CALC:FPOW:POW1:DEF "FilterAlpha=[0.5, 0.0, 0.5]"
Notes	The filter alpha parameter allows the user to adjust the alpha value associated with the root-raised-cosine (RRC) filter type. Set FilterType to RRC in order to utilize this parameter. All array parameters should have the same number of elements. Alternatively, if all the elements are the same value, a single number with no square brackets can be used to define the parameter.
Preset	[0.22]
Range	0.0 - 1.0
Initial S/W Revision	A.14.00

Channel Measurement Function Array

Example	CALC:FPOW:POW1:DEF "Function=[BandPower, PeakPower, BandPower]"
Notes	<p>This parameter array defines what measurement is being made for each individually-specified channel:</p> <p>BandPower: Total power within the specified bandwidth of the channel (dBm)</p> <p>BandDensity: Total power density within the specified bandwidth of the channel (dBm/Hz)</p> <p>PeakPower: The peak power value within the specified bandwidth of the channel (dBm)</p> <p>PeakFrequency: The frequency which corresponds to the peak power value within the specified bandwidth of the channel. This frequency is relative to the center frequency (Hz)</p> <p>XdBBandwidth: The half power (-3.01 dB) bandwidth of the highest amplitude signal that resides within the channel (Hz), dB is configurable using XdBBandwidth parameter</p> <p>OccupiedBandwidth: The bandwidth at which 99% of the total power resides within the channel (Hz), percentage configurable using OccupiedBandwidthPercent parameter</p> <p>All array parameters should have the same number of elements. Alternatively, if all the elements are the same value, a single value with no square brackets can be used to define the parameter.</p>
Preset	[BandPower]
Range	BandPower, BandDensity, PeakPower, PeakFrequency, XdBBandwidth, OccupiedBandwidth
Initial S/W Revision	A.14.00

Channel Offset Frequency Array

Value	Hz
Range	0 to 20 MHz
Preset	[0]
Example	CALC:FPOW:POW1:DEF "OffsetFrequency=[-5e6, 0, 5e6]"
Notes	<p>The offset frequency parameter array defines the difference between the center frequency to the center frequency of each channel.</p> <p>All array parameters should have the same number of elements.</p>
Initial S/W Revision	A.14.00

Channel Occupied Bandwidth Percent Array

Example	CALC:FPOW:POW1:DEF "OccupiedBandwidthPercent =[0.95, 0.95, 0.95]"
Notes	<p>This parameter only applies for channels whose Function is set to OccupiedBandwidth. The occupied bandwidth percent parameter specifies the percent of total power in these channels. The valid range for this parameter is 0.0 to 1.0, where 1.0 represents 100%. The default for this parameter is 0.99, which will return the bandwidth that contains 99% of the total channel power.</p>

Preset	[0.99]
Range	0 – 1.0
Initial S/W Revision	A.14.00

Channel x-dB Bandwidth Array

Value	dB
Range	-200 to 0 dB
Preset	[-3.01]
Example	CALC:FPOW:POW1:DEF " XdBBandwidth =[-6.02, -3.01, -1.0]"
Notes	This parameter only applies for channels whose Function is set to XdBBandwidth. The X dB bandwidth parameter is used to specify the power relative to the peak channel power over which the bandwidth is calculated. The parameter value must be a negative number.
Initial S/W Revision	A.14.00

Define Fast Power Measurement Query (Remote Command Only)

The DEFine? command is used to retrieve a list of all defined parameters in an ASCII string format

M o d e	All
R e m o t e	:CALCulate:FPOWER:POWer [1,2,...,999]:DEFine?
C o m m a n d	
E x a m p l e	:CALC:FPOW:POW1:DEF?

```

p
l
e
-----
N This command query is used to retrieve a list of all defined parameters in an ASCII format.
o The following is an example of the returned results:
t "DCCoupled=False,ElecAttBypass=True,ElecAttenuation=0,IFGain=0,MechAttenuation=0,PreAmpMode=Off,PreSelectorOffset
e =0,UsePreSelector=False,ExternalReferenceFrequency=10000000,FrequencyReferenceSource=AutoExternalFrequencyRefer
s ence,IFType=B40M,LOMode=SLW,SignalInput=FpMainRf,AcquisitionTime=0.001,CenterFrequency=1000000000,Resolution
BW=0,ResolutionBWMode=BestSpeed,DetectorType=RmsAverage,Bandwidth=[1000000],OffsetFrequency=[0],Function=
[BandPower],FilterType=[IBW],FilterAlpha=[0.22],OccupiedBandwidthPercent=[0.99],XdBBandwidth=[-
3.01],DoNoiseCorrection=False,DoSpurSuppression=False,MeasurementMethod=HardwareFFT,IncludePowerSpectrum=False
e,TriggerDelay=0,TriggerLevel=1.2,TriggerSlope=Positive,TriggerSource=Free,TriggerTimeout=1 "
-----
I A.14.00
n
i
t
i
a
l

S
/
W

R
e
v
i
s
i
o
n

```

Configure Fast Power Measurement (Remote Command Only)

The configure command begins hardware setup and returns immediately, with no acquisition made. This can be used in parallel with other hardware operations to effectively hide the hardware setup time.

Mode	All
Remote Command	:CALCulate:FPOWer:POWer[1,2,...,999]:CONFigure
Example	:CALC:FPOW:POW1:CONF
Notes	Option FP2 is required.
Initial S/W Revision	A.14.00

Initiate Fast Power Measurement (Remote Command Only)

The INITiate command begins an acquisition and returns immediately. The results of the measurement can be retrieved using FETCh.

Mode	All
Remote Command	:CALCulate:FPOWER:POWER[1,2,...,999]:INITiate
Example	:CALC:FPOW:POW1:INIT
Notes	Option FP2 is required.
Initial S/W Revision	A.14.00

Fetch Fast Power Measurement (Remote Command Only)

The FETCh command query is used to retrieve the results of an acquisition initiated by the INIT command. The returned results are in ASCII string format. The string begins and ends with quotation marks.

Mode	All
Remote Command	:CALCulate:FPOWER:POWER[1,2,...,999]:FETCh?
Example	:CALC:FPOW:POW1:FETC?
Notes	Option FP2 is required. Returns m comma-separated ASCII values, where m corresponds to the number of bandwidths defined. 1. Declared function return in the 1st specified channel 2. Declared function return in the 2nd specified channel ... m. Declared function return in the last specified channel The INIT and FETC? command sequence performs the same functionality of a single CALC:FPOW:POW[n]? query. Units of the returned values are dependent on the Function parameter for each channel.
Initial S/W Revision	A.14.00

Execute Fast Power Measurement (Remote Command Only)

This command query is used as shorthand for an INIT command immediately followed by a FETC? command. The returned results are in ASCII string format. The string begins and ends with quotation marks.

Mode	All
Remote Command	:CALCulate:FPOWER:POWER[1,2,...,999]?
Example	:CALC:FPOW:POW1?
Notes	Option FP2 is required. See notes for Fast Power Fetch for return format.
Initial S/W Revision	A.14.00

Binary Read Fast Power Measurement (Remote Command Only)

This command query is used as shorthand for an INIT command immediately followed by a FETC? command. The returned results are in a binary format.

Mode	All
Remote Command	:CALCulate:FPOWER:POWER[1,2,...,999]:READ? :CALCulate:FPOWER:POWER[1,2,...,999]:READ1?
Example	:CALC:FPOW:POW1:READ? :CALC:FPOW:POW1:READ1?
Notes	Option FP2 is required. Returns m 4 byte floating point binary values (Little-Endian), where m corresponds to the number of bandwidths defined.
Initial S/W Revision	A.14.00

Diagnostic Binary Read Fast Power Measurement (Remote Command Only)

This command query is used as shorthand for an INIT command immediately followed by a FETC? command. The returned results are in a binary format. This command is used primarily for diagnostic purposes to test for ADC overloads and to visibly inspect the spectrum.

Mode	All
Remote Command	:CALCulate:FPOWER:POWER[1,2,...,999]:READ2?
Example	:CALC:FPOW:POW1:READ2?
Notes	Option FP2 is required. Note: Spectrum data is only returned if the IncludePowerSpectrum parameter is set to True. If IncludePowerSpectrum is False, the number of spectrum points will be zero (0). Units of the returned values are dependent on the Function parameter per channel (e.g. dBm for BandPower, Hz for PeakFrequency). Returns binary data (Little-Endian) that contains information on m amount of channels, along with ADC over range and full spectrum data. The following is the binary format of the response. Bandwidth Return Value 1. Number of channels specified, m [4 byte int] 2. Declared function result for the 1st specified channel [4 byte float] 3. Declared function result for the 2nd specified channel [4 byte float] ... (m + 1). Declared function result for the last (mth) specified channel [4 byte float] ADC Over Range 1. ADC over-range occurred (1: true, 0: false) [2 byte short]

	<p>Spectrum Data</p> <ol style="list-style-type: none"> 1. Number of points in the spectrum data, k [4 byte int] 2. Start frequency of spectrum data (Hz) [8 byte double] 3. Step frequency of spectrum data (Hz) [8 byte double] 4. FFT bin at 1st point (dBm) [4 byte float] 5. FFT bin at 2nd point (dBm) [4 byte float] <p>...</p> <p>(k + 3). FFT bin at last (kth) point (dBm) [4 byte float]</p>
Initial S/W Revision	A.14.00

Format Data: Numeric Data (Remote Command Only)

This command specifies the format of the trace data input and output. It specifies the formats used for trace data during data transfer across any remote port. It affects only the data format for setting and querying trace data for the :TRACe[:DATA], TRACe[:DATA]?, :CALCulate:DATA[n]? and FETCh:SANalyzer[n]? commands and queries.

Remote Command	<pre>:FORMat[:TRACe][:DATA] ASCii INTeger,32 REAL,32 REAL,64 :FORMat[:TRACe][:DATA]?</pre>
Notes	<p>The query response is:</p> <pre>ASCii: ASC,8 REAL,32: REAL,32 REAL,64: REAL,64 INTeger,32: INT,32</pre> <p>When the numeric data format is REAL or ASCii, data is output in the current Y Axis unit. When the data format is INTeger, data is output in units of m dBm (.001 dBm).</p> <p>The INT,32 format returns binary 32-bit integer values in internal units (m dBm), in a definite length block.</p>
Dependencies	<p>Sending a data format spec with an invalid number (for example, INT,48) generates no error. The analyzer simply uses the default (8 for ASCii, 32 for INTeger, 32 for REAL).</p> <p>Sending data to the analyzer which does not conform to the current FORMat specified, results in an error. Sending ASCII data when a definite block is expected generates message -161 "Invalid Block Data" and sending a definite block when ASCII data is expected generates message -121 "Invalid Character in Number".</p>
Preset	ASCii
Backwards Compatibility Notes	Note that the INT,32 format is only applicable to the command, TRACe:DATA. This preserves backwards compatibility for the Swept SA measurement. For all other commands/queries which honor FORMat:DATA, if INT,32 is sent the analyzer will behave as though it were set to REAL,32.
Initial S/W Revision	Prior to A.02.00

The specs for each output type follow:

AScii - Amplitude values are in ASCII, in the current Y Axis Unit, one ASCII character per digit, values separated by commas, each value in the form:

SX.YYYYYEsZZ

Where:

S = sign (+ or -)

X = one digit to left of decimal point

Y = 5 digits to right of decimal point

E = E, exponent header

s = sign of exponent (+ or -)

ZZ = two digit exponent

REAL,32 - Binary 32-bit real values in the current Y Axis Unit, in a definite length block.

REAL,64 - Binary 64-bit real values in the current Y Axis Unit, in a definite length block.

Format Data: Byte Order (Remote Command Only)

This command selects the binary data byte order for data transfer and other queries. It controls whether binary data is transferred in normal or swapped mode. This command affects only the byte order for setting and querying trace data for the :TRACe[:DATA], TRACe[:DATA]? , :CALCulate:DATA[n]? and FETCh:SANalyzer[n]? commands and queries.

By definition any command that says it uses FORMat:DATA uses any format supported by FORMat:DATA.

The NORMal order is a byte sequence that begins with the most significant byte (MSB) first, and ends with the least significant byte (LSB) last in the sequence: 1|2|3|4. SWAPped order is when the byte sequence begins with the LSB first, and ends with the MSB last in the sequence: 4|3|2|1.

Remote Command	:FORMat:BORDER NORMAL SWAPped :FORMat:BORDER?
Preset	NORMal
Initial S/W Revision	Prior to A.02.00

Meas Setup

Accesses the functions that allow you to change the settings for your measurement requirements.

Key Path	Front-panel key
Initial S/W Revision	Prior to A.02.00

Counts

Sets the accumulated number of sampling points for data acquisition. The range is 1.000 kpt (k point) to 2.00000 Gpt (G point) with 1 kpt resolution. Counts couples to Meas Cycles. When the value for counts is changed, the Meas Cycles value will be $(\text{Counts} / \text{SamplingFrequency} * \text{MeasInterval})$.

Key Path	Meas Setup
Mode	SA, WCDMA, C2K, WIMAXOFDMA, TD-SCDMA, 1xEV-DO, DVB-T/H, DTMB (CTTB), ISDB-T, CMMB, LTE, LTE-TDD, Digital Cable TV, WLAN, MSR, LTE-TDD, LTE-AFDD
Remote Command	<code>[[:SENSe]:PStatistic:COUNTs <integer></code> <code>[[:SENSe]:PStatistic:COUNTs?</code>
Example	PST:COUN 5001 PST:COUN?
Couplings	This value is coupled to Meas Cycles. When Counts is changed, the MeasCycles value will be $(\text{Counts} / \text{SamplingFrequency} * \text{MeasInterval})$. TD-SCDMA: When Counts is changed, the MeasCycles value will be $(\text{Counts} / (\text{Sampling Frequency} * \text{Time duration of measured time slots} / 5 \text{ msec}))$, Time duration of measured time slots is determined by Analysis Time Slot and Measure Interval.
Preset	10000000
State Saved	Saved in instrument state.
Min	1000
Max	2000000000
Default Unit	Kpt
Initial S/W Revision	Prior to A.02.00
Modified at S/W Revision	A.02.00, A.03.00

Meas Cycles

Set the number of measurement cycles to calculate power statistic data. This number couples to Counts. The Counts value is $(\text{MeasCycles} * \text{Sampling Frequency} * \text{MeasInterval})$.

When the counts value cannot be divided by $(\text{Sampling Frequency} * \text{MeasInterval})$, this value is displayed as a decimal fraction.

Key Path	Meas Setup
----------	------------

Mode	SA, WCDMA, C2K, WiMAX OFDMA, TD-SCDMA, 1xEV-DO, DVB-T/H, DTMB (CTTB), ISDB-T, CMMB, LTE, LTE-TDD, Digital Cable TV, WLAN, MSR, LTE-TDD, LTE-FDD
Remote Command	[:SENSe] :PStatistic:SWEep:CYCLes <integer> [:SENSe] :PStatistic:SWEep:CYCLes?
Example	PST:SWE:CYCL 1001 PST:SWE:CYCL?
Notes	.
Couplings	The Counts value will be (MeasCycles * Sampling Frequency * MeasInterval). TD-SCDMA: The Counts value will be (MeasCycles * Sampling Frequency * Time duration of measured time slots / 5 msec), Time duration of measured time slots is determined by Analysis Time Slot and Measure Interval.
Preset	Depends on the sampling frequency.
Min	1
Max	Depends on the sampling frequency.
Initial S/W Revision	Prior to A.02.00
Modified at S/W Revision	A.02.00, A.03.00

Meas Interval (Not 1xEVDO)

Sets the number of data points to be used as the measurement interval. This value couples to Counts. The Counts value is (MeasCycles * Sampling Frequency * MeasInterval).

Key Path	Meas Setup
Mode	SA, WCDMA, C2K, WiMAX OFDMA, TD-SCDMA, DVB-T/H, DTMB (CTTB), ISDB-T, CMMB, LTE, LTE-TDD, Digital Cable TV, WLAN, MSR, LTE-TDD, LTE-FDD
Remote Command	[:SENSe] :PStatistic:SWEep:TIME <time> [:SENSe] :PStatistic:SWEep:TIME?
Example	PST:SWE:TIME 2 ms PST:SWE:TIME?
Couplings	The Counts value will be (MeasCycles * Sampling Frequency * MeasInterval). WiMAX OFDMA: The default value depends on Radio Device status. TD-SCDMA: The Counts value will be (MeasCycles * Sampling Frequency * Time duration of measured time slots / 5 msec), Time duration of measured time slots is determined by Analysis Time Slot and Measure Interval. When TriggerSource is RFBurst, this button is grayed.
Preset	Others: 1.0 ms TD-SCDMA: 1 slot LTE-TDD, LTE-TDD: 500 us
Min	Others: 50.0 us TD-SCDMA: 1 slot

Max	Others: 10.0 ms TD-SCDMA: 9 slot
Initial S/W Revision	Prior to A.02.00
Modified at S/W Revision	A.02.00, A.03.00

IF Gain

Sets the IF Gain function to Auto, Low Gain or High Gain. These settings affect sensitivity and IF overloads. This only applies to the RF input. It does not apply to baseband I/Q input.

Key Path	Meas Setup
Dependencies	The IF Gain keys (FFT IF Gain and Swept IF Gain) have no effect when the U7227A USB Preamplifier is connected. This is not annotated or reflected on any softkey; there are no keys grayed out nor any SCPI locked out. The analyzer simply behaves as though both FFT IF Gain and Swept IF Gain are set to Low regardless of the setting on the keys.
Initial S/W Revision	Prior to A.02.00

IF Gain Auto

Activates the Auto Rules for IF Gain When Auto is active, the IF Gain is set to High Gain under any of the following conditions:

- the input attenuator is set to 0 dB
- the preamp is turned On
- the Max Mixer Level is -20 dBm or lower

For other settings, Auto sets IF Gain to Off.

Key Path	Meas Setup, IF Gain
Mode	SA, WCDMA, C2K, WiMAX OFDMA, TD-SCDMA, 1xEV-DO, DVB-T/H, DTMB (CTTB), ISDB-T, CMMB, LTE, LTE-TDD, Digital Cable TV, WLAN, MSR, LTE-TDD, LTE-FDD
Remote Command	<code>[:SENSe] :PStatistic:IF:GAIN:AUTO[:STATe] ON OFF 1 0</code> <code>[:SENSe] :PStatistic:IF:GAIN:AUTO[:STATe] ?</code>
Example	<code>PST:IF:GAIN:AUTO ON</code> <code>PST:IF:GAIN:AUTO?</code>
Notes	IF Gain only applies to the RF input. It does not apply to baseband I/Q input.
Couplings	When either the auto attenuation is active (for example, with electrical attenuator), or the optimize mechanical attenuator range is requested, the IF Gain setting is changed using the following rule. The Auto selection sets IF Gain On under any of the following conditions: <ul style="list-style-type: none"> • the input attenuator is set to 0 dB • the preamp is turned on,

	<ul style="list-style-type: none"> the Max Mixer Level is -20 dBm or lower. For other settings, Auto sets IF Gain to Off.
Preset	OFF
State Saved	Saved in instrument state.
Range	Auto Man
Initial S/W Revision	Prior to A.02.00
Modified at S/W Revision	A.02.00, A.03.00

IF Gain State

Selects the range of IF gain. On sets the high gain option, which allows for better noise level measurements and Off sets low gain when measuring large signals.

Key Path	Meas Setup, IF Gain
Mode	SA, WCDMA, C2K, WIMAXOFDMA, TD-SCDMA, 1xEV-DO, DVB-T/H, DTMB (CTTB), ISDB-T, CMMB, LTE, LTE-TDD, Digital Cable TV, WLAN, MSR, LTE-TDD, LTEAFDD
Remote Command	[:SENSe]:PStatistic:IF:GAIN[:STATe] ON OFF 1 0 [:SENSe]:PStatistic:IF:GAIN[:STATe]?
Example	PST:IF:GAIN ON PST:IF:GAIN?
Notes	IF Gain only applies to the RF input. It does not apply to baseband I/Q input. where ON = high gain OFF = low gain
Preset	OFF
State Saved	Saved in instrument state.
Range	Low Gain (Best for Large Signals) High Gain (Best Noise Level)
Readback Text	Low Gain High Gain
Initial S/W Revision	Prior to A.02.00
Modified at S/W Revision	A.02.00, A.03.00

Meas Preset

Restores all measurement settings to their default values.

Key Path	Meas Setup
Mode	SA, WCDMA, C2K, WIMAXOFDMA, TD-SCDMA, 1xEV-DO, DVB-T/H, DTMB (CTTB), ISDB-T, CMMB, LTE, LTE-TDD, Digital Cable TV, WLAN, MSR, LTE-TDD, LTEAFDD
Remote Command	:CONFigure:PStatistic
Example	CONF:PST

Notes	You must be in the Spectrum Analysis mode, W-CDMA mode, cdma2000 mode, TD-SCDMA mode, DVB-T/H mode, DTMB (CTTB) mode, SDB-T mode, CMMB mode, Digital Cable TV mode or WIMAXOFDMA mode to use this command. Use :INSTRument:SElect to set the mode.
Couplings	Selecting Meas Preset will restore all measurement parameters to their default values.
Initial S/W Revision	Prior to A.02.00
Modified at S/W Revision	A.02.00, A.03.00

10 Power Stat CCDF Measurement
Mode

Mode

See "[Mode](#)" on page 288

Mode Preset

Returns the active mode to a known state.

Mode Preset does the following for the currently active mode:

- Aborts the currently running measurement.
- Brings up the default menu for the mode, with no active function.
- Sets measurement Global settings to their preset values for the active mode only.
- Activates the default measurement.
- Brings up the default menu for the mode.
- Clears the input and output buffers.
- Sets Status Byte to 0.

Mode Preset does not:

- Cause a mode switch
- Affect mode persistent settings
- Affect system settings
- See "[How-To Preset](#)" on page 914 for more information.

Key Path	Front-panel key
Remote Command	:SYSTem:PRESet
Example	:SYST:PRES
Notes	*RST is preferred over :SYST:PRES for remote operation. *RST does a Mode Preset, as done by the :SYST:PRES command, and it sets the measurement mode to Single measurement rather than Continuous for optimal remote control throughput. Clears all pending OPC bits. The Status Byte is set to 0.
Couplings	A Mode Preset aborts the currently running measurement, activates the default measurement, and gets the mode to a consistent state with all of the default couplings set.
Backwards Compatibility Notes	In the X-Series, the legacy "Factory Preset" has been replaced with Mode Preset, which only presets the currently active mode, not the entire instrument. In the X-Series, the way to preset the entire instrument is by using System, Restore System Defaults All, which behaves essentially the same way as restore System Defaults does on ESA and PSA. There is also no "Preset Type" as there is on the PSA. There is a green Mode Preset front-panel key that does a Mode Preset and a white-with-green-letters User Preset front-panel key that does a User Preset. The old PRESet:TYPE command is ignored (without generating an error), and SYST:PRES without a parameter does a Mode Preset, which should cover most backward code compatibility issues. The settings and correction data under the Input/Output front-panel key (examples: Input Z Corr, Ext Amp Gain, etc.) are no longer part of any Mode, so they will not be preset by a Mode Preset. They are preset using Restore Input/Output Defaults, Restore System Defaults All. Note that because User Preset does a Recall State, and all of these settings are saved in State, they ARE recalled when using

	User Preset.
Initial S/W Revision	Prior to A.02.00

How-To Preset

The table below shows all possible presets, their corresponding SCPI commands and front-panel access (key paths). Instrument settings depend on the current measurement context. Some settings are local to the current measurement, some are global (common) across all the measurements in the current mode, and some are global to all the available modes. In a similar way, restoring the settings to their preset state can be done within the different contexts.

Auto Couple - is a measurement local key. It sets all Auto/Man parameter couplings in the measurement to Auto. Any Auto/Man selection that is local to other measurements in the mode will not be affected.

Meas Preset - is a measurement local key. Meas Preset resets all the variables local to the current measurement except the persistent ones.

Mode Preset - resets all the current mode's measurement local and measurement global variables except the persistent ones.

Restore Mode Defaults - resets ALL the Mode variables (and all the Meas global and Meas local variables), including the persistent ones.

Type Of Preset	SCPI Command	Front Panel Access
Auto Couple	:COUPle ALL	Auto Couple front-panel key
Meas Preset	:CONFigure:<Measurement>	Meas Setup Menu
Mode Preset	:SYSTem:PRESet	Mode Preset (green key)
Restore Mode Defaults	:INSTrument:DEFault	Mode Setup Menu
Restore All Mode Defaults	:SYSTem:DEFault MODes	System Menu; Restore System Default Menu
*RST	*RST	not possible (Mode Preset with Single)
Restore Input/Output Defaults	:SYSTem:DEFault INPUt	System Menu; Restore System Default Menu
Restore Power On Defaults	:SYSTem:DEFault PON	System Menu; Restore System Default Menu
Restore Alignment Defaults	:SYSTem:DEFault ALIGN	System Menu; Restore System Default Menu
Restore Miscellaneous Defaults	:SYSTem:DEFault MISC	System Menu; Restore System Default Menu
Restore All System Defaults	:SYSTem:DEFault [ALL] :SYSTem:PRESet:PERsistent	System Menu; Restore System Default Menu
User Preset	:SYSTem:PRESet:USER	User Preset Menu
User Preset All Modes	:SYSTem:PRESet:USER:ALL	User Preset Menu

Power On Mode Preset	:SYSTem:PON:TYPE MODE	System Menu
Power On User Preset	:SYSTem:PON:TYPE USER	System Menu
Power On Last State	:SYSTem:PON:TYPE LAST	System Menu

Mode Setup

See "[Mode Setup](#)" on page 320

Peak Search

There is no 'Peak Search' functionality supported in Power Stat CCDF measurement. The front-panel key displays a blank menu when pressed.

Key Path	Front-panel key
Initial S/W Revision	Prior to A.02.00

10 Power Stat CCDF Measurement
Print

Print

See ["Print" on page 352](#)

Quick Save

The Quick Save front-panel key repeats the most recent save that was performed from the Save menu, with the following exceptions:

- Register saves are not remembered as Saves for the purpose of the Quick Save function
- If the current measurement does not support the last non-register save that was performed, an informational message is generated, “File type not supported for this measurement”

Quick Save repeats the last type of qualified save (that is, a save qualified by the above criteria) in the last save directory by creating a unique filename using the Auto File Naming algorithm described below.

If Quick Save is pressed after startup and before any qualified Save has been performed, the Quick Save function performs a Screen Image save using the current settings for Screen Image saves (current theme, current directory), which then becomes the “last save” for the purpose of subsequent Quick Saves.

The Auto File Naming feature automatically generates a file name for use when saving a file. The filename consists of a prefix and suffix separated by a dot, as is standard for the Windows® file system. A default prefix exists for each of the available file types:

Type	Default Prefix	Menu
State	State_	(Save/Recall)
Trace + State	State_	(Save/Recall)
Screen	Screen_	(Save/Recall)
Amplitude Corrections	Ampcor_	(Import/Export)
Traces	Trace_	(Import/Export)
Limit Lines	LLine_	(Import/Export)
Measurement Result	MeasR_	(Import/Export)
Capture Buffer	CapBuf_	(Import/Export)

A four digit number is appended to the prefix to create a unique file name. The numbering sequence starts at 0000 within each Mode for each file type and updates incrementally to 9999, then wraps to 0000 again. It remembers where it was through a Mode Preset and when leaving and returning to the Mode. It is reset by Restore Misc Defaults and Restore System Defaults and subsequent running of the instrument application. So, for example, the first auto file name generated for State files is State_0000.state. The next is State_0001, and so forth.

One of the key features of Auto File Name is that we guarantee that the Auto File Name will never conflict with an existing file. The algorithm looks for the next available number. If it gets to 9999, then it looks for holes. If it find no holes, that is no more numbers are available, it gives an error.

For example, if when we get to State_0010.state there is already a State_0010.state file in the current directory, it advances the counter to State_0011.state to ensure that no conflict will exist (and then it verifies that State_0011.state also does not exist in the current directory and advances again if it does, and so forth).

If you enter a file name for a given file type, then the prefix becomes the filename you entered instead of the default prefix, followed by an underscore. The last four letters (the suffix) are the 4-digit number.

For example, if you save a measurement results file as “fred.csv”, then the next auto file name chosen for a measurement results save will be fred_0000.csv.

NOTE

Although 0000 is used in the example above, the number that is used is actually the current number in the Meas Results sequence, that is, the number that would have been used if you had not entered your own file name.

NOTE

If the filename you entered ends with _dddd, where d=any number, making it look just like an auto file name, then the next auto file name picks up where you left off with the suffix being dddd + 1.

Key Path	Front-panel key
Notes	No remote command for this key specifically.
Initial S/W Revision	Prior to A.02.00

Recall

The Recall menu lets you choose what you want to recall, and where you want to recall it from. Among the types of files you can recall are **States and Traces**. In addition, an Import (Data) option lets you recall a number of data types stored in CSV files (as used by Excel and other spreadsheet programs).

The default paths for Recall are data type dependent and are the same as for the Save key.

Key Path	Front-panel key
Notes	<p>No remote command for this key specifically, but the :MMEM:LOAD command is available for specific file types. An example is :MMEM:LOAD:STATe <filename>.</p> <p>If you try to recall a State file for a mode that is not licensed or not available in the instrument, an error message will occur and the state will not change.</p>
Backwards Compatibility Notes	<p>In legacy analyzers, it was possible to load a state without affecting the trace data, limit lines or correction data. Similarly (since User Preset is actually loading a state), it was possible to do a User Preset without affecting the trace data, limit lines or correction data.</p> <p>In the X-Series, “state” always includes all of this data; so whenever state is loaded, all of the traces, limit lines and corrections are affected. Although this differs from previous behavior, it is desirable behavior, and should not cause adverse issues for users.</p>
Backwards Compatibility Notes	<p>Recall for the X-Series supports backward compatibility in the sense that you can recall a state file from any X-Series model number and any version of X-Series software. This is only possible if part of the recalling process goes through a limiting step after recalling the mode settings, at least for settings that may vary with version number, model number, option and license differences. If you try to recall a state file onto an instrument with less capability than what was available on the instrument during the save, the recall will ignore the state it doesn't support and it will limit the recalled setting to what it allows.</p> <p>Example: if the saved state includes preamp ON, but the recalling instrument does not have a preamp; the preamp is limited to OFF. Conversely, if you save a state without a preamp, the preamp is OFF in the state file. When this saved file is recalled on an instrument with a licensed preamp, the preamp is changed to OFF. Another example is if the saved state has center frequency set to 20 GHz, but the instrument recalling the saved state is a different model and only supports 13.5 GHz. In this case, the center frequency is limited along with any other frequency based settings. Since the center frequency can't be preserved in this case, the recall limiting tries to at least preserve span to keep the measurement setup as intact as possible.</p> <p>It may be appropriate to issue a warning if the state is limited on the recall; warnings do not go out to SCPI so this would only affect the manual user.</p> <p>Note that there is no state file compatibility outside of the X-Series. For example, you cannot recall a state file from ESA or PSA.</p>
Initial S/W Revision	Prior to A.02.00

State

The Recall State menu lets you choose a register or file from which to recall the state.

The content of a state file includes all of the settings and data required to return the analyzer as closely as possible to the Mode it was in, with the exact settings that were in place, when the save occurred. The Mode settings in each state file include the settings that are affected by Mode Preset, as well as the

additional settings affected by Restore Mode Defaults; all of the Mode's settings. In addition, all of the settings of the Input/Output system are included, even though they are outside of the Mode's state, because they are needed to restore the complete setup. Persistent System settings (for example, GPIB address) are not affected by either a Mode Preset or Restore Mode Defaults, nor are they included in a saved State file.

Since each state file is only for one Mode, the settings for other Modes are unaffected when it is loaded. Recall State will cause a mode switch if the state being recalled is not from the current active mode.

After the recall completes, the message "File <filename> recalled" or "Recalled State Register <register number>" is displayed.

For rapid recalls, the State menu lists 16 registers that you can choose from to recall. Pressing a Register key initiates the recall. You can also select a file from which to recall.

The default path for all State Files is:

My Documents\<<mode name>\state

where <mode name> is the parameter used to select the mode with the INST:SEL command (for example, SA for the Spectrum Analyzer).

See ["More Information" on page 923](#).

Key Path	Recall
Mode	All
Remote Command	:MMEMory:LOAD:STATe <filename>
Example	:MMEM:LOAD:STAT "myState.state" This recalls the file myState.state on the default path
Example	MMEM:LOAD:STAT "MyStateFile.state" This loads the state file data (on the default file directory path) into the instrument state.
Notes	<p>When you pick a file to recall, the analyzer first verifies that the file is recallable in the current instrument by checking the software version and model number of the instrument. If everything matches, a full recall proceeds by aborting the currently running measurement, clearing any pending operations, and then loading the State from the saved state file. You can open state files from any mode, so recalling a State file switches to the mode that was active when the save occurred. After switching to the mode of the saved state file, mode settings and data (if any for the mode) are loaded with values from the saved file. The saved measurement of the mode becomes the newly active measurement and the data relevant to the measurement (if there is any) is recalled.</p> <ul style="list-style-type: none"> • If there is a mismatch between file version or model number or instrument version or model number, the recall function tries to recall as much as possible and returns a warning message. It may limit settings that differ based on model number, licensing or version number. <p>After recalling the state, the Recall State function does the following:</p> <ul style="list-style-type: none"> • Makes the saved measurement for the mode the active measurement. • Clears the input and output buffers. • Status Byte is set to 0. • Executes a *CLS <p>If the file specified is empty an error is generated. If the specified file does not exist, another error is generated. If there is a mismatch between the file and the proper file type, an error is generated. If</p>

	there is a mismatch between file version or model number or instrument version or model number, a warning is displayed. Then it returns to the State menu and File Open dialog goes away. After the Recall, the analyzer exits the Recall menu and returns to the previous menu.
Backwards Compatibility SCPI	:MMEMory:LOAD:STATe 1,<filename> For backwards compatibility, the above syntax is supported. The "1" is simply ignored.
Initial S/W Revision	Prior to A.02.00

More Information

In measurements that support saving Traces, for example, Swept SA, the Trace data is saved along with the State in the State file. When recalling the State, the Trace data is recalled as well. Traces are recalled exactly as they were stored, including the writing mode and update and display modes. If a Trace was updating and visible when the State was saved, it will come back updating and visible, and its data will be rewritten right away. When you use State to save and recall traces, any trace whose data must be preserved should be placed in View or Blank mode before saving.

The following table describes the Trace Save and Recall possibilities:

You want to recall state and one trace's data, leaving other traces unaffected.	Save Trace+State from 1 trace. Make sure that no other traces are updating (they should all be in View or Blank mode) when the save is performed.	On Recall, specify the trace you want to load the one trace's data into. This trace will load in View. All other traces' data will be unaffected, although their trace mode will be as it was when the state save was performed.
You want to recall all traces	Save Trace+State from ALL traces.	On Recall, all traces will come back in View (or Blank if they were in Blank or Background when saved)
You want all traces to load exactly as they were when saved.	Save State	On recall, all traces' mode and data will be exactly as they were when saved. Any traces that were updating will have their data immediately overwritten.

From File...

When you press "From File", the analyzer brings up a Windows dialog and a menu entitled "File Open." This menu allows you to navigate to the various fields in the Windows dialog without using a keyboard or mouse. The Tab and Arrow keys can also be used for dialog navigation.

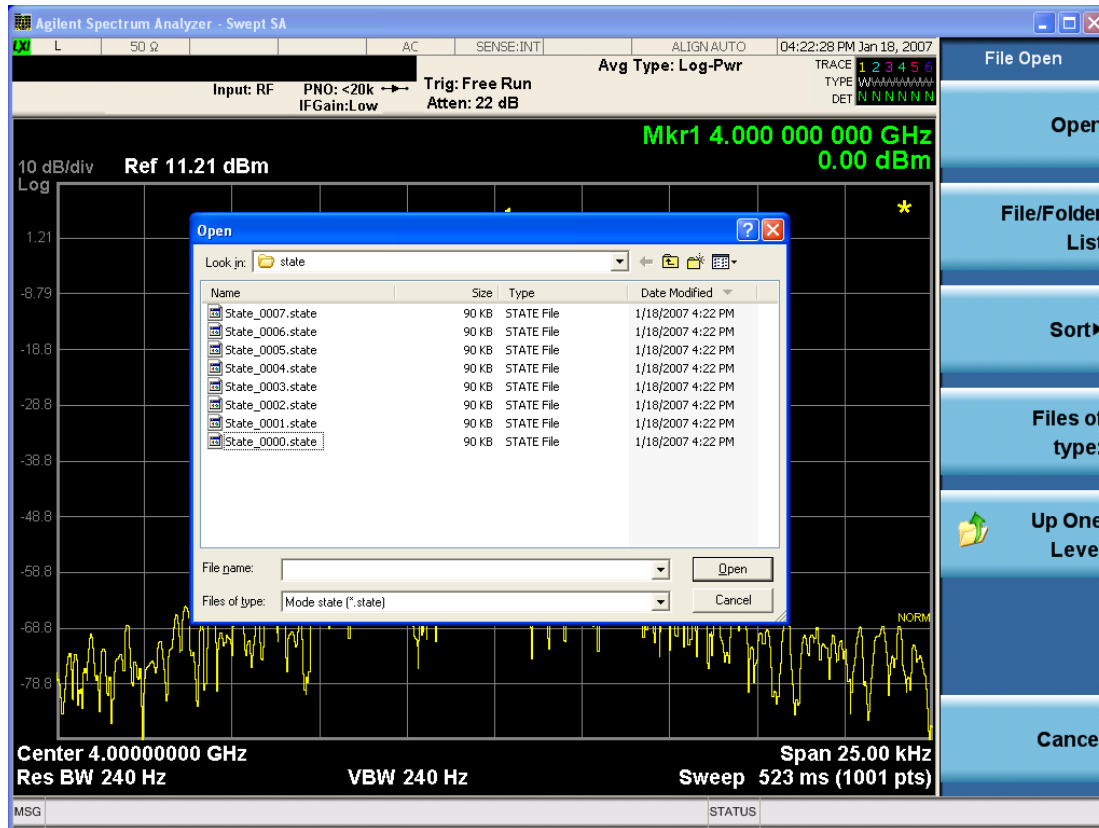

Listed below are the functions of the various fields in the dialog, and the corresponding softkeys:

Open

Performs the recall of the specified file. While the recall is being performed, the floppy icon appears briefly in the Meas bar.

File/Folder List

Enables you to navigate to the center of the dialog that contains the list of files and folders. Once here you can get information about the file and use the tab keys to navigate to the other fields in the dialog, such as Look In.

Look In

The Look In field shows the path from which the file will be recalled and allows you to change the path using the up and down arrow keys to navigate to other paths; the Enter key to open a directory; and the Backspace key to go back one directory. The **Look In field** first uses the last path from the Save As dialog **Save In:** path for that same file type. There is no softkey for directly navigating to the Look In field, but you can use the left tab to get here from the File/Folder List.

User specified paths are remembered when you leave and return to a Mode and are reset back to the default using Restore Mode Defaults.

Sort

Accesses a menu that enables you to sort the files within the File Open dialog. Only one sorting type can be selected at a time and the sorting happens immediately. The sorting types are By Date, By Name, By extension, and By Size.

Files of Type

This field shows the file suffix for the type of file you have selected to recall. For example, if you navigated here while recalling State, "Mode state (*.state)" is in the field. If you navigated here while recalling Trace, ""Mode state (*.trace)" is in the field. If you navigated here while importing a trace data file, "Trace Data (*.csv)" is in the field. For some file types, there is more than one choice in the dropdown menu, which you can select by using the up and down arrow keys and Enter.

Up One Level

This key corresponds to the icon of a folder with the up arrow that is in the tool bar of the dialog. When pressed, it causes the file and folder list to navigate up one level in the directory structure. The Backspace key does the same thing.

Cancel

This key corresponds to the Cancel selection in the dialog. It causes the current **Open** request to be cancelled. The ESC key does the same thing.

Key Path	Recall, State
Notes	Brings up the Open dialog for recalling a State Save Type
Initial S/W Revision	Prior to A.02.00

Edit Register Names

You may enter a custom name on any of the Register keys, to help you remember what you are using that state to save. To do this, press the Edit Register Names key, choose the register whose name you wish to edit, and then enter the desired label using the Alpha Editor or an external PC keyboard.

The maximum number of characters that can be added is 30. In most cases, 30 characters will fit on two lines of the key.

For more information and the SCPI command, see Edit Register Names under the Save, State function.

Key Path	Recall, State
Mode	All
Dependencies	N9060A-7FP or N9060B-2FP license required to edit the register names. When the feature is not licensed, sending the SCPI command generates an error, -221, "Settings conflict;Option not available"
Initial S/W Revision	A.11.00

Register 1 thru Register 16

Selecting any one of these register keys causes the State of the mode from the specified Register to be recalled. Each of the register keys annotates whether it is empty or at what date and time it was last

modified. In addition, you can use the Edit Register Names key under Save, State to enter custom names for each register.

Registers are shared by all modes, so recalling from any one of the registers will cause a mode switch to the mode that was active when the save to the Register occurred.

Although these 16 registers are the only registers available from the front panel, there are 128 state registers available in the instrument. Registers 17–128 are only available from the SCPI interface, using the *RCL command.

After the recall completes, the message "Register <register number> recalled" appears in the message bar. If you are in the Spectrum Analyzer Mode, and you are recalling a register that was saved in the Spectrum Analyzer Mode, then after the recall, you will still be in the Recall Register menu. If the Recall causes you to switch modes, then after the Recall, you will be in the Frequency menu.

If a requested register is empty an error is generated.

Key Path	Recall, State
Example	*RCL 1
Range	1–16 from front panel, 1–128 from SCPI
Readback	Date and time with seconds resolution are displayed on the key OR A custom name of up to 30 characters entered using the Save, State, Edit Register Names key OR “(empty)” if no prior save operation has been performed to this register.
Initial S/W Revision	Prior to A.02.00
Modified at S/W Revision	Prior to A.11.00

Register 1 thru Register 16

Selecting any one of these register keys causes the State of the mode from the specified Register to be recalled. Each of the register keys annotates whether it is empty or at what date and time it was last modified. In addition, you can use the Edit Register Names key under Save, State to enter custom names for each register.

Registers are shared by all modes, so recalling from any one of the registers will cause a mode switch to the mode that was active when the save to the Register occurred.

Although these 16 registers are the only registers available from the front panel, there are 128 state registers available in the instrument. Registers 17–128 are only available from the SCPI interface, using the *RCL command.

After the recall completes, the message "Register <register number> recalled" appears in the message bar. If you are in the Spectrum Analyzer Mode, and you are recalling a register that was saved in the Spectrum Analyzer Mode, then after the recall, you will still be in the Recall Register menu. If the Recall causes you to switch modes, then after the Recall, you will be in the Frequency menu.

If a requested register is empty an error is generated.

Key Path	Recall, State
Example	*RCL 1
Range	1-16 from front panel, 1-128 from SCPI
Readback	Date and time with seconds resolution are displayed on the key OR A custom name of up to 30 characters entered using the Save, State,Edit Register Names key OR “(empty)” if no prior save operation has been performed to this register.
Initial S/W Revision	Prior to A.02.00
Modified at S/W Revision	Prior to A.11.00

Data (Import)

Importing a data file loads data that was previously saved from the current measurement or from other measurements and/or modes that produce compatible data files. The Import Menu only contains Data Types that are supported by the current measurement.

Since the commonly exported data files are in .csv format, the data can be edited by the user prior to importing. This allows you to export a data file, manipulate the data in Excel (the most common PC Application for manipulating .csv files) and then import it.

Importing Data loads measurement data from the specified file into the specified or default destination, depending on the data type selected. Selecting an Import Data menu key will not actually cause the importing to occur, since the analyzer still needs to know from where to get the data. Pressing the Open key in this menu brings up the Open dialog and Open menu that provides you with the options from where to recall the data. Once a filename has been selected or entered in the Open menu, the recall occurs as soon as the Open button is pressed.

Key Path	Recall
Mode	All
Notes	The menu is built from whatever data types are available for the mode. Some keys will be missing completely, so the key locations in the sub-menu will vary. No SCPI command directly controls the Data Type that this key controls. The Data Type is included in the MMEM:LOAD commands.
Dependencies	If a file type is not used by a certain measurement, it is grayed out for that measurement. The key for a file type will not show at all if there are no measurements in the Mode that support it.
Preset	Is not affected by Preset or shutdown, but is reset during Restore Mode Defaults
Readback	The data type that is currently selected
Initial S/W Revision	Prior to A.02.00

Masks

This key enables you to recall a preset mask file from the list. It is only available in SEM measurement under the Data menu: Limit Mask. Limit Mask enables setting a preset limit mask for 802.11p 5MHz and 10MHz system.

You cannot change or create the preset mask file since it is a binary file. This key is valid for the Spectrum Emission Mask measurement.

File location: "My Documents\WLAN\data.masks"

Note that **"My Documents"** is an alias to a directory and its location depends on which user is logged in. At XSA start up, all of the limit mask files in the current user's "My Documents\WLAN\data.masks" directory are overwritten.

File type: Binary

Filename:

11p_5MHz_A.mask

11p_5MHz_B.mask

11p_5MHz_C.mask

11p_5MHz_D.mask

11p_10MHz_A.mask

11p_10MHz_B.mask

11p_10MHz_C.mask

11p_10MHz_D.mask

File extension: .mask

Selecting OPEN under the Import Data menu, opens the above directory enabling you to select a mask file.

Example:

File Location: My Documents/WLAN/data/masks

File Name: 11p_5MHz_A.mask

Key Path	Recall, Data
Mode	WLAN
Remote Command	MME ^M o ^R y:LOAD:MASK <string>
Example	MMEM:LOAD:MASK "11p_5MHz_A.mask"
Initial S/W Revision	A.11.00

Capture Buffer

Capture buffer functionality is only available when measurement is Mod Accuracy and radio standard is not 802.11ac 80+80MHz. The captured data is raw data which is not processed.

Key Path	Recall, Data
Mode	WLAN
Example	MMEM:LOAD:CAPT "MyCaptureData.bin" This loads the file of capture data (on the default file directory path) into the instrument.
Dependencies	Capture buffer data is only available when measurement is Mod Accuracy and radio standard is not 802.11ac 80+80MHz. In other situation, this key is grayed out.
Initial S/W Revision	A.11.00

Open...

When you press "Open", the analyzer brings up a Windows dialog and a menu entitled "File Open." This menu allows you to navigate to the various fields in the Windows dialog without using a keyboard or mouse. The Tab and Arrow keys can also be used for dialog navigation.

See "[From File...](#)" on page 2263 in Recall, State, for a full description of this dialog and menu.

Key Path	Recall, Data
Notes	The key location is mode-dependent and will vary. Brings up Open dialog for recalling a <mode specific> Save Type
Initial S/W Revision	Prior to A.02.00

Restart

The Restart function restarts the current sweep, or measurement, or set of averaged/held sweeps or measurements. If you are Paused, pressing Restart does a Resume.

The Restart function is accessed in several ways:

- Pressing the Restart key
- Sending the remote command INIT:IMMediate
- Sending the remote command INIT:REStart

See "[More Information](#)" on page 930

Key Path	Front-panel key
Remote Command	:INITiate[:IMMediate] :INITiate:REStart
Example	:INIT:IMM :INIT:REST
Notes	:INITiate:REStart and :INITiate:IMMediate perform exactly the same function.
Couplings	Resets average/hold count k. For the first sweep overwrites all active (update=on) traces with new current data. For application modes, it resets other parameters as required by the measurement.
Status Bits/OPC dependencies	This is an Overlapped command. The STATus:OPERation register bits 0 through 8 are cleared. The STATus:QUESTionable register bit 9 (INTegrity sum) is cleared. The SWEEPING bit is set. The MEASURING bit is set.
Backwards Compatibility Notes	For Spectrum Analysis mode in ESA and PSA, the Restart hardkey and the INITiate:REStart command restart trace averages (displayed average count reset to 1) for a trace in Clear Write, but did not restart Max Hold and Min Hold. In the X-Series, the Restart hardkey and the INITiate:REStart command restart not only Trace Average, but MaxHold and MinHold traces as well. For wireless comms modes in ESA and PSA, the Restart hardkey and the INITiate:REStart command restart every measurement, which includes all traces and numeric results. There is no change to this operation.
Initial S/W Revision	Prior to A.02.00

More Information

The **Restart** function first aborts the current sweep/measurement as quickly as possible. It then resets the sweep and trigger systems, sets up the measurement and initiates a new data measurement sequence with a new data acquisition (sweep) taken once the trigger condition is met.

If the analyzer is in the process of aligning when **Restart** is executed, the alignment finishes before the restart function is performed.

Even when set for Single operation, multiple sweeps may be taken when Restart is pressed (for example, when averaging/holding is on). Thus when we say that **Restart** "restarts a measurement," we may mean:

- It restarts the current sweep
- It restarts the current measurement
- It restarts the current set of sweeps if any trace is in Trace Average, Max Hold or Min Hold
- It restarts the current set of measurements if Averaging, or Max Hold, or Min Hold is on for the measurement
- depending on the current settings.

With **Average/Hold Number** (in **Meas Setup** menu) set to 1, or Averaging off, or no trace in Trace Average or Hold, a single sweep is equivalent to a single measurement. A single sweep is taken after the trigger condition is met; and the analyzer stops sweeping once that sweep has completed. However, with **Average/Hold Number** >1 and at least one trace set to **Trace Average, Max Hold, or Min Hold (SA Measurement)** or **Averaging on (most other measurements)**, multiple sweeps/data acquisitions are taken for a single measurement. The trigger condition must be met prior to each sweep. The sweep is stopped when the average count k equals the number N set for **Average/Hold Number**. A measurement average usually applies to all traces, marker results, and numeric results; but sometimes it only applies to the numeric results.

Once the full set of sweeps has been taken, the analyzer will go to idle state. To take one more sweep without resetting the average count, increment the average count by 1, by pressing the step up key while **Average/Hold Number** is the active function, or sending the remote command `CALC:AVER:TCON UP`.

Save

The Save menu lets you choose what you want to save and where you want to save it. Among the types of files you can save are **States**, **Traces**, and **Screen Images**. In addition, an Export (Data) option lets you save a number of data types as CSV files for easy import into Excel and other spreadsheet programs.

Key Path	Front-panel key
Mode	All
Notes	No remote command for this key specifically, but the :MMEM:STORe command is available for specific file types. An example is :MMEM:STOR:STATe <filename>.
Initial S/W Revision	Prior to A.02.00

State

The Save State menu lets you choose a register or file for saving the state.

The content of a state file includes all of the settings and data required to return the analyzer as closely as possible to the Mode it was in, with the exact settings which were in place, when the save occurred. The Mode settings in each state file include the settings that are affected by Mode Preset, as well as the additional settings affected by Restore Mode Defaults; all of the Mode's settings. In addition, all of the settings of the Input/Output system are included, even though they are outside of the Mode's state, because they are needed to restore the complete setup. Persistent System settings (for example, Verbose SCPI) are not affected by either Mode Preset or Restore Mode Defaults, nor are they included in a saved State file.

After the save completes, the message "File <filename> saved" or "State Register <register number> saved" is displayed.

For rapid saving, the State menu lists 16 registers to save to. Pressing a Register key initiates the save. You can also select a file to save to.

The default path for all State Files is:

My Documents\<<mode name>\state

where <mode name> is the parameter used to select the mode with the INST:SEL command (for example, SA for the Spectrum Analyzer).

Key Path	Save
Mode	All
Remote Command	:MMEMory:STORe:STATe <filename>
Example	MMEM:STOR:STATe "MyStateFile.state" This stores the current instrument state data in the file MyStateFile.state in the default directory.
Notes	Both single and double quotes are supported for any filename parameter over remote. After saving to a register, that register's menu key is updated with the date the time, unless a custom label has been entered for that key. After saving to a register, you remain in the Save State menu, so that you can see the Register key

update. After saving to a file, the analyzer automatically returns to the previous menu and any Save As dialog goes away.

Backwards Compatibility SCPI	:MMEMoRY:STORe:STATe 1,<filename>
Initial S/W Revision	Prior to A.02.00

To File . . .

When you press “To File”, the analyzer brings up a Windows dialog and a menu entitled “**Save As.**” This menu allows you to navigate to the various fields in the Windows dialog without using a keyboard or mouse. The Tab and Arrow keys can also be used for dialog navigation.

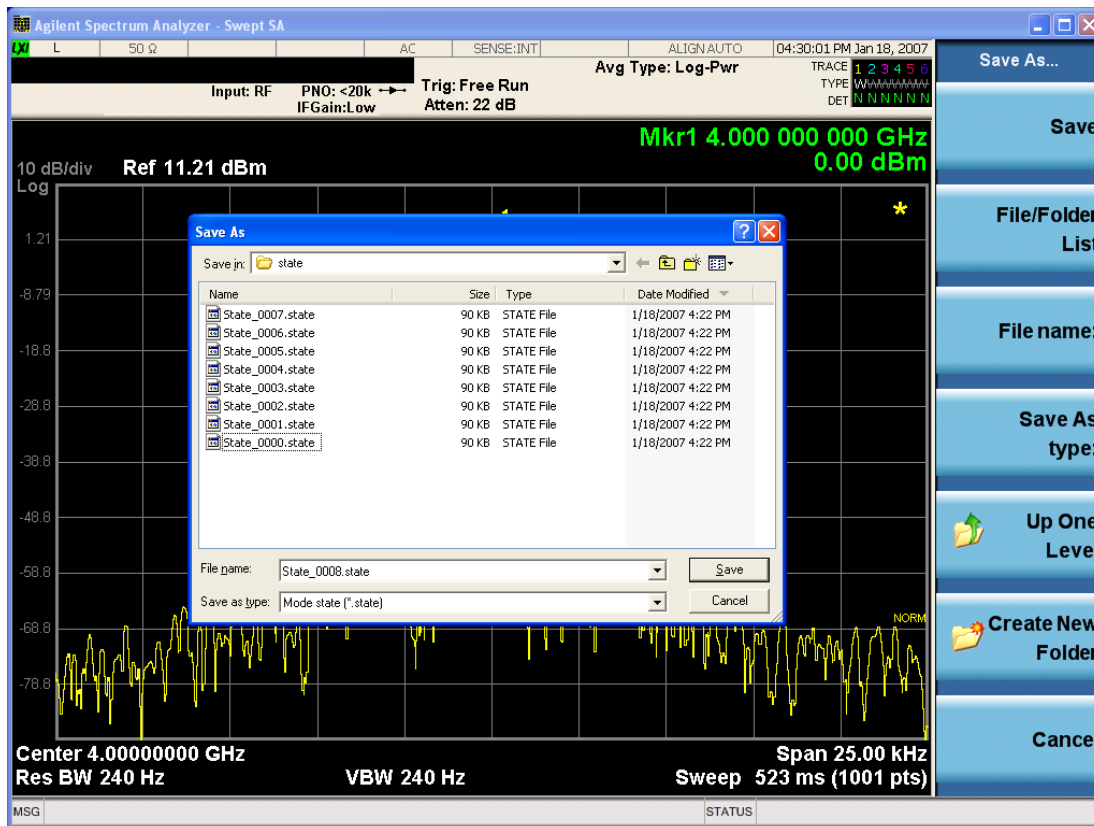

The Listed below

are the functions of the various fields in the dialog, and the corresponding softkeys:

Save

Performs the save to the specified file of the selected type. If the file already exists, a dialog will appear that allows you to replace the existing file by selecting OK, or you can Cancel the request. If you select OK, the file will be overwritten. Using the C: drive is strongly discouraged, since it runs the risk of being overwritten during an instrument software upgrade.

While the save is being performed, the floppy icon appears briefly in the Meas bar.

File/Folder List

Enables you to navigate to the center of the dialog that contains the list of files and folders. Once here you can get information about the file and use the tab keys to navigate to the other fields in the dialog, such as Save In.

Save In

The Save In field shows the path to which the file will be saved and allows you to change the path using the up and down arrow keys to navigate to other paths; the Enter key to open a directory; and the Backspace key to go back one directory. The **Save In field** defaults to the default path for this type of file and remembers the last path you used to save this type of file. There is no softkey for directly navigating to the Save In field but you can use left tab to get here from the File/Folder List.

User specified paths are remembered when you leave and return to a Mode and are reset back to the default using Restore Mode Defaults.

File Name

The File Name field is initially loaded with an automatically generated filename specific to the appropriate Save Type. The automatically generated filename is guaranteed not to conflict with any filename currently in the directory. You may replace or modify this filename using the File Name key. See the ["Quick Save " on page 2259](#) documentation for more on the automatic file naming algorithm.

When you press the File Name key the analyzer displays the Alpha Editor. Use the knob to choose the letter to add and the front-panel Enter key to add the letter to the file name. The BK character moves you back and the FW character moves you forward in the filename. The Select key on the front panel generates a space character. When you are done entering the filename press the Done softkey. This returns back to the **File Open** dialog and menu, but does not cause the save to occur.

Save As Type

This field shows the file suffix for the type of file you have selected to save. For example, if you navigated here while saving State, "Mode state (*.state)" is in the field. If you navigated here from saving Trace, ""Mode state (*.trace)" is in the field. If you navigated here while exporting a trace data file, "Trace Data (*.csv)" is in the field. For some file types, there is more than one choice in the dropdown, which you can select by using the up and down arrow keys and Enter.

Up One Level

This key corresponds to the icon of a folder with the up arrow that is in the tool bar of the dialog. When pressed, it causes the file and folder list to navigate up one level in the directory structure. The Backspace key does the same thing.

Create New Folder

This key corresponds to the icon of a folder with the "*" that is in the tool bar of the dialog. When pressed, a new folder is created in the current directory with the name **New Folder** and you can enter a new folder name using the Alpha Editor.

Cancel

This key corresponds to the Cancel selection in the dialog. It causes the current **Save As** request to be cancelled. The ESC key does the same thing.

Key Path	Save, State
Mode	All
Notes	Brings up Save As dialog for saving a State Save Type
Initial S/W Revision	Prior to A.02.00

Edit Register Names

You may enter a custom name on any of the Register keys, to help you remember what you are using that state to save. To do this, press the Edit Register Names key, choose the register whose name you wish to edit, and then enter the desired label using the Alpha Editor or an external PC keyboard.

The maximum number of characters that can be added is 30. In most cases, 30 characters will fit on two lines of the key.

See ["More Information" on page 935](#)

Key Path	Save, State
Mode	All
Remote Command	:MMEMory:REGister:STATe:LABel <reg number>,"label" :MMEMory:REGister:STATe:LABel? <reg number>
Example	:MMEM:REG:STAT:LAB 1,"my label"
Notes	<reg number> is an integer from 1 to 16. If the SCPI specifies an invalid register number an error message is generated, -222,"Data out of range;Invalid register label number" "label" is a string from 0 to 30 characters in length. If a label exceeds 30 characters, an error message is generated, -150,"String data error;Label clipped to 30 characters" "label" of length 0 erases the custom label and restores the default (time and date) label. E.g.: :MMEM:REG:STAT:LAB 1,""
Dependencies	N9060A-7FP or N9060B-2FP license required to edit the register names. When the feature is not licensed, sending this command generates an error, -221,"Settings conflict;Option not available"
Preset	The names are unaffected by Preset or power cycle but are set to the default label (time and date) on a "Restore System Defaults->Misc"
Initial S/W Revision	A.11.00

More Information

When you edit one of the register names, the time and date field will be replaced by the custom name.

If you delete all the characters in the custom name, it restores the default (time and date).

The register names are stored within the state files, but they are not part of the instrument state; that is, once you have edited a register name, loading a new state will not change that register name. Another consequence of this is that the names will be persistent through a power cycle. Also, if a named state file is transferred to another analyzer, it will bring its custom name along with it.

If you try to edit the name of an empty register, the analyzer will first save the state to have a file to put the name in. If you load a named state file into an analyzer with older firmware it will ignore the metadata.

The *SAV and *RCL commands will not be affected by the custom register names, nor will the MMEM commands.

Register 1 thru Register 16

Selecting any one of these register menu keys causes the State of the currently active mode to be saved to the specified Register. The registers are provided for rapid saving and recalling, since you do not need to specify a filename or navigate to a file. Each of the register menu keys annotates whether it is empty or at what date and time it was last modified. In addition, you can use the Edit Register Names key to enter custom names for each register.

Although these 16 registers are the only registers available from the front panel, there are 128 state registers available in the instrument. Registers 17–128 are only available from the SCPI interface, using the *SAV command.

There is one set of 128 state registers in the instrument, not one set for each Mode. When a state is saved, the Mode it was saved from is saved with it; then when it is recalled, the instrument switches to that Mode.

After the save completes, the corresponding register menu key annotation is updated with the date and time and the message "Register <register number> saved" is displayed.

Key Path	Save, State
Mode	All
Example	*SAV 1
Range	1–16 from front panel, 1–128 from SCPI
Readback	Date and time with seconds resolution are displayed on the key OR A custom name of up to 30 characters entered using the Edit Register Names key OR “(empty)” if no prior save operation has been performed to this register.
Initial S/W Revision	Prior to A.02.00
Modified at S/W Revision	A.11.00

Register 1 thru Register 16

Selecting any one of these register menu keys causes the State of the currently active mode to be saved to the specified Register. The registers are provided for rapid saving and recalling, since you do not need to specify a filename or navigate to a file. Each of the register menu keys annotates whether it is empty or at what date and time it was last modified. In addition, you can use the Edit Register Names key to enter custom names for each register.

Although these 16 registers are the only registers available from the front panel, there are 128 state registers available in the instrument. Registers 17–128 are only available from the SCPI interface, using the *SAV command.

There is one set of 128 state registers in the instrument, not one set for each Mode. When a state is saved, the Mode it was saved from is saved with it; then when it is recalled, the instrument switches to that Mode.

After the save completes, the corresponding register menu key annotation is updated with the date and time and the message "Register <register number> saved" is displayed.

Key Path	Save, State
Mode	All
Example	*SAV 1
Range	1-16 from front panel, 1-128 from SCPI
Readback	Date and time with seconds resolution are displayed on the key OR A custom name of up to 30 characters entered using the Edit Register Names key OR “(empty)” if no prior save operation has been performed to this register.
Initial S/W Revision	Prior to A.02.00
Modified at S/W Revision	A.11.00

Data (Export)

Exporting a data file stores data from the current measurement to mass storage files. The Export Menu only contains data types that are supported by the current measurement.

Since the commonly exported data files are in .csv format, the data can be edited by you prior to importing. This allows you to export a data file, manipulate the data in Excel (the most common PC Application for manipulating .csv files) and then import it.

Selecting an Export Data menu key will not actually cause the exporting to occur, since the analyzer still needs to know where you wish to save the data. Pressing the Save As key in this menu brings up the Save As dialog and Save As menu that allows you to specify the destination file and directory. Once a filename has been selected or entered in the Open menu, the export will occur as soon as the Save key is pressed.

Key Path	Save
Mode	All
Notes	The menu is built from whatever data types are available for the mode. So the key locations in the sub menu will vary. No SCPI command directly controls the Data Type that this key controls. The Data Type is included in the MMEM:STORe commands.
Dependencies	If a file type is not used by a certain measurement, that type is grayed out for that measurement. The key for a file type will not show at all if there are no measurements in the Mode that support it.
Preset	Is not affected by a Preset or shutdown, but is reset during Restore Mode Defaults
Readback	The data type that is currently selected
Initial S/W Revision	Prior to A.02.00

Meas Results

Key Path	Save, Data
Mode	WLAN
Example	MMEM:STOR:RES "MyResultsFile.csv" This stores the measurement results data in the file MyResultsFile.xml in the default directory.
Initial S/W Revision	A.11.00

Capture Buffer

Capture buffer functionality is only available when measurement is Mod Accuracy and radio standard is not 802.11ac 80+80MHz. The captured data is raw data which is not processed.

Key Path	Save, Data
Mode	WLAN
Example	MMEM:STOR:CAPT "MyCaptureData.bin" This stores the capture data in the file MyCaptureData.bin in the default directory.
Dependencies	Capture buffer data is only available when measurement is Mod Accuracy and radio standard is not 802.11ac 80+80MHz. In other measurements, this key is grayed out.
Initial S/W Revision	A.11.00

Save As . . .

When you press "Save As", the analyzer brings up a Windows dialog and a menu entitled "**Save As.**" This menu allows you to navigate to the various fields in the Windows dialog without using a keyboard or mouse. The Tab and Arrow keys can also be used for dialog navigation.

See "[To File . . .](#)" on page 2273 in Save, State for a full description of this dialog and menu.

The default path for saving files is:

For all of the Trace Data Files:

My Documents\`<mode name>`\data\traces

For all of the Limit Data Files:

My Documents\`<mode name>`\data\limits

For all of the Measurement Results Data Files:

My Documents\`<mode name>`\data\`<measurement name>`\results

For all of the Capture Buffer Data Files:

My Documents\`<mode name>`\data\captureBuffer

Key Path	Save, Data
Mode	All
Notes	The key location is mode-dependent and will vary. Brings up the Save As dialog for saving a <mode specific> Save Type. The save is performed immediately and does not wait until the measurement is complete.
Initial S/W Revision	Prior to A.02.00

Screen Image

Pressing Screen Image accesses a menu of functions that enable you to specify a format and location for the saved screen image. It brings up a menu that allows you to specify the color scheme of the Screen Image (Themes) or navigate to the Save As dialog to perform the actual save.

Screen Image files contain an exact representation of the analyzer display. They cannot be loaded back onto the analyzer, but they can be loaded into your PC for use in many popular applications.

The image to be saved is actually captured when the Save front panel key is pressed, and kept in temporary storage to be used if you ask for a Screen Image save. When the Screen Image key is pressed, a "thumbnail" of the captured image is displayed, as shown below:

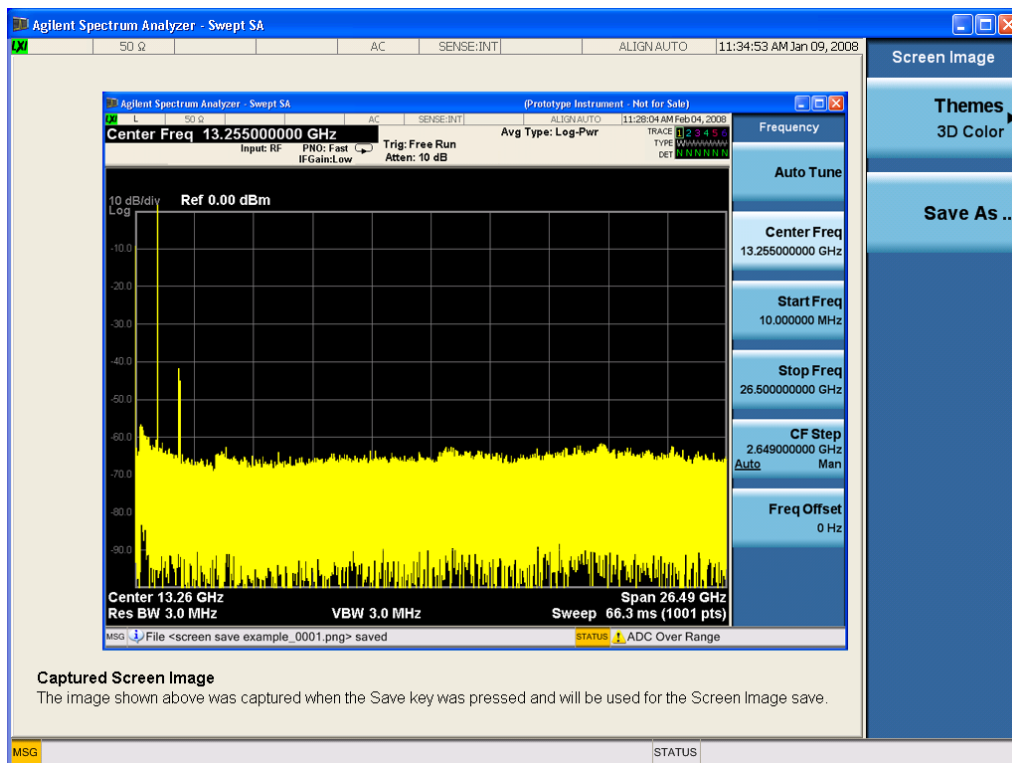

When you continue on into the Save As menu and complete the Screen Image save, the image depicted in the thumbnail is the one that gets saved, showing the menus that were on the screen before going into the Save menus. The save is performed immediately and does not wait until the measurement is complete.

After you have completed the save, the Quick Save front-panel key lets you quickly repeat the last save performed, using an auto-named file, with the current screen data.

NOTE

For versions previous to A.01.55, if you initiate a screen image save by navigating through the Save menus, the image that is saved will contain the Save menu softkeys, not the menus and the active function that were on the screen when you first pressed the Save front panel key.

Key Path	Save
Mode	All
Remote Command	:MMEMory:STORe:SCReem <filename>
Example	:MMEM:STOR:SCR "myScreen.png" This stores the current screen image in the file MyScreenFile.png in the default directory.
Initial S/W Revision	Prior to A.02.00

Themes

Accesses a menu of functions that enable you to choose the theme to be used when saving the screen image.

The **Themes** option is the same as the **Themes** option under the **Display** and **Page Setup** dialogs. It allows you to choose between themes to be used when saving the screen image.

Key Path	Save, Screen Image
Remote Command	:MMEMory:STORe:SCReem:THEMe TDColor TDMonochrome FCOLor FMONochrome :MMEMory:STORe:SCReem:THEMe?
Example	:MMEM:STOR:SCR:THEM TDM
Preset	3D Color; Is not part of Preset, but is reset by Restore Misc Defaults or Restore System Defaults All and survives subsequent running of the modes.
Readback	3D Color 3D Mono Flat Color Flat Mono
Backwards Compatibility Notes	In ESA and PSA we offer the choice of "Reverse Bitmap" or "Reverse Metafile" when saving screen images. This is much like the "Flat Color" theme available in X-Series. Also, if you selected Reverse Bitmap AND a black & white screen image, that would be much like "Flat Monochrome". In other words, each of the X-Series themes has a similar screen image type in ESA/PSA. But they are not identical.
Initial S/W Revision	Prior to A.02.00

3D Color

Selects a standard color theme with each object filled, shaded and colored as designed.

Key Path	Save, Screen Image, Themes
Example	MMEM:STOR:SCR:THEM TDC

Readback	3D Color
Initial S/W Revision	Prior to A.02.00

3D Monochrome

Selects a format that is like 3D color but shades of gray are used instead of colors.

Key Path	Save, Screen Image, Themes
Example	MMEM:STOR:SCR:THEM TDM
Readback	3D Mono
Initial S/W Revision	Prior to A.02.00

Flat Color

Selects a format that is best when the screen is to be printed on an ink printer.

Key Path	Save, Screen Image, Themes
Example	MMEM:STOR:SCR:THEM FCOL
Readback	Flat Color
Initial S/W Revision	Prior to A.02.00

Flat Monochrome

Selects a format that is like Flat Color. But only black is used (no colors, not even gray), and no fill.

Key Path	Save, Screen Image, Themes
Example	MMEM:STOR:SCR:THEM FMON
Readback	Flat Mono
Initial S/W Revision	Prior to A.02.00

Save As...

When you press "Save As", the analyzer brings up a Windows dialog and a menu entitled "**Save As.**" This menu allows you to navigate to the various fields in the Windows dialog without using a keyboard or mouse. The Tab and Arrow keys can also be used for dialog navigation.

See "[To File . . .](#)" on page 2273 in Save, State for a full description of this dialog and menu.

The default path for Screen Images is

My Documents\`<mode name>`\screen.

where <mode name> is the parameter used to select the mode with the INST:SEL command (for example, SA for the Spectrum Analyzer).

Key Path	Save, Screen Image
Notes	Brings up Save As dialog for saving a Screen Image Save Type
Initial S/W Revision	Prior to A.02.00

Mass Storage Catalog (Remote Command Only)

Key path	SCPI Only
Remote Command	:MMEMory:CATalog? [<directory_name>]
Notes	<p>The string must be a valid logical path.</p> <p>Queries disk usage information (drive capacity, free space available) and obtains a list of files and directories in a specified directory in the following format: <numeric_value>,<numeric_value>,{<file_entry>}</p> <p>It returns two numeric parameters and as many strings as there are files and directories. The first parameter indicates the total amount of storage currently used in bytes. The second parameter indicates the total amount of storage available, also in bytes. The <file_entry> is a string. Each <file_entry> indicates the name, type, and size of one file in the directory list: <file_name>,<file_type>,<file_size></p> <p>As the windows file system has an extension that indicates file type, <file_type> is always empty. <file_size> provides the size of the file in bytes. For directories, <file_entry> is surrounded by square brackets and both <file_type> and <file_size> are empty</p>
Initial S/W Revision	Prior to A.02.00

Mass Storage Change Directory (Remote Command Only)

Key path	SCPI Only
Remote Command	:MMEMory:CDIRectory [<directory_name>] :MMEMory:CDIRectory?
Notes	<p>The string must be a valid logical path.</p> <p>Changes the default directory for a mass memory file system. The <directory_name> parameter is a string. If no parameter is specified, the directory is set to the *RST value.</p> <p>At *RST, this value is set to the default user data storage area, that is defined as System.Environment.SpecialFolder.Personal.</p> <p>Query returns full path of the default directory.</p>
Initial S/W Revision	Prior to A.02.00

Mass Storage Copy (Remote Command Only)

Key path	SCPI Only
Remote Command	:MMEMory:COpy <string>,<string>[,<string>,<string>]
Notes	<p>The string must be a valid logical path.</p> <p>Copies an existing file to a new file or an existing directory to a new directory.</p> <p>Two forms of parameters are allowed. The first form has two parameters. In this form, the first parameter specifies the source, and the second parameter specifies the destination.</p> <p>The second form has four parameters. In this form, the first and third parameters specify the source. The second and fourth parameters specify the directories. The first pair of parameters specifies the source. The second pair specifies the destination. An error is generated if the source doesn't exist or the destination file already exists.</p> <p>This command will generate an "access denied" error if the destination is a restricted folder (e.g., C:\Windows) and the current user does not have Power User or Administrator privileges.</p>

Mass Storage Device Copy (Remote Command Only)

This command transfers data to/from a file and a peripheral device.

Key path	SCPI Only
Remote Command	:MMEMory:COpy:DEvice <source_string>,<dest_string>
Notes	<p>The strings must be a valid logical path or a valid device keyword. If the dest_string is a device keyword, the data is copied from the source file to the device. If the source_string is a device keyword, the data is copied to the source file from the device.</p> <p>Valid device keywords are:</p> <p>SNS (smart noise source)</p> <p>An error is generated if the file or device is not found.</p>

Mass Storage Delete (Remote Command Only)

Key path	SCPI Only
Remote Command	:MMEMory:DElete <file_name>[,<directory_name>]
Notes	<p>The string must be a valid logical path.</p> <p>Removes a file from the specified directory. The <file_name> parameter specifies the file name to be removed. This command will generate an "access denied" error if the file is in a restricted folder (e.g., C:\Windows) and the current user does not have Power User or Administrator privileges.</p>
Initial S/W Revision	Prior to A.02.00

Mass Storage Data (Remote Command Only)

Creates a file containing the specified data OR queries the data from an existing file.

Key path	SCPI Only
Remote Command	:MMEMory:DATA <file_name>, <data> :MMEMory:DATA? <file_name>
Notes	The string must be a valid logical path. The command form is MMEMory:DATA <file_name>,<data>. It loads <data> into the file <file_name>. <data> is in 488.2 block format. <file_name> is string data. The query form is MMEMory:DATA? <file_name> with the response being the associated <data> in block format.
Initial S/W Revision	Prior to A.02.00

Mass Storage Make Directory (Remote Command Only)

Key path	SCPI Only
Remote Command	:MMEMory:MDIRectory <directory_name>
Notes	The string must be a valid logical path. Creates a new directory. The <directory_name> parameter specifies the name to be created. This command will generate an “access denied” error if the new directory would be in a restricted folder (e.g., C:\Windows) and the current user does not have Power User or Administrator privileges.
Initial S/W Revision	Prior to A.02.00

Mass Storage Move (Remote Command Only)

Key path	SCPI Only
Remote Command	:MMEMory:MOVE <string>,<string>[,<string>,<string>]
Notes	The string must be a valid logical path. Moves an existing file to a new file or an existing directory to a new directory. Two forms of parameters are allowed. The first form has two parameters. In this form, the first parameter specifies the source, and the second parameter specifies the destination. The second form has four parameters. In this form, the first and third parameters specify the source. The second and fourth parameters specify the directories. The first pair of parameters specifies the source. The second pair specifies the destination. An error is generated if the source doesn't exist or the destination file already exists. This command will generate an “access denied” error if the destination is a restricted folder (e.g., C:\Windows) and the current user does not have Power User or Administrator privileges.
Initial S/W Revision	Prior to A.02.00

Mass Storage Remove Directory (Remote Command Only)

Key path	SCPI Only
Remote Command	:MMEMory:RDIrectory <directory_name>
Notes	<p>The string must be a valid logical path.</p> <p>Removes a directory. The <directory_name> parameter specifies the directory name to be removed. All files and directories under the specified directory shall also be removed.</p> <p>This command will generate an “access denied” error if the folder is a restricted folder (e.g., C:\Windows) or is in a restricted folder and the current user does not have Power User or Administrator privileges.</p>
Initial S/W Revision	Prior to A.02.00

Single (Single Measurement/Sweep)

Sets the analyzer for Single measurement operation. The single/continuous state is Meas Global, so the setting will affect all the measurements. If you are Paused, pressing Single does a Resume.

See ["More Information" on page 946](#)

Key Path	Front-panel key
Example	:INIT:CONT OFF
Notes	See Cont key description.
Backwards Compatibility Notes	<p>For Spectrum Analysis mode in ESA and PSA, the Single hardkey and the INITiate:IMM switched from continuous measurement to single measurement and restarted sweeps and averages (displayed average count reset to 1), but did not restart Max Hold and Min Hold. In the X-Series, the Single hardkey and the INITiate:IMM command initiate a sweep/ measurement/ average sequence/hold sequence including MaxHold and MinHold.</p> <p>For Spectrum Analysis mode in ESA and PSA, the Single hardkey restarted the sweep regardless of whether or not you were in an active sweep or sweep sequence. In the X-Series, Restart does this but Single only restarts the sweep or sweep sequence if you are in the idle state.</p> <p>INIT[:IMM] in ESA & PSA Spectrum Analysis Mode does an implied ABORT. In some other PSA Modes, INIT[:IMM] is ignored if not in the idle state. . The X-Series follows the ESA/PSA SA Mode model, which may cause some Modes to have compatibility problems.</p>
Initial S/W Revision	Prior to A.02.00

More Information

See ["Restart" on page 2270](#) for details on the INIT:IMMEDIATE (Restart) function.

If you are already in single sweep, the INIT:CONT OFF command has no effect.

If you are already in Single Sweep, then pressing the Single key in the middle of a sweep does not restart the sweep or sequence. Similarly, pressing the Single key does not restart the sweep or sequence if the sweep is not in the idle state (for example, if you are taking a very slow sweep, or the analyzer is waiting for a trigger). Instead, it results in a message. "Already in Single, press Restart to initiate a new sweep or sequence". Even though pressing the Single key in the middle of a sweep does not restart the sweep, sending INIT:IMMEDIATE does reset it.

To take one more sweep without resetting the average count, increment the average count by 1, by pressing the step up key while **Average/Hold Number** is the active function, or sending the remote command CALC:AVER:TCON UP.

Source

There is no Source control functionality for this measurement. When this key is pressed, the screen either displays a blank menu, or the previously-selected menu remains unchanged.

Key Path	Front-panel key
----------	-----------------

Span X Scale

The SPAN X Scale key accesses the menu to set the desired horizontal scale.

Key Path	Front-panel key
Initial S/W Revision	Prior to A.02.00

Scale/Div

Enables you to enter a time value to change the horizontal scale.

Key Path	Span X Scale
Mode	SA, WCDMA, C2K, WIMAXOFDMA, TD-SCDMA, 1xEV-DO, DVB-T/H, DTMB (CTTB), ISDB-T, CMMB, LTE, LTE-TDD, Digital Cable TV, WLAN, MSR,, LTE-TDD, LTE-FDD
Remote Command	:DISPlay:PStatistic:VIEW[1]:WINDow2:TRACe:X[:SCALE]:PDIVision <rel_ ampl> :DISPlay:PStatistic:VIEW[1]:WINDow2:TRACe:X[:SCALE]:PDIVision?
Example	DISP:PST:VIEW:WIND2:TRAC:X:PDIV 10 DISP:PST:VIEW:WIND2:TRAC:X:PDIV?
Notes	CCDF measurement has the trace display only at Window 2.
Couplings	See Notes
Preset	2.00
State Saved	Saved in instrument state.
Min	0.1
Max	20
Backwards Compatibility SCPI	:DISPlay:PStatistic:XSCale
Initial S/W Revision	Prior to A.02.00
Modified at S/W Revision	A.02.00, A.03.00

Sweep/Control

Enables you to pause the power statistics CCDF measurement after the current data acquisition is complete. When Paused, the label on the menu key changes to Resume. Press Resume to resume the measurement where it was when it was paused.

Key Path	Front-panel key
Initial S/W Revision	Prior to A.02.00

Pause/Resume

Pauses a measurement after the current data acquisition is complete. When Paused, the label on the key changes to Resume. Press Resume to resume the measurement where it was when it was paused. See ["Pause/Resume" on page 2291](#) for details.

Key Path	Sweep/Control
Initial S/W Revision	Prior to A.02.00

10 Power Stat CCDF Measurement
System

System

See ["System" on page 353](#)

Trace/Detector

Accesses a menu of functions that enable you to control the storage and manipulation of the reference trace, as well as controls the display of the trace data.

Key Path	Front-panel key
Initial S/W Revision	Prior to A.02.00

Store Ref Trace

Copies the currently measured curve as the user-definable reference trace. The captured data remains until the other mode is chosen. Pressing this key also refreshes the reference trace.

No query command is available.

Key Path	Trace/Detector
Mode	SA, WCDMA, C2K, WIMAXOFDMA, TD-SCDMA, 1xEV-DO, DVB-T/H, DTMB (CTTB), ISDB-T, CMMB, LTE, LTE-TDD, Digital Cable TV, WLAN, MSR, LTE-TDD, LTEAFDD
Remote Command	:CALCulate:PSTatistic:STORe:REFerence
Example	CALC:PST:STOR:REF
Backwards Compatibility SCPI	[:SENSe] :PSTatistic:SRTRace
Initial S/W Revision	Prior to A.02.00
Modified at S/W Revision	A.02.00, A.03.00

Ref Trace

Toggles the reference trace display between On and Off.

Key Path	Trace/Detector
Mode	SA, WCDMA, C2K, WIMAXOFDMA, TD-SCDMA, 1xEV-DO, DVB-T/H, DTMB (CTTB), ISDB-T, CMMB, LTE, LTE-TDD, Digital Cable TV, WLAN, MSR, LTE-TDD, LTEAFDD
Remote Command	:DISPlay:PSTatistic:RTRace[:STATe] OFF ON 0 1 :DISPlay:PSTatistic:RTRace[:STATe]?
Example	DISP:PST:RTR OFF DISP:PST:RTR?
Preset	OFF
State Saved	Saved in instrument state.
Range	On Off
Backwards Compatibility SCPI	[:SENSe] :PSTatistic:RTRace[:STATe]
Initial S/W Revision	Prior to A.02.00
Modified at S/W Revision	A.02.00, A.03.00, A.04.00

Gaussian Line

Toggles the Gaussian trace display between On and Off.

Key Path	Trace/Detector
Mode	SA, WCDMA, C2K, WIMAXOFDMA, TD-SCDMA, 1xEV-DO, DVB-T/H, DTMB (CTTB), ISDB-T, CMMB, LTE, LTE-TDD, Digital Cable TV, WLAN, MSR, LTE-TDD, LTE-FDD
Remote Command	:DISPlay:PStatistic:GAUSSian[:STATe] OFF ON 0 1 :DISPlay:PStatistic:GAUSSian[:STATe]?
Example	DISP:PST:GAUS OFF DISP:PST:GAUS?
Preset	ON
State Saved	Saved in instrument state.
Range	On Off
Backwards Compatibility SCPI	[:SENSe]:PStatistic:GAUSSian[:STATe]
Initial S/W Revision	Prior to A.02.00
Modified at S/W Revision	A.02.00, A.03.00, A.04.00

Trigger

See ["Trigger" on page 428](#)

Free Run

See ["Free Run " on page 435](#)

Video

See ["Video \(IF Envelope\) " on page 436](#)

Trigger Level

See ["Trigger Level " on page 436](#)

Trig Slope

See ["Trig Slope " on page 437](#)

Trig Delay

See ["Trig Delay " on page 438](#)

Line

See ["Line " on page 2105](#)

Trig Slope

See ["Trig Slope " on page 2105](#)

Trig Delay

See ["Trig Delay " on page 440](#)

External 1

See ["External 1 " on page 2118](#)

Trigger Level

See ["Trigger Level " on page 2118](#)

Trig Slope

See ["Trig Slope " on page 2119](#)

Trig Delay

See ["Trig Delay " on page 443](#)

Zero Span Delay Comp

See ["Zero Span Delay Comp On/Off" on page 2107](#)

External 2

See ["External 2 "](#) on page 2120

Trigger Level

See ["Trigger Level "](#) on page 2120

Trig Slope

See ["Trig Slope "](#) on page 2121

Trig Delay

See ["Trig Delay "](#) on page 445

Zero Span Delay Comp

See ["Zero Span Delay Comp On/Off"](#) on page 2109

RF Burst

See ["RF Burst "](#) on page 2121

Absolute Trigger

See ["Absolute Trigger Level"](#) on page 2122

Relative Trigger

See ["Relative Trigger Level"](#) on page 2111

Trig Slope

See ["Trigger Slope "](#) on page 2123

Trig Delay

See ["Trig Delay "](#) on page 450

Periodic Timer

See ["Periodic Timer \(Frame Trigger\) "](#) on page 2113

Period

See ["Period "](#) on page 2114

Offset

See ["Offset "](#) on page 2115

Offset Adjust (Remote Command Only)

See ["Offset Adjust \(Remote Command Only\)"](#) on page 2116

Reset Offset Display

See ["Reset Offset Display "](#) on page 2117

Sync Source

See ["Sync Source "](#) on page 2117

Off

See ["Off "](#) on page 2118

External 1

See ["External 1 "](#) on page 2118

Trigger Level

See ["Trigger Level "](#) on page 2118

Trig Slope

See ["Trig Slope "](#) on page 2119

External 2

See ["External 2 "](#) on page 2120

Trigger Level

See ["Trigger Level "](#) on page 2120

Trig Slope

See ["Trig Slope "](#) on page 2121

RF Burst

See ["RF Burst "](#) on page 2121

Absolute Trigger

See ["Absolute Trigger Level"](#) on page 2122

Trig Slope

See ["Trigger Slope "](#) on page 2123

Trig Delay

See ["Trig Delay"](#) on page 460

Auto/Holdoff

See ["Auto/Holdoff "](#) on page 461

Auto Trig

See ["Auto Trig "](#) on page 461

10 Power Stat CCDF Measurement
Trigger

Trig Holdoff

See ["Trig Holdoff"](#) on page 462

User Preset

Accesses a menu that gives you the following three choices:

- User Preset – recalls a state previously saved using the Save User Preset function.
- User Preset All Modes – presets all of the modes in the analyzer
- Save User Preset– saves the current state for the current mode

Key Path	Front-panel key
Backwards Compatibility Notes	<p>User Preset is actually loading a state, and in legacy analyzers, it was possible to load a state without affecting the trace data, limit lines or correction data. Similarly it was possible to do a User Preset without affecting the trace data, limit lines or correction data.</p> <p>In the X-Series, “state” always includes all of this data; so whenever state is loaded, or User Preset is executed, all of the traces, limit lines and corrections are affected. Although this differs from previous behavior, it is desirable behavior, and should not cause adverse issues for users.</p> <p>On ESA and PSA, User Preset affected the entire instrument’s state. In the X-Series, User Preset only recalls the state for the active mode. There is a User Preset file for each mode. User Preset can never cause a mode switch as it can in legacy analyzers. If you want to recall all modes to their user preset file state, you will need to do a User Preset after mode switching into each mode.</p> <p>User Preset recalls mode state which can now include data like traces; whereas on ESA and PSA, User Preset did not affect data.</p>
Initial S/W Revision	Prior to A.02.00

User Preset

User Preset sets the state of the currently active mode back to the state that was previously saved for this mode using the Save User Preset menu key or the SCPI command, SYST:PRES:USER:SAV. It not only recalls the Mode Preset settings, but it also recalls all of the mode persistent settings, and the Input/Output system setting that existed at the time Save User Preset was executed.

If a Save User Preset has not been done at any time, User Preset recalls the default user preset file for the currently active mode. The default user preset files are created if, at power-on, a mode detects there is no user preset file. There will never be a scenario when there is no user preset file to restore. For each mode, the default user preset state is the same state that would be saved if a Save User Preset is performed in each mode right after doing a Restore Mode Default and after a Restore Input/Output Defaults.

The User Preset function does the following:

- Aborts the currently running measurement.
- Sets the mode State to the values defined by Save User Preset.
- Makes the saved measurement for the currently running mode the active measurement.
- Brings up the saved menu for the power-on mode.
- Clears the input and output buffers.
- Sets the Status Byte to 0.

Key Path	User Preset
Remote Command	:SYSTem:PRESet:USER
Example	:SYST:PRES:USER:SAVE:SYST:PRES:USER
Notes	:SYST:PRES:USER:SAVE is used to save the current state as the user preset state. Clears all pending OPC bits. The Status Byte is set to 0. Pressing the User Preset front-panel key while already in the User Preset menu will cause the User Preset to get executed
Couplings	A user preset will cause the currently running measurement to be aborted and cause the saved measurement to be active. Recalling a User Preset file has the same issues that recalling a Save State file has. Some settings may need to be limited and therefore re-coupled, since the capabilities of the mode may have changes when the User Preset file was last saved.
Initial S/W Revision	Prior to A.02.00

User Preset All Modes

Recalls all of the User Preset files for each mode, switches to the power-on mode, and activates the saved measurement from the power-on mode User Preset file.

NOTE

When the instrument is secured, all of the user preset files are converted back to their default user preset files.

The User Preset function does the following:

- Aborts the currently running measurement.
- Switches the Mode to the power-on mode.
- Restores the User Preset files for each mode.
- Makes the saved measurement for the power-on mode the active measurement.
- Brings up the saved menu for the power-on mode.
- Clears the input and output buffers.
- Sets the Status Byte to 0.

Key Path	User Preset
Remote Command	:SYSTem:PRESet:USER:ALL
Example	:SYST:PRES:USER:SAVE:SYST:PRES:USER:ALL
Notes	Clears all pending OPC bits. The Status Byte is set to 0. :SYST:PRES:USER:SAVE is used to save the current state as the user preset state.
Couplings	A user preset will cause the currently running measurement to be aborted, cause a mode switch to the power-on mode, and cause the saved measurement to be active in the power-on mode. Recalling a User Preset file has the same issues that recalling a Save State file has. Some settings may need to be limited and therefore re-coupled, since the capabilities of the mode may have changes when the User Preset file was last saved.
Initial S/W Revision	Prior to A.02.00

Save User Preset

Saves the currently active mode and its State. You can recall this User Preset file by pressing the User Preset menu key or sending the SYST:PRES:USER remote command. This same state is also saved by the Save State function.

Key Path	User Preset
Remote Command	:SYSTem:PRESet:USER:SAVE
Example	:SYST:PRES:USER:SAVE
Notes	:SYST:PRES:SAVE creates the same file as if the user requested a *SAV or a MMEM:STOR:STAT, except User Preset Save does not allow the user to specify the filename or the location of the file.
Initial S/W Revision	Prior to A.02.00

View/Display

Accesses a menu of functions that enable you to control the instrument display as well as turn the bar graph On and Off.

The Power Stat CCDF measurement provides a single view. This is common for both Uplink (MS) and Downlink (BTS). The view consists of the following windows:

"Metrics window" on page 962

"Graph window" on page 963

"Wave window (TD-SCDMA and LTE TDD only)" on page 963

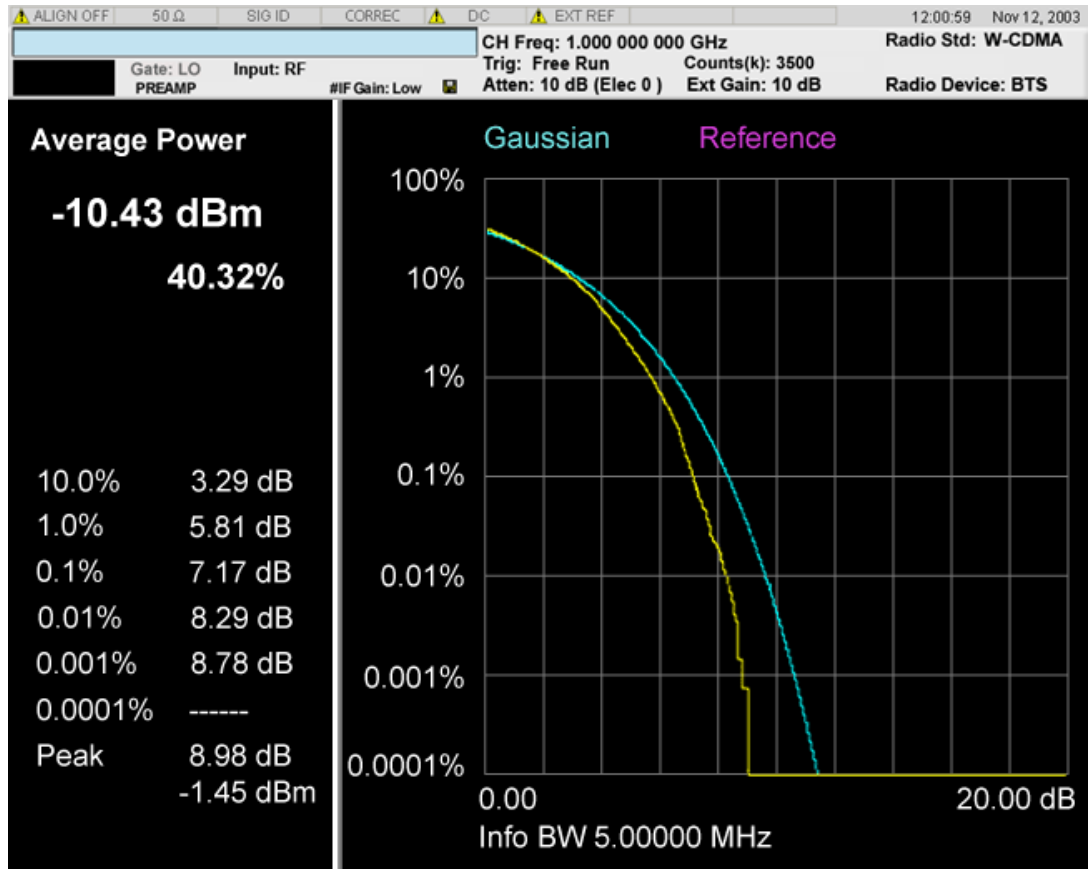

Above: View for Power Stat CCDF Measurement.

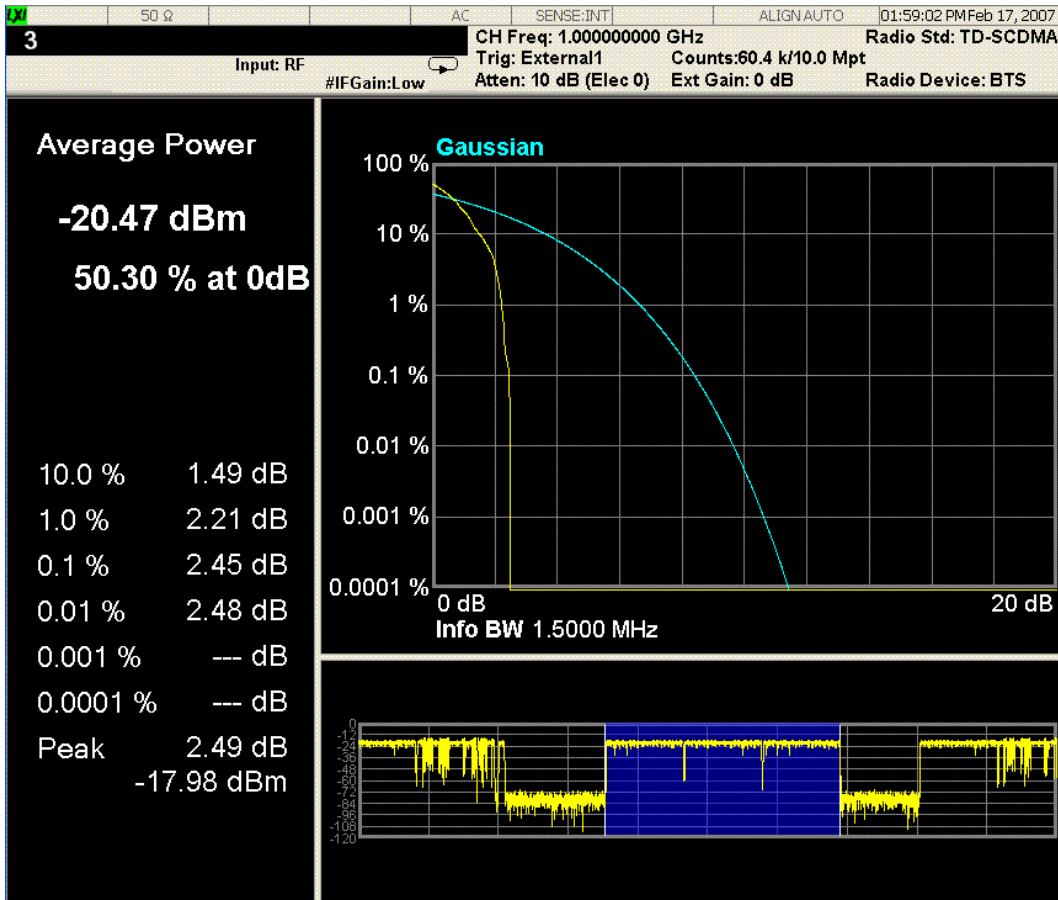

Above: Slot View for Power Stat CCDF Measurement in TD-SCDMA mode.

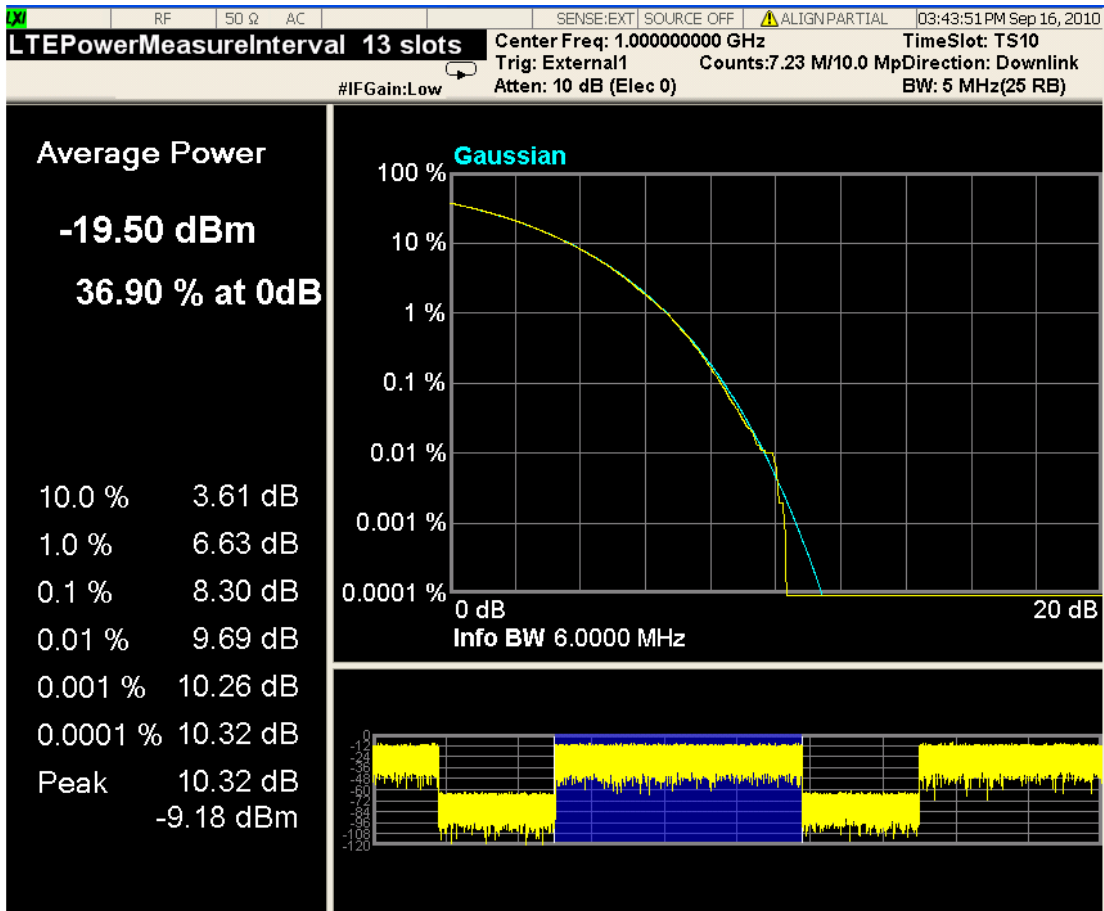

Above: View for Power Stat CCDF Measurement in LTE TDD mode.

Metrics window

Name	Corresponding Results	Explanation
Average Power [dBm]	n=1 1st Average input power	99.99 dBm
Average Power [%]	n=1 2nd Probability at the average input power level	99.99 %
10.0% [dB]	n=1 3rd Power level that has 10% of the power	99.99 dB
1.0% [dB]	n=1 4th Power level that has 1% of the power	99.99 dB
0.1% [dB]	n=1 5th Power level that has 0.1% of the power	99.99 dB
0.01% [dB]	n=1 6th Power level that has 0.01% of the power	99.99 dB
0.001% [dB]	n=1 7th	99.99 dB

Name	Corresponding Results	Explanation
	Power level that has 0.001% of the power	
0.0001% [dB]	n=1 8th	99.99 dB
	Power level that has 0.0001% of the power	
Peak [dB]	n=1 9th	99.99 dB
	Peak power	
Peak[dBm]	This is not available from SCPI using remote commands.	99.99 dBm

Graph window

Marker Operation	Yes
Corresponding Trace	<p>Yellow: Series of 5001 floating the current measured power stat trace. (n=2) Initially all markers refer this trace.</p> <p>Light Blue: Series of 5001 floating point numbers (in percent) that represent the Gaussian trace. (n=3)</p> <p>Violet: series of 5001 floating point numbers (in percent) that represent the user-definable reference trace. (n=4)</p> <p>The Gaussian and Reference trace/line can be removed using the functions under the Trace/Detector key</p>

Wave window (TD-SCDMA and LTE TDD only)

This window is only available under TD-SCDMA mode and LTE TDD mode, and by default this window is closed, it can be turned on or off by using the softkey "Slot View". For more details, refer to the section Slot View .

Marker Operation	No
Corresponding Trace	<p>Yellow: For TD-SCDMA, Waveform of entire TD-SCDMA frame. If measurement range specified by Analysis Time Slot and Measured Time Slot is out of the first frame, the display range extends to two TD-SCDMA frames. For LTETDD, Waveform of 2 continuous LTE type2 frames.</p> <p>Blue: Indicates current measurement range</p>

Key Path	Front-panel key
Initial S/W Revision	Prior to A.02.00

Display

The Display menu is common to most measurements, and is used for configuring items on the display. Some Display menu settings apply to all the measurements in a mode, and some only to the current measurement. Those under the System Display Settings key apply to all measurements in all modes.

Key Path	Display
Key Path	View/Display
Initial S/W Revision	Prior to A.02.00

Annotation

Turns on and off various parts of the display annotation. The annotation is divided up into four categories:

1. Meas Bar: This is the measurement bar at the top of the screen. It does not include the settings panel or the Active Function. Turning off the Meas Bar turns off the settings panel and the Active Function. When the Meas Bar is off, the graticule area expands to fill the area formerly occupied by the Meas Bar.
2. Screen Annotation: this is the annotation and annunciation around the graticule, including any annotation on lines (such as the display line, the threshold line, etc.) This does NOT include the marker number or the N dB result. When off, the graticule expands to fill the entire graticule area.
3. Trace annotation: these are the labels on the traces, showing their detector (or their math mode).
4. Active Function annotation: this is the active function display in the meas bar, and all of the active function values displayed on softkeys.

See the figure below. Each type of annotation can be turned on and off individually.

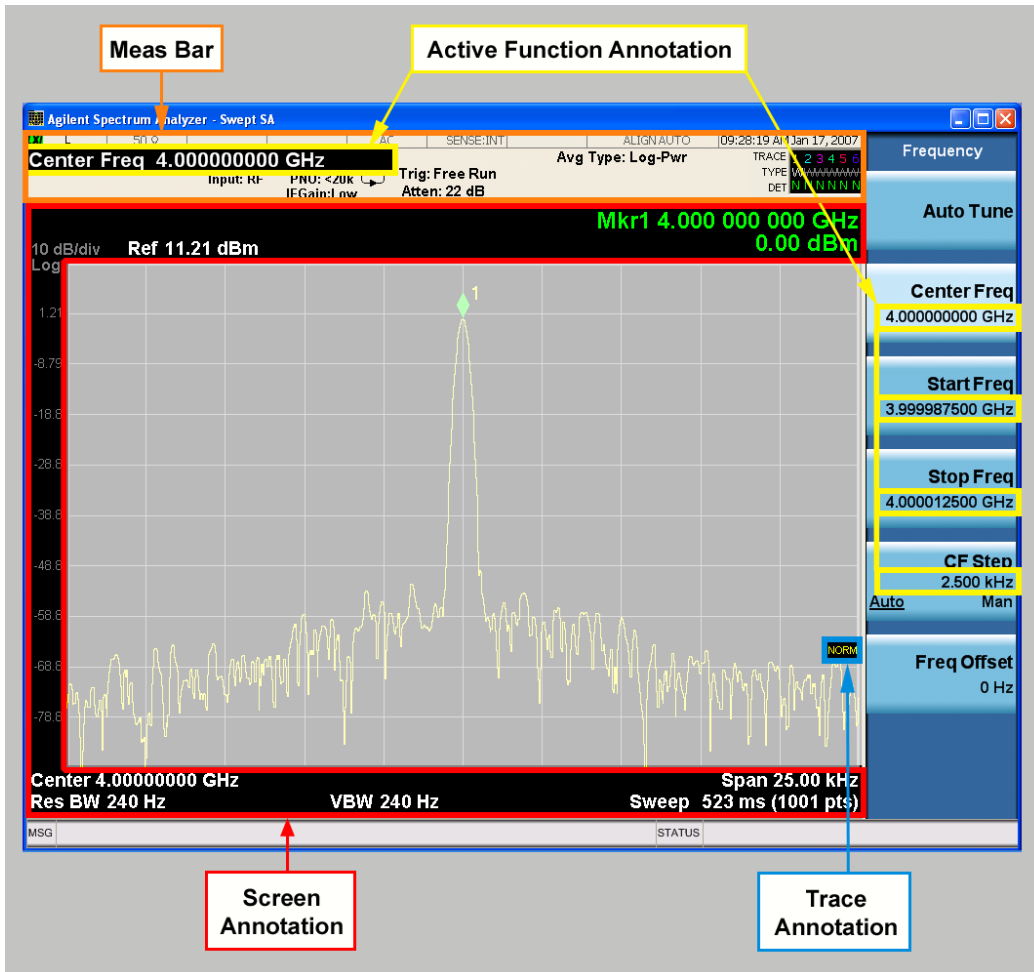

Key Path	View/Display, Display
Initial S/W Revision	Prior to A.02.00

Meas Bar On/Off

This function turns the Measurement Bar on and off, including the settings panel. When off, the graticule area expands to fill the area formerly occupied by the Measurement Bar.

Key Path	View/Display, Display, Annotation
Remote Command	:DISPlay:ANNotation:MBAR[:STATE] OFF ON 0 1 :DISPlay:ANNotation:MBAR[:STATE]?
Example	DISP:ANN:MBAR OFF
Dependencies	Grayed out and forced to OFF when System Display Settings, Annotation is set to Off.
Preset	On This should remain Off through a Preset when System DisplaySettings, Annotation is set to Off.
State Saved	Saved in instrument state.
Initial S/W Revision	Prior to A.02.00

Screen

This controls the display of the annunciation and annotation around the graticule, including any annotation on lines (such as the display line, the threshold line, etc.) and the y-axis annotation. This does NOT include marker annotation (or the N dB result). When off, the graticule expands to fill the entire graticule area, leaving only the 1.5% gap above the graticule as described in the Trace/Detector chapter.

Key Path	View/Display, Display, Annotation
Remote Command	:DISPlay:ANNotation:SCReen[:STATe] OFF ON 0 1 :DISPlay:ANNotation:SCReen[:STATe]?
Example	DISP:ANN:SCR OFF
Dependencies	Grayed-out and forced to OFF when System Display Settings, Annotation is set to Off.
Preset	On This should remain Off through a Preset when System DisplaySettings, Annotation is set to Off
State Saved	Saved in instrument state.
Initial S/W Revision	Prior to A.02.00

Active Function Values On/Off

Turns on and off the active function display in the Meas Bar, and all of the active function values displayed on the softkeys.

Note that all of the softkeys that have active functions have these numeric values blanked when this function is on. This is a security feature..

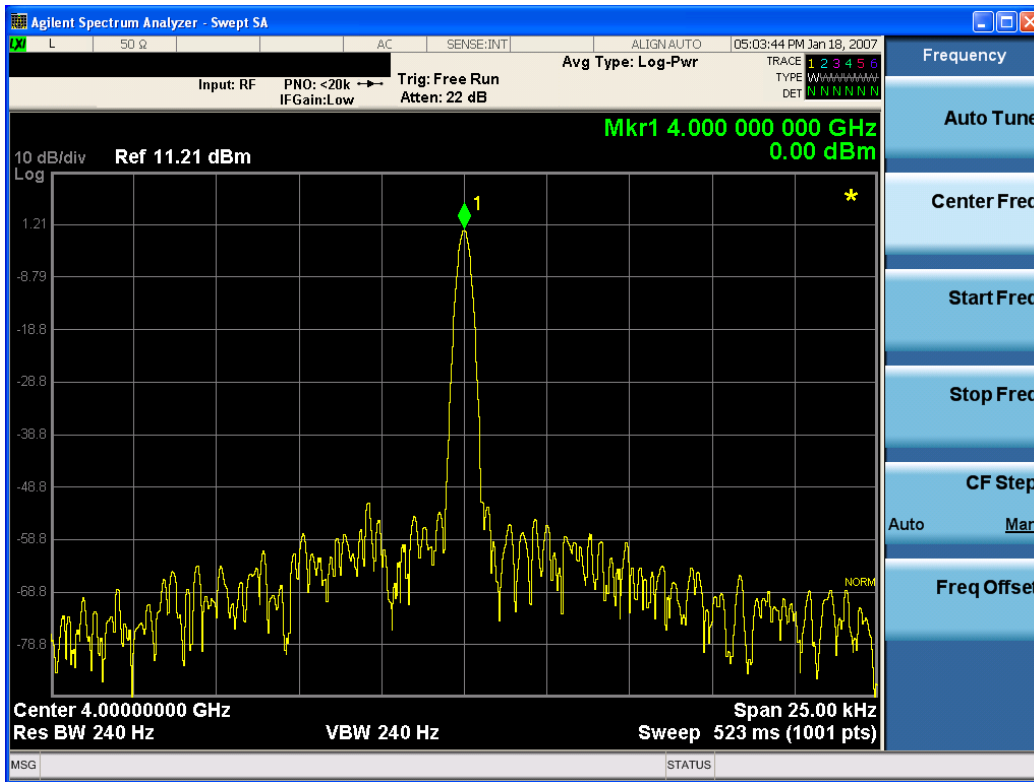

Key Path	View/Display, Display, Annotation
Remote Command	:DISPlay:ACTivefunc[:STATE] ON OFF 1 0 :DISPlay:ACTivefunc[:STATE]?
Example	DISP:ACT OFF
Dependencies	Grayed out and forced to OFF when System Display Settings, Annotation is set to Off.
Preset	On This should remain Off through a Preset when System DisplaySettings, Annotation is set to Off
State Saved	Saved in instrument state.
Initial S/W Revision	Prior to A.02.00

Title

Displays menu keys that enable you to change or clear a title on your display.

Key Path	View/Display, Display
Initial S/W Revision	Prior to A.02.00

Change Title

Writes a title into the "measurement name" field in the banner, for example, "Swept SA".

Press Change Title to enter a new title through the alpha editor. Press Enter or Return to complete the entry. Press ESC to cancel the entry and preserve your existing title.

The display title will replace the measurement name. It remains for this measurement until you press Change Title again, or you recall a state, or a Preset is performed. A title can also be cleared by pressing Title, Clear Title.

NOTE

Notice the inclusion of the <measurement> parameter in the command below. Because each measurement remembers the Display Title, the command must be qualified with the measurement name. For the Swept SA measurement this is not the case; no <measurement> parameter is used when changing the Display Title for the Swept SA measurement.

Key Path	View/Display, Display, Title
Mode	All
Remote Command	:DISPlay:<measurement>:ANNotation:TITLe:DATA <string> :DISPlay:<measurement>:ANNotation:TITLe:DATA?
Example	DISP:ANN:TITL:DATA "This Is My Title" This example is for the Swept SA measurement in the Spectrum Analyzer mode. The SANalyzer <measurement> name is not used. DISP:ACP:ANN:TITL:DATA "This Is My Title" This example is for Measurements other than Swept SA. Both set the title to: This Is My Title
Notes	Pressing this key cancels any active function. When a title is edited the previous title remains intact (it is not cleared) and the cursor goes at the end so that characters can be added or BKSP can be used to go back over previous characters.
Preset	No title (measurement name instead)
State Saved	Saved in instrument state.
Initial S/W Revision	Prior to A.02.00

Clear Title

Clears a title from the front-panel display. Once cleared, the title cannot be retrieved. After the title is cleared, the current Measurement Name replaces it in the title bar.

Key Path	View/Display, Display, Title
Example	The following commands clear the title and restore the measurement's original title: DISP:ANN:TITL:DATA "" This example is for the Swept SA measurement in the Spectrum Analyzer mode. The SANalyzer <measurement> name is not used. DISP:ACP:ANN:TITL:DATA "" This example is for ACP; in measurements other than Swept SA the measurement name is required.
Notes	Uses the :DISPlay:<measurement>:ANNotation:TITLe:DATA <string> command with an empty string (in the Swept SA, the <measurement> is omitted).
Preset	Performed on Preset.
Initial S/W Revision	Prior to A.02.00

Graticule

Pressing Graticule turns the display graticule On or Off. It also turns the graticule y-axis annotation on and off.

Key Path	View/Display, Display
Remote Command	:DISPlay:WINDow[1]:TRACe:GRATicule:GRID[:STATe] OFF ON 0 1 :DISPlay:WINDow[1]:TRACe:GRATicule:GRID[:STATe]?
Example	DISP:WIND:TRAC:GRAT:GRID OFF
Notes	The graticule is the set of horizontal and vertical lines that make up the grid/divisions for the x-axis and y-axis.
Preset	On
State Saved	Saved in instrument state
Initial S/W Revision	Prior to A.02.00

System Display Settings

These settings are "Mode Global" – they affect all modes and measurements and are reset only by Restore Misc Defaults or Restore System Defaults under System.

Key Path	View/Display, Display
Initial S/W Revision	Prior to A.02.00

Annotation Local Settings

This is a Mode Global override of the meas local annotation settings. When it is All Off, it forces ScreenAnnotation, Meas Bar, Trace, and Active Function Values settings to be OFF for all measurements in all modes. This provides the security based "annotation off" function of previous analyzers; hence it uses the legacy SCPI command.

When it is All Off, the Screen, Meas Bar, Trace, and Active Function Values keys under the Display, Annotation menu are grayed out and forced to Off. When Local Settings is selected, you are able to set the local annotation settings on a measurement by measurement basis.

Key Path	View/Display, Display, System Display Settings
Remote Command	:DISPlay:WINDow[1]:ANNotation[:ALL] OFF ON 0 1 :DISPlay:WINDow[1]:ANNotation[:ALL]?
Example	:DISP:WIND:ANN OFF
Preset	On (Set by Restore Misc Defaults)
State Saved	Not saved in instrument state.
Backwards Compatibility Notes	The WINDow parameter and optional subopcode is included for backwards compatibility but ignored – all windows are equally affected.
Initial S/W Revision	Prior to A.02.00

Themes

Accesses a menu of functions that enable you to choose the theme to be used when saving the screen image.

The **Themes** option is the same as the **Themes** option under the **Display** and **Page Setup** dialogs. It allows you to choose between themes to be used when saving the screen image.

Key Path	Save, Screen Image
Remote Command	:MMEMory:STORe:SCReem:THEMe TDColor TDMonochrome FCOLor FMONochrome :MMEMory:STORe:SCReem:THEMe?
Example	:MMEM:STOR:SCR:THEM TDM
Preset	3D Color; Is not part of Preset, but is reset by Restore Misc Defaults or Restore System Defaults All and survives subsequent running of the modes.
Readback	3D Color 3D Mono Flat Color Flat Mono
Backwards Compatibility Notes	In ESA and PSA we offer the choice of "Reverse Bitmap" or "Reverse Metafile" when saving screen images. This is much like the "Flat Color" theme available in X-Series. Also, if you selected Reverse Bitmap AND a black & white screen image, that would be much like "Flat Monochrome". In other words, each of the X-Series themes has a similar screen image type in ESA/PSA. But they are not identical.
Initial S/W Revision	Prior to A.02.00

3D Color

Selects a standard color theme with each object filled, shaded and colored as designed.

Key Path	Save, Screen Image, Themes
Example	MMEM:STOR:SCR:THEM TDC
Readback	3D Color
Initial S/W Revision	Prior to A.02.00

3D Monochrome

Selects a format that is like 3D color but shades of gray are used instead of colors.

Key Path	Save, Screen Image, Themes
Example	MMEM:STOR:SCR:THEM TDM
Readback	3D Mono
Initial S/W Revision	Prior to A.02.00

Flat Color

Selects a format that is best when the screen is to be printed on an ink printer.

Key Path	Save, Screen Image, Themes
Example	MMEM:STOR:SCR:THEM FCOL
Readback	Flat Color
Initial S/W Revision	Prior to A.02.00

Flat Monochrome

Selects a format that is like Flat Color. But only black is used (no colors, not even gray), and no fill.

Key Path	Save, Screen Image, Themes
Example	MMEM:STOR:SCR:THEM FMON
Readback	Flat Mono
Initial S/W Revision	Prior to A.02.00

Backlight

Accesses the display backlight on/off keys. This setting may interact with settings under the Windows "Power" menu.

When the backlight is off, pressing ESC, TAB, SPACE, ENTER, UP, DOWN, LEFT, RIGHT, DEL, BKSP, CTRL, or ALT turns the backlight on without affecting the application. Pressing any other key will turn backlight on and could potentially perform the action as well.

Key Path	View/Display, Display, System Display Settings
Remote Command	:DISPlay:BACKlight ON OFF :DISPlay:BACKlight?
Preset	ON (Set by Restore Misc Defaults)
Initial S/W Revision	Prior to A.02.00

Backlight Intensity

An active function used to set the backlight intensity. It goes from 0 to 100 where 100 is full on and 0 is off. This value is independent of the values set under the Backlight on/off key.

Key Path	View/Display, Display, System Display Settings
Remote Command	:DISPlay:BACKlight:INTensity <integer> :DISPlay:BACKlight:INTensity?
Example	DISP:BACK:INT 50

10 Power Stat CCDF Measurement
View/Display

Preset	100 (Set by Restore Misc Defaults)
Min	0
Max	100
Initial S/W Revision	Prior to A.02.00

11 Spectrum Emission Mask Measurement

The spectrum emission mask measures spurious signal levels in up to six pairs of offset frequencies and relates them to the carrier power. For measurement results and views, see ["View/Display" on page 1186](#).

This topic contains the following sections:

["Measurement Commands for Spectrum Emission Mask" on page 974](#)

["Remote Command Results for Spectrum Emission Mask Measurement" on page 975](#)

["Number of Offsets" on page 995](#)

Measurement Commands for Spectrum Emission Mask

Offsets that are turned off (inactive) return -999.0 when their results are queried via SCPI.

```
:CONFigure:SEMask  
:CONFigure:SEMask:NDEFault  
:INITiate:SEMask  
:FETCh:SEMask[n]?  
:MEASure:SEMask[n]?  
:READ:SEMask[n]?
```

For more measurement related commands, see the SENSE subsystem, and the section "[Remote Measurement Functions](#)" on page 2213.

Remote Command Results for Spectrum Emission Mask Measurement

The following table describes the results returned by the FETCh, MEASure, and READ queries listed above, according to the index value n:

Modes	n	Return Value
All except MSR, WLAN, LTEAFDD, LTEATDD	1	<p>Meas Type: Total Power Reference</p> <p>Returns 82 comma-separated scalar results, in the following order:</p> <ol style="list-style-type: none"> 1. Reserved for the future use, returns -999.0 2. Absolute power at the center frequency (reference) area (dBm) 3. Reserved for the future use, returns -999.0 4. Reserved for the future use, returns -999.0 5. Peak frequency in the center frequency (reference) area (Hz) 6. Reserved for the future use, returns -999.0 7. Reserved for the future use, returns -999.0 8. Reserved for the future use, returns -999.0 9. Reserved for the future use, returns -999.0 10. Reserved for the future use, returns -999.0 11. Relative integrated power on the negative offset A (dBc) 12. Absolute integrated power on the negative offset A (dBm) 13. Relative peak power on the negative offset A (dBc) 14. Absolute peak power on the negative offset A (dBm) 15. Peak power offset frequency from the center or carrier edge frequency in the negative offset A, depending on Offset Frequency Define settings (Hz) 16. Relative integrated power on the positive offset A (dBc) 17. Absolute integrated power on the positive offset A (dBm) 18. Relative peak power on the positive offset A (dBc) 19. Absolute peak power on the positive offset A (dBm) 20. Peak power offset frequency from the center or carrier edge frequency in the positive offset A, depending on Offset Frequency Define settings (Hz) 21. Relative integrated power on the negative offset B (dBc) --- 69. Absolute peak power on the positive offset F (dBm) 70. Peak power offset frequency from the center or carrier edge frequency in the positive offset F, depending on Offset Frequency Define settings (Hz) 71. Minimum margin from limit line on the negative offset A (dB) 72. Minimum margin from limit line on the positive offset A (dB) 73. Minimum margin from limit line on the negative offset B (dB) 74. Minimum margin from limit line on the positive offset B (dB) 75. Minimum margin from limit line on the negative offset C (dB) 76. Minimum margin from limit line on the positive offset C (dB)

Modes	n	Return Value
		77. Minimum margin from limit line on the negative offset D (dB) 78. Minimum margin from limit line on the positive offset D (dB) 79. Minimum margin from limit line on the negative offset E (dB) 80. Minimum margin from limit line on the positive offset E (dB) 81. Minimum margin from limit line on the negative offset F (dB) 82. Minimum margin from limit line on the positive offset F (dB)
All except MSR, WLAN, LTEAFDD, LTEATDD	1	Meas Type: Power Spectral Density Reference Returns 82 comma-separated scalar results, in the following order: 1. Reserved for the future use, returns -999.0 2. Absolute power at the center frequency (reference) area (dBm/Hz) 3. Reserved for the future use, returns -999.0 4. Reserved for the future use, returns -999.0 5. Peak frequency in the center frequency (reference) area (Hz) 6. Reserved for the future use, returns -999.0 7. Reserved for the future use, returns -999.0 8. Reserved for the future use, returns -999.0 9. Reserved for the future use, returns -999.0 10. Reserved for the future use, returns -999.0 11. Relative integrated power on the negative offset A (dB) 12. Absolute integrated power on the negative offset A (dBm/Hz) 13. Relative peak power on the negative offset A (dB) 14. Absolute peak power on the negative offset A (dBm/Hz) 15. Peak power offset frequency from the center or carrier edge frequency in the negative offset A, depending on Offset Frequency Define settings (Hz) 16. Relative integrated power on the positive offset A (dB) 17. Absolute integrated power on the positive offset A (dBm/Hz) 18. Relative peak power on the positive offset A (dB) 19. Absolute peak power on the positive offset A (dBm/Hz) 20. Peak power offset frequency from the center or carrier edge frequency in the positive offset A, depending on Offset Frequency Define settings (Hz) 21. Relative integrated power on the negative offset B (dB) --- 69. Absolute peak power on the positive offset F (dBm/Hz) 70. Peak power offset frequency from the center or carrier edge frequency in the positive offset F, depending on Offset Frequency Define settings (Hz) 71. Minimum margin from limit line on the negative offset A (dB) 72. Minimum margin from limit line on the positive offset A (dB) 73. Minimum margin from limit line on the negative offset B (dB) 74. Minimum margin from limit line on the positive offset B (dB)

Modes	n	Return Value
		75. Minimum margin from limit line on the negative offset C (dB) 76. Minimum margin from limit line on the positive offset C (dB) 77. Minimum margin from limit line on the negative offset D (dB) 78. Minimum margin from limit line on the positive offset D (dB) 79. Minimum margin from limit line on the negative offset E (dB) 80. Minimum margin from limit line on the positive offset E (dB) 81. Minimum margin from limit line on the negative offset F (dB) 82. Minimum margin from limit line on the positive offset F (dB)
All except MSR, WLAN, LTEAFDD, LTEATDD	1	Meas Type: Spectrum Peak Reference Returns 82 comma-separated scalar results, in the following order: <ol style="list-style-type: none"> 1. Reserved for the future use, returns -999.0 2. Peak power at the center frequency (reference) area (dBm) 3. Reserved for the future use, returns -999.0 4. Reserved for the future use, returns -999.0 5. Peak frequency in the center frequency (reference) area (Hz) 6. Reserved for the future use, returns -999.0 7. Reserved for the future use, returns -999.0 8. Reserved for the future use, returns -999.0 9. Reserved for the future use, returns -999.0 10. Reserved for the future use, returns -999.0 11. Reserved for the future use, returns -999.0 12. Reserved for the future use, returns -999.0 13. Relative peak power on the negative offset A (dB) 14. Absolute peak power on the negative offset A (dBm) 15. Peak power offset frequency from the center or carrier edge frequency in the negative offset A, depending on Offset Frequency Define settings (Hz) 16. Reserved for the future use, returns -999.0 17. Reserved for the future use, returns -999.0 18. Relative peak power on the positive offset A (dB) 19. Absolute peak power on the positive offset A (dBm) 20. Peak power offset frequency from the center or carrier edge frequency in the positive offset A, depending on Offset Frequency Define settings (Hz) 21. Reserved for the future use, returns -999.0 --- 69. Absolute peak power on the positive offset F (dBm) 70. Peak power offset frequency from the center or carrier edge frequency in the positive offset F, depending on Offset Frequency Define settings (Hz) 71. Minimum margin from limit line on the negative offset A (dB) 72. Minimum margin from limit line on the positive offset A (dB)

Modes	n	Return Value
		73. Minimum margin from limit line on the negative offset B (dB)
		74. Minimum margin from limit line on the positive offset B (dB)
		75. Minimum margin from limit line on the negative offset C (dB)
		76. Minimum margin from limit line on the positive offset C (dB)
		77. Minimum margin from limit line on the negative offset D (dB)
		78. Minimum margin from limit line on the positive offset D (dB)
		79. Minimum margin from limit line on the negative offset E (dB)
		80. Minimum margin from limit line on the positive offset E (dB)
		81. Minimum margin from limit line on the negative offset F (dB)
		82. Minimum margin from limit line on the positive offset F (dB)
MSR, LTEAFDD, LTEATDD	1	<p>Meas Type: Total Power Reference</p> <p>Returns outer offset results when Non-Contiguous Meas Region is set to Outer, and returns inner offset results when it is set to Inner, in the following order.</p> <ol style="list-style-type: none"> 1. Total Absolute power of carriers of Measure Carrier On if available. Otherwise -999.0 is returned. 2. Absolute reference power. Absolute power at the left reference carrier if Power Ref type is "Left & Right Carriers." Absolute power at the reference carrier of the left sub-block if Power Ref type is "Max Power Carrier in Sub-block." (dBm) 3. Absolute power at the right reference carrier if Power Ref type is "Left & Right Carriers." Absolute power at the reference carrier of the right sub-block if Power Ref type is "Max Power Carrier in Sub-block." Otherwise -999.0 is returned. (dBm) 4. Reserved for the future use, returns -999.0 5. Peak frequency in the ref carrier channel spacing frequency range. Peak frequency in the left ref carrier frequency range if Power Ref Type is "Left & Right Carriers." Peak frequency in the ref carrier frequency range of the left sub-block if Power Ref type is "Max Power Carrier in Sub-block." 6. Peak frequency in the right ref carrier channel spacing frequency range if Power Ref type is "Left & Right Carriers." Peak frequency in the ref carrier frequency range of the right sub-block if Power Ref type is "Max Power Carrier in Sub-block." Otherwise -999.0 is returned. 7. Reserved for the future use, returns -999.0 8. Reserved for the future use, returns -999.0 9. Reserved for the future use, returns -999.0 10. Reserved for the future use, returns -999.0 11. Relative integrated power on the negative offset A (dBc) 12. Absolute integrated power on the negative offset A (dBm) 13. Relative peak power on the negative offset A (dBc) 14. Absolute peak power on the negative offset A (dBm) 15. Peak power offset frequency from the center or carrier edge frequency in the negative offset A, depending on Offset Frequency Define settings (Hz) 16. Relative integrated power on the positive offset A (dBc) 17. Absolute integrated power on the positive offset A (dBm)

Modes	n	Return Value
		18. Relative peak power on the positive offset A (dBc)
		19. Absolute peak power on the positive offset A (dBm)
		20. Peak power offset frequency from the center or carrier edge frequency in the positive offset A, depending on Offset Frequency Define settings (Hz)
		21. Relative integrated power on the negative offset B (dBc)

		69. Absolute peak power on the positive offset F (dBm)
		70. Peak power offset frequency from the center or carrier edge frequency in the positive offset F, depending on Offset Frequency Define settings (Hz)
		71. Minimum margin from limit line on the negative offset A (dB)
		72. Minimum margin from limit line on the positive offset A (dB)
		73. Minimum margin from limit line on the negative offset B (dB)
		74. Minimum margin from limit line on the positive offset B (dB)
		75. Minimum margin from limit line on the negative offset C (dB)
		76. Minimum margin from limit line on the positive offset C (dB)
		77. Minimum margin from limit line on the negative offset D (dB)
		78. Minimum margin from limit line on the positive offset D (dB)
		79. Minimum margin from limit line on the negative offset E (dB)
		80. Minimum margin from limit line on the positive offset E (dB)
		81. Minimum margin from limit line on the negative offset F (dB)
		82. Minimum margin from limit line on the positive offset F (dB)
MSR , LTEAFDD, LTEATDD	1	<p>Meas Type: Power Spectral Density Reference Returns outer offset results when Non-Contiguous Meas Region is set to Outer, and returns inner offset results when it is set to Inner, in the following order.</p> <ol style="list-style-type: none"> 1. Total Absolute power of carriers of Measure Carrier On if available. Otherwise -999.0 is returned. (dBm) 2. Absolute reference power. Absolute power at the left reference carrier if Power Ref type is "Left & Right Carriers." Absolute power at the reference carrier of the left sub-block if Power Ref type is "Max Power Carrier in Sub-block." (dBm/Hz) 3. Absolute power at the right reference carrier if Power Ref type is "Left & Right Carriers." Absolute power at the reference carrier of the right sub-block if Power Ref type is "Max Power Carrier in Sub-block." Otherwise -999.0 is returned. (dBm/Hz) 4. Reserved for the future use, returns -999.0 5. Peak frequency in the ref carrier channel spacing frequency range . Peak frequency in the left ref carrier frequency range if Power Ref type is "Left & Right Carriers." Peak frequency in the ref carrier frequency range of the left sub-block if Power Ref type is "Max Power Carrier in Sub-block." 6. Peak frequency in the right ref carrier channel spacing frequency range if Power Ref type is "Left & Right Carriers." Peak frequency in the ref carrier frequency range of the right sub-block if Power Ref type is "Max Power Carrier in Sub-block." Otherwise -999.0 is returned. 7. Reserved for the future use, returns -999.0

Modes	n	Return Value
		8. Reserved for the future use, returns -999.0
		9. Reserved for the future use, returns -999.0
		10. Reserved for the future use, returns -999.0
		11. Relative integrated power on the negative offset A (dBc)
		12. Absolute integrated power on the negative offset A (dBm/Hz)
		13. Relative peak power on the negative offset A (dBc)
		14. Absolute peak power on the negative offset A (dBm/Hz)
		15. Peak power offset frequency from the center or carrier edge frequency in the negative offset A, depending on Offset Frequency Define settings (Hz)
		16. Relative integrated power on the positive offset A (dBc)
		17. Absolute integrated power on the positive offset A (dBm/Hz)
		18. Relative peak power on the positive offset A (dBc)
		19. Absolute peak power on the positive offset A (dBm/Hz)
		20. Peak power offset frequency from the center or carrier edge frequency in the positive offset A, depending on Offset Frequency Define settings (Hz)
		21. Relative integrated power on the negative offset B (dBc)

		69. Absolute peak power on the positive offset F (dBm/Hz)
		70. Peak power offset frequency from the center or carrier edge frequency in the positive offset F, depending on Offset Frequency Define settings (Hz)
		71. Minimum margin from limit line on the negative offset A (dB)
		72. Minimum margin from limit line on the positive offset A (dB)
		73. Minimum margin from limit line on the negative offset B (dB)
		74. Minimum margin from limit line on the positive offset B (dB)
		75. Minimum margin from limit line on the negative offset C (dB)
		76. Minimum margin from limit line on the positive offset C (dB)
		77. Minimum margin from limit line on the negative offset D (dB)
		78. Minimum margin from limit line on the positive offset D (dB)
		79. Minimum margin from limit line on the negative offset E (dB)
		80. Minimum margin from limit line on the positive offset E (dB)
		81. Minimum margin from limit line on the negative offset F (dB)
		82. Minimum margin from limit line on the positive offset F (dB)
MSR, LTEAFDD, LTEATDD	1	<p>Meas Type: Spectrum Peak Reference</p> <p>Returns outer offset results when Non-Contiguous Meas Region is set to Outer, and returns inner offset results when it is set to Inner, in the following order.</p> <ol style="list-style-type: none"> 1. Total Absolute power of carriers of Measure Carrier On if available. Otherwise -999.0 is returned. (dBm) 2. Peak reference power. Peak power at the left reference carrier if Power Ref type is "Left & Right Carriers." Peak power at the reference carrier of the left sub-block if Power Ref type is "Max Power Carrier in Sub-block." (dBm)

Modes	n	Return Value
		3. Peak power at the right reference carrier if Power Ref type is "Left & Right Carriers." Peak power at the reference carrier of the right sub-block if Power Ref type is "Max Power Carrier in Sub-block." Otherwise -999.0 is returned. (dBm)
		4. Reserved for the future use, returns -999.0
		5. Peak frequency in the ref carrier channel spacing frequency range. Peak frequency in the left ref carrier frequency range if Power Ref type is "Left & Right Carriers." Peak frequency in the ref carrier frequency range of the left sub-block if Power Ref type is "Max Power Carrier in Sub-block."
		6. Peak frequency in the right ref carrier channel spacing frequency range if Power Ref type is "Left & Right Carriers." Peak frequency in the ref carrier frequency range of the right sub-block if Power Ref type is "Max Power Carrier in Sub-block." Otherwise -999.0 is returned.
		7. Reserved for the future use, returns -999.0
		8. Reserved for the future use, returns -999.0
		9. Reserved for the future use, returns -999.0
		10. Reserved for the future use, returns -999.0
		11. Relative integrated power on the negative offset A (dBc)
		12. Absolute integrated power on the negative offset A (dBm)
		13. Relative peak power on the negative offset A (dBc)
		14. Absolute peak power on the negative offset A (dBm)
		15. Peak power offset frequency from the center or carrier edge frequency in the negative offset A, depending on Offset Frequency Define settings (Hz)
		16. Relative integrated power on the positive offset A (dBc)
		17. Absolute integrated power on the positive offset A (dBm)
		18. Relative peak power on the positive offset A (dBc)
		19. Absolute peak power on the positive offset A (dBm)
		20. Peak power offset frequency from the center or carrier edge frequency in the positive offset A, depending on Offset Frequency Define settings (Hz)
		21. Relative integrated power on the negative offset B (dBc)

		69. Absolute peak power on the positive offset F (dBm)
		70. Peak power offset frequency from the center or carrier edge frequency in the positive offset F, depending on Offset Frequency Define settings (Hz)
		71. Minimum margin from limit line on the negative offset A (dB)
		72. Minimum margin from limit line on the positive offset A (dB)
		73. Minimum margin from limit line on the negative offset B (dB)
		74. Minimum margin from limit line on the positive offset B (dB)
		75. Minimum margin from limit line on the negative offset C (dB)
		76. Minimum margin from limit line on the positive offset C (dB)
		77. Minimum margin from limit line on the negative offset D (dB)
		78. Minimum margin from limit line on the positive offset D (dB)
		79. Minimum margin from limit line on the negative offset E (dB)
		80. Minimum margin from limit line on the positive offset E (dB)

Modes	n	Return Value
		81. Minimum margin from limit line on the negative offset F (dB)
		82. Minimum margin from limit line on the positive offset F (dB)
WLAN, with radio standard 802.11 ac (80 MHz + 80 MHz)	1	<p>Meas Type: Total Power Reference Returns 82 comma-separated scalar results, in the following order:</p> <ol style="list-style-type: none"> 1. Reserved for the future use, returns -999.0 2. Absolute reference power (dBm) 3. Absolute power of the carrier of which the frequency is indicated by Freq Segment 1 (dBm) 4. Absolute power of the carrier of which the frequency is indicated by Freq Segment 2 (dBm) 5. Peak frequency in the center frequency (reference) area (Hz) 6. Reserved for the future use, returns -999.0 7. Reserved for the future use, returns -999.0 8. Reserved for the future use, returns -999.0 9. Reserved for the future use, returns -999.0 10. Reserved for the future use, returns -999.0 11. Relative integrated power on the negative offset A (dBc) 12. Absolute integrated power on the negative offset A (dBm) 13. Relative peak power on the negative offset A (dBc) 14. Absolute peak power on the negative offset A (dBm) 15. Peak power offset frequency from the center or carrier edge frequency in the negative offset A, depending on Offset Frequency Define settings (Hz) 16. Relative integrated power on the positive offset A (dBc) 17. Absolute integrated power on the positive offset A (dBm) 18. Relative peak power on the positive offset A (dBc) 19. Absolute peak power on the positive offset A (dBm) 20. Peak power offset frequency from the center or carrier edge frequency in the positive offset A, depending on Offset Frequency Define settings (Hz) 21. Relative integrated power on the negative offset B (dBc) <p>---</p> <ol style="list-style-type: none"> 69. Absolute peak power on the positive offset F (dBm) 70. Peak power offset frequency from the center or carrier edge frequency in the positive offset F, depending on Offset Frequency Define settings (Hz) 71. Minimum margin from limit line on the negative offset A (dB) 72. Minimum margin from limit line on the positive offset A (dB) 73. Minimum margin from limit line on the negative offset B (dB) 74. Minimum margin from limit line on the positive offset B (dB) 75. Minimum margin from limit line on the negative offset C (dB) 76. Minimum margin from limit line on the positive offset C (dB) 77. Minimum margin from limit line on the negative offset D (dB) 78. Minimum margin from limit line on the positive offset D (dB)

Modes	n	Return Value
		79. Minimum margin from limit line on the negative offset E (dB) 80. Minimum margin from limit line on the positive offset E (dB) 81. Minimum margin from limit line on the negative offset F (dB) 82. Minimum margin from limit line on the positive offset F (dB)
WLAN, with radio standard 802.11 ac (80 MHz + 80 MHz)	1	Meas Type: Power Spectral Density Reference Returns 82 comma-separated scalar results, in the following order: 1. Reserved for the future use, returns -999.0 2. Absolute reference power (dBm/Hz) 3. Absolute power of the carrier of which the frequency is indicated by Freq Segment 1 (dBm/Hz) 4. Absolute power of the carrier of which the frequency is indicated by Freq Segment 2 (dBm/Hz) 5. Peak frequency in the center frequency (reference) area (Hz) 6. Reserved for the future use, returns -999.0 7. Reserved for the future use, returns -999.0 8. Reserved for the future use, returns -999.0 9. Reserved for the future use, returns -999.0 10. Reserved for the future use, returns -999.0 11. Relative integrated power on the negative offset A (dB) 12. Absolute integrated power on the negative offset A (dBm/Hz) 13. Relative peak power on the negative offset A (dB) 14. Absolute peak power on the negative offset A (dBm/Hz) 15. Peak power offset frequency from the center or carrier edge frequency in the negative offset A, depending on Offset Frequency Define settings (Hz) 16. Relative integrated power on the positive offset A (dB) 17. Absolute integrated power on the positive offset A (dBm/Hz) 18. Relative peak power on the positive offset A (dB) 19. Absolute peak power on the positive offset A (dBm/Hz) 20. Peak power offset frequency from the center or carrier edge frequency in the positive offset A, depending on Offset Frequency Define settings (Hz) 21. Relative integrated power on the negative offset B (dB) --- 69. Absolute peak power on the positive offset F (dBm/Hz) 70. Peak power offset frequency from the center or carrier edge frequency in the positive offset F, depending on Offset Frequency Define settings (Hz) 71. Minimum margin from limit line on the negative offset A (dB) 72. Minimum margin from limit line on the positive offset A (dB) 73. Minimum margin from limit line on the negative offset B (dB) 74. Minimum margin from limit line on the positive offset B (dB) 75. Minimum margin from limit line on the negative offset C (dB) 76. Minimum margin from limit line on the positive offset C (dB)

Modes	n	Return Value
		77. Minimum margin from limit line on the negative offset D (dB) 78. Minimum margin from limit line on the positive offset D (dB) 79. Minimum margin from limit line on the negative offset E (dB) 80. Minimum margin from limit line on the positive offset E (dB) 81. Minimum margin from limit line on the negative offset F (dB) 82. Minimum margin from limit line on the positive offset F (dB)
All	2	Returns the displayed frequency domain spectrum trace data separated by comma. The number of data points is 2001.
All	3	Returns the displayed frequency domain absolute limit trace data separated by comma. The number of data points is 2001.
All	4	Returns the displayed frequency domain relative limit trace data separated by comma. The number of data points is 2001.
All (see details)	5	<p>Meas Type: Total Power Reference Returns comma-separated scalar values (in dBm) of the absolute integrated power of the segment frequencies. The length of the result depends on the number of available offset (See "Number of Offsets" on page 995).</p> <ol style="list-style-type: none"> 1. Total power reference (dBm) 2. Reserved for the future use, returns -999.0 3. Absolute integrated power at negative offset frequency (A) 4. Absolute integrated power at positive offset frequency (A) <p>---</p> <ol style="list-style-type: none"> 25. Absolute integrated power at negative offset frequency (L) 26. Absolute integrated power at positive offset frequency (L) <p>In MSR and LTE-Advanced FDD/TDD mode. Returns outer offset results when Non-Contiguous Meas Region is set to Outer, and returns inner offset results when it is set to Inner, in the following order.</p> <ol style="list-style-type: none"> 1. Ref carrier power. Left ref carrier power if Power Ref type is "Left & Right Carriers." Ref carrier power of the left sub-block if Power Ref type is "Max Power Carrier in Sub-block." (dBm) 2. Right ref carrier power if Ref channel type is "Left & Right Carriers." Ref carrier power of the right sub-block if Power Ref type is "Max Power Carrier in Sub-block." Otherwise -999.0 is returned. (dBm) 3. Absolute integrated power at negative offset frequency (A) 4. Absolute integrated power at positive offset frequency (A) <p>---</p> <ol style="list-style-type: none"> 25. Absolute integrated power at negative offset frequency (L) 26. Absolute integrated power at positive offset frequency (L) <p>In WLAN mode. Returns 26 comma-separated scalar values (in dBm) of the absolute integrated power of the segment frequencies:</p> <ol style="list-style-type: none"> 1. Ref carrier power (dBm) 2. Reserved for the future use, returns -999.0

Modes	n	Return Value
		3. Absolute integrated power at negative offset frequency (A) 4. Absolute integrated power at positive offset frequency (A) --- 25. Absolute integrated power at negative offset frequency (L) 26. Absolute integrated power at positive offset frequency (L) If the result is not available, -999.0 is returned. The number of values returned is subject to change in future releases.
All (see details)	5	<p data-bbox="488 606 959 634">Meas Type: Power Spectral Density Reference</p> <p data-bbox="488 638 1398 730">Returns comma-separated scalar values (in dBm/Hz) of the absolute integrated power of the segment frequencies. The length of the result depends on the number of available offset (See "Number of Offsets" on page 995).</p> <p data-bbox="488 741 1084 890">1. Power spectral density reference (dBm/Hz) 2. Reserved for the future use, returns -999.0 3. Absolute integrated power at negative offset frequency (A) 4. Absolute integrated power at positive offset frequency (A) ---</p> <p data-bbox="488 940 1097 1010">25. Absolute integrated power at negative offset frequency (L) 26. Absolute integrated power at positive offset frequency (L)</p> <p data-bbox="488 1020 922 1047">In MSR and LTE-Advanced FDD/TDD mode.</p> <p data-bbox="488 1058 1440 1121">Returns outer offset results when Non-Contiguous Meas Region is set to Outer, and returns inner offset results when it is set to Inner, in the following order.</p> <p data-bbox="488 1131 1440 1293">1. Ref carrier power. Left ref carrier power if Power Ref type is "Left & Right Carriers" Ref carrier power of the left sub-block if Power Ref type is "Max Power Carrier in Sub-block." (dBm/Hz) 2. Right ref carrier power if Power Ref type is "Left & Right Carriers." Ref carrier power of the right sub-block if Power Ref type is "Max Power Carrier in Sub-block." Otherwise -999.0 is returned. (dBm/Hz) 3. Absolute integrated power at negative offset frequency (A) 4. Absolute integrated power at positive offset frequency (A) ---</p> <p data-bbox="488 1428 1097 1497">25. Absolute integrated power at negative offset frequency (L) 26. Absolute integrated power at positive offset frequency (L)</p> <p data-bbox="488 1507 643 1535">In WLAN mode.</p> <p data-bbox="488 1545 1440 1608">Returns 26 comma-separated scalar values (in dBm/Hz) of the absolute integrated power of the segment frequencies:</p> <p data-bbox="488 1619 1084 1768">1. Ref carrier power (dBm/Hz) 2. Reserved for the future use, returns -999.0 3. Absolute integrated power at negative offset frequency (A) 4. Absolute integrated power at positive offset frequency (A) ---</p> <p data-bbox="488 1818 1097 1845">25. Absolute integrated power at negative offset frequency (L)</p>

Modes	n	Return Value
		<p>26. Absolute integrated power at positive offset frequency (L)</p> <p>If the result is not available, -999.0 is returned.</p> <p>The number of values returned is subject to change in future releases.</p>
All (see details)	5	<p>Meas Type: Spectrum Peak Reference</p> <p>Returns comma-separated scalar values (in dBm) of the absolute peak power of the segment frequencies. The length of the result depends on the number of available offset (See "Number of Offsets" on page 995).</p> <ol style="list-style-type: none"> 1. Spectrum Peak Power reference (dBm) 2. Reserved for the future use, returns -999.0 3. Absolute peak power at negative offset frequency (A) 4. Absolute peak power at positive offset frequency (A) <p>---</p> <p>25. Absolute peak power at negative offset frequency (L)</p> <p>26. Absolute peak power at positive offset frequency (L)</p> <p>In MSR and LTE-Advanced FDD/TDD mode.</p> <p>Returns outer offset results when Non-Contiguous Meas Region is set to Outer, and returns inner offset results when it is set to Inner, in the following order.</p> <ol style="list-style-type: none"> 1. Spectrum Peak Power reference of ref carrier. Spectrum Peak Power reference of left ref carrier if Power Ref type is "Left & Right Carriers." Spectrum Peak Power reference of the left sub-block if Power Ref type is "Max Power Carrier in Sub-block." (dBm) 2. Spectrum Peak Power reference of right ref carrier power if Power Ref type is "Left & Right carriers." Spectrum Peak Power reference of the right sub-block if Power Ref type is "Max Power Carrier in Sub-block." Otherwise -999.0 is returned. (dBm) 3. Absolute peak power at negative offset frequency (A) 4. Absolute peak power at positive offset frequency (A) <p>---</p> <p>25. Absolute peak power at negative offset frequency (L)</p> <p>26. Absolute peak power at positive offset frequency (L)</p> <p>If the result is not available, -999.0 is returned.</p> <p>The number of values returned is subject to change in future releases.</p>
All	6	<p>Meas Type: Total Power Reference</p> <p>Returns comma-separated scalar values (in dBc) of the integrated power relative to the carrier at the segment frequencies. The length of the result depends on the number of available offset (See "Number of Offsets" on page 995).</p> <p>When in the MSR and LTE-Advanced FDD/TDD mode, returns outer offset results when Non-Contiguous Meas Region is set to Outer, and returns inner offset results when it is set to Inner, in the following order.</p> <ol style="list-style-type: none"> 1. Reserved for the future use, returns -999.0 2. Reserved for the future use, returns -999.0 3. Relative integrated power at negative offset frequency (A)

Modes	n	Return Value
		<p>4. Relative integrated power at positive offset frequency (A)</p> <p>---</p> <p>25. Relative integrated power at negative offset frequency (L)</p> <p>26. Relative integrated power at positive offset frequency (L)</p> <p>If the result is not available, -999.0 is returned.</p> <p>The number of values returned is subject to change in future releases.</p>
All	6	<p>Meas Type: Power Spectral Density Reference</p> <p>Returns comma-separated scalar values (in dBc/Hz) of the integrated power relative to the carrier at the segment frequencies. The length of the result depends on the number of available offset (See "Number of Offsets" on page 995).</p> <p>When in the MSR and LTE-Advanced FDD/TDD mode, returns outer offset results when Non-Contiguous Meas Region is set to Outer, and returns inner offset results when it is set to Inner, in the following order.</p> <p>Returns -999.0 for the offsets if in WLAN:</p> <ol style="list-style-type: none"> 1. Reserved for the future use, returns -999.0 2. Reserved for the future use, returns -999.0 3. Relative integrated power at negative offset frequency (A) 4. Relative integrated power at positive offset frequency (A) <p>---</p> <p>25. Relative integrated power at negative offset frequency (L)</p> <p>26. Relative integrated power at positive offset frequency (L)</p> <p>If the result is not available, -999.0 is returned.</p> <p>The number of values returned is subject to change in future releases.</p>
All	6	<p>Meas Type: Spectrum Peak Reference</p> <p>Returns comma-separated scalar values (in dB) of the integrated power relative to the carrier at the segment frequencies. The length of the result depends on the number of available offset (See "Number of Offsets" on page 995).</p> <p>When in the MSR and LTE-Advanced FDD/TDD mode, returns outer offset results when Non-Contiguous Meas Region is set to Outer, and returns inner offset results when it is set to Inner, in the following order.</p> <ol style="list-style-type: none"> 1. Reserved for the future use, returns -999.0 2. Reserved for the future use, returns -999.0 3. Relative peak power at negative offset frequency (A) 4. Relative peak power at positive offset frequency (A) <p>---</p> <p>25. Relative peak power at negative offset frequency (L)</p> <p>26. Relative peak power at positive offset frequency (L)</p> <p>If the result is not available, -999.0 is returned.</p> <p>The number of values returned is subject to change in future releases.</p>
All	7	

Modes	n	Return Value
		<p>Returns comma-separated pass/fail test results (0=passed, or 1=failed) determined by testing the minimum margin point from the limit line that is determined each offset's Limits setting. The length of the result depends on the number of available offset (See "Number of Offsets" on page 995).</p> <p>When in the MSR and LTE-Advanced FDD/TDD mode, returns outer offset results when Non-Contiguous Meas Region is set to Outer, and returns inner offset results when it is set to Inner, in the following order.</p> <ol style="list-style-type: none"> 1. Reserved for the future use, returns -999.0 2. Reserved for the future use, returns -999.0 3. At negative offset frequency (A) 4. At positive offset frequency (A) --- 25. At negative offset frequency (L) 26. At positive offset frequency (L) <p>The number of values returned is subject to change in future releases.</p>
All	8	<p>Offset Pass/Fail.</p> <p>Returns comma-separated pass/fail test results (0=passed, or 1=failed) determined by testing the minimum margin point from the limit line that is determined each offset's Limits setting. The length of the result depends on the number of available offset (See "Number of Offsets" on page 995).</p> <p>When in the MSR and LTE-Advanced FDD/TDD mode, returns outer offset results when Non-Contiguous Meas Region is set to Outer, and returns inner offset results when it is set to Inner, in the following order.</p> <p>Note: These results (n=8) are the same as n=7 result.</p> <ol style="list-style-type: none"> 1. Reserved for the future use, returns -999.0 2. Reserved for the future use, returns -999.0 3. At negative offset frequency (A) 4. At positive offset frequency (A) --- 25. At negative offset frequency (L) 26. At positive offset frequency (L) <p>The number of values returned is subject to change in future releases.</p>
All	9	<p>Offset Peak Power Freq.</p> <p>Returns comma-separated scalar values of frequency (in Hz) that have peak power from center or carrier edge frequency in each offset, depending on Offset Frequency Define settings. The length of the result depends on the number of available offset (See "Number of Offsets" on page 995).</p> <p>When in the MSR and LTE-Advanced FDD/TDD mode, returns outer offset results when Non-Contiguous Meas Region is set to Outer, and returns inner offset results when it is set to Inner, in the following order.</p> <ol style="list-style-type: none"> 1. Reserved for the future use, returns -999.0 2. Reserved for the future use, returns -999.0 3. Negative offset frequency (A)

Modes	n	Return Value
		<p>4. Positive offset frequency (A)</p> <p>---</p> <p>25. Negative offset frequency (L)</p> <p>26. Positive offset frequency (L)</p> <p>If the result is not available, -999.0 is returned.</p> <p>The number of values returned is subject to change in future releases.</p>
All	10	<p>Offset Abs Peak Power.</p> <p>Returns comma-separated scalar values (in dBm) of the absolute peak power of the segment frequencies. The length of the result depends on the number of available offset (See "Number of Offsets" on page 995).</p> <p>When in the MSR and LTE-Advanced FDD/TDD mode, returns outer offset results when Non-Contiguous Meas Region is set to Outer, and returns inner offset results when it is set to Inner, in the following order.</p> <ol style="list-style-type: none"> 1. Reserved for the future use, returns -999.0 2. Reserved for the future use, returns -999.0 3. At negative offset frequency (A) 4. At positive offset frequency (A) <p>---</p> <ol style="list-style-type: none"> 25. At negative offset frequency (L) 26. At positive offset frequency (L) <p>If the result is not available, -999.0 is returned.</p> <p>The number of values returned is subject to change in future releases.</p>
All	11	<p>Offset Rel Peak Power.</p> <p>Returns comma-separated scalar values in dBc (dB if MeasType = PSD) of the peak power relative to the carrier at the segment frequencies. The length of the result depends on the number of available offset (See "Number of Offsets" on page 995).</p> <p>When in the MSR and LTE-Advanced FDD/TDD mode, returns outer offset results when Non-Contiguous Meas Region is set to Outer, and returns inner offset results when it is set to Inner, in the following order.</p> <ol style="list-style-type: none"> 1. Reserved for the future use, returns -999.0 2. Reserved for the future use, returns -999.0 3. At negative offset frequency (A) 4. At positive offset frequency (A) <p>---</p> <ol style="list-style-type: none"> 25. At negative offset frequency (L) 26. At positive offset frequency (L) <p>If the result is not available, -999.0 is returned.</p> <p>The number of values returned is subject to change in future releases.</p>
All	12	<p>Returns the power result (the peak power of the signal in the ref channel) when Meas Type is Spectrum Peak reference. Otherwise, the value returned will be -999.0.</p> <p>When in the MSR and LTE-Advanced FDD/TDD mode, returns outer offset results when Non-</p>

Modes	n	Return Value
		Contiguous Meas Region is set to Outer, and returns inner offset results when it is set to Inner, in the following order.
MSR, LTEAFDD, LTEATDD only	13	<p>Meas Type: Total Power Reference Returns outer offset results when Non-Contiguous Meas Region is set to Outer, and returns inner offset results when it is set to Inner, in the following order.</p> <ol style="list-style-type: none"> 1. Total Absolute power of carriers of Measure Carrier On if Power Ref Type is "Max Power Carrier," "Max Power Carrier in Sub-block," or "RF Bandwidth." Otherwise NaN (9.91E+37) is returned. (dBm) 2. Absolute reference power. Absolute power at the left reference carrier if Power Ref type is "Left & Right Carriers." Absolute power at the reference carrier of the left sub-block if Power Ref type is "Max Power Carrier in Sub-block." (dBm) 3. Absolute power at the right reference carrier if Power Ref type is "Left & Right Carriers." Absolute power at the reference carrier of the right sub-block if Power Ref type is "Max Power Carrier in Sub-block." Otherwise NaN (9.91E+37) is returned. (dBm) 4. Peak frequency in the measured ref carrier frequency range. Peak frequency in the left ref carrier frequency range if Power Ref type is "Left & Right Carriers." Peak frequency in the ref carrier frequency range of the left sub-block if Power Ref type is "Max Power Carrier in Sub-block." (Hz) 5. Peak frequency in the right ref carrier frequency range if Power Ref type is "Left & Right Carriers." Peak frequency in the ref carrier frequency range of the right sub-block if Power Ref type is "Max Power Carrier in Sub-block." Otherwise NaN (9.91E+37) is returned. (Hz) <p>If the result is not available, NaN (9.91E+37) is returned. The number of values returned is subject to change in future releases.</p>
MSR, LTEAFDD, LTEATDD only	13	<p>Meas Type: Power Spectral Density Reference Returns outer offset results when Non-Contiguous Meas Region is set to Outer, and returns inner offset results when it is set to Inner, in the following order.</p> <ol style="list-style-type: none"> 1. Total Absolute power of carriers of Measure Carrier On if Power Ref Type is "Max Power Carrier," "Max Power Carrier in Sub-block," or "RF Bandwidth." Otherwise NaN (9.91E+37) is returned. (dBm) 2. Absolute reference power. Absolute power at the left reference carrier if Power Ref type is "Left & Right Carriers." Absolute power at the reference carrier of the left sub-block if Power Ref type is "Max Power Carrier in Sub-block." (dBm/Hz) 3. Absolute power at the right reference carrier if Power Ref type is "Left & Right Carriers." Absolute power at the reference carrier of the right sub-block if Power Ref type is "Max Power Carrier in Sub-block." Otherwise NaN (9.91E+37) is returned. (dBm/Hz) 4. Peak frequency in the measured ref carrier frequency range. Peak frequency in the left ref carrier frequency range if Power Ref type is "Left & Right Carriers." Peak frequency in the ref carrier frequency range of the left sub-block if Power Ref type is "Max Power Carrier in Sub-block." (Hz) 5. Peak frequency in the right ref carrier frequency range if Power Ref type is "Left & Right Carriers." Peak frequency in the ref carrier frequency range of the right sub-block if Power Ref

Modes	n	Return Value
		<p>type is "Max Power Carrier in Sub-block." Otherwise NaN (9.91E+37) is returned. (Hz)</p> <p>If the result is not available, NaN (9.91E+37) is returned.</p> <p>The number of values returned is subject to change in future releases.</p>
MSR, LTEAFDD, LTEATDD only	13	<p>Meas Type: Power Spectrum Peak Reference</p> <p>Returns outer offset results when Non-Contiguous Meas Region is set to Outer, and returns inner offset results when it is set to Inner, in the following order.</p> <ol style="list-style-type: none"> 1. Total Absolute power of carriers of Measure Carrier On if Power Ref Type is "Max Power Carrier," "Max Power Carrier in Sub-block," or "RF Bandwidth." Otherwise NaN (9.91E+37) is returned. (dBm) 2. Peak reference power. Peak power at the left reference carrier if Power Ref type is "Left & Right Carriers." Peak power at the reference carrier of the left sub-block if Power Ref type is "Max Power Carrier in Sub-block." (dBm) 3. Peak power at the right reference carrier if Power Ref type is "Left & Right Carriers." Peak power at the reference carrier of the right sub-block if Power Ref type is "Max Power Carrier in Sub-block." Otherwise NaN (9.91E+37) is returned. (dBm) 4. Peak frequency in the measured ref carrier frequency range. Peak frequency in the left ref carrier frequency range if Power Ref type is "Left & Right Carriers." Peak frequency in the ref carrier frequency range of the left sub-block if Power Ref type is "Max Power Carrier in Sub-block." (Hz) 5. Peak frequency in the right ref carrier frequency range if Power Ref type is "Left & Right Carriers." Peak frequency in the ref carrier frequency range of the right sub-block if Power Ref type is "Max Power Carrier in Sub-block." Otherwise NaN (9.91E+37) is returned. (Hz) <p>If the result is not available, NaN (9.91E+37) is returned.</p> <p>The number of values returned is subject to change in future releases.</p>
All	14	<p>Meas Type: Total Power Reference</p> <p>Returns comma-separated scalar results, in the following order:</p> <p>When in the MSR and LTE-Advanced FDD/TDD mode, returns outer offset results when Non-Contiguous Meas Region is set to Outer, and returns inner offset results when it is set to Inner, in the following order.</p> <ol style="list-style-type: none"> 1. Relative integrated power on the negative offset A (dBc) 2. Absolute integrated power on the negative offset A (dBm) 3. Relative peak power on the negative offset A (dBc) 4. Absolute peak power on the negative offset A (dBm) 5. Peak power offset frequency from the center or carrier edge frequency in the negative offset A, depending on Offset Frequency Define settings (Hz) 6. Relative integrated power on the positive offset A (dBc) 7. Absolute integrated power on the positive offset A (dBm) 8. Relative peak power on the positive offset A (dBc) 9. Absolute peak power on the positive offset A (dBm)

Modes	n	Return Value
		<p>10. Peak power offset frequency from the center or carrier edge frequency in the positive offset A, depending on Offset Frequency Define settings (Hz)</p> <p>11. Relative integrated power on the negative offset B (dBc)</p> <p>---</p> <p>119. Absolute peak power on the positive offset L (dBm)</p> <p>120. Peak power offset frequency from the center or carrier edge frequency in the positive offset L, depending on Offset Frequency Define settings (Hz)</p> <p>If the result is not available, NaN (9.91 E+37) is returned.</p> <p>The length of the result depends on the number of available offset (See "Number of Offsets" on page 995).</p> <p>The number of values returned is subject to change in future releases.</p>
All	14	<p>Meas Type: Power Spectral Density Reference</p> <p>Returns comma-separated scalar results, in the following order:</p> <p>When in the MSR and LTE-Advanced FDD/TDD mode, returns outer offset results when Non-Contiguous Meas Region is set to Outer, and returns inner offset results when it is set to Inner, in the following order.</p> <ol style="list-style-type: none"> 1. Relative integrated power on the negative offset A (dB) 2. Absolute integrated power on the negative offset A (dBm/Hz) 3. Relative peak power on the negative offset A (dB) 4. Absolute peak power on the negative offset A (dBm/Hz) 5. Peak power offset frequency from the center or carrier edge frequency in the negative offset A, depending on Offset Frequency Define settings (Hz) 6. Relative integrated power on the positive offset A (dB) 7. Absolute integrated power on the positive offset A (dBm/Hz) 8. Relative peak power on the positive offset A (dB) 9. Absolute peak power on the positive offset A (dBm/Hz) 10. Peak power offset frequency from the center or carrier edge frequency in the positive offset A, depending on Offset Frequency Define settings (Hz) 11. Relative integrated power on the negative offset B (dB) <p>---</p> <p>119. Absolute peak power on the positive offset L (dBm/Hz)</p> <p>120. Peak power offset frequency from the center or carrier edge frequency in the positive offset L, depending on Offset Frequency Define settings (Hz)</p> <p>If the result is not available, NaN (9.91 E+37) is returned.</p> <p>The length of the result depends on the number of available offset (See "Number of Offsets" on page 995).</p> <p>The number of values returned is subject to change in future releases.</p>
All	14	<p>Meas Type: Spectrum Peak Reference</p> <p>Returns comma-separated scalar results, in the following order:</p>

Modes	n	Return Value
		<p>When in the MSR and LTE-Advanced FDD/TDD mode, returns outer offset results when Non-Contiguous Meas Region is set to Outer, and returns inner offset results when it is set to Inner, in the following order.</p> <ol style="list-style-type: none"> 1. Reserved for the future use, returns NaN (9.91E+37) 2. Reserved for the future use, returns NaN (9.91E+37) 3. Relative peak power on the negative offset A (dB) 4. Absolute peak power on the negative offset A (dBm) 5. Peak power offset frequency from the center or carrier edge frequency in the negative offset A, depending on Offset Frequency Define settings (Hz) 6. Reserved for the future use, returns NaN (9.91E+37) 7. Reserved for the future use, returns NaN (9.91E+37) 8. Relative peak power on the positive offset A (dB) 9. Absolute peak power on the positive offset A (dBm) 10. Peak power offset frequency from the center or carrier edge frequency in the positive offset A, depending on Offset Frequency Define settings (Hz) 11. Relative integrated power on the negative offset B (dB) <p>---</p> <ol style="list-style-type: none"> 119. Absolute peak power on the positive offset L (dBm) 120. Peak power offset frequency from the center or carrier edge frequency in the positive offset L, depending on Offset Frequency Define settings (Hz) <p>If the result is not available, NaN (9.91E+37) is returned.</p> <p>The length of the result depends on the number of available offset (See "Number of Offsets" on page 995).</p> <p>The number of values returned is subject to change in future releases.</p>
All	15	<p>Meas Type: Total Power Reference</p> <p>Returns comma-separated scalar results, in the following order:</p> <p>When in the MSR and LTE-Advanced FDD/TDD mode, returns outer offset results when Non-Contiguous Meas Region is set to Outer, and returns inner offset results when it is set to Inner, in the following order.</p> <ol style="list-style-type: none"> 1. Minimum margin from limit line on the negative offset A (dB) 2. Minimum margin from limit line on the positive offset A (dB) 3. Minimum margin from limit line on the negative offset B (dB) 4. Minimum margin from limit line on the positive offset B (dB) <p>---</p> <ol style="list-style-type: none"> 23. Minimum margin from limit line on the negative offset L (dB) 24. Minimum margin from limit line on the positive offset L (dB) <p>If the result is not available, NaN (9.91E+37) is returned.</p> <p>The length of the result depends on the number of available offset (See "Number of Offsets" on page 995).</p> <p>The number of values returned is subject to change in future releases.</p>
MSR, LTEAFDD,	16	

Modes	n	Return Value
LTEATDD only		Returns number of carriers comma-separated scalar results, in the following order: 1. Absolute power of carrier 1 (dBm) 2. Absolute power of carrier 2 (dBm) --- number of carriers-1. Absolute power of carrier (number of carriers)-1 (dBm) number of carriers. Absolute power of carrier (number of carriers)-1 (dBm) If Measure Carrier of the corresponding carrier is no, NaN (9.91E+37) is returned.
WLAN only	16	Returns two carriers comma-separated scalar results when the radio standard is 802.11 ac 80+80 MHz. And returns NaN otherwise. 1. Absolute power of carrier segment 1 (dBm) 2. Absolute power of carrier segment 2 (dBm)
MSR, LTEAFDD, LTEATDD only	17	Returns the displayed frequency domain combined limit trace data separated by comma. Combined trace is a mixed trace of both absolute limit trace and relative limit trace according to the fail mask condition. The number of data points is 2001.

Number of Offsets

The number of available offsets varies depending on the mode and option as below.

Mode	The number of available offsets
MSR, LTEAFDD, LTEATDD	12 (Offset A to L)
WLAN	12 (Offset A to L)
Other modes with option N9060A-7FP	12 (Offset A to L)
Other modes without option N9060A-7FP	6 (Offset A to F)

Key Path	Meas
Initial S/W Revision	Prior to A.02.00
Modified at S/W Revision	A.11.00, A.14.00

AMPTD Y Scale

Accesses a menu of functions that enable you to set the vertical scale parameters. The parameter values are measurement independent except all Attenuation values and Internal Preamp selections that are measurement global.

Key Path	Front-panel key
Initial S/W Revision	Prior to A.02.00

Ref Value

Sets the value for the absolute power reference. However, since Auto Scaling defaults to On, this value is automatically determined by the measurement result. When you set a value manually, Auto Scaling automatically changes to Off.

Key Path	AMPTD Y Scale
Mode	SA, WCDMA, C2K, WIMAX OFDMA, TD-SCDMA, 1xEVDO, DTMB (CTTB), DVB-T/H, ISDB-T, CMMB, LTE, LTETDD, Digital Cable TV, WLAN, MSR, LTEAFDD, LTEATDD
Remote Command	:DISPlay:SEMAsk:VIEW[1]:WINDow[1]:TRACe:Y[:SCALE]:RLEVel <real> :DISPlay:SEMAsk:VIEW[1]:WINDow[1]:TRACe:Y[:SCALE]:RLEVel?
Example	DISP:SEM:VIEW:WIND:TRAC:Y:RLEV 100 DISP:SEM:VIEW:WIND:TRAC:Y:RLEV?
Notes	You must be in the mode that includes SEM measurement to use this command. Use :INSTrument:SElect to set the mode.
Couplings	When the Auto Scaling is On, this value is automatically determined by the measurement result. When you set a value manually, Auto Scaling automatically changed to Off.
Preset	10.0 dBm
State Saved	Saved in instrument state.
Min	-250 dBm
Max	250 dBm
Initial S/W Revision	Prior to A.02.00
Modified at S/W Revision	A.02.00, A.03.00

Attenuation

This menu controls the attenuator functions and interactions between the attenuation system components.

There are two attenuator configurations in the X-Series. One is a dual attenuator configuration consisting of a mechanical attenuator and an optional electronic attenuator. The other configuration uses a single attenuator with combined mechanical and electronic sections that controls all the attenuation functions. Different models in the X-Series come with different configurations.

See "Dual Attenuator Configurations:" on page 997

See "Single Attenuator Configuration:" on page 998

Most Attenuation settings are the same for all measurements – they do not change as you change measurements. Settings like these are called “Meas Global” and are unaffected by Meas Preset.

Key Path	AMPTD Y Scale
Scope	Meas Global
Dependencies	In measurements that support the I/Q inputs, this key is unavailable when I/Q is the selected input, and is replaced by the Range key in that case.
Readback Line	Contains a summary in [] brackets of the current total attenuation. See the descriptions of the , " (Mech) Atten " on page 2160, and "Enable Elec Atten" on page 2162 keys for more detail on the contributors to the total attenuation. Note that when "Pre-Adjust for Min Clip" is on, this value can change at the start of every measurement.
Initial S/W Revision	Prior to A.02.00
Modified at S/W Revision	A.03.00

Dual Attenuator Configurations:

Configuration 1: Mechanical attenuator + optional electronic attenuator

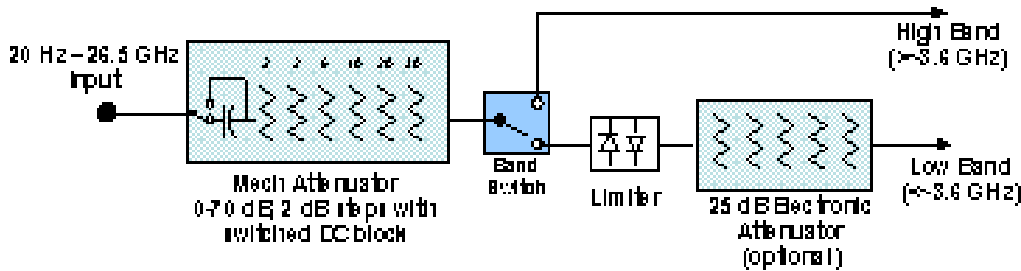

Configuration 2: Mechanical attenuator, no optional electronic attenuator

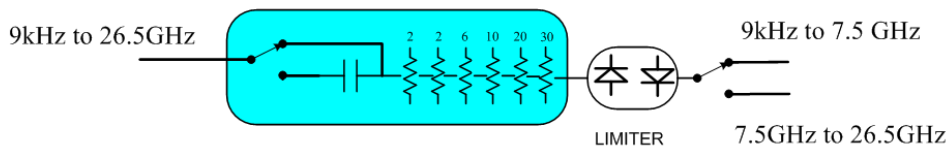

(note that Configuration 2 is not strictly speaking a dual-section attenuator, since there is no electronic section available. However, it behaves exactly like Configuration 1 without the Electronic Attenuator option EA3, therefore for the sake of this document it is grouped into the “Dual Attenuator” configuration)

Single Attenuator Configuration:

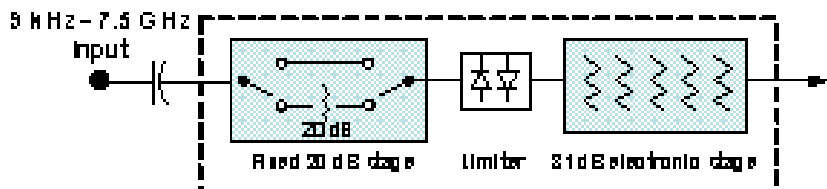

You can tell which attenuator configuration you have by pressing the Attenuation key, which (in most Modes) opens the Attenuation menu. If the first key in the Attenuation menu says Mech Atten you have the dual attenuator configuration. If the first key says Atten you have the single attenuator configuration.

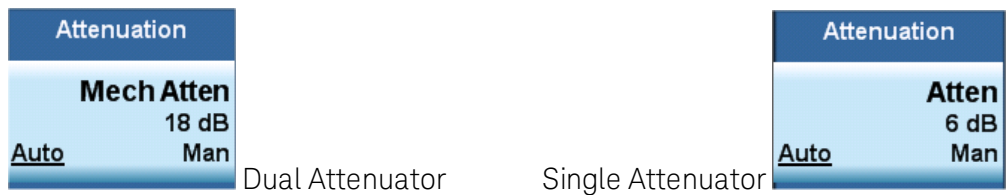

In the single attenuator configuration, you control the attenuation with a single control, as the fixed stage has only two states. In the dual attenuator configuration, both stages have significant range so you are given separate control of the mechanical and electronic attenuator stages.

When you have the dual attenuator configuration, you may still have only a single attenuator, because unless option EA3 (the Electronic Attenuator option) is available, and you purchase it, you will have only the mechanical attenuator.

(Mech) Atten

This key is labeled Mech Atten in dual attenuator models and Atten in single attenuator models. In the dual attenuator configuration, this key only affects the mechanical attenuator.

This key lets you modify the attenuation applied to the RF input signal path. This value is normally auto coupled to the Ref Level, the Internal Preamp Gain, any External Gain that is entered, and the Max Mixer Level, as described in the table below.

See ["Attenuator Configurations and Auto/Man" on page 1000](#)

Key Path	AMPTD Y Scale, Attenuation
Remote Command	<pre>[:SENSe]:POWeR[:RF]:ATTenuation <rel_ampl> [:SENSe]:POWeR[:RF]:ATTenuation? [:SENSe]:POWeR[:RF]:ATTenuation:AUTO OFF ON 0 1 [:SENSe]:POWeR[:RF]:ATTenuation:AUTO?</pre>
Example	<p>POW:ATT 20</p> <p>Dual attenuator configuration: sets the mechanical attenuator to 20 dB</p> <p>Single attenuator mode: sets the main attenuation to 20 dB (see below for definition of “main” attenuation).</p> <p>If the attenuator was in Auto, it sets it to Manual.</p>
Dependencies	Some measurements do not support the Auto setting of (Mech) Atten. In these measurements, the

Auto/Man selection is not available, and the Auto/Man line on the key disappears.

In dual attenuator configurations, when the electronic attenuator is enabled, the mechanical attenuator has no auto setting and the Auto/Man line on the key disappears. The state of Auto/Man is remembered and restored when the electronic attenuator is once again disabled. This is described in more detail in the ["Enable Elec Atten" on page 2162](#) key description.

See ["Attenuator Configurations and Auto/Man" on page 1000](#) for more information on the Auto/Man functionality of Attenuation.

Couplings

When (Mech) Atten is in Auto, it uses the following algorithm to determine a value:
 If the USB Preamp is connected to USB, use 0 dB.
 Otherwise, $Atten = ReferenceLevel + PreAmpGain + ExternalGain - RefLevelOffset - MaxMixerLevel + IF\ Gain$.
 Limit this value to be between 6 dB and the Max value. No value below 6 dB can ever be chosen by Auto.
 The resulting value is rounded up to the largest value possible given the attenuation step setting. That is, 50.01 dB would change to 60 dB (for a 10 dB attenuation step).
 The "IF Gain" term in the equation above is either 0 dB or +10 dB, depending on the settings of FFT IF Gain, Swept IF Gain, max Ref Level and the Auto/Man setting of Mech Atten.
 In External Mixing and BBIQ, where the Attenuator is not in the signal path, the Attenuator setting changes as described above when (Mech) Atten is in Auto, but no changes are made to the actual attenuator hardware setting until the input is changed back to the RF Input.

Preset
 The preset for Mech Attenuation is "Auto."
 The Auto value of attenuation is:
 CXA, EXA, MXA and PXA: 10 dB

State Saved
 Saved in instrument state

Min
 0 dB
 The attenuation set by this key cannot be decreased below 6 dB with the knob or step keys. To get to a value below 6 dB it has to be directly entered from the keypad or via SCPI. This protects from adjusting the attenuation to a dangerously small value which can put the instrument at risk of damage to input circuitry. However, if the current mechanical attenuation is below 6 dB it can be increased with the knob and step keys, but not decreased.

Max
 CXA N9000A-503/507: 50 dB
 CXA N9000A-513/526: 70dB
 EXA: 60 dB
 MXA and PXA: 70 dB
 In the single attenuator configuration, the total of ATT and EATT cannot exceed 50 dB, so if the EATT is set to 24 dB first, the main attenuation cannot be greater than 26 dB and will be reduced accordingly; if the main attenuator is set to 40 dB first, EATT cannot be greater than 10 dB.

Initial S/W Revision
 Prior to A.02.00

Modified at S/W Revision
 A.03.00

Attenuator Configurations and Auto/Man

As described in the Attenuation key description, there are two distinct attenuator configurations available in the X-Series, the single attenuator and dual attenuator configurations. In dual attenuator configurations, we have the mechanical attenuation and the electronic attenuation, and the current total attenuation is the sum of the electronic + mechanical attenuation. In single attenuator configurations, we refer to the attenuation set using the (Mech) Atten key (or POW:ATT SCPI) as the “main” attenuation; and the attenuation that is set by the SCPI command POW:EATT as the “soft” attenuation (the POW:EATT command is honored even in the single attenuator configuration, for compatibility purposes). Then the current total attenuation is the sum of the main + soft attenuation. See the Elec Atten key description for more on “soft” attenuation.

In the dual attenuator configuration, when the electronic attenuator is enabled, there is no Auto/Man functionality for the mechanical attenuator, and the third line of the key label (the Auto/Man line) disappears:

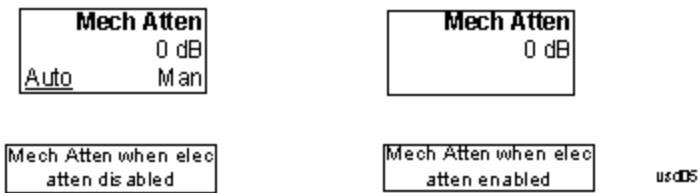

Enable Elec Atten

Enables the Electronic Attenuator.

The electronic attenuator offers finer steps than the mechanical attenuator, has no acoustical noise, is faster, and is less subject to wear. These advantages primarily aid in remote operation and are negligible for front panel use. See ["Using the Electronic Attenuator: Pros and Cons" on page 1002](#) for a detailed discussion of the pros and cons of using the electronic attenuator.

For the single attenuator configuration, for SCPI backwards compatibility, the “soft” attenuation feature replaces the dual attenuator configuration’s electronic attenuator. All the same couplings and limitations apply. See ["Attenuator Configurations and Auto/Man" on page 2162](#)

See ["More Information" on page 1001](#)

Key Path	AMPTD Y Scale, Attenuation
Remote Command	[:SENSe] : POWer [:RF] : EATTenuation : STATE OFF ON 0 1 [:SENSe] : POWer [:RF] : EATTenuation : STATE ?
Example	POW:EATT:STAT ON
Dependencies	This key only appears in Dual Attenuator models with an Electronic Attenuator installed. It does not appear in models with the Single Attenuator configuration, as in the single attenuator configuration there is no “electronic attenuator” there is only a single integrated attenuator (which has both a mechanical and electronic stage). However, in the single attenuator configuration, EATT SCPI commands are accepted for compatibility with other X-series instruments and set a “soft” attenuation as described in "Attenuator Configurations and Auto/Man" on page 2162 . The electronic attenuator (and the “soft” attenuation function provided in single attenuator configurations) is unavailable above 3.6 GHz. Therefore, if the Stop Frequency of the analyzer is > 3.6 GHz then the Enable Elec Atten key will be OFF and grayed out.

	<p>If the Internal Preamp is on, meaning it is set to Low Band or Full, the electronic attenuator (and the “soft” attenuation function provided in single attenuator configurations) is unavailable. In this case the Enable Elec Atten key will be OFF and grayed out.</p> <p>If either of the above is true, if the SCPI command is sent, an error indicating that the electronic attenuator is unavailable will be sent.</p> <p>If the electronic/soft Attenuator is enabled, then the Stop Freq of the analyzer is limited to 3.6 GHz and the Internal Preamp is unavailable.</p> <p>The SCPI-only “soft” electronic attenuation for the single-attenuator configuration is not available in all measurements; in particular, it is not available in the Swept SA measurement.</p>
Couplings	Enabling and disabling the Electronic Attenuator affects the setting of the Mechanical Attenuator (in dual attenuator configurations). This is described in more detail below this table.
Preset	OFF for Swept SA measurement; ON for all other measurements that support the electronic attenuator
State Saved	Saved in instrument state
Initial S/W Revision	Prior to A.02.00
Modified at S/W Revision	A.03.00

More Information

Mechanical Attenuator Transition Rules

When the Electronic Attenuator is enabled, the Mechanical Attenuator transitions to a state that has no Auto function. Below are the rules for transitioning the Mechanical Attenuator. NOTE that the information below ONLY applies to the dual attenuator configurations, and ONLY when the Electronic Attenuator is installed:

When the Electronic Attenuation is enabled from a disabled state:

- The Mechanical Attenuator is initialized to 10 dB (this is its optimal performance setting). You can then set it as desired with SCPI, numeric keypad, step keys, or knob, and it behaves as it normally would in manual mode
- The Auto/Man state of (Mech) Atten is saved
- The Auto/Man line on the (Mech) Atten key disappears and the auto rules are disabled
- The Electronic Attenuator is set to 10 dB less than the previous value of the Mechanical Attenuator, within the limitation that it must stay within the range of 0 to 24 dB of attenuation.

Examples in the dual attenuator configuration:

- Mech Atten at 20 dB. Elec Atten enabled, Mech Atten set to 10 dB, and Elec Atten set to 10 dB. New total attenuation equals the value before Elec Atten enabled.
- Mech Atten at 0 dB. Elec Atten enabled, Mech Atten set to 10 dB, and Elec Atten set to 0 dB. New total attenuation does not equal the value before Elec Atten enabled.
- Mech Atten at 40 dB. Elec Atten enabled, Mech Atten set to 10 dB, and Elec Atten set to 24 dB. New total attenuation does not equal the value before Elec Atten enabled.

When the Electronic Attenuation is disabled from an enabled state:

- The Elec Atten key is grayed out
- The Auto/Man state of (Mech) Atten is restored
- If now in Auto, (Mech) Atten recouples
- If now in Man, (Mech) Atten is set to the value of total attenuation that existed before the Elec Atten was disabled. The resulting value is rounded up to the smallest value possible given the (Mech) Atten Step setting - (That is, 57 dB changes to 58 dB when (Mech) Atten Step is 2 dB.)

Using the Electronic Attenuator: Pros and Cons

The electronic attenuator offers finer steps than the mechanical attenuator, has no acoustical noise, is faster, and is less subject to wear.

The “finer steps” advantage of the electronic attenuator is beneficial in optimizing the alignment of the analyzer dynamic range to the signal power in the front panel as well as remote use. Thus, you can achieve improved relative signal measurement accuracy. Compared to a mechanical attenuator with 2 dB steps, the 1 dB resolution of the electronic attenuator only gives better resolution when the odd-decibel steps are used. Those odd-decibel steps are less accurately calibrated than the even-decibel steps, so one tradeoff for this superior relative accuracy is reduced absolute amplitude accuracy.

Another disadvantage of the electronic attenuator is that the spectrum analyzer loses its “Auto” setting, making operation less convenient.

Also, the relationship between the dynamic range specifications (TOI, SHI, compression and noise) and instrument performance are less well-known with the electrical attenuator. With the mechanical attenuator, TOI, SHI and compression threshold levels increase dB-for-dB with increasing attenuation, and the noise floor does as well. With the electronic attenuator, there is an excess attenuation of about 1 to 3 dB between 0 and 3.6 GHz, making the effective TOI, SHI, and so forth, less well known. Excess attenuation is the actual attenuation relative to stated attenuation. Excess attenuation is accounted for in the analyzer calibration

Elec Atten

Controls the Electronic Attenuator in dual attenuator configurations. This key does not appear in single attenuator configurations, as the control of both the mechanical and electronic stages of the single attenuator is integrated into the single Atten key.

Key Path	AMPTD Y Scale, Attenuation
Remote Command	[:SENSe] :POWer [:RF] :EATTenuation <rel_ampl> [:SENSe] :POWer [:RF] :EATTenuation?
Notes	Electronic Attenuation’s specification is defined only when Mechanical Attenuation is 6 dB.
Dependencies	This key only appears in Dual Attenuator models with an Electronic Attenuator installed. It does not appear in models with the Single Attenuator configuration, as in the single attenuator configuration there is no “electronic attenuator” there is only a single integrated attenuator (which has both a mechanical and electronic stage). However, in the single attenuator configuration, EATT SCPI commands are accepted for compatibility with other X-series instruments and set a “soft” attenuation as described in "Attenuator Configurations and Auto/Man" on page 2162 . The “soft” attenuation is treated as an addition to the “main” attenuation value set by the Atten softkey or the

	POW:ATT SCPI command and affects the total attenuation displayed on the Attenuation key and the Meas Bar. When Enable Elec Atten is off or grayed out, the Elec Atten key is grayed out.
Preset	0 dB
State Saved	Saved in instrument state
Min	0 dB
Max	Dual attenuator configuration: 24 dB Single attenuator configuration: the total of ATT and EATT cannot exceed 50 dB, so if the EATT is set to 24 dB first, the main attenuation cannot be greater than 26 dB and will be reduced accordingly; if the main attenuator is set to 40 dB first, EATT cannot be greater than 10 dB
Initial S/W Revision	Prior to A.02.00
Modified at S/W Revision	A.03.00

Adjust Atten for Min Clip

Sets the combination of mechanical and electronic attenuation and gain based on the current measured signal level so that clipping will be at a minimum.

This is an "immediate action" function, that is, it executes once, when the key is pressed.

This key is grayed out in measurements that do not support this functionality. The spectrum analyzer measurement, Swept SA, does not support this functionality.

Key Path	AMPTD Y Scale, Attenuation
Remote Command	<code>[:SENSe] :POWer [:RF] :RANGe :OPTimize IMMEDIATE</code>
Initial S/W Revision	Prior to A.02.00
Modified at S/W Revision	A.03.00

Pre-Adjust for Min Clip

If this function is on, it does the adjustment described under "[Adjust Atten for Min Clip](#)" on page 2165 each time a measurement restarts. Therefore, in Continuous measurement mode, it only executes before the first measurement.

In dual attenuator models, you can set Elec+Mech Atten, in which case both attenuators participate in the autoranging, or Elec Atten Only, in which case the mechanical attenuator does not participate in the autoranging. This latter case results in less wear on the mechanical attenuator and is usually faster.

This key is grayed out in measurements that do not support this functionality. The spectrum analyzer measurement, Swept SA, does not support this functionality.

Key Path	AMPTD Y Scale, Attenuation
Remote Command	<code>[:SENSe] :POWer [:RF] :RANGe :OPTimize :ATTenuation OFF ELECTRical COMBined</code>

	<code>[:SENSe] :POWer [:RF] :RANGe:OPTimize:ATTenuation?</code>
Notes	The SCPI parameter ELECtrical sets this function to On in single attenuator models. The SCPI parameter COMBined is mapped to ELECtrical in single attenuator models; if you send COMBined, it sets the function to On and returns ELEC to a query.
Dependencies	This key only appears in Dual Attenuator models with an Electronic Attenuator installed. In instruments with Dual Attenuator model, when Enable Elec Atten is off or grayed out, the Pre-Adjust for Min Clip key is grayed out.
Preset	OFF for Swept SA measurement; ON for all other measurements that support Pre-Adjust for Min Clip
State Saved	Saved in instrument state
Range	Dual attenuator models: Off Elec Atten Only Mech + Elec Atten Single attenuator models: Off On
Initial S/W Revision	Prior to A.02.00
Modified at S/W Revision	A.03.00

Remote Command	<code>[:SENSe] :POWer [:RF] :RANGe:AUTO ON OFF 1 0</code> <code>[:SENSe] :POWer [:RF] :RANGe:AUTO?</code>
Notes	ON aliases to "Elec Atten Only" (:POW:RANG:OPT:ATT ELEC) OFF aliases to "Off" (:POW:RANG:OPT:ATT OFF) The query :POW:RANG:AUTO? returns true if :POW:RANG:OPT:ATT is not "Off"
Initial S/W Revision	Prior to A.02.00

Off

Turns Pre-Adjust for Min Clip off. This is the default setting.

This key is grayed out in measurements that do not support this functionality. The spectrum analyzer measurement, Swept SA, does not support this functionality.

Key Path	AMPTD Y Scale, Attenuation, Pre-Adjust for Min Clip
Example	:POW:RANGe:OPT:ATT OFF
Initial S/W Revision	Prior to A.02.00

Elec Atten Only

Selects only the electric attenuator to participate in auto ranging. This offers less wear on the mechanical attenuator and is usually faster.

This key is grayed out in measurements that do not support this functionality. The spectrum analyzer measurement, Swept SA, does not support this functionality.

Key Path	AMPTD Y Scale, Attenuation, Pre-Adjust for Min Clip
Example	:POW:RANGe:OPT:ATT ELEC
Initial S/W Revision	Prior to A.02.00

Mech + Elec Atten

In dual attenuator models, this selects both attenuators participate in the autoranging.

This key is grayed out in measurements that do not support this functionality. The spectrum analyzer measurement, Swept SA, does not support this functionality.

Key Path	AMPTD Y Scale, Attenuation, Pre-Adjust for Min Clip
Example	:POW:RANGe:OPT:ATT COMB
Initial S/W Revision	Prior to A.02.00

(Mech) Atten Step

This controls the step size used when making adjustments to the input attenuation.

This key is labeled Mech Atten Step in dual attenuator models and Atten Step in single attenuator models. In the dual attenuator configuration, this key only affects the step size of the mechanical attenuator.

Key Path	AMPTD Y Scale, Attenuation
Remote Command	[:SENSe] :POWer [:RF] :ATTenuation :STEP [:INCRement] 10 dB 2 dB [:SENSe] :POWer [:RF] :ATTenuation :STEP [:INCRement] ?
Example	POW:ATT:STEP 2
Notes	Note this feature works like a 1-N choice from the front panel, but it takes a specific value (in dB) when used remotely. The only valid values are 2 and 10.
Dependencies	Blanked in CXA and EXA if option FSA (2 dB steps) is not present. If blanked, attempts to set it via SCPI will yield an error.
Couplings	When the attenuation step size changes, the current mechanical attenuation value is adjusted (if necessary) to be quantized to the new step size. That is, if step is set to 10 dB, mech atten is increased if necessary so it is a multiple of 10 dB
Preset	PXA and MXA: 2 dB EXA and CXA: 10 dB (2 dB with option FSA)
State Saved	Saved in instrument state
Initial S/W Revision	Prior to A.02.00
Modified at S/W Revision	A.03.00

Scale/Div

Sets the units-per-division of the vertical scale in the logarithmic display. When Auto Scaling is On, the scale per division value is automatically determined by the measurement result. When you set a value manually, Auto Scaling automatically changes to Off.

Key Path	AMPTD Y Scale
Mode	SA, WCDMA, C2K, WIMAX OFDMA, TD-SCDMA, 1xEVDO, DTMB (CTTB), DVB-T/H, ISDB-T, CMMB, LTE, LTETDD, Digital Cable TV, WLAN, MSR, LTEAFDD, LTEATDD
Remote Command	:DISPlay:SEMask:VIEW[1]:WINDow[1]:TRACe:Y[:SCALe]:PDIVision <rel_ampl> :DISPlay:SEMask:VIEW[1]:WINDow[1]:TRACe:Y[:SCALe]:PDIVision?
Example	DISP:SEM:VIEW:WIND:TRAC:Y:PDIV 15dB DISP:SEM:VIEW:WIND:TRAC:Y:PDIV?
Notes	You must be in the mode that includes SEM measurement to use this command. Use :INSTrument:SElect to set the mode.
Couplings	When the Auto Scaling is On, this value is automatically determined by the measurement result. When you set a value manually, Auto Scaling automatically changes to Off.
Preset	10 dB
State Saved	Saved in instrument state
Min	0.10 dB
Max	20.00 dB
Initial S/W Revision	Prior to A.02.00
Modified at S/W Revision	A.02.00, A.03.00

Presel Center

When this key is pressed, the centering of the preselector filter is adjusted to optimize the amplitude accuracy at the frequency of the selected marker. If the selected marker is not on when Presel Center is pressed, the analyzer will turn on the selected marker, perform a peak search, and then perform centering on the marker's center frequency. If the selected marker is already on and between the start and stop frequencies of the analyzer, the analyzer performs the preselector calibration on that marker's frequency. If the selected marker is already on, but outside the frequency range between Start Freq and Stop Freq, the analyzer will first perform a peak search, and then perform centering on the marker's center frequency.

The value displayed on the Presel Adjust key will change to reflect the new preselector tuning (see Presel Adjust).

A number of considerations should be observed to ensure proper operation. See ["Proper Preselector Operation" on page 1007](#).

Key Path	AMPTD Y Scale
Remote Command	[:SENSe]:POWer[:RF]:PCENter
Example	POW:PCEN
Notes	Note that the rules outlined above under the key description apply for the remote command as well

	as the key. The result of the command is dependent on marker position, and so forth. Any message shown by the key press is also shown in response to the remote command.
Dependencies	<ul style="list-style-type: none"> • Grayed out if the microwave preselector is off.) • If the selected marker's frequency is below Band 1, advisory message 0.5001 is generated and no action is taken. • Grayed out if entirely in Band 0. • Blank in models that do not include a preselector, such as option 503. If the SCPI is sent in these instruments, it is accepted without error, and the query always returns 0. • Grayed out in the Spectrogram View.
Couplings	<p>The active marker position determines where the centering will be attempted.</p> <p>If the analyzer is in a measurement such as averaging when centering is initiated, the act of centering the preselector will restart averaging but the first average trace will not be taken until the centering is completed.</p>
Status Bits/OPC dependencies	<p>When centering the preselector, *OPC will not return true until the process is complete and a subsequent measurement has completed, nor will results be returned to a READ or MEASure command.</p> <p>The Measuring bit should remain set while this command is operating and should not go false until the subsequent sweep/measurement has completed.</p>
Initial S/W Revision	Prior to A.02.00
Modified at S/W Revision	A.03.00

Proper Preselector Operation

A number of considerations should be observed to ensure proper operation:

1. If the selected marker is off, the analyzer will turn on a marker, perform a peak search, and adjust the preselector using the selected marker's frequency. It uses the "highest peak" peak search method unqualified by threshold or excursion, so that there is no chance of a 'no peak found' error. It continues with that peak, even if it is the peak of just noise. Therefore, for this operation to work properly, there should be a signal on screen in a preselected range for the peak search to find.
2. If the selected marker is already on, the analyzer will attempt the centering at that marker's frequency. There is no preselector for signals below about 3.6 GHz, therefore if the marker is on a signal below 3.6 GHz, no centering will be attempted and an advisory message generated
3. In some models, the preselector can be bypassed. If it is bypassed, no centering will be attempted in that range and a message will be generated.

Preselector Adjust

Allows you to manually adjust the preselector filter frequency to optimize its response to the signal of interest. This function is only available when **"Presel Center" on page 2168** is available.

For general purpose signal analysis, using Presel Center is recommended. Centering the filter minimizes the impact of long-term preselector drift. Presel Adjust can be used instead to manually optimize the

preselector. One application of manual optimization would be to peak the preselector response, which both optimizes the signal-to-noise ratio and minimizes amplitude variations due to small (short-term) preselector drifting.

Key Path	AMPTD Y Scale
Scope	Meas Global
Remote Command	[:SENSe] :POWer [:RF] :PADJust <freq> [:SENSe] :POWer [:RF] :PADJust?
Example	POW:PADJ 100KHz POW:PADJ?
Notes	The value on the key reads out to 0.1 MHz resolution.
Dependencies	<ul style="list-style-type: none"> • Grayed out if microwave preselector is off.) • Grayed out if entirely in Band 0. • Blank in models that do not include a preselector, such as option 503. If the SCPI is sent in these instruments, it is accepted without error, and the query always returns 0. • Grayed out in the Spectrogram View.
Preset	0 MHz
State Saved	The Presel Adjust value set by Presel Center, or by manually adjusting Presel Adjust, is not saved in instrument state, and does not survive a Preset or power cycle.
Min	-500 MHz
Max	500 MHz
Default Unit	Hz
Backwards Compatibility SCPI	[:SENSe] :POWer [:RF] :MW:PADJust [:SENSe] :POWer [:RF] :MMW:PADJust PSA had multiple preselectors, but the X-Series has only one. These commands simply alias to [:SENSe] :POWer [:RF] :PADJust
Initial S/W Revision	Prior to A.02.00
Modified at S/W Revision	A.03.00

Remote Command	[:SENSe] :POWer [:RF] :PADJust:PRESelector MWAVE MMWave EXTERNAL [:SENSe] :POWer [:RF] :PADJust:PRESelector?
Notes	PSA had multiple preselectors, and you could select which preselector to adjust. Since the X-Series has only one mm/uW preselector, the preselector selection softkey is no longer available. However, to provide backward compatibility, we accept the legacy remote commands. The command form has no effect, the query always returns MWAVE
Initial S/W Revision	Prior to A.02.00

μW Path Control

Sets the μW Path Control function to Auto, standard path, μW Preselector Bypass (Option MPB) and Low Noise Path(Option LNP).

Key Path	AMPTD/Y Scale
Initial S/W Revision	A.14.50

μW Path Control Auto

Activates the auto rules for μW Path Control. When Auto is active, the μW Path Control is set to Preselector Bypass in modulation analysis and spectral flatness measurement; it is set to standard path in other measurements.

Key Path	AMPTD/Y Scale
Remote Command	<code>[:SENSe] :POWeR [:RF] :MW :PATH :AUTO ON OFF 1 0</code> <code>[:SENSe] :POWeR [:RF] :MW :PATH :AUTO ?</code>
Example	<code>POW:MW:PATH:AUTO ON</code> <code>POW:MW:PATH:AUTO ?</code>
Couplings	When Auto is active, the μW Path Control is set to μW Preselector Bypass in IQ measurements (IQ waveform, CCDF, PVT, EVM, Spetrum flatness and WLS); it is set to standard path in other measurements.
Preset	ON
Range	Off On
Initial S/W Revision	A.14.50

Standard Path

This path gives the best remote-control throughput, minimizes acoustic noise from switching and minimizes the risk of wear in the hardware switches, particularly in remote test scenarios where both low band and high band setups will follow in rapid succession.

In this path, the bypass of the low band/high band switch and microwave preamp is never activated, which can cause some noise degradation but preserves the life of the bypass switch.

Key Path	AMPTD Y Scale, μW Path Control
Example	<code>:POW:MW:PATH STD</code>
Readback Text	Standard Path
Initial S/W Revision	A.04.00

Low Noise Path Enable

You may choose Low Noise Path Enable, which gives a lower noise floor under some circumstances, particularly when operating in the 21–26.5 GHz region. With the Low Noise Path enabled, the low band/high band switch and microwave preamp are bypassed whenever all of the following are true:

- The analyzer is not in the Low Band, meaning:
- the start frequency is above 3.5 GHz and
- the stop frequency is above 3.6 GHz.
- the internal preamp is not installed or (if installed) is set to Off or Low Band

Note that this means that, when any part of a sweep is done in Low Band, the Low Noise Path is not used, whether or not the Low Noise Path Enable is selected in the user interface. Also, if the preamp is turned on, the Low Noise Path is not used, whether or not the Low Noise Path Enable is selected in the user interface. The only time the Low Noise Path is used is when Low Noise Path Enable is selected, the sweep is completely in High Band (> 3.6 GHz) and no preamp is in use.

See "[More Information](#)" on page 1010

Key Path	AMPTD Y Scale, μ W Path Control
Measurement	Swept SA
Example	:POW:MW:PATH LNP
Notes	For measurements that use IQ acquisition, the low noise path is used when the Center Frequency is in High Band (> 3.6 GHz) and no preamp is in use. In other words, the rules above are modified to use only the center frequency to qualify which path to switch in. This is not the case for FFT's in the Swept SA measurement; they use the same rules as swept measurements.
Dependencies	Key is blanked if current mode does not support it. Key is grayed out if mode supports it but current measurement does not support it. Unless Option LNP is present and licensed, key is blank and if SCPI command sent, error -241, "Hardware missing; Option not installed" is generated.
Readback Text	Low Noise Path Enable
Initial S/W Revision	A.04.00

More Information

The user should understand that the Low Noise Path, while giving improved DANL, has the disadvantage of decreased TOI performance and decreased gain compression performance relative to the standard path.

The user should also understand that the bypass switch is a mechanical switch and has finite life, so if the Low Noise Path is enabled, it is possible to cause frequent cycling of this switch by frequently changing analyzer settings such that the above conditions hold true only some of the time. A user making tests of this nature should consider opting for the Standard Path, which will never throw the bypass switch, at the expense of some degraded noise performance.

The low noise path is useful for situations where the signal level is so low that the analyzer performance is dominated by noise even with 0 dB attenuation, but still high enough that the preamp option would have excessive third-order intermodulation or compression. The preamp, if purchased and used, gives better noise floor than does the “Low Noise Path.” However, its compression threshold and third-order intercept are much poorer than that of the non-preamp path. There are some applications, typically for signals around -30 dBm, for which the third-order dynamic range of the standard path is good enough, but the noise floor is not low enough even with 0 dB input attenuation. When the third-order dynamic range of the preamp path is too little and the noise floor of the standard path is too high, the Low Noise Path can provide the best dynamic range

The graph below illustrates the concept. It shows, in red, the performance of an analyzer at different attenuation settings, both with the preamp on and off, in a measurement that is affected by both analyzer noise and analyzer TOI. The green shows the best available dynamic range, offset by 0.5 dB for clarity. The blue shows how the best available dynamic range improves for moderate signal levels with the low noise path switched in. In this illustration, the preamp improves the noise floor by 15 dB while degrading the third-order intercept by 30 dB, and the low noise path reduces loss by 8 dB. The attenuator step size is 2 dB.

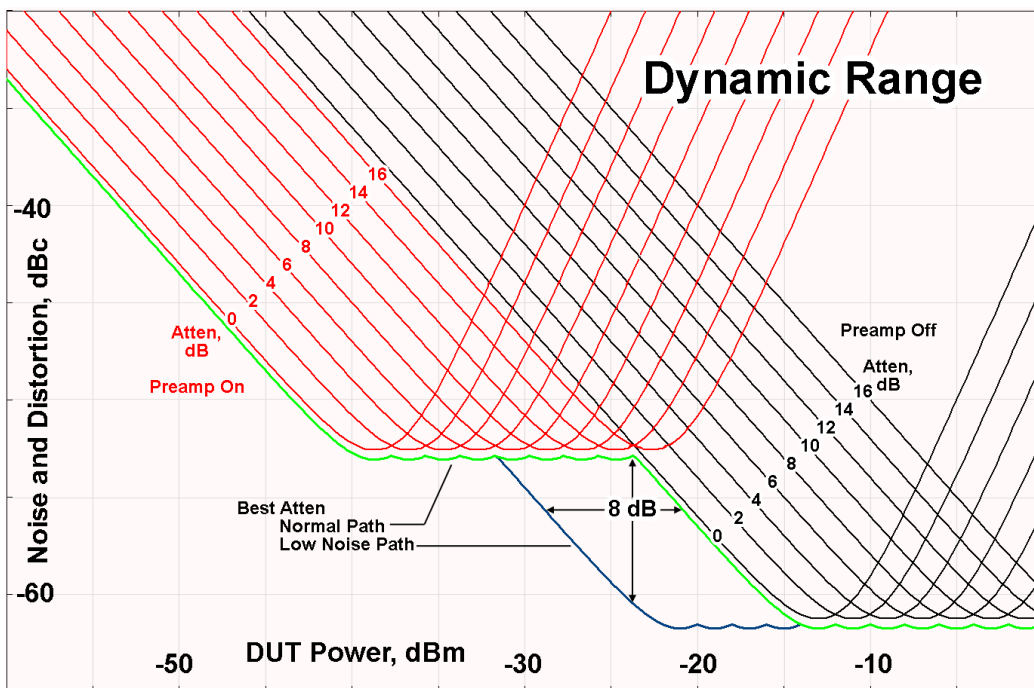

There are other times where selecting the low noise path improves performance, too. Compression-limited measurements such as finding the nulls in a pulsed-RF spectrum can profit from the low noise path in a way similar to the TOI-limited measurement illustrated. Accuracy can be improved when the low noise path allows the optimum attenuation to increase from a small amount like 0, 2 or 4 dB to a larger amount, giving better return loss at the analyzer input. Harmonic measurements, such as second and third harmonic levels, are much improved using the low noise path because of the superiority of that path for harmonic (though not intermodulation) distortion performance.

μW Preselector Bypass

This key toggles the preselector bypass switch for band 1 and higher. When the microwave preselector is on, the signal path is preselected. When the microwave preselector is off, the signal path is not preselected. The preselected path is the normal path for the analyzer.

The preselector is a tunable bandpass filter which prevents signals away from the frequency of interest from combining in the mixer to generate in-band spurious signals (images). The consequences of using a preselector filter are its limited bandwidth, the amplitude and phase ripple in its passband, and any amplitude and phase instability due to center frequency drift.

Option MPB or pre-selector bypass provides an unpreselected input mixer path for certain X-Series signal analyzers with frequency ranges above 3.6 GHz. This signal path allows a wider bandwidth and less amplitude variability, which is an advantage when doing modulation analysis and broadband signal analysis. The disadvantage is that, without the preselector, image signals will be displayed. Another disadvantage of bypassing the preselector is increased LO emission levels at the front panel input port.

Image responses are separated from the real signal by twice the 1st IF. For IF Paths of 10 MHz and 25 MHz, the 1st IF is 322.5 MHz, so the image response and the real signal will be separated by 645 MHz. The 1st IF will be different for other IF Path settings. When viewing a real signal and its corresponding image response in internal mixing, the image response will be to the left of the real signal.

Also, the image response and the real signal typically have the same amplitude and exhibit the same shape factor.

However, if Option FS1, Fast Sweep Capability, is enabled, the image response in the Swept SA measurement will appear lower in amplitude and have a much wider shape factor compared to the real signal.

Key Path	AMPTD Y Scale, μW Path Control
Example	:POW:MW:PATH MPB
Dependencies	Key is blanked if current mode does not support it. Key is grayed out if mode supports it but current measurement does not support it. Key is blank unless Option MPB is present and licensed. If SCPI command sent when MPB not present, error -241, "Hardware missing; Option not installed" is generated.
Readback Text	μW Preselector Bypass
Initial S/W Revision	A.04.00

Remote Command	[:SENSe] :POWer [:RF] :MW:PRESelector [:STATe] ON OFF 0 1 [:SENSe] :POWer [:RF] :MW:PRESelector [:STATe] ?
Example	:POW:MW:PRE OFF Bypasses the microwave preselector
Notes	The ON parameter sets the STD path (:POW:MW:PATH STD) The OFF parameter sets path MPB (:POW:MW:PATH MPB)
Preset	ON

Internal Preamp

Accesses a menu of keys that control the internal preamps. Turning on the preamp gives a better noise figure, but a poorer TOI to noise floor dynamic range. You can optimize this setting for your particular measurement.

The instrument takes the preamp gain into account as it sweeps. If you sweep outside of the range of the preamp the instrument will also account for that. The displayed result will always reflect the correct gain.

For some measurements, when the preamp is on and any part of the displayed frequency range is below the lowest frequency for which the preamp has specifications, a warning condition message appears in the status line. For example, for a preamp with a 9 kHz lowest specified frequency: "Preamp: Accy unspec'd below 9 kHz".

Key Path	AMPTD Y Scale
Scope	Meas Global
Remote Command	[:SENSe] :POWer [:RF] :GAIN [:STATE] OFF ON 0 1 [:SENSe] :POWer [:RF] :GAIN [:STATE] ?
Dependencies	Preamp is not available on all hardware platforms. If the preamp is not present or is unlicensed, the key is not shown. The preamp is not available when the electronic/soft attenuator is enabled.
Couplings	The act of connecting the U7227A USB Preamplifier to one of the analyzer's USB ports will cause the Internal Preamp to be switched on. When this happens an informational message will be generated: "Internal Preamp turned on for optimal operation with USB Preamp." Note that if the Internal Preamp was already on, there will be no change to the setting, but if it was Off it will be switched On, to Full Range. Note that this same action occurs when the SA mode is selected while the USB Preamp is connected to one of the analyzer's USB ports, if it is the first time that the SA mode has run since powerup, or if the last time the SA mode was running the USB Preamp was NOT connected. Subsequently disconnecting the USB Preamp from USB does not change the Internal Preamp setting nor restore the previous setting.
Preset	OFF
State Saved	Saved in instrument state
Initial S/W Revision	Prior to A.02.00
Modified at S/W Revision	A.14.00

Key Path	AMPTD Y Scale, Internal Preamp
Scope	Meas Global
Remote Command	[:SENSe] :POWer [:RF] :GAIN :BAND LOW FULL [:SENSe] :POWer [:RF] :GAIN :BAND ?
Dependencies	Preamp is not available on all hardware platforms. If the preamp is not present or is unlicensed, the key is not shown. If a POW:GAIN:BAND FULL command is sent when a low band preamp is available, the preamp band

	parameter is to LOW instead of FULL, and an "Option not installed" message is generated.
Preset	LOW
State Saved	Saved in instrument state
Initial S/W Revision	Prior to A.02.00

Off

Turns the internal preamp off

Key Path	AMPTD Y Scale, Internal Preamp
Example	:POW:GAIN OFF
Readback	Off
Initial S/W Revision	Prior to A.02.00

Low Band

Sets the internal preamp to use only the low band.

The frequency range of the installed (optional) low-band preamp is displayed in square brackets on the Low Band key label.

Key Path	AMPTD Y Scale, Internal Preamp
Example	:POW:GAIN ON :POW:GAIN:BAND LOW
Readback	Low Band
Initial S/W Revision	Prior to A.02.00

Full Range

Sets the internal preamp to use its full range. The low band (0–3.6 GHz or 0–3GHz, depending on the model) is supplied by the low band preamp and the frequencies above low band are supplied by the high band preamp.

The frequency range of the installed (optional) preamp is displayed in square brackets on the Full Range key label. If the high band option is not installed the Full Range key does not appear.

Key Path	AMPTD Y Scale, Internal Preamp
Example	:POW:GAIN ON :POW:GAIN:BAND FULL
Readback	Full Range
Initial S/W Revision	Prior to A.02.00

Ref Position

Positions the reference level at the top, center or bottom of the Y scale display. Changing the reference position does not affect the reference level value.

Key Path	AMPTD Y Scale
Mode	SA, WCDMA, C2K, WIMAX OFDMA, TD-SCDMA, 1xEVDO, DTMB (CTTB), DVB-T/H, ISDB-T, CMMB, LTE, LTE-TDD, Digital Cable TV, WLAN, MSR, LTEAFDD, LTEATDD
Remote Command	:DISPlay:SEMask:VIEW[1]:WINDow[1]:TRACe:Y[:SCALe]:RPOStion TOP CENTER BOTTom :DISPlay:SEMask:VIEW[1]:WINDow[1]:TRACe:Y[:SCALe]:RPOStion?
Example	DISP:SEM:VIEW:WIND:TRAC:Y:RPOS BOTT DISP:SEM:VIEW:WIND:TRAC:Y:RPOS?
Notes	You must be in the mode that includes SEM measurement to use this command. Use :INSTrument:SElect to set the mode.
Preset	TOP
State Saved	Saved in instrument state
Range	Top Ctr Bot
Initial S/W Revision	Prior to A.02.00
Modified at S/W Revision	A.02.00, A.03.00

Auto Scaling

Toggles the Auto Scaling function between On and Off.

When Auto Scaling is On and the Restart front-panel key is pressed, the analyzer automatically determines the scale per division and reference values based on the measurement results. When you set a value to either Scale/Div or Ref Value manually, Auto Scaling automatically changes to Off.

Key Path	AMPTD Y Scale
Mode	SA, WCDMA, C2K, WIMAX OFDMA, TD-SCDMA, 1xEVDO, DTMB (CTTB), DVB-T/H, ISDB-T, CMMB, LTE, LTE-TDD, Digital Cable TV, WLAN, MSR, LTEAFDD, LTEATDD
Remote Command	:DISPlay:SEMask:VIEW[1]:WINDow[1]:TRACe:Y[:SCALe]:COUPle 0 1 ON OFF :DISPlay:SEMask:VIEW[1]:WINDow[1]:TRACe:Y[:SCALe]:COUPle?
Example	DISP:SEM:VIEW:WIND:TRAC:Y:COUP OFF DISP:SEM:VIEW:WIND:TRAC:Y:COUP?
Notes	You must be in the mode that includes SEM measurement to use this command. Use :INSTrument:SElect to set the mode.
Couplings	When Auto Scaling is On, upon pressing the Restart front-panel key, this function automatically determines the scale per division and reference values based on the measurement results. When you set a value to either Scale/Div or Ref Value manually, Auto Scaling automatically changes

11 Spectrum Emission Mask Measurement
AMPTD Y Scale

	to Off.
Preset	ON
State Saved	Saved in instrument state
Range	On Off
Initial S/W Revision	Prior to A.02.00
Modified at S/W Revision	A.02.00, A.03.00

Auto Couple

The Auto Couple feature provides a quick and convenient way to automatically couple multiple instrument settings. This helps ensure accurate measurements and optimum dynamic range. When the Auto Couple feature is activated, either from the front panel or remotely, all parameters of the current measurement that have an Auto/Manual mode are set to Auto mode and all measurement settings dependent on (or coupled to) the Auto/Man parameters are automatically adjusted for optimal performance.

However, the Auto Couple key actions are confined to the current measurement only. It does not affect other measurements in the mode, and it does not affect markers, marker functions, or trace or display attributes.

See ["More Information" on page 1017](#)

Key Path	Front-panel key
Remote Command	:COUPle ALL NONE
Example	:COUP ALL
Notes	:COUPle ALL puts all Auto/Man parameters in Auto mode (equivalent to pressing the Auto Couple key). :COUPLE NONE puts all Auto/Man parameters in manual mode. It decouples all the coupled instrument parameters and is not recommended for making measurements.
Initial S/W Revision	Prior to A.02.00

More Information

There are two types of functions that have Auto/Manual modes.

Auto/Man Active Function keys

An Auto/Man toggle key controls the binary state associated with an instrument parameter by toggling between Auto (where the parameter is automatically coupled to the other parameters it is dependent upon) and Man (where the parameter is controlled independent of the other parameters), as well as making the parameter the active function. The current mode is indicated on the softkey with either Auto or Man underlined as illustrated below.



Auto/Man 1-of-N keys

An Auto/Man 1-of-N key allows you to manually pick from a list of parameter values, or place the function in Auto, in which case the value is automatically selected (and indicated) as shown below. If in Auto, Auto is underlined on the calling key. If in manual operation, manual is indicated on the calling key. But the calling key does not actually toggle the function, it simply opens the menu.

11 Spectrum Emission Mask Measurement
Auto Couple

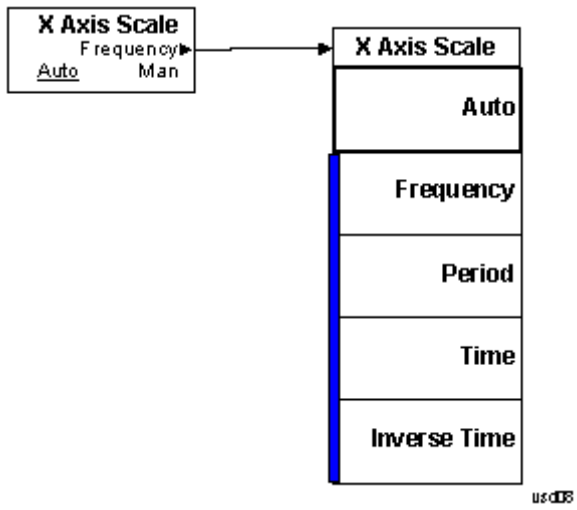

BW

Accesses a menu of functions that enable you to select the type of filter for the measurement.

Key Path	Front-panel key
Initial S/W Revision	Prior to A.02.00
Modified at S/W Revision	A.03.00

Filter Type

Selects the type of bandwidth filter that is used in Carrier and Offsets.

When Gaussian or Flattop is selected, selected filter is applied to carriers and all offsets.

When Auto Sense is selected, filter type is automatically selected for each carriers and offsets, so that measurement speed and accuracy is optimized.

Key Path	BW
Mode	SA, WCDMA, C2K, WIMAX OFDMA, TD-SCDMA, 1xEVDO, DVB-T/H, DTMB (CTTB), ISDB-T, CMMB, LTE, LTE-TDD, Digital Cable TV, WLAN, MSR, LTEAFDD, LTEATDD
Remote Command	[:SENSe] :SEMask :BANDwidth :SHAPE ASENse GAUSSian FLATtop [:SENSe] :SEMask :BANDwidth :SHAPE?
Example	SEM:BAND:SHAP GAUS SEM:BAND:SHAP?
Couplings	See the description above
Preset	ASENse
State Saved	Saved in instrument state
Range	Auto Sense (each offset and carrier) Gaussian (all offsets and carriers) Flattop (all offsets and carriers)
Initial S/W Revision	A.03.00

Cont (Continuous Measurement/Sweep)

Sets the analyzer for Continuous measurement operation. The single/continuous state is Meas Global so the setting will affect all measurements. If you are Paused, pressing Cont does a Resume.

Key Path	Front-panel key
Remote Command	:INITiate:CONTinuous OFF ON 0 1 :INITiate:CONTinuous?
Example	:INIT:CONT 0 puts analyzer in Single measurement operation. :INIT:CONT 1 puts analyzer in Continuous measurement operation
Preset	ON (Note that SYST:PRESet sets INIT:CONT to ON but *RST sets INIT:CONT to OFF)
State Saved	Saved in instrument state
Backwards Compatibility Notes	For Spectrum Analysis mode in ESA and PSA, there is no Cont hardkey, instead there is a Sweep Single/Cont key. In these analyzers, switching the Sweep Single/Cont key from Single to Cont restarts averages (displayed average count reset to 1), but does not restart Max Hold and Min Hold. The X-Series has Single and Cont keys in place of the SweepSingleCont key. In the X-Series, if in single measurement, the Cont key (and INIT:CONT ON) switches to continuous measurement, but never restarts a measurement and never resets a sweep.
Initial S/W Revision	Prior to A.02.00

In Swept SA Measurement (Spectrum Analysis Mode):

The analyzer takes repetitive sweeps, averages, measurements, etc., when in Continuous mode. When the average count reaches the Average/Hold Number the count stops incrementing, but the analyzer keeps sweeping. See the Trace/Detector section for the averaging formula used both before and after the Average/Hold Number is reached. The trigger condition must be met prior to each sweep. The type of trace processing for multiple sweeps, is set under the Trace/Detector key, with choices of Trace Average, Max Hold, or Min Hold.

In Other Measurements/Modes:

With Avg/Hold Num (in the Meas Setup menu) set to Off or set to On with a value of 1, a sweep is taken after the trigger condition is met; and the analyzer continues to take new sweeps after the current sweep has completed and the trigger condition is again met. However, with Avg/Hold Num set to On with a value >1, multiple sweeps (data acquisitions) are taken for the measurement. The trigger condition must be met prior to each sweep. The sweep is not stopped when the average count k equals the number N set for Avg/Hold Num is reached, but the number k stops incrementing. A measurement average usually applies to all traces, marker results, and numeric results. But sometimes it only applies to the numeric results.

If the analyzer is in Single measurement, pressing the Cont key does not change k and does not cause the sweep to be reset; the only action is to put the analyzer into Continuous measurement operation.

If it is already in continuous sweep:

the INIT:CONT 1 command has no effect

the INIT:CONT 0 command will place the analyzer in Single Sweep but will have no effect on the current sequence until $k = N$, at which point the current sequence will stop and the instrument will go to the idle state.

11 Spectrum Emission Mask Measurement
File

File

See "File" on page 348

FREQ Channel

Accesses a menu of keys that allow you to control the Frequency and Channel parameters of the instrument.

Some features in the Frequency menu are the same for all measurements – they do not change as you change measurements. Settings like these are called “Meas Global” and are unaffected by Meas Preset. For example, the Center Freq setting is the same for all measurements – it does not change as you change measurements.

Key Path	Front-panel key
Initial S/W Revision	Prior to A.02.00

Center Freq

Sets the frequency that corresponds to the horizontal center of the graticule (when frequency Scale Type is set to linear). While adjusting the Center Frequency the Span is held constant, which means that both Start Frequency and Stop Frequency will change.

Pressing Center Freq also sets the frequency entry mode to Center/Span. In Center/Span mode, the center frequency and span values are displayed below the graticule, and the default active function in the Frequency menu is Center Freq.

The center frequency setting is the same for all measurements within a mode, that is, it is Meas Global. Some modes are also able to share a Mode Global center frequency value. If this is the case, the Mode will have a Global Settings key in its Mode Setup menu.

The Center Freq function sets (and queries) the Center Frequency for the currently selected input. If your analyzer has multiple inputs, and you select another input, the Center Freq changes to the value for that input. SCPI commands are available to directly set the Center Freq for a specific input.

Center Freq is remembered as you go from input to input. Thus you can set a Center Freq of 10 GHz with the RF Input selected, change to BBIQ and set a Center Freq of 20 MHz, then switch to External Mixing and set a Center Freq of 60 GHz, and when you go back to the RF Input the Center Freq will go back to 10 GHz; back to BBIQ and it is 20 MHz; back to External Mixing and it is 60 GHz.

See ["RF Center Freq" on page 1026](#)

See [Ext Mix Center Freq](#)

See ["I/Q Center Freq" on page 1028](#)

See ["Center Frequency Presets" on page 1024](#)

Key Path	FREQ Channel
Scope	Meas Global
Remote Command	[:SENSe] :FREQuency :CENTer <freq> [:SENSe] :FREQuency :CENTer?

Example	FREQ:CENT 50 MHz FREQ:CENT UP changes the center frequency to 150 MHz if you use FREQ:CENT:STEP 100 MHz to set the center frequency step size to 100 MHz FREQ:CENT?
Notes	This command sets either the RF or I/Q Center Frequency depending on the selected input. For RF input it is equivalent to FREQ:RF:CENT For I/Q input it is equivalent to FREQ:IQ:CENT Preset and Max values are dependent on Hardware Options (5xx) If no terminator (e.g. MHz) is sent the terminator Hz is used. If a terminator with unit other than Frequency is used, an invalid suffix error message is generated.
Dependencies	The Center Frequency can be limited by Start or Stop Freq limits, if the Span is so large that Start or Stop reach their limit.
Couplings	When operating in "swept span", any value of the Center Frequency or Span that is within the frequency range of the analyzer is allowed when the value is being set through the front panel numeric key pad or the SCPI command. The other parameter is forced to a different value if needed, to keep the Start and the Stop Frequencies within the analyzer's frequency range
Preset	Depends on instrument maximum frequency, mode, measurement, and selected input. See "Center Frequency Presets" on page 1024 and "RF Center Freq" on page 1026 and Ext Mix Center Freq and "I/Q Center Freq" on page 1028 .
State Saved	Saved in instrument state
Min	Depends on instrument maximum frequency, mode, measurement, and selected input.. See "Center Frequency Presets" on page 1024 and "RF Center Freq" on page 1026 and "I/Q Center Freq" on page 1028 .
Max	Depends on instrument maximum frequency, mode, measurement, and selected input.. See "Center Frequency Presets" on page 1024 and "RF Center Freq" on page 1026 and "I/Q Center Freq" on page 1028 .
Default Unit	Hz
Status Bits/OPC	Non-overlapped
Dependencies	
Initial S/W Revision	Prior to A.02.00

Center Frequency Presets

The following table provides the Center Frequency Presets for the Spectrum Analyzer mode, and the Max Freq, for the various frequency options:

Freq Option	CF after Mode Preset	Stop Freq after Mode Preset	Max Freq (can't tune)

			above)
503 (all but N9000A)	1.805 GHz	3.6 GHz	3.7 GHz
503 (N9000A)	1.505 GHz	3.0 GHz	3.08 GHz
507 (all but N9000A)	3.505 GHz	7.0 GHz	7.1 GHz
507 (N9000A)	3.755 GHz	7.5 GHz	7.58 GHz
508 (all but N9038A)	1.805 GHz	3.6 GHz	8.5 GHz
508 (N9038A)	4.205 GHz	8.4 GHz	8.5 GHz
513	6.805 GHz	13.6 GHz	13.8 GHz
526 (all but N9000A and N9038A)	13.255 GHz	26.5 GHz	27.0 GHz
526 (N9000A)	13.255 GHz	26.5 GHz	26.55 GHz
526 (N9038A)	1.805 GHz	3.6 GHz	27.0 GHz
532	16.005 GHz	32.0 GHz	32.5 GHz
543	21.505 GHz	43.0 GHz	TBD
544	22.005 GHz	44.0 GHz	44.5 GHz
550	25.005 GHz	50.0 GHz	51 GHz

Input 2:

Model	CF after Mode Preset	Stop Freq after Mode Preset	Max Freq (can't tune above)
N9000A opt C75	0.7505GHz	1.5 GHz	1.58 GHz
N9038A	505 MHz	1 GHz	1.000025 GHz

Tracking Generator Frequency Limits (N9000A only):

Tracking Generator Option	Min Freq (clips to this freq when turn TG on and	If above this Freq, Stop Freq clipped to this Freq when	Max Freq (can't tune above) while TG

	can't tune below while TG on)	TG turned on	on
T03	9 kHz	3.0 GHz	3.08 GHz
T06	9 kHz	6.0 GHz	6.05 GHz

The following table shows the Center Frequency Presets for modes other than Spectrum Analyzer:

Mode	CF Preset for RF
WCDMA	1 GHz
WIMAXOFDMA,	1 GHz
BASIC	1 GHz
ADEMOD	1 GHz
VSA	1 GHz
TDSCDMA	1 GHz
PNOISE	1 GHz
LTE	1 GHz
LTETDD	1 GHz
MSR	1 GHz
GSM	935.2 MHz
NFIGURE	1.505 GHz

RF Center Freq

SCPI command for specifying the RF Center Frequency. This command will set the Center Frequency to be used when the RF input is selected, even if the RF input is not the input that is selected at the time the command is sent. Note that the Center Freq function in the Frequency menu on the front panel always applies to the currently selected input.

Scope	Meas Global
Remote Command	[:SENSe] :FREQuency:RF:CENTer <freq> [:SENSe] :FREQuency:RF:CENTer?
Example	FREQ:RF:CENT 30 MHz
Notes	This command is the same in all modes, but the parameter is Measurement Global. So the value is independent in each mode and common across all the measurements in the mode.
Dependencies	If the electronic/soft attenuator is enabled, any attempt to set Center Frequency such that the Stop Frequency would be >3.6 GHz fails and results in an advisory message. If the equivalent SCPI command is sent, this same message is generated as part of a “-221, Settings conflict” warning. If Source Mode is set to Tracking, and the Max or Min Center Freq is therefore limited by the limits of the source, a warning message is generated, “Data out of range;clipped to source max/min” if these limits are exceeded. Note that for an external source, these limits can be affected by the settings of

	Source Numerator, Source Denominator and Power Sweep.
Preset	See table above
State Saved	Saved in instrument state.
Min	-79.999995 MHz, unless Source Mode is set to Tracking, in which case it is limited by the minimum frequency of the Source
Max	See table above. Basically instrument maximum frequency - 5 Hz. Note that, if the Source Mode is set to Tracking, the effective instrument maximum frequency may be limited by the source maximum frequency. If the knob or step keys are being used, also depends on the value of the other three interdependent parameters Span, Start Frequency and Stop Frequency
Initial S/W Revision	Prior to A.02.00
Modified at S/W Revision	A.03.00

Ext Mix Center Freq

SCPI command for specifying the External Mixer Center Frequency. This command will set the Center Frequency to be used when the External Mixer is selected, even if the External Mixer input is not the input which is selected at the time the command is sent. Note that the Center Freq function in the Frequency menu on the front panel always applies to the currently selected input.

Scope	Meas Global
Remote Command	<code>[:SENSe] :FREQuency:EMIXer:CENTer <freq></code> <code>[:SENSe] :FREQuency:EMIXer:CENTer?</code>
Example	<code>:FREQ:EMIX:CENT 60 GHz</code> <code>:FREQ:EMIX:CENT?</code>
Notes	This command is the same in all modes, but the parameter is Measurement Global. So the value is independent in each mode and common across all the measurements in the mode.
Couplings	When returning to External Mixing after having been switched to one of the other inputs (e.g., RF), you will come back into the settings that you had when you left External Mixing. So you will come back to the band you were in with the Center Frequency that you had. However, Span is not an input-dependent parameter, therefore you will bring the span over from the other input. Therefore, the analyzer comes back with the span from the previous input, limited as necessary by the current mixer setup.
Preset	When a Mode Preset is performed while in External Mixing, the Start frequency of the current Mode is set to the nominal Min Freq of the lowest harmonic range in the Harmonic Table for the current mixer setup. Similarly, the Stop frequency of the current Mode is set to the nominal Max Freq of the highest harmonic range in the Harmonic Table. The Center Freq thus presets to the point arithmetically equidistant from these two frequencies. If the current measurement has a limited Span available to it, and cannot achieve the Span shown in the table ($\text{Span} = \text{Stop Freq} - \text{Start Freq}$), the analyzer uses the maximum Span the measurement allows, and still sets the Center Freq to the midpoint of the Start and Stop Freq values in the Harmonic Table.

	<p>When Restore Input/Output Defaults is performed, the mixer presets to the 11970A, whose Start and Stop frequencies are 26.5 and 40 GHz respectively. The center of these two frequencies is 33.25 GHz.</p> <p>Therefore, after a Restore Input/Output Defaults, if you go into External Mixing and do a Mode Preset while in the Spectrum Analyzer Mode, the resulting Center Freq is 33.25 GHz.</p>
State Saved	Saved in instrument state.
Min	The minimum frequency in the currently selected mixer band + 5 Hz
Max	The maximum frequency in the currently selected mixer band – 5 Hz If the knob or step keys are being used, also depends on the value of the other three interdependent parameters Span, Start Frequency and Stop Frequency
Initial S/W Revision	A.08.01

I/Q Center Freq

SCPI command for specifying the I/Q Center Frequency. This command will set the Center Frequency to be used when the I/Q input is selected, even if the I/Q input is not the input which is selected at the time the command is sent. Note that the Center Freq function in the Frequency menu on the front panel always applies to the currently selected input.

Scope	Meas Global
Remote Command	[:SENSe]:FREQuency:IQ:CENTer <freq> [:SENSe]:FREQuency:IQ:CENTer?
Example	FREQ:IQ:CENT: 30 MHz
Notes	This command is the same in all modes, but the parameter is Measurement Global. So the value is independent in each mode and common across all the measurements in the mode.
Preset	0 Hz
State Saved	Saved in instrument state.
Min	-40.049995 MHz
Max	40.049995 MHz
Initial S/W Revision	Prior to A.02.00

CF Step

Changes the step size for the center frequency and start and stop frequency functions. Once a step size has been selected and the center frequency function is active, the step keys (and the UP|DOWN parameters for Center Frequency from remote commands) change the center frequency by the step-size value. The step size function is useful for finding harmonics and sidebands beyond the current frequency span of the analyzer.

Note that the start and stop frequencies also step by the CF Step value.

Key Path	FREQ Channel
Remote Command	[:SENSe] :FREQuency:CENTer:STEP [:INCRement] <freq> [:SENSe] :FREQuency:CENTer:STEP [:INCRement] ? [:SENSe] :FREQuency:CENTer:STEP:AUTO OFF ON 0 1 [:SENSe] :FREQuency:CENTer:STEP:AUTO?
Example	FREQ:CENT:STEP:AUTO ON FREQ:CENT:STEP 500 MHz FREQ:CENT UP increases the current center frequency value by 500 MHz FREQ:CENT:STEP? FREQ:CENT:STEP:AUTO?
Notes	Preset and Max values are depending on Hardware Options (503, 507, 508, 513, 526)
Notes	Preset and Max values are dependent on Hardware Options (5xx)
Dependencies	Freq Offset is not available in External Mixing. In this case the Freq Offset key is grayed out and shows a value of zero. It will once again be available, and show the previously set value, when you return to the RF Input.
Dependencies	Span, RBW, Center frequency If the electronic/soft attenuator is enabled, any attempt to change the value of the center frequency >3.6 GHz by pressing the Up-arrow key, fails and results in an advisory message. If the equivalent SCPI command is sent, this same message is generated as part of a “-221, Settings conflict” warning.
Couplings	When auto-coupled in a non-zero span, the center frequency step size is set to 10% of the span. When auto-coupled in zero span, the center frequency step size is set to the equivalent -3 dB RBW value.
Preset	Auto ADEMOD: 1 MHz ON
State Saved	Saved in instrument state
Min	– (the maximum frequency of the instrument). That is, 27 GHz max freq instrument has a CF step range of +/- 27 GHz. Note that this is the maximum frequency given the current settings of the instrument, so in External Mixing, for example, it is the maximum frequency of the current mixer band.
Max	The maximum frequency of the instrument. That is, 27 GHz max freq instrument has a CF step range of +/- 27 GHz. Note that this is the maximum frequency given the current settings of the instrument, so in External Mixing, for example, it is the maximum frequency of the current mixer band.
Default Unit	Hz
Status Bits/OPC dependencies	non-overlapped
Initial S/W Revision	Prior to A.02.00
Modified at S/W Revision	A.03.00

11 Spectrum Emission Mask Measurement
Input/Output

Input/Output

See "[Input/Output](#)" on page 194

Marker

Accesses a menu that enables you to select, set up and control the markers for the current measurement. If there are no active markers, Marker selects marker 1, sets it to Normal and places it at the center of the display. You can turn on and control up to 12 markers.

Key Path	Front-panel key
Initial S/W Revision	Prior to A.02.00

Select Marker

Displays 12 markers available for selection.

Key Path	Marker
Initial S/W Revision	Prior to A.02.00

Marker Type

Sets the marker control mode to Normal and Off. If the selected marker is Off, pressing Marker sets it to Normal and places it at the center of the screen on the trace determined by the Marker Trace rules. At the same time, Marker X Axis Value appears on the Active Function area. The marker X axis value entered in the active function area will display the marker value to its full entered precision. If the current control mode for the measurement is Off, there is no active function and the active function is turned off.

Key Path	Marker
Mode	SA, WCDMA, C2K, WIMAX OFDMA, TD-SCDMA, 1xEVDO, DTMB (CTTB), DVB-T/H, ISDB-T, CMMB, LTE, LTE-TDD, Digital Cable TV, WLAN, MSR, LTEAFDD, LTEATDD
Remote Command	:CALCulate:SEMask:MARKer[1] 2 ... 12:MODE POSition OFF :CALCulate:SEMask:MARKer[1] 2 ... 12:MODE?
Example	CALC:SEM:MARK:MODE POS CALC:SEM:MARK:MODE?
Notes	If the selected marker is Off, pressing Marker sets it to Normal and places it at the center of the screen on the trace determined by the Marker Trace rules. At the same time, Marker X Axis Value appears on the Active Function area. Default Active Function: the active function for the selected marker's current control mode. Note that if the current control mode is Off, there is no active function and the active function is turned off. Active Function Display: the marker X axis value entered in the active function area will display the marker value to its full entered precision.
Preset	OFF OFF OFF OFF OFF OFF OFF OFF OFF OFF OFF OFF
State Saved	Saved in instrument state
Range	Normal Off
Initial S/W Revision	Prior to A.02.00
Modified at S/W Revision	A.02.00, A.03.00

Couple Markers

When this function is true, moving any marker causes an equal X Axis movement of every other marker that is not Off. By “equal X Axis movement” we mean that we preserve the difference between each marker’s X Axis value (in the fundamental x-axis units of the trace that marker is on) and the X Axis value of the marker being moved (in the same fundamental x-axis units).

Key Path	Marker
Mode	SA, WCDMA, C2K, WIMAX OFDMA, TD-SCDMA, 1xEVDO, DTMB (CTTB), DVB-T/H, ISDB-T, CMMB, LTE, LTETDD, Digital Cable TV, WLAN, MSR, LTEAFDD, LTEATDD
Remote Command	:CALCulate:SEMask:MARKer:COUPle[:STATe] ON OFF 1 0 :CALCulate:SEMask:MARKer:COUPle[:STATe]?
Example	CALC:SEM:MARK:COUP ON CALC:SEM:MARK:COUP?
Preset	OFF
State Saved	Saved in instrument state
Range	On Off
Initial S/W Revision	Prior to A.02.00
Modified at S/W Revision	A.02.00, A.03.00

All Markers Off

Turns all active markers off in all views.

Key Path	Marker
Mode	SA, WCDMA, C2K, WIMAX OFDMA, TD-SCDMA, 1xEVDO, DTMB (CTTB), DVB-T/H, ISDB-T, CMMB, LTE, LTETDD, Digital Cable TV, WLAN, MSR, LTEAFDD, LTEATDD
Remote Command	:CALCulate:SEMask:MARKer:AOFF
Example	CALC:SEM:MARK:AOFF
Initial S/W Revision	Prior to A.02.00
Modified at S/W Revision	A.02.00, A.03.00

Marker X Axis Value (Remote Command Only)

Sets the marker X Axis value in the current marker X Axis Scale unit. It has no effect if the control mode is Off, but is the SCPI equivalent of entering an X value if the control mode is Normal.

Mode	SA, WCDMA, C2K, WIMAX OFDMA, TD-SCDMA, 1xEVDO, DTMB (CTTB), DVB-T/H ISDB-T, CMMB, LTE, LTETDD, Digital Cable TV, WLAN, MSR, LTEAFDD, LTEATDD
Remote Command	:CALCulate:SEMask:MARKer[1] 2 ... 12:X <freq>

	:CALCulate:SEMask:MARKer[1] 2 ... 12:X?
Example	CALC:SEM:MARK3:X 1.0 GHz CALC:SEM:MARK3:X?
Notes	<p>If no suffix is sent it will use the fundamental units for the current marker X Axis Scale. If a suffix is sent that does not match the current marker X Axis Scale unit, an error "Invalid suffix" will be generated.</p> <p>The query returns the marker's absolute X Axis value if the control mode is Normal. The query is returned in the fundamental units for the current marker X Axis scale. If the marker is Off the response is not a number.</p> <p>When a Marker is turned on, it is placed center of the screen on the trace. Therefore the default value depends on instrument condition, although the Preset/Default is defined as 1.5 GHz.</p>
Preset	After a preset, , all Markers are turned OFF, , so a Marker X Axis Value query will return a not a number (NAN).
State Saved	No
Min	-9.9E+37
Max	9.9E+37
Initial S/W Revision	Prior to A.02.00
Modified at S/W Revision	A.02.00, A.03.00

Marker X Axis Position (Remote Command Only)

Sets the marker X position in trace points. It has no effect if the control mode is Off, but is the SCPI equivalent of entering a value if the control mode is Normal, except in trace points rather than X Axis Scale units. The entered value is immediately translated into the current X Axis Scale units for setting the value of the marker.

Mode	SA, WCDMA, C2K, WIMAX OFDMA, TD-SCDMA, 1xEVDO, DTMB (CTTB), DVB-T/H, ISDB-T, CMMB, LTE, LTETDD, Digital Cable TV, WLAN, MSR, LTEAFDD, LTEATDD
Remote Command	:CALCulate:SEMask:MARKer[1] 2 ... 12:X:POsition <real> :CALCulate:SEMask:MARKer[1] 2 ... 12:X:POsition?
Example	CALC:SEM:MARK10:X:POS 1001 CALC:SEM:MARK10:X:POS?
Notes	<p>The query returns the marker's absolute X Axis value in trace points if the control mode is Normal. The value is returned as a real number, not an integer, corresponding to the translation from X Axis Scale units to trace points . If the marker is Off the response is not a number.</p> <p>When a Marker is turned on, it is placed center of the screen on the trace. Therefore the default value depends on the instrument condition although the Preset/Default is defined as 6507 (this value might be the expected value when all the offsets are on).</p>
Preset	After a preset, , all Markers are turned OFF, , so a Marker X Axis Value query will return a not a number (NAN).
State Saved	No

Min	-9.9E+37
Max	9.9E+37
Initial S/W Revision	Prior to A.02.00
Modified at S/W Revision	A.02.00, A.03.00

Marker Y Axis Value (Remote Command Only)

Returns the marker Y Axis value in the current marker Y Axis unit.

Mode	SA, WCDMA, C2K, WIMAX OFDMA, TD-SCDMA, 1xEVDO, DTMB (CTTB), DVB-T/H, ISDB-T, CMMB, LTE, LTETDD, Digital Cable TV, WLAN, MSR, LTEAFDD, LTEATDD
Remote Command	:CALCulate:SEMask:MARKer[1] 2 ... 12:Y?
Example	CALC:SEM:MARK11:Y 10 dBm CALC:SEM:MARK11:Y?
Notes	Since the result value is always calculated from acquisition data, the default value is arbitrary, although the Preset/Default values is defined.
Preset	Result dependent on markers setup and signal source
State Saved	No
Backwards Compatibility SCPI	:CALCulate:SEMask:MARKer[1] 2 ... 12:FUNction:RESult?
Initial S/W Revision	Prior to A.02.00
Modified at S/W Revision	A.02.00, A.03.00

Marker Function

There are no 'Marker Functions' supported in Spectrum Emission Mask so this front-panel key displays a blank menu when pressed.

Key Path	Front-panel key
Initial S/W Revision	Prior to A.02.00

Marker To

There is no 'Marker To' functionality supported in Spectrum Emission Mask so this front-panel key displays a blank menu when pressed.

Key Path	Front-panel key
Initial S/W Revision	Prior to A.02.00

Meas

The information in this section is common to all measurements. For key and remote command information for a specific measurement, refer to the section that describes the measurement of interest.

Measurements available under the Meas key are specific to the current Mode.

When viewing Help for measurements, note the following:

NOTE

Operation for some keys differs between measurements. The information displayed in Help pertains to the current measurement. To see how a key operates in a different measurement, exit Help (press the Cancel Esc key), select the measurement, then reenter Help (press the Help key) and press that key.

Key Path	Front-panel key
Initial S/W Revision	Prior to A.02.00

Remote Measurement Functions

This section contains the following topics:

"Measurement Group of Commands" on page 2214

"Current Measurement Query (Remote Command Only)" on page 2216

"Limit Test Current Results (Remote Command Only)" on page 2216

"Data Query (Remote Command Only)" on page 2216

"Calculate/Compress Trace Data Query (Remote Command Only)" on page 2217

"Calculate Peaks of Trace Data (Remote Command Only)" on page 2222

"Hardware-Accelerated Fast Power Measurement (Remote Command Only)" on page 2223

"Format Data: Numeric Data (Remote Command Only)" on page 2237

"Format Data: Byte Order (Remote Command Only)" on page 2238

Initial S/W Revision	Prior to A.02.00
----------------------	------------------

Measurement Group of Commands

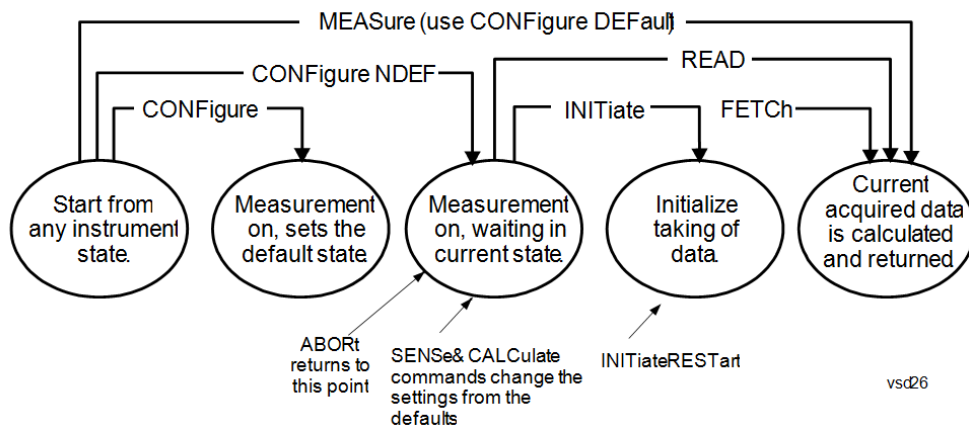

Measure Commands:

:MEASure:<measurement>[n]?

This is a fast single-command way to make a measurement using the factory default instrument settings. These are the settings and units that conform to the Mode Setup settings (e.g. radio standard) that you have currently selected.

- Stops the current measurement (if any) and sets up the instrument for the specified measurement using the factory defaults
- Initiates the data acquisition for the measurement
- Blocks other SCPI communication, waiting until the measurement is complete before returning results.
- If the function does averaging, it is turned on and the number of averages is set to 10.
- After the data is valid it returns the scalar results, or the trace data, for the specified measurement. The type of data returned may be defined by an [n] value that is sent with the command.
- The scalar measurement results will be returned if the optional [n] value is not included, or is set to 1. If the [n] value is set to a value other than 1, the selected trace data results will be returned. See each command for details of what types of scalar results or trace data results are available.
- ASCII is the default format for the data output. (Older versions of Spectrum Analysis and Phase Noise mode measurements only use ASCII.) The binary data formats should be used for handling large blocks of data since they are smaller and faster than the ASCII format. Refer to the FORMat:DATA command for more information.

If you need to change some of the measurement parameters from the factory default settings you can set up the measurement with the CONFIgure command. Use the commands in the SENSe:<measurement> and CALCulate:<measurement> subsystems to change the settings. Then you can use the READ? command to initiate the measurement and query the results.

If you need to repeatedly make a given measurement with settings other than the factory defaults, you can use the commands in the SENSe:<measurement> and CALCulate:<measurement> subsystems to set up the measurement. Then use the READ? command to initiate the measurement and query results.

Measurement settings persist if you initiate a different measurement and then return to a previous one. Use READ:<measurement>? if you want to use those persistent settings. If you want to go back to the default settings, use MEASure:<measurement>?.

Configure Commands:

:CONFIgure:<measurement>

This command stops the current measurement (if any) and sets up the instrument for the specified measurement using

the factory default instrument settings. It does not initiate the taking of measurement data unless INIT:CONTinuous is ON. If you change any measurement settings after using the CONFigure command, the READ command can be used to initiate a measurement without changing the settings back to their defaults.

In the Swept SA measurement in Spectrum Analyzer mode the CONFigure command also turns the averaging function on and sets the number of averages to 10 for all measurements.

:CONFigure: <measurement>: NDEFault stops the current measurement and changes to the specified measurement. It does not change the settings to the defaults. It does not initiate the taking of measurement data unless INIT:CONTinuous is ON.

The CONFigure? query returns the current measurement name.

The CONFigure:CATalog? query returns a quoted string of all licensed measurement names in the current mode. For example, "SAN, CHP, OBW, ACP, PST, TXP, SPUR, SEM, LIST".

Fetch Commands:

:FETCh:<measurement>[n]?

This command puts selected data from the most recent measurement into the output buffer. Use FETCh if you have already made a good measurement and you want to return several types of data (different [n] values, for example, both scalars and trace data) from a single measurement. FETCh saves you the time of re-making the measurement. You can only FETCh results from the measurement that is currently active, it will not change to a different measurement. An error message is reported if a measurement other than the current one is specified.

If you need to get new measurement data, use the READ command, which is equivalent to an INITiate followed by a FETCh.

The scalar measurement results will be returned if the optional [n] value is not included, or is set to 1. If the [n] value is set to a value other than 1, the selected trace data results will be returned. See each command for details of what types of scalar results or trace data results are available. The binary data formats should be used for handling large blocks of data since they are smaller and transfer faster than the ASCII format. (FORMat:DATA)

FETCh may be used to return results other than those specified with the original READ or MEASure command that you sent.

INITiate Commands:

:INITiate:<measurement>

This command is not available for measurements in all the instrument modes:

- Initiates a trigger cycle for the specified measurement, but does not output any data. You must then use the FETCh<meas> command to return data. If a measurement other than the current one is specified, the instrument will switch to that measurement and then initiate it.
 - For example, suppose you have previously initiated the ACP measurement, but now you are running the channel power measurement. If you send INIT:ACP? it will change from channel power to ACP and will initiate an ACP measurement.
 - Does not change any of the measurement settings. For example, if you have previously started the ACP measurement and you send INIT:ACP? it will initiate a new ACP measurement using the same instrument settings as the last time ACP was run.
 - If your selected measurement is currently active (in the idle state) it triggers the measurement, assuming the trigger conditions are met. Then it completes one trigger cycle. Depending upon the measurement and the number of averages, there may be multiple data acquisitions, with multiple trigger events, for one full trigger cycle. It also holds off additional commands on GPIB until the acquisition is complete.
-

READ Commands:

:READ:<measurement>[n]?

- Does not preset the measurement to the factory default settings. For example, if you have previously initiated the ACP
-

measurement and you send READ:ACP? it will initiate a new measurement using the same instrument settings.

- Initiates the measurement and puts valid data into the output buffer. If a measurement other than the current one is specified, the instrument will switch to that measurement before it initiates the measurement and returns results.
 - For example, suppose you have previously initiated the ACP measurement, but now you are running the channel power measurement. Then you send READ:ACP? It will change from channel power back to ACP and, using the previous ACP settings, will initiate the measurement and return results.
 - Blocks other SCPI communication, waiting until the measurement is complete before returning the results
 - If the optional [n] value is not included, or is set to 1, the scalar measurement results will be returned. If the [n] value is set to a value other than 1, the selected trace data results will be returned. See each command for details of what types of scalar results or trace data results are available. The binary data formats should be used when handling large blocks of data since they are smaller and faster than the ASCII format. (FORMat:DATA)
-

Initial S/W Revision	Prior to A.02.00
----------------------	------------------

Current Measurement Query (Remote Command Only)

This command returns the name of the measurement that is currently running.

Remote Command	:CONFigure?
-----------------------	-------------

Example	CONF?
----------------	-------

Initial S/W Revision	Prior to A.02.00
----------------------	------------------

Limit Test Current Results (Remote Command Only)

Queries the status of the current measurement limit testing. It returns a 0 if the measured results pass when compared with the current limits. It returns a 1 if the measured results fail any limit tests.

Remote Command	:CALCulate:CLIMits:FAIL?
-----------------------	--------------------------

Example	CALC:CLIM:FAIL? queries the current measurement to see if it fails the defined limits. Returns a 0 or 1: 0 it passes, 1 it fails.
----------------	--

Initial S/W Revision	Prior to A.02.00
----------------------	------------------

Data Query (Remote Command Only)

Returns the designated measurement data for the currently selected measurement and subopcode.

n = any valid subopcode for the current measurement. See the measurement command results table for your current measurement, for information about what data is returned for the subopcodes.

This command uses the data setting specified by the FORMat:BOReDer and FORMat:DATA commands and can return real or ASCII data. (See the format command descriptions under Input/Output in the Analyzer Setup section.)

Remote Command	:CALCulate:DATA[n]?
Notes	The return trace depends on the measurement. In CALCulate:<meas>:DATA[n], n is any valid subopcode for the current measurement. It returns the same data as the FETCH:<measurement>? query where <measurement> is the current measurement.
Initial S/W Revision	Prior to A.02.00

Calculate/Compress Trace Data Query (Remote Command Only)

Returns compressed data for the currently selected measurement and sub-opcode [n].

n = any valid sub-opcode for that measurement. See the MEASure:<measurement>? command description of your specific measurement for information on the data that can be returned.

The data is returned in the current Y Axis Unit of the analyzer. The command is used with a sub-opcode <n> (default=1) to specify the trace. With trace queries, it is best if the analyzer is not sweeping during the query. Therefore, it is generally advisable to be in Single Sweep, or Update=Off.

This command is used to compress or decimate a long trace to extract and return only the desired data. A typical example would be to acquire N frames of GSM data and return the mean power of the first burst in each frame. The command can also be used to identify the best curve fit for the data.

Remote Command	:CALCulate:DATA<n>:COMPRESS? BLOCK CFIT MAXimum MINimum MEAN DMEan RMS RMSCubed SAMPLE SDEVIation PPHase [,<soffset> [,<length>[,<roffset>[,<rlimit>]]]]
Example	To query the mean power of a set of GSM bursts: Supply a signal that is a set of GSM bursts. Select the IQ Waveform measurement (in IQ Analyzer Mode). Set the sweep time to acquire at least one burst. Set the triggers such that acquisition happens at a known position relative to a burst. Then query the mean burst levels using, CALC:DATA2:COMP? MEAN, 24e-6, 526e-6 (These parameter values correspond to GSM signals, where 526e-6 is the length of the burst in the slot and you just want 1 burst.)
Notes	The command supports 5 parameters. Note that the last 4 (<soffset>, <length>, <roffset>, <rlimit>) are optional. But these optional parameters must be entered in the specified order. For example, if you want to specify <length>, then you must also specify <soffset>. See details below for a definition of each of these parameters. This command uses the data in the format specified by FORMat:DATA, returning either binary or ASCII data.
Initial S/W Revision	Prior to A.02.00

- BLOCK or block data - returns all the data points from the region of the trace data that you specify. For example, it could be used to return the data points of an input signal over several timeslots, excluding the portions of the trace data that you do not want. (This is x,y pairs for trace data and I,Q pairs for complex data.)

- CFIT or curve fit - applies curve fitting routines to the data. <soffset> and <length> are required to define the data that you want. <roffset> is an optional parameter for the desired order of the curve equation. The query will return the following values: the x-offset (in seconds) and the curve coefficients ((order + 1) values).

MIN, MAX, MEAN, DME, RMS, RMSC, SAMP, SDEV and PPH return one data value for each specified region (or <length>) of trace data, for as many regions as possible until you run out of trace data (using <roffset> to specify regions). Or they return the number of regions you specify (using <rlimit>) ignoring any data beyond that.

- MINimum - returns the minimum data point (y value) for the specified region(s) of trace data. For I/Q trace data, the minimum magnitude of the I/Q pairs is returned.
- MAXimum - returns the maximum data point (y value) for the specified region(s) of trace data. For I/Q trace data, the maximum magnitude of the I/Q pairs is returned.
- MEAN - returns a single value that is the arithmetic mean of the data point values (in dB/ dBm) for the specified region(s) of trace data. For I/Q trace data, the mean of the magnitudes of the I/Q pairs is returned. See the following equations.

•

NOTE

If the original trace data is in dB, this function returns the arithmetic mean of those log values, not log of the mean power which is a more useful value. The mean of the log is the better measurement technique when measuring CW signals in the presence of noise. The mean of the power, expressed in dB, is useful in power measurements such as Channel Power. To achieve the mean of the power, use the RMS option.

Equation 1

Mean Value of Data Points for Specified Region(s)

$$MEAN = \frac{1}{n} \sum_{X_i \in \text{region}(s)} X_i$$

where X_i is a data point value, and n is the number of data points in the specified region(s).

Equation 2

Mean Value of I/Q Data Pairs for Specified Region(s)

$$MEAN = \frac{1}{n} \sum_{X_i \in \text{region}(s)} |X_i|$$

where $|X_i|$ is the magnitude of an I/Q pair, and n is the number of I/Q pairs in the specified region(s).

- DMEan - returns a single value that is the mean power (in dB/ dBm) of the data point values for the specified region(s) of trace data. See the following equation:

Equation 3

DMEan Value of Data Points for Specified Region(s)

$$\text{DME} = 10 \times \log_{10} \left(\frac{1}{n} \sum_{X_i \in \text{region}(s)} 10^{\frac{X_i}{10}} \right)$$

- RMS - returns a single value that is the average power on a root-mean-squared voltage scale (arithmetic rms) of the data point values for the specified region(s) of trace data. See the following equation.

NOTE

For I/Q trace data, the rms of the magnitudes of the I/Q pairs is returned. See the following equation. This function is very useful for I/Q trace data. However, if the original trace data is in dB, this function returns the rms of the log values which is not usually needed.

Equation 4

RMS Value of Data Points for Specified Region(s)

$$\text{RMS} = \sqrt{\frac{1}{n} \sum_{X_i \in \text{region}(s)} X_i^2}$$

where X_i is a data point value, and n is the number of data points in the specified region(s).

Equation 5

RMS Value of I/Q Data Pairs for Specified Region(s)

$$\text{RMS} = \sqrt{\frac{1}{n} \sum_{X_i \in \text{region}(s)} X_i X_i^*}$$

where X_i is the complex value representation of an I/Q pair, X_i^* its conjugate complex number, and n is the number of I/Q pairs in the specified region(s).

Once you have the rms value for a region of trace data (linear or I/Q), you may want to calculate the mean power. You must convert this rms value (peak volts) to power in dBm:

$$10 \times \log[10 \times (\text{rms value})^2]$$

- SAMPLe - returns the first data value (x,y pair) for the specified region(s) of trace data. For I/Q trace data, the first I/Q pair is returned.
- SDEViation - returns a single value that is the arithmetic standard deviation for the data point values for the specified region(s) of trace data. See the following equation.
- For I/Q trace data, the standard deviation of the magnitudes of the I/Q pairs is returned. See the following equation.

Equation 6

Standard Deviation of Data Point Values for Specified Region(s)

$$\text{SDEV} = \sqrt{\frac{1}{n} \sum_{X_i \in \text{region}(s)} (X_i - \bar{X})^2}$$

where X_i is a data point value, \bar{X} is the arithmetic mean of the data point values for the specified region (s), and n is the number of data points in the specified region(s).

$$\text{SDEV} = \sqrt{\frac{1}{n} \sum_{X_i \in \text{region}(s)} (|X_i| - \bar{X})^2}$$

where $|X_i|$ is the magnitude of an I/Q pair, \bar{X} is the mean of the magnitudes for the specified region(s), and n is the number of data points in the specified region(s).

- PPHase - returns the x,y pairs of both rms power (dBm) and arithmetic mean phase (radian) for every specified region and frequency offset (Hz). The number of pairs is defined by the specified number of regions. This parameter can be used for I/Q vector ($n=0$) in Waveform (time domain) measurement and all parameters are specified by data point in PPHase.

The rms power of the specified region may be expressed as:

$$\text{Power} = 10 \times \log [10 \times (\text{RMS I/Q value})] + 10.$$

The RMS I/Q value (peak volts) is:

$$\sqrt{\frac{1}{n} \sum_{X_i \in \text{region}} X_i X_i^*}$$

where X_i is the complex value representation of an I/Q pair, X_i^* its conjugate complex number, and n is the number of I/Q pairs in the specified region.

The arithmetic mean phase of the specified region may be expressed as:

$$\frac{1}{n} \sum_{Y_i \in \text{region}} Y_i$$

where Y_i is the unwrapped phase of I/Q pair with applying frequency correction and n is the number of I/Q pairs in the specified region.

The frequency correction is made by the frequency offset calculated by the arithmetic mean of every specified region's frequency offset. Each frequency offset is calculated by the least square method against the unwrapped phase of I/Q pair.

Sample Trace Data - Constant Envelope

(See below for explanation of variables.)

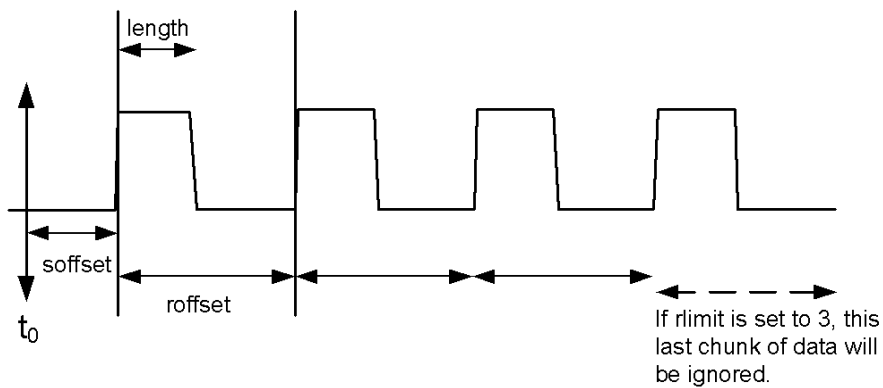

Sample Trace Data - Not Constant Envelope

(See below for explanation of variables.)



<soffset> - start offset is an optional real number. (It is in seconds for time-domain traces, and is a dimensionless index 0 to Npoints - 1, for frequency-domain traces). It specifies the amount of data at the beginning of the trace that will be ignored before the decimation process starts. It is the time or frequency change from the start of the trace to the point where you want to start using the data. The default value is zero.

<length> - is an optional real number. (It is in seconds for time-domain traces, and is a dimensionless index 0 to Npoints - 1, for frequency-domain traces). It defines how much data will be compressed into one value. This parameter has a default value equal to the current trace length.

<roffset> - repeat offset is an optional real number. (It is in seconds for time-domain traces, and is a dimensionless index 0 to Npoints - 1, for frequency-domain traces). It defines the beginning of the next field of trace elements to be compressed. This is relative to the beginning of the previous field. This parameter has a default value equal to the <length> variable. Note that this parameter is used for a completely different purpose when curve fitting (see CFIT above).

<rlimit> - repeat limit is an optional integer. It specifies the number of data items that you want returned. It will ignore any additional items beyond that number. You can use the Start offset and the Repeat limit to pick out exactly what part of the data you want to use. The default value is all the data.

Calculate Peaks of Trace Data (Remote Command Only)

Returns a list of all the peaks for the currently selected measurement and sub-opcode [n]. The peaks must meet the requirements of the peak threshold and excursion values.

n = any valid sub-opcode for the current measurement. See the MEASure:<measurement> command description of your specific measurement for information on the data that can be returned.

The command can only be used with specific sub-opcodes with measurement results that are trace data. Both real and complex traces can be searched, but complex traces are converted to magnitude in dBm. In many measurements the sub-opcode n=0, is the raw trace data which cannot be searched for peaks. And Sub-opcode n=1, is often calculated results values which also cannot be searched for peaks.

This command uses the data setting specified by the FORMat:BORDER and FORMat:DATA commands and can return real or ASCII data. If the format is set to INT,32, it returns REAL,32 data.

The command has four types of parameters:

- Threshold (in dBm)
- Excursion (in dB)
- Sorting order (amplitude, frequency, time)
- Optional in some measurements: Display line use (all, > display line, < display line)

Remote Command	<p>For Swept SA measurement:</p> <pre>:CALCulate:DATA[1] 2 ... 6:PEAKs? <threshold>,<excursion>[,AMPLitude FREQuency TIME[,ALL GTDLine LTDLine]]</pre> <p>For most other measurements:</p> <pre>:CALCulate:DATA[1] 2 ... 6:PEAKs? <threshold>,<excursion>[,AMPLitude FREQuency TIME]</pre>
-----------------------	--

Example	<p>Example for Swept SA measurement in Spectrum Analyzer Mode:</p> <p>CALC:DATA4:PEAK? -40, 10, FREQ, GTDL This will identify the peaks of trace 4 that are above -40 dBm, with excursions of at least 10 dB. The peaks are returned in order of increasing frequency, starting with the lowest frequency. Only the peaks that are above the display line are returned.</p> <p>Query Results 1:</p> <p>With FORMat:DATA REAL, 32 selected, it returns a list of floating-point numbers. The first value in the list is the number of peak points that are in the following list. A peak point consists of two values: a peak amplitude followed by its corresponding frequency (or time).</p> <p>If no peaks are found the peak list will consist of only the number of peaks, (0).</p>
----------------	---

Notes	<p><n> - is the trace that will be used</p> <p><threshold> - is the level below which trace data peaks are ignored. Note that the threshold value is required and is always used as a peak criterion. To effectively disable the threshold criterion for this command, provide a substantially low threshold value such as -200 dBm. Also note that the threshold value used in this command is independent of and has no effect on the threshold value stored under the Peak Criteria menu.</p> <p><excursion> - is the minimum amplitude variation (rise and fall) required for a signal to be identified as peak. Note that the excursion value is required and is always used as a peak criterion. To effectively disable the excursion criterion for this command, provide the minimum value of 0.0 dB. Also note that the excursion value used in this command is independent of and has no effect on the</p>
--------------	---

excursion value stored under the Peak Criteria menu.

Values must be provided for threshold and excursion. The sorting and display line parameters are optional (defaults are AMPLitude and ALL).

Note that there is always a Y-axis value for the display line, regardless of whether the display line state is on or off. It is the current Y-axis value of the display line which is used by this command to determine whether a peak should be reported

Sorting order:

AMPLitude - lists the peaks in order of descending amplitude, with the highest peak first (default if optional parameter not sent)

FREQUENCY - lists the peaks in order of occurrence, left to right across the x-axis.

TIME - lists the peaks in order of occurrence, left to right across the x-axis.

Peaks vs. Display Line:

ALL - lists all of the peaks found (default if optional parameter not sent).

GTDLine (greater than display line) - lists all of the peaks found above the display line.

LTDLine (less than display line) - lists all of the peaks found below the display line.

Initial S/W Revision	Prior to A.02.00
----------------------	------------------

Hardware-Accelerated Fast Power Measurement (Remote Command Only)

The Fast Power option (FP2) enables very fast channel power measurements for instruments with the prerequisite hardware (DP2 and/or B40). It accomplishes this by performing real-time overlapped FFTs at the hardware layer, using software for basic post-processing before returning the result to the user. The upshot of this approach is improved throughput for user applications that require many sequential power measurements.

The analysis bandwidth of FP2 is limited by the licenses in the instrument, but its maximum overall analysis bandwidth per acquisition is 40 MHz.

FP2 is remote-only, which means the instrument does not switch to any particular mode or measurement. FP2 commands can be sent while another application is in use on the front panel.

Each Fast Power measurement can be predefined using an array index, and up to 1,000 measurements can be stored. In the following documentation, instances of [1,2,...,999] can be substituted with a particular measurement index, e.g. CALC:FPOW:POW1?, CALC:FPOW:POW2?, CALC:FPOW:POW134?. In this way, power measurements can be defined one time in a batch, and then executed multiple times without having to redefine them, similar to “list mode” on other measurements.

In addition to basic channel power measurements, there are a number of other measurement “functions” for each channel, including peak power, peak frequency, and power spectral density. See the Function parameter for more information.

Reset Fast Power Measurement (Remote Command Only)

Resets the measurement configuration to the defaults.

Mode	All
Remote Command	:CALCulate:FPOWer:POWer[1,2,...,999]:RESet
Example	:CALC:FPOW:POW1:RES

Notes	Option FP2 is required.
Initial S/W Revision	A.14.00

Define Fast Power Measurement (Remote Command Only)

Fast Power acquisitions are configured using the DEFine command. This command accepts a comma-delimited string of configuration parameters and their appropriate values, which are all specified in the subsection below.

Mode	All
Remote Command	:CALCulate:FPOWER:POWer[1,2,...,999]:DEFine "configuration string"
Example	:CALC:FPOW:POW1:DEF "CenterFrequency=2e9, AcquisitionTime=0.005"
Notes	See below for a list of measurement variables that can be defined in the configuration string.
Initial S/W Revision	A.14.00

Acquisition Time

Value	Time (s)
Range	0 s to 1 s
Preset	0.001 s
Example	CALC:FPOW:POW1:DEF "AcquisitionTime=0.002"
Notes	The acquisition time parameter sets the time in which the entire spectrum is measured. An increase in the acquisition time yields an improvement in measurement repeatability.
Initial S/W Revision	A.14.00

Center Frequency

Value	Frequency (Hz)
Range	0 Hz to maximum instrument frequency
Preset	1 GHz
Example	CALC:FPOW:POW1:DEF "CenterFrequency=2e9"
Notes	The center frequency parameter sets the frequency in which the measurement is centered around. The OffsetFrequency parameter is calculated relative to the center frequency.
Initial S/W Revision	A.14.00

DC Coupled

Value	Boolean
Range	True (DC Coupled) or False (AC Coupled)
Preset	False
Example	CALC:FPOW:POW1:DEF "DCCoupled=True"
Notes	The DC coupled parameter allows the user to specify whether the DC blocking capacitor is utilized. Set parameter to true when measuring frequencies below 10 MHz.
Initial S/W Revision	A.14.00

DetectorType

Example	CALC:FPOW:POW1:DEF "DetectorType=Peak"
Notes	Option FP2 is required. The detector type parameter allows the user to choose whether a RMS average or peak value is used during the measurement.
Preset	RmsAverage
Range	RmsAverage, Peak
Initial S/W Revision	A.14.00

Do Noise Correction

Value	Boolean
Range	True (enable noise correction) or False (disable noise correction)
Preset	False
Example	CALC:FPOW:POW1:DEF "DoNoiseCorrection=True"
Notes	When noise correction is enabled, the linear noise power contributed by the analyzer is subtracted from all measurements. This effectively lowers the noise floor of the analyzer. When noise correction is enabled, the first measurement for a given set of input parameters will take extra time. This is because the analyzer takes an extra acquisition with the RF input disconnected from the analyzer's front end to measure the noise of just the analyzer. The measured noise floor is stored in a cache so the noise acquisition will occur only once for the same state settings. In other words, if noise correction was turned on and the analyzer made an acquisition at frequency A, then frequency B, and back again to frequency A, the hidden initial noise floor acquisition would only occur for the first acquisition at frequency A and the cached noise floor would be used the second time frequency A was measured.
Initial S/W Revision	A.14.00

Do Spur Suppression

Value	Boolean
Range	True (enable spur suppression) or False (disable spur suppression)
Preset	False
Example	CALC:FPOW:POW1:DEF "DoSpurSuppression=True"
Notes	<p>When measuring very low level signals, or when large out-of-band inputs are input into the analyzer, sometimes unwanted spurs and residuals can appear in the measured spectrum. Spur suppression is a method to help minimize the levels of these internally generated spurs and residuals.</p> <p>When spur suppression is enabled, the analyzer will automatically take two acquisitions using two different internal analog LO frequencies. The FFT spectrums from both acquisitions are combined by taking the minimum power between both traces on a per FFT bin basis. External signals will have the same amplitude for both traces and therefore will return the expected amplitudes. However, low level spurs and residuals generated internally to the analyzer tend to move to different FFT bins depending on the internal analog LO frequency used, and therefore tend to be suppressed using this spur suppression method.</p> <p>Because two acquisitions, rather than a single acquisition, are made when spur suppression is enabled, the measurement time will always be slower when spur suppression is enabled.</p>
Initial S/W Revision	A.14.00

Electronic Attenuator Bypass

Value	Boolean
Range	True (bypass electronic attenuator) or False (use electronic attenuator)
Preset	True
Example	CALC:FPOW:POW1:DEF "ElecAttBypass =False"
Notes	The electronic attenuation bypass parameter allows the user to either utilize or bypass the electronic attenuator. The electronic attenuator is only available for frequencies up to 3.6 GHz. Set parameter to true when using frequencies above 3.6 GHz and set the parameter to false when using the preamp.
Initial S/W Revision	A.14.00

Electronic Attenuation

Value	dB
Range	0 - 24 dB (1 dB steps)
Preset	0 dB
Example	CALC:FPOW:POW1:DEF "ElecAttenuation=10"
Notes	<p>Option EA3 is required.</p> <p>The electronic attenuation value parameter sets the amount of electrical attenuation from 0 to 24 dB (1 dB steps).</p>

Set "ElecAttBypass=False" to make sure the electronic attenuator path is enabled.

Initial S/W Revision	A.14.00
-------------------------	---------

IF Gain

Value	dB
Range	-6 - 16 dB (1 dB steps)
Preset	0 dB
Example	CALC:FPOW:POW1:DEF "IFGain=10"
Notes	The IF gain parameter allows the user to specify the gain at the IF stage anywhere from -6 to 16 dB (1 dB steps). This is an advanced feature, and for most cases this should remain at its default value of 0 dB.
Initial S/W Revision	A.14.00

IF Type

Example	CALC:FPOW:POW1:DEF "IFType=B25M"
Notes	The IF type parameter allows the user to select between different IF paths. For example, if the signal is less than 25 MHz wide, then the user can select the B25M path to take advantage of additional filtering on this analog IF path.
Preset	B40M
Range	B10M, B25M, B40M
Initial S/W Revision	A.14.00

Include Power Spectrum

Value	Boolean
Range	True (return both channel power and full power spectrum) or False (returns only channel power)
Preset	False
Example	CALC:FPOW:POW1:DEF "IncludePowerSpectrum=True"
Notes	The power spectrum parameter allows the user to read data on the entire spectrum for diagnostic purposes. It is not recommended for production use. See CALC:FPOW:POW[n]:READ2? for details on the binary format of the response.
Initial S/W Revision	A.14.00

Mechanical Attenuation

Value	dB
Range	0 – 70 dB (2 dB steps)
Preset	0 dB
Example	CALC:FPOW:POW1:DEF "MechAttenuation=10"
Notes	The mechanical attenuation value parameter sets the amount of mechanical attenuation anywhere from 0 to 70 dB (2 dB steps).
Initial S/W Revision	A.14.00

Preamp Mode

Example	CALC:FPOW:POW1:DEF "PreAmpMode=Low"
Notes	The license for the appropriate preamp is required. The preamp mode parameter specifies whether the preamps are being utilized. Low allows any preamps up to 3.6 GHz, and Full allows all licensed preamps. Set "ElecAttBypass=True" in order to utilize any preamps.
Preset	Off
Range	Off, Low, Full
Initial S/W Revision	A.14.00

Resolution Bandwidth Mode

Example	CALC:FPOW:POW1:DEF "PreAmpMode=Low"
Notes	The resolution bandwidth mode parameter allows the user to choose whether the RBW filter is automatically or manually set. The BestSpeed value minimizes measurement time, while the Narrowest value minimizes RBW size (minimum of two FFT bins per RBW). To manually specify an RBW, set this parameter to Explicit, and set the ResolutionBW parameter to the desired value.
Preset	BestSpeed
Range	BestSpeed, Narrowest, Explicit
Initial S/W Revision	A.14.00

Resolution Bandwidth

Value	Hz
Preset	0 Hz

Example	CALC:FPOW:POW1:DEF "ResolutionBW=25e3"
Notes	The resolution bandwidth parameter sets the 3-dB bandwidth of the RBW filter. The ResolutionBWMode parameter must be set to Explicit in order to manually set the RBW.
Initial S/W Revision	A.14.00

Trigger Delay

Value	Seconds
Range	0 – 1 s
Preset	0 s
Example	CALC:FPOW:POW1:DEF "TriggerDelay=0.025"
Notes	The trigger delay parameter sets the time after an external trigger is detected until the measurement is performed.
Initial S/W Revision	A.14.00

Trigger Level

Value	Volts
Range	-5 to 5 V
Preset	1.2 V
Example	CALC:FPOW:POW1:DEF "TriggerLevel=2"
Notes	The trigger level parameter sets the voltage value at which an external trigger is detected.
Initial S/W Revision	A.14.00

Trigger Slope

Example	CALC:FPOW:POW1:DEF "TriggerSlope=Negative"
Notes	The trigger slope parameter indicates the direction of the edge trigger voltage for detection.
Preset	Positive
Range	Positive, Negative
Initial S/W Revision	A.14.00

Trigger Source

Example	CALC:FPOW:POW1:DEF "TriggerSource=Ext1 "
Notes	The trigger source parameter allows the user to choose between measurement's triggering freely or controlled by an external input. Ext1 and Ext2 correspond to Trigger 1 In and Trigger 2 In, respectively.
Preset	Free
Range	Free, Ext1, Ext2
Initial S/W Revision	A.14.00

Trigger Timeout

Value	Seconds
Range	0 - 1 s
Preset	1 s
Example	CALC:FPOW:POW1:DEF "TriggerTimeout=0.1"
Notes	The trigger timeout parameter sets the time in which the analyzer will wait for a trigger before automatically performing the measurement.
Initial S/W Revision	A.14.00

Signal Input

Example	CALC:FPOW:POW1:DEF "SignalInput=Fp50MHzCW"
Notes	The signal input parameter allows the user to select between using the main RF input or the internal analyzer reference CW signal of 50 MHz.
Preset	FpMainRf
Range	FpMainRf, Fp50MHzCW
Initial S/W Revision	A.14.00

Use Preselector

Value	Boolean
Range	True (use preselector above 3.6 GHz), or False (preselector bypassed)
Preset	False
Example	CALC:FPOW:POW1:DEF "UsePreSelector=True"
Notes	The preselector parameter allows the user to either utilize or bypass the front end tunable filter at frequencies above 3.6 GHz. For frequencies below 3.6 GHz, the preselector is automatically

bypassed, so you do not need to set this parameter to False in those cases.

Initial S/W Revision	A.14.00
----------------------	---------

Channel Bandwidth Array

Value	Hz
Range	0 to 40 MHz
Preset	[1 e6]
Example	CALC:FPOW:POW1:DEF "Bandwidth=[3.84e6, 5e6, 3.84e6]"
Notes	The bandwidth parameter array defines the bandwidth of each channel that will be measured. All array parameters should have the same number of elements. Alternatively, if all the elements are the same value, a single number with no square brackets can be used to define the parameter.
Initial S/W Revision	A.14.00

Channel Filter Type Array

Example	CALC:FPOW:POW1:DEF "FilterType=[RRC, IBW, RRC]"
Notes	The filter type parameter allows the user to choose between an integration bandwidth (IBW) filter or a root-raised-cosine (RRC) filter. The integration bandwidth filter weighs all frequencies within the bandwidth equally. The root-raised-cosine filter has an associated shape parameter, defined by the FilterAlpha parameter. All array parameters should have the same number of elements. Alternatively, if all the elements are the same value, a single value with no square brackets can be used to define the parameter.
Preset	[IBW]
Range	IBW, RRC
Initial S/W Revision	A.14.00

Channel Filter Alpha Array

Example	CALC:FPOW:POW1:DEF "FilterAlpha=[0.5, 0.0, 0.5]"
Notes	The filter alpha parameter allows the user to adjust the alpha value associated with the root-raised-cosine (RRC) filter type. Set FilterType to RRC in order to utilize this parameter. All array parameters should have the same number of elements. Alternatively, if all the elements are the same value, a single number with no square brackets can be used to define the parameter.
Preset	[0.22]
Range	0.0 - 1.0
Initial S/W Revision	A.14.00

Channel Measurement Function Array

Example	CALC:FPOW:POW1:DEF "Function=[BandPower, PeakPower, BandPower]"
Notes	<p>This parameter array defines what measurement is being made for each individually-specified channel:</p> <p>BandPower: Total power within the specified bandwidth of the channel (dBm)</p> <p>BandDensity: Total power density within the specified bandwidth of the channel (dBm/Hz)</p> <p>PeakPower: The peak power value within the specified bandwidth of the channel (dBm)</p> <p>PeakFrequency: The frequency which corresponds to the peak power value within the specified bandwidth of the channel. This frequency is relative to the center frequency (Hz)</p> <p>XdBBandwidth: The half power (-3.01 dB) bandwidth of the highest amplitude signal that resides within the channel (Hz), dB is configurable using XdBBandwidth parameter</p> <p>OccupiedBandwidth: The bandwidth at which 99% of the total power resides within the channel (Hz), percentage configurable using OccupiedBandwidthPercent parameter</p> <p>All array parameters should have the same number of elements. Alternatively, if all the elements are the same value, a single value with no square brackets can be used to define the parameter.</p>
Preset	[BandPower]
Range	BandPower, BandDensity, PeakPower, PeakFrequency, XdBBandwidth, OccupiedBandwidth
Initial S/W Revision	A.14.00

Channel Offset Frequency Array

Value	Hz
Range	0 to 20 MHz
Preset	[0]
Example	CALC:FPOW:POW1:DEF "OffsetFrequency=[-5e6, 0, 5e6]"
Notes	<p>The offset frequency parameter array defines the difference between the center frequency to the center frequency of each channel.</p> <p>All array parameters should have the same number of elements.</p>
Initial S/W Revision	A.14.00

Channel Occupied Bandwidth Percent Array

Example	CALC:FPOW:POW1:DEF "OccupiedBandwidthPercent =[0.95, 0.95, 0.95]"
Notes	<p>This parameter only applies for channels whose Function is set to OccupiedBandwidth. The occupied bandwidth percent parameter specifies the percent of total power in these channels. The valid range for this parameter is 0.0 to 1.0, where 1.0 represents 100%. The default for this parameter is 0.99, which will return the bandwidth that contains 99% of the total channel power.</p>

Preset	[0.99]
Range	0 – 1.0
Initial S/W Revision	A.14.00

Channel x-dB Bandwidth Array

Value	dB
Range	-200 to 0 dB
Preset	[-3.01]
Example	CALC:FPOW:POW1:DEF " XdBBandwidth =[-6.02, -3.01, -1.0]"
Notes	This parameter only applies for channels whose Function is set to XdBBandwidth. The X dB bandwidth parameter is used to specify the power relative to the peak channel power over which the bandwidth is calculated. The parameter value must be a negative number.
Initial S/W Revision	A.14.00

Define Fast Power Measurement Query (Remote Command Only)

The DEFine? command is used to retrieve a list of all defined parameters in an ASCII string format

M o d e	All
R e m o t e	:CALCulate:FPOWER:POWER[1,2,...,999]:DEFine?
C o m m a n d	
E x a m p l e	:CALC:FPOW:POW1:DEF?

```

p
l
e
-----
N This command query is used to retrieve a list of all defined parameters in an ASCII format.
o The following is an example of the returned results:
t "DCCoupled=False,ElecAttBypass=True,ElecAttenuation=0,IFGain=0,MechAttenuation=0,PreAmpMode=Off,PreSelectorOffset
e =0,UsePreSelector=False,ExternalReferenceFrequency=10000000,FrequencyReferenceSource=AutoExternalFrequencyRefer
s ence,IFType=B40M,LOMode=SLW,SignalInput=FpMainRf,AcquisitionTime=0.001,CenterFrequency=1000000000,Resolution
BW=0,ResolutionBWMode=BestSpeed,DetectorType=RmsAverage,Bandwidth=[1000000],OffsetFrequency=[0],Function=
[BandPower],FilterType=[IBW],FilterAlpha=[0.22],OccupiedBandwidthPercent=[0.99],XdBBandwidth=[-
3.01],DoNoiseCorrection=False,DoSpurSuppression=False,MeasurementMethod=HardwareFFT,IncludePowerSpectrum=False,
e,TriggerDelay=0,TriggerLevel=1.2,TriggerSlope=Positive,TriggerSource=Free,TriggerTimeout=1"
-----
I A.14.00
n
i
t
i
a
l

S
/
W

R
e
v
i
s
i
o
n

```

Configure Fast Power Measurement (Remote Command Only)

The configure command begins hardware setup and returns immediately, with no acquisition made. This can be used in parallel with other hardware operations to effectively hide the hardware setup time.

Mode	All
Remote Command	:CALCulate:FPOWer:POWer[1,2,...,999]:CONFigure
Example	:CALC:FPOW:POW1:CONF
Notes	Option FP2 is required.
Initial S/W Revision	A.14.00

Initiate Fast Power Measurement (Remote Command Only)

The INITiate command begins an acquisition and returns immediately. The results of the measurement can be retrieved using FETCh.

Mode	All
Remote Command	:CALCulate:FPOWER:POWER[1,2,...,999]:INITiate
Example	:CALC:FPOW:POW1:INIT
Notes	Option FP2 is required.
Initial S/W Revision	A.14.00

Fetch Fast Power Measurement (Remote Command Only)

The FETCh command query is used to retrieve the results of an acquisition initiated by the INIT command. The returned results are in ASCII string format. The string begins and ends with quotation marks.

Mode	All
Remote Command	:CALCulate:FPOWER:POWER[1,2,...,999]:FETCh?
Example	:CALC:FPOW:POW1:FETC?
Notes	Option FP2 is required. Returns m comma-separated ASCII values, where m corresponds to the number of bandwidths defined. 1. Declared function return in the 1st specified channel 2. Declared function return in the 2nd specified channel ... m. Declared function return in the last specified channel The INIT and FETC? command sequence performs the same functionality of a single CALC:FPOW:POW[n]? query. Units of the returned values are dependent on the Function parameter for each channel.
Initial S/W Revision	A.14.00

Execute Fast Power Measurement (Remote Command Only)

This command query is used as shorthand for an INIT command immediately followed by a FETC? command. The returned results are in ASCII string format. The string begins and ends with quotation marks.

Mode	All
Remote Command	:CALCulate:FPOWER:POWER[1,2,...,999]?
Example	:CALC:FPOW:POW1?
Notes	Option FP2 is required. See notes for Fast Power Fetch for return format.
Initial S/W Revision	A.14.00

Binary Read Fast Power Measurement (Remote Command Only)

This command query is used as shorthand for an INIT command immediately followed by a FETC? command. The returned results are in a binary format.

Mode	All
Remote Command	:CALCulate:FPOWER:POWER[1,2,...,999]:READ? :CALCulate:FPOWER:POWER[1,2,...,999]:READ1?
Example	:CALC:FPOW:POW1:READ? :CALC:FPOW:POW1:READ1?
Notes	Option FP2 is required. Returns m 4 byte floating point binary values (Little-Endian), where m corresponds to the number of bandwidths defined.
Initial S/W Revision	A.14.00

Diagnostic Binary Read Fast Power Measurement (Remote Command Only)

This command query is used as shorthand for an INIT command immediately followed by a FETC? command. The returned results are in a binary format. This command is used primarily for diagnostic purposes to test for ADC overloads and to visibly inspect the spectrum.

Mode	All
Remote Command	:CALCulate:FPOWER:POWER[1,2,...,999]:READ2?
Example	:CALC:FPOW:POW1:READ2?
Notes	Option FP2 is required. Note: Spectrum data is only returned if the IncludePowerSpectrum parameter is set to True. If IncludePowerSpectrum is False, the number of spectrum points will be zero (0). Units of the returned values are dependent on the Function parameter per channel (e.g. dBm for BandPower, Hz for PeakFrequency). Returns binary data (Little-Endian) that contains information on m amount of channels, along with ADC over range and full spectrum data. The following is the binary format of the response. Bandwidth Return Value 1. Number of channels specified, m [4 byte int] 2. Declared function result for the 1st specified channel [4 byte float] 3. Declared function result for the 2nd specified channel [4 byte float] ... (m + 1). Declared function result for the last (mth) specified channel [4 byte float] ADC Over Range 1. ADC over-range occurred (1: true, 0: false) [2 byte short]

	<p>Spectrum Data</p> <ol style="list-style-type: none"> 1. Number of points in the spectrum data, k [4 byte int] 2. Start frequency of spectrum data (Hz) [8 byte double] 3. Step frequency of spectrum data (Hz) [8 byte double] 4. FFT bin at 1st point (dBm) [4 byte float] 5. FFT bin at 2nd point (dBm) [4 byte float] <p>...</p> <p>(k + 3). FFT bin at last (kth) point (dBm) [4 byte float]</p>
Initial S/W Revision	A.14.00

Format Data: Numeric Data (Remote Command Only)

This command specifies the format of the trace data input and output. It specifies the formats used for trace data during data transfer across any remote port. It affects only the data format for setting and querying trace data for the :TRACe[:DATA], TRACe[:DATA]?, :CALCulate:DATA[n]? and FETCh:SANalyzer[n]? commands and queries.

Remote Command	<pre>:FORMat[:TRACe][:DATA] ASCii INTeger,32 REAL,32 REAL,64</pre> <pre>:FORMat[:TRACe][:DATA]?</pre>
Notes	<p>The query response is:</p> <pre>ASCii: ASC,8</pre> <pre>REAL,32: REAL,32</pre> <pre>REAL,64: REAL,64</pre> <pre>INTeger,32: INT,32</pre> <p>When the numeric data format is REAL or ASCii, data is output in the current Y Axis unit. When the data format is INTeger, data is output in units of m dBm (.001 dBm).</p> <p>The INT,32 format returns binary 32-bit integer values in internal units (m dBm), in a definite length block.</p>
Dependencies	<p>Sending a data format spec with an invalid number (for example, INT,48) generates no error. The analyzer simply uses the default (8 for ASCii, 32 for INTeger, 32 for REAL).</p> <p>Sending data to the analyzer which does not conform to the current FORMat specified, results in an error. Sending ASCII data when a definite block is expected generates message -161 "Invalid Block Data" and sending a definite block when ASCII data is expected generates message -121 "Invalid Character in Number".</p>
Preset	ASCii
Backwards Compatibility Notes	Note that the INT,32 format is only applicable to the command, TRACe:DATA. This preserves backwards compatibility for the Swept SA measurement. For all other commands/queries which honor FORMat:DATA, if INT,32 is sent the analyzer will behave as though it were set to REAL,32.
Initial S/W Revision	Prior to A.02.00

The specs for each output type follow:

AScii - Amplitude values are in ASCII, in the current Y Axis Unit, one ASCII character per digit, values separated by commas, each value in the form:

SX.YYYYYEsZZ

Where:

S = sign (+ or -)

X = one digit to left of decimal point

Y = 5 digits to right of decimal point

E = E, exponent header

s = sign of exponent (+ or -)

ZZ = two digit exponent

REAL,32 - Binary 32-bit real values in the current Y Axis Unit, in a definite length block.

REAL,64 - Binary 64-bit real values in the current Y Axis Unit, in a definite length block.

Format Data: Byte Order (Remote Command Only)

This command selects the binary data byte order for data transfer and other queries. It controls whether binary data is transferred in normal or swapped mode. This command affects only the byte order for setting and querying trace data for the :TRACe[:DATA], TRACe[:DATA]? , :CALCulate:DATA[n]? and FETCh:SANalyzer[n]? commands and queries.

By definition any command that says it uses FORMat:DATA uses any format supported by FORMat:DATA.

The NORMal order is a byte sequence that begins with the most significant byte (MSB) first, and ends with the least significant byte (LSB) last in the sequence: 1|2|3|4. SWAPped order is when the byte sequence begins with the LSB first, and ends with the MSB last in the sequence: 4|3|2|1.

Remote Command	:FORMat:BORDER NORMAL SWAPped :FORMat:BORDER?
Preset	NORMal
Initial S/W Revision	Prior to A.02.00

Meas Setup

Displays the setup menu for the currently selected measurement.

Key Path	Front-panel key
Initial S/W Revision	Prior to A.02.00

Avg/Hold Num

Toggles averaging On or Off in addition to enabling you to set the number of measurement averages used to calculate the measurement result. The average is displayed at the end of each sweep. After the specified number of average counts, the average mode (termination control) setting determines the average action.

In the remote mode, use the Average State command to turn averaging on or off.

Key Path	Meas Setup
Mode	SA, WCDMA, C2K, WIMAX OFDMA, TD-SCDMA, 1xEVDO, DTMB (CTTB), DVB-T/H, ISDB-T, CMMB, LTE, LTE-TDD, Digital Cable TV, WLAN, MSR, LTEAFDD, LTEATDD
Remote Command	[:SENSe]:SEMask:AVERage:COUNT <integer> [:SENSe]:SEMask:AVERage:COUNT? [:SENSe]:SEMask:AVERage[:STATe] ON OFF 1 0 [:SENSe]:SEMask:AVERage[:STATe]?
Example	SEM:AVER:COUN 100 SEM:AVER:COUN? SEM:AVER ON SEM:AVER?
Notes	You must be in the mode that includes SEM measurement to use this command. Use :INSTrument:SElect to set the mode.
Preset	10 OFF
State Saved	Saved in instrument state.
Min	1
Max	10000
Initial S/W Revision	Prior to A.02.00
Modified at S/W Revision	A.02.00, A.03.00

Meas Type

Accesses a menu that enables you to select one of the following measurement reference types:

- Total Pwr Ref – Sets the reference to the total carrier power and the measured data is shown in dBc and dBm.
- PSD Ref – Sets the reference to the mean power spectral density of the carrier and the measured data is shown in dB and dBm/Hz.
- Spectrum Peak Ref – Sets the reference to the spectrum peak power of the carrier and the measured data is shown in dB and dBm.

Key Path	Meas Setup
Mode	SA, WCDMA, C2K, WIMAX OFDMA, TD-SCDMA, 1xEVDO, DTMB (CTTB), DVB-T/H, ISDB-T, CMMB, LTE, LTEFDD, Digital Cable TV, WLAN, MSR, LTEAFDD, LTEATDD
Remote Command	[:SENSe] :SEMAsk:TYPE PSDRef TPreRef SPRef [:SENSe] :SEMAsk:TYPE?
Example	SEM:TYPE PSDR SEM:TYPE?
Notes	You must be in the mode that includes SEM measurement to use this command. Use :INSTRument:SElect to set the mode.
Preset	SA, , WCDMA, , C2K, , TD-SCDMA, , 1xEVDO, , DTMB (CTTB), , DVB-T/H, , ISDB-T, , CMMB, , LTE, , LTEFDD, , Digital Cable TV, , MSR, , LTEAFDD, , LTEATDD: TPreRef WIMAX OFDMA, WLAN: SPRef
State Saved	Saved in instrument state.
Range	Total Pwr Ref PSD Ref Spectrum Peak Ref
Initial S/W Revision	Prior to A.02.00
Modified at S/W Revision	A.02.00, A.03.00

Ref Channel

Accesses a menu that enables you to set up the measurement parameters used to calculate the power in the reference channel.

Key Path	Meas Setup
Initial S/W Revision	Prior to A.02.00

Integ BW

Specifies the integration bandwidth used to calculate the power in the reference channel.

Key Path	Meas Setup, Ref Channel
Mode	SA, WCDMA, C2K, WIMAX OFDMA, TD-SCDMA, 1xEVDO, DTMB (CTTB), DVB-T/H, ISDB-T, CMMB, LTE, LTEFDD, Digital Cable TV, WLAN
Remote Command	[:SENSe] :SEMAsk:BANDwidth [1] 2:INTegration <bandwidth> [:SENSe] :SEMAsk:BANDwidth [1] 2:INTegration?

Example	SEM:BAND:INT 10 MHz SEM:BAND:INT?
Notes	10% . 100% of Channel Span Parameter Value Bandwidth sub op code, 1 is for BTS, 2 for MS. Default is BTS. You must be in the mode that includes SEM measurement to use this command. Use :INSTrument:SElect to set the mode.
Dependencies	For MSR and LTE-Advanced FDD/TDD mode, this key is blank.
Couplings	Cannot be higher than the channel Span. If lower than 1/10 of channel Span, then the channel Span is reduced to be 10 times the Integ BW.
Preset	SA: 3.84 MHz WCDMA: 3.84 MHz 3.84 MHz C2K: 1.23 MHz 1.23 MHz WIMAX OFDMA: 10 MHz 10 MHz TD-SCDMA: 1.28 MHz 1.28 MHz 1xEVDO: 1.23MHz DTMB (CTTB): 7.56MHz DVB-T/H: 7.61MHz ISDB-T: 5.6MHz CMMB: 7.512MHz LTE: 4.515MHz 4.5MHz LTETDD: 4.515MHz 4.5MHz Digital Cable TV: 6.9MHz WLAN: if Radio Std is 802.11a/g(OFDM/DSSS-OFDM)/802.11n(20 MHz)/ 802.11ac (20 MHz): 18 MHz if Radio Std is 802.11b/g(DSSS/CCK/PBCC): 22 MHz if Radio Std is 802.11n(40MHz)/ 802.11ac (40 MHz): 38 MHz if Radio Std is 802.11ac (80 MHz): 78 MHz if Radio Std is 802.11ac (160 MHz): 158 MHz if Radio Std is 802.11ac (80 MHz + 80 MHz): 78 MHz
State Saved	Saved in instrument state.
Min	1 kHz
Max	645 MHz
Initial S/W Revision	Prior to A.02.00
Modified at S/W Revision	A.02.00, A.03.00

Span

Specifies the span used to calculate the power in the reference channel.

Key Path	Meas Setup, Ref Channel
----------	-------------------------

Mode	SA, WCDMA, C2K, WIMAX OFDMA, TD-SCDMA, 1xEVDO, DTMB (CTTB), DVB-T/H, ISDB-T, LTE, LTETDD, CMMB, Digital Cable TV, WLAN
Remote Command	[:SENSe] :SEMAsk:FREQuency [1] 2 :SPAN <freq> [:SENSe] :SEMAsk:FREQuency [1] 2 :SPAN?
Example	SEM:FREQ:SPAN 3MHz SEM:FREQ:SPAN?
Notes	Frequency sub op code, 1 is for BTS, 2 for MS. Default is BTS. You must be in the mode that includes SEM measurement to use this command. Use :INSTrument:SElect to set the mode.
Dependencies	For MSR and LTE-Advanced FDD/TDD mode, this key is blank.
Couplings	Range 1 kHz to 50 MHz (although restricted by Integ BW). If you set the channel Span lower than channel Integ BW, they will both track each other. As you increase the channel Span, the Integ BW will also increase if it is less than 1/10 of the channel Span. For WLAN 802.11ac (80 + 80 MHz), the channel span is coupled with the difference between the center frequencies of the two carriers. When the difference is either less than 80 MHz or greater than 565 MHz, a “setting conflict” error message is displayed. Chan Span = Carrier Spacing + Chan IntegBW;
Preset	SA: 5.0 MHz WCDMA: 5.0 MHz 5.0 MHz C2K: 1.25 MHz 1.25 MHz WIMAX OFDMA: 10 MHz 10 MHz TD-SCDMA: 1.6 MHz 1.6 MHz 1xEVDO: 1.25 MHz DTMB (CTTB): 10 MHz DVB-T/H: 10 MHz ISDB-T: 8 MHz CMMB: 10 MHz LTE: 5 MHz LTETDD: 5 MHz Digital Cable TV: 10 MHz WLAN: if Radio Std is 802.11a/g(OFDM/DSSS-OFDM)/802.11n(20 MHz)/ 802.11ac (20 MHz): 18 MHz if Radio Std is 802.11b/g(DSSS/CCK/PBCC): 22 MHz if Radio Std is 802.11n(40MHz)/ 802.11ac (40 MHz): 38 MHz if Radio Std is 802.11ac (80 MHz): 78 MHz if Radio Std is 802.11ac (160 MHz): 158 MHz if Radio Std is 802.11ac (80 MHz + 80 MHz): 240 MHz
State Saved	Saved in instrument state.
Min	1 kHz
Max	645 MHz
Initial S/W Revision	Prior to A.02.00
Modified at S/W Revision	A.02.00, A.03.00

Sweep Time

Sets the sweep time used to calculate the power in the reference channel. Sweep Time can be set manually or put in auto mode.

Key Path	Meas Setup, Ref Channel
Mode	SA, WCDMA, C2K, WIMAX OFDMA, TD-SCDMA, 1xEVDO, DTMB (CTTB), DVB-T/H, ISDB-T, CMMB, LTE, LTE-TDD, Digital Cable TV, WLAN, MSR, LTEAFDD, LTEATDD
Remote Command	[:SENSe]:SEMask:SWEep[1] 2:TIME <time> [:SENSe]:SEMask:SWEep[1] 2:TIME? [:SENSe]:SEMask:SWEep[1] 2:TIME:AUTO OFF 0 ON 1 [:SENSe]:SEMask:SWEep[1] 2:TIME:AUTO?
Example	SEM:SWE:TIME 9ms SEM:SWE:TIME? SEM:SWE:TIME:AUTO OFF SEM:SWE:TIME:AUTO?
Notes	Sub op code, 1 is for BTS, 2 for MS. Default is BTS. You must be in the mode that includes SEM measurement to use this command. Use :INSTrument:SElect to set the mode.
Couplings	When the time is set manually, Auto is set to OFF. Value is coupled with Channel Detector selection, Channel Resolution BW, Channel Video BW if the state is Auto. When set to Auto, the Sweep Time is automatically calculated
Preset	Automatically calculated ON
State Saved	Saved in instrument state.
Min	1 ms
Max	4000 s
Initial S/W Revision	Prior to A.02.00
Modified at S/W Revision	A.02.00, A.03.00

Res BW

Sets the resolution bandwidth used to calculate the power in the reference channel. The Channel Resolution BW can be set manually or put in to auto mode.

MSR Auto RBW:

In the MSR resolution bandwidth is predefined for each radio format. When carriers are configured with multiple radio formats, the narrowest RBW is selected.

LTE	1.4 MHz	13
	3 MHz	27
	5 MHz	47
	10 MHz	91
	15 MHz	150
	20 MHz	180
W-CDMA		75
GSM		30

In LTE-Advanced FDD/TDD, the resolution bandwidth is predefined based on the corresponding bandwidth of the single LTE carrier, which is listed above. When ResBW mode is Auto, the narrowest RBW is selected.

Key Path	Meas Setup, Ref Channel
Mode	SA, WCDMA, C2K, WIMAX OFDMA, TD-SCDMA, 1xEVDO, DTMB (CTTB), DVB-T/H, ISDB-T, CMMB, LTE, LTE-TDD, Digital Cable TV, WLAN, MSR, LTEAFDD, LTEATDD
Remote Command	<pre>[:SENSe]:SEMAsk:BANDwidth[1] 2[:RESolution] <bandwidth> [:SENSe]:SEMAsk:BANDwidth[1] 2[:RESolution]? [:SENSe]:SEMAsk:BANDwidth[1] 2[:RESolution]:AUTO OFF ON 1 0 [:SENSe]:SEMAsk:BANDwidth[1] 2[:RESolution]:AUTO?</pre>
Example	<pre>SEM:BAND 100 kHz SEM:BAND? SEM:BAND:AUTO ON SEM:BAND:AUTO?</pre>
Notes	<p>Bandwidth sub op code, 1 is for BTS, 2 for MS. Default is BTS.</p> <p>You must be in the mode that includes SEM measurement to use this command. Use :INSTrument:SElect to set the mode.</p>
Couplings	<p>When Res BW is set manually, Channel Resolution BW Mode is set to MANual.</p> <p>Value is coupled with Channel Detector selection, Channel Sweep Time, Channel Video BW.</p> <p>When set to Auto, the resolution bandwidth is automatically calculated.</p>
Preset	<pre>SA: 100 kHz WCDMA: 75 kHz C2K: 24 kHz WIMAX OFDMA: 100 kHz TD-SCDMA: 30 kHz 1xEVDO: 30.0 kHz DTMB (CTTB): 3.9 kHz DVB-T/H: 3.9 kHz ISDB-T: 10 kHz CMMB: 3.9 kHz</pre>

	LTE, , LTETDD, , MSR, , LTEAFDD, , LTEATDD:Auto (47 kHz) Digital Cable TV: 3.9 kHz WLAN: 100 kHz ON
State Saved	Saved in instrument state.
Min	1 Hz
Max	8 MHz
Backwards Compatibility SCPI	[:SENSe] :SEMAsk:BWIDth[1] 2 [:RESolution]
Initial S/W Revision	Prior to A.02.00
Modified at S/W Revision	A.02.00, A.03.00

Video BW

Sets the video bandwidth used to calculate the power in the reference channel. The Channel Video BW can be set manually or put in to auto mode.

Key Path	Meas Setup, Ref Channel
Mode	SA, WCDMA, C2K, WIMAX OFDMA, TD-SCDMA, 1xEVDO, DTMB (CTTB), DVB-T/H, ISDB-T, CMMB, LTE, LTETDD, Digital Cable TV, WLAN, MSR, LTEAFDD, LTEATDD
Remote Command	[:SENSe] :SEMAsk:BANDwidth[1] 2:VIDeo <bandwidth> [:SENSe] :SEMAsk:BANDwidth[1] 2:VIDeo? [:SENSe] :SEMAsk:BANDwidth[1] 2:VIDeo:AUTO OFF ON 1 0 [:SENSe] :SEMAsk:BANDwidth[1] 2:VIDeo:AUTO?
Example	SEM:BAND:VID 100 kHz SEM:BAND:VID? SEM:BAND:VID:AUTO ON SEM:BAND:VID:AUTO?
Notes	Bandwidth sub op code, 1 is for BTS, 2 for MS. Default is BTS. You must be in the mode that includes SEM measurement to use this command. Use :INSTrument:SElect to set the mode.
Couplings	When Video BW is set manually, Channel Video BW Mode is set to MANual Value is coupled with Channel Detector selection, Channel Sweep Time, Channel Resolution BW. When set to Auto, the video bandwidth is automatically calculated.
Preset	SA: 100 kHz WCDMA: 75 kHz C2K: 24 kHz WIMAX OFDMA: 30 kHz TD-SCDMA: 300 kHz 1xEVDO: 300.0 kHz

	DTMB (CTTB): 39 kHz DVB-T/H: 39 kHz ISDB-T: 1 kHz CMMB: 39 kHz LTE, MSR, LTEAFDD, LTEATDD: Auto LTETDD: Auto Digital Cable TV: 39 kHz WLAN: Auto ON
State Saved	Saved in instrument state.
Min	1 Hz
Max	50 MHz
Backwards Compatibility SCPI	[:SENSe] :SEMAsk:BWIDth [1] 2 :VIDeo
Initial S/W Revision	Prior to A.02.00
Modified at S/W Revision	A.02.00, A.03.00

VBW/RBW

Sets the Video BW/Resolution BW Ratio to calculate the Channel Resolution BW and Channel Video BW. The VBW/RBW Ratio can be set manually or put in to auto mode.

Key Path	Meas Setup, Ref Channel
Mode	SA, WCDMA, C2K, WIMAX OFDMA, TD-SCDMA mode, 1xEVDO, DTMB (CTTB), DVB-T/H, ISDB-T, CMMB, LTE, LTETDD, Digital Cable TV, WLAN, MSR, LTEAFDD, LTEATDD
Remote Command	[:SENSe] :SEMAsk:BA NDwidth [1] 2 :VIDeo:RATio <real> [:SENSe] :SEMAsk:BA NDwidth [1] 2 :VIDeo:RATio [:SENSe] :SEMAsk:BA NDwidth [1] 2 :VIDeo:RATio:AUTO OFF ON 1 0 [:SENSe] :SEMAsk:BA NDwidth [1] 2 :VIDeo:RATio:AUTO?
Example	SEM:BA ND:VID:RAT 0.1 SEM:BA ND:VID:RAT? SEM:BA ND:VID:RAT:AUTO ON SEM:BA ND:VID:RAT:AUTO?
Notes	Bandwidth sub op code, 1 is for BTS, 2 for MS. Default is BTS. You must be in the mode that includes SEM measurement to use this command. Use :INSTrument:SElect to set the mode.
Couplings	When Video BW/Res BW is set manually, Channel VBW/RBW Ratio Mode is set to MANual When set to Auto, the VBW/RBW Ratio is automatically calculated.
Preset	SA, WCDMA, C2K: 1.0 WIMAX OFDMA: 0.3

	TD-SCDMA: 10 1xEVDO: 10.0 DTMB (CTTB): 10 DVB-T/H: 10 ISDB-T: 0.1 CMMB: 10 LTE, MSR: Auto LTEAFDD,LTEATDD:Auto LTETDD: Auto Digital Cable TV: 10 WLAN: Auto ON
State Saved	Saved in instrument state.
Min	0.00001
Max	3000000
Backwards Compatibility SCPI	[:SENSe] :SEMask:BWIDth [1] 2 :VIDeo:RATio
Initial S/W Revision	Prior to A.02.00
Modified at S/W Revision	A.02.00, A.03.00

Power Ref (for the modes except MSR and LTE-Advanced FDD/TDD)

Sets the power reference in the carrier that will be used to compute the relative values for the offsets.

Key Path	Meas Setup, Ref Channel
Initial S/W Revision	Prior to A.02.00

Total Power

Sets the power in the carrier (ref channel) that is used to compute the relative power values for the offsets. When the state is set to auto, this value is set to the measured carrier reference power. When set to manual, the result takes on the last measured value, or can be manually entered.

For WLAN 802.11ac (80 MHz + 80 MHz), the higher of the power readouts of the two carriers is used for computing the relative power values for the offset.

Key Path	Meas Setup, Ref Channel, Power Ref
Mode	SA, WCDMA, C2K, WIMAX OFDMA, TD-SCDMA, 1xEVDO, DTMB (CTTB), DVB-T/H, ISDB-T, CMMB, LTE, LTETDD, Digital Cable TV, WLAN, MSR, LTEAFDD, LTEATDD
Remote Command	[:SENSe] :SEMask:CARRier [:POWER] <real> [:SENSe] :SEMask:CARRier [:POWER] ?

	<code>[:SENSe] :SEMAsk :CARRier :AUTO [:STATe] OFF ON 1 0</code>
	<code>[:SENSe] :SEMAsk :CARRier :AUTO [:STATe] ?</code>
Example	SEM:CARR 100dBm SEM:CARR? SEM:CARR:AUTO OFF SEM:CARR:AUTO?
Notes	The min and max values given are for Meas Type = Total Pwr Ref. You must be in the mode that includes SEM measurement to use this command. Use :INSTrument:SElect to set the mode.. This BAF SCPI command is available in all the Meas Type case. This BAF SCPI command is not available in MSR and LTE-Advanced FDD/TDD mode.
Dependencies	This "Total Power Ref" parameter is coupled with the "Meas Type" parameter. The softkey is active when Meas Type is set to Total Power Ref. Otherwise, it is grayed out.
Preset	Measured carrier reference power
State Saved	Saved in instrument state.
Min	-200 dBm
Max	200 dBm
Initial S/W Revision	Prior to A.02.00
Modified at S/W Revision	A.02.00, A.03.00

PSD

Sets the power spectral density in the carrier that is used to compute the relative power spectral density values for the offsets when Meas Type is set to PSD Ref. When the state is set to auto, this will be set to the measured carrier power spectral density.

For WLAN 802.11ac (80 MHz + 80 MHz), the higher of the power density readouts of the two carriers is used for computing the relative PSD values for the offset.

Key Path	Meas Setup, Ref Chan, Power Ref
Mode	SA, WCDMA, C2K , WIMAX OFDMA, TD-SCDMA, 1xEVDO, DTMB (CTTB), DVB-T/H, ISDB-T, CMMB, LTE, LTE-TDD, Digital Cable TV, WLAN, MSR, LTEAFDD, LTEATDD
Remote Command	<code>[:SENSe] :SEMAsk :CARRier :CPSD <real></code> <code>[:SENSe] :SEMAsk :CARRier :CPSD?</code>
Example	SEM:CARR:CPSD -80 SEM:CARR:CPSD?
Notes	Although the default value is defined, the value is recalculated by the measurement result just after completing the measurement. Carrier sub op code. 1 for BTS, 2 for MS. Default is BTS. You must be in the mode that includes SEM measurement to use this command. Use :INSTrument:SElect to set the mode.

Dependencies	See Couplings
Couplings	This "PSD" parameter is coupled with the "Meas Type" parameter. The key will be active if the Meas Type is set to PSD. Otherwise, it is grayed out.
Preset	Measured carrier PSD reference power
State Saved	Saved in instrument state.
Min	-200
Max	200
Initial S/W Revision	Prior to A.02.00
Modified at S/W Revision	A.02.00, A.03.00

Spectrum Peak

Sets the spectrum peak power in the carrier that is used to compute the relative power spectral density values for the offsets when Meas Type is set to Spectrum Peak. When the state is set to auto, this is set to the measured carrier spectrum peak power. When set to manual, the result takes on the last measured value, or can be manually entered

Key Path	Meas Setup, Ref Channel, Power Ref
Mode	SA, WCDMA, C2K, WIMAX OFDMA, TD-SCDMA, 1xEVDO, DTMB (CTTB), DVB-T/H, ISDB-T, CMMB, LTE, LTE-TDD, Digital Cable TV, WLAN
Remote Command	<code>[:SENSe] :SEMAsk :CARRier :PEAK [:POWER] <real></code> <code>[:SENSe] :SEMAsk :CARRier :PEAK [:POWER] ?</code>
Example	SEM:CARR:PEAK -80 SEM:CARR:PEAK:POWER?
Notes	Although the default value is defined, the value is recalculated by the measurement result just after completing the measurement. Carrier sub op code. 1 for BTS, 2 for MS. Default is BTS. You must be in the mode that includes SEM measurement to use this command. Use :INSTrument:SElect to set the mode.
Dependencies	See Couplings
Couplings	This "Spectrum Peak Ref" parameter is coupled with the "Meas Type" parameter. This softkey is active when the "Meas Type" is set to "Spectrum Peak Ref". Otherwise, grayout.
Preset	Measured carrier Spectrum Peak reference power
State Saved	Saved in instrument state.
Min	-200
Max	200
Initial S/W Revision	Prior to A.02.00
Modified at S/W Revision	A.02.00, A.03.00

Offset/Limits

Accesses a menu that enables you to set up the measurement parameters for offset pairs. For example, you can assign the start and stop frequencies, select the resolution bandwidth, and set the sweep time. When in the MSR and LTE-Advanced FDD/TDD mode, the softkey label changes to Outer Offset/Limits.

Key Path	Meas Setup
Initial S/W Revision	Prior to A.02.00
Modified at S/W Revision	A.14.00

Select Offset

Selects the offset (upper and lower) and displays the memory selection menu that enables you to store a set of parameter values for the offset, such as Start Freq, Stop Freq, Sweep Time, Res BW, Meas BW, Abs Start, and Abs Stop. Only one selection at a time is shown on this menu key label.

Key Path	Meas Setup, Offset/Limits
Mode	SA, WCDMA, C2K, WIMAX OFDMA, TD-SCDMA, 1xEVDO, DTMB (CTTB), DVB-T/H, ISDB-T, CMMB, LTE, LTE-TDD, Digital Cable TV, WLAN, MSR, LTEAFDD, LTEATDD
Preset	A
Range	MSR, LTEATDD, LTEAFDD, WLAN: A B C D E F G H I J K L Other modes without option N9060A-7FP: A B C D E F Other modes with option N9060A-7FP: A B C D E F G H I J K L
Initial S/W Revision	Prior to A.02.00
Modified at S/W Revision	A.02.00, A.03.00, A.10.00, A.11.00, A.14.00

Start Freq

Specifies the start frequency for the currently selected offset. Also enables you to toggle that offset between On and Off.

Missing values are not permitted; that is, if you want to change values 2 and 6, you must send all values up to 6. Subsequent values will remain as they were. The query for this parameter always returns 12 values.

Key Path	Meas Setup, Offset/Limits
Mode	SA, WCDMA, C2K, WIMAX OFDMA, TD-SCDMA, 1xEVDO, DTMB (CTTB), DVB-T/H, ISDB-T, CMMB, LTE, LTE-TDD, Digital Cable TV, WLAN, MSR, LTEAFDD, LTEATDD
Remote Command	[:SENSE] :SEMAsk:OFFSet [1] 2 [:OUTer] :LIST:FREQuency:STARt <freq>, ... [:SENSE] :SEMAsk:OFFSet [1] 2 [:OUTer] :LIST:FREQuency:STARt? [:SENSE] :SEMAsk:OFFSet [1] 2 [:OUTer] :LIST:STATE ON OFF 1 0, ... [:SENSE] :SEMAsk:OFFSet [1] 2 [:OUTer] :LIST:STATE?
Example	SEM:OFFS2:LIST:FREQ:STAR 2.515 MHz, , 2.715 MHz, , 3.515 MHz, , 4.00 MHz, , 8.00 MHz, , 12.50 MHz

	<p>SEM:OFFS2:LIST:FREQ:STAR? SEM:OFFS:LIST:STAT ON, , ON, , ON, , OFF, , OFF, , OFF SEM:OFFS:LIST:STAT?</p>
Notes	<p>Comma separated list of values. OFFSet1 is for BTS, 2 for MS. Default is BTS. You must be in the mode that includes SEM measurement to use this command. Use :INSTrument:SElect to set the mode.</p>
Couplings	<p>Coupled to Stop Freq. When the start freq goes above the stop freq, the stop freq is automatically adjusted to the start freq plus 100 Hz. If the current mode is DVB-T/H, this value will be modified automatically according to the limit type and the output power of the transmitter which is less or more than 25 W. If the current mode is ISDB-T, this value will be modified automatically according to the limit type.</p>
Preset	<p>For modes (except MSR, , LTEAFDD, , LTEATDD and WLAN) without option N9060A-7FP, , the preset value is as follows. SA: 2.515 MHz, , 2.715 MHz, , 3.515 MHz, , 4.00 MHz, , 8.00 MHz, , 12.50 MHz WCDMA: 2.515 MHz, , 2.715 MHz, , 3.515 MHz, , 4.000 MHz, , 8.000 MHz, , 12.50 MHz 2.515MHz, , 4.000 MHz, , 7.500 MHz, , 8.500 MHz, , 12.5 MHz, , 15 MHz C2K: 750.0 kHz, , 780.0 kHz, , 1.980 MHz, , 3.25 MHz, , 7.0 MHz, , 7.0 MHz 885 kHz, , 1.980 MHz, , 2.250 MHz, , 8.0 MHz, , 12.0 MHz, , 12.0 MHz WIMAX OFDMA: 4.75 MHz, 5.45 MHz, 9.75 MHz, 14.75 MHz, 19.75 MHz, 24.75 MHz 4.75 MHz, 5.45 MHz, 9.75 MHz, 14.75 MHz, 19.75 MHz, 24.75 MHz TD-SCDMA: 81 5kHz, 1015 kHz, 1815 kHz, 2.3 MHz, , , 2.3 MHz, , 2.3 MHz 815 kHz, 1.8 MHz, 2.9 MHz, , 2.9 MHz, 2.9 MHz, , 2.9 MHz 1xEVDO: 750.0 kHz, , 780.0 kHz, , 1.98 MHz, , 3.25 MHz, , 7 MHz, , 7 MHz 885.0 kHz, , 1.98 MHz, , 1.98 MHz, , 1.98 MHz, , 1.98 MHz DTMB (CTTB): 3.8 MHz, , 4.2 MHz, , 6 MHz, , 6 MHz, , 6 MHz, 6 MHz 6MHz, , 6MHz, , 6MHz, , 6MHz, , 6MHz, , 6MHz DVB-T/H: 3.81 MHz, , 4.2 MHz, , 6 MHz, , 6 MHz, , 6 MHz, , 6 MHz 6MHz, , 6MHz, , 6MHz, , 6MHz, , 6MHz ISDB-T: 2.79 MHz, , 2.86 MHz, , 3.0 MHz, , 4.36 MHz, , 6 MHz, , 6 MHz 6MHz, , 6MHz, , 6MHz, , 6MHz, , 6MHz, , 6MHz CMMB: 3.8 MHz, , 4.2 MHz, , 8.0 MHz, , 6 MHz, , 6 MHz, , 6 MHz 6MHz, , 6MHz, , 6MHz, , 6MHz, , 6MHz LTE, , LTETDD: 50 kHz, , 5.05 MHz, , 10.5 MHz, , 15.00 MHz, , 30 MHz, , 40 MHz 15.00 kHz, 1.5 MHz, 5.5 MHz, 6.5 MHz, 10 MHz, 20MHz Digital Cable TV: 3.8 MHz, , 4.2 MHz, , 6 MHz, , 6 MHz, , 6 MHz, , 6 MHz 6MHz, , 6MHz, , 6MHz, , 6MHz, , 6MHz, , 6MHz When option N9060A-7FP is installed in these modes, the preset value of Offset G ~ L is the same as the Offset F value. ----- WLAN: if Radio Std is 802.11a/g(OFDM/DSSS-OFDM)/802.11n(20MHz): 9 MHz, , 11 MHz, , 20 MHz, , 30</p>

MHz, , 50 MHz, , 216 MHz, , 216 MHz, , 216 MHz, , 216 MHz, , 216 MHz, , 216 MHz, , 216 MHz

if Radio Std is 802.11b/g(DSSS/CCK/PBCC): 11 MHz, , 22 MHz, , 50 MHz, , 70 MHz, , 90 MHz, ,
100 MHz, , 100 MHz, , 100 MHz, , 100 MHz, , 100 MHz, , 100 MHz

if Radio Std is 802.11n(20MHz): 9 MHz, , 11 MHz, , 20 MHz, , 30 MHz, , 50 MHz, , 100 MHz, , 100
MHz, , 100 MHz, , 100 MHz, , 100 MHz, , 100 MHz

if Radio Std is 802.11n(40MHz): 19 MHz, , 21 MHz, , 40 MHz, , 60 MHz, , 100 MHz, , 200 MHz, ,
200 MHz, , 200 MHz, , 200 MHz, , 200 MHz, , 200 MHz

if Radio Std is 802.11ac(20MHz): 9 MHz, , 11 MHz, , 20 MHz, , 30 MHz, , 30 MHz, , 30 MHz, , 30
MHz, , 30 MHz, , 30 MHz, , 30 MHz, , 30 MHz

if Radio Std is 802.11ac(40MHz): 19 MHz, , 21 MHz, , 40 MHz, , 60 MHz, , 60 MHz, , 60 MHz, , 60
MHz, , 60 MHz, , 60 MHz, , 60 MHz, , 60 MHz

if Radio Std is 802.11ac(80MHz): 39 MHz, , 41 MHz, , 80 MHz, , 120 MHz, , 120 MHz, , 120 MHz, ,
120 MHz, , 120 MHz, , 120 MHz, , 120 MHz, , 120 MHz

if Radio Std is 802.11ac(160MHz): 79 MHz, , 81 MHz, , 160 MHz, , 240 MHz, , 240 MHz, , 240
MHz, , 240 MHz, , 240 MHz, , 240 MHz, , 240 MHz, , 240 MHz

if Radio Std is 802.11ac(80 MHz + 80MHz): 0 MHz, , 40 MHz, , 79 MHz, , 159 MHz, , 161 MHz, ,
200 MHz, , 240 MHz, , 240 MHz, , 240 MHz, , 240 MHz, , 240 MHz

MSR:15 kHz, , 215kHz, , 1.015MHz, , 1.5MHz, , 10.5MHz, , 15.00MHz, , 30MHz, , 30MHz, ,
30MHz, , 30MHz, , 30MHz, , 30MHz | 15kHz, , 215kHz, , 1.015MHz, , 1.5MHz, , 10.5MHz, ,
15.00MHz, , 30MHz, , 30MHz, , 30MHz, , 30MHz, , 30MHz, , 30MHz

LTEAFDD, , LTEATDD: 50 kHz, , 5.05 MHz, , 10.5 MHz, , 15.00 MHz, , 30 MHz, , 40 MHz, , 40
MHz, 40 MHz, 40 MHz, 40 MHz, 40 MHz | 15.00 kHz, 1.5 MHz, 5.5 MHz, 6.5 MHz, 10
MHz, 20MHz, , 20MHz, , 20MHz, , 20MHz, , 20MHz, , 20MHz

For modes (except MSR, , LTEAFDD, , LTEATDD and WLAN) without option N9060A-7FP, , the
preset value is as follows.

SA: ON, ON, ON, ON, ON, OFF

WCDMA: ON, , ON, , ON, , ON, , OFF|ON, , ON, , ON, , OFF, , OFF

C2K: ON, , ON, , ON, , OFF, , OFF, , OFF|ON, , ON, , OFF, , OFF, , OFF, , OFF

WIMAX OFDMA: ON, , ON, , ON, , OFF, , OFF, , OFF|ON, , ON, , ON, , OFF, , OFF, , OFF

TD-SCDMA: ON, , ON, , ON, , ON, , OFF, , OFF|ON, , ON, , ON, , OFF, , OFF, , OFF

1xEVDO: ON, , ON, , ON, , OFF, , OFF, , OFF| ON, , ON, , OFF, , OFF, , OFF, , OFF

DTMB (CTTB), , DVB-T/H, , CMMB, , Digital Cable TV: ON, , ON, , ON, , OFF, , OFF, , OFF

ISDB-T: ON, ON, ON, ON, OFF, OFF

LTE, , LTETDD: ON, , ON, , ON, , OFF, , OFF, , OFF|ON, ON, ON, ON, OFF, OFF

When option N9060A-7FP is installed in these modes, , the preset value of Offset G ~ L is the same
as the Offset F value.

WLAN:

if Radio Std is 802.11b/g(DSSS/CCK/PBCC): ON, , ON, , OFF, , OFF, , OFF, , OFF, , OFF, ,
OFF, , OFF, , OFF, , OFF

if Radio Std is 802.11a/g(OFDM/DSSS-OFDM)/802.11n(20MHz/40MHz): ON, , ON, , ON, , ON, ,
OFF, , OFF, , OFF, , OFF, , OFF, , OFF, , OFF, , OFF

if Radio Std is 802.11ac (20 MHz/ 40 MHz/ 80 MHz/ 160 MHz): ON, , ON, , ON, , ON, , OFF, , OFF, ,
OFF, , OFF, , OFF, , OFF, , OFF, , OFF

	if Radio Std is 802.11ac (80 MHz + 80 MHz): ON, , ON, , ON, , ON, , ON, , ON, , OFF, , OFF, , OFF, , OFF, , OFF MSR:ON, , ON, , ON, , ON, , ON, , OFF, , OFF, , OFF, , OFF, , OFF, , OFF, , OFF ON, , ON, , ON, , ON, , ON, , OFF, , OFF, , OFF, , OFF, , OFF, , OFF, , OFF LTEAFDD, , LTEATDD: ON, , ON, , ON, , OFF, , OFF, , OFF, , OFF, , OFF, , OFF, , OFF, , OFF, , OFF ON, , ON, , ON, , ON, , OFF, , OFF, , OFF, , OFF, , OFF, , OFF, , OFF, , OFF, , OFF
State Saved	Saved in instrument state.
Min	0 Hz
Max	499.9999 MHz
Initial S/W Revision	Prior to A.02.00
Modified at S/W Revision	A.02.00, A.03.00, A.10.00, A.11.00, A.14.00

Stop Freq

Specifies the stop frequency for the currently selected offset.

Missing values are not permitted; that is, if you want to change values 2 and 6, you must send all values up to 6. Subsequent values will remain as they were. The query for this parameter always returns 12 values.

Key Path	Meas Setup, Offset/Limits
Mode	SA, WCDMA, C2K, WIMAX OFDMA, TD-SCDMA, 1xEVDO, DTMB (CTTB), DVB-T/H, ISDB-T, CMMB, LTE, LTE-TDD, Digital Cable TV, WLAN, MSR, LTEAFDD, LTEATDD
Remote Command	[:SENSe] :SEMAsk:OFFSet [1] 2 [:OUTer] :LIST:FREQuency:STOP <freq>, ... [:SENSe] :SEMAsk:OFFSet [1] 2 [:OUTer] :LIST:FREQuency:STOP?
Example	SEM:OFFS:LIST:FREQ:STOP 2.715 MHz, , 3.515 MHz, , 4.00 MHz, , 8.00 MHz, , 12.50 MHz, , 15.0 MHz SEM:OFFS:LIST:FREQ:STOP?
Notes	Comma separated list of values. OFFSet1 is for BTS, 2 for MS. Default is BTS. You must be in the mode that includes SEM measurement to use this command. Use :INSTrument:SElect to set the mode.
Couplings	Coupled to Start Freq. When the stop freq goes below the start freq, the start freq is automatically adjusted to the stop freq minus 100 Hz. If the current mode is DVB-T/H, this value will be modified automatically according to the limit type and the output power of the transmitter which is less or more than 25 W. If the current mode is ISDB-T, this value will be modified automatically according to the limit type.
Preset	For modes (except MSR, , LTEAFDD, , LTEATDD and WLAN) without option N9060A-7FP, , the preset value is as follows. SA: 2.715 MHz, , 3.515 MHz, , 4.00 MHz, , 8.00 MHz, , 12.50 MHz, , 15.0 MHz WCDMA:2.715 MHz, , 3.515 MHz, , 4.000 MHz, , 8.000 MHz, , 12.50 MHz, , 15.0 MHz 3.485 MHz, , 7.500 MHz, , 8.500 MHz, , 12.00 MHz, , 15.00 MHz, , 18.0 MHz

C2K: 780.0kHz, 1.980 MHz, 4.0 MHz, 4.0 MHz, 12.0 MHz, 12.0 MHz|1.980 MHz, 4.0 MHz, 4.0 MHz, 11.5 MHz, 14.5 MHz, 14.5 MHz

WIMAX OFDMA: 5.45 MHz, 9.75 MHz, 14.75 MHz, 19.75 MHz, 24.75 MHz, 29.75 MHz|5.45 MHz, 9.75 MHz, 14.75 MHz, 19.75 MHz, 24.75 MHz, 29.75 MHz

TD-SCDMA:

1015 kHz, 1815kHz, 2.3 MHz, 4 MHz, 4 MHz, 4 MHz|1.8 MHz, 2385 kHz, 3.5 MHz, 3.5 MHz, 3.5 MHz, 3.5 MHz

1xEVDO: 780.0 kHz, 1.98 MHz, 4.0 MHz, 4.0 MHz, 12 MHz, 12 MHz|1.98 MHz, 4.0 MHz, 4.0 MHz, 4.0 MHz, 4.0 MHz, 4.0 MHz

DTMB (CTTB): 4.2 MHz, 6 MHz, 12 MHz, 12 MHz, 12 MHz, 12 MHz|12 MHz, 12 MHz, 12 MHz, 12 MHz, 12 MHz, 12 MHz, 12 MHz

DVB-T/H: 4.2 MHz, 6 MHz, 12 MHz, 12 MHz, 12 MHz, 12 MHz|12 MHz, 12 MHz, 12 MHz, 12 MHz, 12 MHz, 12 MHz

ISDB-T: 2.86 MHz, 3.0 MHz, 4.36 MHz, 15.0 MHz, 15.0 MHz, 15.0 MHz|15MHz, 15MHz, 15MHz, 15MHz, 15MHz, 15MHz

CMMB: 4.2 MHz, 8.0 MHz, 12.0 MHz, 12.0 MHz, 12.0 MHz, 12.0 MHz|12 MHz, 12 MHz, 12 MHz, 12 MHz, 12 MHz, 12 MHz

LTE, LTETDD: 5.05 MHz, 10.05 MHz, 15 MHz, 30 MHz, 40 MHz, 50 MHz|985.0 kHz, 4.50 MHz, 5.5001 MHz, 9.50 MHz, 20 MHz, 40 MHz

Digital Cable TV: 4.2 MHz, 6.0 MHz, 12.0 MHz, 12.0 MHz, 12.0 MHz, 12.0 MHz, 12 MHz, 12 MHz, 12 MHz, 12 MHz, 12 MHz, 12 MHz

When option N9060A-7FP is installed in these modes, the preset value of Offset G ~ L is the same as the Offset F value.

WLAN:

if Radio Std is 802.11a/g(OFDM/DSSS-OFDM)/802.11n(20MHz): 11 MHz, 20 MHz, 30 MHz, 50 MHz, 100 MHz, 250 MHz, 250 MHz, 250 MHz, 250 MHz, 250 MHz, 250 MHz, 250 MHz

if Radio Std is 802.11b/g(DSSS/CCK/PBCC): 22 MHz, 50 MHz, 70 MHz, 90 MHz, 100 MHz, 120 MHz, 120 MHz, 120 MHz, 120 MHz, 120 MHz, 120 MHz, 120 MHz

if Radio Std is 802.11n(20MHz): 11 MHz, 20 MHz, 30 MHz, 50 MHz, 100 MHz, 200 MHz, 200 MHz, 200 MHz, 200 MHz, 200 MHz, 200 MHz, 200 MHz

if Radio Std is 802.11n(40MHz): 21 MHz, 40 MHz, 60 MHz, 100 MHz, 200 MHz, 300 MHz, 300 MHz, 300 MHz, 300 MHz, 300 MHz, 300 MHz, 300 MHz

if Radio Std is 802.11ac(20MHz): 11 MHz, 20 MHz, 30 MHz, 50 MHz, 50 MHz, 50 MHz, 50 MHz, 50 MHz, 50 MHz, 50 MHz, 50 MHz, 50 MHz

if Radio Std is 802.11ac(40MHz): 21 MHz, 40 MHz, 60 MHz, 100 MHz, 100 MHz, 100 MHz, 100 MHz, 100 MHz, 100 MHz, 100 MHz, 100 MHz, 100 MHz

if Radio Std is 802.11ac(80MHz): 41 MHz, 80 MHz, 120 MHz, 200 MHz, 200 MHz, 200 MHz, 200 MHz, 200 MHz, 200 MHz, 200 MHz, 200 MHz, 200 MHz

if Radio Std is 802.11ac(160MHz): 81 MHz, 160 MHz, 240 MHz, 400 MHz, 400 MHz, 400 MHz, 400 MHz, 400 MHz, 400 MHz, 400 MHz, 400 MHz, 400 MHz

if Radio Std is 802.11ac(80 MHz + 80MHz): 40 MHz, 79 MHz, 81 MHz, 161 MHz, 200 MHz, 240 MHz, 260 MHz, 260 MHz, 260 MHz, 260 MHz, 260 MHz, 260 MHz

MSR: 215kHz, 1.015MHz, 1.5MHz, 10.5MHz, 50MHz, 50MHz, 50MHz, 50MHz, 50MHz, 50MHz, 50MHz, 50MHz

	50MHz, , 50MHz, , 50MHz LTEAFDD, , LTEATDD: 5.05 MHz, , 10.05 MHz, , 15 MHz, , 30 MHz, , 40 MHz, , 50 MHz, , 50 MHz, , 50 MHz, , 50 MHz, , 50 MHz, , 50 MHz 985.0 kHz, , 4.50 MHz, , 5.5001 MHz, , 9.50 MHz, 20 MHz, , 40 MHz, , 40 MHz, , 40 MHz, , 40 MHz, , 40 MHz, , 40 MHz, , 40 MHz
State Saved	Saved in instrument state.
Min	100 Hz
Max	500 MHz
Initial S/W Revision	Prior to A.02.00
Modified at S/W Revision	A.02.00, A.03.00, A.10.00, A.11.00, A.14.00

Sweep Time

Specifies the sweep time for the currently selected offset and enables you to toggle the Sweep Time mode between Auto and Man.

Missing values are not permitted; that is, if you want to change values 2 and 6, you must send all values up to 6. Subsequent values will remain as they were. The query for this parameter always returns 12 values.

Key Path	Meas Setup, Offset/Limits
Mode	SA, WCDMA, C2K, WIMAX OFDMA, TD-SCDMA, 1xEVDO, DTMB (CTTB), DVB-T/H, ISDB-T, CMMB, LTE, LTE-TDD, Digital Cable TV, WLAN, MSR, LTEAFDD, LTEATDD
Remote Command	[:SENSe] :SEMask:OFFSet [1] 2 [:OUTer] :LIST:SWEep:TIME <time>, ... [:SENSe] :SEMask:OFFSet [1] 2 [:OUTer] :LIST:SWEep:TIME? [:SENSe] :SEMask:OFFSet [1] 2 [:OUTer] :LIST:SWEep:TIME:AUTO ON OFF 1 0, ... [:SENSe] :SEMask:OFFSet [1] 2 [:OUTer] :LIST:SWEep:TIME:AUTO?
Example	SEM:OFFS2:LIST:SWE:TIME 1.0 ms, , 3.4 ms, , 2.08 ms, , 1.0 ms, , 1.0 ms, , 1.0 ms SEM:OFFS2:LIST:SWE:TIME? SEM:OFFS2:LIST:SWE:TIME:AUTO ON, , ON, , ON, , ON, , OFF, , OFF SEM:OFFS2:LIST:SWE:TIME:AUTO?
Notes	Comma separated list of values. OFFSet1 is for BTS, 2 for MS. Default is BTS. You must be in the mode that includes SEM measurement to use this command. Use :INSTrument:SElect to set the mode.
Couplings	When the sweep time is set manually, Sweep Time Mode is set to MANual. If the current mode is DVB-T/H, this value will be modified automatically according to the output power of the transmitter which is less or more than 25W. If the current mode is ISDB-T, this value will be modified automatically according to the limit type.
Preset	Automatically calculated Modes (except MSR, , LTEAFDD, , LTEATDD and WLAN) without option N9060A-7FP: ON, ON, ON, ON, ON, ON

	Modes (except MSR, , LTEAFDD, , LTEATDD and WLAN) with option N9060A-7FP: ON, ON, ON, ON, ON, ON, ON, ON, ON, ON, ON, ON, ON, ON, ON, ON WLAN: ON, ON, ON, ON, ON, ON, ON, ON, ON, , ON, ON, ON, ON, ON MSR: ON,ON,ON,ON,ON,ON,ON,ON,ON,ON,ON,ON,ON,ON,ON,ON LTEAFDD, , LTEATDD: ON, ON, ON, ON, ON, ON, ON, ON, ON, ON, ON, ON ON, ON, ON, ON, ON, ON, ON, ON, ON, ON, ON, ON, ON
State Saved	Saved in instrument state.
Min	1 ms
Max	4000 s
Backwards Compatibility SCPI	[:SENSE] :SEMAsk:OFFSet [1] 2 :LIST:SWEep [:TIME]
Initial S/W Revision	Prior to A.02.00
Modified at S/W Revision	A.02.00, A.03.00, A.10.00, A.11.00, A.14.00

Offset Side

Specifies which offset side to measure.

You can turn off (not use) specific offsets with [:SENSE] :SEMAsk:OFFSet[n][:OUTer] :LIST:STATe.

- **BOTH** – Both of the negative (lower) and positive (upper) sidebands
- **NEGative** – Negative (lower) sideband only
- **POSitive** – Positive (upper) sideband only

Missing values are not permitted; that is, if you want to change values 2 and 6, you must send all values up to 6. Subsequent values will remain as they were. The query for this parameter always returns 12 values.

The figure below shows the relation between the negative/positive offset side setups and the upper/lower results in the MSR and LTE-Advanced FDD/TDD.

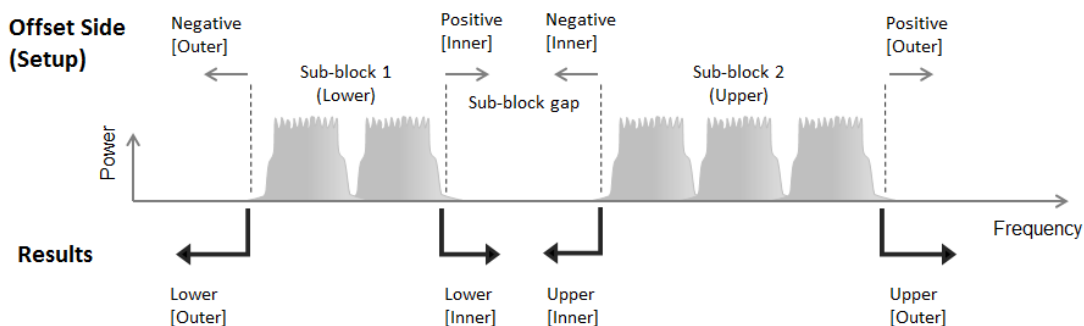

Key Path	Meas Setup, Offset/Limits
Mode	SA, WCDMA, C2K, WIMAX OFDMA, TD-SCDMA, 1xEVDO, DTMB (CTTB), DVB-T/H, ISDB-T, CMMB, LTE, LTE-TDD, Digital Cable TV, WLAN, MSR, LTEAFDD, LTEATDD
Remote Command	[:SENSE] :SEMAsk:OFFSet [1] 2 [:OUTer] :LIST:SIDE BOTH NEGative

	POSitive, ... [:SENSe]:SEMask:OFFSet[1] 2[:OUTer]:LIST:SIDE?
Example	SEM:OFFS:LIST:SIDE BOTH, , NEG, , NEG, , POS, , POS, , POS SEM:OFFS:LIST:SIDE?
Notes	Comma separated list of values. OFFSet1 is for BTS, 2 for MS. Default is BTS. You must be in the mode that includes SEM measurement to use this command. Use :INSTrument:SElect to set the mode.
Preset	Modes (except MSR, , LTEAFDD, , LTEATDD and WLAN) without option N9060A-7FP: BOTH, , BOTH, , BOTH, , BOTH, , BOTH Modes (except MSR, , LTEAFDD, , LTEATDD and WLAN) with option N9060A-7FP: BOTH, , BOTH, , BOTH, , BOTH, , BOTH, , BOTH, , BOTH, , BOTH, , BOTH, , BOTH, , BOTH MSR: BOTH, , BOTH, , BOTH, , BOTH, , BOTH, , BOTH, , BOTH, , BOTH, , BOTH, , BOTH, , BOTH, , BOTH LTEAFDD, LTEATDD: BOTH, , BOTH, , BOTH, , BOTH, , BOTH, , BOTH, , BOTH, , BOTH, , BOTH, , BOTH, , BOTH BOTH, , BOTH, , BOTH, , BOTH, , BOTH, , BOTH, , BOTH, , BOTH, , BOTH, , BOTH, , BOTH WLAN: BOTH, , BOTH, , BOTH, , BOTH, , BOTH, , BOTH, , BOTH, , BOTH, , BOTH, , BOTH, , BOTH, , BOTH
State Saved	Saved in instrument state.
Range	Neg Both Pos
Initial S/W Revision	Prior to A.02.00
Modified at S/W Revision	A.02.00, A.03.00, A.10.00, A.11.00, A.14.00

Res BW

Specifies which Resolution BW filter to use when measuring the currently selected offset.

Offset Res BW Mode allows the instrument to determine the optimum Resolution BW filter to use when measuring the currently selected offset.. When changing the Meas BW parameter, if the Res BW needs to be changed to adhere to the rule

$(N \times \text{Res BW}) \leq (\text{Stop freq of the offset} - \text{Start freq of the offset})$,

where N is the multiplier, this setting will automatically be changed to manual.

Missing values are not permitted; that is, if you want to change values 2 and 6, you must send all values up to 6. Subsequent values will remain as they were. The query for this parameter always returns 12 values.

Key Path	Meas Setup, Offset/Limits
Mode	SA, WCDMA, C2K, WIMAX OFDMA, TD-SCDMA, 1xEVDO mode, DTMB (CTTB), DVB-T/H, ISDB-T, CMMB, LTE, LTE-TDD, Digital Cable TV, WLAN, MSR, LTEAFDD, LTEATDD
Remote Command	[:SENSe]:SEMask:OFFSet[1] 2[:OUTer]:LIST:BANDwidth[:RESolution] <bandwidth>, ... [:SENSe]:SEMask:OFFSet[1] 2[:OUTer]:LIST:BANDwidth[:RESolution]?

	<pre>[:SENSe] :SEMAsk:OFFSet [1] 2 [:OUTer] :LIST:BAWdth [:RESolution] :AUTO OFF ON 1 0, ... [:SENSe] :SEMAsk:OFFSet [1] 2 [:OUTer] :LIST:BAWdth [:RESolution] :AUTO?</pre>
Example	<pre>SEM:OFFS2:LIST:BAWdth 30.0 kHz, , 30.0 kHz, , 30.0 kHz, , 1.00 MHz, 1.00 MHz, , 1.00 MHz SEM:OFFS2:LIST:BAWdth? SEM:OFFS:LIST:BAWdth:AUTO 1,1,1,1,1,1 SEM:OFFS:LIST:BAWdth:AUTO?</pre>
Notes	<p>Comma separated list of values.</p> <p>OFFSet1 is for BTS, 2 for MS. Default is BTS.</p> <p>You must be in the mode that includes SEM measurement to use this command. Use :INSTrument:SElect to set the mode.</p>
Couplings	<p>Coupled to Start and Stop offset and Meas BW multiplier. This parameter must adhere to the rule (N x Res BW) <= (Stop freq of the offset - Start freq of the offset), where N is the multiplier. If the multiplier is changed, the Res BW will be changed to ensure this. When set manually, Res BW Coupling is set to manual.</p> <p>The resolution bandwidth is coupled to the offset width determined by the start frequency and stop frequency.</p>
Preset	<p>For modes (except MSR, , LTEAFDD, , LTEATDD and WLAN) without option N9060A-7FP, , the preset value is as follows.</p> <p>SA: 30.0 kHz, , 30.0 kHz, , 30.0 kHz, , 1.00 MHz, 1.00 MHz, , 1.00 MHz</p> <p>WCDMA: 30.00 kHz, , 30.00 kHz, , 30.00 kHz, , 100.00 kHz, , 1.000 MHz, , 1.00 MHz 30.00 kHz, , 1.000 MHz, , 1.000 MHz, , 1.000 MHz, , 1.000 MHz, , 1.00 MHz</p> <p>C2K: 3.00 kHz, , 30.00 kHz, , 30.00 kHz, , 6.2 kHz, , 1.000 MHz, , 1.00 MHz 30.00 kHz, , 30.00 kHz, , 6.2 kHz, , 1.000 MHz, , 1.000 MHz, , 1.00 MHz</p> <p>WIMAX OFDMA: 100 KHz, , 100 KHz, , 100 KHz, , 100 KHz, , 100 KHz, , 100 KHz 100 KHz, , 100 KHz, , 100 KHz, , 100 KHz, , 100 KHz</p> <p>TD-SCDMA: 30 kHz, , 30 kHz, , 30 kHz, , 50 kHz, , 1 MHz, , 1 MHz 30 kHz, , 30 kHz, , 50 kHz, , 1 MHz, , 1 MHz, , 1 MHz</p> <p>1xEVDO: 30.00 kHz, , 30.00 kHz, , 30.00 kHz, , 6.2 kHz, , 1.000 MHz, , 1.000 MHz 30.00 kHz, , 30.00 kHz, , 30.00 kHz, , 30.00 kHz, , 30.00 kHz</p> <p>DTMB (CTTB), , DVB-T/H, , CMMB, , Digital Cable TV: 3.9 kHz, , 3.9 kHz, , 3.9 kHz, , 3.9 kHz, , 3.9 kHz, , 3.9 kHz 30.00 kHz, , 1.000 MHz, , 1.000 MHz, , 1.000 MHz, , 1.000 MHz, , 1.00 MHz</p> <p>ISDB-T: 10.0 kHz, , 10.0 kHz, , 10.0 kHz, , 10.0 kHz, , 10. kHz, , 10.0 kHz 30.00 kHz, , 1.000 MHz, , 1.000 MHz, , 1.000 MHz, , 1.000 MHz, , 1.00 MHz</p> <p>LTE, , LTETDD: 51 kHz, , 100 kHz, , 1.0 MHz, , 1.0 MHz, 1.0 MHz, , 1.0 MHz 15.0 kHz, , 510 kHz, 1.0 MHz, 1.0 MHz, 1.0 MHz, 1.0 MHz</p> <p>When option N9060A-7FP is installed in these modes, , the preset value of Offset G ~ L is the same as the Offset F value.</p> <p>-----</p> <p>WLAN: 100 KHz, , 100 KHz, , 100 KHz, , 100 KHz, , 100 KHz, , 100 KHz, , 100 KHz, , 100 KHz, , 100 KHz, , 100 KHz, , 100 KHz</p> <p>MSR: 30kHz, , 30kHz, , 30kHz, , 1.0MHz, 1.0MHz, , 1.0MHz, , 1.0MHz, , 1.0MHz, , 1.0MHz, , 1.0MHz, , 1.0MHz 30kHz, , 30kHz, , 30kHz, , 1.0MHz, 1.0MHz, , 1.0MHz, , 1.0MHz, , 1.0MHz, , 1.0MHz, , 1.0MHz</p>

	<p>LTEAFDD, , LTEATDD: 51 kHz, , 100 kHz, , 1.0 MHz, , 1.0 MHz, 1.0 MHz, , 1.0 MHz, 1.0 MHz, 1.0 MHz, 1.0 MHz, 1.0 MHz, 1.0 MHz, 1.0 MHz 15.0 kHz, , 510 kHz, 1.0 MHz, 1.0 MHz, 1.0 MHz, 1.0 MHz, 1.0 MHz, 1.0 MHz, 1.0 MHz, 1.0 MHz, 1.0 MHz, 1.0 MHz</p> <p>Modes (except MSR, , LTEAFDD, , LTEATDD and WLAN) without option N9060A-7FP: OFF, , OFF, , OFF, , OFF, , OFF, , OFF OFF, , OFF, , OFF, , OFF, , OFF, , OFF</p> <p>Modes (except MSR, , LTEAFDD, , LTEATDD and WLAN) with option N9060A-7FP: OFF, , OFF, , OFF, , OFF, , OFF, , OFF, , OFF, , OFF, , OFF, , OFF, , OFF, , OFF OFF, , OFF, , OFF, , OFF, , OFF, , OFF, , OFF, , OFF, , OFF, , OFF, , OFF, , OFF, , OFF</p> <p>MSR: OFF, , OFF, , OFF, , OFF, , OFF, , OFF, , OFF, , OFF, , OFF, , OFF, , OFF OFF, , OFF, , OFF, , OFF, , OFF, , OFF, , OFF, , OFF, , OFF, , OFF, , OFF, , OFF, , OFF</p> <p>LTEAFDD, , LTEATDD: OFF, , OFF, , OFF, , OFF, , OFF, , OFF, , OFF, , OFF, , OFF, , OFF, , OFF, , OFF OFF, , OFF, , OFF, , OFF, , OFF, , OFF, , OFF, , OFF, , OFF, , OFF, , OFF, , OFF</p> <p>WLAN: OFF, , OFF, , OFF, , OFF, , OFF, , OFF, , OFF, , OFF, , OFF, , OFF, , OFF OFF, , OFF, , OFF, , OFF, , OFF, , OFF, , OFF, , OFF, , OFF, , OFF, , OFF</p>
State Saved	Saved in instrument state.
Min	1 Hz
Max	8 MHz
Backwards Compatibility SCPI	[:SENSe] :SEMAsk:OFFSet [1] 2 :LIST:BWIDth [:RESolution]
Initial S/W Revision	Prior to A.02.00
Modified at S/W Revision	A.02.00, A.03.00, A.10.00, A.11.00, A.14.00

Meas BW

Allows you to specify a multiplier of Res BW for the measurement integration bandwidth.

Meas BW is multiplier integer number. It shows a ratio between Integration BW and Resolution BW of the measurement result.

$$\text{Integ BW} = \text{Meas BW} * \text{Resolution BW}$$

Integration BW is desired resolution bandwidth and Resolution BW is actual bandwidth for sweep. Measurement sweeps with Resolution BW and Meas BW compensates sweep resolution bandwidth to Integration BW.

If you set this parameter greater than 1, you can set Resolution BW narrower to avoid carrier power leakage effect to the offset power integration.

Missing values are not permitted; that is, if you want to change values 2 and 6, you must send all values up to 6. Subsequent values will remain as they were. The query for this parameter always returns 12 values.

Key Path	Meas Setup, Offset/Limits
Mode	SA, WCDMA, C2K, WIMAX OFDMA, TD-SCDMA, 1xEVDO, DTMB (CTTB), DVB-T/HISDB-T, CMMB, LTE, LTETDD, Digital Cable TV, WLAN
Remote Command	[:SENSe] :SEMAsk:OFFSet [1] 2 [:OUTer] :LIST:BWIDth:IMULti <integer>, ... [:SENSe] :SEMAsk:OFFSet [1] 2 [:OUTer] :LIST:BWIDth:IMULti?

Example	SEM:OFFS2:LIST:BAND:IMUL 1,1,1,1,1,1 SEM:OFFS2:LIST:BAND:IMUL?
Notes	Comma separated list of values. OFFSet1 is for BTS, 2 for MS. Default is BTS. You must be in the mode that includes SEM measurement to use this command. Use :INSTrument:SElect to set the mode.
Couplings	This parameter must adhere to the rule (N x Res BW) <= (Stop freq of the offset - Start freq of the offset), where N is the multiplier. If the Res Bw is changed, the multiplier will be changed to ensure this.
Preset	For modes (except MSR, , LTEAFDD, , LTEATDD and WLAN) without option N9060A-7FP, , the preset value is as follows. SA: 1, 1, 1, 1, 1, 1 WCDMA: 1, , 1, , 1, , 10, , 1, , 1 1, , 1, , 1, , 1, , 1 C2K: 10, 1, 1, 1, 1, 1 1, 1, 1, 1, 1, 1 WIMAX OFDMA, , 1xEVDO: 1, , 1, , 1, , 1, , 1 1, , 1, , 1, , 1, , 1 TD-SCDMA:1, , 1, , 1, , 20, , 1, , 1 1, , 1, , 20, , 1, , 1, , 1 DTMB (CTTB), , DVB-T/H, , ISDB-T, , CMMB, , Digital Cable TV: 1, , 1, , 1, , 1, , 1 1, , 1, , 1, , 1, , 1 LTE, , LTETDD: 2, , 1, , 1, , 1, , 1, , 1 2, , 2, , 1, , 1, , 1, , 1 When option N9060A-7FP is installed in these modes, , the preset value of Offset G ~ L is the same as the Offset F value. ----- WLAN: 1, 1, 1, 1, 1, 1, 1, 1, 1, 1, 1, 1 MSR: 1, , 1, , 1, , 1, , 1, , 1, , 1, , 1, , 1, , 1 1, , 1, , 1, , 1, , 1, , 1, , 1, , 1, , 1, , 1 LTEAFDD, , LTEATDD: 2, , 1, , 1, , 1, , 1, , 1, , 1, , 1, , 1, , 1 2, , 2, , 1, , 1, , 1, , 1, , 1, , 1, , 1, , 1
State Saved	Saved in instrument state.
Min	1
Max	1000
Backwards Compatibility SCPI	[:SENSe] :SEMAsk:OFFSet [1] 2 :LIST:BWIDth:IMULti
Initial S/W Revision	Prior to A.02.00
Modified at S/W Revision	A.02.00, A.03.00, A.10.00, A.11.00, A.14.00

Video BW

Changes the analyzer post-detection filter.

Missing values are not permitted; that is, if you want to change values 2 and 6, you must send all values up to 6. Subsequent values will remain as they were. The query for this parameter always returns 12 values.

Key Path	Meas Setup, Offset/Limits
-----------------	---------------------------

Mode	SA, WCDMA, C2K, WIMAXOFDMA, TD-SCDMA, 1xEVDO, DTMB (CTTB), DVB-T/H, ISDB-T, CMMB, LTE, LTE-TDD, Digital Cable TV, WLAN, MSR, LTEAFDD, LTEATDD
Remote Command	[:SENSe]:SEMask:OFFSet [1] 2 [:OUTer]:LIST:BANDwidth:VIDeo <freq>, ... [:SENSe]:SEMask:OFFSet [1] 2 [:OUTer]:LIST:BANDwidth:VIDeo? [:SENSe]:SEMask:OFFSet [1] 2 [:OUTer]:LIST:BANDwidth:VIDeo:AUTO OFF ON 0 1, ... [:SENSe]:SEMask:OFFSet [1] 2 [:OUTer]:LIST:BANDwidth:VIDeo:AUTO?
Example	SEM:OFFS2:LIST:BAND:VID 3.00 kHz, , 3.00 kHz, , 3.00 kHz, , 100.0 kHz, 100.0 kHz, , 100.0 kHz SEM:OFFS2:LIST:BAND:VID? SEM:OFFS2:LIST:BAND:VID:AUTO ON, , ON, , ON, , ON, , ON, , ON SEM:OFFS2:LIST:BAND:VID:AUTO?
Notes	Comma separated list of values. OFFSet1 is for BTS, 2 for MS. Default is BTS. You must be in the mode that includes SEM measurement to use this command. Use :INSTrument:SElect to set the mode.
Preset	ISDB-T: 1.0kHz, , 1.0kHz, , 1.0kHz, , 1.0kHz, , 1.0kHz, , 1.0kHz Other than ISDB-T: Automatically Calculated Modes (except MSR, , LTEAFDD, , LTEATDD, , WLAN, , ISDB-T) without option N9060A-7FP: ON, , ON, , ON, , ON, , ON ON, , ON, , ON, , ON, , ON Modes (except MSR, , LTEAFDD, , LTEATDD, , WLAN, , ISDB-T) with option N9060A-7FP:ON, , ON, , ON, , ON, , ON, , ON, , ON, , ON, , ON, , ON, , ON ON, , ON, , ON, , ON, , ON, , ON, , ON, , ON, , ON ----- MSR, , LTEAFDD, , LTEATDD: ON, , ON, , ON, , ON, , ON, , ON, , ON, , ON, , ON, , ON ON, , ON, , ON, , ON, , ON, , ON, , ON, , ON, , ON, , ON, , ON WLAN: ON, , ON, , ON, , ON, , ON, , ON, , ON, , ON, , ON, , ON, , ON ON, , ON, , ON, , ON, , ON, , ON, , ON, , ON, , ON ISDB-T: OFF, , OFF, , OFF, , OFF, , OFF OFF, , OFF, , OFF, , OFF, , OFF, , OFF
State Saved	Saved in instrument state.
Min	1 Hz
Max	50 MHz
Backwards Compatibility SCPI	[:SENSe]:SEMask:OFFSet [1] 2 :LIST:BWIDth:VIDeo
Initial S/W Revision	Prior to A.02.00
Modified at S/W Revision	A.02.00, A.03.00, A.10.00, A.11.00, A.14.00

VBW/RBW

Selects the ratio between the video and resolution bandwidths.

Missing values are not permitted; that is, if you want to change values 2 and 6, you must send all values up to 6. Subsequent values will remain as they were. The query for this parameter always returns 12 values.

Key Path	Meas Setup, Offset/Limits
Mode	SA, WCDMA, C2K, WIMAX OFDMA, TD-SCDMA, 1xEVDO, DTMB (CTTB), DVB-T/H, ISDB-T, CMMB, LTE, LTETDD, Digital Cable TV, WLAN, MSR, LTEAFDD, LTEATDD
Remote Command	<pre>[:SENSe]:SEMAsk:OFFSet[1] 2[:OUTer]:LIST:BANDwidth:VIDeo:RATio <real>, ... [:SENSe]:SEMAsk:OFFSet[1] 2[:OUTer]:LIST:BANDwidth:VIDeo:RATio? [:SENSe]:SEMAsk:OFFSet[1] 2[:OUTer]:LIST:BANDwidth:VIDeo:RATio:AUTO OFF ON 0 1, ... [:SENSe]:SEMAsk:OFFSet[1] 2[:OUTer]:LIST:BANDwidth:VIDeo:RATio:AUTO?</pre>
Example	<pre>SEM:OFFS2:LIST:BAND:VID:RAT 0.1, , 0.1, , 0.1, , 0.1, , 0.1, , 0.1 SEM:OFFS2:LIST:BAND:VID:RAT? SEM:OFFS2:LIST:BAND:VID:RAT:AUTO ON, , ON, , ON, , ON, , ON SEM:OFFS2:LIST:BAND:VID:RAT:AUTO?</pre>
Notes	<p>Comma separated list of values.</p> <p>OFFSet1 is for BTS, 2 for MS. Default is BTS.</p> <p>You must be in the mode that includes SEM measurement to use this command. Use :INSTrument:SElect to set the mode.</p>
Preset	<p>For modes (except MSR, , LTEAFDD, , LTEATDD and WLAN) without option N9060A-7FP, , the preset value is as follows.</p> <p>SA, , WCDMA, , C2K, , LTE, , LTETDD: 0.01, , 0.01, , 0.01, , 0.01, , 0.01, , 0.01 0.01, , 0.01, , 0.01, , 0.01, , 0.01, , 0.01</p> <p>WIMAX OFDMA: 0.3, , 0.3, , 0.3, , 0.3, , 0.3</p> <p>TD-SCDMA: 10, , 10, , 10, , 10, , 1, , 1 10, , 10, , 10, , 1, , 1, , 1</p> <p>1xEVDO: 10, , 10, , 10, , 10, , 10, , 10 10, , 10, , 10, , 10, , 10</p> <p>DTMB (CTTB), , DVB-T/H, , CMMB, , Digital Cable TV: 10, , 10, , 10, , 10, , 10, , 10 10, , 10, , 10, , 10, , 10, , 10</p> <p>ISDB-T: 0.1, , 0.1, , 0.1, , 0.1, , 0.1, , 0.1 10, , 10, , 10, , 10, , 10, , 10</p> <p>When option N9060A-7FP is installed in these modes, , the preset value of Offset G ~ L is the same as the Offset F value.</p> <p>-----</p> <p>WLAN: 0.3, , 0.3, , 0.3, , 0.3, , 0.3, , 0.3, , 0.3, , 0.3, , 0.3, , 0.3, , 0.3</p> <p>MSR, , LTEAFDD, , LTEATDD: 0.01, , 0.01, , 0.01, , 0.01, , 0.01, , 0.01, , 0.01, , 0.01, , 0.01, , 0.01, , 0.01, , 0.01 0.01, , 0.01, , 0.01, , 0.01, , 0.01, , 0.01, , 0.01, , 0.01, , 0.01, , 0.01, , 0.01, , 0.01, , 0.01</p> <p>Modes (except MSR, , LTEAFDD, , LTEATDD and WLAN) without option N9060A-7FP: OFF, , OFF, , OFF, , OFF, , OFF OFF, , OFF, , OFF, , OFF, , OFF, , OFF, , OFF</p> <p>Modes (except MSR, , LTEAFDD, , LTEATDD and WLAN) with option N9060A-7FP: OFF, , OFF, , OFF, , OFF, , OFF, , OFF, , OFF, , OFF, , OFF, , OFF, , OFF OFF, , OFF, , OFF, , OFF, , OFF, , OFF, , OFF, , OFF, , OFF, , OFF, , OFF, , OFF, , OFF, , OFF, , OFF</p> <p>MSR, , LTEAFDD, , LTEATDD: OFF, , OFF, , OFF, , OFF, , OFF, , OFF, , OFF, , OFF, , OFF, , OFF, , OFF, , OFF OFF, , OFF, , OFF, , OFF, , OFF, , OFF, , OFF, , OFF, , OFF, , OFF, , OFF, , OFF, , OFF</p> <p>WLAN: OFF, , OFF, , OFF, , OFF, , OFF, , OFF, , OFF, , OFF, , OFF, , OFF, , OFF, , OFF OFF, , OFF, , OFF, , OFF, , OFF, , OFF, , OFF, , OFF, , OFF, , OFF, , OFF, , OFF, , OFF</p>

State Saved	Saved in instrument state.
Min	0.00001
Max	3000000
Initial S/W Revision	Prior to A.02.00
Modified at S/W Revision	A.02.00, A.03.00, A.10.00, A.11.00, A.14.00

Limits

Accesses a menu that enables you to set the power limits for start and stop frequencies of the selected offsets.

Key Path	Meas Setup
Initial S/W Revision	Prior to A.02.00

Select Offset

Selects the offset (upper and lower) and displays the memory selection menu that enables you to store a set of parameter values for the offset, such as Start Freq, Stop Freq, Sweep Time, Res BW, Meas BW, Abs Start, and Abs Stop. Only one selection at a time is shown on this menu key label.

Key Path	Meas Setup, Offset/Limits
Mode	SA, WCDMA, C2K, WIMAX OFDMA, TD-SCDMA, 1xEVDO, DTMB (CTTB), DVB-T/H, ISDB-T, CMMB, LTE, LTE-TDD, Digital Cable TV, WLAN, MSR, LTEAFDD, LTEATDD
Preset	A
Range	MSR, LTEATDD, LTEAFDD, WLAN: A B C D E F G H J K L Other modes without option N9060A-7FP: A B C D E F Other modes with option N9060A-7FP: A B C D E F G H J K L
Initial S/W Revision	Prior to A.02.00
Modified at S/W Revision	A.02.00, A.03.00, A.10.00, A.11.00, A.14.00

Abs Start

Sets the absolute power level limit at the start frequency for the selected offset. The absolute power level limit ranges from -200 to +50 dBm.

The fail condition for each offset channel is set remotely by [:SENSe]:SEMAsk:OFFSet[n]
[:OUTer]:LIST:TEST.

You can turn off (not use) specific offset channels remotely with [:SENSe]:SEMAsk:OFFSet[n]
[:OUTer]:LIST:STATe.

The SCPI query returns values currently set to the absolute power test limits.

Missing values are not permitted; that is, if you want to change values 2 and 6, you must send all values up to 6. Subsequent values will remain as they were. The query for this parameter always returns 12 values.

Key Path	Meas Setup, Offset/Limit, Limits
Mode	SA, WCDMA, C2K, WIMAX OFDMA, TD-SCDMA, 1xEVDO, DTMB (CTTB), DVB-T/H, ISDB-T, CMMB, LTE, LTETDD, Digital Cable TV, WLAN, MSR, LTEAFDD, LTEATDD
Remote Command	[:SENSe] :SEMAsk:OFFSet [1] 2 [:OUTer] :LIST:STARt:ABSolute <real>, ... [:SENSe] :SEMAsk:OFFSet [1] 2 [:OUTer] :LIST:STARt:ABSolute?
Example	SEM:OFFS2:LIST:STAR:ABS -12.50 dBm, , -12.50 dBm, , -24.50 dBm, , -11.50 dBm, , -11.50 dBm, , -11.50 dBm SEM:OFFS2:LIST:STAR:ABS?
Notes	Comma separated list of values. OFFSet1 is for BTS, 2 for MS. Default is BTS. You must be in the mode that includes SEM measurement to use this command. Use :INSTrument:SElect to set the mode.
Couplings	If the current mode is DVB-T/H, this value will be modified automatically according to the limit type and the output power of the transmitter which is less or more than 25W. If the current mode is ISDB-T, this value will be modified automatically according to the limit type.
Preset	For modes (except MSR, , LTEAFDD, , LTEATDD and WLAN) without option N9060A-7FP, , the preset value is as follows. SA, , WIMAX OFDMA: -14.00 dBm, , -14.00 dBm, , -26.00 dBm, , -13.00 dBm, , -13.00 dBm, , -13.00 dBm WCDMA: -12.50 dBm, , -12.50 dBm, , -24.50 dBm, , -11.50 dBm, , -11.50 dBm, , -11.50 dBm -69.6 dBm, , -54.3 dBm, , -54.3 dBm, , -54.3 dBm, , -54.3 dBm, , -54.3 dBm C2K: -27.00 dBm, , -27.00 dBm, , -27.00 dBm, , -46.00 dBm, , -13.00 dBm, , -13.00 dBm -70.13 dBm, , -70.13 dBm, , -35.00 dBm, , -13.00 dBm, , -13.00 dBm, , -13.00 dBm TD-SCDMA: -28 dBm, , -28 dBm, , -36 dBm, , -21 dBm, , -21 dBm, , -21 dBm -71.3 dBm, , -71.3 dBm, , -56.07 dBm, , -56.07 dBm, , -56.07 dBm, , -56.07 dBm 1xEVDO: -27.0dBm, , -27.00 dBm, , -27.00 dBm, , -46.00 dBm, , -13.00 dBm, , -13.00 dBm -70.13 dBm, , -70.13 dBm, , -70.13 dBm, , -70.13 dBm, , -70.13 dBm, , -70.13 dBm DTMB (CTTB): -14.0 dBm, , -14.0 dBm, , -26.0 dBm, , -13.0 dBm, , -13.0 dBm, , -13.0 dBm -13.0 dBm, , -13.0 dBm, , -13.0 dBm, , -13.0 dBm, , -13.0 dBm, , -13.0 dBm DVB-T/H: 11.2 dBm, , -29 dBm, , -41 dBm, , -66 dBm, , -82 dBm, , -82 dBm -82 dBm, , -82 dBm, , -82 dBm, , -82 dBm, ISDB-T, , CMMB, , Digital Cable TV: 50.0 dBm, , 50.0 dBm, , 50.0 dBm, , 50.0 dBm, , 50.0 dBm, , 50.0 dBm 50.0 dBm, , 50.0 dBm, , 50.0 dBm, , 50.0 dBm, , 50.0 dBm, , 50.0 dBm LTE, , LTETDD: -5.5 dBm, , -12.5 dBm, , -15.0 dBm, , -15.0 dBm, , -15.0 dBm, , -15.0 dBm -13.5 dBm, , -8.5 dBm, , -11.5 dBm, , -23.5 dBm, , -23.5 dBm, , -23.5 dBm When option N9060A-7FP is installed in these modes, , the preset value of Offset G ~ L is the same as the Offset F value. ----- WLAN: if Radio Std is 802.11a/g(OFDM/DSSS-OFDM): 16.00 dBm, , -4.00 dBm, , -12.00 dBm, , -

	24.00 dBm, , -24.00 dBm, , -24.00 dBm, , -24.00 dBm, , -24.00 dBm, , -24.00 dBm, , -24.00 dBm, , -24.00 dBm if Radio Std is 802.11b/g(DSSS/CCK/PBCC): -10 dBm, , -30 dBm, , -30 dBm, , -30 dBm, , -30 dBm, , -30 dBm, , -30 dBm, , -30 dBm, , -30 dBm, , -30 dBm, , -30 dBm, , -30 dBm if Radio Std is 802.11n(20MHz) or 802.11ac(20MHz): 16.00 dBm, , -4.00 dBm, , -12.00 dBm, , -63.00 dBm, , -63.00 dBm, , -63.00 dBm, , -63.00 dBm, , -63.00 dBm, , -63.00 dBm, , -63.00 dBm, , -63.00 dBm if Radio Std is 802.11n(40MHz) or 802.11ac(40MHz): 16.00 dBm, , -4.00 dBm, , -12.00 dBm, , -66.00 dBm, , -66.00 dBm, , -66.00 dBm, -66.00 dBm, , -66.00 dBm, , -66.00 dBm, , -66.00 dBm, -66.00 dBm, , -66.00 dBm if Radio Std is 802.11ac(80MHz/160MHz): 16.00 dBm, , -4.00 dBm, , -12.00 dBm, , -69.00 dBm, , -69.00 dBm, , -69.00 dBm, , -69.00 dBm, , -69.00 dBm, , -69.00 dBm, , -69.00 dBm, , -69.00 dBm, , -69.00 dBm if Radio Std is 802.11ac (80 MHz + 80 MHz): -69.00 dBm, , -69.00 dBm, , -69.00 dBm, , -69.00 dBm, , -69.00 dBm, , -69.00 dBm, , -69.00 dBm, , -69.00 dBm, , -69.00 dBm, , -69.00 dBm, , -69.00 dBm, , -69.00 dBm MSR: -12.5 dBm, , -12.5 dBm, , -24.5 dBm, , -11.5 dBm, , -15.0 dBm, , -15.0 dBm, , -15.0 dBm, , -15.0 dBm, , -15.0 dBm, , -15.0 dBm, , -15.0 dBm, , -12.5 dBm, , -12.5 dBm, , -24.5 dBm, , -11.5 dBm, , -15.0 dBm, , -15.0 dBm, , -15.0 dBm, , -15.0 dBm, , -15.0 dBm, , -15.0 dBm, , -15.0 dBm, , -15.0 dBm LTEAFDD, , LTEATDD: -5.5 dBm, , -12.5 dBm, , -15.0 dBm, , -15.0 dBm, , -15.0 dBm, , -15.0 dBm, , -15.0 dBm, , -15.0 dBm, , -15.0 dBm, , -15.0 dBm, , -15.0 dBm, , -13.5 dBm, , -8.5 dBm, , -11.5 dBm, , -23.5 dBm, , -23.5 dBm, , -23.5 dBm, , -23.5 dBm, , -23.5 dBm, , -23.5 dBm, , -23.5 dBm, , -23.5 dBm, , -23.5 dBm
State Saved	Saved in instrument state.
Min	-200 dBm
Max	50 dBm
Initial S/W Revision	Prior to A.02.00
Modified at S/W Revision	A.02.00, A.03.00, A.10.00, A.11.00, A.14.00

Abs Stop

Sets the absolute power level limit at the stop frequency for the selected offset. The absolute power level limit ranges from -200 to +50 dBm. You can also toggle this function between couple and manual. If set to Couple, the Abs Stop power level limit is coupled to Abs Start to result in a flat limit line. If set to Man, Abs Start and Abs Stop take different values to result in a sloped limit line.

The SCPI query returns values currently set to the offset stop absolute power limits.

Missing values are not permitted; that is, if you want to change values 2 and 6, you must send all values up to 6. Subsequent values will remain as they were. The query for this parameter always returns 12 values.

Key Path	Meas Setup, Offset/Limits, Limits
Mode	SA, WCDMA, C2K, WIMAX OFDMA, TD-SCDMA, 1xEVDO, DTMB (CTTB), DVB-T/H, ISDB-T, CMMB, LTE, LTE-TDD, Digital Cable TV, WLAN, MSR, LTEAFDD, LTEATDD

Remote Command	<pre>[:SENSe]:SEMAsk:OFFSet[1] 2[:OUTer]:LIST:STOP:ABSolute <real>, ... [:SENSe]:SEMAsk:OFFSet[1] 2[:OUTer]:LIST:STOP:ABSolute? [:SENSe]:SEMAsk:OFFSet[1] 2[:OUTer]:LIST:STOP:ABSolute:COUPle ON OFF 1 0, ... [:SENSe]:SEMAsk:OFFSet[1] 2[:OUTer]:LIST:STOP:ABSolute:COUPle?</pre>
Example	<pre>SEM:OFFS:LIST:STOP:ABS -12.50 dBm, , -24.50 dBm, , -24.50 dBm, , -11.50 dBm, , -11.50 dBm, , -11.50 dBm SEM:OFFS1:LIST:STOP:ABS? SEM:OFFS:LIST:STOP:ABS:COUP ON, , OFF, , ON, , ON, , ON, , ON SEM:OFFS:LIST:STOP:ABS:COUP?</pre>
Notes	<p>Comma separated list of values. OFFSet1 is for BTS, 2 for MS. Default is BTS. You must be in the mode that includes SEM measurement to use this command. Use :INSTrument:SElect to set the mode.</p>
Couplings	<p>Coupled to Abs Start if "Auto" is selected, that is, the Stop value is equal to the Start value. If the current mode is DVB-T/H, this value will be modified automatically according to the limit type and the output power of the transmitter which is less or more than 25W. If the current mode is ISDB-T, this value will be modified automatically according to the limit type.</p>
Preset	<p>For modes (except MSR, , LTEAFDD, , LTEATDD and WLAN) without option N9060A-7FP, , the preset value is as follows.</p> <pre>SA, , WIMAX OFDMA: -14.00 dBm, , -26.00 dBm, , -26.00 dBm, , -13.00 dBm, , -13.00 dBm, , - 13.00 dBm WCDMA: -12.50 dBm, , -24.50 dBm, , -24.50 dBm, , -11.50 dBm, , -11.50 dBm, , -11.50 dBm - 69.6 dBm, , -54.3 dBm, , -54.3 dBm, , -54.3 dBm, , -54.3 dBm, , -54.3 dBm C2K: -27.00 dBm, , -27.00 dBm, , -27.00 dBm, , -46.00 dBm, , -13.00 dBm, , -13.00 dBm - 70.13 dBm, , -70.13 dBm, , -35.00 dBm, , -13.00 dBm, , -13.00 dBm, , -13.00 dBm TD-SCDMA: -28 dBm, , -36 dBm, , -36 dBm, , -21 dBm, , -21 dBm, , -21 dBm -71.3 dBm, , -71.3 dBm, , -56.07 dBm, , -56.07 dBm, , -56.07 dBm, , -56.07 dBm 1xEVDO: -27dBm, , -27.00 dBm, , -27.00 dBm, , -46.00 dBm, , -13.00 dBm, , -13.00 dBm - 70.13 dBm, , -70.13 dBm, , -70.13 dBm, , -70.13 dBm, , -70.13 dBm, , -70.13 dBm DTMB (CTTB): -14.0 dBm, , -26.0 dBm, , -26.0 dBm, , -13.0 dBm, , -13.0 dBm, , -13.0 dBm - 13.0 dBm, , -13.0 dBm, , -13.0 dBm, , -13.0 dBm, , -13.0 dBm, , -13.0 dBm DVB-T/H: -29 dBm, , -41 dBm, , -66 dBm, , -82 dBm, , -82 dBm, , -82 dBm -82 dBm, , -82 dBm, , -82 dBm, , -82 dBm, , -82 dBm, , -82 dBm, ISDB-TCMMB, , Digital Cable TV: 50.0 dBm, , 50.0 dBm, , 50.0 dBm, , 50.0 dBm, , 50.0 dBm 50.0 dBm, , 50.0 dBm, , 50.0 dBm, , 50.0 dBm, , 50.0 dBm, , 50.0 dBm LTE, , LTETDD:-12.5 dBm, , -12.5 dBm, , -15.0 dBm, , -15.0 dBm, , -15.0 dBm, , -15.0 dBm - 13.5 dBm, , -8.5 dBm, , -11.5 dBm, , -23.5 dBm, , -23.5 dBm, , -23.5 dBm When option N9060A-7FP is installed in these modes, , the preset value of Offset G ~ L is the same as the Offset F value. ----- WLAN:</pre>

if Radio Std is 802.11a/g(OFDM/DSSS-OFDM): -4.00 dBm, , -12.00 dBm, , -24.00 dBm, , -24.00 dBm, , -24.00 dBm, , -24.00 dBm, , -24.00 dBm, , -24.00 dBm, , -24.00 dBm, , -24.00 dBm, , -24.00 dBm

if Radio Std is 802.11b/g(DSSS/CCK/PBCC): -10 dBm, , -30 dBm, , -30 dBm, , -30 dBm, , -30 dBm, , -30 dBm, , -30 dBm, , -30 dBm, , -30 dBm, , -30 dBm, , -30 dBm

if Radio Std is 802.11n(20MHz) or 802.11ac(20MHz): -4.00 dBm, , -12.00 dBm, , -24.00 dBm, , -63.00 dBm, , -63.00 dBm, , -63.00 dBm, , -63.00 dBm, , -63.00 dBm, , -63.00 dBm, , -63.00 dBm, , -63.00 dBm

if Radio Std is 802.11n(40MHz) or 802.11ac(40MHz): -4.00 dBm, , -12.00 dBm, , -24.00 dBm, , -66.00 dBm, , -66.00 dBm, , -66.00 dBm, , -66.00 dBm, , -66.00 dBm, , -66.00 dBm, , -66.00 dBm, , -66.00 dBm

if Radio Std is 802.11ac(80MHz/160MHz): -4.00 dBm, , -12.00 dBm, , -24.00 dBm, , -69.00 dBm, , -69.00 dBm, , -69.00 dBm, -69.00 dBm, , -69.00 dBm, , -69.00 dBm, -69.00 dBm, , -69.00 dBm

if Radio Std is 802.11ac (80 + 80 MHz): -69.00 dBm, , -69.00 dBm, , -69.00 dBm, , -69.00 dBm, , -69.00 dBm, , -69.00 dBm, , -69.00 dBm, , -69.00 dBm, , -69.00 dBm, , -69.00 dBm, , -69.00 dBm

MSR:-12.5 dBm, , -24.5 dBm, , -11.5 dBm, , -15.0 dBm, , -15.0 dBm, , -15.0 dBm, , -15.0 dBm, , -15.0 dBm, , -15.0 dBm, , -15.0 dBm, , -15.0 dBm, -12.5 dBm, , -24.5 dBm, , -11.5 dBm, , -15.0 dBm, , -15.0 dBm, , -15.0 dBm, , -15.0 dBm, , -15.0 dBm, , -15.0 dBm, , -15.0 dBm, , -15.0 dBm, , -15.0 dBm

LTEAFDD, , LTEATDD:-12.5 dBm, , -12.5 dBm, , -15.0 dBm, , -15.0 dBm, , -15.0 dBm, , -15.0 dBm, , -15.0 dBm, , -15.0 dBm, , -15.0 dBm, , -15.0 dBm, -13.5 dBm, , -8.5 dBm, , -11.5 dBm, , -23.5 dBm, , -23.5 dBm, , -23.5 dBm -23.5 dBm, , -23.5 dBm, , -23.5 dBm, , -23.5 dBm, , -23.5 dBm, , -23.5 dBm

For modes (except MSR, , LTEAFDD, , LTEATDD and WLAN) without option N9060A-7FP, , the preset value is as follows.

SA,WIMAX OFDMA: ON, OFF, ON, ON, ON, ON

WCDMA: ON, , OFF, , ON, , ON, , ON, , ON|ON, , ON, , ON, , ON, , ON

C2K: ON, , ON, , ON, , ON, , OFF|ON, , ON, , ON, , ON, , ON, , OFF

TD-SCDMA: ON, , OFF, , ON, , ON, , ON, , ON|ON, , ON, , ON, , ON, , ON, , ON

1xEVDO: ON, , ON, , ON, , ON, , ON, , OFF|ON, , ON, , ON, , ON, , ON, , OFF

DTMB (CTTB): ON, OFF, ON, ON, ON, ON

DVB-T/H, , ISDB-T, , CMMB, , Digital Cable TV: OFF, , OFF, , OFF, , OFF, , OFF, , OFF

LTE, , LTEATDD: OFF, , ON, , ON, , ON, , ON, , ON|ON, , ON, , ON, , ON, , ON, , ON

When option N9060A-7FP is installed in these modes, , the preset value of Offset G ~ L is the same as the Offset F value.

WLAN:

if Radio Std is 802.11a/g(OFDM/DSSS-OFDM)/802.11n(20MHz/40MHz)/802.11 ac (20MHz/40MHz/80MHz/160MHz): OFF, , OFF, , OFF, , ON, , ON, , ON, , ON, , ON, , ON, , ON, , ON, , ON

if Radio Std is 802.11 ac(80+80 MHz): ON, , ON, , ON, , ON, , ON, , ON, , ON, , ON, , ON, , ON, , ON, , ON

if Radio Std is 802.11b/g(DSSS/CCK/PBCC): ON, , ON, , ON, , ON, , ON, , ON, , ON, , ON, , ON, , ON, , ON, , ON

	, ON, , ON MSR: ON, , OFF, , OFF, , OFF, , ON, , OFF, , OFF, , OFF, , OFF, , OFF, , OFF ON, , OFF, , OFF, , OFF, , ON, , OFF, , OFF, , OFF, , OFF, , OFF, , OFF, , OFF, , OFF LTEAFDD, , LTEATDD: OFF, , ON, , ON, , ON, , ON, , ON, , ON, , ON, , ON, , ON, , ON ON, , ON, , ON, , ON, , ON, , ON, , ON, , ON, , ON, , ON, , ON
State Saved	Saved in instrument state.
Min	-200 dBm
Max	50 dBm
Initial S/W Revision	Prior to A.02.00
Modified at S/W Revision	A.02.00, A.03.00, A.10.00, A.11.00, A.14.00

Rel Start

Sets a relative power level limit at the start frequency for the selected offset. The relative power level limit ranges from -200 to +50 dBc.

The fail condition is set remotely by [:SENSE]:SEMAsk:OFFSet[n][:OUTer]:LIST:TEST for each offset channel test.

You can turn off (not use) specific offset channels remotely with [:SENSE]:SEMAsk:OFFSet[n][:OUTer]:LIST:STATe.

The SCPI query returns values currently set to the relative power test limits.

Missing values are not permitted; that is, if you want to change values 2 and 6, you must send all values up to 6. Subsequent values will remain as they were. The query for this parameter always returns 12 values.

Key Path	Meas Setup, Offset/Limits, Limits
Mode	SA, WCDMA, C2K, WIMAX OFDMA, TD-SCDMA, 1xEVDO, DTMB (CTTB), DVB-T/H, ISDB-T, CMMB, LTE, LTE-TDD, Digital Cable TV, WLAN, MSR, LTEAFDD, LTEATDD
Remote Command	[:SENSE]:SEMAsk:OFFSet[1] 2[:OUTer]:LIST:STARt:RCARrier <rel_ampl>, ... [:SENSE]:SEMAsk:OFFSet[1] 2[:OUTer]:LIST:STARt:RCARrier?
Example	SEM:OFFS:LIST:STAR:RCAR -30, , -30, , -30, , -30, , -30, , -30 SEM:OFFS:LIST:STAR:RCAR?

Notes

Comma separated list of values.
OFFSet1 is for BTS, 2 for MS. Default is BTS.
You must be in the mode that includes SEM measurement to use this command. Use :INSTRument:SElect to set the mode.

Couplings

If the current mode is DVB-T/H, this value will be modified automatically according to the limit type the output power of the transmitter which is less or more than 25W.
If the current mode is ISDB-T, this value will be modified automatically according to the limit type.
If the current mode is WLAN and radio std is 802.11n, Rel Start limits will be set to following values

when frequency changed to above 5GHz:

0 dB, -20.00 dB, -28.00 dB, -40.00 dB, -40.00 dB, -40.00 dB, -40.00 dB, -40.00 dB, -40.00 dB, -40.00 dB, -40.00 dB, -40.00 dB

Preset

For modes (except MSR, LTEAFDD, LTEATDD and WLAN) without option N9060A-7FP, the preset value is as follows.

SA: -30.00 dB, -30.00 dB, -30.00 dB, -30.00 dB, -30.00 dB, -30.00 dB

WCDMA: -30.00 dB, -30.00 dB, -30.00 dB, -30.00 dB, -30.00 dB, -30.00 dB, -30.00 dB, -30.00 dB, -33.73 dB, -34.00 dB, -37.50 dB, -47.50 dB, -47.50 dB, -47.50 dB

C2K: -45.00 dB, -45.00 dB, -55.00 dB, -55.00 dB, -55.00 dB, -55.00 dB, -55.00 dB, -55.00 dB, -42.00 dB, -54.00 dB, -54.00 dB, -54.00 dB, -54.00 dB, -54.00 dB

WIMAX OFDMA: 0 dB, -25 dB, -32 dB, -50 dB, -50 dB, -50 dB

TD-SCDMA: -54.00 dB, -54.00 dB, -62.00 dB, -47.00 dB, -47.00 dB, -47.00 dB, -47.00 dB, -47.00 dB, -49.00 dB, -44.00 dB, -44.00 dB, -44.00 dB, -44.00 dB, -44.00 dB

1xEVDO: -45dBc, -45.00 dB, -55.00 dB, -55.00 dB, -55.00 dB, -55.00 dB, -55.00 dB, -55.00 dB, -42dBc, -54.00 dB, -54.00 dB, -54.00 dB, -54.00 dB, -54.00 dB

DTMB (CTTB): -32.8 dB, -83 dB, -95 dB, -120 dB, -120 dB, -120 dB, -120 dB, -120 dB, -120 dB, -120 dB, -120 dB, -120 dB, -120 dB, -120 dB

DVB-T/H: -30 dB, -30 dB, -30 dB, -30 dB, -30 dB, -30 dB, -30 dB, -30 dB, -30 dB, -30 dB, -30 dB, -30 dB, -30 dB, -30 dB, -30 dB

ISDB-T: -27.4 dB, -47.4 dB, -54.4 dB, XXX, 50 dB, 50 dB, 50 dB, 50 dB, 50 dB, 50 dB, 50 dB, 50 dB, 50 dB, 50 dB, 50 dB; XXX is coupled with the total power reference, it is -57.4 dB when $P \leq 0.025 W$, -67.4 dB when $P = 0.25 W$, $-(73.4 + 10 \log P)$ dB when $0.25 W < P < 2.5 W$ or $0.025 W < P < 0.25 W$, -77.4 dB when $P > 2.5 W$.

CMMB: -37 dB, -72 dB, -84 dB, -90 dB, -90 dB, -90 dB, -90 dB, -90 dB, -90 dB, -90 dB, -90 dB, -90 dB, -90 dB, -90 dB, -90 dB

LTE, LTEATDD: 0 dB, 0 dB, 0 dB, 0 dB, 0 dB, 0 dB, 0 dB, 0 dB, 0 dB, 0 dB, 0 dB, 0 dB, 0 dB, 0 dB, 0 dB

Digital Cable TV: 0 dB, 0 dB, 0 dB, 0 dB, 0 dB, 0 dB, 0 dB, 0 dB, 0 dB, 0 dB, 0 dB, 0 dB, 0 dB, 0 dB, 0 dB

When option N9060A-7FP is installed in these modes, the preset value of Offset G ~ L is the same as the Offset F value.

WLAN:

if Radio Std is 802.11a/g(OFDM/DSSS-OFDM): 0 dB, -20.00 dB, -28.00 dB, -40.00 dB, -40.00 dB, -47.00 dB, -47.00 dB, -47.00 dB, -47.00 dB, -47.00 dB, -47.00 dB, -47.00 dB, -47.00 dB, -47.00 dB, -47.00 dB

if Radio Std is 802.11b/g(DSSS/CCK/PBCC): -30 dB, -50 dB, -50 dB, -50 dB, -50 dB, -50 dB, -50 dB, -50 dB, -50 dB, -50 dB, -50 dB, -50 dB, -50 dB, -50 dB, -50 dB

if Radio Std is 802.11n(20MHz/40MHz): 0 dB, -20.00 dB, -28.00 dB, -45.00 dB, -45.00 dB, -45.00 dB, -45.00 dB, -45.00 dB, -45.00 dB, -45.00 dB, -45.00 dB, -45.00 dB, -45.00 dB, -45.00 dB, -45.00 dB

if Radio Std is 802.11ac (20 MHz/ 40 MHz/ 80 MHz/ 160 MHz): 0 dB, -20.00 dB, -28.00 dB, -40.00 dB, -40.00 dB, -40.00 dB, -40.00 dB, -40.00 dB, -40.00 dB, -40.00 dB, -40.00 dB, -40.00 dB, -40.00 dB, -40.00 dB, -40.00 dB

if Radio Std is 802.11ac(80 MHz + 80MHz): -40.00 dB, -28.00 dB, -20 dB, 0 dB, -20 dB, -28 dB, -40 dB, -40 dB, -40.00 dB, -40.00 dB, -40.00 dB, -40.00 dB, -40.00 dB, -40.00 dB, -40.00 dB

MSR, LTEAFDD, LTEATDD: 0 dB, 0 dB, 0 dB, 0 dB, 0 dB, 0 dB, 0 dB, 0 dB, 0 dB, 0 dB, 0 dB, 0 dB, 0 dB, 0 dB, 0 dB

	0 dB, , 0 dB 0 dB, , 0 dB, , 0 dB, , 0 dB, , 0 dB, , 0 dB, , 0 dB, , 0 dB, , 0 dB, , 0 dB, , 0 dB
State Saved	Saved in instrument state.
Min	-200 dB
Max	50 dB
Initial S/W Revision	Prior to A.02.00
Modified at S/W Revision	A.02.00, A.03.00, A.10.00, A.11.00, A.14.00

Rel Stop

Sets a relative power level limit at the stop frequency for the selected offset. The relative power level limit ranges from -200 to +50 dBc.

The fail condition is set remotely by [:SENSe]:SEMask:OFFSet[n][:OUTer]:LIST:TEST for each offset channel.

You can turn off (not use) specific offset channels remotely with [:SENSe]:SEMask:OFFSet[n][:OUTer]:LIST:STATe.

The SCPI query returns values currently set to the offset stop relative power limits.

Missing values are not permitted; that is, if you want to change values 2 and 6, you must send all values up to 6. Subsequent values will remain as they were. The query for this parameter always returns 12 values.

Key Path	Meas Setup, Offset/Limits, Limits
Mode	SA, WCDMA, C2K, WIMAX OFDMA, TD-SCDMA, 1xEVDO, DTMB (CTTB), DVB-T/H, ISDB-T, CMMB, LTE, LTE-TDD, Digital Cable TV, WLAN, MSR, LTEAFDD, LTEATDD
Remote Command	[:SENSe]:SEMask:OFFSet[1] 2[:OUTer]:LIST:STOP:RCARrier <rel_ampl>, ... [:SENSe]:SEMask:OFFSet[1] 2[:OUTer]:LIST:STOP:RCARrier? [:SENSe]:SEMask:OFFSet[1] 2[:OUTer]:LIST:STOP:RCARrier:COUPle ON OFF 1 0, ... [:SENSe]:SEMask:OFFSet[1] 2[:OUTer]:LIST:STOP:RCARrier:COUPle?
Example	SEM:OFFS:LIST:STOP:RCAR -30, , -30, , -30, , -30, , -30, , -30 SEM:OFFS:LIST:STOP:RCAR? SEM:OFFS:LIST:STOP:RCAR:COUP ON, , ON, , ON, , ON, , ON SEM:OFFS:LIST:STOP:RCAR:COUP?
Notes	Comma separated list of values. OFFSet1 is for BTS, 2 for MS. Default is BTS. You must be in the mode that includes SEM measurement to use this command. Use :INSTrument:SElect to set the mode.
Couplings	Coupled to Rel Start if "Auto" is selected, that is, Start is made the same as Stop. If the current mode is DVB-T/H, this value will be modified automatically according to the limit type and the output power of the transmitter which is less or more than 25W. If the current mode is ISDB-T, this value will be modified automatically according to the limit type.

If the current mode is WLAN and radio std is 802.11n, Rel Stop limits will be set to following values when frequency changed to above 5GHz:
-20.00 dB, -28.00 dB, -40.00 dB, -40.00 dB, -40.00 dB, -40.00 dB, -40.00 dB, -40.00 dB, -40.00 dB, -40.00 dB, -40.00 dB, -40.00 dB

Preset

For modes (except MSR, , LTEAFDD, , LTEATDD and WLAN) without option N9060A-7FP, , the preset value is as follows.
SA: -30.00 dB, , -30.00 dB, , -30.00 dB, , -30.00 dB, , -30.00 dB, , -30.00 dB
WCDMA: -30.00 dB, , -30.00 dB, , -30.00 dB, , -30.00 dB, , -30.00 dB, , -30.00 dB|-48.28 dB, , -37.50 dB, , -47.50 dB, , -47.50 dB, , -47.50 dB, , -47.50 dB
C2K: -45.00 dB, , -45.00 dB, , -55.00 dB, , -55.00 dB, , -55.00 dB, , -55.00 dB|-42.00 dB, , -54.00 dB, , -54.00 dB, , -54.00 dB, , -54.00 dB, , -54.00 dB
WIMAX OFDMA: -25 dB, , -32 dB, , -50 dB, , -50 dB, , -50 dB, , -50 dB
TD-SCDMA: -54.00 dB, , -62.00 dB, , -62.00 dB, , -47.00 dB, , -47.00 dB, , -47.00 dB|-49.00 dB, , -58.945 dB, , -44.00 dB, , -44.00 dB, , -44.00 dB, , -44.00 dB
1xEVDO: -45dB, , -45.00 dB, , -55.00 dB, , -55.00 dB, , -55.00 dB, , -55.00 dB|-42dB, , -54.00 dB, , -54.00 dB, , -54.00 dB, , -54.00 dB
DTMB (CTTB): -83 dB, , -95 dB, , -120 dB, , -120 dB, , -120 dB, , -120 dB|-120 dB, , -120 dB, , -120 dB, , -120 dB, , -120 dB
DVB-T/H: -73 dB, , -85 dB, , -110 dB, , -126 dB, , -126 dB, , -126 dB|-126 dB, , -126 dB, , -126 dB, , -126 dB, , -126 dB
ISDB-T: -47.4 dB, , -54.4 dB, , XXX, , 50 dB, , 50 dB, , 50 dB |50 dB, , 50 dB, , 50 dB, , 50 dB, , 50 dB, , 50 dB; XXX is coupled with the total power reference P, it is -57.4 dB when $P \leq 0.025$ W, , -67.4 dB when $P = 0.25$ W, , $-(73.4 + 10 \log P)$ dB when 0.25 W < $P \leq 2.5$ W or 0.025 W < $P < 0.25$ W, , -77.4 dB when $P > 2.5$ W.
CMMB: -72 dB, , -84 dB, , -90 dB, , -90 dB, , -90 dB, , -90 dB|-90 dB, , -90 dB, , -90 dB, , -90 dB, , -90 dB
LTE, , LTETDD: 0 dB, , 0 dB, , 0 dB, , 0 dB, , 0 dB, , 0 dB
Digital Cable TV: 0 dB, , 0 dB, , 0 dB, , 0 dB, , 0 dB, , 0 dB |0 dB, , 0 dB, , 0 dB, , 0 dB, , 0 dB, , 0 dB
When option N9060A-7FP is installed in these modes, , the preset value of Offset G ~ L is the same as the Offset F value.

WLAN:
if Radio Std is 802.11a/g(OFDM/DSSS-OFDM): -20.00 dB, , -28.00 dB, , -40.00 dB, , -40.00 dB, , -47.00 dB, , -47.00 dB, , -47.00 dB, , -47.00 dB, , -47.00 dB, , -47.00 dB, , -47.00 dB, , -47.00 dB
if Radio Std is 802.11b/g(DSSS/CCK/PBCC): -30 dB, , -50 dB, , -50 dB, , -50 dB, , -50 dB, , -50 dB, , -50 dB, , -50 dB, , -50 dB, , -50 dB, , -50 dB
if Radio Std is 802.11n(20MHz/40MHz): -20.00 dB, , -28.00 dB, , -45.00 dB, , -45.00 dB, , -45.00 dB, , -45.00 dB, , -45.00 dB, , -45.00 dB, , -45.00 dB, , -45.00 dB, , -45.00 dB
if Radio Std is 802.11ac (20 MHz/ 40 MHz/ 80 MHz/ 160 MHz): -20.00 dB, , -28.00 dB, , -40.00 dB, , -40.00 dB, , -40.00 dB, , -40.00 dB, , -40.00 dB, , -40.00 dB, , -40.00 dB, , -40.00 dB, , -40.00 dB, , -40.00 dB
if Radio Std is 802.11ac(80 MHz + 80MHz): -28.00 dB, , -20.00 dB, , 0 dB, , -20.00 dB, , -28.00

- OR checks against both limits, failing if either of the limits is broken.
- AND will only display a fail if both of the limits are broken.

The absolute or relative power limit value for each offset channel can be set remotely with [:SENSe]:SEMask:OFFSet[n][:OUTer]:LIST:ABSolute or [:SENSe]:SEMask:OFFSet[n][:OUTer]:LIST:RCARrier.

You can turn off (not use) specific offset channels remotely with [:SENSe]:SEMask:OFFSet[n][:OUTer]:LIST:STATe.

Missing values are not permitted; that is, if you want to change values 2 and 6, you must send all values up to 6. Subsequent values will remain as they were. The query for this parameter always returns 12 values.

Key Path	Meas Setup, Offset/Limits, Limits
Mode	SA, WCDMA, C2K, WIMAX OFDMA, TD-SCDMA, 1xEVDO, DTMB (CTTB), DVB-T/H, ISDB-T, CMMB, LTE, LTEFDD, Digital Cable TV, WLAN, MSR, LTEAFDD, LTEATDD
Remote Command	[:SENSe]:SEMask:OFFSet[1] 2[:OUTer]:LIST:TEST ABSolute AND OR RELative, ... [:SENSe]:SEMask:OFFSet[1] 2[:OUTer]:LIST:TEST?
Example	SEM:OFFS:LIST:TEST ABS, , ABS, , ABS, , ABS, , ABS, , ABS SEM:OFFS:LIST:TEST?
Notes	Comma separated list of values. You must be in the mode that includes SEM measurement to use this command. Use :INSTrument:SElect to set the mode.
Couplings	None If the current mode is DVB-T/H, this value will be modified automatically according to the limit type and the output power of the transmitter which is less or more than 25W.
Preset	For modes (except MSR, LTEAFDD, , LTEATDD and WLAN) without option N9060A-7FP, , the preset value is as follows. SA: ABS, ABS, ABS, ABS, ABS, ABS, ABS WCDMA: ABS, , ABS, , ABS, , ABS, , ABS AND, , AND, , AND, , AND, , AND C2K: REL, , REL, , REL, , ABS, , REL, , REL AND, , AND, , ABS, , REL, , REL, , REL WIMAX OFDMA: REL, , REL, , REL, , REL, , REL REL, , REL, , REL, , REL, , REL TD-SCDMA: ABS, , ABS, , ABS, , ABS, , ABS AND, , AND, , AND, , AND, , AND 1xEVDO: REL, , REL, , REL, , ABS, , REL, , REL AND, , AND, , AND, , OR, , AND, , AND DTMB (CTTB), ISDB-T, CMMB: REL, , REL, , REL, , REL, , REL REL, , REL, , REL, , REL, , REL, , REL DVB-T/H: ABS, , ABS, , ABS, , ABS, , ABS ABS, , ABS, , ABS, , ABS, , ABS LTE, , LTDTDD: ABS, , ABS, , ABS, , ABS, , ABS, , ABS Digital Cable TV: REL, , REL, , REL, , REL, , REL REL, , REL, , REL, , REL, , REL When option N9060A-7FP is installed in these modes, , the preset value of Offset G ~ L is the same as the Offset F value. ----- WLAN:

	if Radio Std is 802.11a/g(OFDM/DSSS-OFDM) or 802.11b/g(DSSS/CCK/PBCC): REL, , REL, , REL, , REL, , REL, , REL, , REL, , REL, , REL, , REL, , REL
	if Radio Std is 802.11n(20MHz/40MHz): REL, , REL, , REL, , AND, , AND, , AND, , AND, , AND, , AND, , AND, , AND
	if Radio Std is 802.11ac (20 MHz/ 40 MHz/ 80 MHz/ 160 MHz): REL, , REL, , REL, , AND, , AND, , AND, , AND, , AND, , AND, , AND, , AND, , AND
	if Radio Std is 802.11ac (80 MHz + 80MHz): REL, , REL, , REL, , REL, , REL, , REL, , AND, , AND, , AND, , AND, , AND, , AND
	MSR, , LTEAFDD, , LTEATDD: ABS, , ABS, , ABS, , ABS, , ABS, , ABS, , ABS, , ABS, , ABS, , ABS, , ABS, , ABS

State Saved	Saved in instrument state.
Range	Absolute Relative Abs AND Rel Abs OR Rel
Initial S/W Revision	Prior to A.02.00
Modified at S/W Revision	A.02.00, A.03.00, A.10.00, A.11.00, A.14.00

Offset Freq Define

This key enables you to select “Offset” definition. Each standard defines each “Offset” from Carrier.

Meas BW Edge means the edge of resolution band width that is represented by Meas BW and Res BW settings. Actual center frequency of Meas BW and the limit line have ½ Meas BW offset when the Meas BW Edge is selected.

3GPP2 requires the “Carrier Center to Meas BW Edge” definition. LTE conformance test requires “Carrier Edge to Meas BW Center” and/or “Carrier Edge to Meas BW Edge” definition

- **CTOCenter** – From carrier center to the center of offset measuring filter*
- **CTOEdge** – From carrier center to the nominal –3 dB point of the offset measuring filter* closer to the carrier
- **ETOCenter** – From Center Frequency – Span of Ref Channel / 2 (for lower offset), Center Frequency + Span of Ref Channel / 2 (for upper offset) of the carrier closest to each offset to the center of offset measuring filter*
- **ETOEdge** – From Center Frequency – Span of Ref Channel / 2 (for lower offset), Center Frequency + Span of Ref Channel / 2 (for upper offset) of the carrier closest to each offset to the nominal –3 dB point of the offset measuring filter* closer to the carrier

*Measuring filter = Meas BW (N) x Res BW

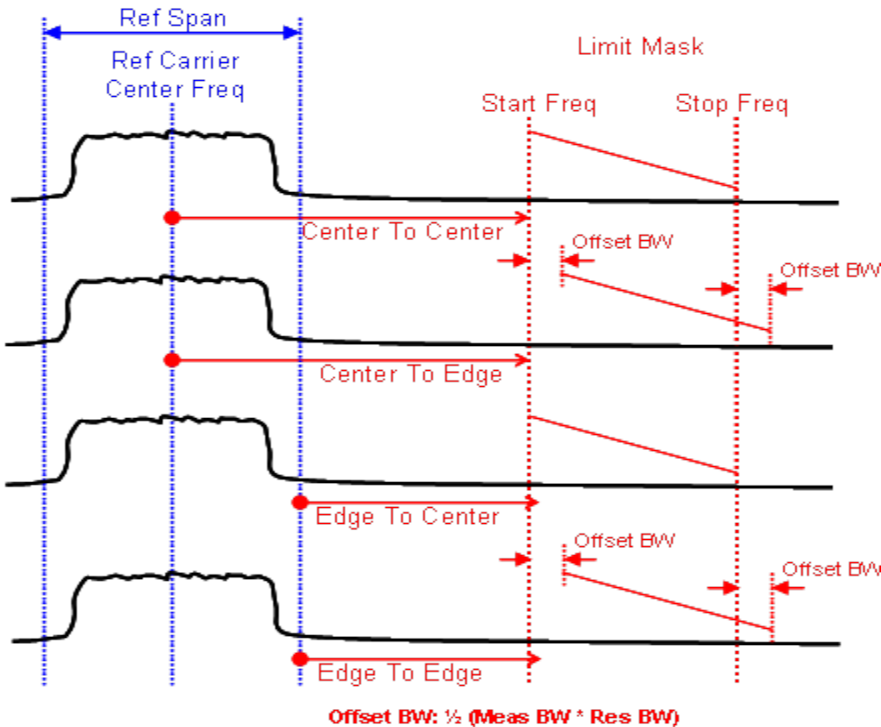
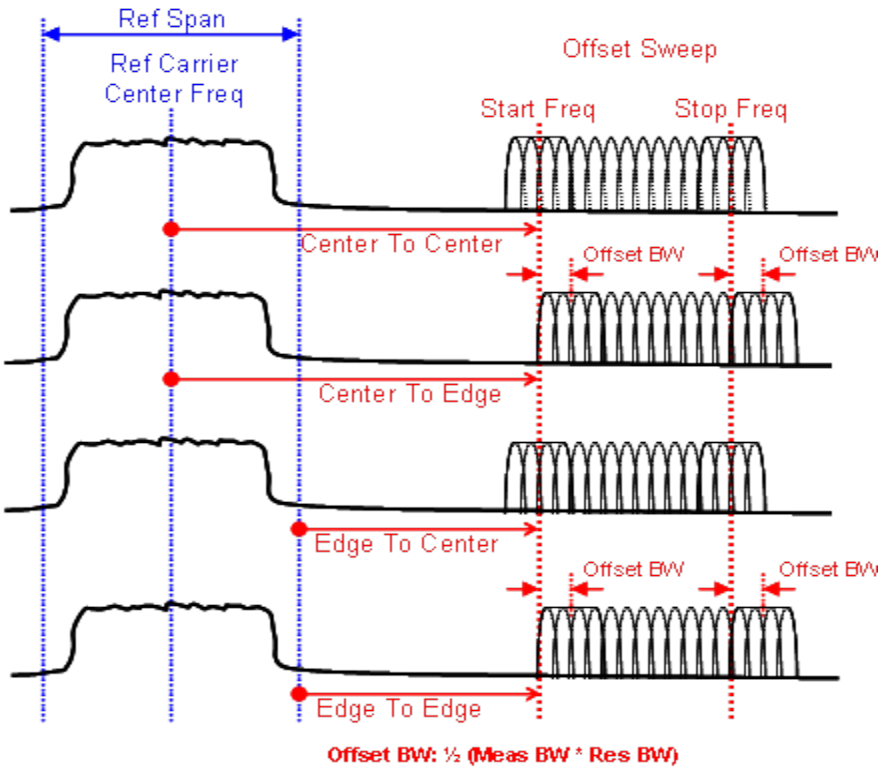

Key Path	Meas Setup, Offset/Limits
Mode	SA, WCDMA, C2K, WIMAX OFDMA, TD-SCDMA, 1xEVDO, DVB-T/H, DTMB (CTTB), ISDB-T, CMMB, LTE, LTETDD, Digital Cable TV, WLAN
Remote Command	[:SENSe] :SEMAsk:OFFSet [1] 2 :TYPE CTOCenter CTOEdge ETOCenter ETOEdge [:SENSe] :SEMAsk:OFFSet [1] 2 :TYPE?
Example	SEM:OFFS:TYPE ETOC SEM:OFFS:TYPE?
Notes	You must be in the mode that includes SEM measurements to use this command. Use :INSTrument:SElect to set the mode. For the MSR and LTE-Advanced FDD/TDD mode, see Offset Freq Define (Only for MSR and LTE-Advanced FDD/TDD) .
Preset	SA, , WCDMA, , WIMAX OFDMA, , TD-SCDMA, , DVB-T/H, , DTMB (CTTB), , ISDB-T, , CMMB, , Digital Cable TV: CTOC C2K: CTOE 1xEVDO: CTOE LTE: ETOC LTETDD: ETOC
State Saved	Saved in instrument state.
Range	Carrier Center To Meas BW Center Carrier Center To Meas BW Edge Carrier Edge To Meas BW Center Carrier Edge To Meas BW Edge
Initial S/W Revision	A.03.00

80+80 MHz Mask (Only for WLAN)

The key “80+80 MHz Mask” is visible only when the license for 802.11 ac format is available, and is only enabled when the radio standard is 802.11ac (80 MHz + 80 MHz). The mask lines could be drawn in two different ways, according to the IEEE 802.11ac standard (entry 22.3.18.1) when the key’s value is “Auto”; or by the user-defined specifications listed in the Offset/Limits menu.

Key Path	Meas Setup
Mode	WLAN
Remote Command	[:SENSe] :SEMAsk:T80Mask:AUTO ON OFF 1 0 [:SENSe] :SEMAsk:T80Mask:AUTO?
Example	SEM:T80M:AUTO 1 SEM:T80M:AUTO?
Notes	You must be in the WLAN mode to use this command. Use :INSTrument:SElect to set the mode.
Dependencies	See Couplings
Couplings	When the value of the “80+80 MHz Mask” key is Auto, the offset frequencies and the offset relative limits are calculated based on the spacing between the center frequencies of the two carriers according to the IEEE 802.11ac standard. All the keys except “Offset”, “Relative Atten”, “Offset Side” and “Limits” displayed on the “Offset/Limits” panel gray out. All the keys displayed on the “Limits”

panel gray out as well. On top of that, the displayed values of the keys on the “Offset/Limits” panel are not used in the measurement! On top of that, the channel span will be set to the value satisfying the equations below if its previous value is less than the value calculated through the equations.

$$\text{Chan Span} = \text{spacing between the two carriers} + \text{Chan IntegBW};$$
 When the value of the 80+80 MHz Mask key is Man, the keys that were previously grayed out will be enabled again.

State Saved	Saved in instrument state.
Range	Auto Man

Method

Sets the measurement method:

- **Integ BW**—enables you to set the channel integration bandwidth.
- **RRC Weight**—selects Root Raised Cosine (RRC) filtering of the carriers. The α value (rolloff) for the filter is set to the value of the Filter Alpha parameter.

Key Path	Meas Setup
Mode	SA, WCDMA, WIMAX OFDMA, TD-SCDMA, DTMB (CTTB), DVB-T/H, ISDB-T, CMMB, LTE, LTETDD, Digital Cable TV, WLAN, MSR, LTEAFDD, LTEATDD
Remote Command	[:SENSe] :SEMAsk:FILTer [:RRC] [:STATe] OFF ON 0 1 [:SENSe] :SEMAsk:FILTer [:RRC] [:STATe] ?
Example	SEM:FILT ON SEM:FILT?
Notes	For the C2K and 1xEVDO mode, this key is not available. 1 ON = RRC Weight, 0 OFF = IntegBW You must be in the mode that includes SEM measurement to use this command. Use :INSTrument:SElect to set the mode.
Dependencies	WLAN: RRC Weight is not supported when the radio standard is WLAN 802.11ac (80+80MHz).
Preset	SA, , WIMAX OFDMA, , DVB-T/H, , ISDB-T, , CMMB, , LTE, , LTETDD, , WLAN, , MSR, , LTEAFDD, , LTEATDD: OFF WCDMA, , TD-SCDMA, , DTMB (CTTB), , Digital Cable TV: ON
State Saved	Saved in instrument state.
Range	RRCWeight IntegBW
Initial S/W Revision	Prior to A.02.00
Modified at S/W Revision	A.02.00, A.03.00

Filter Alpha

Sets the alpha value for the RRC Filter.

Key Path	Meas Setup
Mode	SA, WCDMA, WIMAX OFDMA, TD-SCDMA, DTMB (CTTB), DVB-T/H, ISDB-T, CMMB, LTE, LTETDD, Digital Cable TV, MSR, LTEAFDD, LTEATDD
Remote Command	<code>[:SENSe] :SEMAsk:FILTer [:RRC] :ALPHa <real></code> <code>[:SENSe] :SEMAsk:FILTer [:RRC] :ALPHa?</code>
Example	SEM:FILT:ALPH 0.3 SEM:FILT:ALPH?
Notes	For the C2K and 1xEVDO mode, this key is not available. You must be in the mode that includes SEM measurement to use this command. Use :INSTrument:SElect to set the mode.
Preset	0.22 DTMB (CTTB): 0.05 Digital Cable TV: 0.15
State Saved	Saved in instrument state.
Min	0.01
Max	1.0
Initial S/W Revision	Prior to A.02.00
Modified at S/W Revision	A.02.00, A.03.00

Meas Preset

Restores all the measurement parameters to their default values.

Key Path	Meas Setup
Mode	SA, WCDMA, C2K, WIMAX OFDMA, TD-SCDMA, 1xEVDO, DTMB (CTTB), DVB-T/H, ISDB-T, CMMB, LTE, LTETDD, Digital Cable TV, WLAN, MSR, LTEAFDD, LTEATDD
Remote Command	<code>:CONFIgure:SEMAsk</code>
Example	CONF:SEM
Notes	You must be in the mode that includes SEM measurement to use this command. Use :INSTrument:SElect to set the mode.
Couplings	Selecting Meas Preset will restore all measurement parameters to their default values.
Initial S/W Revision	Prior to A.02.00
Modified at S/W Revision	A.02.00, A.03.00

Mode

See "Mode" on page 288

Mode Preset

Returns the active mode to a known state.

Mode Preset does the following for the currently active mode:

- Aborts the currently running measurement.
- Brings up the default menu for the mode, with no active function.
- Sets measurement Global settings to their preset values for the active mode only.
- Activates the default measurement.
- Brings up the default menu for the mode.
- Clears the input and output buffers.
- Sets Status Byte to 0.

Mode Preset does not:

- Cause a mode switch
- Affect mode persistent settings
- Affect system settings
- See "[How-To Preset](#)" on page 1105 for more information.

Key Path	Front-panel key
Remote Command	:SYSTem:PRESet
Example	:SYST:PRES
Notes	*RST is preferred over :SYST:PRES for remote operation. *RST does a Mode Preset, as done by the :SYST:PRES command, and it sets the measurement mode to Single measurement rather than Continuous for optimal remote control throughput. Clears all pending OPC bits. The Status Byte is set to 0.
Couplings	A Mode Preset aborts the currently running measurement, activates the default measurement, and gets the mode to a consistent state with all of the default couplings set.
Backwards Compatibility Notes	In the X-Series, the legacy "Factory Preset" has been replaced with Mode Preset, which only presets the currently active mode, not the entire instrument. In the X-Series, the way to preset the entire instrument is by using System, Restore System Defaults All, which behaves essentially the same way as restore System Defaults does on ESA and PSA. There is also no "Preset Type" as there is on the PSA. There is a green Mode Preset front-panel key that does a Mode Preset and a white-with-green-letters User Preset front-panel key that does a User Preset. The old PRESet:TYPE command is ignored (without generating an error), and SYST:PRES without a parameter does a Mode Preset, which should cover most backward code compatibility issues. The settings and correction data under the Input/Output front-panel key (examples: Input Z Corr, Ext Amp Gain, etc.) are no longer part of any Mode, so they will not be preset by a Mode Preset. They are preset using Restore Input/Output Defaults, Restore System Defaults All. Note that because User Preset does a Recall State, and all of these settings are saved in State, they ARE recalled when using

	User Preset.
Initial S/W Revision	Prior to A.02.00

How-To Preset

The table below shows all possible presets, their corresponding SCPI commands and front-panel access (key paths). Instrument settings depend on the current measurement context. Some settings are local to the current measurement, some are global (common) across all the measurements in the current mode, and some are global to all the available modes. In a similar way, restoring the settings to their preset state can be done within the different contexts.

Auto Couple - is a measurement local key. It sets all Auto/Man parameter couplings in the measurement to Auto. Any Auto/Man selection that is local to other measurements in the mode will not be affected.

Meas Preset - is a measurement local key. Meas Preset resets all the variables local to the current measurement except the persistent ones.

Mode Preset - resets all the current mode's measurement local and measurement global variables except the persistent ones.

Restore Mode Defaults - resets ALL the Mode variables (and all the Meas global and Meas local variables), including the persistent ones.

Type Of Preset	SCPI Command	Front Panel Access
Auto Couple	:COUPlE ALL	Auto Couple front-panel key
Meas Preset	:CONFIgure:<Measurement>	Meas Setup Menu
Mode Preset	:SYSTem:PRESet	Mode Preset (green key)
Restore Mode Defaults	:INSTrument:DEFault	Mode Setup Menu
Restore All Mode Defaults	:SYSTem:DEFault MODEs	System Menu; Restore System Default Menu
*RST	*RST	not possible (Mode Preset with Single)
Restore Input/Output Defaults	:SYSTem:DEFault INPut	System Menu; Restore System Default Menu
Restore Power On Defaults	:SYSTem:DEFault PON	System Menu; Restore System Default Menu
Restore Alignment Defaults	:SYSTem:DEFault ALIGn	System Menu; Restore System Default Menu
Restore Miscellaneous Defaults	:SYSTem:DEFault MISC	System Menu; Restore System Default Menu
Restore All System Defaults	:SYSTem:DEFault [ALL] :SYSTem:PRESet:PERSistent	System Menu; Restore System Default Menu
User Preset	:SYSTem:PRESet:USER	User Preset Menu
User Preset All Modes	:SYSTem:PRESet:USER:ALL	User Preset Menu

11 Spectrum Emission Mask Measurement
Mode Preset

Power On Mode Preset	:SYSTem:PON:TYPE MODE	System Menu
Power On User Preset	:SYSTem:PON:TYPE USER	System Menu
Power On Last State	:SYSTem:PON:TYPE LAST	System Menu

Mode Setup

See "Mode Setup" on page 320

Peak Search

There is no 'Peak Search' supported in Spectrum Emission Mask so this front-panel key displays a blank menu when pressed.

Key Path	Front-panel key
Initial S/W Revision	Prior to A.02.00

Print

See "Print" on page 352

Quick Save

The Quick Save front-panel key repeats the most recent save that was performed from the Save menu, with the following exceptions:

- Register saves are not remembered as Saves for the purpose of the Quick Save function
- If the current measurement does not support the last non-register save that was performed, an informational message is generated, “File type not supported for this measurement”

Quick Save repeats the last type of qualified save (that is, a save qualified by the above criteria) in the last save directory by creating a unique filename using the Auto File Naming algorithm described below.

If Quick Save is pressed after startup and before any qualified Save has been performed, the Quick Save function performs a Screen Image save using the current settings for Screen Image saves (current theme, current directory), which then becomes the “last save” for the purpose of subsequent Quick Saves.

The Auto File Naming feature automatically generates a file name for use when saving a file. The filename consists of a prefix and suffix separated by a dot, as is standard for the Windows® file system. A default prefix exists for each of the available file types:

Type	Default Prefix	Menu
State	State_	(Save/Recall)
Trace + State	State_	(Save/Recall)
Screen	Screen_	(Save/Recall)
Amplitude Corrections	Ampcor_	(Import/Export)
Traces	Trace_	(Import/Export)
Limit Lines	LLine_	(Import/Export)
Measurement Result	MeasR_	(Import/Export)
Capture Buffer	CapBuf_	(Import/Export)

A four digit number is appended to the prefix to create a unique file name. The numbering sequence starts at 0000 within each Mode for each file type and updates incrementally to 9999, then wraps to 0000 again. It remembers where it was through a Mode Preset and when leaving and returning to the Mode. It is reset by Restore Misc Defaults and Restore System Defaults and subsequent running of the instrument application. So, for example, the first auto file name generated for State files is State_0000.state. The next is State_0001, and so forth.

One of the key features of Auto File Name is that we guarantee that the Auto File Name will never conflict with an existing file. The algorithm looks for the next available number. If it gets to 9999, then it looks for holes. If it find no holes, that is no more numbers are available, it gives an error.

For example, if when we get to State_0010.state there is already a State_0010.state file in the current directory, it advances the counter to State_0011.state to ensure that no conflict will exist (and then it verifies that State_0011.state also does not exist in the current directory and advances again if it does, and so forth).

If you enter a file name for a given file type, then the prefix becomes the filename you entered instead of the default prefix, followed by an underscore. The last four letters (the suffix) are the 4-digit number.

For example, if you save a measurement results file as “fred.csv”, then the next auto file name chosen for a measurement results save will be fred_0000.csv.

NOTE Although 0000 is used in the example above, the number that is used is actually the current number in the Meas Results sequence, that is, the number that would have been used if you had not entered your own file name.

NOTE If the filename you entered ends with _dddd, where d=any number, making it look just like an auto file name, then the next auto file name picks up where you left off with the suffix being dddd + 1.

Key Path	Front-panel key
Notes	No remote command for this key specifically.
Initial S/W Revision	Prior to A.02.00

Recall

The Recall menu lets you choose what you want to recall, and where you want to recall it from. Among the types of files you can recall are **States and Traces**. In addition, an Import (Data) option lets you recall a number of data types stored in CSV files (as used by Excel and other spreadsheet programs).

The default paths for Recall are data type dependent and are the same as for the Save key.

Key Path	Front-panel key
Notes	<p>No remote command for this key specifically, but the :MMEM:LOAD command is available for specific file types. An example is :MMEM:LOAD:STATE <filename>.</p> <p>If you try to recall a State file for a mode that is not licensed or not available in the instrument, an error message will occur and the state will not change.</p>
Backwards Compatibility Notes	<p>In legacy analyzers, it was possible to load a state without affecting the trace data, limit lines or correction data. Similarly (since User Preset is actually loading a state), it was possible to do a User Preset without affecting the trace data, limit lines or correction data.</p> <p>In the X-Series, “state” always includes all of this data; so whenever state is loaded, all of the traces, limit lines and corrections are affected. Although this differs from previous behavior, it is desirable behavior, and should not cause adverse issues for users.</p>
Backwards Compatibility Notes	<p>Recall for the X-Series supports backward compatibility in the sense that you can recall a state file from any X-Series model number and any version of X-Series software. This is only possible if part of the recalling process goes through a limiting step after recalling the mode settings, at least for settings that may vary with version number, model number, option and license differences. If you try to recall a state file onto an instrument with less capability than what was available on the instrument during the save, the recall will ignore the state it doesn't support and it will limit the recalled setting to what it allows.</p> <p>Example: if the saved state includes preamp ON, but the recalling instrument does not have a preamp; the preamp is limited to OFF. Conversely, if you save a state without a preamp, the preamp is OFF in the state file. When this saved file is recalled on an instrument with a licensed preamp, the preamp is changed to OFF. Another example is if the saved state has center frequency set to 20 GHz, but the instrument recalling the saved state is a different model and only supports 13.5 GHz. In this case, the center frequency is limited along with any other frequency based settings. Since the center frequency can't be preserved in this case, the recall limiting tries to at least preserve span to keep the measurement setup as intact as possible.</p> <p>It may be appropriate to issue a warning if the state is limited on the recall; warnings do not go out to SCPI so this would only affect the manual user.</p> <p>Note that there is no state file compatibility outside of the X-Series. For example, you cannot recall a state file from ESA or PSA.</p>
Initial S/W Revision	Prior to A.02.00

State

The Recall State menu lets you choose a register or file from which to recall the state.

The content of a state file includes all of the settings and data required to return the analyzer as closely as possible to the Mode it was in, with the exact settings that were in place, when the save occurred. The Mode settings in each state file include the settings that are affected by Mode Preset, as well as the

additional settings affected by Restore Mode Defaults; all of the Mode’s settings. In addition, all of the settings of the Input/Output system are included, even though they are outside of the Mode’s state, because they are needed to restore the complete setup. Persistent System settings (for example, GPIB address) are not affected by either a Mode Preset or Restore Mode Defaults, nor are they included in a saved State file.

Since each state file is only for one Mode, the settings for other Modes are unaffected when it is loaded. Recall State will cause a mode switch if the state being recalled is not from the current active mode.

After the recall completes, the message "File <filename> recalled" or “Recalled State Register <register number>” is displayed.

For rapid recalls, the State menu lists 16 registers that you can choose from to recall. Pressing a Register key initiates the recall. You can also select a file from which to recall.

The default path for all State Files is:

My Documents\<<mode name>\state

where <mode name> is the parameter used to select the mode with the INST:SEL command (for example, SA for the Spectrum Analyzer).

See "[More Information](#)" on page 1114.

Key Path	Recall
Mode	All
Remote Command	:MMEMory:LOAD:STATe <filename>
Example	:MMEM:LOAD:STAT "myState.state" This recalls the file myState.state on the default path
Example	MMEM:LOAD:STAT "MyStateFile.state" This loads the state file data (on the default file directory path) into the instrument state.
Notes	<p>When you pick a file to recall, the analyzer first verifies that the file is recallable in the current instrument by checking the software version and model number of the instrument. If everything matches, a full recall proceeds by aborting the currently running measurement, clearing any pending operations, and then loading the State from the saved state file. You can open state files from any mode, so recalling a State file switches to the mode that was active when the save occurred. After switching to the mode of the saved state file, mode settings and data (if any for the mode) are loaded with values from the saved file. The saved measurement of the mode becomes the newly active measurement and the data relevant to the measurement (if there is any) is recalled.</p> <ul style="list-style-type: none"> • If there is a mismatch between file version or model number or instrument version or model number, the recall function tries to recall as much as possible and returns a warning message. It may limit settings that differ based on model number, licensing or version number. <p>After recalling the state, the Recall State function does the following:</p> <ul style="list-style-type: none"> • Makes the saved measurement for the mode the active measurement. • Clears the input and output buffers. • Status Byte is set to 0. • Executes a *CLS <p>If the file specified is empty an error is generated. If the specified file does not exist, another error is generated. If there is a mismatch between the file and the proper file type, an error is generated. If</p>

	there is a mismatch between file version or model number or instrument version or model number, a warning is displayed. Then it returns to the State menu and File Open dialog goes away. After the Recall, the analyzer exits the Recall menu and returns to the previous menu.
Backwards Compatibility SCPI	:MMEMory:LOAD:STATe 1,<filename> For backwards compatibility, the above syntax is supported. The "1" is simply ignored.
Initial S/W Revision	Prior to A.02.00

More Information

In measurements that support saving Traces, for example, Swept SA, the Trace data is saved along with the State in the State file. When recalling the State, the Trace data is recalled as well. Traces are recalled exactly as they were stored, including the writing mode and update and display modes. If a Trace was updating and visible when the State was saved, it will come back updating and visible, and its data will be rewritten right away. When you use State to save and recall traces, any trace whose data must be preserved should be placed in View or Blank mode before saving.

The following table describes the Trace Save and Recall possibilities:

You want to recall state and one trace's data, leaving other traces unaffected.	Save Trace+State from 1 trace. Make sure that no other traces are updating (they should all be in View or Blank mode) when the save is performed.	On Recall, specify the trace you want to load the one trace's data into. This trace will load in View. All other traces' data will be unaffected, although their trace mode will be as it was when the state save was performed.
You want to recall all traces	Save Trace+State from ALL traces.	On Recall, all traces will come back in View (or Blank if they were in Blank or Background when saved)
You want all traces to load exactly as they were when saved.	Save State	On recall, all traces' mode and data will be exactly as they were when saved. Any traces that were updating will have their data immediately overwritten.

From File...

When you press "From File", the analyzer brings up a Windows dialog and a menu entitled "File Open." This menu allows you to navigate to the various fields in the Windows dialog without using a keyboard or mouse. The Tab and Arrow keys can also be used for dialog navigation.

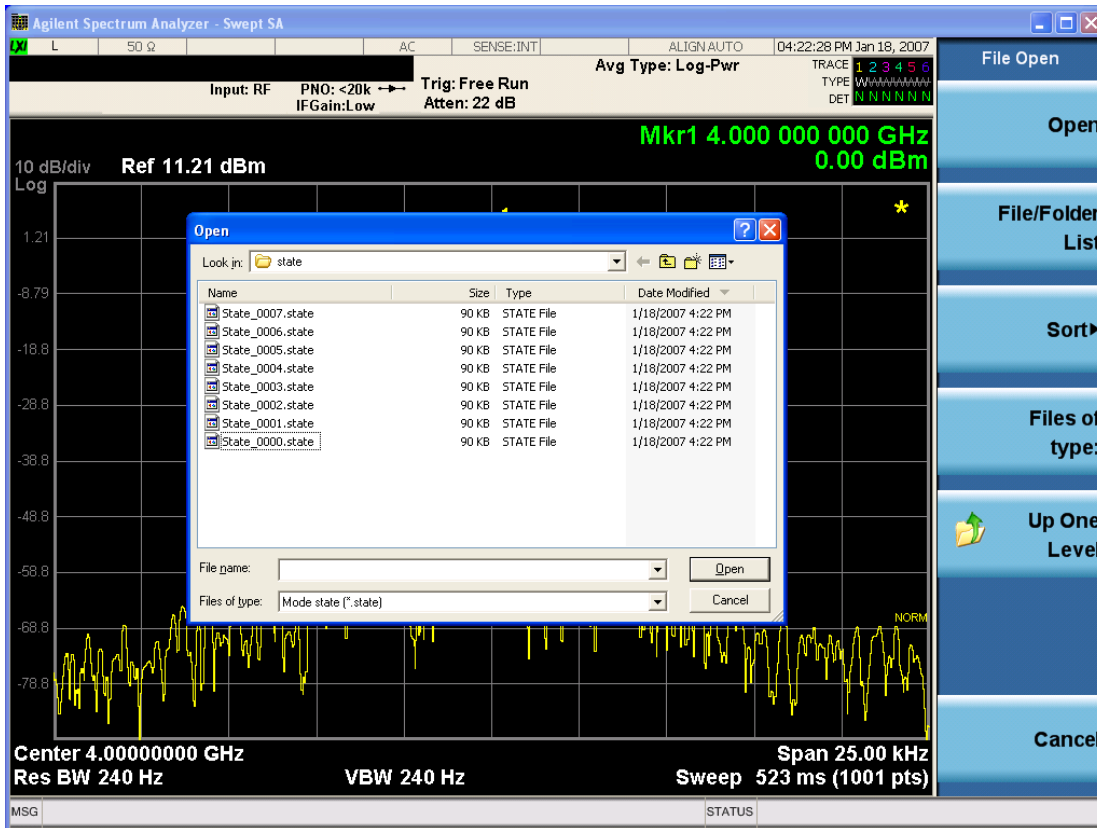

Listed below are the functions of the various fields in the dialog, and the corresponding softkeys:

Open

Performs the recall of the specified file. While the recall is being performed, the floppy icon appears briefly in the Meas bar.

File/Folder List

Enables you to navigate to the center of the dialog that contains the list of files and folders. Once here you can get information about the file and use the tab keys to navigate to the other fields in the dialog, such as Look In.

Look In

The Look In field shows the path from which the file will be recalled and allows you to change the path using the up and down arrow keys to navigate to other paths; the Enter key to open a directory; and the Backspace key to go back one directory. The **Look In field** first uses the last path from the Save As dialog **Save In:** path for that same file type. There is no softkey for directly navigating to the Look In field, but you can use the left tab to get here from the File/Folder List.

User specified paths are remembered when you leave and return to a Mode and are reset back to the default using Restore Mode Defaults.

Sort

Accesses a menu that enables you to sort the files within the File Open dialog. Only one sorting type can be selected at a time and the sorting happens immediately. The sorting types are By Date, By Name, By extension, and By Size.

Files of Type

This field shows the file suffix for the type of file you have selected to recall. For example, if you navigated here while recalling State, "Mode state (*.state)" is in the field. If you navigated here while recalling Trace, ""Mode state (*.trace)" is in the field. If you navigated here while importing a trace data file, "Trace Data (*.csv)" is in the field. For some file types, there is more than one choice in the dropdown menu, which you can select by using the up and down arrow keys and Enter.

Up One Level

This key corresponds to the icon of a folder with the up arrow that is in the tool bar of the dialog. When pressed, it causes the file and folder list to navigate up one level in the directory structure. The Backspace key does the same thing.

Cancel

This key corresponds to the Cancel selection in the dialog. It causes the current **Open** request to be cancelled. The ESC key does the same thing.

Key Path	Recall, State
Notes	Brings up the Open dialog for recalling a State Save Type
Initial S/W Revision	Prior to A.02.00

Edit Register Names

You may enter a custom name on any of the Register keys, to help you remember what you are using that state to save. To do this, press the Edit Register Names key, choose the register whose name you wish to edit, and then enter the desired label using the Alpha Editor or an external PC keyboard.

The maximum number of characters that can be added is 30. In most cases, 30 characters will fit on two lines of the key.

For more information and the SCPI command, see Edit Register Names under the Save, State function.

Key Path	Recall, State
Mode	All
Dependencies	N9060A-7FP or N9060B-2FP license required to edit the register names. When the feature is not licensed, sending the SCPI command generates an error, -221, "Settings conflict;Option not available"
Initial S/W Revision	A.11.00

Register 1 thru Register 16

Selecting any one of these register keys causes the State of the mode from the specified Register to be recalled. Each of the register keys annotates whether it is empty or at what date and time it was last

modified. In addition, you can use the Edit Register Names key under Save, State to enter custom names for each register.

Registers are shared by all modes, so recalling from any one of the registers will cause a mode switch to the mode that was active when the save to the Register occurred.

Although these 16 registers are the only registers available from the front panel, there are 128 state registers available in the instrument. Registers 17–128 are only available from the SCPI interface, using the *RCL command.

After the recall completes, the message "Register <register number> recalled" appears in the message bar. If you are in the Spectrum Analyzer Mode, and you are recalling a register that was saved in the Spectrum Analyzer Mode, then after the recall, you will still be in the Recall Register menu. If the Recall causes you to switch modes, then after the Recall, you will be in the Frequency menu.

If a requested register is empty an error is generated.

Key Path	Recall, State
Example	*RCL 1
Range	1–16 from front panel, 1–128 from SCPI
Readback	Date and time with seconds resolution are displayed on the key OR A custom name of up to 30 characters entered using the Save, State, Edit Register Names key OR “(empty)” if no prior save operation has been performed to this register.
Initial S/W Revision	Prior to A.02.00
Modified at S/W Revision	Prior to A.11.00

Register 1 thru Register 16

Selecting any one of these register keys causes the State of the mode from the specified Register to be recalled. Each of the register keys annotates whether it is empty or at what date and time it was last modified. In addition, you can use the Edit Register Names key under Save, State to enter custom names for each register.

Registers are shared by all modes, so recalling from any one of the registers will cause a mode switch to the mode that was active when the save to the Register occurred.

Although these 16 registers are the only registers available from the front panel, there are 128 state registers available in the instrument. Registers 17–128 are only available from the SCPI interface, using the *RCL command.

After the recall completes, the message "Register <register number> recalled" appears in the message bar. If you are in the Spectrum Analyzer Mode, and you are recalling a register that was saved in the Spectrum Analyzer Mode, then after the recall, you will still be in the Recall Register menu. If the Recall causes you to switch modes, then after the Recall, you will be in the Frequency menu.

If a requested register is empty an error is generated.

Key Path	Recall, State
Example	*RCL 1
Range	1-16 from front panel, 1-128 from SCPI
Readback	Date and time with seconds resolution are displayed on the key OR A custom name of up to 30 characters entered using the Save, State,Edit Register Names key OR “(empty)” if no prior save operation has been performed to this register.
Initial S/W Revision	Prior to A.02.00
Modified at S/W Revision	Prior to A.11.00

Data (Import)

Importing a data file loads data that was previously saved from the current measurement or from other measurements and/or modes that produce compatible data files. The Import Menu only contains Data Types that are supported by the current measurement.

Since the commonly exported data files are in .csv format, the data can be edited by the user prior to importing. This allows you to export a data file, manipulate the data in Excel (the most common PC Application for manipulating .csv files) and then import it.

Importing Data loads measurement data from the specified file into the specified or default destination, depending on the data type selected. Selecting an Import Data menu key will not actually cause the importing to occur, since the analyzer still needs to know from where to get the data. Pressing the Open key in this menu brings up the Open dialog and Open menu that provides you with the options from where to recall the data. Once a filename has been selected or entered in the Open menu, the recall occurs as soon as the Open button is pressed.

Key Path	Recall
Mode	All
Notes	The menu is built from whatever data types are available for the mode. Some keys will be missing completely, so the key locations in the sub-menu will vary. No SCPI command directly controls the Data Type that this key controls. The Data Type is included in the MMEM:LOAD commands.
Dependencies	If a file type is not used by a certain measurement, it is grayed out for that measurement. The key for a file type will not show at all if there are no measurements in the Mode that support it.
Preset	Is not affected by Preset or shutdown, but is reset during Restore Mode Defaults
Readback	The data type that is currently selected
Initial S/W Revision	Prior to A.02.00

Masks

This key enables you to recall a preset mask file from the list. It is only available in SEM measurement under the Data menu: Limit Mask. Limit Mask enables setting a preset limit mask for 802.11p 5MHz and 10MHz system.

You cannot change or create the preset mask file since it is a binary file. This key is valid for the Spectrum Emission Mask measurement.

File location: "My Documents\WLAN\data.masks"

Note that "**My Documents**" is an alias to a directory and its location depends on which user is logged in. At XSA start up, all of the limit mask files in the current user's "My Documents\WLAN\data.masks" directory are overwritten.

File type: Binary

Filename:

11p_5MHz_A.mask

11p_5MHz_B.mask

11p_5MHz_C.mask

11p_5MHz_D.mask

11p_10MHz_A.mask

11p_10MHz_B.mask

11p_10MHz_C.mask

11p_10MHz_D.mask

File extension: .mask

Selecting OPEN under the Import Data menu, opens the above directory enabling you to select a mask file.

Example:

File Location: My Documents/WLAN/data/masks

File Name: 11p_5MHz_A.mask

Key Path	Recall, Data
Mode	WLAN
Remote Command	MMEMoRY:LOAD:MASK <string>
Example	MMEM:LOAD:MASK "11p_5MHz_A.mask"
Initial S/W Revision	A.11.00

Capture Buffer

Capture buffer functionality is only available when measurement is Mod Accuracy and radio standard is not 802.11ac 80+80MHz. The captured data is raw data which is not processed.

Key Path	Recall, Data
Mode	WLAN
Example	MMEM:LOAD:CAPT "MyCaptureData.bin" This loads the file of capture data (on the default file directory path) into the instrument.
Dependencies	Capture buffer data is only available when measurement is Mod Accuracy and radio standard is not 802.11ac 80+80MHz. In other situation, this key is grayed out.
Initial S/W Revision	A.11.00

Open...

When you press "Open", the analyzer brings up a Windows dialog and a menu entitled "File Open." This menu allows you to navigate to the various fields in the Windows dialog without using a keyboard or mouse. The Tab and Arrow keys can also be used for dialog navigation.

See "[From File...](#)" on page 2263 in Recall, State, for a full description of this dialog and menu.

Key Path	Recall, Data
Notes	The key location is mode-dependent and will vary. Brings up Open dialog for recalling a <mode specific> Save Type
Initial S/W Revision	Prior to A.02.00

Restart

The Restart function restarts the current sweep, or measurement, or set of averaged/held sweeps or measurements. If you are Paused, pressing Restart does a Resume.

The Restart function is accessed in several ways:

- Pressing the Restart key
- Sending the remote command INIT:IMMEDIATE
- Sending the remote command INIT:RESTART

See "[More Information](#)" on page 1121

Key Path	Front-panel key
Remote Command	:INITiate[:IMMEDIATE] :INITiate:RESTART
Example	:INIT:IMM :INIT:REST
Notes	:INITiate:RESTART and :INITiate:IMMEDIATE perform exactly the same function.
Couplings	Resets average/hold count k. For the first sweep overwrites all active (update=on) traces with new current data. For application modes, it resets other parameters as required by the measurement.
Status Bits/OPC dependencies	This is an Overlapped command. The STATUS:OPERation register bits 0 through 8 are cleared. The STATUS:QUESTIONable register bit 9 (INTEgrity sum) is cleared. The SWEEPING bit is set. The MEASURING bit is set.
Backwards Compatibility Notes	For Spectrum Analysis mode in ESA and PSA, the Restart hardkey and the INITiate:RESTART command restart trace averages (displayed average count reset to 1) for a trace in Clear Write, but did not restart Max Hold and Min Hold. In the X-Series, the Restart hardkey and the INITiate:RESTART command restart not only Trace Average, but MaxHold and MinHold traces as well. For wireless comms modes in ESA and PSA, the Restart hardkey and the INITiate:RESTART command restart every measurement, which includes all traces and numeric results. There is no change to this operation.
Initial S/W Revision	Prior to A.02.00

More Information

The **Restart** function first aborts the current sweep/measurement as quickly as possible. It then resets the sweep and trigger systems, sets up the measurement and initiates a new data measurement sequence with a new data acquisition (sweep) taken once the trigger condition is met.

If the analyzer is in the process of aligning when **Restart** is executed, the alignment finishes before the restart function is performed.

Even when set for Single operation, multiple sweeps may be taken when Restart is pressed (for example, when averaging/holding is on). Thus when we say that **Restart** "restarts a measurement," we may mean:

- It restarts the current sweep
- It restarts the current measurement
- It restarts the current set of sweeps if any trace is in Trace Average, Max Hold or Min Hold
- It restarts the current set of measurements if Averaging, or Max Hold, or Min Hold is on for the measurement
- depending on the current settings.

With **Average/Hold Number** (in **Meas Setup** menu) set to 1, or Averaging off, or no trace in Trace Average or Hold, a single sweep is equivalent to a single measurement. A single sweep is taken after the trigger condition is met; and the analyzer stops sweeping once that sweep has completed. However, with **Average/Hold Number** >1 and at least one trace set to **Trace Average, Max Hold, or Min Hold (SA Measurement)** or **Averaging on (most other measurements)**, multiple sweeps/data acquisitions are taken for a single measurement. The trigger condition must be met prior to each sweep. The sweep is stopped when the average count k equals the number N set for **Average/Hold Number**. A measurement average usually applies to all traces, marker results, and numeric results; but sometimes it only applies to the numeric results.

Once the full set of sweeps has been taken, the analyzer will go to idle state. To take one more sweep without resetting the average count, increment the average count by 1, by pressing the step up key while **Average/Hold Number** is the active function, or sending the remote command `CALC:AVER:TCON UP`.

Save

The Save menu lets you choose what you want to save and where you want to save it. Among the types of files you can save are **States**, **Traces**, and **Screen Images**. In addition, an Export (Data) option lets you save a number of data types as CSV files for easy import into Excel and other spreadsheet programs.

Key Path	Front-panel key
Mode	All
Notes	No remote command for this key specifically, but the :MMEM:STORe command is available for specific file types. An example is :MMEM:STOR:STATe <filename>.
Initial S/W Revision	Prior to A.02.00

State

The Save State menu lets you choose a register or file for saving the state.

The content of a state file includes all of the settings and data required to return the analyzer as closely as possible to the Mode it was in, with the exact settings which were in place, when the save occurred. The Mode settings in each state file include the settings that are affected by Mode Preset, as well as the additional settings affected by Restore Mode Defaults; all of the Mode's settings. In addition, all of the settings of the Input/Output system are included, even though they are outside of the Mode's state, because they are needed to restore the complete setup. Persistent System settings (for example, Verbose SCPI) are not affected by either Mode Preset or Restore Mode Defaults, nor are they included in a saved State file.

After the save completes, the message "File <filename> saved" or "State Register <register number> saved" is displayed.

For rapid saving, the State menu lists 16 registers to save to. Pressing a Register key initiates the save. You can also select a file to save to.

The default path for all State Files is:

My Documents\<<mode name>\state

where <mode name> is the parameter used to select the mode with the INST:SEL command (for example, SA for the Spectrum Analyzer).

Key Path	Save
Mode	All
Remote Command	:MMEMory:STORe:STATe <filename>
Example	MMEM:STOR:STATe "MyStateFile.state" This stores the current instrument state data in the file MyStateFile.state in the default directory.
Notes	Both single and double quotes are supported for any filename parameter over remote. After saving to a register, that register's menu key is updated with the date the time, unless a custom label has been entered for that key. After saving to a register, you remain in the Save State menu, so that you can see the Register key

update. After saving to a file, the analyzer automatically returns to the previous menu and any Save As dialog goes away.

Backwards Compatibility SCPI :MMEMory:STORe:STATe 1,<filename>

For backwards compatibility, the above syntax is supported. The "1" is simply ignored. The command is sequential.

Initial S/W Revision Prior to A.02.00

To File . . .

When you press “To File”, the analyzer brings up a Windows dialog and a menu entitled “Save As.” This menu allows you to navigate to the various fields in the Windows dialog without using a keyboard or mouse. The Tab and Arrow keys can also be used for dialog navigation.

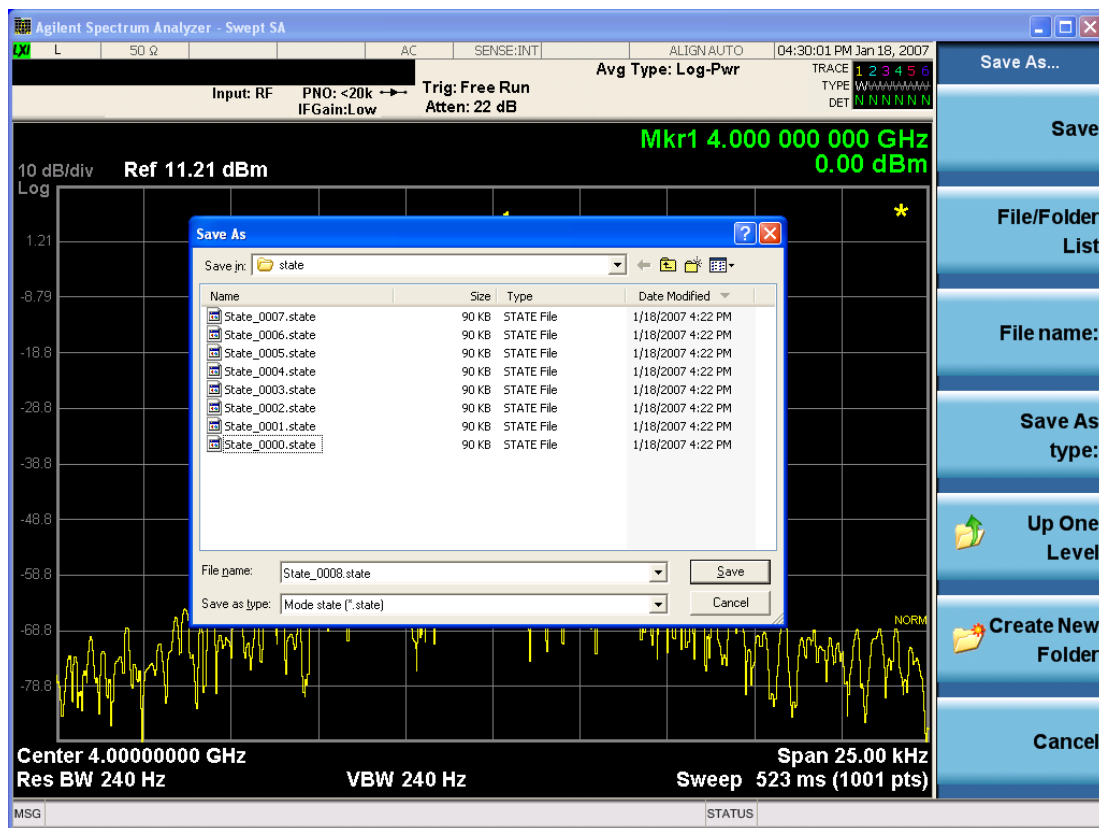

The Listed below

are the functions of the various fields in the dialog, and the corresponding softkeys:

Save

Performs the save to the specified file of the selected type. If the file already exists, a dialog will appear that allows you to replace the existing file by selecting OK, or you can Cancel the request. If you select OK, the file will be overwritten. Using the C: drive is strongly discouraged, since it runs the risk of being overwritten during an instrument software upgrade.

While the save is being performed, the floppy icon appears briefly in the Meas bar.

File/Folder List

Enables you to navigate to the center of the dialog that contains the list of files and folders. Once here you can get information about the file and use the tab keys to navigate to the other fields in the dialog, such as Save In.

Save In

The Save In field shows the path to which the file will be saved and allows you to change the path using the up and down arrow keys to navigate to other paths; the Enter key to open a directory; and the Backspace key to go back one directory. The **Save In field** defaults to the default path for this type of file and remembers the last path you used to save this type of file. There is no softkey for directly navigating to the Save In field but you can use left tab to get here from the File/Folder List.

User specified paths are remembered when you leave and return to a Mode and are reset back to the default using Restore Mode Defaults.

File Name

The File Name field is initially loaded with an automatically generated filename specific to the appropriate Save Type. The automatically generated filename is guaranteed not to conflict with any filename currently in the directory. You may replace or modify this filename using the File Name key. See the ["Quick Save " on page 2259](#) documentation for more on the automatic file naming algorithm.

When you press the File Name key the analyzer displays the Alpha Editor. Use the knob to choose the letter to add and the front-panel Enter key to add the letter to the file name. The BK character moves you back and the FW character moves you forward in the filename. The Select key on the front panel generates a space character. When you are done entering the filename press the Done softkey. This returns back to the **File Open** dialog and menu, but does not cause the save to occur.

Save As Type

This field shows the file suffix for the type of file you have selected to save. For example, if you navigated here while saving State, "Mode state (*.state)" is in the field. If you navigated here from saving Trace, ""Mode state (*.trace)" is in the field. If you navigated here while exporting a trace data file, "Trace Data (*.csv)" is in the field. For some file types, there is more than one choice in the dropdown, which you can select by using the up and down arrow keys and Enter.

Up One Level

This key corresponds to the icon of a folder with the up arrow that is in the tool bar of the dialog. When pressed, it causes the file and folder list to navigate up one level in the directory structure. The Backspace key does the same thing.

Create New Folder

This key corresponds to the icon of a folder with the "*" that is in the tool bar of the dialog. When pressed, a new folder is created in the current directory with the name **New Folder** and you can enter a new folder name using the Alpha Editor.

Cancel

This key corresponds to the Cancel selection in the dialog. It causes the current **Save As** request to be cancelled. The ESC key does the same thing.

Key Path	Save, State
Mode	All
Notes	Brings up Save As dialog for saving a State Save Type
Initial S/W Revision	Prior to A.02.00

Edit Register Names

You may enter a custom name on any of the Register keys, to help you remember what you are using that state to save. To do this, press the Edit Register Names key, choose the register whose name you wish to edit, and then enter the desired label using the Alpha Editor or an external PC keyboard.

The maximum number of characters that can be added is 30. In most cases, 30 characters will fit on two lines of the key.

See ["More Information" on page 1126](#)

Key Path	Save, State
Mode	All
Remote Command	:MMEMory:REGister:STATe:LABel <reg number>,"label" :MMEMory:REGister:STATe:LABel? <reg number>
Example	:MMEM:REG:STAT:LAB 1,"my label"
Notes	<reg number> is an integer from 1 to 16. If the SCPI specifies an invalid register number an error message is generated, -222,"Data out of range;Invalid register label number" "label" is a string from 0 to 30 characters in length. If a label exceeds 30 characters, an error message is generated, -150,"String data error;Label clipped to 30 characters" "label" of length 0 erases the custom label and restores the default (time and date) label. E.g.: :MMEM:REG:STAT:LAB 1,""
Dependencies	N9060A-7FP or N9060B-2FP license required to edit the register names. When the feature is not licensed, sending this command generates an error, -221,"Settings conflict;Option not available"
Preset	The names are unaffected by Preset or power cycle but are set to the default label (time and date) on a "Restore System Defaults->Misc"
Initial S/W Revision	A.11.00

More Information

When you edit one of the register names, the time and date field will be replaced by the custom name.

If you delete all the characters in the custom name, it restores the default (time and date).

The register names are stored within the state files, but they are not part of the instrument state; that is, once you have edited a register name, loading a new state will not change that register name. Another consequence of this is that the names will be persistent through a power cycle. Also, if a named state file is transferred to another analyzer, it will bring its custom name along with it.

If you try to edit the name of an empty register, the analyzer will first save the state to have a file to put the name in. If you load a named state file into an analyzer with older firmware it will ignore the metadata.

The *SAV and *RCL commands will not be affected by the custom register names, nor will the MMEM commands.

Register 1 thru Register 16

Selecting any one of these register menu keys causes the State of the currently active mode to be saved to the specified Register. The registers are provided for rapid saving and recalling, since you do not need to specify a filename or navigate to a file. Each of the register menu keys annotates whether it is empty or at what date and time it was last modified. In addition, you can use the Edit Register Names key to enter custom names for each register.

Although these 16 registers are the only registers available from the front panel, there are 128 state registers available in the instrument. Registers 17–128 are only available from the SCPI interface, using the *SAV command.

There is one set of 128 state registers in the instrument, not one set for each Mode. When a state is saved, the Mode it was saved from is saved with it; then when it is recalled, the instrument switches to that Mode.

After the save completes, the corresponding register menu key annotation is updated with the date and time and the message "Register <register number> saved" is displayed.

Key Path	Save, State
Mode	All
Example	*SAV 1
Range	1–16 from front panel, 1–128 from SCPI
Readback	Date and time with seconds resolution are displayed on the key OR A custom name of up to 30 characters entered using the Edit Register Names key OR “(empty)” if no prior save operation has been performed to this register.
Initial S/W Revision	Prior to A.02.00
Modified at S/W Revision	A.11.00

Register 1 thru Register 16

Selecting any one of these register menu keys causes the State of the currently active mode to be saved to the specified Register. The registers are provided for rapid saving and recalling, since you do not need to specify a filename or navigate to a file. Each of the register menu keys annotates whether it is empty or at what date and time it was last modified. In addition, you can use the Edit Register Names key to enter custom names for each register.

Although these 16 registers are the only registers available from the front panel, there are 128 state registers available in the instrument. Registers 17–128 are only available from the SCPI interface, using the *SAV command.

There is one set of 128 state registers in the instrument, not one set for each Mode. When a state is saved, the Mode it was saved from is saved with it; then when it is recalled, the instrument switches to that Mode.

After the save completes, the corresponding register menu key annotation is updated with the date and time and the message "Register <register number> saved" is displayed.

Key Path	Save, State
Mode	All
Example	*SAV 1
Range	1-16 from front panel, 1-128 from SCPI
Readback	Date and time with seconds resolution are displayed on the key OR A custom name of up to 30 characters entered using the Edit Register Names key OR “(empty)” if no prior save operation has been performed to this register.
Initial S/W Revision	Prior to A.02.00
Modified at S/W Revision	A.11.00

Data (Export)

Exporting a data file stores data from the current measurement to mass storage files. The Export Menu only contains data types that are supported by the current measurement.

Since the commonly exported data files are in .csv format, the data can be edited by you prior to importing. This allows you to export a data file, manipulate the data in Excel (the most common PC Application for manipulating .csv files) and then import it.

Selecting an Export Data menu key will not actually cause the exporting to occur, since the analyzer still needs to know where you wish to save the data. Pressing the Save As key in this menu brings up the Save As dialog and Save As menu that allows you to specify the destination file and directory. Once a filename has been selected or entered in the Open menu, the export will occur as soon as the Save key is pressed.

Key Path	Save
Mode	All
Notes	The menu is built from whatever data types are available for the mode. So the key locations in the sub menu will vary. No SCPI command directly controls the Data Type that this key controls. The Data Type is included in the MMEM:STORe commands.
Dependencies	If a file type is not used by a certain measurement, that type is grayed out for that measurement. The key for a file type will not show at all if there are no measurements in the Mode that support it.
Preset	Is not affected by a Preset or shutdown, but is reset during Restore Mode Defaults
Readback	The data type that is currently selected
Initial S/W Revision	Prior to A.02.00

Meas Results

Key Path	Save, Data
Mode	WLAN
Example	MMEM:STOR:RES "MyResultsFile.csv" This stores the measurement results data in the file MyResultsFile.xml in the default directory.
Initial S/W Revision	A.11.00

Capture Buffer

Capture buffer functionality is only available when measurement is Mod Accuracy and radio standard is not 802.11ac 80+80MHz. The captured data is raw data which is not processed.

Key Path	Save, Data
Mode	WLAN
Example	MMEM:STOR:CAPT "MyCaptureData.bin" This stores the capture data in the file MyCaptureData.bin in the default directory.
Dependencies	Capture buffer data is only available when measurement is Mod Accuracy and radio standard is not 802.11ac 80+80MHz. In other measurements, this key is grayed out.
Initial S/W Revision	A.11.00

Save As . . .

When you press "Save As", the analyzer brings up a Windows dialog and a menu entitled "**Save As.**" This menu allows you to navigate to the various fields in the Windows dialog without using a keyboard or mouse. The Tab and Arrow keys can also be used for dialog navigation.

See "[To File . . .](#)" on page 2273 in Save, State for a full description of this dialog and menu.

The default path for saving files is:

For all of the Trace Data Files:

My Documents\`<mode name>`\data\traces

For all of the Limit Data Files:

My Documents\`<mode name>`\data\limits

For all of the Measurement Results Data Files:

My Documents\`<mode name>`\data\`<measurement name>`\results

For all of the Capture Buffer Data Files:

My Documents\`<mode name>`\data\captureBuffer

Key Path	Save, Data
Mode	All
Notes	The key location is mode-dependent and will vary. Brings up the Save As dialog for saving a <mode specific> Save Type. The save is performed immediately and does not wait until the measurement is complete.
Initial S/W Revision	Prior to A.02.00

Screen Image

Pressing Screen Image accesses a menu of functions that enable you to specify a format and location for the saved screen image. It brings up a menu that allows you to specify the color scheme of the Screen Image (Themes) or navigate to the Save As dialog to perform the actual save.

Screen Image files contain an exact representation of the analyzer display. They cannot be loaded back onto the analyzer, but they can be loaded into your PC for use in many popular applications.

The image to be saved is actually captured when the Save front panel key is pressed, and kept in temporary storage to be used if you ask for a Screen Image save. When the Screen Image key is pressed, a "thumbnail" of the captured image is displayed, as shown below:

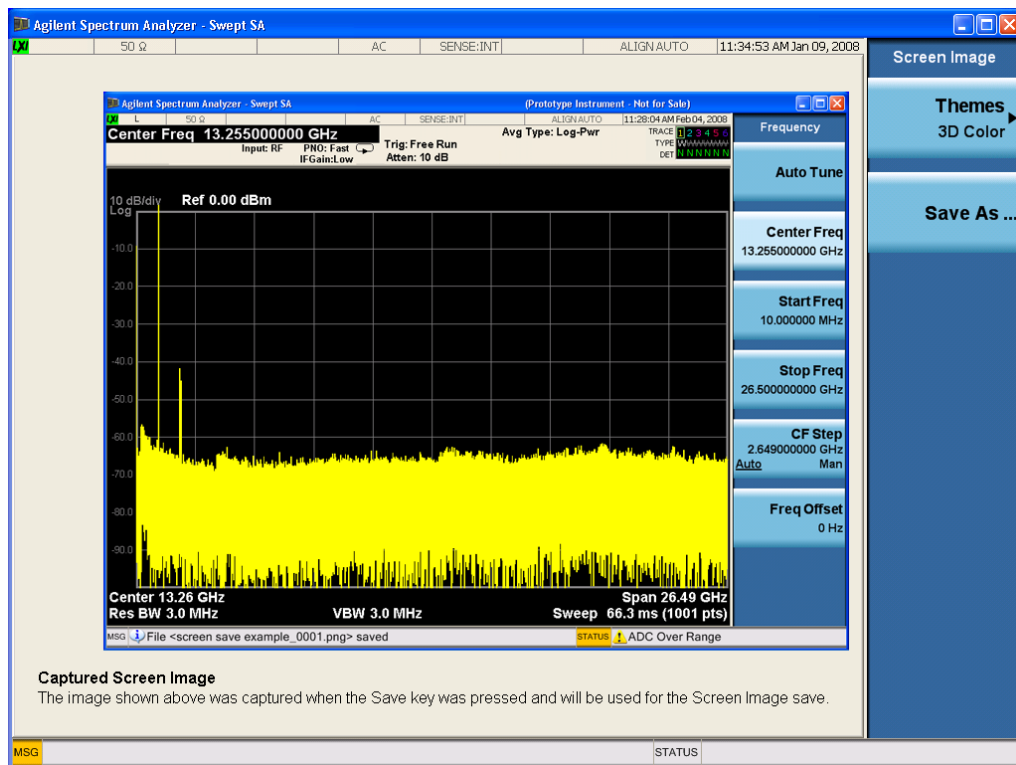

When you continue on into the Save As menu and complete the Screen Image save, the image depicted in the thumbnail is the one that gets saved, showing the menus that were on the screen before going into the Save menus. The save is performed immediately and does not wait until the measurement is complete.

After you have completed the save, the Quick Save front-panel key lets you quickly repeat the last save performed, using an auto-named file, with the current screen data.

NOTE

For versions previous to A.01.55, if you initiate a screen image save by navigating through the Save menus, the image that is saved will contain the Save menu softkeys, not the menus and the active function that were on the screen when you first pressed the Save front panel key.

Key Path	Save
Mode	All
Remote Command	:MMEMory:STORe:SCReem <filename>
Example	:MMEM:STOR:SCR "myScreen.png" This stores the current screen image in the file MyScreenFile.png in the default directory.
Initial S/W Revision	Prior to A.02.00

Themes

Accesses a menu of functions that enable you to choose the theme to be used when saving the screen image.

The **Themes** option is the same as the **Themes** option under the **Display** and **Page Setup** dialogs. It allows you to choose between themes to be used when saving the screen image.

Key Path	Save, Screen Image
Remote Command	:MMEMory:STORe:SCReem:THEMe TDColor TDMonochrome FCOLOR FMONochrome :MMEMory:STORe:SCReem:THEMe?
Example	:MMEM:STOR:SCR:THEM TDM
Preset	3D Color; Is not part of Preset, but is reset by Restore Misc Defaults or Restore System Defaults All and survives subsequent running of the modes.
Readback	3D Color 3D Mono Flat Color Flat Mono
Backwards Compatibility Notes	In ESA and PSA we offer the choice of "Reverse Bitmap" or "Reverse Metafile" when saving screen images. This is much like the "Flat Color" theme available in X-Series. Also, if you selected Reverse Bitmap AND a black & white screen image, that would be much like "Flat Monochrome". In other words, each of the X-Series themes has a similar screen image type in ESA/PSA. But they are not identical.
Initial S/W Revision	Prior to A.02.00

3D Color

Selects a standard color theme with each object filled, shaded and colored as designed.

Key Path	Save, Screen Image, Themes
Example	MMEM:STOR:SCR:THEM TDC

Readback	3D Color
Initial S/W Revision	Prior to A.02.00

3D Monochrome

Selects a format that is like 3D color but shades of gray are used instead of colors.

Key Path	Save, Screen Image, Themes
Example	MMEM:STOR:SCR:THEM TDM
Readback	3D Mono
Initial S/W Revision	Prior to A.02.00

Flat Color

Selects a format that is best when the screen is to be printed on an ink printer.

Key Path	Save, Screen Image, Themes
Example	MMEM:STOR:SCR:THEM FCOL
Readback	Flat Color
Initial S/W Revision	Prior to A.02.00

Flat Monochrome

Selects a format that is like Flat Color. But only black is used (no colors, not even gray), and no fill.

Key Path	Save, Screen Image, Themes
Example	MMEM:STOR:SCR:THEM FMON
Readback	Flat Mono
Initial S/W Revision	Prior to A.02.00

Save As...

When you press "Save As", the analyzer brings up a Windows dialog and a menu entitled "**Save As.**" This menu allows you to navigate to the various fields in the Windows dialog without using a keyboard or mouse. The Tab and Arrow keys can also be used for dialog navigation.

See "[To File . . .](#)" on page 2273 in Save, State for a full description of this dialog and menu.

The default path for Screen Images is

My Documents\`<mode name>`\screen.

where <mode name> is the parameter used to select the mode with the INST:SEL command (for example, SA for the Spectrum Analyzer).

Key Path	Save, Screen Image
Notes	Brings up Save As dialog for saving a Screen Image Save Type
Initial S/W Revision	Prior to A.02.00

Mass Storage Catalog (Remote Command Only)

Key path	SCPI Only
Remote Command	:MMEMory:CATalog? [<directory_name>]
Notes	<p>The string must be a valid logical path.</p> <p>Queries disk usage information (drive capacity, free space available) and obtains a list of files and directories in a specified directory in the following format: <numeric_value>,<numeric_value>,{<file_entry>}</p> <p>It returns two numeric parameters and as many strings as there are files and directories. The first parameter indicates the total amount of storage currently used in bytes. The second parameter indicates the total amount of storage available, also in bytes. The <file_entry> is a string. Each <file_entry> indicates the name, type, and size of one file in the directory list: <file_name>,<file_type>,<file_size></p> <p>As the windows file system has an extension that indicates file type, <file_type> is always empty. <file_size> provides the size of the file in bytes. For directories, <file_entry> is surrounded by square brackets and both <file_type> and <file_size> are empty</p>
Initial S/W Revision	Prior to A.02.00

Mass Storage Change Directory (Remote Command Only)

Key path	SCPI Only
Remote Command	:MMEMory:CDIRectory [<directory_name>] :MMEMory:CDIRectory?
Notes	<p>The string must be a valid logical path.</p> <p>Changes the default directory for a mass memory file system. The <directory_name> parameter is a string. If no parameter is specified, the directory is set to the *RST value.</p> <p>At *RST, this value is set to the default user data storage area, that is defined as System.Environment.SpecialFolder.Personal.</p> <p>Query returns full path of the default directory.</p>
Initial S/W Revision	Prior to A.02.00

Mass Storage Copy (Remote Command Only)

Key path	SCPI Only
Remote Command	:MMEMory:COpy <string>,<string>[,<string>,<string>]
Notes	<p>The string must be a valid logical path.</p> <p>Copies an existing file to a new file or an existing directory to a new directory.</p> <p>Two forms of parameters are allowed. The first form has two parameters. In this form, the first parameter specifies the source, and the second parameter specifies the destination.</p> <p>The second form has four parameters. In this form, the first and third parameters specify the source. The second and fourth parameters specify the directories. The first pair of parameters specifies the source. The second pair specifies the destination. An error is generated if the source doesn't exist or the destination file already exists.</p> <p>This command will generate an "access denied" error if the destination is a restricted folder (e.g., C:\Windows) and the current user does not have Power User or Administrator privileges.</p>

Mass Storage Device Copy (Remote Command Only)

This command transfers data to/from a file and a peripheral device.

Key path	SCPI Only
Remote Command	:MMEMory:COpy:DEvice <source_string>,<dest_string>
Notes	<p>The strings must be a valid logical path or a valid device keyword. If the dest_string is a device keyword, the data is copied from the source file to the device. If the source_string is a device keyword, the data is copied to the source file from the device.</p> <p>Valid device keywords are:</p> <p>SNS (smart noise source)</p> <p>An error is generated if the file or device is not found.</p>

Mass Storage Delete (Remote Command Only)

Key path	SCPI Only
Remote Command	:MMEMory:DElete <file_name>[,<directory_name>]
Notes	<p>The string must be a valid logical path.</p> <p>Removes a file from the specified directory. The <file_name> parameter specifies the file name to be removed. This command will generate an "access denied" error if the file is in a restricted folder (e.g., C:\Windows) and the current user does not have Power User or Administrator privileges.</p>
Initial S/W Revision	Prior to A.02.00

Mass Storage Data (Remote Command Only)

Creates a file containing the specified data OR queries the data from an existing file.

Key path	SCPI Only
Remote Command	:MMEMory:DATA <file_name>, <data> :MMEMory:DATA? <file_name>
Notes	The string must be a valid logical path. The command form is MMEMory:DATA <file_name>,<data>. It loads <data> into the file <file_name>. <data> is in 488.2 block format. <file_name> is string data. The query form is MMEMory:DATA? <file_name> with the response being the associated <data> in block format.
Initial S/W Revision	Prior to A.02.00

Mass Storage Make Directory (Remote Command Only)

Key path	SCPI Only
Remote Command	:MMEMory:MDIRectory <directory_name>
Notes	The string must be a valid logical path. Creates a new directory. The <directory_name> parameter specifies the name to be created. This command will generate an “access denied” error if the new directory would be in a restricted folder (e.g., C:\Windows) and the current user does not have Power User or Administrator privileges.
Initial S/W Revision	Prior to A.02.00

Mass Storage Move (Remote Command Only)

Key path	SCPI Only
Remote Command	:MMEMory:MOVE <string>,<string>[,<string>,<string>]
Notes	The string must be a valid logical path. Moves an existing file to a new file or an existing directory to a new directory. Two forms of parameters are allowed. The first form has two parameters. In this form, the first parameter specifies the source, and the second parameter specifies the destination. The second form has four parameters. In this form, the first and third parameters specify the source. The second and fourth parameters specify the directories. The first pair of parameters specifies the source. The second pair specifies the destination. An error is generated if the source doesn't exist or the destination file already exists. This command will generate an “access denied” error if the destination is a restricted folder (e.g., C:\Windows) and the current user does not have Power User or Administrator privileges.
Initial S/W Revision	Prior to A.02.00

Mass Storage Remove Directory (Remote Command Only)

Key path	SCPI Only
Remote Command	:MMEMory:RDIRectory <directory_name>
Notes	<p>The string must be a valid logical path.</p> <p>Removes a directory. The <directory_name> parameter specifies the directory name to be removed. All files and directories under the specified directory shall also be removed.</p> <p>This command will generate an “access denied” error if the folder is a restricted folder (e.g., C:\Windows) or is in a restricted folder and the current user does not have Power User or Administrator privileges.</p>
Initial S/W Revision	Prior to A.02.00

Single (Single Measurement/Sweep)

Sets the analyzer for Single measurement operation. The single/continuous state is Meas Global, so the setting will affect all the measurements. If you are Paused, pressing Single does a Resume.

See ["More Information" on page 1137](#)

Key Path	Front-panel key
Example	:INIT:CONT OFF
Notes	See Cont key description.
Backwards Compatibility Notes	<p>For Spectrum Analysis mode in ESA and PSA, the Single hardkey and the INITiate:IMM switched from continuous measurement to single measurement and restarted sweeps and averages (displayed average count reset to 1), but did not restart Max Hold and Min Hold. In the X-Series, the Single hardkey and the INITiate:IMM command initiate a sweep/ measurement/ average sequence/hold sequence including MaxHold and MinHold.</p> <p>For Spectrum Analysis mode in ESA and PSA, the Single hardkey restarted the sweep regardless of whether or not you were in an active sweep or sweep sequence. In the X-Series, Restart does this but Single only restarts the sweep or sweep sequence if you are in the idle state.</p> <p>INIT[:IMM] in ESA & PSA Spectrum Analysis Mode does an implied ABORT. In some other PSA Modes, INIT[:IMM] is ignored if not in the idle state. . The X-Series follows the ESA/PSA SA Mode model, which may cause some Modes to have compatibility problems.</p>
Initial S/W Revision	Prior to A.02.00

More Information

See ["Restart" on page 2270](#) for details on the INIT:IMMEDIATE (Restart) function.

If you are already in single sweep, the INIT:CONT OFF command has no effect.

If you are already in Single Sweep, then pressing the Single key in the middle of a sweep does not restart the sweep or sequence. Similarly, pressing the Single key does not restart the sweep or sequence if the sweep is not in the idle state (for example, if you are taking a very slow sweep, or the analyzer is waiting for a trigger). Instead, it results in a message. "Already in Single, press Restart to initiate a new sweep or sequence". Even though pressing the Single key in the middle of a sweep does not restart the sweep, sending INIT:IMMEDIATE does reset it.

To take one more sweep without resetting the average count, increment the average count by 1, by pressing the step up key while **Average/Hold Number** is the active function, or sending the remote command CALC:AVER:TCON UP.

Source

There is no Source control functionality for this measurement. When this key is pressed, the screen either displays a blank menu, or the previously-selected menu remains unchanged.

Key Path	Front-panel key
----------	-----------------

Span X Scale

Accesses a menu of functions that enable you to set the horizontal scale parameters.

Key Path	Front-panel key
Initial S/W Revision	A.11.00

Ref Value

Sets the X reference value.

Key Path	SPAN X Scale
Mode	BASIC, PNOISE, WCDMA, C2K, GSM, WIMAXOFDMA, TDSCDMA, 1XEVDO, DVB, DTMB, ISDBT, CMMB, LTE, LTETDD, DCTV, WLAN, MSR, LTEAFDD, LTEATDD
Remote Command	:DISPlay:SEMask:VIEW[1]:WINDow[1]:TRACe:X[:SCALE]:RLEVel <freq> :DISPlay:SEMask:VIEW[1]:WINDow[1]:TRACe:X[:SCALE]:RLEVel?
Example	DISP:SEM:VIEW:WIND:TRAC:X:RLEV 10 DISP:SEM:VIEW:WIND:TRAC:X:RLEV?
Notes	You must be in the mode that includes SEM measurement to use this command. Use :INSTrument:SElect to set the mode.
Couplings	If Auto Scaling is set to On, this value is automatically determined by the measurement result. When you set this value manually, Auto Scaling automatically changes to Off.
Preset	1.0 GHz
State Saved	Saved in instrument state.
Min	-1000 GHz
Max	1000 GHz
Default Unit	Hz
Initial S/W Revision	A.11.00

Scale/Div

Sets the horizontal scale.

Key Path	SPAN X Scale
Mode	BASIC, PNOISE, WCDMA, C2K, GSM, WIMAXOFDMA, TDSCDMA, 1XEVDO, DVB, DTMB, ISDBT, CMMB, LTE, LTETDD, DCTV, WLAN, MSR, LTEAFDD, LTEATDD
Remote Command	:DISPlay:SEMask:VIEW[1]:WINDow[1]:TRACe:X[:SCALE]:PDIVision <freq> :DISPlay:SEMask:VIEW[1]:WINDow[1]:TRACe:X[:SCALE]:PDIVision ?
Example	DISP:SEM:VIEW:WIND:TRAC:X:PDIV 500 DISP:SEM:VIEW:WIND:TRAC:X:PDIV?

Notes	You must be in a mode that includes the SEM measurement to use this command. Use INSTRUMENT:SElect to set the mode.
Couplings	If Auto Scaling is set to On, this value is automatically determined by the measurement result. When you set this value manually, Auto Scaling automatically changes to Off.
Preset	Automatically Calculated
State Saved	Yes Saved in instrument state.
Min	1 Hz
Max	10.0 GHz
Initial S/W Revision	A.11.00

Ref Position

Sets the reference position for the X axis to Left, Center or Right.

Key Path	SPAN X Scale
Mode	BASIC, PNOISE, WCDMA, C2K, GSM, WIMAXOFDMA, TDSCDMA, 1XEVD0, DVB, DTMB, ISDBT, CMMB, LTE, LTETDD, DCTV, WLAN, MSR, LTEAFDD, LTEATDD
Remote Command	:DISPlay:SEMAsk:VIEW[1]:WINDow[1]:TRACe:X[:SCALe]:RPOSition LEFT CENTER RIGHT :DISPlay:SEMAsk:VIEW[1]:WINDow[1]:TRACe:X[:SCALe]:RPOSition?
Example	DISP:SEM:VIEW:WIND:TRAC:X:RPOS LEFT DISP:SEM:VIEW:WIND:TRAC:X:RPOS?
Notes	You must be in a mode that includes the SEM measurement to use this command. Use INSTRUMENT:SElect to set the mode.
Preset	CENTER
State Saved	Yes Saved in instrument state.
Range	Left Ctr Right
Initial S/W Revision	A.11.00

Auto Scaling

Toggles the scale coupling function between On and Off.

Key Path	SPAN X Scale
Mode	BASIC, PNOISE, WCDMA, C2K, GSM, WIMAXOFDMA, TDSCDMA, 1XEVD0, DVB, DTMB, ISDBT, CMMB, LTE, LTETDD, DCTV, WLAN, MSR, LTEAFDD, LTEATDD
Remote Command	:DISPlay:SEMAsk:VIEW[1]:WINDow[1]:TRACe:X[:SCALe]:COUPlE 0 1 OFF ON :DISPlay:SEMAsk:VIEW[1]:WINDow[1]:TRACe:X[:SCALe]:COUPlE?
Example	DISP:SEM:VIEW:WIND:TRAC:X:COUP ON

DISP:SEM:VIEW:WIND:TRAC:X:COUP?	
Notes	You must be in a mode that includes the SEM measurement to use this command. Use INSTRument:SElect to set the mode.
Couplings	When Auto Scaling is On and the Restart front-panel key is pressed, this function automatically determines the scale per division and reference values based on the measurement results. When you set a value to either Scale/Div or Ref Value manually, Auto Scaling automatically changes to Off.
Preset	1
State Saved	Yes Saved in instrument state.
Range	On Off
Initial S/W Revision	A.11.00

Sweep/Control

Displays a menu that enables you to set up and control the sweep time, gate method, and source of the current measurement. See ["Sweep/Control" on page 2291](#) for more information.

Key Path	Front-panel key
Initial S/W Revision	Prior to A.02.00

Pause

Pauses a measurement after the current data acquisition is complete. When Paused, the label on the key changes to Resume. Pressing the Resume key resumes the measurement at the point it was at when paused. See ["Pause/Resume" on page 2291](#) for more details.

Key Path	Sweep/Control
Initial S/W Revision	Prior to A.02.00

Gate

Accesses a menu that enables you to control the gating function. The Gate functionality is used to view signals best viewed by qualifying them with other events.

Gate setup parameters are the same for all measurements – they do not change as you change measurements. Settings like these are called “Meas Global” and are unaffected by Meas Preset.

Note that Sweep Time autocoupling rules and annotation are changed by Gate being on.

Key Path	Sweep/Control
Scope	Meas Global
Readback	The state and method of Gate, as [Off, LO] or [On, Video]. Note that for measurements that only support gated LO, the method is nonetheless read back, but always as LO.
Initial S/W Revision	Prior to A.02.00

Gate On/Off

Turns the gate function on and off.

When the Gate Function is on, the selected Gate Method is used along with the gate settings and the signal at the gate source to control the sweep and video system with the gate signal. Not all measurements allow every type of Gate Methods.

When Gate is on, the annunciation in the measurement bar reflects that it is on and what method is used, as seen in the following "Gate: LO" annunciator graphic.

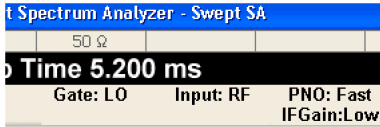

Key Path	Sweep/Control, Gate
Remote Command	[:SENSe] :SWEep:EGATe [:STATe] OFF ON 0 1 [:SENSe] :SWEep:EGATe [:STATe] ?
Example	SWE:EGAT ON SWE:EGAT?
Dependencies	<p>The function is unavailable (grayed out) and Off when:</p> <ul style="list-style-type: none"> • Gate Method is LO or Video and FFT Sweep Type is manually selected. • Gate Method is FFT and Swept Sweep Type is manually selected. • Marker Count is ON. <p>The following are unavailable whenever Gate is on:</p> <ul style="list-style-type: none"> • FFT under Sweep Type when Method=LO or Video or Swept under Sweep Type when Method=FFT • Marker Count <p>While Gate is on, the Auto Rules for Sweep Type are modified so that the choice agrees with the Gate Method: i.e., FFT for Method = FFT and Swept for Method = LO or Video.</p> <p>The Gate softkey and all SCPI under the [:SENSe]:SWEep:EGATe SCPI node are grayed out when Source Mode is Tracking with an external source. This is because the Gate circuitry is used to sync the external source. If the Tracking Source is turned on, the Gate is turned off.</p> <p>When in the ACP measurement:</p> <ul style="list-style-type: none"> • When Meas Method is RBW or FAST, this function is unavailable and the key is grayed out. • Whenever Gate is on, Meas Method, RBW or FAST is unavailable and keys for those are grayed out. • When Gate is on, Offset Res BW and Offset Video BW are ignored (if you set these values) and the measurement works as if all Offset Res BW and all Offset Video BW are coupled with the Res BW and the Video BW under the BW menu. When Gate is on, the Offset BW key in the Offset/Limit menu is grayed out.
Preset	Off LTETDD: On
State Saved	Saved in instrument state
Range	On Off
Backwards Compatibility SCPI	[:SENSe] :SWEep:TIME:GATE[:STATe] ESA compatibility
Backwards Compatibility Notes	In ESA, Trig Delay (On) and Gate (On) could not be active at the same time.. This dependency does not exist in PSA or in the X-Series.
Initial S/W Revision	Prior to A.02.00

Gate View On/Off

Turning on Gate View in the Swept SA measurement provides a single-window gate view display..

Turning on Gate View in other measurements shows the split-screen Gate View. In these measurements, when the Gate View is on, the regular view of the current measurement traces and results are reduced vertically to about 70% of the regular height. The Zero Span window, showing the positions of the Gate, is shown between the Measurement Bar and the reduced measurement window. By reducing the height of the measurement window, some of the annotation on the Data Display may not fit and is not shown.

Key Path	Sweep/Control, Gate
Remote Command	[:SENSe] :SWEep:EGATe:VIEW ON OFF 1 0 [:SENSe] :SWEep:EGATe:VIEW?
Example	SWE:EGAT:VIEW ON turns on the gate view.
Dependencies	In the Swept SA measurement: In Gate View, the regular Sweep Time key is grayed out . When pressed, the grayed out key puts up the informational message "Use Gate View Sweep Time in the Gate menu." In the other measurements: When you turn Gate View on, the lower window takes on the current state of the instrument. Upon leaving Gate View, the instrument takes on the state of the lower window. When you turn Gate View on, the upper window Sweep Time is set to the gate view sweep time.
Couplings	These couplings apply to the Swept SA measurement: <ul style="list-style-type: none"> • When Gate View is turned on, the instrument is set to Zero Span. • Gate View automatically turns off whenever a Span other than Zero is selected. • Gate View automatically turns off if you press the Last Span key while in Gate View, and the instrument returns to the Span it was in before entering Gate View (even if that is Zero Span). • When Gate View is turned on, the sweep time used is the gate view sweep time. This is set according to the rules in section "Gate View Setup" on page 2101 • When Gate View is turned off, Sweep Time is set to the normal Swept SA measurement sweep time. • If Gate View is on and Gate is off, then turning on Gate turns off Gate View.
Preset	OFF
State Saved	Saved in instrument state
Range	On Off
Initial S/W Revision	Prior to A.02.00

A sample of the Gate View screen in the Swept SA measurement is shown in the following graphic :

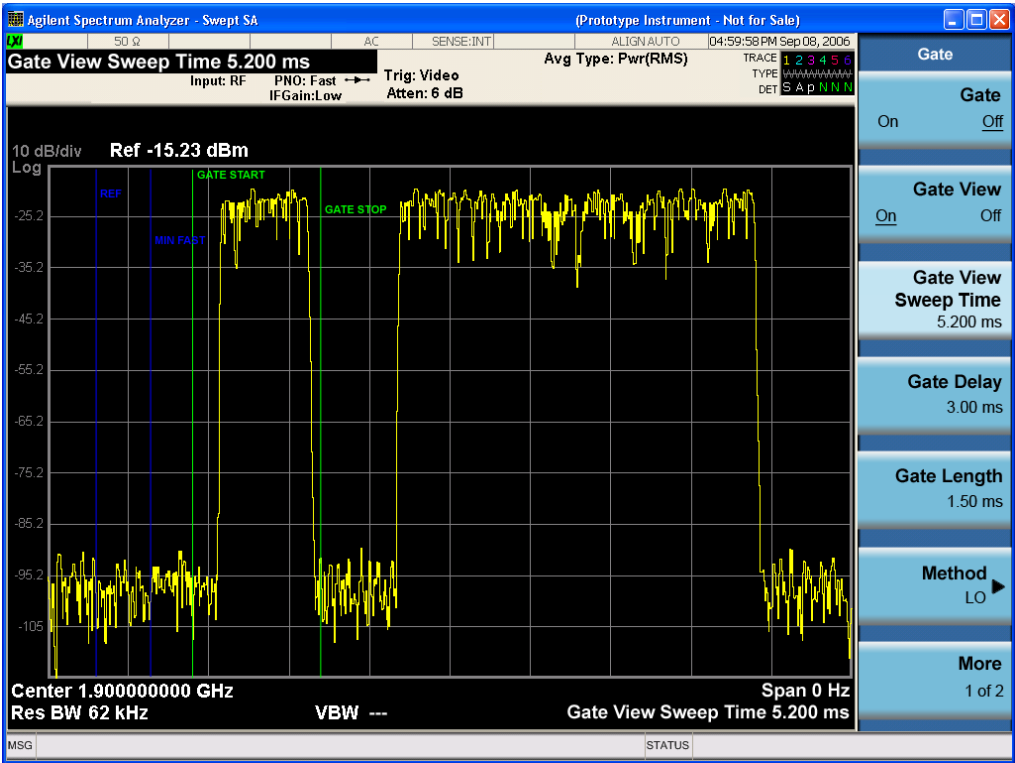

A sample of the Gate View screen in other measurements is shown in the following graphic. This example is for the ACP measurement:

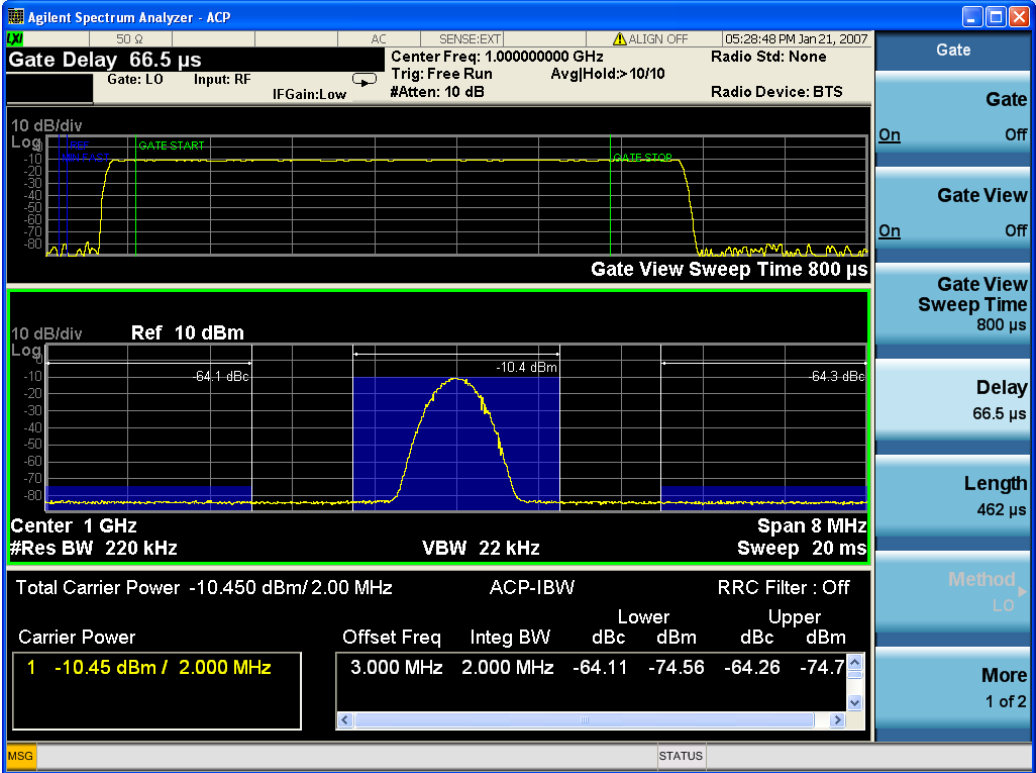

Turning Gate View off returns the analyzer to the Normal measurement view.

In the Swept SA, the normal measurement view is the single-window Swept SA view. When returning to this view, the Swept SA measurement returns to the Span it was in before entering **Gate View** (even if that is Zero Span).

The **Gate View** window is triggered from the Gate Source, with zero trigger delay. Also, when updating the **Gate View** window, the Gate itself must not operate. So it is internally shut off while the gate view window is being updated. For the Swept SA measurement, this means that the Gate is internally shut off whenever the gate view window is displayed. The measurement bar and softkeys continue to show the Trigger source for the main sweep window and give no indication that the Gate is shut off or that the Gate View window is triggered from the Gate Source.

When in **Gate View**, vertical lines are displayed in the Gate View window as follows:

- Green lines are displayed at the gate edges as follows: in Edge Gate, a line is shown for Delay and one for the end of the Gate period, defined by Length. In Level Gate a line is shown only for Delay. You can adjust the position of the green lines by adjusting the gate length and the gate delay. These lines update in the Gate View window as the active function changes, even if the window is not being updated. In Gated LO and Gated Video, these lines are positioned relative to the delay reference line (not relative to 0 time). In Gated FFT, their location is relative to the left edge of the screen.
- A blue line is displayed showing the delay reference, that is, the reference point for the Gate Delay within the Zero Span window. The blue line represents where (in time) the effective location of the gate start would be if the gate were programmed to zero delay.
-
- The second blue line is labeled "MIN FAST" as shown in the figure above because it represents the minimum Gate Delay for fast Gated LO operation. This line is only displayed in Gated LO. You cannot scroll (knob) or decrement (down key) the Gate Delay to less than that represented by the position of this line, it can only be set below this position manually, although once there it can be moved freely with the knob while below the line.
- A yellow line in the Gated Video case only, is displayed at Blength, where Blength is the display point (bucket) length for the swept trace, which is given by the sweep time for that trace divided by number of Points - 1. So it is referenced to 0 time, not to the delay reference. This line is labeled NEXT PT (it is not shown in the figure above because the figure above is for Gated LO).
- The yellow line represents the edge of a display point (bucket). Normally in Gated Video, the bucket length must be selected so that it exceeds the off time of the burst. There is another way to use the analyzer in Gated Video measurements, and that is to set the bucket width much shorter than the off time of the burst. Then use the Max Hold trace function to fill in "missing" buckets more slowly. This allows you to see some of the patterns of the Gated Video results earlier, though seeing a completely filled-in spectrum later.

Gate View Setup

Accesses a menu that enables you to setup parameters relevant to the Gate View

Key Path	Sweep/Control, Gate
Scope	Meas Global
Initial S/W Revision	A.10.00

Gate View Sweep Time

Controls the sweep time in the Gate View window. To provide an optimal view of the gate signal, the analyzer initializes Gate View Sweep Time based on the current settings of Gate Delay and Gate Length.

Key Path	Sweep/Control, Gate, Gate View Setup
Remote Command	[:SENSe] :SWEep:EGATe:TIME <time> [:SENSe] :SWEep:EGATe:TIME?
Example	SWE:EGAT:TIME 500 ms
Dependencies	Gate View Sweep Time is initialized: <ul style="list-style-type: none"> • On Preset (after initializing delay and length). • Every time the Gate Method is set/changed. <p>Additionally, in the Swept SA measurement, whenever you do a Preset, or leave Gate View, the analyzer remembers the Gate Delay and Gate Length settings. Then, when returning to Gate View, if the current Gate Delay and/or Gate Length do not match the remembered values Gate View Sweep Time is re-initialized.</p> <ol style="list-style-type: none"> 1. Compute the location of the "gate stop" line, which you know is at time $t = t_{min} + \text{GateDelay} + \text{GateLength}$.
Preset	519.3 μ s WiMAX OFDMA: 5 ms GSM/EDGE: 1 ms
State Saved	Saved in instrument state
Max	6000 s
Initial S/W Revision	Prior to A.02.00

Gate View Start Time

Controls the time at the left edge of the Gate View.

Key Path	Sweep/Control, Gate, Gate View Setup
Remote Command	[:SENSe] :SWEep:EGATe:VIEW:STARt <time> [:SENSe] :SWEep:EGATe:VIEW:STARt?
Example	SWE:EGAT:VIEW:STAR 10ms
Notes	Units of time are required or no units; otherwise an invalid suffix error message will be generated. See error -131.
Preset	0 ms
State Saved	Saved in instrument state
Min	0
Max	500 ms
Initial S/W Revision	A.10.00

Gate Delay

Controls the length of time from the time the gate condition goes True until the gate is turned on.

Key Path	Sweep/Control, Gate
Remote Command	[:SENSe] :SWEep:EGATe:DELay <time> [:SENSe] :SWEep:EGATe:DELay?
Example	SWE:EGAT:DELay 500ms SWE:EGAT:DELay?
Notes	Units of time are required or no units; otherwise an invalid suffix error message will be generated.
Preset	57.7 us WiMAX OFDMA: 71 us GSM/EDGE: 600 us WLAN: 500 us
State Saved	Saved in instrument state
Min	0.0 us
Max	100 s
Backwards Compatibility SCPI	[:SENSe] :SWEep:TIME:GATE:DELay ESA compatibility
Initial S/W Revision	Prior to A.02.00

Gate Length

Controls the length of time that the gate is on after it opens.

Key Path	Sweep/Control, Gate
Remote Command	[:SENSe] :SWEep:EGATe:LENGth <time> [:SENSe] :SWEep:EGATe:LENGth?
Example	SWE:EGAT:LENG 1 SWE:EGAT:LENG?
Notes	Units of time are required or no units; otherwise an invalid suffix error message will be generated.
Dependencies	<p>Grayed out when Gate Method is set to FFT in which case the label changes to that shown below.</p>  <p>The key is also grayed out if Gate Control = Level.</p>
Preset	461.6 us

	WiMAX OFDMA: 50 us GSM/EDGE: 200 us WLAN: 1.54 ms
State Saved	Saved in instrument state
Min	100 ns
Max	5 s
Backwards Compatibility SCPI	[:SENSe]:SWEep:TIME:GATE:LENGth ESA compatibility
Initial S/W Revision	Prior to A.02.00

Gate Source

The menus under the Gate Source key are the same as those under the Trigger key, with the exception that neither Free Run nor Video are available as Gate Source selections. However, a different SCPI command is used to select the Gate Source (see table below) because you may independently set the Gate Source and the Trigger Source.

Any changes to the settings in the setup menus under each Gate Source selection key (for example: Trigger Level, Trigger Delay, etc.) also affect the corresponding settings under the Trigger menu keys. The SCPI commands used for these are the same for Trigger and Gate, since there is only one setting which affects both Gate and Trigger. Example: to set the Trigger Level for External 1 you use the command :TRIG:EXT1:LEV regardless of whether you are using External 1 as a Trigger Source or a Gate Source.

Key Path	Sweep/Control, Gate
Remote Command	[:SENSe]:SWEep:EGATe:SOURce EXTernal1 EXTernal2 LINE FRAME RFBurst [:SENSe]:SWEep:EGATe:SOURce?
Dependencies	In some models, there is no second External input. In these models, the External 2 key is blanked and the EXTernal2 parameter will generate a “Hardware missing; Not available for this model number” error.
Preset	EXTernal 1 GSM/EDGE, MSR: FRAME LTETDD: EXTernal 1 When Direction is Downlink, FRAME when Direction is Uplink.
Backwards Compatibility Notes	In ESA, there is a single Gate input port. In PSA, the Gate Source may be taken from one of two specified input ports. In the X-Series, any Trigger Source can be a Gate Source.
Initial S/W Revision	Prior to A.02.00
Modified at S/W Revision	A.03.00, A.14.00

Line

Pressing this key, when it is not selected, selects the line signal as the trigger. A new sweep/measurement will start synchronized with the next cycle of the line voltage. Pressing this key, when it is already selected, access the line trigger setup menu.

Key Path	Trigger
Example	TRIG:SOUR LINE Swept SA measurement TRIG:<meas>:SOUR LINE Measurements other than Swept SA
Dependencies	Line trigger is not available when operating from a "dc power source", for example, when the instrument is powered from batteries.
State Saved	Saved in instrument state
Status Bits/OPC dependencies	The Status Operation Register bit 5 "Waiting for Trigger" is set at the same time as the Sweeping or Measuring bit is set. It is cleared when the trigger actually occurs (that is, after the trigger event occurs and all the applicable trigger criteria have been met). A corresponding pop-up message ("Waiting for trigger") is generated if no trigger signal appears after approximately 2 sec. This message goes away when a trigger signal appears.
Initial S/W Revision	Prior to A.02.00

Trig Slope

Controls the trigger polarity. It is set positive to trigger on a rising edge and negative to trigger on a falling edge.

Key Path	Trigger, Line
Remote Command	:TRIGger[:SEquence]:LINE:SLOPe POSitive NEGative :TRIGger[:SEquence]:LINE:SLOPe?
Example	TRIG:LINE:SLOP NEG
Preset	POSitive
State Saved	Saved in instrument state
Backwards Compatibility Notes	The legacy :TRIGger[:SEquence]:SLOPe command affects the slopes for the VID, LINE, EXT1, EXT2, and RFB triggers.
Initial S/W Revision	Prior to A.02.00

External 1

Pressing this key, when it is not selected, selects an external input signal as the trigger. A new sweep/measurement will start when the external trigger condition is met using the external 1 input connector on the rear panel.

Pressing this key, when it is already selected, accesses the external 1 trigger setup menu.

Key Path	Trigger
Example	TRIG:SOUR EXT1 Swept SA measurement TRIG:<meas>:SOUR EXT1 Measurements other than Swept SA
Dependencies	Grayed out if in use by Point Trigger in the Source Setup menu. Forced to Free Run if already selected and Point Trigger is set to External 1.
State Saved	Saved in instrument state
Status Bits/OPC dependencies	The Status Operation Register bit 5 "Waiting for Trigger" is set at the same time as the Sweeping or Measuring bit is set. It is cleared when the trigger actually occurs (that is, after the trigger event occurs and all the applicable trigger criteria have been met). A corresponding pop-up message ("Waiting for trigger") is generated if no trigger signal appears after approximately 2 sec. This message goes away when a trigger signal appears.
Initial S/W Revision	Prior to A.02.00

Trigger Level

Sets the value where the external 1 trigger input will trigger a new sweep/measurement.

Key Path	Trigger, External 1
Remote Command	:TRIGger[:SEquence]:EXTernal1:LEVel <level> :TRIGger[:SEquence]:EXTernal1:LEVel?
Example	TRIG:EXT1:LEV 0.4 V
Couplings	This same level is used for the Ext1 trigger source in the Trigger menu, for the Ext1 selection in the Periodic Timer sync source (in the Trigger menu and in the Gate Source menu), and also for the Ext1 selection in the Gate Source menu.
Preset	1.2 V
State Saved	Saved in instrument state
Min	-5 V
Max	5 V
Default Unit	V
Backwards Compatibility SCPI	:TRIGger[:SEquence]:EXTernal:LEVel For backward compatibility, the parameter EXTernal is mapped to EXTernal1
Backwards Compatibility SCPI	:TRIGger[:SEquence]:FRAME:EXTernal1:LEVel
Initial S/W Revision	Prior to A.02.00

Trig Slope

Controls the trigger polarity. It is set positive to trigger on a rising edge and negative to trigger on a falling edge.

Key Path	Trigger, External 1
Remote Command	:TRIGger[:SEquence]:EXTernal1:SLOPe POSitive NEGative :TRIGger[:SEquence]:EXTernal1:SLOPe?
Example	TRIG:EXT1:SLOP NEG
Couplings	This same slope is used in the Ext1 selection for the trigger source in the Trigger menu and for the period timer sync source (in the Trigger menu and in the Gate Source menu).
Preset	POSitive
State Saved	Saved in instrument state
Backwards Compatibility SCPI	:TRIGger[:SEquence]:EXTernal:SLOPe For backward compatibility, the parameter EXTernal is mapped to EXTernal1
Backwards Compatibility SCPI	:TRIGger[:SEquence]:FRAMe:EXTernal1:SLOPe
Backwards Compatibility Notes	The legacy :TRIGger[:SEquence]:SLOPe command affects the slopes for the VID, LINE, EXT1, EXT2, and RFB triggers.
Initial S/W Revision	Prior to A.02.00

Zero Span Delay Comp On/Off

In zero span, there is a natural delay in the signal path, which comes from the RBW filter. This is usually desirable, as it allows you to trigger on events and also see those events, because the signal is delayed from the trigger event. However, in some cases it is desirable to eliminate this delay, so that trigger events line up exactly with the zero time point in zero span. You can use the Zero Span Delay Comp On/Off feature to enable or disable zero span delay compensation.

Key Path	Trigger, External 1
Remote Command	:TRIGger[:SEquence]:EXTernal1:DELay:COMPensation OFF ON 0 1 :TRIGger[:SEquence]:EXTernal1:DELay:COMPensation?
Example	TRIG:EXT1:DEL:COMP ON
Dependencies	No effect except in zero-span, but not locked out in nonzero spans. Blanked in modes that do not support zero-span measurements. If the SCPI command is sent when the key is blanked, an error is returned: -221, "Settings conflict; Feature not supported for this measurement" In analyzers shipping N9060A, this feature requires N9060A-7FP.
Preset	OFF
State Saved	Saved in instrument state
Initial S/W Revision	A.11.00

External 2

Pressing this key, when it is not selected, selects an external input signal as the trigger. A new sweep/measurement will start when the external trigger condition is met using the external 2 input

connector. The external trigger 2 input connector is on the rear panel.

Pressing this key, when it is already selected, accesses the external 2 trigger setup menu.

Key Path	Trigger
Example	TRIG:SOUR EXT2 Swept SA measurement TRIG:<meas>:SOUR EXT2 Measurements other than Swept SA
Dependencies	In some models, there is no second External input. In these models, the External 2 key is blanked and the EXTernal2 parameter will generate a "Hardware missing; Not available for this model number" message. Grayed out if in use by Point Trigger in the Source Setup menu. Forced to Free Run if already selected and Point Trigger is set to External 2.
State Saved	Saved in instrument state
Status Bits/OPC dependencies	The Status Operation Register bit 5 "Waiting for Trigger" is set at the same time as the Sweeping or Measuring bit is set. It is cleared when the trigger actually occurs (that is, after the trigger event occurs and all the applicable trigger criteria have been met). A corresponding pop-up message ("Waiting for trigger") is generated if no trigger signal appears after approximately 2 sec. This message goes away when a trigger signal appears.
Initial S/W Revision	Prior to A.02.00
Modified at S/W Revision	A.03.00

Trigger Level

Sets the value where the external 2 trigger input will trigger a new sweep/measurement.

Key Path	Trigger, External 2
Remote Command	:TRIGger[:SEquence]:EXTernal2:LEVel :TRIGger[:SEquence]:EXTernal2:LEVel?
Example	TRIG:EXT2:LEV 1.1 V
Couplings	This same level is used for the Ext2 trigger source in the Trigger menu, for the Ext2 selection in the Periodic Timer sync source (in the Trigger menu and in the Gate Source menu), and also for the Ext2 selection in the Gate Source menu.
Preset	1.2 V
State Saved	Saved in instrument state
Min	-5 V
Max	5 V
Default Unit	V
Backwards Compatibility SCPI	:TRIGger[:SEquence]:FRAMe:EXTernal2:LEVel
Initial S/W Revision	Prior to A.02.00

Trig Slope

Controls the trigger polarity. It is set positive to trigger on a rising edge and negative to trigger on a falling edge.

Key Path	Trigger, External 2
Remote Command	:TRIGger[:SEquence]:EXternal2:SLOPe POSitive NEGative :TRIGger[:SEquence]:EXternal2:SLOPe?
Example	TRIG:EXT2:SLOP NEG
Couplings	This same slope is used in the Ext2 selection for the trigger source in the Trigger menu and for the period timer sync source (in the Trigger menu and in the Gate Source menu).
Preset	POSitive
State Saved	Saved in instrument state
Backwards Compatibility SCPI	:TRIGger[:SEquence]:FRAMe:EXternal2:SLOPe
Backwards Compatibility Notes	The legacy :TRIGger[:SEquence]:SLOPe command affects the slopes for the VID, LINE, EXT1, EXT2, and RFB triggers.
Initial S/W Revision	Prior to A.02.00

Zero Span Delay Comp On/Off

In zero span, there is a natural delay in the signal path, which comes from the RBW filter. This is usually desirable, as it allows you to trigger on events and also see those events, because the signal is delayed from the trigger event. However, in some cases it is desirable to eliminate this delay, so that trigger events line up exactly with the zero time point in zero span. You can use the Zero Span Delay Comp On/Off feature to enable or disable zero span delay compensation.

Key Path	Trigger, External 2
Remote Command	:TRIGger[:SEquence]:EXternal2:DELAy:COMPensation OFF ON 0 1 :TRIGger[:SEquence]:EXternal2:DELAy:COMPensation?
Example	TRIG:EXT2:DEL:COMP ON
Dependencies	No effect except in zero-span, but not locked out in nonzero spans. Blanked in modes that do not support zero-span measurements. If the SCPI command is sent when the key is blanked, an error is returned: -221, "Settings conflict; Feature not supported for this measurement" In analyzers shipping N9060A, this feature requires N9060A-7FP.
Preset	OFF
State Saved	Saved in instrument state
Initial S/W Revision	A.11.00

RF Burst

Pressing this key, when it is not selected, selects the RF Burst as the trigger. A new sweep/measurement will start when an RF burst envelope signal is identified from the signal at the RF Input connector. Pressing this key, when it is already selected, accesses the RF Burst trigger setup menu.

In some models, a variety of burst trigger circuitry is available, resulting in various available burst trigger bandwidths. The analyzer automatically chooses the appropriate trigger path based on the hardware configuration and other settings of the analyzer.

Key Path	Trigger
Example	TRIG:SOUR RFB Swept SA measurement TRIG:<meas>:SOUR RFB Measurements other than Swept SA
State Saved	Saved in instrument state
Status Bits/OPC dependencies	The Status Operation Register bit 5 "Waiting for Trigger" is set at the same time as the Sweeping or Measuring bit is set. It is cleared when the trigger actually occurs (that is, after the trigger event occurs and all the applicable trigger criteria have been met). A corresponding pop-up message ("Waiting for trigger") is generated if no trigger signal appears after approximately 2 sec. This message goes away when a trigger signal appears.
Backwards Compatibility Notes	The legacy command: :TRIGger[:SEQuence]:RFBurst:FSElectivity[:STATe] OFF ON 0 1 is not supported in the X-Series, as the hardware to do Frequency Selective burst triggers does not exist in X-Series.
Initial S/W Revision	Prior to A.02.00
Modified at S/W Revision	A.04.00

Absolute Trigger Level

Sets the absolute trigger level for the RF burst envelope.

When using the External Mixing path, the Absolute Trigger Level is uncalibrated because the factory default was set to accommodate the expected IF levels for the RF path.

Key Path	Trigger, RF Burst
Scope	Meas Global
Remote Command	:TRIGger[:SEQuence]:RFBurst:LEVel:ABSolute <ampl> :TRIGger[:SEQuence]:RFBurst:LEVel:ABSolute?
Example	TRIG:RFB:LEV:ABS 10 dBm sets the trigger level of the RF burst envelope signal to the absolute level of 10 dBm
Notes	Sending this command does not switch the setting from relative to absolute; to switch it you need to send the :TRIGger[:SEQuence]:RFBurst:LEVel:TYPE command, below. Amplitude Corrections are not taken into account by the Absolute Trigger Level. For example, if you have given yourself effective gain with an amplitude correction factor, the Absolute Trigger will not fire until you have set the trigger level that far below the displayed signal level, rather than simply to

	the displayed signal level. This is only true for Amplitude Corrections, not External Gain or Ref Level Offset functions. If mode is Bluetooth, the default value is -50 dBm.
Couplings	This same level is used for the RF Burst trigger source in the Trigger menu, for the RF Burst selection in the Periodic Timer sync source (in the Trigger menu and in the Gate Source menu), and also for the RF Burst selection in the Gate Source menu
Preset	-20 dBm
State Saved	Saved in instrument state
Min	-200 dBm
Max	100 dBm
Default Unit	depends on the current selected Y-Axis unit
Backwards Compatibility SCPI	:TRIGger[:SEquence]:FRAME:RFBurst:LEVel:ABSolute
Initial S/W Revision	Prior to A.02.00
Modified at S/W Revision	A.04.00

Key Path	Trigger, RF Burst
Remote Command	:TRIGger[:SEquence]:RFBurst:LEVel:TYPE ABSolute RELative :TRIGger[:SEquence]:RFBurst:LEVel:TYPE?
Example	TRIG:RFB:LEV:TYPE REL sets the trigger level type of the RF burst trigger to Relative.
Preset	ABSolute
State Saved	Saved in instrument state
Initial S/W Revision	Prior to A.02.00
Modified at S/W Revision	A.04.00

Relative Trigger Level

Sets the relative trigger level for the RF burst envelope.

In some models, the relative burst trigger function is implemented in hardware. In other models, without the advanced triggering hardware required, the relative burst trigger function is implemented in software in some measurements, and is unavailable in other measurements.

When implemented in software, the relative RF Burst trigger function is implemented as follows:

1. The measurement starts with the absolute RF Burst trigger setting. If it cannot get a trigger with that level, auto trigger fires and the acquisition starts anyway. After the acquisition, the measurement searches for the peak in the acquired waveform and saves it.

2. Now, in the next cycle of the measurement, the measurement determines a new absolute RF Burst level based on the peak value from the first measurement and the Relative RF Burst Trigger Level (always 0 or negative dB) set by the user. The following formula is used:
 3. absolute RF Burst level = peak level of the previous acquisition + relative RF Burst level
 4. If the new absolute RF Burst level differs from the previous by more than 0.5 dB, the new level is sent to the hardware; otherwise it is not updated (to avoid slowing down the acquisition)
- Steps 2 and 3 repeat for subsequent measurements.

Key Path	Trigger, RF Burst
Scope	Meas Global
Remote Command	:TRIGger[:SEquence]:RFBurst:LEVel:RELative <rel_ampl> :TRIGger[:SEquence]:RFBurst:LEVel:RELative?
Example	TRIG:RFB:LEV:REL -10 dB sets the trigger level of the RF burst envelope signal to the relative level of -10 dB
Notes	Sending this command does not switch the setting from absolute to relative; to switch it you need to send the :TRIGger[:SEquence]:RFBurst:LEVel:TYPE command, above. The relative trigger level is not available in some measurements. In those measurements the RELative parameter, and the :TRIGger[:SEquence]:RFBurst:LEVel:TYPE command (above), will generate an error if sent.
Dependencies	This key is grayed out and Absolute Trigger Level selected if the required hardware is not present in your analyzer and the current measurement does not support Relative triggering.
Preset	-6 dB GSM: -25 dB
State Saved	Saved in instrument state
Min	-45 dB
Max	0 dB
Default Unit	dB or dBc
Backwards Compatibility SCPI	:TRIGger[:SEquence]:RFBurst:LEVel This legacy command is aliased to :TRIGger[:SEquence]:RFBurst:LEVel:RELative because the PSA had ONLY relative burst triggering
Initial S/W Revision	Prior to A.02.00
Modified at S/W Revision	A.04.00

Trigger Slope

It is set positive to trigger on a rising edge and negative to trigger on a falling edge.

Key Path	Trigger, RF Burst
Remote Command	:TRIGger[:SEquence]:RFBurst:SLOPe Positive NEGative :TRIGger[:SEquence]:RFBurst:SLOPe?

Example	TRIG:RFB:SLOP NEG
Couplings	This same slope is used in the RF Burst selection for the trigger source in the Trigger menu and for the period timer sync source (in the Trigger menu and in the Gate Source menu).
Preset	POSitive
State Saved	Saved in instrument state
Backwards Compatibility SCPI	:TRIGger[:SEQuence]:FRAMe:RFBurst:SLOPe
Backwards Compatibility Notes	The legacy :TRIGger[:SEQuence]:SLOPe command affects the slopes for the VID, LINE, EXT1, EXT2, and RFB triggers.
Initial S/W Revision	Prior to A.02.00

Periodic Timer (Frame Trigger)

Pressing this key, when it is not selected, selects the internal periodic timer signal as the trigger. Triggering occurrences are set by the **Period** parameter, which is modified by the **Sync Source** and **Offset**. Pressing this key, when it is already selected, accesses the periodic timer trigger setup functions.

If you do not have a sync source selected (it is Off), then the internal timer will not be synchronized with any external timing events.

Key Path	Trigger
Example	TRIG:SOUR FRAM Swept SA measurement TRIG:<meas>:SOUR FRAM Measurements other than Swept SA
State Saved	Saved in instrument state
Readback	[Sync: <value of Sync Source>], for example, [Sync: External 1]
Status Bits/OPC dependencies	The Status Operation Register bit 5 "Waiting for Trigger" is set at the same time as the Sweeping or Measuring bit is set. It is cleared when the trigger actually occurs (that is, after the trigger event occurs and all the applicable trigger criteria have been met). A corresponding pop-up message ("Waiting for trigger") is generated if no trigger signal appears after approximately 2 sec. This message goes away when a trigger signal appears.
Initial S/W Revision	Prior to A.02.00

Periodic Timer Triggering:

This feature selects the internal periodic timer signal as the trigger. Trigger occurrences are set by the **Periodic Timer** parameter, which is modified by the **Sync Source** and **Offset**.

The figure below shows the action of the periodic timer trigger. Before reviewing the figure, we'll explain some uses for the periodic trigger.

A common application is measuring periodic burst RF signals for which a trigger signal is not easily available. For example, we might be measuring a TDMA radio which bursts every 20 ms. Let's assume that the 20 ms period is very consistent. Let's also assume that we do not have an external trigger source

available that is synchronized with the period, and that the signal-to-noise ratio of the signal is not high enough to provide a clean RF burst trigger at all of the analysis frequencies. For example, we might want to measure spurious transmissions at an offset from the carrier that is larger than the bandwidth of the RF burst trigger. In this application, we can set the Periodic Timer to a 20.00 ms period and adjust the offset from that timer to position our trigger just where we want it. If we find that the 20.00 ms is not exactly right, we can adjust the period slightly to minimize the drift between the period timer and the signal to be measured.

A second way to use this feature would be to use **Sync Source** temporarily, instead of **Offset**. In this case, we might tune to the signal in a narrow span and use the RF Burst trigger to synchronize the periodic timer. Then we would turn the sync source off so that it would not miss-trigger. Miss-triggering can occur when we are tuned so far away from the RF burst trigger that it is no longer reliable.

A third example would be to synchronize to a signal that has a reference time element of much longer period than the period of interest. In some CDMA applications, it is useful to look at signals with a short periodicity, by synchronizing that periodicity to the "even-second clock" edge that happens every two seconds. Thus, we could connect the even-second clock trigger to Ext1 and use then Ext1 as the sync source for the periodic timer.

The figure below illustrates this third example. The top trace represents the even-second clock. It causes the periodic timer to synchronize with the leading edge shown. The analyzer trigger occurs at a time delayed by the accumulated offset from the period trigger event. The periodic timer continues to run, and triggers continue to occur, with a periodicity determined by the analyzer time base. The timer output (labeled "late event") will drift away from its ideal time due to imperfect matching between the time base of the signal being measured and the time base of the analyzer, and also because of imperfect setting of the period parameter. But the synchronization is restored on the next even-second clock event. ("Accumulated offset" is described in the in the **Offset** function section.)

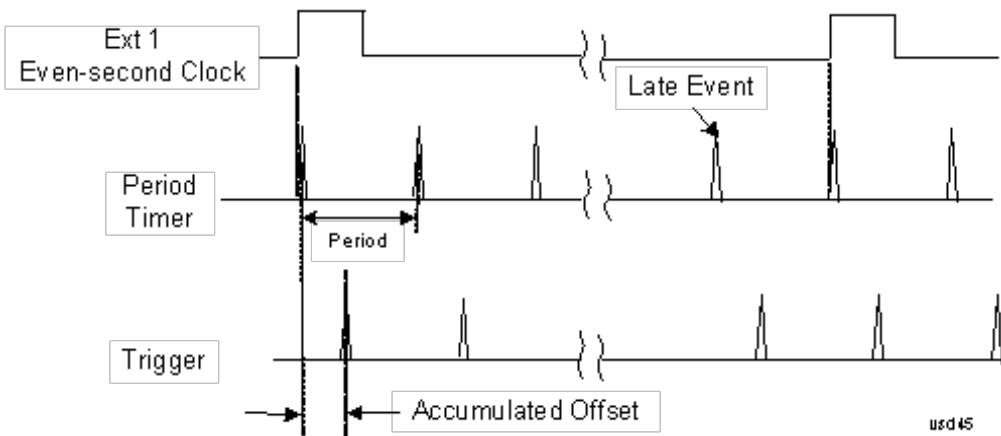

Period

Sets the period of the internal periodic timer clock. For digital communications signals, this is usually set to the frame period of your current input signal. In the case that sync source is not set to OFF, and the external sync source rate is changed for some reason, the periodic timer is synchronized at the every external synchronization pulse by resetting the internal state of the timer circuit.

Key Path	Trigger, Periodic Timer
Remote Command	:TRIGger[:SEquence]:FRAMe:PERIOD <time>

	:TRIGger[:SEquence]:FRAMe:PERiod?
Example	TRIG:FRAM:PER 100 ms
Dependencies	The invalid data indicator turns on when the period is changed, until the next sweep/measurement completes.
Couplings	The same period is used in the Gate Source selection of the period timer.
Preset	20 ms GSM: 4.615383
State Saved	Saved in instrument state
Min	100.000 ns
Max	559.0000 ms
Default Unit	S
Initial S/W Revision	Prior to A.02.00

Offset

Adjusts the accumulated offset between the periodic timer events and the trigger event. Adjusting the accumulated offset is different than setting an offset, and requires explanation.

The periodic timer is usually not synchronized with any external events, so the timing of its output events has no absolute meaning. Since the timing relative to external events (RF signals) is important, you need to be able to adjust (offset) it. However, you have no direct way to see when the periodic timer events occur. All that you can see is the trigger timing. When you want to adjust the trigger timing, you will be changing the internal offset between the periodic timer events and the trigger event. Because the absolute value of that internal offset is unknown, we will just call that the accumulated offset. Whenever the Offset parameter is changed, you are changing that accumulated offset. You can reset the displayed offset using Reset Offset Display. Changing the display does not change the value of the accumulated offset, and you can still make additional changes to accumulated offset.

To avoid ambiguity, we define that an increase in the "offset" parameter, either from the knob or the SCPI adjust command, serves to delay the timing of the trigger event.

Key Path	Trigger, Periodic Timer
Remote Command	:TRIGger[:SEquence]:FRAMe:OFFSet <time> :TRIGger[:SEquence]:FRAMe:OFFSet?
Example	TRIG:FRAM:OFFS 1.2 ms
Notes	The front panel interface (for example, the knob), and this command, adjust the accumulated offset, which is shown on the active function display. However, the actual amount sent to the hardware each time the offset is updated is the delta value, that is, the current accumulated offset value minus the previous accumulated offset value. Note that the accumulated offset value is essentially arbitrary; it represents the accumulated offset from the last time the offset was zeroed (with the Reset Offset Display key). Note that this command does not change the period of the trigger waveform. Note also that Offset is used only when the sync source is set to OFF, otherwise delay is used, see section "Trig Delay" on page 460.

	An increase in the "offset" parameter, either from the knob or the SCPI adjust command, serves to delay the timing of the trigger event.
Notes	When the SCPI command is sent the value shown on the key (and the Active Function, if this happens to be the active function) is updated with the new value. However, the actual amount sent to the hardware is the delta value, that is, the current accumulated offset value minus the previous accumulated offset value. The SCPI query simply returns the value currently showing on the key.
Dependencies	The invalid data indicator turns on when the offset is changed, until the next sweep/measurement completes.
Couplings	The same offset is used in the Gate Source selection of the period timer.
Preset	0 s
State Saved	Saved in instrument state
Min	-10.000 s
Max	10.000 s
Default Unit	S
Initial S/W Revision	Prior to A.02.00

Offset Adjust (Remote Command Only)

This remote command does not work at all like the related front panel keys. This command lets you advance the phase of the frame trigger by the amount you specify.

It does not change the period of the trigger waveform. If the command is sent multiple times, it advances the phase of the frame trigger an additional amount each time it is sent. Negative numbers are permitted.

Remote Command	:TRIGger[:SEquence]:FRAMe:ADJust <time>
Example	TRIG:FRAM:ADJ 1.2 ms
Notes	Note also that Offset is used only when the sync source is set to OFF, otherwise delay is used, see section " Trig Delay " on page 460 An increase in the "offset" parameter, either from the knob or the SCPI adjust command, serves to delay the timing of the trigger event.
Notes	The front panel interface (for example, the knob) and the :TRIG:FRAM:OFFS command adjust the accumulated offset, which is shown on the active function display. However, the actual amount sent to the hardware is the delta value, that is, the current offset value minus the previous offset value. When the SCPI command is sent the value shown on the key (and the Active Function, if this happens to be the active function) is updated by increasing it (or decreasing it if the value sent is negative) by the amount specified in the SCPI command. This is a "command only" SCPI command, with no query.
Dependencies	The invalid data indicator turns on when the offset is changed, until the next sweep/measurement completes.
Couplings	The same offset is used in the Gate Source selection of the period timer.
Preset	0 s

State Saved	Saved in instrument state
Min	-10.000 s
Max	10.000 s
Default Unit	S
Initial S/W Revision	Prior to A.02.00

Reset Offset Display

Resets the value of the periodic trigger offset display setting to 0.0 seconds. The current displayed trigger location may include an offset value defined with the Offset key. Pressing this key redefines the currently displayed trigger location as the new trigger point that is 0.0 s offset. The Offset key can then be used to add offset relative to this new timing.

Key Path	Trigger, Periodic Timer
Remote Command	:TRIGger[:SEquence]:FRAMe:OFFSet:DISPlay:RESet
Example	TRIG:FRAM:OFFS:DISP:RES
Initial S/W Revision	Prior to A.02.00

Sync Source

Selects a signal source for you to synchronize your periodic timer trigger to, otherwise you are triggering at some arbitrary location in the frame. Synchronization reduces the precision requirements on the setting of the period.

For convenience you may adjust the level and slope of the selected sync source in a conditional branch setup menu accessed from the Sync Source menu. Note that these settings match those in the **Trigger** and **Gate Source** menus; that is, each trigger source has only one value of level and slope, regardless of which menu it is accessed from.

Key Path	Trigger, Periodic Timer
Remote Command	:TRIGger[:SEquence]:FRAMe:SYNC EXTernal1 EXTernal2 RFBurst OFF :TRIGger[:SEquence]:FRAMe:SYNC?
Example	TRIG:FRAM:SYNC EXT2
Dependencies	In some models, there is no second External input. In these models, the External 2 key is blanked and the EXTernal2 parameter will generate a "Hardware missing; Not available for this model number" message.
Preset	Off GSM/EDGE, MSR,LTE,LTETDD: RFBurst
State Saved	Saved in instrument state
Readback	The current setting is read back to this key and it is also Readback to the previous Periodic Timer trigger key.

Backwards Compatibility SCPI	:TRIGger[:SEquence]:FRAMe:SYNC EXTernal
Initial S/W Revision	Prior to A.02.00
Modified at S/W Revision	A.03.00, A.14.00

Off

Turns off the sync source for your periodic trigger. With the sync source off, the timing will drift unless the signal source frequency is locked to the analyzer frequency reference.

Key Path	Trigger, Periodic Timer, Sync Source
Example	TRIG:FRAM:SYNC OFF
Readback	Off
Initial S/W Revision	Prior to A.02.00

External 1

Pressing this key, when it is not selected, selects an external input signal as the trigger. A new sweep/measurement will start when the external trigger condition is met using the external 1 input connector on the rear panel.

Pressing this key, when it is already selected, accesses the external 1 trigger setup menu.

Key Path	Trigger
Example	TRIG:SOUR EXT1 Swept SA measurement TRIG:<meas>:SOUR EXT1 Measurements other than Swept SA
Dependencies	Grayed out if in use by Point Trigger in the Source Setup menu. Forced to Free Run if already selected and Point Trigger is set to External 1.
State Saved	Saved in instrument state
Status Bits/OPC dependencies	The Status Operation Register bit 5 "Waiting for Trigger" is set at the same time as the Sweeping or Measuring bit is set. It is cleared when the trigger actually occurs (that is, after the trigger event occurs and all the applicable trigger criteria have been met). A corresponding pop-up message ("Waiting for trigger") is generated if no trigger signal appears after approximately 2 sec. This message goes away when a trigger signal appears.
Initial S/W Revision	Prior to A.02.00

Trigger Level

Sets the value where the external 1 trigger input will trigger a new sweep/measurement.

Key Path	Trigger, External 1
Remote Command	:TRIGger[:SEquence]:EXTErnal1:LEVel <level> :TRIGger[:SEquence]:EXTErnal1:LEVel?
Example	TRIG:EXT1:LEV 0.4 V
Couplings	This same level is used for the Ext1 trigger source in the Trigger menu, for the Ext1 selection in the Periodic Timer sync source (in the Trigger menu and in the Gate Source menu), and also for the Ext1 selection in the Gate Source menu.
Preset	1.2 V
State Saved	Saved in instrument state
Min	-5 V
Max	5 V
Default Unit	V
Backwards Compatibility SCPI	:TRIGger[:SEquence]:EXTErnal:LEVel For backward compatibility, the parameter EXTErnal is mapped to EXTErnal1
Backwards Compatibility SCPI	:TRIGger[:SEquence]:FRAME:EXTErnal1:LEVel
Initial S/W Revision	Prior to A.02.00

Trig Slope

Controls the trigger polarity. It is set positive to trigger on a rising edge and negative to trigger on a falling edge.

Key Path	Trigger, External 1
Remote Command	:TRIGger[:SEquence]:EXTErnal1:SLOPe POSitive NEGative :TRIGger[:SEquence]:EXTErnal1:SLOPe?
Example	TRIG:EXT1:SLOP NEG
Couplings	This same slope is used in the Ext1 selection for the trigger source in the Trigger menu and for the period timer sync source (in the Trigger menu and in the Gate Source menu).
Preset	POSitive
State Saved	Saved in instrument state
Backwards Compatibility SCPI	:TRIGger[:SEquence]:EXTErnal:SLOPe For backward compatibility, the parameter EXTErnal is mapped to EXTErnal1
Backwards Compatibility SCPI	:TRIGger[:SEquence]:FRAME:EXTErnal1:SLOPe
Backwards Compatibility Notes	The legacy :TRIGger[:SEquence]:SLOPe command affects the slopes for the VID, LINE, EXT1, EXT2, and RFB triggers.
Initial S/W Revision	Prior to A.02.00

External 2

Pressing this key, when it is not selected, selects an external input signal as the trigger. A new sweep/measurement will start when the external trigger condition is met using the external 2 input connector. The external trigger 2 input connector is on the rear panel.

Pressing this key, when it is already selected, accesses the external 2 trigger setup menu.

Key Path	Trigger
Example	TRIG:SOUR EXT2 Swept SA measurement TRIG:<meas>:SOUR EXT2 Measurements other than Swept SA
Dependencies	In some models, there is no second External input. In these models, the External 2 key is blanked and the EXTernal2 parameter will generate a "Hardware missing; Not available for this model number" message. Grayed out if in use by Point Trigger in the Source Setup menu. Forced to Free Run if already selected and Point Trigger is set to External 2.
State Saved	Saved in instrument state
Status Bits/OPC dependencies	The Status Operation Register bit 5 "Waiting for Trigger" is set at the same time as the Sweeping or Measuring bit is set. It is cleared when the trigger actually occurs (that is, after the trigger event occurs and all the applicable trigger criteria have been met). A corresponding pop-up message ("Waiting for trigger") is generated if no trigger signal appears after approximately 2 sec. This message goes away when a trigger signal appears.
Initial S/W Revision	Prior to A.02.00
Modified at S/W Revision	A.03.00

Trigger Level

Sets the value where the external 2 trigger input will trigger a new sweep/measurement.

Key Path	Trigger, External 2
Remote Command	:TRIGger[:SEquence]:EXTernal2:LEVel :TRIGger[:SEquence]:EXTernal2:LEVel?
Example	TRIG:EXT2:LEV 1.1 V
Couplings	This same level is used for the Ext2 trigger source in the Trigger menu, for the Ext2 selection in the Periodic Timer sync source (in the Trigger menu and in the Gate Source menu), and also for the Ext2 selection in the Gate Source menu.
Preset	1.2 V
State Saved	Saved in instrument state
Min	-5 V
Max	5 V
Default Unit	V
Backwards Compatibility SCPI	:TRIGger[:SEquence]:FRAMe:EXTernal2:LEVel
Initial S/W Revision	Prior to A.02.00

Trig Slope

Controls the trigger polarity. It is set positive to trigger on a rising edge and negative to trigger on a falling edge.

Key Path	Trigger, External 2
Remote Command	:TRIGger[:SEQuence]:EXTernal2:SLOPe POSitive NEGative :TRIGger[:SEQuence]:EXTernal2:SLOPe?
Example	TRIG:EXT2:SLOP NEG
Couplings	This same slope is used in the Ext2 selection for the trigger source in the Trigger menu and for the period timer sync source (in the Trigger menu and in the Gate Source menu).
Preset	POSitive
State Saved	Saved in instrument state
Backwards Compatibility SCPI	:TRIGger[:SEQuence]:FRAMe:EXTernal2:SLOPe
Backwards Compatibility Notes	The legacy :TRIGger[:SEQuence]:SLOPe command affects the slopes for the VID, LINE, EXT1, EXT2, and RFB triggers.
Initial S/W Revision	Prior to A.02.00

RF Burst

Pressing this key, when it is not selected, selects the RF Burst as the trigger. A new sweep/measurement will start when an RF burst envelope signal is identified from the signal at the RF Input connector. Pressing this key, when it is already selected, accesses the RF Burst trigger setup menu.

In some models, a variety of burst trigger circuitry is available, resulting in various available burst trigger bandwidths. The analyzer automatically chooses the appropriate trigger path based on the hardware configuration and other settings of the analyzer.

Key Path	Trigger
Example	TRIG:SOUR RFB Swept SA measurement TRIG:< meas>:SOUR RFB Measurements other than Swept SA
State Saved	Saved in instrument state
Status Bits/OPC dependencies	The Status Operation Register bit 5 "Waiting for Trigger" is set at the same time as the Sweeping or Measuring bit is set. It is cleared when the trigger actually occurs (that is, after the trigger event occurs and all the applicable trigger criteria have been met). A corresponding pop-up message ("Waiting for trigger") is generated if no trigger signal appears after approximately 2 sec. This message goes away when a trigger signal appears.
Backwards Compatibility Notes	The legacy command: :TRIGger[:SEQuence]:RFBurst:FSElectivity[:STATe] OFF ON 0 1 is not supported in the X-Series, as the hardware to do Frequency Selective burst triggers does not exist in X-Series.

Initial S/W Revision	Prior to A.02.00
Modified at S/W Revision	A.04.00

Absolute Trigger Level

Sets the absolute trigger level for the RF burst envelope.

When using the External Mixing path, the Absolute Trigger Level is uncalibrated because the factory default was set to accommodate the expected IF levels for the RF path.

Key Path	Trigger, RF Burst
Scope	Meas Global
Remote Command	:TRIGger[:SEquence]:RFBurst:LEVel:ABSolute <ampl> :TRIGger[:SEquence]:RFBurst:LEVel:ABSolute?
Example	TRIG:RFB:LEV:ABS 10 dBm sets the trigger level of the RF burst envelope signal to the absolute level of 10 dBm
Notes	Sending this command does not switch the setting from relative to absolute; to switch it you need to send the :TRIGger[:SEquence]:RFBurst:LEVel:TYPE command, below. Amplitude Corrections are not taken into account by the Absolute Trigger Level. For example, if you have given yourself effective gain with an amplitude correction factor, the Absolute Trigger will not fire until you have set the trigger level that far below the displayed signal level, rather than simply to the displayed signal level. This is only true for Amplitude Corrections, not External Gain or Ref Level Offset functions. If mode is Bluetooth, the default value is -50 dBm.
Couplings	This same level is used for the RF Burst trigger source in the Trigger menu, for the RF Burst selection in the Periodic Timer sync source (in the Trigger menu and in the Gate Source menu), and also for the RF Burst selection in the Gate Source menu
Preset	-20 dBm
State Saved	Saved in instrument state
Min	-200 dBm
Max	100 dBm
Default Unit	depends on the current selected Y-Axis unit
Backwards Compatibility SCPI	:TRIGger[:SEquence]:FRAME:RFBurst:LEVel:ABSolute
Initial S/W Revision	Prior to A.02.00
Modified at S/W Revision	A.04.00

Key Path	Trigger, RF Burst
Remote Command	:TRIGger[:SEquence]:RFBurst:LEVel:TYPE ABSolute RELative :TRIGger[:SEquence]:RFBurst:LEVel:TYPE?

Example	TRIG:RFB:LEV:TYPE REL sets the trigger level type of the RF burst trigger to Relative.
Preset	ABSolute
State Saved	Saved in instrument state
Initial S/W Revision	Prior to A.02.00
Modified at S/W Revision	A.04.00

Trigger Slope

It is set positive to trigger on a rising edge and negative to trigger on a falling edge.

Key Path	Trigger, RF Burst
Remote Command	:TRIGger[:SEquence]:RFBurst:SLOPe POSitive NEGative :TRIGger[:SEquence]:RFBurst:SLOPe?
Example	TRIG:RFB:SLOP NEG
Couplings	This same slope is used in the RF Burst selection for the trigger source in the Trigger menu and for the period timer sync source (in the Trigger menu and in the Gate Source menu).
Preset	POSitive
State Saved	Saved in instrument state
Backwards Compatibility SCPI	:TRIGger[:SEquence]:FRAME:RFBurst:SLOPe
Backwards Compatibility Notes	The legacy :TRIGger[:SEquence]:SLOPe command affects the slopes for the VID, LINE, EXT1, EXT2, and RFB triggers.
Initial S/W Revision	Prior to A.02.00

Sync Holdoff

Sync Holdoff specifies the duration that the sync source signal must be kept false before the transition to true to be recognized as the sync timing. The periodic timer phase is aligned when the sync source signal becomes true, after the Holdoff time is satisfied.

A holdoff of 2 ms will work with most WiMAX signals, but there may be cases where the burst off duration is less than 1 ms and this value will need to be changed.

Key Path	Trigger, Periodic Timer
Remote Command	:TRIGger[:SEquence]:FRAME:SYNC:HOLDoff <time> :TRIGger[:SEquence]:FRAME:SYNC:HOLDoff? :TRIGger[:SEquence]:FRAME:SYNC:HOLDoff:STATE OFF ON 0 1 :TRIGger[:SEquence]:FRAME:SYNC:HOLDoff:STATE?
Preset	On, 1.000 ms

State Saved	Saved in instrument state
Min	0 ms
Max	+500 ms
Default Unit	s
Initial S/W Revision	Prior to A.02.00

Control Edge/Level

Sets the method of controlling the gating function from the gating signal.

Edge

In Edge triggering, the gate opens (after the Delay) on the selected edge (for example, positive) of the gate signal and closes on the alternate edge (for example, negative).

Level

In Level triggering, the gate opens (after the Delay) when the gate signal has achieved a certain level and stays open as long as that level is maintained.

Key Path	Sweep/Control, Gate
Remote Command	[:SENSE] :SWEep:EGATe:CONTRol EDGE LEVel [:SENSE] :SWEep:EGATe:CONTRol?
Example	SWE:EGAT:CONT EDGE
Dependencies	If the Gate Method is FFT the Control key is grayed out and Edge is selected. If the Gate Source is TV, Frame or Line, the Control key is grayed out and Edge is selected.
Preset	EDGE
State Saved	Saved in instrument state
Backwards Compatibility SCPI	[:SENSE] :SWEep:TIME:GATE:TYPE ESA Compatibility
Initial S/W Revision	Prior to A.02.00

Gate Holdoff

Lets you increase or decrease the wait time after a gate event ends before the analyzer will respond to the next gate signal.

After any Gate event finishes, the analyzer must wait for the sweep system to settle before it can respond to another Gate signal. The analyzer calculates a "wait time," taking into account a number of factors, including RBW and Phase Noise Optimization settings. The goal is to achieve the same accuracy when gated as in ungated operation. The figure below illustrates this concept:

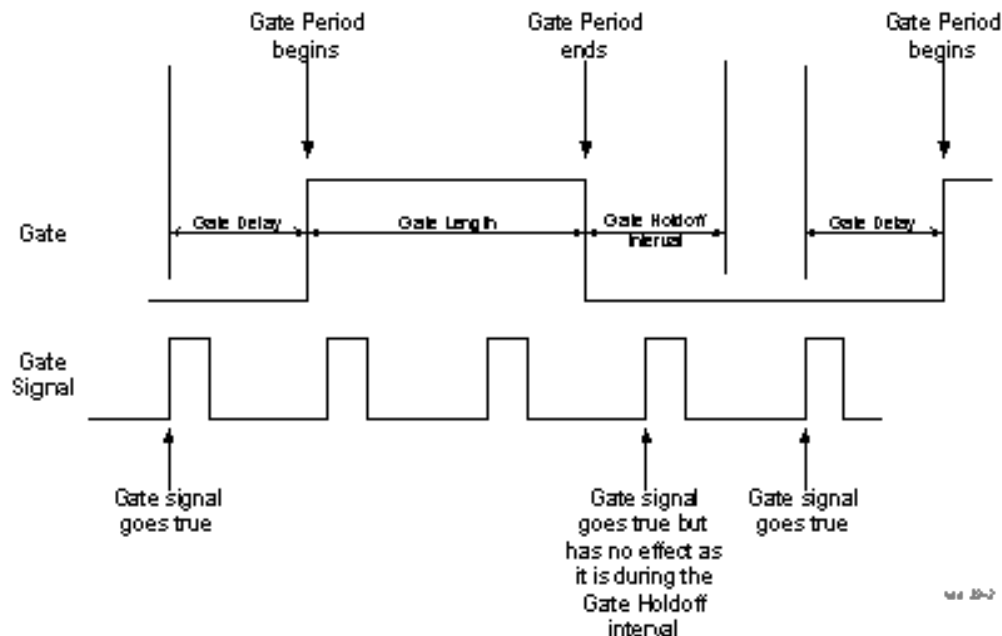

When Gate Holdoff is in Auto, the wait time calculated by the analyzer is used. When Gate Time is in Manual, the user may adjust the wait time, usually decreasing it in order to achieve greater speed, but at the risk of decreasing accuracy.

When the Method key is set to Video or FFT, the Gate Holdoff function has no effect.

In measurements that do not support Auto, the value shown when Auto is selected is “---” and the manually set holdoff is returned to a query.

Key Path	Sweep/Control, Gate
Remote Command	<pre>[:SENSe] :SWEep:EGATe:HOLDoff <time> [:SENSe] :SWEep:EGATe:HOLDoff? [:SENSe] :SWEep:EGATe:HOLDoff:AUTO OFF ON 0 1 [:SENSe] :SWEep:EGATe:HOLDoff:AUTO?</pre>
Example	<pre>SWE:EGAT:HOLD 0.0002 SWE:EGAT:HOLD? SWE:EGAT:HOLD:AUTO ON SWE:EGAT:HOLD:AUTO?</pre>
Couplings	<p>When Gate Holdoff is Auto, the Gate Holdoff key shows the value calculated by the analyzer for the wait time.</p> <p>Pressing the Gate Holdoff key while it is in Auto and not selected, causes the key to become selected and allows the user to adjust the value. If the value is adjusted, the setting changes to Man.</p> <p>Pressing the Gate Holdoff key, while it is in Auto and selected, does not change the value of Gate Holdoff, but causes the setting to change to Man. Now the user can adjust the value.</p> <p>Pressing the key while it is in Man and selected, cause the value to change back to Auto.</p> <p>Pressing the key while it is in Man and not selected, causes the key to become selected and allows the user to adjust the value.</p>

	When Method is set to Video or FFT, the Gate Holdoff function has no effect.
Preset	Auto Auto/On
State Saved	Saved in instrument state
Min	1 μ sec
Max	1 sec
Initial S/W Revision	Prior to A.02.00

Gate Delay Compensation

This function allows you to select an RBW-dependent value by which to adjust the gate delay, to compensate for changes in the delay caused by RBW effects.

You can select between uncompensated operation and two types of compensation, Delay Until RBW Settled and Compensate for RBW Group Delay.

See ["More Information" on page 1172](#)

Key Path	Sweep/Control, Gate
Scope	Meas Global
Remote Command	[:SENSe] :SWEep:EGATe:DELaY:COMPensation:TYPE OFF SETTled GDELaY [:SENSe] :SWEep:EGATe:DELaY:COMPensation:TYPE?
Example	SWE:EGAT:DEL:COMP:TYPE SETT SWE:EGAT:DEL:COMP:TYPE?
Notes	Although this function is Meas Global, there are some measurements that do not support this function. In those measurements the operation will be Uncompensated. Going into one of those measurements will not change the Meas Global selection; it will simply display the grayed-out menu key with "Uncompensated" showing as the selection. This is a non-forceful grayout, so the SCPI command is still accepted. If Gate Delay Compensation is not supported at all within a particular mode, the key is not displayed, and if the SCPI command is sent while in a measurement within that mode, an "Undefined Header" message is generated. Measurements that do not support this function include: Swept SA
Preset	TD-SCDMA mode: Compensate for RBW Group Delay All other modes: Delay Until RBW Settled
State Saved	Saved in instrument state
Range	Uncompensated Delay Until RBW Settled Compensate for RBW Group Delay
Readback text	Uncompensated Settled Group Delay
Initial S/W Revision	Prior to A.02.00
Modified at S/W Revision	A.11.0

More Information

Selecting Uncompensated means that the actual gate delay is as you sets it.

Selecting Delay Until RBW Settled causes the gate delay to be increased above the user setting by an amount equal to $3.06/\text{RBW}$. This compensated delay causes the GATE START and GATE STOP lines on the display to move by the compensation amount, and the actual hardware gate delay to be increased by the same amount. All the other gate lines (for example, MIN FAST) are unaffected. If the RBW subsequently changes, the compensation is readjusted for the new RBW. The value shown on the Gate Delay key does NOT change.

Delay Until RBW Settled allows excellent measurements of gated signals, by allowing the IF to settle following any transient that affects the burst. Excellent measurements also require that the analysis region not extend into the region affected by the falling edge of the burst. Thus, excellent measurements can only be made over a width that declines with narrowing RBWs, which is achieved by decreasing the gate length below the user setting by an amount equal to $2.53/\text{RBW}$. Therefore, for general purpose compensation, you will still want to change the gate length with changes in RBW even if the gate delay is compensated. The compensated Gate Length is limited by the analyzer so that it will never go below 10% of the value shown on the Gate Length key, as otherwise the sweep times could get very long. Anytime the Gate Length and RBW values combine in such a way that this limiting takes place, a warning is displayed. For measurements which contain multiple sweeps with different RBW like SEM and SPUR, the smallest RBW is used for this limiting.

Selecting Compensate for RBW Group Delay causes the gate delay to be increased above the user setting by an amount equal to $1.81/\text{RBW}$. This compensated delay causes the GATE START, GATE STOP lines on the display to move by the compensation amount, and the actual hardware gate delay to be increased by the same amount. All the other gate lines (for example, MIN FAST) are unaffected. If the RBW subsequently changes, the compensation is readjusted for the new RBW. The value shown on the Gate Delay key does NOT change. Compensate for RBW Group Delay also includes gate length compensation; the gate length itself is adjusted as necessary to attempt to compensate for delay effects imposed by the RBW.

Compensate for RBW Group Delay is similar to Delay Until RBW Settled, but compensates for the group delay of the RBW filter, rather than the filter settling time. As the RBW gets narrow, this can allow the settling tail of the RBW to affect the beginning part of the gated measurement, and allow the beginning of the RBW settling transient to affect the end of the gated measurement. These two effects are symmetric because the RBW response is symmetric. Because the gate length is not automatically compensated, some users might find this compensation to be more intuitive than compensation for RBW settling.

Min Fast Position Query (Remote Command Only)

This command queries the position of the MIN FAST line, relative to the delay reference (REF) line. See section ["Gate View On/Off" on page 2098](#). If this query is sent while not in gate view, the MinFast calculation is performed based on the current values of the appropriate parameters and the result is returned. Knowing this value lets you set an optimal gate delay value for the current measurement setup.

Remote Command	<code>[:SENSe] :SWEep:EGATe:MINFast?</code>
Example	<code>SWE:EGAT:MIN?</code>
Initial S/W Revision	Prior to A.02.00

Gate Preset (Remote Command Only)

Presets the time-gated spectrum analysis capability.

This command sets gate parameter values to the ESA preset values, as follows:

Gate trigger type = edge

Gate polarity = positive

Gate delay = 1 us

Gate length = 1 us

Remote Command	<code>[[:SENSe]:SWEep:TIME:GATE:PRESet</code> ESA Compatibility
Initial S/W Revision	Prior to A.02.00

Gate Level (Remote Command Only)

Sets the gate input transition point level for the external TRIGGER inputs on the front and rear panel. This is a legacy command for PSA compatibility. It is simply an alias to the equivalent trigger level command.

Remote Command	<code>[[:SENSe]:SWEep:EGATE:EXTernal[1] 2:LEVel <voltage></code> <code>[[:SENSe]:SWEep:EGATE:EXTernal[1] 2:LEVel?</code>
Notes	This command is simply an alias to <code>:TRIGger[:SEQUence]:EXTernal[1] 2:LEVel</code> For details refer
Initial S/W Revision	Prior to A.02.00

Gate Polarity (Remote Command Only)

Sets the polarity for the gate signal. This setup is now done using the gate trigger's slope setting.

When Positive (Pos) is selected, a positive-going edge (Edge) or a high voltage (Level) will satisfy the gate condition, after the delay set with the Gate Delay key. When Negative (Neg) is selected, a negative-going edge (Edge) or a low voltage (Level) will satisfy the gate condition after the delay.

Remote Command	<code>[[:SENSe]:SWEep:EGATE:POLarity</code> NEGative POSitive <code>[[:SENSe]:SWEep:EGATE:POLarity?</code>
Example	<code>SWE:EGAT:POL NEG</code> <code>SWE:EGAT:POL?</code>
Preset	POSitive
State Saved	Saved in instrument state
Backwards Compatibility SCPI	<code>[[:SENSe]:SWEep:TIME:GATE:POLarity</code> ESA compatibility
Initial S/W Revision	Prior to A.02.00

11 Spectrum Emission Mask Measurement
Sweep/Control

Remote Command	<code>[:SENSe] :SWEep:TIME:GATE:LEVel HIGH LOW</code> <code>[:SENSe] :SWEep:TIME:GATE:LEVel?</code> ESA compatibility
Preset	HIGH
Initial S/W Revision	Prior to A.02.00

System

See "System" on page 353

Trace/Detector

Accesses a menu of functions that enable you to control trace and detector for the current measurement.

Key Path	Front-panel key
Initial S/W Revision	Prior to A.02.00

Trace Type

Allows you to select the type of trace for the current measurement. The menu contains a 1-of-N selection of the trace type (Clear Write, Average, Max Hold, Min Hold).

Key Path	Trace/Detector
Mode	SA, WCDMA, C2K, WIMAX OFDMA, TD-SCDMA, 1xEVDO, DTMB (CTTB), DVB-T/H, ISDB-T, CMMB, LTE, LTEFDD, Digital Cable TV, WLAN, MSR, LTEAFDD, LTEATDD
Remote Command	:TRACe:SEMask:TYPE WRITe AVERAge MAXHold MINHold :TRACe:SEMask:TYPE?
Example	TRAC:SEM:TYPE MINH TRAC:SEM:TYPE?
Notes	WRITe = Clear Write AVERAge = Average MAXHold = Maximum Hold MINHold = Minimum Hold
Couplings	When Detector setting is "Auto" ([:SENSe]:SEMask:DETECTOR:AUTO?), Detector ([:SENSe]:SEMask:DETECTOR[:FUNCTION]?) switches aligning with the switch of this parameter: "NORMal" with WRITe (Clear Write), "AVERAge" with AVERAge, "POSitive (peak)" with MAXHold, and "NEGative (peak)" with MINHold.
Preset	AVERAge
State Saved	Saved in instrument state.
Range	WRITe AVERAge MAXHold MINHold
Initial S/W Revision	Prior to A.02.00
Modified at S/W Revision	A.02.00, A.03.00

Chan Detector

Accesses a menu of functions that enable you to control the detectors for reference channel. The following choices are available:

- Auto—the detector selected depends on marker functions, trace functions, average type, and the trace averaging function.
- Normal—the detector determines the peak of the CW-like signals, and it yields alternating maximums and minimums of noise-like signals. This is also referred to as Rosenfell detection.

- Average—the detector determines the average of the signal within the sweep points. The averaging method depends upon the Average Type selection (voltage, power or log scales).
- Peak—the detector determines the maximum of the signal within the sweep points.
- Sample—the detector indicates the instantaneous level of the signal at the center of the sweep points represented by each display point.
- Negative Peak—the detector determines the minimum of the signal within the sweep points.

Key Path	Trace/Detector
Initial S/W Revision	Prior to A.02.00

Chan Detector Auto

Sets the detector to the default detection mode for the reference channel. This mode is dependent upon the current reference channel conditions.

Key Path	Trace/Detector
Mode	SA, WCDMA, C2K, WIMAX OFDMA, TD-SCDMA, 1xEVDO, DTMB (CTTB), DVB-T/H, ISDB-T, CMMB, LTE, LTE-TDD, Digital Cable TV, WLAN, MSR, LTEAFDD, LTEATDD
Remote Command	[:SENSe] :SEMAsk:DETEctor:CARRier:AUTO ON OFF 1 0 [:SENSe] :SEMAsk:DETEctor:CARRier:AUTO?
Example	SEM:DET:CARR:AUTO OFF SEM:DET:CARR:AUTO?
Notes	See Couplings in the Trace Type section. You must be in the mode that includes SEM measurement to use this command. Use :INSTrument:SElect to set the mode.
Preset	ON
State Saved	Saved in instrument state
Range	On Off
Initial S/W Revision	Prior to A.02.00
Modified at S/W Revision	A.02.00, A.03.00

Chan Detector Selection

Selects the detector mode for the reference channel.

Key Path	Trace/Detector
Mode	SA, WCDMA, C2K, WIMAX OFDMA, TD-SCDMA, 1xEVDO, DTMB (CTTB), DVB-T/H, ISDB-T, CMMB, LTE, LTE-TDD, Digital Cable TV, WLAN, MSR, LTEAFDD, LTEATDD
Remote Command	[:SENSe] :SEMAsk:DETEctor:CARRier[:FUNction] AVERAge NEGative NORMal POSitive SAMPlE [:SENSe] :SEMAsk:DETEctor:CARRier[:FUNction]?

Example	SEM:DET:CARR NEG SEM:DET:CARR?
Notes	When you manually select a detector (instead of selecting Auto), that detector is used regardless of other analyzer settings. Note: This detector setting affects the reference channel. There is not a per trace detector. You must be in the mode that includes SEM measurement to use this command. Use :INSTrument:SElect to set the mode.
Couplings	See Couplings in the Trace Type section.
Preset	AVERage
State Saved	Saved in instrument state.
Range	Normal Average Peak Sample Negative Peak
Initial S/W Revision	Prior to A.02.00
Modified at S/W Revision	A.02.00, A.03.00

Offset Detector

Accesses a menu of functions that enable you to control the detector for offsets. The following choices are available.

- Auto– the detector selected depends on marker functions, trace functions, average type, and the trace averaging function.
- Normal–the detector determines the peak of the CW-like signals, and it yields alternating maximums and minimums of noise-like signals. This is also referred to as Rosenfell detection.
- Average–the detector determines the average of the signal within the sweep points. The averaging method depends upon the Average Type selection (voltage, power or log scales).
- Peak–the detector determines the maximum of the signal within the sweep points.
- Sample–the detector indicates the instantaneous level of the signal at the center of the sweep points represented by each display point.
- Negative Peak–the detector determines the minimum of the signal within the sweep points.

Key Path	Trace/Detector
Initial S/W Revision	Prior to A.02.00

Offset Detector Auto

Sets the detector to the default detection mode for the offsets. This mode is dependent upon the current signal conditions of the offsets.

Key Path	Trace/Detector
Mode	SA, WCDMA, C2K, WIMAX OFDMA, TD-SCDMA, 1xEVDO, DTMB (CTTB), DVB-T/H, ISDB-T, CMMB,

	LTE, LTE-TDD, Digital Cable TV, WLAN, MSR, LTEAFDD, LTEATDD
Remote Command	[:SENSe] :SEMAsk:DETEctor:OFFSet:AUTO ON OFF 1 0 [:SENSe] :SEMAsk:DETEctor:OFFSet:AUTO?
Example	SEM:DET:OFFS:AUTO OFF SEM:DET:OFFS:AUTO?
Notes	See Couplings in the Trace Type section. You must be in the mode that includes SEM measurement to use this command. Use :INSTrument:SElect to set the mode.
Preset	ON
State Saved	Saved in instrument state.
Range	On Off
Initial S/W Revision	Prior to A.02.00
Modified at S/W Revision	A.02.00, A.03.00

Offset Detector Selection

Selects the detector mode for the offsets.

Key Path	Trace/Detector
Mode	SA, WCDMA, C2K, WIMAX OFDMA, TD-SCDMA, 1xEVDO, DTMB (CTTB), DVB-T/H, ISDB-T, CMMB, LTE, LTE-TDD, Digital Cable TV, WLAN, MSR, LTEAFDD, LTEATDD
Remote Command	[:SENSe] :SEMAsk:DETEctor:OFFSet[:FUNction] AVERAge NEGAtive NORMAl POSitive SAMPlE [:SENSe] :SEMAsk:DETEctor:OFFSet[:FUNction]?
Example	SEM:DET:OFFS AVER SEM:DET:OFFS?
Notes	When you manually select a detector (instead of selecting Auto), that detector is used regardless of other analyzer settings. Note: This detector setting has effects all offsets. There is not a per trace detector. You must be in the mode that includes SEM measurement to use this command. Use :INSTrument:SElect to set the mode.
Couplings	See Couplings in the Trace Type section.
Preset	POSitive
State Saved	Saved in instrument state.
Range	Normal Average Peak Sample Negative Peak
Initial S/W Revision	Prior to A.02.00
Modified at S/W Revision	A.02.00, A.03.00

Trigger

See ["Trigger" on page 428](#)

Free Run

See ["Free Run " on page 435](#)

Video

See ["Video \(IF Envelope\) " on page 436](#)

Trigger Level

See ["Trigger Level " on page 436](#)

Trig Slope

See ["Trig Slope " on page 437](#)

Trig Delay

See ["Trig Delay " on page 438](#)

Line

See ["Line " on page 2105](#)

Trig Slope

See ["Trig Slope " on page 2105](#)

Trig Delay

See ["Trig Delay " on page 440](#)

External 1

See ["External 1 " on page 2118](#)

Trigger Level

See ["Trigger Level " on page 2118](#)

Trig Slope

See ["Trig Slope " on page 2119](#)

Trig Delay

See ["Trig Delay " on page 443](#)

Zero Span Delay Comp

See ["Zero Span Delay Comp On/Off" on page 2107](#)

External 2

See ["External 2 "](#) on page 2120

Trigger Level

See ["Trigger Level "](#) on page 2120

Trig Slope

See ["Trig Slope "](#) on page 2121

Trig Delay

See ["Trig Delay "](#) on page 445

Zero Span Delay Comp

See ["Zero Span Delay Comp On/Off"](#) on page 2109

RF Burst

See ["RF Burst "](#) on page 2121

Absolute Trigger

See ["Absolute Trigger Level"](#) on page 2122

Relative Trigger

See ["Relative Trigger Level"](#) on page 2111

Trig Slope

See ["Trigger Slope "](#) on page 2123

Trig Delay

See ["Trig Delay "](#) on page 450

Periodic Timer

See ["Periodic Timer \(Frame Trigger\) "](#) on page 2113

Period

See ["Period "](#) on page 2114

Offset

See ["Offset "](#) on page 2115

Reset Offset Display

See ["Reset Offset Display "](#) on page 2117

Sync Source

See "[Sync Source](#) " on page 2117

Off

See "[Off](#) " on page 2118

External 1

See "[External 1](#) " on page 2118

Trigger Level

See "[Trigger Level](#) " on page 2118

Trig Slope

See "[Trig Slope](#) " on page 2119

External 2

See "[External 2](#) " on page 2120

Trigger Level

See "[Trigger Level](#) " on page 2120

Trig Slope

See "[Trig Slope](#) " on page 2121

RF Burst

See "[RF Burst](#) " on page 2121

Absolute Trigger

See "[Absolute Trigger Level](#)" on page 2122

Trig Slope

See "[Trigger Slope](#) " on page 2123

Trig Delay

See "[Trig Delay](#)" on page 460

Auto/Holdoff

See "[Auto/Holdoff](#) " on page 461

Auto Trig

See "[Auto Trig](#) " on page 461

Trig Holdoff

See "[Trig Holdoff](#) " on page 462

User Preset

Accesses a menu that gives you the following three choices:

- User Preset – recalls a state previously saved using the Save User Preset function.
- User Preset All Modes – presets all of the modes in the analyzer
- Save User Preset– saves the current state for the current mode

Key Path	Front-panel key
Backwards Compatibility Notes	<p>User Preset is actually loading a state, and in legacy analyzers, it was possible to load a state without affecting the trace data, limit lines or correction data. Similarly it was possible to do a User Preset without affecting the trace data, limit lines or correction data.</p> <p>In the X-Series, “state” always includes all of this data; so whenever state is loaded, or User Preset is executed, all of the traces, limit lines and corrections are affected. Although this differs from previous behavior, it is desirable behavior, and should not cause adverse issues for users.</p> <p>On ESA and PSA, User Preset affected the entire instrument’s state. In the X-Series, User Preset only recalls the state for the active mode. There is a User Preset file for each mode. User Preset can never cause a mode switch as it can in legacy analyzers. If you want to recall all modes to their user preset file state, you will need to do a User Preset after mode switching into each mode.</p> <p>User Preset recalls mode state which can now include data like traces; whereas on ESA and PSA, User Preset did not affect data.</p>
Initial S/W Revision	Prior to A.02.00

User Preset

User Preset sets the state of the currently active mode back to the state that was previously saved for this mode using the Save User Preset menu key or the SCPI command, SYST:PRES:USER:SAV. It not only recalls the Mode Preset settings, but it also recalls all of the mode persistent settings, and the Input/Output system setting that existed at the time Save User Preset was executed.

If a Save User Preset has not been done at any time, User Preset recalls the default user preset file for the currently active mode. The default user preset files are created if, at power-on, a mode detects there is no user preset file. There will never be a scenario when there is no user preset file to restore. For each mode, the default user preset state is the same state that would be saved if a Save User Preset is performed in each mode right after doing a Restore Mode Default and after a Restore Input/Output Defaults.

The User Preset function does the following:

- Aborts the currently running measurement.
- Sets the mode State to the values defined by Save User Preset.
- Makes the saved measurement for the currently running mode the active measurement.
- Brings up the saved menu for the power-on mode.
- Clears the input and output buffers.
- Sets the Status Byte to 0.

Key Path	User Preset
Remote Command	:SYSTem:PRESet:USER
Example	:SYST:PRES:USER:SAVE:SYST:PRES:USER
Notes	:SYST:PRES:USER:SAVE is used to save the current state as the user preset state. Clears all pending OPC bits. The Status Byte is set to 0. Pressing the User Preset front-panel key while already in the User Preset menu will cause the User Preset to get executed
Couplings	A user preset will cause the currently running measurement to be aborted and cause the saved measurement to be active. Recalling a User Preset file has the same issues that recalling a Save State file has. Some settings may need to be limited and therefore re-coupled, since the capabilities of the mode may have changes when the User Preset file was last saved.
Initial S/W Revision	Prior to A.02.00

User Preset All Modes

Recalls all of the User Preset files for each mode, switches to the power-on mode, and activates the saved measurement from the power-on mode User Preset file.

NOTE

When the instrument is secured, all of the user preset files are converted back to their default user preset files.

The User Preset function does the following:

- Aborts the currently running measurement.
- Switches the Mode to the power-on mode.
- Restores the User Preset files for each mode.
- Makes the saved measurement for the power-on mode the active measurement.
- Brings up the saved menu for the power-on mode.
- Clears the input and output buffers.
- Sets the Status Byte to 0.

Key Path	User Preset
Remote Command	:SYSTem:PRESet:USER:ALL
Example	:SYST:PRES:USER:SAVE:SYST:PRES:USER:ALL
Notes	Clears all pending OPC bits. The Status Byte is set to 0. :SYST:PRES:USER:SAVE is used to save the current state as the user preset state.
Couplings	A user preset will cause the currently running measurement to be aborted, cause a mode switch to the power-on mode, and cause the saved measurement to be active in the power-on mode. Recalling a User Preset file has the same issues that recalling a Save State file has. Some settings may need to be limited and therefore re-coupled, since the capabilities of the mode may have changes when the User Preset file was last saved.
Initial S/W Revision	Prior to A.02.00

Save User Preset

Saves the currently active mode and its State. You can recall this User Preset file by pressing the User Preset menu key or sending the SYST:PRES:USER remote command. This same state is also saved by the Save State function.

Key Path	User Preset
Remote Command	:SYSTem:PRESet:USER:SAVE
Example	:SYST:PRES:USER:SAVE
Notes	:SYST:PRES:SAVE creates the same file as if the user requested a *SAV or a MMEM:STOR:STAT, except User Preset Save does not allow the user to specify the filename or the location of the file.
Initial S/W Revision	Prior to A.02.00

View/Display

Accesses a menu of functions that enable you to control the instrument display.

The following keys select how the results are displayed:

- **Abs Pwr Freq**—displays the absolute power levels in dBm and the corresponding frequencies in the text window.
- **Rel Pwr Freq**—displays the relative power levels in dBc and the corresponding frequencies in the text window.
- **Integrated Power**—displays the absolute and relative power levels integrated throughout the bandwidths between the start and stop frequencies in the text window.
- **Carrier Info**—displays the carrier configuration information with measure powers. (Only available in MSR and LTE-Advanced FDD/TDD)

["View Selection by Name \(Remote Command Only\)" on page 1186](#)

["Views Selection by Number \(Remote Command only\)" on page 1187](#)

View Selection by Name (Remote Command Only)

Key Path	View/Display
Mode	SA, WCDMA, C2K, WIMAX OFDMA, TD-SCDMA, 1xEVDO, DTMB (CTTB), DVB-T/H, ISDB-T, CMMB, LTE, LTETDD, Digital Cable TV, WLAN, MSR, LTEAFDD, LTEATDD
Remote Command	:DISPlay:SEMask:VIEW[:SElect] APFReq RPFReq IPOWer CINformation :DISPlay:SEMask:VIEW[:SElect]?
Example	DISP:SEM:VIEW IPOW DISP:SEM:VIEW?
Notes	You must be in the mode that includes SEM measurement to use this command. Use :INSTrument:SElect to set the mode.
Dependencies	In the SA mode, when "Radio Standard" is set to WLAN, IPOWer is not available and the key is grayed out. CINformation is available only in MSR and LTE-Advanced FDD/TDD mode, otherwise the key is blank.
Presets	SA, , WCDMA, , C2K, , TD-SCDMA, , 1xEVDO, , DTMB (CTTB), , DVB-T/H, , ISDB-T, , CMMB, , LTE, , LTETDD, , Digital Cable TV, , MSR, , LTEAFDD, , LTEATDD: APFReq WIMAX OFDMA, WLAN: RPFReq
State Saved	Saved in instrument state.
Range	Abs Pwr & Freq Rel Pwr & Freq Integrated Power Carrier Info
Initial S/W Revision	Prior to A.02.00
Modified at S/W Revision	A.02.00, A.03.00, A.10.00

Views Selection by Number (Remote Command only)

The following numerical selections determine how the results are displayed:

1. displays the absolute power levels in dBm and the corresponding frequencies in the text window.
2. displays the relative power levels in dBc and the corresponding frequencies in the text window.
3. displays the absolute and relative power levels integrated throughout the bandwidths between the start and stop frequencies in the text window.
4. displays the carrier info table. (Only available in MSR and LTE-Advanced FDD/TDD)

Mode	SA, WCDMA, C2K, WIMAX OFDMA, TD-SCDMA, 1xEVDO, DTMB (CTTB), DVB-T/H, ISDB-T, CMMB, LTE, LTE-TDD, Digital Cable TV, WLAN, MSR, LTEAFDD, LTEATDD
Remote Command	:DISPlay:SEMask:VIEW:NSElect <integer> :DISPlay:SEMask:VIEW:NSElect?
Example	DISP:SEM:VIEW:NSEL 2 DISP:SEM:VIEW:NSEL?
Notes	In the SA mode, when "Radio Standard" is set to WLAN, Option 3 is not available. Option 4 is available only in MSR and LTE-Advanced FDD/TDD mode. You must be in the mode that includes SEM measurement to use this command. Use :INSTrument:SElect to set the mode.
Preset	SA, , WCDMA, , C2K, , TD-SCDMA, , 1xEVDO, , DTMB (CTTB), , DVB-T/H, , ISDB-T, , CMMB, , LTE, , LTE-TDD, , Digital Cable TV, , MSR, , LTEAFDD, , LTEATDD: 1 WIMAX OFDMA, WLAN: 2
State Saved	Saved in instrument state.
Min	1
Max	MSR, LTEAFDD, LTEATDD: 4 Other modes: 3
Initial S/W Revision	Prior to A.02.00
Modified at S/W Revision	A.02.00, A.03.00, A.10.00

Key Path	Front-panel key
Initial S/W Revision	Prior to A.02.00

Display

The Display menu is common to most measurements, and is used for configuring items on the display. Some Display menu settings apply to all the measurements in a mode, and some only to the current measurement. Those under the System Display Settings key apply to all measurements in all modes.

Key Path	Display
-----------------	---------

Key Path	View/Display
Initial S/W Revision	Prior to A.02.00

Annotation

Turns on and off various parts of the display annotation. The annotation is divided up into four categories:

1. Meas Bar: This is the measurement bar at the top of the screen. It does not include the settings panel or the Active Function. Turning off the Meas Bar turns off the settings panel and the Active Function. When the Meas Bar is off, the graticule area expands to fill the area formerly occupied by the Meas Bar.
2. Screen Annotation: this is the annotation and annunciation around the graticule, including any annotation on lines (such as the display line, the threshold line, etc.) This does NOT include the marker number or the N dB result. When off, the graticule expands to fill the entire graticule area.
3. Trace annotation: these are the labels on the traces, showing their detector (or their math mode).
4. Active Function annotation: this is the active function display in the meas bar, and all of the active function values displayed on softkeys.

See the figure below. Each type of annotation can be turned on and off individually.

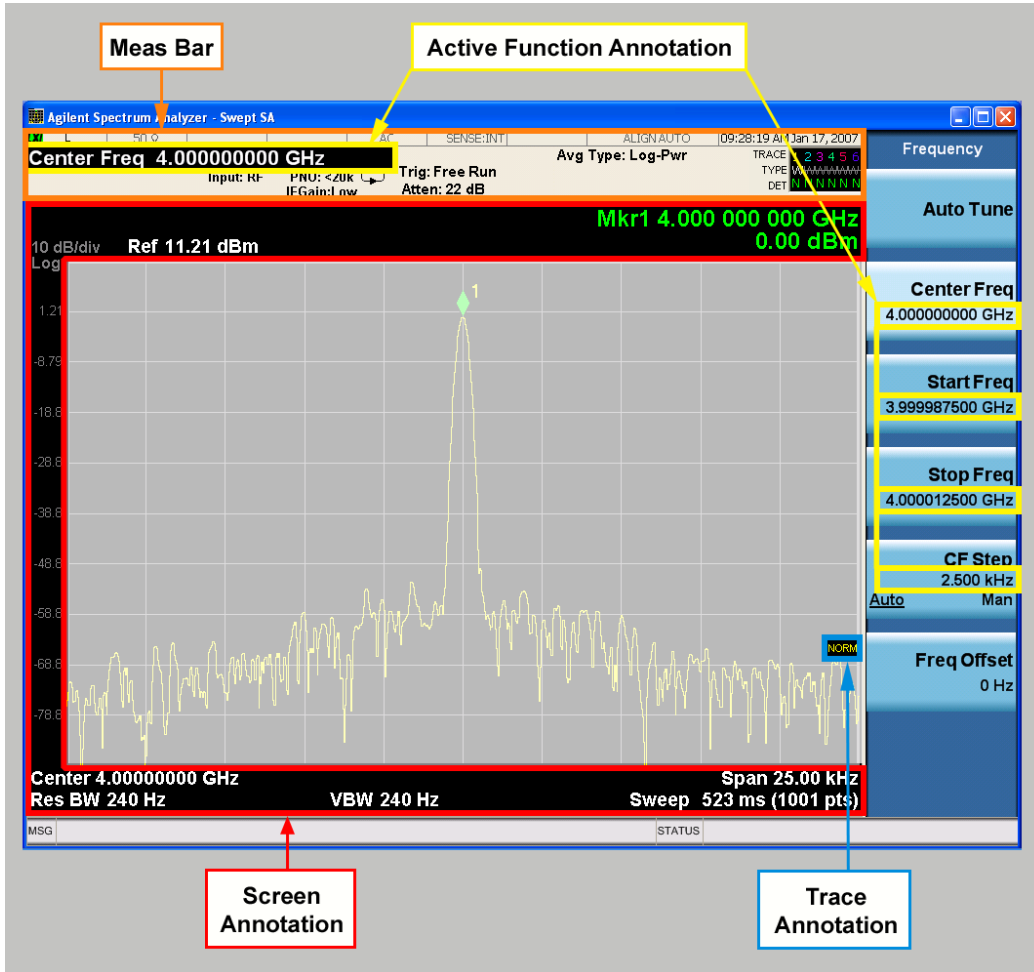

Key Path	View/Display, Display
Initial S/W Revision	Prior to A.02.00

Meas Bar On/Off

This function turns the Measurement Bar on and off, including the settings panel. When off, the graticule area expands to fill the area formerly occupied by the Measurement Bar.

Key Path	View/Display, Display, Annotation
Remote Command	:DISPlay:ANNotation:MBAR[:STATE] OFF ON 0 1 :DISPlay:ANNotation:MBAR[:STATE]?
Example	DISP:ANN:MBAR OFF
Dependencies	Grayed out and forced to OFF when System Display Settings, Annotation is set to Off.
Preset	On This should remain Off through a Preset when System DisplaySettings, Annotation is set to Off.
State Saved	Saved in instrument state.
Initial S/W Revision	Prior to A.02.00

Screen

This controls the display of the annunciation and annotation around the graticule, including any annotation on lines (such as the display line, the threshold line, etc.) and the y-axis annotation. This does NOT include marker annotation (or the N dB result). When off, the graticule expands to fill the entire graticule area, leaving only the 1.5% gap above the graticule as described in the Trace/Detector chapter.

Key Path	View/Display, Display, Annotation
Remote Command	:DISPlay:ANNotation:SCReen[:STATe] OFF ON 0 1 :DISPlay:ANNotation:SCReen[:STATe]?
Example	DISP:ANN:SCR OFF
Dependencies	Grayed-out and forced to OFF when System Display Settings, Annotation is set to Off.
Preset	On This should remain Off through a Preset when System DisplaySettings, Annotation is set to Off
State Saved	Saved in instrument state.
Initial S/W Revision	Prior to A.02.00

Active Function Values On/Off

Turns on and off the active function display in the Meas Bar, and all of the active function values displayed on the softkeys.

Note that all of the softkeys that have active functions have these numeric values blanked when this function is on. This is a security feature..

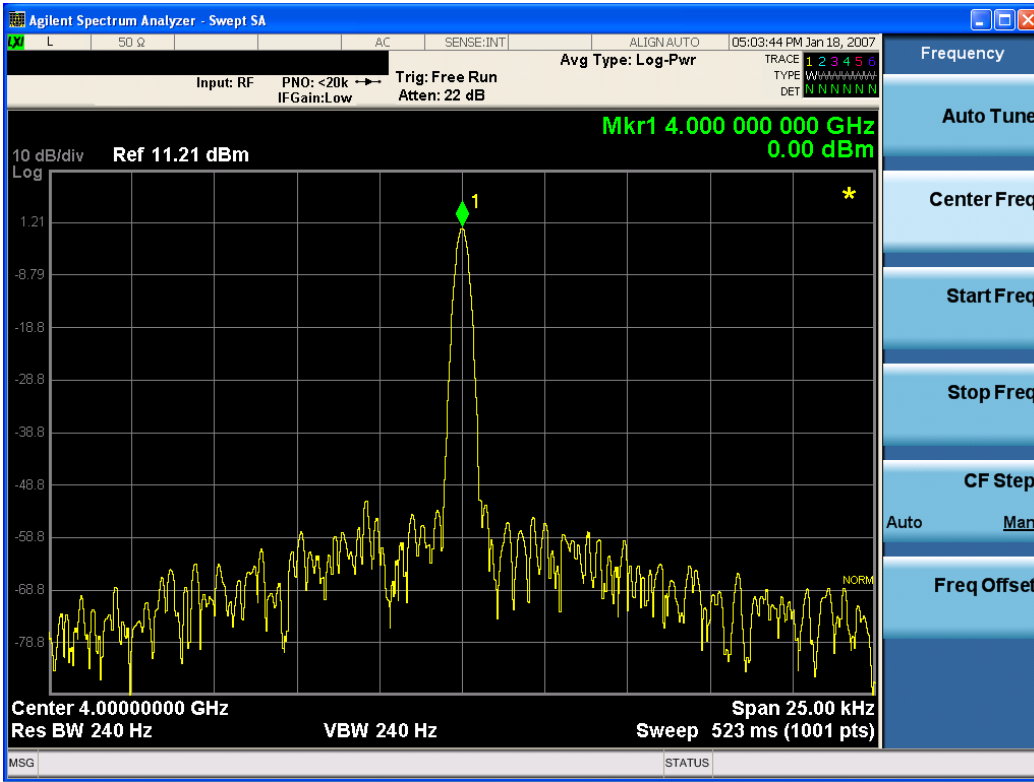

Key Path	View/Display, Display, Annotation
Remote Command	:DISPlay:ACTivefunc[:STATE] ON OFF 1 0 :DISPlay:ACTivefunc[:STATE]?
Example	DISP:ACT OFF
Dependencies	Grayed out and forced to OFF when System Display Settings, Annotation is set to Off.
Preset	On This should remain Off through a Preset when System DisplaySettings, Annotation is set to Off
State Saved	Saved in instrument state.
Initial S/W Revision	Prior to A.02.00

Title

Displays menu keys that enable you to change or clear a title on your display.

Key Path	View/Display, Display
Initial S/W Revision	Prior to A.02.00

Change Title

Writes a title into the "measurement name" field in the banner, for example, "Swept SA".

Press Change Title to enter a new title through the alpha editor. Press Enter or Return to complete the entry. Press ESC to cancel the entry and preserve your existing title.

The display title will replace the measurement name. It remains for this measurement until you press Change Title again, or you recall a state, or a Preset is performed. A title can also be cleared by pressing Title, Clear Title.

NOTE

Notice the inclusion of the <measurement> parameter in the command below. Because each measurement remembers the Display Title, the command must be qualified with the measurement name. For the Swept SA measurement this is not the case; no <measurement> parameter is used when changing the Display Title for the Swept SA measurement.

Key Path	View/Display, Display, Title
Mode	All
Remote Command	:DISPlay:<measurement>:ANNotation:TITLe:DATA <string> :DISPlay:<measurement>:ANNotation:TITLe:DATA?
Example	DISP:ANN:TITL:DATA "This Is My Title" This example is for the Swept SA measurement in the Spectrum Analyzer mode. The SANalyzer <measurement> name is not used. DISP:ACP:ANN:TITL:DATA "This Is My Title" This example is for Measurements other than Swept SA. Both set the title to: This Is My Title
Notes	Pressing this key cancels any active function. When a title is edited the previous title remains intact (it is not cleared) and the cursor goes at the end so that characters can be added or BKSP can be used to go back over previous characters.
Preset	No title (measurement name instead)
State Saved	Saved in instrument state.
Initial S/W Revision	Prior to A.02.00

Clear Title

Clears a title from the front-panel display. Once cleared, the title cannot be retrieved. After the title is cleared, the current Measurement Name replaces it in the title bar.

Key Path	View/Display, Display, Title
Example	The following commands clear the title and restore the measurement's original title: DISP:ANN:TITL:DATA "" This example is for the Swept SA measurement in the Spectrum Analyzer mode. The SANalyzer <measurement> name is not used. DISP:ACP:ANN:TITL:DATA "" This example is for ACP; in measurements other than Swept SA the measurement name is required.
Notes	Uses the :DISPlay:<measurement>:ANNotation:TITLe:DATA <string> command with an empty string (in the Swept SA, the <measurement> is omitted).
Preset	Performed on Preset.
Initial S/W Revision	Prior to A.02.00

Graticule

Pressing Graticule turns the display graticule On or Off. It also turns the graticule y-axis annotation on and off.

Key Path	View/Display, Display
Remote Command	:DISPlay:WINDow[1]:TRACe:GRATicule:GRID[:STATe] OFF ON 0 1 :DISPlay:WINDow[1]:TRACe:GRATicule:GRID[:STATe]?
Example	DISP:WIND:TRAC:GRAT:GRID OFF
Notes	The graticule is the set of horizontal and vertical lines that make up the grid/divisions for the x-axis and y-axis.
Preset	On
State Saved	Saved in instrument state
Initial S/W Revision	Prior to A.02.00

System Display Settings

These settings are "Mode Global" – they affect all modes and measurements and are reset only by Restore Misc Defaults or Restore System Defaults under System.

Key Path	View/Display, Display
Initial S/W Revision	Prior to A.02.00

Annotation Local Settings

This is a Mode Global override of the meas local annotation settings. When it is All Off, it forces ScreenAnnotation, Meas Bar, Trace, and Active Function Values settings to be OFF for all measurements in all modes. This provides the security based "annotation off" function of previous analyzers; hence it uses the legacy SCPI command.

When it is All Off, the Screen, Meas Bar, Trace, and Active Function Values keys under the Display, Annotation menu are grayed out and forced to Off. When Local Settings is selected, you are able to set the local annotation settings on a measurement by measurement basis.

Key Path	View/Display, Display, System Display Settings
Remote Command	:DISPlay:WINDow[1]:ANNOtation[:ALL] OFF ON 0 1 :DISPlay:WINDow[1]:ANNOtation[:ALL]?
Example	:DISP:WIND:ANN OFF
Preset	On (Set by Restore Misc Defaults)
State Saved	Not saved in instrument state.
Backwards Compatibility Notes	The WINDow parameter and optional subopcode is included for backwards compatibility but ignored – all windows are equally affected.
Initial S/W Revision	Prior to A.02.00

Themes

Accesses a menu of functions that enable you to choose the theme to be used when saving the screen image.

The **Themes** option is the same as the **Themes** option under the **Display** and **Page Setup** dialogs. It allows you to choose between themes to be used when saving the screen image.

Key Path	Save, Screen Image
Remote Command	:MMEMory:STORe:SCReen:THEMe TDColor TDMonochrome FCOLor FMONochrome :MMEMory:STORe:SCReen:THEMe?
Example	:MMEM:STOR:SCR:THEM TDM
Preset	3D Color; Is not part of Preset, but is reset by Restore Misc Defaults or Restore System Defaults All and survives subsequent running of the modes.
Readback	3D Color 3D Mono Flat Color Flat Mono
Backwards Compatibility Notes	In ESA and PSA we offer the choice of "Reverse Bitmap" or "Reverse Metafile" when saving screen images. This is much like the "Flat Color" theme available in X-Series. Also, if you selected Reverse Bitmap AND a black & white screen image, that would be much like "Flat Monochrome". In other words, each of the X-Series themes has a similar screen image type in ESA/PSA. But they are not identical.
Initial S/W Revision	Prior to A.02.00

3D Color

Selects a standard color theme with each object filled, shaded and colored as designed.

Key Path	Save, Screen Image, Themes
Example	MMEM:STOR:SCR:THEM TDC
Readback	3D Color
Initial S/W Revision	Prior to A.02.00

3D Monochrome

Selects a format that is like 3D color but shades of gray are used instead of colors.

Key Path	Save, Screen Image, Themes
Example	MMEM:STOR:SCR:THEM TDM
Readback	3D Mono
Initial S/W Revision	Prior to A.02.00

Flat Color

Selects a format that is best when the screen is to be printed on an ink printer.

Key Path	Save, Screen Image, Themes
Example	MMEM:STOR:SCR:THEM FCOL
Readback	Flat Color
Initial S/W Revision	Prior to A.02.00

Flat Monochrome

Selects a format that is like Flat Color. But only black is used (no colors, not even gray), and no fill.

Key Path	Save, Screen Image, Themes
Example	MMEM:STOR:SCR:THEM FMON
Readback	Flat Mono
Initial S/W Revision	Prior to A.02.00

Backlight

Accesses the display backlight on/off keys. This setting may interact with settings under the Windows "Power" menu.

When the backlight is off, pressing ESC, TAB, SPACE, ENTER, UP, DOWN, LEFT, RIGHT, DEL, BKSP, CTRL, or ALT turns the backlight on without affecting the application. Pressing any other key will turn backlight on and could potentially perform the action as well.

Key Path	View/Display, Display, System Display Settings
Remote Command	:DISPlay:BACKlight ON OFF :DISPlay:BACKlight?
Preset	ON (Set by Restore Misc Defaults)
Initial S/W Revision	Prior to A.02.00

Backlight Intensity

An active function used to set the backlight intensity. It goes from 0 to 100 where 100 is full on and 0 is off. This value is independent of the values set under the Backlight on/off key.

Key Path	View/Display, Display, System Display Settings
Remote Command	:DISPlay:BACKlight:INTensity <integer> :DISPlay:BACKlight:INTensity?
Example	DISP:BACK:INT 50

Preset	100 (Set by Restore Misc Defaults)
Min	0
Max	100
Initial S/W Revision	Prior to A.02.00

Abs Pwr Freq

Sets the display to the Absolute Peak Power and Frequency view. The views differ depending on the setting of the measurement type (Meas Type) under the Measurement Setup menu.

["Abs Peak Pwr & Freq \(Total Pwr Ref\)" on page 1196](#)

["Abs Peak Pwr & Freq \(PSD Ref\)" on page 1198](#)

["Abs Peak Pwr & Freq \(Spectrum Pk Ref\)" on page 1200](#)

Abs Peak Pwr & Freq (Total Pwr Ref)

This view consists of the following two windows:

["Trace Window" on page 1198](#)

["Results Window " on page 1198](#)

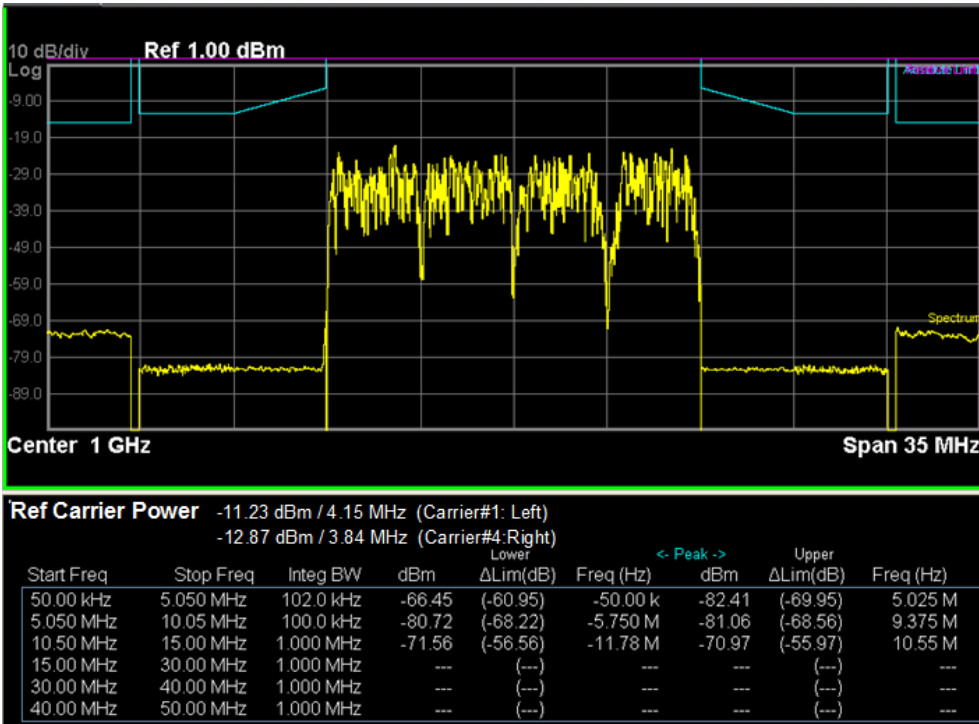
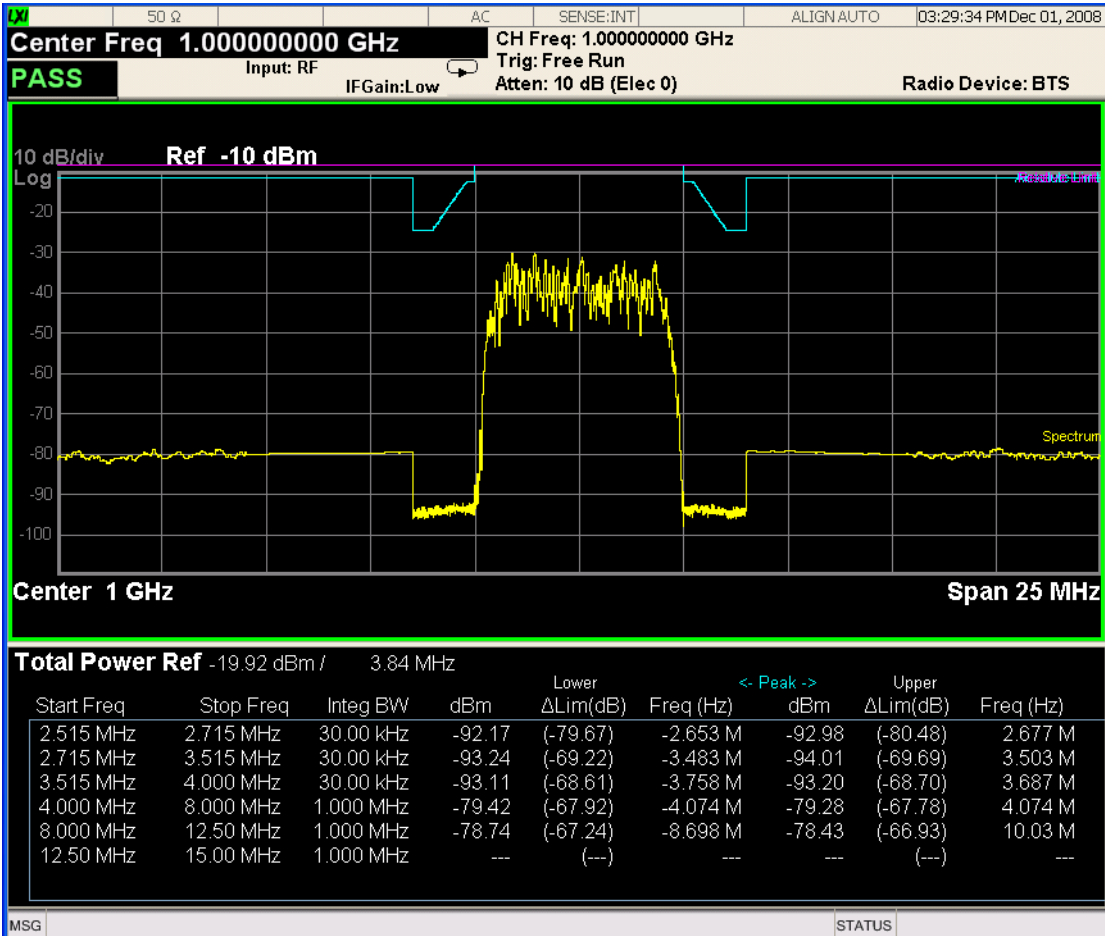

Trace Window

Corresponding Trace	yellow - Combined trace from carrier and each offset
---------------------	--

Results Window

Name	Corresponding Results
Total Pwr Ref	n=1 2nd element Absolute power at the reference area. Channel Integration Bandwidth
Start (Hz)	Start frequency for offset
Stop (Hz)	Stop frequency for offset
Meas BW (Hz)	Measurement bandwidth for offset
Lower Peak (dBm)	Absolute peak power on minimum margin point of the negative offset
Lower Δ lim (dB)	Minimum margin from limit line which is decided by Fail Mask setting on the negative offset
Lower Freq (Hz)	Frequency on minimum margin point of the negative offset
Upper Peak (dBm)	Absolute peak power on minimum margin point of the positive offset
Upper Δ lim (dB)	Minimum margin from limit line which is decided by Fail Mask setting on the positive offset
Upper Freq (Hz)	Frequency on minimum margin point of the positive offset

Abs Peak Pwr & Freq (PSD Ref)

This view consists of the following two windows:

["Trace Window" on page 1200](#)

["Results Window " on page 1200](#)

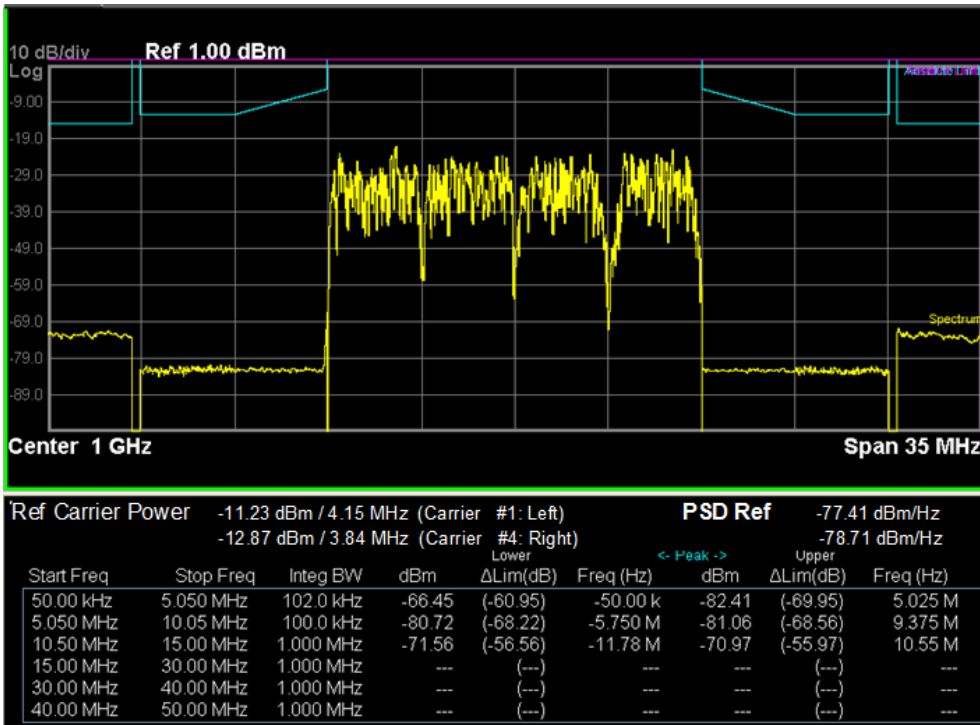
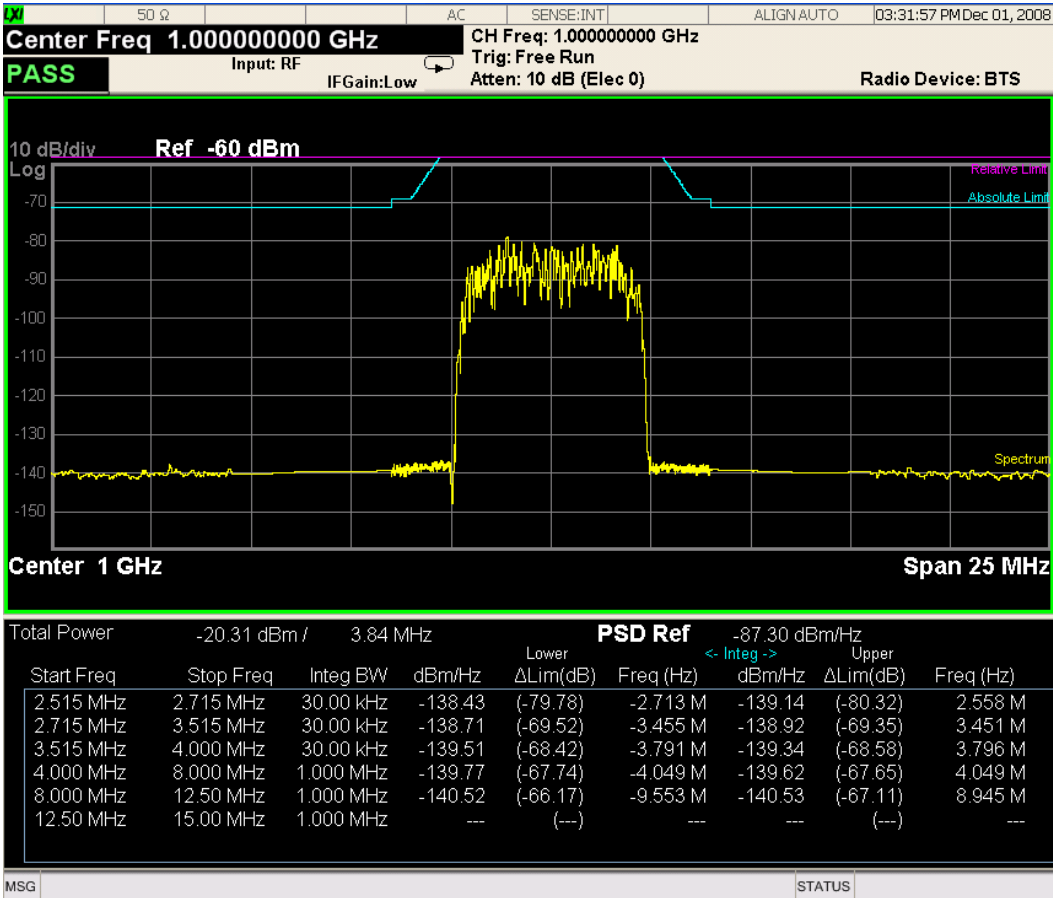

Trace Window

Corresponding Trace	yellow - Combined trace from carrier and each offset
---------------------	--

Results Window

Name	Corresponding Results
Total Pwr	n=1 2nd element Absolute power at the reference area. Channel Integration Bandwidth
PSD Ref	n=5 1st element Power spectral density reference at the reference area
Start (Hz)	Start frequency for offset
Stop (Hz)	Stop frequency for offset
Meas BW (Hz)	Measurement bandwidth for offset
Lower (dBm/Hz)	Absolute power spectrum density of the negative offset
Lower Δ lim (dB)	Minimum margin from limit line which is decided by Fail Mask setting on the negative offset
Lower Freq (Hz)	Frequency on minimum margin point of the negative offset
Upper (dBm/Hz)	Absolute power spectrum density of the positive offset
Upper Δ lim (dB)	Minimum margin from limit line which is decided by Fail Mask setting on the positive offset
Upper Freq (Hz)	Frequency on minimum margin point of the positive offset

Abs Peak Pwr & Freq (Spectrum Pk Ref)

This view consists of the following two windows:

["Trace Window" on page 1200](#)

["Results Window " on page 1200](#)

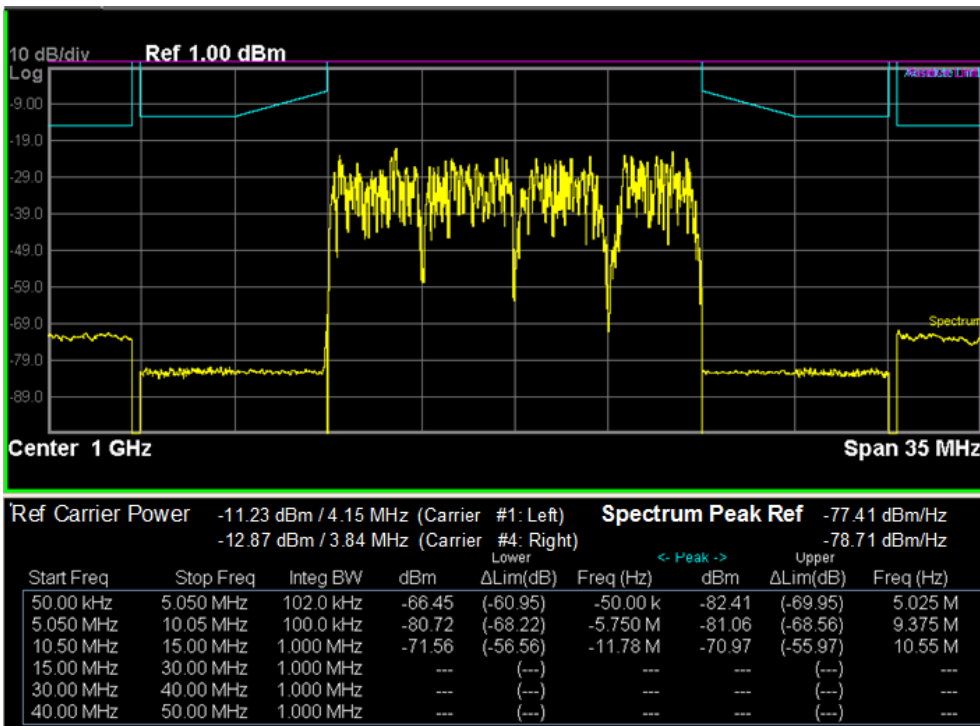
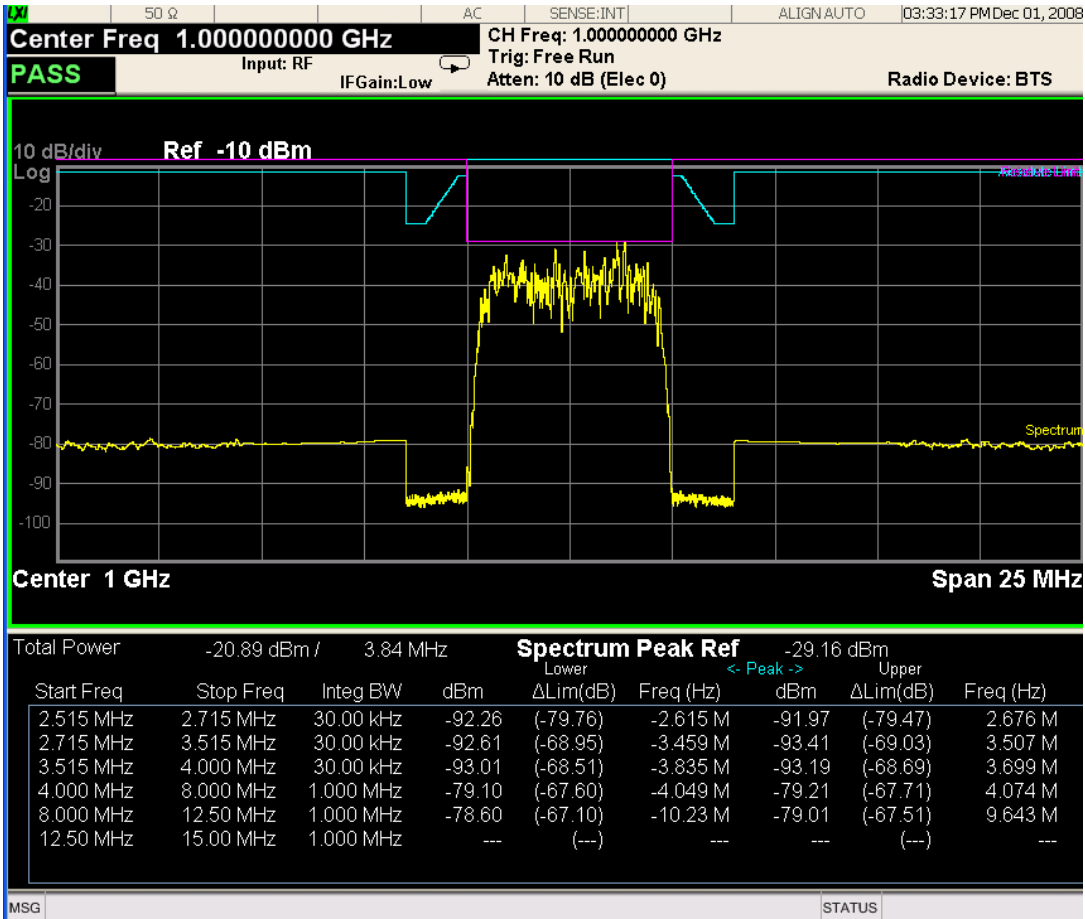

Trace Window

Corresponding Trace	yellow - Combined trace from carrier and each offset
---------------------	--

Results Window

Name	Corresponding Results
Total Pwr	Absolute power at the reference area. Channel Integration Bandwidth
Spectrum Peak Ref	n=5 1st element Spectrum peak power reference at the reference area
Start (Hz)	Start frequency for offset
Stop (Hz)	Stop frequency for offset
Meas BW (Hz)	Measurement bandwidth for offset
Lower(dBm)	Absolute peak power on minimum margin point of the negative offset
Lower Δ lim (dB)	Minimum margin from limit line which is decided by Fail Mask setting on the negative offset
Lower Freq (Hz)	Frequency on minimum margin point of the negative offset
Upper (dBm)	Absolute peak power on minimum margin point of the positive offset
Upper Δ lim (dB)	Minimum margin from limit line which is decided by Fail Mask setting on the positive offset
Upper Freq (Hz)	Frequency on minimum margin point of the positive offset

Key Path	View/Display
Initial S/W Revision	Prior to A.02.00

Rel Pwr Freq

Sets the display to the Relative Peak Power and Frequency view. The views differ depending on the setting of the measurement type (Meas Type) under the Measurement Setup menu.

["Rel Peak Pwr & Freq \(Total Pwr Ref\)" on page 1202](#)

["Rel Peak Pwr & Freq \(PSD Ref\)" on page 1204](#)

["Rel Peak Pwr & Freq \(Spectrum Pk Ref\)" on page 1205](#)

Rel Peak Pwr & Freq (Total Pwr Ref)

This view consists of the following two windows:

["Trace Window" on page 1203](#)

["Results Window" on page 1203](#)

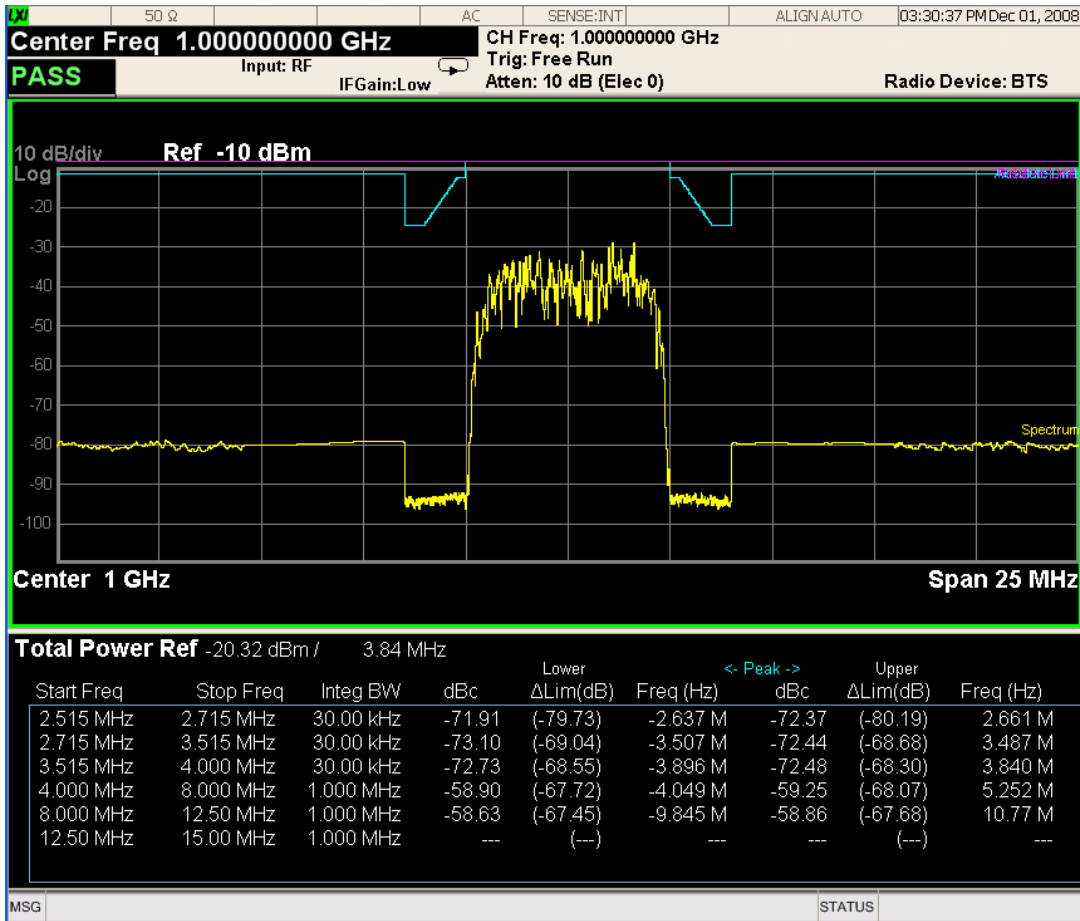

Trace Window

Corresponding Trace	yellow - Combined trace from carrier and each offset
---------------------	--

Results Window

Name	Corresponding Results
Total Pwr Ref	n=1 2nd element Absolute power at the reference area.
	Channel Integration Bandwidth
Start (Hz)	Start frequency for offset
Stop (Hz)	Stop frequency for offset
Meas BW (Hz)	Measurement bandwidth for offset
Lower Peak (dBc)	Relative peak power on minimum margin point of the negative offset
Lower ΔLim (dB)	Minimum margin from limit line which is decided by Fail Mask setting on the negative offset

Name	Corresponding Results
Lower Freq (Hz)	Frequency on minimum margin point of the negative offset
Upper Peak (dBc)	Relative peak power on minimum margin point of the positive offset
Upper ΔLim (dB)	Minimum margin from limit line which is decided by Fail Mask setting on the positive offset
Upper Freq (Hz)	Frequency on minimum margin point of the positive offset

Rel Peak Pwr & Freq (PSD Ref)

This view consists of the following two windows:

"Trace Window" on page 1204

"Results Window" on page 1205

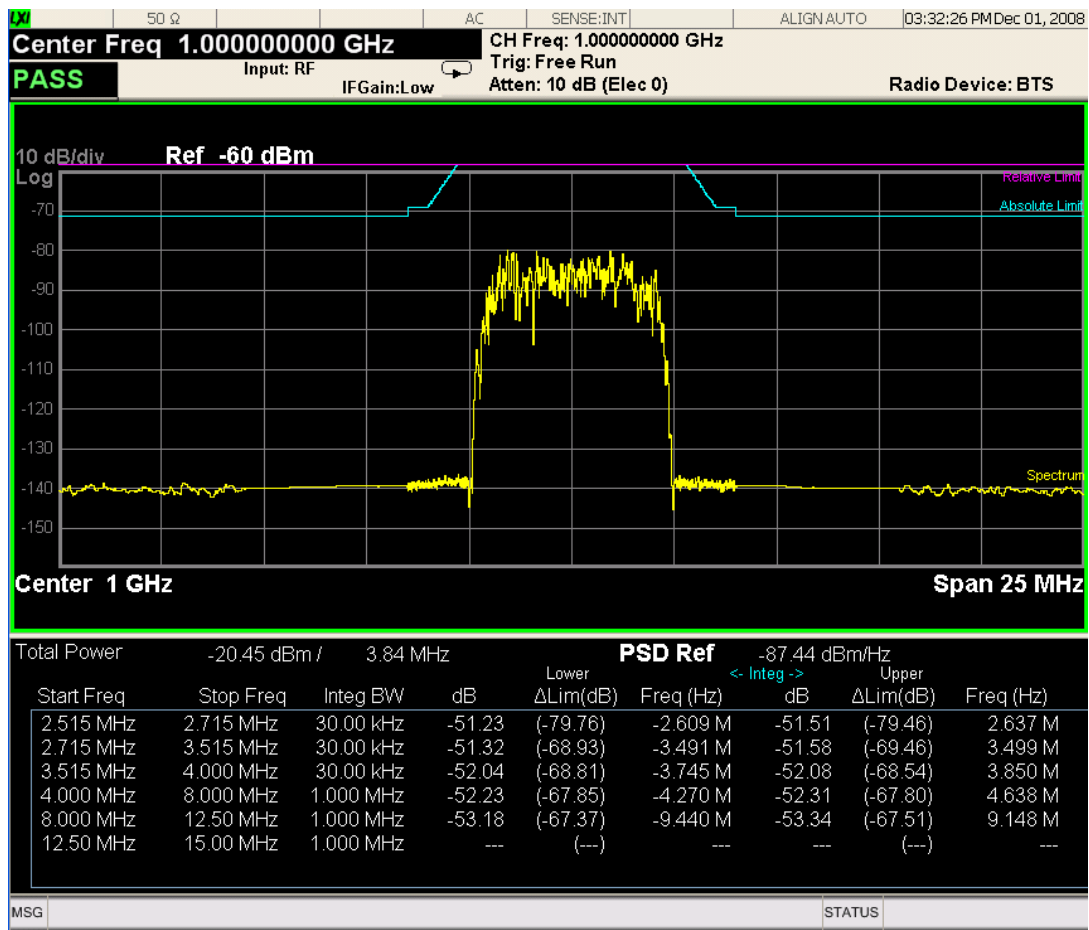

Trace Window

Corresponding Trace	yellow - Combined trace from carrier and each offset
---------------------	--

Results Window

Name	Corresponding Results
Total Pwr	n=1 2nd element Absolute power at the reference area.
	Channel Integration Bandwidth
PSD Ref	n=5 1st element Power spectral density reference at the reference area
Start (Hz)	Start frequency for offset
Stop (Hz)	Stop frequency for offset
Meas BW (Hz)	Measurement bandwidth for offset
Lower (dB)	Relative power spectrum density of the negative offset
Lower Δ Lim (dB)	Minimum margin from limit line which is decided by Fail Mask setting on the negative offset
Lower Freq (Hz)	Frequency on minimum margin point of the negative offset
Upper (dB)	Relative power spectrum density of the positive offset
Upper Δ Lim (dB)	Minimum margin from limit line which is decided by Fail Mask setting on the positive offset
Upper Freq (Hz)	Frequency on minimum margin point of the positive offset

Rel Peak Pwr & Freq (Spectrum Pk Ref)

This view consists of the following two windows:

"Trace Window" on page 1203

"Results Window" on page 1203

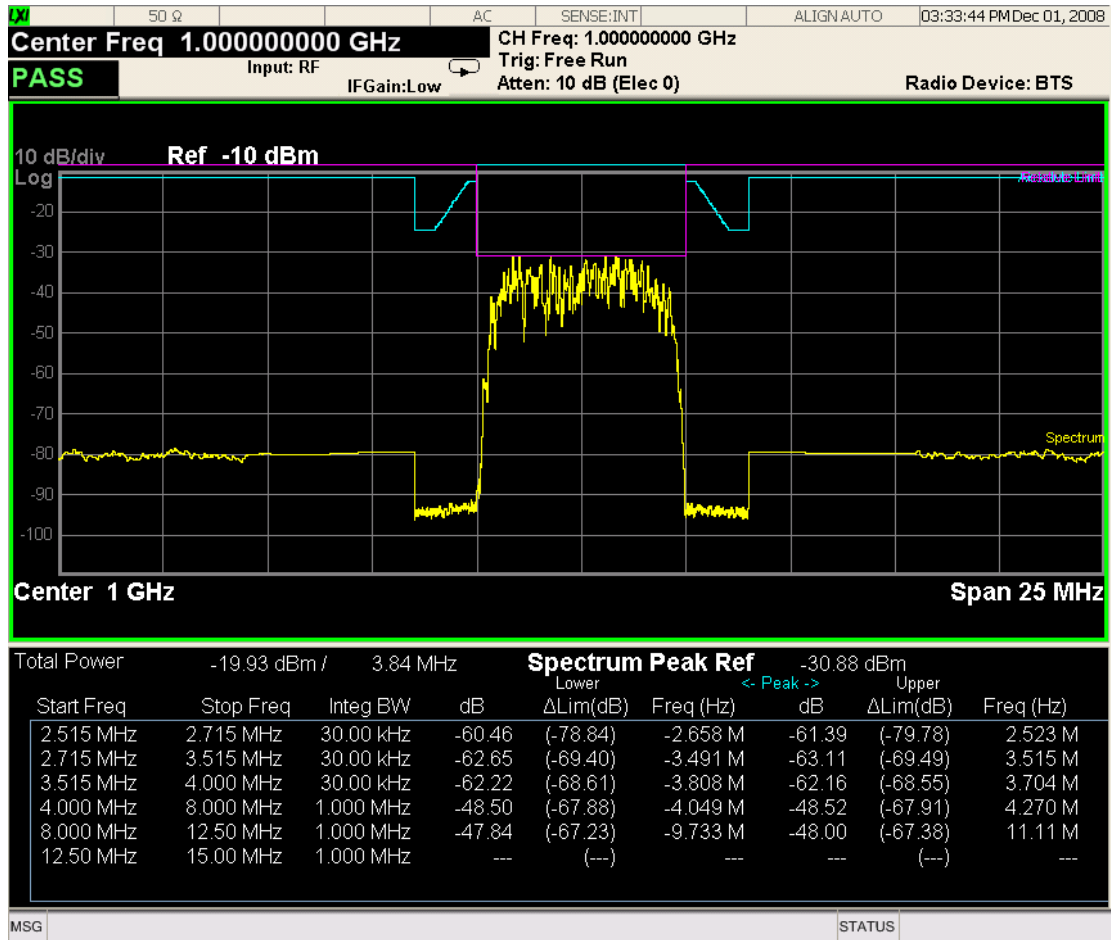

Trace Window

Corresponding Trace	yellow - Combined trace from carrier and each offset
---------------------	--

Results Window

Name	Corresponding Results
Total Pwr	Absolute power at the reference area.
	Channel Integration Bandwidth
Spectrum Peak Ref	n=5 1st element Spectrum peak power reference at the reference area
Start (Hz)	Start frequency for offset
Stop (Hz)	Stop frequency for offset
Meas BW (Hz)	Measurement bandwidth for offset
Lower Peak (dB)	Relative peak power on minimum margin point of the negative offset
Lower ΔLim (dB)	Minimum margin from limit line which is decided by Fail Mask setting

Name	Corresponding Results
	on the negative offset
Lower Freq (Hz)	Frequency on minimum margin point of the negative offset
Upper Peak (dB)	Relative peak power on minimum margin point of the positive offset
Upper ΔLim (dB)	Minimum margin from limit line which is decided by Fail Mask setting on the positive offset
Upper Freq (Hz)	Frequency on minimum margin point of the positive offset

Key Path	View/Display
Initial S/W Revision	Prior to A.02.00

Integrated Power

Sets the display to the Integrated Power view. The views differ depending on the setting of the measurement type (Meas Type) under the Measurement Setup menu.

"Integrated Power (Total Pwr Ref)" on page 1207

"Integrated Power (PSD Ref)" on page 1210

"Integrated Power (Spectrum Pk Ref)" on page 1213

Integrated Power (Total Pwr Ref)

"Trace Window" on page 1209

"Results Window" on page 1209

11 Spectrum Emission Mask Measurement
View/Display

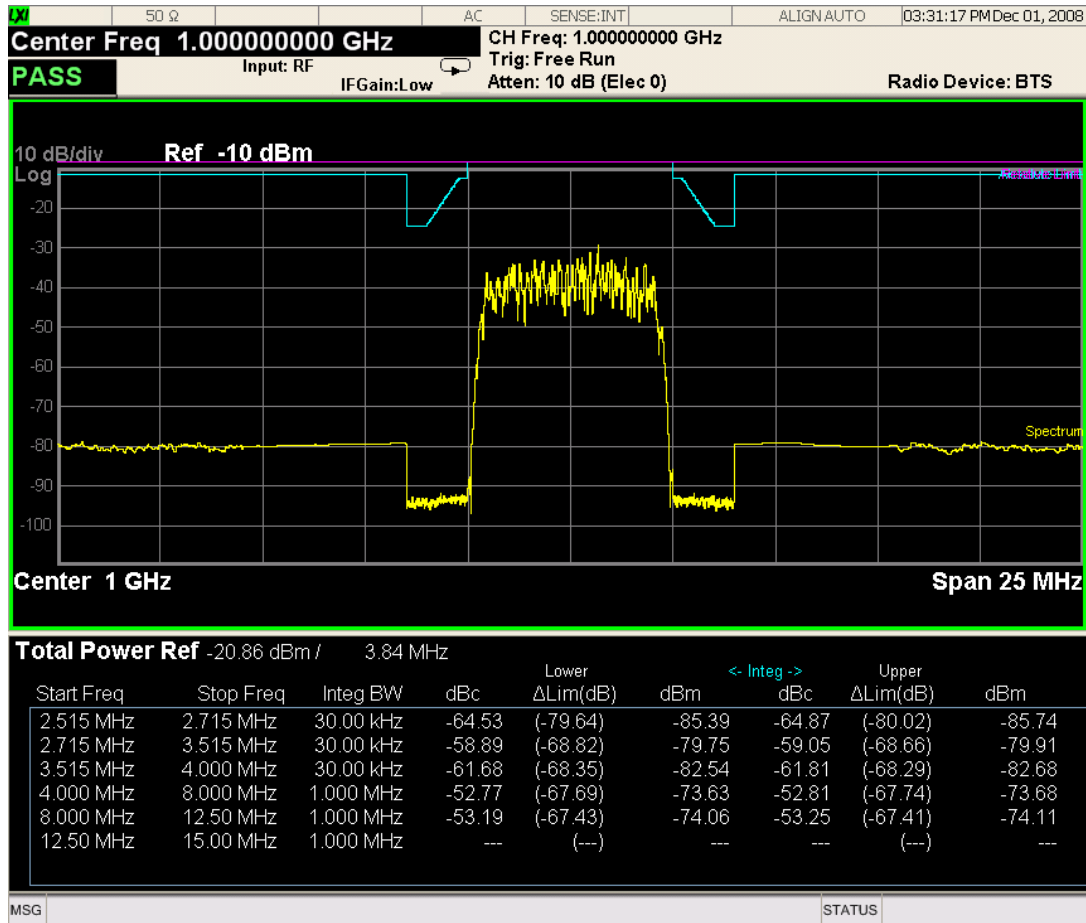

For WLAN 802.11ac (80 + 80 MHz), power readouts of both of the carriers are displayed in the lower result window.

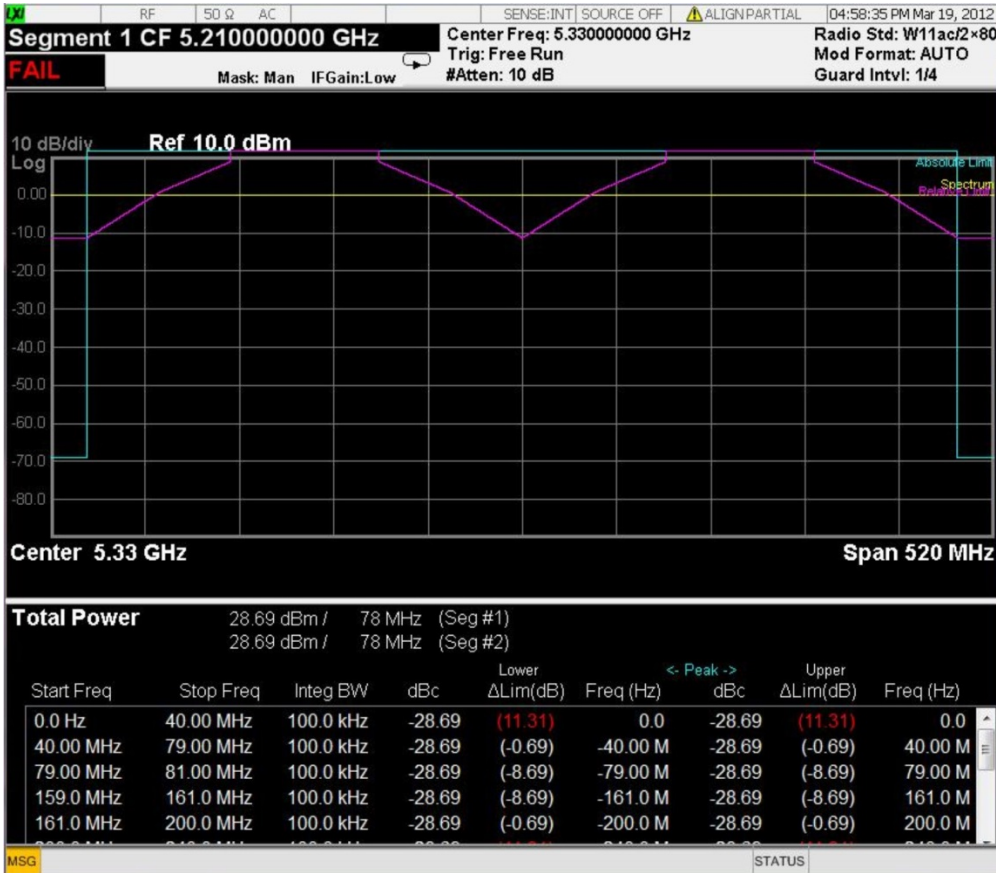

Trace Window

Corresponding Trace yellow - Combined trace from carrier and each offset

Results Window

Name	Corresponding Results
Total Pwr Ref	n=1 2nd element Absolute power at the reference area.
	Channel Integration Bandwidth
Start (Hz)	Start frequency for offset
Stop (Hz)	Stop frequency for offset
Meas BW (Hz)	Measurement bandwidth for offset
Lower Integ (dBc)	Relative integrated power on the negative offset
Lower ΔLim (dB)	Minimum margin from limit line which is decided by Fail Mask setting on the negative offset
Lower Integ (dBm)	Absolute integrated power on the negative offset

Name	Corresponding Results
Upper Integ (dBc)	Relative integrated power on the positive offset
Upper ΔLim (dB)	Minimum margin from limit line which is decided by Fail Mask setting on the positive offset
Upper Integ (dBm)	Absolute integrated power on the positive offset

Integrated Power (PSD Ref)

"Trace Window" on page 1212

"Results Window" on page 1212

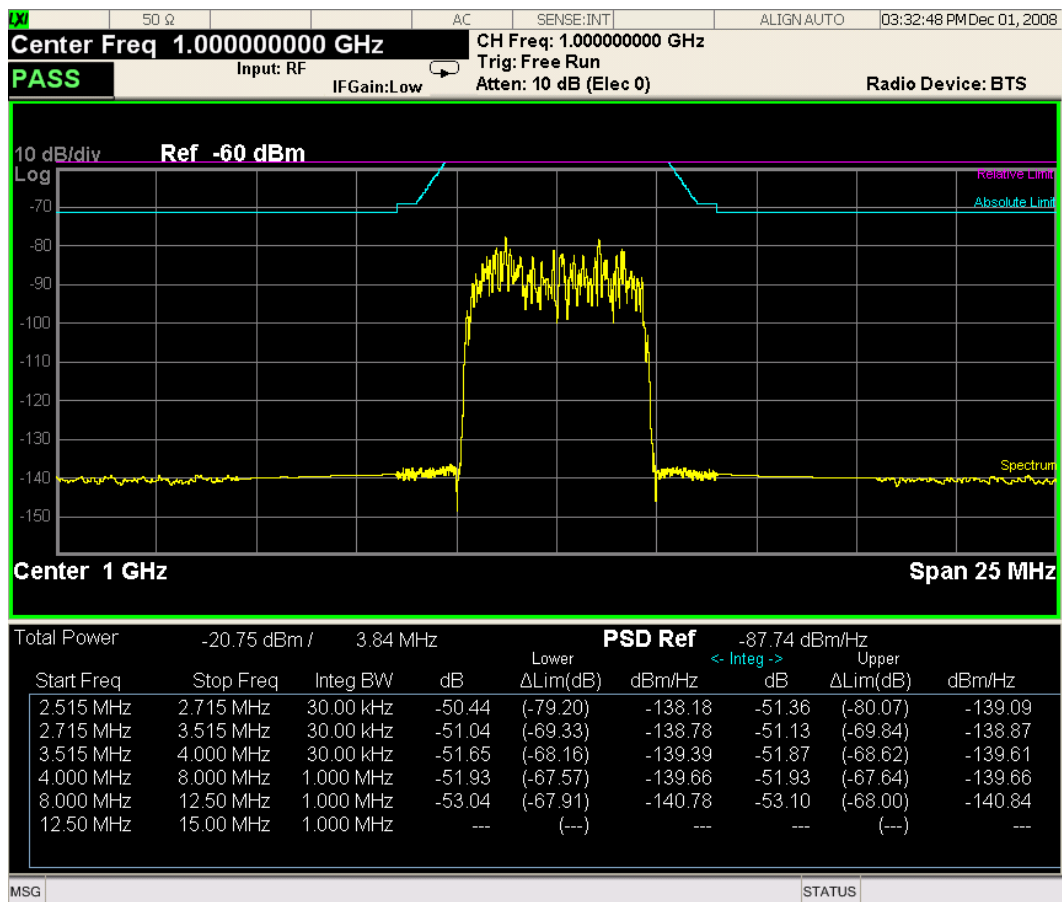



For WLAN 802.11ac (80 + 80 MHz), power readouts of both of the carriers are displayed in the lower result window.

11 Spectrum Emission Mask Measurement
View/Display

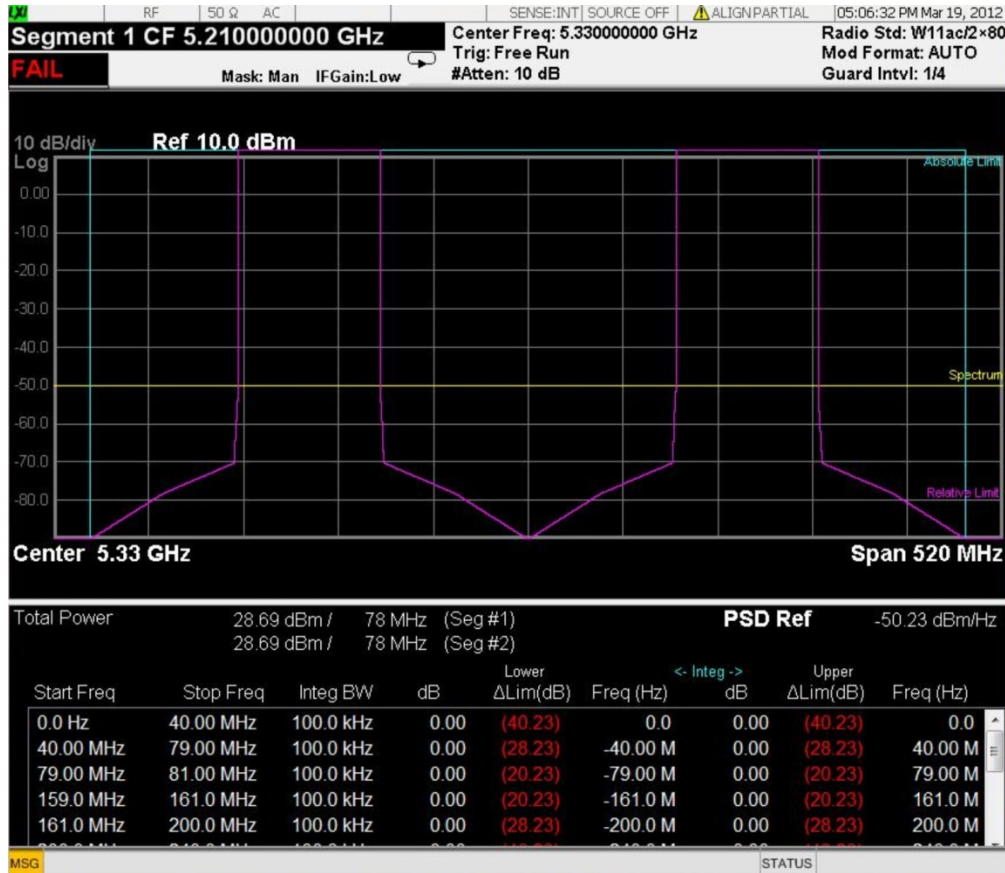

Trace Window

Corresponding Trace yellow - Combined trace from carrier and each offset

Results Window

Name	Corresponding Results
Total Pwr	n=1 2nd element Absolute power at the reference area.
	Channel Integration Bandwidth
PSD Ref	n=5 1st element Power spectral density reference at the reference area
Start (Hz)	Start frequency for offset
Stop (Hz)	Stop frequency for offset
Meas BW (Hz)	Measurement bandwidth for offset
Lower (dB)	Relative power spectrum density of the negative offset
Lower ΔLim (dB)	Minimum margin from limit line which is decided by Fail Mask setting on the negative offset

Name	Corresponding Results
Lower (dBm/Hz)	Absolute power spectrum density of the negative offset
Upper (dB)	Relative power spectrum density of the positive offset
Upper ΔLim (dB)	Minimum margin from limit line which is decided by Fail Mask setting on the positive offset
Upper (dBm/Hz)	Absolute power spectrum density of the negative offset

Integrated Power (Spectrum Pk Ref)

"Trace Window" on page 1209

"Results Window" on page 1209

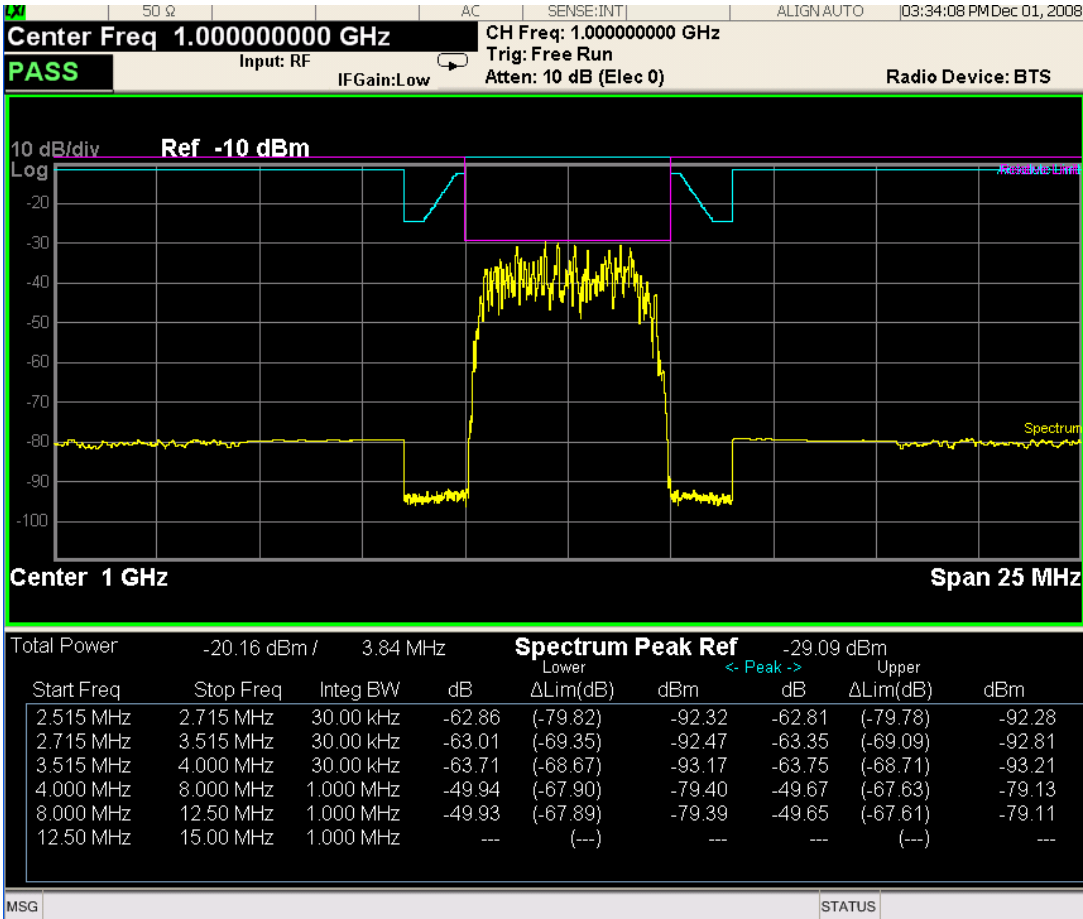

For WLAN 802.11 ac (80 + 80 MHz), power readouts of both of the carriers are displayed in the lower result window.

11 Spectrum Emission Mask Measurement
View/Display



Trace Window

Corresponding Trace yellow - Combined trace from carrier and each offset

Results Window

Name	Corresponding Results
Total Pwr	Absolute power at the reference area.
	Channel Integration Bandwidth
Spectrum Peak Ref	n=5 1st element Peak power at the reference area
Start (Hz)	Start frequency for offset
Stop (Hz)	Stop frequency for offset
Meas BW (Hz)	Measurement bandwidth for offset
Lower Peak (dB)	Relative peak power on minimum margin point of the negative offset
Lower Δlim (dB)	Minimum margin from limit line which is decided by Fail Mask setting on the negative offset

Name	Corresponding Results
Lower Peak (dBm)	Absolute peak power on minimum margin point of the negative offset
Upper Peak (dB)	Relative peak power on minimum margin point of the positive offset
Upper Δlim (dB)	Minimum margin from limit line which is decided by Fail Mask setting on the positive offset
Upper Peak (dBm)	Absolute peak power on minimum margin point of the positive offset

Key Path	View/Display
Initial S/W Revision	Prior to A.02.00

Limit Lines

Toggles the limit lines display function for the spectrum emission mask measurements On and Off.

Key Path	View/Display
Mode	SA, WCDMA, C2K, WIMAX OFDMA, TD-SCDMA, 1xEVDO, DTMB (CTTB), DVB-T/H, ISDB-T, CMMB, LTE, LTE-TDD, Digital Cable TV, WLAN, MSR, LTEAFDD, LTEATDD
Remote Command	:CALCulate:SEMask:LLINE:STATE ON OFF 1 0 :CALCulate:SEMask:LLINE:STATE?
Example	CALC:SEM:LLIN:STAT OFF CALC:SEM:LLIN:STAT?
Notes	You must be in the mode that includes SEM measurement to use this command. Use :INSTrument:SElect to set the mode.
Preset	ON
State Saved	Saved in instrument state.
Range	On Off
Initial S/W Revision	Prior to A.02.00
Modified at S/W Revision	A.02.00, A.03.00

12 Spurious Emissions Measurement

The Spurious Emissions measurement identifies and determines the power level of spurious emissions in certain frequency bands. For measurement results and views, see ["View/Display" on page 1391](#).

This topic contains the following sections:

["Measurement Commands for Spurious Emissions" on page 1218](#)

["Remote Command Results for Spurious Emissions Measurement" on page 1219](#)

Measurement Commands for Spurious Emissions

The following commands can be used to retrieve the measurement results:

`:CONFigure:SPURious`

`:CONFigure:SPURious:NDEFault`

`:INITiate:SPURious`

`:FETCh:SPURious [n]?`

`:READ:SPURious [n]?`

`:MEASure:SPURious [n]?`

For more measurement related commands, see the SENSE subsystem, and the section "[Remote Measurement Functions](#)" on page 2213.

Remote Command Results for Spurious Emissions Measurement

The following table describes the results returned by the FETCh, MEASure, and READ queries listed above, according to the index value n. Note that the queries are not available when viewing the Range Table.

n	Return Value
1 (or not supplied)	Returns a variable-length (1+6*Spurs – up to 1201 entries) comma separated list containing detailed information in the following format: 1. Number of spurs in following list (Integer) 2.[Repeat the following for each spur] a.Spur # b.Range # Spur was located (Integer) c.Frequency of Spur (Hz, Float64) d.Amplitude of Spur (dBm, Float32) e.Absolute Limit (dBm, Float32) f.Pass or Fail (1 0, Boolean)
2 – 21	Returns a comma separated list of the trace data for the selected range (where range number = n – 1) using Detector 1. If selected range is not active SCPI_NAN is returned for each trace data element where SCPI_NAN = 9.91E37.
22	Returns the number of spurs found.
23 – 42	Returns a comma separated list of the trace data for the selected range (where range number = n – 22) using Detector 2. If selected range is not active or Detector 2 selection is off, SCPI_NAN is returned for each trace data element where SCPI_NAN = 9.91E37.
Key Path	Meas
Initial S/W Revision	Prior to A.02.00

AMPTD Y Scale

AMPTD Y Scale opens a menu of functions that enable you to modify the Amplitude parameters.

Key Path	Front-panel key
Initial S/W Revision	Prior to A.02.00

Ref Value

Sets the value for the absolute power reference. When Auto Scaling for the Y-axis is off, the measurement uses the current reference level settings. When Auto Scaling for the Y-axis is on, the analyzer will set the reference level such that the absolute limit will be positioned two divisions down from the top of the display.

Key Path	AMPTD Y Scale
Mode	SA, WCDMA, WIMAX OFDMA, TD-SCDMA,C2k, 1xEV-DO, DVB-T/H, LTE, LTETDD, WLAN, MSR, LTEAFDD, LTEATDD
Remote Command	:DISPlay:SPURious:VIEW[1]:WINDow[1]:TRACe:Y[:SCALe]:RLEVel < real> :DISPlay:SPURious:VIEW[1]:WINDow[1]:TRACe:Y[:SCALe]:RLEVel?
Example	DISP:SPUR:VIEW:WIND:TRAC:Y:RLEV -50 dBm DISP:SPUR:VIEW:WIND:TRAC:Y:RLEV?
Notes	You must be in the Spectrum Analysis mode, W-CDMA mode, cdma2000 mode, DVB-T/H mode, TD-SCDMA mode, LTE mode, LTETDD mode, WLAN mode, MSR, LTE-Advanced FDD/TDD mode or WiMAX mode to use this command. Use INSTRument:SElect to set the mode.
Couplings	When the Y Auto Scaling is off, the measurement uses the current reference level settings. When the Y Auto Scaling is on, the analyzer automatically sets the reference level such that the absolute limit is positioned two divisions down from the top of the display. This is the most useful setting when searching for spurs. The algorithm used for determining the ref level is Ref Level = Absolute Limit + (2 * Scale/Div). All other reference level settings are left as the current base instrument settings.
Preset	0.00 dBm
State Saved	Saved in instrument state.
Min	-250.0 dBm
Max	250.0 dBm
Initial S/W Revision	Prior to A.02.00
Modified at S/W Revision	A.03.00

Attenuation

This menu controls the attenuator functions and interactions between the attenuation system components.

There are two attenuator configurations in the X-Series. One is a dual attenuator configuration consisting of a mechanical attenuator and an optional electronic attenuator. The other configuration uses a single

attenuator with combined mechanical and electronic sections that controls all the attenuation functions. Different models in the X-Series come with different configurations.

See ["Dual Attenuator Configurations:" on page 1221](#)

See ["Single Attenuator Configuration:" on page 1222](#)

Most Attenuation settings are the same for all measurements – they do not change as you change measurements. Settings like these are called “Meas Global” and are unaffected by Meas Preset.

Key Path	AMPTD Y Scale
Scope	Meas Global
Dependencies	In measurements that support the I/Q inputs, this key is unavailable when I/Q is the selected input, and is replaced by the Range key in that case.
Readback Line	Contains a summary in [] brackets of the current total attenuation. See the descriptions of the , " (Mech) Atten " on page 2160, and " Enable Elec Atten " on page 2162 keys for more detail on the contributors to the total attenuation. Note that when "Pre-Adjust for Min Clip" is on, this value can change at the start of every measurement.
Initial S/W Revision	Prior to A.02.00
Modified at S/W Revision	A.03.00

Dual Attenuator Configurations:

Configuration 1: Mechanical attenuator + optional electronic attenuator

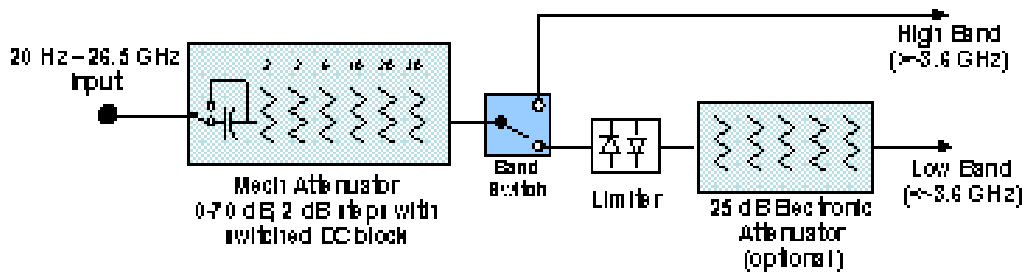

Configuration 2: Mechanical attenuator, no optional electronic attenuator

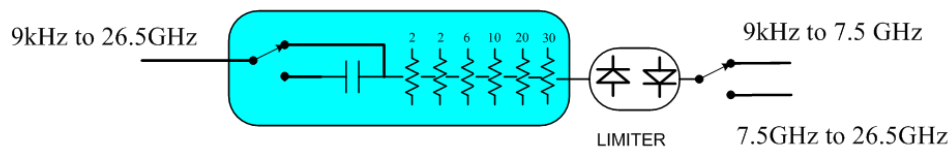

(note that Configuration 2 is not strictly speaking a dual-section attenuator, since there is no electronic section available. However, it behaves exactly like Configuration 1 without the Electronic Attenuator option EA3, therefore for the sake of this document it is grouped into the “Dual Attenuator” configuration)

Single Attenuator Configuration:

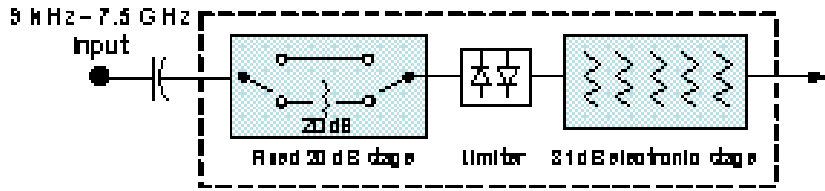

You can tell which attenuator configuration you have by pressing the Attenuation key, which (in most Modes) opens the Attenuation menu. If the first key in the Attenuation menu says Mech Atten you have the dual attenuator configuration. If the first key says Atten you have the single attenuator configuration.

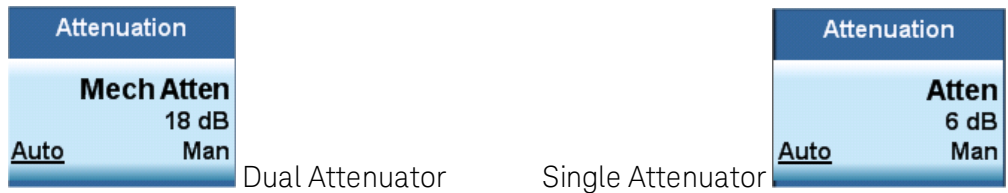

In the single attenuator configuration, you control the attenuation with a single control, as the fixed stage has only two states. In the dual attenuator configuration, both stages have significant range so you are given separate control of the mechanical and electronic attenuator stages.

When you have the dual attenuator configuration, you may still have only a single attenuator, because unless option EA3 (the Electronic Attenuator option) is available, and you purchase it, you will have only the mechanical attenuator.

(Mech) Atten

This key is labeled Mech Atten in dual attenuator models and Atten in single attenuator models. In the dual attenuator configuration, this key only affects the mechanical attenuator.

This key lets you modify the attenuation applied to the RF input signal path. This value is normally auto coupled to the Ref Level, the Internal Preamp Gain, any External Gain that is entered, and the Max Mixer Level, as described in the table below.

See ["Attenuator Configurations and Auto/Man" on page 1224](#)

Key Path	AMPTD Y Scale, Attenuation
Remote Command	<pre>[:SENSe]:POWer[:RF]:ATTenuation <rel_ampl> [:SENSe]:POWer[:RF]:ATTenuation? [:SENSe]:POWer[:RF]:ATTenuation:AUTO OFF ON 0 1 [:SENSe]:POWer[:RF]:ATTenuation:AUTO?</pre>
Example	<p>POW:ATT 20</p> <p>Dual attenuator configuration: sets the mechanical attenuator to 20 dB</p> <p>Single attenuator mode: sets the main attenuation to 20 dB (see below for definition of “main” attenuation).</p> <p>If the attenuator was in Auto, it sets it to Manual.</p>
Dependencies	Some measurements do not support the Auto setting of (Mech) Atten. In these measurements, the

Auto/Man selection is not available, and the Auto/Man line on the key disappears.

In dual attenuator configurations, when the electronic attenuator is enabled, the mechanical attenuator has no auto setting and the Auto/Man line on the key disappears. The state of Auto/Man is remembered and restored when the electronic attenuator is once again disabled. This is described in more detail in the ["Enable Elec Atten" on page 2162](#) key description.

See ["Attenuator Configurations and Auto/Man" on page 1224](#) for more information on the Auto/Man functionality of Attenuation.

Couplings

When (Mech) Atten is in Auto, it uses the following algorithm to determine a value:

If the USB Preamp is connected to USB, use 0 dB.

Otherwise, $Atten = ReferenceLevel + PreAmpGain + ExternalGain - RefLevelOffset - MaxMixerLevel + IF\ Gain$.

Limit this value to be between 6 dB and the Max value. No value below 6 dB can ever be chosen by Auto.

The resulting value is rounded up to the largest value possible given the attenuation step setting. That is, 50.01 dB would change to 60 dB (for a 10 dB attenuation step).

The "IF Gain" term in the equation above is either 0 dB or +10 dB, depending on the settings of FFT IF Gain, Swept IF Gain, max Ref Level and the Auto/Man setting of Mech Atten.

In External Mixing and BBIQ, where the Attenuator is not in the signal path, the Attenuator setting changes as described above when (Mech) Atten is in Auto, but no changes are made to the actual attenuator hardware setting until the input is changed back to the RF Input.

Preset The preset for Mech Attenuation is "Auto."
The Auto value of attenuation is:
CXA, EXA, MXA and PXA: 10 dB

State Saved Saved in instrument state

Min 0 dB

The attenuation set by this key cannot be decreased below 6 dB with the knob or step keys. To get to a value below 6 dB it has to be directly entered from the keypad or via SCPI. This protects from adjusting the attenuation to a dangerously small value which can put the instrument at risk of damage to input circuitry. However, if the current mechanical attenuation is below 6 dB it can be increased with the knob and step keys, but not decreased.

Max CXA N9000A-503/507: 50 dB
CXA N9000A-513/526: 70dB
EXA: 60 dB
MXA and PXA: 70 dB

In the single attenuator configuration, the total of ATT and EATT cannot exceed 50 dB, so if the EATT is set to 24 dB first, the main attenuation cannot be greater than 26 dB and will be reduced accordingly; if the main attenuator is set to 40 dB first, EATT cannot be greater than 10 dB.

Initial S/W Revision Prior to A.02.00

Modified at S/W Revision A.03.00

Attenuator Configurations and Auto/Man

As described in the Attenuation key description, there are two distinct attenuator configurations available in the X-Series, the single attenuator and dual attenuator configurations. In dual attenuator configurations, we have the mechanical attenuation and the electronic attenuation, and the current total attenuation is the sum of the electronic + mechanical attenuation. In single attenuator configurations, we refer to the attenuation set using the (Mech) Atten key (or POW:ATT SCPI) as the “main” attenuation; and the attenuation that is set by the SCPI command POW:EATT as the “soft” attenuation (the POW:EATT command is honored even in the single attenuator configuration, for compatibility purposes). Then the current total attenuation is the sum of the main + soft attenuation. See the Elec Atten key description for more on “soft” attenuation.

In the dual attenuator configuration, when the electronic attenuator is enabled, there is no Auto/Man functionality for the mechanical attenuator, and the third line of the key label (the Auto/Man line) disappears:

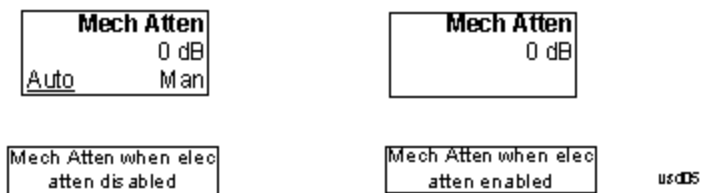

Enable Elec Atten

Enables the Electronic Attenuator.

The electronic attenuator offers finer steps than the mechanical attenuator, has no acoustical noise, is faster, and is less subject to wear. These advantages primarily aid in remote operation and are negligible for front panel use. See ["Using the Electronic Attenuator: Pros and Cons" on page 1226](#) for a detailed discussion of the pros and cons of using the electronic attenuator.

For the single attenuator configuration, for SCPI backwards compatibility, the “soft” attenuation feature replaces the dual attenuator configuration’s electronic attenuator. All the same couplings and limitations apply. See ["Attenuator Configurations and Auto/Man" on page 2162](#)

See ["More Information" on page 1225](#)

Key Path	AMPTD Y Scale, Attenuation
Remote Command	[:SENSe] : POWer [:RF] : EATTenuation : STATE OFF ON 0 1 [:SENSe] : POWer [:RF] : EATTenuation : STATE ?
Example	POW:EATT:STAT ON
Dependencies	This key only appears in Dual Attenuator models with an Electronic Attenuator installed. It does not appear in models with the Single Attenuator configuration, as in the single attenuator configuration there is no “electronic attenuator” there is only a single integrated attenuator (which has both a mechanical and electronic stage). However, in the single attenuator configuration, EATT SCPI commands are accepted for compatibility with other X-series instruments and set a “soft” attenuation as described in "Attenuator Configurations and Auto/Man" on page 2162 . The electronic attenuator (and the “soft” attenuation function provided in single attenuator configurations) is unavailable above 3.6 GHz. Therefore, if the Stop Frequency of the analyzer is > 3.6 GHz then the Enable Elec Atten key will be OFF and grayed out.

	<p>If the Internal Preamp is on, meaning it is set to Low Band or Full, the electronic attenuator (and the “soft” attenuation function provided in single attenuator configurations) is unavailable. In this case the Enable Elec Atten key will be OFF and grayed out.</p> <p>If either of the above is true, if the SCPI command is sent, an error indicating that the electronic attenuator is unavailable will be sent.</p> <p>If the electronic/soft Attenuator is enabled, then the Stop Freq of the analyzer is limited to 3.6 GHz and the Internal Preamp is unavailable.</p> <p>The SCPI-only “soft” electronic attenuation for the single-attenuator configuration is not available in all measurements; in particular, it is not available in the Swept SA measurement.</p>
Couplings	Enabling and disabling the Electronic Attenuator affects the setting of the Mechanical Attenuator (in dual attenuator configurations). This is described in more detail below this table.
Preset	OFF for Swept SA measurement; ON for all other measurements that support the electronic attenuator
State Saved	Saved in instrument state
Initial S/W Revision	Prior to A.02.00
Modified at S/W Revision	A.03.00

More Information

Mechanical Attenuator Transition Rules

When the Electronic Attenuator is enabled, the Mechanical Attenuator transitions to a state that has no Auto function. Below are the rules for transitioning the Mechanical Attenuator. NOTE that the information below ONLY applies to the dual attenuator configurations, and ONLY when the Electronic Attenuator is installed:

When the Electronic Attenuation is enabled from a disabled state:

- The Mechanical Attenuator is initialized to 10 dB (this is its optimal performance setting). You can then set it as desired with SCPI, numeric keypad, step keys, or knob, and it behaves as it normally would in manual mode
- The Auto/Man state of (Mech) Atten is saved
- The Auto/Man line on the (Mech) Atten key disappears and the auto rules are disabled
- The Electronic Attenuator is set to 10 dB less than the previous value of the Mechanical Attenuator, within the limitation that it must stay within the range of 0 to 24 dB of attenuation.

Examples in the dual attenuator configuration:

- Mech Atten at 20 dB. Elec Atten enabled, Mech Atten set to 10 dB, and Elec Atten set to 10 dB. New total attenuation equals the value before Elec Atten enabled.
- Mech Atten at 0 dB. Elec Atten enabled, Mech Atten set to 10 dB, and Elec Atten set to 0 dB. New total attenuation does not equal the value before Elec Atten enabled.
- Mech Atten at 40 dB. Elec Atten enabled, Mech Atten set to 10 dB, and Elec Atten set to 24 dB. New total attenuation does not equal the value before Elec Atten enabled.

When the Electronic Attenuation is disabled from an enabled state:

- The Elec Atten key is grayed out
- The Auto/Man state of (Mech) Atten is restored
- If now in Auto, (Mech) Atten recouples
- If now in Man, (Mech) Atten is set to the value of total attenuation that existed before the Elec Atten was disabled. The resulting value is rounded up to the smallest value possible given the (Mech) Atten Step setting - (That is, 57 dB changes to 58 dB when (Mech) Atten Step is 2 dB.)

Using the Electronic Attenuator: Pros and Cons

The electronic attenuator offers finer steps than the mechanical attenuator, has no acoustical noise, is faster, and is less subject to wear.

The “finer steps” advantage of the electronic attenuator is beneficial in optimizing the alignment of the analyzer dynamic range to the signal power in the front panel as well as remote use. Thus, you can achieve improved relative signal measurement accuracy. Compared to a mechanical attenuator with 2 dB steps, the 1 dB resolution of the electronic attenuator only gives better resolution when the odd-decibel steps are used. Those odd-decibel steps are less accurately calibrated than the even-decibel steps, so one tradeoff for this superior relative accuracy is reduced absolute amplitude accuracy.

Another disadvantage of the electronic attenuator is that the spectrum analyzer loses its “Auto” setting, making operation less convenient.

Also, the relationship between the dynamic range specifications (TOI, SHI, compression and noise) and instrument performance are less well-known with the electrical attenuator. With the mechanical attenuator, TOI, SHI and compression threshold levels increase dB-for-dB with increasing attenuation, and the noise floor does as well. With the electronic attenuator, there is an excess attenuation of about 1 to 3 dB between 0 and 3.6 GHz, making the effective TOI, SHI, and so forth, less well known. Excess attenuation is the actual attenuation relative to stated attenuation. Excess attenuation is accounted for in the analyzer calibration

Elec Atten

Controls the Electronic Attenuator in dual attenuator configurations. This key does not appear in single attenuator configurations, as the control of both the mechanical and electronic stages of the single attenuator is integrated into the single Atten key.

Key Path	AMPTD Y Scale, Attenuation
Remote Command	[:SENSe] :POWer [:RF] :EATTenuation <rel_ampl> [:SENSe] :POWer [:RF] :EATTenuation?
Notes	Electronic Attenuation’s specification is defined only when Mechanical Attenuation is 6 dB.
Dependencies	This key only appears in Dual Attenuator models with an Electronic Attenuator installed. It does not appear in models with the Single Attenuator configuration, as in the single attenuator configuration there is no “electronic attenuator” there is only a single integrated attenuator (which has both a mechanical and electronic stage). However, in the single attenuator configuration, EATT SCPI commands are accepted for compatibility with other X-series instruments and set a “soft” attenuation as described in "Attenuator Configurations and Auto/Man" on page 2162 . The “soft” attenuation is treated as an addition to the “main” attenuation value set by the Atten softkey or the

	POW:ATT SCPI command and affects the total attenuation displayed on the Attenuation key and the Meas Bar. When Enable Elec Atten is off or grayed out, the Elec Atten key is grayed out.
Preset	0 dB
State Saved	Saved in instrument state
Min	0 dB
Max	Dual attenuator configuration: 24 dB Single attenuator configuration: the total of ATT and EATT cannot exceed 50 dB, so if the EATT is set to 24 dB first, the main attenuation cannot be greater than 26 dB and will be reduced accordingly; if the main attenuator is set to 40 dB first, EATT cannot be greater than 10 dB
Initial S/W Revision	Prior to A.02.00
Modified at S/W Revision	A.03.00

Adjust Atten for Min Clip

Sets the combination of mechanical and electronic attenuation and gain based on the current measured signal level so that clipping will be at a minimum.

This is an "immediate action" function, that is, it executes once, when the key is pressed.

This key is grayed out in measurements that do not support this functionality. The spectrum analyzer measurement, Swept SA, does not support this functionality.

Key Path	AMPTD Y Scale, Attenuation
Remote Command	<code>[:SENSe] :POWer [:RF] :RANGe:OPTimize IMMEDIATE</code>
Initial S/W Revision	Prior to A.02.00
Modified at S/W Revision	A.03.00

Pre-Adjust for Min Clip

If this function is on, it does the adjustment described under "[Adjust Atten for Min Clip](#)" on page 2165 each time a measurement restarts. Therefore, in Continuous measurement mode, it only executes before the first measurement.

In dual attenuator models, you can set Elec+Mech Atten, in which case both attenuators participate in the autoranging, or Elec Atten Only, in which case the mechanical attenuator does not participate in the autoranging. This latter case results in less wear on the mechanical attenuator and is usually faster.

This key is grayed out in measurements that do not support this functionality. The spectrum analyzer measurement, Swept SA, does not support this functionality.

Key Path	AMPTD Y Scale, Attenuation
Remote Command	<code>[:SENSe] :POWer [:RF] :RANGe:OPTimize:ATTenuation OFF ELECTRical COMBined</code>

	<code>[:SENSe] :POWer [:RF] :RANGe:OPTimize:ATTenuation?</code>
Notes	The SCPI parameter ELECtrical sets this function to On in single attenuator models. The SCPI parameter COMBined is mapped to ELECtrical in single attenuator models; if you send COMBined, it sets the function to On and returns ELEC to a query.
Dependencies	This key only appears in Dual Attenuator models with an Electronic Attenuator installed. In instruments with Dual Attenuator model, when Enable Elec Atten is off or grayed out, the Pre-Adjust for Min Clip key is grayed out.
Preset	OFF for Swept SA measurement; ON for all other measurements that support Pre-Adjust for Min Clip
State Saved	Saved in instrument state
Range	Dual attenuator models: Off Elec Atten Only Mech + Elec Atten Single attenuator models: Off On
Initial S/W Revision	Prior to A.02.00
Modified at S/W Revision	A.03.00

Remote Command	<code>[:SENSe] :POWer [:RF] :RANGe:AUTO ON OFF 1 0</code> <code>[:SENSe] :POWer [:RF] :RANGe:AUTO?</code>
Notes	ON aliases to "Elec Atten Only" (:POW:RANG:OPT:ATT ELEC) OFF aliases to "Off" (:POW:RANG:OPT:ATT OFF) The query :POW:RANG:AUTO? returns true if :POW:RANG:OPT:ATT is not "Off"
Initial S/W Revision	Prior to A.02.00

Off

Turns Pre-Adjust for Min Clip off. This is the default setting.

This key is grayed out in measurements that do not support this functionality. The spectrum analyzer measurement, Swept SA, does not support this functionality.

Key Path	AMPTD Y Scale, Attenuation, Pre-Adjust for Min Clip
Example	:POW:RANGe:OPT:ATT OFF
Initial S/W Revision	Prior to A.02.00

Elec Atten Only

Selects only the electric attenuator to participate in auto ranging. This offers less wear on the mechanical attenuator and is usually faster.

This key is grayed out in measurements that do not support this functionality. The spectrum analyzer measurement, Swept SA, does not support this functionality.

Key Path	AMPTD Y Scale, Attenuation, Pre-Adjust for Min Clip
Example	:POW:RANGe:OPT:ATT ELEC
Initial S/W Revision	Prior to A.02.00

Mech + Elec Atten

In dual attenuator models, this selects both attenuators participate in the autoranging.

This key is grayed out in measurements that do not support this functionality. The spectrum analyzer measurement, Swept SA, does not support this functionality.

Key Path	AMPTD Y Scale, Attenuation, Pre-Adjust for Min Clip
Example	:POW:RANGe:OPT:ATT COMB
Initial S/W Revision	Prior to A.02.00

(Mech) Atten Step

This controls the step size used when making adjustments to the input attenuation.

This key is labeled Mech Atten Step in dual attenuator models and Atten Step in single attenuator models. In the dual attenuator configuration, this key only affects the step size of the mechanical attenuator.

Key Path	AMPTD Y Scale, Attenuation
Remote Command	[:SENSe] :POWer [:RF] :ATTenuation :STEP [:INCRement] 10 dB 2 dB [:SENSe] :POWer [:RF] :ATTenuation :STEP [:INCRement] ?
Example	POW:ATT:STEP 2
Notes	Note this feature works like a 1-N choice from the front panel, but it takes a specific value (in dB) when used remotely. The only valid values are 2 and 10.
Dependencies	Blanked in CXA and EXA if option FSA (2 dB steps) is not present. If blanked, attempts to set it via SCPI will yield an error.
Couplings	When the attenuation step size changes, the current mechanical attenuation value is adjusted (if necessary) to be quantized to the new step size. That is, if step is set to 10 dB, mech atten is increased if necessary so it is a multiple of 10 dB
Preset	PXA and MXA: 2 dB EXA and CXA: 10 dB (2 dB with option FSA)
State Saved	Saved in instrument state
Initial S/W Revision	Prior to A.02.00
Modified at S/W Revision	A.03.00

Scale/Div

Sets the units per division of the vertical scale in the logarithmic display. However, since the Auto Scaling is defaulted to On, this value is automatically determined by the measurement result. When you set a value manually, Auto Scaling automatically changes to Off.

Key Path	AMPTD Y Scale
Mode	SA, WCDMA, C2K, WIMAX OFDMA, TD-SCDMA, DVB-T/H, LTE, LTE-TDD, WLAN, MSR, LTEAFDD, LTEATDD
Remote Command	:DISPlay:SPURious:VIEW[1]:WINDow[1]:TRACe:Y[:SCALe]:PDIVision <rel_ ampl> :DISPlay:SPURious:VIEW[1]:WINDow[1]:TRACe:Y[:SCALe]:PDIVision?
Example	DISP:SPUR:VIEW:WIND:TRAC:Y:PDIV 10 dB DISP:SPUR:VIEW:WIND:TRAC:Y:PDIV?
Notes	You must be in the Spectrum Analysis mode, W-CDMA mode, cdma2000 mode, DVB-T/H mode, TD-SCDMA, LTE mode, LTE TDD mode, WLAN mode, MSR, LTE-Advanced FDD/TDD mode or WiMAX mode to use this command. Use INSTRument:SElect to set the mode.
Couplings	When Auto Scaling is On, this value is automatically determined by the measurement result. When you set a value manually, Auto Scaling automatically changes to Off.
Preset	10.00 dB
State Saved	Saved in instrument state.
Range	0.10 dB to 20.00 dB
Min	0.10 dB
Max	20.00 dB
Initial S/W Revision	Prior to A.02.00
Modified at S/W Revision	A.03.00

Presel Center

When this key is pressed, the centering of the preselector filter is adjusted to optimize the amplitude accuracy at the frequency of the selected marker. If the selected marker is not on when Presel Center is pressed, the analyzer will turn on the selected marker, perform a peak search, and then perform centering on the marker's center frequency. If the selected marker is already on and between the start and stop frequencies of the analyzer, the analyzer performs the preselector calibration on that marker's frequency. If the selected marker is already on, but outside the frequency range between Start Freq and Stop Freq, the analyzer will first perform a peak search, and then perform centering on the marker's center frequency.

The value displayed on the Presel Adjust key will change to reflect the new preselector tuning (see Presel Adjust).

A number of considerations should be observed to ensure proper operation. See ["Proper Preselector Operation" on page 1231](#).

Key Path	AMPTD Y Scale
-----------------	---------------

Remote Command	<code>[:SENSe] :POWer [:RF] :PCENter</code>
Example	POW:PCEN
Notes	Note that the rules outlined above under the key description apply for the remote command as well as the key. The result of the command is dependent on marker position, and so forth. Any message shown by the key press is also shown in response to the remote command.
Dependencies	<ul style="list-style-type: none"> • Grayed out if the microwave preselector is off.) • If the selected marker's frequency is below Band 1, advisory message 0.5001 is generated and no action is taken. • Grayed out if entirely in Band 0. • Blank in models that do not include a preselector, such as option 503. If the SCPI is sent in these instruments, it is accepted without error, and the query always returns 0. • Grayed out in the Spectrogram View.
Couplings	<p>The active marker position determines where the centering will be attempted.</p> <p>If the analyzer is in a measurement such as averaging when centering is initiated, the act of centering the preselector will restart averaging but the first average trace will not be taken until the centering is completed.</p>
Status Bits/OPC dependencies	<p>When centering the preselector, *OPC will not return true until the process is complete and a subsequent measurement has completed, nor will results be returned to a READ or MEASure command.</p> <p>The Measuring bit should remain set while this command is operating and should not go false until the subsequent sweep/measurement has completed.</p>
Initial S/W Revision	Prior to A.02.00
Modified at S/W Revision	A.03.00

Proper Preselector Operation

A number of considerations should be observed to ensure proper operation:

1. If the selected marker is off, the analyzer will turn on a marker, perform a peak search, and adjust the preselector using the selected marker's frequency. It uses the "highest peak" peak search method unqualified by threshold or excursion, so that there is no chance of a 'no peak found' error. It continues with that peak, even if it is the peak of just noise. Therefore, for this operation to work properly, there should be a signal on screen in a preselected range for the peak search to find.
2. If the selected marker is already on, the analyzer will attempt the centering at that marker's frequency. There is no preselector for signals below about 3.6 GHz, therefore if the marker is on a signal below 3.6 GHz, no centering will be attempted and an advisory message generated
3. In some models, the preselector can be bypassed. If it is bypassed, no centering will be attempted in that range and a message will be generated.

Preselector Adjust

Allows you to manually adjust the preselector filter frequency to optimize its response to the signal of interest. This function is only available when "Presel Center" on page 2168 is available.

For general purpose signal analysis, using Presel Center is recommended. Centering the filter minimizes the impact of long-term preselector drift. Presel Adjust can be used instead to manually optimize the preselector. One application of manual optimization would be to peak the preselector response, which both optimizes the signal-to-noise ratio and minimizes amplitude variations due to small (short-term) preselector drifting.

Key Path	AMPTD Y Scale
Scope	Meas Global
Remote Command	<code>[:SENSe] :POWeR [:RF] :PADJust <freq></code> <code>[:SENSe] :POWeR [:RF] :PADJust?</code>
Example	POW:PADJ 100KHz POW:PADJ?
Notes	The value on the key reads out to 0.1 MHz resolution.
Dependencies	<ul style="list-style-type: none"> • Grayed out if microwave preselector is off.) • Grayed out if entirely in Band 0. • Blank in models that do not include a preselector, such as option 503. If the SCPI is sent in these instruments, it is accepted without error, and the query always returns 0. • Grayed out in the Spectrogram View.
Preset	0 MHz
State Saved	The Presel Adjust value set by Presel Center, or by manually adjusting Presel Adjust, is not saved in instrument state, and does not survive a Preset or power cycle.
Min	-500 MHz
Max	500 MHz
Default Unit	Hz
Backwards Compatibility SCPI	<code>[:SENSe] :POWeR [:RF] :MW :PADJust</code> <code>[:SENSe] :POWeR [:RF] :MMW :PADJust</code> PSA had multiple preselectors, but the X-Series has only one. These commands simply alias to <code>[:SENSe] :POWeR [:RF] :PADJust</code>
Initial S/W Revision	Prior to A.02.00
Modified at S/W Revision	A.03.00

Remote Command	<code>[:SENSe] :POWeR [:RF] :PADJust :PRESelector MWAVE MMWave EXTeRnal</code> <code>[:SENSe] :POWeR [:RF] :PADJust :PRESelector?</code>
Notes	PSA had multiple preselectors, and you could select which preselector to adjust. Since the X-Series has only one mm/uW preselector, the preselector selection softkey is no longer available. However,

to provide backward compatibility, we accept the legacy remote commands.
The command form has no effect, the query always returns MWAVE

Initial S/W Revision	Prior to A.02.00
----------------------	------------------

μW Path Control

Sets the μW Path Control function to Auto, standard path, μW Preselector Bypass (Option MPB) and Low Noise Path (Option LNP).

Key Path	AMPTD/Y Scale
----------	---------------

Initial S/W Revision	A.14.50
----------------------	---------

μW Path Control Auto

Activates the auto rules for μW Path Control. When Auto is active, the μW Path Control is set to Preselector Bypass in modulation analysis and spectral flatness measurement; it is set to standard path in other measurements.

Key Path	AMPTD/Y Scale
----------	---------------

Remote Command	[:SENSe] :POWer [:RF] :MW:PATH:AUTO ON OFF 1 0 [:SENSe] :POWer [:RF] :MW:PATH:AUTO?
-----------------------	--

Example	POW:MW:PATH:AUTO ON POW:MW:PATH:AUTO?
----------------	--

Couplings	When Auto is active, the μW Path Control is set to μW Preselector Bypass in IQ measurements (IQ waveform, CCDF, PVT, EVM, Spetrum flatness and WLS); it is set to standard path in other measurements.
-----------	--

Preset	ON
--------	----

Range	Off On
-------	--------

Initial S/W Revision	A.14.50
----------------------	---------

Standard Path

This path gives the best remote-control throughput, minimizes acoustic noise from switching and minimizes the risk of wear in the hardware switches, particularly in remote test scenarios where both low band and high band setups will follow in rapid succession.

In this path, the bypass of the low band/high band switch and microwave preamp is never activated, which can cause some noise degradation but preserves the life of the bypass switch.

Key Path	AMPTD Y Scale, μW Path Control
----------	--------------------------------

Example	:POW:MW:PATH STD
Readback Text	Standard Path
Initial S/W Revision	A.04.00

Low Noise Path Enable

You may choose Low Noise Path Enable, which gives a lower noise floor under some circumstances, particularly when operating in the 21–26.5 GHz region. With the Low Noise Path enabled, the low band/high band switch and microwave preamp are bypassed whenever all of the following are true:

- The analyzer is not in the Low Band, meaning:
- the start frequency is above 3.5 GHz and
- the stop frequency is above 3.6 GHz.
- the internal preamp is not installed or (if installed) is set to Off or Low Band

Note that this means that, when any part of a sweep is done in Low Band, the Low Noise Path is not used, whether or not the Low Noise Path Enable is selected in the user interface. Also, if the preamp is turned on, the Low Noise Path is not used, whether or not the Low Noise Path Enable is selected in the user interface. The only time the Low Noise Path is used is when Low Noise Path Enable is selected, the sweep is completely in High Band (> 3.6 GHz) and no preamp is in use.

See "[More Information](#)" on page 1235

Key Path	AMPTD Y Scale, μ W Path Control
Measurement	Swept SA
Example	:POW:MW:PATH LNP
Notes	<p>For measurements that use IQ acquisition, the low noise path is used when the Center Frequency is in High Band (> 3.6 GHz) and no preamp is in use.</p> <p>In other words, the rules above are modified to use only the center frequency to qualify which path to switch in.</p> <p>This is not the case for FFT's in the Swept SA measurement; they use the same rules as swept measurements.</p>
Dependencies	<p>Key is blanked if current mode does not support it.</p> <p>Key is grayed out if mode supports it but current measurement does not support it.</p> <p>Unless Option LNP is present and licensed, key is blank and if SCPI command sent, error -241, "Hardware missing; Option not installed" is generated.</p>
Readback Text	Low Noise Path Enable
Initial S/W Revision	A.04.00

More Information

The user should understand that the Low Noise Path, while giving improved DANL, has the disadvantage of decreased TOI performance and decreased gain compression performance relative to the standard path.

The user should also understand that the bypass switch is a mechanical switch and has finite life, so if the Low Noise Path is enabled, it is possible to cause frequent cycling of this switch by frequently changing analyzer settings such that the above conditions hold true only some of the time. A user making tests of this nature should consider opting for the Standard Path, which will never throw the bypass switch, at the expense of some degraded noise performance.

The low noise path is useful for situations where the signal level is so low that the analyzer performance is dominated by noise even with 0 dB attenuation, but still high enough that the preamp option would have excessive third-order intermodulation or compression. The preamp, if purchased and used, gives better noise floor than does the “Low Noise Path.” However, its compression threshold and third-order intercept are much poorer than that of the non-preamp path. There are some applications, typically for signals around -30 dBm, for which the third-order dynamic range of the standard path is good enough, but the noise floor is not low enough even with 0 dB input attenuation. When the third-order dynamic range of the preamp path is too little and the noise floor of the standard path is too high, the Low Noise Path can provide the best dynamic range

The graph below illustrates the concept. It shows, in red, the performance of an analyzer at different attenuation settings, both with the preamp on and off, in a measurement that is affected by both analyzer noise and analyzer TOI. The green shows the best available dynamic range, offset by 0.5 dB for clarity. The blue shows how the best available dynamic range improves for moderate signal levels with the low noise path switched in. In this illustration, the preamp improves the noise floor by 15 dB while degrading the third-order intercept by 30 dB, and the low noise path reduces loss by 8 dB. The attenuator step size is 2 dB.

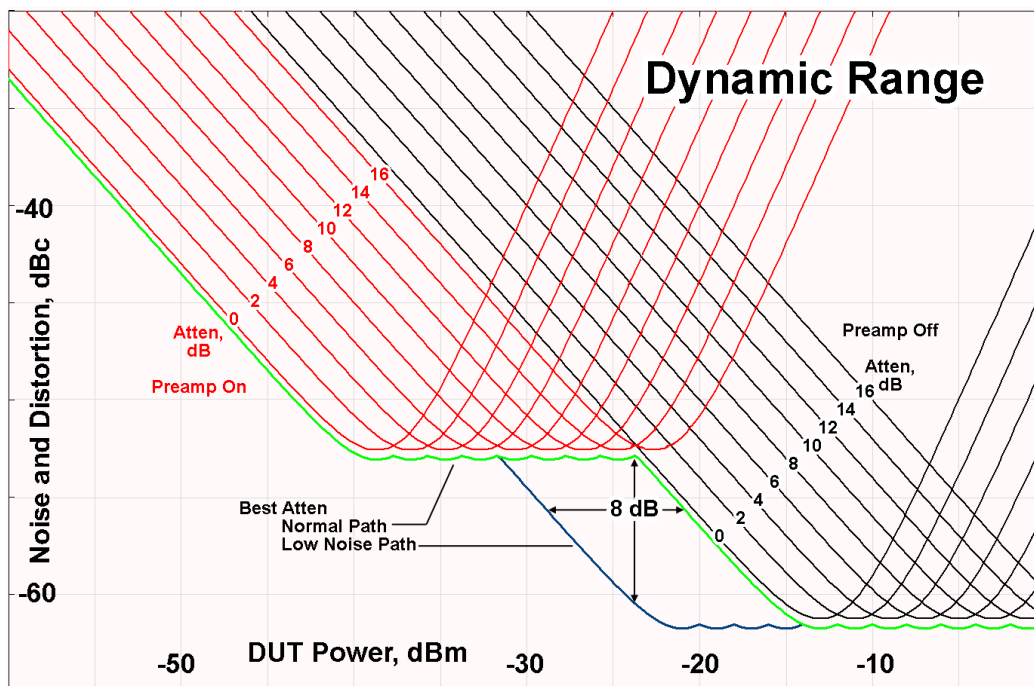

There are other times where selecting the low noise path improves performance, too. Compression-limited measurements such as finding the nulls in a pulsed-RF spectrum can profit from the low noise path in a way similar to the TOI-limited measurement illustrated. Accuracy can be improved when the low noise path allows the optimum attenuation to increase from a small amount like 0, 2 or 4 dB to a larger amount, giving better return loss at the analyzer input. Harmonic measurements, such as second and third harmonic levels, are much improved using the low noise path because of the superiority of that path for harmonic (though not intermodulation) distortion performance.

μW Preselector Bypass

This key toggles the preselector bypass switch for band 1 and higher. When the microwave preselector is on, the signal path is preselected. When the microwave preselector is off, the signal path is not preselected. The preselected path is the normal path for the analyzer.

The preselector is a tunable bandpass filter which prevents signals away from the frequency of interest from combining in the mixer to generate in-band spurious signals (images). The consequences of using a preselector filter are its limited bandwidth, the amplitude and phase ripple in its passband, and any amplitude and phase instability due to center frequency drift.

Option MPB or pre-selector bypass provides an unpreselected input mixer path for certain X-Series signal analyzers with frequency ranges above 3.6 GHz. This signal path allows a wider bandwidth and less amplitude variability, which is an advantage when doing modulation analysis and broadband signal analysis. The disadvantage is that, without the preselector, image signals will be displayed. Another disadvantage of bypassing the preselector is increased LO emission levels at the front panel input port.

Image responses are separated from the real signal by twice the 1st IF. For IF Paths of 10 MHz and 25 MHz, the 1st IF is 322.5 MHz, so the image response and the real signal will be separated by 645 MHz. The 1st IF will be different for other IF Path settings. When viewing a real signal and its corresponding image response in internal mixing, the image response will be to the left of the real signal.

Also, the image response and the real signal typically have the same amplitude and exhibit the same shape factor.

However, if Option FS1, Fast Sweep Capability, is enabled, the image response in the Swept SA measurement will appear lower in amplitude and have a much wider shape factor compared to the real signal.

Key Path	AMPTD Y Scale, μW Path Control
Example	:POW:MW:PATH MPB
Dependencies	Key is blanked if current mode does not support it. Key is grayed out if mode supports it but current measurement does not support it. Key is blank unless Option MPB is present and licensed. If SCPI command sent when MPB not present, error -241, "Hardware missing; Option not installed" is generated.
Readback Text	μW Preselector Bypass
Initial S/W Revision	A.04.00

Remote Command	[:SENSe] :POWer [:RF] :MW:PRESelector [:STATe] ON OFF 0 1 [:SENSe] :POWer [:RF] :MW:PRESelector [:STATe] ?
-----------------------	---

Example	:POW:MW:PRES OFF Bypasses the microwave preselector
Notes	The ON parameter sets the STD path (:POW:MW:PATH STD) The OFF parameter sets path MPB (:POW:MW:PATH MPB)
Preset	ON

Internal Preamp

Accesses a menu of keys that control the internal preamps. Turning on the preamp gives a better noise figure, but a poorer TOI to noise floor dynamic range. You can optimize this setting for your particular measurement.

The instrument takes the preamp gain into account as it sweeps. If you sweep outside of the range of the preamp the instrument will also account for that. The displayed result will always reflect the correct gain.

For some measurements, when the preamp is on and any part of the displayed frequency range is below the lowest frequency for which the preamp has specifications, a warning condition message appears in the status line. For example, for a preamp with a 9 kHz lowest specified frequency: "Preamp: Accy unspec'd below 9 kHz".

Key Path	AMPTD Y Scale
Scope	Meas Global
Remote Command	[:SENSe] :POWer [:RF] :GAIN [:STATe] OFF ON 0 1 [:SENSe] :POWer [:RF] :GAIN [:STATe] ?
Dependencies	Preamp is not available on all hardware platforms. If the preamp is not present or is unlicensed, the key is not shown. The preamp is not available when the electronic/soft attenuator is enabled.
Couplings	The act of connecting the U7227A USB Preamplifier to one of the analyzer's USB ports will cause the Internal Preamp to be switched on. When this happens an informational message will be generated: "Internal Preamp turned on for optimal operation with USB Preamp." Note that if the Internal Preamp was already on, there will be no change to the setting, but if it was Off it will be switched On, to Full Range. Note that this same action occurs when the SA mode is selected while the USB Preamp is connected to one of the analyzer's USB ports, if it is the first time that the SA mode has run since powerup, or if the last time the SA mode was running the USB Preamp was NOT connected. Subsequently disconnecting the USB Preamp from USB does not change the Internal Preamp setting nor restore the previous setting.
Preset	OFF
State Saved	Saved in instrument state
Initial S/W Revision	Prior to A.02.00
Modified at S/W Revision	A.14.00

Key Path	AMPTD Y Scale, Internal Preamp
Scope	Meas Global
Remote Command	<code>[:SENSe] :POWer [:RF] :GAIN:BAND LOW FULL</code> <code>[:SENSe] :POWer [:RF] :GAIN:BAND?</code>
Dependencies	Preamp is not available on all hardware platforms. If the preamp is not present or is unlicensed, the key is not shown. If a POW:GAIN:BAND FULL command is sent when a low band preamp is available, the preamp band parameter is to LOW instead of FULL, and an "Option not installed" message is generated.
Preset	LOW
State Saved	Saved in instrument state
Initial S/W Revision	Prior to A.02.00

Off

Turns the internal preamp off

Key Path	AMPTD Y Scale, Internal Preamp
Example	<code>:POW:GAIN OFF</code>
Readback	Off
Initial S/W Revision	Prior to A.02.00

Low Band

Sets the internal preamp to use only the low band.

The frequency range of the installed (optional) low-band preamp is displayed in square brackets on the Low Band key label.

Key Path	AMPTD Y Scale, Internal Preamp
Example	<code>:POW:GAIN ON</code> <code>:POW:GAIN:BAND LOW</code>
Readback	Low Band
Initial S/W Revision	Prior to A.02.00

Full Range

Sets the internal preamp to use its full range. The low band (0–3.6 GHz or 0–3GHz, depending on the model) is supplied by the low band preamp and the frequencies above low band are supplied by the high band preamp.

The frequency range of the installed (optional) preamp is displayed in square brackets on the Full Range key label. If the high band option is not installed the Full Range key does not appear.

Key Path	AMPTD Y Scale, Internal Preamp
Example	:POW:GAIN ON :POW:GAIN:BAND FULL
Readback	Full Range
Initial S/W Revision	Prior to A.02.00

Auto Scaling

Toggles the Auto Scaling function between On and Off.

Key Path	AMPTD Y Scale
Mode	SA, WCDMA, C2K, WIMAX OFDMA, TD-SCDMA, DVB-T/H, LTE, LTETDD, WLAN, MSR, LTEAFDD, LTEATDD
Remote Command	:DISPlay:SPURious:VIEW[1]:WINDow[1]:TRACe:Y[:SCALe]:COUPle 0 1 OFF ON :DISPlay:SPURious:VIEW[1]:WINDow[1]:TRACe:Y[:SCALe]:COUPle?
Example	DISP:SPUR:VIEW:WIND:TRAC:Y:COUP OFF DISP:SPUR:VIEW:WIND:TRAC:Y:COUP?
Couplings	When Auto Scaling is On and the Restart front-panel key is pressed, this function automatically determines the scale per division and reference values based on the measurement results. When you set a value to either Scale/Div or Ref Value manually, Auto Scaling automatically changes to Off. When the Y Auto Scaling is off, the measurement uses the current reference level settings. When the Y Auto Scaling is on, the analyzer automatically sets the reference level such that the absolute limit is positioned two divisions down from the top of the display. This is the most useful setting when searching for spurs. The algorithm used for determining the ref level is Ref Level = Absolute Limit + (2 * Scale/Div). All other reference level settings are left as the current base instrument settings.
Preset	1
State Saved	Saved in instrument state.
Range	On Off
Backwards Compatibility SCPI	[:SENSe] : SPURious : POWer [:RF] : RANGe : AUTO
Initial S/W Revision	Prior to A.02.00
Modified at S/W Revision	A.03.00

Auto Couple

The Auto Couple feature provides a quick and convenient way to automatically couple multiple instrument settings. This helps ensure accurate measurements and optimum dynamic range. When the Auto Couple feature is activated, either from the front panel or remotely, all parameters of the current measurement that have an Auto/Manual mode are set to Auto mode and all measurement settings dependent on (or coupled to) the Auto/Man parameters are automatically adjusted for optimal performance.

However, the Auto Couple key actions are confined to the current measurement only. It does not affect other measurements in the mode, and it does not affect markers, marker functions, or trace or display attributes.

See ["More Information" on page 1240](#)

Key Path	Front-panel key
Remote Command	:COUPLe ALL NONE
Example	:COUP ALL
Notes	:COUPLe ALL puts all Auto/Man parameters in Auto mode (equivalent to pressing the Auto Couple key). :COUPLE NONE puts all Auto/Man parameters in manual mode. It decouples all the coupled instrument parameters and is not recommended for making measurements.
Initial S/W Revision	Prior to A.02.00

More Information

There are two types of functions that have Auto/Manual modes.

Auto/Man Active Function keys

An Auto/Man toggle key controls the binary state associated with an instrument parameter by toggling between Auto (where the parameter is automatically coupled to the other parameters it is dependent upon) and Man (where the parameter is controlled independent of the other parameters), as well as making the parameter the active function. The current mode is indicated on the softkey with either Auto or Man underlined as illustrated below.



Auto/Man 1-of-N keys

An Auto/Man 1-of-N key allows you to manually pick from a list of parameter values, or place the function in Auto, in which case the value is automatically selected (and indicated) as shown below. If in Auto, Auto is underlined on the calling key. If in manual operation, manual is indicated on the calling key. But the calling key does not actually toggle the function, it simply opens the menu.

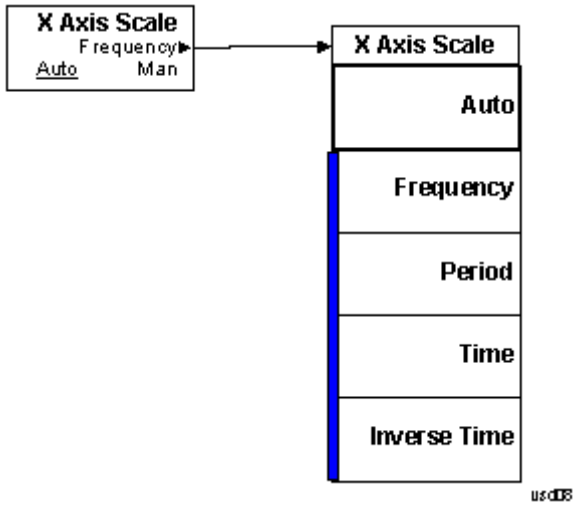

BW

BW is unavailable in the Spurious Emissions measurement. When pressed, this key displays a blank menu.

Key Path	Front-panel key
Initial S/W Revision	Prior to A.02.00

Cont (Continuous Measurement/Sweep)

Sets the analyzer for Continuous measurement operation. The single/continuous state is Meas Global so the setting will affect all measurements. If you are Paused, pressing Cont does a Resume.

Key Path	Front-panel key
Remote Command	:INITiate:CONTinuous OFF ON 0 1 :INITiate:CONTinuous?
Example	:INIT:CONT 0 puts analyzer in Single measurement operation. :INIT:CONT 1 puts analyzer in Continuous measurement operation
Preset	ON (Note that SYST:PRESet sets INIT:CONT to ON but *RST sets INIT:CONT to OFF)
State Saved	Saved in instrument state
Backwards Compatibility Notes	For Spectrum Analysis mode in ESA and PSA, there is no Cont hardkey, instead there is a Sweep Single/Cont key. In these analyzers, switching the Sweep Single/Cont key from Single to Cont restarts averages (displayed average count reset to 1), but does not restart Max Hold and Min Hold. The X-Series has Single and Cont keys in place of the SweepSingleCont key. In the X-Series, if in single measurement, the Cont key (and INIT:CONT ON) switches to continuous measurement, but never restarts a measurement and never resets a sweep.
Initial S/W Revision	Prior to A.02.00

In Swept SA Measurement (Spectrum Analysis Mode):

The analyzer takes repetitive sweeps, averages, measurements, etc., when in Continuous mode. When the average count reaches the Average/Hold Number the count stops incrementing, but the analyzer keeps sweeping. See the Trace/Detector section for the averaging formula used both before and after the Average/Hold Number is reached. The trigger condition must be met prior to each sweep. The type of trace processing for multiple sweeps, is set under the Trace/Detector key, with choices of Trace Average, Max Hold, or Min Hold.

In Other Measurements/Modes:

With Avg/Hold Num (in the Meas Setup menu) set to Off or set to On with a value of 1, a sweep is taken after the trigger condition is met; and the analyzer continues to take new sweeps after the current sweep has completed and the trigger condition is again met. However, with Avg/Hold Num set to On with a value >1, multiple sweeps (data acquisitions) are taken for the measurement. The trigger condition must be met prior to each sweep. The sweep is not stopped when the average count k equals the number N set for Avg/Hold Num is reached, but the number k stops incrementing. A measurement average usually applies to all traces, marker results, and numeric results. But sometimes it only applies to the numeric results.

If the analyzer is in Single measurement, pressing the Cont key does not change k and does not cause the sweep to be reset; the only action is to put the analyzer into Continuous measurement operation.

If it is already in continuous sweep:

the INIT:CONT 1 command has no effect

12 Spurious Emissions Measurement
Cont (Continuous Measurement/Sweep)

the INIT:CONT 0 command will place the analyzer in Single Sweep but will have no effect on the current sequence until $k = N$, at which point the current sequence will stop and the instrument will go to the idle state.

File

See "File" on page 348

FREQ Channel

Accesses a menu of keys that allow you to control the Frequency and Channel parameters of the instrument.

Some features in the Frequency menu are the same for all measurements – they do not change as you change measurements. Settings like these are called “Meas Global” and are unaffected by Meas Preset. For example, the Center Freq setting is the same for all measurements - it does not change as you change measurements.

Key Path	Front-panel key
Initial S/W Revision	Prior to A.02.00

Center Freq

Sets the frequency that corresponds to the horizontal center of the graticule (when frequency Scale Type is set to linear). While adjusting the Center Frequency the Span is held constant, which means that both Start Frequency and Stop Frequency will change.

Pressing Center Freq also sets the frequency entry mode to Center/Span. In Center/Span mode, the center frequency and span values are displayed below the graticule, and the default active function in the Frequency menu is Center Freq.

The center frequency setting is the same for all measurements within a mode, that is, it is Meas Global. Some modes are also able to share a Mode Global center frequency value. If this is the case, the Mode will have a Global Settings key in its Mode Setup menu.

The Center Freq function sets (and queries) the Center Frequency for the currently selected input. If your analyzer has multiple inputs, and you select another input, the Center Freq changes to the value for that input. SCPI commands are available to directly set the Center Freq for a specific input.

Center Freq is remembered as you go from input to input. Thus you can set a Center Freq of 10 GHz with the RF Input selected, change to BBIQ and set a Center Freq of 20 MHz, then switch to External Mixing and set a Center Freq of 60 GHz, and when you go back to the RF Input the Center Freq will go back to 10 GHz; back to BBIQ and it is 20 MHz; back to External Mixing and it is 60 GHz.

See ["RF Center Freq" on page 1249](#)

See [Ext Mix Center Freq](#)

See ["I/Q Center Freq" on page 1251](#)

See ["Center Frequency Presets" on page 1247](#)

Key Path	FREQ Channel
Scope	Meas Global
Remote Command	<code>[:SENSe] :FREQuency:CENTer <freq></code> <code>[:SENSe] :FREQuency:CENTer?</code>

Example	FREQ:CENT 50 MHz FREQ:CENT UP changes the center frequency to 150 MHz if you use FREQ:CENT:STEP 100 MHz to set the center frequency step size to 100 MHz FREQ:CENT?
Notes	This command sets either the RF or I/Q Center Frequency depending on the selected input. For RF input it is equivalent to FREQ:RF:CENT For I/Q input it is equivalent to FREQ:IQ:CENT Preset and Max values are dependent on Hardware Options (5xx) If no terminator (e.g. MHz) is sent the terminator Hz is used. If a terminator with unit other than Frequency is used, an invalid suffix error message is generated.
Dependencies	The Center Frequency can be limited by Start or Stop Freq limits, if the Span is so large that Start or Stop reach their limit.
Couplings	When operating in “swept span”, any value of the Center Frequency or Span that is within the frequency range of the analyzer is allowed when the value is being set through the front panel numeric key pad or the SCPI command. The other parameter is forced to a different value if needed, to keep the Start and the Stop Frequencies within the analyzer’s frequency range
Preset	Depends on instrument maximum frequency, mode, measurement, and selected input. See "Center Frequency Presets" on page 1247 and "RF Center Freq" on page 1249 and Ext Mix Center Freq and "I/Q Center Freq" on page 1251 .
State Saved	Saved in instrument state
Min	Depends on instrument maximum frequency, mode, measurement, and selected input.. See "Center Frequency Presets" on page 1247 and "RF Center Freq" on page 1249 and "I/Q Center Freq" on page 1251 .
Max	Depends on instrument maximum frequency, mode, measurement, and selected input.. See "Center Frequency Presets" on page 1247 and "RF Center Freq" on page 1249 and "I/Q Center Freq" on page 1251 .
Default Unit	Hz
Status Bits/OPC	Non-overlapped
Dependencies	
Initial S/W Revision	Prior to A.02.00

Center Frequency Presets

The following table provides the Center Frequency Presets for the Spectrum Analyzer mode, and the Max Freq, for the various frequency options:

Freq Option	CF after Mode Preset	Stop Freq after Mode Preset	Max Freq (can't tune)

12 Spurious Emissions Measurement
FREQ Channel

			above)
503 (all but N9000A)	1.805 GHz	3.6 GHz	3.7 GHz
503 (N9000A)	1.505 GHz	3.0 GHz	3.08 GHz
507 (all but N9000A)	3.505 GHz	7.0 GHz	7.1 GHz
507 (N9000A)	3.755 GHz	7.5 GHz	7.58 GHz
508 (all but N9038A)	1.805 GHz	3.6 GHz	8.5 GHz
508 (N9038A)	4.205 GHz	8.4 GHz	8.5 GHz
513	6.805 GHz	13.6 GHz	13.8 GHz
526 (all but N9000A and N9038A)	13.255 GHz	26.5 GHz	27.0 GHz
526 (N9000A)	13.255 GHz	26.5 GHz	26.55 GHz
526 (N9038A)	1.805 GHz	3.6 GHz	27.0 GHz
532	16.005 GHz	32.0 GHz	32.5 GHz
543	21.505 GHz	43.0 GHz	TBD
544	22.005 GHz	44.0 GHz	44.5 GHz
550	25.005 GHz	50.0 GHz	51 GHz

Input 2:

Model	CF after Mode Preset	Stop Freq after Mode Preset	Max Freq (can't tune above)
N9000A opt C75	0.7505GHz	1.5 GHz	1.58 GHz
N9038A	505 MHz	1 GHz	1.000025 GHz

Tracking Generator Frequency Limits (N9000A only):

Tracking Generator Option	Min Freq (clips to this freq when turn TG on and	If above this Freq, Stop Freq clipped to this Freq when	Max Freq (can't tune above) while TG

	can't tune below while TG on)	TG turned on	on
T03	9 kHz	3.0 GHz	3.08 GHz
T06	9 kHz	6.0 GHz	6.05 GHz

The following table shows the Center Frequency Presets for modes other than Spectrum Analyzer:

Mode	CF Preset for RF
WCDMA	1 GHz
WIMAXOFDMA,	1 GHz
BASIC	1 GHz
ADEMOD	1 GHz
VSA	1 GHz
TDSCDMA	1 GHz
PNOISE	1 GHz
LTE	1 GHz
LTETDD	1 GHz
MSR	1 GHz
GSM	935.2 MHz
NFIGURE	1.505 GHz

RF Center Freq

SCPI command for specifying the RF Center Frequency. This command will set the Center Frequency to be used when the RF input is selected, even if the RF input is not the input that is selected at the time the command is sent. Note that the Center Freq function in the Frequency menu on the front panel always applies to the currently selected input.

Scope	Meas Global
Remote Command	<code>[:SENSe] :FREQuency:RF:CENTer <freq></code> <code>[:SENSe] :FREQuency:RF:CENTer?</code>
Example	FREQ:RF:CENT 30 MHz
Notes	This command is the same in all modes, but the parameter is Measurement Global. So the value is independent in each mode and common across all the measurements in the mode.
Dependencies	If the electronic/soft attenuator is enabled, any attempt to set Center Frequency such that the Stop Frequency would be >3.6 GHz fails and results in an advisory message. If the equivalent SCPI command is sent, this same message is generated as part of a “-221, Settings conflict” warning. If Source Mode is set to Tracking, and the Max or Min Center Freq is therefore limited by the limits of the source, a warning message is generated, “Data out of range;clipped to source max/min” if these limits are exceeded. Note that for an external source, these limits can be affected by the settings of

	Source Numerator, Source Denominator and Power Sweep.
Preset	See table above
State Saved	Saved in instrument state.
Min	-79.999995 MHz, unless Source Mode is set to Tracking, in which case it is limited by the minimum frequency of the Source
Max	See table above. Basically instrument maximum frequency – 5 Hz. Note that, if the Source Mode is set to Tracking, the effective instrument maximum frequency may be limited by the source maximum frequency. If the knob or step keys are being used, also depends on the value of the other three interdependent parameters Span, Start Frequency and Stop Frequency
Initial S/W Revision	Prior to A.02.00
Modified at S/W Revision	A.03.00

Ext Mix Center Freq

SCPI command for specifying the External Mixer Center Frequency. This command will set the Center Frequency to be used when the External Mixer is selected, even if the External Mixer input is not the input which is selected at the time the command is sent. Note that the Center Freq function in the Frequency menu on the front panel always applies to the currently selected input.

Scope	Meas Global
Remote Command	<code>[:SENSe] :FREQuency:EMIXer:CENTer <freq></code> <code>[:SENSe] :FREQuency:EMIXer:CENTer?</code>
Example	<code>:FREQ:EMIX:CENT 60 GHz</code> <code>:FREQ:EMIX:CENT?</code>
Notes	This command is the same in all modes, but the parameter is Measurement Global. So the value is independent in each mode and common across all the measurements in the mode.
Couplings	When returning to External Mixing after having been switched to one of the other inputs (e.g., RF), you will come back into the settings that you had when you left External Mixing. So you will come back to the band you were in with the Center Frequency that you had. However, Span is not an input-dependent parameter, therefore you will bring the span over from the other input. Therefore, the analyzer comes back with the span from the previous input, limited as necessary by the current mixer setup.
Preset	When a Mode Preset is performed while in External Mixing, the Start frequency of the current Mode is set to the nominal Min Freq of the lowest harmonic range in the Harmonic Table for the current mixer setup. Similarly, the Stop frequency of the current Mode is set to the nominal Max Freq of the highest harmonic range in the Harmonic Table. The Center Freq thus presets to the point arithmetically equidistant from these two frequencies. If the current measurement has a limited Span available to it, and cannot achieve the Span shown in the table (Span=Stop Freq – Start Freq), the analyzer uses the maximum Span the measurement allows, and still sets the Center Freq to the midpoint of the Start and Stop Freq values in the Harmonic Table.

	<p>When Restore Input/Output Defaults is performed, the mixer presets to the 11970A, whose Start and Stop frequencies are 26.5 and 40 GHz respectively. The center of these two frequencies is 33.25 GHz.</p> <p>Therefore, after a Restore Input/Output Defaults, if you go into External Mixing and do a Mode Preset while in the Spectrum Analyzer Mode, the resulting Center Freq is 33.25 GHz.</p>
State Saved	Saved in instrument state.
Min	The minimum frequency in the currently selected mixer band + 5 Hz
Max	The maximum frequency in the currently selected mixer band – 5 Hz If the knob or step keys are being used, also depends on the value of the other three interdependent parameters Span, Start Frequency and Stop Frequency
Initial S/W Revision	A.08.01

I/Q Center Freq

SCPI command for specifying the I/Q Center Frequency. This command will set the Center Frequency to be used when the I/Q input is selected, even if the I/Q input is not the input which is selected at the time the command is sent. Note that the Center Freq function in the Frequency menu on the front panel always applies to the currently selected input.

Scope	Meas Global
Remote Command	[:SENSe]:FREQuency:IQ:CENTer <freq> [:SENSe]:FREQuency:IQ:CENTer?
Example	FREQ:IQ:CENT: 30 MHz
Notes	This command is the same in all modes, but the parameter is Measurement Global. So the value is independent in each mode and common across all the measurements in the mode.
Preset	0 Hz
State Saved	Saved in instrument state.
Min	-40.049995 MHz
Max	40.049995 MHz
Initial S/W Revision	Prior to A.02.00

CF Step

Changes the step size for the center frequency and start and stop frequency functions. Once a step size has been selected and the center frequency function is active, the step keys (and the UP|DOWN parameters for Center Frequency from remote commands) change the center frequency by the step-size value. The step size function is useful for finding harmonics and sidebands beyond the current frequency span of the analyzer.

Note that the start and stop frequencies also step by the CF Step value.

Key Path	FREQ Channel
Remote Command	<pre>[:SENSe] :FREQuency:CENTer:STEP [:INCRement] <freq> [:SENSe] :FREQuency:CENTer:STEP [:INCRement] ? [:SENSe] :FREQuency:CENTer:STEP:AUTO OFF ON 0 1 [:SENSe] :FREQuency:CENTer:STEP:AUTO?</pre>
Example	<pre>FREQ:CENT:STEP:AUTO ON FREQ:CENT:STEP 500 MHz FREQ:CENT UP increases the current center frequency value by 500 MHz FREQ:CENT:STEP? FREQ:CENT:STEP:AUTO?</pre>
Notes	Preset and Max values are depending on Hardware Options (503, 507, 508, 513, 526)
Notes	Preset and Max values are dependent on Hardware Options (5xx)
Dependencies	Freq Offset is not available in External Mixing. In this case the Freq Offset key is grayed out and shows a value of zero. It will once again be available, and show the previously set value, when you return to the RF Input.
Dependencies	Span, RBW, Center frequency If the electronic/soft attenuator is enabled, any attempt to change the value of the center frequency >3.6 GHz by pressing the Up-arrow key, fails and results in an advisory message. If the equivalent SCPI command is sent, this same message is generated as part of a “-221, Settings conflict” warning.
Couplings	When auto-coupled in a non-zero span, the center frequency step size is set to 10% of the span. When auto-coupled in zero span, the center frequency step size is set to the equivalent -3 dB RBW value.
Preset	Auto ADEM0D: 1 MHz ON
State Saved	Saved in instrument state
Min	– (the maximum frequency of the instrument). That is, 27 GHz max freq instrument has a CF step range of +/- 27 GHz. Note that this is the maximum frequency given the current settings of the instrument, so in External Mixing, for example, it is the maximum frequency of the current mixer band.
Max	The maximum frequency of the instrument. That is, 27 GHz max freq instrument has a CF step range of +/- 27 GHz. Note that this is the maximum frequency given the current settings of the instrument, so in External Mixing, for example, it is the maximum frequency of the current mixer band.
Default Unit	Hz
Status Bits/OPC dependencies	non-overlapped
Initial S/W Revision	Prior to A.02.00
Modified at S/W Revision	A.03.00

Input/Output

See "Input/Output" on page 194

Marker

Displays the menu keys that enable you to select, set up and control the markers for the current measurement.

Key Path	Front-panel key
Initial S/W Revision	Prior to A.02.00

Select Marker

Displays 12 markers available for selection.

Key Path	Marker
Initial S/W Revision	Prior to A.02.00

Marker Type

Sets the marker control mode to Normal, Delta and Off. Normal enables you to activate the selected marker to read the power level and time. Delta enables you to read the differences in the power levels and time scales between the selected marker and the next marker. Off enables you to turn off the selected marker.

All interactions and dependencies detailed under the key description are enforced when the remote command is sent.

Key Path	Marker
Mode	SA, WCDMA, C2K, WIMAX OFDMA, TD-SCDMA, 1xEV-DO, DVB-T/H, LTE, LTE-TDD, WLAN, MSR, LTE-AFDD, LTE-TDD
Remote Command	:CALCulate:SPURious:MARKer[1] 2 ... 12:MODE POSITION DELTa OFF :CALCulate:SPURious:MARKer[1] 2 ... 12:MODE?
Example	CALC:SPUR:MARK:MODE POS CALC:SPUR:MARK:MODE?

Notes

If the selected marker is Off, pressing Marker sets it to Normal and places it at the center of the screen on the trace determined by the Marker Trace rules. At the same time, Marker X Axis Value appears on the Active Function area.

Default Active Function: the active function for the selected marker's current control mode. If the current control mode is Off, there is no active function and the active function is turned off.

Active Function Display: the marker X axis value entered in the active function area will display the marker value to its full entered precision.

You must be in the cdma2000 mode, 1xEV-DO mode, TD-SCDMA mode, W-CDMA mode, DVB-T/H mode, GSM/EDGE mode, LTE mode, LTE TDD mode, WLAN mode, MSR, LTE-Advanced FDD/TDD mode or WiMAX mode to use this command. Use INSTRument:SElect to set the mode.

Preset	=OFF
State Saved	Saved in instrument state.
Range	Normal Delta Off
Initial S/W Revision	Prior to A.02.00
Modified at S/W Revision	A.03.00

Properties

Accesses the Properties menu to set certain properties of the selected marker.

Key Path	Marker
Initial S/W Revision	Prior to A.02.00

Select Marker

Displays 12 markers available for selection.

Key Path	Marker
Initial S/W Revision	Prior to A.02.00

Relative To

Selects the marker the selected marker will be relative to (its reference marker).

Every marker has another marker to which it is relative. This marker is referred to as the "reference marker" for that marker. This attribute is set by the Marker, Properties, Relative To key. The marker must be a Delta marker to make this attribute relevant. If it is a Delta marker, the reference marker determines how the marker is controlled and how its value is displayed. A marker cannot be relative to itself.

Key Path	Marker, Properties
Mode	SA, WCDMA, C2K, WIMAX OFDMA, TD-SCDMA, 1xEV-DO, DVB-T/H, LTE, LTE-TDD, WLAN, MSR, LTEAFDD, LTEATDD
Remote Command	:CALCulate:SPURious:MARKer[1] 2 ... 12:REFerence <integer> :CALCulate:SPURious:MARKer[1] 2 ... 12:REFerence?
Example	CALC:SPUR:MARK3:REF 5 CALC:SPUR:MARK:REF?
Notes	A marker cannot be relative to itself so that choice is grayed out, and if sent from SCPI generates error -221: "Settings conflict; marker cannot be relative to itself." When queried a single value will be returned (the specified marker numbers relative marker). You must be in the Spectrum Analysis mode, GSM mode, LTE mode, LTE TDD mode, WLAN mode, MSR, LTE-Advanced FDD/TDD mode or WiMAX mode or TD-SCDMA mode to use this command.

	Use INSTRument:SElect to set the mode.
Preset	2 3 4 5 6 7 8 9 10 11 12 1
State Saved	Saved in instrument state.
Min	1
Max	12
Initial S/W Revision	Prior to A.02.00
Modified at S/W Revision	A.03.00

Couple Markers

When this function is true, moving any marker causes an equal X Axis movement of every other marker which is not Off. By “equal X Axis movement” we mean that we preserve the difference between each marker’s X Axis value (in the fundamental x-axis units of the trace that marker is on) and the X Axis value of the marker being moved (in the same fundamental x-axis units).

Key Path	Marker
Mode	SA, WCDMA, C2K, WIMAX OFDMA, TD-SCDMA, 1xEV-DO, DVB-T/H, LTE, LTETDD, WLAN, MSR, LTEAFDD, LTEATDD
Remote Command	:CALCulate:SPURious:MARKer:COUPle[:STATe] ON OFF 1 0 :CALCulate:SPURious:MARKer:COUPle[:STATe]?
Example	CALC:SPUR:MARK:COUP ON CALC:SPUR:MARK:COUP?
Preset	OFF
State Saved	Saved in instrument state.
Range	On Off
Initial S/W Revision	Prior to A.02.00
Modified at S/W Revision	A.03.00

All Markers Off

Turns off all markers.

Key Path	Marker
Mode	SA, WCDMA, C2K, WIMAX OFDMA, TD-SCDMA, 1xEV-DO, DVB-T/H, LTE, LTETDD, WLAN, MSR, LTEAFDD, LTEATDD
Remote Command	:CALCulate:SPURious:MARKer:AOFF
Example	CALC:SPUR:MARK:AOFF
Initial S/W Revision	Prior to A.02.00
Modified at S/W Revision	A.03.00

Marker X Axis Value (Remote Command only)

Sets the Marker X Axis value in the current marker X Axis Scale unit. It has no effect if the control mode is Off, but is the SCPI equivalent of entering an X value if the control mode is Normal or Delta.

Mode	SA, WCDMA, C2K, WIMAX OFDMA, TD-SCDMA, DVB-T/H, LTE, LTE-TDD, WLAN, MSR, LTEAFDD, LTEATDD
Remote Command	:CALCulate:SPURious:MARKer[1] 2 ... 12:X <freq> :CALCulate:SPURious:MARKer[1] 2 ... 12:X?
Example	CALC:SPUR:MARK2:X 25 kHz CALC:SPUR:MARK3:X?
Notes	If no suffix is sent it will use the fundamental units for the current marker X Axis Scale. If a suffix is sent that does not match the current marker X Axis Scale unit, an error "Invalid suffix" will be generated. The query returns the absolute X Axis marker value if the control mode is Normal, or the offset from the reference marker if the control mode is Delta. The query is returned in the fundamental units for the current marker X Axis scale: Hz for Frequency and Inverse Time, seconds for Period and Time. If the marker is Off, the response is not a number.
Preset	1 GHz
State Saved	No
Min	-9.9E+37
Max	9.9E+37
Initial S/W Revision	Prior to A.02.00
Modified at S/W Revision	A.03.00

Marker X Axis Position (Remote Command only)

Sets the Marker X position in trace points. It has no effect if the control mode is Off, but is the SCPI equivalent of entering a value if the control mode is Normal or Delta - except in trace points rather than X Axis Scale units. The entered value is immediately translated into the current X Axis Scale units for setting the value of the marker.

Mode	SA, WCDMA, C2K, WIMAX OFDMA, TD-SCDMA, 1xEV-DO, DVB-T/H, LTE, LTE-TDD, WLAN, MSR, LTEAFDD, LTEATDD
Remote Command	:CALCulate:SPURious:MARKer[1] 2 ... 12:X:POSition <integer> :CALCulate:SPURious:MARKer[1] 2 ... 12:X:POSition?
Example	CALC:SPUR:MARK10:X:POS 300 CALC:SPUR:MARK10:X:POS?
Notes	The query returns the absolute X Axis marker value in trace points if the control mode is Normal, or the offset from the reference marker in trace points if the control mode is Delta. The value is returned as a real number, not an integer, corresponding to the translation from X Axis Scale units to trace points. If the marker is Off the response is not a number.
Preset	300

State Saved	No
Min	-9.9E+37
Max	9.9E+37
Initial S/W Revision	Prior to A.02.00
Modified at S/W Revision	A.03.00

Marker Y Axis Value (Remote Command only)

Returns the marker Y Axis value in the current marker Y Axis unit.

Mode	SA, WCDMA, C2K, WIMAX OFDMA, TD-SCDMA, 1xEV-DO, DVB-T/H, LTE, LTE-TDD, WLAN, MSR, LTEAFDD, LTEATDD
Remote Command	:CALCulate:SPURious:MARKer[1 2 ... 12:Y?
Example	CALC:SPUR:MARK11:Y?
Notes	If no suffix is sent, it will use the current Y Axis unit. If a suffix is sent that does not have units of absolute amplitude, an error "Invalid suffix" will be generated.
Preset	Depends on Y axis range of selected Trace.
State Saved	No
Initial S/W Revision	Prior to A.02.00
Modified at S/W Revision	A.03.00

Marker Function

There are no 'Marker Functions' supported in Spurious Emissions so this front-panel key displays a blank menu when pressed.

Key Path	Front-panel key
Initial S/W Revision	Prior to A.02.00

Marker To

There is no 'Marker To' functionality supported in Spurious Emissions, so this front-panel key displays a blank menu when pressed.

Key Path	Front-panel key
Initial S/W Revision	Prior to A.02.00

Meas

The information in this section is common to all measurements. For key and remote command information for a specific measurement, refer to the section that describes the measurement of interest.

Measurements available under the Meas key are specific to the current Mode.

When viewing Help for measurements, note the following:

NOTE

Operation for some keys differs between measurements. The information displayed in Help pertains to the current measurement. To see how a key operates in a different measurement, exit Help (press the Cancel Esc key), select the measurement, then reenter Help (press the Help key) and press that key.

Key Path	Front-panel key
Initial S/W Revision	Prior to A.02.00

Remote Measurement Functions

This section contains the following topics:

["Measurement Group of Commands" on page 2214](#)

["Current Measurement Query \(Remote Command Only\)" on page 2216](#)

["Limit Test Current Results \(Remote Command Only\)" on page 2216](#)

["Data Query \(Remote Command Only\)" on page 2216](#)

["Calculate/Compress Trace Data Query \(Remote Command Only\)" on page 2217](#)

["Calculate Peaks of Trace Data \(Remote Command Only\)" on page 2222](#)

["Hardware-Accelerated Fast Power Measurement \(Remote Command Only\)" on page 2223](#)

["Format Data: Numeric Data \(Remote Command Only\)" on page 2237](#)

["Format Data: Byte Order \(Remote Command Only\)" on page 2238](#)

Initial S/W Revision	Prior to A.02.00
----------------------	------------------

Measurement Group of Commands

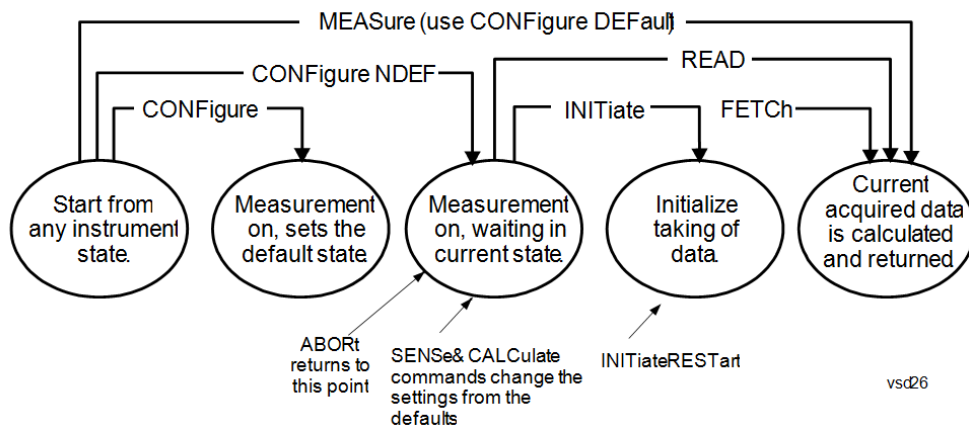

Measure Commands:

:MEASure:<measurement>[n]?

This is a fast single-command way to make a measurement using the factory default instrument settings. These are the settings and units that conform to the Mode Setup settings (e.g. radio standard) that you have currently selected.

- Stops the current measurement (if any) and sets up the instrument for the specified measurement using the factory defaults
- Initiates the data acquisition for the measurement
- Blocks other SCPI communication, waiting until the measurement is complete before returning results.
- If the function does averaging, it is turned on and the number of averages is set to 10.
- After the data is valid it returns the scalar results, or the trace data, for the specified measurement. The type of data returned may be defined by an [n] value that is sent with the command.
- The scalar measurement results will be returned if the optional [n] value is not included, or is set to 1. If the [n] value is set to a value other than 1, the selected trace data results will be returned. See each command for details of what types of scalar results or trace data results are available.
- ASCII is the default format for the data output. (Older versions of Spectrum Analysis and Phase Noise mode measurements only use ASCII.) The binary data formats should be used for handling large blocks of data since they are smaller and faster than the ASCII format. Refer to the FORMat:DATA command for more information.

If you need to change some of the measurement parameters from the factory default settings you can set up the measurement with the CONFigure command. Use the commands in the SENSE:<measurement> and CALCulate:<measurement> subsystems to change the settings. Then you can use the READ? command to initiate the measurement and query the results.

If you need to repeatedly make a given measurement with settings other than the factory defaults, you can use the commands in the SENSE:<measurement> and CALCulate:<measurement> subsystems to set up the measurement. Then use the READ? command to initiate the measurement and query results.

Measurement settings persist if you initiate a different measurement and then return to a previous one. Use READ:<measurement>? if you want to use those persistent settings. If you want to go back to the default settings, use MEASure:<measurement>?.

Configure Commands:

:CONFigure:<measurement>

This command stops the current measurement (if any) and sets up the instrument for the specified measurement using

the factory default instrument settings. It does not initiate the taking of measurement data unless INIT:CONTInuous is ON. If you change any measurement settings after using the CONFigure command, the READ command can be used to initiate a measurement without changing the settings back to their defaults.

In the Swept SA measurement in Spectrum Analyzer mode the CONFigure command also turns the averaging function on and sets the number of averages to 10 for all measurements.

:CONFigure: <measurement>: NDEFault stops the current measurement and changes to the specified measurement. It does not change the settings to the defaults. It does not initiate the taking of measurement data unless INIT:CONTInuous is ON.

The CONFigure? query returns the current measurement name.

The CONFigure:CATalog? query returns a quoted string of all licensed measurement names in the current mode. For example, "SAN, CHP, OBW, ACP, PST, TXP, SPUR, SEM, LIST".

Fetch Commands:

:FETCh:<measurement>[n]?

This command puts selected data from the most recent measurement into the output buffer. Use FETCh if you have already made a good measurement and you want to return several types of data (different [n] values, for example, both scalars and trace data) from a single measurement. FETCh saves you the time of re-making the measurement. You can only FETCh results from the measurement that is currently active, it will not change to a different measurement. An error message is reported if a measurement other than the current one is specified.

If you need to get new measurement data, use the READ command, which is equivalent to an INITiate followed by a FETCh.

The scalar measurement results will be returned if the optional [n] value is not included, or is set to 1. If the [n] value is set to a value other than 1, the selected trace data results will be returned. See each command for details of what types of scalar results or trace data results are available. The binary data formats should be used for handling large blocks of data since they are smaller and transfer faster than the ASCII format. (FORMat:DATA)

FETCh may be used to return results other than those specified with the original READ or MEASure command that you sent.

INITiate Commands:

:INITiate:<measurement>

This command is not available for measurements in all the instrument modes:

- Initiates a trigger cycle for the specified measurement, but does not output any data. You must then use the FETCh<meas> command to return data. If a measurement other than the current one is specified, the instrument will switch to that measurement and then initiate it.
- For example, suppose you have previously initiated the ACP measurement, but now you are running the channel power measurement. If you send INIT:ACP? it will change from channel power to ACP and will initiate an ACP measurement.
- Does not change any of the measurement settings. For example, if you have previously started the ACP measurement and you send INIT:ACP? it will initiate a new ACP measurement using the same instrument settings as the last time ACP was run.
- If your selected measurement is currently active (in the idle state) it triggers the measurement, assuming the trigger conditions are met. Then it completes one trigger cycle. Depending upon the measurement and the number of averages, there may be multiple data acquisitions, with multiple trigger events, for one full trigger cycle. It also holds off additional commands on GPIB until the acquisition is complete.

READ Commands:

:READ:<measurement>[n]?

- Does not preset the measurement to the factory default settings. For example, if you have previously initiated the ACP
-

measurement and you send READ:ACP? it will initiate a new measurement using the same instrument settings.

- Initiates the measurement and puts valid data into the output buffer. If a measurement other than the current one is specified, the instrument will switch to that measurement before it initiates the measurement and returns results.
 - For example, suppose you have previously initiated the ACP measurement, but now you are running the channel power measurement. Then you send READ:ACP? It will change from channel power back to ACP and, using the previous ACP settings, will initiate the measurement and return results.
 - Blocks other SCPI communication, waiting until the measurement is complete before returning the results
 - If the optional [n] value is not included, or is set to 1, the scalar measurement results will be returned. If the [n] value is set to a value other than 1, the selected trace data results will be returned. See each command for details of what types of scalar results or trace data results are available. The binary data formats should be used when handling large blocks of data since they are smaller and faster than the ASCII format. (FORMat:DATA)
-

Initial S/W Revision	Prior to A.02.00
----------------------	------------------

Current Measurement Query (Remote Command Only)

This command returns the name of the measurement that is currently running.

Remote Command	:CONFigure?
-----------------------	-------------

Example	CONF?
----------------	-------

Initial S/W Revision	Prior to A.02.00
----------------------	------------------

Limit Test Current Results (Remote Command Only)

Queries the status of the current measurement limit testing. It returns a 0 if the measured results pass when compared with the current limits. It returns a 1 if the measured results fail any limit tests.

Remote Command	:CALCulate:CLIMits:FAIL?
-----------------------	--------------------------

Example	CALC:CLIM:FAIL? queries the current measurement to see if it fails the defined limits. Returns a 0 or 1: 0 it passes, 1 it fails.
----------------	--

Initial S/W Revision	Prior to A.02.00
----------------------	------------------

Data Query (Remote Command Only)

Returns the designated measurement data for the currently selected measurement and subopcode.

n = any valid subopcode for the current measurement. See the measurement command results table for your current measurement, for information about what data is returned for the subopcodes.

This command uses the data setting specified by the FORMat:BORDER and FORMat:DATA commands and can return real or ASCII data. (See the format command descriptions under Input/Output in the Analyzer Setup section.)

Remote Command	:CALCulate:DATA[n]?
Notes	The return trace depends on the measurement. In CALCulate:<meas>:DATA[n], n is any valid subopcode for the current measurement. It returns the same data as the FETCH:<measurement>? query where <measurement> is the current measurement.
Initial S/W Revision	Prior to A.02.00

Calculate/Compress Trace Data Query (Remote Command Only)

Returns compressed data for the currently selected measurement and sub-opcode [n].

n = any valid sub-opcode for that measurement. See the MEASure:<measurement>? command description of your specific measurement for information on the data that can be returned.

The data is returned in the current Y Axis Unit of the analyzer. The command is used with a sub-opcode <n> (default=1) to specify the trace. With trace queries, it is best if the analyzer is not sweeping during the query. Therefore, it is generally advisable to be in Single Sweep, or Update=Off.

This command is used to compress or decimate a long trace to extract and return only the desired data. A typical example would be to acquire N frames of GSM data and return the mean power of the first burst in each frame. The command can also be used to identify the best curve fit for the data.

Remote Command	:CALCulate:DATA<n>:COMPRESS? BLOCK CFIT MAXimum MINimum MEAN DMEan RMS RMSCubed SAMPLE SDEVIation PPHase [,<soffset> [,<length>[,<roffset>[,<rlimit>]]]]
Example	To query the mean power of a set of GSM bursts: Supply a signal that is a set of GSM bursts. Select the IQ Waveform measurement (in IQ Analyzer Mode). Set the sweep time to acquire at least one burst. Set the triggers such that acquisition happens at a known position relative to a burst. Then query the mean burst levels using, CALC:DATA2:COMP? MEAN, 24e-6, 526e-6 (These parameter values correspond to GSM signals, where 526e-6 is the length of the burst in the slot and you just want 1 burst.)
Notes	The command supports 5 parameters. Note that the last 4 (<soffset>, <length>, <roffset>, <rlimit>) are optional. But these optional parameters must be entered in the specified order. For example, if you want to specify <length>, then you must also specify <soffset>. See details below for a definition of each of these parameters. This command uses the data in the format specified by FORMat:DATA, returning either binary or ASCII data.
Initial S/W Revision	Prior to A.02.00

- BLOCK or block data - returns all the data points from the region of the trace data that you specify. For example, it could be used to return the data points of an input signal over several timeslots, excluding the portions of the trace data that you do not want. (This is x,y pairs for trace data and I,Q pairs for complex data.)

- CFIT or curve fit - applies curve fitting routines to the data. <soffset> and <length> are required to define the data that you want. <roffset> is an optional parameter for the desired order of the curve equation. The query will return the following values: the x-offset (in seconds) and the curve coefficients ((order + 1) values).

MIN, MAX, MEAN, DME, RMS, RMSC, SAMP, SDEV and PPH return one data value for each specified region (or <length>) of trace data, for as many regions as possible until you run out of trace data (using <roffset> to specify regions). Or they return the number of regions you specify (using <rlimit>) ignoring any data beyond that.

- MINimum - returns the minimum data point (y value) for the specified region(s) of trace data. For I/Q trace data, the minimum magnitude of the I/Q pairs is returned.
- MAXimum - returns the maximum data point (y value) for the specified region(s) of trace data. For I/Q trace data, the maximum magnitude of the I/Q pairs is returned.
- MEAN - returns a single value that is the arithmetic mean of the data point values (in dB/ dBm) for the specified region(s) of trace data. For I/Q trace data, the mean of the magnitudes of the I/Q pairs is returned. See the following equations.

NOTE If the original trace data is in dB, this function returns the arithmetic mean of those log values, not log of the mean power which is a more useful value. The mean of the log is the better measurement technique when measuring CW signals in the presence of noise. The mean of the power, expressed in dB, is useful in power measurements such as Channel Power. To achieve the mean of the power, use the RMS option.

Equation 1

Mean Value of Data Points for Specified Region(s)

$$MEAN = \frac{1}{n} \sum_{X_i \in \text{region}(s)} X_i$$

where X_i is a data point value, and n is the number of data points in the specified region(s).

Equation 2

Mean Value of I/Q Data Pairs for Specified Region(s)

$$MEAN = \frac{1}{n} \sum_{X_i \in \text{region}(s)} |X_i|$$

where $|X_i|$ is the magnitude of an I/Q pair, and n is the number of I/Q pairs in the specified region(s).

- DMEan - returns a single value that is the mean power (in dB/ dBm) of the data point values for the specified region(s) of trace data. See the following equation:

Equation 3

DMEan Value of Data Points for Specified Region(s)

$$\text{DME} = 10 \times \log_{10} \left(\frac{1}{n} \sum_{X_i \in \text{region}(s)} 10^{\frac{X_i}{10}} \right)$$

- RMS - returns a single value that is the average power on a root-mean-squared voltage scale (arithmetic rms) of the data point values for the specified region(s) of trace data. See the following equation.

NOTE

For I/Q trace data, the rms of the magnitudes of the I/Q pairs is returned. See the following equation. This function is very useful for I/Q trace data. However, if the original trace data is in dB, this function returns the rms of the log values which is not usually needed.

Equation 4

RMS Value of Data Points for Specified Region(s)

$$\text{RMS} = \sqrt{\frac{1}{n} \sum_{X_i \in \text{region}(s)} X_i^2}$$

where X_i is a data point value, and n is the number of data points in the specified region(s).

Equation 5

RMS Value of I/Q Data Pairs for Specified Region(s)

$$\text{RMS} = \sqrt{\frac{1}{n} \sum_{X_i \in \text{region}(s)} X_i X_i^*}$$

where X_i is the complex value representation of an I/Q pair, X_i^* its conjugate complex number, and n is the number of I/Q pairs in the specified region(s).

Once you have the rms value for a region of trace data (linear or I/Q), you may want to calculate the mean power. You must convert this rms value (peak volts) to power in dBm:

$$10 \times \log[10 \times (\text{rms value})^2]$$

- SAMPLe - returns the first data value (x,y pair) for the specified region(s) of trace data. For I/Q trace data, the first I/Q pair is returned.
- SDEViation - returns a single value that is the arithmetic standard deviation for the data point values for the specified region(s) of trace data. See the following equation.
- For I/Q trace data, the standard deviation of the magnitudes of the I/Q pairs is returned. See the following equation.

Equation 6

Standard Deviation of Data Point Values for Specified Region(s)

$$\text{SDEV} = \sqrt{\frac{1}{n} \sum_{X_i \in \text{region}(s)} (X_i - \bar{X})^2}$$

where X_i is a data point value, \bar{X} is the arithmetic mean of the data point values for the specified region (s), and n is the number of data points in the specified region(s).

$$\text{SDEV} = \sqrt{\frac{1}{n} \sum_{X_i \in \text{region}(s)} (|X_i| - \bar{X})^2}$$

where $|X_i|$ is the magnitude of an I/Q pair, \bar{X} is the mean of the magnitudes for the specified region(s), and n is the number of data points in the specified region(s).

- PPHase - returns the x,y pairs of both rms power (dBm) and arithmetic mean phase (radian) for every specified region and frequency offset (Hz). The number of pairs is defined by the specified number of regions. This parameter can be used for I/Q vector ($n=0$) in Waveform (time domain) measurement and all parameters are specified by data point in PPHase.

The rms power of the specified region may be expressed as:

$$\text{Power} = 10 \times \log [10 \times (\text{RMS I/Q value})] + 10.$$

The RMS I/Q value (peak volts) is:

$$\sqrt{\frac{1}{n} \sum_{X_i \in \text{region}} X_i X_i^*}$$

where X_i is the complex value representation of an I/Q pair, X_i^* its conjugate complex number, and n is the number of I/Q pairs in the specified region.

The arithmetic mean phase of the specified region may be expressed as:

$$\frac{1}{n} \sum_{Y_i \in \text{region}} Y_i$$

where Y_i is the unwrapped phase of I/Q pair with applying frequency correction and n is the number of I/Q pairs in the specified region.

The frequency correction is made by the frequency offset calculated by the arithmetic mean of every specified region's frequency offset. Each frequency offset is calculated by the least square method against the unwrapped phase of I/Q pair.

Sample Trace Data - Constant Envelope

(See below for explanation of variables.)

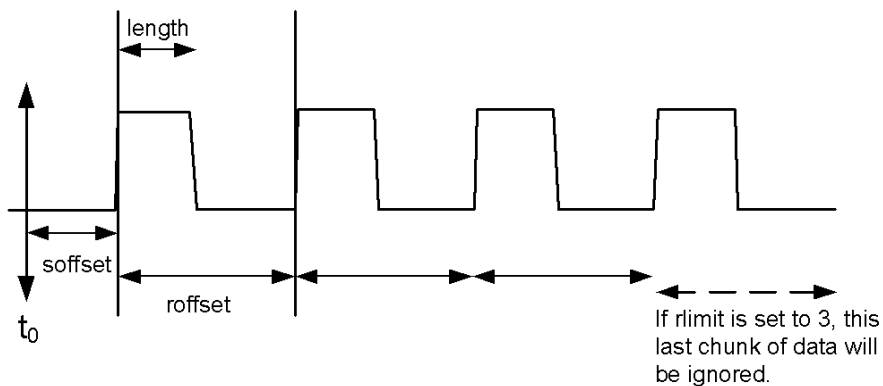

Sample Trace Data - Not Constant Envelope

(See below for explanation of variables.)



<soffset> - start offset is an optional real number. (It is in seconds for time-domain traces, and is a dimensionless index 0 to Npoints - 1, for frequency-domain traces). It specifies the amount of data at the beginning of the trace that will be ignored before the decimation process starts. It is the time or frequency change from the start of the trace to the point where you want to start using the data. The default value is zero.

<length> - is an optional real number. (It is in seconds for time-domain traces, and is a dimensionless index 0 to Npoints - 1, for frequency-domain traces). It defines how much data will be compressed into one value. This parameter has a default value equal to the current trace length.

<roffset> - repeat offset is an optional real number. (It is in seconds for time-domain traces, and is a dimensionless index 0 to Npoints - 1, for frequency-domain traces). It defines the beginning of the next field of trace elements to be compressed. This is relative to the beginning of the previous field. This parameter has a default value equal to the <length> variable. Note that this parameter is used for a completely different purpose when curve fitting (see CFIT above).

<rlimit> - repeat limit is an optional integer. It specifies the number of data items that you want returned. It will ignore any additional items beyond that number. You can use the Start offset and the Repeat limit to pick out exactly what part of the data you want to use. The default value is all the data.

Calculate Peaks of Trace Data (Remote Command Only)

Returns a list of all the peaks for the currently selected measurement and sub-opcode [n]. The peaks must meet the requirements of the peak threshold and excursion values.

n = any valid sub-opcode for the current measurement. See the MEASure:<measurement> command description of your specific measurement for information on the data that can be returned.

The command can only be used with specific sub-opcodes with measurement results that are trace data. Both real and complex traces can be searched, but complex traces are converted to magnitude in dBm. In many measurements the sub-opcode n=0, is the raw trace data which cannot be searched for peaks. And Sub-opcode n=1, is often calculated results values which also cannot be searched for peaks.

This command uses the data setting specified by the FORMat:BORDER and FORMat:DATA commands and can return real or ASCII data. If the format is set to INT,32, it returns REAL,32 data.

The command has four types of parameters:

- Threshold (in dBm)
- Excursion (in dB)
- Sorting order (amplitude, frequency, time)
- Optional in some measurements: Display line use (all, > display line, < display line)

Remote Command	<p>For Swept SA measurement:</p> <pre>:CALCulate:DATA[1] 2 ... 6:PEAKs? <threshold>,<excursion>[,AMPLitude FREQuency TIME[,ALL GTDLine LTDLine]]</pre> <p>For most other measurements:</p> <pre>:CALCulate:DATA[1] 2 ... 6:PEAKs? <threshold>,<excursion>[,AMPLitude FREQuency TIME]</pre>
-----------------------	--

Example	<p>Example for Swept SA measurement in Spectrum Analyzer Mode:</p> <p>CALC:DATA4:PEAK? -40, 10, FREQ, GTDL This will identify the peaks of trace 4 that are above -40 dBm, with excursions of at least 10 dB. The peaks are returned in order of increasing frequency, starting with the lowest frequency. Only the peaks that are above the display line are returned.</p> <p>Query Results 1:</p> <p>With FORMat:DATA REAL, 32 selected, it returns a list of floating-point numbers. The first value in the list is the number of peak points that are in the following list. A peak point consists of two values: a peak amplitude followed by its corresponding frequency (or time).</p> <p>If no peaks are found the peak list will consist of only the number of peaks, (0).</p>
----------------	---

Notes	<p><n> - is the trace that will be used</p> <p><threshold> - is the level below which trace data peaks are ignored. Note that the threshold value is required and is always used as a peak criterion. To effectively disable the threshold criterion for this command, provide a substantially low threshold value such as -200 dBm. Also note that the threshold value used in this command is independent of and has no effect on the threshold value stored under the Peak Criteria menu.</p> <p><excursion> - is the minimum amplitude variation (rise and fall) required for a signal to be identified as peak. Note that the excursion value is required and is always used as a peak criterion. To effectively disable the excursion criterion for this command, provide the minimum value of 0.0 dB. Also note that the excursion value used in this command is independent of and has no effect on the</p>
--------------	---

excursion value stored under the Peak Criteria menu.

Values must be provided for threshold and excursion. The sorting and display line parameters are optional (defaults are AMPLitude and ALL).

Note that there is always a Y-axis value for the display line, regardless of whether the display line state is on or off. It is the current Y-axis value of the display line which is used by this command to determine whether a peak should be reported

Sorting order:

AMPLitude - lists the peaks in order of descending amplitude, with the highest peak first (default if optional parameter not sent)

FREQUency - lists the peaks in order of occurrence, left to right across the x-axis.

TIME - lists the peaks in order of occurrence, left to right across the x-axis.

Peaks vs. Display Line:

ALL - lists all of the peaks found (default if optional parameter not sent).

GTDLine (greater than display line) - lists all of the peaks found above the display line.

LTDLine (less than display line) - lists all of the peaks found below the display line.

Initial S/W Revision	Prior to A.02.00
----------------------	------------------

Hardware-Accelerated Fast Power Measurement (Remote Command Only)

The Fast Power option (FP2) enables very fast channel power measurements for instruments with the prerequisite hardware (DP2 and/or B40). It accomplishes this by performing real-time overlapped FFTs at the hardware layer, using software for basic post-processing before returning the result to the user. The upshot of this approach is improved throughput for user applications that require many sequential power measurements.

The analysis bandwidth of FP2 is limited by the licenses in the instrument, but its maximum overall analysis bandwidth per acquisition is 40 MHz.

FP2 is remote-only, which means the instrument does not switch to any particular mode or measurement. FP2 commands can be sent while another application is in use on the front panel.

Each Fast Power measurement can be predefined using an array index, and up to 1,000 measurements can be stored. In the following documentation, instances of [1,2,...,999] can be substituted with a particular measurement index, e.g. CALC:FPOW:POW1?, CALC:FPOW:POW2?, CALC:FPOW:POW134?. In this way, power measurements can be defined one time in a batch, and then executed multiple times without having to redefine them, similar to “list mode” on other measurements.

In addition to basic channel power measurements, there are a number of other measurement “functions” for each channel, including peak power, peak frequency, and power spectral density. See the Function parameter for more information.

Reset Fast Power Measurement (Remote Command Only)

Resets the measurement configuration to the defaults.

Mode	All
Remote Command	:CALCulate:FPOWer:POWer[1,2,...,999]:RESet
Example	:CALC:FPOW:POW1:RES

Notes	Option FP2 is required.
Initial S/W Revision	A.14.00

Define Fast Power Measurement (Remote Command Only)

Fast Power acquisitions are configured using the DEFine command. This command accepts a comma-delimited string of configuration parameters and their appropriate values, which are all specified in the subsection below.

Mode	All
Remote Command	:CALCulate:FPOWER:POWer[1,2,...,999]:DEFine "configuration string"
Example	:CALC:FPOW:POW1:DEF "CenterFrequency=2e9, AcquisitionTime=0.005"
Notes	See below for a list of measurement variables that can be defined in the configuration string.
Initial S/W Revision	A.14.00

Acquisition Time

Value	Time (s)
Range	0 s to 1 s
Preset	0.001 s
Example	CALC:FPOW:POW1:DEF "AcquisitionTime=0.002"
Notes	The acquisition time parameter sets the time in which the entire spectrum is measured. An increase in the acquisition time yields an improvement in measurement repeatability.
Initial S/W Revision	A.14.00

Center Frequency

Value	Frequency (Hz)
Range	0 Hz to maximum instrument frequency
Preset	1 GHz
Example	CALC:FPOW:POW1:DEF "CenterFrequency=2e9"
Notes	The center frequency parameter sets the frequency in which the measurement is centered around. The OffsetFrequency parameter is calculated relative to the center frequency.
Initial S/W Revision	A.14.00

DC Coupled

Value	Boolean
Range	True (DC Coupled) or False (AC Coupled)
Preset	False
Example	CALC:FPOW:POW1:DEF "DCCoupled=True"
Notes	The DC coupled parameter allows the user to specify whether the DC blocking capacitor is utilized. Set parameter to true when measuring frequencies below 10 MHz.
Initial S/W Revision	A.14.00

DetectorType

Example	CALC:FPOW:POW1:DEF "DetectorType=Peak"
Notes	Option FP2 is required. The detector type parameter allows the user to choose whether a RMS average or peak value is used during the measurement.
Preset	RmsAverage
Range	RmsAverage, Peak
Initial S/W Revision	A.14.00

Do Noise Correction

Value	Boolean
Range	True (enable noise correction) or False (disable noise correction)
Preset	False
Example	CALC:FPOW:POW1:DEF "DoNoiseCorrection=True"
Notes	When noise correction is enabled, the linear noise power contributed by the analyzer is subtracted from all measurements. This effectively lowers the noise floor of the analyzer. When noise correction is enabled, the first measurement for a given set of input parameters will take extra time. This is because the analyzer takes an extra acquisition with the RF input disconnected from the analyzer's front end to measure the noise of just the analyzer. The measured noise floor is stored in a cache so the noise acquisition will occur only once for the same state settings. In other words, if noise correction was turned on and the analyzer made an acquisition at frequency A, then frequency B, and back again to frequency A, the hidden initial noise floor acquisition would only occur for the first acquisition at frequency A and the cached noise floor would be used the second time frequency A was measured.
Initial S/W Revision	A.14.00

Do Spur Suppression

Value	Boolean
Range	True (enable spur suppression) or False (disable spur suppression)
Preset	False
Example	CALC:FPOW:POW1:DEF "DoSpurSuppression=True"
Notes	<p>When measuring very low level signals, or when large out-of-band inputs are input into the analyzer, sometimes unwanted spurs and residuals can appear in the measured spectrum. Spur suppression is a method to help minimize the levels of these internally generated spurs and residuals.</p> <p>When spur suppression is enabled, the analyzer will automatically take two acquisitions using two different internal analog LO frequencies. The FFT spectrums from both acquisitions are combined by taking the minimum power between both traces on a per FFT bin basis. External signals will have the same amplitude for both traces and therefore will return the expected amplitudes. However, low level spurs and residuals generated internally to the analyzer tend to move to different FFT bins depending on the internal analog LO frequency used, and therefore tend to be suppressed using this spur suppression method.</p> <p>Because two acquisitions, rather than a single acquisition, are made when spur suppression is enabled, the measurement time will always be slower when spur suppression is enabled.</p>
Initial S/W Revision	A.14.00

Electronic Attenuator Bypass

Value	Boolean
Range	True (bypass electronic attenuator) or False (use electronic attenuator)
Preset	True
Example	CALC:FPOW:POW1:DEF "ElecAttBypass =False"
Notes	The electronic attenuation bypass parameter allows the user to either utilize or bypass the electronic attenuator. The electronic attenuator is only available for frequencies up to 3.6 GHz. Set parameter to true when using frequencies above 3.6 GHz and set the parameter to false when using the preamp.
Initial S/W Revision	A.14.00

Electronic Attenuation

Value	dB
Range	0 - 24 dB (1 dB steps)
Preset	0 dB
Example	CALC:FPOW:POW1:DEF "ElecAttenuation=10"
Notes	<p>Option EA3 is required.</p> <p>The electronic attenuation value parameter sets the amount of electrical attenuation from 0 to 24 dB (1 dB steps).</p>

Set "ElecAttBypass=False" to make sure the electronic attenuator path is enabled.

Initial S/W Revision	A.14.00
-------------------------	---------

IF Gain

Value	dB
Range	-6 - 16 dB (1 dB steps)
Preset	0 dB
Example	CALC:FPOW:POW1:DEF "IFGain=10"
Notes	The IF gain parameter allows the user to specify the gain at the IF stage anywhere from -6 to 16 dB (1 dB steps). This is an advanced feature, and for most cases this should remain at its default value of 0 dB.
Initial S/W Revision	A.14.00

IF Type

Example	CALC:FPOW:POW1:DEF "IFType=B25M"
Notes	The IF type parameter allows the user to select between different IF paths. For example, if the signal is less than 25 MHz wide, then the user can select the B25M path to take advantage of additional filtering on this analog IF path.
Preset	B40M
Range	B10M, B25M, B40M
Initial S/W Revision	A.14.00

Include Power Spectrum

Value	Boolean
Range	True (return both channel power and full power spectrum) or False (returns only channel power)
Preset	False
Example	CALC:FPOW:POW1:DEF "IncludePowerSpectrum=True"
Notes	The power spectrum parameter allows the user to read data on the entire spectrum for diagnostic purposes. It is not recommended for production use. See CALC:FPOW:POW[n]:READ2? for details on the binary format of the response.
Initial S/W Revision	A.14.00

Mechanical Attenuation

Value	dB
Range	0 – 70 dB (2 dB steps)
Preset	0 dB
Example	CALC:FPOW:POW1:DEF "MechAttenuation=10"
Notes	The mechanical attenuation value parameter sets the amount of mechanical attenuation anywhere from 0 to 70 dB (2 dB steps).
Initial S/W Revision	A.14.00

Preamp Mode

Example	CALC:FPOW:POW1:DEF "PreAmpMode=Low"
Notes	The license for the appropriate preamp is required. The preamp mode parameter specifies whether the preamps are being utilized. Low allows any preamps up to 3.6 GHz, and Full allows all licensed preamps. Set "ElecAttBypass=True" in order to utilize any preamps.
Preset	Off
Range	Off, Low, Full
Initial S/W Revision	A.14.00

Resolution Bandwidth Mode

Example	CALC:FPOW:POW1:DEF "PreAmpMode=Low"
Notes	The resolution bandwidth mode parameter allows the user to choose whether the RBW filter is automatically or manually set. The BestSpeed value minimizes measurement time, while the Narrowest value minimizes RBW size (minimum of two FFT bins per RBW). To manually specify an RBW, set this parameter to Explicit, and set the ResolutionBW parameter to the desired value.
Preset	BestSpeed
Range	BestSpeed, Narrowest, Explicit
Initial S/W Revision	A.14.00

Resolution Bandwidth

Value	Hz
Preset	0 Hz

Example	CALC:FPOW:POW1:DEF "ResolutionBW=25e3"
Notes	The resolution bandwidth parameter sets the 3-dB bandwidth of the RBW filter. The ResolutionBWMode parameter must be set to Explicit in order to manually set the RBW.
Initial S/W Revision	A.14.00

Trigger Delay

Value	Seconds
Range	0 – 1 s
Preset	0 s
Example	CALC:FPOW:POW1:DEF "TriggerDelay=0.025"
Notes	The trigger delay parameter sets the time after an external trigger is detected until the measurement is performed.
Initial S/W Revision	A.14.00

Trigger Level

Value	Volts
Range	-5 to 5 V
Preset	1.2 V
Example	CALC:FPOW:POW1:DEF "TriggerLevel=2"
Notes	The trigger level parameter sets the voltage value at which an external trigger is detected.
Initial S/W Revision	A.14.00

Trigger Slope

Example	CALC:FPOW:POW1:DEF "TriggerSlope=Negative"
Notes	The trigger slope parameter indicates the direction of the edge trigger voltage for detection.
Preset	Positive
Range	Positive, Negative
Initial S/W Revision	A.14.00

Trigger Source

Example	CALC:FPOW:POW1:DEF "TriggerSource=Ext1"
Notes	The trigger source parameter allows the user to choose between measurement's triggering freely or controlled by an external input. Ext1 and Ext2 correspond to Trigger 1 In and Trigger 2 In, respectively.
Preset	Free
Range	Free, Ext1, Ext2
Initial S/W Revision	A.14.00

Trigger Timeout

Value	Seconds
Range	0 - 1 s
Preset	1 s
Example	CALC:FPOW:POW1:DEF "TriggerTimeout=0.1"
Notes	The trigger timeout parameter sets the time in which the analyzer will wait for a trigger before automatically performing the measurement.
Initial S/W Revision	A.14.00

Signal Input

Example	CALC:FPOW:POW1:DEF "SignalInput=Fp50MHzCW"
Notes	The signal input parameter allows the user to select between using the main RF input or the internal analyzer reference CW signal of 50 MHz.
Preset	FpMainRf
Range	FpMainRf, Fp50MHzCW
Initial S/W Revision	A.14.00

Use Preselector

Value	Boolean
Range	True (use preselector above 3.6 GHz), or False (preselector bypassed)
Preset	False
Example	CALC:FPOW:POW1:DEF "UsePreSelector=True"
Notes	The preselector parameter allows the user to either utilize or bypass the front end tunable filter at frequencies above 3.6 GHz. For frequencies below 3.6 GHz, the preselector is automatically

bypassed, so you do not need to set this parameter to False in those cases.

Initial S/W Revision A.14.00

Channel Bandwidth Array

Value	Hz
Range	0 to 40 MHz
Preset	[1 e6]
Example	CALC:FPOW:POW1:DEF "Bandwidth=[3.84e6, 5e6, 3.84e6]"
Notes	The bandwidth parameter array defines the bandwidth of each channel that will be measured. All array parameters should have the same number of elements. Alternatively, if all the elements are the same value, a single number with no square brackets can be used to define the parameter.
Initial S/W Revision	A.14.00

Channel Filter Type Array

Example	CALC:FPOW:POW1:DEF "FilterType=[RRC, IBW, RRC]"
Notes	The filter type parameter allows the user to choose between an integration bandwidth (IBW) filter or a root-raised-cosine (RRC) filter. The integration bandwidth filter weighs all frequencies within the bandwidth equally. The root-raised-cosine filter has an associated shape parameter, defined by the FilterAlpha parameter. All array parameters should have the same number of elements. Alternatively, if all the elements are the same value, a single value with no square brackets can be used to define the parameter.
Preset	[IBW]
Range	IBW, RRC
Initial S/W Revision	A.14.00

Channel Filter Alpha Array

Example	CALC:FPOW:POW1:DEF "FilterAlpha=[0.5, 0.0, 0.5]"
Notes	The filter alpha parameter allows the user to adjust the alpha value associated with the root-raised-cosine (RRC) filter type. Set FilterType to RRC in order to utilize this parameter. All array parameters should have the same number of elements. Alternatively, if all the elements are the same value, a single number with no square brackets can be used to define the parameter.
Preset	[0.22]
Range	0.0 – 1.0
Initial S/W Revision	A.14.00

Channel Measurement Function Array

Example	CALC:FPOW:POW1:DEF "Function=[BandPower, PeakPower, BandPower]"
Notes	<p>This parameter array defines what measurement is being made for each individually-specified channel:</p> <p>BandPower: Total power within the specified bandwidth of the channel (dBm)</p> <p>BandDensity: Total power density within the specified bandwidth of the channel (dBm/Hz)</p> <p>PeakPower: The peak power value within the specified bandwidth of the channel (dBm)</p> <p>PeakFrequency: The frequency which corresponds to the peak power value within the specified bandwidth of the channel. This frequency is relative to the center frequency (Hz)</p> <p>XdBBandwidth: The half power (-3.01 dB) bandwidth of the highest amplitude signal that resides within the channel (Hz), dB is configurable using XdBBandwidth parameter</p> <p>OccupiedBandwidth: The bandwidth at which 99% of the total power resides within the channel (Hz), percentage configurable using OccupiedBandwidthPercent parameter</p> <p>All array parameters should have the same number of elements. Alternatively, if all the elements are the same value, a single value with no square brackets can be used to define the parameter.</p>
Preset	[BandPower]
Range	BandPower, BandDensity, PeakPower, PeakFrequency, XdBBandwidth, OccupiedBandwidth
Initial S/W Revision	A.14.00

Channel Offset Frequency Array

Value	Hz
Range	0 to 20 MHz
Preset	[0]
Example	CALC:FPOW:POW1:DEF "OffsetFrequency=[-5e6, 0, 5e6]"
Notes	<p>The offset frequency parameter array defines the difference between the center frequency to the center frequency of each channel.</p> <p>All array parameters should have the same number of elements.</p>
Initial S/W Revision	A.14.00

Channel Occupied Bandwidth Percent Array

Example	CALC:FPOW:POW1:DEF "OccupiedBandwidthPercent =[0.95, 0.95, 0.95]"
Notes	<p>This parameter only applies for channels whose Function is set to OccupiedBandwidth. The occupied bandwidth percent parameter specifies the percent of total power in these channels. The valid range for this parameter is 0.0 to 1.0, where 1.0 represents 100%. The default for this parameter is 0.99, which will return the bandwidth that contains 99% of the total channel power.</p>

Preset	[0.99]
Range	0 – 1.0
Initial S/W Revision	A.14.00

Channel x-dB Bandwidth Array

Value	dB
Range	-200 to 0 dB
Preset	[-3.01]
Example	CALC:FPOW:POW1:DEF " XdBBandwidth =[-6.02, -3.01, -1.0]"
Notes	This parameter only applies for channels whose Function is set to XdBBandwidth. The X dB bandwidth parameter is used to specify the power relative to the peak channel power over which the bandwidth is calculated. The parameter value must be a negative number.
Initial S/W Revision	A.14.00

Define Fast Power Measurement Query (Remote Command Only)

The DEFine? command is used to retrieve a list of all defined parameters in an ASCII string format

M o d e	All
R e m o t e	:CALCulate:FPOWER:POWer [1,2,...,999]:DEFine?
C o m m a n d	
E x a m p l e	:CALC:FPOW:POW1:DEF?

```

p
l
e
-----
N This command query is used to retrieve a list of all defined parameters in an ASCII format.
o The following is an example of the returned results:
t "DCCoupled=False,ElecAttBypass=True,ElecAttenuation=0,IFGain=0,MechAttenuation=0,PreAmpMode=Off,PreSelectorOffset
e =0,UsePreSelector=False,ExternalReferenceFrequency=10000000,FrequencyReferenceSource=AutoExternalFrequencyRefer
s ence,IFType=B40M,LOMode=SLW,SignalInput=FpMainRf,AcquisitionTime=0.001,CenterFrequency=1000000000,Resolution
BW=0,ResolutionBWMode=BestSpeed,DetectorType=RmsAverage,Bandwidth=[1000000],OffsetFrequency=[0],Function=
[BandPower],FilterType=[IBW],FilterAlpha=[0.22],OccupiedBandwidthPercent=[0.99],XdBBandwidth=[-
3.01],DoNoiseCorrection=False,DoSpurSuppression=False,MeasurementMethod=HardwareFFT,IncludePowerSpectrum=False
e,TriggerDelay=0,TriggerLevel=1.2,TriggerSlope=Positive,TriggerSource=Free,TriggerTimeout=1 "
-----
I A.14.00
n
i
t
i
a
l

S
/
W

R
e
v
i
s
i
o
n

```

Configure Fast Power Measurement (Remote Command Only)

The configure command begins hardware setup and returns immediately, with no acquisition made. This can be used in parallel with other hardware operations to effectively hide the hardware setup time.

Mode	All
Remote Command	:CALCulate:FPOWer:POWer[1,2,...,999]:CONFigure
Example	:CALC:FPOW:POW1:CONF
Notes	Option FP2 is required.
Initial S/W Revision	A.14.00

Initiate Fast Power Measurement (Remote Command Only)

The INITiate command begins an acquisition and returns immediately. The results of the measurement can be retrieved using FETCh.

Mode	All
Remote Command	:CALCulate:FPOWER:POWER[1,2,...,999]:INITiate
Example	:CALC:FPOW:POW1:INIT
Notes	Option FP2 is required.
Initial S/W Revision	A.14.00

Fetch Fast Power Measurement (Remote Command Only)

The FETCh command query is used to retrieve the results of an acquisition initiated by the INIT command. The returned results are in ASCII string format. The string begins and ends with quotation marks.

Mode	All
Remote Command	:CALCulate:FPOWER:POWER[1,2,...,999]:FETCh?
Example	:CALC:FPOW:POW1:FETC?
Notes	Option FP2 is required. Returns m comma-separated ASCII values, where m corresponds to the number of bandwidths defined. 1. Declared function return in the 1st specified channel 2. Declared function return in the 2nd specified channel ... m. Declared function return in the last specified channel The INIT and FETC? command sequence performs the same functionality of a single CALC:FPOW:POW[n]? query. Units of the returned values are dependent on the Function parameter for each channel.
Initial S/W Revision	A.14.00

Execute Fast Power Measurement (Remote Command Only)

This command query is used as shorthand for an INIT command immediately followed by a FETC? command. The returned results are in ASCII string format. The string begins and ends with quotation marks.

Mode	All
Remote Command	:CALCulate:FPOWER:POWER[1,2,...,999]?
Example	:CALC:FPOW:POW1?
Notes	Option FP2 is required. See notes for Fast Power Fetch for return format.
Initial S/W Revision	A.14.00

Binary Read Fast Power Measurement (Remote Command Only)

This command query is used as shorthand for an INIT command immediately followed by a FETC? command. The returned results are in a binary format.

Mode	All
Remote Command	:CALCulate:FPOWER:POWER[1,2,...,999]:READ? :CALCulate:FPOWER:POWER[1,2,...,999]:READ1?
Example	:CALC:FPOW:POW1:READ? :CALC:FPOW:POW1:READ1?
Notes	Option FP2 is required. Returns m 4 byte floating point binary values (Little-Endian), where m corresponds to the number of bandwidths defined.
Initial S/W Revision	A.14.00

Diagnostic Binary Read Fast Power Measurement (Remote Command Only)

This command query is used as shorthand for an INIT command immediately followed by a FETC? command. The returned results are in a binary format. This command is used primarily for diagnostic purposes to test for ADC overloads and to visibly inspect the spectrum.

Mode	All
Remote Command	:CALCulate:FPOWER:POWER[1,2,...,999]:READ2?
Example	:CALC:FPOW:POW1:READ2?
Notes	Option FP2 is required. Note: Spectrum data is only returned if the IncludePowerSpectrum parameter is set to True. If IncludePowerSpectrum is False, the number of spectrum points will be zero (0). Units of the returned values are dependent on the Function parameter per channel (e.g. dBm for BandPower, Hz for PeakFrequency). Returns binary data (Little-Endian) that contains information on m amount of channels, along with ADC over range and full spectrum data. The following is the binary format of the response. Bandwidth Return Value 1. Number of channels specified, m [4 byte int] 2. Declared function result for the 1st specified channel [4 byte float] 3. Declared function result for the 2nd specified channel [4 byte float] ... (m + 1). Declared function result for the last (mth) specified channel [4 byte float] ADC Over Range 1. ADC over-range occurred (1: true, 0: false) [2 byte short]

	<p>Spectrum Data</p> <ol style="list-style-type: none"> 1. Number of points in the spectrum data, k [4 byte int] 2. Start frequency of spectrum data (Hz) [8 byte double] 3. Step frequency of spectrum data (Hz) [8 byte double] 4. FFT bin at 1st point (dBm) [4 byte float] 5. FFT bin at 2nd point (dBm) [4 byte float] ... (k + 3). FFT bin at last (kth) point (dBm) [4 byte float]
Initial S/W Revision	A.14.00

Format Data: Numeric Data (Remote Command Only)

This command specifies the format of the trace data input and output. It specifies the formats used for trace data during data transfer across any remote port. It affects only the data format for setting and querying trace data for the :TRACe[:DATA], TRACe[:DATA]?, :CALCulate:DATA[n]? and FETCh:SANalyzer[n]? commands and queries.

Remote Command	<pre>:FORMat[:TRACe][:DATA] ASCii INTeger,32 REAL,32 REAL,64 :FORMat[:TRACe][:DATA]?</pre>
Notes	<p>The query response is:</p> <pre>ASCii: ASC,8 REAL,32: REAL,32 REAL,64: REAL,64 INTeger,32: INT,32</pre> <p>When the numeric data format is REAL or ASCii, data is output in the current Y Axis unit. When the data format is INTeger, data is output in units of m dBm (.001 dBm).</p> <p>The INT,32 format returns binary 32-bit integer values in internal units (m dBm), in a definite length block.</p>
Dependencies	<p>Sending a data format spec with an invalid number (for example, INT,48) generates no error. The analyzer simply uses the default (8 for ASCii, 32 for INTeger, 32 for REAL).</p> <p>Sending data to the analyzer which does not conform to the current FORMat specified, results in an error. Sending ASCII data when a definite block is expected generates message -161 "Invalid Block Data" and sending a definite block when ASCII data is expected generates message -121 "Invalid Character in Number".</p>
Preset	ASCii
Backwards Compatibility Notes	Note that the INT,32 format is only applicable to the command, TRACe:DATA. This preserves backwards compatibility for the Swept SA measurement. For all other commands/queries which honor FORMat:DATA, if INT,32 is sent the analyzer will behave as though it were set to REAL,32.
Initial S/W Revision	Prior to A.02.00

The specs for each output type follow:

AScii - Amplitude values are in ASCII, in the current Y Axis Unit, one ASCII character per digit, values separated by commas, each value in the form:

SX.YYYYYEsZZ

Where:

S = sign (+ or -)

X = one digit to left of decimal point

Y = 5 digits to right of decimal point

E = E, exponent header

s = sign of exponent (+ or -)

ZZ = two digit exponent

REAL,32 - Binary 32-bit real values in the current Y Axis Unit, in a definite length block.

REAL,64 - Binary 64-bit real values in the current Y Axis Unit, in a definite length block.

Format Data: Byte Order (Remote Command Only)

This command selects the binary data byte order for data transfer and other queries. It controls whether binary data is transferred in normal or swapped mode. This command affects only the byte order for setting and querying trace data for the :TRACe[:DATA], TRACe[:DATA]? , :CALCulate:DATA[n]? and FETCh:SANalyzer[n]? commands and queries.

By definition any command that says it uses FORMat:DATA uses any format supported by FORMat:DATA.

The NORMal order is a byte sequence that begins with the most significant byte (MSB) first, and ends with the least significant byte (LSB) last in the sequence: 1|2|3|4. SWAPped order is when the byte sequence begins with the LSB first, and ends with the MSB last in the sequence: 4|3|2|1.

Remote Command	:FORMat:BORDER NORMAL SWAPped :FORMat:BORDER?
Preset	NORMal
Initial S/W Revision	Prior to A.02.00

Meas Setup

Displays the measurement setup menu for the currently selected measurement.

Key Path	Front-panel key
Initial S/W Revision	Prior to A.02.00

Avg/Hold Num

Specifies the number of measurement averages used to calculate the measurement result. The average is displayed at the end of each sweep.

Average State allows you to turn averaging on or off.

Key Path	Meas Setup
Mode	SA, WCDMA, C2K, WiMAX OFDMA, CDMA1xEVDO, TD-SCDMA, DVB-T/H, LTE, LTE-TDD, WLAN, MSR, LTE-AFDD, LTE-TDD
Remote Command	[:SENSe]:SPURious:AVERage:COUNT <integer> [:SENSe]:SPURious:AVERage:COUNT? [:SENSe]:SPURious:AVERage[:STATE] ON OFF 1 0 [:SENSe]:SPURious:AVERage[:STATE]?
Example	SPUR:AVER:COUN 2500 SPUR:AVER:COUN? SPUR:AVER ON SPUR:AVER?
Notes	You must be in the Spectrum Analysis mode, W-CDMA mode, cdma2000 mode, DVB-T/H mode, TD-SCDMA mode, LTE mode, LTE TDD mode, WLAN mode, MSR, LTE-Advanced FDD/TDD mode or WiMAX mode to use this command. Use INSTRument:SElect to set the mode.
Preset	10 OFF
State Saved	Saved in instrument state.
Min	1
Max	10000
Initial S/W Revision	Prior to A.02.00
Modified at S/W Revision	A.03.00

Avg Mode

Enables you to set the averaging mode.

- When set to Exponential (Exp) the measurement averaging continues using the specified number of averages to compute each averaged value. The average will be displayed at the end of each sweep.

- When set to Repeat, the measurement resets the average counter each time the specified number of averages is reached.

Key Path	Meas Setup
Mode	SA, WCDMA, WIMAX OFDMA, TD-SCDMA, DVB-T/H, LTE, LTETDD, WLAN, MSR, LTEAFDD, LTEATDD
Remote Command	[:SENSe] :SPURious:AVErAge:TCONtrol EXPonential REPeat [:SENSe] :SPURious:AVErAge:TCONtrol?
Example	SPUR:AVER:TCON REP SPUR:AVER:TCON?
Notes	You must be in the cdma2000 mode, TD-SCDMA mode, W-CDMA mode, DVB-T/H mode, GSM/EDGE mode, LTE mode, LTE TDD mode, WLAN mode, MSR, LTE-Advanced FDD/TDD mode or WiMAX mode to use this command. Use INSTRUMENT:SElect to set the mode.
Preset	EXPonential
State Saved	Saved in instrument state.
Range	Exp Repeat
Initial S/W Revision	Prior to A.02.00
Modified at S/W Revision	A.03.00

Range Table

Enables you to set range parameters.

To change a parameter, select the appropriate menu softkey and enter the value using the numeric keypad or the knob. The analyzer settings will be updated with the new parameter values.

When the current view is the Range Table view, the selected range is highlighted and displayed in the Range Table automatically. With the normal window arrangement, up to five ranges are displayed. In the zoom mode, all 20 ranges can be displayed.

In the Range Table window, there are three tables corresponding to each page of the Range Table menu. When the Range Table key is pressed, the table of the first menu page is displayed.

The Displayed table is changed by changing the Range Table menu page. It can also be changed by a remote command. When the Range Table is changed by the command, the menu page changes accordingly if the Range Table menu is displayed.

Key Path	Meas Setup
Initial S/W Revision	Prior to A.02.00

Range

Changing the range updates the values on the other menu keys so that they reflect the settings for the selected range. If Range is turned on, it will be used as part of the measurement. If it is off, it will be excluded. A range is made up of the next fifteen parameters. This parameter can send up to 20 values. The

location in the list sent corresponds to the range the value is associated with. Missing values are not permitted; that is, if you want to change values 2 and 6 you must send all values up to 6. Subsequent values will remain as they were. The query for this parameter always returns 20 values.

Key Path	Meas Setup, Range Table
Mode	SA, WCDMA, C2K, 1xEV-DO, WIMAX OFDMA, TD-SCDMA, DVB-T/H, LTE, LTE-TDD, MSR, LTEAFDD, LTEATDD
Remote Command	<pre> :DISPlay:SPURious:VIEW:RANGe[:SElect] <integer> :DISPlay:SPURious:VIEW:RANGe[:SElect]? [:SENSe]:SPURious[:RANGe][:LIST]:STATe ON OFF 1 0, ON OFF 1 0 [:SENSe]:SPURious[:RANGe][:LIST]:STATe? </pre>
Example	<pre> DISP:SPUR:VIEW:RANG 2 DISP:SPUR:VIEW:RANG? SPUR:STAT ON SPUR:STAT? </pre>
Notes	You must be in cdma2000 mode, TD-SCDMA mode, W-CDMA mode, DVB-T/H mode, GSM/EDGE mode, LTE mode, LTE TDD mode, MSR, LTE-Advanced FDD/TDD mode or WiMAX mode to use this command. Use INSTRUMENT:SElect to set the mode.
Preset	<pre> 1 SA, WIMAX OFDMA:ON, ON, ON, ON, ON, OFF, OFF, OFF, OFF, OFF, OFF, OFF, OFF, OFF, OFF, OFF, OFF, OFF, OFF, OFF WCDMA:ON, ON, ON, ON, ON, ON, ON, ON, OFF, OFF, OFF, OFF, OFF, OFF, OFF, OFF, OFF, OFF, OFF, OFF, OFF C2k, 1xEV-DO: ON, ON, ON, ON, OFF, OFF, OFF, OFF, OFF, OFF, OFF, OFF, OFF, OFF, OFF, OFF, OFF, OFF, OFF, OFF TD-SCDMA: ON, ON, ON, ON, OFF, OFF, OFF, OFF, OFF, OFF, OFF, OFF, OFF, OFF, OFF, OFF, OFF, OFF, OFF, OFF, OFF DVB-T/H: ON, ON, ON, ON, ON, ON, ON, OFF, OFF, OFF, OFF, OFF, OFF, OFF, OFF, OFF, OFF, OFF, OFF, OFF, OFF LTE, MSR, LTEAFDD: ON, ON, ON, ON, ON, ON, ON, OFF, OFF, OFF, OFF, OFF, OFF, OFF, OFF, OFF, OFF, OFF, OFF, OFF, OFF LTE-TDD, LT LTEATDD: OFF, OFF, ON, ON, ON, ON, ON, OFF, OFF, OFF, OFF, OFF, OFF, OFF, OFF, OFF, OFF, OFF, OFF, OFF, OFF </pre>
State Saved	Not saved in State
Min	1
Max	20
Initial S/W Revision	Prior to A.02.00
Modified at S/W Revision	A.03.00, A.10.00

Start Freq

Sets the start frequency of the analyzer. This parameter can send up to 20 values. The location where the start frequency occurs in the list sent to the measurement corresponds to the range the value is associated with.

Missing values are not permitted. If you want to change values 2 and 6 you must send all values up to 6. Subsequent values will remain as they were. The query for this parameter always returns 20 values.

Key Path	Meas Setup, Range Table
Mode	SA, WCDMA, C2K, WIMAX OFDMA, TD-SCDMA, 1xEV-DO, DVB-T/H, LTE, LTETDD, WLAN
Remote Command	[[:SENSE]:SPURious[:RANGE][:LIST]:FREQuency:STARt <freq>, <freq>, <freq>, <freq>, <freq>, <freq>, <freq>, <freq>, <freq>, <freq>, <freq>, <freq>, <freq>, <freq>, <freq>, <freq>, <freq>, <freq>, <freq>, <freq>] [[:SENSe]:SPURious[:RANGE][:LIST]:FREQuency:STARt?
Example	SPUR:FREQ:STAR 9 kHz, 150 kHz, 30 MHz, 1GHz, 1.5 GHz, 1.5 GHz, 1.5 GHz, 1.5 GHz, 1.5 GHz, 1.5 GHz, 1.5 GHz, 1.5 GHz, 1.5 GHz, 1.5 GHz, 1.5 GHz, 1.5 GHz, 1.5 GHz, 1.5 GHz, 1.5 GHz, 1.5 GHz, 1.5 GHz SPUR:FREQ:STAR?
Notes	You must be in cdma2000 mode, TD-SCDMA mode, W-CDMA mode, DVB-T/H, GSM/EDGE mode, LTE mode, LTE TDD mode, WLAN mode, MSR or WiMAX mode to use this command. Use INSTRument:SElect to set the mode.
Preset	SA, WIMAX OFDMA:+1.92000000E+009, +1.89350000E+009, +2.10000000E+009, +2.17500000E+009, +8.00000000E+008, +1.50000000E+009, +1.50000000E+009, +1.50000000E+009, +1.50000000E+009, +1.50000000E+009, +1.50000000E+009, +1.50000000E+009, +1.50000000E+009, +1.50000000E+009, +1.50000000E+009, +1.50000000E+009, +1.50000000E+009, +1.50000000E+009, +1.50000000E+009, +1.50000000E+009 WCDMA:9kHz, 150kHz, 30MHz, 1GHz, 2.1GHz, 2.1GHz, 2.1774GHz, 2.18GHz, 1.5GHz, 1.5GHz, 1.5GHz, 1.5GHz, 1.5GHz, 1.5GHz, 1.5GHz, 1.5GHz, 1.5GHz, 1.5GHz, 1.5GHz, 1.5GHz C2K, 1xEV-DO: 9kHz, 150kHz, 30 MHz, 1GHz, 2.5GHz, 2.5GHz, 2.5GHz, 2.5 GHz, 2.5 GHz, 2.5 GHz, 2.5 GHz, 2.5 GHz, 2.5 GHz, 2.5 GHz, 2.5 GHz, 2.5 GHz, 2.5 GHz, 2.5 GHz, 2.5 GHz, 2.5 GHz TD-SCDMA: 9 kHz, 150 kHz, 30 MHz, 1GHz, 1.5 GHz, 1.5 GHz, 1.5 GHz, 1.5 GHz, 1.5 GHz, 1.5 GHz, 1.5 GHz, 1.5 GHz, 1.5 GHz, 1.5 GHz, 1.5 GHz, 1.5 GHz, 1.5 GHz, 1.5 GHz, 1.5 GHz, 1.5 GHz, 1.5 GHz DVB-T/H: 9kHz, 174MHz, 400MHz, 790MHz, 862MHz, 1GHz, 1.5GHz, 1.5GHz, 1.5GHz, 1.5GHz, 1.5GHz, 1.5GHz, 1.5GHz, 1.5GHz, 1.5GHz, 1.5GHz, 1.5GHz, 1.5GHz, 1.5GHz, 1.5GHz, 1.5GHz, 1.5GHz, 1.5GHz LTE, MSR: 9 kHz, 150 kHz, 30 MHz, 1 GHz, 1.92GHz, 1.98 GHz, 2.18 GHz, 1.5 GHz, 1.5 GHz, 1.5 GHz, 1.5 GHz, 1.5 GHz, 1.5 GHz, 1.5 GHz, 1.5 GHz, 1.5 GHz, 1.5 GHz, 1.5 GHz, 1.5 GHz, 1.5 GHz, 1.5 GHz, 1.5 GHz, 1.5 GHz LTETDD: 9 kHz, 150 kHz, 30 MHz, 1 GHz, 1.90GHz, 2.01 GHz, 2.025 GHz, 1.5 GHz, 1.5 GHz, 1.5 GHz, 1.5 GHz, 1.5 GHz, 1.5 GHz, 1.5 GHz, 1.5 GHz, 1.5 GHz, 1.5 GHz, 1.5 GHz, 1.5 GHz, 1.5 GHz, 1.5 GHz, 1.5 GHz, 1.5 GHz WLAN: 9 kHz, 150 kHz, 30 MHz, 1 GHz, 1.5 GHz, 1.5 GHz, 1.5 GHz, 1.5 GHz, 1.5 GHz, 1.5 GHz, 1.5 GHz, 1.5 GHz, 1.5 GHz, 1.5 GHz, 1.5 GHz, 1.5 GHz, 1.5 GHz, 1.5 GHz, 1.5 GHz, 1.5 GHz, 1.5 GHz, 1.5 GHz
State Saved	Saved in instrument state.
Min	-80 MHz

Max	Hardware Dependent: Option 503: 3699999990 Option 508: 8499999990 Option 513: 1379999990 Option 526: 2699999990
Initial S/W Revision	Prior to A.02.00
Modified at S/W Revision	A.03.00

Stop Freq

Sets the stop frequency of the analyzer. This parameter can send up to 20 values.

The location of where the stop frequency occurs in the list sent to the measurement corresponds to the range the value is associated with.

Missing values are not permitted. If you want to change values 2 and 6 you must send all values up to 6. Subsequent values will remain as they were. The query for this parameter always returns 20 values.

Key Path	Meas Setup, Range Table
Mode	SA, WCDMA, C2K, WIMAX OFDMA, TD-SCDMA, 1xEV-DO, DVB-T/H, WLAN
Remote Command	[:SENSE] :SPURious [:RANGE] [:LIST] :FREQuency:STOP <freq>, <freq>, <freq>, <freq>, <freq>, <freq>, <freq>, <freq>, <freq>, <freq>, <freq>, <freq>, <freq>, <freq>, <freq>, <freq>, <freq>, <freq>, <freq> [:SENSe] :SPURious [:RANGE] [:LIST] :FREQuency:STOP?
Example	SPUR:FREQ:STOP 150kHz, 30MHz, 1GHz, 2.1GHz, 2.1GHz, 2.1774GHz, 2.18GHz, 12.75GHz, 2.5GHz, 2.5GHz, 2.5GHz, 2.5GHz, 2.5GHz, 2.5GHz, 2.5GHz, 2.5GHz, 2.5GHz, 2.5GHz, 2.5GHz, 2.5GHz SPUR:FREQ:STOP?
Notes	You must be in cdma2000 mode, TD-SCDMA mode, W-CDMA mode, DVB-T/H, GSM/EDGE mode, LTE mode, LTE TDD mode, WLAN mode, MSR or WiMAX mode to use this command. Use INSTRument:SElect to set the mode.
Preset	SA, WIMAX OFDMA:+1.98000000E+009, +1.91960000E+009, +2.10150000E+009, +2.18000000E+009, +1.00000000E+009, +2.50000000E+009, +2.50000000E+009, +2.50000000E+009, +2.50000000E+009, +2.50000000E+009, +2.50000000E+009, +2.50000000E+009, +2.50000000E+009, +2.50000000E+009, +2.50000000E+009, +2.50000000E+009, +2.50000000E+009, +2.50000000E+009, +2.50000000E+009 WCDMA:150kHz, 30MHz, 1GHz, 2.1GHz, 2.1GHz, 2.1774GHz, 2.18GHz, 12.75GHz, 2.5GHz, 2.5GHz, 2.5GHz, 2.5GHz, 2.5GHz, 2.5GHz, 2.5GHz, 2.5GHz, 2.5GHz, 2.5GHz, 2.5GHz, 2.5GHz C2K, 1xEV-DO: 150kHz, 30 MHz, 1GHz, 5GHz, 2.5GHz, 2.5GHz, 2.5GHz, 2.5 GHz, 2.5 GHz, 2.5 GHz, 2.5 GHz, 2.5 GHz, 2.5 GHz, 2.5 GHz, 2.5 GHz, 2.5 GHz, 2.5 GHz, 2.5 GHz TD-SCDMA: 150kHz, 30 MHz, 1GHz, 12.75GHz, 2.5 GHz, 2.5 GHz, 2.5 GHz, 2.5 GHz, 2.5 GHz, 2.5 GHz, 2.5 GHz, 2.5 GHz, 2.5 GHz, 2.5 GHz, 2.5 GHz, 2.5 GHz, 2.5 GHz DVB-T/H: 174MHz, 400MHz, 790MHz, 862MHz, 1GHz, 4.5GHz, 2.5GHz, 2.5GHz, 2.5GHz,

	2.5GHz, 2.5GHz, 2.5GHz, 2.5GHz, 2.5GHz, 2.5GHz, 2.5GHz, 2.5GHz, 2.5GHz, 2.5GHz, 2.5GHz LTE, MSR: 150kHz, 30MHz, 1GHz, 1.92GHz, 1.98GHz, 2.1GHz, 12.75GHz, 2.5GHz, 2.5GHz, 2.5GHz, 2.5GHz, 2.5GHz, 2.5GHz, 2.5GHz, 2.5GHz, 2.5GHz, 2.5GHz, 2.5GHz, 2.5GHz LTETDD: 150kHz, 30MHz, 1GHz, 1.90GHz, 2.01GHz, 2.025GHz, 12.75GHz, 2.5GHz, 2.5GHz, 2.5GHz, 2.5GHz, 2.5GHz, 2.5GHz, 2.5GHz, 2.5GHz, 2.5GHz, 2.5GHz, 2.5GHz, 2.5GHz WLAN: 150 kHz, 30 MHz, 1 GHz, 12.75 GHz, 2.5 GHz, 2.5 GHz, 2.5 GHz, 2.5 GHz, 2.5 GHz, 2.5 GHz, 2.5 GHz, 2.5 GHz, 2.5 GHz, 2.5 GHz, 2.5 GHz, 2.5 GHz, 2.5 GHz, 2.5 GHz, 2.5 GHz
State Saved	Saved in instrument state.
Min	-79999990
Max	Hardware Dependent: Option 503: 3.7 GHz Option 508: 8.5 GHz Option 513: 13.8 GHz Option 526: 27.0 GHz
Initial S/W Revision	Prior to A.02.00
Modified at S/W Revision	A.03.00

Res BW

Sets the resolution bandwidth of the analyzer. This parameter can send up to 20 values.

The location of where the resolution bandwidth occurs in the list sent to the measurement corresponds to the range the value is associated with.

Missing values are not permitted. In other words, if you want to change values 2 and 6 you must send all values up to 6. Subsequent values will remain as they were. The query for this parameter always returns 20 values.

Key Path	Meas Setup, Range Table
Mode	SA, WCDMA, C2K, WIMAX OFDMA, TD-SCDMA, 1xEV-DO, DVB-T/H, LTE, LTETDD, WLAN, MSR, LTEAFDD, LTEATDD
Remote Command	<pre>[:SENSe]:SPURious[:RANGe][:LIST]:BANDwidth[:RESolution] <freq>, <freq>, <freq>, <freq>, <freq>, <freq>, <freq>, <freq>, <freq>, <freq>, <freq>, <freq>, <freq>, <freq>, <freq>, <freq>, <freq>, <freq>, <freq>, <freq> [:SENSe]:SPURious[:RANGe][:LIST]:BANDwidth[:RESolution]? [:SENSe]:SPURious[:RANGe][:LIST]:BANDwidth[:RESolution]:AUTO OFF ON 0 1, OFF ON 0 1, OFF ON 0 1, OFF ON 0 1, OFF ON 0 1, OFF ON 0 1, OFF ON 0 1, OFF ON 0 1, OFF ON 0 1, OFF ON 0 1, OFF ON 0 1, OFF ON 0 1, OFF ON 0 1, OFF ON 0 1, OFF ON 0 1, OFF ON 0 1, OFF ON 0 1, OFF ON 0 1, OFF ON 0 1, OFF ON 0 1 [:SENSe]:SPURious[:RANGe][:LIST]:BANDwidth[:RESolution]:AUTO?</pre>
Example	SPUR:BAND 1kHz, 10kHz, 100kHz, 1MHz, 1MHz, 1MHz, 1MHz, 3MHz, 3MHz, 3MHz, 3MHz,

	<p>3MHz, 3MHz, 3MHz, 3MHz, 3MHz, 3MHz, 3MHz, 3MHz, 3MHz</p> <p>SPUR:BAND?</p> <p>SPUR:BWID:AUTO ON, ON, ON, OFF, OFF, OFF, OFF, OFF, ON, ON, ON, ON, OFF, OFF, OFF, OFF, OFF, OFF, ON, ON</p> <p>SPUR:BWID:AUTO?</p>
Notes	<p>You must be in cdma2000 mode, TD-SCDMA mode, W-CDMA mode, DVB-T/H, GSM/EDGE mode, LTE mode, LTE TDD mode, WLAN mode, MSR, LTE-Advanced FDD/TDD mode or WiMAX mode to use this command. Use INSTRument:SElect to set the mode.</p>
Preset	<p>SA, WIMAX OFDMA:1.2MHz, 0.51MHz, 0.1MHz, 0.1MHz, 4MHz, 3MHz, 3MHz, 3MHz, 3MHz, 3MHz, 3MHz, 3MHz, 3MHz, 3MHz, 3MHz, 3MHz, 3MHz, 3MHz, 3MHz, 3MHz, 3MHz</p> <p>WCDMA:1kHz, 10kHz, 100kHz, 1MHz, 1MHz, 1MHz, 1MHz, 1MHz, 3MHz, 3MHz, 3MHz, 3MHz, 3MHz, 3MHz, 3MHz, 3MHz, 3MHz, 3MHz, 3MHz, 3MHz, 3MHz</p> <p>C2k, 1xEV-DO: 1kHz, 10kHz, 100kHz, 1MHz, 1MHz, 1MHz, 1MHz, 3MHz, 3MHz, 3MHz, 3MHz, 3MHz, 3MHz, 3MHz, 3MHz, 3MHz, 3MHz, 3MHz, 3MHz, 3MHz, 3MHz</p> <p>TD-SCDMA: 1kHz, 10kHz, 100kHz, 1MHz, 3MHz, 3MHz, 3MHz, 3MHz, 3MHz, 3MHz, 3MHz, 3MHz, 3MHz, 3MHz, 3MHz, 3MHz, 3MHz, 3MHz, 3MHz, 3MHz, 3MHz</p> <p>DVB-T/H: 100kHz, 3.9kHz, 100kHz, 3.9kHz, 100kHz, 100kHz, 3MHz, 3MHz, 3MHz, 3MHz, 3MHz, 3MHz, 3MHz, 3MHz, 3MHz, 3MHz, 3MHz, 3MHz, 3MHz, 3MHz, 3MHz</p> <p>LTE, MSR, LTEAFDD: 1kHz, 10kHz, 100kHz, 1MHz, 100kHz, 1MHz, 1MHz, 3MHz, 3MHz, 3MHz, 3MHz, 3MHz, 3MHz, 3MHz, 3MHz, 3MHz, 3MHz, 3MHz, 3MHz, 3MHz, 3MHz</p> <p>LTETDD, LTEATDD: 1kHz, 10kHz, 100kHz, 1MHz, 1MHz, 1MHz, 1MHz, 3MHz, 3MHz, 3MHz, 3MHz, 3MHz, 3MHz, 3MHz, 3MHz, 3MHz, 3MHz, 3MHz, 3MHz, 3MHz, 3MHz</p> <p>WLAN:</p> <p>1kHz, 10kHz, 100kHz, 1MHz, 3MHz, 3MHz, 3MHz, 3MHz, 3MHz, 3MHz, 3MHz, 3MHz, 3MHz, 3MHz, 3MHz, 3MHz, 3MHz, 3MHz, 3MHz, 3MHz, 3MHz</p> <p>SA, WIMAX OFDMA:OFF, OFF, OFF, OFF, OFF, ON, ON, ON, ON, ON, ON, ON, ON, ON, ON, ON, ON, ON, ON, ON, ON, ON, ON, ON</p> <p>WCDMA:OFF, OFF, OFF, OFF, OFF, OFF, OFF, OFF, ON, ON, ON, ON, ON, ON, ON, ON, ON, ON, ON, ON, ON, ON, ON, ON</p> <p>C2k, 1xEV-DO:OFF, OFF, OFF, OFF, OFF, OFF, OFF, ON, ON, ON, ON, ON, ON, ON, ON, ON, ON, ON, ON, ON, ON, ON, ON, ON</p> <p>TD-SCDMA: OFF, OFF, OFF, OFF, ON</p> <p>DVB-T/H:</p> <p>OFF, OFF, OFF, OFF, OFF, OFF, ON, ON, ON, ON, ON, ON, ON, ON, ON, ON, ON, ON, ON, ON, ON, ON, ON, ON</p> <p>LTE, MSR, LTEAFDD: OFF, OFF, OFF, OFF, OFF, OFF, OFF, ON, ON, ON, ON, ON, ON, ON, ON, ON, ON, ON, ON, ON, ON, ON, ON, ON</p> <p>LTETDD, LTEATDD: OFF, OFF, OFF, OFF, OFF, OFF, OFF, ON, ON, ON, ON, ON, ON, ON, ON, ON, ON, ON, ON, ON, ON, ON, ON, ON</p> <p>WLAN:</p> <p>OFF, OFF, OFF, OFF, ON</p>
State Saved	Saved in instrument state.
Min	1 Hz

Max	8 MHz
Backwards Compatibility SCPI	[:SENSE] : SPURious [:RANGE] [:LIST] : BWIDth [:RESolution]
Initial S/W Revision	Prior to A.02.00
Modified at S/W Revision	A.03.00

Video BW

Sets the Video BW mode of the analyzer. This can be Auto, where the analyzer determines the optimum setting, or Manual, where you determine the setting. This parameter can send up to 20 values. The location in the list sent corresponds to the range the value is associated with. Missing values are not permitted; that is, if you want to change values 2 and 6 you must send all values up to 6. Subsequent values will remain as they were. The query for this parameter always returns 20 values.

Key Path	Meas Setup, Range Table
Mode	SA, WCDMA, C2K, WIMAX OFDMA, TD-SCDMA, 1xEV-DO, DVB-T/H, LTE, LTETDD, WLAN, MSR, LTEAFDD, LTEATDD
Remote Command	<pre>[:SENSE] : SPURious [:RANGE] [:LIST] : BANDwidth : VIDeo <freq>, <freq>, <freq>, <freq>, <freq>, <freq>, <freq>, <freq>, <freq>, <freq>, <freq>, <freq>, <freq>, <freq>, <freq>, <freq>, <freq>, <freq>, <freq> [:SENSE] : SPURious [:RANGE] [:LIST] : BANDwidth : VIDeo? [:SENSE] : SPURious [:RANGE] [:LIST] : BANDwidth : VIDeo : AUTO OFF ON 0 1, OFF ON 0 1 [:SENSE] : SPURious [:RANGE] [:LIST] : BANDwidth : VIDeo : AUTO?</pre>
Example	<pre>SPUR:BAND:VID 1kHz, 10kHz, 100kHz, 1MHz, 1MHz, 1MHz, 1MHz, 3MHz, 3MHz, 3MHz, 3MHz, 3MHz, 3MHz, 3MHz, 3MHz, 3MHz, 3MHz, 3MHz, 3MHz, 3MHz, 3MHz SPUR:BAND:VID? SPUR:BAND:VID:AUTO ON, ON, OFF, OFF, OFF, ON, ON, ON, OFF, OFF, OFF, OFF, OFF, OFF, ON, ON, ON, ON, ON SPUR:BAND:VID:AUTO?</pre>
Notes	You must be in the cdma2000 mode, 1xEV-DO mode, TD-SCDMA mode, W-CDMA mode, DVB-T/H mode, GSM/EDGE mode, LTE mode, LTE TDD mode, WLAN mode, MSR, LTE-Advanced FDD/TDD mode or WiMAX mode to use this command. Use INSTRUMENT:SElect to set the mode.
Preset	<p>SA, WCDMA, C2K, WIMAX OFDMA, TD-SCDMA, 1xEV-DO, DVB-T/H WLAN: Automatically calculated</p> <p>LTE, MSR, LTEATDD: 4.7kHz, 47kHz, 470kHz, 5MHz, 470kHz, 5MHz, 5MHz, 300kHz, 300kHz, 300kHz, 300kHz, 300kHz, 300kHz, 300kHz, 300kHz, 300kHz, 300kHz, 300kHz, 300kHz, 300kHz, 300kHz</p> <p>LTETDD, LTEATDD: 4.7kHz, 47kHz, 470kHz, 5MHz, 470kHz, 5MHz, 5MHz, 300kHz, 300kHz, 300kHz, 300kHz, 300kHz, 300kHz, 300kHz, 300kHz, 300kHz, 300kHz, 300kHz, 300kHz, 300kHz, 300kHz</p> <p>ON, ON, ON, ON, ON, ON, ON, ON, ON, ON, ON, ON, ON, ON, ON, ON, ON, ON, ON, ON</p>

Abs Start Limit

Determines the limit above which spurs will report a failing. If Abs Stop Limit Mode is set to Auto, this is coupled to Abs Stop Limit to make a flat limit line. If set to Man, Abs Start Limit and Abs Stop Limit can take different values to make a sloped limit line.

If the Limit Line Test parameter is off then any spurs which are found to be above the current 'Peak Excursion' will be added to the results table. From these spurs, the amplitude will be checked using the abs limit start and abs limit stop parameters and then calculate the limit. An 'F' will be appended to the amplitude value of the spur if the measured amplitude is above the limit. If the Limit Line Test is on, only the spurs whose amplitudes exceed the limit will be reported.

This parameter can send up to 20 values. The location in the list sent corresponds to the range of the associated value. Missing values are not permitted. If you want to change values 2 and 6 you must send all values up to 6. Subsequent values will remain as they were. The query for this parameter always returns 20 values.

Key Path	Meas Setup, Range Table
Mode	SA, WCDMA, C2K, WIMAX OFDMA, TD-SCDMA, 1xEV-DO, DVB-T/H, LTE, LTETDD, WLAN, MSR, LTEAFDD, LTEATDD
Remote Command	:CALCulate:SPURious[:RANGe][:LIST]:LIMit:ABSolute[:UPPer]:DATA[:START] <ampl>, <ampl>, <ampl>, <ampl>, <ampl>, <ampl>, <ampl>, <ampl>, <ampl>, <ampl>, <ampl>, <ampl>, <ampl>, <ampl>, <ampl>, <ampl>, <ampl>, <ampl>, <ampl>, <ampl> :CALCulate:SPURious[:RANGe][:LIST]:LIMit:ABSolute[:UPPer]:DATA[:START]?
Example	CALC:SPUR:LIM:ABS:DATA 0, 0, 0, 0, 0, 0, 0, 0, 0, 0, 0, 0, 0, 0, 0, 0, 0, 0, 0, 0 CALC:SPUR:LIM:ABS:DATA?
Preset	SA, WIMAX OFDMA: -5.00000000E+001, -5.00000000E+001, -5.00000000E+001, -5.00000000E+001, -5.00000000E+001, -5.00000000E+001, -5.00000000E+001, -5.00000000E+001, -5.00000000E+001, -5.00000000E+001, -5.00000000E+001, -5.00000000E+001, -5.00000000E+001, -5.00000000E+001, -5.00000000E+001, -5.00000000E+001, -5.00000000E+001, -5.00000000E+001, -5.00000000E+001, -5.00000000E+001 WCDMA: -36dBm, -36dBm, -36dBm, -30dBm, -25dBm, -15dBm, -25dBm, -30dBm, -50dBm, -50dBm, -50dBm, -50dBm, -50dBm, -50dBm, -50dBm, -50dBm, -50dBm, -50dBm, -50dBm, -50dBm, -50dBm C2K, 1xEV-DO: -13 dBm, -13dBm, -13 dBm, -13 dBm, -50 dBm, -50 dBm, -50 dBm, -50 dBm, -50 dBm, -50 dBm, -50 dBm, -50 dBm, -50 dBm, -50 dBm, -50 dBm, -50 dBm, -50 dBm, -50 dBm, -50 dBm, -50 dBm TD-SCDMA: -13 dBm, -13dBm, -13 dBm, -13 dBm, -50 dBm, -50 dBm, -50 dBm, -50 dBm, -50 dBm, -50 dBm, -50 dBm, -50 dBm, -50 dBm, -50 dBm, -50 dBm, -50 dBm, -50 dBm, -50 dBm, -50 dBm, -50 dBm DVB-T/H: -36dBm, -82dBm, -36dBm, -76dBm, -36dBm, -30dBm, -50dBm, -50dBm, -50dBm, -50dBm, -50dBm, -50dBm, -50dBm, -50dBm, -50dBm, -50dBm, -50dBm, -50dBm, -50dBm, -50dBm, -50dBm LTE, MSR, LTEAFDD: -36dBm, -36dBm, -36dBm, -30dBm, -96dBm, -30dBm, -30dBm, -50dBm, -50dBm, -50dBm, -50dBm, -50dBm, -50dBm, -50dBm, -50dBm, -50dBm, -50dBm, -50dBm, -50dBm, -50dBm, -50dBm

	-50dBm, -50dBm, -50dBm, -50dBm, -50dBm, -50dBm, -50dBm, -50dBm, -50dBm, -50dBm, -50dBm, -50dBm
	LTETDD, LTEATDD: -36dBm, -36dBm, -36dBm, -30dBm, -96dBm, -30dBm, -30dBm, -50dBm, -50dBm, -50dBm, -50dBm, -50dBm, -50dBm, -50dBm, -50dBm, -50dBm, -50dBm, -50dBm, -50dBm
	WLAN: -36dBm, -36dBm, -36dBm, -30dBm, -50dBm, -50dBm, -50dBm, -50dBm, -50dBm, -50dBm, -50dBm, -50dBm, -50dBm, -50dBm, -50dBm, -50dBm, -50dBm, -50dBm, -50dBm
State Saved	Saved in instrument state.
Min	-150.0 dBm
Max	50.0 dBm
Initial S/W Revision	Prior to A.02.00
Modified at S/W Revision	A.03.00

Abs Stop Limit

Abs Stop Limit is used to determine the limit above which spurs will report a failing. If Abs Stop Limit Mode is set to Auto, this is coupled to Abs Start Limit to make a flat limit line. If set to Man, Abs Start Limit and Abs Stop Limit can take different values to make a sloped limit line.

Abs Stop Limit Mode, when set to Couple, couples Abs Start Limit and Abs Stop Limit to make a flat limit line. If set to Man, Abs Start and Abs Stop can take different values to make a sloped limit line.

This parameter can send up to 20 values. The location in the list sent corresponds to the range of the associated value. Missing values are not permitted; that is, if you want to change values 2 and 6 you must send all values up to 6. Subsequent values will remain as they were. The query for this parameter always returns 20 values.

Key Path	Meas Setup, Range Table
Mode	SA, WCDMA, C2K, WIMAX OFDMA, TD-SCDMA, 1xEV-DO, DVB-T/H, LTE, LTETDD, WLAN, MSR, LTEAFDD, LTEATDD
Remote Command	<pre> :CALCulate:SPURious[:RANGE][:LIST]:LIMit:ABSolute[:UPPer]:DATA:STOP <ampl>, <ampl>, <ampl>, <ampl>, <ampl>, <ampl>, <ampl>, <ampl>, <ampl>, <ampl>, <ampl>, <ampl>, <ampl>, <ampl>, <ampl>, <ampl>, <ampl>, <ampl>, <ampl>, <ampl>, <ampl>, <ampl> :CALCulate:SPURious[:RANGE][:LIST]:LIMit:ABSolute[:UPPer]:DATA:STOP? :CALCulate:SPURious[:RANGE][:LIST]:LIMit:ABSolute [:UPPer]:DATA:STOP:AUTO OFF ON 0 1, OFF ON 0 1 :CALCulate:SPURious[:RANGE][:LIST]:LIMit:ABSolute [:UPPer]:DATA:STOP:AUTO? </pre>
Example	CALC:SPUR:LIM:ABS:DATA:STOP -25, -25, -25, -25, -25, -25, -25, -25, -25, -25, -25, -

	25, -25, -25, -25, -25, -25, -25, -25 CALC:SPUR:LIM:ABS:DATA:STOP? CALC:SPUR:LIM:ABS:DATA:STOP:AUTO ON, ON CALC:SPUR:LIM:ABS:DATA:STOP:AUTO?
Preset	SA, WIMAX OFDMA: -5.00000000E+001, -5.00000000E+001, -5.00000000E+001, -5.00000000E+001, -5.00000000E+001, -5.00000000E+001, -5.00000000E+001, -5.00000000E+001, -5.00000000E+001, -5.00000000E+001, -5.00000000E+001, -5.00000000E+001, -5.00000000E+001, -5.00000000E+001, -5.00000000E+001, -5.00000000E+001, -5.00000000E+001, -5.00000000E+001 WCDMA: -36dBm, -36dBm, -36dBm, -30dBm, -25dBm, -15dBm, -25dBm, -30dBm, -50dBm, -50dBm, -50dBm, -50dBm, -50dBm, -50dBm, -50dBm, -50dBm, -50dBm, -50dBm, -50dBm, -50dBm, -50dBm, -50dBm C2K, 1xEV-DO: -13 dBm, -13dBm, -13 dBm, -13 dBm, -50 dBm, -50 dBm, -50 dBm, -50 dBm, -50 dBm, -50 dBm, -50 dBm, -50 dBm, -50 dBm, -50 dBm, -50 dBm, -50 dBm, -50 dBm, -50 dBm, -50 dBm, -50 dBm, -50 dBm, -50 dBm TD-SCDMA: -13 dBm, -13dBm, -13 dBm, -13 dBm, -50 dBm, -50 dBm, -50 dBm, -50 dBm, -50 dBm, -50 dBm, -50 dBm, -50 dBm, -50 dBm, -50 dBm, -50 dBm, -50 dBm, -50 dBm, -50 dBm, -50 dBm, -50 dBm, -50 dBm, -50 dBm DVB-T/H: -36dBm, -82dBm, -36dBm, -76dBm, -36dBm, -30dBm, -50dBm, -50dBm, -50dBm, -50dBm, -50dBm, -50dBm, -50dBm, -50dBm, -50dBm, -50dBm, -50dBm, -50dBm, -50dBm, -50dBm, -50dBm, -50dBm LTE, MSR, LTEAFDD: -36dBm, -36dBm, -36dBm, -30dBm, -96dBm, -30dBm, -30dBm, -50dBm, -50dBm, -50dBm, -50dBm, -50dBm, -50dBm, -50dBm, -50dBm, -50dBm, -50dBm, -50dBm, -50dBm, -50dBm, -50dBm, -50dBm LTETDD, LTEATDD: -36dBm, -36dBm, -36dBm, -52dBm, -52dBm, -30dBm, -30dBm, -50dBm, -50dBm, -50dBm, -50dBm, -50dBm, -50dBm, -50dBm, -50dBm, -50dBm, -50dBm, -50dBm, -50dBm, -50dBm, -50dBm, -50dBm WLAN: -36dBm, -36dBm, -36dBm, -30dBm, -50dBm, -50dBm, -50dBm, -50dBm, -50dBm, -50dBm, -50dBm, -50dBm, -50dBm, -50dBm, -50dBm, -50dBm, -50dBm, -50dBm, -50dBm, -50dBm, -50dBm, -50dBm, -50dBm ON, ON
State Saved	Saved in instrument state.
Min	-150.0 dBm
Max	50.0 dBm
Initial S/W Revision	Prior to A.02.00
Modified at S/W Revision	A.03.00

Peak Excursion

Sets the minimum amplitude variation of signals that can be identified as peaks. If a value of 6 dB is selected, peaks that rise and fall more than 6 dB above the peak threshold value are identified.

This parameter can send up to 20 values. The location in the list sent corresponds to the range of the associated value. Missing values are not permitted. If you want to change values 2 and 6 you must send all values up to 6. Subsequent values will remain as they were. The query for this parameter always returns 20 values.

Key Path	Meas Setup, Range Table
Mode	SA, WCDMA, C2K, WIMAX OFDMA, TD-SCDMA, 1xEV-DO, DVB-T/H, LTE, LTETDD, WLAN, MSR, LTEAFDD, LTEATDD
Remote Command	[:SENSe] :SPURious [:RANGe] [:LIST] :PEAK:EXCursion <rel_ampl>, <rel_ampl>, <rel_ampl>, <rel_ampl>, <rel_ampl>, <rel_ampl>, <rel_ampl>, <rel_ampl>, <rel_ampl>, <rel_ampl>, <rel_ampl>, <rel_ampl>, <rel_ampl>, <rel_ampl>, <rel_ampl>, <rel_ampl>, <rel_ampl>, <rel_ampl>, <rel_ampl>, <rel_ampl> [:SENSe] :SPURious [:RANGe] [:LIST] :PEAK:EXCursion?
Example	SPUR:PEAK:EXC 20, 20 SPUR:PEAK:EXC?
Preset	+6.00000000E+000, +6.00000000E+000, +6.00000000E+000, +6.00000000E+000, +6.00000000E+000, +6.00000000E+000, +6.00000000E+000, +6.00000000E+000, +6.00000000E+000, +6.00000000E+000, +6.00000000E+000, +6.00000000E+000, +6.00000000E+000, +6.00000000E+000, +6.00000000E+000, +6.00000000E+000, +6.00000000E+000, +6.00000000E+000, +6.00000000E+000, +6.00000000E+000
State Saved	Saved in instrument state.
Min	0.0 dB
Max	100.0 dB
Initial S/W Revision	Prior to A.02.00
Modified at S/W Revision	A.03.00

Pk Threshold

Sets the minimum amplitude of signals that can be identified as peaks. For example, if a value of -90 dBm is selected, only peaks that rise and fall more than the peak excursion value which are above -90 dBm are identified.

This parameter can send up to 20 values. The location in the list sent corresponds to the range of the associated value. Missing values are not permitted. If you want to change values 2 and 6 you must send all values up to 6. Subsequent values will remain as they were. The query for this parameter always returns 20 values.

Key Path	Meas Setup, Range Table
Mode	SA, WCDMA, C2K, WIMAX OFDMA, TD-SCDMA, 1xEV-DO, DVB-T/H, LTE, LTETDD, WLAN, MSR, LTEAFDD, LTEATDD
Remote Command	[:SENSe] :SPURious [:RANGe] [:LIST] :PEAK:THReshold <real>, <real>, <real>, <real>, <real>, <real>, <real>, <real>, <real>, <real>, <real>, <real>, <real>, <real>, <real>, <real>, <real>, <real>, <real>, <real>

	<pre><real>, <real>, <real>, <real>, <real>, <real>, <real>, <real>, <real>, <real>, <real>, <real>, <real>, <real>, <real>, <real>, <real> [:SENSe]:SPURious[:RANGe][:LIST]:PEAK:THReshold?</pre>
Example	<pre>SPUR:PEAK:THR 0,0,0 SPUR:PEAK:THR?</pre>
Preset	<pre>-9.00000000E+001, -9.00000000E+001, -9.00000000E+001, -9.00000000E+001, - 9.00000000E+001, -9.00000000E+001, -9.00000000E+001, -9.00000000E+001, - 9.00000000E+001, -9.00000000E+001, -9.00000000E+001, -9.00000000E+001, - 9.00000000E+001, -9.00000000E+001, -9.00000000E+001, -9.00000000E+001, - 9.00000000E+001, -9.00000000E+001, -9.00000000E+001, -9.00000000E+001</pre>
State Saved	Saved in instrument state.
Min	-200
Max	0
Initial S/W Revision	Prior to A.02.00
Modified at S/W Revision	A.03.00, A.07.00

Attenuation

Defines attenuation value for each range.

- When Auto state is ON, attenuation value under AMPTD Y Scale is used.
- When Auto state is OFF, this value is used as mechanical attenuation value without electric attenuation.

Key Path	Meas Setup, Range Table
Mode	SA, WCDMA, C2K, WIMAX OFDMA, TD-SCDMA, 1xEV-DO, DVB-T/H, LTE, LTETDD, WLAN, MSR, LTEAFDD, LTEATDD
Remote Command	<pre>[:SENSe]:SPURious[:RANGe][:LIST]:ATTenuation <rel_ampl>, <rel_ampl>, <rel_ampl>, <rel_ampl>, <rel_ampl>, <rel_ampl>, <rel_ampl>, <rel_ampl>, <rel_ampl>, <rel_ampl>, <rel_ampl>, <rel_ampl>, <rel_ampl>, <rel_ampl>, <rel_ampl>, <rel_ampl>, <rel_ampl>, <rel_ampl>, <rel_ampl>, <rel_ampl> [:SENSe]:SPURious[:RANGe][:LIST]:ATTenuation? [:SENSe]:SPURious[:RANGe][:LIST]:ATTenuation:AUTO OFF ON 0 1, OFF ON 0 1, OFF ON 0 1, OFF ON 0 1, OFF ON 0 1, OFF ON 0 1, OFF ON 0 1, OFF ON 0 1, OFF ON 0 1, OFF ON 0 1, OFF ON 0 1, OFF ON 0 1, OFF ON 0 1, OFF ON 0 1, OFF ON 0 1, OFF ON 0 1, OFF ON 0 1, OFF ON 0 1, OFF ON 0 1, OFF ON 0 1 [:SENSe]:SPURious[:RANGe][:LIST]:ATTenuation:AUTO?</pre>
Example	<pre>SPUR:ATT 10dB, 10dB, 10dB, 10dB, 10dB, 10dB, 10dB, 10dB, 10dB, 10dB, 10dB, 10dB, 10dB, 10dB, 10dB, 10dB, 10dB, 10dB, 10dB, 10dB SPUR:ATT? SPUR:ATT:AUTO 0, 0, 0, 0, 0, 0, 0, 0, 0, 0, 0, 0, 0, 0, 0, 0, 0, 0, 0, 0 SPUR:ATT:AUTO?</pre>

Sweep Time

Sets the sweep time mode of the analyzer. This can be Auto, where the analyzer determines the optimum setting, or Manual, where you determine the setting.

This parameter can send up to 20 values. The location in the list sent corresponds to the range of the associated value. Missing values are not permitted. If you want to change values 2 and 6 you must send all values up to 6. Subsequent values will remain as they were. The query for this parameter always returns 20 values.

Key Path	Meas Setup, Range Table
Mode	SA, WCDMA, C2K, WIMAX OFDMA, TD-SCDMA, 1xEV-DO, DVB-T/H, LTE, LTETDD, WLAN, MSR, LTEAFDD, LTEATDD
Remote Command	<pre>[[:SENSe]:SPURious[:RANGe][:LIST]:SWEep:TIME <time>, <time>, <time>, <time>, <time>, <time>, <time>, <time>, <time>, <time>, <time>, <time>, <time>, <time>, <time>, <time>, <time>, <time>, <time>, <time> [:SENSe]:SPURious[:RANGe][:LIST]:SWEep:TIME? [:SENSe]:SPURious[:RANGe][:LIST]:SWEep:TIME:AUTO OFF ON 0 1,OFF ON ON 0 1,OFF ON 0 1,OFF ON 0 1,OFF ON 0 1,OFF ON 0 1,OFF ON 0 1,OFF ON 0 1,OFF ON 0 1,OFF ON 0 1,OFF ON 0 1,OFF ON 0 1,OFF ON 0 1,OFF ON 0 1,OFF ON 0 1,OFF ON 0 1,OFF ON 0 1,OFF ON 0 1,OFF ON 0 1,OFF ON 0 1,OFF ON 0 1 [:SENSe]:SPURious[:RANGe][:LIST]:SWEep:TIME:AUTO?</pre>
Example	<pre>SPUR:SWE:TIME 10, 10 SPUR:SWE:TIME? SPUR:SWE:TIME:AUTO ON, ON, ON, ON, ON, ON, ON, ON, ON, ON, ON, ON, ON, ON, ON, ON, ON, ON, ON, ON SPUR:SWE:TIME:AUTO?</pre>
Notes	You must be in cdma2000 mode, TD-SCDMA mode, W-CDMA mode, DVB-T/H, SA mode, LTE mode, LTE TDD mode, WLAN mode, MSR, LTE-Advanced FDD/TDD mode or WiMAX mode to use this command. Use INSTRument:SElect to set the mode.
Preset	Automatically calculated
State Saved	Saved in instrument state.
Min	1.0E-3
Max	2.0E+3
Initial S/W Revision	Prior to A.02.00
Modified at S/W Revision	A.03.00

Points

Sets the number of points per sweep for the measurement. This parameter can send up to 20 values. The location in the list sent corresponds to the range of the associated value. Missing values are not permitted. If you want to change values 2 and 6 you must send all values up to 6. Subsequent values will remain as they were. The query for this parameter always returns 20 values.

The Points mode can be manual, where you determine the setting or auto, where the analyzer determines the number of trace points to ensure the sweep points resolution equals RBW/2. This is calculated using the following algorithm:

Points = (Stop Freq – Start Freq) / (ResBW / 2), with the computed values being clipped to a minimum of 601 and a maximum of 20001.

This parameter can send up to 20 values. The location in the list sent corresponds to the range the value is associated with. Missing values are not permitted; that is, if you want to change values 2 and 6 you must send all values up to 6. Subsequent values will remain as they were. The query for this parameter always returns 20 values.

Key Path	Meas Setup, Range Table
Mode	SA, WCDMA, C2K, WIMAX OFDMA, TD-SCDMA, 1xEV-DO, DVB-T/H, LTE, LTETDD, WLAN, MSR, LTEAFDD, LTEATDD
Remote Command	<pre>[:SENSe] :SPURious [:RANGe] [:LIST] :SWEep:POINts <integer> [:SENSe] :SPURious [:RANGe] [:LIST] :SWEep:POINts? [:SENSe] :SPURious [:RANGe] [:LIST] :SWEep:POINts:AUTO OFF ON 0 1, OFF ON 0 1, OFF ON 0 1, OFF ON 0 1, OFF ON 0 1, OFF ON 0 1, OFF ON 0 1, OFF ON 0 1, OFF ON 0 1, OFF ON 0 1, OFF ON 0 1, OFF ON 0 1, OFF ON 0 1, OFF ON 0 1, OFF ON 0 1, OFF ON 0 1, OFF ON 0 1, OFF ON 0 1, OFF ON 0 1, OFF ON 0 1 [:SENSe] :SPURious [:RANGe] [:LIST] :SWEep:POINts:AUTO?</pre>
Example	<pre>SPUR:SWE:POIN 1001,1001,1001 SPUR:SWE:POIN? SPUR:SWE:POIN:AUTO ON,ON,ON SPUR:SWE:POIN:AUTO?</pre>
Preset	<pre>SA, WIMAX OFDMA, DVB-T/H, WLAN: +601, +601 WCDMA: 601, 2985, 9700, 1100, 601, 601, 601, 10570, 601, 601, 601, 601, 601, 601, 601, 601, 601, 601, 601, 601 C2K: 601, 601, 9970, 11750, , 601, 601, 601, 601, 601, 601, 601, 601, 601, 601, 601, 601, 601, 601, 601, 601 CDMA1xEVDO: 601, 601, 9970, 11750, 601, 601, 601, 10570, 601, 601, 601, 601, 601, 601, 601, 601, 601, 601, 601, 601 TD-SCDMA: 601, 5970, 19400, 20001, 601, 601, 601, 601, 601, 601, 601, 601, 601, 601, 601, 601, 601, 601, 601, 601, 601 LTE, LTETDD, MSR, LTEAFDD, LTEATDD : Automatically calculated. WLAN: Automatically calculated. OFF, OFF, OFF, OFF, OFF, OFF, OFF, OFF, OFF, OFF, OFF, OFF, OFF, OFF, OFF, OFF, OFF, OFF, OFF LTE, LTETDD, WLAN, MSR, LTEAFDD, LTEATDD: ON, ON, ON, ON, ON, ON, ON, ON, ON, ON, ON, ON, ON, ON, ON, ON, ON, ON, ON</pre>
State Saved	Saved in instrument state.
Min	101

Max	20001
Initial S/W Revision	Prior to A.02.00
Modified at S/W Revision	A.03.00

IF Gain

Sets the IF Gain function to Auto, On (the extra 10 dB) or Off. These settings affect sensitivity and IF overloads. A switched IF amplifier with approximately 10 dB of gain is available. This amplifier takes full advantage of the RF dynamic range of the analyzer. When it can be turned on without an overload, the dynamic range is always better with the amplifier on than off.

Key Path	Meas Setup, Range Table
Dependencies	The IF Gain keys (FFT IF Gain and Swept IF Gain) have no effect when the U7227A USB Preamp is connected. This is not annotated or reflected on any softkey; there are no keys grayed out nor any SCPI locked out. The analyzer simply behaves as though both FFT IF Gain and Swept IF Gain are set to Low regardless of the setting on the keys.
Initial S/W Revision	Prior to A.02.00

IF Gain Auto

Activates the rules for auto IF Gain.

Mode	SA, WCDMA, C2K, WIMAX OFDMA, TD-SCDMA, 1xEV-DO, DVB-T/H, LTE, LTE4DD, WLAN, MSR, LTEAFDD, LTEATDD
Remote Command	[:SENSe] : SPURious : IF : GAIN : AUTO [: STATE] OFF ON 0 1, OFF ON 0 1, OFF ON 0 1, OFF ON 0 1, OFF ON 0 1, OFF ON 0 1, OFF ON 0 1, OFF ON 0 1, OFF ON 0 1, OFF ON 0 1, OFF ON 0 1, OFF ON 0 1, OFF ON 0 1, OFF ON 0 1, OFF ON 0 1, OFF ON 0 1, OFF ON 0 1 [:SENSe] : SPURious : IF : GAIN : AUTO [: STATE] ?
Example	SPUR:IF:GAIN:AUTO ON,ON SPUR:IF:GAIN:AUTO?
Couplings	When the sweep type is Swept, 'Auto' sets IF Gain to High Gain under any of the following conditions: the input attenuator is set to 0 dB, the preamp is turned on, or the Max Mixer Level is -20 dBm or lower. For other settings using the swept sweep type, auto sets IF Gain to Low Gain.
Preset	OFF, OFF
State Saved	Saved in instrument state.
Range	Auto Man
Initial S/W Revision	Prior to A.02.00
Modified at S/W Revision	A.03.00

IF Gain State

Selects the range of IF Gain.

Mode	SA, WCDMA, C2K, WIMAX OFDMA, TD-SCDMA, 1xEV-DO, DVB-T/H, LTE, LTE-TDD, WLAN, MSR, LTE-AFDD, LTE-TDD
Remote Command	[:SENSe] :SPURious:IF:GAIN[:STATe] OFF ON 0 1, OFF ON 0 1, OFF ON 0 1, OFF ON 0 1, OFF ON 0 1, OFF ON 0 1, OFF ON 0 1, OFF ON 0 1, OFF ON 0 1, OFF ON 0 1, OFF ON 0 1, OFF ON 0 1, OFF ON 0 1, OFF ON 0 1, OFF ON 0 1, OFF ON 0 1, OFF ON 0 1, OFF ON 0 1, OFF ON 0 1, OFF ON 0 1 [:SENSe] :SPURious:IF:GAIN[:STATe] ?
Example	SPUR:IF:GAIN ON,ON SPUR:IF:GAIN?
Preset	OFF, OFF, OFF, OFF, OFF, OFF, OFF, OFF, OFF, OFF, OFF, OFF, OFF, OFF, OFF, OFF, OFF, OFF
State Saved	Saved in instrument state.
Range	Low Gain (Best for Large Signals) High Gain (Best Noise Level)
Initial S/W Revision	Prior to A.02.00

Meas Type

Selects either Examine or Full measurement type. This parameter is coupled to the average mode. Therefore, if the examine measurement type is selected, the measurement sets the average mode to exponential. If the full measurement type is selected, the measurement sets the average mode to repeat. The behavior of each measurement type is described in the table below. When averaging is on, trace averaging is used as each active range is measured. Averaging is not used at any other time.

Type	Single	Continuous		
No Spurs Found	Spurs Found	No Spurs Found	Spurs Found	
Examine	All active ranges are measured. On completion the measurement is set to the idle state and the 'No Spurs' happening is displayed.	All active ranges are measured and the spurs found reported. On completion the measurement is set to the idle state and the trace containing the worst spur restored. The spur menu key is enabled. A marker is also added which is set to the frequency of the worst spur.	All active ranges are measured. On completion the SA remains set to last range checked with an active trace and the 'No Spurs' happening is displayed.	All active ranges are measured and the spurs found reported. On completion the SA is set to the range containing the worst spur found and continually sweeps this range. Note that the trace is continually updated but the metrics results aren't updated until restart to keep the initial results as references. Use marker readouts to refer the latest results. The spur menu key is enabled. A marker is also added which is set to the frequency of

Type	Single	Continuous		
No Spurs Found	Spurs Found	No Spurs Found	Spurs Found	the worst spur.
Full	All active ranges are measured. On completion measurement is set to idle state and the 'No Spurs' happening is displayed.	All active ranges are measured and spurs found reported. On completion the measurement is set to the idle state, displaying the trace of the last active range.	Measurement continually cycles through all active ranges.	All active ranges are measured and spurs found reported. On each cycle of the active ranges the spurs found are reset. This ensures any remote queries retrieve the trace data that matches the currently displayed results.

Key Path	Meas Setup
Mode	SA, WCDMA, C2K, WIMAX OFDMA, TD-SCDMA, 1xEV-DO, DVB-T/H, LTE, LTETDD, WLAN, MSR, LTEAFDD, LTEATDD
Remote Command	[:SENSe] :SPURious :TYPE EXAMine FULL [:SENSe] :SPURious :TYPE ?
Example	SPUR:TYPE FULL SPUR:TYPE ?
Preset	EXAMine
State Saved	Saved in instrument state.
Range	Examine Full
Initial S/W Revision	Prior to A.02.00
Modified at S/W Revision	A.03.00

Spur

Displays any spurs found. It is only enabled when the measurement type is set to examine and will turn on upon completion of a measurement. Once the Spur menu key has been enabled, you can view any spur. The measurement sets the analyzer to the range in which the currently selected spur was found. The range settings only changes if the spur selected is in a range which is different from the current range settings. A marker is used to identify the currently selected spur on the trace.

Key Path	Meas Setup
Mode	SA, WCDMA, C2K, WIMAX OFDMA, CDMA1xEVDO, TD-SCDMA, DVB-T/H, LTE, LTETDD, WLAN, MSR, LTEAFDD, LTEATDD
Remote Command	[:SENSe] :SPURious :SPUR <integer> [:SENSe] :SPURious :SPUR ?
Example	SPUR:SPUR 55

	SPUR:SPUR?
Preset	1
State Saved	No
Min	1
Max	200
Initial S/W Revision	Prior to A.02.00
Modified at S/W Revision	A.03.00

Spurious Report Mode

Selects the spurious report mode.

- Select Limit Line Test (LIMTest) to report only spurs above the limit line. Any spurs reported will cause the measurement to fail. See Abs Start Limit for more information.
- Select All Spurs (ALL) to report all spurs detected by Peak Threshold and Peak Excursion.
- Select Minimum Margin (MMARgin) to report only the spur with the minimum margin from the limit line. For the spur above the limit, its margin is defined as the negative margin. If there are more than one spurs above the limit, only one spur with the largest negative margin is reported.

Key Path	Meas Setup
Mode	SA, WCDMA, C2K, WIMAX OFDMA, TD-SCDMA, 1xEV-DO, DVB-T/H, LTE, LTETDD, WLAN, MSR, LTEAFDD, LTEATDD
Remote Command	[:SENSe] : SPURious : REPT : MODE ALL LIMTest MMARgin [:SENSe] : SPURious : REPT : MODE ?
Example	SPUR:REPT:MODE LIMIT SPUR:REPT:MODE?
Dependencies	MMARgin is available only when option N9060A-7FP is installed.
Preset	ALL
State Saved	Saved in instrument state.
Range	All Spurs Limit Test Minimum Margin
Initial S/W Revision	Prior to A.02.00
Modified at S/W Revision	A.03.00, A.11.00

Meas Preset

Restores all measurement parameters to their default values.

Key Path	Meas Setup
Mode	SA, WCDMA, C2K, WIMAX OFDMA, TD-SCDMA, 1xEV-DO, DVB-T/H, LTE, LTETDD, WLAN, MSR, LTEAFDD, LTEATDD

Remote Command	:CONFigure:SPURious
Example	CONF:SPUR
Initial S/W Revision	Prior to A.02.00
Modified at S/W Revision	A.03.00

Fast Spurious Meas (Remote Command only)

This command is provided as the backward compatibility SCPI command of the Fast Spurious Measurement. Since this command is another representation of Spurious Report Mode, this command is coupled with the command.

When set to ON, only spurs above the limit line are reported. This is the same as Spurious Report Mode "LIMTest".

When set to OFF, all detected spurs are reported. This is the same as Spurious Report Mode "ALL."

Mode	SA, WCDMA, C2K, WIMAX OFDMA, TD-SCDMA, 1xEV-DO, DVB-T/H, WLAN, MSR, LTEAFDD, LTEATDD
Remote Command	[:SENSe] :SPURious:FSMeas ON OFF 1 0 [:SENSe] :SPURious:FSMeas?
Example	SPUR:FSM ON SPUR:FSM?
Couplings	If SPUR:REPT:MODE is ALL, this parameter is OFF. If SPUR:REPT:MODE is LIMTest, this parameter is ON.
Preset	OFF
State Saved	Saved in instrument state.
Initial S/W Revision	A.04.00

12 Spurious Emissions Measurement
Mode

Mode

See "[Mode](#)" on page 288

Mode Preset

Returns the active mode to a known state.

Mode Preset does the following for the currently active mode:

- Aborts the currently running measurement.
- Brings up the default menu for the mode, with no active function.
- Sets measurement Global settings to their preset values for the active mode only.
- Activates the default measurement.
- Brings up the default menu for the mode.
- Clears the input and output buffers.
- Sets Status Byte to 0.

Mode Preset does not:

- Cause a mode switch
- Affect mode persistent settings
- Affect system settings
- See "[How-To Preset](#)" on page 1312 for more information.

Key Path	Front-panel key
Remote Command	:SYSTem:PRESet
Example	:SYST:PRES
Notes	*RST is preferred over :SYST:PRES for remote operation. *RST does a Mode Preset, as done by the :SYST:PRES command, and it sets the measurement mode to Single measurement rather than Continuous for optimal remote control throughput. Clears all pending OPC bits. The Status Byte is set to 0.
Couplings	A Mode Preset aborts the currently running measurement, activates the default measurement, and gets the mode to a consistent state with all of the default couplings set.
Backwards Compatibility Notes	In the X-Series, the legacy "Factory Preset" has been replaced with Mode Preset, which only presets the currently active mode, not the entire instrument. In the X-Series, the way to preset the entire instrument is by using System, Restore System Defaults All, which behaves essentially the same way as restore System Defaults does on ESA and PSA. There is also no "Preset Type" as there is on the PSA. There is a green Mode Preset front-panel key that does a Mode Preset and a white-with-green-letters User Preset front-panel key that does a User Preset. The old PRESet:TYPE command is ignored (without generating an error), and SYST:PRES without a parameter does a Mode Preset, which should cover most backward code compatibility issues. The settings and correction data under the Input/Output front-panel key (examples: Input Z Corr, Ext Amp Gain, etc.) are no longer part of any Mode, so they will not be preset by a Mode Preset. They are preset using Restore Input/Output Defaults, Restore System Defaults All. Note that because User Preset does a Recall State, and all of these settings are saved in State, they ARE recalled when using

	User Preset.
Initial S/W Revision	Prior to A.02.00

How-To Preset

The table below shows all possible presets, their corresponding SCPI commands and front-panel access (key paths). Instrument settings depend on the current measurement context. Some settings are local to the current measurement, some are global (common) across all the measurements in the current mode, and some are global to all the available modes. In a similar way, restoring the settings to their preset state can be done within the different contexts.

Auto Couple - is a measurement local key. It sets all Auto/Man parameter couplings in the measurement to Auto. Any Auto/Man selection that is local to other measurements in the mode will not be affected.

Meas Preset - is a measurement local key. Meas Preset resets all the variables local to the current measurement except the persistent ones.

Mode Preset - resets all the current mode's measurement local and measurement global variables except the persistent ones.

Restore Mode Defaults - resets ALL the Mode variables (and all the Meas global and Meas local variables), including the persistent ones.

Type Of Preset	SCPI Command	Front Panel Access
Auto Couple	:COUPle ALL	Auto Couple front-panel key
Meas Preset	:CONFigure:<Measurement>	Meas Setup Menu
Mode Preset	:SYSTem:PRESet	Mode Preset (green key)
Restore Mode Defaults	:INSTrument:DEFault	Mode Setup Menu
Restore All Mode Defaults	:SYSTem:DEFault MODes	System Menu; Restore System Default Menu
*RST	*RST	not possible (Mode Preset with Single)
Restore Input/Output Defaults	:SYSTem:DEFault INPUt	System Menu; Restore System Default Menu
Restore Power On Defaults	:SYSTem:DEFault PON	System Menu; Restore System Default Menu
Restore Alignment Defaults	:SYSTem:DEFault ALIGN	System Menu; Restore System Default Menu
Restore Miscellaneous Defaults	:SYSTem:DEFault MISC	System Menu; Restore System Default Menu
Restore All System Defaults	:SYSTem:DEFault [ALL] :SYSTem:PRESet:PERsistent	System Menu; Restore System Default Menu
User Preset	:SYSTem:PRESet:USER	User Preset Menu
User Preset All Modes	:SYSTem:PRESet:USER:ALL	User Preset Menu

Power On Mode Preset	:SYSTem:PON:TYPE MODE	System Menu
Power On User Preset	:SYSTem:PON:TYPE USER	System Menu
Power On Last State	:SYSTem:PON:TYPE LAST	System Menu

Mode Setup

See "[Mode Setup](#)" on page 320

Peak Search

Performs a peak search and opens the Peak Search menu. The Peak Search functions allow you to define specific search criteria to determine which signals can be considered peaks, excluding unwanted signals from the search.

Places the selected marker on the trace point with the maximum y-axis value for that marker's trace.

Key Path	Front-panel key
Mode	SA, WCDMA, C2K, WIMAX OFDMA, 1xEV-DO, DVB-T/H, LTE, LTETDD, WLAN, MSR, LTEAFDD, LTEATDD
Remote Command	:CALCulate:SPURious:MARKer[1] 2 ... 12:MAXimum
Example	CALC:SPUR:MARK2:MAX
Initial S/W Revision	Prior to A.02.00
Modified at S/W Revision	A.03.00

Next Peak

Moves the selected marker to the peak that has the next highest amplitude less than the current marker value.

Key Path	Peak Search
Mode	SA, WCDMA, C2K, WIMAX OFDMA, TD-SCDMA, 1xEV-DO, DVB-T/H, LTE, LTETDD, WLAN, MSR, LTEAFDD, LTEATDD
Remote Command	:CALCulate:SPURious:MARKer[1] 2 ... 12:MAXimum:NEXT
Example	CALC:SPUR:MARK2:MAX:NEXT
Initial S/W Revision	Prior to A.02.00
Modified at S/W Revision	A.03.00

Next Pk Right

Moves the selected marker to the nearest peak to the right of the current marker which meets all enabled peak criteria.

Key Path	Peak Search
Mode	SA, WCDMA, C2K, WIMAX OFDMA, TD-SCDMA, 1xEV-DO, DVB-T/H, LTE, LTETDD, WLAN
Remote Command	:CALCulate:SPURious:MARKer[1] 2 ... 12:MAXimum:RIGHT
Example	CALC:SPUR:MARK2:MAX:RIGH
Initial S/W Revision	Prior to A.02.00
Modified at S/W Revision	A.03.00

Next Pk Left

Moves the selected marker to the nearest peak to the left of the current marker which meets all enabled peak criteria.

Key Path	Peak Search
Mode	SA, WCDMA, C2K, WIMAX OFDMA, TD-SCDMA, 1xEV-DO, DVB-T/H, LTE, LTETDD, WLAN, MSR, LTEAFDD, LTEATDD
Remote Command	:CALCulate:SPURious:MARKer[1 2 ... 12:MAXimum:LEFT
Example	CALC:SPUR:MARK2:MAX:LEFT
Initial S/W Revision	Prior to A.02.00
Modified at S/W Revision	A.03.00

Marker Delta

Performs the same function as the Delta 1-of-N selection key in the Marker menu. This sets the control mode for the selected marker to Delta mode. See the Marker section for the complete description of this function. The key is duplicated here in the Peak Search Menu to allow you to conveniently perform a peak search and change the control of the Marker mode to Delta without having to access two separate menus.

Key Path	Peak Search
Initial S/W Revision	Prior to A.02.00

Pk-Pk Search

Finds and displays the amplitude and frequency (or time, if in zero span) differences between the highest and lowest y-axis value.

Key Path	Peak Search
Mode	SA, WCDMA, C2K, WIMAX OFDMA, TD-SCDMA, 1xEV-DO, DVB-T/H, LTE, LTETDD, WLAN, MSR, LTEAFDD, LTEATDD
Remote Command	:CALCulate:SPURious:MARKer[1 2 ... 12:PTPeak
Example	CALC:SPUR:MARK:PTP
Notes	Turns on the Marker Δ
Dependencies	This key is not available (key is grayed-out) when Coupled Markers is on.
Initial S/W Revision	Prior to A.02.00
Modified at S/W Revision	A.03.00

Min Search

Moves the selected marker to the minimum y-axis value on the current trace.

Key Path	Peak Search
Mode	SA, WCDMA, C2K, WIMAX OFDMA, TD-SCDMA, 1xEV-DO, DVB-T/H, LTE, LTETDD, WLAN, MSR, LTEAFDD, LTEATDD
Remote Command	:CALCulate:SPURious:MARKer[1] 2 ... 12:MINimum
Example	CALC:SPUR:MARK:MIN
Initial S/W Revision	Prior to A.02.00
Modified at S/W Revision	A.03.00

12 Spurious Emissions Measurement
Print

Print

See ["Print" on page 352](#)

Quick Save

The Quick Save front-panel key repeats the most recent save that was performed from the Save menu, with the following exceptions:

- Register saves are not remembered as Saves for the purpose of the Quick Save function
- If the current measurement does not support the last non-register save that was performed, an informational message is generated, “File type not supported for this measurement”

Quick Save repeats the last type of qualified save (that is, a save qualified by the above criteria) in the last save directory by creating a unique filename using the Auto File Naming algorithm described below.

If Quick Save is pressed after startup and before any qualified Save has been performed, the Quick Save function performs a Screen Image save using the current settings for Screen Image saves (current theme, current directory), which then becomes the “last save” for the purpose of subsequent Quick Saves.

The Auto File Naming feature automatically generates a file name for use when saving a file. The filename consists of a prefix and suffix separated by a dot, as is standard for the Windows® file system. A default prefix exists for each of the available file types:

Type	Default Prefix	Menu
State	State_	(Save/Recall)
Trace + State	State_	(Save/Recall)
Screen	Screen_	(Save/Recall)
Amplitude Corrections	Ampcor_	(Import/Export)
Traces	Trace_	(Import/Export)
Limit Lines	LLine_	(Import/Export)
Measurement Result	MeasR_	(Import/Export)
Capture Buffer	CapBuf_	(Import/Export)

A four digit number is appended to the prefix to create a unique file name. The numbering sequence starts at 0000 within each Mode for each file type and updates incrementally to 9999, then wraps to 0000 again. It remembers where it was through a Mode Preset and when leaving and returning to the Mode. It is reset by Restore Misc Defaults and Restore System Defaults and subsequent running of the instrument application. So, for example, the first auto file name generated for State files is State_0000.state. The next is State_0001, and so forth.

One of the key features of Auto File Name is that we guarantee that the Auto File Name will never conflict with an existing file. The algorithm looks for the next available number. If it gets to 9999, then it looks for holes. If it find no holes, that is no more numbers are available, it gives an error.

For example, if when we get to State_0010.state there is already a State_0010.state file in the current directory, it advances the counter to State_0011.state to ensure that no conflict will exist (and then it verifies that State_0011.state also does not exist in the current directory and advances again if it does, and so forth).

If you enter a file name for a given file type, then the prefix becomes the filename you entered instead of the default prefix, followed by an underscore. The last four letters (the suffix) are the 4-digit number.

For example, if you save a measurement results file as “fred.csv”, then the next auto file name chosen for a measurement results save will be fred_0000.csv.

NOTE

Although 0000 is used in the example above, the number that is used is actually the current number in the Meas Results sequence, that is, the number that would have been used if you had not entered your own file name.

NOTE

If the filename you entered ends with _dddd, where d=any number, making it look just like an auto file name, then the next auto file name picks up where you left off with the suffix being dddd + 1.

Key Path	Front-panel key
Notes	No remote command for this key specifically.
Initial S/W Revision	Prior to A.02.00

Recall

The Recall menu lets you choose what you want to recall, and where you want to recall it from. Among the types of files you can recall are **States and Traces**. In addition, an Import (Data) option lets you recall a number of data types stored in CSV files (as used by Excel and other spreadsheet programs).

The default paths for Recall are data type dependent and are the same as for the Save key.

Key Path	Front-panel key
Notes	<p>No remote command for this key specifically, but the :MMEM:LOAD command is available for specific file types. An example is :MMEM:LOAD:STATe <filename>.</p> <p>If you try to recall a State file for a mode that is not licensed or not available in the instrument, an error message will occur and the state will not change.</p>
Backwards Compatibility Notes	<p>In legacy analyzers, it was possible to load a state without affecting the trace data, limit lines or correction data. Similarly (since User Preset is actually loading a state), it was possible to do a User Preset without affecting the trace data, limit lines or correction data.</p> <p>In the X-Series, “state” always includes all of this data; so whenever state is loaded, all of the traces, limit lines and corrections are affected. Although this differs from previous behavior, it is desirable behavior, and should not cause adverse issues for users.</p>
Backwards Compatibility Notes	<p>Recall for the X-Series supports backward compatibility in the sense that you can recall a state file from any X-Series model number and any version of X-Series software. This is only possible if part of the recalling process goes through a limiting step after recalling the mode settings, at least for settings that may vary with version number, model number, option and license differences. If you try to recall a state file onto an instrument with less capability than what was available on the instrument during the save, the recall will ignore the state it doesn't support and it will limit the recalled setting to what it allows.</p> <p>Example: if the saved state includes preamp ON, but the recalling instrument does not have a preamp; the preamp is limited to OFF. Conversely, if you save a state without a preamp, the preamp is OFF in the state file. When this saved file is recalled on an instrument with a licensed preamp, the preamp is changed to OFF. Another example is if the saved state has center frequency set to 20 GHz, but the instrument recalling the saved state is a different model and only supports 13.5 GHz. In this case, the center frequency is limited along with any other frequency based settings. Since the center frequency can't be preserved in this case, the recall limiting tries to at least preserve span to keep the measurement setup as intact as possible.</p> <p>It may be appropriate to issue a warning if the state is limited on the recall; warnings do not go out to SCPI so this would only affect the manual user.</p> <p>Note that there is no state file compatibility outside of the X-Series. For example, you cannot recall a state file from ESA or PSA.</p>
Initial S/W Revision	Prior to A.02.00

State

The Recall State menu lets you choose a register or file from which to recall the state.

The content of a state file includes all of the settings and data required to return the analyzer as closely as possible to the Mode it was in, with the exact settings that were in place, when the save occurred. The Mode settings in each state file include the settings that are affected by Mode Preset, as well as the

additional settings affected by Restore Mode Defaults; all of the Mode's settings. In addition, all of the settings of the Input/Output system are included, even though they are outside of the Mode's state, because they are needed to restore the complete setup. Persistent System settings (for example, GPIB address) are not affected by either a Mode Preset or Restore Mode Defaults, nor are they included in a saved State file.

Since each state file is only for one Mode, the settings for other Modes are unaffected when it is loaded. Recall State will cause a mode switch if the state being recalled is not from the current active mode.

After the recall completes, the message "File <filename> recalled" or "Recalled State Register <register number>" is displayed.

For rapid recalls, the State menu lists 16 registers that you can choose from to recall. Pressing a Register key initiates the recall. You can also select a file from which to recall.

The default path for all State Files is:

My Documents\<<mode name>\state

where <mode name> is the parameter used to select the mode with the INST:SEL command (for example, SA for the Spectrum Analyzer).

See "[More Information](#)" on page 1323.

Key Path	Recall
Mode	All
Remote Command	:MMEMory:LOAD:STATe <filename>
Example	:MMEM:LOAD:STAT "myState.state" This recalls the file myState.state on the default path
Example	MMEM:LOAD:STAT "MyStateFile.state" This loads the state file data (on the default file directory path) into the instrument state.
Notes	<p>When you pick a file to recall, the analyzer first verifies that the file is recallable in the current instrument by checking the software version and model number of the instrument. If everything matches, a full recall proceeds by aborting the currently running measurement, clearing any pending operations, and then loading the State from the saved state file. You can open state files from any mode, so recalling a State file switches to the mode that was active when the save occurred. After switching to the mode of the saved state file, mode settings and data (if any for the mode) are loaded with values from the saved file. The saved measurement of the mode becomes the newly active measurement and the data relevant to the measurement (if there is any) is recalled.</p> <ul style="list-style-type: none"> • If there is a mismatch between file version or model number or instrument version or model number, the recall function tries to recall as much as possible and returns a warning message. It may limit settings that differ based on model number, licensing or version number. <p>After recalling the state, the Recall State function does the following:</p> <ul style="list-style-type: none"> • Makes the saved measurement for the mode the active measurement. • Clears the input and output buffers. • Status Byte is set to 0. • Executes a *CLS <p>If the file specified is empty an error is generated. If the specified file does not exist, another error is generated. If there is a mismatch between the file and the proper file type, an error is generated. If</p>

	there is a mismatch between file version or model number or instrument version or model number, a warning is displayed. Then it returns to the State menu and File Open dialog goes away. After the Recall, the analyzer exits the Recall menu and returns to the previous menu.
Backwards Compatibility SCPI	:MMEMory:LOAD:STATe 1,<filename> For backwards compatibility, the above syntax is supported. The "1" is simply ignored.
Initial S/W Revision	Prior to A.02.00

More Information

In measurements that support saving Traces, for example, Swept SA, the Trace data is saved along with the State in the State file. When recalling the State, the Trace data is recalled as well. Traces are recalled exactly as they were stored, including the writing mode and update and display modes. If a Trace was updating and visible when the State was saved, it will come back updating and visible, and its data will be rewritten right away. When you use State to save and recall traces, any trace whose data must be preserved should be placed in View or Blank mode before saving.

The following table describes the Trace Save and Recall possibilities:

You want to recall state and one trace's data, leaving other traces unaffected.	Save Trace+State from 1 trace. Make sure that no other traces are updating (they should all be in View or Blank mode) when the save is performed.	On Recall, specify the trace you want to load the one trace's data into. This trace will load in View. All other traces' data will be unaffected, although their trace mode will be as it was when the state save was performed.
You want to recall all traces	Save Trace+State from ALL traces.	On Recall, all traces will come back in View (or Blank if they were in Blank or Background when saved)
You want all traces to load exactly as they were when saved.	Save State	On recall, all traces' mode and data will be exactly as they were when saved. Any traces that were updating will have their data immediately overwritten.

From File...

When you press "From File", the analyzer brings up a Windows dialog and a menu entitled "File Open." This menu allows you to navigate to the various fields in the Windows dialog without using a keyboard or mouse. The Tab and Arrow keys can also be used for dialog navigation.

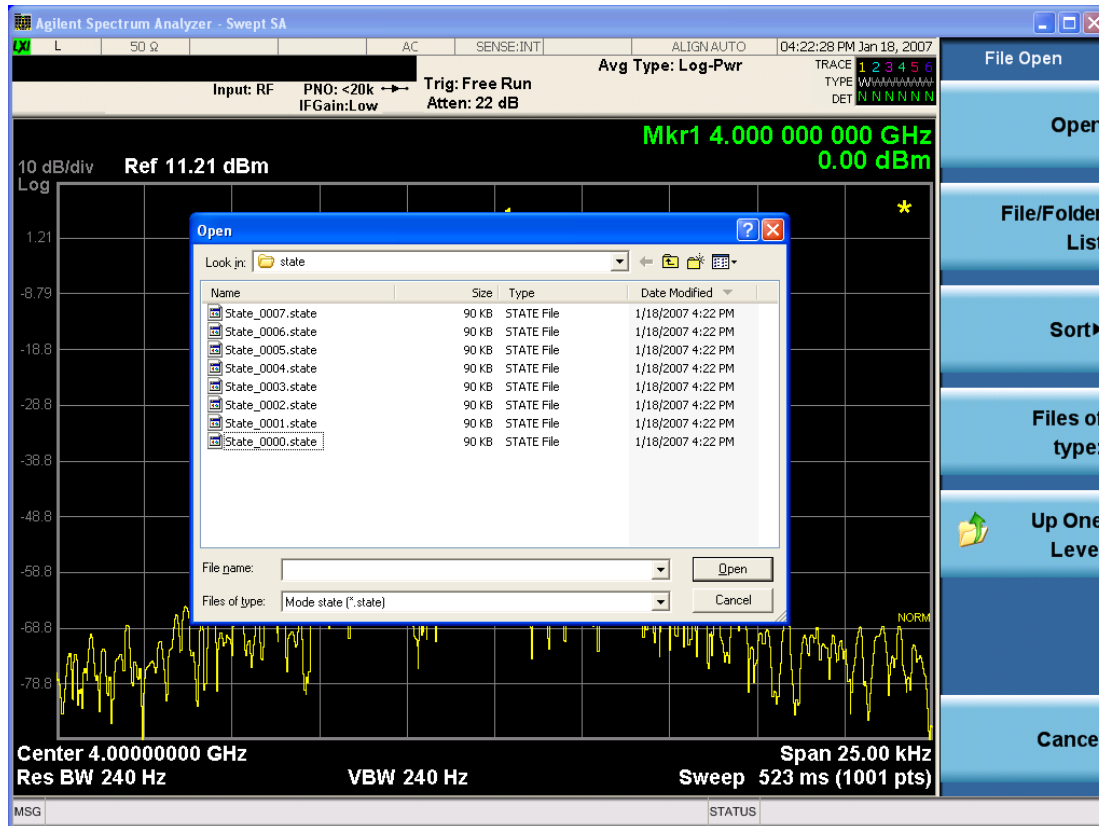

Listed below are the functions of the various fields in the dialog, and the corresponding softkeys:

Open

Performs the recall of the specified file. While the recall is being performed, the floppy icon appears briefly in the Meas bar.

File/Folder List

Enables you to navigate to the center of the dialog that contains the list of files and folders. Once here you can get information about the file and use the tab keys to navigate to the other fields in the dialog, such as Look In.

Look In

The Look In field shows the path from which the file will be recalled and allows you to change the path using the up and down arrow keys to navigate to other paths; the Enter key to open a directory; and the Backspace key to go back one directory. The **Look In field** first uses the last path from the Save As dialog **Save In:** path for that same file type. There is no softkey for directly navigating to the Look In field, but you can use the left tab to get here from the File/Folder List.

User specified paths are remembered when you leave and return to a Mode and are reset back to the default using Restore Mode Defaults.

Sort

Accesses a menu that enables you to sort the files within the File Open dialog. Only one sorting type can be selected at a time and the sorting happens immediately. The sorting types are By Date, By Name, By extension, and By Size.

Files of Type

This field shows the file suffix for the type of file you have selected to recall. For example, if you navigated here while recalling State, "Mode state (*.state)" is in the field. If you navigated here while recalling Trace, ""Mode state (*.trace)" is in the field. If you navigated here while importing a trace data file, "Trace Data (*.csv)" is in the field. For some file types, there is more than one choice in the dropdown menu, which you can select by using the up and down arrow keys and Enter.

Up One Level

This key corresponds to the icon of a folder with the up arrow that is in the tool bar of the dialog. When pressed, it causes the file and folder list to navigate up one level in the directory structure. The Backspace key does the same thing.

Cancel

This key corresponds to the Cancel selection in the dialog. It causes the current **Open** request to be cancelled. The ESC key does the same thing.

Key Path	Recall, State
Notes	Brings up the Open dialog for recalling a State Save Type
Initial S/W Revision	Prior to A.02.00

Edit Register Names

You may enter a custom name on any of the Register keys, to help you remember what you are using that state to save. To do this, press the Edit Register Names key, choose the register whose name you wish to edit, and then enter the desired label using the Alpha Editor or an external PC keyboard.

The maximum number of characters that can be added is 30. In most cases, 30 characters will fit on two lines of the key.

For more information and the SCPI command, see Edit Register Names under the Save, State function.

Key Path	Recall, State
Mode	All
Dependencies	N9060A-7FP or N9060B-2FP license required to edit the register names. When the feature is not licensed, sending the SCPI command generates an error, -221, "Settings conflict;Option not available"
Initial S/W Revision	A.11.00

Register 1 thru Register 16

Selecting any one of these register keys causes the State of the mode from the specified Register to be recalled. Each of the register keys annotates whether it is empty or at what date and time it was last

modified. In addition, you can use the Edit Register Names key under Save, State to enter custom names for each register.

Registers are shared by all modes, so recalling from any one of the registers will cause a mode switch to the mode that was active when the save to the Register occurred.

Although these 16 registers are the only registers available from the front panel, there are 128 state registers available in the instrument. Registers 17–128 are only available from the SCPI interface, using the *RCL command.

After the recall completes, the message "Register <register number> recalled" appears in the message bar. If you are in the Spectrum Analyzer Mode, and you are recalling a register that was saved in the Spectrum Analyzer Mode, then after the recall, you will still be in the Recall Register menu. If the Recall causes you to switch modes, then after the Recall, you will be in the Frequency menu.

If a requested register is empty an error is generated.

Key Path	Recall, State
Example	*RCL 1
Range	1–16 from front panel, 1–128 from SCPI
Readback	Date and time with seconds resolution are displayed on the key OR A custom name of up to 30 characters entered using the Save, State, Edit Register Names key OR “(empty)” if no prior save operation has been performed to this register.
Initial S/W Revision	Prior to A.02.00
Modified at S/W Revision	Prior to A.11.00

Register 1 thru Register 16

Selecting any one of these register keys causes the State of the mode from the specified Register to be recalled. Each of the register keys annotates whether it is empty or at what date and time it was last modified. In addition, you can use the Edit Register Names key under Save, State to enter custom names for each register.

Registers are shared by all modes, so recalling from any one of the registers will cause a mode switch to the mode that was active when the save to the Register occurred.

Although these 16 registers are the only registers available from the front panel, there are 128 state registers available in the instrument. Registers 17–128 are only available from the SCPI interface, using the *RCL command.

After the recall completes, the message "Register <register number> recalled" appears in the message bar. If you are in the Spectrum Analyzer Mode, and you are recalling a register that was saved in the Spectrum Analyzer Mode, then after the recall, you will still be in the Recall Register menu. If the Recall causes you to switch modes, then after the Recall, you will be in the Frequency menu.

If a requested register is empty an error is generated.

Key Path	Recall, State
Example	*RCL 1
Range	1-16 from front panel, 1-128 from SCPI
Readback	Date and time with seconds resolution are displayed on the key OR A custom name of up to 30 characters entered using the Save, State,Edit Register Names key OR “(empty)” if no prior save operation has been performed to this register.
Initial S/W Revision	Prior to A.02.00
Modified at S/W Revision	Prior to A.11.00

Data (Import)

Importing a data file loads data that was previously saved from the current measurement or from other measurements and/or modes that produce compatible data files. The Import Menu only contains Data Types that are supported by the current measurement.

Since the commonly exported data files are in .csv format, the data can be edited by the user prior to importing. This allows you to export a data file, manipulate the data in Excel (the most common PC Application for manipulating .csv files) and then import it.

Importing Data loads measurement data from the specified file into the specified or default destination, depending on the data type selected. Selecting an Import Data menu key will not actually cause the importing to occur, since the analyzer still needs to know from where to get the data. Pressing the Open key in this menu brings up the Open dialog and Open menu that provides you with the options from where to recall the data. Once a filename has been selected or entered in the Open menu, the recall occurs as soon as the Open button is pressed.

Key Path	Recall
Mode	All
Notes	The menu is built from whatever data types are available for the mode. Some keys will be missing completely, so the key locations in the sub-menu will vary. No SCPI command directly controls the Data Type that this key controls. The Data Type is included in the MMEM:LOAD commands.
Dependencies	If a file type is not used by a certain measurement, it is grayed out for that measurement. The key for a file type will not show at all if there are no measurements in the Mode that support it.
Preset	Is not affected by Preset or shutdown, but is reset during Restore Mode Defaults
Readback	The data type that is currently selected
Initial S/W Revision	Prior to A.02.00

Masks

This key enables you to recall a preset mask file from the list. It is only available in SEM measurement under the Data menu: Limit Mask. Limit Mask enables setting a preset limit mask for 802.11p 5MHz and 10MHz system.

You cannot change or create the preset mask file since it is a binary file. This key is valid for the Spectrum Emission Mask measurement.

File location: "My Documents\WLAN\data\masks"

Note that "**My Documents**" is an alias to a directory and its location depends on which user is logged in. At XSA start up, all of the limit mask files in the current user's "My Documents\WLAN\data\masks" directory are overwritten.

File type: Binary

Filename:

11p_5MHz_A.mask

11p_5MHz_B.mask

11p_5MHz_C.mask

11p_5MHz_D.mask

11p_10MHz_A.mask

11p_10MHz_B.mask

11p_10MHz_C.mask

11p_10MHz_D.mask

File extension: .mask

Selecting OPEN under the Import Data menu, opens the above directory enabling you to select a mask file.

Example:

File Location: My Documents/WLAN/data/masks

File Name: 11p_5MHz_A.mask

Key Path	Recall, Data
Mode	WLAN
Remote Command	MMEMOry:LOAD:MASK <string>
Example	MMEM:LOAD:MASK "11p_5MHz_A.mask"
Initial S/W Revision	A.11.00

Capture Buffer

Capture buffer functionality is only available when measurement is Mod Accuracy and radio standard is not 802.11ac 80+80MHz. The captured data is raw data which is not processed.

Key Path	Recall, Data
Mode	WLAN
Example	MMEM:LOAD:CAPT "MyCaptureData.bin" This loads the file of capture data (on the default file directory path) into the instrument.
Dependencies	Capture buffer data is only available when measurement is Mod Accuracy and radio standard is not 802.11ac 80+80MHz. In other situation, this key is grayed out.
Initial S/W Revision	A.11.00

Open...

When you press "Open", the analyzer brings up a Windows dialog and a menu entitled "File Open." This menu allows you to navigate to the various fields in the Windows dialog without using a keyboard or mouse. The Tab and Arrow keys can also be used for dialog navigation.

See "[From File...](#)" on page 2263 in Recall, State, for a full description of this dialog and menu.

Key Path	Recall, Data
Notes	The key location is mode-dependent and will vary. Brings up Open dialog for recalling a <mode specific> Save Type
Initial S/W Revision	Prior to A.02.00

Restart

The Restart function restarts the current sweep, or measurement, or set of averaged/held sweeps or measurements. If you are Paused, pressing Restart does a Resume.

The Restart function is accessed in several ways:

- Pressing the Restart key
- Sending the remote command INIT:IMMediate
- Sending the remote command INIT:REStart

See "[More Information](#)" on page 1330

Key Path	Front-panel key
Remote Command	:INITiate[:IMMediate] :INITiate:REStart
Example	:INIT:IMM :INIT:REST
Notes	:INITiate:REStart and :INITiate:IMMediate perform exactly the same function.
Couplings	Resets average/hold count k. For the first sweep overwrites all active (update=on) traces with new current data. For application modes, it resets other parameters as required by the measurement.
Status Bits/OPC dependencies	This is an Overlapped command. The STATus:OPERation register bits 0 through 8 are cleared. The STATus:QUESTionable register bit 9 (INTegrity sum) is cleared. The SWEEPING bit is set. The MEASURING bit is set.
Backwards Compatibility Notes	For Spectrum Analysis mode in ESA and PSA, the Restart hardkey and the INITiate:REStart command restart trace averages (displayed average count reset to 1) for a trace in Clear Write, but did not restart Max Hold and Min Hold. In the X-Series, the Restart hardkey and the INITiate:REStart command restart not only Trace Average, but MaxHold and MinHold traces as well. For wireless comms modes in ESA and PSA, the Restart hardkey and the INITiate:REStart command restart every measurement, which includes all traces and numeric results. There is no change to this operation.
Initial S/W Revision	Prior to A.02.00

More Information

The **Restart** function first aborts the current sweep/measurement as quickly as possible. It then resets the sweep and trigger systems, sets up the measurement and initiates a new data measurement sequence with a new data acquisition (sweep) taken once the trigger condition is met.

If the analyzer is in the process of aligning when **Restart** is executed, the alignment finishes before the restart function is performed.

Even when set for Single operation, multiple sweeps may be taken when Restart is pressed (for example, when averaging/holding is on). Thus when we say that **Restart** "restarts a measurement," we may mean:

- It restarts the current sweep
- It restarts the current measurement
- It restarts the current set of sweeps if any trace is in Trace Average, Max Hold or Min Hold
- It restarts the current set of measurements if Averaging, or Max Hold, or Min Hold is on for the measurement
- depending on the current settings.

With **Average/Hold Number** (in **Meas Setup** menu) set to 1, or Averaging off, or no trace in Trace Average or Hold, a single sweep is equivalent to a single measurement. A single sweep is taken after the trigger condition is met; and the analyzer stops sweeping once that sweep has completed. However, with **Average/Hold Number** >1 and at least one trace set to **Trace Average, Max Hold, or Min Hold (SA Measurement)** or **Averaging on (most other measurements)**, multiple sweeps/data acquisitions are taken for a single measurement. The trigger condition must be met prior to each sweep. The sweep is stopped when the average count k equals the number N set for **Average/Hold Number**. A measurement average usually applies to all traces, marker results, and numeric results; but sometimes it only applies to the numeric results.

Once the full set of sweeps has been taken, the analyzer will go to idle state. To take one more sweep without resetting the average count, increment the average count by 1, by pressing the step up key while **Average/Hold Number** is the active function, or sending the remote command `CALC:AVER:TCON UP`.

Save

The Save menu lets you choose what you want to save and where you want to save it. Among the types of files you can save are **States**, **Traces**, and **Screen Images**. In addition, an Export (Data) option lets you save a number of data types as CSV files for easy import into Excel and other spreadsheet programs.

Key Path	Front-panel key
Mode	All
Notes	No remote command for this key specifically, but the :MMEM:STORe command is available for specific file types. An example is :MMEM:STOR:STATe <filename>.
Initial S/W Revision	Prior to A.02.00

State

The Save State menu lets you choose a register or file for saving the state.

The content of a state file includes all of the settings and data required to return the analyzer as closely as possible to the Mode it was in, with the exact settings which were in place, when the save occurred. The Mode settings in each state file include the settings that are affected by Mode Preset, as well as the additional settings affected by Restore Mode Defaults; all of the Mode's settings. In addition, all of the settings of the Input/Output system are included, even though they are outside of the Mode's state, because they are needed to restore the complete setup. Persistent System settings (for example, Verbose SCPI) are not affected by either Mode Preset or Restore Mode Defaults, nor are they included in a saved State file.

After the save completes, the message "File <filename> saved" or "State Register <register number> saved" is displayed.

For rapid saving, the State menu lists 16 registers to save to. Pressing a Register key initiates the save. You can also select a file to save to.

The default path for all State Files is:

My Documents\<<mode name>\state

where <mode name> is the parameter used to select the mode with the INST:SEL command (for example, SA for the Spectrum Analyzer).

Key Path	Save
Mode	All
Remote Command	:MMEMory:STORe:STATe <filename>
Example	MMEM:STOR:STATe "MyStateFile.state" This stores the current instrument state data in the file MyStateFile.state in the default directory.
Notes	Both single and double quotes are supported for any filename parameter over remote. After saving to a register, that register's menu key is updated with the date the time, unless a custom label has been entered for that key. After saving to a register, you remain in the Save State menu, so that you can see the Register key

update. After saving to a file, the analyzer automatically returns to the previous menu and any Save As dialog goes away.

Backwards Compatibility SCPI	:MMEMoRY:STORe:STATe 1,<filename>
Initial S/W Revision	Prior to A.02.00

To File . . .

When you press “To File”, the analyzer brings up a Windows dialog and a menu entitled “**Save As.**” This menu allows you to navigate to the various fields in the Windows dialog without using a keyboard or mouse. The Tab and Arrow keys can also be used for dialog navigation.

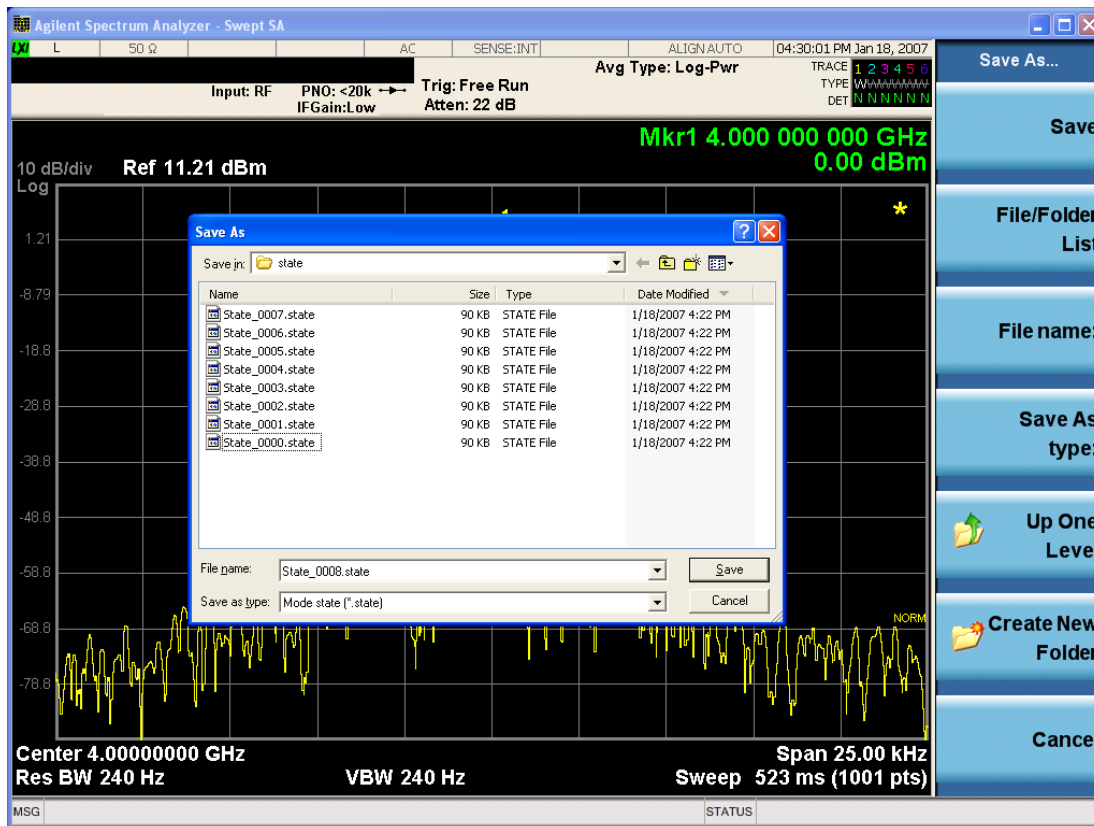

The Listed below

are the functions of the various fields in the dialog, and the corresponding softkeys:

Save

Performs the save to the specified file of the selected type. If the file already exists, a dialog will appear that allows you to replace the existing file by selecting OK, or you can Cancel the request. If you select OK, the file will be overwritten. Using the C: drive is strongly discouraged, since it runs the risk of being overwritten during an instrument software upgrade.

While the save is being performed, the floppy icon appears briefly in the Meas bar.

File/Folder List

Enables you to navigate to the center of the dialog that contains the list of files and folders. Once here you can get information about the file and use the tab keys to navigate to the other fields in the dialog, such as Save In.

Save In

The Save In field shows the path to which the file will be saved and allows you to change the path using the up and down arrow keys to navigate to other paths; the Enter key to open a directory; and the Backspace key to go back one directory. The **Save In field** defaults to the default path for this type of file and remembers the last path you used to save this type of file. There is no softkey for directly navigating to the Save In field but you can use left tab to get here from the File/Folder List.

User specified paths are remembered when you leave and return to a Mode and are reset back to the default using Restore Mode Defaults.

File Name

The File Name field is initially loaded with an automatically generated filename specific to the appropriate Save Type. The automatically generated filename is guaranteed not to conflict with any filename currently in the directory. You may replace or modify this filename using the File Name key. See the ["Quick Save " on page 2259](#) documentation for more on the automatic file naming algorithm.

When you press the File Name key the analyzer displays the Alpha Editor. Use the knob to choose the letter to add and the front-panel Enter key to add the letter to the file name. The BK character moves you back and the FW character moves you forward in the filename. The Select key on the front panel generates a space character. When you are done entering the filename press the Done softkey. This returns back to the **File Open** dialog and menu, but does not cause the save to occur.

Save As Type

This field shows the file suffix for the type of file you have selected to save. For example, if you navigated here while saving State, "Mode state (*.state)" is in the field. If you navigated here from saving Trace, ""Mode state (*.trace)" is in the field. If you navigated here while exporting a trace data file, "Trace Data (*.csv)" is in the field. For some file types, there is more than one choice in the dropdown, which you can select by using the up and down arrow keys and Enter.

Up One Level

This key corresponds to the icon of a folder with the up arrow that is in the tool bar of the dialog. When pressed, it causes the file and folder list to navigate up one level in the directory structure. The Backspace key does the same thing.

Create New Folder

This key corresponds to the icon of a folder with the "*" that is in the tool bar of the dialog. When pressed, a new folder is created in the current directory with the name **New Folder** and you can enter a new folder name using the Alpha Editor.

Cancel

This key corresponds to the Cancel selection in the dialog. It causes the current **Save As** request to be cancelled. The ESC key does the same thing.

Key Path	Save, State
Mode	All
Notes	Brings up Save As dialog for saving a State Save Type
Initial S/W Revision	Prior to A.02.00

Edit Register Names

You may enter a custom name on any of the Register keys, to help you remember what you are using that state to save. To do this, press the Edit Register Names key, choose the register whose name you wish to edit, and then enter the desired label using the Alpha Editor or an external PC keyboard.

The maximum number of characters that can be added is 30. In most cases, 30 characters will fit on two lines of the key.

See ["More Information" on page 1335](#)

Key Path	Save, State
Mode	All
Remote Command	:MMEMory:REGister:STATe:LABel <reg number>,"label" :MMEMory:REGister:STATe:LABel? <reg number>
Example	:MMEM:REG:STAT:LAB 1,"my label"
Notes	<reg number> is an integer from 1 to 16. If the SCPI specifies an invalid register number an error message is generated, -222,"Data out of range;Invalid register label number" "label" is a string from 0 to 30 characters in length. If a label exceeds 30 characters, an error message is generated, -150,"String data error;Label clipped to 30 characters" "label" of length 0 erases the custom label and restores the default (time and date) label. E.g.: :MMEM:REG:STAT:LAB 1,""
Dependencies	N9060A-7FP or N9060B-2FP license required to edit the register names. When the feature is not licensed, sending this command generates an error, -221,"Settings conflict;Option not available"
Preset	The names are unaffected by Preset or power cycle but are set to the default label (time and date) on a "Restore System Defaults->Misc"
Initial S/W Revision	A.11.00

More Information

When you edit one of the register names, the time and date field will be replaced by the custom name.

If you delete all the characters in the custom name, it restores the default (time and date).

The register names are stored within the state files, but they are not part of the instrument state; that is, once you have edited a register name, loading a new state will not change that register name. Another consequence of this is that the names will be persistent through a power cycle. Also, if a named state file is transferred to another analyzer, it will bring its custom name along with it.

If you try to edit the name of an empty register, the analyzer will first save the state to have a file to put the name in. If you load a named state file into an analyzer with older firmware it will ignore the metadata.

The *SAV and *RCL commands will not be affected by the custom register names, nor will the MMEM commands.

Register 1 thru Register 16

Selecting any one of these register menu keys causes the State of the currently active mode to be saved to the specified Register. The registers are provided for rapid saving and recalling, since you do not need to specify a filename or navigate to a file. Each of the register menu keys annotates whether it is empty or at what date and time it was last modified. In addition, you can use the Edit Register Names key to enter custom names for each register.

Although these 16 registers are the only registers available from the front panel, there are 128 state registers available in the instrument. Registers 17–128 are only available from the SCPI interface, using the *SAV command.

There is one set of 128 state registers in the instrument, not one set for each Mode. When a state is saved, the Mode it was saved from is saved with it; then when it is recalled, the instrument switches to that Mode.

After the save completes, the corresponding register menu key annotation is updated with the date and time and the message "Register <register number> saved" is displayed.

Key Path	Save, State
Mode	All
Example	*SAV 1
Range	1–16 from front panel, 1–128 from SCPI
Readback	Date and time with seconds resolution are displayed on the key OR A custom name of up to 30 characters entered using the Edit Register Names key OR “(empty)” if no prior save operation has been performed to this register.
Initial S/W Revision	Prior to A.02.00
Modified at S/W Revision	A.11.00

Register 1 thru Register 16

Selecting any one of these register menu keys causes the State of the currently active mode to be saved to the specified Register. The registers are provided for rapid saving and recalling, since you do not need to specify a filename or navigate to a file. Each of the register menu keys annotates whether it is empty or at what date and time it was last modified. In addition, you can use the Edit Register Names key to enter custom names for each register.

Although these 16 registers are the only registers available from the front panel, there are 128 state registers available in the instrument. Registers 17–128 are only available from the SCPI interface, using the *SAV command.

There is one set of 128 state registers in the instrument, not one set for each Mode. When a state is saved, the Mode it was saved from is saved with it; then when it is recalled, the instrument switches to that Mode.

After the save completes, the corresponding register menu key annotation is updated with the date and time and the message "Register <register number> saved" is displayed.

Key Path	Save, State
Mode	All
Example	*SAV 1
Range	1-16 from front panel, 1-128 from SCPI
Readback	Date and time with seconds resolution are displayed on the key OR A custom name of up to 30 characters entered using the Edit Register Names key OR “(empty)” if no prior save operation has been performed to this register.
Initial S/W Revision	Prior to A.02.00
Modified at S/W Revision	A.11.00

Data (Export)

Exporting a data file stores data from the current measurement to mass storage files. The Export Menu only contains data types that are supported by the current measurement.

Since the commonly exported data files are in .csv format, the data can be edited by you prior to importing. This allows you to export a data file, manipulate the data in Excel (the most common PC Application for manipulating .csv files) and then import it.

Selecting an Export Data menu key will not actually cause the exporting to occur, since the analyzer still needs to know where you wish to save the data. Pressing the Save As key in this menu brings up the Save As dialog and Save As menu that allows you to specify the destination file and directory. Once a filename has been selected or entered in the Open menu, the export will occur as soon as the Save key is pressed.

Key Path	Save
Mode	All
Notes	The menu is built from whatever data types are available for the mode. So the key locations in the sub menu will vary. No SCPI command directly controls the Data Type that this key controls. The Data Type is included in the MMEM:STORe commands.
Dependencies	If a file type is not used by a certain measurement, that type is grayed out for that measurement. The key for a file type will not show at all if there are no measurements in the Mode that support it.
Preset	Is not affected by a Preset or shutdown, but is reset during Restore Mode Defaults
Readback	The data type that is currently selected
Initial S/W Revision	Prior to A.02.00

Meas Results

Key Path	Save, Data
Mode	WLAN
Example	MMEM:STOR:RES "MyResultsFile.csv" This stores the measurement results data in the file MyResultsFile.xml in the default directory.
Initial S/W Revision	A.11.00

Capture Buffer

Capture buffer functionality is only available when measurement is Mod Accuracy and radio standard is not 802.11ac 80+80MHz. The captured data is raw data which is not processed.

Key Path	Save, Data
Mode	WLAN
Example	MMEM:STOR:CAPT "MyCaptureData.bin" This stores the capture data in the file MyCaptureData.bin in the default directory.
Dependencies	Capture buffer data is only available when measurement is Mod Accuracy and radio standard is not 802.11ac 80+80MHz. In other measurements, this key is grayed out.
Initial S/W Revision	A.11.00

Save As . . .

When you press "Save As", the analyzer brings up a Windows dialog and a menu entitled "**Save As.**" This menu allows you to navigate to the various fields in the Windows dialog without using a keyboard or mouse. The Tab and Arrow keys can also be used for dialog navigation.

See "[To File . . .](#)" on page 2273 in Save, State for a full description of this dialog and menu.

The default path for saving files is:

For all of the Trace Data Files:

My Documents\`<mode name>`\data\traces

For all of the Limit Data Files:

My Documents\`<mode name>`\data\limits

For all of the Measurement Results Data Files:

My Documents\`<mode name>`\data\`<measurement name>`\results

For all of the Capture Buffer Data Files:

My Documents\`<mode name>`\data\captureBuffer

Key Path	Save, Data
Mode	All
Notes	The key location is mode-dependent and will vary. Brings up the Save As dialog for saving a <mode specific> Save Type. The save is performed immediately and does not wait until the measurement is complete.
Initial S/W Revision	Prior to A.02.00

Screen Image

Pressing Screen Image accesses a menu of functions that enable you to specify a format and location for the saved screen image. It brings up a menu that allows you to specify the color scheme of the Screen Image (Themes) or navigate to the Save As dialog to perform the actual save.

Screen Image files contain an exact representation of the analyzer display. They cannot be loaded back onto the analyzer, but they can be loaded into your PC for use in many popular applications.

The image to be saved is actually captured when the Save front panel key is pressed, and kept in temporary storage to be used if you ask for a Screen Image save. When the Screen Image key is pressed, a "thumbnail" of the captured image is displayed, as shown below:

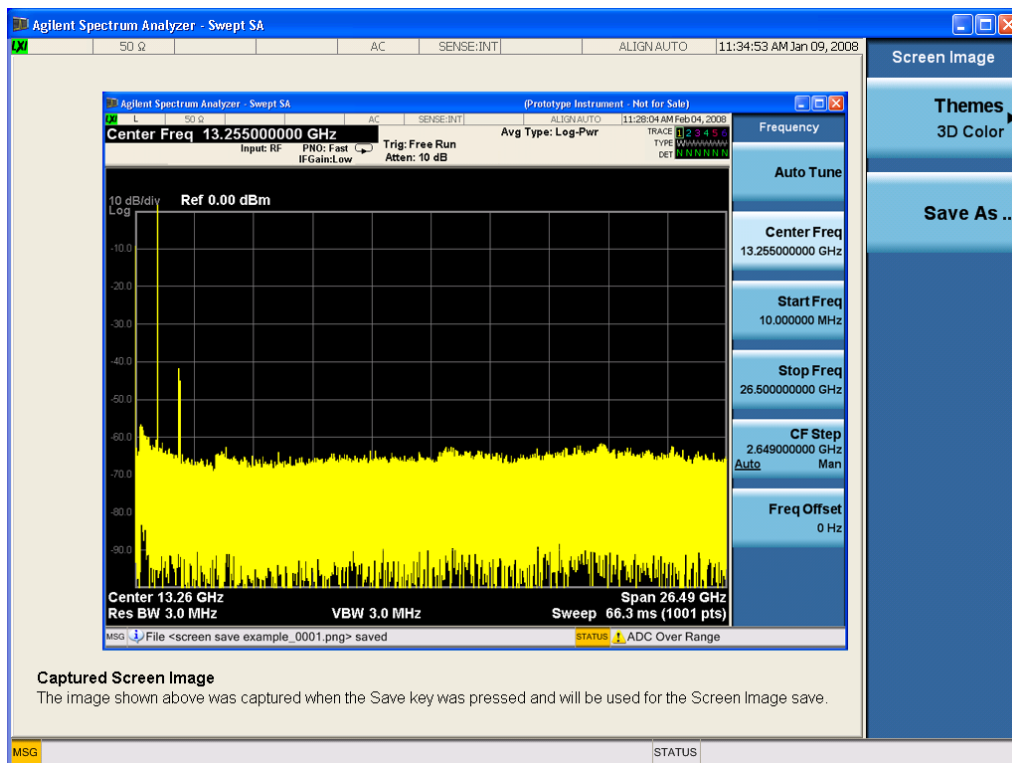

When you continue on into the Save As menu and complete the Screen Image save, the image depicted in the thumbnail is the one that gets saved, showing the menus that were on the screen before going into the Save menus. The save is performed immediately and does not wait until the measurement is complete.

After you have completed the save, the Quick Save front-panel key lets you quickly repeat the last save performed, using an auto-named file, with the current screen data.

NOTE

For versions previous to A.01.55, if you initiate a screen image save by navigating through the Save menus, the image that is saved will contain the Save menu softkeys, not the menus and the active function that were on the screen when you first pressed the Save front panel key.

Key Path	Save
Mode	All
Remote Command	:MMEMory:STORe:SCReen <filename>
Example	:MMEM:STOR:SCR "myScreen.png" This stores the current screen image in the file MyScreenFile.png in the default directory.
Initial S/W Revision	Prior to A.02.00

Themes

Accesses a menu of functions that enable you to choose the theme to be used when saving the screen image.

The **Themes** option is the same as the **Themes** option under the **Display** and **Page Setup** dialogs. It allows you to choose between themes to be used when saving the screen image.

Key Path	Save, Screen Image
Remote Command	:MMEMory:STORe:SCReen:THEMe TDColor TDMonochrome FCOLor FMONochrome :MMEMory:STORe:SCReen:THEMe?
Example	:MMEM:STOR:SCR:THEM TDM
Preset	3D Color; Is not part of Preset, but is reset by Restore Misc Defaults or Restore System Defaults All and survives subsequent running of the modes.
Readback	3D Color 3D Mono Flat Color Flat Mono
Backwards Compatibility Notes	In ESA and PSA we offer the choice of "Reverse Bitmap" or "Reverse Metafile" when saving screen images. This is much like the "Flat Color" theme available in X-Series. Also, if you selected Reverse Bitmap AND a black & white screen image, that would be much like "Flat Monochrome". In other words, each of the X-Series themes has a similar screen image type in ESA/PSA. But they are not identical.
Initial S/W Revision	Prior to A.02.00

3D Color

Selects a standard color theme with each object filled, shaded and colored as designed.

Key Path	Save, Screen Image, Themes
Example	MMEM:STOR:SCR:THEM TDC

Readback	3D Color
Initial S/W Revision	Prior to A.02.00

3D Monochrome

Selects a format that is like 3D color but shades of gray are used instead of colors.

Key Path	Save, Screen Image, Themes
Example	MMEM:STOR:SCR:THEM TDM
Readback	3D Mono
Initial S/W Revision	Prior to A.02.00

Flat Color

Selects a format that is best when the screen is to be printed on an ink printer.

Key Path	Save, Screen Image, Themes
Example	MMEM:STOR:SCR:THEM FCOL
Readback	Flat Color
Initial S/W Revision	Prior to A.02.00

Flat Monochrome

Selects a format that is like Flat Color. But only black is used (no colors, not even gray), and no fill.

Key Path	Save, Screen Image, Themes
Example	MMEM:STOR:SCR:THEM FMON
Readback	Flat Mono
Initial S/W Revision	Prior to A.02.00

Save As...

When you press "Save As", the analyzer brings up a Windows dialog and a menu entitled "**Save As.**" This menu allows you to navigate to the various fields in the Windows dialog without using a keyboard or mouse. The Tab and Arrow keys can also be used for dialog navigation.

See "[To File . . .](#)" on page 2273 in Save, State for a full description of this dialog and menu.

The default path for Screen Images is

My Documents\`<mode name>`\screen.

where <mode name> is the parameter used to select the mode with the INST:SEL command (for example, SA for the Spectrum Analyzer).

Key Path	Save, Screen Image
Notes	Brings up Save As dialog for saving a Screen Image Save Type
Initial S/W Revision	Prior to A.02.00

Mass Storage Catalog (Remote Command Only)

Key path	SCPI Only
Remote Command	:MMEMory:CATalog? [<directory_name>]
Notes	<p>The string must be a valid logical path.</p> <p>Queries disk usage information (drive capacity, free space available) and obtains a list of files and directories in a specified directory in the following format:</p> <p><numeric_value>,<numeric_value>,{<file_entry>}</p> <p>It returns two numeric parameters and as many strings as there are files and directories. The first parameter indicates the total amount of storage currently used in bytes. The second parameter indicates the total amount of storage available, also in bytes. The <file_entry> is a string. Each <file_entry> indicates the name, type, and size of one file in the directory list:</p> <p><file_name>,<file_type>,<file_size></p> <p>As the windows file system has an extension that indicates file type, <file_type> is always empty. <file_size> provides the size of the file in bytes. For directories, <file_entry> is surrounded by square brackets and both <file_type> and <file_size> are empty</p>
Initial S/W Revision	Prior to A.02.00

Mass Storage Change Directory (Remote Command Only)

Key path	SCPI Only
Remote Command	:MMEMory:CDIRectory [<directory_name>] :MMEMory:CDIRectory?
Notes	<p>The string must be a valid logical path.</p> <p>Changes the default directory for a mass memory file system. The <directory_name> parameter is a string. If no parameter is specified, the directory is set to the *RST value.</p> <p>At *RST, this value is set to the default user data storage area, that is defined as System.Environment.SpecialFolder.Personal.</p> <p>Query returns full path of the default directory.</p>
Initial S/W Revision	Prior to A.02.00

Mass Storage Copy (Remote Command Only)

Key path	SCPI Only
Remote Command	:MMEMory:COpy <string>,<string>[,<string>,<string>]
Notes	<p>The string must be a valid logical path.</p> <p>Copies an existing file to a new file or an existing directory to a new directory.</p> <p>Two forms of parameters are allowed. The first form has two parameters. In this form, the first parameter specifies the source, and the second parameter specifies the destination.</p> <p>The second form has four parameters. In this form, the first and third parameters specify the source. The second and fourth parameters specify the directories. The first pair of parameters specifies the source. The second pair specifies the destination. An error is generated if the source doesn't exist or the destination file already exists.</p> <p>This command will generate an "access denied" error if the destination is a restricted folder (e.g., C:\Windows) and the current user does not have Power User or Administrator privileges.</p>

Mass Storage Device Copy (Remote Command Only)

This command transfers data to/from a file and a peripheral device.

Key path	SCPI Only
Remote Command	:MMEMory:COpy:DEvice <source_string>,<dest_string>
Notes	<p>The strings must be a valid logical path or a valid device keyword. If the dest_string is a device keyword, the data is copied from the source file to the device. If the source_string is a device keyword, the data is copied to the source file from the device.</p> <p>Valid device keywords are:</p> <p>SNS (smart noise source)</p> <p>An error is generated if the file or device is not found.</p>

Mass Storage Delete (Remote Command Only)

Key path	SCPI Only
Remote Command	:MMEMory:DElete <file_name>[,<directory_name>]
Notes	<p>The string must be a valid logical path.</p> <p>Removes a file from the specified directory. The <file_name> parameter specifies the file name to be removed. This command will generate an "access denied" error if the file is in a restricted folder (e.g., C:\Windows) and the current user does not have Power User or Administrator privileges.</p>
Initial S/W Revision	Prior to A.02.00

Mass Storage Data (Remote Command Only)

Creates a file containing the specified data OR queries the data from an existing file.

Key path	SCPI Only
Remote Command	:MMEMory:DATA <file_name>, <data> :MMEMory:DATA? <file_name>
Notes	The string must be a valid logical path. The command form is MMEMory:DATA <file_name>,<data>. It loads <data> into the file <file_name>. <data> is in 488.2 block format. <file_name> is string data. The query form is MMEMory:DATA? <file_name> with the response being the associated <data> in block format.
Initial S/W Revision	Prior to A.02.00

Mass Storage Make Directory (Remote Command Only)

Key path	SCPI Only
Remote Command	:MMEMory:MDIRectory <directory_name>
Notes	The string must be a valid logical path. Creates a new directory. The <directory_name> parameter specifies the name to be created. This command will generate an “access denied” error if the new directory would be in a restricted folder (e.g., C:\Windows) and the current user does not have Power User or Administrator privileges.
Initial S/W Revision	Prior to A.02.00

Mass Storage Move (Remote Command Only)

Key path	SCPI Only
Remote Command	:MMEMory:MOVE <string>,<string>[,<string>,<string>]
Notes	The string must be a valid logical path. Moves an existing file to a new file or an existing directory to a new directory. Two forms of parameters are allowed. The first form has two parameters. In this form, the first parameter specifies the source, and the second parameter specifies the destination. The second form has four parameters. In this form, the first and third parameters specify the source. The second and fourth parameters specify the directories. The first pair of parameters specifies the source. The second pair specifies the destination. An error is generated if the source doesn't exist or the destination file already exists. This command will generate an “access denied” error if the destination is a restricted folder (e.g., C:\Windows) and the current user does not have Power User or Administrator privileges.
Initial S/W Revision	Prior to A.02.00

Mass Storage Remove Directory (Remote Command Only)

Key path	SCPI Only
Remote Command	<code>:MMEMory:RDIrectory <directory_name></code>
Notes	<p>The string must be a valid logical path.</p> <p>Removes a directory. The <directory_name> parameter specifies the directory name to be removed. All files and directories under the specified directory shall also be removed.</p> <p>This command will generate an “access denied” error if the folder is a restricted folder (e.g., C:\Windows) or is in a restricted folder and the current user does not have Power User or Administrator privileges.</p>
Initial S/W Revision	Prior to A.02.00

Single (Single Measurement/Sweep)

Sets the analyzer for Single measurement operation. The single/continuous state is Meas Global, so the setting will affect all the measurements. If you are Paused, pressing Single does a Resume.

See "[More Information](#)" on page 1346

Key Path	Front-panel key
Example	:INIT:CONT OFF
Notes	See Cont key description.
Backwards Compatibility Notes	<p>For Spectrum Analysis mode in ESA and PSA, the Single hardkey and the INITiate:IMM switched from continuous measurement to single measurement and restarted sweeps and averages (displayed average count reset to 1), but did not restart Max Hold and Min Hold. In the X-Series, the Single hardkey and the INITiate:IMM command initiate a sweep/ measurement/ average sequence/hold sequence including MaxHold and MinHold.</p> <p>For Spectrum Analysis mode in ESA and PSA, the Single hardkey restarted the sweep regardless of whether or not you were in an active sweep or sweep sequence. In the X-Series, Restart does this but Single only restarts the sweep or sweep sequence if you are in the idle state.</p> <p>INIT[:IMM] in ESA & PSA Spectrum Analysis Mode does an implied ABORT. In some other PSA Modes, INIT[:IMM] is ignored if not in the idle state. . The X-Series follows the ESA/PSA SA Mode model, which may cause some Modes to have compatibility problems.</p>
Initial S/W Revision	Prior to A.02.00

More Information

See "[Restart](#)" on page 2270 for details on the INIT:IMMEDIATE (Restart) function.

If you are already in single sweep, the INIT:CONT OFF command has no effect.

If you are already in Single Sweep, then pressing the Single key in the middle of a sweep does not restart the sweep or sequence. Similarly, pressing the Single key does not restart the sweep or sequence if the sweep is not in the idle state (for example, if you are taking a very slow sweep, or the analyzer is waiting for a trigger). Instead, it results in a message. "Already in Single, press Restart to initiate a new sweep or sequence". Even though pressing the Single key in the middle of a sweep does not restart the sweep, sending INIT:IMMEDIATE does reset it.

To take one more sweep without resetting the average count, increment the average count by 1, by pressing the step up key while **Average/Hold Number** is the active function, or sending the remote command CALC:AVER:TCON UP.

Source

There is no Source control functionality for this measurement. When this key is pressed, the screen either displays a blank menu, or the previously-selected menu remains unchanged.

Key Path	Front-panel key
----------	-----------------

Span X Scale

Span X Scale is unavailable in the Spurious Emissions measurement. When pressed, this key displays a blank menu.

Key Path	Front-panel key
Initial S/W Revision	Prior to A.02.00

Sweep/Control

Accesses the Sweep/Control menu keys used to set up and control the sweep time and source.

Key Path	Front-panel key
Initial S/W Revision	Prior to A.02.00

Sweep Setup

Sets the sweep functions that control the sweep state and time.

Key Path	Sweep/Control
Initial S/W Revision	Prior to A.02.00

Auto Sweep Time Rules

Switches the analyzer between normal and accuracy sweep states. Setting Auto Sweep Time to Accy will result in slower sweep times, usually about three times as long, but better amplitude accuracy for CW signals. The instrument amplitude accuracy specifications only apply when Auto Sweep Time is set to Accy.

Additional amplitude errors which occur when Auto Sweep Time is set to Norm are usually well under 0.1 dB, though this is not guaranteed. Because of the faster sweep times and still low errors, Norm is the preferred setting of Auto Sweep Time. Auto Sweep Time is set to Norm on a Preset or Auto Couple. This means that in the Preset or Auto Coupled state, instrument amplitude accuracy specifications do not apply.

Key Path	Sweep/Control, Sweep Setup
Mode	SA, WCDMA, C2K, WIMAX OFDMA, TD-SCDMA, 1xEV-DO, DVB-T/H, LTE, LTETDD, WLAN, MSR, LTEAFDD, LTEATDD
Remote Command	[:SENSe] :SPURious :SWEep :TIME :AUTO :RULEs NORMal ACCuracy [:SENSe] :SPURious :SWEep :TIME :AUTO :RULEs ?
Example	SPUR:SWE:TIME:AUTO:RUL ACC SPUR:SWE:TIME:AUTO:RUL?
Notes	In Zero Span, this key is irrelevant and inaccessible (because the whole Sweep Setup menu is grayed out), however, Sweep Setup settings can be changed remotely with no error indication.
Preset	NORMal
State Saved	Saved in instrument state.
Range	Norm Accy
Initial S/W Revision	Prior to A.02.00
Modified at S/W Revision	A.03.00

Sweep Type

Sets the sweep type of the spurious measurement to either Auto or Swept. When in Auto, the selections of swept type of ranges are governed by the Best Speed Sweep Type Rule, and FFT analysis might be chosen for some ranges if it speeds up the measurement.

Key Path	Sweep/Control, Sweep Setup
Mode	SA, WCDMA, C2K, WIMAX OFDMA, TD-SCDMA, 1xEV-DO, DVB-T/H, LTE, LTE-TDD, WLAN, MSR, LTE-AFDD, LTE-TDD
Remote Command	[:SENSe] :SPURious [:RANGe] :ALL:SWEep:TYPE:AUTO OFF ON 0 1 [:SENSe] :SPURious [:RANGe] :ALL:SWEep:TYPE:AUTO?
Example	SPUR:ALL:SWE:TYPE:AUTO 1 SPUR:ALL:SWE:TYPE:AUTO?
Dependencies	This parameter is available only when option N9060A-7FP is installed.
Preset	ON
State Saved	Saved in instrument state.
Range	Auto Swept
Initial S/W Revision	A.11.00

Pause

Pauses a measurement after the current data acquisition is complete.

When paused, the label on the key changes to Resume. Pressing Resume resumes the measurement at the point it was at when paused.

See "[Pause/Resume](#)" on page 2291 for more information.

Key Path	Sweep/Control
Initial S/W Revision	Prior to A.02.00

Gate

Accesses a menu that enables you to control the gating function. The Gate functionality is used to view signals best viewed by qualifying them with other events.

Gate setup parameters are the same for all measurements – they do not change as you change measurements. Settings like these are called “Meas Global” and are unaffected by Meas Preset.

Note that Sweep Time autocoupling rules and annotation are changed by Gate being on.

Key Path	Sweep/Control
Scope	Meas Global
Readback	

The state and method of Gate, as [Off, LO] or [On, Video]. Note that for measurements that only support gated LO, the method is nonetheless read back, but always as LO.

Initial S/W Revision Prior to A.02.00

Gate On/Off

Turns the gate function on and off.

When the Gate Function is on, the selected Gate Method is used along with the gate settings and the signal at the gate source to control the sweep and video system with the gate signal. Not all measurements allow every type of Gate Methods.

When Gate is on, the annunciation in the measurement bar reflects that it is on and what method is used, as seen in the following "Gate: LO" annunciator graphic.

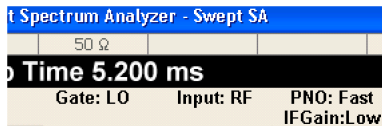

Key Path	Sweep/Control, Gate
Remote Command	[:SENSe] :SWEep:EGATe [:STATe] OFF ON 0 1 [:SENSe] :SWEep:EGATe [:STATe] ?
Example	SWE:EGAT ON SWE:EGAT?

Dependencies

The function is unavailable (grayed out) and Off when:

- Gate Method is LO or Video and FFT Sweep Type is manually selected.
- Gate Method is FFT and Swept Sweep Type is manually selected.
- Marker Count is ON.

The following are unavailable whenever Gate is on:

- FFT under Sweep Type when Method=LO or Video or Swept under Sweep Type when Method=FFT
- Marker Count

While Gate is on, the Auto Rules for Sweep Type are modified so that the choice agrees with the Gate Method: i.e., FFT for Method = FFT and Swept for Method = LO or Video.

The Gate softkey and all SCPI under the [:SENSe]:SWEep:EGATe SCPI node are grayed out when Source Mode is Tracking with an external source. This is because the Gate circuitry is used to sync the external source. If the Tracking Source is turned on, the Gate is turned off.

When in the ACP measurement:

- When Meas Method is RBW or FAST, this function is unavailable and the key is grayed out.
- Whenever Gate is on, Meas Method, RBW or FAST is unavailable and keys for those are grayed out.
- When Gate is on, Offset Res BW and Offset Video BW are ignored (if you set these values) and the

	measurement works as if all Offset Res BW and all Offset Video BW are coupled with the Res BW and the Video BW under the BW menu. When Gate is on, the Offset BW key in the Offset/Limit menu is grayed out.
Preset	Off LTETDD: On
State Saved	Saved in instrument state
Range	On Off
Backwards Compatibility SCPI	[:SENSe]:SWEep:TIME:GATE[:STATe] ESA compatibility
Backwards Compatibility Notes	In ESA, Trig Delay (On) and Gate (On) could not be active at the same time.. This dependency does not exist in PSA or in the X-Series.
Initial S/W Revision	Prior to A.02.00

Gate View On/Off

Turning on Gate View in the Swept SA measurement provides a single-window gate view display..

Turning on Gate View in other measurements shows the split-screen Gate View. In these measurements, when the Gate View is on, the regular view of the current measurement traces and results are reduced vertically to about 70% of the regular height. The Zero Span window, showing the positions of the Gate, is shown between the Measurement Bar and the reduced measurement window. By reducing the height of the measurement window, some of the annotation on the Data Display may not fit and is not shown.

Key Path	Sweep/Control, Gate
Remote Command	[:SENSe]:SWEep:EGATe:VIEW ON OFF 1 0 [:SENSe]:SWEep:EGATe:VIEW?
Example	SWE:EGAT:VIEW ON turns on the gate view.
Dependencies	In the Swept SA measurement: In Gate View, the regular Sweep Time key is grayed out . When pressed, the grayed out key puts up the informational message "Use Gate View Sweep Time in the Gate menu." In the other measurements: When you turn Gate View on, the lower window takes on the current state of the instrument. Upon leaving Gate View, the instrument takes on the state of the lower window. When you turn Gate View on, the upper window Sweep Time is set to the gate view sweep time.
Couplings	These couplings apply to the Swept SA measurement: <ul style="list-style-type: none"> • When Gate View is turned on, the instrument is set to Zero Span. • Gate View automatically turns off whenever a Span other than Zero is selected. • Gate View automatically turns off if you press the Last Span key while in Gate View, and the instrument returns to the Span it was in before entering Gate View (even if that is Zero Span). • When Gate View is turned on, the sweep time used is the gate view sweep time. This is set according to the rules in section "Gate View Setup" on page 2101 • When Gate View is turned off, Sweep Time is set to the normal Swept SA measurement sweep time.

- If Gate View is on and Gate is off, then turning on Gate turns off Gate View.

Preset	OFF
State Saved	Saved in instrument state
Range	On Off
Initial S/W Revision	Prior to A.02.00

A sample of the Gate View screen in the Swept SA measurement is shown in the following graphic :

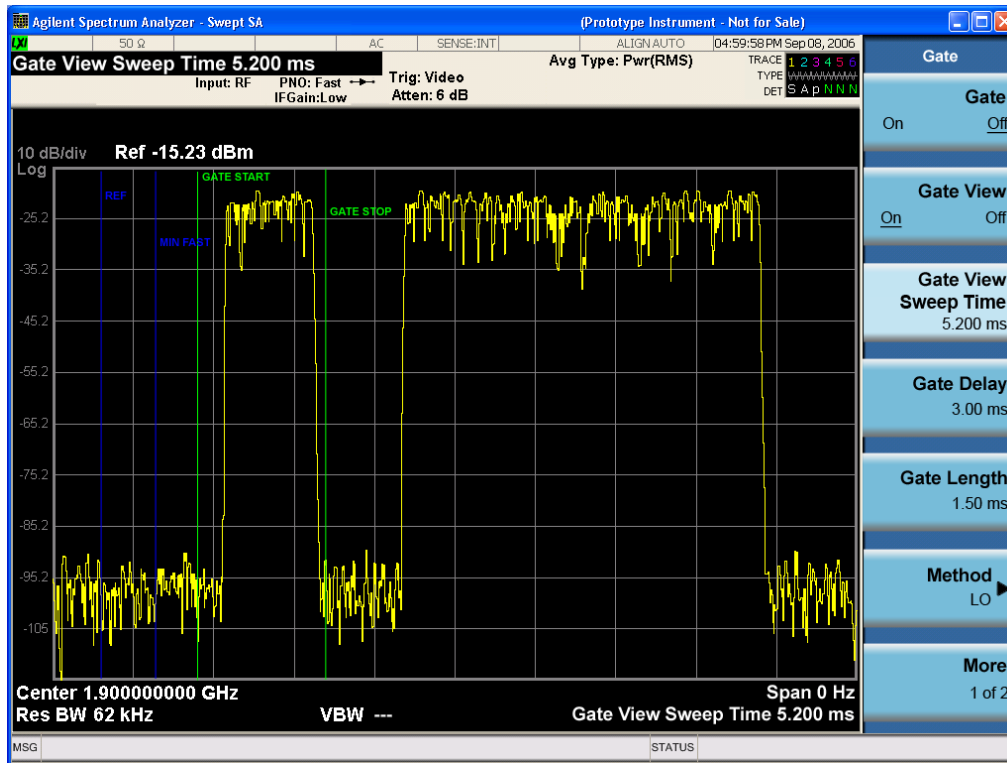

A sample of the Gate View screen in other measurements is shown in the following graphic . This example is for the ACP measurement:

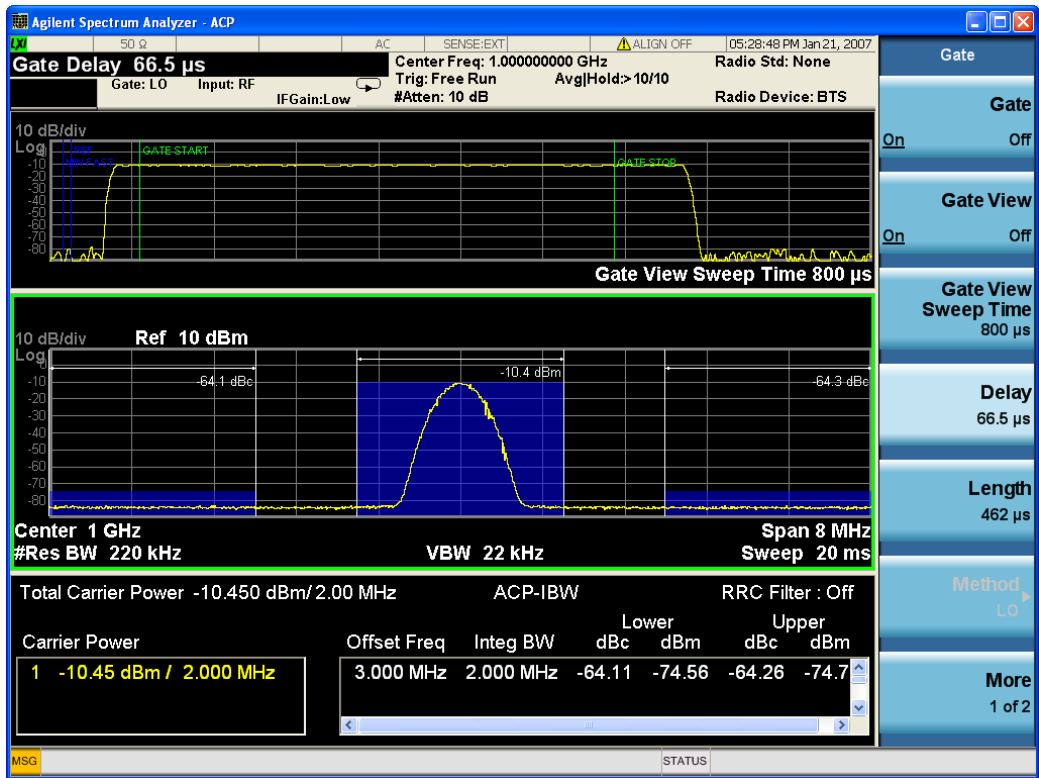

Turning Gate View off returns the analyzer to the Normal measurement view.

In the Swept SA, the normal measurement view is the single-window Swept SA view. When returning to this view, the Swept SA measurement returns to the Span it was in before entering **Gate View** (even if that is Zero Span).

The **Gate View** window is triggered from the Gate Source, with zero trigger delay. Also, when updating the **Gate View** window, the Gate itself must not operate. So it is internally shut off while the gate view window is being updated. For the Swept SA measurement, this means that the Gate is internally shut off whenever the gate view window is displayed. The measurement bar and softkeys continue to show the Trigger source for the main sweep window and give no indication that the Gate is shut off or that the Gate View window is triggered from the Gate Source.

When in **Gate View**, vertical lines are displayed in the Gate View window as follows:

- Green lines are displayed at the gate edges as follows: in Edge Gate, a line is shown for Delay and one for the end of the Gate period, defined by Length. In Level Gate a line is shown only for Delay. You can adjust the position of the green lines by adjusting the gate length and the gate delay. These lines update in the Gate View window as the active function changes, even if the window is not being updated. In Gated LO and Gated Video, these lines are positioned relative to the delay reference line (not relative to 0 time). In Gated FFT, their location is relative to the left edge of the screen.
- A blue line is displayed showing the delay reference, that is, the reference point for the Gate Delay within the Zero Span window. The blue line represents where (in time) the effective location of the gate start would be if the gate were programmed to zero delay.

- The second blue line is labeled "MIN FAST" as shown in the figure above because it represents the minimum Gate Delay for fast Gated LO operation. This line is only displayed in Gated LO. You cannot scroll (knob) or decrement (down key) the Gate Delay to less than that represented by the position of this line, it can only be set below this position manually, although once there it can be moved freely with the knob while below the line.
- A yellow line in the Gated Video case only, is displayed at $Blength$, where $Blength$ is the display point (bucket) length for the swept trace, which is given by the sweep time for that trace divided by number of Points - 1. So it is referenced to 0 time, not to the delay reference. This line is labeled NEXT PT (it is not shown in the figure above because the figure above is for Gated LO).
- The yellow line represents the edge of a display point (bucket). Normally in Gated Video, the bucket length must be selected so that it exceeds the off time of the burst. There is another way to use the analyzer in Gated Video measurements, and that is to set the bucket width much shorter than the off time of the burst. Then use the Max Hold trace function to fill in "missing" buckets more slowly. This allows you to see some of the patterns of the Gated Video results earlier, though seeing a completely filled-in spectrum later.

Gate View Setup

Accesses a menu that enables you to setup parameters relevant to the Gate View

Key Path	Sweep/Control, Gate
Scope	Meas Global
Initial S/W Revision	A.10.00

Gate View Sweep Time

Controls the sweep time in the Gate View window. To provide an optimal view of the gate signal, the analyzer initializes Gate View Sweep Time based on the current settings of Gate Delay and Gate Length.

Key Path	Sweep/Control, Gate, Gate View Setup
Remote Command	[:SENSe] :SWEep:EGATe:TIME <time> [:SENSe] :SWEep:EGATe:TIME?
Example	SWE:EGAT:TIME 500 ms
Dependencies	Gate View Sweep Time is initialized: <ul style="list-style-type: none"> • On Preset (after initializing delay and length). • Every time the Gate Method is set/changed. <p>Additionally, in the Swept SA measurement, whenever you do a Preset, or leave Gate View, the analyzer remembers the Gate Delay and Gate Length settings. Then, when returning to Gate View, if the current Gate Delay and/or Gate Length do not match the remembered values Gate View Sweep Time is re-initialized.</p> <ol style="list-style-type: none"> 1. Compute the location of the "gate stop" line, which you know is at time $t = t_{min} + GateDelay + GateLength$.
Preset	519.3 μ s

	WiMAX OFDMA: 5 ms GSM/EDGE: 1 ms
State Saved	Saved in instrument state
Max	6000 s
Initial S/W Revision	Prior to A.02.00

Gate View Start Time

Controls the time at the left edge of the Gate View.

Key Path	Sweep/Control, Gate, Gate View Setup
Remote Command	[:SENSe] :SWEep:EGATe:VIEW:STARt <time> [:SENSe] :SWEep:EGATe:VIEW:STARt?
Example	SWE:EGAT:VIEW:STAR 10ms
Notes	Units of time are required or no units; otherwise an invalid suffix error message will be generated. See error -131.
Preset	0 ms
State Saved	Saved in instrument state
Min	0
Max	500 ms
Initial S/W Revision	A.10.00

Gate Delay

Controls the length of time from the time the gate condition goes True until the gate is turned on.

Key Path	Sweep/Control, Gate
Remote Command	[:SENSe] :SWEep:EGATe:DELAy <time> [:SENSe] :SWEep:EGATe:DELAy?
Example	SWE:EGAT:DELAy 500ms SWE:EGAT:DELAy?
Notes	Units of time are required or no units; otherwise an invalid suffix error message will be generated.
Preset	57.7 us WiMAX OFDMA: 71 us GSM/EDGE: 600 us WLAN: 500 us
State Saved	Saved in instrument state

Min	0.0 us
Max	100 s
Backwards Compatibility SCPI	[:SENSe]:SWEep:TIME:GATE:DELay ESA compatibility
Initial S/W Revision	Prior to A.02.00

Gate Length

Controls the length of time that the gate is on after it opens.

Key Path	Sweep/Control, Gate
Remote Command	[:SENSe]:SWEep:EGATe:LENGth <time> [:SENSe]:SWEep:EGATe:LENGth?
Example	SWE:EGAT:LENG 1 SWE:EGAT:LENG?
Notes	Units of time are required or no units; otherwise an invalid suffix error message will be generated.

Dependencies

Grayed out when Gate Method is set to FFT in which case the label changes to that shown below.



The key is also grayed out if Gate Control = Level.

Preset	461.6 us WiMAX OFDMA: 50 us GSM/EDGE: 200 us WLAN: 1.54 ms
State Saved	Saved in instrument state
Min	100 ns
Max	5 s
Backwards Compatibility SCPI	[:SENSe]:SWEep:TIME:GATE:LENGth ESA compatibility
Initial S/W Revision	Prior to A.02.00

Gate Source

The menus under the Gate Source key are the same as those under the Trigger key, with the exception that neither Free Run nor Video are available as Gate Source selections. However, a different SCPI command

is used to select the Gate Source (see table below) because you may independently set the Gate Source and the Trigger Source.

Any changes to the settings in the setup menus under each Gate Source selection key (for example: Trigger Level, Trigger Delay, etc.) also affect the corresponding settings under the Trigger menu keys. The SCPI commands used for these are the same for Trigger and Gate, since there is only one setting which affects both Gate and Trigger. Example: to set the Trigger Level for External 1 you use the command :TRIG:EXT1:LEV regardless of whether you are using External 1 as a Trigger Source or a Gate Source.

Key Path	Sweep/Control, Gate
Remote Command	[:SENSe] :SWEep:EGATe:SOURce EXTernal1 EXTernal2 LINE FRAMe RFBurst [:SENSe] :SWEep:EGATe:SOURce?
Dependencies	In some models, there is no second External input. In these models, the External 2 key is blanked and the EXTernal2 parameter will generate a "Hardware missing; Not available for this model number" error.
Preset	EXTernal 1 GSM/EDGE, MSR: FRAMe LTETDD: EXTernal 1When Direction is Downlink, FRAMe when Direction is Uplink.
Backwards Compatibility Notes	In ESA, there is a single Gate input port. In PSA, the Gate Source may be taken from one of two specified input ports. In the X-Series, any Trigger Source can be a Gate Source.
Initial S/W Revision	Prior to A.02.00
Modified at S/W Revision	A.03.00, A.14.00

Line

Pressing this key, when it is not selected, selects the line signal as the trigger. A new sweep/measurement will start synchronized with the next cycle of the line voltage. Pressing this key, when it is already selected, access the line trigger setup menu.

Key Path	Trigger
Example	TRIG:SOUR LINE Swept SA measurement TRIG:<meas>:SOUR LINE Measurements other than Swept SA
Dependencies	Line trigger is not available when operating from a "dc power source", for example, when the instrument is powered from batteries.
State Saved	Saved in instrument state
Status Bits/OPC dependencies	The Status Operation Register bit 5 "Waiting for Trigger" is set at the same time as the Sweeping or Measuring bit is set. It is cleared when the trigger actually occurs (that is, after the trigger event occurs and all the applicable trigger criteria have been met). A corresponding pop-up message ("Waiting for trigger") is generated if no trigger signal appears after approximately 2 sec. This message goes away when a trigger signal appears.
Initial S/W Revision	Prior to A.02.00

Trig Slope

Controls the trigger polarity. It is set positive to trigger on a rising edge and negative to trigger on a falling edge.

Key Path	Trigger, Line
Remote Command	:TRIGger[:SEquence]:LINE:SLOPe POSitive NEGative :TRIGger[:SEquence]:LINE:SLOPe?
Example	TRIG:LINE:SLOP NEG
Preset	POSitive
State Saved	Saved in instrument state
Backwards Compatibility Notes	The legacy :TRIGger[:SEquence]:SLOPe command affects the slopes for the VID, LINE, EXT1, EXT2, and RFB triggers.
Initial S/W Revision	Prior to A.02.00

External 1

Pressing this key, when it is not selected, selects an external input signal as the trigger. A new sweep/measurement will start when the external trigger condition is met using the external 1 input connector on the rear panel.

Pressing this key, when it is already selected, accesses the external 1 trigger setup menu.

Key Path	Trigger
Example	TRIG:SOUR EXT1 Swept SA measurement TRIG:<meas>:SOUR EXT1 Measurements other than Swept SA
Dependencies	Grayed out if in use by Point Trigger in the Source Setup menu. Forced to Free Run if already selected and Point Trigger is set to External 1.
State Saved	Saved in instrument state
Status Bits/OPC dependencies	The Status Operation Register bit 5 "Waiting for Trigger" is set at the same time as the Sweeping or Measuring bit is set. It is cleared when the trigger actually occurs (that is, after the trigger event occurs and all the applicable trigger criteria have been met). A corresponding pop-up message ("Waiting for trigger") is generated if no trigger signal appears after approximately 2 sec. This message goes away when a trigger signal appears.
Initial S/W Revision	Prior to A.02.00

Trigger Level

Sets the value where the external 1 trigger input will trigger a new sweep/measurement.

Key Path	Trigger, External 1
Remote Command	:TRIGger[:SEquence]:EXTernal1:LEVel <level>

	:TRIGger[:SEquence]:EXTernal:LEVel?
Example	TRIG:EXT1:LEV 0.4 V
Couplings	This same level is used for the Ext1 trigger source in the Trigger menu, for the Ext1 selection in the Periodic Timer sync source (in the Trigger menu and in the Gate Source menu), and also for the Ext1 selection in the Gate Source menu.
Preset	1.2 V
State Saved	Saved in instrument state
Min	-5 V
Max	5 V
Default Unit	V
Backwards Compatibility SCPI	:TRIGger[:SEquence]:EXTernal:LEVel
Backwards Compatibility SCPI	For backward compatibility, the parameter EXTernal is mapped to EXTernal1
Backwards Compatibility SCPI	:TRIGger[:SEquence]:FRAMe:EXTernal1:LEVel
Initial S/W Revision	Prior to A.02.00

Trig Slope

Controls the trigger polarity. It is set positive to trigger on a rising edge and negative to trigger on a falling edge.

Key Path	Trigger, External 1
Remote Command	:TRIGger[:SEquence]:EXTernal:SLOPe POSitive NEGative :TRIGger[:SEquence]:EXTernal:SLOPe?
Example	TRIG:EXT1:SLOP NEG
Couplings	This same slope is used in the Ext1 selection for the trigger source in the Trigger menu and for the period timer sync source (in the Trigger menu and in the Gate Source menu).
Preset	POSitive
State Saved	Saved in instrument state
Backwards Compatibility SCPI	:TRIGger[:SEquence]:EXTernal:SLOPe
Backwards Compatibility SCPI	For backward compatibility, the parameter EXTernal is mapped to EXTernal1
Backwards Compatibility SCPI	:TRIGger[:SEquence]:FRAMe:EXTernal1:SLOPe
Backwards Compatibility Notes	The legacy :TRIGger[:SEquence]:SLOPe command affects the slopes for the VID, LINE, EXT1, EXT2, and RFB triggers.
Initial S/W Revision	Prior to A.02.00

Zero Span Delay Comp On/Off

In zero span, there is a natural delay in the signal path, which comes from the RBW filter. This is usually desirable, as it allows you to trigger on events and also see those events, because the signal is delayed from the trigger event. However, in some cases it is desirable to eliminate this delay, so that trigger events line up exactly with the zero time point in zero span. You can use the Zero Span Delay Comp On/Off feature to enable or disable zero span delay compensation.

Key Path	Trigger, External 1
Remote Command	:TRIGger[:SEquence]:EXTernal1:DElay:COMPensation OFF ON 0 1 :TRIGger[:SEquence]:EXTernal1:DElay:COMPensation?
Example	TRIG:EXT1:DEL:COMP ON
Dependencies	No effect except in zero-span, but not locked out in nonzero spans. Blanked in modes that do not support zero-span measurements. If the SCPI command is sent when the key is blanked, an error is returned: -221, "Settings conflict; Feature not supported for this measurement" In analyzers shipping N9060A, this feature requires N9060A-7FP.
Preset	OFF
State Saved	Saved in instrument state
Initial S/W Revision	A.11.00

External 2

Pressing this key, when it is not selected, selects an external input signal as the trigger. A new sweep/measurement will start when the external trigger condition is met using the external 2 input connector. The external trigger 2 input connector is on the rear panel.

Pressing this key, when it is already selected, accesses the external 2 trigger setup menu.

Key Path	Trigger
Example	TRIG:SOUR EXT2 Swept SA measurement TRIG:<meas>:SOUR EXT2 Measurements other than Swept SA
Dependencies	In some models, there is no second External input. In these models, the External 2 key is blanked and the EXTernal2 parameter will generate a "Hardware missing; Not available for this model number" message. Grayed out if in use by Point Trigger in the Source Setup menu. Forced to Free Run if already selected and Point Trigger is set to External 2.
State Saved	Saved in instrument state
Status Bits/OPC dependencies	The Status Operation Register bit 5 "Waiting for Trigger" is set at the same time as the Sweeping or Measuring bit is set. It is cleared when the trigger actually occurs (that is, after the trigger event occurs and all the applicable trigger criteria have been met). A corresponding pop-up message ("Waiting for trigger") is generated if no trigger signal appears after approximately 2 sec. This message goes away when a trigger signal appears.

Initial S/W Revision	Prior to A.02.00
Modified at S/W Revision	A.03.00

Trigger Level

Sets the value where the external 2 trigger input will trigger a new sweep/measurement.

Key Path	Trigger, External 2
Remote Command	:TRIGger[:SEquence]:EXTernal2:LEVel :TRIGger[:SEquence]:EXTernal2:LEVel?
Example	TRIG:EXT2:LEV 1.1 V
Couplings	This same level is used for the Ext2 trigger source in the Trigger menu, for the Ext2 selection in the Periodic Timer sync source (in the Trigger menu and in the Gate Source menu), and also for the Ext2 selection in the Gate Source menu.
Preset	1.2 V
State Saved	Saved in instrument state
Min	-5 V
Max	5 V
Default Unit	V
Backwards Compatibility SCPI	:TRIGger[:SEquence]:FRAMe:EXTernal2:LEVel
Initial S/W Revision	Prior to A.02.00

Trig Slope

Controls the trigger polarity. It is set positive to trigger on a rising edge and negative to trigger on a falling edge.

Key Path	Trigger, External 2
Remote Command	:TRIGger[:SEquence]:EXTernal2:SLOPe POSitive NEGative :TRIGger[:SEquence]:EXTernal2:SLOPe?
Example	TRIG:EXT2:SLOP NEG
Couplings	This same slope is used in the Ext2 selection for the trigger source in the Trigger menu and for the period timer sync source (in the Trigger menu and in the Gate Source menu).
Preset	POSitive
State Saved	Saved in instrument state
Backwards Compatibility SCPI	:TRIGger[:SEquence]:FRAMe:EXTernal2:SLOPe
Backwards Compatibility Notes	The legacy :TRIGger[:SEquence]:SLOPe command affects the slopes for the VID, LINE, EXT1, EXT2, and RFB triggers.
Initial S/W Revision	Prior to A.02.00

Zero Span Delay Comp On/Off

In zero span, there is a natural delay in the signal path, which comes from the RBW filter. This is usually desirable, as it allows you to trigger on events and also see those events, because the signal is delayed from the trigger event. However, in some cases it is desirable to eliminate this delay, so that trigger events line up exactly with the zero time point in zero span. You can use the Zero Span Delay Comp On/Off feature to enable or disable zero span delay compensation.

Key Path	Trigger, External 2
Remote Command	:TRIGger[:SEQuence]:EXTernal2:DELay:COMPensation OFF ON 0 1 :TRIGger[:SEQuence]:EXTernal2:DELay:COMPensation?
Example	TRIG:EXT2:DEL:COMP ON
Dependencies	No effect except in zero-span, but not locked out in nonzero spans. Blanked in modes that do not support zero-span measurements. If the SCPI command is sent when the key is blanked, an error is returned: -221, "Settings conflict; Feature not supported for this measurement" In analyzers shipping N9060A, this feature requires N9060A-7FP.
Preset	OFF
State Saved	Saved in instrument state
Initial S/W Revision	A.11.00

RF Burst

Pressing this key, when it is not selected, selects the RF Burst as the trigger. A new sweep/measurement will start when an RF burst envelope signal is identified from the signal at the RF Input connector. Pressing this key, when it is already selected, accesses the RF Burst trigger setup menu.

In some models, a variety of burst trigger circuitry is available, resulting in various available burst trigger bandwidths. The analyzer automatically chooses the appropriate trigger path based on the hardware configuration and other settings of the analyzer.

Key Path	Trigger
Example	TRIG:SOUR RFB Swept SA measurement TRIG:<meas>:SOUR RFB Measurements other than Swept SA
State Saved	Saved in instrument state
Status Bits/OPC dependencies	The Status Operation Register bit 5 "Waiting for Trigger" is set at the same time as the Sweeping or Measuring bit is set. It is cleared when the trigger actually occurs (that is, after the trigger event occurs and all the applicable trigger criteria have been met). A corresponding pop-up message ("Waiting for trigger") is generated if no trigger signal appears after approximately 2 sec. This message goes away when a trigger signal appears.
Backwards Compatibility Notes	The legacy command: :TRIGger[:SEQuence]:RFBurst:FSElectivity[:STATe] OFF ON 0 1

	is not supported in the X-Series, as the hardware to do Frequency Selective burst triggers does not exist in X-Series.
Initial S/W Revision	Prior to A.02.00
Modified at S/W Revision	A.04.00

Absolute Trigger Level

Sets the absolute trigger level for the RF burst envelope.

When using the External Mixing path, the Absolute Trigger Level is uncalibrated because the factory default was set to accommodate the expected IF levels for the RF path.

Key Path	Trigger, RF Burst
Scope	Meas Global
Remote Command	:TRIGger[:SEquence]:RFBurst:LEVel:ABSolute <ampl> :TRIGger[:SEquence]:RFBurst:LEVel:ABSolute?
Example	TRIG:RFB:LEV:ABS 10 dBm sets the trigger level of the RF burst envelope signal to the absolute level of 10 dBm
Notes	Sending this command does not switch the setting from relative to absolute; to switch it you need to send the :TRIGger[:SEquence]:RFBurst:LEVel:TYPE command, below. Amplitude Corrections are not taken into account by the Absolute Trigger Level. For example, if you have given yourself effective gain with an amplitude correction factor, the Absolute Trigger will not fire until you have set the trigger level that far below the displayed signal level, rather than simply to the displayed signal level. This is only true for Amplitude Corrections, not External Gain or Ref Level Offset functions. If mode is Bluetooth, the default value is -50 dBm.
Couplings	This same level is used for the RF Burst trigger source in the Trigger menu, for the RF Burst selection in the Periodic Timer sync source (in the Trigger menu and in the Gate Source menu), and also for the RF Burst selection in the Gate Source menu
Preset	-20 dBm
State Saved	Saved in instrument state
Min	-200 dBm
Max	100 dBm
Default Unit	depends on the current selected Y-Axis unit
Backwards Compatibility SCPI	:TRIGger[:SEquence]:FRAMe:RFBurst:LEVel:ABSolute
Initial S/W Revision	Prior to A.02.00
Modified at S/W Revision	A.04.00

Key Path	Trigger, RF Burst
Remote Command	:TRIGger[:SEquence]:RFBurst:LEVel:TYPE ABSolute RELative

	:TRIGger[:SEquence]:RFBurst:LEVel:TYPE?
Example	TRIG:RFB:LEV:TYPE REL sets the trigger level type of the RF burst trigger to Relative.
Preset	ABSolute
State Saved	Saved in instrument state
Initial S/W Revision	Prior to A.02.00
Modified at S/W Revision	A.04.00

Relative Trigger Level

Sets the relative trigger level for the RF burst envelope.

In some models, the relative burst trigger function is implemented in hardware. In other models, without the advanced triggering hardware required, the relative burst trigger function is implemented in software in some measurements, and is unavailable in other measurements.

When implemented in software, the relative RF Burst trigger function is implemented as follows:

1. The measurement starts with the absolute RF Burst trigger setting. If it cannot get a trigger with that level, auto trigger fires and the acquisition starts anyway. After the acquisition, the measurement searches for the peak in the acquired waveform and saves it.
2. Now, in the next cycle of the measurement, the measurement determines a new absolute RF Burst level based on the peak value from the first measurement and the Relative RF Burst Trigger Level (always 0 or negative dB) set by the user. The following formula is used:
3. absolute RF Burst level = peak level of the previous acquisition + relative RF Burst level
4. If the new absolute RF Burst level differs from the previous by more than 0.5 dB, the new level is sent to the hardware; otherwise it is not updated (to avoid slowing down the acquisition)

Steps 2 and 3 repeat for subsequent measurements.

Key Path	Trigger, RF Burst
Scope	Meas Global
Remote Command	:TRIGger[:SEquence]:RFBurst:LEVel:RELative <rel_amp> :TRIGger[:SEquence]:RFBurst:LEVel:RELative?
Example	TRIG:RFB:LEV:REL -10 dB sets the trigger level of the RF burst envelope signal to the relative level of -10 dB
Notes	Sending this command does not switch the setting from absolute to relative; to switch it you need to send the :TRIGger[:SEquence]:RFBurst:LEVel:TYPE command, above. The relative trigger level is not available in some measurements. In those measurements the RELative parameter, and the :TRIGger[:SEquence]:RFBurst:LEVel:TYPE command (above), will generate an error if sent.
Dependencies	This key is grayed out and Absolute Trigger Level selected if the required hardware is not present in your analyzer and the current measurement does not support Relative triggering.

Preset	-6 dB GSM: -25 dB
State Saved	Saved in instrument state
Min	-45 dB
Max	0 dB
Default Unit	dB or dBc
Backwards Compatibility SCPI	:TRIGger[:SEquence]:RFBurst:LEVel This legacy command is aliased to :TRIGger[:SEquence]:RFBurst:LEVel:RELative because the PSA had ONLY relative burst triggering
Initial S/W Revision	Prior to A.02.00
Modified at S/W Revision	A.04.00

Trigger Slope

It is set positive to trigger on a rising edge and negative to trigger on a falling edge.

Key Path	Trigger, RF Burst
Remote Command	:TRIGger[:SEquence]:RFBurst:SLOPe POSitive NEGative :TRIGger[:SEquence]:RFBurst:SLOPe?
Example	TRIG:RFB:SLOP NEG
Couplings	This same slope is used in the RF Burst selection for the trigger source in the Trigger menu and for the period timer sync source (in the Trigger menu and in the Gate Source menu).
Preset	POSitive
State Saved	Saved in instrument state
Backwards Compatibility SCPI	:TRIGger[:SEquence]:FRAMe:RFBurst:SLOPe
Backwards Compatibility Notes	The legacy :TRIGger[:SEquence]:SLOPe command affects the slopes for the VID, LINE, EXT1, EXT2, and RFB triggers.
Initial S/W Revision	Prior to A.02.00

Periodic Timer (Frame Trigger)

Pressing this key, when it is not selected, selects the internal periodic timer signal as the trigger. Triggering occurrences are set by the **Period** parameter, which is modified by the **Sync Source** and **Offset**. Pressing this key, when it is already selected, accesses the periodic timer trigger setup functions.

If you do not have a sync source selected (it is Off), then the internal timer will not be synchronized with any external timing events.

Key Path	Trigger
Example	TRIG:SOUR FRAM Swept SA measurement

	TRIG:<meas>:SOUR FRAM Measurements other than Swept SA
State Saved	Saved in instrument state
Readback	[Sync: <value of Sync Source>], for example, [Sync: External 1]
Status Bits/OPC dependencies	The Status Operation Register bit 5 "Waiting for Trigger" is set at the same time as the Sweeping or Measuring bit is set. It is cleared when the trigger actually occurs (that is, after the trigger event occurs and all the applicable trigger criteria have been met). A corresponding pop-up message ("Waiting for trigger") is generated if no trigger signal appears after approximately 2 sec. This message goes away when a trigger signal appears.
Initial S/W Revision	Prior to A.02.00

Periodic Timer Triggering:

This feature selects the internal periodic timer signal as the trigger. Trigger occurrences are set by the **Periodic Timer** parameter, which is modified by the **Sync Source** and **Offset**.

The figure below shows the action of the periodic timer trigger. Before reviewing the figure, we'll explain some uses for the periodic trigger.

A common application is measuring periodic burst RF signals for which a trigger signal is not easily available. For example, we might be measuring a TDMA radio which bursts every 20 ms. Let's assume that the 20 ms period is very consistent. Let's also assume that we do not have an external trigger source available that is synchronized with the period, and that the signal-to-noise ratio of the signal is not high enough to provide a clean RF burst trigger at all of the analysis frequencies. For example, we might want to measure spurious transmissions at an offset from the carrier that is larger than the bandwidth of the RF burst trigger. In this application, we can set the Periodic Timer to a 20.00 ms period and adjust the offset from that timer to position our trigger just where we want it. If we find that the 20.00 ms is not exactly right, we can adjust the period slightly to minimize the drift between the period timer and the signal to be measured.

A second way to use this feature would be to use **Sync Source** temporarily, instead of **Offset**. In this case, we might tune to the signal in a narrow span and use the RF Burst trigger to synchronize the periodic timer. Then we would turn the sync source off so that it would not miss-trigger. Miss-triggering can occur when we are tuned so far away from the RF burst trigger that it is no longer reliable.

A third example would be to synchronize to a signal that has a reference time element of much longer period than the period of interest. In some CDMA applications, it is useful to look at signals with a short periodicity, by synchronizing that periodicity to the "even-second clock" edge that happens every two seconds. Thus, we could connect the even-second clock trigger to Ext1 and use then Ext1 as the sync source for the periodic timer.

The figure below illustrates this third example. The top trace represents the even-second clock. It causes the periodic timer to synchronize with the leading edge shown. The analyzer trigger occurs at a time delayed by the accumulated offset from the period trigger event. The periodic timer continues to run, and triggers continue to occur, with a periodicity determined by the analyzer time base. The timer output (labeled "late event") will drift away from its ideal time due to imperfect matching between the time base of the signal being measured and the time base of the analyzer, and also because of imperfect setting of the

period parameter. But the synchronization is restored on the next even-second clock event. ("Accumulated offset" is described in the in the **Offset** function section.)

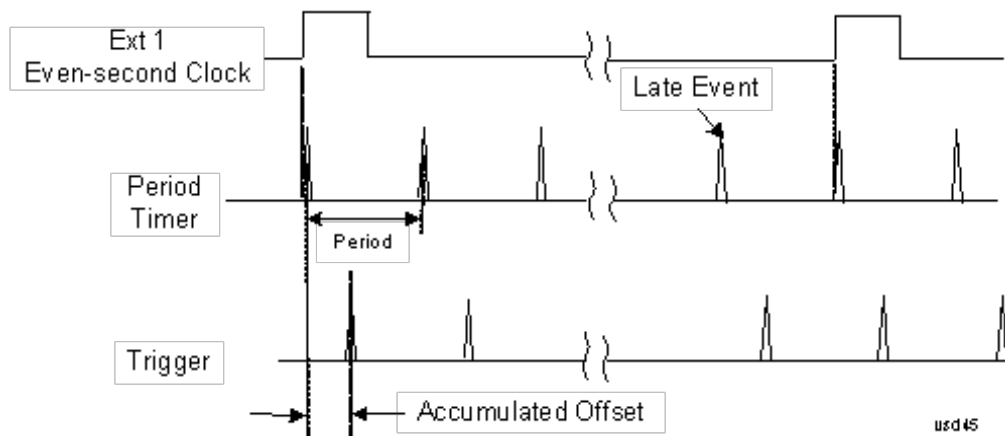

Period

Sets the period of the internal periodic timer clock. For digital communications signals, this is usually set to the frame period of your current input signal. In the case that sync source is not set to OFF, and the external sync source rate is changed for some reason, the periodic timer is synchronized at the every external synchronization pulse by resetting the internal state of the timer circuit.

Key Path	Trigger, Periodic Timer
Remote Command	:TRIGger[:SEquence]:FRAMe:PERiod <time> :TRIGger[:SEquence]:FRAMe:PERiod?
Example	TRIG:FRAM:PER 100 ms
Dependencies	The invalid data indicator turns on when the period is changed, until the next sweep/measurement completes.
Couplings	The same period is used in the Gate Source selection of the period timer.
Preset	20 ms GSM: 4.615383
State Saved	Saved in instrument state
Min	100.000 ns
Max	559.0000 ms
Default Unit	S
Initial S/W Revision	Prior to A.02.00

Offset

Adjusts the accumulated offset between the periodic timer events and the trigger event. Adjusting the accumulated offset is different than setting an offset, and requires explanation.

The periodic timer is usually not synchronized with any external events, so the timing of its output events has no absolute meaning. Since the timing relative to external events (RF signals) is important, you need to

be able to adjust (offset) it. However, you have no direct way to see when the periodic timer events occur. All that you can see is the trigger timing. When you want to adjust the trigger timing, you will be changing the internal offset between the periodic timer events and the trigger event. Because the absolute value of that internal offset is unknown, we will just call that the accumulated offset. Whenever the Offset parameter is changed, you are changing that accumulated offset. You can reset the displayed offset using Reset Offset Display. Changing the display does not change the value of the accumulated offset, and you can still make additional changes to accumulated offset.

To avoid ambiguity, we define that an increase in the "offset" parameter, either from the knob or the SCPI adjust command, serves to delay the timing of the trigger event.

Key Path	Trigger, Periodic Timer
Remote Command	:TRIGger[:SEquence]:FRAMe:OFFSet <time> :TRIGger[:SEquence]:FRAMe:OFFSet?
Example	TRIG:FRAM:OFFS 1.2 ms
Notes	<p>The front panel interface (for example, the knob), and this command, adjust the accumulated offset, which is shown on the active function display. However, the actual amount sent to the hardware each time the offset is updated is the delta value, that is, the current accumulated offset value minus the previous accumulated offset value. Note that the accumulated offset value is essentially arbitrary; it represents the accumulated offset from the last time the offset was zeroed (with the Reset Offset Display key).</p> <p>Note that this command does not change the period of the trigger waveform. Note also that Offset is used only when the sync source is set to OFF, otherwise delay is used, see section "Trig Delay" on page 460.</p> <p>An increase in the "offset" parameter, either from the knob or the SCPI adjust command, serves to delay the timing of the trigger event.</p>
Notes	<p>When the SCPI command is sent the value shown on the key (and the Active Function, if this happens to be the active function) is updated with the new value. However, the actual amount sent to the hardware is the delta value, that is, the current accumulated offset value minus the previous accumulated offset value.</p> <p>The SCPI query simply returns the value currently showing on the key.</p>
Dependencies	The invalid data indicator turns on when the offset is changed, until the next sweep/measurement completes.
Couplings	The same offset is used in the Gate Source selection of the period timer.
Preset	0 s
State Saved	Saved in instrument state
Min	-10.000 s
Max	10.000 s
Default Unit	S
Initial S/W Revision	Prior to A.02.00

Offset Adjust (Remote Command Only)

This remote command does not work at all like the related front panel keys. This command lets you advance the phase of the frame trigger by the amount you specify.

It does not change the period of the trigger waveform. If the command is sent multiple times, it advances the phase of the frame trigger an additional amount each time it is sent. Negative numbers are permitted.

Remote Command	:TRIGger[:SEquence]:FRAMe:ADJust <time>
Example	TRIG:FRAM:ADJ 1.2 ms
Notes	Note also that Offset is used only when the sync source is set to OFF, otherwise delay is used, see section "Trig Delay" on page 460 An increase in the "offset" parameter, either from the knob or the SCPI adjust command, serves to delay the timing of the trigger event.
Notes	The front panel interface (for example, the knob) and the :TRIG:FRAM:OFFS command adjust the accumulated offset, which is shown on the active function display. However, the actual amount sent to the hardware is the delta value, that is, the current offset value minus the previous offset value. When the SCPI command is sent the value shown on the key (and the Active Function, if this happens to be the active function) is updated by increasing it (or decreasing it if the value sent is negative) by the amount specified in the SCPI command. This is a "command only" SCPI command, with no query.
Dependencies	The invalid data indicator turns on when the offset is changed, until the next sweep/measurement completes.
Couplings	The same offset is used in the Gate Source selection of the period timer.
Preset	0 s
State Saved	Saved in instrument state
Min	-10.000 s
Max	10.000 s
Default Unit	S
Initial S/W Revision	Prior to A.02.00

Reset Offset Display

Resets the value of the periodic trigger offset display setting to 0.0 seconds. The current displayed trigger location may include an offset value defined with the Offset key. Pressing this key redefines the currently displayed trigger location as the new trigger point that is 0.0 s offset. The Offset key can then be used to add offset relative to this new timing.

Key Path	Trigger, Periodic Timer
Remote Command	:TRIGger[:SEquence]:FRAMe:OFFSet:DISPlay:RESet
Example	TRIG:FRAM:OFFS:DISP:RES
Initial S/W Revision	Prior to A.02.00

Sync Source

Selects a signal source for you to synchronize your periodic timer trigger to, otherwise you are triggering at some arbitrary location in the frame. Synchronization reduces the precision requirements on the setting of the period.

For convenience you may adjust the level and slope of the selected sync source in a conditional branch setup menu accessed from the Sync Source menu. Note that these settings match those in the **Trigger** and **Gate Source** menus; that is, each trigger source has only one value of level and slope, regardless of which menu it is accessed from.

Key Path	Trigger, Periodic Timer
Remote Command	:TRIGger[:SEquence]:FRAMe:SYNC EXTernal1 EXTernal2 RFBurst OFF :TRIGger[:SEquence]:FRAMe:SYNC?
Example	TRIG:FRAM:SYNC EXT2
Dependencies	In some models, there is no second External input. In these models, the External 2 key is blanked and the EXTernal2 parameter will generate a "Hardware missing; Not available for this model number" message.
Preset	Off GSM/EDGE, MSR,LTE,LTETDD: RFBurst
State Saved	Saved in instrument state
Readback	The current setting is read back to this key and it is also Readback to the previous Periodic Timer trigger key.
Backwards Compatibility SCPI	:TRIGger[:SEquence]:FRAMe:SYNC EXTernal For backward compatibility, the parameter EXTernal is mapped to EXTernal1
Initial S/W Revision	Prior to A.02.00
Modified at S/W Revision	A.03.00, A.14.00

Off

Turns off the sync source for your periodic trigger. With the sync source off, the timing will drift unless the signal source frequency is locked to the analyzer frequency reference.

Key Path	Trigger, Periodic Timer, Sync Source
Example	TRIG:FRAM:SYNC OFF
Readback	Off
Initial S/W Revision	Prior to A.02.00

External 1

Pressing this key, when it is not selected, selects an external input signal as the trigger. A new sweep/measurement will start when the external trigger condition is met using the external 1 input connector on the rear panel.

Pressing this key, when it is already selected, accesses the external 1 trigger setup menu.

Key Path	Trigger
Example	TRIG:SOUR EXT1 Swept SA measurement

	TRIG:<meas>:SOUR EXT1 Measurements other than Swept SA
Dependencies	Grayed out if in use by Point Trigger in the Source Setup menu. Forced to Free Run if already selected and Point Trigger is set to External 1.
State Saved	Saved in instrument state
Status Bits/OPC dependencies	The Status Operation Register bit 5 "Waiting for Trigger" is set at the same time as the Sweeping or Measuring bit is set. It is cleared when the trigger actually occurs (that is, after the trigger event occurs and all the applicable trigger criteria have been met). A corresponding pop-up message ("Waiting for trigger") is generated if no trigger signal appears after approximately 2 sec. This message goes away when a trigger signal appears.
Initial S/W Revision	Prior to A.02.00

Trigger Level

Sets the value where the external 1 trigger input will trigger a new sweep/measurement.

Key Path	Trigger, External 1
Remote Command	:TRIGger[:SEquence]:EXTernal1:LEVel <level> :TRIGger[:SEquence]:EXTernal1:LEVel?
Example	TRIG:EXT1:LEV 0.4 V
Couplings	This same level is used for the Ext1 trigger source in the Trigger menu, for the Ext1 selection in the Periodic Timer sync source (in the Trigger menu and in the Gate Source menu), and also for the Ext1 selection in the Gate Source menu.
Preset	1.2 V
State Saved	Saved in instrument state
Min	-5 V
Max	5 V
Default Unit	V
Backwards Compatibility SCPI	:TRIGger[:SEquence]:EXTernal:LEVel For backward compatibility, the parameter EXTernal is mapped to EXTernal1
Backwards Compatibility SCPI	:TRIGger[:SEquence]:FRAMe:EXTernal1:LEVel
Initial S/W Revision	Prior to A.02.00

Trig Slope

Controls the trigger polarity. It is set positive to trigger on a rising edge and negative to trigger on a falling edge.

Key Path	Trigger, External 1
Remote Command	:TRIGger[:SEquence]:EXTernal1:SLOPe POSitive NEGative

	:TRIGger[:SEQuence]:EXTernal1:SLOPe?
Example	TRIG:EXT1:SLOP NEG
Couplings	This same slope is used in the Ext1 selection for the trigger source in the Trigger menu and for the period timer sync source (in the Trigger menu and in the Gate Source menu).
Preset	POSitive
State Saved	Saved in instrument state
Backwards Compatibility SCPI	:TRIGger[:SEQuence]:EXTernal:SLOPe For backward compatibility, the parameter EXTernal is mapped to EXTernal1
Backwards Compatibility SCPI	:TRIGger[:SEQuence]:FRAMe:EXTernal1:SLOPe
Backwards Compatibility Notes	The legacy :TRIGger[:SEQuence]:SLOPe command affects the slopes for the VID, LINE, EXT1, EXT2, and RFB triggers.
Initial S/W Revision	Prior to A.02.00

External 2

Pressing this key, when it is not selected, selects an external input signal as the trigger. A new sweep/measurement will start when the external trigger condition is met using the external 2 input connector. The external trigger 2 input connector is on the rear panel.

Pressing this key, when it is already selected, accesses the external 2 trigger setup menu.

Key Path	Trigger
Example	TRIG:SOUR EXT2 Swept SA measurement TRIG:<meas>:SOUR EXT2 Measurements other than Swept SA
Dependencies	In some models, there is no second External input. In these models, the External 2 key is blanked and the EXTernal2 parameter will generate a "Hardware missing; Not available for this model number" message. Grayed out if in use by Point Trigger in the Source Setup menu. Forced to Free Run if already selected and Point Trigger is set to External 2.
State Saved	Saved in instrument state
Status Bits/OPC dependencies	The Status Operation Register bit 5 "Waiting for Trigger" is set at the same time as the Sweeping or Measuring bit is set. It is cleared when the trigger actually occurs (that is, after the trigger event occurs and all the applicable trigger criteria have been met). A corresponding pop-up message ("Waiting for trigger") is generated if no trigger signal appears after approximately 2 sec. This message goes away when a trigger signal appears.
Initial S/W Revision	Prior to A.02.00
Modified at S/W Revision	A.03.00

Trigger Level

Sets the value where the external 2 trigger input will trigger a new sweep/measurement.

Key Path	Trigger, External 2
Remote Command	:TRIGger[:SEquence]:EXTernal2:LEVel :TRIGger[:SEquence]:EXTernal2:LEVel?
Example	TRIG:EXT2:LEV 1.1 V
Couplings	This same level is used for the Ext2 trigger source in the Trigger menu, for the Ext2 selection in the Periodic Timer sync source (in the Trigger menu and in the Gate Source menu), and also for the Ext2 selection in the Gate Source menu.
Preset	1.2 V
State Saved	Saved in instrument state
Min	-5 V
Max	5 V
Default Unit	V
Backwards Compatibility SCPI	:TRIGger[:SEquence]:FRAMe:EXTernal2:LEVel
Initial S/W Revision	Prior to A.02.00

Trig Slope

Controls the trigger polarity. It is set positive to trigger on a rising edge and negative to trigger on a falling edge.

Key Path	Trigger, External 2
Remote Command	:TRIGger[:SEquence]:EXTernal2:SLOPe POSitive NEGative :TRIGger[:SEquence]:EXTernal2:SLOPe?
Example	TRIG:EXT2:SLOP NEG
Couplings	This same slope is used in the Ext2 selection for the trigger source in the Trigger menu and for the period timer sync source (in the Trigger menu and in the Gate Source menu).
Preset	POSitive
State Saved	Saved in instrument state
Backwards Compatibility SCPI	:TRIGger[:SEquence]:FRAMe:EXTernal2:SLOPe
Backwards Compatibility Notes	The legacy :TRIGger[:SEquence]:SLOPe command affects the slopes for the VID, LINE, EXT1, EXT2, and RFB triggers.
Initial S/W Revision	Prior to A.02.00

RF Burst

Pressing this key, when it is not selected, selects the RF Burst as the trigger. A new sweep/measurement will start when an RF burst envelope signal is identified from the signal at the RF Input connector. Pressing this key, when it is already selected, accesses the RF Burst trigger setup menu.

In some models, a variety of burst trigger circuitry is available, resulting in various available burst trigger bandwidths. The analyzer automatically chooses the appropriate trigger path based on the hardware configuration and other settings of the analyzer.

Key Path	Trigger
Example	TRIG:SOUR RFB Swept SA measurement TRIG:<meas>:SOUR RFB Measurements other than Swept SA
State Saved	Saved in instrument state
Status Bits/OPC dependencies	The Status Operation Register bit 5 "Waiting for Trigger" is set at the same time as the Sweeping or Measuring bit is set. It is cleared when the trigger actually occurs (that is, after the trigger event occurs and all the applicable trigger criteria have been met). A corresponding pop-up message ("Waiting for trigger") is generated if no trigger signal appears after approximately 2 sec. This message goes away when a trigger signal appears.
Backwards Compatibility Notes	The legacy command: :TRIGger[:SEquence]:RFBurst:FSElectivity[:STATe] OFF ON 0 1 is not supported in the X-Series, as the hardware to do Frequency Selective burst triggers does not exist in X-Series.
Initial S/W Revision	Prior to A.02.00
Modified at S/W Revision	A.04.00

Absolute Trigger Level

Sets the absolute trigger level for the RF burst envelope.

When using the External Mixing path, the Absolute Trigger Level is uncalibrated because the factory default was set to accommodate the expected IF levels for the RF path.

Key Path	Trigger, RF Burst
Scope	Meas Global
Remote Command	:TRIGger[:SEquence]:RFBurst:LEVel:ABSolute <ampl> :TRIGger[:SEquence]:RFBurst:LEVel:ABSolute?
Example	TRIG:RFB:LEV:ABS 10 dBm sets the trigger level of the RF burst envelope signal to the absolute level of 10 dBm
Notes	Sending this command does not switch the setting from relative to absolute; to switch it you need to send the :TRIGger[:SEquence]:RFBurst:LEVel:TYPE command, below. Amplitude Corrections are not taken into account by the Absolute Trigger Level. For example, if you have given yourself effective gain with an amplitude correction factor, the Absolute Trigger will not fire until you have set the trigger level that far below the displayed signal level, rather than simply to the displayed signal level. This is only true for Amplitude Corrections, not External Gain or Ref Level Offset functions. If mode is Bluetooth, the default value is -50 dBm.
Couplings	This same level is used for the RF Burst trigger source in the Trigger menu, for the RF Burst selection in the Periodic Timer sync source (in the Trigger menu and in the Gate Source menu), and also for the

	RF Burst selection in the Gate Source menu
Preset	-20 dBm
State Saved	Saved in instrument state
Min	-200 dBm
Max	100 dBm
Default Unit	depends on the current selected Y-Axis unit
Backwards Compatibility SCPI	:TRIGger[:SEquence]:FRAME:RFBurst:LEVel:ABSolute
Initial S/W Revision	Prior to A.02.00
Modified at S/W Revision	A.04.00

Key Path	Trigger, RF Burst
Remote Command	:TRIGger[:SEquence]:RFBurst:LEVel:TYPE ABSolute RELative :TRIGger[:SEquence]:RFBurst:LEVel:TYPE?
Example	TRIG:RFB:LEV:TYPE REL sets the trigger level type of the RF burst trigger to Relative.
Preset	ABSolute
State Saved	Saved in instrument state
Initial S/W Revision	Prior to A.02.00
Modified at S/W Revision	A.04.00

Trigger Slope

It is set positive to trigger on a rising edge and negative to trigger on a falling edge.

Key Path	Trigger, RF Burst
Remote Command	:TRIGger[:SEquence]:RFBurst:SLOPe POSitive NEGative :TRIGger[:SEquence]:RFBurst:SLOPe?
Example	TRIG:RFB:SLOP NEG
Couplings	This same slope is used in the RF Burst selection for the trigger source in the Trigger menu and for the period timer sync source (in the Trigger menu and in the Gate Source menu).
Preset	POSitive
State Saved	Saved in instrument state
Backwards Compatibility SCPI	:TRIGger[:SEquence]:FRAME:RFBurst:SLOPe
Backwards Compatibility Notes	The legacy :TRIGger[:SEquence]:SLOPe command affects the slopes for the VID, LINE, EXT1, EXT2, and RFB triggers.
Initial S/W Revision	Prior to A.02.00

Sync Holdoff

Sync Holdoff specifies the duration that the sync source signal must be kept false before the transition to true to be recognized as the sync timing. The periodic timer phase is aligned when the sync source signal becomes true, after the Holdoff time is satisfied.

A holdoff of 2 ms will work with most WiMAX signals, but there may be cases where the burst off duration is less than 1 ms and this value will need to be changed.

Key Path	Trigger, Periodic Timer
Remote Command	:TRIGger[:SEquence]:FRAMe:SYNC:HOLDoff <time> :TRIGger[:SEquence]:FRAMe:SYNC:HOLDoff? :TRIGger[:SEquence]:FRAMe:SYNC:HOLDoff:STATe OFF ON 0 1 :TRIGger[:SEquence]:FRAMe:SYNC:HOLDoff:STATe?
Preset	On, 1.000 ms
State Saved	Saved in instrument state
Min	0 ms
Max	+500 ms
Default Unit	s
Initial S/W Revision	Prior to A.02.00

Control Edge/Level

Sets the method of controlling the gating function from the gating signal.

Edge

In Edge triggering, the gate opens (after the Delay) on the selected edge (for example, positive) of the gate signal and closes on the alternate edge (for example, negative).

Level

In Level triggering, the gate opens (after the Delay) when the gate signal has achieved a certain level and stays open as long as that level is maintained.

Key Path	Sweep/Control, Gate
Remote Command	[:SENSe]:SWEep:EGATe:CONTRol EDGE LEVEl [:SENSe]:SWEep:EGATe:CONTRol?
Example	SWE:EGAT:CONT EDGE
Dependencies	If the Gate Method is FFT the Control key is grayed out and Edge is selected. If the Gate Source is TV, Frame or Line, the Control key is grayed out and Edge is selected.
Preset	EDGE
State Saved	Saved in instrument state
Backwards Compatibility SCPI	[:SENSe]:SWEep:TIME:GATE:TYPE ESA Compatibility
Initial S/W Revision	Prior to A.02.00

Gate Holdoff

Lets you increase or decrease the wait time after a gate event ends before the analyzer will respond to the next gate signal.

After any Gate event finishes, the analyzer must wait for the sweep system to settle before it can respond to another Gate signal. The analyzer calculates a "wait time," taking into account a number of factors, including RBW and Phase Noise Optimization settings. The goal is to achieve the same accuracy when gated as in ungated operation. The figure below illustrates this concept:

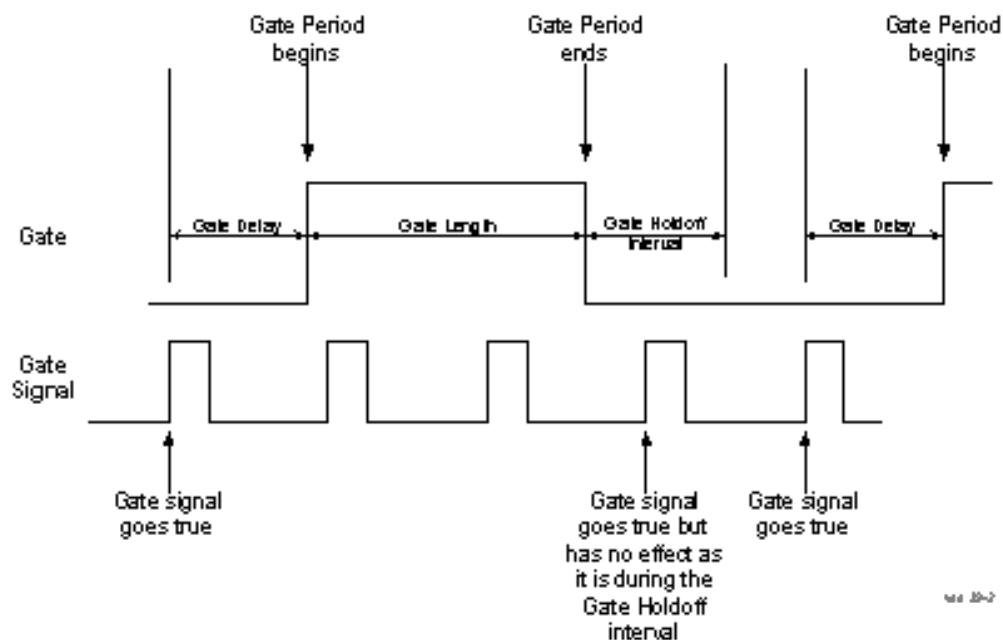

When Gate Holdoff is in Auto, the wait time calculated by the analyzer is used. When Gate Time is in Manual, the user may adjust the wait time, usually decreasing it in order to achieve greater speed, but at the risk of decreasing accuracy.

When the Method key is set to Video or FFT, the Gate Holdoff function has no effect.

In measurements that do not support Auto, the value shown when Auto is selected is “---” and the manually set holdoff is returned to a query.

Key Path	Sweep/Control, Gate
Remote Command	<pre>[:SENSe]:SWEep:EGATe:HOLDoff <time> [:SENSe]:SWEep:EGATe:HOLDoff? [:SENSe]:SWEep:EGATe:HOLDoff:AUTO OFF ON 0 1 [:SENSe]:SWEep:EGATe:HOLDoff:AUTO?</pre>
Example	<pre>SWE:EGAT:HOLD 0.0002 SWE:EGAT:HOLD? SWE:EGAT:HOLD:AUTO ON</pre>

SWE:EGAT:HOLD:AUTO?	
Couplings	<p>When Gate Holdoff is Auto, the Gate Holdoff key shows the value calculated by the analyzer for the wait time.</p> <p>Pressing the Gate Holdoff key while it is in Auto and not selected, causes the key to become selected and allows the user to adjust the value. If the value is adjusted, the setting changes to Man.</p> <p>Pressing the Gate Holdoff key, while it is in Auto and selected, does not change the value of Gate Holdoff, but causes the setting to change to Man. Now the user can adjust the value.</p> <p>Pressing the key while it is in Man and selected, cause the value to change back to Auto.</p> <p>Pressing the key while it is in Man and not selected, causes the key to become selected and allows the user to adjust the value.</p> <p>When Method is set to Video or FFT, the Gate Holdoff function has no effect.</p>
Preset	<p>Auto</p> <p>Auto/On</p>
State Saved	Saved in instrument state
Min	1 μ sec
Max	1 sec
Initial S/W Revision	Prior to A.02.00

Gate Delay Compensation

This function allows you to select an RBW-dependent value by which to adjust the gate delay, to compensate for changes in the delay caused by RBW effects.

You can select between uncompensated operation and two types of compensation, Delay Until RBW Settled and Compensate for RBW Group Delay.

See ["More Information" on page 1380](#)

Key Path	Sweep/Control, Gate
Scope	Meas Global
Remote Command	<pre>[:SENSe] :SWEep:EGATe:DELAy:COMPensation:TYPE OFF SETTled GDELAy [:SENSe] :SWEep:EGATe:DELAy:COMPensation:TYPE?</pre>
Example	<pre>SWE:EGAT:DEL:COMP:TYPE SETT SWE:EGAT:DEL:COMP:TYPE?</pre>
Notes	<p>Although this function is Meas Global, there are some measurements that do not support this function. In those measurements the operation will be Uncompensated. Going into one of those measurements will not change the Meas Global selection; it will simply display the grayed-out menu key with "Uncompensated" showing as the selection. This is a non-forceful grayout, so the SCPI command is still accepted.</p> <p>If Gate Delay Compensation is not supported at all within a particular mode, the key is not displayed, and if the SCPI command is sent while in a measurement within that mode, an "Undefined Header" message is generated.</p> <p>Measurements that do not support this function include:</p>

Swept SA	
Preset	TD-SCDMA mode: Compensate for RBW Group Delay All other modes: Delay Until RBW Settled
State Saved	Saved in instrument state
Range	Uncompensated Delay Until RBW Settled Compensate for RBW Group Delay
Readback text	Uncompensated Settled Group Delay
Initial S/W Revision	Prior to A.02.00
Modified at S/W Revision	A.11.0

More Information

Selecting Uncompensated means that the actual gate delay is as you sets it.

Selecting Delay Until RBW Settled causes the gate delay to be increased above the user setting by an amount equal to $3.06/\text{RBW}$. This compensated delay causes the GATE START and GATE STOP lines on the display to move by the compensation amount, and the actual hardware gate delay to be increased by the same amount. All the other gate lines (for example, MIN FAST) are unaffected. If the RBW subsequently changes, the compensation is readjusted for the new RBW. The value shown on the Gate Delay key does NOT change.

Delay Until RBW Settled allows excellent measurements of gated signals, by allowing the IF to settle following any transient that affects the burst. Excellent measurements also require that the analysis region not extend into the region affected by the falling edge of the burst. Thus, excellent measurements can only be made over a width that declines with narrowing RBWs, which is achieved by decreasing the gate length below the user setting by an amount equal to $2.53/\text{RBW}$. Therefore, for general purpose compensation, you will still want to change the gate length with changes in RBW even if the gate delay is compensated. The compensated Gate Length is limited by the analyzer so that it will never go below 10% of the value shown on the Gate Length key, as otherwise the sweep times could get very long. Anytime the Gate Length and RBW values combine in such a way that this limiting takes place, a warning is displayed. For measurements which contain multiple sweeps with different RBW like SEM and SPUR, the smallest RBW is used for this limiting.

Selecting Compensate for RBW Group Delay causes the gate delay to be increased above the user setting by an amount equal to $1.81/\text{RBW}$. This compensated delay causes the GATE START, GATE STOP lines on the display to move by the compensation amount, and the actual hardware gate delay to be increased by the same amount. All the other gate lines (for example, MIN FAST) are unaffected. If the RBW subsequently changes, the compensation is readjusted for the new RBW. The value shown on the Gate Delay key does NOT change. Compensate for RBW Group Delay also includes gate length compensation; the gate length itself is adjusted as necessary to attempt to compensate for delay effects imposed by the RBW.

Compensate for RBW Group Delay is similar to Delay Until RBW Settled, but compensates for the group delay of the RBW filter, rather than the filter settling time. As the RBW gets narrow, this can allow the settling tail of the RBW to affect the beginning part of the gated measurement, and allow the beginning of the RBW settling transient to affect the end of the gated measurement. These two effects are symmetric

because the RBW response is symmetric. Because the gate length is not automatically compensated, some users might find this compensation to be more intuitive than compensation for RBW settling.

Min Fast Position Query (Remote Command Only)

This command queries the position of the MIN FAST line, relative to the delay reference (REF) line. See section "[Gate View On/Off](#)" on page 2098. If this query is sent while not in gate view, the MinFast calculation is performed based on the current values of the appropriate parameters and the result is returned. Knowing this value lets you set an optimal gate delay value for the current measurement setup.

Remote Command	<code>[:SENSe] :SWEep:EGATe:MINFast?</code>
Example	<code>SWE:EGAT:MIN?</code>
Initial S/W Revision	Prior to A.02.00

Gate Preset (Remote Command Only)

Presets the time-gated spectrum analysis capability.

This command sets gate parameter values to the ESA preset values, as follows:

Gate trigger type = edge

Gate polarity = positive

Gate delay = 1 us

Gate length = 1 us

Remote Command	<code>[:SENSe] :SWEep:TIME:GATE:PRESet</code> ESA Compatibility
Initial S/W Revision	Prior to A.02.00

Gate Level (Remote Command Only)

Sets the gate input transition point level for the external TRIGGER inputs on the front and rear panel. This is a legacy command for PSA compatibility. It is simply an alias to the equivalent trigger level command.

Remote Command	<code>[:SENSe] :SWEep:EGATe:EXTernal [1] 2 :LEVel <voltage></code> <code>[:SENSe] :SWEep:EGATe:EXTernal [1] 2 :LEVel?</code>
Notes	This command is simply an alias to <code>:TRIGger[:SEQUence]:EXTernal[1] 2:LEVel</code> For details refer
Initial S/W Revision	Prior to A.02.00

Gate Polarity (Remote Command Only)

Sets the polarity for the gate signal. This setup is now done using the gate trigger's slope setting.

When Positive (Pos) is selected, a positive-going edge (Edge) or a high voltage (Level) will satisfy the gate condition, after the delay set with the Gate Delay key. When Negative (Neg) is selected, a negative-going edge (Edge) or a low voltage (Level) will satisfy the gate condition after the delay.

Remote Command	<code>[:SENSe] :SWEep:EGATe:POLarity NEGative POSitive</code> <code>[:SENSe] :SWEep:EGATe:POLarity?</code>
Example	<code>SWE:EGAT:POL NEG</code> <code>SWE:EGAT:POL?</code>
Preset	POSitive
State Saved	Saved in instrument state
Backwards Compatibility SCPI	<code>[:SENSe] :SWEep:TIME:GATE:POLarity</code> ESA compatibility
Initial S/W Revision	Prior to A.02.00

Remote Command	<code>[:SENSe] :SWEep:TIME:GATE:LEVel HIGH LOW</code> <code>[:SENSe] :SWEep:TIME:GATE:LEVel?</code> ESA compatibility
Preset	HIGH
Initial S/W Revision	Prior to A.02.00

System

See "System" on page 353

Trace/Detector

Trace/Detector is unavailable in the Spurious Emissions measurement. When pressed, this key displays a blank menu.

Key Path	Front-panel key
Initial S/W Revision	Prior to A.02.00

Trigger

See ["Trigger" on page 428](#)

Free Run

See ["Free Run " on page 435](#)

Video

See ["Video \(IF Envelope\) " on page 436](#)

Trigger Level

See ["Trigger Level " on page 436](#)

Trig Slope

See ["Trig Slope " on page 437](#)

Trig Delay

See ["Trig Delay " on page 438](#)

Line

See ["Line " on page 2105](#)

Trig Slope

See ["Trig Slope " on page 2105](#)

Trig Delay

See ["Trig Delay " on page 440](#)

External 1

See ["External 1 " on page 2118](#)

Trigger Level

See ["Trigger Level " on page 2118](#)

Trig Slope

See ["Trig Slope " on page 2119](#)

Trig Delay

See ["Trig Delay " on page 443](#)

Zero Span Delay Comp

See ["Zero Span Delay Comp On/Off" on page 2107](#)

External 2

See ["External 2 "](#) on page 2120

Trigger Level

See ["Trigger Level "](#) on page 2120

Trig Slope

See ["Trig Slope "](#) on page 2121

Trig Delay

See ["Trig Delay "](#) on page 445

Zero Span Delay Comp

See ["Zero Span Delay Comp On/Off"](#) on page 2109

RF Burst

See ["RF Burst "](#) on page 2121

Absolute Trigger

See ["Absolute Trigger Level"](#) on page 2122

Relative Trigger

See ["Relative Trigger Level"](#) on page 2111

Trig Slope

See ["Trigger Slope "](#) on page 2123

Trig Delay

See ["Trig Delay "](#) on page 450

Periodic Timer

See ["Periodic Timer \(Frame Trigger\) "](#) on page 2113

Period

See ["Period "](#) on page 2114

Offset

See ["Offset "](#) on page 2115

Reset Offset Display

See ["Reset Offset Display "](#) on page 2117

Sync Source

See ["Sync Source "](#) on page 2117

Off

See ["Off "](#) on page 2118

External 1

See ["External 1 "](#) on page 2118

Trigger Level

See ["Trigger Level "](#) on page 2118

Trig Slope

See ["Trig Slope "](#) on page 2119

External 2

See ["External 2 "](#) on page 2120

Trigger Level

See ["Trigger Level "](#) on page 2120

Trig Slope

See ["Trig Slope "](#) on page 2121

RF Burst

See ["RF Burst "](#) on page 2121

Absolute Trigger

See ["Absolute Trigger Level"](#) on page 2122

Trig Slope

See ["Trigger Slope "](#) on page 2123

Trig Delay

See ["Trig Delay"](#) on page 460

Auto/Holdoff

See ["Auto/Holdoff "](#) on page 461

Auto Trig

See ["Auto Trig "](#) on page 461

Trig Holdoff

See ["Trig Holdoff "](#) on page 462

User Preset

Accesses a menu that gives you the following three choices:

- User Preset – recalls a state previously saved using the Save User Preset function.
- User Preset All Modes – presets all of the modes in the analyzer
- Save User Preset– saves the current state for the current mode

Key Path	Front-panel key
Backwards Compatibility Notes	<p>User Preset is actually loading a state, and in legacy analyzers, it was possible to load a state without affecting the trace data, limit lines or correction data. Similarly it was possible to do a User Preset without affecting the trace data, limit lines or correction data.</p> <p>In the X-Series, “state” always includes all of this data; so whenever state is loaded, or User Preset is executed, all of the traces, limit lines and corrections are affected. Although this differs from previous behavior, it is desirable behavior, and should not cause adverse issues for users.</p> <p>On ESA and PSA, User Preset affected the entire instrument’s state. In the X-Series, User Preset only recalls the state for the active mode. There is a User Preset file for each mode. User Preset can never cause a mode switch as it can in legacy analyzers. If you want to recall all modes to their user preset file state, you will need to do a User Preset after mode switching into each mode.</p> <p>User Preset recalls mode state which can now include data like traces; whereas on ESA and PSA, User Preset did not affect data.</p>
Initial S/W Revision	Prior to A.02.00

User Preset

User Preset sets the state of the currently active mode back to the state that was previously saved for this mode using the Save User Preset menu key or the SCPI command, SYST:PRES:USER:SAV. It not only recalls the Mode Preset settings, but it also recalls all of the mode persistent settings, and the Input/Output system setting that existed at the time Save User Preset was executed.

If a Save User Preset has not been done at any time, User Preset recalls the default user preset file for the currently active mode. The default user preset files are created if, at power-on, a mode detects there is no user preset file. There will never be a scenario when there is no user preset file to restore. For each mode, the default user preset state is the same state that would be saved if a Save User Preset is performed in each mode right after doing a Restore Mode Default and after a Restore Input/Output Defaults.

The User Preset function does the following:

- Aborts the currently running measurement.
- Sets the mode State to the values defined by Save User Preset.
- Makes the saved measurement for the currently running mode the active measurement.
- Brings up the saved menu for the power-on mode.
- Clears the input and output buffers.
- Sets the Status Byte to 0.

Key Path	User Preset
Remote Command	:SYSTem:PRESet:USER
Example	:SYST:PRES:USER:SAVE:SYST:PRES:USER
Notes	:SYST:PRES:USER:SAVE is used to save the current state as the user preset state. Clears all pending OPC bits. The Status Byte is set to 0. Pressing the User Preset front-panel key while already in the User Preset menu will cause the User Preset to get executed
Couplings	A user preset will cause the currently running measurement to be aborted and cause the saved measurement to be active. Recalling a User Preset file has the same issues that recalling a Save State file has. Some settings may need to be limited and therefore re-coupled, since the capabilities of the mode may have changes when the User Preset file was last saved.
Initial S/W Revision	Prior to A.02.00

User Preset All Modes

Recalls all of the User Preset files for each mode, switches to the power-on mode, and activates the saved measurement from the power-on mode User Preset file.

NOTE

When the instrument is secured, all of the user preset files are converted back to their default user preset files.

The User Preset function does the following:

- Aborts the currently running measurement.
- Switches the Mode to the power-on mode.
- Restores the User Preset files for each mode.
- Makes the saved measurement for the power-on mode the active measurement.
- Brings up the saved menu for the power-on mode.
- Clears the input and output buffers.
- Sets the Status Byte to 0.

Key Path	User Preset
Remote Command	:SYSTem:PRESet:USER:ALL
Example	:SYST:PRES:USER:SAVE:SYST:PRES:USER:ALL
Notes	Clears all pending OPC bits. The Status Byte is set to 0. :SYST:PRES:USER:SAVE is used to save the current state as the user preset state.
Couplings	A user preset will cause the currently running measurement to be aborted, cause a mode switch to the power-on mode, and cause the saved measurement to be active in the power-on mode. Recalling a User Preset file has the same issues that recalling a Save State file has. Some settings may need to be limited and therefore re-coupled, since the capabilities of the mode may have changes when the User Preset file was last saved.
Initial S/W Revision	Prior to A.02.00

Save User Preset

Saves the currently active mode and its State. You can recall this User Preset file by pressing the User Preset menu key or sending the SYST:PRES:USER remote command. This same state is also saved by the Save State function.

Key Path	User Preset
Remote Command	:SYSTem:PRESet:USER:SAVE
Example	:SYST:PRES:USER:SAVE
Notes	:SYST:PRES:SAVE creates the same file as if the user requested a *SAV or a MMEM:STOR:STAT, except User Preset Save does not allow the user to specify the filename or the location of the file.
Initial S/W Revision	Prior to A.02.00

View/Display

Accesses a menu that includes keys that enables you to control the instrument display.

For details of available views, see [View Selection](#).

For details of remote commands associated with views, see [Range Table Selection \(SCPI only command\)](#).

Key Path	Front-panel key
Initial S/W Revision	Prior to A.02.00

Display

The Display menu is common to most measurements, and is used for configuring items on the display. Some Display menu settings apply to all the measurements in a mode, and some only to the current measurement. Those under the System Display Settings key apply to all measurements in all modes.

Key Path	Display
Key Path	View/Display
Initial S/W Revision	Prior to A.02.00

Annotation

Turns on and off various parts of the display annotation. The annotation is divided up into four categories:

1. Meas Bar: This is the measurement bar at the top of the screen. It does not include the settings panel or the Active Function. Turning off the Meas Bar turns off the settings panel and the Active Function. When the Meas Bar is off, the graticule area expands to fill the area formerly occupied by the Meas Bar.
2. Screen Annotation: this is the annotation and annunciation around the graticule, including any annotation on lines (such as the display line, the threshold line, etc.) This does NOT include the marker number or the N dB result. When off, the graticule expands to fill the entire graticule area.
3. Trace annotation: these are the labels on the traces, showing their detector (or their math mode).
4. Active Function annotation: this is the active function display in the meas bar, and all of the active function values displayed on softkeys.

See the figure below. Each type of annotation can be turned on and off individually.

12 Spurious Emissions Measurement
View/Display

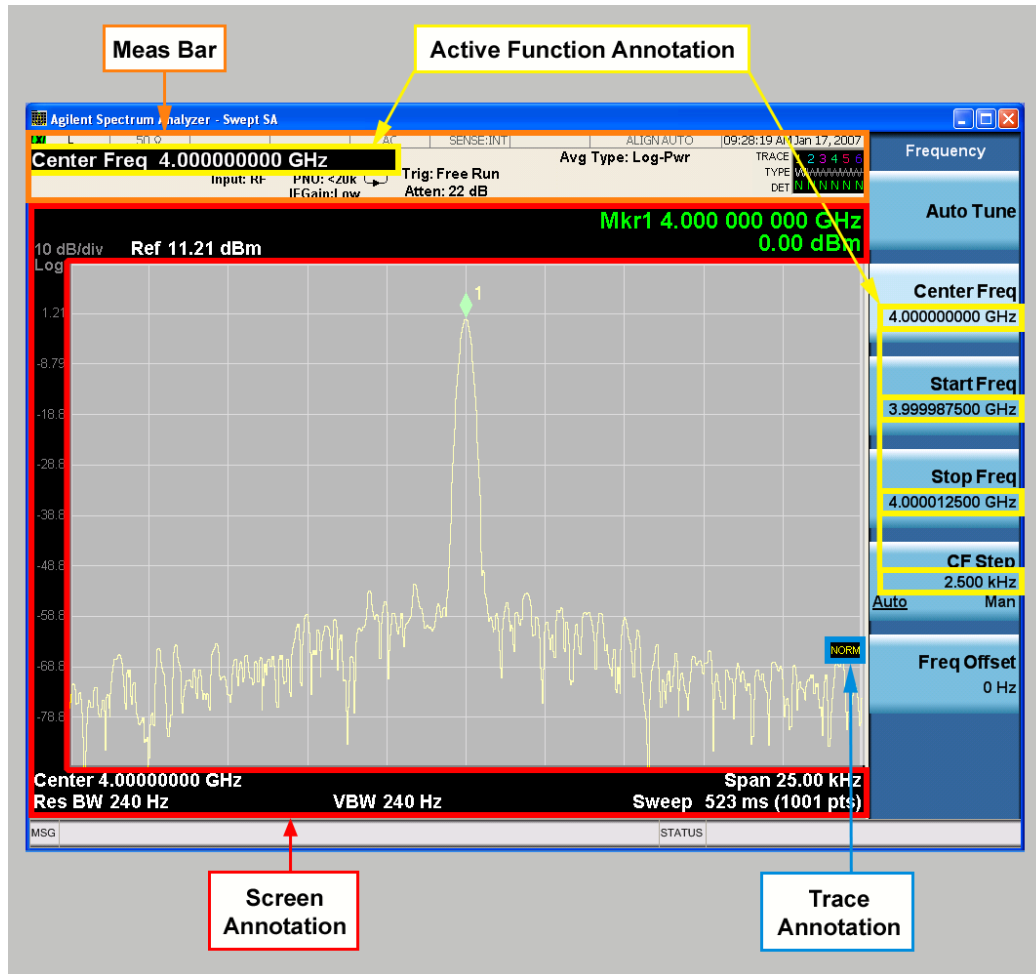

Key Path	View/Display, Display
Initial S/W Revision	Prior to A.02.00

Meas Bar On/Off

This function turns the Measurement Bar on and off, including the settings panel. When off, the graticule area expands to fill the area formerly occupied by the Measurement Bar.

Key Path	View/Display, Display, Annotation
Remote Command	:DISPlay:ANNOtation:MBAR[:STATe] OFF ON 0 1 :DISPlay:ANNOtation:MBAR[:STATe]?
Example	DISP:ANN:MBAR OFF
Dependencies	Grayed out and forced to OFF when System Display Settings, Annotation is set to Off.
Preset	On This should remain Off through a Preset when System DisplaySettings, Annotation is set to Off.
State Saved	Saved in instrument state.
Initial S/W Revision	Prior to A.02.00

Screen

This controls the display of the annunciation and annotation around the graticule, including any annotation on lines (such as the display line, the threshold line, etc.) and the y-axis annotation. This does NOT include marker annotation (or the N dB result). When off, the graticule expands to fill the entire graticule area, leaving only the 1.5% gap above the graticule as described in the Trace/Detector chapter.

Key Path	View/Display, Display, Annotation
Remote Command	:DISPlay:ANNotation:SCReen[:STATe] OFF ON 0 1 :DISPlay:ANNotation:SCReen[:STATe]?
Example	DISP:ANN:SCR OFF
Dependencies	Grayed-out and forced to OFF when System Display Settings, Annotation is set to Off.
Preset	On This should remain Off through a Preset when System DisplaySettings, Annotation is set to Off
State Saved	Saved in instrument state.
Initial S/W Revision	Prior to A.02.00

Active Function Values On/Off

Turns on and off the active function display in the Meas Bar, and all of the active function values displayed on the softkeys.

Note that all of the softkeys that have active functions have these numeric values blanked when this function is on. This is a security feature..

12 Spurious Emissions Measurement
View/Display

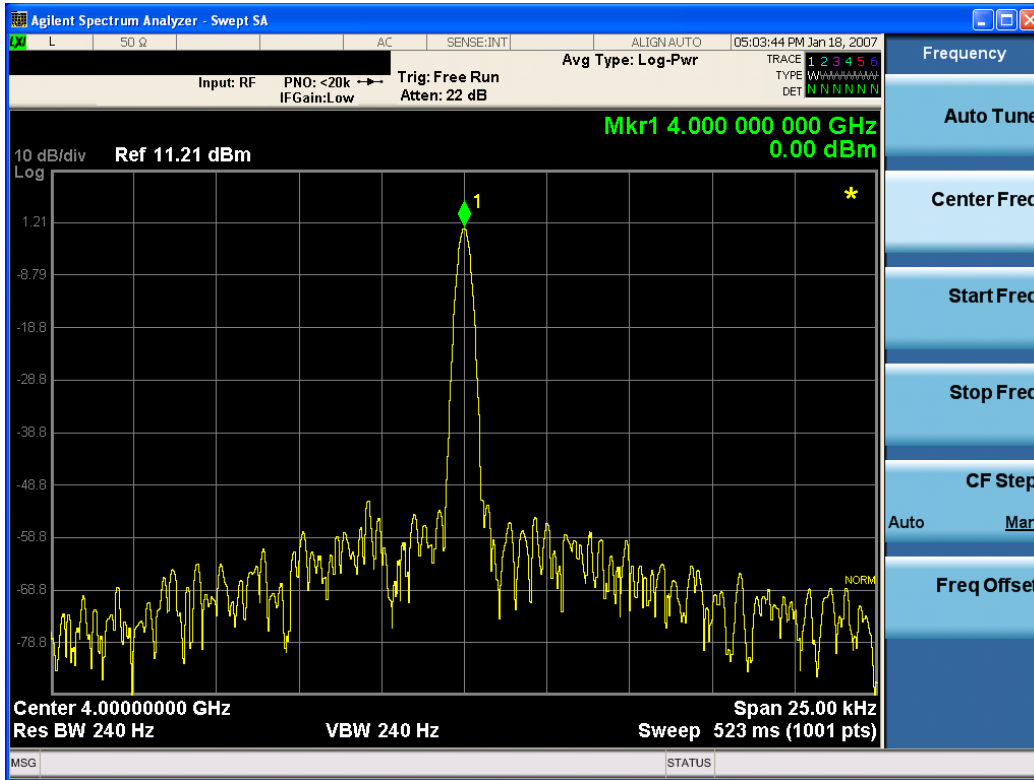

Key Path	View/Display, Display, Annotation
Remote Command	:DISPlay:ACTivefunc[:STATE] ON OFF 1 0 :DISPlay:ACTivefunc[:STATE]?
Example	DISP:ACT OFF
Dependencies	Grayed out and forced to OFF when System Display Settings, Annotation is set to Off.
Preset	On This should remain Off through a Preset when System DisplaySettings, Annotation is set to Off
State Saved	Saved in instrument state.
Initial S/W Revision	Prior to A.02.00

Title

Displays menu keys that enable you to change or clear a title on your display.

Key Path	View/Display, Display
Initial S/W Revision	Prior to A.02.00

Change Title

Writes a title into the "measurement name" field in the banner, for example, "Swept SA".

Press Change Title to enter a new title through the alpha editor. Press Enter or Return to complete the entry. Press ESC to cancel the entry and preserve your existing title.

The display title will replace the measurement name. It remains for this measurement until you press Change Title again, or you recall a state, or a Preset is performed. A title can also be cleared by pressing Title, Clear Title.

NOTE

Notice the inclusion of the <measurement> parameter in the command below. Because each measurement remembers the Display Title, the command must be qualified with the measurement name. For the Swept SA measurement this is not the case; no <measurement> parameter is used when changing the Display Title for the Swept SA measurement.

Key Path	View/Display, Display, Title
Mode	All
Remote Command	:DISPlay:<measurement>:ANNotation:TITLe:DATA <string> :DISPlay:<measurement>:ANNotation:TITLe:DATA?
Example	DISP:ANN:TITL:DATA "This Is My Title" This example is for the Swept SA measurement in the Spectrum Analyzer mode. The SANalyzer <measurement> name is not used. DISP:ACP:ANN:TITL:DATA "This Is My Title" This example is for Measurements other than Swept SA. Both set the title to: This Is My Title
Notes	Pressing this key cancels any active function. When a title is edited the previous title remains intact (it is not cleared) and the cursor goes at the end so that characters can be added or BKSP can be used to go back over previous characters.
Preset	No title (measurement name instead)
State Saved	Saved in instrument state.
Initial S/W Revision	Prior to A.02.00

Clear Title

Clears a title from the front-panel display. Once cleared, the title cannot be retrieved. After the title is cleared, the current Measurement Name replaces it in the title bar.

Key Path	View/Display, Display, Title
Example	The following commands clear the title and restore the measurement's original title: DISP:ANN:TITL:DATA "" This example is for the Swept SA measurement in the Spectrum Analyzer mode. The SANalyzer <measurement> name is not used. DISP:ACP:ANN:TITL:DATA "" This example is for ACP; in measurements other than Swept SA the measurement name is required.
Notes	Uses the :DISPlay:<measurement>:ANNotation:TITLe:DATA <string> command with an empty string (in the Swept SA, the <measurement> is omitted).
Preset	Performed on Preset.
Initial S/W Revision	Prior to A.02.00

Graticule

Pressing Graticule turns the display graticule On or Off. It also turns the graticule y-axis annotation on and off.

Key Path	View/Display, Display
Remote Command	:DISPlay:WINDow[1]:TRACe:GRATicule:GRID[:STATe] OFF ON 0 1 :DISPlay:WINDow[1]:TRACe:GRATicule:GRID[:STATe]?
Example	DISP:WIND:TRAC:GRAT:GRID OFF
Notes	The graticule is the set of horizontal and vertical lines that make up the grid/divisions for the x-axis and y-axis.
Preset	On
State Saved	Saved in instrument state
Initial S/W Revision	Prior to A.02.00

System Display Settings

These settings are "Mode Global" – they affect all modes and measurements and are reset only by Restore Misc Defaults or Restore System Defaults under System.

Key Path	View/Display, Display
Initial S/W Revision	Prior to A.02.00

Annotation Local Settings

This is a Mode Global override of the meas local annotation settings. When it is All Off, it forces ScreenAnnotation, Meas Bar, Trace, and Active Function Values settings to be OFF for all measurements in all modes. This provides the security based "annotation off" function of previous analyzers; hence it uses the legacy SCPI command.

When it is All Off, the Screen, Meas Bar, Trace, and Active Function Values keys under the Display, Annotation menu are grayed out and forced to Off. When Local Settings is selected, you are able to set the local annotation settings on a measurement by measurement basis.

Key Path	View/Display, Display, System Display Settings
Remote Command	:DISPlay:WINDow[1]:ANNotation[:ALL] OFF ON 0 1 :DISPlay:WINDow[1]:ANNotation[:ALL]?
Example	:DISP:WIND:ANN OFF
Preset	On (Set by Restore Misc Defaults)
State Saved	Not saved in instrument state.
Backwards Compatibility Notes	The WINDow parameter and optional subopcode is included for backwards compatibility but ignored – all windows are equally affected.
Initial S/W Revision	Prior to A.02.00

Themes

Accesses a menu of functions that enable you to choose the theme to be used when saving the screen image.

The **Themes** option is the same as the **Themes** option under the **Display** and **Page Setup** dialogs. It allows you to choose between themes to be used when saving the screen image.

Key Path	Save, Screen Image
Remote Command	:MMEMory:STORe:SCReem:THEMe TDColor TDMonochrome FCOlor FMONochrome :MMEMory:STORe:SCReem:THEMe?
Example	:MMEM:STOR:SCR:THEM TDM
Preset	3D Color; Is not part of Preset, but is reset by Restore Misc Defaults or Restore System Defaults All and survives subsequent running of the modes.
Readback	3D Color 3D Mono Flat Color Flat Mono
Backwards Compatibility Notes	In ESA and PSA we offer the choice of "Reverse Bitmap" or "Reverse Metafile" when saving screen images. This is much like the "Flat Color" theme available in X-Series. Also, if you selected Reverse Bitmap AND a black & white screen image, that would be much like "Flat Monochrome". In other words, each of the X-Series themes has a similar screen image type in ESA/PSA. But they are not identical.
Initial S/W Revision	Prior to A.02.00

3D Color

Selects a standard color theme with each object filled, shaded and colored as designed.

Key Path	Save, Screen Image, Themes
Example	MMEM:STOR:SCR:THEM TDC
Readback	3D Color
Initial S/W Revision	Prior to A.02.00

3D Monochrome

Selects a format that is like 3D color but shades of gray are used instead of colors.

Key Path	Save, Screen Image, Themes
Example	MMEM:STOR:SCR:THEM TDM
Readback	3D Mono
Initial S/W Revision	Prior to A.02.00

Flat Color

Selects a format that is best when the screen is to be printed on an ink printer.

Key Path	Save, Screen Image, Themes
Example	MMEM:STOR:SCR:THEM FCOL
Readback	Flat Color
Initial S/W Revision	Prior to A.02.00

Flat Monochrome

Selects a format that is like Flat Color. But only black is used (no colors, not even gray), and no fill.

Key Path	Save, Screen Image, Themes
Example	MMEM:STOR:SCR:THEM FMON
Readback	Flat Mono
Initial S/W Revision	Prior to A.02.00

Backlight

Accesses the display backlight on/off keys. This setting may interact with settings under the Windows "Power" menu.

When the backlight is off, pressing ESC, TAB, SPACE, ENTER, UP, DOWN, LEFT, RIGHT, DEL, BKSP, CTRL, or ALT turns the backlight on without affecting the application. Pressing any other key will turn backlight on and could potentially perform the action as well.

Key Path	View/Display, Display, System Display Settings
Remote Command	:DISPlay:BACKlight ON OFF :DISPlay:BACKlight?
Preset	ON (Set by Restore Misc Defaults)
Initial S/W Revision	Prior to A.02.00

Backlight Intensity

An active function used to set the backlight intensity. It goes from 0 to 100 where 100 is full on and 0 is off. This value is independent of the values set under the Backlight on/off key.

Key Path	View/Display, Display, System Display Settings
Remote Command	:DISPlay:BACKlight:INTensity <integer> :DISPlay:BACKlight:INTensity?
Example	DISP:BACK:INT 50

Preset	100 (Set by Restore Misc Defaults)
Min	0
Max	100
Initial S/W Revision	Prior to A.02.00

View Selection

Selects the desired view. The following views are available:

- **"Graph + Metrics" on page 1399** – The lower window displays a list of spurs detected in a measurement cycle. The upper window displays a trace of the range that contains the currently selected spur.
- **"Range Table" on page 1400** – The lower window displays settings of ranges. The upper window displays a trace of the currently selected range.
- **"All Ranges" on page 1403** – The lower window displays a list of spurs detected in a measurement cycle. The upper window displays a merged trace of all the ranges.

Key Path	View/Display
Mode	SA, WCDMA, C2K, 1xEV-DO, WIMAX OFDMA, TD-SCDMA, DVB-T/H, LTE, LTETDD, MSR, LTEAFDD, LTEATDD
Remote Command	:DISPlay:SPURious:VIEW[:SElect] RESult RANGe ALL :DISPlay:SPURious:VIEW[:SElect]?
Example	DISP:SPUR:VIEW RANG DISP:SPUR:VIEW?
Notes	You must be in cdma2000 mode, TD-SCDMA mode, W-CDMA mode, DVB-T/H mode, GSM/EDGE mode, LTE mode, LTE TDD mode, LTE-Advanced FDD/TDD mode, MSR or WiMAX mode to use this command. Use INSTRUMENT:SElect to set the mode.
Preset	RESult
State Saved	No
Range	Graph + Metrics Range Table All Ranges
Initial S/W Revision	A.10.00
Modified at S/W Revision	A.11.00

Graph + Metrics

Select Graph + Metrics to view measurement results.

- The lower window displays a list of spurs detected in a measurement cycle. The currently selected spur, which is highlighted, can be changed by the Spur softkey in the Meas Setup menu.
- The upper window displays a trace of the range that contains the currently selected spur.

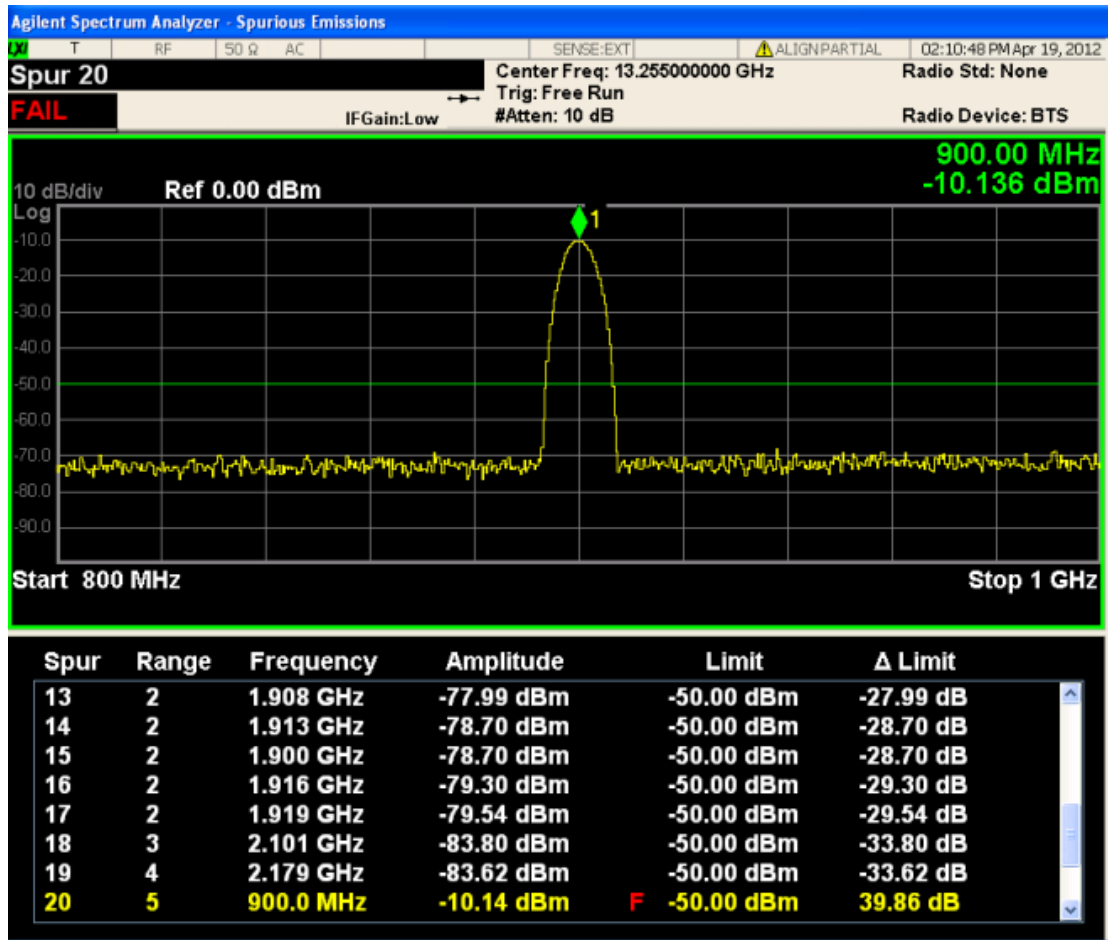

Result	Units	Min	Max
Spur	N/A	0	200
Range	N/A	1	20
Frequency	Hz	Analyzer Min	Analyzer Max
Amplitude	dBm	-150	50
Limit	dBm	-150	50

The spurs listed are within the current value of the Marker Peak Excursion setting of the absolute limit. All of the spurs listed passed. Any spur that has failed the absolute limit will have an 'F' beside it.

Range Table

Select Range Table to view range settings.

- The upper window displays a trace of the range specified by the Range key under Range Table in Meas Setup.
- The lower window displays the range setting.

All enabled range may not be displayed with the normal window arrangement. Even in that case, the instrument always displays the highlighted line in the table. When you zoom the lower window, all 20 ranges can be displayed.

When the range state is OFF, “---” appears, to indicate the range is inactive.

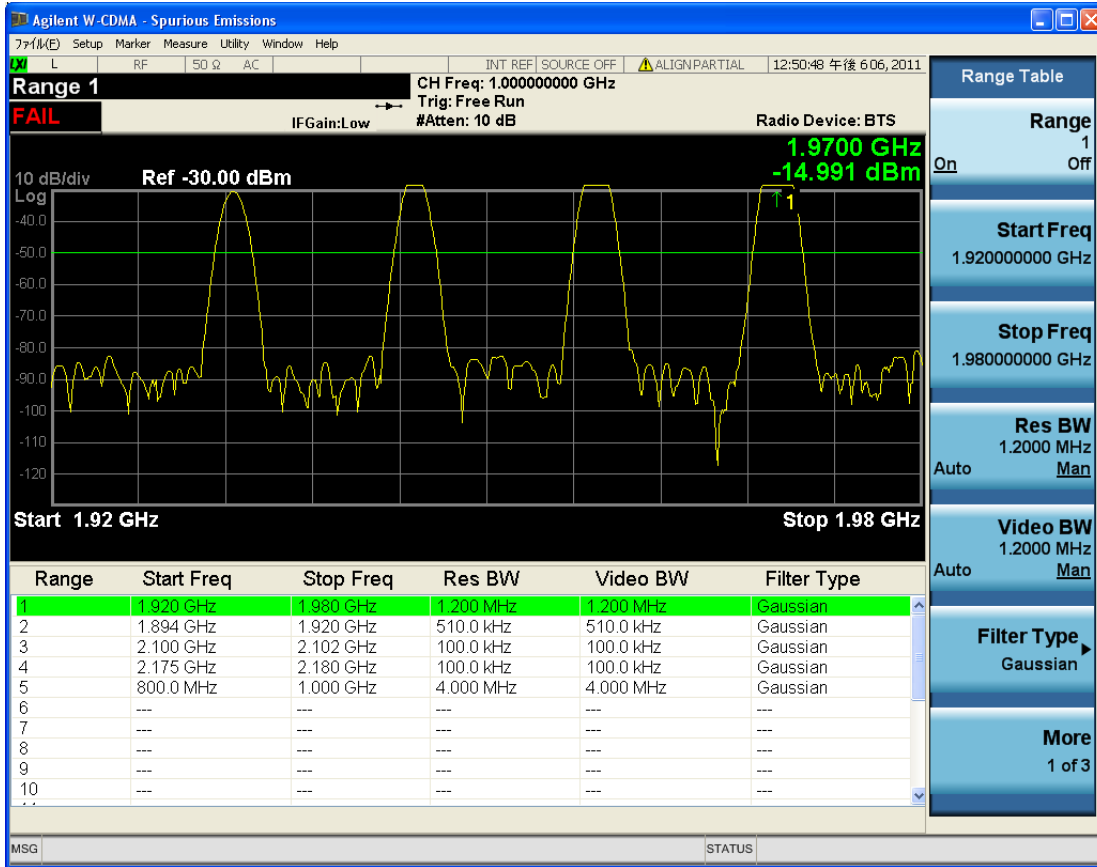

12 Spurious Emissions Measurement
View/Display

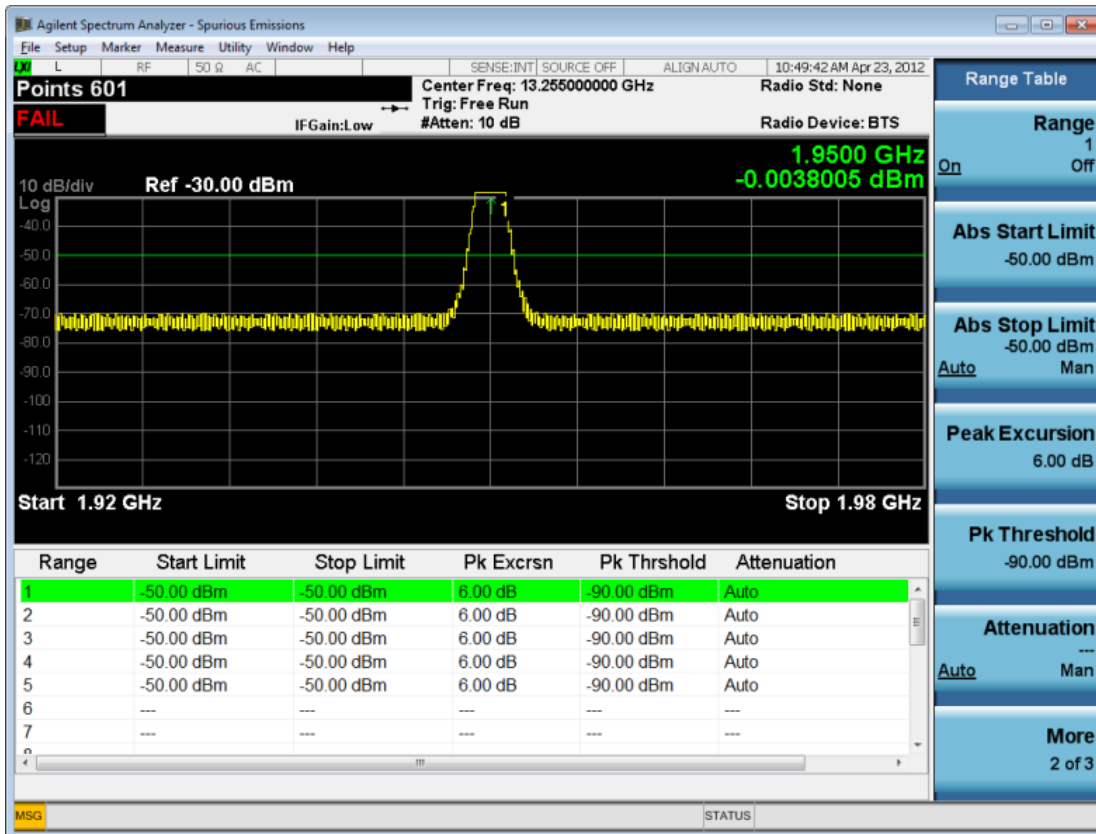

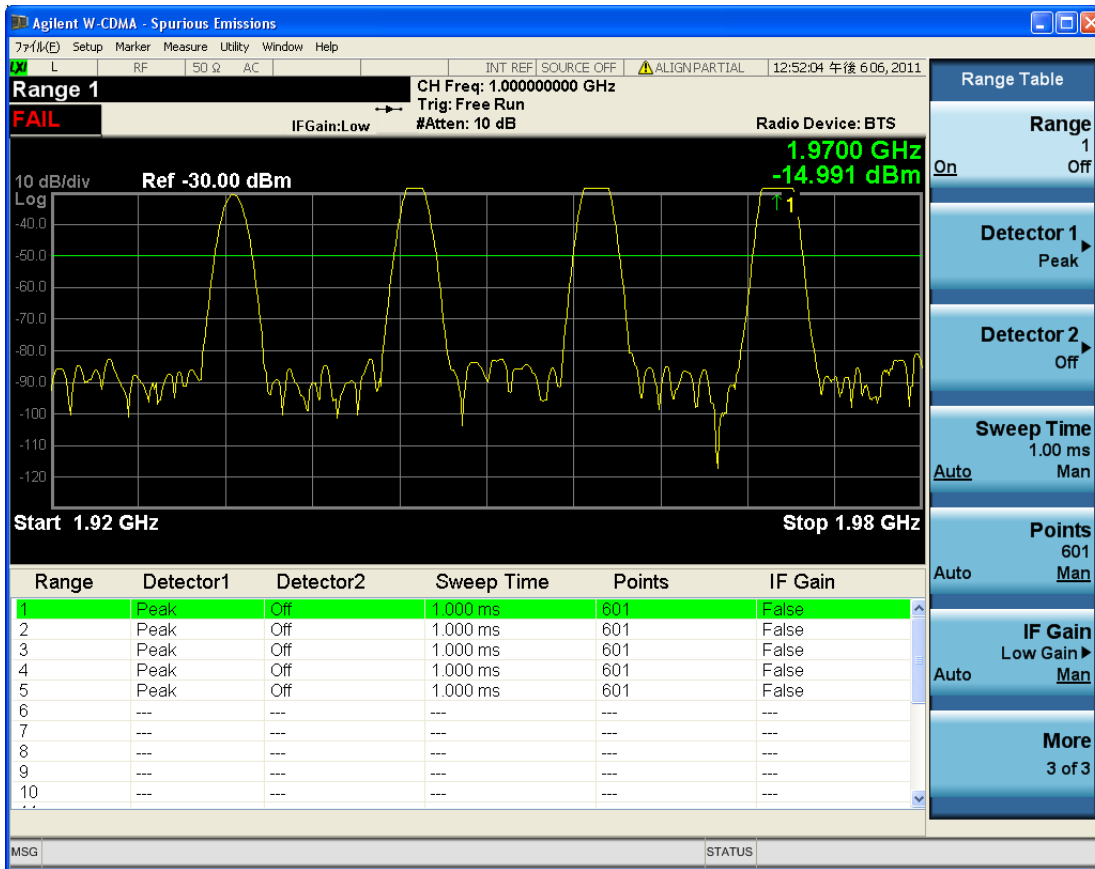

All Ranges

Select All Ranges to view measurement results for all the ranges.

- The upper window displays a merged trace of all the ranges.
- The lower window displays a list of spurs detected in a measurement cycle. The currently selected spur, which is highlighted, can be changed by the Spur softkey in the Meas Setup menu.

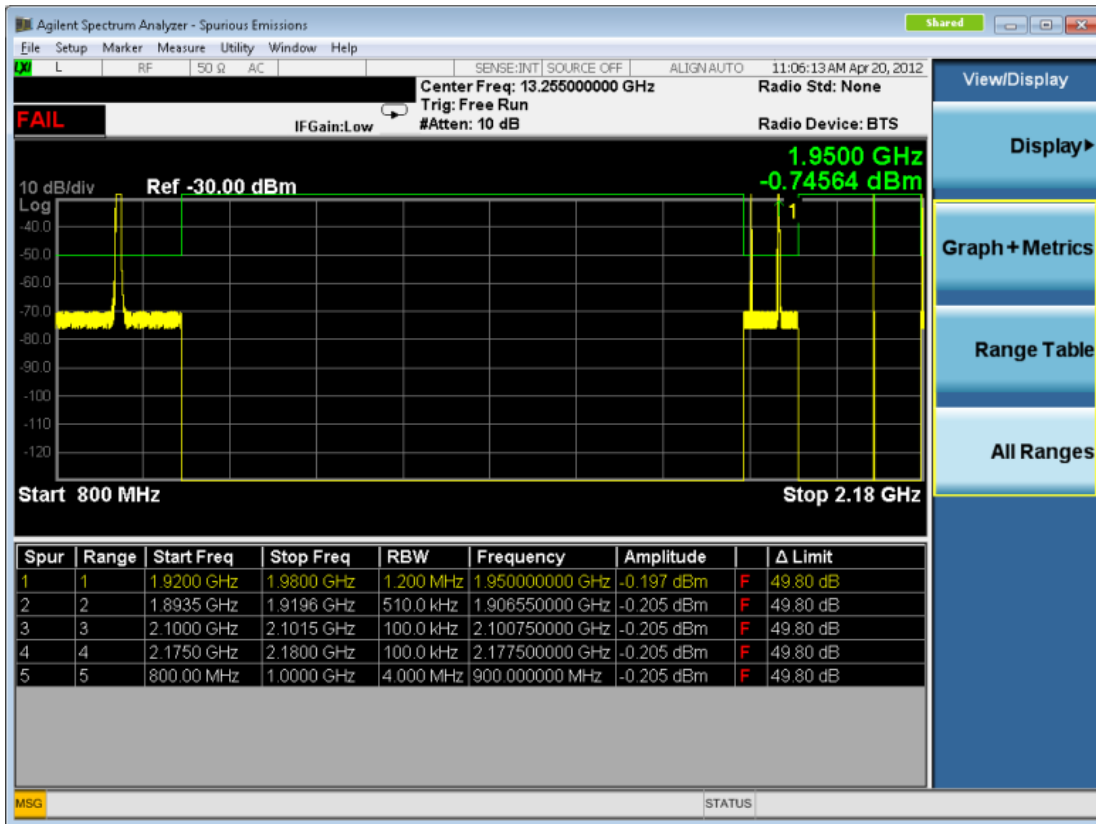

Range Table Selection (SCPI only command)

Switches contents of Range Table. There are three tables in the Range Table window, corresponding to each page of the Range Table menu. If the Range Table menu is displayed, this command changes the page of the Range Table menu too. Pressing the Range Table softkey always changes the current Range Table to 1.

Key Path	SCPI only
Mode	SA, WCDMA, C2K, 1xEV-DO, WIMAX OFDMA, TD-SCDMA, DVB-T/H, LTE, LTE TDD, WLAN, MSR, LTE FDD, LTE TDD
Remote Command	:DISPlay:SPURious:VIEW:RANGe:TABLE <integer> :DISPlay:SPURious:VIEW:RANGe:TABLE?
Example	DISP:SPUR:VIEW:RANG:TABL 2 DISP:SPUR:VIEW:RANG:TABL?
Notes	You must be in cdma2000 mode, TD-SCDMA mode, W-CDMA mode, DVB-T/H mode, GSM/EDGE mode, LTE mode, LTE TDD mode, WLAN mode, LTE-Advanced FDD/TDD mode, MSR or WiMAX mode to use this command. Use INSTRument:SElect to set the mode.
Preset	1
State Saved	No
Min	1
Max	3
Initial S/W Revision	A.10.00

13 Power vs. Time Measurement Overview

This measurement is designed for testing 802.11b signal. It measures power vs. time in the time domain. From envelop of power vs. time trace, transient periods (power-on ramp period or power-down ramp period) can be detected, then the transient periods can be compared with limits specified in specification for pass/fail judgment. Use INSTRument:SElect to set the mode. For measurement results and views, see the following sections:

["Measurement Commands for Power vs. Time Measurement" on page 1408](#)

["Remote Command Results for Power vs Time Measurement" on page 1409](#)

Measurement Commands for Power vs. Time Measurement

The following commands are used to retrieve the measurement results:

:CONFigure:PVTime

:CONFigure:PVTime:NDEFault

:INITiate:PVTime

:FETCh:PVTime[n]?

:READ:PVTime[n]?

:MEASure:PVTime[n]?

For more measurement related commands, see the SENSE subsystem, and the section "[Remote Measurement Functions](#)" on page 2213.

Remote Command Results for Power vs Time Measurement

N	Results Returned
0	Returns unprocessed I/Q trace data, as a series of comma-separated trace points, in volts. The I values are listed first in each pair, using the 0 through even-indexed values. The Q values are the odd-indexed values.
not specified or n = 1	Returns comma-separated scalar results, in the following order: Return -999.0 (BWCC to PSA WLAN) Return Power-on Ramp Time (us) Return Power-down Ramp Time (us) Return overall PASS/FAIL (0:Pass, 1: Fail) Return Power-on Ramp PASS/FAIL (0:Pass, 1: Fail) Return Power-down Ramp PASS/FAIL (0:Pass, 1: Fail) Return Start Level (dBm) for ramp up Return Start Level (dBm) for ramp down Return Stop Level (dBm) for ramp up Return Stop Level (dBm) for ramp down Return Max Ramp Up Time (us) (limit value) Return Max Ramp Down Time (us) (limit value)
2	Return waveform of Power-on Ramp, the length is determined by Ramp Time Length
3	Return waveform of Power-down Ramp, the length is determined by Ramp Time Length
4	Return waveform of full burst, the length is actual burst length

Key Path	Meas
Initial S/W Revision	A.10.01

AMPTD Y Scale

Accesses the AMPTD Y Scale menu that allows you to set desired vertical scale settings.

Key Path	Front Panel
Initial S/W Revision	A.10.01

Ref Value (Burst View)

Sets the absolute power reference.

Key Path	AMPTD Y Scale
Mode	WLAN
Remote Command	:DISPlay:PVTime:VIEW[1]:WINDow[1]:TRACe:Y[:SCALe]:RLEVel <real> :DISPlay:PVTime:VIEW[1]:WINDow[1]:TRACe:Y[:SCALe]:RLEVel?
Example	DISP:PVT:VIEW:WIND:TRAC:Y:SCAL:RLEV 5dbm DISP:PVT:VIEW:WIND:TRAC:Y:SCAL:RLEV?
Couplings	When Y Auto Scale is set to On, this value is automatically determined by the measurement result. When you set this value manually, Y Auto Scale is automatically set to Off.
Preset	10.00
State Saved	Saved in instrument state.
Min	-250.0
Max	250.0
Initial S/W Revision	A.10.01

Attenuation

This menu controls the attenuator functions and interactions between the attenuation system components.

There are two attenuator configurations in the X-Series. One is a dual attenuator configuration consisting of a mechanical attenuator and an optional electronic attenuator. The other configuration uses a single attenuator with combined mechanical and electronic sections that controls all the attenuation functions. Different models in the X-Series come with different configurations.

See ["Dual Attenuator Configurations:" on page 1411](#)

See ["Single Attenuator Configuration:" on page 1411](#)

Most Attenuation settings are the same for all measurements – they do not change as you change measurements. Settings like these are called “Meas Global” and are unaffected by Meas Preset.

Key Path	AMPTD Y Scale
----------	---------------

Scope	Meas Global
Dependencies	In measurements that support the I/Q inputs, this key is unavailable when I/Q is the selected input, and is replaced by the Range key in that case.
Readback Line	Contains a summary in [] brackets of the current total attenuation. See the descriptions of the , " (Mech) Atten " on page 2160, and " Enable Elec Atten " on page 2162 keys for more detail on the contributors to the total attenuation. Note that when "Pre-Adjust for Min Clip" is on, this value can change at the start of every measurement.
Initial S/W Revision	Prior to A.02.00
Modified at S/W Revision	A.03.00

Dual Attenuator Configurations:

Configuration 1: Mechanical attenuator + optional electronic attenuator

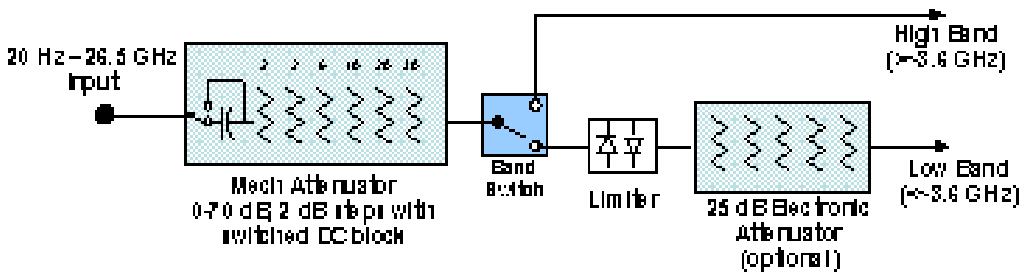

Configuration 2: Mechanical attenuator, no optional electronic attenuator

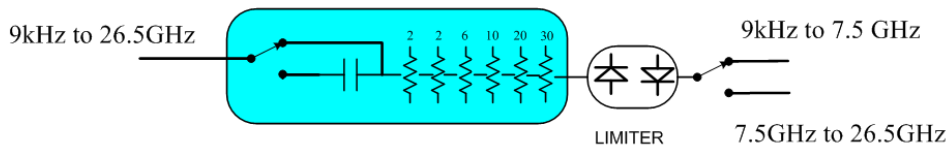

(note that Configuration 2 is not strictly speaking a dual-section attenuator, since there is no electronic section available. However, it behaves exactly like Configuration 1 without the Electronic Attenuator option EA3, therefore for the sake of this document it is grouped into the "Dual Attenuator" configuration)

Single Attenuator Configuration:

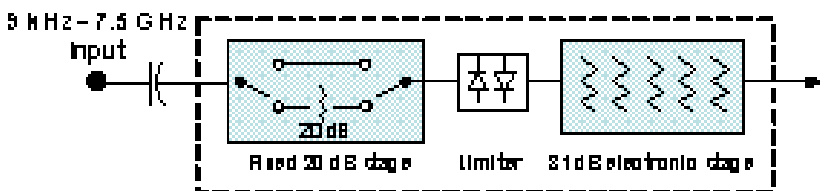

You can tell which attenuator configuration you have by pressing the Attenuation key, which (in most Modes) opens the Attenuation menu. If the first key in the Attenuation menu says Mech Atten you have the dual attenuator configuration. If the first key says Atten you have the single attenuator configuration.

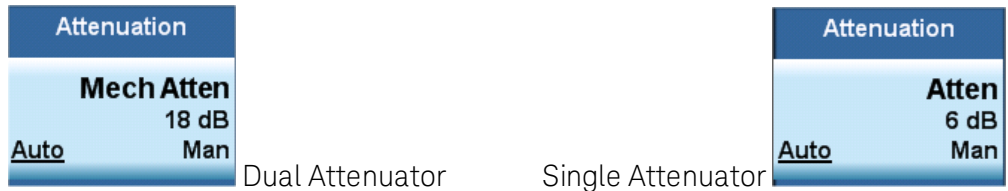

In the single attenuator configuration, you control the attenuation with a single control, as the fixed stage has only two states. In the dual attenuator configuration, both stages have significant range so you are given separate control of the mechanical and electronic attenuator stages.

When you have the dual attenuator configuration, you may still have only a single attenuator, because unless option EA3 (the Electronic Attenuator option) is available, and you purchase it, you will have only the mechanical attenuator.

(Mech) Atten

This key is labeled Mech Atten in dual attenuator models and Atten in single attenuator models. In the dual attenuator configuration, this key only affects the mechanical attenuator.

This key lets you modify the attenuation applied to the RF input signal path. This value is normally auto coupled to the Ref Level, the Internal Preamp Gain, any External Gain that is entered, and the Max Mixer Level, as described in the table below.

See "[Attenuator Configurations and Auto/Man](#)" on page 1413

Key Path	AMPTD Y Scale, Attenuation
Remote Command	<pre>[:SENSe] : POWer [:RF] : ATTenuation <rel_amp1> [:SENSe] : POWer [:RF] : ATTenuation? [:SENSe] : POWer [:RF] : ATTenuation : AUTO OFF ON 0 1 [:SENSe] : POWer [:RF] : ATTenuation : AUTO ?</pre>
Example	<p>POW:ATT 20</p> <p>Dual attenuator configuration: sets the mechanical attenuator to 20 dB</p> <p>Single attenuator mode: sets the main attenuation to 20 dB (see below for definition of "main" attenuation).</p> <p>If the attenuator was in Auto, it sets it to Manual.</p>
Dependencies	<p>Some measurements do not support the Auto setting of (Mech) Atten. In these measurements, the Auto/Man selection is not available, and the Auto/Man line on the key disappears.</p> <p>In dual attenuator configurations, when the electronic attenuator is enabled, the mechanical attenuator has no auto setting and the Auto/Man line on the key disappears. The state of Auto/Man is remembered and restored when the electronic attenuator is once again disabled. This is described in more detail in the "Enable Elec Atten" on page 2162 key description.</p> <p>See "Attenuator Configurations and Auto/Man" on page 1413 for more information on the Auto/Man functionality of Attenuation.</p>

Couplings

	<p>When (Mech) Atten is in Auto, it uses the following algorithm to determine a value: If the USB Preamp is connected to USB, use 0 dB. Otherwise, $\text{Atten} = \text{ReferenceLevel} + \text{PreAmpGain} + \text{ExternalGain} - \text{RefLevelOffset} - \text{MaxMixerLevel} + \text{IF Gain}$. Limit this value to be between 6 dB and the Max value. No value below 6 dB can ever be chosen by Auto. The resulting value is rounded up to the largest value possible given the attenuation step setting. That is, 50.01 dB would change to 60 dB (for a 10 dB attenuation step). The "IF Gain" term in the equation above is either 0 dB or +10 dB, depending on the settings of FFT IF Gain, Swept IF Gain, max Ref Level and the Auto/Man setting of Mech Atten. In External Mixing and BBIQ, where the Attenuator is not in the signal path, the Attenuator setting changes as described above when (Mech) Atten is in Auto, but no changes are made to the actual attenuator hardware setting until the input is changed back to the RF Input.</p>
Preset	<p>The preset for Mech Attenuation is "Auto." The Auto value of attenuation is: CXA, EXA, MXA and PXA: 10 dB</p>
State Saved	Saved in instrument state
Min	<p>0 dB The attenuation set by this key cannot be decreased below 6 dB with the knob or step keys. To get to a value below 6 dB it has to be directly entered from the keypad or via SCPI. This protects from adjusting the attenuation to a dangerously small value which can put the instrument at risk of damage to input circuitry. However, if the current mechanical attenuation is below 6 dB it can be increased with the knob and step keys, but not decreased.</p>
Max	<p>CXA N9000A-503/507: 50 dB CXA N9000A-513/526: 70dB EXA: 60 dB MXA and PXA: 70 dB In the single attenuator configuration, the total of ATT and EATT cannot exceed 50 dB, so if the EATT is set to 24 dB first, the main attenuation cannot be greater than 26 dB and will be reduced accordingly; if the main attenuator is set to 40 dB first, EATT cannot be greater than 10 dB.</p>
Initial S/W Revision	Prior to A.02.00
Modified at S/W Revision	A.03.00

Attenuator Configurations and Auto/Man

As described in the Attenuation key description, there are two distinct attenuator configurations available in the X-Series, the single attenuator and dual attenuator configurations. In dual attenuator configurations, we have the mechanical attenuation and the electronic attenuation, and the current total attenuation is the sum of the electronic + mechanical attenuation. In single attenuator configurations, we refer to the attenuation set using the (Mech) Atten key (or POW:ATT SCPI) as the "main" attenuation; and the attenuation that is set by the SCPI command POW:EATT as the "soft" attenuation (the POW:EATT command is honored even in the single attenuator configuration, for compatibility purposes). Then the

current total attenuation is the sum of the main + soft attenuation. See the Elec Atten key description for more on “soft” attenuation.

In the dual attenuator configuration, when the electronic attenuator is enabled, there is no Auto/Man functionality for the mechanical attenuator, and the third line of the key label (the Auto/Man line) disappears:

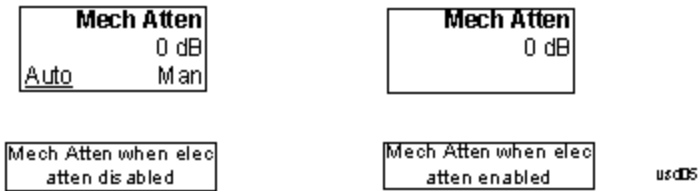

Enable Elec Atten

Enables the Electronic Attenuator.

The electronic attenuator offers finer steps than the mechanical attenuator, has no acoustical noise, is faster, and is less subject to wear. These advantages primarily aid in remote operation and are negligible for front panel use. See ["Using the Electronic Attenuator: Pros and Cons" on page 1416](#) for a detailed discussion of the pros and cons of using the electronic attenuator.

For the single attenuator configuration, for SCPI backwards compatibility, the “soft” attenuation feature replaces the dual attenuator configuration’s electronic attenuator. All the same couplings and limitations apply. See ["Attenuator Configurations and Auto/Man" on page 2162](#)

See ["More Information" on page 1415](#)

Key Path	AMPTD Y Scale, Attenuation
Remote Command	[:SENSe] :POWeR [:RF] :EATTenuation :STATe OFF ON 0 1 [:SENSe] :POWeR [:RF] :EATTenuation :STATe ?
Example	POW:EATT:STAT ON
Dependencies	<p>This key only appears in Dual Attenuator models with an Electronic Attenuator installed. It does not appear in models with the Single Attenuator configuration, as in the single attenuator configuration there is no “electronic attenuator” there is only a single integrated attenuator (which has both a mechanical and electronic stage). However, in the single attenuator configuration, EATT SCPI commands are accepted for compatibility with other X-series instruments and set a “soft” attenuation as described in "Attenuator Configurations and Auto/Man" on page 2162.</p> <p>The electronic attenuator (and the “soft” attenuation function provided in single attenuator configurations) is unavailable above 3.6 GHz. Therefore, if the Stop Frequency of the analyzer is > 3.6 GHz then the Enable Elec Atten key will be OFF and grayed out.</p> <p>If the Internal Preamp is on, meaning it is set to Low Band or Full, the electronic attenuator (and the “soft” attenuation function provided in single attenuator configurations) is unavailable. In this case the Enable Elec Atten key will be OFF and grayed out.</p> <p>If either of the above is true, if the SCPI command is sent, an error indicating that the electronic attenuator is unavailable will be sent.</p> <p>If the electronic/soft Attenuator is enabled, then the Stop Freq of the analyzer is limited to 3.6 GHz and the Internal Preamp is unavailable.</p> <p>The SCPI-only “soft” electronic attenuation for the single-attenuator configuration is not available in</p>

	all measurements; in particular, it is not available in the Swept SA measurement.
Couplings	Enabling and disabling the Electronic Attenuator affects the setting of the Mechanical Attenuator (in dual attenuator configurations). This is described in more detail below this table.
Preset	OFF for Swept SA measurement; ON for all other measurements that support the electronic attenuator
State Saved	Saved in instrument state
Initial S/W Revision	Prior to A.02.00
Modified at S/W Revision	A.03.00

More Information

Mechanical Attenuator Transition Rules

When the Electronic Attenuator is enabled, the Mechanical Attenuator transitions to a state that has no Auto function. Below are the rules for transitioning the Mechanical Attenuator. NOTE that the information below ONLY applies to the dual attenuator configurations, and ONLY when the Electronic Attenuator is installed:

When the Electronic Attenuation is enabled from a disabled state:

- The Mechanical Attenuator is initialized to 10 dB (this is its optimal performance setting). You can then set it as desired with SCPI, numeric keypad, step keys, or knob, and it behaves as it normally would in manual mode
- The Auto/Man state of (Mech) Atten is saved
- The Auto/Man line on the (Mech) Atten key disappears and the auto rules are disabled
- The Electronic Attenuator is set to 10 dB less than the previous value of the Mechanical Attenuator, within the limitation that it must stay within the range of 0 to 24 dB of attenuation.

Examples in the dual attenuator configuration:

- Mech Atten at 20 dB. Elec Atten enabled, Mech Atten set to 10 dB, and Elec Atten set to 10 dB. New total attenuation equals the value before Elec Atten enabled.
- Mech Atten at 0 dB. Elec Atten enabled, Mech Atten set to 10 dB, and Elec Atten set to 0 dB. New total attenuation does not equal the value before Elec Atten enabled.
- Mech Atten at 40 dB. Elec Atten enabled, Mech Atten set to 10 dB, and Elec Atten set to 24 dB. New total attenuation does not equal the value before Elec Atten enabled.

When the Electronic Attenuation is disabled from an enabled state:

- The Elec Atten key is grayed out
- The Auto/Man state of (Mech) Atten is restored
- If now in Auto, (Mech) Atten recouples

- If now in Man, (Mech) Atten is set to the value of total attenuation that existed before the Elec Atten was disabled. The resulting value is rounded up to the smallest value possible given the (Mech) Atten Step setting - (That is, 57 dB changes to 58 dB when (Mech) Atten Step is 2 dB.)

Using the Electronic Attenuator: Pros and Cons

The electronic attenuator offers finer steps than the mechanical attenuator, has no acoustical noise, is faster, and is less subject to wear.

The “finer steps” advantage of the electronic attenuator is beneficial in optimizing the alignment of the analyzer dynamic range to the signal power in the front panel as well as remote use. Thus, you can achieve improved relative signal measurement accuracy. Compared to a mechanical attenuator with 2 dB steps, the 1 dB resolution of the electronic attenuator only gives better resolution when the odd-decibel steps are used. Those odd-decibel steps are less accurately calibrated than the even-decibel steps, so one tradeoff for this superior relative accuracy is reduced absolute amplitude accuracy.

Another disadvantage of the electronic attenuator is that the spectrum analyzer loses its “Auto” setting, making operation less convenient.

Also, the relationship between the dynamic range specifications (TOI, SHI, compression and noise) and instrument performance are less well-known with the electrical attenuator. With the mechanical attenuator, TOI, SHI and compression threshold levels increase dB-for-dB with increasing attenuation, and the noise floor does as well. With the electronic attenuator, there is an excess attenuation of about 1 to 3 dB between 0 and 3.6 GHz, making the effective TOI, SHI, and so forth, less well known. Excess attenuation is the actual attenuation relative to stated attenuation. Excess attenuation is accounted for in the analyzer calibration

Elec Atten

Controls the Electronic Attenuator in dual attenuator configurations. This key does not appear in single attenuator configurations, as the control of both the mechanical and electronic stages of the single attenuator is integrated into the single Atten key.

Key Path	AMPTD Y Scale, Attenuation
Remote Command	<code>[:SENSe] :POWer [:RF] :EATTenuation <rel_amp></code> <code>[:SENSe] :POWer [:RF] :EATTenuation?</code>
Notes	Electronic Attenuation's specification is defined only when Mechanical Attenuation is 6 dB.
Dependencies	This key only appears in Dual Attenuator models with an Electronic Attenuator installed. It does not appear in models with the Single Attenuator configuration, as in the single attenuator configuration there is no “electronic attenuator” there is only a single integrated attenuator (which has both a mechanical and electronic stage). However, in the single attenuator configuration, EATT SCPI commands are accepted for compatibility with other X-series instruments and set a “soft” attenuation as described in "Attenuator Configurations and Auto/Man" on page 2162 . The “soft” attenuation is treated as an addition to the “main” attenuation value set by the Atten softkey or the POW:ATT SCPI command and affects the total attenuation displayed on the Attenuation key and the Meas Bar. When Enable Elec Atten is off or grayed out, the Elec Atten key is grayed out.
Preset	0 dB
State Saved	Saved in instrument state

Min	0 dB
Max	Dual attenuator configuration: 24 dB Single attenuator configuration: the total of ATT and EATT cannot exceed 50 dB, so if the EATT is set to 24 dB first, the main attenuation cannot be greater than 26 dB and will be reduced accordingly; if the main attenuator is set to 40 dB first, EATT cannot be greater than 10 dB
Initial S/W Revision	Prior to A.02.00
Modified at S/W Revision	A.03.00

Adjust Atten for Min Clip

Sets the combination of mechanical and electronic attenuation and gain based on the current measured signal level so that clipping will be at a minimum.

This is an "immediate action" function, that is, it executes once, when the key is pressed.

This key is grayed out in measurements that do not support this functionality. The spectrum analyzer measurement, Swept SA, does not support this functionality.

Key Path	AMPTD Y Scale, Attenuation
Remote Command	<code>[:SENSe] :POWer [:RF] :RANGe:OPTimize IMMEDIATE</code>
Initial S/W Revision	Prior to A.02.00
Modified at S/W Revision	A.03.00

Pre-Adjust for Min Clip

If this function is on, it does the adjustment described under ["Adjust Atten for Min Clip" on page 2165](#) each time a measurement restarts. Therefore, in Continuous measurement mode, it only executes before the first measurement.

In dual attenuator models, you can set Elec+Mech Atten, in which case both attenuators participate in the autoranging, or Elec Atten Only, in which case the mechanical attenuator does not participate in the autoranging. This latter case results in less wear on the mechanical attenuator and is usually faster.

This key is grayed out in measurements that do not support this functionality. The spectrum analyzer measurement, Swept SA, does not support this functionality.

Key Path	AMPTD Y Scale, Attenuation
Remote Command	<code>[:SENSe] :POWer [:RF] :RANGe:OPTimize:ATTenuation OFF ELECTrical COMBined</code> <code>[:SENSe] :POWer [:RF] :RANGe:OPTimize:ATTenuation?</code>
Notes	The SCPI parameter ELECTrical sets this function to On in single attenuator models. The SCPI parameter COMBined is mapped to ELECTrical in single attenuator models; if you send COMBined, it sets the function to On and returns ELEC to a query.
Dependencies	This key only appears in Dual Attenuator models with an Electronic Attenuator installed.

	In instruments with Dual Attenuator model, when Enable Elec Atten is off or grayed out, the Pre-Adjust for Min Clip key is grayed out.
Preset	OFF for Swept SA measurement; ON for all other measurements that support Pre-Adjust for Min Clip
State Saved	Saved in instrument state
Range	Dual attenuator models: Off Elec Atten Only Mech + Elec Atten Single attenuator models: Off On
Initial S/W Revision	Prior to A.02.00
Modified at S/W Revision	A.03.00

Remote Command	<code>[:SENSe] :POWer [:RF] :RANGe :AUTO ON OFF 1 0</code> <code>[:SENSe] :POWer [:RF] :RANGe :AUTO?</code>
Notes	ON aliases to "Elec Atten Only" (:POW:RANG:OPT:ATT ELEC) OFF aliases to "Off" (:POW:RANG:OPT:ATT OFF) The query :POW:RANG:AUTO? returns true if :POW:RANG:OPT:ATT is not "Off"
Initial S/W Revision	Prior to A.02.00

Off

Turns Pre-Adjust for Min Clip off. This is the default setting.

This key is grayed out in measurements that do not support this functionality. The spectrum analyzer measurement, Swept SA, does not support this functionality.

Key Path	AMPTD Y Scale, Attenuation, Pre-Adjust for Min Clip
Example	:POW:RANGe:OPT:ATT OFF
Initial S/W Revision	Prior to A.02.00

Elec Atten Only

Selects only the electric attenuator to participate in auto ranging. This offers less wear on the mechanical attenuator and is usually faster.

This key is grayed out in measurements that do not support this functionality. The spectrum analyzer measurement, Swept SA, does not support this functionality.

Key Path	AMPTD Y Scale, Attenuation, Pre-Adjust for Min Clip
Example	:POW:RANGe:OPT:ATT ELEC
Initial S/W Revision	Prior to A.02.00

Mech + Elec Atten

In dual attenuator models, this selects both attenuators participate in the autoranging.

This key is grayed out in measurements that do not support this functionality. The spectrum analyzer measurement, Swept SA, does not support this functionality.

Key Path	AMPTD Y Scale, Attenuation, Pre-Adjust for Min Clip
Example	:POW:RANGe:OPT:ATT COMB
Initial S/W Revision	Prior to A.02.00

(Mech) Atten Step

This controls the step size used when making adjustments to the input attenuation.

This key is labeled Mech Atten Step in dual attenuator models and Atten Step in single attenuator models. In the dual attenuator configuration, this key only affects the step size of the mechanical attenuator.

Key Path	AMPTD Y Scale, Attenuation
Remote Command	<code>[:SENSe] :POWer [:RF] :ATTenuation :STEP [:INCRement] 10 dB 2 dB</code> <code>[:SENSe] :POWer [:RF] :ATTenuation :STEP [:INCRement] ?</code>
Example	POW:ATT:STEP 2
Notes	Note this feature works like a 1-N choice from the front panel, but it takes a specific value (in dB) when used remotely. The only valid values are 2 and 10.
Dependencies	Blanked in CXA and EXA if option FSA (2 dB steps) is not present. If blanked, attempts to set it via SCPI will yield an error.
Couplings	When the attenuation step size changes, the current mechanical attenuation value is adjusted (if necessary) to be quantized to the new step size. That is, if step is set to 10 dB, mech atten is increased if necessary so it is a multiple of 10 dB
Preset	PXA and MXA: 2 dB EXA and CXA: 10 dB (2 dB with option FSA)
State Saved	Saved in instrument state
Initial S/W Revision	Prior to A.02.00
Modified at S/W Revision	A.03.00

Scale/Div(Burst View)

Allows you to enter a numeric value to change the vertical display sensitivity.

Key Path	AMPTD Y Scale
----------	---------------

Mode	WLAN
Remote Command	:DISPlay:PVTime:VIEW[1]:WINDow[1]:TRACe:Y[:SCALe]:PDIVision <rel_ampl> :DISPlay:PVTime:VIEW[1]:WINDow[1]:TRACe:Y[:SCALe]:PDIVision?
Example	DISP:PVT:VIEW:WIND:TRAC:Y:PDIV 5 dB DISP:PVT:VIEW:WIND:TRAC:Y:PDIV?
Couplings	When the Auto Scale is On, this value is automatically determined by the measurement result. When you set a value manually, Auto Scale automatically changes to Off.
Preset	10.00 dB
State Saved	Saved in instrument state.
Min	0.10 dB
Max	20.00 dB
Initial S/W Revision	A.10.01

Presel Center

When this key is pressed, the centering of the preselector filter is adjusted to optimize the amplitude accuracy at the frequency of the selected marker. If the selected marker is not on when Presel Center is pressed, the analyzer will turn on the selected marker, perform a peak search, and then perform centering on the marker's center frequency. If the selected marker is already on and between the start and stop frequencies of the analyzer, the analyzer performs the preselector calibration on that marker's frequency. If the selected marker is already on, but outside the frequency range between Start Freq and Stop Freq, the analyzer will first perform a peak search, and then perform centering on the marker's center frequency.

The value displayed on the Presel Adjust key will change to reflect the new preselector tuning (see Presel Adjust).

A number of considerations should be observed to ensure proper operation. See ["Proper Preselector Operation" on page 1421](#).

Key Path	AMPTD Y Scale
Remote Command	[:SENSE]:POWer[:RF]:PCENter
Example	POW:PCEN
Notes	Note that the rules outlined above under the key description apply for the remote command as well as the key. The result of the command is dependent on marker position, and so forth. Any message shown by the key press is also shown in response to the remote command.
Dependencies	<ul style="list-style-type: none"> • Grayed out if the microwave preselector is off.) • If the selected marker's frequency is below Band 1, advisory message 0.5001 is generated and no action is taken. • Grayed out if entirely in Band 0. • Blank in models that do not include a preselector, such as option 503. If the SCPI is sent in these instruments, it is accepted without error, and the query always returns 0. • Grayed out in the Spectrogram View.

Couplings	The active marker position determines where the centering will be attempted. If the analyzer is in a measurement such as averaging when centering is initiated, the act of centering the preselector will restart averaging but the first average trace will not be taken until the centering is completed.
Status Bits/OPC dependencies	When centering the preselector, *OPC will not return true until the process is complete and a subsequent measurement has completed, nor will results be returned to a READ or MEASure command. The Measuring bit should remain set while this command is operating and should not go false until the subsequent sweep/measurement has completed.
Initial S/W Revision	Prior to A.02.00
Modified at S/W Revision	A.03.00

Proper Preselector Operation

A number of considerations should be observed to ensure proper operation:

1. If the selected marker is off, the analyzer will turn on a marker, perform a peak search, and adjust the preselector using the selected marker's frequency. It uses the "highest peak" peak search method unqualified by threshold or excursion, so that there is no chance of a 'no peak found' error. It continues with that peak, even if it is the peak of just noise. Therefore, for this operation to work properly, there should be a signal on screen in a preselected range for the peak search to find.
2. If the selected marker is already on, the analyzer will attempt the centering at that marker's frequency. There is no preselector for signals below about 3.6 GHz, therefore if the marker is on a signal below 3.6 GHz, no centering will be attempted and an advisory message generated
3. In some models, the preselector can be bypassed. If it is bypassed, no centering will be attempted in that range and a message will be generated.

Preselector Adjust

Allows you to manually adjust the preselector filter frequency to optimize its response to the signal of interest. This function is only available when "[Presel Center](#)" on page 2168 is available.

For general purpose signal analysis, using Presel Center is recommended. Centering the filter minimizes the impact of long-term preselector drift. Presel Adjust can be used instead to manually optimize the preselector. One application of manual optimization would be to peak the preselector response, which both optimizes the signal-to-noise ratio and minimizes amplitude variations due to small (short-term) preselector drifting.

Key Path	AMPTD Y Scale
Scope	Meas Global
Remote Command	[:SENSe] :POWer [:RF] :PADJust <freq> [:SENSe] :POWer [:RF] :PADJust?
Example	POW:PADJ 100KHz

POW:PADJ?	
Notes	The value on the key reads out to 0.1 MHz resolution.
Dependencies	<ul style="list-style-type: none"> • Grayed out if microwave preselector is off.) • Grayed out if entirely in Band 0. • Blank in models that do not include a preselector, such as option 503. If the SCPI is sent in these instruments, it is accepted without error, and the query always returns 0. • Grayed out in the Spectrogram View.
Preset	0 MHz
State Saved	The Presel Adjust value set by Presel Center, or by manually adjusting Presel Adjust, is not saved in instrument state, and does not survive a Preset or power cycle.
Min	-500 MHz
Max	500 MHz
Default Unit	Hz
Backwards Compatibility SCPI	<pre>[:SENSe] :POWer [:RF] :MW :PADJust</pre> <pre>[:SENSe] :POWer [:RF] :MMW :PADJust</pre> <p>PSA had multiple preselectors, but the X-Series has only one. These commands simply alias to [:SENSe]:POWER[:RF]:PADJust</p>
Initial S/W Revision	Prior to A.02.00
Modified at S/W Revision	A.03.00

Remote Command	<pre>[:SENSe] :POWer [:RF] :PADJust :PRESelector MWAVE MMWave EXTERNAL</pre> <pre>[:SENSe] :POWer [:RF] :PADJust :PRESelector?</pre>
Notes	<p>PSA had multiple preselectors, and you could select which preselector to adjust. Since the X-Series has only one mm/uW preselector, the preselector selection softkey is no longer available. However, to provide backward compatibility, we accept the legacy remote commands.</p> <p>The command form has no effect, the query always returns MWAVE</p>
Initial S/W Revision	Prior to A.02.00

μW Path Control

Sets the μW Path Control function to Auto, standard path, μW Preselector Bypass (Option MPB) and Low Noise Path(Option LNP).

Key Path	AMPTD/Y Scale
Initial S/W Revision	A.14.50

μW Path Control Auto

Activates the auto rules for μW Path Control. When Auto is active, the μW Path Control is set to Preselector Bypass in modulation analysis and spectral flatness measurement; it is set to standard path in other measurements.

Key Path	AMPTD/Y Scale
Remote Command	[:SENSe] :POWer [:RF] :MW:PATH:AUTO ON OFF 1 0 [:SENSe] :POWer [:RF] :MW:PATH:AUTO?
Example	POW:MW:PATH:AUTO ON POW:MW:PATH:AUTO?
Couplings	When Auto is active, the μW Path Control is set to μW Preselector Bypass in IQ measurements (IQ waveform, CCDF, PVT, EVM, Spetrum flatness and WLS); it is set to standard path in other measurements.
Preset	ON
Range	Off On
Initial S/W Revision	A.14.50

Standard Path

This path gives the best remote-control throughput, minimizes acoustic noise from switching and minimizes the risk of wear in the hardware switches, particularly in remote test scenarios where both low band and high band setups will follow in rapid succession.

In this path, the bypass of the low band/high band switch and microwave preamp is never activated, which can cause some noise degradation but preserves the life of the bypass switch.

Key Path	AMPTD Y Scale, μW Path Control
Example	:POW:MW:PATH STD
Readback Text	Standard Path
Initial S/W Revision	A.04.00

Low Noise Path Enable

You may choose Low Noise Path Enable, which gives a lower noise floor under some circumstances, particularly when operating in the 21–26.5 GHz region. With the Low Noise Path enabled, the low band/high band switch and microwave preamp are bypassed whenever all of the following are true:

- The analyzer is not in the Low Band, meaning:
- the start frequency is above 3.5 GHz and
- the stop frequency is above 3.6 GHz.
- the internal preamp is not installed or (if installed) is set to Off or Low Band

Note that this means that, when any part of a sweep is done in Low Band, the Low Noise Path is not used, whether or not the Low Noise Path Enable is selected in the user interface. Also, if the preamp is turned on, the Low Noise Path is not used, whether or not the Low Noise Path Enable is selected in the user interface. The only time the Low Noise Path is used is when Low Noise Path Enable is selected, the sweep is completely in High Band (> 3.6 GHz) and no preamp is in use.

See ["More Information" on page 1424](#)

Key Path	AMPTD Y Scale, μ W Path Control
Measurement	Swept SA
Example	:POW:MW:PATH LNP
Notes	<p>For measurements that use IQ acquisition, the low noise path is used when the Center Frequency is in High Band (> 3.6 GHz) and no preamp is in use.</p> <p>In other words, the rules above are modified to use only the center frequency to qualify which path to switch in.</p> <p>This is not the case for FFT's in the Swept SA measurement; they use the same rules as swept measurements.</p>
Dependencies	<p>Key is blanked if current mode does not support it.</p> <p>Key is grayed out if mode supports it but current measurement does not support it.</p> <p>Unless Option LNP is present and licensed, key is blank and if SCPI command sent, error -241, "Hardware missing; Option not installed" is generated.</p>
Readback Text	Low Noise Path Enable
Initial S/W Revision	A.04.00

More Information

The user should understand that the Low Noise Path, while giving improved DANL, has the disadvantage of decreased TOI performance and decreased gain compression performance relative to the standard path.

The user should also understand that the bypass switch is a mechanical switch and has finite life, so if the Low Noise Path is enabled, it is possible to cause frequent cycling of this switch by frequently changing analyzer settings such that the above conditions hold true only some of the time. A user making tests of this nature should consider opting for the Standard Path, which will never throw the bypass switch, at the expense of some degraded noise performance.

The low noise path is useful for situations where the signal level is so low that the analyzer performance is dominated by noise even with 0 dB attenuation, but still high enough that the preamp option would have excessive third-order intermodulation or compression. The preamp, if purchased and used, gives better noise floor than does the "Low Noise Path." However, its compression threshold and third-order intercept are much poorer than that of the non-preamp path. There are some applications, typically for signals around -30 dBm, for which the third-order dynamic range of the standard path is good enough, but the noise floor is not low enough even with 0 dB input attenuation. When the third-order dynamic range of the preamp path is too little and the noise floor of the standard path is too high, the Low Noise Path can provide the best dynamic range

The graph below illustrates the concept. It shows, in red, the performance of an analyzer at different attenuation settings, both with the preamp on and off, in a measurement that is affected by both analyzer

noise and analyzer TOI. The green shows the best available dynamic range, offset by 0.5 dB for clarity. The blue shows how the best available dynamic range improves for moderate signal levels with the low noise path switched in. In this illustration, the preamp improves the noise floor by 15 dB while degrading the third-order intercept by 30 dB, and the low noise path reduces loss by 8 dB. The attenuator step size is 2 dB.

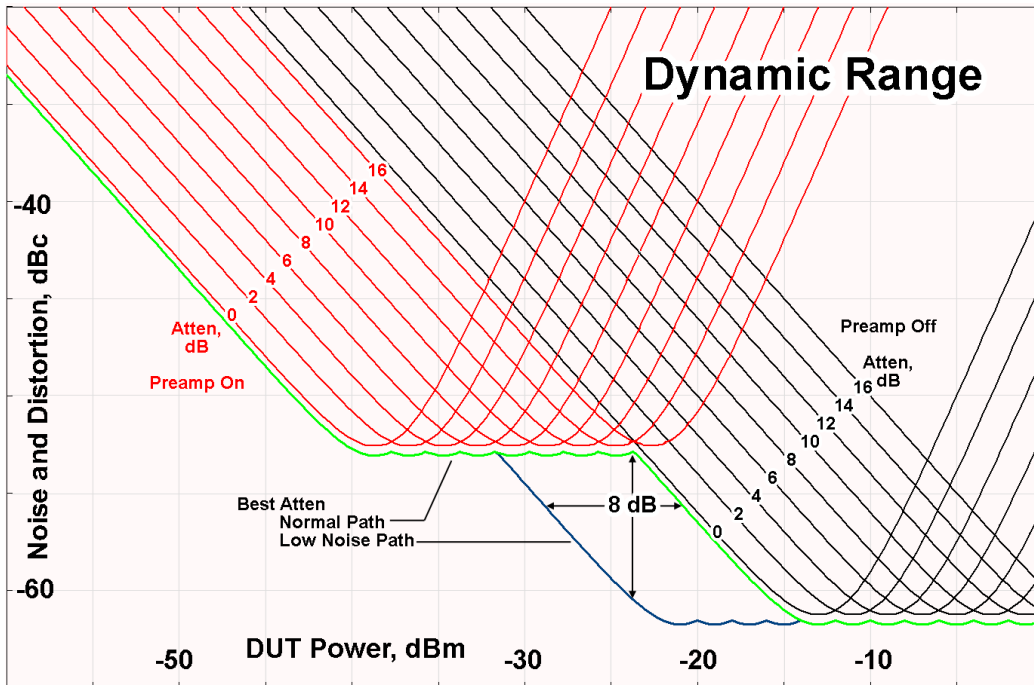

There are other times where selecting the low noise path improves performance, too. Compression-limited measurements such as finding the nulls in a pulsed-RF spectrum can profit from the low noise path in a way similar to the TOI-limited measurement illustrated. Accuracy can be improved when the low noise path allows the optimum attenuation to increase from a small amount like 0, 2 or 4 dB to a larger amount, giving better return loss at the analyzer input. Harmonic measurements, such as second and third harmonic levels, are much improved using the low noise path because of the superiority of that path for harmonic (though not intermodulation) distortion performance.

μW Preselector Bypass

This key toggles the preselector bypass switch for band 1 and higher. When the microwave preselector is on, the signal path is preselected. When the microwave preselector is off, the signal path is not preselected. The preselected path is the normal path for the analyzer.

The preselector is a tunable bandpass filter which prevents signals away from the frequency of interest from combining in the mixer to generate in-band spurious signals (images). The consequences of using a preselector filter are its limited bandwidth, the amplitude and phase ripple in its passband, and any amplitude and phase instability due to center frequency drift.

Option MPB or pre-selector bypass provides an unpreselected input mixer path for certain X-Series signal analyzers with frequency ranges above 3.6 GHz. This signal path allows a wider bandwidth and less amplitude variability, which is an advantage when doing modulation analysis and broadband signal analysis. The disadvantage is that, without the preselector, image signals will be displayed. Another disadvantage of bypassing the preselector is increased LO emission levels at the front panel input port.

Image responses are separated from the real signal by twice the 1st IF. For IF Paths of 10 MHz and 25 MHz, the 1st IF is 322.5 MHz, so the image response and the real signal will be separated by 645 MHz. The 1st IF will be different for other IF Path settings. When viewing a real signal and its corresponding image response in internal mixing, the image response will be to the left of the real signal.

Also, the image response and the real signal typically have the same amplitude and exhibit the same shape factor.

However, if Option FS1, Fast Sweep Capability, is enabled, the image response in the Swept SA measurement will appear lower in amplitude and have a much wider shape factor compared to the real signal.

Key Path	AMPTD Y Scale, μ W Path Control
Example	:POW:MW:PATH MPB
Dependencies	Key is blanked if current mode does not support it. Key is grayed out if mode supports it but current measurement does not support it. Key is blank unless Option MPB is present and licensed. If SCPI command sent when MPB not present, error -241, "Hardware missing; Option not installed" is generated.
Readback Text	μ W Preselector Bypass
Initial S/W Revision	A.04.00

Remote Command	[:SENSe] :POWer [:RF] :MW:PRESelector [:STATe] ON OFF 0 1 [:SENSe] :POWer [:RF] :MW:PRESelector [:STATe] ?
Example	:POW:MW:PRES OFF Bypasses the microwave preselector
Notes	The ON parameter sets the STD path (:POW:MW:PATH STD) The OFF parameter sets path MPB (:POW:MW:PATH MPB)
Preset	ON

Internal Preamp

Accesses a menu of keys that control the internal preamps. Turning on the preamp gives a better noise figure, but a poorer TOI to noise floor dynamic range. You can optimize this setting for your particular measurement.

The instrument takes the preamp gain into account as it sweeps. If you sweep outside of the range of the preamp the instrument will also account for that. The displayed result will always reflect the correct gain.

For some measurements, when the preamp is on and any part of the displayed frequency range is below the lowest frequency for which the preamp has specifications, a warning condition message appears in the status line. For example, for a preamp with a 9 kHz lowest specified frequency: "Preamp: Accy unspec'd below 9 kHz".

Key Path	AMPTD Y Scale
-----------------	---------------

Scope	Meas Global
Remote Command	[:SENSe] :POWer [:RF] :GAIN[:STATe] OFF ON 0 1 [:SENSe] :POWer [:RF] :GAIN[:STATe] ?
Dependencies	Preamp is not available on all hardware platforms. If the preamp is not present or is unlicensed, the key is not shown. The preamp is not available when the electronic/soft attenuator is enabled.
Couplings	The act of connecting the U7227A USB Preamplifier to one of the analyzer's USB ports will cause the Internal Preamp to be switched on. When this happens an informational message will be generated: "Internal Preamp turned on for optimal operation with USB Preamp." Note that if the Internal Preamp was already on, there will be no change to the setting, but if it was Off it will be switched On, to Full Range. Note that this same action occurs when the SA mode is selected while the USB Preamp is connected to one of the analyzer's USB ports, if it is the first time that the SA mode has run since powerup, or if the last time the SA mode was running the USB Preamp was NOT connected. Subsequently disconnecting the USB Preamp from USB does not change the Internal Preamp setting nor restore the previous setting.
Preset	OFF
State Saved	Saved in instrument state
Initial S/W Revision	Prior to A.02.00
Modified at S/W Revision	A.14.00

Key Path	AMPTD Y Scale, Internal Preamp
Scope	Meas Global
Remote Command	[:SENSe] :POWer [:RF] :GAIN:BAND LOW FULL [:SENSe] :POWer [:RF] :GAIN:BAND?
Dependencies	Preamp is not available on all hardware platforms. If the preamp is not present or is unlicensed, the key is not shown. If a POW:GAIN:BAND FULL command is sent when a low band preamp is available, the preamp band parameter is to LOW instead of FULL, and an "Option not installed" message is generated.
Preset	LOW
State Saved	Saved in instrument state
Initial S/W Revision	Prior to A.02.00

Off

Turns the internal preamp off

Key Path	AMPTD Y Scale, Internal Preamp
----------	--------------------------------

Example	:POW:GAIN OFF
Readback	Off
Initial S/W Revision	Prior to A.02.00

Low Band

Sets the internal preamp to use only the low band.

The frequency range of the installed (optional) low-band preamp is displayed in square brackets on the Low Band key label.

Key Path	AMPTD Y Scale, Internal Preamp
Example	:POW:GAIN ON :POW:GAIN:BAND LOW
Readback	Low Band
Initial S/W Revision	Prior to A.02.00

Full Range

Sets the internal preamp to use its full range. The low band (0–3.6 GHz or 0–3GHz, depending on the model) is supplied by the low band preamp and the frequencies above low band are supplied by the high band preamp.

The frequency range of the installed (optional) preamp is displayed in square brackets on the Full Range key label. If the high band option is not installed the Full Range key does not appear.

Key Path	AMPTD Y Scale, Internal Preamp
Example	:POW:GAIN ON :POW:GAIN:BAND FULL
Readback	Full Range
Initial S/W Revision	Prior to A.02.00

Ref Position(Burst View)

Allows you to set the display reference position to the top, center, or bottom of the display.

Key Path	AMPTD Y Scale
Mode	WLAN
Remote Command	:DISPlay:PVTime:VIEW[1]:WINDow[1]:TRACe:Y[:SCALE]:RPOSition TOP CENTer BOTTom :DISPlay:PVTime:VIEW[1]:WINDow[1]:TRACe:Y[:SCALE]:RPOSition?

Example	:DISP:PVT:VIEW:WIND:TRAC:Y:SCAL:RPOS CENT :DISP:PVT:VIEW:WIND:TRAC:Y:SCAL:RPOS?
Preset	TOP
State Saved	Saved in instrument state.
Range	Top Ctr Bot
Initial S/W Revision	A.10.01

Auto Scaling(Burst View)

Allows you to toggle the Y axis Auto Scaling function between On and Off.

Key Path	AMPTD Y Scale
Mode	WLAN
Remote Command	:DISPlay:PVTtime:VIEW[1]:WINDow[1]:TRACe:Y[:SCALe]:COUPLe 0 1 OFF ON :DISPlay:PVTtime:VIEW[1]:WINDow[1]:TRACe:Y[:SCALe]:COUPLe?
Example	:DISP:PVT:VIEW:WIND:TRAC:Y:COUP ON :DISP:PVT:VIEW:WIND:TRAC:Y:COUP?
Couplings	When Auto Scaling is On, and you press the Restart front-panel key, this function automatically determines the scale per division and reference values based on the measurement results. When you manually set a value for the Y Rel Value or Y Scale/Div, this parameter is automatically set to Off.
Preset	ON
State Saved	Saved in instrument state.
Range	On Off
Initial S/W Revision	A.10.01

Attenuation

This menu controls both the electrical and mechanical attenuators and their interactions. The value read back on the key in square brackets is the current Total (Elec + Mech) attenuation. When in Pre-Adjust for Min Clip mode, this value can change at the start of every measurement.

Operation of this key is identical across several measurements. For details about this key, see "[Attenuation](#)" on page 2158 in the "Common Measurement Functions".

Auto Couple

The Auto Couple feature provides a quick and convenient way to automatically couple multiple instrument settings. This helps ensure accurate measurements and optimum dynamic range. When the Auto Couple feature is activated, either from the front panel or remotely, all parameters of the current measurement that have an Auto/Manual mode are set to Auto mode and all measurement settings dependent on (or coupled to) the Auto/Man parameters are automatically adjusted for optimal performance.

However, the Auto Couple key actions are confined to the current measurement only. It does not affect other measurements in the mode, and it does not affect markers, marker functions, or trace or display attributes.

See ["More Information" on page 1430](#)

Key Path	Front-panel key
Remote Command	:COUPLe ALL NONE
Example	:COUP ALL
Notes	:COUPLe ALL puts all Auto/Man parameters in Auto mode (equivalent to pressing the Auto Couple key). :COUPLE NONE puts all Auto/Man parameters in manual mode. It decouples all the coupled instrument parameters and is not recommended for making measurements.
Initial S/W Revision	Prior to A.02.00

More Information

There are two types of functions that have Auto/Manual modes.

Auto/Man Active Function keys

An Auto/Man toggle key controls the binary state associated with an instrument parameter by toggling between Auto (where the parameter is automatically coupled to the other parameters it is dependent upon) and Man (where the parameter is controlled independent of the other parameters), as well as making the parameter the active function. The current mode is indicated on the softkey with either Auto or Man underlined as illustrated below.



Auto/Man 1-of-N keys

An Auto/Man 1-of-N key allows you to manually pick from a list of parameter values, or place the function in Auto, in which case the value is automatically selected (and indicated) as shown below. If in Auto, Auto is underlined on the calling key. If in manual operation, manual is indicated on the calling key. But the calling key does not actually toggle the function, it simply opens the menu.

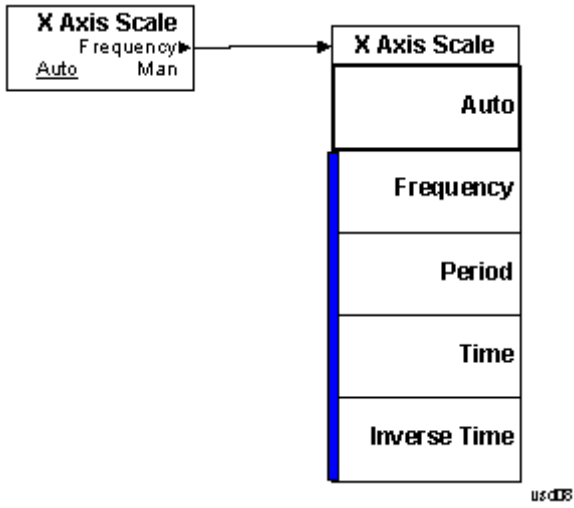

BW

Accesses a menu that allows you to control bandwidth settings.

Key Path	BW
Initial S/W Revision	A.10.01

BW

This key allows you to set the Bandwidth of the signal being measured.

Preset To Standard	Info BW	Notes
1.4 MHz (6 RB)	1.5 MHz	
3.0 MHz (15 RB)	3.0 MHz	
5.0 MHz (25 RB)	5.0 MHz	
10.0 MHz (50 RB)	10.0 MHz	Need B25 opt
15.0 MHz (75 RB)	25.0 MHz	Need B25 opt
20.0 MHz (100 RB)	25.0 MHz	Need B25 opt

Bandwidth	BS Info BW	UE Info BW	Notes
1.4 MHz (6 RB)	1.095 MHz	1.08 MHz	Need B40 or wider
3.0 MHz (15 RB)	2.715 MHz	2.7 MHz	Need B40 or wider
5.0 MHz (25 RB)	4.515 MHz	4.5 MHz	Need B40 or wider
10.0 MHz (50 RB)	9.015 MHz	9.0 MHz	Need B40 or wider
15.0 MHz (75 RB)	13.515 MHz	13.5 MHz	Need B40 or wider
20.0 MHz (100 RB)	18.015 MHz	18.0 MHz	Need B40 or wider

Key Path	BW
Mode	LTETDD, LTE
Remote Command	<code>[:SENSe] :PVTime :BANDwidth <freq></code> <code>[:SENSe] :PVTime :BANDwidth?</code>
Example	PVT:BAND 6.0 MHz PVT:BAND?
Couplings	This parameter is coupled with Preset to Standard in Mode Setup Menu. The relationship is in the table above.
Preset	5.0 MHz on B25 4.515MHz on B40

State Saved	Saved in instrument state.
Min	10 Hz
Max	Hardware Dependent: No Option = 10 MHz Option B25 = 25 MHz Option B40 = 40 MHz Option B85 = 85 MHz Option B1A = 125 MHz Option B1X = 140 MHz Option B1Y = 160 MHz
Initial S/W Revision	A.03.00
Modified at S/W Revision	A.13.00

Filter Type

Allows you to select a Gaussian or a Flattop filter. A Gaussian is typically preferred but a Flattop is desirable under certain conditions.

Key Path	BW
Mode	WLAN
Remote Command	<code>[:SENSe] :PVTtime:BANDwidth:TYPE GAUSSian FLATtop</code> <code>[:SENSe] :PVTtime:BANDwidth:TYPE?</code>
Example	<code>PVT:BAND:TYPE GAUS</code> <code>PVT:BAND:TYPE?</code>
Notes	This selects either a Gaussian or Flat (Flattop) filter. Gaussian is the better choice when looking at the overall burst, or rising and falling edges, because it has excellent pulse response. For most Time vs. Power measurements, the user is not mainly interested in trading off time domain accuracy vs. noise, but is more interested in total power accuracy vs. noise. If you want to want to examine just the useful part of the burst, choose Flat. This is an advanced control that normally does not need to be changed. Setting this to a value other than the factory default, may cause invalid measurement results. –FLATtop – a filter with a flat amplitude response, that provides the best amplitude accuracy. –GAUSSian – a filter with Gaussian characteristics, that provides the best pulse response.
Preset	GAUSSian
State Saved	Saved in instrument state.
Range	Gaussian Flattop
Initial S/W Revision	A.10.01

Cont (Continuous Measurement/Sweep)

Sets the analyzer for Continuous measurement operation. The single/continuous state is Meas Global so the setting will affect all measurements. If you are Paused, pressing Cont does a Resume.

Key Path	Front-panel key
Remote Command	:INITiate:CONTinuous OFF ON 0 1 :INITiate:CONTinuous?
Example	:INIT:CONT 0 puts analyzer in Single measurement operation. :INIT:CONT 1 puts analyzer in Continuous measurement operation
Preset	ON (Note that SYST:PRESet sets INIT:CONT to ON but *RST sets INIT:CONT to OFF)
State Saved	Saved in instrument state
Backwards Compatibility Notes	For Spectrum Analysis mode in ESA and PSA, there is no Cont hardkey, instead there is a Sweep Single/Cont key. In these analyzers, switching the Sweep Single/Cont key from Single to Cont restarts averages (displayed average count reset to 1), but does not restart Max Hold and Min Hold. The X-Series has Single and Cont keys in place of the SweepSingleCont key. In the X-Series, if in single measurement, the Cont key (and INIT:CONT ON) switches to continuous measurement, but never restarts a measurement and never resets a sweep.
Initial S/W Revision	Prior to A.02.00

In Swept SA Measurement (Spectrum Analysis Mode):

The analyzer takes repetitive sweeps, averages, measurements, etc., when in Continuous mode. When the average count reaches the Average/Hold Number the count stops incrementing, but the analyzer keeps sweeping. See the Trace/Detector section for the averaging formula used both before and after the Average/Hold Number is reached. The trigger condition must be met prior to each sweep. The type of trace processing for multiple sweeps, is set under the Trace/Detector key, with choices of Trace Average, Max Hold, or Min Hold.

In Other Measurements/Modes:

With Avg/Hold Num (in the Meas Setup menu) set to Off or set to On with a value of 1, a sweep is taken after the trigger condition is met; and the analyzer continues to take new sweeps after the current sweep has completed and the trigger condition is again met. However, with Avg/Hold Num set to On with a value >1, multiple sweeps (data acquisitions) are taken for the measurement. The trigger condition must be met prior to each sweep. The sweep is not stopped when the average count k equals the number N set for Avg/Hold Num is reached, but the number k stops incrementing. A measurement average usually applies to all traces, marker results, and numeric results. But sometimes it only applies to the numeric results.

If the analyzer is in Single measurement, pressing the Cont key does not change k and does not cause the sweep to be reset; the only action is to put the analyzer into Continuous measurement operation.

If it is already in continuous sweep:

the INIT:CONT 1 command has no effect

the INIT:CONT 0 command will place the analyzer in Single Sweep but will have no effect on the current sequence until $k = N$, at which point the current sequence will stop and the instrument will go to the idle state.

13 Power vs. Time Measurement Overview
File

File

See "File" on page 348

FREQ Channel

Accesses a menu of keys that allow you to control the Frequency and Channel parameters of the instrument.

Some features in the Frequency menu are the same for all measurements – they do not change as you change measurements. Settings like these are called “Meas Global” and are unaffected by Meas Preset. For example, the Center Freq setting is the same for all measurements – it does not change as you change measurements.

Key Path	Front-panel key
Initial S/W Revision	Prior to A.02.00

CF Step

Changes the step size for the center frequency and start and stop frequency functions. Once a step size has been selected and the center frequency function is active, the step keys (and the UP|DOWN parameters for Center Frequency from remote commands) change the center frequency by the step-size value. The step size function is useful for finding harmonics and sidebands beyond the current frequency span of the analyzer.

Note that the start and stop frequencies also step by the CF Step value.

Key Path	FREQ Channel
Remote Command	<pre>[:SENSe]:FREQuency:CENTer:STEP[:INCRement] <freq> [:SENSe]:FREQuency:CENTer:STEP[:INCRement]? [:SENSe]:FREQuency:CENTer:STEP:AUTO OFF ON 0 1 [:SENSe]:FREQuency:CENTer:STEP:AUTO?</pre>
Example	<pre>FREQ:CENT:STEP:AUTO ON FREQ:CENT:STEP 500 MHz FREQ:CENT UP increases the current center frequency value by 500 MHz FREQ:CENT:STEP? FREQ:CENT:STEP:AUTO?</pre>
Notes	Preset and Max values are depending on Hardware Options (503, 507, 508, 513, 526)
Notes	Preset and Max values are dependent on Hardware Options (5xx)
Dependencies	Freq Offset is not available in External Mixing. In this case the Freq Offset key is grayed out and shows a value of zero. It will once again be available, and show the previously set value, when you return to the RF Input.
Dependencies	Span, RBW, Center frequency If the electronic/soft attenuator is enabled, any attempt to change the value of the center frequency >3.6 GHz by pressing the Up-arrow key, fails and results in an advisory message. If the equivalent

	SCPI command is sent, this same message is generated as part of a “-221, Settings conflict” warning.
Couplings	When auto-coupled in a non-zero span, the center frequency step size is set to 10% of the span. When auto-coupled in zero span, the center frequency step size is set to the equivalent -3 dB RBW value.
Preset	Auto ADEM0D: 1 MHz ON
State Saved	Saved in instrument state
Min	- (the maximum frequency of the instrument). That is, 27 GHz max freq instrument has a CF step range of +/- 27 GHz. Note that this is the maximum frequency given the current settings of the instrument, so in External Mixing, for example, it is the maximum frequency of the current mixer band.
Max	The maximum frequency of the instrument. That is, 27 GHz max freq instrument has a CF step range of +/- 27 GHz. Note that this is the maximum frequency given the current settings of the instrument, so in External Mixing, for example, it is the maximum frequency of the current mixer band.
Default Unit	Hz
Status Bits/OPC dependencies	non-overlapped
Initial S/W Revision	Prior to A.02.00
Modified at S/W Revision	A.03.00

Input/Output

See "Input/Output" on page 194

Marker

Accesses the menu that allows you to select, set up, and control the markers for the current measurement. Sets the marker control mode as described under Normal, Delta, and Off, below. All interactions and dependencies detailed under the softkey description are enforced when the remote command is sent.

See Marker in the "Common Measurement Functions" for more information.

Key Path	Front-panel key
Initial S/W Revision	A.03.00

Select Marker

Accesses a menu that allows you to activate one or more markers

See Marker in the "Marker Functions" section for more information.

Key Path	Marker
Initial S/W Revision	A.03.00

Marker Type

Sets the marker control mode. If the selected marker is Off, pressing Marker sets it to Normal and places it at the center of the screen on the trace determined by the Marker Trace rules. At the same time, the reference value of the selected marker appears on the Active Function area.

Active Function Display: Marker X-axis value

Default Active Function: the active function for the selected marker's current control mode. If the current control mode is Off, there is no active function and the active function is turned off.

The marker X axis value entered in the active function area will display the marker value to its full entered precision.

Key Path	Marker
Mode	LTETDD, LTE, LTEATDD, LTEAFDD
Remote Command	:CALCulate:PVTime:MARKer[1] 2 ... 12:MODE POSition DELTA OFF :CALCulate:PVTime:MARKer[1] 2 ... 12:MODE?
Example	:CALC:PVT:MARK:MODE OFF :CALC:PVT:MARK:MODE?
Notes	If the selected marker is Off, pressing Marker sets it to Normal and places it at the center of the screen on the trace determined by the Marker Trace rules. At the same time, Marker X Axis Value appears in the Active Function area. Default Active Function: the active function for the selected marker's current control mode. Note that if the current control mode is Off, there is no active function and the active function is turned off.

	Active Function Display: the marker X axis value entered in the active function area will display the marker value to its fully entered precision.
Preset	OFF
State Saved	Saved in instrument state.
Range	Normal Delta Off
Initial S/W Revision	A.03.00

Properties

Accesses a menu that allows you to set marker properties and to access the marker trace menu.

Key Path	Marker
Initial S/W Revision	A.03.00

Select Marker

Accesses a menu that allows you to activate one or more markers

See Marker in the “Marker Functions” section for more information.

Key Path	Marker
Initial S/W Revision	A.03.00

Relative To

Selects the marker that the selected marker will be relative to, which is referred to as its “reference marker”.

Key Path	Marker, Properties
Mode	TD-SCDMA
Remote Command	:CALCulate:PVTime:MARKer[1] 2 ... 12:REFErence <integer> :CALCulate:PVTime:MARKer[1] 2 ... 12:REFErence?
Example	:CALC:PVT:MARK5:REF 1 :CALC:PVT:MARK5:REF?
Notes	When queried, a single value will be returned - the specified marker number's relative marker.
Preset	2 3 4 5 6 7 8 9 10 11 12 1
State Saved	Saved in instrument state.
Min	1
Max	12
Initial S/W Revision	A.01.60 or later

Marker Trace

Assigns the specified marker to the designated trace.

Key Path	Marker, Properties
Mode	LTETDD, LTE, LTEATDD, LTEAFDD
Remote Command	:CALCulate:PVTTime:MARKer[1] 2 ... 12:TRACe RFENvelope MAXHold MINHold :CALCulate:PVTTime:MARKer[1] 2 ... 12:TRACe?
Example	:CALC:PVT:MARK:TRAC MINH :CALC:PVT:MARK:TRAC?
Preset	RFENvelope
State Saved	Saved in instrument state.
Range	RF Envelope Max Hold RF Envelope Min Hold RF Envelope
Initial S/W Revision	A.03.00

Couple Marker

When this function is invoked, moving any marker causes an “equal X Axis movement” of every other marker which is active. By “equal X Axis movement” we mean that the difference between each marker’s X Axis value (in the fundamental x-axis units of the trace that marker is on) is preserved, as is the X Axis value of the marker being moved (in the same fundamental X-axis units).

NOTE This may result in markers going off screen.

Key Path	Marker, More
Mode	LTETDD, LTE, LTEATDD, LTEAFDD
Remote Command	:CALCulate:PVTTime:MARKer:COUPle[:STATe] ON OFF 1 0 :CALCulate:PVTTime:MARKer:COUPle[:STATe]?
Example	CALC:PVT:MARK:COUP ON CALC:PVT:MARK:COUP?
Preset	OFF
State Saved	Saved in instrument state.
Range	On Off
Initial S/W Revision	A.03.00

All Markers Off

Turns all markers Off.

Key Path	Marker, More
Mode	LTETDD, LTE, LTEATDD, LTEAFDD
Remote Command	:CALCulate:PVTme:MARKer:AOff
Example	:CALC:PVT:MARK:AOff
Initial S/W Revision	A.03.00

Marker To

There is no 'Marker To' functionality supported in Power vs. Time measurement so this front-panel key will display a blank menu when pressed

Key Path	Front-panel key
Initial S/W Revision	A.10.01

Meas

The information in this section is common to all measurements. For key and remote command information for a specific measurement, refer to the section that describes the measurement of interest.

Measurements available under the Meas key are specific to the current Mode.

When viewing Help for measurements, note the following:

NOTE

Operation for some keys differs between measurements. The information displayed in Help pertains to the current measurement. To see how a key operates in a different measurement, exit Help (press the Cancel Esc key), select the measurement, then reenter Help (press the Help key) and press that key.

Key Path	Front-panel key
Initial S/W Revision	Prior to A.02.00

Remote Measurement Functions

This section contains the following topics:

["Measurement Group of Commands" on page 2214](#)

["Current Measurement Query \(Remote Command Only\)" on page 2216](#)

["Limit Test Current Results \(Remote Command Only\)" on page 2216](#)

["Data Query \(Remote Command Only\)" on page 2216](#)

["Calculate/Compress Trace Data Query \(Remote Command Only\)" on page 2217](#)

["Calculate Peaks of Trace Data \(Remote Command Only\)" on page 2222](#)

["Hardware-Accelerated Fast Power Measurement \(Remote Command Only\)" on page 2223](#)

["Format Data: Numeric Data \(Remote Command Only\)" on page 2237](#)

["Format Data: Byte Order \(Remote Command Only\)" on page 2238](#)

Initial S/W Revision	Prior to A.02.00
----------------------	------------------

Measurement Group of Commands

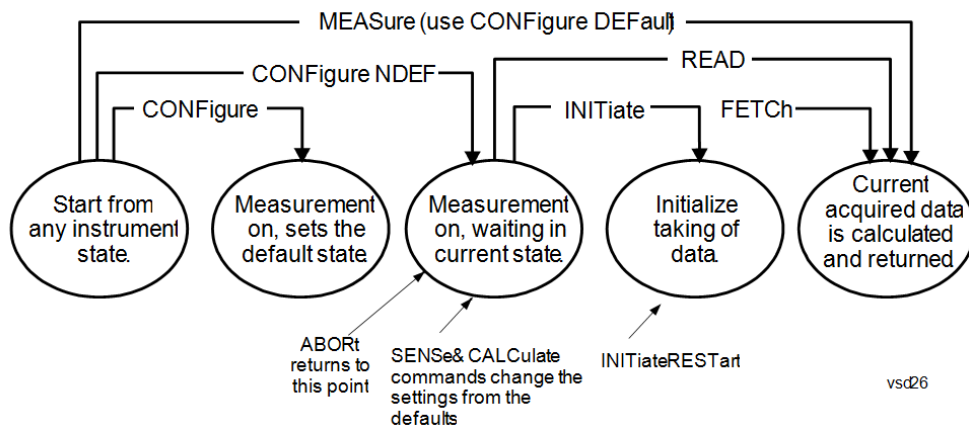

Measure Commands:

:MEASure:<measurement>[n]?

This is a fast single-command way to make a measurement using the factory default instrument settings. These are the settings and units that conform to the Mode Setup settings (e.g. radio standard) that you have currently selected.

- Stops the current measurement (if any) and sets up the instrument for the specified measurement using the factory defaults
- Initiates the data acquisition for the measurement
- Blocks other SCPI communication, waiting until the measurement is complete before returning results.
- If the function does averaging, it is turned on and the number of averages is set to 10.
- After the data is valid it returns the scalar results, or the trace data, for the specified measurement. The type of data returned may be defined by an [n] value that is sent with the command.
- The scalar measurement results will be returned if the optional [n] value is not included, or is set to 1. If the [n] value is set to a value other than 1, the selected trace data results will be returned. See each command for details of what types of scalar results or trace data results are available.
- ASCII is the default format for the data output. (Older versions of Spectrum Analysis and Phase Noise mode measurements only use ASCII.) The binary data formats should be used for handling large blocks of data since they are smaller and faster than the ASCII format. Refer to the FORMat:DATA command for more information.

If you need to change some of the measurement parameters from the factory default settings you can set up the measurement with the CONFigure command. Use the commands in the SENSE:<measurement> and CALCulate:<measurement> subsystems to change the settings. Then you can use the READ? command to initiate the measurement and query the results.

If you need to repeatedly make a given measurement with settings other than the factory defaults, you can use the commands in the SENSE:<measurement> and CALCulate:<measurement> subsystems to set up the measurement. Then use the READ? command to initiate the measurement and query results.

Measurement settings persist if you initiate a different measurement and then return to a previous one. Use READ:<measurement>? if you want to use those persistent settings. If you want to go back to the default settings, use MEASure:<measurement>?.

Configure Commands:

:CONFigure:<measurement>

This command stops the current measurement (if any) and sets up the instrument for the specified measurement using

the factory default instrument settings. It does not initiate the taking of measurement data unless INIT:CONTInuous is ON. If you change any measurement settings after using the CONFigure command, the READ command can be used to initiate a measurement without changing the settings back to their defaults.

In the Swept SA measurement in Spectrum Analyzer mode the CONFigure command also turns the averaging function on and sets the number of averages to 10 for all measurements.

:CONFigure: <measurement>: NDEFault stops the current measurement and changes to the specified measurement. It does not change the settings to the defaults. It does not initiate the taking of measurement data unless INIT:CONTInuous is ON.

The CONFigure? query returns the current measurement name.

The CONFigure:CATalog? query returns a quoted string of all licensed measurement names in the current mode. For example, "SAN, CHP, OBW, ACP, PST, TXP, SPUR, SEM, LIST".

Fetch Commands:

:FETCh:<measurement>[n]?

This command puts selected data from the most recent measurement into the output buffer. Use FETCh if you have already made a good measurement and you want to return several types of data (different [n] values, for example, both scalars and trace data) from a single measurement. FETCh saves you the time of re-making the measurement. You can only FETCh results from the measurement that is currently active, it will not change to a different measurement. An error message is reported if a measurement other than the current one is specified.

If you need to get new measurement data, use the READ command, which is equivalent to an INITiate followed by a FETCh.

The scalar measurement results will be returned if the optional [n] value is not included, or is set to 1. If the [n] value is set to a value other than 1, the selected trace data results will be returned. See each command for details of what types of scalar results or trace data results are available. The binary data formats should be used for handling large blocks of data since they are smaller and transfer faster than the ASCII format. (FORMat:DATA)

FETCh may be used to return results other than those specified with the original READ or MEASure command that you sent.

INITiate Commands:

:INITiate:<measurement>

This command is not available for measurements in all the instrument modes:

- Initiates a trigger cycle for the specified measurement, but does not output any data. You must then use the FETCh<meas> command to return data. If a measurement other than the current one is specified, the instrument will switch to that measurement and then initiate it.
 - For example, suppose you have previously initiated the ACP measurement, but now you are running the channel power measurement. If you send INIT:ACP? it will change from channel power to ACP and will initiate an ACP measurement.
 - Does not change any of the measurement settings. For example, if you have previously started the ACP measurement and you send INIT:ACP? it will initiate a new ACP measurement using the same instrument settings as the last time ACP was run.
 - If your selected measurement is currently active (in the idle state) it triggers the measurement, assuming the trigger conditions are met. Then it completes one trigger cycle. Depending upon the measurement and the number of averages, there may be multiple data acquisitions, with multiple trigger events, for one full trigger cycle. It also holds off additional commands on GPIB until the acquisition is complete.
-

READ Commands:

:READ:<measurement>[n]?

- Does not preset the measurement to the factory default settings. For example, if you have previously initiated the ACP
-

measurement and you send READ:ACP? it will initiate a new measurement using the same instrument settings.

- Initiates the measurement and puts valid data into the output buffer. If a measurement other than the current one is specified, the instrument will switch to that measurement before it initiates the measurement and returns results.
 - For example, suppose you have previously initiated the ACP measurement, but now you are running the channel power measurement. Then you send READ:ACP? It will change from channel power back to ACP and, using the previous ACP settings, will initiate the measurement and return results.
 - Blocks other SCPI communication, waiting until the measurement is complete before returning the results
 - If the optional [n] value is not included, or is set to 1, the scalar measurement results will be returned. If the [n] value is set to a value other than 1, the selected trace data results will be returned. See each command for details of what types of scalar results or trace data results are available. The binary data formats should be used when handling large blocks of data since they are smaller and faster than the ASCII format. (FORMat:DATA)
-

Initial S/W Revision	Prior to A.02.00
----------------------	------------------

Current Measurement Query (Remote Command Only)

This command returns the name of the measurement that is currently running.

Remote Command	:CONFigure?
-----------------------	-------------

Example	CONF?
----------------	-------

Initial S/W Revision	Prior to A.02.00
----------------------	------------------

Limit Test Current Results (Remote Command Only)

Queries the status of the current measurement limit testing. It returns a 0 if the measured results pass when compared with the current limits. It returns a 1 if the measured results fail any limit tests.

Remote Command	:CALCulate:CLIMits:FAIL?
-----------------------	--------------------------

Example	CALC:CLIM:FAIL? queries the current measurement to see if it fails the defined limits. Returns a 0 or 1: 0 it passes, 1 it fails.
----------------	--

Initial S/W Revision	Prior to A.02.00
----------------------	------------------

Data Query (Remote Command Only)

Returns the designated measurement data for the currently selected measurement and subopcode.

n = any valid subopcode for the current measurement. See the measurement command results table for your current measurement, for information about what data is returned for the subopcodes.

This command uses the data setting specified by the FORMat:BORDER and FORMat:DATA commands and can return real or ASCII data. (See the format command descriptions under Input/Output in the Analyzer Setup section.)

Remote Command	:CALCulate:DATA[n]?
Notes	The return trace depends on the measurement. In CALCulate:<meas>:DATA[n], n is any valid subopcode for the current measurement. It returns the same data as the FETCH:<measurement>? query where <measurement> is the current measurement.
Initial S/W Revision	Prior to A.02.00

Calculate/Compress Trace Data Query (Remote Command Only)

Returns compressed data for the currently selected measurement and sub-opcode [n].

n = any valid sub-opcode for that measurement. See the MEASure:<measurement>? command description of your specific measurement for information on the data that can be returned.

The data is returned in the current Y Axis Unit of the analyzer. The command is used with a sub-opcode <n> (default=1) to specify the trace. With trace queries, it is best if the analyzer is not sweeping during the query. Therefore, it is generally advisable to be in Single Sweep, or Update=Off.

This command is used to compress or decimate a long trace to extract and return only the desired data. A typical example would be to acquire N frames of GSM data and return the mean power of the first burst in each frame. The command can also be used to identify the best curve fit for the data.

Remote Command	:CALCulate:DATA<n>:COMPRESS? BLOCK CFIT MAXimum MINimum MEAN DMEan RMS RMSCubed SAMPLE SDEVIation PPHase [,<soffset> [,<length>[,<roffset>[,<rlimit>]]]]
Example	To query the mean power of a set of GSM bursts: Supply a signal that is a set of GSM bursts. Select the IQ Waveform measurement (in IQ Analyzer Mode). Set the sweep time to acquire at least one burst. Set the triggers such that acquisition happens at a known position relative to a burst. Then query the mean burst levels using, CALC:DATA2:COMP? MEAN, 24e-6, 526e-6 (These parameter values correspond to GSM signals, where 526e-6 is the length of the burst in the slot and you just want 1 burst.)
Notes	The command supports 5 parameters. Note that the last 4 (<soffset>, <length>, <roffset>, <rlimit>) are optional. But these optional parameters must be entered in the specified order. For example, if you want to specify <length>, then you must also specify <soffset>. See details below for a definition of each of these parameters. This command uses the data in the format specified by FORMat:DATA, returning either binary or ASCII data.
Initial S/W Revision	Prior to A.02.00

- BLOCK or block data - returns all the data points from the region of the trace data that you specify. For example, it could be used to return the data points of an input signal over several timeslots, excluding the portions of the trace data that you do not want. (This is x,y pairs for trace data and I,Q pairs for complex data.)

- CFIT or curve fit - applies curve fitting routines to the data. <soffset> and <length> are required to define the data that you want. <roffset> is an optional parameter for the desired order of the curve equation. The query will return the following values: the x-offset (in seconds) and the curve coefficients ((order + 1) values).

MIN, MAX, MEAN, DME, RMS, RMSC, SAMP, SDEV and PPH return one data value for each specified region (or <length>) of trace data, for as many regions as possible until you run out of trace data (using <roffset> to specify regions). Or they return the number of regions you specify (using <rlimit>) ignoring any data beyond that.

- MINimum - returns the minimum data point (y value) for the specified region(s) of trace data. For I/Q trace data, the minimum magnitude of the I/Q pairs is returned.
- MAXimum - returns the maximum data point (y value) for the specified region(s) of trace data. For I/Q trace data, the maximum magnitude of the I/Q pairs is returned.
- MEAN - returns a single value that is the arithmetic mean of the data point values (in dB/ dBm) for the specified region(s) of trace data. For I/Q trace data, the mean of the magnitudes of the I/Q pairs is returned. See the following equations.

•

NOTE If the original trace data is in dB, this function returns the arithmetic mean of those log values, not log of the mean power which is a more useful value. The mean of the log is the better measurement technique when measuring CW signals in the presence of noise. The mean of the power, expressed in dB, is useful in power measurements such as Channel Power. To achieve the mean of the power, use the RMS option.

Equation 1

Mean Value of Data Points for Specified Region(s)

$$\text{MEAN} = \frac{1}{n} \sum_{X_i \in \text{region}(s)} X_i$$

where X_i is a data point value, and n is the number of data points in the specified region(s).

Equation 2

Mean Value of I/Q Data Pairs for Specified Region(s)

$$\text{MEAN} = \frac{1}{n} \sum_{X_i \in \text{region}(s)} |X_i|$$

where $|X_i|$ is the magnitude of an I/Q pair, and n is the number of I/Q pairs in the specified region(s).

- DMEan - returns a single value that is the mean power (in dB/ dBm) of the data point values for the specified region(s) of trace data. See the following equation:

Equation 3

DMEan Value of Data Points for Specified Region(s)

$$\text{DME} = 10 \times \log_{10} \left(\frac{1}{n} \sum_{X_i \in \text{region}(s)} 10^{\frac{X_i}{10}} \right)$$

- RMS - returns a single value that is the average power on a root-mean-squared voltage scale (arithmetic rms) of the data point values for the specified region(s) of trace data. See the following equation.

NOTE

For I/Q trace data, the rms of the magnitudes of the I/Q pairs is returned. See the following equation. This function is very useful for I/Q trace data. However, if the original trace data is in dB, this function returns the rms of the log values which is not usually needed.

Equation 4

RMS Value of Data Points for Specified Region(s)

$$\text{RMS} = \sqrt{\frac{1}{n} \sum_{X_i \in \text{region}(s)} X_i^2}$$

where X_i is a data point value, and n is the number of data points in the specified region(s).

Equation 5

RMS Value of I/Q Data Pairs for Specified Region(s)

$$\text{RMS} = \sqrt{\frac{1}{n} \sum_{X_i \in \text{region}(s)} X_i X_i^*}$$

where X_i is the complex value representation of an I/Q pair, X_i^* its conjugate complex number, and n is the number of I/Q pairs in the specified region(s).

Once you have the rms value for a region of trace data (linear or I/Q), you may want to calculate the mean power. You must convert this rms value (peak volts) to power in dBm:

$$10 \times \log[10 \times (\text{rms value})^2]$$

- SAMPLe - returns the first data value (x,y pair) for the specified region(s) of trace data. For I/Q trace data, the first I/Q pair is returned.
- SDEViation - returns a single value that is the arithmetic standard deviation for the data point values for the specified region(s) of trace data. See the following equation.
- For I/Q trace data, the standard deviation of the magnitudes of the I/Q pairs is returned. See the following equation.

Equation 6

Standard Deviation of Data Point Values for Specified Region(s)

$$\text{SDEV} = \sqrt{\frac{1}{n} \sum_{X_i \in \text{region}(s)} (X_i - \bar{X})^2}$$

where X_i is a data point value, \bar{X} is the arithmetic mean of the data point values for the specified region (s), and n is the number of data points in the specified region(s).

$$\text{SDEV} = \sqrt{\frac{1}{n} \sum_{X_i \in \text{region}(s)} (|X_i| - \bar{X})^2}$$

where $|X_i|$ is the magnitude of an I/Q pair, \bar{X} is the mean of the magnitudes for the specified region(s), and n is the number of data points in the specified region(s).

- PPHase - returns the x,y pairs of both rms power (dBm) and arithmetic mean phase (radian) for every specified region and frequency offset (Hz). The number of pairs is defined by the specified number of regions. This parameter can be used for I/Q vector ($n=0$) in Waveform (time domain) measurement and all parameters are specified by data point in PPHase.

The rms power of the specified region may be expressed as:

$$\text{Power} = 10 \times \log [10 \times (\text{RMS I/Q value})] + 10.$$

The RMS I/Q value (peak volts) is:

$$\sqrt{\frac{1}{n} \sum_{X_i \in \text{region}} X_i X_i^*}$$

where X_i is the complex value representation of an I/Q pair, X_i^* its conjugate complex number, and n is the number of I/Q pairs in the specified region.

The arithmetic mean phase of the specified region may be expressed as:

$$\frac{1}{n} \sum_{Y_i \in \text{region}} Y_i$$

where Y_i is the unwrapped phase of I/Q pair with applying frequency correction and n is the number of I/Q pairs in the specified region.

The frequency correction is made by the frequency offset calculated by the arithmetic mean of every specified region's frequency offset. Each frequency offset is calculated by the least square method against the unwrapped phase of I/Q pair.

Sample Trace Data - Constant Envelope

(See below for explanation of variables.)

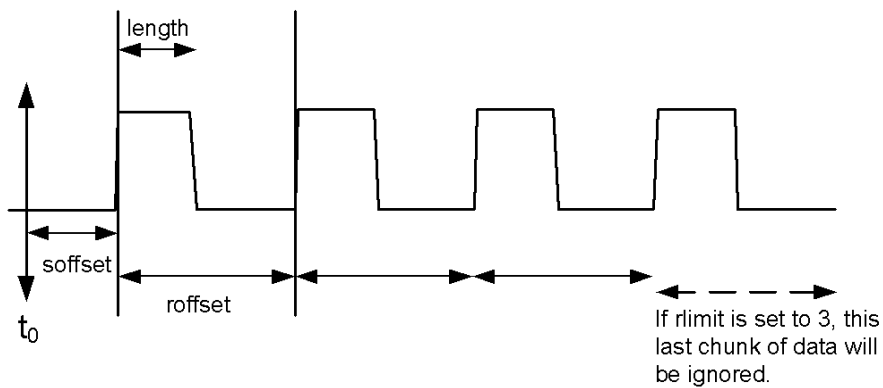

Sample Trace Data - Not Constant Envelope

(See below for explanation of variables.)



<soffset> - start offset is an optional real number. (It is in seconds for time-domain traces, and is a dimensionless index 0 to Npoints - 1, for frequency-domain traces). It specifies the amount of data at the beginning of the trace that will be ignored before the decimation process starts. It is the time or frequency change from the start of the trace to the point where you want to start using the data. The default value is zero.

<length> - is an optional real number. (It is in seconds for time-domain traces, and is a dimensionless index 0 to Npoints - 1, for frequency-domain traces). It defines how much data will be compressed into one value. This parameter has a default value equal to the current trace length.

<roffset> - repeat offset is an optional real number. (It is in seconds for time-domain traces, and is a dimensionless index 0 to Npoints - 1, for frequency-domain traces). It defines the beginning of the next field of trace elements to be compressed. This is relative to the beginning of the previous field. This parameter has a default value equal to the <length> variable. Note that this parameter is used for a completely different purpose when curve fitting (see CFIT above).

<rlimit> - repeat limit is an optional integer. It specifies the number of data items that you want returned. It will ignore any additional items beyond that number. You can use the Start offset and the Repeat limit to pick out exactly what part of the data you want to use. The default value is all the data.

Calculate Peaks of Trace Data (Remote Command Only)

Returns a list of all the peaks for the currently selected measurement and sub-opcode [n]. The peaks must meet the requirements of the peak threshold and excursion values.

n = any valid sub-opcode for the current measurement. See the MEASure:<measurement> command description of your specific measurement for information on the data that can be returned.

The command can only be used with specific sub-opcodes with measurement results that are trace data. Both real and complex traces can be searched, but complex traces are converted to magnitude in dBm. In many measurements the sub-opcode n=0, is the raw trace data which cannot be searched for peaks. And Sub-opcode n=1, is often calculated results values which also cannot be searched for peaks.

This command uses the data setting specified by the FORMat:BORDER and FORMat:DATA commands and can return real or ASCII data. If the format is set to INT,32, it returns REAL,32 data.

The command has four types of parameters:

- Threshold (in dBm)
- Excursion (in dB)
- Sorting order (amplitude, frequency, time)
- Optional in some measurements: Display line use (all, > display line, < display line)

Remote Command	<p>For Swept SA measurement:</p> <pre>:CALCulate:DATA[1] 2 ... 6:PEAKs? <threshold>,<excursion>[,AMPLitude FREQuency TIME[,ALL GTDLine LTDLine]]</pre> <p>For most other measurements:</p> <pre>:CALCulate:DATA[1] 2 ... 6:PEAKs? <threshold>,<excursion>[,AMPLitude FREQuency TIME]</pre>
-----------------------	--

Example	<p>Example for Swept SA measurement in Spectrum Analyzer Mode:</p> <p>CALC:DATA4:PEAK? -40, 10, FREQ, GTDL This will identify the peaks of trace 4 that are above -40 dBm, with excursions of at least 10 dB. The peaks are returned in order of increasing frequency, starting with the lowest frequency. Only the peaks that are above the display line are returned.</p> <p>Query Results 1:</p> <p>With FORMat:DATA REAL, 32 selected, it returns a list of floating-point numbers. The first value in the list is the number of peak points that are in the following list. A peak point consists of two values: a peak amplitude followed by its corresponding frequency (or time).</p> <p>If no peaks are found the peak list will consist of only the number of peaks, (0).</p>
----------------	---

Notes	<p><n> - is the trace that will be used</p> <p><threshold> - is the level below which trace data peaks are ignored. Note that the threshold value is required and is always used as a peak criterion. To effectively disable the threshold criterion for this command, provide a substantially low threshold value such as -200 dBm. Also note that the threshold value used in this command is independent of and has no effect on the threshold value stored under the Peak Criteria menu.</p> <p><excursion> - is the minimum amplitude variation (rise and fall) required for a signal to be identified as peak. Note that the excursion value is required and is always used as a peak criterion. To effectively disable the excursion criterion for this command, provide the minimum value of 0.0 dB. Also note that the excursion value used in this command is independent of and has no effect on the</p>
--------------	---

excursion value stored under the Peak Criteria menu.

Values must be provided for threshold and excursion. The sorting and display line parameters are optional (defaults are AMPLitude and ALL).

Note that there is always a Y-axis value for the display line, regardless of whether the display line state is on or off. It is the current Y-axis value of the display line which is used by this command to determine whether a peak should be reported

Sorting order:

AMPLitude - lists the peaks in order of descending amplitude, with the highest peak first (default if optional parameter not sent)

FREQUENCY - lists the peaks in order of occurrence, left to right across the x-axis.

TIME - lists the peaks in order of occurrence, left to right across the x-axis.

Peaks vs. Display Line:

ALL - lists all of the peaks found (default if optional parameter not sent).

GTDLine (greater than display line) - lists all of the peaks found above the display line.

LTDLine (less than display line) - lists all of the peaks found below the display line.

Initial S/W Revision	Prior to A.02.00
----------------------	------------------

Hardware-Accelerated Fast Power Measurement (Remote Command Only)

The Fast Power option (FP2) enables very fast channel power measurements for instruments with the prerequisite hardware (DP2 and/or B40). It accomplishes this by performing real-time overlapped FFTs at the hardware layer, using software for basic post-processing before returning the result to the user. The upshot of this approach is improved throughput for user applications that require many sequential power measurements.

The analysis bandwidth of FP2 is limited by the licenses in the instrument, but its maximum overall analysis bandwidth per acquisition is 40 MHz.

FP2 is remote-only, which means the instrument does not switch to any particular mode or measurement. FP2 commands can be sent while another application is in use on the front panel.

Each Fast Power measurement can be predefined using an array index, and up to 1,000 measurements can be stored. In the following documentation, instances of [1,2,...,999] can be substituted with a particular measurement index, e.g. CALC:FPOW:POW1?, CALC:FPOW:POW2?, CALC:FPOW:POW134?. In this way, power measurements can be defined one time in a batch, and then executed multiple times without having to redefine them, similar to “list mode” on other measurements.

In addition to basic channel power measurements, there are a number of other measurement “functions” for each channel, including peak power, peak frequency, and power spectral density. See the Function parameter for more information.

Reset Fast Power Measurement (Remote Command Only)

Resets the measurement configuration to the defaults.

Mode	All
Remote Command	:CALCulate:FPOWer:POWer[1,2,...,999]:RESet
Example	:CALC:FPOW:POW1:RES

Notes	Option FP2 is required.
Initial S/W Revision	A.14.00

Define Fast Power Measurement (Remote Command Only)

Fast Power acquisitions are configured using the DEFine command. This command accepts a comma-delimited string of configuration parameters and their appropriate values, which are all specified in the subsection below.

Mode	All
Remote Command	:CALCulate:FPOWer:POWer[1,2,...,999]:DEFine "configuration string"
Example	:CALC:FPOW:POW1:DEF "CenterFrequency=2e9, AcquisitionTime=0.005"
Notes	See below for a list of measurement variables that can be defined in the configuration string.
Initial S/W Revision	A.14.00

Acquisition Time

Value	Time (s)
Range	0 s to 1 s
Preset	0.001 s
Example	CALC:FPOW:POW1:DEF "AcquisitionTime=0.002"
Notes	The acquisition time parameter sets the time in which the entire spectrum is measured. An increase in the acquisition time yields an improvement in measurement repeatability.
Initial S/W Revision	A.14.00

Center Frequency

Value	Frequency (Hz)
Range	0 Hz to maximum instrument frequency
Preset	1 GHz
Example	CALC:FPOW:POW1:DEF "CenterFrequency=2e9"
Notes	The center frequency parameter sets the frequency in which the measurement is centered around. The OffsetFrequency parameter is calculated relative to the center frequency.
Initial S/W Revision	A.14.00

DC Coupled

Value	Boolean
Range	True (DC Coupled) or False (AC Coupled)
Preset	False
Example	CALC:FPOW:POW1:DEF "DCCoupled=True"
Notes	The DC coupled parameter allows the user to specify whether the DC blocking capacitor is utilized. Set parameter to true when measuring frequencies below 10 MHz.
Initial S/W Revision	A.14.00

DetectorType

Example	CALC:FPOW:POW1:DEF "DetectorType=Peak"
Notes	Option FP2 is required. The detector type parameter allows the user to choose whether a RMS average or peak value is used during the measurement.
Preset	RmsAverage
Range	RmsAverage, Peak
Initial S/W Revision	A.14.00

Do Noise Correction

Value	Boolean
Range	True (enable noise correction) or False (disable noise correction)
Preset	False
Example	CALC:FPOW:POW1:DEF "DoNoiseCorrection=True"
Notes	When noise correction is enabled, the linear noise power contributed by the analyzer is subtracted from all measurements. This effectively lowers the noise floor of the analyzer. When noise correction is enabled, the first measurement for a given set of input parameters will take extra time. This is because the analyzer takes an extra acquisition with the RF input disconnected from the analyzer's front end to measure the noise of just the analyzer. The measured noise floor is stored in a cache so the noise acquisition will occur only once for the same state settings. In other words, if noise correction was turned on and the analyzer made an acquisition at frequency A, then frequency B, and back again to frequency A, the hidden initial noise floor acquisition would only occur for the first acquisition at frequency A and the cached noise floor would be used the second time frequency A was measured.
Initial S/W Revision	A.14.00

Do Spur Suppression

Value	Boolean
Range	True (enable spur suppression) or False (disable spur suppression)
Preset	False
Example	CALC:FPOW:POW1:DEF "DoSpurSuppression=True"
Notes	<p>When measuring very low level signals, or when large out-of-band inputs are input into the analyzer, sometimes unwanted spurs and residuals can appear in the measured spectrum. Spur suppression is a method to help minimize the levels of these internally generated spurs and residuals.</p> <p>When spur suppression is enabled, the analyzer will automatically take two acquisitions using two different internal analog LO frequencies. The FFT spectrums from both acquisitions are combined by taking the minimum power between both traces on a per FFT bin basis. External signals will have the same amplitude for both traces and therefore will return the expected amplitudes. However, low level spurs and residuals generated internally to the analyzer tend to move to different FFT bins depending on the internal analog LO frequency used, and therefore tend to be suppressed using this spur suppression method.</p> <p>Because two acquisitions, rather than a single acquisition, are made when spur suppression is enabled, the measurement time will always be slower when spur suppression is enabled.</p>
Initial S/W Revision	A.14.00

Electronic Attenuator Bypass

Value	Boolean
Range	True (bypass electronic attenuator) or False (use electronic attenuator)
Preset	True
Example	CALC:FPOW:POW1:DEF "ElecAttBypass =False"
Notes	The electronic attenuation bypass parameter allows the user to either utilize or bypass the electronic attenuator. The electronic attenuator is only available for frequencies up to 3.6 GHz. Set parameter to true when using frequencies above 3.6 GHz and set the parameter to false when using the preamp.
Initial S/W Revision	A.14.00

Electronic Attenuation

Value	dB
Range	0 - 24 dB (1 dB steps)
Preset	0 dB
Example	CALC:FPOW:POW1:DEF "ElecAttenuation=10"
Notes	<p>Option EA3 is required.</p> <p>The electronic attenuation value parameter sets the amount of electrical attenuation from 0 to 24 dB (1 dB steps).</p>

Set "ElecAttBypass=False" to make sure the electronic attenuator path is enabled.

Initial S/W Revision	A.14.00
----------------------	---------

IF Gain

Value	dB
Range	-6 - 16 dB (1 dB steps)
Preset	0 dB
Example	CALC:FPOW:POW1:DEF "IFGain=10"
Notes	The IF gain parameter allows the user to specify the gain at the IF stage anywhere from -6 to 16 dB (1 dB steps). This is an advanced feature, and for most cases this should remain at its default value of 0 dB.
Initial S/W Revision	A.14.00

IF Type

Example	CALC:FPOW:POW1:DEF "IFType=B25M"
Notes	The IF type parameter allows the user to select between different IF paths. For example, if the signal is less than 25 MHz wide, then the user can select the B25M path to take advantage of additional filtering on this analog IF path.
Preset	B40M
Range	B10M, B25M, B40M
Initial S/W Revision	A.14.00

Include Power Spectrum

Value	Boolean
Range	True (return both channel power and full power spectrum) or False (returns only channel power)
Preset	False
Example	CALC:FPOW:POW1:DEF "IncludePowerSpectrum=True"
Notes	The power spectrum parameter allows the user to read data on the entire spectrum for diagnostic purposes. It is not recommended for production use. See CALC:FPOW:POW[n]:READ2? for details on the binary format of the response.
Initial S/W Revision	A.14.00

Mechanical Attenuation

Value	dB
Range	0 – 70 dB (2 dB steps)
Preset	0 dB
Example	CALC:FPOW:POW1:DEF "MechAttenuation=10"
Notes	The mechanical attenuation value parameter sets the amount of mechanical attenuation anywhere from 0 to 70 dB (2 dB steps).
Initial S/W Revision	A.14.00

Preamp Mode

Example	CALC:FPOW:POW1:DEF "PreAmpMode=Low"
Notes	The license for the appropriate preamp is required. The preamp mode parameter specifies whether the preamps are being utilized. Low allows any preamps up to 3.6 GHz, and Full allows all licensed preamps. Set "ElecAttBypass=True" in order to utilize any preamps.
Preset	Off
Range	Off, Low, Full
Initial S/W Revision	A.14.00

Resolution Bandwidth Mode

Example	CALC:FPOW:POW1:DEF "PreAmpMode=Low"
Notes	The resolution bandwidth mode parameter allows the user to choose whether the RBW filter is automatically or manually set. The BestSpeed value minimizes measurement time, while the Narrowest value minimizes RBW size (minimum of two FFT bins per RBW). To manually specify an RBW, set this parameter to Explicit, and set the ResolutionBW parameter to the desired value.
Preset	BestSpeed
Range	BestSpeed, Narrowest, Explicit
Initial S/W Revision	A.14.00

Resolution Bandwidth

Value	Hz
Preset	0 Hz

Example	CALC:FPOW:POW1:DEF "ResolutionBW=25e3"
Notes	The resolution bandwidth parameter sets the 3-dB bandwidth of the RBW filter. The ResolutionBWMode parameter must be set to Explicit in order to manually set the RBW.
Initial S/W Revision	A.14.00

Trigger Delay

Value	Seconds
Range	0 – 1 s
Preset	0 s
Example	CALC:FPOW:POW1:DEF "TriggerDelay=0.025"
Notes	The trigger delay parameter sets the time after an external trigger is detected until the measurement is performed.
Initial S/W Revision	A.14.00

Trigger Level

Value	Volts
Range	-5 to 5 V
Preset	1.2 V
Example	CALC:FPOW:POW1:DEF "TriggerLevel=2"
Notes	The trigger level parameter sets the voltage value at which an external trigger is detected.
Initial S/W Revision	A.14.00

Trigger Slope

Example	CALC:FPOW:POW1:DEF "TriggerSlope=Negative"
Notes	The trigger slope parameter indicates the direction of the edge trigger voltage for detection.
Preset	Positive
Range	Positive, Negative
Initial S/W Revision	A.14.00

Trigger Source

Example	CALC:FPOW:POW1:DEF "TriggerSource=Ext1 "
Notes	The trigger source parameter allows the user to choose between measurement's triggering freely or controlled by an external input. Ext1 and Ext2 correspond to Trigger 1 In and Trigger 2 In, respectively.
Preset	Free
Range	Free, Ext1, Ext2
Initial S/W Revision	A.14.00

Trigger Timeout

Value	Seconds
Range	0 - 1 s
Preset	1 s
Example	CALC:FPOW:POW1:DEF "TriggerTimeout=0.1"
Notes	The trigger timeout parameter sets the time in which the analyzer will wait for a trigger before automatically performing the measurement.
Initial S/W Revision	A.14.00

Signal Input

Example	CALC:FPOW:POW1:DEF "SignalInput=Fp50MHzCW"
Notes	The signal input parameter allows the user to select between using the main RF input or the internal analyzer reference CW signal of 50 MHz.
Preset	FpMainRf
Range	FpMainRf, Fp50MHzCW
Initial S/W Revision	A.14.00

Use Preselector

Value	Boolean
Range	True (use preselector above 3.6 GHz), or False (preselector bypassed)
Preset	False
Example	CALC:FPOW:POW1:DEF "UsePreSelector=True"
Notes	The preselector parameter allows the user to either utilize or bypass the front end tunable filter at frequencies above 3.6 GHz. For frequencies below 3.6 GHz, the preselector is automatically

bypassed, so you do not need to set this parameter to False in those cases.

Initial S/W Revision A.14.00

Channel Bandwidth Array

Value	Hz
Range	0 to 40 MHz
Preset	[1 e6]
Example	CALC:FPOW:POW1:DEF "Bandwidth=[3.84e6, 5e6, 3.84e6]"
Notes	The bandwidth parameter array defines the bandwidth of each channel that will be measured. All array parameters should have the same number of elements. Alternatively, if all the elements are the same value, a single number with no square brackets can be used to define the parameter.
Initial S/W Revision	A.14.00

Channel Filter Type Array

Example	CALC:FPOW:POW1:DEF "FilterType=[RRC, IBW, RRC]"
Notes	The filter type parameter allows the user to choose between an integration bandwidth (IBW) filter or a root-raised-cosine (RRC) filter. The integration bandwidth filter weighs all frequencies within the bandwidth equally. The root-raised-cosine filter has an associated shape parameter, defined by the FilterAlpha parameter. All array parameters should have the same number of elements. Alternatively, if all the elements are the same value, a single value with no square brackets can be used to define the parameter.
Preset	[IBW]
Range	IBW, RRC
Initial S/W Revision	A.14.00

Channel Filter Alpha Array

Example	CALC:FPOW:POW1:DEF "FilterAlpha=[0.5, 0.0, 0.5]"
Notes	The filter alpha parameter allows the user to adjust the alpha value associated with the root-raised-cosine (RRC) filter type. Set FilterType to RRC in order to utilize this parameter. All array parameters should have the same number of elements. Alternatively, if all the elements are the same value, a single number with no square brackets can be used to define the parameter.
Preset	[0.22]
Range	0.0 – 1.0
Initial S/W Revision	A.14.00

Channel Measurement Function Array

Example	CALC:FPOW:POW1:DEF "Function=[BandPower, PeakPower, BandPower]"
Notes	<p>This parameter array defines what measurement is being made for each individually-specified channel:</p> <p>BandPower: Total power within the specified bandwidth of the channel (dBm)</p> <p>BandDensity: Total power density within the specified bandwidth of the channel (dBm/Hz)</p> <p>PeakPower: The peak power value within the specified bandwidth of the channel (dBm)</p> <p>PeakFrequency: The frequency which corresponds to the peak power value within the specified bandwidth of the channel. This frequency is relative to the center frequency (Hz)</p> <p>XdBBandwidth: The half power (-3.01 dB) bandwidth of the highest amplitude signal that resides within the channel (Hz), dB is configurable using XdBBandwidth parameter</p> <p>OccupiedBandwidth: The bandwidth at which 99% of the total power resides within the channel (Hz), percentage configurable using OccupiedBandwidthPercent parameter</p> <p>All array parameters should have the same number of elements. Alternatively, if all the elements are the same value, a single value with no square brackets can be used to define the parameter.</p>
Preset	[BandPower]
Range	BandPower, BandDensity, PeakPower, PeakFrequency, XdBBandwidth, OccupiedBandwidth
Initial S/W Revision	A.14.00

Channel Offset Frequency Array

Value	Hz
Range	0 to 20 MHz
Preset	[0]
Example	CALC:FPOW:POW1:DEF "OffsetFrequency=[-5e6, 0, 5e6]"
Notes	<p>The offset frequency parameter array defines the difference between the center frequency to the center frequency of each channel.</p> <p>All array parameters should have the same number of elements.</p>
Initial S/W Revision	A.14.00

Channel Occupied Bandwidth Percent Array

Example	CALC:FPOW:POW1:DEF "OccupiedBandwidthPercent =[0.95, 0.95, 0.95]"
Notes	<p>This parameter only applies for channels whose Function is set to OccupiedBandwidth. The occupied bandwidth percent parameter specifies the percent of total power in these channels. The valid range for this parameter is 0.0 to 1.0, where 1.0 represents 100%. The default for this parameter is 0.99, which will return the bandwidth that contains 99% of the total channel power.</p>

Preset	[0.99]
Range	0 - 1.0
Initial S/W Revision	A.14.00

Channel x-dB Bandwidth Array

Value	dB
Range	-200 to 0 dB
Preset	[-3.01]
Example	CALC:FPOW:POW1:DEF " XdBBandwidth =[-6.02, -3.01, -1.0]"
Notes	This parameter only applies for channels whose Function is set to XdBBandwidth. The X dB bandwidth parameter is used to specify the power relative to the peak channel power over which the bandwidth is calculated. The parameter value must be a negative number.
Initial S/W Revision	A.14.00

Define Fast Power Measurement Query (Remote Command Only)

The DEFine? command is used to retrieve a list of all defined parameters in an ASCII string format

M o d e	All
R e m o t e	:CALCulate:FPOWER:POWer [1,2,...,999]:DEFine?
C o m m a n d	
E x a m p l e	:CALC:FPOW:POW1:DEF?

```

p
l
e
N This command query is used to retrieve a list of all defined parameters in an ASCII format.
o The following is an example of the returned results:
t "DCCoupled=False,ElecAttBypass=True,ElecAttenuation=0,IFGain=0,MechAttenuation=0,PreAmpMode=Off,PreSelectorOffset
e =0,UsePreSelector=False,ExternalReferenceFrequency=10000000,FrequencyReferenceSource=AutoExternalFrequencyRefer
s ence,IFType=B40M,LOMode=SLW,SignalInput=FpMainRf,AcquisitionTime=0.001,CenterFrequency=1000000000,Resolution
BW=0,ResolutionBWMode=BestSpeed,DetectorType=RmsAverage,Bandwidth=[1000000],OffsetFrequency=[0],Function=
[BandPower],FilterType=[IBW],FilterAlpha=[0.22],OccupiedBandwidthPercent=[0.99],XdBBandwidth=[-
3.01],DoNoiseCorrection=False,DoSpurSuppression=False,MeasurementMethod=HardwareFFT,IncludePowerSpectrum=False
e,TriggerDelay=0,TriggerLevel=1.2,TriggerSlope=Positive,TriggerSource=Free,TriggerTimeout=1"
I A.14.00
n
i
t
i
a
l
S
/
W
R
e
v
i
s
i
o
n

```

Configure Fast Power Measurement (Remote Command Only)

The configure command begins hardware setup and returns immediately, with no acquisition made. This can be used in parallel with other hardware operations to effectively hide the hardware setup time.

Mode	All
Remote Command	:CALCulate:FPOWER:POWER[1,2,...,999]:CONFigure
Example	:CALC:FPOW:POW1:CONF
Notes	Option FP2 is required.
Initial S/W Revision	A.14.00

Initiate Fast Power Measurement (Remote Command Only)

The INITiate command begins an acquisition and returns immediately. The results of the measurement can be retrieved using FETCh.

Mode	All
Remote Command	:CALCulate:FPOWER:POWER[1,2,...,999]:INITiate
Example	:CALC:FPOW:POW1:INIT
Notes	Option FP2 is required.
Initial S/W Revision	A.14.00

Fetch Fast Power Measurement (Remote Command Only)

The FETCh command query is used to retrieve the results of an acquisition initiated by the INIT command. The returned results are in ASCII string format. The string begins and ends with quotation marks.

Mode	All
Remote Command	:CALCulate:FPOWER:POWER[1,2,...,999]:FETCh?
Example	:CALC:FPOW:POW1:FETC?
Notes	Option FP2 is required. Returns m comma-separated ASCII values, where m corresponds to the number of bandwidths defined. 1. Declared function return in the 1st specified channel 2. Declared function return in the 2nd specified channel ... m. Declared function return in the last specified channel The INIT and FETC? command sequence performs the same functionality of a single CALC:FPOW:POW[n]? query. Units of the returned values are dependent on the Function parameter for each channel.
Initial S/W Revision	A.14.00

Execute Fast Power Measurement (Remote Command Only)

This command query is used as shorthand for an INIT command immediately followed by a FETC? command. The returned results are in ASCII string format. The string begins and ends with quotation marks.

Mode	All
Remote Command	:CALCulate:FPOWER:POWER[1,2,...,999]?
Example	:CALC:FPOW:POW1?
Notes	Option FP2 is required. See notes for Fast Power Fetch for return format.
Initial S/W Revision	A.14.00

Binary Read Fast Power Measurement (Remote Command Only)

This command query is used as shorthand for an INIT command immediately followed by a FETC? command. The returned results are in a binary format.

Mode	All
Remote Command	:CALCulate:FPOWER:POWER[1,2,...,999]:READ? :CALCulate:FPOWER:POWER[1,2,...,999]:READ1?
Example	:CALC:FPOW:POW1:READ? :CALC:FPOW:POW1:READ1?
Notes	Option FP2 is required. Returns m 4 byte floating point binary values (Little-Endian), where m corresponds to the number of bandwidths defined.
Initial S/W Revision	A.14.00

Diagnostic Binary Read Fast Power Measurement (Remote Command Only)

This command query is used as shorthand for an INIT command immediately followed by a FETC? command. The returned results are in a binary format. This command is used primarily for diagnostic purposes to test for ADC overloads and to visibly inspect the spectrum.

Mode	All
Remote Command	:CALCulate:FPOWER:POWER[1,2,...,999]:READ2?
Example	:CALC:FPOW:POW1:READ2?
Notes	Option FP2 is required. Note: Spectrum data is only returned if the IncludePowerSpectrum parameter is set to True. If IncludePowerSpectrum is False, the number of spectrum points will be zero (0). Units of the returned values are dependent on the Function parameter per channel (e.g. dBm for BandPower, Hz for PeakFrequency). Returns binary data (Little-Endian) that contains information on m amount of channels, along with ADC over range and full spectrum data. The following is the binary format of the response. Bandwidth Return Value 1. Number of channels specified, m [4 byte int] 2. Declared function result for the 1st specified channel [4 byte float] 3. Declared function result for the 2nd specified channel [4 byte float] ... (m + 1). Declared function result for the last (mth) specified channel [4 byte float] ADC Over Range 1. ADC over-range occurred (1: true, 0: false) [2 byte short]

	<p>Spectrum Data</p> <ol style="list-style-type: none"> 1. Number of points in the spectrum data, k [4 byte int] 2. Start frequency of spectrum data (Hz) [8 byte double] 3. Step frequency of spectrum data (Hz) [8 byte double] 4. FFT bin at 1st point (dBm) [4 byte float] 5. FFT bin at 2nd point (dBm) [4 byte float] <p>...</p> <p>(k + 3). FFT bin at last (kth) point (dBm) [4 byte float]</p>
Initial S/W Revision	A.14.00

Format Data: Numeric Data (Remote Command Only)

This command specifies the format of the trace data input and output. It specifies the formats used for trace data during data transfer across any remote port. It affects only the data format for setting and querying trace data for the :TRACe[:DATA], TRACe[:DATA]?, :CALCulate:DATA[n]? and FETCh:SANalyzer[n]? commands and queries.

Remote Command	<pre>:FORMat[:TRACe][:DATA] ASCii INTeger,32 REAL,32 REAL,64 :FORMat[:TRACe][:DATA]?</pre>
Notes	<p>The query response is:</p> <pre>ASCii: ASC,8 REAL,32: REAL,32 REAL,64: REAL,64 INTeger,32: INT,32</pre> <p>When the numeric data format is REAL or ASCii, data is output in the current Y Axis unit. When the data format is INTeger, data is output in units of m dBm (.001 dBm).</p> <p>The INT,32 format returns binary 32-bit integer values in internal units (m dBm), in a definite length block.</p>
Dependencies	<p>Sending a data format spec with an invalid number (for example, INT,48) generates no error. The analyzer simply uses the default (8 for ASCii, 32 for INTeger, 32 for REAL).</p> <p>Sending data to the analyzer which does not conform to the current FORMat specified, results in an error. Sending ASCII data when a definite block is expected generates message -161 "Invalid Block Data" and sending a definite block when ASCII data is expected generates message -121 "Invalid Character in Number".</p>
Preset	ASCii
Backwards Compatibility Notes	Note that the INT,32 format is only applicable to the command, TRACe:DATA. This preserves backwards compatibility for the Swept SA measurement. For all other commands/queries which honor FORMat:DATA, if INT,32 is sent the analyzer will behave as though it were set to REAL,32.
Initial S/W Revision	Prior to A.02.00

The specs for each output type follow:

AScii - Amplitude values are in ASCII, in the current Y Axis Unit, one ASCII character per digit, values separated by commas, each value in the form:

SX.YYYYYEsZZ

Where:

S = sign (+ or -)

X = one digit to left of decimal point

Y = 5 digits to right of decimal point

E = E, exponent header

s = sign of exponent (+ or -)

ZZ = two digit exponent

REAL,32 - Binary 32-bit real values in the current Y Axis Unit, in a definite length block.

REAL,64 - Binary 64-bit real values in the current Y Axis Unit, in a definite length block.

Format Data: Byte Order (Remote Command Only)

This command selects the binary data byte order for data transfer and other queries. It controls whether binary data is transferred in normal or swapped mode. This command affects only the byte order for setting and querying trace data for the :TRACe[:DATA], TRACe[:DATA]? , :CALCulate:DATA[n]? and FETCh:SANalyzer[n]? commands and queries.

By definition any command that says it uses FORMat:DATA uses any format supported by FORMat:DATA.

The NORMal order is a byte sequence that begins with the most significant byte (MSB) first, and ends with the least significant byte (LSB) last in the sequence: 1|2|3|4. SWAPped order is when the byte sequence begins with the LSB first, and ends with the MSB last in the sequence: 4|3|2|1.

Remote Command	:FORMat:BORDER NORMal SWAPped :FORMat:BORDER?
Preset	NORMal
Initial S/W Revision	Prior to A.02.00

Meas Setup

Accesses the measurement setup menu for the current measurement.

Key Path	Meas Setup
Initial S/W Revision	A.10.01

Avg Number

Used to specify the number of data acquisitions that are averaged. After the specified number of average counts, the averaging mode (termination control) setting determines the averaging action.

- On - Sets measurement averaging on.
- Off - Sets measurement averaging off.

Key Path	Meas Setup
Mode	WLAN
Remote Command	[:SENSe]:PVTime:AVERage:COUNT <integer> [:SENSe]:PVTime:AVERage:COUNT? [:SENSe]:PVTime:AVERage[:STATe] OFF ON 0 1 [:SENSe]:PVTime:AVERage[:STATe]?
Example	PVT:AVER:COUN 1 PVT:AVER:COUN? PVT:AVER OFF PVT:AVER?
Preset	10 OFF
State Saved	Saved in instrument state.
Min	1
Max	10000
Initial S/W Revision	A.10.01

Avg Mode

Selects the type of termination control used for the averaging function. This selection only affects the averaging after the number of N averages is reached (set using the Averages, Avg Bursts, or Avg Number key).

Exponential averaging SCPI:EXPOnential	When Measure is set at Cont, data acquisitions continue indefinitely. After N averages, exponential averaging is used with a weighting factor of N (the displayed average count stops at N). Exponential averaging weights new data more than old data, which allows tracking of slow-changing signals. The weighting factor N is set
---	---

	using the Averages, Avg Bursts key.
Repeat averaging SCPI:REPeat	When Measure is set at Cont, data acquisitions continue indefinitely. After N averages is reached, all previous result data is cleared and the average count is set back to 1. This is equivalent to being in Measure Single and pressing the Restart key when the Single measurement finishes.

Key Path	Meas Setup
Mode	WLAN
Remote Command	[:SENSe] :PVTime :AVERage :TCONtrol EXPOnential REPeat [:SENSe] :PVTime :AVERage :TCONtrol ?
Example	PVT:AVER:TCON REP PVT:AVER:TCON?
Preset	EXPOnential
State Saved	Saved in instrument state.
Range	Exp Repeat
Initial S/W Revision	A.10.01

Avg Type

Specifies the type of trace and result averaging to use.

This parameter is valid only for Measure Trace.

KEY:Pwr Avg (RMS) SCPI:RMS POWER	True power averaging that is equivalent to taking the RMS value of the voltage. It is the most accurate type of averaging.
KEY:Log-Pwr Avg (Video) SCPI:LOG LPOWER	Simulates the traditional spectrum analyzer type of averaging by averaging the log of the power.

Key Path	Meas Setup
Mode	WLAN
Remote Command	[:SENSe] :PVTime :AVERage :TYPE LOG RMS [:SENSe] :PVTime :AVERage :TYPE ?
Example	PVT:AVER:TYPE LOG PVT:AVER:TYPE?
Preset	RMS
State Saved	Saved in instrument state.
Range	Pwr Avg (RMS) Log-Pwr Avg(Video)
Initial S/W Revision	A.10.01

Burst Time

This parameter specifies the accurate burst length for RF burst to be measured. It is needed to be set as accurate as possible, or the ramp down time may be lost.

Key Path	Meas Setup
Mode	WLAN
Remote Command	<code>[:SENSe] :PVTime:BURSt:TIME <time></code> <code>[:SENSe] :PVTime:BURSt:TIME?</code>
Example	PVT:BURS:TIME 1.0 PVT:BURS:TIME?
Preset	965.455 us (1024bytes, 11M CCK modulation, long preamble)
State Saved	Saved in instrument state.
Min	1.0 us
Max	20.0 ms
Backwards Compatibility SCPI	<code>[:SENSe] :PVTime:BURSt</code>
Initial S/W Revision	A.10.01

Ramp Time Length

This parameter indicates the searching window length from which the ramp on and down is searched. If it is set shorter than actual ramp time, the ramp may be lost.

Key Path	Meas Setup
Mode	WLAN
Remote Command	<code>[:SENSe] :PVTime:RSLength <time></code> <code>[:SENSe] :PVTime:RSLength?</code>
Example	PVT:RSL 1.0 PVT:RSL?
Preset	15.0 us
State Saved	Saved in instrument state.
Min	1.0 us
Max	50.0 us
Backwards Compatibility SCPI	<code>[:SENSe] :PVTime:RTIME</code>
Initial S/W Revision	A.10.01

Limits

Accesses the Limits menu allows you to set up the test limit length for the specified time period. You can define ramp up and ramp down segments. The Fail menu will allow you to set the fail/pass criteria of the limit check

Key Path	Meas Setup
Initial S/W Revision	A.10.01

Max Ramp Down Time

It used as threshold which can judge whether the real measured ramp down time can be passed or not. If real measured ramp down time exceeds Max Ramp Down Time, then ramp down time measurement fails, otherwise, it passes.

Key Path	Meas Setup, Limits
Mode	WLAN
Remote Command	:CALCulate:PVTime:LIMit:RDTime <time> :CALCulate:PVTime:LIMit:RDTime?
Example	CALC:PVT:LIM:RDT 2us CALC:PVT:LIM:RDT?
Preset	2.0us
State Saved	Saved in instrument state.
Min	0.1 us
Max	10.0 us
Backwards Compatibility SCPI	:CALCulate:PVTime:LIMit:DRTime
Initial S/W Revision	A.10.01

Max Ramp Up Time

It used as threshold which can judge whether the real measured ramp up time can be passed or not. If real measured ramp up time exceeds Max Ramp Up Time, then ramp up time measurement fails, otherwise, it passes.

Key Path	Meas Setup, Limits
Mode	WLAN
Remote Command	:CALCulate:PVTime:LIMit:RUTime <time> :CALCulate:PVTime:LIMit:RUTime?
Example	CALC:PVT:LIM:RUT 2us CALC:PVT:LIM:RUT?
Preset	2.0us

State Saved	Saved in instrument state.
Min	0.1 us
Max	10.0 us
Backwards Compatibility SCPI	:CALCulate:PVTime:LIMit:URTime
Initial S/W Revision	A.10.01

Fail

Specifies the fail condition of the limit for the ramp time.

KEY:PowerUp Ramp SCPI:UP	The measurement reports "FAIL" if the ramp up time exceeds the max ramp up time limit.
KEY:Power Down Ramp SCPI:DOWN	The measurement reports "FAIL" if the ramp down time exceeds the max ramp down time limit.
KEY:Both SCPI:BOTH	The measurement reports "FAIL" if both Up and Down fail

Key Path	Meas Setup, Limits
Mode	WLAN
Remote Command	:CALCulate:PVTime:FAIL UP DOWN BOTH :CALCulate:PVTime:FAIL?
Example	CALC:PVT:FAIL UP CALC:PVT:FAIL?
Preset	BOTH
State Saved	Saved in instrument state.
Range	PowerUp Ramp Power Down Ramp Both
Backwards Compatibility SCPI	[:SENSE] :PVTime:LIST:FAIL
Initial S/W Revision	A.10.01

Threshold

Accesses the setup menu to set the thresholds used to find ramp up and ramp down part in burst signal.

Key Path	Meas Setup
Initial S/W Revision	A.10.01

Ramp Up Start Level

It specifies the relative value between ramp up start level and max power level measured in ramp time length.

Key Path	Meas Setup, Threshold
Mode	WLAN
Remote Command	<code>[:SENSe] :PVTime:THReshold:UP:STARt <rel_ampl></code> <code>[:SENSe] :PVTime:THReshold:UP:STARt?</code>
Example	<code>PVT:THR:UP:STAR -50.0</code> <code>PVT:THR:UP:STAR?</code>
Notes	This BWCC command will set the start level of both power-up and power-down at one time. Please note, the unit of the level is percent and they will be converted to dB by 20log.
Preset	-20.000 dB
State Saved	Saved in instrument state.
Min	-120.000 dB
Max	0.000 dB
Backwards Compatibility SCPI	<code>[:SENSe] :PVTime:LIST:LEVel:STARt</code>
Initial S/W Revision	A.10.01

Ramp Up End Level

It specifies the relative value between ramp up end level and max power level measured in ramp time length.

Key Path	Meas Setup, Threshold
Mode	WLAN
Remote Command	<code>[:SENSe] :PVTime:THReshold:UP:STOP <rel_ampl></code> <code>[:SENSe] :PVTime:THReshold:UP:STOP?</code>
Example	<code>PVT:THR:UP:STOP -50.0</code> <code>PVT:THR:UP:STOP?</code>
Notes	This BWCC command will set the start level of both power-up and power-down at one time. Please note, the unit of the level is percent and they will be converted to dB by 20log.
Preset	-0.915 dB
State Saved	Saved in instrument state.
Min	-120.000 dB
Max	0.000 dB
Backwards Compatibility SCPI	<code>[:SENSe] :PVTime:LIST:LEVel:STARt</code>
Initial S/W Revision	A.10.01

Ramp Down Start Level

It specifies the relative value between ramp down start level and max power level measured in ramp time length

Key Path	Meas Setup, Threshold
Mode	WLAN
Remote Command	<code>[:SENSe] :PVTime:THReshold:DOWN:STARt <rel_ampl></code> <code>[:SENSe] :PVTime:THReshold:DOWN:STARt?</code>
Example	<code>PVT:THR:DOWN:STAR -50.0</code> <code>PVT:THR:DOWN:STAR?</code>
Notes	This BWCC command will set the stop level of both power-up and power-down at one time. Please note, the unit of the level is percent and they will be converted to dB by 20log.
Preset	-0.915 dB
State Saved	Saved in instrument state.
Min	-120.000 dB
Max	0.000 dB
Backwards Compatibility SCPI	<code>[:SENSe] :PVTime:LIST:LEVel:END</code>
Initial S/W Revision	A.10.01

Ramp Down End Level

It specifies the relative value between ramp down end level and max power level measured in ramp time length.

Key Path	Meas Setup, Threshold
Mode	WLAN
Remote Command	<code>[:SENSe] :PVTime:THReshold:DOWN:STOP <rel_ampl></code> <code>[:SENSe] :PVTime:THReshold:DOWN:STOP?</code>
Example	<code>PVT:THR:DOWN:STOP -50.0</code> <code>PVT:THR:DOWN:STOP?</code>
Notes	This BWCC command will set the stop level of both power-up and power-down at one time. Please note, the unit of the level is percent and they will be converted to dB by 20log.
Preset	-20.000 dB
State Saved	Saved in instrument state.
Min	-120.000 Db
Max	0.000 dB
Backwards Compatibility SCPI	<code>[:SENSe] :PVTime:LIST:LEVel:END</code>
Initial S/W Revision	A.10.01

IF Gain

Accesses the menu that sets ranging in the digital IF when acquiring an I/Q time record.

See ["More Information about IF Gain" on page 1478](#).

NOTE This function is not affected by RF Input Range attenuation.

Key Path	Meas Setup
Initial S/W Revision	A.10.01

More Information about IF Gain

To take full advantage of the RF dynamic range of the analyzer, you can manually turn on or turn off a switched digital IF amplifier. When it is turned on, the signal will get approximately 10 dB of gain.

- Setting IF Gain to Man and selecting High Gain will turn on the digital IF amplifier and get an extra 10 dB gain.
- Setting IF Gain to Auto will activate the Auto rules for IF Gain.

These settings affect sensitivity and IF overloads.

IF Gain Auto

Activates the Auto Rules for IF Gain. When Auto is active, the IF Gain is set to High Gain under any of the following conditions:

- the input attenuator is set to 0 dB
- the preamp is turned On
- the Max Mixer Level is -20 dBm or lower

For other settings, Auto sets IF Gain to Off.

Key Path	Meas Setup,IF Gain
Mode	WLAN
Remote Command	[:SENSe] :PVTime :IF:GAIN:AUTO [:STATe] ON OFF 1 0 [:SENSe] :PVTime :IF:GAIN:AUTO [:STATe] ?
Example	PVT:IF:GAIN:AUTO ON PVT:IF:GAIN:AUTO?
Couplings	When either the auto attenuation is active (for example, with an electrical attenuator), or the optimize mechanical attenuator range is requested, the IF Gain setting is changed using the following rule. The Auto selection sets IF Gain On under any of the following conditions: <ul style="list-style-type: none"> • the input attenuator is set to 0 dB • the preamp is turned on,

	<ul style="list-style-type: none"> the Max Mixer Level is -20 dBm or lower. For other settings, Auto sets IF Gain to Off.
Preset	OFF
State Saved	Saved in instrument state.
Range	Auto Man
Initial S/W Revision	A.10.01

IF Gain State

Selects the range of IF gain.

- On sets the high gain option, which allows for better noise level measurements.
- Off sets low gain when measuring large signals.

When this parameter is changed manually from front panel, IF Gain Auto will become Man.

Key Path	Meas Setup, IF Gain
Mode	WLAN
Remote Command	[:SENSe]:PVTIme:IF:GAIN[:STATe] ON OFF 1 0 [:SENSe]:PVTIme:IF:GAIN[:STATe]?
Example	PVT:IF:GAIN ON PVT:IF:GAIN?
Notes	where ON = high gain OFF = low gain
Preset	OFF
State Saved	Saved in instrument state.
Range	Low Gain (Best for Large Signals) High Gain (Best Noise Level)
Readback Text	Low Gain High Gain
Initial S/W Revision	A.10.01

Meas Preset

Returns parameters for the current measurement to those set by the factory.

Key Path	Meas Setup, More
Mode	WLAN
Remote Command	:CONFigure:PVTIme
Example	CONF:PVT
Initial S/W Revision	A.10.01

Mode

See "[Mode](#)" on page 288

Mode Preset

Returns the active mode to a known state.

Mode Preset does the following for the currently active mode:

- Aborts the currently running measurement.
- Brings up the default menu for the mode, with no active function.
- Sets measurement Global settings to their preset values for the active mode only.
- Activates the default measurement.
- Brings up the default menu for the mode.
- Clears the input and output buffers.
- Sets Status Byte to 0.

Mode Preset does not:

- Cause a mode switch
- Affect mode persistent settings
- Affect system settings
- See "[How-To Preset](#)" on page 1482 for more information.

Key Path	Front-panel key
Remote Command	:SYSTem:PRESet
Example	:SYST:PRES
Notes	*RST is preferred over :SYST:PRES for remote operation. *RST does a Mode Preset, as done by the :SYST:PRES command, and it sets the measurement mode to Single measurement rather than Continuous for optimal remote control throughput. Clears all pending OPC bits. The Status Byte is set to 0.
Couplings	A Mode Preset aborts the currently running measurement, activates the default measurement, and gets the mode to a consistent state with all of the default couplings set.
Backwards Compatibility Notes	In the X-Series, the legacy "Factory Preset" has been replaced with Mode Preset, which only presets the currently active mode, not the entire instrument. In the X-Series, the way to preset the entire instrument is by using System, Restore System Defaults All, which behaves essentially the same way as restore System Defaults does on ESA and PSA. There is also no "Preset Type" as there is on the PSA. There is a green Mode Preset front-panel key that does a Mode Preset and a white-with-green-letters User Preset front-panel key that does a User Preset. The old PRESet:TYPE command is ignored (without generating an error), and SYST:PRES without a parameter does a Mode Preset, which should cover most backward code compatibility issues. The settings and correction data under the Input/Output front-panel key (examples: Input Z Corr, Ext Amp Gain, etc.) are no longer part of any Mode, so they will not be preset by a Mode Preset. They are preset using Restore Input/Output Defaults, Restore System Defaults All. Note that because User Preset does a Recall State, and all of these settings are saved in State, they ARE recalled when using

	User Preset.
Initial S/W Revision	Prior to A.02.00

How-To Preset

The table below shows all possible presets, their corresponding SCPI commands and front-panel access (key paths). Instrument settings depend on the current measurement context. Some settings are local to the current measurement, some are global (common) across all the measurements in the current mode, and some are global to all the available modes. In a similar way, restoring the settings to their preset state can be done within the different contexts.

Auto Couple - is a measurement local key. It sets all Auto/Man parameter couplings in the measurement to Auto. Any Auto/Man selection that is local to other measurements in the mode will not be affected.

Meas Preset - is a measurement local key. Meas Preset resets all the variables local to the current measurement except the persistent ones.

Mode Preset - resets all the current mode's measurement local and measurement global variables except the persistent ones.

Restore Mode Defaults - resets ALL the Mode variables (and all the Meas global and Meas local variables), including the persistent ones.

Type Of Preset	SCPI Command	Front Panel Access
Auto Couple	:COUPle ALL	Auto Couple front-panel key
Meas Preset	:CONFigure:<Measurement>	Meas Setup Menu
Mode Preset	:SYSTem:PRESet	Mode Preset (green key)
Restore Mode Defaults	:INSTrument:DEFault	Mode Setup Menu
Restore All Mode Defaults	:SYSTem:DEFault MODes	System Menu; Restore System Default Menu
*RST	*RST	not possible (Mode Preset with Single)
Restore Input/Output Defaults	:SYSTem:DEFault INPUt	System Menu; Restore System Default Menu
Restore Power On Defaults	:SYSTem:DEFault PON	System Menu; Restore System Default Menu
Restore Alignment Defaults	:SYSTem:DEFault ALIGN	System Menu; Restore System Default Menu
Restore Miscellaneous Defaults	:SYSTem:DEFault MISC	System Menu; Restore System Default Menu
Restore All System Defaults	:SYSTem:DEFault [ALL] :SYSTem:PRESet:PERsistent	System Menu; Restore System Default Menu
User Preset	:SYSTem:PRESet:USER	User Preset Menu
User Preset All Modes	:SYSTem:PRESet:USER:ALL	User Preset Menu

Power On Mode Preset	:SYSTem:PON:TYPE MODE	System Menu
Power On User Preset	:SYSTem:PON:TYPE USER	System Menu
Power On Last State	:SYSTem:PON:TYPE LAST	System Menu

Mode Setup

See "[Mode Setup](#)" on page 320

Peak Search

Places the selected marker on the trace point with the maximum y-axis value for that marker's trace. Pressing Peak Search with the selected marker off causes the selected marker to be set to Normal, then a peak search is immediately performed.

Key Path	Front-panel key
Mode	LTETDD, LTE,, LTEATDD, LTEAFDD
Remote Command	:CALCulate:PVTime:MARKer[1] 2 ... 12:MAXimum
Example	CALC:PVT:MARK2:MAX
Initial S/W Revision	A.03.00

13 Power vs. Time Measurement Overview
Print

Print

See ["Print" on page 352](#)

Properties

Accesses a menu that allows you to set marker properties and to access the marker trace menu.

Key Path	Marker
Initial S/W Revision	A.03.00

Quick Save

The Quick Save front-panel key repeats the most recent save that was performed from the Save menu, with the following exceptions:

- Register saves are not remembered as Saves for the purpose of the Quick Save function
- If the current measurement does not support the last non-register save that was performed, an informational message is generated, “File type not supported for this measurement”

Quick Save repeats the last type of qualified save (that is, a save qualified by the above criteria) in the last save directory by creating a unique filename using the Auto File Naming algorithm described below.

If Quick Save is pressed after startup and before any qualified Save has been performed, the Quick Save function performs a Screen Image save using the current settings for Screen Image saves (current theme, current directory), which then becomes the “last save” for the purpose of subsequent Quick Saves.

The Auto File Naming feature automatically generates a file name for use when saving a file. The filename consists of a prefix and suffix separated by a dot, as is standard for the Windows® file system. A default prefix exists for each of the available file types:

Type	Default Prefix	Menu
State	State_	(Save/Recall)
Trace + State	State_	(Save/Recall)
Screen	Screen_	(Save/Recall)
Amplitude Corrections	Ampcor_	(Import/Export)
Traces	Trace_	(Import/Export)
Limit Lines	LLine_	(Import/Export)
Measurement Result	MeasR_	(Import/Export)
Capture Buffer	CapBuf_	(Import/Export)

A four digit number is appended to the prefix to create a unique file name. The numbering sequence starts at 0000 within each Mode for each file type and updates incrementally to 9999, then wraps to 0000 again. It remembers where it was through a Mode Preset and when leaving and returning to the Mode. It is reset by Restore Misc Defaults and Restore System Defaults and subsequent running of the instrument application. So, for example, the first auto file name generated for State files is State_0000.state. The next is State_0001, and so forth.

One of the key features of Auto File Name is that we guarantee that the Auto File Name will never conflict with an existing file. The algorithm looks for the next available number. If it gets to 9999, then it looks for holes. If it find no holes, that is no more numbers are available, it gives an error.

For example, if when we get to State_0010.state there is already a State_0010.state file in the current directory, it advances the counter to State_0011.state to ensure that no conflict will exist (and then it verifies that State_0011.state also does not exist in the current directory and advances again if it does, and so forth).

If you enter a file name for a given file type, then the prefix becomes the filename you entered instead of the default prefix, followed by an underscore. The last four letters (the suffix) are the 4-digit number.

For example, if you save a measurement results file as “fred.csv”, then the next auto file name chosen for a measurement results save will be fred_0000.csv.

NOTE Although 0000 is used in the example above, the number that is used is actually the current number in the Meas Results sequence, that is, the number that would have been used if you had not entered your own file name.

NOTE If the filename you entered ends with _dddd, where d=any number, making it look just like an auto file name, then the next auto file name picks up where you left off with the suffix being dddd + 1.

Key Path	Front-panel key
Notes	No remote command for this key specifically.
Initial S/W Revision	Prior to A.02.00

Recall

The Recall menu lets you choose what you want to recall, and where you want to recall it from. Among the types of files you can recall are **States and Traces**. In addition, an Import (Data) option lets you recall a number of data types stored in CSV files (as used by Excel and other spreadsheet programs).

The default paths for Recall are data type dependent and are the same as for the Save key.

Key Path	Front-panel key
Notes	<p>No remote command for this key specifically, but the :MMEM:LOAD command is available for specific file types. An example is :MMEM:LOAD:STATe <filename>.</p> <p>If you try to recall a State file for a mode that is not licensed or not available in the instrument, an error message will occur and the state will not change.</p>
Backwards Compatibility Notes	<p>In legacy analyzers, it was possible to load a state without affecting the trace data, limit lines or correction data. Similarly (since User Preset is actually loading a state), it was possible to do a User Preset without affecting the trace data, limit lines or correction data.</p> <p>In the X-Series, "state" always includes all of this data; so whenever state is loaded, all of the traces, limit lines and corrections are affected. Although this differs from previous behavior, it is desirable behavior, and should not cause adverse issues for users.</p>
Backwards Compatibility Notes	<p>Recall for the X-Series supports backward compatibility in the sense that you can recall a state file from any X-Series model number and any version of X-Series software. This is only possible if part of the recalling process goes through a limiting step after recalling the mode settings, at least for settings that may vary with version number, model number, option and license differences. If you try to recall a state file onto an instrument with less capability than what was available on the instrument during the save, the recall will ignore the state it doesn't support and it will limit the recalled setting to what it allows.</p> <p>Example: if the saved state includes preamp ON, but the recalling instrument does not have a preamp; the preamp is limited to OFF. Conversely, if you save a state without a preamp, the preamp is OFF in the state file. When this saved file is recalled on an instrument with a licensed preamp, the preamp is changed to OFF. Another example is if the saved state has center frequency set to 20 GHz, but the instrument recalling the saved state is a different model and only supports 13.5 GHz. In this case, the center frequency is limited along with any other frequency based settings. Since the center frequency can't be preserved in this case, the recall limiting tries to at least preserve span to keep the measurement setup as intact as possible.</p> <p>It may be appropriate to issue a warning if the state is limited on the recall; warnings do not go out to SCPI so this would only affect the manual user.</p> <p>Note that there is no state file compatibility outside of the X-Series. For example, you cannot recall a state file from ESA or PSA.</p>
Initial S/W Revision	Prior to A.02.00

State

The Recall State menu lets you choose a register or file from which to recall the state.

The content of a state file includes all of the settings and data required to return the analyzer as closely as possible to the Mode it was in, with the exact settings that were in place, when the save occurred. The Mode settings in each state file include the settings that are affected by Mode Preset, as well as the

additional settings affected by Restore Mode Defaults; all of the Mode’s settings. In addition, all of the settings of the Input/Output system are included, even though they are outside of the Mode’s state, because they are needed to restore the complete setup. Persistent System settings (for example, GPIB address) are not affected by either a Mode Preset or Restore Mode Defaults, nor are they included in a saved State file.

Since each state file is only for one Mode, the settings for other Modes are unaffected when it is loaded. Recall State will cause a mode switch if the state being recalled is not from the current active mode.

After the recall completes, the message "File <filename> recalled" or “Recalled State Register <register number>” is displayed.

For rapid recalls, the State menu lists 16 registers that you can choose from to recall. Pressing a Register key initiates the recall. You can also select a file from which to recall.

The default path for all State Files is:

My Documents\<<mode name>\state

where <mode name> is the parameter used to select the mode with the INST:SEL command (for example, SA for the Spectrum Analyzer).

See "[More Information](#)" on page 1492.

Key Path	Recall
Mode	All
Remote Command	:MMEMory:LOAD:STATe <filename>
Example	:MMEM:LOAD:STAT "myState.state" This recalls the file myState.state on the default path
Example	MMEM:LOAD:STAT "MyStateFile.state" This loads the state file data (on the default file directory path) into the instrument state.
Notes	<p>When you pick a file to recall, the analyzer first verifies that the file is recallable in the current instrument by checking the software version and model number of the instrument. If everything matches, a full recall proceeds by aborting the currently running measurement, clearing any pending operations, and then loading the State from the saved state file. You can open state files from any mode, so recalling a State file switches to the mode that was active when the save occurred. After switching to the mode of the saved state file, mode settings and data (if any for the mode) are loaded with values from the saved file. The saved measurement of the mode becomes the newly active measurement and the data relevant to the measurement (if there is any) is recalled.</p> <ul style="list-style-type: none"> • If there is a mismatch between file version or model number or instrument version or model number, the recall function tries to recall as much as possible and returns a warning message. It may limit settings that differ based on model number, licensing or version number. <p>After recalling the state, the Recall State function does the following:</p> <ul style="list-style-type: none"> • Makes the saved measurement for the mode the active measurement. • Clears the input and output buffers. • Status Byte is set to 0. • Executes a *CLS <p>If the file specified is empty an error is generated. If the specified file does not exist, another error is generated. If there is a mismatch between the file and the proper file type, an error is generated. If</p>

	there is a mismatch between file version or model number or instrument version or model number, a warning is displayed. Then it returns to the State menu and File Open dialog goes away. After the Recall, the analyzer exits the Recall menu and returns to the previous menu.
Backwards Compatibility SCPI	:MMEMory:LOAD:STATe 1,<filename> For backwards compatibility, the above syntax is supported. The "1" is simply ignored.
Initial S/W Revision	Prior to A.02.00

More Information

In measurements that support saving Traces, for example, Swept SA, the Trace data is saved along with the State in the State file. When recalling the State, the Trace data is recalled as well. Traces are recalled exactly as they were stored, including the writing mode and update and display modes. If a Trace was updating and visible when the State was saved, it will come back updating and visible, and its data will be rewritten right away. When you use State to save and recall traces, any trace whose data must be preserved should be placed in View or Blank mode before saving.

The following table describes the Trace Save and Recall possibilities:

You want to recall state and one trace's data, leaving other traces unaffected.	Save Trace+State from 1 trace. Make sure that no other traces are updating (they should all be in View or Blank mode) when the save is performed.	On Recall, specify the trace you want to load the one trace's data into. This trace will load in View. All other traces' data will be unaffected, although their trace mode will be as it was when the state save was performed.
You want to recall all traces	Save Trace+State from ALL traces.	On Recall, all traces will come back in View (or Blank if they were in Blank or Background when saved)
You want all traces to load exactly as they were when saved.	Save State	On recall, all traces' mode and data will be exactly as they were when saved. Any traces that were updating will have their data immediately overwritten.

From File...

When you press "From File", the analyzer brings up a Windows dialog and a menu entitled "File Open." This menu allows you to navigate to the various fields in the Windows dialog without using a keyboard or mouse. The Tab and Arrow keys can also be used for dialog navigation.



Listed below are the functions of the various fields in the dialog, and the corresponding softkeys:

Open

Performs the recall of the specified file. While the recall is being performed, the floppy icon appears briefly in the Meas bar.

File/Folder List

Enables you to navigate to the center of the dialog that contains the list of files and folders. Once here you can get information about the file and use the tab keys to navigate to the other fields in the dialog, such as Look In.

Look In

The Look In field shows the path from which the file will be recalled and allows you to change the path using the up and down arrow keys to navigate to other paths; the Enter key to open a directory; and the Backspace key to go back one directory. The **Look In field** first uses the last path from the Save As dialog **Save In:** path for that same file type. There is no softkey for directly navigating to the Look In field, but you can use the left tab to get here from the File/Folder List.

User specified paths are remembered when you leave and return to a Mode and are reset back to the default using Restore Mode Defaults.

Sort

Accesses a menu that enables you to sort the files within the File Open dialog. Only one sorting type can be selected at a time and the sorting happens immediately. The sorting types are By Date, By Name, By extension, and By Size.

Files of Type

This field shows the file suffix for the type of file you have selected to recall. For example, if you navigated here while recalling State, "Mode state (*.state)" is in the field. If you navigated here while recalling Trace, ""Mode state (*.trace)" is in the field. If you navigated here while importing a trace data file, "Trace Data (*.csv)" is in the field. For some file types, there is more than one choice in the dropdown menu, which you can select by using the up and down arrow keys and Enter.

Up One Level

This key corresponds to the icon of a folder with the up arrow that is in the tool bar of the dialog. When pressed, it causes the file and folder list to navigate up one level in the directory structure. The Backspace key does the same thing.

Cancel

This key corresponds to the Cancel selection in the dialog. It causes the current **Open** request to be cancelled. The ESC key does the same thing.

Key Path	Recall, State
Notes	Brings up the Open dialog for recalling a State Save Type
Initial S/W Revision	Prior to A.02.00

Edit Register Names

You may enter a custom name on any of the Register keys, to help you remember what you are using that state to save. To do this, press the Edit Register Names key, choose the register whose name you wish to edit, and then enter the desired label using the Alpha Editor or an external PC keyboard.

The maximum number of characters that can be added is 30. In most cases, 30 characters will fit on two lines of the key.

For more information and the SCPI command, see Edit Register Names under the Save, State function.

Key Path	Recall, State
Mode	All
Dependencies	N9060A-7FP or N9060B-2FP license required to edit the register names. When the feature is not licensed, sending the SCPI command generates an error, -221, "Settings conflict;Option not available"
Initial S/W Revision	A.11.00

Register 1 thru Register 16

Selecting any one of these register keys causes the State of the mode from the specified Register to be recalled. Each of the register keys annotates whether it is empty or at what date and time it was last

modified. In addition, you can use the Edit Register Names key under Save, State to enter custom names for each register.

Registers are shared by all modes, so recalling from any one of the registers will cause a mode switch to the mode that was active when the save to the Register occurred.

Although these 16 registers are the only registers available from the front panel, there are 128 state registers available in the instrument. Registers 17–128 are only available from the SCPI interface, using the *RCL command.

After the recall completes, the message "Register <register number> recalled" appears in the message bar. If you are in the Spectrum Analyzer Mode, and you are recalling a register that was saved in the Spectrum Analyzer Mode, then after the recall, you will still be in the Recall Register menu. If the Recall causes you to switch modes, then after the Recall, you will be in the Frequency menu.

If a requested register is empty an error is generated.

Key Path	Recall, State
Example	*RCL 1
Range	1–16 from front panel, 1–128 from SCPI
Readback	Date and time with seconds resolution are displayed on the key OR A custom name of up to 30 characters entered using the Save, State, Edit Register Names key OR “(empty)” if no prior save operation has been performed to this register.
Initial S/W Revision	Prior to A.02.00
Modified at S/W Revision	Prior to A.11.00

Register 1 thru Register 16

Selecting any one of these register keys causes the State of the mode from the specified Register to be recalled. Each of the register keys annotates whether it is empty or at what date and time it was last modified. In addition, you can use the Edit Register Names key under Save, State to enter custom names for each register.

Registers are shared by all modes, so recalling from any one of the registers will cause a mode switch to the mode that was active when the save to the Register occurred.

Although these 16 registers are the only registers available from the front panel, there are 128 state registers available in the instrument. Registers 17–128 are only available from the SCPI interface, using the *RCL command.

After the recall completes, the message "Register <register number> recalled" appears in the message bar. If you are in the Spectrum Analyzer Mode, and you are recalling a register that was saved in the Spectrum Analyzer Mode, then after the recall, you will still be in the Recall Register menu. If the Recall causes you to switch modes, then after the Recall, you will be in the Frequency menu.

If a requested register is empty an error is generated.

Key Path	Recall, State
Example	*RCL 1
Range	1-16 from front panel, 1-128 from SCPI
Readback	Date and time with seconds resolution are displayed on the key OR A custom name of up to 30 characters entered using the Save, State, Edit Register Names key OR "(empty)" if no prior save operation has been performed to this register.
Initial S/W Revision	Prior to A.02.00
Modified at S/W Revision	Prior to A.11.00

Data (Import)

Importing a data file loads data that was previously saved from the current measurement or from other measurements and/or modes that produce compatible data files. The Import Menu only contains Data Types that are supported by the current measurement.

Since the commonly exported data files are in .csv format, the data can be edited by the user prior to importing. This allows you to export a data file, manipulate the data in Excel (the most common PC Application for manipulating .csv files) and then import it.

Importing Data loads measurement data from the specified file into the specified or default destination, depending on the data type selected. Selecting an Import Data menu key will not actually cause the importing to occur, since the analyzer still needs to know from where to get the data. Pressing the Open key in this menu brings up the Open dialog and Open menu that provides you with the options from where to recall the data. Once a filename has been selected or entered in the Open menu, the recall occurs as soon as the Open button is pressed.

Key Path	Recall
Mode	All
Notes	The menu is built from whatever data types are available for the mode. Some keys will be missing completely, so the key locations in the sub-menu will vary. No SCPI command directly controls the Data Type that this key controls. The Data Type is included in the MMEM:LOAD commands.
Dependencies	If a file type is not used by a certain measurement, it is grayed out for that measurement. The key for a file type will not show at all if there are no measurements in the Mode that support it.
Preset	Is not affected by Preset or shutdown, but is reset during Restore Mode Defaults
Readback	The data type that is currently selected
Initial S/W Revision	Prior to A.02.00

Masks

This key enables you to recall a preset mask file from the list. It is only available in SEM measurement under the Data menu: Limit Mask. Limit Mask enables setting a preset limit mask for 802.11p 5MHz and 10MHz system.

You cannot change or create the preset mask file since it is a binary file. This key is valid for the Spectrum Emission Mask measurement.

File location: "My Documents\WLAN\data.masks"

Note that "**My Documents**" is an alias to a directory and its location depends on which user is logged in. At XSA start up, all of the limit mask files in the current user's "My Documents\WLAN\data.masks" directory are overwritten.

File type: Binary

Filename:

11p_5MHz_A.mask

11p_5MHz_B.mask

11p_5MHz_C.mask

11p_5MHz_D.mask

11p_10MHz_A.mask

11p_10MHz_B.mask

11p_10MHz_C.mask

11p_10MHz_D.mask

File extension: .mask

Selecting OPEN under the Import Data menu, opens the above directory enabling you to select a mask file.

Example:

File Location: My Documents/WLAN/data/masks

File Name: 11p_5MHz_A.mask

Key Path	Recall, Data
Mode	WLAN
Remote Command	MMEMory:LOAD:MASK <string>
Example	MMEM:LOAD:MASK "11p_5MHz_A.mask"
Initial S/W Revision	A.11.00

Capture Buffer

Capture buffer functionality is only available when measurement is Mod Accuracy and radio standard is not 802.11ac 80+80MHz. The captured data is raw data which is not processed.

Key Path	Recall, Data
Mode	WLAN
Example	MMEM:LOAD:CAPT "MyCaptureData.bin" This loads the file of capture data (on the default file directory path) into the instrument.
Dependencies	Capture buffer data is only available when measurement is Mod Accuracy and radio standard is not 802.11ac 80+80MHz. In other situation, this key is grayed out.
Initial S/W Revision	A.11.00

Open...

When you press "Open", the analyzer brings up a Windows dialog and a menu entitled "File Open." This menu allows you to navigate to the various fields in the Windows dialog without using a keyboard or mouse. The Tab and Arrow keys can also be used for dialog navigation.

See "[From File...](#)" on page 2263 in Recall, State, for a full description of this dialog and menu.

Key Path	Recall, Data
Notes	The key location is mode-dependent and will vary. Brings up Open dialog for recalling a <mode specific> Save Type
Initial S/W Revision	Prior to A.02.00

Restart

The Restart function restarts the current sweep, or measurement, or set of averaged/held sweeps or measurements. If you are Paused, pressing Restart does a Resume.

The Restart function is accessed in several ways:

- Pressing the Restart key
- Sending the remote command INIT:IMMEDIATE
- Sending the remote command INIT:RESTART

See "[More Information](#)" on page 1499

Key Path	Front-panel key
Remote Command	:INITiate[:IMMEDIATE] :INITiate:RESTART
Example	:INIT:IMM :INIT:REST
Notes	:INITiate:RESTART and :INITiate:IMMEDIATE perform exactly the same function.
Couplings	Resets average/hold count k. For the first sweep overwrites all active (update=on) traces with new current data. For application modes, it resets other parameters as required by the measurement.
Status Bits/OPC dependencies	This is an Overlapped command. The STATUS:OPERation register bits 0 through 8 are cleared. The STATUS:QUESTIONable register bit 9 (INTEgrity sum) is cleared. The SWEEPING bit is set. The MEASURING bit is set.
Backwards Compatibility Notes	For Spectrum Analysis mode in ESA and PSA, the Restart hardkey and the INITiate:RESTART command restart trace averages (displayed average count reset to 1) for a trace in Clear Write, but did not restart Max Hold and Min Hold. In the X-Series, the Restart hardkey and the INITiate:RESTART command restart not only Trace Average, but MaxHold and MinHold traces as well. For wireless comms modes in ESA and PSA, the Restart hardkey and the INITiate:RESTART command restart every measurement, which includes all traces and numeric results. There is no change to this operation.
Initial S/W Revision	Prior to A.02.00

More Information

The **Restart** function first aborts the current sweep/measurement as quickly as possible. It then resets the sweep and trigger systems, sets up the measurement and initiates a new data measurement sequence with a new data acquisition (sweep) taken once the trigger condition is met.

If the analyzer is in the process of aligning when **Restart** is executed, the alignment finishes before the restart function is performed.

Even when set for Single operation, multiple sweeps may be taken when Restart is pressed (for example, when averaging/holding is on). Thus when we say that **Restart** "restarts a measurement," we may mean:

- It restarts the current sweep
- It restarts the current measurement
- It restarts the current set of sweeps if any trace is in Trace Average, Max Hold or Min Hold
- It restarts the current set of measurements if Averaging, or Max Hold, or Min Hold is on for the measurement
- depending on the current settings.

With **Average/Hold Number** (in **Meas Setup** menu) set to 1, or Averaging off, or no trace in Trace Average or Hold, a single sweep is equivalent to a single measurement. A single sweep is taken after the trigger condition is met; and the analyzer stops sweeping once that sweep has completed. However, with **Average/Hold Number** >1 and at least one trace set to **Trace Average, Max Hold, or Min Hold (SA Measurement)** or **Averaging on (most other measurements)**, multiple sweeps/data acquisitions are taken for a single measurement. The trigger condition must be met prior to each sweep. The sweep is stopped when the average count k equals the number N set for **Average/Hold Number**. A measurement average usually applies to all traces, marker results, and numeric results; but sometimes it only applies to the numeric results.

Once the full set of sweeps has been taken, the analyzer will go to idle state. To take one more sweep without resetting the average count, increment the average count by 1, by pressing the step up key while **Average/Hold Number** is the active function, or sending the remote command `CALC:AVER:TCON UP`.

Save

The Save menu lets you choose what you want to save and where you want to save it. Among the types of files you can save are **States**, **Traces**, and **Screen Images**. In addition, an Export (Data) option lets you save a number of data types as CSV files for easy import into Excel and other spreadsheet programs.

Key Path	Front-panel key
Mode	All
Notes	No remote command for this key specifically, but the :MMEM:STORe command is available for specific file types. An example is :MMEM:STOR:STATe <filename>.
Initial S/W Revision	Prior to A.02.00

State

The Save State menu lets you choose a register or file for saving the state.

The content of a state file includes all of the settings and data required to return the analyzer as closely as possible to the Mode it was in, with the exact settings which were in place, when the save occurred. The Mode settings in each state file include the settings that are affected by Mode Preset, as well as the additional settings affected by Restore Mode Defaults; all of the Mode's settings. In addition, all of the settings of the Input/Output system are included, even though they are outside of the Mode's state, because they are needed to restore the complete setup. Persistent System settings (for example, Verbose SCPI) are not affected by either Mode Preset or Restore Mode Defaults, nor are they included in a saved State file.

After the save completes, the message "File <filename> saved" or "State Register <register number> saved" is displayed.

For rapid saving, the State menu lists 16 registers to save to. Pressing a Register key initiates the save. You can also select a file to save to.

The default path for all State Files is:

My Documents\<<mode name>\state

where <mode name> is the parameter used to select the mode with the INST:SEL command (for example, SA for the Spectrum Analyzer).

Key Path	Save
Mode	All
Remote Command	:MMEMory:STORe:STATe <filename>
Example	MMEM:STOR:STATe "MyStateFile.state" This stores the current instrument state data in the file MyStateFile.state in the default directory.
Notes	Both single and double quotes are supported for any filename parameter over remote. After saving to a register, that register's menu key is updated with the date the time, unless a custom label has been entered for that key. After saving to a register, you remain in the Save State menu, so that you can see the Register key

update. After saving to a file, the analyzer automatically returns to the previous menu and any Save As dialog goes away.

Backwards Compatibility SCPI :MMEMory:STORe:STATe 1,<filename>

For backwards compatibility, the above syntax is supported. The "1" is simply ignored. The command is sequential.

Initial S/W Revision Prior to A.02.00

To File . . .

When you press “To File”, the analyzer brings up a Windows dialog and a menu entitled “Save As.” This menu allows you to navigate to the various fields in the Windows dialog without using a keyboard or mouse. The Tab and Arrow keys can also be used for dialog navigation.

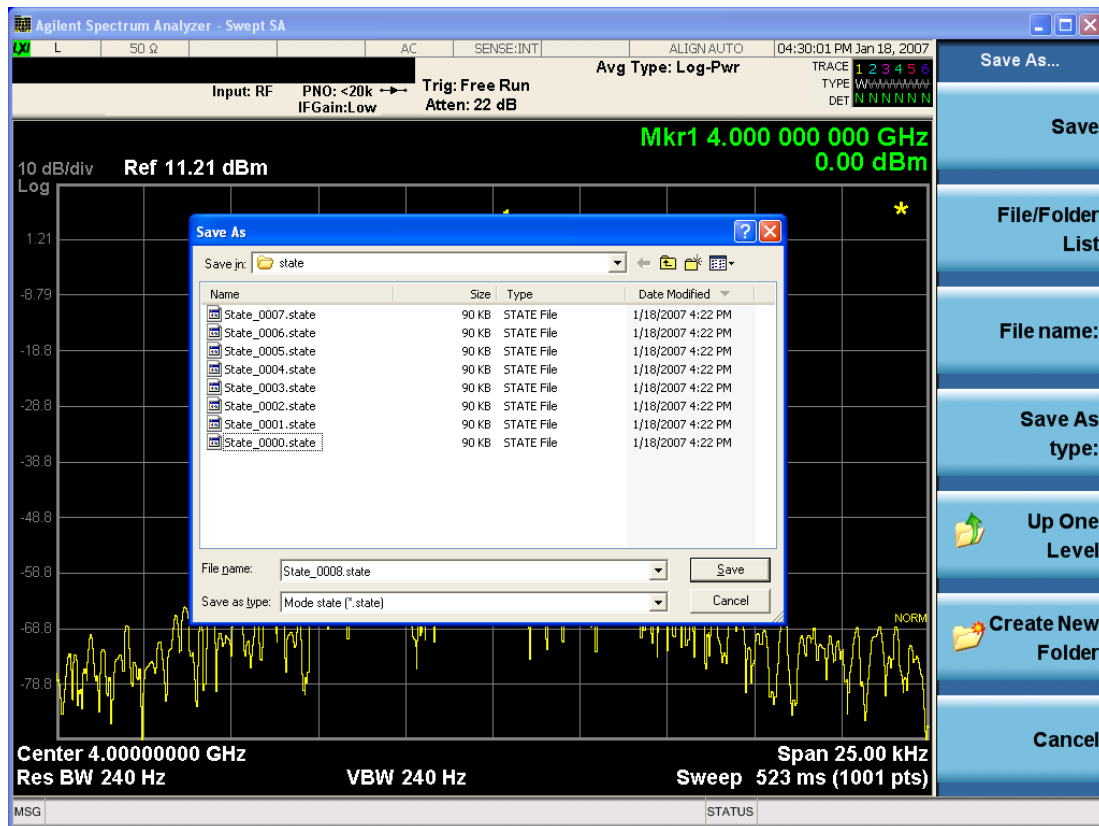

The Listed below

are the functions of the various fields in the dialog, and the corresponding softkeys:

Save

Performs the save to the specified file of the selected type. If the file already exists, a dialog will appear that allows you to replace the existing file by selecting OK, or you can Cancel the request. If you select OK, the file will be overwritten. Using the C: drive is strongly discouraged, since it runs the risk of being overwritten during an instrument software upgrade.

While the save is being performed, the floppy icon appears briefly in the Meas bar.

File/Folder List

Enables you to navigate to the center of the dialog that contains the list of files and folders. Once here you can get information about the file and use the tab keys to navigate to the other fields in the dialog, such as Save In.

Save In

The Save In field shows the path to which the file will be saved and allows you to change the path using the up and down arrow keys to navigate to other paths; the Enter key to open a directory; and the Backspace key to go back one directory. The **Save In field** defaults to the default path for this type of file and remembers the last path you used to save this type of file. There is no softkey for directly navigating to the Save In field but you can use left tab to get here from the File/Folder List.

User specified paths are remembered when you leave and return to a Mode and are reset back to the default using Restore Mode Defaults.

File Name

The File Name field is initially loaded with an automatically generated filename specific to the appropriate Save Type. The automatically generated filename is guaranteed not to conflict with any filename currently in the directory. You may replace or modify this filename using the File Name key. See the ["Quick Save " on page 2259](#) documentation for more on the automatic file naming algorithm.

When you press the File Name key the analyzer displays the Alpha Editor. Use the knob to choose the letter to add and the front-panel Enter key to add the letter to the file name. The BK character moves you back and the FW character moves you forward in the filename. The Select key on the front panel generates a space character. When you are done entering the filename press the Done softkey. This returns back to the **File Open** dialog and menu, but does not cause the save to occur.

Save As Type

This field shows the file suffix for the type of file you have selected to save. For example, if you navigated here while saving State, "Mode state (*.state)" is in the field. If you navigated here from saving Trace, ""Mode state (*.trace)" is in the field. If you navigated here while exporting a trace data file, "Trace Data (*.csv)" is in the field. For some file types, there is more than one choice in the dropdown, which you can select by using the up and down arrow keys and Enter.

Up One Level

This key corresponds to the icon of a folder with the up arrow that is in the tool bar of the dialog. When pressed, it causes the file and folder list to navigate up one level in the directory structure. The Backspace key does the same thing.

Create New Folder

This key corresponds to the icon of a folder with the "*" that is in the tool bar of the dialog. When pressed, a new folder is created in the current directory with the name **New Folder** and you can enter a new folder name using the Alpha Editor.

Cancel

This key corresponds to the Cancel selection in the dialog. It causes the current **Save As** request to be cancelled. The ESC key does the same thing.

Key Path	Save, State
Mode	All
Notes	Brings up Save As dialog for saving a State Save Type
Initial S/W Revision	Prior to A.02.00

Edit Register Names

You may enter a custom name on any of the Register keys, to help you remember what you are using that state to save. To do this, press the Edit Register Names key, choose the register whose name you wish to edit, and then enter the desired label using the Alpha Editor or an external PC keyboard.

The maximum number of characters that can be added is 30. In most cases, 30 characters will fit on two lines of the key.

See ["More Information" on page 1504](#)

Key Path	Save, State
Mode	All
Remote Command	:MMEMory:REGister:STATe:LABel <reg number>,"label" :MMEMory:REGister:STATe:LABel? <reg number>
Example	:MMEM:REG:STAT:LAB 1,"my label"
Notes	<reg number> is an integer from 1 to 16. If the SCPI specifies an invalid register number an error message is generated, -222,"Data out of range;Invalid register label number" "label" is a string from 0 to 30 characters in length. If a label exceeds 30 characters, an error message is generated, -150,"String data error;Label clipped to 30 characters" "label" of length 0 erases the custom label and restores the default (time and date) label. E.g.: :MMEM:REG:STAT:LAB 1,""
Dependencies	N9060A-7FP or N9060B-2FP license required to edit the register names. When the feature is not licensed, sending this command generates an error, -221,"Settings conflict;Option not available"
Preset	The names are unaffected by Preset or power cycle but are set to the default label (time and date) on a "Restore System Defaults->Misc"
Initial S/W Revision	A.11.00

More Information

When you edit one of the register names, the time and date field will be replaced by the custom name.

If you delete all the characters in the custom name, it restores the default (time and date).

The register names are stored within the state files, but they are not part of the instrument state; that is, once you have edited a register name, loading a new state will not change that register name. Another consequence of this is that the names will be persistent through a power cycle. Also, if a named state file is transferred to another analyzer, it will bring its custom name along with it.

If you try to edit the name of an empty register, the analyzer will first save the state to have a file to put the name in. If you load a named state file into an analyzer with older firmware it will ignore the metadata.

The *SAV and *RCL commands will not be affected by the custom register names, nor will the MMEM commands.

Register 1 thru Register 16

Selecting any one of these register menu keys causes the State of the currently active mode to be saved to the specified Register. The registers are provided for rapid saving and recalling, since you do not need to specify a filename or navigate to a file. Each of the register menu keys annotates whether it is empty or at what date and time it was last modified. In addition, you can use the Edit Register Names key to enter custom names for each register.

Although these 16 registers are the only registers available from the front panel, there are 128 state registers available in the instrument. Registers 17–128 are only available from the SCPI interface, using the *SAV command.

There is one set of 128 state registers in the instrument, not one set for each Mode. When a state is saved, the Mode it was saved from is saved with it; then when it is recalled, the instrument switches to that Mode.

After the save completes, the corresponding register menu key annotation is updated with the date and time and the message "Register <register number> saved" is displayed.

Key Path	Save, State
Mode	All
Example	*SAV 1
Range	1–16 from front panel, 1–128 from SCPI
Readback	Date and time with seconds resolution are displayed on the key OR A custom name of up to 30 characters entered using the Edit Register Names key OR “(empty)” if no prior save operation has been performed to this register.
Initial S/W Revision	Prior to A.02.00
Modified at S/W Revision	A.11.00

Register 1 thru Register 16

Selecting any one of these register menu keys causes the State of the currently active mode to be saved to the specified Register. The registers are provided for rapid saving and recalling, since you do not need to specify a filename or navigate to a file. Each of the register menu keys annotates whether it is empty or at what date and time it was last modified. In addition, you can use the Edit Register Names key to enter custom names for each register.

Although these 16 registers are the only registers available from the front panel, there are 128 state registers available in the instrument. Registers 17–128 are only available from the SCPI interface, using the *SAV command.

There is one set of 128 state registers in the instrument, not one set for each Mode. When a state is saved, the Mode it was saved from is saved with it; then when it is recalled, the instrument switches to that Mode.

After the save completes, the corresponding register menu key annotation is updated with the date and time and the message "Register <register number> saved" is displayed.

Key Path	Save, State
Mode	All
Example	*SAV 1
Range	1-16 from front panel, 1-128 from SCPI
Readback	Date and time with seconds resolution are displayed on the key OR A custom name of up to 30 characters entered using the Edit Register Names key OR "(empty)" if no prior save operation has been performed to this register.
Initial S/W Revision	Prior to A.02.00
Modified at S/W Revision	A.11.00

Data (Export)

Exporting a data file stores data from the current measurement to mass storage files. The Export Menu only contains data types that are supported by the current measurement.

Since the commonly exported data files are in .csv format, the data can be edited by you prior to importing. This allows you to export a data file, manipulate the data in Excel (the most common PC Application for manipulating .csv files) and then import it.

Selecting an Export Data menu key will not actually cause the exporting to occur, since the analyzer still needs to know where you wish to save the data. Pressing the Save As key in this menu brings up the Save As dialog and Save As menu that allows you to specify the destination file and directory. Once a filename has been selected or entered in the Open menu, the export will occur as soon as the Save key is pressed.

Key Path	Save
Mode	All
Notes	The menu is built from whatever data types are available for the mode. So the key locations in the sub menu will vary. No SCPI command directly controls the Data Type that this key controls. The Data Type is included in the MMEM:STORe commands.
Dependencies	If a file type is not used by a certain measurement, that type is grayed out for that measurement. The key for a file type will not show at all if there are no measurements in the Mode that support it.
Preset	Is not affected by a Preset or shutdown, but is reset during Restore Mode Defaults
Readback	The data type that is currently selected
Initial S/W Revision	Prior to A.02.00

Meas Results

Key Path	Save, Data
Mode	WLAN
Example	MMEM:STOR:RES "MyResultsFile.csv" This stores the measurement results data in the file MyResultsFile.xml in the default directory.
Initial S/W Revision	A.11.00

Capture Buffer

Capture buffer functionality is only available when measurement is Mod Accuracy and radio standard is not 802.11ac 80+80MHz. The captured data is raw data which is not processed.

Key Path	Save, Data
Mode	WLAN
Example	MMEM:STOR:CAPT "MyCaptureData.bin" This stores the capture data in the file MyCaptureData.bin in the default directory.
Dependencies	Capture buffer data is only available when measurement is Mod Accuracy and radio standard is not 802.11ac 80+80MHz. In other measurements, this key is grayed out.
Initial S/W Revision	A.11.00

Save As . . .

When you press "Save As", the analyzer brings up a Windows dialog and a menu entitled "**Save As.**" This menu allows you to navigate to the various fields in the Windows dialog without using a keyboard or mouse. The Tab and Arrow keys can also be used for dialog navigation.

See "[To File . . .](#)" on page 2273 in Save, State for a full description of this dialog and menu.

The default path for saving files is:

For all of the Trace Data Files:

My Documents\`<mode name>`\data\traces

For all of the Limit Data Files:

My Documents\`<mode name>`\data\limits

For all of the Measurement Results Data Files:

My Documents\`<mode name>`\data\`<measurement name>`\results

For all of the Capture Buffer Data Files:

My Documents\`<mode name>`\data\captureBuffer

Key Path	Save, Data
Mode	All
Notes	The key location is mode-dependent and will vary. Brings up the Save As dialog for saving a <mode specific> Save Type. The save is performed immediately and does not wait until the measurement is complete.
Initial S/W Revision	Prior to A.02.00

Screen Image

Pressing Screen Image accesses a menu of functions that enable you to specify a format and location for the saved screen image. It brings up a menu that allows you to specify the color scheme of the Screen Image (Themes) or navigate to the Save As dialog to perform the actual save.

Screen Image files contain an exact representation of the analyzer display. They cannot be loaded back onto the analyzer, but they can be loaded into your PC for use in many popular applications.

The image to be saved is actually captured when the Save front panel key is pressed, and kept in temporary storage to be used if you ask for a Screen Image save. When the Screen Image key is pressed, a "thumbnail" of the captured image is displayed, as shown below:

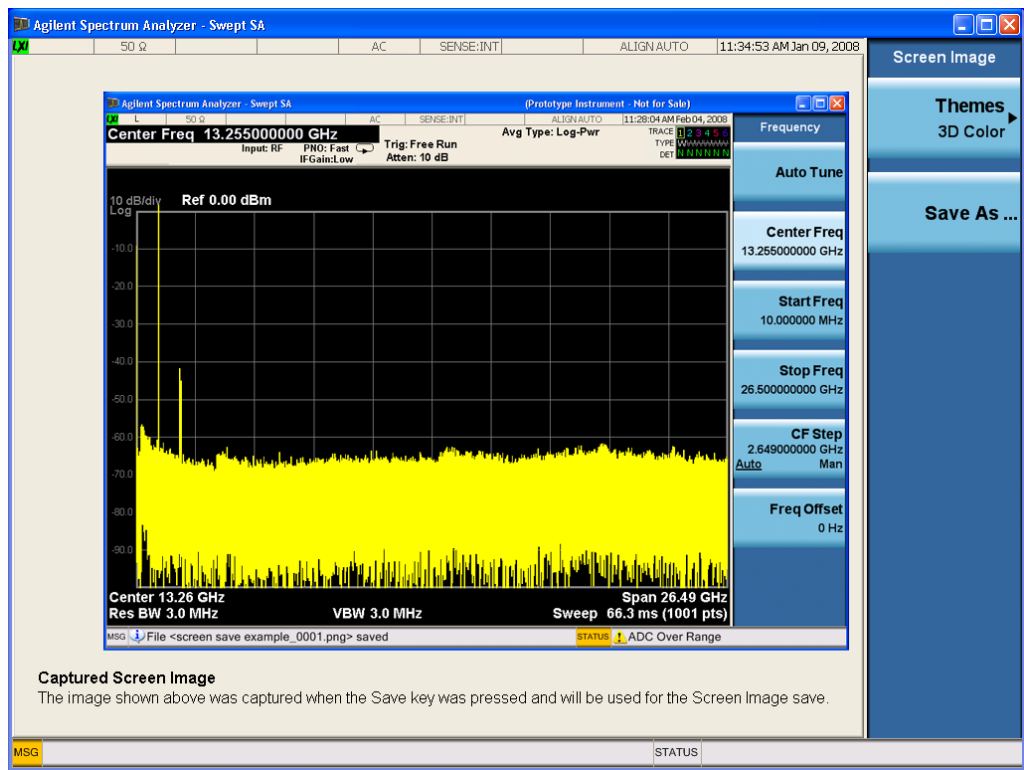

When you continue on into the Save As menu and complete the Screen Image save, the image depicted in the thumbnail is the one that gets saved, showing the menus that were on the screen before going into the Save menus. The save is performed immediately and does not wait until the measurement is complete.

After you have completed the save, the Quick Save front-panel key lets you quickly repeat the last save performed, using an auto-named file, with the current screen data.

NOTE For versions previous to A.01.55, if you initiate a screen image save by navigating through the Save menus, the image that is saved will contain the Save menu softkeys, not the menus and the active function that were on the screen when you first pressed the Save front panel key.

Key Path	Save
Mode	All
Remote Command	:MMEMory:STORe:SCReem <filename>
Example	:MMEM:STOR:SCR "myScreen.png" This stores the current screen image in the file MyScreenFile.png in the default directory.
Initial S/W Revision	Prior to A.02.00

Themes

Accesses a menu of functions that enable you to choose the theme to be used when saving the screen image.

The **Themes** option is the same as the **Themes** option under the **Display** and **Page Setup** dialogs. It allows you to choose between themes to be used when saving the screen image.

Key Path	Save, Screen Image
Remote Command	:MMEMory:STORe:SCReem:THEMe TDColor TDMonochrome FCOLOR FMONochrome :MMEMory:STORe:SCReem:THEMe?
Example	:MMEM:STOR:SCR:THEM TDM
Preset	3D Color; Is not part of Preset, but is reset by Restore Misc Defaults or Restore System Defaults All and survives subsequent running of the modes.
Readback	3D Color 3D Mono Flat Color Flat Mono
Backwards Compatibility Notes	In ESA and PSA we offer the choice of "Reverse Bitmap" or "Reverse Metafile" when saving screen images. This is much like the "Flat Color" theme available in X-Series. Also, if you selected Reverse Bitmap AND a black & white screen image, that would be much like "Flat Monochrome". In other words, each of the X-Series themes has a similar screen image type in ESA/PSA. But they are not identical.
Initial S/W Revision	Prior to A.02.00

3D Color

Selects a standard color theme with each object filled, shaded and colored as designed.

Key Path	Save, Screen Image, Themes
Example	MMEM:STOR:SCR:THEM TDC

Readback	3D Color
Initial S/W Revision	Prior to A.02.00

3D Monochrome

Selects a format that is like 3D color but shades of gray are used instead of colors.

Key Path	Save, Screen Image, Themes
Example	MMEM:STOR:SCR:THEM TDM
Readback	3D Mono
Initial S/W Revision	Prior to A.02.00

Flat Color

Selects a format that is best when the screen is to be printed on an ink printer.

Key Path	Save, Screen Image, Themes
Example	MMEM:STOR:SCR:THEM FCOL
Readback	Flat Color
Initial S/W Revision	Prior to A.02.00

Flat Monochrome

Selects a format that is like Flat Color. But only black is used (no colors, not even gray), and no fill.

Key Path	Save, Screen Image, Themes
Example	MMEM:STOR:SCR:THEM FMON
Readback	Flat Mono
Initial S/W Revision	Prior to A.02.00

Save As...

When you press "Save As", the analyzer brings up a Windows dialog and a menu entitled "**Save As.**" This menu allows you to navigate to the various fields in the Windows dialog without using a keyboard or mouse. The Tab and Arrow keys can also be used for dialog navigation.

See "[To File . . .](#)" on page 2273 in Save, State for a full description of this dialog and menu.

The default path for Screen Images is

My Documents\`<mode name>`\screen.

where <mode name> is the parameter used to select the mode with the INST:SEL command (for example, SA for the Spectrum Analyzer).

Key Path	Save, Screen Image
Notes	Brings up Save As dialog for saving a Screen Image Save Type
Initial S/W Revision	Prior to A.02.00

Mass Storage Catalog (Remote Command Only)

Key path	SCPI Only
Remote Command	:MMEMory:CATalog? [<directory_name>]
Notes	<p>The string must be a valid logical path.</p> <p>Queries disk usage information (drive capacity, free space available) and obtains a list of files and directories in a specified directory in the following format: <numeric_value>,<numeric_value>,{<file_entry>}</p> <p>It returns two numeric parameters and as many strings as there are files and directories. The first parameter indicates the total amount of storage currently used in bytes. The second parameter indicates the total amount of storage available, also in bytes. The <file_entry> is a string. Each <file_entry> indicates the name, type, and size of one file in the directory list: <file_name>,<file_type>,<file_size></p> <p>As the windows file system has an extension that indicates file type, <file_type> is always empty. <file_size> provides the size of the file in bytes. For directories, <file_entry> is surrounded by square brackets and both <file_type> and <file_size> are empty</p>
Initial S/W Revision	Prior to A.02.00

Mass Storage Change Directory (Remote Command Only)

Key path	SCPI Only
Remote Command	:MMEMory:CDIRectory [<directory_name>] :MMEMory:CDIRectory?
Notes	<p>The string must be a valid logical path.</p> <p>Changes the default directory for a mass memory file system. The <directory_name> parameter is a string. If no parameter is specified, the directory is set to the *RST value.</p> <p>At *RST, this value is set to the default user data storage area, that is defined as System.Environment.SpecialFolder.Personal.</p> <p>Query returns full path of the default directory.</p>
Initial S/W Revision	Prior to A.02.00

Mass Storage Copy (Remote Command Only)

Key path	SCPI Only
Remote Command	:MMEMory:COpy <string>,<string>[,<string>,<string>]
Notes	<p>The string must be a valid logical path.</p> <p>Copies an existing file to a new file or an existing directory to a new directory.</p> <p>Two forms of parameters are allowed. The first form has two parameters. In this form, the first parameter specifies the source, and the second parameter specifies the destination.</p> <p>The second form has four parameters. In this form, the first and third parameters specify the source. The second and fourth parameters specify the directories. The first pair of parameters specifies the source. The second pair specifies the destination. An error is generated if the source doesn't exist or the destination file already exists.</p> <p>This command will generate an "access denied" error if the destination is a restricted folder (e.g., C:\Windows) and the current user does not have Power User or Administrator privileges.</p>

Mass Storage Device Copy (Remote Command Only)

This command transfers data to/from a file and a peripheral device.

Key path	SCPI Only
Remote Command	:MMEMory:COpy:DEvice <source_string>,<dest_string>
Notes	<p>The strings must be a valid logical path or a valid device keyword. If the dest_string is a device keyword, the data is copied from the source file to the device. If the source_string is a device keyword, the data is copied to the source file from the device.</p> <p>Valid device keywords are:</p> <p>SNS (smart noise source)</p> <p>An error is generated if the file or device is not found.</p>

Mass Storage Delete (Remote Command Only)

Key path	SCPI Only
Remote Command	:MMEMory:DElete <file_name>[,<directory_name>]
Notes	<p>The string must be a valid logical path.</p> <p>Removes a file from the specified directory. The <file_name> parameter specifies the file name to be removed. This command will generate an "access denied" error if the file is in a restricted folder (e.g., C:\Windows) and the current user does not have Power User or Administrator privileges.</p>
Initial S/W Revision	Prior to A.02.00

Mass Storage Data (Remote Command Only)

Creates a file containing the specified data OR queries the data from an existing file.

Key path	SCPI Only
Remote Command	:MMEMory:DATA <file_name>, <data> :MMEMory:DATA? <file_name>
Notes	The string must be a valid logical path. The command form is MMEMory:DATA <file_name>,<data>. It loads <data> into the file <file_name>. <data> is in 488.2 block format. <file_name> is string data. The query form is MMEMory:DATA? <file_name> with the response being the associated <data> in block format.
Initial S/W Revision	Prior to A.02.00

Mass Storage Make Directory (Remote Command Only)

Key path	SCPI Only
Remote Command	:MMEMory:MDIRectory <directory_name>
Notes	The string must be a valid logical path. Creates a new directory. The <directory_name> parameter specifies the name to be created. This command will generate an “access denied” error if the new directory would be in a restricted folder (e.g., C:\Windows) and the current user does not have Power User or Administrator privileges.
Initial S/W Revision	Prior to A.02.00

Mass Storage Move (Remote Command Only)

Key path	SCPI Only
Remote Command	:MMEMory:MOVE <string>,<string>[,<string>,<string>]
Notes	The string must be a valid logical path. Moves an existing file to a new file or an existing directory to a new directory. Two forms of parameters are allowed. The first form has two parameters. In this form, the first parameter specifies the source, and the second parameter specifies the destination. The second form has four parameters. In this form, the first and third parameters specify the source. The second and fourth parameters specify the directories. The first pair of parameters specifies the source. The second pair specifies the destination. An error is generated if the source doesn't exist or the destination file already exists. This command will generate an “access denied” error if the destination is a restricted folder (e.g., C:\Windows) and the current user does not have Power User or Administrator privileges.
Initial S/W Revision	Prior to A.02.00

Mass Storage Remove Directory (Remote Command Only)

Key path	SCPI Only
Remote Command	<code>:MMEMory:RDIRectory <directory_name></code>
Notes	<p>The string must be a valid logical path.</p> <p>Removes a directory. The <directory_name> parameter specifies the directory name to be removed. All files and directories under the specified directory shall also be removed.</p> <p>This command will generate an “access denied” error if the folder is a restricted folder (e.g., C:\Windows) or is in a restricted folder and the current user does not have Power User or Administrator privileges.</p>
Initial S/W Revision	Prior to A.02.00

Single (Single Measurement/Sweep)

Sets the analyzer for Single measurement operation. The single/continuous state is Meas Global, so the setting will affect all the measurements. If you are Paused, pressing Single does a Resume.

See "[More Information](#)" on page 1515

Key Path	Front-panel key
Example	:INIT:CONT OFF
Notes	See Cont key description.
Backwards Compatibility Notes	<p>For Spectrum Analysis mode in ESA and PSA, the Single hardkey and the INITiate:IMM switched from continuous measurement to single measurement and restarted sweeps and averages (displayed average count reset to 1), but did not restart Max Hold and Min Hold. In the X-Series, the Single hardkey and the INITiate:IMM command initiate a sweep/ measurement/ average sequence/hold sequence including MaxHold and MinHold.</p> <p>For Spectrum Analysis mode in ESA and PSA, the Single hardkey restarted the sweep regardless of whether or not you were in an active sweep or sweep sequence. In the X-Series, Restart does this but Single only restarts the sweep or sweep sequence if you are in the idle state.</p> <p>INIT[:IMM] in ESA & PSA Spectrum Analysis Mode does an implied ABORT. In some other PSA Modes, INIT[:IMM] is ignored if not in the idle state. . The X-Series follows the ESA/PSA SA Mode model, which may cause some Modes to have compatibility problems.</p>
Initial S/W Revision	Prior to A.02.00

More Information

See "[Restart](#)" on page 2270 for details on the INIT:IMMEDIATE (Restart) function.

If you are already in single sweep, the INIT:CONT OFF command has no effect.

If you are already in Single Sweep, then pressing the Single key in the middle of a sweep does not restart the sweep or sequence. Similarly, pressing the Single key does not restart the sweep or sequence if the sweep is not in the idle state (for example, if you are taking a very slow sweep, or the analyzer is waiting for a trigger). Instead, it results in a message. "Already in Single, press Restart to initiate a new sweep or sequence". Even though pressing the Single key in the middle of a sweep does not restart the sweep, sending INIT:IMMEDIATE does reset it.

To take one more sweep without resetting the average count, increment the average count by 1, by pressing the step up key while **Average/Hold Number** is the active function, or sending the remote command CALC:AVER:TCON UP.

Source

There is no Source control functionality for this measurement. When this key is pressed, the screen either displays a blank menu, or the previously-selected menu remains unchanged.

Key Path	Front-panel key
----------	-----------------

SPAN X Scale

Accesses a menu of functions that enable you set the horizontal scale parameters.

Key Path	Front-panel key
Initial S/W Revision	A.10.01

Ref Value(Burst View)

Allows you to set the display X reference value.

Key Path	SPAN X Scale
Mode	WLAN
Remote Command	:DISPlay:PVTime:VIEW[1]:WINDow[1]:TRACe:X[:SCALe]:RLEVel <time> :DISPlay:PVTime:VIEW[1]:WINDow[1]:TRACe:X[:SCALe]:RLEVel?
Example	DISP:PVT:VIEW:WIND:TRACE:X:RLEV 1s DISP:PVT:VIEW:WIND:TRACE:X:RLEV?
Notes	If X Auto Scale is On, this value is automatically determined by the measurement result. When a value is set manually, X Auto Scale is automatically set to Off.
Couplings	See Notes
Preset	0 s
State Saved	Saved in instrument state.
Min	-10.0 s
Max	10.00 s
Initial S/W Revision	A.10.01

Scale/Div(Burst View)

Allows you to set the display X scale/division value.

Key Path	SPAN X Scale
Mode	WLAN
Remote Command	:DISPlay:PVTime:VIEW[1]:WINDow[1]:TRACe:X[:SCALe]:PDIVision <time> :DISPlay:PVTime:VIEW[1]:WINDow[1]:TRACe:X[:SCALe]:PDIVision?
Example	:DISP:PVT:VIEW:WIND:TRACE:X:PDIV 1ms :DISP:PVT:VIEW:WIND:TRACE:X:PDIV?
Notes	If X Auto Scale is set to On, this value is automatically determined by the measurement result. When a value is set manually, X Auto Scale is automatically set to Off.
Couplings	See Notes
Preset	1.0 ms

State Saved	Saved in instrument state.
Min	1.00 ns
Max	1.00 s
Initial S/W Revision	A.10.01
MIN/MAX/DEF Support	Yes

Ref Position(Burst View)

Allows you to set the X reference position to the left, center, or right of the display.

Key Path	SPAN X Scale
Mode	WLAN
Remote Command	:DISPlay:PVTime:VIEW[1]:WINDow[1]:TRACe:X[:SCALe]:RPOStion LEFT CENTER RIGHT :DISPlay:PVTime:VIEW[1]:WINDow[1]:TRACe:X[:SCALe]:RPOStion?
Example	:DISP:PVT:VIEW:WIND:TRACe:X:RPOS LEFT :DISP:PVT:VIEW:WIND:TRACe:X:RPOS?
Preset	LEFT
State Saved	Saved in instrument state.
Range	Left Ctr Right
Initial S/W Revision	A.10.01

Auto Scaling(Burst View)

Allows you to toggle the X Auto Scale function between On and Off.

Key Path	SPAN X Scale
Mode	WLAN
Remote Command	:DISPlay:PVTime:VIEW[1]:WINDow[1]:TRACe:X[:SCALe]:COUPLe 0 1 OFF ON :DISPlay:PVTime:VIEW[1]:WINDow[1]:TRACe:X[:SCALe]:COUPLe?
Example	:DISP:PVT:VIEW:WIND:TRACe:X:COUP OFF :DISP:PVT:VIEW:WIND:TRACe:X:COUP?
Notes	Upon pressing the Restart front-panel key, the scale coupling function automatically determines the scale per division and reference values, based on the measurement results, if this parameter is set to On. When you manually set a value to either X Rel Value or X Scale/Div, X Auto Scale is automatically set to Off.
Couplings	See Notes
Preset	ON

State Saved	Saved in instrument state.
Range	On Off
Initial S/W Revision	A.10.01

Sweep/Control

Accesses a menu that enables you to configure the Sweep and Control functions of the analyzer, such as Sweep Time and Gating.

Key Path	Front-panel key
Initial S/W Revision	Prior to A.02.00

Pause/Resume

Pauses a measurement after the current data acquisition is complete.

When Paused, the label on the key changes to Resume. Pressing Resume un-pauses the measurement. When you are Paused, pressing Restart, Single or Cont does a Resume.

Key Path	Sweep/Control
Remote Command	:INITiate:PAUSE
Dependencies	Grayed out in Measurements that do not support Pausing. Blanked in Modes that do not support Pausing.
Initial S/W Revision	Prior to A.02.00

Key Path	Sweep/Control
Remote Command	:INITiate:RESume
Dependencies	Grayed out in Measurements that do not support Pausing. Blanked in Modes that do not support Pausing.
Initial S/W Revision	Prior to A.02.00

Abort (Remote Command Only)

This command is used to stop the current measurement. It aborts the current measurement as quickly as possible, resets the sweep and trigger systems, and puts the measurement into an "idle" state. If the analyzer is in the process of aligning when ABORT is sent, the alignment finishes before the abort function is performed. So ABORT does not abort an alignment.

If the analyzer is set for Continuous measurement, it sets up the measurement and initiates a new data measurement sequence with a new data acquisition (sweep) taken once the trigger condition is met.

If the analyzer is set for Single measurement, it remains in the "idle" state until an :INIT:IMM command is received.

Remote Command	:ABORT
Example	:ABOR

Notes	<p>If :INITiate:CONTinuous is ON, then a new continuous measurement will start immediately; with sweep (data acquisition) occurring once the trigger condition has been met.</p> <p>If :INITiate:CONTinuous is OFF, then :INITiate:IMMediate is used to start a single measurement; with sweep (data acquisition) occurring once the trigger condition has been met.</p>
Dependencies	<p>For continuous measurement, ABORt is equivalent to the Restart key.</p> <p>Not all measurements support the abort command.</p>
Status Bits/OPC dependencies	<p>The STATus:OPERation register bits 0 through 8 are cleared.</p> <p>The STATus:QUEStionable register bit 9 (INTEgrity sum) is cleared.</p> <p>Since all the bits that feed into OPC are cleared by the ABORt, the ABORt will cause the *OPC query to return true.</p>
Initial S/W Revision	<p>Prior to A.02.00</p>

System

See ["System" on page 353](#)

Trace/Detector

Accesses a menu that allows you to control trace settings.

NOTE

Max/Min Hold Traces will be held during the averaging cycle.

Key Path	Front-panel key
Initial S/W Revision	A.03.00

Max Hold Trace

This key allows you to make the Max Hold Trace visible or invisible in the display..

Key Path	Trace/Detector
Mode	LTETDD, LTE, LTEATDD, LTEAFDD
Remote Command	:DISPlay:PVTtime:VIEW[1]:WINDow[1]:TRACe:MAXHold[:STATe] ON OFF 1 0 :DISPlay:PVTtime:VIEW[1]:WINDow[1]:TRACe:MAXHold[:STATe]?
Example	:DISP:PVT:VIEW:WIND:TRAC:MAXH ON :DISP:PVT:VIEW:WIND:TRAC:MAXH?
Couplings	While Rise & Fall view is selected, this key will be grayed out. Rise & Fall view will not support trace max/min hold.
Preset	OFF
State Saved	Saved in instrument state.
Range	On Off
Initial S/W Revision	A.03.00

Min Hold Trace

This key allows you to make the Min Hold Trace visible or invisible in the display.

Key Path	Trace/Detector
Mode	LTETDD, LTE, LTEATDD, LTEAFDD
Remote Command	:DISPlay:PVTtime:VIEW[1]:WINDow[1]:TRACe:MINHold[:STATe] ON OFF 1 0 :DISPlay:PVTtime:VIEW[1]:WINDow[1]:TRACe:MINHold[:STATe]?
Example	:DISP:PVT:VIEW:WIND:TRAC:MINH ON :DISP:PVT:VIEW:WIND:TRAC:MINH?
Couplings	While Rise & Fall view is selected, this key will be grayed out. Rise & Fall view will not support trace max/min hold.
Preset	OFF

13 Power vs. Time Measurement Overview
Trace/Detector

State Saved	Saved in instrument state.
Range	On Off
Initial S/W Revision	A.03.00

Trigger

See ["Trigger" on page 428](#)

Free Run

See ["Free Run " on page 435](#)

Video

See ["Video \(IF Envelope\) " on page 436](#)

Trigger Level

See ["Trigger Level " on page 436](#)

Trig Slope

See ["Trig Slope " on page 437](#)

Trig Delay

See ["Trig Delay " on page 438](#)

External 1

See ["External 1 " on page 2118](#)

Trigger Level

See ["Trigger Level " on page 2118](#)

Trig Slope

See ["Trig Slope " on page 2119](#)

Trig Delay

See ["Trig Delay " on page 443](#)

Zero Span Delay Comp

See ["Zero Span Delay Comp On/Off" on page 2107](#)

External 2

See ["External 2 " on page 2120](#)

Trigger Level

See ["Trigger Level " on page 2120](#)

Trig Slope

See ["Trig Slope " on page 2121](#)

Trig Delay

See ["Trig Delay "](#) on page 445

Zero Span Delay Comp

See ["Zero Span Delay Comp On/Off"](#) on page 2109

RF Burst

See ["RF Burst "](#) on page 2121

Absolute Trigger

See ["Absolute Trigger Level"](#) on page 2122

Relative Trigger

See ["Relative Trigger Level"](#) on page 2111

Trig Slope

See ["Trigger Slope "](#) on page 2123

Trig Delay

See ["Trig Delay "](#) on page 450

Periodic Timer

See ["Periodic Timer \(Frame Trigger\) "](#) on page 2113

Period

See ["Period "](#) on page 2114

Offset

See ["Offset "](#) on page 2115

Offset Adjust (Remote Command Only)

See ["Offset Adjust \(Remote Command Only\)"](#) on page 2116

Reset Offset Display

See ["Reset Offset Display "](#) on page 2117

Sync Source

See ["Sync Source "](#) on page 2117

Off

See ["Off "](#) on page 2118

External 1

See ["External 1 "](#) on page 2118

Trigger Level

See ["Trigger Level "](#) on page 2118

Trig Slope

See ["Trig Slope "](#) on page 2119

External 2

See ["External 2 "](#) on page 2120

Trigger Level

See ["Trigger Level "](#) on page 2120

Trig Slope

See ["Trig Slope "](#) on page 2121

RF Burst

See ["RF Burst "](#) on page 2121

Absolute Trigger

See ["Absolute Trigger Level"](#) on page 2122

Trig Slope

See ["Trigger Slope "](#) on page 2123

Trig Delay

See ["Trig Delay"](#) on page 460

Auto/Holdoff

See ["Auto/Holdoff "](#) on page 461

Auto Trig

See ["Auto Trig "](#) on page 461

Trig Holdoff

See ["Trig Holdoff "](#) on page 462

Holdoff Type

See [___](#) on page X

User Preset

Accesses a menu that gives you the following three choices:

- User Preset – recalls a state previously saved using the Save User Preset function.
- User Preset All Modes – presets all of the modes in the analyzer
- Save User Preset– saves the current state for the current mode

Key Path	Front-panel key
Backwards Compatibility Notes	<p>User Preset is actually loading a state, and in legacy analyzers, it was possible to load a state without affecting the trace data, limit lines or correction data. Similarly it was possible to do a User Preset without affecting the trace data, limit lines or correction data.</p> <p>In the X-Series, “state” always includes all of this data; so whenever state is loaded, or User Preset is executed, all of the traces, limit lines and corrections are affected. Although this differs from previous behavior, it is desirable behavior, and should not cause adverse issues for users.</p> <p>On ESA and PSA, User Preset affected the entire instrument’s state. In the X-Series, User Preset only recalls the state for the active mode. There is a User Preset file for each mode. User Preset can never cause a mode switch as it can in legacy analyzers. If you want to recall all modes to their user preset file state, you will need to do a User Preset after mode switching into each mode.</p> <p>User Preset recalls mode state which can now include data like traces; whereas on ESA and PSA, User Preset did not affect data.</p>
Initial S/W Revision	Prior to A.02.00

User Preset

User Preset sets the state of the currently active mode back to the state that was previously saved for this mode using the Save User Preset menu key or the SCPI command, SYST:PRES:USER:SAV. It not only recalls the Mode Preset settings, but it also recalls all of the mode persistent settings, and the Input/Output system setting that existed at the time Save User Preset was executed.

If a Save User Preset has not been done at any time, User Preset recalls the default user preset file for the currently active mode. The default user preset files are created if, at power-on, a mode detects there is no user preset file. There will never be a scenario when there is no user preset file to restore. For each mode, the default user preset state is the same state that would be saved if a Save User Preset is performed in each mode right after doing a Restore Mode Default and after a Restore Input/Output Defaults.

The User Preset function does the following:

- Aborts the currently running measurement.
- Sets the mode State to the values defined by Save User Preset.
- Makes the saved measurement for the currently running mode the active measurement.
- Brings up the saved menu for the power-on mode.
- Clears the input and output buffers.
- Sets the Status Byte to 0.

Key Path	User Preset
Remote Command	:SYSTem:PRESet:USER
Example	:SYST:PRES:USER:SAVE:SYST:PRES:USER
Notes	:SYST:PRES:USER:SAVE is used to save the current state as the user preset state. Clears all pending OPC bits. The Status Byte is set to 0. Pressing the User Preset front-panel key while already in the User Preset menu will cause the User Preset to get executed
Couplings	A user preset will cause the currently running measurement to be aborted and cause the saved measurement to be active. Recalling a User Preset file has the same issues that recalling a Save State file has. Some settings may need to be limited and therefore re-coupled, since the capabilities of the mode may have changes when the User Preset file was last saved.
Initial S/W Revision	Prior to A.02.00

User Preset All Modes

Recalls all of the User Preset files for each mode, switches to the power-on mode, and activates the saved measurement from the power-on mode User Preset file.

NOTE

When the instrument is secured, all of the user preset files are converted back to their default user preset files.

The User Preset function does the following:

- Aborts the currently running measurement.
- Switches the Mode to the power-on mode.
- Restores the User Preset files for each mode.
- Makes the saved measurement for the power-on mode the active measurement.
- Brings up the saved menu for the power-on mode.
- Clears the input and output buffers.
- Sets the Status Byte to 0.

Key Path	User Preset
Remote Command	:SYSTem:PRESet:USER:ALL
Example	:SYST:PRES:USER:SAVE:SYST:PRES:USER:ALL
Notes	Clears all pending OPC bits. The Status Byte is set to 0. :SYST:PRES:USER:SAVE is used to save the current state as the user preset state.
Couplings	A user preset will cause the currently running measurement to be aborted, cause a mode switch to the power-on mode, and cause the saved measurement to be active in the power-on mode. Recalling a User Preset file has the same issues that recalling a Save State file has. Some settings may need to be limited and therefore re-coupled, since the capabilities of the mode may have changes when the User Preset file was last saved.
Initial S/W Revision	Prior to A.02.00

Save User Preset

Saves the currently active mode and its State. You can recall this User Preset file by pressing the User Preset menu key or sending the SYST:PRES:USER remote command. This same state is also saved by the Save State function.

Key Path	User Preset
Remote Command	:SYSTem:PRESet:USER:SAVE
Example	:SYST:PRES:USER:SAVE
Notes	:SYST:PRES:SAVE creates the same file as if the user requested a *SAV or a MMEM:STOR:STAT, except User Preset Save does not allow the user to specify the filename or the location of the file.
Initial S/W Revision	Prior to A.02.00

View/Display

Accesses the View menu for the current measurement. The available views are specific to the current measurement selected under the Meas key. Many of the lower-level menu keys are also the same across all measurements. Unique functions are described below.

All Soft Keys in the “View/Display” menu work regardless of which result window currently has the focus.

The View/Display menu includes two View Selection keys as shown below, which allow you to select the desired view of the measurement.

View	Name	Description
1	Burst (SCPI: ALL)	View Burst envelope, the length of burst can be determined by slot number in mode setup.
2	Rise & Fall (SCPI: BOTH)	Zooms in on the rising and falling portions of the burst being tested.

View Selection by name

Key Path	View/Display
Mode	WLAN
Remote Command	:DISPlay:PVTime:VIEW[:SElect] ALL BOTH :DISPlay:PVTime:VIEW[:SElect]?
Example	DISP:PVT:VIEW:SEL ALL DISP:PVT:VIEW:SEL?
Preset	ALL
State Saved	Saved in instrument state.
Range	Burst Rise & Fall
Initial S/W Revision	A.10.01

Mode	WLAN
Remote Command	:DISPlay:PVTime:VIEW:NSElect <integer> :DISPlay:PVTime:VIEW:NSElect?
Example	DISP:PVT:VIEW:NSEL 2 DISP:PVT:VIEW:NSEL?
Notes	1: Burst 2: Rise & Fall You must be in the WLAN mode to use this command. Use INSTRument:SElect to set the mode.
Preset	1
State Saved	Saved in instrument state.
Min	1
Max	2
Initial S/W Revision	A.10.01

Display

The Display menu is common to most measurements, and is used for configuring items on the display. Some Display menu settings apply to all the measurements in a mode, and some only to the current measurement. Those under the System Display Settings key apply to all measurements in all modes.

Key Path	Display
Key Path	View/Display
Initial S/W Revision	Prior to A.02.00

Annotation

Turns on and off various parts of the display annotation. The annotation is divided up into four categories:

1. Meas Bar: This is the measurement bar at the top of the screen. It does not include the settings panel or the Active Function. Turning off the Meas Bar turns off the settings panel and the Active Function. When the Meas Bar is off, the graticule area expands to fill the area formerly occupied by the Meas Bar.
2. Screen Annotation: this is the annotation and annunciation around the graticule, including any annotation on lines (such as the display line, the threshold line, etc.) This does NOT include the marker number or the N dB result. When off, the graticule expands to fill the entire graticule area.
3. Trace annotation: these are the labels on the traces, showing their detector (or their math mode).
4. Active Function annotation: this is the active function display in the meas bar, and all of the active function values displayed on softkeys.

See the figure below. Each type of annotation can be turned on and off individually.

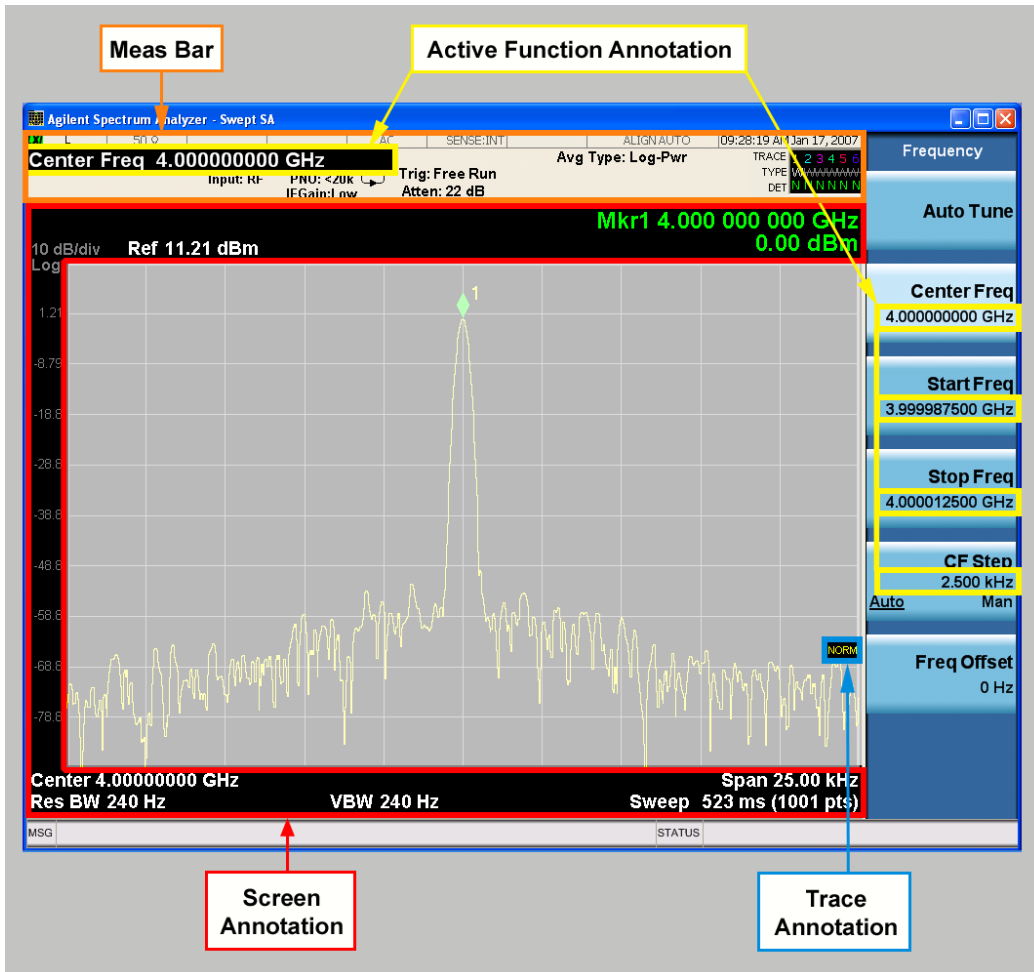

Key Path	View/Display, Display
Initial S/W Revision	Prior to A.02.00

Meas Bar On/Off

This function turns the Measurement Bar on and off, including the settings panel. When off, the graticule area expands to fill the area formerly occupied by the Measurement Bar.

Key Path	View/Display, Display, Annotation
Remote Command	:DISPlay:ANNotation:MBAR[:STATE] OFF ON 0 1 :DISPlay:ANNotation:MBAR[:STATE]?
Example	DISP:ANN:MBAR OFF
Dependencies	Grayed out and forced to OFF when System Display Settings, Annotation is set to Off.
Preset	On This should remain Off through a Preset when System DisplaySettings, Annotation is set to Off.
State Saved	Saved in instrument state.
Initial S/W Revision	Prior to A.02.00

Screen

This controls the display of the annunciation and annotation around the graticule, including any annotation on lines (such as the display line, the threshold line, etc.) and the y-axis annotation. This does NOT include marker annotation (or the N dB result). When off, the graticule expands to fill the entire graticule area, leaving only the 1.5% gap above the graticule as described in the Trace/Detector chapter.

Key Path	View/Display, Display, Annotation
Remote Command	:DISPlay:ANNotation:SCReen[:STATe] OFF ON 0 1 :DISPlay:ANNotation:SCReen[:STATe]?
Example	DISP:ANN:SCR OFF
Dependencies	Grayed-out and forced to OFF when System Display Settings, Annotation is set to Off.
Preset	On This should remain Off through a Preset when System DisplaySettings, Annotation is set to Off
State Saved	Saved in instrument state.
Initial S/W Revision	Prior to A.02.00

Active Function Values On/Off

Turns on and off the active function display in the Meas Bar, and all of the active function values displayed on the softkeys.

Note that all of the softkeys that have active functions have these numeric values blanked when this function is on. This is a security feature..

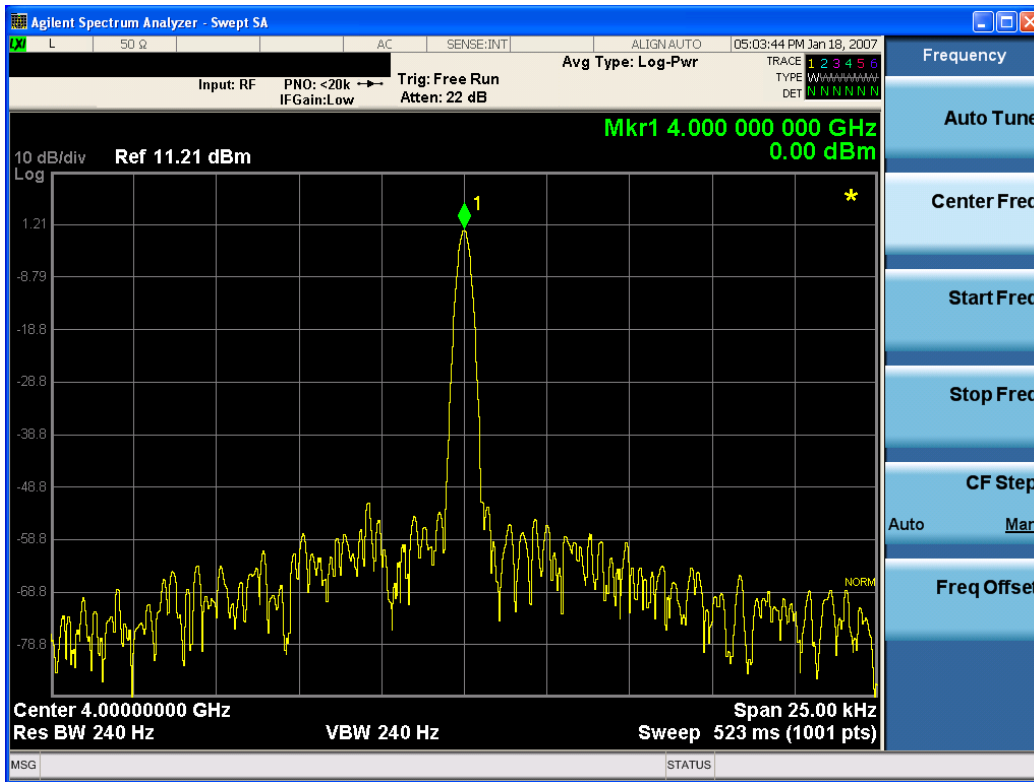

Key Path	View/Display, Display, Annotation
Remote Command	:DISPlay:ACTivefunc[:STATE] ON OFF 1 0 :DISPlay:ACTivefunc[:STATE]?
Example	DISP:ACT OFF
Dependencies	Grayed out and forced to OFF when System Display Settings, Annotation is set to Off.
Preset	On This should remain Off through a Preset when System DisplaySettings, Annotation is set to Off
State Saved	Saved in instrument state.
Initial S/W Revision	Prior to A.02.00

Title

Displays menu keys that enable you to change or clear a title on your display.

Key Path	View/Display, Display
Initial S/W Revision	Prior to A.02.00

Change Title

Writes a title into the "measurement name" field in the banner, for example, "Swept SA".

Press Change Title to enter a new title through the alpha editor. Press Enter or Return to complete the entry. Press ESC to cancel the entry and preserve your existing title.

The display title will replace the measurement name. It remains for this measurement until you press Change Title again, or you recall a state, or a Preset is performed. A title can also be cleared by pressing Title, Clear Title.

NOTE

Notice the inclusion of the <measurement> parameter in the command below. Because each measurement remembers the Display Title, the command must be qualified with the measurement name. For the Swept SA measurement this is not the case; no <measurement> parameter is used when changing the Display Title for the Swept SA measurement.

Key Path	View/Display, Display, Title
Mode	All
Remote Command	:DISPlay:<measurement>:ANNotation:TITLe:DATA <string> :DISPlay:<measurement>:ANNotation:TITLe:DATA?
Example	DISP:ANN:TITL:DATA "This Is My Title" This example is for the Swept SA measurement in the Spectrum Analyzer mode. The SANalyzer <measurement> name is not used. DISP:ACP:ANN:TITL:DATA "This Is My Title" This example is for Measurements other than Swept SA. Both set the title to: This Is My Title
Notes	Pressing this key cancels any active function. When a title is edited the previous title remains intact (it is not cleared) and the cursor goes at the end so that characters can be added or BKSP can be used to go back over previous characters.
Preset	No title (measurement name instead)
State Saved	Saved in instrument state.
Initial S/W Revision	Prior to A.02.00

Clear Title

Clears a title from the front-panel display. Once cleared, the title cannot be retrieved. After the title is cleared, the current Measurement Name replaces it in the title bar.

Key Path	View/Display, Display, Title
Example	The following commands clear the title and restore the measurement's original title: DISP:ANN:TITL:DATA "" This example is for the Swept SA measurement in the Spectrum Analyzer mode. The SANalyzer <measurement> name is not used. DISP:ACP:ANN:TITL:DATA "" This example is for ACP; in measurements other than Swept SA the measurement name is required.
Notes	Uses the :DISPlay:<measurement>:ANNotation:TITLe:DATA <string> command with an empty string (in the Swept SA, the <measurement> is omitted).
Preset	Performed on Preset.
Initial S/W Revision	Prior to A.02.00

Graticule

Pressing Graticule turns the display graticule On or Off. It also turns the graticule y-axis annotation on and off.

Key Path	View/Display, Display
Remote Command	:DISPlay:WINDow[1]:TRACe:GRATicule:GRID[:STATe] OFF ON 0 1 :DISPlay:WINDow[1]:TRACe:GRATicule:GRID[:STATe]?
Example	DISP:WIND:TRAC:GRAT:GRID OFF
Notes	The graticule is the set of horizontal and vertical lines that make up the grid/divisions for the x-axis and y-axis.
Preset	On
State Saved	Saved in instrument state
Initial S/W Revision	Prior to A.02.00

System Display Settings

These settings are "Mode Global" – they affect all modes and measurements and are reset only by Restore Misc Defaults or Restore System Defaults under System.

Key Path	View/Display, Display
Initial S/W Revision	Prior to A.02.00

Annotation Local Settings

This is a Mode Global override of the meas local annotation settings. When it is All Off, it forces ScreenAnnotation, Meas Bar, Trace, and Active Function Values settings to be OFF for all measurements in all modes. This provides the security based "annotation off" function of previous analyzers; hence it uses the legacy SCPI command.

When it is All Off, the Screen, Meas Bar, Trace, and Active Function Values keys under the Display, Annotation menu are grayed out and forced to Off. When Local Settings is selected, you are able to set the local annotation settings on a measurement by measurement basis.

Key Path	View/Display, Display, System Display Settings
Remote Command	:DISPlay:WINDow[1]:ANNOtation[:ALL] OFF ON 0 1 :DISPlay:WINDow[1]:ANNOtation[:ALL]?
Example	:DISP:WIND:ANN OFF
Preset	On (Set by Restore Misc Defaults)
State Saved	Not saved in instrument state.
Backwards Compatibility Notes	The WINDow parameter and optional subopcode is included for backwards compatibility but ignored – all windows are equally affected.
Initial S/W Revision	Prior to A.02.00

Themes

Accesses a menu of functions that enable you to choose the theme to be used when saving the screen image.

The **Themes** option is the same as the **Themes** option under the **Display** and **Page Setup** dialogs. It allows you to choose between themes to be used when saving the screen image.

Key Path	Save, Screen Image
Remote Command	:MMEMory:STORe:SCReen:THEMe TDColor TDMonochrome FCOLor FMONochrome :MMEMory:STORe:SCReen:THEMe?
Example	:MMEM:STOR:SCR:THEM TDM
Preset	3D Color; Is not part of Preset, but is reset by Restore Misc Defaults or Restore System Defaults All and survives subsequent running of the modes.
Readback	3D Color 3D Mono Flat Color Flat Mono
Backwards Compatibility Notes	In ESA and PSA we offer the choice of "Reverse Bitmap" or "Reverse Metafile" when saving screen images. This is much like the "Flat Color" theme available in X-Series. Also, if you selected Reverse Bitmap AND a black & white screen image, that would be much like "Flat Monochrome". In other words, each of the X-Series themes has a similar screen image type in ESA/PSA. But they are not identical.
Initial S/W Revision	Prior to A.02.00

3D Color

Selects a standard color theme with each object filled, shaded and colored as designed.

Key Path	Save, Screen Image, Themes
Example	MMEM:STOR:SCR:THEM TDC
Readback	3D Color
Initial S/W Revision	Prior to A.02.00

3D Monochrome

Selects a format that is like 3D color but shades of gray are used instead of colors.

Key Path	Save, Screen Image, Themes
Example	MMEM:STOR:SCR:THEM TDM
Readback	3D Mono
Initial S/W Revision	Prior to A.02.00

Flat Color

Selects a format that is best when the screen is to be printed on an ink printer.

Key Path	Save, Screen Image, Themes
Example	MMEM:STOR:SCR:THEM FCOL
Readback	Flat Color
Initial S/W Revision	Prior to A.02.00

Flat Monochrome

Selects a format that is like Flat Color. But only black is used (no colors, not even gray), and no fill.

Key Path	Save, Screen Image, Themes
Example	MMEM:STOR:SCR:THEM FMON
Readback	Flat Mono
Initial S/W Revision	Prior to A.02.00

Backlight

Accesses the display backlight on/off keys. This setting may interact with settings under the Windows "Power" menu.

When the backlight is off, pressing ESC, TAB, SPACE, ENTER, UP, DOWN, LEFT, RIGHT, DEL, BKSP, CTRL, or ALT turns the backlight on without affecting the application. Pressing any other key will turn backlight on and could potentially perform the action as well.

Key Path	View/Display, Display, System Display Settings
Remote Command	:DISPlay:BACKlight ON OFF :DISPlay:BACKlight?
Preset	ON (Set by Restore Misc Defaults)
Initial S/W Revision	Prior to A.02.00

Backlight Intensity

An active function used to set the backlight intensity. It goes from 0 to 100 where 100 is full on and 0 is off. This value is independent of the values set under the Backlight on/off key.

Key Path	View/Display, Display, System Display Settings
Remote Command	:DISPlay:BACKlight:INTensity <integer> :DISPlay:BACKlight:INTensity?
Example	DISP:BACK:INT 50

Preset	100 (Set by Restore Misc Defaults)
Min	0
Max	100
Initial S/W Revision	Prior to A.02.00

Burst View

This view shows power vs. time for a WLAN modulated burst. The view has two windows:

- "RF Envelope window" on page 1540(upper)
- "Result Metrics window" on page 1541(lower)

The figure below shows an example of the Burst View.

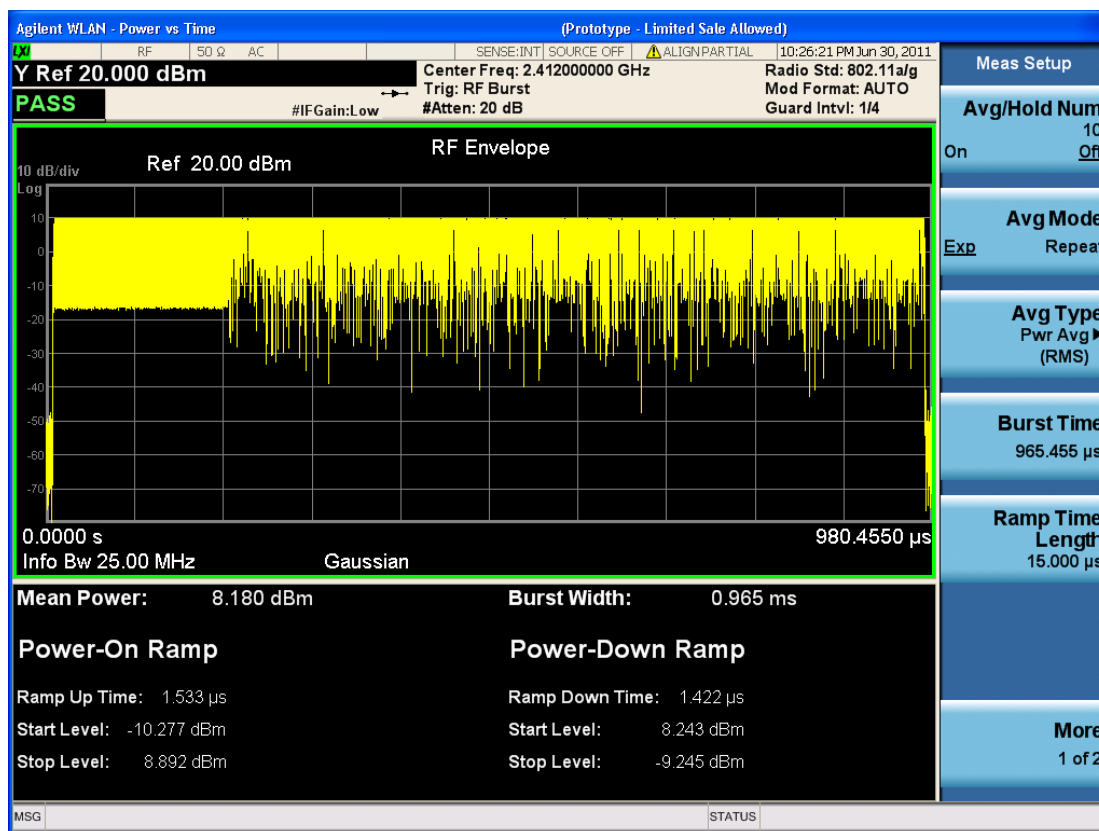

RF Envelope window

This table illustrates the details of RF envelope window:

Marker Operation	Yes
Corresponding Trace	Yellow: Signal wave form, n=2, 3, 4 Blue: Ramp up/down lines

Result Metrics window

This table illustrates the details of metrics window:

Name	Corresponding Results	Display Format
Power-On Ramp	n=1 1st	99.999 ms
Power-Down Ramp	n=1 2nd	99.999 ms

Key Path	Front-panel key
Initial S/W Revision	A.10.01

Burst Line

Turns the burst line On or Off.

Key Path	View/Display,Burst
Mode	WLAN
Remote Command	:DISPlay:PVTime:BLINes[:STATe] OFF ON 0 1 :DISPlay:PVTime:BLIN[:STATe]?
Example	:DISP:PVT:BLIN ON :DISP:PVT:BLIN?
Preset	OFF
State Saved	Saved in instrument state.
Range	On Off
Initial S/W Revision	A.10.01

Rise & Fall View

This view has three windows:

Rising RF Envelope Window.	The parameters of this window are identical to those of the RF Envelop Window in the Burst view.
Falling RF Envelope Window.	The parameters of this window are identical to those of the RF Envelop Window in the Burst view.
Numeric Results Window.	The parameters of this window are identical to those of the Numeric Results Window in the Burst view.

The figure below shows an example of the Rise & Fall View.

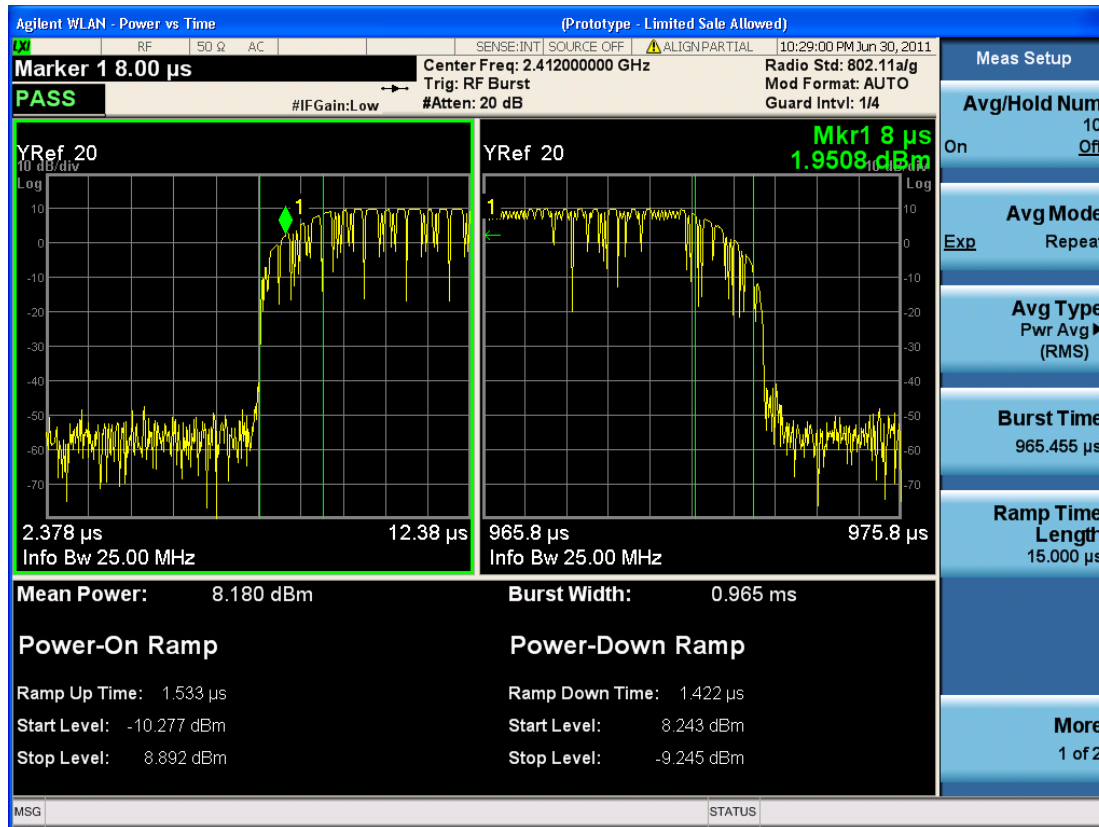

Key Path	View/Display
Mode	WLAN
Initial S/W Revision	A.10.01

Ramp Lines

Turns the ramp lines On or Off.

Key Path	View/Display
Mode	WLAN
Remote Command	:DISPlay:PVTtime:RAMP[:STATE] OFF ON 0 1 :DISPlay:PVTtime:RAMP[:STATE]?
Example	:DISP:PVT:RAMP ON :DISP:PVT:RAMP?
Preset	OFF
State Saved	Saved in instrument state.
Range	On Off
Initial S/W Revision	A.10.01

14 Spectral Flatness Measurement

Variation in carrier flatness of OFDM signals in IEEE 802.11a/g/n will reduce demodulation margins and degrade link performance. The spectral flatness measurement applies to test carrier flatness of OFDM signals in IEEE 802.11a/g and 802.11n Draft Version 11.

This topic contains the following sections:

["Measurement Commands for Spectral Flatness Measurement" on page 1546](#)

["Remote Command Results for Spectral Flatness Measurement" on page 1547](#)

Measurement Commands for Spectral Flatness Measurement

The following commands are used to retrieve the measurement results:

`:CONFigure:FLATness`

`:INITiate:FLATness`

`:FETCh:FLATness [n] ?`

`:READ:FLATness [n] ?`

`:MEASure:FLATness [n] ?`

Remote Command Results for Spectral Flatness Measurement

The following table displays the returned results from the (FETCh|MEASure|READ):FLAT commands, indexed by subopcode:

n	Results Returned
0	Returns unprocessed I/Q trace data, as a series of comma-separated trace points, in volts. The I values are listed first in each pair, using the 0 through even-indexed values. The Q values are the odd-indexed values.
not specified or n = 1	<p>Returns comma-separated scalar results, in the following order:</p> <ol style="list-style-type: none"> 1. Return maximum peak energy deviation within all active sub-carriers. Different standard has different number of sub-carriers. Please refer to section 2.2, Measurement Algorithm. 2. Return PASS/FAIL (1:Fail, 0: Pass) 3. Return signal format; <ol style="list-style-type: none"> 0: 802.11a/g; 1: 802.11n 20MHz Non-HT 2: 802.11n 20MHz HT-greenfield 3: 802.11n 20MHz HT-Mixed 4: 802.11n 40MHz Non-HT Duplicate 5: 802.11n 40MHz HT-greenfield 6: 802.11n 40MHz HT-Mixed 7: 802.11n 40MHz MCS32 8. 802.11ac 20MHz 9. 802.11ac 40MHz VHT 10. 802.11ac 40MHz Non-HT Duplicate 11. 802.11ac 80MHz VHT 12. 802.11ac 80MHz Non-HT Duplicate 13. 802.11ac 160MHz 14. 802.11ac 160MHz Non-HT Duplicate
2	Return float values which stand for the energy deviations of each spectral lines. The exact number of values refers to section 2.2, Measurement Algorithm.
3	<p>Return Spectral Flatness results of each section – summary data for spectral flatness results of each section:</p> <ol style="list-style-type: none"> 1. Max Subcarrier Flatness Value (dB) in section 1 – a floating point number in dB. 2. Max Subcarrier Flatness Value to Upper Limit 1 (dB) – a floating point number in dB. 3. Max Subcarrier Flatness Index for section 1 – an integer number 4. Min Subcarrier Flatness Value (dB) in section 1 – a floating point number in dB. 5. Min Subcarrier Flatness Value to Lower Limit 1 (dB) – a floating point number in dB. 6. Min Subcarrier Flatness Index for section 1 – an integer number 7. Max Subcarrier Flatness Value (dB) in section 2 – a floating point number in dB. 8. Max Subcarrier Flatness Value to Upper Limit 2 (dB) – a floating point number in dB. 9. Max Subcarrier Flatness Index for section 2 – an integer number 10. Min Subcarrier Flatness Value (dB) in section 2 – a floating point number in dB.

-
- 11. Min Subcarrier Flatness Value to Lower Limit 2 (dB) – a floating point number in dB.
 - 12. Min Subcarrier Flatness Index for section 2 – an integer number
-

This key selects the Spectral Flatness measurement.

Key Path	Meas
Mode	WLAN
Initial S/W Revision	A.10.01

AMPTD Y Scale

Accesses the AMPTD Y Scale menu that allows you to set desired vertical scale settings.

Key Path	Front Panel key
Initial S/W Revision	A.10.01

Ref Value

Sets the relative power reference.

Key Path	AMPTD Y Scale
Mode	WLAN
Remote Command	:DISPlay:FLATness:VIEW[1]:WINDow[1]:TRACe:Y[:SCALe]:RLEVel <rel_ampl> :DISPlay:FLATness:VIEW[1]:WINDow[1]:TRACe:Y[:SCALe]:RLEVel?
Example	DISP:FLAT:VIEW:WIND:TRAC:Y:RLEV 5db DISP:FLAT:VIEW:WIND:TRAC:Y:RLEV?
Couplings	When Auto Scaling is set to On, this value is automatically determined by the measurement result. When you set this value manually, Auto Scaling is automatically set to Off.
Preset	4.0
State Saved	Saved in instrument state.
Min	-20.0
Max	20.0
Initial S/W Revision	A.10.01

Attenuation

This menu controls the attenuator functions and interactions between the attenuation system components.

There are two attenuator configurations in the X-Series. One is a dual attenuator configuration consisting of a mechanical attenuator and an optional electronic attenuator. The other configuration uses a single attenuator with combined mechanical and electronic sections that controls all the attenuation functions. Different models in the X-Series come with different configurations.

See ["Dual Attenuator Configurations:" on page 1550](#)

See ["Single Attenuator Configuration:" on page 1550](#)

Most Attenuation settings are the same for all measurements – they do not change as you change measurements. Settings like these are called “Meas Global” and are unaffected by Meas Preset.

Key Path	AMPTD Y Scale
----------	---------------

Scope	Meas Global
Dependencies	In measurements that support the I/Q inputs, this key is unavailable when I/Q is the selected input, and is replaced by the Range key in that case.
Readback Line	Contains a summary in [] brackets of the current total attenuation. See the descriptions of the , " (Mech) Atten " on page 2160, and " Enable Elec Atten " on page 2162 keys for more detail on the contributors to the total attenuation. Note that when "Pre-Adjust for Min Clip" is on, this value can change at the start of every measurement.
Initial S/W Revision	Prior to A.02.00
Modified at S/W Revision	A.03.00

Dual Attenuator Configurations:

Configuration 1: Mechanical attenuator + optional electronic attenuator

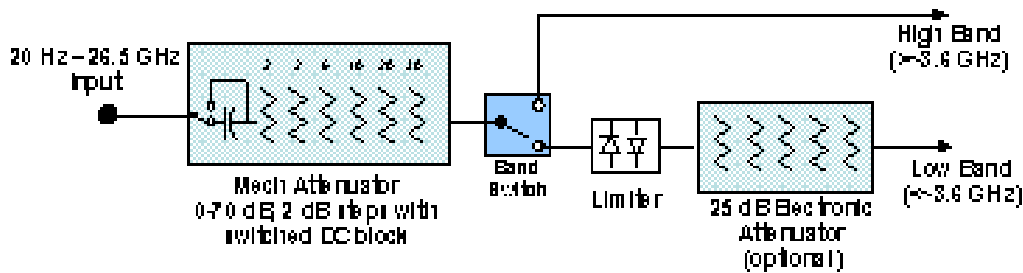

Configuration 2: Mechanical attenuator, no optional electronic attenuator

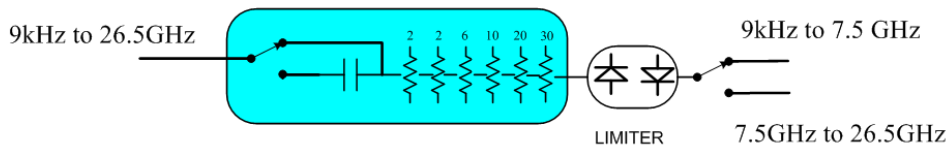

(note that Configuration 2 is not strictly speaking a dual-section attenuator, since there is no electronic section available. However, it behaves exactly like Configuration 1 without the Electronic Attenuator option EA3, therefore for the sake of this document it is grouped into the "Dual Attenuator" configuration)

Single Attenuator Configuration:

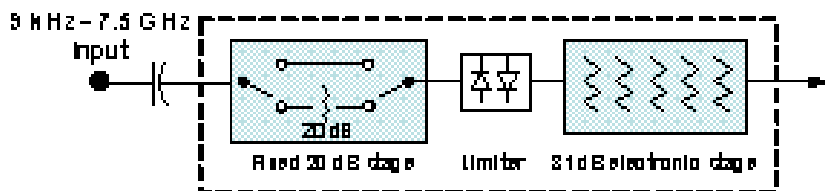

You can tell which attenuator configuration you have by pressing the Attenuation key, which (in most Modes) opens the Attenuation menu. If the first key in the Attenuation menu says Mech Atten you have the dual attenuator configuration. If the first key says Atten you have the single attenuator configuration.

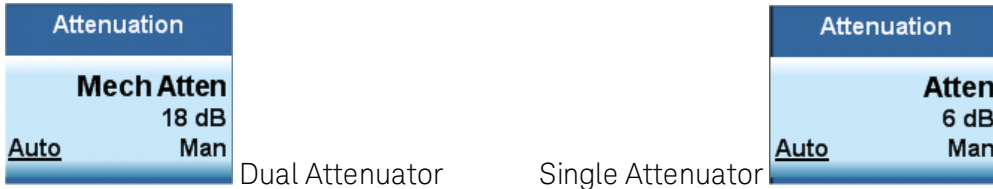

In the single attenuator configuration, you control the attenuation with a single control, as the fixed stage has only two states. In the dual attenuator configuration, both stages have significant range so you are given separate control of the mechanical and electronic attenuator stages.

When you have the dual attenuator configuration, you may still have only a single attenuator, because unless option EA3 (the Electronic Attenuator option) is available, and you purchase it, you will have only the mechanical attenuator.

(Mech) Atten

This key is labeled Mech Atten in dual attenuator models and Atten in single attenuator models. In the dual attenuator configuration, this key only affects the mechanical attenuator.

This key lets you modify the attenuation applied to the RF input signal path. This value is normally auto coupled to the Ref Level, the Internal Preamp Gain, any External Gain that is entered, and the Max Mixer Level, as described in the table below.

See ["Attenuator Configurations and Auto/Man" on page 1552](#)

Key Path	AMPTD Y Scale, Attenuation
Remote Command	[:SENSe]:POWer[:RF]:ATTenuation <rel_amp1> [:SENSe]:POWer[:RF]:ATTenuation? [:SENSe]:POWer[:RF]:ATTenuation:AUTO OFF ON 0 1 [:SENSe]:POWer[:RF]:ATTenuation:AUTO?
Example	POW:ATT 20 Dual attenuator configuration: sets the mechanical attenuator to 20 dB Single attenuator mode: sets the main attenuation to 20 dB (see below for definition of "main" attenuation). If the attenuator was in Auto, it sets it to Manual.
Dependencies	Some measurements do not support the Auto setting of (Mech) Atten. In these measurements, the Auto/Man selection is not available, and the Auto/Man line on the key disappears. In dual attenuator configurations, when the electronic attenuator is enabled, the mechanical attenuator has no auto setting and the Auto/Man line on the key disappears. The state of Auto/Man is remembered and restored when the electronic attenuator is once again disabled. This is described in more detail in the "Enable Elec Atten" on page 2162 key description. See "Attenuator Configurations and Auto/Man" on page 1552 for more information on the Auto/Man functionality of Attenuation.
Couplings	

	<p>When (Mech) Atten is in Auto, it uses the following algorithm to determine a value: If the USB Preamp is connected to USB, use 0 dB. Otherwise, $Atten = ReferenceLevel + PreAmpGain + ExternalGain - RefLevelOffset - MaxMixerLevel + IF\ Gain$. Limit this value to be between 6 dB and the Max value. No value below 6 dB can ever be chosen by Auto. The resulting value is rounded up to the largest value possible given the attenuation step setting. That is, 50.01 dB would change to 60 dB (for a 10 dB attenuation step). The "IF Gain" term in the equation above is either 0 dB or +10 dB, depending on the settings of FFT IF Gain, Swept IF Gain, max Ref Level and the Auto/Man setting of Mech Atten. In External Mixing and BBIQ, where the Attenuator is not in the signal path, the Attenuator setting changes as described above when (Mech) Atten is in Auto, but no changes are made to the actual attenuator hardware setting until the input is changed back to the RF Input.</p>
Preset	<p>The preset for Mech Attenuation is "Auto." The Auto value of attenuation is: CXA, EXA, MXA and PXA: 10 dB</p>
State Saved	<p>Saved in instrument state</p>
Min	<p>0 dB The attenuation set by this key cannot be decreased below 6 dB with the knob or step keys. To get to a value below 6 dB it has to be directly entered from the keypad or via SCPI. This protects from adjusting the attenuation to a dangerously small value which can put the instrument at risk of damage to input circuitry. However, if the current mechanical attenuation is below 6 dB it can be increased with the knob and step keys, but not decreased.</p>
Max	<p>CXA N9000A-503/507: 50 dB CXA N9000A-513/526: 70dB EXA: 60 dB MXA and PXA: 70 dB In the single attenuator configuration, the total of ATT and EATT cannot exceed 50 dB, so if the EATT is set to 24 dB first, the main attenuation cannot be greater than 26 dB and will be reduced accordingly; if the main attenuator is set to 40 dB first, EATT cannot be greater than 10 dB.</p>
Initial S/W Revision	<p>Prior to A.02.00</p>
Modified at S/W Revision	<p>A.03.00</p>

Attenuator Configurations and Auto/Man

As described in the Attenuation key description, there are two distinct attenuator configurations available in the X-Series, the single attenuator and dual attenuator configurations. In dual attenuator configurations, we have the mechanical attenuation and the electronic attenuation, and the current total attenuation is the sum of the electronic + mechanical attenuation. In single attenuator configurations, we refer to the attenuation set using the (Mech) Atten key (or POW:ATT SCPI) as the "main" attenuation; and the attenuation that is set by the SCPI command POW:EATT as the "soft" attenuation (the POW:EATT command is honored even in the single attenuator configuration, for compatibility purposes). Then the

current total attenuation is the sum of the main + soft attenuation. See the Elec Atten key description for more on “soft” attenuation.

In the dual attenuator configuration, when the electronic attenuator is enabled, there is no Auto/Man functionality for the mechanical attenuator, and the third line of the key label (the Auto/Man line) disappears:



Enable Elec Atten

Enables the Electronic Attenuator.

The electronic attenuator offers finer steps than the mechanical attenuator, has no acoustical noise, is faster, and is less subject to wear. These advantages primarily aid in remote operation and are negligible for front panel use. See ["Using the Electronic Attenuator: Pros and Cons" on page 1555](#) for a detailed discussion of the pros and cons of using the electronic attenuator.

For the single attenuator configuration, for SCPI backwards compatibility, the “soft” attenuation feature replaces the dual attenuator configuration’s electronic attenuator. All the same couplings and limitations apply. See ["Attenuator Configurations and Auto/Man" on page 2162](#)

See ["More Information" on page 1554](#)

Key Path	AMPTD Y Scale, Attenuation
Remote Command	[:SENSe]:POWer[:RF]:EATTenuation:STATe OFF ON 0 1 [:SENSe]:POWer[:RF]:EATTenuation:STATe?
Example	POW:EATT:STAT ON
Dependencies	<p>This key only appears in Dual Attenuator models with an Electronic Attenuator installed. It does not appear in models with the Single Attenuator configuration, as in the single attenuator configuration there is no “electronic attenuator” there is only a single integrated attenuator (which has both a mechanical and electronic stage). However, in the single attenuator configuration, EATT SCPI commands are accepted for compatibility with other X-series instruments and set a “soft” attenuation as described in "Attenuator Configurations and Auto/Man" on page 2162.</p> <p>The electronic attenuator (and the “soft” attenuation function provided in single attenuator configurations) is unavailable above 3.6 GHz. Therefore, if the Stop Frequency of the analyzer is > 3.6 GHz then the Enable Elec Atten key will be OFF and grayed out.</p> <p>If the Internal Preamp is on, meaning it is set to Low Band or Full, the electronic attenuator (and the “soft” attenuation function provided in single attenuator configurations) is unavailable. In this case the Enable Elec Atten key will be OFF and grayed out.</p> <p>If either of the above is true, if the SCPI command is sent, an error indicating that the electronic attenuator is unavailable will be sent.</p> <p>If the electronic/soft Attenuator is enabled, then the Stop Freq of the analyzer is limited to 3.6 GHz and the Internal Preamp is unavailable.</p> <p>The SCPI-only “soft” electronic attenuation for the single-attenuator configuration is not available in</p>

	all measurements; in particular, it is not available in the Swept SA measurement.
Couplings	Enabling and disabling the Electronic Attenuator affects the setting of the Mechanical Attenuator (in dual attenuator configurations). This is described in more detail below this table.
Preset	OFF for Swept SA measurement; ON for all other measurements that support the electronic attenuator
State Saved	Saved in instrument state
Initial S/W Revision	Prior to A.02.00
Modified at S/W Revision	A.03.00

More Information

Mechanical Attenuator Transition Rules

When the Electronic Attenuator is enabled, the Mechanical Attenuator transitions to a state that has no Auto function. Below are the rules for transitioning the Mechanical Attenuator. NOTE that the information below ONLY applies to the dual attenuator configurations, and ONLY when the Electronic Attenuator is installed:

When the Electronic Attenuation is enabled from a disabled state:

- The Mechanical Attenuator is initialized to 10 dB (this is its optimal performance setting). You can then set it as desired with SCPI, numeric keypad, step keys, or knob, and it behaves as it normally would in manual mode
- The Auto/Man state of (Mech) Atten is saved
- The Auto/Man line on the (Mech) Atten key disappears and the auto rules are disabled
- The Electronic Attenuator is set to 10 dB less than the previous value of the Mechanical Attenuator, within the limitation that it must stay within the range of 0 to 24 dB of attenuation.

Examples in the dual attenuator configuration:

- Mech Atten at 20 dB. Elec Atten enabled, Mech Atten set to 10 dB, and Elec Atten set to 10 dB. New total attenuation equals the value before Elec Atten enabled.
- Mech Atten at 0 dB. Elec Atten enabled, Mech Atten set to 10 dB, and Elec Atten set to 0 dB. New total attenuation does not equal the value before Elec Atten enabled.
- Mech Atten at 40 dB. Elec Atten enabled, Mech Atten set to 10 dB, and Elec Atten set to 24 dB. New total attenuation does not equal the value before Elec Atten enabled.

When the Electronic Attenuation is disabled from an enabled state:

- The Elec Atten key is grayed out
- The Auto/Man state of (Mech) Atten is restored
- If now in Auto, (Mech) Atten recouples

- If now in Man, (Mech) Atten is set to the value of total attenuation that existed before the Elec Atten was disabled. The resulting value is rounded up to the smallest value possible given the (Mech) Atten Step setting - (That is, 57 dB changes to 58 dB when (Mech) Atten Step is 2 dB.)

Using the Electronic Attenuator: Pros and Cons

The electronic attenuator offers finer steps than the mechanical attenuator, has no acoustical noise, is faster, and is less subject to wear.

The “finer steps” advantage of the electronic attenuator is beneficial in optimizing the alignment of the analyzer dynamic range to the signal power in the front panel as well as remote use. Thus, you can achieve improved relative signal measurement accuracy. Compared to a mechanical attenuator with 2 dB steps, the 1 dB resolution of the electronic attenuator only gives better resolution when the odd-decibel steps are used. Those odd-decibel steps are less accurately calibrated than the even-decibel steps, so one tradeoff for this superior relative accuracy is reduced absolute amplitude accuracy.

Another disadvantage of the electronic attenuator is that the spectrum analyzer loses its “Auto” setting, making operation less convenient.

Also, the relationship between the dynamic range specifications (TOI, SHI, compression and noise) and instrument performance are less well-known with the electrical attenuator. With the mechanical attenuator, TOI, SHI and compression threshold levels increase dB-for-dB with increasing attenuation, and the noise floor does as well. With the electronic attenuator, there is an excess attenuation of about 1 to 3 dB between 0 and 3.6 GHz, making the effective TOI, SHI, and so forth, less well known. Excess attenuation is the actual attenuation relative to stated attenuation. Excess attenuation is accounted for in the analyzer calibration

Elec Atten

Controls the Electronic Attenuator in dual attenuator configurations. This key does not appear in single attenuator configurations, as the control of both the mechanical and electronic stages of the single attenuator is integrated into the single Atten key.

Key Path	AMPTD Y Scale, Attenuation
Remote Command	<code>[:SENSe] :POWer [:RF] :EATTenuation <rel_ampl></code> <code>[:SENSe] :POWer [:RF] :EATTenuation?</code>
Notes	Electronic Attenuation's specification is defined only when Mechanical Attenuation is 6 dB.
Dependencies	This key only appears in Dual Attenuator models with an Electronic Attenuator installed. It does not appear in models with the Single Attenuator configuration, as in the single attenuator configuration there is no “electronic attenuator” there is only a single integrated attenuator (which has both a mechanical and electronic stage). However, in the single attenuator configuration, EATT SCPI commands are accepted for compatibility with other X-series instruments and set a “soft” attenuation as described in "Attenuator Configurations and Auto/Man" on page 2162 . The “soft” attenuation is treated as an addition to the “main” attenuation value set by the Atten softkey or the POW:ATT SCPI command and affects the total attenuation displayed on the Attenuation key and the Meas Bar. When Enable Elec Atten is off or grayed out, the Elec Atten key is grayed out.
Preset	0 dB
State Saved	Saved in instrument state

Min	0 dB
Max	Dual attenuator configuration: 24 dB Single attenuator configuration: the total of ATT and EATT cannot exceed 50 dB, so if the EATT is set to 24 dB first, the main attenuation cannot be greater than 26 dB and will be reduced accordingly; if the main attenuator is set to 40 dB first, EATT cannot be greater than 10 dB
Initial S/W Revision	Prior to A.02.00
Modified at S/W Revision	A.03.00

Adjust Atten for Min Clip

Sets the combination of mechanical and electronic attenuation and gain based on the current measured signal level so that clipping will be at a minimum.

This is an "immediate action" function, that is, it executes once, when the key is pressed.

This key is grayed out in measurements that do not support this functionality. The spectrum analyzer measurement, Swept SA, does not support this functionality.

Key Path	AMPTD Y Scale, Attenuation
Remote Command	<code>[:SENSe] :POWeR [:RF] :RANGe:OPTimize IMMEDIATE</code>
Initial S/W Revision	Prior to A.02.00
Modified at S/W Revision	A.03.00

Pre-Adjust for Min Clip

If this function is on, it does the adjustment described under "[Adjust Atten for Min Clip](#)" on page 2165 each time a measurement restarts. Therefore, in Continuous measurement mode, it only executes before the first measurement.

In dual attenuator models, you can set Elec+Mech Atten, in which case both attenuators participate in the autoranging, or Elec Atten Only, in which case the mechanical attenuator does not participate in the autoranging. This latter case results in less wear on the mechanical attenuator and is usually faster.

This key is grayed out in measurements that do not support this functionality. The spectrum analyzer measurement, Swept SA, does not support this functionality.

Key Path	AMPTD Y Scale, Attenuation
Remote Command	<code>[:SENSe] :POWeR [:RF] :RANGe:OPTimize:ATTenuation OFF ELEctrical COMBined</code> <code>[:SENSe] :POWeR [:RF] :RANGe:OPTimize:ATTenuation?</code>
Notes	The SCPI parameter ELEctrical sets this function to On in single attenuator models. The SCPI parameter COMBined is mapped to ELEctrical in single attenuator models; if you send COMBined, it sets the function to On and returns ELEC to a query.
Dependencies	This key only appears in Dual Attenuator models with an Electronic Attenuator installed.

	In instruments with Dual Attenuator model, when Enable Elec Atten is off or grayed out, the Pre-Adjust for Min Clip key is grayed out.
Preset	OFF for Swept SA measurement; ON for all other measurements that support Pre-Adjust for Min Clip
State Saved	Saved in instrument state
Range	Dual attenuator models: Off Elec Atten Only Mech + Elec Atten Single attenuator models: Off On
Initial S/W Revision	Prior to A.02.00
Modified at S/W Revision	A.03.00

Remote Command	<code>[:SENSe] :POWer [:RF] :RANGe :AUTO ON OFF 1 0</code> <code>[:SENSe] :POWer [:RF] :RANGe :AUTO ?</code>
Notes	ON aliases to "Elec Atten Only" (:POW:RANG:OPT:ATT ELEC) OFF aliases to "Off" (:POW:RANG:OPT:ATT OFF) The query :POW:RANG:AUTO? returns true if :POW:RANG:OPT:ATT is not "Off"
Initial S/W Revision	Prior to A.02.00

Off

Turns Pre-Adjust for Min Clip off. This is the default setting.

This key is grayed out in measurements that do not support this functionality. The spectrum analyzer measurement, Swept SA, does not support this functionality.

Key Path	AMPTD Y Scale, Attenuation, Pre-Adjust for Min Clip
Example	:POW:RANG:OPT:ATT OFF
Initial S/W Revision	Prior to A.02.00

Elec Atten Only

Selects only the electric attenuator to participate in auto ranging. This offers less wear on the mechanical attenuator and is usually faster.

This key is grayed out in measurements that do not support this functionality. The spectrum analyzer measurement, Swept SA, does not support this functionality.

Key Path	AMPTD Y Scale, Attenuation, Pre-Adjust for Min Clip
Example	:POW:RANG:OPT:ATT ELEC
Initial S/W Revision	Prior to A.02.00

Mech + Elec Atten

In dual attenuator models, this selects both attenuators participate in the autoranging.

This key is grayed out in measurements that do not support this functionality. The spectrum analyzer measurement, Swept SA, does not support this functionality.

Key Path	AMPTD Y Scale, Attenuation, Pre-Adjust for Min Clip
Example	:POW:RANGe:OPT:ATT COMB
Initial S/W Revision	Prior to A.02.00

(Mech) Atten Step

This controls the step size used when making adjustments to the input attenuation.

This key is labeled Mech Atten Step in dual attenuator models and Atten Step in single attenuator models. In the dual attenuator configuration, this key only affects the step size of the mechanical attenuator.

Key Path	AMPTD Y Scale, Attenuation
Remote Command	[:SENSe] :POWer [:RF] :ATTenuation :STEP [:INCRement] 10 dB 2 dB [:SENSe] :POWer [:RF] :ATTenuation :STEP [:INCRement] ?
Example	POW:ATT:STEP 2
Notes	Note this feature works like a 1-N choice from the front panel, but it takes a specific value (in dB) when used remotely. The only valid values are 2 and 10.
Dependencies	Blanked in CXA and EXA if option FSA (2 dB steps) is not present. If blanked, attempts to set it via SCPI will yield an error.
Couplings	When the attenuation step size changes, the current mechanical attenuation value is adjusted (if necessary) to be quantized to the new step size. That is, if step is set to 10 dB, mech atten is increased if necessary so it is a multiple of 10 dB
Preset	PXA and MXA: 2 dB EXA and CXA: 10 dB (2 dB with option FSA)
State Saved	Saved in instrument state
Initial S/W Revision	Prior to A.02.00
Modified at S/W Revision	A.03.00

Scale/Div

Allows you to enter a numeric value to change vertical display sensitivity.

Key Path	AMPTD Y Scale
----------	---------------

Mode	WLAN
Remote Command	:DISPlay:FLATness:VIEW[1]:WINDow[1]:TRACe:Y[:SCALE]:PDIVision <rel_ ampl> :DISPlay:FLATness:VIEW[1]:WINDow[1]:TRACe:Y[:SCALE]:PDIVision?
Example	DISP:FLAT:VIEW:WIND:TRAC:Y:PDIV 10dB DISP:FLAT:VIEW:WIND:TRAC:Y:PDIV?
Couplings	When the Auto Scaling is set to On, this value is automatically determined by the measurement result. When you set a value manually, Auto Scaling is automatically set to Off.
Preset	1.0 dB
State Saved	Saved in instrument state.
Min	0.1 dB
Max	5.0 dB
Initial S/W Revision	A.10.01

Presel Center

When this key is pressed, the centering of the preselector filter is adjusted to optimize the amplitude accuracy at the frequency of the selected marker. If the selected marker is not on when Presel Center is pressed, the analyzer will turn on the selected marker, perform a peak search, and then perform centering on the marker's center frequency. If the selected marker is already on and between the start and stop frequencies of the analyzer, the analyzer performs the preselector calibration on that marker's frequency. If the selected marker is already on, but outside the frequency range between Start Freq and Stop Freq, the analyzer will first perform a peak search, and then perform centering on the marker's center frequency.

The value displayed on the Presel Adjust key will change to reflect the new preselector tuning (see Presel Adjust).

A number of considerations should be observed to ensure proper operation. See ["Proper Preselector Operation" on page 1560](#).

Key Path	AMPTD Y Scale
Remote Command	[:SENSe]:POWer[:RF]:PCENter
Example	POW:PCEN
Notes	Note that the rules outlined above under the key description apply for the remote command as well as the key. The result of the command is dependent on marker position, and so forth. Any message shown by the key press is also shown in response to the remote command.
Dependencies	<ul style="list-style-type: none"> • Grayed out if the microwave preselector is off.) • If the selected marker's frequency is below Band 1, advisory message 0.5001 is generated and no action is taken. • Grayed out if entirely in Band 0. • Blank in models that do not include a preselector, such as option 503. If the SCPI is sent in these instruments, it is accepted without error, and the query always returns 0. • Grayed out in the Spectrogram View.

Couplings	The active marker position determines where the centering will be attempted. If the analyzer is in a measurement such as averaging when centering is initiated, the act of centering the preselector will restart averaging but the first average trace will not be taken until the centering is completed.
Status Bits/OPC dependencies	When centering the preselector, *OPC will not return true until the process is complete and a subsequent measurement has completed, nor will results be returned to a READ or MEASure command. The Measuring bit should remain set while this command is operating and should not go false until the subsequent sweep/measurement has completed.
Initial S/W Revision	Prior to A.02.00
Modified at S/W Revision	A.03.00

Proper Preselector Operation

A number of considerations should be observed to ensure proper operation:

1. If the selected marker is off, the analyzer will turn on a marker, perform a peak search, and adjust the preselector using the selected marker's frequency. It uses the "highest peak" peak search method unqualified by threshold or excursion, so that there is no chance of a 'no peak found' error. It continues with that peak, even if it is the peak of just noise. Therefore, for this operation to work properly, there should be a signal on screen in a preselected range for the peak search to find.
2. If the selected marker is already on, the analyzer will attempt the centering at that marker's frequency. There is no preselector for signals below about 3.6 GHz, therefore if the marker is on a signal below 3.6 GHz, no centering will be attempted and an advisory message generated
3. In some models, the preselector can be bypassed. If it is bypassed, no centering will be attempted in that range and a message will be generated.

Preselector Adjust

Allows you to manually adjust the preselector filter frequency to optimize its response to the signal of interest. This function is only available when "Presel Center" on page 2168 is available.

For general purpose signal analysis, using Presel Center is recommended. Centering the filter minimizes the impact of long-term preselector drift. Presel Adjust can be used instead to manually optimize the preselector. One application of manual optimization would be to peak the preselector response, which both optimizes the signal-to-noise ratio and minimizes amplitude variations due to small (short-term) preselector drifting.

Key Path	AMPTD Y Scale
Scope	Meas Global
Remote Command	<code>[:SENSe] :POWer [:RF] :PADJust <freq></code> <code>[:SENSe] :POWer [:RF] :PADJust?</code>

Example	POW:PADJ 100KHz POW:PADJ?
Notes	The value on the key reads out to 0.1 MHz resolution.
Dependencies	<ul style="list-style-type: none"> • Grayed out if microwave preselector is off.) • Grayed out if entirely in Band 0. • Blank in models that do not include a preselector, such as option 503. If the SCPI is sent in these instruments, it is accepted without error, and the query always returns 0. • Grayed out in the Spectrogram View.
Preset	0 MHz
State Saved	The Presel Adjust value set by Presel Center, or by manually adjusting Presel Adjust, is not saved in instrument state, and does not survive a Preset or power cycle.
Min	-500 MHz
Max	500 MHz
Default Unit	Hz
Backwards Compatibility SCPI	<pre>[:SENSe] :POWer [:RF] :MW :PADJust</pre> <pre>[:SENSe] :POWer [:RF] :MMW :PADJust</pre> <p>PSA had multiple preselectors, but the X-Series has only one. These commands simply alias to [:SENSe]:POWer[:RF]:PADJust</p>
Initial S/W Revision	Prior to A.02.00
Modified at S/W Revision	A.03.00

Remote Command	<pre>[:SENSe] :POWer [:RF] :PADJust :PRESelector MWAVE MMWave EXTernal</pre> <pre>[:SENSe] :POWer [:RF] :PADJust :PRESelector?</pre>
Notes	<p>PSA had multiple preselectors, and you could select which preselector to adjust. Since the X-Series has only one mm/uW preselector, the preselector selection softkey is no longer available. However, to provide backward compatibility, we accept the legacy remote commands.</p> <p>The command form has no effect, the query always returns MWAVE</p>
Initial S/W Revision	Prior to A.02.00

μW Path Control

Sets the μW Path Control function to Auto, standard path, μW Preselector Bypass (Option MPB) and Low Noise Path(Option LNP).

Key Path	AMPTD/Y Scale
Initial S/W Revision	A.14.50

μW Path Control Auto

Activates the auto rules for μW Path Control. When Auto is active, the μW Path Control is set to Preselector Bypass in modulation analysis and spectral flatness measurement; it is set to standard path in other measurements.

Key Path	AMPTD/Y Scale
Remote Command	[:SENSe] :POWer [:RF] :MW:PATH:AUTO ON OFF 1 0 [:SENSe] :POWer [:RF] :MW:PATH:AUTO?
Example	POW:MW:PATH:AUTO ON POW:MW:PATH:AUTO?
Couplings	When Auto is active, the μW Path Control is set to μW Preselector Bypass in IQ measurements (IQ waveform, CCDF, PVT, EVM, Spetrum flatness and WLS); it is set to standard path in other measurements.
Preset	ON
Range	Off On
Initial S/W Revision	A.14.50

Standard Path

This path gives the best remote-control throughput, minimizes acoustic noise from switching and minimizes the risk of wear in the hardware switches, particularly in remote test scenarios where both low band and high band setups will follow in rapid succession.

In this path, the bypass of the low band/high band switch and microwave preamp is never activated, which can cause some noise degradation but preserves the life of the bypass switch.

Key Path	AMPTD Y Scale, μW Path Control
Example	:POW:MW:PATH STD
Readback Text	Standard Path
Initial S/W Revision	A.04.00

Low Noise Path Enable

You may choose Low Noise Path Enable, which gives a lower noise floor under some circumstances, particularly when operating in the 21–26.5 GHz region. With the Low Noise Path enabled, the low band/high band switch and microwave preamp are bypassed whenever all of the following are true:

- The analyzer is not in the Low Band, meaning:
- the start frequency is above 3.5 GHz and
- the stop frequency is above 3.6 GHz.
- the internal preamp is not installed or (if installed) is set to Off or Low Band

Note that this means that, when any part of a sweep is done in Low Band, the Low Noise Path is not used, whether or not the Low Noise Path Enable is selected in the user interface. Also, if the preamp is turned on, the Low Noise Path is not used, whether or not the Low Noise Path Enable is selected in the user interface. The only time the Low Noise Path is used is when Low Noise Path Enable is selected, the sweep is completely in High Band (> 3.6 GHz) and no preamp is in use.

See ["More Information" on page 1563](#)

Key Path	AMPTD Y Scale, μ W Path Control
Measurement	Swept SA
Example	:POW:MW:PATH LNP
Notes	<p>For measurements that use IQ acquisition, the low noise path is used when the Center Frequency is in High Band (> 3.6 GHz) and no preamp is in use.</p> <p>In other words, the rules above are modified to use only the center frequency to qualify which path to switch in.</p> <p>This is not the case for FFT's in the Swept SA measurement; they use the same rules as swept measurements.</p>
Dependencies	<p>Key is blanked if current mode does not support it.</p> <p>Key is grayed out if mode supports it but current measurement does not support it.</p> <p>Unless Option LNP is present and licensed, key is blank and if SCPI command sent, error -241, "Hardware missing; Option not installed" is generated.</p>
Readback Text	Low Noise Path Enable
Initial S/W Revision	A.04.00

More Information

The user should understand that the Low Noise Path, while giving improved DANL, has the disadvantage of decreased TOI performance and decreased gain compression performance relative to the standard path.

The user should also understand that the bypass switch is a mechanical switch and has finite life, so if the Low Noise Path is enabled, it is possible to cause frequent cycling of this switch by frequently changing analyzer settings such that the above conditions hold true only some of the time. A user making tests of this nature should consider opting for the Standard Path, which will never throw the bypass switch, at the expense of some degraded noise performance.

The low noise path is useful for situations where the signal level is so low that the analyzer performance is dominated by noise even with 0 dB attenuation, but still high enough that the preamp option would have excessive third-order intermodulation or compression. The preamp, if purchased and used, gives better noise floor than does the "Low Noise Path." However, its compression threshold and third-order intercept are much poorer than that of the non-preamp path. There are some applications, typically for signals around -30 dBm, for which the third-order dynamic range of the standard path is good enough, but the noise floor is not low enough even with 0 dB input attenuation. When the third-order dynamic range of the preamp path is too little and the noise floor of the standard path is too high, the Low Noise Path can provide the best dynamic range

The graph below illustrates the concept. It shows, in red, the performance of an analyzer at different attenuation settings, both with the preamp on and off, in a measurement that is affected by both analyzer

noise and analyzer TOI. The green shows the best available dynamic range, offset by 0.5 dB for clarity. The blue shows how the best available dynamic range improves for moderate signal levels with the low noise path switched in. In this illustration, the preamp improves the noise floor by 15 dB while degrading the third-order intercept by 30 dB, and the low noise path reduces loss by 8 dB. The attenuator step size is 2 dB.

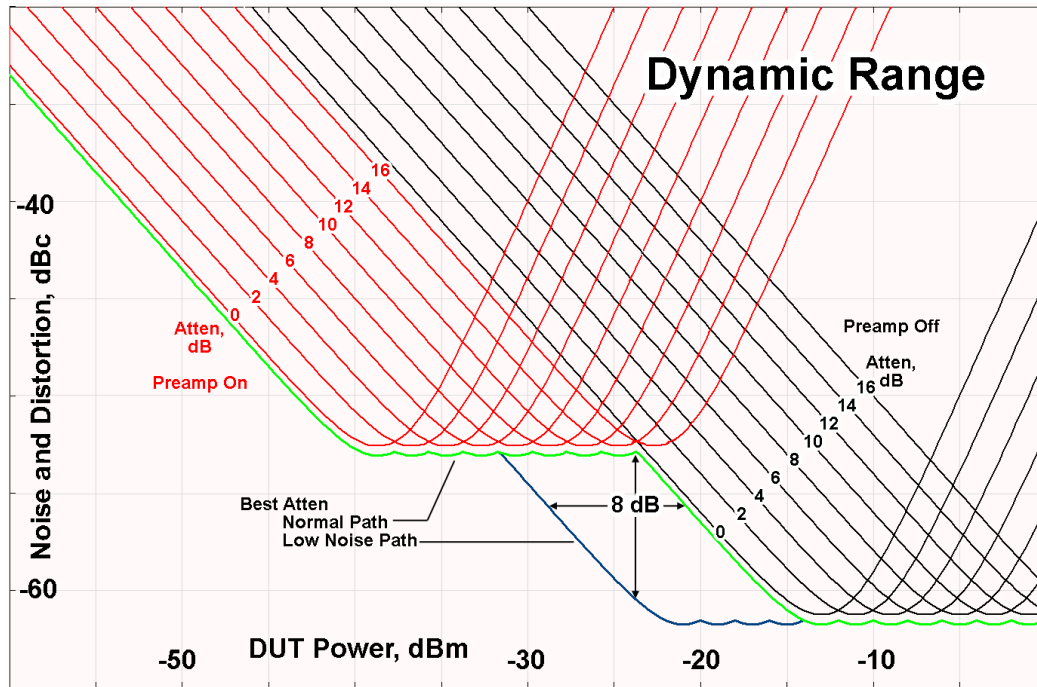

There are other times where selecting the low noise path improves performance, too. Compression-limited measurements such as finding the nulls in a pulsed-RF spectrum can profit from the low noise path in a way similar to the TOI-limited measurement illustrated. Accuracy can be improved when the low noise path allows the optimum attenuation to increase from a small amount like 0, 2 or 4 dB to a larger amount, giving better return loss at the analyzer input. Harmonic measurements, such as second and third harmonic levels, are much improved using the low noise path because of the superiority of that path for harmonic (though not intermodulation) distortion performance.

μW Preselector Bypass

This key toggles the preselector bypass switch for band 1 and higher. When the microwave preselector is on, the signal path is preselected. When the microwave preselector is off, the signal path is not preselected. The preselected path is the normal path for the analyzer.

The preselector is a tunable bandpass filter which prevents signals away from the frequency of interest from combining in the mixer to generate in-band spurious signals (images). The consequences of using a preselector filter are its limited bandwidth, the amplitude and phase ripple in its passband, and any amplitude and phase instability due to center frequency drift.

Option MPB or pre-selector bypass provides an unpreselected input mixer path for certain X-Series signal analyzers with frequency ranges above 3.6 GHz. This signal path allows a wider bandwidth and less amplitude variability, which is an advantage when doing modulation analysis and broadband signal analysis. The disadvantage is that, without the preselector, image signals will be displayed. Another disadvantage of bypassing the preselector is increased LO emission levels at the front panel input port.

Image responses are separated from the real signal by twice the 1st IF. For IF Paths of 10 MHz and 25 MHz, the 1st IF is 322.5 MHz, so the image response and the real signal will be separated by 645 MHz. The 1st IF will be different for other IF Path settings. When viewing a real signal and its corresponding image response in internal mixing, the image response will be to the left of the real signal.

Also, the image response and the real signal typically have the same amplitude and exhibit the same shape factor.

However, if Option FS1, Fast Sweep Capability, is enabled, the image response in the Swept SA measurement will appear lower in amplitude and have a much wider shape factor compared to the real signal.

Key Path	AMPTD Y Scale, μ W Path Control
Example	:POW:MW:PATH MPB
Dependencies	Key is blanked if current mode does not support it. Key is grayed out if mode supports it but current measurement does not support it. Key is blank unless Option MPB is present and licensed. If SCPI command sent when MPB not present, error -241, "Hardware missing; Option not installed" is generated.
Readback Text	μ W Preselector Bypass
Initial S/W Revision	A.04.00

Remote Command	[:SENSe] :POWer [:RF] :MW:PRESelector [:STATe] ON OFF 0 1 [:SENSe] :POWer [:RF] :MW:PRESelector [:STATe] ?
Example	:POW:MW:PRES OFF Bypasses the microwave preselector
Notes	The ON parameter sets the STD path (:POW:MW:PATH STD) The OFF parameter sets path MPB (:POW:MW:PATH MPB)
Preset	ON

Internal Preamp

Accesses a menu of keys that control the internal preamps. Turning on the preamp gives a better noise figure, but a poorer TOI to noise floor dynamic range. You can optimize this setting for your particular measurement.

The instrument takes the preamp gain into account as it sweeps. If you sweep outside of the range of the preamp the instrument will also account for that. The displayed result will always reflect the correct gain.

For some measurements, when the preamp is on and any part of the displayed frequency range is below the lowest frequency for which the preamp has specifications, a warning condition message appears in the status line. For example, for a preamp with a 9 kHz lowest specified frequency: "Preamp: Accy unspec'd below 9 kHz".

Key Path	AMPTD Y Scale
----------	---------------

Scope	Meas Global
Remote Command	<code>[:SENSe] :POWeR [:RF] :GAIN [:STATe] OFF ON 0 1</code> <code>[:SENSe] :POWeR [:RF] :GAIN [:STATe] ?</code>
Dependencies	Preamp is not available on all hardware platforms. If the preamp is not present or is unlicensed, the key is not shown. The preamp is not available when the electronic/soft attenuator is enabled.
Couplings	The act of connecting the U7227A USB Preamplifier to one of the analyzer's USB ports will cause the Internal Preamp to be switched on. When this happens an informational message will be generated: "Internal Preamp turned on for optimal operation with USB Preamp." Note that if the Internal Preamp was already on, there will be no change to the setting, but if it was Off it will be switched On, to Full Range. Note that this same action occurs when the SA mode is selected while the USB Preamp is connected to one of the analyzer's USB ports, if it is the first time that the SA mode has run since powerup, or if the last time the SA mode was running the USB Preamp was NOT connected. Subsequently disconnecting the USB Preamp from USB does not change the Internal Preamp setting nor restore the previous setting.
Preset	OFF
State Saved	Saved in instrument state
Initial S/W Revision	Prior to A.02.00
Modified at S/W Revision	A.14.00

Key Path	AMPTD Y Scale, Internal Preamp
Scope	Meas Global
Remote Command	<code>[:SENSe] :POWeR [:RF] :GAIN :BAND LOW FULL</code> <code>[:SENSe] :POWeR [:RF] :GAIN :BAND ?</code>
Dependencies	Preamp is not available on all hardware platforms. If the preamp is not present or is unlicensed, the key is not shown. If a POW:GAIN:BAND FULL command is sent when a low band preamp is available, the preamp band parameter is to LOW instead of FULL, and an "Option not installed" message is generated.
Preset	LOW
State Saved	Saved in instrument state
Initial S/W Revision	Prior to A.02.00

Off

Turns the internal preamp off

Key Path	AMPTD Y Scale, Internal Preamp
----------	--------------------------------

Example	:POW:GAIN OFF
Readback	Off
Initial S/W Revision	Prior to A.02.00

Low Band

Sets the internal preamp to use only the low band.

The frequency range of the installed (optional) low-band preamp is displayed in square brackets on the Low Band key label.

Key Path	AMPTD Y Scale, Internal Preamp
Example	:POW:GAIN ON :POW:GAIN:BAND LOW
Readback	Low Band
Initial S/W Revision	Prior to A.02.00

Full Range

Sets the internal preamp to use its full range. The low band (0–3.6 GHz or 0–3GHz, depending on the model) is supplied by the low band preamp and the frequencies above low band are supplied by the high band preamp.

The frequency range of the installed (optional) preamp is displayed in square brackets on the Full Range key label. If the high band option is not installed the Full Range key does not appear.

Key Path	AMPTD Y Scale, Internal Preamp
Example	:POW:GAIN ON :POW:GAIN:BAND FULL
Readback	Full Range
Initial S/W Revision	Prior to A.02.00

Ref Position

Allows you to set the display reference position to the top, center, or bottom of the display.

Key Path	AMPTD Y Scale
Mode	WLAN
Remote Command	:DISPlay:FLATness:VIEW[1]:WINDow[1]:TRACe:Y[:SCALe]:RPOSition TOP CENTer BOTTom :DISPlay:FLATness:VIEW[1]:WINDow[1]:TRACe:Y[:SCALe]:RPOSition?

Example	DISP:FLAT:VIEW:WIND:TRAC:Y:RPOS CENT DISP:FLAT:VIEW:WIND:TRAC:Y:RPOS?
Preset	TOP
State Saved	Saved in instrument state.
Range	Top Ctr Bot
Initial S/W Revision	A.10.01

Auto Scaling

Allows you to toggle the Y axis Auto Scaling function between On and Off.

Key Path	AMPTD Y Scale
Mode	WLAN
Remote Command	:DISPlay:FLATness:VIEW[1]:WINDow[1]:TRACe:Y[:SCALe]:COUPle 0 1 OFF ON :DISPlay:FLATness:VIEW[1]:WINDow[1]:TRACe:Y[:SCALe]:COUPle?
Example	DISP:FLAT:VIEW:WIND:TRAC:Y:COUP 0 DISP:FLAT:VIEW:WIND:TRAC:Y:COUP?
Couplings	When Auto Scaling is On and you press the Restart front-panel key, this function automatically determines the scale per division and reference values based on the measurement results. When you manually set a value for the Rel Value or Scale/Div, this parameter is automatically set to Off.
Preset	ON
State Saved	Saved in instrument state.
Range	On Off
Initial S/W Revision	A.10.01

Attenuation

Accesses a menu of functions that enable you to change attenuation settings. This key has read-back text that describes the total attenuator value.

See AMPTD Y Scale, "[Attenuation](#)" on page 2158 for more information.

Key Path	AMPTD Y Scale
Initial S/W Revision	A.10.01

Internal Preamp

Accesses a menu of functions that enable you to control the internal preamplifiers.

See AMPTD Y Scale, "[Internal Preamp](#)" on page 2174 for more information.

Key Path	AMPTD Y Scale
Initial S/W Revision	A.10.01

Auto Couple

The Auto Couple feature provides a quick and convenient way to automatically couple multiple instrument settings. This helps ensure accurate measurements and optimum dynamic range. When the Auto Couple feature is activated, either from the front panel or remotely, all parameters of the current measurement that have an Auto/Manual mode are set to Auto mode and all measurement settings dependent on (or coupled to) the Auto/Man parameters are automatically adjusted for optimal performance.

However, the Auto Couple key actions are confined to the current measurement only. It does not affect other measurements in the mode, and it does not affect markers, marker functions, or trace or display attributes.

See ["More Information" on page 1570](#)

Key Path	Front-panel key
Remote Command	:COUPLe ALL NONE
Example	:COUP ALL
Notes	:COUPLe ALL puts all Auto/Man parameters in Auto mode (equivalent to pressing the Auto Couple key). :COUPLE NONE puts all Auto/Man parameters in manual mode. It decouples all the coupled instrument parameters and is not recommended for making measurements.
Initial S/W Revision	Prior to A.02.00

More Information

There are two types of functions that have Auto/Manual modes.

Auto/Man Active Function keys

An Auto/Man toggle key controls the binary state associated with an instrument parameter by toggling between Auto (where the parameter is automatically coupled to the other parameters it is dependent upon) and Man (where the parameter is controlled independent of the other parameters), as well as making the parameter the active function. The current mode is indicated on the softkey with either Auto or Man underlined as illustrated below.



Auto/Man 1-of-N keys

An Auto/Man 1-of-N key allows you to manually pick from a list of parameter values, or place the function in Auto, in which case the value is automatically selected (and indicated) as shown below. If in Auto, Auto is underlined on the calling key. If in manual operation, manual is indicated on the calling key. But the calling key does not actually toggle the function, it simply opens the menu.

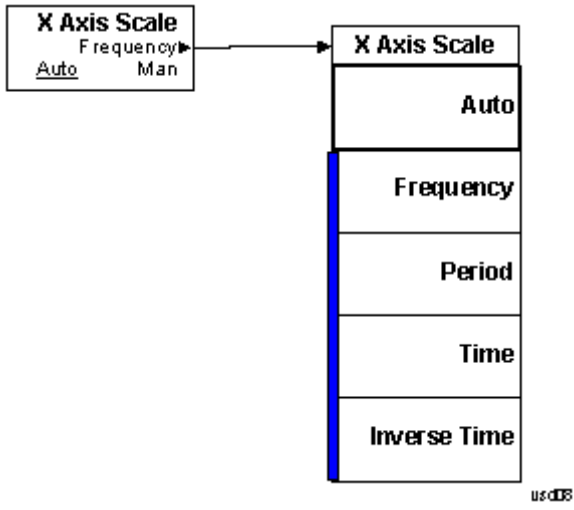

BW

Accesses a menu that allows you to control bandwidth settings.

Key Path	Front-panel key
Initial S/W Revision	A.10.01

Info BW

Sets the information bandwidth This is the bandwidth used for the power measurement. The optimal setting occurs when the bandwidth is wide enough to pass all the power of the bursted signal, while not being so wide that it passes noise, which reduces dynamic range and diminishes the accuracy of low level measurements.

Key Path	BW
Mode	WLAN
Remote Command	[:SENSe] :FLATness :BANDwidth [:RESolution] <bandwidth> [:SENSe] :FLATness :BANDwidth [:RESolution] ?
Example	FLAT:BAND 1 kHz FLAT:BAND?
Dependencies	Default and Max Value are coupled with Hardware and Radio Std
Couplings	Info BW is coupled with subcarrier spacing value.
Preset	Hardware Dependent: B25 = 25 MHz B40, for Radio Std is 802.11a/b/g = 25MHz 802.11 n with 20M selection = 25MHz 802.11 n with 40M selection = 40MHz 802.11 ac with 20M selection = 25MHz 802.11 ac with 40M selection = 40MHz B1X, for Radio Std is 802.11 ac with 80M selection = 80MHz B1Y, for Radio Std is 802.11 ac with 160M selection = 160MHz
State Saved	Saved in instrument state.
Min	1 kHz
Max	Hardware Dependent: B25 = 25 MHz WB (40 MHz or wider) = Hardware Option Limit
Backwards Compatibility SCPI	[:SENSe] :FLATness :IFBW
Initial S/W Revision	A.10.01

Filter Type

Allows you to select a Gaussian or a Flattop filter. A Flattop is recommended in this measurement because Flattop will bring the less flatness distortion than Gaussian.

Key Path	BW
Mode	WLAN
Remote Command	[:SENSE] :FLATness :BANDwidth :TYPE GAUSSian FLATtop [:SENSE] :FLATness :BANDwidth :TYPE?
Example	FLAT:BAND:TYPE GAUS FLAT:BAND:TYPE?
Notes	<p>This selects either a Gaussian or Flat (Flattop) filter. Gaussian is the better choice when looking at the overall burst, or rising and falling edges, because it has excellent pulse response. For most Time vs. Power measurements, the user is not mainly interested in trading off time domain accuracy vs. noise, but is more interested in total power accuracy vs. noise.</p> <p>If you want to want to examine just the useful part of the burst, choose Flat. This is an advanced control that normally does not need to be changed. Setting this to a value other than the factory default, may cause invalid measurement results.</p> <p>–FLATtop – a filter with a flat amplitude response, that provides the best amplitude accuracy.</p> <p>–GAUSSian – a filter with Gaussian characteristics, that provides the best pulse response.</p>
Preset	FLATtop
State Saved	Saved in instrument state.
Range	Gaussian Flattop
Initial S/W Revision	A.10.01

Cont (Continuous Measurement/Sweep)

Sets the analyzer for Continuous measurement operation. The single/continuous state is Meas Global so the setting will affect all measurements. If you are Paused, pressing Cont does a Resume.

Key Path	Front-panel key
Remote Command	:INITiate:CONTinuous OFF ON 0 1 :INITiate:CONTinuous?
Example	:INIT:CONT 0 puts analyzer in Single measurement operation. :INIT:CONT 1 puts analyzer in Continuous measurement operation
Preset	ON (Note that SYST:PRESet sets INIT:CONT to ON but *RST sets INIT:CONT to OFF)
State Saved	Saved in instrument state
Backwards Compatibility Notes	For Spectrum Analysis mode in ESA and PSA, there is no Cont hardkey, instead there is a Sweep Single/Cont key. In these analyzers, switching the Sweep Single/Cont key from Single to Cont restarts averages (displayed average count reset to 1), but does not restart Max Hold and Min Hold. The X-Series has Single and Cont keys in place of the SweepSingleCont key. In the X-Series, if in single measurement, the Cont key (and INIT:CONT ON) switches to continuous measurement, but never restarts a measurement and never resets a sweep.
Initial S/W Revision	Prior to A.02.00

In Swept SA Measurement (Spectrum Analysis Mode):

The analyzer takes repetitive sweeps, averages, measurements, etc., when in Continuous mode. When the average count reaches the Average/Hold Number the count stops incrementing, but the analyzer keeps sweeping. See the Trace/Detector section for the averaging formula used both before and after the Average/Hold Number is reached. The trigger condition must be met prior to each sweep. The type of trace processing for multiple sweeps, is set under the Trace/Detector key, with choices of Trace Average, Max Hold, or Min Hold.

In Other Measurements/Modes:

With Avg/Hold Num (in the Meas Setup menu) set to Off or set to On with a value of 1, a sweep is taken after the trigger condition is met; and the analyzer continues to take new sweeps after the current sweep has completed and the trigger condition is again met. However, with Avg/Hold Num set to On with a value >1, multiple sweeps (data acquisitions) are taken for the measurement. The trigger condition must be met prior to each sweep. The sweep is not stopped when the average count k equals the number N set for Avg/Hold Num is reached, but the number k stops incrementing. A measurement average usually applies to all traces, marker results, and numeric results. But sometimes it only applies to the numeric results.

If the analyzer is in Single measurement, pressing the Cont key does not change k and does not cause the sweep to be reset; the only action is to put the analyzer into Continuous measurement operation.

If it is already in continuous sweep:

the INIT:CONT 1 command has no effect

the INIT:CONT 0 command will place the analyzer in Single Sweep but will have no effect on the current sequence until $k = N$, at which point the current sequence will stop and the instrument will go to the idle state.

14 Spectral Flatness Measurement
File

File

See "File" on page 348

FREQ Channel

Accesses a menu of keys that allow you to control the Frequency and Channel parameters of the instrument.

Some features in the Frequency menu are the same for all measurements – they do not change as you change measurements. Settings like these are called “Meas Global” and are unaffected by Meas Preset. For example, the Center Freq setting is the same for all measurements – it does not change as you change measurements.

Key Path	Front-panel key
Initial S/W Revision	Prior to A.02.00

Center Freq

Sets the frequency that corresponds to the horizontal center of the graticule (when frequency Scale Type is set to linear). While adjusting the Center Frequency the Span is held constant, which means that both Start Frequency and Stop Frequency will change.

Pressing Center Freq also sets the frequency entry mode to Center/Span. In Center/Span mode, the center frequency and span values are displayed below the graticule, and the default active function in the Frequency menu is Center Freq.

The center frequency setting is the same for all measurements within a mode, that is, it is Meas Global. Some modes are also able to share a Mode Global center frequency value. If this is the case, the Mode will have a Global Settings key in its Mode Setup menu.

The Center Freq function sets (and queries) the Center Frequency for the currently selected input. If your analyzer has multiple inputs, and you select another input, the Center Freq changes to the value for that input. SCPI commands are available to directly set the Center Freq for a specific input.

Center Freq is remembered as you go from input to input. Thus you can set a Center Freq of 10 GHz with the RF Input selected, change to BBIQ and set a Center Freq of 20 MHz, then switch to External Mixing and set a Center Freq of 60 GHz, and when you go back to the RF Input the Center Freq will go back to 10 GHz; back to BBIQ and it is 20 MHz; back to External Mixing and it is 60 GHz.

See ["RF Center Freq" on page 1580](#)

See [Ext Mix Center Freq](#)

See ["I/Q Center Freq" on page 1582](#)

See ["Center Frequency Presets" on page 1578](#)

Key Path	FREQ Channel
Scope	Meas Global
Remote Command	[:SENSe] :FREQuency :CENTer <freq> [:SENSe] :FREQuency :CENTer?

Example	FREQ:CENT 50 MHz FREQ:CENT UP changes the center frequency to 150 MHz if you use FREQ:CENT:STEP 100 MHz to set the center frequency step size to 100 MHz FREQ:CENT?
Notes	This command sets either the RF or I/Q Center Frequency depending on the selected input. For RF input it is equivalent to FREQ:RF:CENT For I/Q input it is equivalent to FREQ:IQ:CENT Preset and Max values are dependent on Hardware Options (5xx) If no terminator (e.g. MHz) is sent the terminator Hz is used. If a terminator with unit other than Frequency is used, an invalid suffix error message is generated.
Dependencies	The Center Frequency can be limited by Start or Stop Freq limits, if the Span is so large that Start or Stop reach their limit.
Couplings	When operating in "swept span", any value of the Center Frequency or Span that is within the frequency range of the analyzer is allowed when the value is being set through the front panel numeric key pad or the SCPI command. The other parameter is forced to a different value if needed, to keep the Start and the Stop Frequencies within the analyzer's frequency range
Preset	Depends on instrument maximum frequency, mode, measurement, and selected input. See "Center Frequency Presets" on page 1578 and "RF Center Freq" on page 1580 and Ext Mix Center Freq and "I/Q Center Freq" on page 1582 .
State Saved	Saved in instrument state
Min	Depends on instrument maximum frequency, mode, measurement, and selected input.. See "Center Frequency Presets" on page 1578 and "RF Center Freq" on page 1580 and "I/Q Center Freq" on page 1582 .
Max	Depends on instrument maximum frequency, mode, measurement, and selected input.. See "Center Frequency Presets" on page 1578 and "RF Center Freq" on page 1580 and "I/Q Center Freq" on page 1582 .
Default Unit	Hz
Status Bits/OPC	Non-overlapped
Dependencies	
Initial S/W Revision	Prior to A.02.00

Center Frequency Presets

The following table provides the Center Frequency Presets for the Spectrum Analyzer mode, and the Max Freq, for the various frequency options:

Freq Option	CF after Mode Preset	Stop Freq after Mode Preset	Max Freq (can't tune)

			above)
503 (all but N9000A)	1.805 GHz	3.6 GHz	3.7 GHz
503 (N9000A)	1.505 GHz	3.0 GHz	3.08 GHz
507 (all but N9000A)	3.505 GHz	7.0 GHz	7.1 GHz
507 (N9000A)	3.755 GHz	7.5 GHz	7.58 GHz
508 (all but N9038A)	1.805 GHz	3.6 GHz	8.5 GHz
508 (N9038A)	4.205 GHz	8.4 GHz	8.5 GHz
513	6.805 GHz	13.6 GHz	13.8 GHz
526 (all but N9000A and N9038A)	13.255 GHz	26.5 GHz	27.0 GHz
526 (N9000A)	13.255 GHz	26.5 GHz	26.55 GHz
526 (N9038A)	1.805 GHz	3.6 GHz	27.0 GHz
532	16.005 GHz	32.0 GHz	32.5 GHz
543	21.505 GHz	43.0 GHz	TBD
544	22.005 GHz	44.0 GHz	44.5 GHz
550	25.005 GHz	50.0 GHz	51 GHz

Input 2:

Model	CF after Mode Preset	Stop Freq after Mode Preset	Max Freq (can't tune above)
N9000A opt C75	0.7505GHz	1.5 GHz	1.58 GHz
N9038A	505 MHz	1 GHz	1.000025 GHz

Tracking Generator Frequency Limits (N9000A only):

Tracking Generator Option	Min Freq (clips to this freq when turn TG on and	If above this Freq, Stop Freq clipped to this Freq when	Max Freq (can't tune above) while TG

	can't tune below while TG on)	TG turned on	on
T03	9 kHz	3.0 GHz	3.08 GHz
T06	9 kHz	6.0 GHz	6.05 GHz

The following table shows the Center Frequency Presets for modes other than Spectrum Analyzer:

Mode	CF Preset for RF
WCDMA	1 GHz
WIMAXOFDMA,	1 GHz
BASIC	1 GHz
ADEMOD	1 GHz
VSA	1 GHz
TDSCDMA	1 GHz
PNOISE	1 GHz
LTE	1 GHz
LTETDD	1 GHz
MSR	1 GHz
GSM	935.2 MHz
NFIGURE	1.505 GHz

RF Center Freq

SCPI command for specifying the RF Center Frequency. This command will set the Center Frequency to be used when the RF input is selected, even if the RF input is not the input that is selected at the time the command is sent. Note that the Center Freq function in the Frequency menu on the front panel always applies to the currently selected input.

Scope	Meas Global
Remote Command	<code>[:SENSe] :FREQuency:RF:CENTer <freq></code> <code>[:SENSe] :FREQuency:RF:CENTer?</code>
Example	FREQ:RF:CENT 30 MHz
Notes	This command is the same in all modes, but the parameter is Measurement Global. So the value is independent in each mode and common across all the measurements in the mode.
Dependencies	If the electronic/soft attenuator is enabled, any attempt to set Center Frequency such that the Stop Frequency would be >3.6 GHz fails and results in an advisory message. If the equivalent SCPI command is sent, this same message is generated as part of a “-221, Settings conflict” warning. If Source Mode is set to Tracking, and the Max or Min Center Freq is therefore limited by the limits of the source, a warning message is generated, “Data out of range;clipped to source max/min” if these limits are exceeded. Note that for an external source, these limits can be affected by the settings of

	Source Numerator, Source Denominator and Power Sweep.
Preset	See table above
State Saved	Saved in instrument state.
Min	-79.999995 MHz, unless Source Mode is set to Tracking, in which case it is limited by the minimum frequency of the Source
Max	See table above. Basically instrument maximum frequency - 5 Hz. Note that, if the Source Mode is set to Tracking, the effective instrument maximum frequency may be limited by the source maximum frequency. If the knob or step keys are being used, also depends on the value of the other three interdependent parameters Span, Start Frequency and Stop Frequency
Initial S/W Revision	Prior to A.02.00
Modified at S/W Revision	A.03.00

Ext Mix Center Freq

SCPI command for specifying the External Mixer Center Frequency. This command will set the Center Frequency to be used when the External Mixer is selected, even if the External Mixer input is not the input which is selected at the time the command is sent. Note that the Center Freq function in the Frequency menu on the front panel always applies to the currently selected input.

Scope	Meas Global
Remote Command	<code>[:SENSe] :FREQuency:EMIXer:CENTer <freq></code> <code>[:SENSe] :FREQuency:EMIXer:CENTer?</code>
Example	<code>:FREQ:EMIX:CENT 60 GHz</code> <code>:FREQ:EMIX:CENT?</code>
Notes	This command is the same in all modes, but the parameter is Measurement Global. So the value is independent in each mode and common across all the measurements in the mode.
Couplings	When returning to External Mixing after having been switched to one of the other inputs (e.g., RF), you will come back into the settings that you had when you left External Mixing. So you will come back to the band you were in with the Center Frequency that you had. However, Span is not an input-dependent parameter, therefore you will bring the span over from the other input. Therefore, the analyzer comes back with the span from the previous input, limited as necessary by the current mixer setup.
Preset	When a Mode Preset is performed while in External Mixing, the Start frequency of the current Mode is set to the nominal Min Freq of the lowest harmonic range in the Harmonic Table for the current mixer setup. Similarly, the Stop frequency of the current Mode is set to the nominal Max Freq of the highest harmonic range in the Harmonic Table. The Center Freq thus presets to the point arithmetically equidistant from these two frequencies. If the current measurement has a limited Span available to it, and cannot achieve the Span shown in the table ($\text{Span} = \text{Stop Freq} - \text{Start Freq}$), the analyzer uses the maximum Span the measurement allows, and still sets the Center Freq to the midpoint of the Start and Stop Freq values in the Harmonic Table.

	<p>When Restore Input/Output Defaults is performed, the mixer presets to the 11970A, whose Start and Stop frequencies are 26.5 and 40 GHz respectively. The center of these two frequencies is 33.25 GHz.</p> <p>Therefore, after a Restore Input/Output Defaults, if you go into External Mixing and do a Mode Preset while in the Spectrum Analyzer Mode, the resulting Center Freq is 33.25 GHz.</p>
State Saved	Saved in instrument state.
Min	The minimum frequency in the currently selected mixer band + 5 Hz
Max	<p>The maximum frequency in the currently selected mixer band – 5 Hz</p> <p>If the knob or step keys are being used, also depends on the value of the other three interdependent parameters Span, Start Frequency and Stop Frequency</p>
Initial S/W Revision	A.08.01

I/Q Center Freq

SCPI command for specifying the I/Q Center Frequency. This command will set the Center Frequency to be used when the I/Q input is selected, even if the I/Q input is not the input which is selected at the time the command is sent. Note that the Center Freq function in the Frequency menu on the front panel always applies to the currently selected input.

Scope	Meas Global
Remote Command	<pre>[:SENSe] :FREQuency:IQ:CENTer <freq></pre> <pre>[:SENSe] :FREQuency:IQ:CENTer?</pre>
Example	FREQ:IQ:CENT: 30 MHz
Notes	This command is the same in all modes, but the parameter is Measurement Global. So the value is independent in each mode and common across all the measurements in the mode.
Preset	0 Hz
State Saved	Saved in instrument state.
Min	-40.049995 MHz
Max	40.049995 MHz
Initial S/W Revision	Prior to A.02.00

CF Step

Changes the step size for the center frequency and start and stop frequency functions. Once a step size has been selected and the center frequency function is active, the step keys (and the UP|DOWN parameters for Center Frequency from remote commands) change the center frequency by the step-size value. The step size function is useful for finding harmonics and sidebands beyond the current frequency span of the analyzer.

Note that the start and stop frequencies also step by the CF Step value.

Key Path	FREQ Channel
Remote Command	[:SENSe] :FREQuency:CENTer:STEP [:INCRement] <freq> [:SENSe] :FREQuency:CENTer:STEP [:INCRement] ? [:SENSe] :FREQuency:CENTer:STEP:AUTO OFF ON 0 1 [:SENSe] :FREQuency:CENTer:STEP:AUTO?
Example	FREQ:CENT:STEP:AUTO ON FREQ:CENT:STEP 500 MHz FREQ:CENT UP increases the current center frequency value by 500 MHz FREQ:CENT:STEP? FREQ:CENT:STEP:AUTO?
Notes	Preset and Max values are depending on Hardware Options (503, 507, 508, 513, 526)
Notes	Preset and Max values are dependent on Hardware Options (5xx)
Dependencies	Freq Offset is not available in External Mixing. In this case the Freq Offset key is grayed out and shows a value of zero. It will once again be available, and show the previously set value, when you return to the RF Input.
Dependencies	Span, RBW, Center frequency If the electronic/soft attenuator is enabled, any attempt to change the value of the center frequency >3.6 GHz by pressing the Up-arrow key, fails and results in an advisory message. If the equivalent SCPI command is sent, this same message is generated as part of a “-221, Settings conflict” warning.
Couplings	When auto-coupled in a non-zero span, the center frequency step size is set to 10% of the span. When auto-coupled in zero span, the center frequency step size is set to the equivalent -3 dB RBW value.
Preset	Auto ADEMOD: 1 MHz ON
State Saved	Saved in instrument state
Min	– (the maximum frequency of the instrument). That is, 27 GHz max freq instrument has a CF step range of +/- 27 GHz. Note that this is the maximum frequency given the current settings of the instrument, so in External Mixing, for example, it is the maximum frequency of the current mixer band.
Max	The maximum frequency of the instrument. That is, 27 GHz max freq instrument has a CF step range of +/- 27 GHz. Note that this is the maximum frequency given the current settings of the instrument, so in External Mixing, for example, it is the maximum frequency of the current mixer band.
Default Unit	Hz
Status Bits/OPC dependencies	non-overlapped
Initial S/W Revision	Prior to A.02.00
Modified at S/W Revision	A.03.00

14 Spectral Flatness Measurement
Input/Output

Input/Output

See "[Input/Output](#)" on page 194

Marker

Accesses the menu that allow you to select, set up, and control the markers for the current measurement.

Key Path	Front-panel key
Initial S/W Revision	A.10.01

Select Marker

Displays 12 markers available for selection.

Key Path	Marker
Initial S/W Revision	A.10.01

Marker Type

Sets the marker control mode. If the selected marker is Off, pressing Marker sets it to Normal and places it at the center of the screen on the trace determined by the Marker Trace rules. At the same time, Marker X axis value of the selected marker appears on the Active Function area.

Key Path	Marker
Mode	WLAN
Remote Command	:CALCulate:FLATness:MARKer[1] 2 ... 12:MODE POSition DELTa OFF :CALCulate:FLATness:MARKer[1] 2 ... 12:MODE?
Example	CALC:FLAT:MARK:MODE POS CALC:FLAT:MARK:MODE?
Notes	If the selected marker is Off, pressing Marker sets it to Normal and places it at the center of the screen on the trace determined by the Marker Trace rules. At the same time, Marker X Axis Value appears on the Active Function area. Default Active Function: The active function for the selected marker's current control mode. If the current control mode is Off, there is no active function and the active function is turned off. Active Function Display: The marker X axis value for flatness graph
Preset	OFF
State Saved	Saved in instrument state.
Range	Normal Delta Off
Initial S/W Revision	A.10.01

Relative To

Selects the marker that the selected marker is relative to (its reference marker).

Key Path	Marker, Properties
Mode	WLAN
Remote Command	:CALCulate:FLATness:MARKer[1] 2 ... 12:REFerence <integer> :CALCulate:FLATness:MARKer[1] 2 ... 12:REFerence?
Example	CALC:FLAT:MARK:REF 3 CALC:FLAT:MARK:REF?
Notes	A marker cannot be relative to itself so that choice is grayed out, and if sent from SCPI generates error -221: "Settings conflict; marker cannot be relative to itself." When queried, a single value is returned (the specified marker number's relative marker).
Preset	2 3 4 5 6 7 8 9 10 11 12 1
State Saved	Saved in instrument state.
Min	1
Max	12
Initial S/W Revision	A.10.01

Select Marker

Displays 12 markers available for selection.

Key Path	Marker
Initial S/W Revision	A.10.01

Relative To

Assigns the reference marker for a marker in Delta mode.

Key Path	Marker, Properties
Remote Command	:CALCulate:NFIGure:MARKer[1] 2 ... 4:REFerence <int> :CALCulate:NFIGure:MARKer[1] 2 ... 4:REFerence?
Example	CALC:NFIG:MARK[3]:REF 2
Remote Command Notes	This command (not the query) causes the specified marker to become selected.
Preset	By default, marker X is relative to marker X+1 except for marker 4 which is relative to marker 1.
Preset	By default, marker X is relative to marker X+1 except for marker 4 which is relative to marker 1.
Initial S/W Revision	Prior to A.04.00

Marker Trace

Assigns the specified marker to the designated trace.

Key Path	Marker
Mode	WLAN
Remote Command	:CALCulate:FLATness:MARKer[1] 2 ... 12:TRACe FLATness ULIMit LLIMit :CALCulate:FLATness:MARKer[1] 2 ... 12:TRACe?
Example	CALC:FLAT:MARK2:TRAC FLAT CALC:FLAT:MARK:TRAC?
Preset	Flatness Trace
State Saved	Saved in instrument state.
Range	Flatness Trace Upper Limit Lower Limit
Initial S/W Revision	A.10.01

Couple Markers

Toggles the state of the markers to be coupled On or Off. When this function is true (On), moving any marker causes an “equal X Axis movement” of every other marker which is active. By “equal X Axis movement” we mean that we preserve the difference between each marker’s X Axis value (in the fundamental x-axis units of the trace that marker is on) and the X Axis value of the marker being moved (in the same fundamental x-axis units).

This may result in markers going offscreen.

Key Path	Marker
Mode	WLAN
Remote Command	:CALCulate:FLATness:MARKer:COUPlE[:STATe] ON OFF 1 0 :CALCulate:FLATness:MARKer:COUPlE[:STATe]?
Example	CALC:FLAT:MARK:COUP ON CALC:FLAT:MARK:COUP?
Preset	OFF
State Saved	Saved in instrument state.
Range	On Off
Initial S/W Revision	A.10.01

All Markers Off

Turns off all markers.

Key Path	Marker
----------	--------

Mode	WLAN
Remote Command	:CALCulate:FLATness:MARKer:AOff
Example	CALC:FLAT:MARK:AOff
Initial S/W Revision	A.10.01

Marker X Axis Value

Sets the marker X Axis value in the current marker X Axis Scale unit. It has no effect if the control mode is Off, but is the SCPI equivalent of entering an X value if the control mode is Normal or Delta.

Mode	WLAN
Remote Command	:CALCulate:FLATness:MARKer[1] 2 ... 12:X <real> :CALCulate:FLATness:MARKer[1] 2 ... 12:X?
Example	CALC:FLAT:MARK3:X 0 CALC:FLAT:MARK3:X?
Preset	After a preset, all markers are set to Off, so a Marker X Axis Value query will return a not a number (NAN).
State Saved	No
Min	-9.9E+37
Max	9.9E+37.
Initial S/W Revision	A.10.01

Marker X Axis Position (Remote Command only)

Sets the marker X position in trace points. It has no effect if the control mode is Off, but is the SCPI equivalent of entering a value if the control mode is Normal or Delta - except in trace points rather than X Axis Scale units. The entered value is immediately translated into the current X Axis Scale units for setting the value of the marker.

Mode	WLAN
Remote Command	:CALCulate:FLATness:MARKer[1] 2 ... 12:X:POSition <real> :CALCulate:FLATness:MARKer[1] 2 ... 12:X:POSition?
Example	CALC:FLAT:MARK10:X:POS 10 CALC:FLAT:MARK10:X:POS?
Notes	The query returns the marker's absolute X Axis value in trace points if the control mode is Normal, or the offset from the marker's reference marker in trace points, if the control mode is Delta. The value is returned as a real number, not an integer, corresponding to the translation from X Axis Scale units to trace points. If the marker is Off the response is not a number(NAN).
Preset	After a preset, all markers are set to Off, so Marker X Axis Position query will return a not a number (NAN).

State Saved	No
Min	-9.9E+37
Max	9.9E+37
Initial S/W Revision	A.10.01

Marker Y Axis Value (Remote Command only)

Queries the marker Y Axis value in the current marker Y Axis unit.

Mode	WLAN
Remote Command	:CALCulate:FLATness:MARKer[1] 2 ... 12:Y?
Example	CALC:FLAT:MARK11:Y?
Preset	Result dependant on Markers setup and signal source
State Saved	No
Initial S/W Revision	A.10.01

Marker Function

There are no 'Marker Functions' supported in this measurement, so this front-panel key displays a blank menu when pressed.

Key Path	Front Panel
Initial S/W Revision	A.10.01

Marker To

There is no 'Marker To' functionality supported in this measurement, so this front-panel key displays a blank key menu when pressed.

Key Path	Front Panel
Initial S/W Revision	A.10.01

Meas

The information in this section is common to all measurements. For key and remote command information for a specific measurement, refer to the section that describes the measurement of interest.

Measurements available under the Meas key are specific to the current Mode.

When viewing Help for measurements, note the following:

NOTE

Operation for some keys differs between measurements. The information displayed in Help pertains to the current measurement. To see how a key operates in a different measurement, exit Help (press the Cancel Esc key), select the measurement, then reenter Help (press the Help key) and press that key.

Key Path	Front-panel key
Initial S/W Revision	Prior to A.02.00

Remote Measurement Functions

This section contains the following topics:

["Measurement Group of Commands" on page 2214](#)

["Current Measurement Query \(Remote Command Only\)" on page 2216](#)

["Limit Test Current Results \(Remote Command Only\)" on page 2216](#)

["Data Query \(Remote Command Only\)" on page 2216](#)

["Calculate/Compress Trace Data Query \(Remote Command Only\)" on page 2217](#)

["Calculate Peaks of Trace Data \(Remote Command Only\)" on page 2222](#)

["Hardware-Accelerated Fast Power Measurement \(Remote Command Only\)" on page 2223](#)

["Format Data: Numeric Data \(Remote Command Only\)" on page 2237](#)

["Format Data: Byte Order \(Remote Command Only\)" on page 2238](#)

Initial S/W Revision	Prior to A.02.00
----------------------	------------------

Measurement Group of Commands

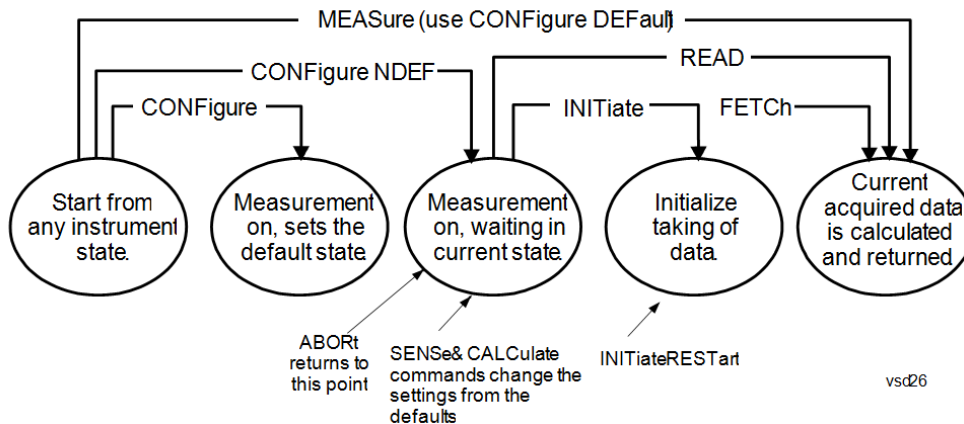

Measure Commands:

:MEASure:<measurement>[n]?

This is a fast single-command way to make a measurement using the factory default instrument settings. These are the settings and units that conform to the Mode Setup settings (e.g. radio standard) that you have currently selected.

- Stops the current measurement (if any) and sets up the instrument for the specified measurement using the factory defaults
- Initiates the data acquisition for the measurement
- Blocks other SCPI communication, waiting until the measurement is complete before returning results.
- If the function does averaging, it is turned on and the number of averages is set to 10.
- After the data is valid it returns the scalar results, or the trace data, for the specified measurement. The type of data returned may be defined by an [n] value that is sent with the command.
- The scalar measurement results will be returned if the optional [n] value is not included, or is set to 1. If the [n] value is set to a value other than 1, the selected trace data results will be returned. See each command for details of what types of scalar results or trace data results are available.
- ASCII is the default format for the data output. (Older versions of Spectrum Analysis and Phase Noise mode measurements only use ASCII.) The binary data formats should be used for handling large blocks of data since they are smaller and faster than the ASCII format. Refer to the FORMat:DATA command for more information.

If you need to change some of the measurement parameters from the factory default settings you can set up the measurement with the CONFigure command. Use the commands in the SENSe:<measurement> and CALCulate:<measurement> subsystems to change the settings. Then you can use the READ? command to initiate the measurement and query the results.

If you need to repeatedly make a given measurement with settings other than the factory defaults, you can use the commands in the SENSe:<measurement> and CALCulate:<measurement> subsystems to set up the measurement. Then use the READ? command to initiate the measurement and query results.

Measurement settings persist if you initiate a different measurement and then return to a previous one. Use READ:<measurement>? if you want to use those persistent settings. If you want to go back to the default settings, use MEASure:<measurement>?.

Configure Commands:

:CONFigure:<measurement>

This command stops the current measurement (if any) and sets up the instrument for the specified measurement using

the factory default instrument settings. It does not initiate the taking of measurement data unless INIT:CONTinuous is ON. If you change any measurement settings after using the CONFigure command, the READ command can be used to initiate a measurement without changing the settings back to their defaults.

In the Swept SA measurement in Spectrum Analyzer mode the CONFigure command also turns the averaging function on and sets the number of averages to 10 for all measurements.

:CONFigure: <measurement>: NDEFault stops the current measurement and changes to the specified measurement. It does not change the settings to the defaults. It does not initiate the taking of measurement data unless INIT:CONTinuous is ON.

The CONFigure? query returns the current measurement name.

The CONFigure:CATalog? query returns a quoted string of all licensed measurement names in the current mode. For example, "SAN, CHP, OBW, ACP, PST, TXP, SPUR, SEM, LIST".

Fetch Commands:

:FETCh:<measurement>[n]?

This command puts selected data from the most recent measurement into the output buffer. Use FETCh if you have already made a good measurement and you want to return several types of data (different [n] values, for example, both scalars and trace data) from a single measurement. FETCh saves you the time of re-making the measurement. You can only FETCh results from the measurement that is currently active, it will not change to a different measurement. An error message is reported if a measurement other than the current one is specified.

If you need to get new measurement data, use the READ command, which is equivalent to an INITiate followed by a FETCh.

The scalar measurement results will be returned if the optional [n] value is not included, or is set to 1. If the [n] value is set to a value other than 1, the selected trace data results will be returned. See each command for details of what types of scalar results or trace data results are available. The binary data formats should be used for handling large blocks of data since they are smaller and transfer faster than the ASCII format. (FORMat:DATA)

FETCh may be used to return results other than those specified with the original READ or MEASure command that you sent.

INITiate Commands:

:INITiate:<measurement>

This command is not available for measurements in all the instrument modes:

- Initiates a trigger cycle for the specified measurement, but does not output any data. You must then use the FETCh<meas> command to return data. If a measurement other than the current one is specified, the instrument will switch to that measurement and then initiate it.
 - For example, suppose you have previously initiated the ACP measurement, but now you are running the channel power measurement. If you send INIT:ACP? it will change from channel power to ACP and will initiate an ACP measurement.
 - Does not change any of the measurement settings. For example, if you have previously started the ACP measurement and you send INIT:ACP? it will initiate a new ACP measurement using the same instrument settings as the last time ACP was run.
 - If your selected measurement is currently active (in the idle state) it triggers the measurement, assuming the trigger conditions are met. Then it completes one trigger cycle. Depending upon the measurement and the number of averages, there may be multiple data acquisitions, with multiple trigger events, for one full trigger cycle. It also holds off additional commands on GPIB until the acquisition is complete.
-

READ Commands:

:READ:<measurement>[n]?

- Does not preset the measurement to the factory default settings. For example, if you have previously initiated the ACP
-

measurement and you send READ:ACP? it will initiate a new measurement using the same instrument settings.

- Initiates the measurement and puts valid data into the output buffer. If a measurement other than the current one is specified, the instrument will switch to that measurement before it initiates the measurement and returns results.
 - For example, suppose you have previously initiated the ACP measurement, but now you are running the channel power measurement. Then you send READ:ACP? It will change from channel power back to ACP and, using the previous ACP settings, will initiate the measurement and return results.
 - Blocks other SCPI communication, waiting until the measurement is complete before returning the results
 - If the optional [n] value is not included, or is set to 1, the scalar measurement results will be returned. If the [n] value is set to a value other than 1, the selected trace data results will be returned. See each command for details of what types of scalar results or trace data results are available. The binary data formats should be used when handling large blocks of data since they are smaller and faster than the ASCII format. (FORMat:DATA)
-

Initial S/W Revision	Prior to A.02.00
----------------------	------------------

Current Measurement Query (Remote Command Only)

This command returns the name of the measurement that is currently running.

Remote Command	:CONFigure?
-----------------------	-------------

Example	CONF?
----------------	-------

Initial S/W Revision	Prior to A.02.00
----------------------	------------------

Limit Test Current Results (Remote Command Only)

Queries the status of the current measurement limit testing. It returns a 0 if the measured results pass when compared with the current limits. It returns a 1 if the measured results fail any limit tests.

Remote Command	:CALCulate:CLIMits:FAIL?
-----------------------	--------------------------

Example	CALC:CLIM:FAIL? queries the current measurement to see if it fails the defined limits. Returns a 0 or 1: 0 it passes, 1 it fails.
----------------	--

Initial S/W Revision	Prior to A.02.00
----------------------	------------------

Data Query (Remote Command Only)

Returns the designated measurement data for the currently selected measurement and subopcode.

n = any valid subopcode for the current measurement. See the measurement command results table for your current measurement, for information about what data is returned for the subopcodes.

This command uses the data setting specified by the FORMat:BORDER and FORMat:DATA commands and can return real or ASCII data. (See the format command descriptions under Input/Output in the Analyzer Setup section.)

Remote Command	:CALCulate:DATA[n]?
Notes	The return trace depends on the measurement. In CALCulate:<meas>:DATA[n], n is any valid subopcode for the current measurement. It returns the same data as the FETCH:<measurement>? query where <measurement> is the current measurement.
Initial S/W Revision	Prior to A.02.00

Calculate/Compress Trace Data Query (Remote Command Only)

Returns compressed data for the currently selected measurement and sub-opcode [n].

n = any valid sub-opcode for that measurement. See the MEASure:<measurement>? command description of your specific measurement for information on the data that can be returned.

The data is returned in the current Y Axis Unit of the analyzer. The command is used with a sub-opcode <n> (default=1) to specify the trace. With trace queries, it is best if the analyzer is not sweeping during the query. Therefore, it is generally advisable to be in Single Sweep, or Update=Off.

This command is used to compress or decimate a long trace to extract and return only the desired data. A typical example would be to acquire N frames of GSM data and return the mean power of the first burst in each frame. The command can also be used to identify the best curve fit for the data.

Remote Command	:CALCulate:DATA<n>:COMPRESS? BLOCK CFIT MAXimum MINimum MEAN DMEan RMS RMSCubed SAMPLE SDEVIation PPHase [,<soffset> [,<length>[,<roffset>[,<rlimit>]]]]
Example	To query the mean power of a set of GSM bursts: Supply a signal that is a set of GSM bursts. Select the IQ Waveform measurement (in IQ Analyzer Mode). Set the sweep time to acquire at least one burst. Set the triggers such that acquisition happens at a known position relative to a burst. Then query the mean burst levels using, CALC:DATA2:COMP? MEAN, 24e-6, 526e-6 (These parameter values correspond to GSM signals, where 526e-6 is the length of the burst in the slot and you just want 1 burst.)
Notes	The command supports 5 parameters. Note that the last 4 (<soffset>, <length>, <roffset>, <rlimit>) are optional. But these optional parameters must be entered in the specified order. For example, if you want to specify <length>, then you must also specify <soffset>. See details below for a definition of each of these parameters. This command uses the data in the format specified by FORMat:DATA, returning either binary or ASCII data.
Initial S/W Revision	Prior to A.02.00

- BLOCK or block data - returns all the data points from the region of the trace data that you specify. For example, it could be used to return the data points of an input signal over several timeslots, excluding the portions of the trace data that you do not want. (This is x,y pairs for trace data and I,Q pairs for complex data.)

- CFIT or curve fit - applies curve fitting routines to the data. <soffset> and <length> are required to define the data that you want. <roffset> is an optional parameter for the desired order of the curve equation. The query will return the following values: the x-offset (in seconds) and the curve coefficients ((order + 1) values).

MIN, MAX, MEAN, DME, RMS, RMSC, SAMP, SDEV and PPH return one data value for each specified region (or <length>) of trace data, for as many regions as possible until you run out of trace data (using <roffset> to specify regions). Or they return the number of regions you specify (using <rlimit>) ignoring any data beyond that.

- MINimum - returns the minimum data point (y value) for the specified region(s) of trace data. For I/Q trace data, the minimum magnitude of the I/Q pairs is returned.
- MAXimum - returns the maximum data point (y value) for the specified region(s) of trace data. For I/Q trace data, the maximum magnitude of the I/Q pairs is returned.
- MEAN - returns a single value that is the arithmetic mean of the data point values (in dB/ dBm) for the specified region(s) of trace data. For I/Q trace data, the mean of the magnitudes of the I/Q pairs is returned. See the following equations.

-

NOTE

If the original trace data is in dB, this function returns the arithmetic mean of those log values, not log of the mean power which is a more useful value. The mean of the log is the better measurement technique when measuring CW signals in the presence of noise. The mean of the power, expressed in dB, is useful in power measurements such as Channel Power. To achieve the mean of the power, use the RMS option.

Equation 1

Mean Value of Data Points for Specified Region(s)

$$\text{MEAN} = \frac{1}{n} \sum_{X_i \in \text{region}(s)} X_i$$

where X_i is a data point value, and n is the number of data points in the specified region(s).

Equation 2

Mean Value of I/Q Data Pairs for Specified Region(s)

$$\text{MEAN} = \frac{1}{n} \sum_{X_i \in \text{region}(s)} |X_i|$$

where $|X_i|$ is the magnitude of an I/Q pair, and n is the number of I/Q pairs in the specified region(s).

- DMEan - returns a single value that is the mean power (in dB/ dBm) of the data point values for the specified region(s) of trace data. See the following equation:

Equation 3

DMEan Value of Data Points for Specified Region(s)

$$\text{DME} = 10 \times \log_{10} \left(\frac{1}{n} \sum_{X_i \in \text{region}(s)} 10^{\frac{X_i}{10}} \right)$$

- RMS - returns a single value that is the average power on a root-mean-squared voltage scale (arithmetic rms) of the data point values for the specified region(s) of trace data. See the following equation.

NOTE

For I/Q trace data, the rms of the magnitudes of the I/Q pairs is returned. See the following equation. This function is very useful for I/Q trace data. However, if the original trace data is in dB, this function returns the rms of the log values which is not usually needed.

Equation 4

RMS Value of Data Points for Specified Region(s)

$$\text{RMS} = \sqrt{\frac{1}{n} \sum_{X_i \in \text{region}(s)} X_i^2}$$

where X_i is a data point value, and n is the number of data points in the specified region(s).

Equation 5

RMS Value of I/Q Data Pairs for Specified Region(s)

$$\text{RMS} = \sqrt{\frac{1}{n} \sum_{X_i \in \text{region}(s)} X_i X_i^*}$$

where X_i is the complex value representation of an I/Q pair, X_i^* its conjugate complex number, and n is the number of I/Q pairs in the specified region(s).

Once you have the rms value for a region of trace data (linear or I/Q), you may want to calculate the mean power. You must convert this rms value (peak volts) to power in dBm:

$$10 \times \log[10 \times (\text{rms value})^2]$$

- SAMPlE - returns the first data value (x,y pair) for the specified region(s) of trace data. For I/Q trace data, the first I/Q pair is returned.
- SDEViation - returns a single value that is the arithmetic standard deviation for the data point values for the specified region(s) of trace data. See the following equation.
- For I/Q trace data, the standard deviation of the magnitudes of the I/Q pairs is returned. See the following equation.

Equation 6

Standard Deviation of Data Point Values for Specified Region(s)

$$\text{SDEV} = \sqrt{\frac{1}{n} \sum_{X_i \in \text{region}(s)} (X_i - \bar{X})^2}$$

where X_i is a data point value, \bar{X} is the arithmetic mean of the data point values for the specified region (s), and n is the number of data points in the specified region(s).

$$\text{SDEV} = \sqrt{\frac{1}{n} \sum_{X_i \in \text{region}(s)} (|X_i| - \bar{X})^2}$$

where $|X_i|$ is the magnitude of an I/Q pair, \bar{X} is the mean of the magnitudes for the specified region(s), and n is the number of data points in the specified region(s).

- PPHase - returns the x,y pairs of both rms power (dBm) and arithmetic mean phase (radian) for every specified region and frequency offset (Hz). The number of pairs is defined by the specified number of regions. This parameter can be used for I/Q vector ($n=0$) in Waveform (time domain) measurement and all parameters are specified by data point in PPHase.

The rms power of the specified region may be expressed as:

$$\text{Power} = 10 \times \log [10 \times (\text{RMS I/Q value})] + 10.$$

The RMS I/Q value (peak volts) is:

$$\sqrt{\frac{1}{n} \sum_{X_i \in \text{region}} X_i X_i^*}$$

where X_i is the complex value representation of an I/Q pair, X_i^* its conjugate complex number, and n is the number of I/Q pairs in the specified region.

The arithmetic mean phase of the specified region may be expressed as:

$$\frac{1}{n} \sum_{Y_i \in \text{region}} Y_i$$

where Y_i is the unwrapped phase of I/Q pair with applying frequency correction and n is the number of I/Q pairs in the specified region.

The frequency correction is made by the frequency offset calculated by the arithmetic mean of every specified region's frequency offset. Each frequency offset is calculated by the least square method against the unwrapped phase of I/Q pair.

Sample Trace Data - Constant Envelope

(See below for explanation of variables.)

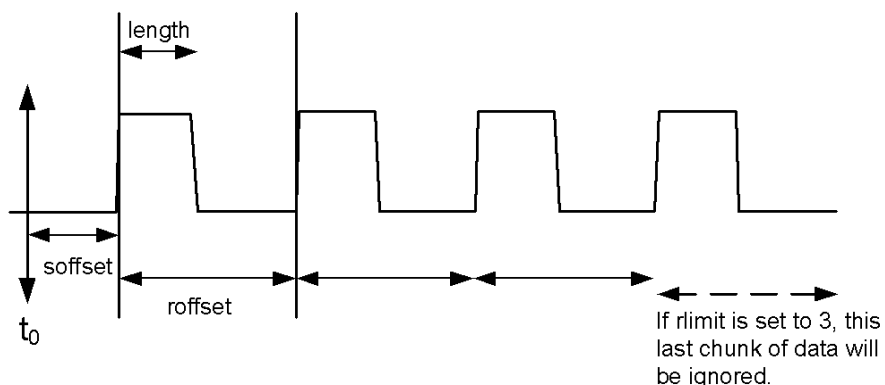

Sample Trace Data - Not Constant Envelope

(See below for explanation of variables.)

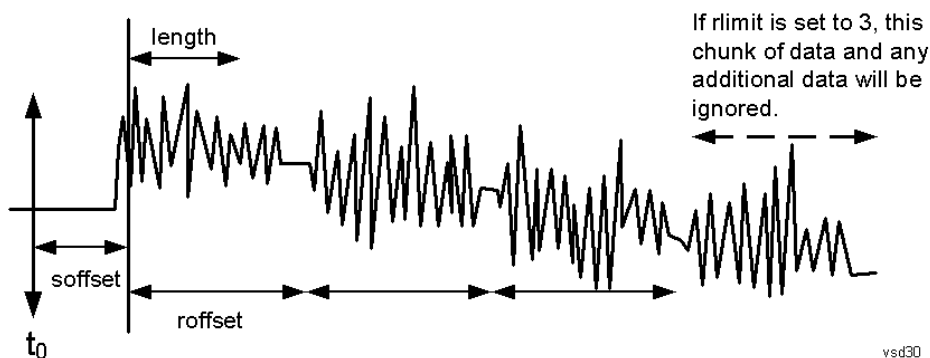

<soffset> - start offset is an optional real number. (It is in seconds for time-domain traces, and is a dimensionless index 0 to Npoints - 1, for frequency-domain traces). It specifies the amount of data at the beginning of the trace that will be ignored before the decimation process starts. It is the time or frequency change from the start of the trace to the point where you want to start using the data. The default value is zero.

<length> - is an optional real number. (It is in seconds for time-domain traces, and is a dimensionless index 0 to Npoints - 1, for frequency-domain traces). It defines how much data will be compressed into one value. This parameter has a default value equal to the current trace length.

<roffset> - repeat offset is an optional real number. (It is in seconds for time-domain traces, and is a dimensionless index 0 to Npoints - 1, for frequency-domain traces). It defines the beginning of the next field of trace elements to be compressed. This is relative to the beginning of the previous field. This parameter has a default value equal to the <length> variable. Note that this parameter is used for a completely different purpose when curve fitting (see CFIT above).

<rlimit> - repeat limit is an optional integer. It specifies the number of data items that you want returned. It will ignore any additional items beyond that number. You can use the Start offset and the Repeat limit to pick out exactly what part of the data you want to use. The default value is all the data.

Calculate Peaks of Trace Data (Remote Command Only)

Returns a list of all the peaks for the currently selected measurement and sub-opcode [n]. The peaks must meet the requirements of the peak threshold and excursion values.

n = any valid sub-opcode for the current measurement. See the MEASure:<measurement> command description of your specific measurement for information on the data that can be returned.

The command can only be used with specific sub-opcodes with measurement results that are trace data. Both real and complex traces can be searched, but complex traces are converted to magnitude in dBm. In many measurements the sub-opcode n=0, is the raw trace data which cannot be searched for peaks. And Sub-opcode n=1, is often calculated results values which also cannot be searched for peaks.

This command uses the data setting specified by the FORMat:BORDER and FORMat:DATA commands and can return real or ASCII data. If the format is set to INT,32, it returns REAL,32 data.

The command has four types of parameters:

- Threshold (in dBm)
- Excursion (in dB)
- Sorting order (amplitude, frequency, time)
- Optional in some measurements: Display line use (all, > display line, < display line)

Remote Command	<p>For Swept SA measurement:</p> <pre>:CALCulate:DATA[1] 2 ... 6:PEAKs? <threshold>,<excursion>[,AMPLitude FREQuency TIME[,ALL GTDLline LTDLine]]</pre> <p>For most other measurements:</p> <pre>:CALCulate:DATA[1] 2 ... 6:PEAKs? <threshold>,<excursion>[,AMPLitude FREQuency TIME]</pre>
Example	<p>Example for Swept SA measurement in Spectrum Analyzer Mode:</p> <p>CALC:DATA4:PEAK? -40, 10, FREQ, GTDL This will identify the peaks of trace 4 that are above -40 dBm, with excursions of at least 10 dB. The peaks are returned in order of increasing frequency, starting with the lowest frequency. Only the peaks that are above the display line are returned.</p> <p>Query Results 1:</p> <p>With FORMat:DATA REAL, 32 selected, it returns a list of floating-point numbers. The first value in the list is the number of peak points that are in the following list. A peak point consists of two values: a peak amplitude followed by its corresponding frequency (or time).</p> <p>If no peaks are found the peak list will consist of only the number of peaks, (0).</p>
Notes	<p><n> - is the trace that will be used</p> <p><threshold> - is the level below which trace data peaks are ignored. Note that the threshold value is required and is always used as a peak criterion. To effectively disable the threshold criterion for this command, provide a substantially low threshold value such as -200 dBm. Also note that the threshold value used in this command is independent of and has no effect on the threshold value stored under the Peak Criteria menu.</p> <p><excursion> - is the minimum amplitude variation (rise and fall) required for a signal to be identified as peak. Note that the excursion value is required and is always used as a peak criterion. To effectively disable the excursion criterion for this command, provide the minimum value of 0.0 dB. Also note that the excursion value used in this command is independent of and has no effect on the</p>

excursion value stored under the Peak Criteria menu.

Values must be provided for threshold and excursion. The sorting and display line parameters are optional (defaults are AMPLitude and ALL).

Note that there is always a Y-axis value for the display line, regardless of whether the display line state is on or off. It is the current Y-axis value of the display line which is used by this command to determine whether a peak should be reported
Sorting order:

AMPLitude - lists the peaks in order of descending amplitude, with the highest peak first (default if optional parameter not sent)

FREQuency - lists the peaks in order of occurrence, left to right across the x-axis.

TIME - lists the peaks in order of occurrence, left to right across the x-axis.

Peaks vs. Display Line:

ALL - lists all of the peaks found (default if optional parameter not sent).

GTDLine (greater than display line) - lists all of the peaks found above the display line.

LTDLine (less than display line) - lists all of the peaks found below the display line.

Initial S/W Revision	Prior to A.02.00
----------------------	------------------

Hardware-Accelerated Fast Power Measurement (Remote Command Only)

The Fast Power option (FP2) enables very fast channel power measurements for instruments with the prerequisite hardware (DP2 and/or B40). It accomplishes this by performing real-time overlapped FFTs at the hardware layer, using software for basic post-processing before returning the result to the user. The upshot of this approach is improved throughput for user applications that require many sequential power measurements.

The analysis bandwidth of FP2 is limited by the licenses in the instrument, but its maximum overall analysis bandwidth per acquisition is 40 MHz.

FP2 is remote-only, which means the instrument does not switch to any particular mode or measurement. FP2 commands can be sent while another application is in use on the front panel.

Each Fast Power measurement can be predefined using an array index, and up to 1,000 measurements can be stored. In the following documentation, instances of [1,2,...,999] can be substituted with a particular measurement index, e.g. CALC:FPOW:POW1?, CALC:FPOW:POW2?, CALC:FPOW:POW134?. In this way, power measurements can be defined one time in a batch, and then executed multiple times without having to redefine them, similar to “list mode” on other measurements.

In addition to basic channel power measurements, there are a number of other measurement “functions” for each channel, including peak power, peak frequency, and power spectral density. See the Function parameter for more information.

Reset Fast Power Measurement (Remote Command Only)

Resets the measurement configuration to the defaults.

Mode	All
Remote Command	:CALCulate:FPOWer:POWer [1, 2, ..., 999] :RESet
Example	:CALC:FPOW:POW1:RES

Notes	Option FP2 is required.
Initial S/W Revision	A.14.00

Define Fast Power Measurement (Remote Command Only)

Fast Power acquisitions are configured using the DEFine command. This command accepts a comma-delimited string of configuration parameters and their appropriate values, which are all specified in the subsection below.

Mode	All
Remote Command	:CALCulate:FPOWer:POWer[1,2,...,999]:DEFine "configuration string"
Example	:CALC:FPOW:POW1:DEF "CenterFrequency=2e9, AcquisitionTime=0.005"
Notes	See below for a list of measurement variables that can be defined in the configuration string.
Initial S/W Revision	A.14.00

Acquisition Time

Value	Time (s)
Range	0 s to 1 s
Preset	0.001 s
Example	CALC:FPOW:POW1:DEF "AcquisitionTime=0.002"
Notes	The acquisition time parameter sets the time in which the entire spectrum is measured. An increase in the acquisition time yields an improvement in measurement repeatability.
Initial S/W Revision	A.14.00

Center Frequency

Value	Frequency (Hz)
Range	0 Hz to maximum instrument frequency
Preset	1 GHz
Example	CALC:FPOW:POW1:DEF "CenterFrequency=2e9"
Notes	The center frequency parameter sets the frequency in which the measurement is centered around. The OffsetFrequency parameter is calculated relative to the center frequency.
Initial S/W Revision	A.14.00

DC Coupled

Value	Boolean
Range	True (DC Coupled) or False (AC Coupled)
Preset	False
Example	CALC:FPOW:POW1:DEF "DCCoupled=True"
Notes	The DC coupled parameter allows the user to specify whether the DC blocking capacitor is utilized. Set parameter to true when measuring frequencies below 10 MHz.
Initial S/W Revision	A.14.00

DetectorType

Example	CALC:FPOW:POW1:DEF "DetectorType=Peak"
Notes	Option FP2 is required. The detector type parameter allows the user to choose whether a RMS average or peak value is used during the measurement.
Preset	RmsAverage
Range	RmsAverage, Peak
Initial S/W Revision	A.14.00

Do Noise Correction

Value	Boolean
Range	True (enable noise correction) or False (disable noise correction)
Preset	False
Example	CALC:FPOW:POW1:DEF "DoNoiseCorrection=True"
Notes	When noise correction is enabled, the linear noise power contributed by the analyzer is subtracted from all measurements. This effectively lowers the noise floor of the analyzer. When noise correction is enabled, the first measurement for a given set of input parameters will take extra time. This is because the analyzer takes an extra acquisition with the RF input disconnected from the analyzer's front end to measure the noise of just the analyzer. The measured noise floor is stored in a cache so the noise acquisition will occur only once for the same state settings. In other words, if noise correction was turned on and the analyzer made an acquisition at frequency A, then frequency B, and back again to frequency A, the hidden initial noise floor acquisition would only occur for the first acquisition at frequency A and the cached noise floor would be used the second time frequency A was measured.
Initial S/W Revision	A.14.00

Do Spur Suppression

Value	Boolean
Range	True (enable spur suppression) or False (disable spur suppression)
Preset	False
Example	CALC:FPOW:POW1:DEF "DoSpurSuppression=True"
Notes	<p>When measuring very low level signals, or when large out-of-band inputs are input into the analyzer, sometimes unwanted spurs and residuals can appear in the measured spectrum. Spur suppression is a method to help minimize the levels of these internally generated spurs and residuals.</p> <p>When spur suppression is enabled, the analyzer will automatically take two acquisitions using two different internal analog LO frequencies. The FFT spectrums from both acquisitions are combined by taking the minimum power between both traces on a per FFT bin basis. External signals will have the same amplitude for both traces and therefore will return the expected amplitudes. However, low level spurs and residuals generated internally to the analyzer tend to move to different FFT bins depending on the internal analog LO frequency used, and therefore tend to be suppressed using this spur suppression method.</p> <p>Because two acquisitions, rather than a single acquisition, are made when spur suppression is enabled, the measurement time will always be slower when spur suppression is enabled.</p>
Initial S/W Revision	A.14.00

Electronic Attenuator Bypass

Value	Boolean
Range	True (bypass electronic attenuator) or False (use electronic attenuator)
Preset	True
Example	CALC:FPOW:POW1:DEF "ElecAttBypass =False"
Notes	The electronic attenuation bypass parameter allows the user to either utilize or bypass the electronic attenuator. The electronic attenuator is only available for frequencies up to 3.6 GHz. Set parameter to true when using frequencies above 3.6 GHz and set the parameter to false when using the preamp.
Initial S/W Revision	A.14.00

Electronic Attenuation

Value	dB
Range	0 – 24 dB (1 dB steps)
Preset	0 dB
Example	CALC:FPOW:POW1:DEF "ElecAttenuation=10"
Notes	<p>Option EA3 is required.</p> <p>The electronic attenuation value parameter sets the amount of electrical attenuation from 0 to 24 dB (1 dB steps).</p>

Set "ElecAttBypass=False" to make sure the electronic attenuator path is enabled.

Initial S/W Revision	A.14.00
-------------------------	---------

IF Gain

Value	dB
Range	-6 - 16 dB (1 dB steps)
Preset	0 dB
Example	CALC:FPOW:POW1:DEF "IFGain=10"
Notes	The IF gain parameter allows the user to specify the gain at the IF stage anywhere from -6 to 16 dB (1 dB steps). This is an advanced feature, and for most cases this should remain at its default value of 0 dB.
Initial S/W Revision	A.14.00

IF Type

Example	CALC:FPOW:POW1:DEF "IFType=B25M"
Notes	The IF type parameter allows the user to select between different IF paths. For example, if the signal is less than 25 MHz wide, then the user can select the B25M path to take advantage of additional filtering on this analog IF path.
Preset	B40M
Range	B10M, B25M, B40M
Initial S/W Revision	A.14.00

Include Power Spectrum

Value	Boolean
Range	True (return both channel power and full power spectrum) or False (returns only channel power)
Preset	False
Example	CALC:FPOW:POW1:DEF "IncludePowerSpectrum=True"
Notes	The power spectrum parameter allows the user to read data on the entire spectrum for diagnostic purposes. It is not recommended for production use. See CALC:FPOW:POW[n]:READ2? for details on the binary format of the response.
Initial S/W Revision	A.14.00

Mechanical Attenuation

Value	dB
Range	0 – 70 dB (2 dB steps)
Preset	0 dB
Example	CALC:FPOW:POW1:DEF "MechAttenuation=10"
Notes	The mechanical attenuation value parameter sets the amount of mechanical attenuation anywhere from 0 to 70 dB (2 dB steps).
Initial S/W Revision	A.14.00

Preamp Mode

Example	CALC:FPOW:POW1:DEF "PreAmpMode=Low"
Notes	The license for the appropriate preamp is required. The preamp mode parameter specifies whether the preamps are being utilized. Low allows any preamps up to 3.6 GHz, and Full allows all licensed preamps. Set "ElecAttBypass=True" in order to utilize any preamps.
Preset	Off
Range	Off, Low, Full
Initial S/W Revision	A.14.00

Resolution Bandwidth Mode

Example	CALC:FPOW:POW1:DEF "PreAmpMode=Low"
Notes	The resolution bandwidth mode parameter allows the user to choose whether the RBW filter is automatically or manually set. The BestSpeed value minimizes measurement time, while the Narrowest value minimizes RBW size (minimum of two FFT bins per RBW). To manually specify an RBW, set this parameter to Explicit, and set the ResolutionBW parameter to the desired value.
Preset	BestSpeed
Range	BestSpeed, Narrowest, Explicit
Initial S/W Revision	A.14.00

Resolution Bandwidth

Value	Hz
Preset	0 Hz

Example	CALC:FPOW:POW1:DEF "ResolutionBW=25e3"
Notes	The resolution bandwidth parameter sets the 3-dB bandwidth of the RBW filter. The ResolutionBWMode parameter must be set to Explicit in order to manually set the RBW.
Initial S/W Revision	A.14.00

Trigger Delay

Value	Seconds
Range	0 - 1 s
Preset	0 s
Example	CALC:FPOW:POW1:DEF "TriggerDelay=0.025"
Notes	The trigger delay parameter sets the time after an external trigger is detected until the measurement is performed.
Initial S/W Revision	A.14.00

Trigger Level

Value	Volts
Range	-5 to 5 V
Preset	1.2 V
Example	CALC:FPOW:POW1:DEF "TriggerLevel=2"
Notes	The trigger level parameter sets the voltage value at which an external trigger is detected.
Initial S/W Revision	A.14.00

Trigger Slope

Example	CALC:FPOW:POW1:DEF "TriggerSlope=Negative"
Notes	The trigger slope parameter indicates the direction of the edge trigger voltage for detection.
Preset	Positive
Range	Positive, Negative
Initial S/W Revision	A.14.00

Trigger Source

Example	CALC:FPOW:POW1:DEF "TriggerSource=Ext1"
Notes	The trigger source parameter allows the user to choose between measurement's triggering freely or controlled by an external input. Ext1 and Ext2 correspond to Trigger 1 In and Trigger 2 In, respectively.
Preset	Free
Range	Free, Ext1, Ext2
Initial S/W Revision	A.14.00

Trigger Timeout

Value	Seconds
Range	0 – 1 s
Preset	1 s
Example	CALC:FPOW:POW1:DEF "TriggerTimeout=0.1"
Notes	The trigger timeout parameter sets the time in which the analyzer will wait for a trigger before automatically performing the measurement.
Initial S/W Revision	A.14.00

Signal Input

Example	CALC:FPOW:POW1:DEF "SignalInput=Fp50MHzCW"
Notes	The signal input parameter allows the user to select between using the main RF input or the internal analyzer reference CW signal of 50 MHz.
Preset	FpMainRf
Range	FpMainRf, Fp50MHzCW
Initial S/W Revision	A.14.00

Use Preselector

Value	Boolean
Range	True (use preselector above 3.6 GHz), or False (preselector bypassed)
Preset	False
Example	CALC:FPOW:POW1:DEF "UsePreSelector=True"
Notes	The preselector parameter allows the user to either utilize or bypass the front end tunable filter at frequencies above 3.6 GHz. For frequencies below 3.6 GHz, the preselector is automatically

bypassed, so you do not need to set this parameter to False in those cases.

Initial S/W Revision A.14.00

Channel Bandwidth Array

Value	Hz
Range	0 to 40 MHz
Preset	[1e6]
Example	CALC:FPOW:POW1:DEF "Bandwidth=[3.84e6, 5e6, 3.84e6]"
Notes	The bandwidth parameter array defines the bandwidth of each channel that will be measured. All array parameters should have the same number of elements. Alternatively, if all the elements are the same value, a single number with no square brackets can be used to define the parameter.
Initial S/W Revision	A.14.00

Channel Filter Type Array

Example	CALC:FPOW:POW1:DEF "FilterType=[RRC, IBW, RRC]"
Notes	The filter type parameter allows the user to choose between an integration bandwidth (IBW) filter or a root-raised-cosine (RRC) filter. The integration bandwidth filter weighs all frequencies within the bandwidth equally. The root-raised-cosine filter has an associated shape parameter, defined by the FilterAlpha parameter. All array parameters should have the same number of elements. Alternatively, if all the elements are the same value, a single value with no square brackets can be used to define the parameter.
Preset	[IBW]
Range	IBW, RRC
Initial S/W Revision	A.14.00

Channel Filter Alpha Array

Example	CALC:FPOW:POW1:DEF "FilterAlpha=[0.5, 0.0, 0.5]"
Notes	The filter alpha parameter allows the user to adjust the alpha value associated with the root-raised-cosine (RRC) filter type. Set FilterType to RRC in order to utilize this parameter. All array parameters should have the same number of elements. Alternatively, if all the elements are the same value, a single number with no square brackets can be used to define the parameter.
Preset	[0.22]
Range	0.0 – 1.0
Initial S/W Revision	A.14.00

Channel Measurement Function Array

Example	CALC:FPOW:POW1:DEF "Function=[BandPower, PeakPower, BandPower]"
Notes	<p>This parameter array defines what measurement is being made for each individually-specified channel:</p> <p>BandPower: Total power within the specified bandwidth of the channel (dBm)</p> <p>BandDensity: Total power density within the specified bandwidth of the channel (dBm/Hz)</p> <p>PeakPower: The peak power value within the specified bandwidth of the channel (dBm)</p> <p>PeakFrequency: The frequency which corresponds to the peak power value within the specified bandwidth of the channel. This frequency is relative to the center frequency (Hz)</p> <p>XdBBandwidth: The half power (-3.01 dB) bandwidth of the highest amplitude signal that resides within the channel (Hz), dB is configurable using XdBBandwidth parameter</p> <p>OccupiedBandwidth: The bandwidth at which 99% of the total power resides within the channel (Hz), percentage configurable using OccupiedBandwidthPercent parameter</p> <p>All array parameters should have the same number of elements. Alternatively, if all the elements are the same value, a single value with no square brackets can be used to define the parameter.</p>
Preset	[BandPower]
Range	BandPower, BandDensity, PeakPower, PeakFrequency, XdBBandwidth, OccupiedBandwidth
Initial S/W Revision	A.14.00

Channel Offset Frequency Array

Value	Hz
Range	0 to 20 MHz
Preset	[0]
Example	CALC:FPOW:POW1:DEF "OffsetFrequency=[-5e6, 0, 5e6]"
Notes	<p>The offset frequency parameter array defines the difference between the center frequency to the center frequency of each channel.</p> <p>All array parameters should have the same number of elements.</p>
Initial S/W Revision	A.14.00

Channel Occupied Bandwidth Percent Array

Example	CALC:FPOW:POW1:DEF "OccupiedBandwidthPercent =[0.95, 0.95, 0.95]"
Notes	<p>This parameter only applies for channels whose Function is set to OccupiedBandwidth. The occupied bandwidth percent parameter specifies the percent of total power in these channels. The valid range for this parameter is 0.0 to 1.0, where 1.0 represents 100%. The default for this parameter is 0.99, which will return the bandwidth that contains 99% of the total channel power.</p>

Preset	[0.99]
Range	0 - 1.0
Initial S/W Revision	A.14.00

Channel x-dB Bandwidth Array

Value	dB
Range	-200 to 0 dB
Preset	[-3.01]
Example	CALC:FPOW:POW1:DEF " XdBBandwidth =[-6.02, -3.01, -1.0]"
Notes	This parameter only applies for channels whose Function is set to XdBBandwidth. The X dB bandwidth parameter is used to specify the power relative to the peak channel power over which the bandwidth is calculated. The parameter value must be a negative number.
Initial S/W Revision	A.14.00

Define Fast Power Measurement Query (Remote Command Only)

The DEFine? command is used to retrieve a list of all defined parameters in an ASCII string format

M	All
o	
d	
e	
R	:CALCulate:FPOWer:POWer[1,2,...,999]:DEFine?
e	
m	
o	
t	
e	
C	
o	
m	
m	
a	
n	
d	
E	:CALC:FPOW:POW1:DEF?
x	
a	
m	

p
l
e

N This command query is used to retrieve a list of all defined parameters in an ASCII format.

O The following is an example of the returned results:

S "DCCoupled=False,ElecAttBypass=True,ElecAttenuation=0,IFGain=0,MechAttenuation=0,PreAmpMode=Off,PreSelectorOffset=0,UsePreSelector=False,ExternalReferenceFrequency=1000000,FrequencyReferenceSource=AutoExternalFrequencyReference,IFType=B40M,LOMode=SLW,SignalInput=FpMainRf,AcquisitionTime=0.001,CenterFrequency=100000000,ResolutionBW=0,ResolutionBWMode=BestSpeed,DetectorType=RmsAverage,Bandwidth=[1000000],OffsetFrequency=[0],Function=[BandPower],FilterType=[IBW],FilterAlpha=[0.22],OccupiedBandwidthPercent=[0.99],XdBBandwidth=[-3.01],DoNoiseCorrection=False,DoSpurSuppression=False,MeasurementMethod=HardwareFFT,IncludePowerSpectrum=False,TriggerDelay=0,TriggerLevel=1.2,TriggerSlope=Positive,TriggerSource=Free,TriggerTimeout=1"

I A.14.00

n
i
t
i
a
l

S
/
W

R
e
v
i
s
i
o
n

Configure Fast Power Measurement (Remote Command Only)

The configure command begins hardware setup and returns immediately, with no acquisition made. This can be used in parallel with other hardware operations to effectively hide the hardware setup time.

Mode	All
Remote Command	:CALCulate:FPOWER:POWER[1,2,...,999]:CONFigure
Example	:CALC:FPOW:POW1:CONF
Notes	Option FP2 is required.
Initial S/W Revision	A.14.00

Initiate Fast Power Measurement (Remote Command Only)

The INITiate command begins an acquisition and returns immediately. The results of the measurement can be retrieved using FETCh.

Mode	All
Remote Command	:CALCulate:FPOWer:POWer[1,2,...,999]:INITiate
Example	:CALC:FPOW:POW1:INIT
Notes	Option FP2 is required.
Initial S/W Revision	A.14.00

Fetch Fast Power Measurement (Remote Command Only)

The FETCh command query is used to retrieve the results of an acquisition initiated by the INIT command. The returned results are in ASCII string format. The string begins and ends with quotation marks.

Mode	All
Remote Command	:CALCulate:FPOWer:POWer[1,2,...,999]:FETCh?
Example	:CALC:FPOW:POW1:FETC?
Notes	Option FP2 is required. Returns m comma-separated ASCII values, where m corresponds to the number of bandwidths defined. 1. Declared function return in the 1st specified channel 2. Declared function return in the 2nd specified channel ... m. Declared function return in the last specified channel The INIT and FETC? command sequence performs the same functionality of a single CALC:FPOW:POW[n]? query. Units of the returned values are dependent on the Function parameter for each channel.
Initial S/W Revision	A.14.00

Execute Fast Power Measurement (Remote Command Only)

This command query is used as shorthand for an INIT command immediately followed by a FETC? command. The returned results are in ASCII string format. The string begins and ends with quotation marks.

Mode	All
Remote Command	:CALCulate:FPOWer:POWer[1,2,...,999]?
Example	:CALC:FPOW:POW1?
Notes	Option FP2 is required. See notes for Fast Power Fetch for return format.
Initial S/W Revision	A.14.00

Binary Read Fast Power Measurement (Remote Command Only)

This command query is used as shorthand for an INIT command immediately followed by a FETC? command. The returned results are in a binary format.

Mode	All
Remote Command	:CALCulate:FPOWER:POWER[1,2,...,999]:READ? :CALCulate:FPOWER:POWER[1,2,...,999]:READ1?
Example	:CALC:FPOW:POW1:READ? :CALC:FPOW:POW1:READ1?
Notes	Option FP2 is required. Returns m 4 byte floating point binary values (Little-Endian), where m corresponds to the number of bandwidths defined.
Initial S/W Revision	A.14.00

Diagnostic Binary Read Fast Power Measurement (Remote Command Only)

This command query is used as shorthand for an INIT command immediately followed by a FETC? command. The returned results are in a binary format. This command is used primarily for diagnostic purposes to test for ADC overloads and to visibly inspect the spectrum.

Mode	All
Remote Command	:CALCulate:FPOWER:POWER[1,2,...,999]:READ2?
Example	:CALC:FPOW:POW1:READ2?
Notes	Option FP2 is required. Note: Spectrum data is only returned if the IncludePowerSpectrum parameter is set to True. If IncludePowerSpectrum is False, the number of spectrum points will be zero (0). Units of the returned values are dependent on the Function parameter per channel (e.g. dBm for BandPower, Hz for PeakFrequency). Returns binary data (Little-Endian) that contains information on m amount of channels, along with ADC over range and full spectrum data. The following is the binary format of the response. Bandwidth Return Value 1. Number of channels specified, m [4 byte int] 2. Declared function result for the 1st specified channel [4 byte float] 3. Declared function result for the 2nd specified channel [4 byte float] ... (m + 1). Declared function result for the last (mth) specified channel [4 byte float] ADC Over Range 1. ADC over-range occurred (1: true, 0: false) [2 byte short]

	Spectrum Data
	1. Number of points in the spectrum data, k [4 byte int]
	2. Start frequency of spectrum data (Hz) [8 byte double]
	3. Step frequency of spectrum data (Hz) [8 byte double]
	4. FFT bin at 1st point (dBm) [4 byte float]
	5. FFT bin at 2nd point (dBm) [4 byte float]
	...
	(k + 3). FFT bin at last (kth) point (dBm) [4 byte float]
Initial S/W Revision	A.14.00

Format Data: Numeric Data (Remote Command Only)

This command specifies the format of the trace data input and output. It specifies the formats used for trace data during data transfer across any remote port. It affects only the data format for setting and querying trace data for the :TRACe[:DATA], TRACe[:DATA]?, :CALCulate:DATA[n]? and FETCh:SANalyzer[n]? commands and queries.

Remote Command	:FORMat[:TRACe][:DATA] ASCii INTEger,32 REAL,32 REAL,64 :FORMat[:TRACe][:DATA]?
Notes	The query response is: ASCii: ASC,8 REAL,32: REAL,32 REAL,64: REAL,64 INTEger,32: INT,32 When the numeric data format is REAL or ASCii, data is output in the current Y Axis unit. When the data format is INTEger, data is output in units of m dBm (.001 dBm). The INT,32 format returns binary 32-bit integer values in internal units (m dBm), in a definite length block.
Dependencies	Sending a data format spec with an invalid number (for example, INT,48) generates no error. The analyzer simply uses the default (8 for ASCii, 32 for INTEger, 32 for REAL). Sending data to the analyzer which does not conform to the current FORMat specified, results in an error. Sending ASCII data when a definite block is expected generates message -161 "Invalid Block Data" and sending a definite block when ASCII data is expected generates message -121 "Invalid Character in Number".
Preset	ASCii
Backwards Compatibility Notes	Note that the INT,32 format is only applicable to the command, TRACe:DATA. This preserves backwards compatibility for the Swept SA measurement. For all other commands/queries which honor FORMat:DATA, if INT,32 is sent the analyzer will behave as though it were set to REAL,32.
Initial S/W Revision	Prior to A.02.00

The specs for each output type follow:

AScii - Amplitude values are in ASCII, in the current Y Axis Unit, one ASCII character per digit, values separated by commas, each value in the form:

SX.YYYYYEsZZ

Where:

S = sign (+ or -)

X = one digit to left of decimal point

Y = 5 digits to right of decimal point

E = E, exponent header

s = sign of exponent (+ or -)

ZZ = two digit exponent

REAL,32 - Binary 32-bit real values in the current Y Axis Unit, in a definite length block.

REAL,64 - Binary 64-bit real values in the current Y Axis Unit, in a definite length block.

Format Data: Byte Order (Remote Command Only)

This command selects the binary data byte order for data transfer and other queries. It controls whether binary data is transferred in normal or swapped mode. This command affects only the byte order for setting and querying trace data for the :TRACe[:DATA], TRACe[:DATA]? , :CALCulate:DATA[n]? and FETCh:SANalyzer[n]? commands and queries.

By definition any command that says it uses FORMat:DATA uses any format supported by FORMat:DATA.

The NORMal order is a byte sequence that begins with the most significant byte (MSB) first, and ends with the least significant byte (LSB) last in the sequence: 1|2|3|4. SWAPped order is when the byte sequence begins with the LSB first, and ends with the MSB last in the sequence: 4|3|2|1.

Remote Command	:FORMat:BORDER NORMal SWAPped :FORMat:BORDER?
Preset	NORMal
Initial S/W Revision	Prior to A.02.00

Meas Setup

Accesses the measurement setup menu for the current measurement.

Key Path	Front-panel key
Initial S/W Revision	A.10.01

Avg Number

Used to specify the number of data acquisitions that are averaged. After the specified number of average counts, the averaging mode (termination control) setting determines the averaging action.

- On - Sets measurement averaging on.
- Off - Sets measurement averaging off.

Key Path	Meas Setup
Mode	WLAN
Remote Command	[:SENSe]:FLATness:AVErAge:COUNt <integer> [:SENSe]:FLATness:AVErAge:COUNt? [:SENSe]:FLATness:AVErAge[:STATe] OFF ON 0 1 [:SENSe]:FLATness:AVErAge[:STATe]?
Example	FLAT:AVER:COUN 1 FLAT:AVER:COUN? FLAT:AVER OFF FLAT:AVER?
Preset	10 OFF
State Saved	Saved in instrument state.
Min	1
Max	10000
Initial S/W Revision	A.10.01

Avg Mode

Selects the type of termination control used for the averaging function. This determines the averaging action after the specified number of data acquisitions (average count) is reached.

KEY:Exponential SCPI:EXPonential	After the average count is reached, each successive data acquisition is exponentially weighted and combined with the existing average.
KEY:Repeat SCPI:REPeat	After reaching the average count, the averaging is reset and a new average is started.

Key Path	Meas Setup
Mode	WLAN
Remote Command	<code>[:SENSe] :FLATness :AVERage :TCONtrol EXPonential REPEAT</code> <code>[:SENSe] :FLATness :AVERage :TCONtrol ?</code>
Example	FLAT:AVER:TCON REP FLAT:AVER:TCON?
Preset	REPEAT
State Saved	Saved in instrument state.
Range	Exp Repeat
Initial S/W Revision	A.10.01

Search Length

Enables you to specify the Search Length for WLAN spectral flatness measurement. Please note, this parameter determines the length of data to be acquired. In order to assure channel estimation, preamble should be included in, therefore Search Length should not be less than summation of long preamble, short preamble and payload, or actual data.

Key Path	Meas Setup
Mode	WLAN
Remote Command	<code>[:SENSe] :FLATness :SLENgth <time></code> <code>[:SENSe] :FLATness :SLENgth ?</code>
Example	FLAT:SLEN 1ms FLAT:SLEN?
Preset	500us
State Saved	Saved in instrument state.
Min	28.0 us
Max	Hardware Dependent: 4000000 / Sampling Rate B25: Sampling Rate = 45M (when info BW is 25MHz); WB (B40 or Wider): Sampling Rate = Info BW * 1.25
Backwards Compatibility SCPI	<code>[:SENSe] :FLATness :TIME :SEARChlen <time></code>
Initial S/W Revision	A.10.01

Limits

Accesses the Format/Limits menu, which contains features that enable you to do limit check.

For IEEE 802.11a/g-ERP-OFDM/g-DSSS-OFDM specification, Section 1 includes the carriers -16...-1 and 1...16, Section 2 includes -26...-17 and 17... 26.

For IEEE 802.11n, 20MHz specification, Section 1 includes the carriers -16...-1 and 1...16, Section 2 includes -28...-17 and 17... 28.

For IEEE 802.11n, 40MHz transmission specification (excluding HT duplicate and Non-HT Duplicate), Section 1 includes the carriers -42...-2 and 2...42, while Section 2 includes -58...-43 and 43... 58.

For IEEE 802.11n, 40MHz Duplicate mode (including HT and Non-HT duplicate) , Section 1 includes the carriers -42 to -33, -31 to -6, +6 to +31, and +33 to +42, while Section 2 includes -58...-43 and 43... 58.

For IEEE 802.11ac, 20MHz specification, Section 1 includes the carriers -16...-1 and 1...16, Section 2 includes -28...-17 and 17... 28.

For IEEE 802.11ac, 40MHz transmission specification , Section 1 includes the carriers -42...-2 and 2...42, while Section 2 includes -58...-43 and 43... 58.

For IEEE 802.11n, 40MHz Non-HT duplicate mode , Section 1 includes the carriers -42 to -33, -31 to -6, +6 to +31, and +33 to +42, while Section 2 includes -58...-43 and 43... 58.

For IEEE 802.11ac, 80MHz transmission specification , Section 1 includes the carriers -84...-2 and 2...84, while Section 2 includes -122...-85 and 85... 122.

For IEEE 802.11n, 80MHz Non-HT duplicate mode , Section 1 includes the carriers -84 to -70, -58 to -33, -31 to -6, +6 to +31, and +33 to +58, +70 to +84, while Section 2 includes -122...-97, -95 to -85and +85... +95, +97 to +122.

For IEEE 802.11ac, 160MHz transmission specification , there is only one Section which includes the carriers -250...-6 and 6...250.

To be compatible with PSA existing commands, the X-Series WLAN Spectral Flatness measurement also provides the BWCC commands to configure the limit parameters, those commands will accept array parameters rather than single one, and the default values will be kept the same.

Key Path	Meas Setup
Initial S/W Revision	A.10.01

Upper Limit Section 1

This parameter allows you to specify upper deviation limit (dB) of the Section 1

Key Path	Meas Setup, Limit
Mode	WLAN
Remote Command	:CALCulate:FLATness:LIMit:UPPer:SECTion1 <rel_amp> :CALCulate:FLATness:LIMit:UPPer:SECTion1?
Example	CALC:FLAT:LIM:UPP:SECT1 2.0 CALC:FLAT:LIM:UPP:SECT1?
Notes	The BWCC commands will set All upper limit once, including Segment 1 (Section 1) and Segment 2 (Section 2). If there is only one input parameter, Segment 1 upper limit will be set; if more than 2

	input parameters, only the first 2 will be uses as Segment 1 and 2 upper limit.
Preset	4.00 for 802.11ac and 802.11n standard 2.00 for others
State Saved	Saved in instrument state.
Min	0.10
Max	10.00
Backwards Compatibility SCPI	:CALCulate:FLATness:SEGment:LIST:LIMit:UPPer <rel_ampl>, <rel_ampl> :CALCulate:FLATness:SEGment:LIST:LIMit:UPPer?
Initial S/W Revision	A.10.01

Lower Limit Section 1

This parameter allows you to specify lower deviation limit (dB) of the Section 1.

Key Path	Meas Setup, Limit
Mode	WLAN
Remote Command	:CALCulate:FLATness:LIMit:LOWer:SECTion1 <rel_ampl> :CALCulate:FLATness:LIMit:LOWer:SECTion1?
Example	CALC:FLAT:LIM:LOW:SECT1 -2.0 CALC:FLAT:LIM:LOW:SECT1?
Notes	The BWCC commands will set All lower limit once, including Segment 1(Section 1) and Segment 2 (Section 2). If there is only one input parameter, Segment 1 lower limit will be set; if more than 2 input parameters, only the first 2 will be uses as Segment 1 and 2 lower limit.
Preset	-4.00 for 802.11ac 20MHz/40MHz/80MHz, and 802.11n -6.00 for 802.11ac 160MHz -2.00 for others
State Saved	Saved in instrument state.
Min	-10.00
Max	-0.10
Backwards Compatibility SCPI	:CALCulate:FLATness:SEGment:LIST:LIMit:LOWer <rel_ampl>, <rel_ampl> :CALCulate:FLATness:SEGment:LIST:LIMit:LOWer?
Initial S/W Revision	A.10.01

Upper Limit Section 2

This parameter allows you to specify upper deviation limit (dB) of the Section 2.

Key Path	Meas Setup, Limit
Mode	WLAN

Remote Command	:CALCulate:FLATness:LIMit:UPPer:SECTion2 <rel_amp> :CALCulate:FLATness:LIMit:UPPer:SECTion2?
Example	CALC:FLAT:LIM:UPP:SECT2 2.0 CALC:FLAT:LIM:UPP:SECT2?
Notes	The BWCC commands will set All upper limit once, including Segment 1 (Section 1) and Segment 2 (Section 2). If there is only one input parameter, Segment 1 upper limit will be set; if more than 2 input parameters, only the first 2 will be uses as Segment 1 and 2 upper limit.
Preset	4.00 for 802.11ac and 802.11n standard 2.00 for others
State Saved	Saved in instrument state.
Min	0.10
Max	10.00
Backwards Compatibility SCPI	:CALCulate:FLATness:SEGment:LIST:LIMit:UPPer <rel_ampl>, <rel_ampl> :CALCulate:FLATness:SEGment:LIST:LIMit:UPPer?
Initial S/W Revision	A.10.01

Lower Limit Section 2

This parameter allows you to specify lower deviation limit (dB) of the Section 2.

Key Path	Meas Setup, Limit
Mode	WLAN
Remote Command	:CALCulate:FLATness:LIMit:LOWer:SECTion2 <rel_amp> :CALCulate:FLATness:LIMit:LOWer:SECTion2?
Example	CALC:FLAT:LIM:LOW:SECT2 -2.0 CALC:FLAT:LIM:LOW:SECT2?
Notes	The BWCC commands will set All lower limit once, including Segment 1 (Section 1) and Segment 2 (Section 2). If there is only one input parameter, Segment 1 lower limit will be set; if more than 2 input parameters, only the first 2 will be uses as Segment 1 and 2 lower limit.
Preset	-6.00 for 802.11ac and 802.11n standard -4.00 for others
State Saved	Saved in instrument state.
Min	-10.00
Max	-0.10
Backwards Compatibility SCPI	:CALCulate:FLATness:SEGment:LIST:LIMit:LOWer <rel_ampl>, <rel_ampl> :CALCulate:FLATness:SEGment:LIST:LIMit:LOWer?
Initial S/W Revision	A.10.01

Advanced

Accesses advanced measurement setup features. These features are intended for the advanced user.

Key Path	Meas Setup, More
Initial S/W Revision	A.10.01

IF Gain

Accesses the menu that sets ranging in the digital IF when acquiring an I/Q time record.

See "[More Information about IF Gain](#)" on page 1623.

NOTE This function is not affected by RF Input Range attenuation.

Key Path	Meas Setup, More
Initial S/W Revision	A.10.01

More Information about IF Gain

To take full advantage of the RF dynamic range of the analyzer, you can manually turn on or turn off a switched digital IF amplifier. When it is turned on, the signal will get approximately 10 dB of gain.

- Setting IF Gain to Man and selecting High Gain will turn on the digital IF amplifier and get an extra 10 dB gain.
- Setting IF Gain to Auto will activate the Auto rules for IF Gain.

These settings affect sensitivity and IF overloads.

IF Gain Auto

Activates the Auto Rules for IF Gain. When Auto is active, the IF Gain is set to High Gain under any of the following conditions:

- the input attenuator is set to 0 dB
- the preamp is turned On
- the Max Mixer Level is -20 dBm or lower

For other settings, Auto sets IF Gain to Off.

Key Path	Meas Setup, More, Advanced
Mode	WLAN
Remote Command	[:SENSe] :FLATness :IF :GAIN :AUTO [:STATe] ON OFF 1 0 [:SENSe] :FLATness :IF :GAIN :AUTO [:STATe] ?
Example	FLAT:IF:GAIN:AUTO ON FLAT:IF:GAIN:AUTO?

Couplings	When either the auto attenuation is active (for example, with an electrical attenuator), or the optimize mechanical attenuator range is requested, the IF Gain setting is changed using the following rule. The Auto selection sets IF Gain On under any of the following conditions: the input attenuator is set to 0 dB the preamp is turned on, the Max Mixer Level is -20 dBm or lower. For other settings, Auto sets IF Gain to Off.
Preset	OFF
State Saved	Saved in instrument state.
Range	Auto Man
Initial S/W Revision	A.10.01

IF Gain State

Selects the range of IF gain.

- On sets the high gain option, which allows for better noise level measurements.
- Off sets low gain when measuring large signals.

When this parameter is changed manually from front panel, IF Gain Auto will become Man.

Key Path	Meas Setup, More, Advanced ,IF Gain
Mode	WLAN
Remote Command	[:SENSe] :FLATness :IF :GAIN [:STATe] ON OFF 1 0 [:SENSe] :FLATness :IF :GAIN [:STATe] ?
Example	FLAT:IF:GAIN ON FLAT:IF:GAIN?
Notes	where ON = high gain OFF = low gain
Preset	OFF
State Saved	Saved in instrument state.
Range	Low Gain (Best for Large Signals) High Gain (Best Noise Level)
Readback Text	Low Gain High Gain
Initial S/W Revision	A.10.01

Symbol Timing Adjust

Normally, when demodulating of an OFDM symbol, the guard interval is skipped over, and an FFT is performed on the last portion of the symbol time. However, this means that the FFT would include the

transition region between this symbol and the following symbol. To avoid this, it is generally beneficial to back up away from the end of the symbol time, and use a part of the guard interval.

This parameter Symbol Timing Adjust controls how far the FFT part of the symbol is adjusted away from the end of the symbol time. The value is in terms of percent of the used (FFT) part of the symbol time.

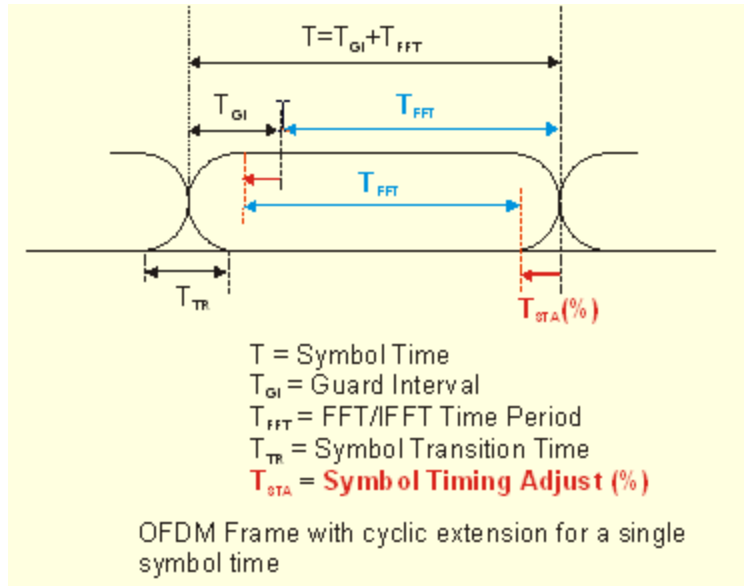

Key Path	Meas Setup, Advanced
Mode	WLAN
Remote Command	[:SENSe]:FLATness:TADJust <percent> [:SENSe]:FLATness:TADJust?
Example	FLAT:TADJ -3.125 FLAT:TADJ?
Couplings	The Min Value of Symbol Timing Adjust is $-100.0 * \text{Guard Interval}$. The value of Symbol Timing Adjust clipped to times of 1/128. (For 11n, Bebob's support can be clipped to 1/256, to keep simple, we use 1/128 also).
Preset	-3.125%
State Saved	Saved in instrument state.
Min	$-100.0 * \text{Guard Interval}$
Max	0.0
Backwards Compatibility SCPI	[:SENSe]:FLATness:TIMadj <percent>
Initial S/W Revision	A.10.01

Sync Training Sequence

This parameter specifies synchronization method to use when synchronizing to the start of the OFDM burst. The valid values are Short or Long. A value of Short means to search for and synchronize to an 802.11a preamble short symbol sequence.

A value of Long means to search for and synchronize to an 802.11a/g preamble long symbol sequence (also called the channel estimation sequence).

Key Path	Meas Setup, Advanced
Mode	WLAN
Remote Command	[:SENSe] : FLATness : STSequence LONG SHORt [:SENSe] : FLATness : STSequence ?
Example	FLAT:STS LONG FLAT:STS ?
Notes	Only used in 802.11a/g (OFDM), 801.11g (DSSS-OFDM) measurement, otherwise it will be grayed out. If SCPI command is sent to change this value, it generate message “-221 Setting conflict; Sync Training Sequence is not available for current Radio Setting”
Preset	SHORt
State Saved	Saved in instrument state.
Backwards Compatibility SCPI	[:SENSe] : FLATness : SYNCseq
Initial S/W Revision	A.10.01

PhNoise Opt

The Phase Noise Optimization setting affects the phase noise distribution on the analyzer's LO.

Key Path	Meas Setup, Advanced
Mode	WLAN
Remote Command	[:SENSe] : FLATness : FREQuency : SYNThesis [:STATe] 1 2 3 [:SENSe] : FLATness : FREQuency : SYNThesis [:STATe] ?
Example	FLAT:FREQ:SYNT 1 FLAT:FREQ:SYNT ?
Notes	Parameter: 1: Best Close-in Φ Noise, optimizes phase noise for small frequency offsets from the carrier. 2: Best Wide-offset Φ Noise, optimizes phase noise for wide frequency offsets from the carrier. 3: Fast Tuning, optimizes LO for tuning speed The actual behavior varies somewhat depending on model number and option; you always get fast tuning by choosing #3, but in some models, the “Fast Tuning” choice is identical to the “Best Close-In” choice. Specifically: <ul style="list-style-type: none"> Models with option EP1 (for example PXA), have a two-loop local oscillator, which switches to a single loop for fast tuning

	<ul style="list-style-type: none"> Models with option EP2 (available, for example, for MXA), use a different loop bandwidth for the fast-tuning choice, which is a compromise between tuning speed and phase noise, giving good tuning speed at all offsets, although not as good as for Close-In; this is useful when you have to look across a wide range of spans <p>In all other cases, Fast Tuning is the same as Best Close-In.</p>
Dependencies	Does not appear in all models. The key is blank in those models, but the SCPI command is accepted for compatibility (although no action is taken).
Preset	Default value is different depend on hardware configuration. Models with option EP2 (available, for example, for MXA), default value is 3; For other cases, default value is 2.
State Saved	Saved in instrument state.
Readback Text	Close-in Wide-offset Fast Tuning

Spectrum

Sets a spectrum to either normal or invert for demodulation related measurements. If invert is set, the upper and lower spectrums are swapped.

The invert function conjugates the spectrum, which is equivalent to taking the negative of the quadrature component in demodulation. The correct setting (Normal or Invert) depends on whether the signal at the input of the instrument has a high or a low side mix.

Key Path	Meas Setup, Advanced
Mode	WLAN
Remote Command	:CALCulate:FLATness:SPECTrum INVert NORMal :CALCualte:FLATness:SPECTrum?
Example	CALC:FLAT:SPEC INV CALC:FLAT:SPEC?
Preset	NORMal
State Saved	Saved in instrument state.
Range	Normal Invert
Backwards Compatibility SCPI	[[:SENSe]:FLATness:MIRRorspec OFF ON 0 1
Initial S/W Revision	A.10.01

Meas Preset

Returns parameters for the current measurement to those set by the factory.

Key Path	Meas Setup
Mode	WLAN

14 Spectral Flatness Measurement
Meas Setup

Remote Command	:CONFigure:FLATness
Example	CONF:FLAT
Initial S/W Revision	A.10.01

Mode

See "Mode" on page 288

Mode Preset

Returns the active mode to a known state.

Mode Preset does the following for the currently active mode:

- Aborts the currently running measurement.
- Brings up the default menu for the mode, with no active function.
- Sets measurement Global settings to their preset values for the active mode only.
- Activates the default measurement.
- Brings up the default menu for the mode.
- Clears the input and output buffers.
- Sets Status Byte to 0.

Mode Preset does not:

- Cause a mode switch
- Affect mode persistent settings
- Affect system settings
- See "[How-To Preset](#)" on page 1631 for more information.

Key Path	Front-panel key
Remote Command	:SYSTem:PRESet
Example	:SYST:PRES
Notes	*RST is preferred over :SYST:PRES for remote operation. *RST does a Mode Preset, as done by the :SYST:PRES command, and it sets the measurement mode to Single measurement rather than Continuous for optimal remote control throughput. Clears all pending OPC bits. The Status Byte is set to 0.
Couplings	A Mode Preset aborts the currently running measurement, activates the default measurement, and gets the mode to a consistent state with all of the default couplings set.
Backwards Compatibility Notes	In the X-Series, the legacy "Factory Preset" has been replaced with Mode Preset, which only presets the currently active mode, not the entire instrument. In the X-Series, the way to preset the entire instrument is by using System, Restore System Defaults All, which behaves essentially the same way as restore System Defaults does on ESA and PSA. There is also no "Preset Type" as there is on the PSA. There is a green Mode Preset front-panel key that does a Mode Preset and a white-with-green-letters User Preset front-panel key that does a User Preset. The old PRESet:TYPE command is ignored (without generating an error), and SYST:PRES without a parameter does a Mode Preset, which should cover most backward code compatibility issues. The settings and correction data under the Input/Output front-panel key (examples: Input Z Corr, Ext Amp Gain, etc.) are no longer part of any Mode, so they will not be preset by a Mode Preset. They are preset using Restore Input/Output Defaults, Restore System Defaults All. Note that because User Preset does a Recall State, and all of these settings are saved in State, they ARE recalled when using

	User Preset.
Initial S/W Revision	Prior to A.02.00

How-To Preset

The table below shows all possible presets, their corresponding SCPI commands and front-panel access (key paths). Instrument settings depend on the current measurement context. Some settings are local to the current measurement, some are global (common) across all the measurements in the current mode, and some are global to all the available modes. In a similar way, restoring the settings to their preset state can be done within the different contexts.

Auto Couple - is a measurement local key. It sets all Auto/Man parameter couplings in the measurement to Auto. Any Auto/Man selection that is local to other measurements in the mode will not be affected.

Meas Preset - is a measurement local key. Meas Preset resets all the variables local to the current measurement except the persistent ones.

Mode Preset - resets all the current mode's measurement local and measurement global variables except the persistent ones.

Restore Mode Defaults - resets ALL the Mode variables (and all the Meas global and Meas local variables), including the persistent ones.

Type Of Preset	SCPI Command	Front Panel Access
Auto Couple	:COUPlE ALL	Auto Couple front-panel key
Meas Preset	:CONFigure:<Measurement>	Meas Setup Menu
Mode Preset	:SYSTem:PRESet	Mode Preset (green key)
Restore Mode Defaults	:INSTrument:DEFault	Mode Setup Menu
Restore All Mode Defaults	:SYSTem:DEFault MODEs	System Menu; Restore System Default Menu
*RST	*RST	not possible (Mode Preset with Single)
Restore Input/Output Defaults	:SYSTem:DEFault INPut	System Menu; Restore System Default Menu
Restore Power On Defaults	:SYSTem:DEFault PON	System Menu; Restore System Default Menu
Restore Alignment Defaults	:SYSTem:DEFault ALIGn	System Menu; Restore System Default Menu
Restore Miscellaneous Defaults	:SYSTem:DEFault MISC	System Menu; Restore System Default Menu
Restore All System Defaults	:SYSTem:DEFault [ALL] :SYSTem:PRESet:PERSistent	System Menu; Restore System Default Menu
User Preset	:SYSTem:PRESet:USER	User Preset Menu
User Preset All Modes	:SYSTem:PRESet:USER:ALL	User Preset Menu

14 Spectral Flatness Measurement
Mode Preset

Power On Mode Preset	:SYSTem:PON:TYPE MODE	System Menu
Power On User Preset	:SYSTem:PON:TYPE USER	System Menu
Power On Last State	:SYSTem:PON:TYPE LAST	System Menu

Mode Setup

See ["Mode Setup" on page 320](#)

Peak Search

Places the selected marker on the trace point that has the maximum y-axis value for that marker's trace. Pressing Peak Search with the selected marker Off causes the selected marker to be set to Normal; then a peak search is immediately performed.

Key Path	Front-panel key
Mode	WLAN
Remote Command	:CALCulate:FLATness:MARKer[1 2 ... 12:MAXimum
Example	CALC:FLAT:MARK:MAX
Initial S/W Revision	A.10.01

Print

See "Print" on page 352

Quick Save

The Quick Save front-panel key repeats the most recent save that was performed from the Save menu, with the following exceptions:

- Register saves are not remembered as Saves for the purpose of the Quick Save function
- If the current measurement does not support the last non-register save that was performed, an informational message is generated, “File type not supported for this measurement”

Quick Save repeats the last type of qualified save (that is, a save qualified by the above criteria) in the last save directory by creating a unique filename using the Auto File Naming algorithm described below.

If Quick Save is pressed after startup and before any qualified Save has been performed, the Quick Save function performs a Screen Image save using the current settings for Screen Image saves (current theme, current directory), which then becomes the “last save” for the purpose of subsequent Quick Saves.

The Auto File Naming feature automatically generates a file name for use when saving a file. The filename consists of a prefix and suffix separated by a dot, as is standard for the Windows® file system. A default prefix exists for each of the available file types:

Type	Default Prefix	Menu
State	State_	(Save/Recall)
Trace + State	State_	(Save/Recall)
Screen	Screen_	(Save/Recall)
Amplitude Corrections	Ampcor_	(Import/Export)
Traces	Trace_	(Import/Export)
Limit Lines	LLine_	(Import/Export)
Measurement Result	MeasR_	(Import/Export)
Capture Buffer	CapBuf_	(Import/Export)

A four digit number is appended to the prefix to create a unique file name. The numbering sequence starts at 0000 within each Mode for each file type and updates incrementally to 9999, then wraps to 0000 again. It remembers where it was through a Mode Preset and when leaving and returning to the Mode. It is reset by Restore Misc Defaults and Restore System Defaults and subsequent running of the instrument application. So, for example, the first auto file name generated for State files is State_0000.state. The next is State_0001, and so forth.

One of the key features of Auto File Name is that we guarantee that the Auto File Name will never conflict with an existing file. The algorithm looks for the next available number. If it gets to 9999, then it looks for holes. If it find no holes, that is no more numbers are available, it gives an error.

For example, if when we get to State_0010.state there is already a State_0010.state file in the current directory, it advances the counter to State_0011.state to ensure that no conflict will exist (and then it verifies that State_0011.state also does not exist in the current directory and advances again if it does, and so forth).

If you enter a file name for a given file type, then the prefix becomes the filename you entered instead of the default prefix, followed by an underscore. The last four letters (the suffix) are the 4-digit number.

For example, if you save a measurement results file as “fred.csv”, then the next auto file name chosen for a measurement results save will be fred_0000.csv.

NOTE

Although 0000 is used in the example above, the number that is used is actually the current number in the Meas Results sequence, that is, the number that would have been used if you had not entered your own file name.

NOTE

If the filename you entered ends with _dddd, where d=any number, making it look just like an auto file name, then the next auto file name picks up where you left off with the suffix being dddd + 1.

Key Path	Front-panel key
Notes	No remote command for this key specifically.
Initial S/W Revision	Prior to A.02.00

Recall

The Recall menu lets you choose what you want to recall, and where you want to recall it from. Among the types of files you can recall are **States and Traces**. In addition, an Import (Data) option lets you recall a number of data types stored in CSV files (as used by Excel and other spreadsheet programs).

The default paths for Recall are data type dependent and are the same as for the Save key.

Key Path	Front-panel key
Notes	<p>No remote command for this key specifically, but the :MMEM:LOAD command is available for specific file types. An example is :MMEM:LOAD:STATe <filename>.</p> <p>If you try to recall a State file for a mode that is not licensed or not available in the instrument, an error message will occur and the state will not change.</p>
Backwards Compatibility Notes	<p>In legacy analyzers, it was possible to load a state without affecting the trace data, limit lines or correction data. Similarly (since User Preset is actually loading a state), it was possible to do a User Preset without affecting the trace data, limit lines or correction data.</p> <p>In the X-Series, “state” always includes all of this data; so whenever state is loaded, all of the traces, limit lines and corrections are affected. Although this differs from previous behavior, it is desirable behavior, and should not cause adverse issues for users.</p>
Backwards Compatibility Notes	<p>Recall for the X-Series supports backward compatibility in the sense that you can recall a state file from any X-Series model number and any version of X-Series software. This is only possible if part of the recalling process goes through a limiting step after recalling the mode settings, at least for settings that may vary with version number, model number, option and license differences. If you try to recall a state file onto an instrument with less capability than what was available on the instrument during the save, the recall will ignore the state it doesn't support and it will limit the recalled setting to what it allows.</p> <p>Example: if the saved state includes preamp ON, but the recalling instrument does not have a preamp; the preamp is limited to OFF. Conversely, if you save a state without a preamp, the preamp is OFF in the state file. When this saved file is recalled on an instrument with a licensed preamp, the preamp is changed to OFF. Another example is if the saved state has center frequency set to 20 GHz, but the instrument recalling the saved state is a different model and only supports 13.5 GHz. In this case, the center frequency is limited along with any other frequency based settings. Since the center frequency can't be preserved in this case, the recall limiting tries to at least preserve span to keep the measurement setup as intact as possible.</p> <p>It may be appropriate to issue a warning if the state is limited on the recall; warnings do not go out to SCPI so this would only affect the manual user.</p> <p>Note that there is no state file compatibility outside of the X-Series. For example, you cannot recall a state file from ESA or PSA.</p>
Initial S/W Revision	Prior to A.02.00

State

The Recall State menu lets you choose a register or file from which to recall the state.

The content of a state file includes all of the settings and data required to return the analyzer as closely as possible to the Mode it was in, with the exact settings that were in place, when the save occurred. The Mode settings in each state file include the settings that are affected by Mode Preset, as well as the

additional settings affected by Restore Mode Defaults; all of the Mode’s settings. In addition, all of the settings of the Input/Output system are included, even though they are outside of the Mode’s state, because they are needed to restore the complete setup. Persistent System settings (for example, GPIB address) are not affected by either a Mode Preset or Restore Mode Defaults, nor are they included in a saved State file.

Since each state file is only for one Mode, the settings for other Modes are unaffected when it is loaded. Recall State will cause a mode switch if the state being recalled is not from the current active mode.

After the recall completes, the message "File <filename> recalled" or “Recalled State Register <register number>” is displayed.

For rapid recalls, the State menu lists 16 registers that you can choose from to recall. Pressing a Register key initiates the recall. You can also select a file from which to recall.

The default path for all State Files is:

My Documents\<<mode name>\state

where <mode name> is the parameter used to select the mode with the INST:SEL command (for example, SA for the Spectrum Analyzer).

See "[More Information](#)" on page 1640.

Key Path	Recall
Mode	All
Remote Command	:MMEMory:LOAD:STATe <filename>
Example	:MMEM:LOAD:STAT "myState.state" This recalls the file myState.state on the default path
Example	MMEM:LOAD:STAT "MyStateFile.state" This loads the state file data (on the default file directory path) into the instrument state.
Notes	<p>When you pick a file to recall, the analyzer first verifies that the file is recallable in the current instrument by checking the software version and model number of the instrument. If everything matches, a full recall proceeds by aborting the currently running measurement, clearing any pending operations, and then loading the State from the saved state file. You can open state files from any mode, so recalling a State file switches to the mode that was active when the save occurred. After switching to the mode of the saved state file, mode settings and data (if any for the mode) are loaded with values from the saved file. The saved measurement of the mode becomes the newly active measurement and the data relevant to the measurement (if there is any) is recalled.</p> <ul style="list-style-type: none"> • If there is a mismatch between file version or model number or instrument version or model number, the recall function tries to recall as much as possible and returns a warning message. It may limit settings that differ based on model number, licensing or version number. <p>After recalling the state, the Recall State function does the following:</p> <ul style="list-style-type: none"> • Makes the saved measurement for the mode the active measurement. • Clears the input and output buffers. • Status Byte is set to 0. • Executes a *CLS <p>If the file specified is empty an error is generated. If the specified file does not exist, another error is generated. If there is a mismatch between the file and the proper file type, an error is generated. If</p>

	there is a mismatch between file version or model number or instrument version or model number, a warning is displayed. Then it returns to the State menu and File Open dialog goes away. After the Recall, the analyzer exits the Recall menu and returns to the previous menu.
Backwards Compatibility SCPI	:MMEMory:LOAD:STATe 1,<filename> For backwards compatibility, the above syntax is supported. The "1" is simply ignored.
Initial S/W Revision	Prior to A.02.00

More Information

In measurements that support saving Traces, for example, Swept SA, the Trace data is saved along with the State in the State file. When recalling the State, the Trace data is recalled as well. Traces are recalled exactly as they were stored, including the writing mode and update and display modes. If a Trace was updating and visible when the State was saved, it will come back updating and visible, and its data will be rewritten right away. When you use State to save and recall traces, any trace whose data must be preserved should be placed in View or Blank mode before saving.

The following table describes the Trace Save and Recall possibilities:

You want to recall state and one trace's data, leaving other traces unaffected.	Save Trace+State from 1 trace. Make sure that no other traces are updating (they should all be in View or Blank mode) when the save is performed.	On Recall, specify the trace you want to load the one trace's data into. This trace will load in View. All other traces' data will be unaffected, although their trace mode will be as it was when the state save was performed.
You want to recall all traces	Save Trace+State from ALL traces.	On Recall, all traces will come back in View (or Blank if they were in Blank or Background when saved)
You want all traces to load exactly as they were when saved.	Save State	On recall, all traces' mode and data will be exactly as they were when saved. Any traces that were updating will have their data immediately overwritten.

From File...

When you press "From File", the analyzer brings up a Windows dialog and a menu entitled "File Open." This menu allows you to navigate to the various fields in the Windows dialog without using a keyboard or mouse. The Tab and Arrow keys can also be used for dialog navigation.

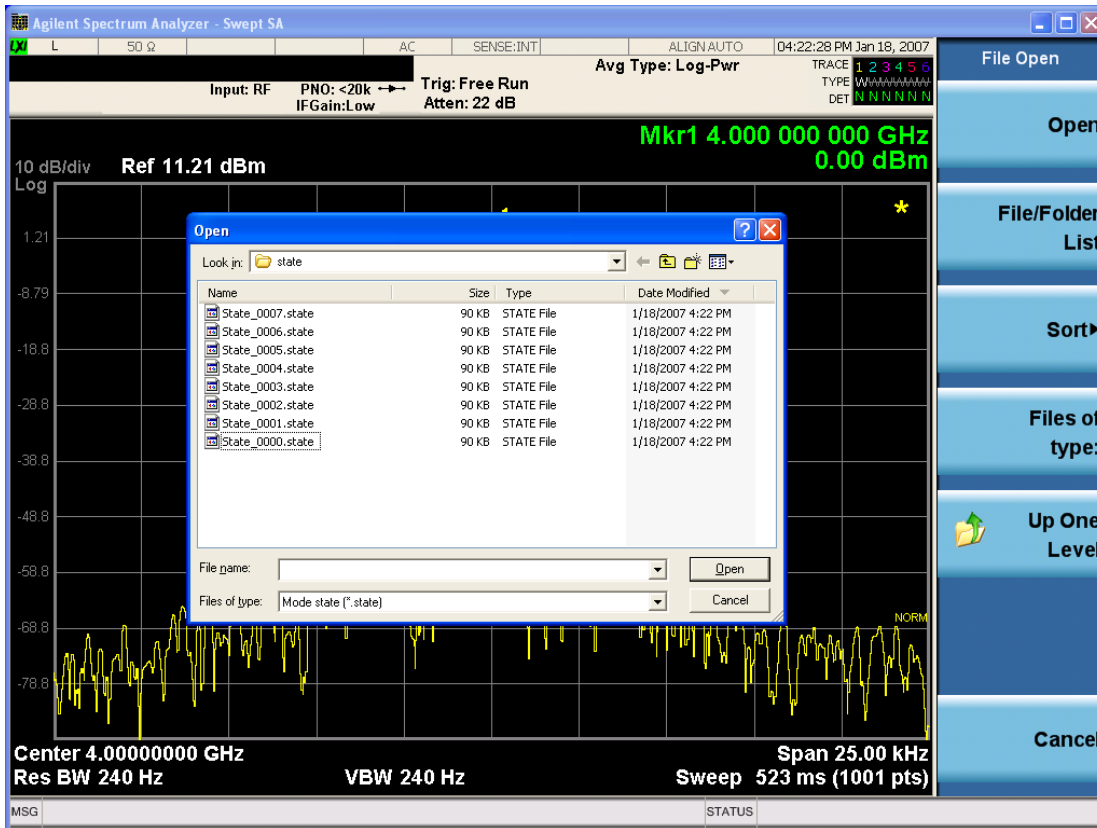

Listed below are the functions of the various fields in the dialog, and the corresponding softkeys:

Open

Performs the recall of the specified file. While the recall is being performed, the floppy icon appears briefly in the Meas bar.

File/Folder List

Enables you to navigate to the center of the dialog that contains the list of files and folders. Once here you can get information about the file and use the tab keys to navigate to the other fields in the dialog, such as Look In.

Look In

The Look In field shows the path from which the file will be recalled and allows you to change the path using the up and down arrow keys to navigate to other paths; the Enter key to open a directory; and the Backspace key to go back one directory. The **Look In field** first uses the last path from the Save As dialog **Save In:** path for that same file type. There is no softkey for directly navigating to the Look In field, but you can use the left tab to get here from the File/Folder List.

User specified paths are remembered when you leave and return to a Mode and are reset back to the default using Restore Mode Defaults.

Sort

Accesses a menu that enables you to sort the files within the File Open dialog. Only one sorting type can be selected at a time and the sorting happens immediately. The sorting types are By Date, By Name, By extension, and By Size.

Files of Type

This field shows the file suffix for the type of file you have selected to recall. For example, if you navigated here while recalling State, "Mode state (*.state)" is in the field. If you navigated here while recalling Trace, ""Mode state (*.trace)" is in the field. If you navigated here while importing a trace data file, "Trace Data (*.csv)" is in the field. For some file types, there is more than one choice in the dropdown menu, which you can select by using the up and down arrow keys and Enter.

Up One Level

This key corresponds to the icon of a folder with the up arrow that is in the tool bar of the dialog. When pressed, it causes the file and folder list to navigate up one level in the directory structure. The Backspace key does the same thing.

Cancel

This key corresponds to the Cancel selection in the dialog. It causes the current **Open** request to be cancelled. The ESC key does the same thing.

Key Path	Recall, State
Notes	Brings up the Open dialog for recalling a State Save Type
Initial S/W Revision	Prior to A.02.00

Edit Register Names

You may enter a custom name on any of the Register keys, to help you remember what you are using that state to save. To do this, press the Edit Register Names key, choose the register whose name you wish to edit, and then enter the desired label using the Alpha Editor or an external PC keyboard.

The maximum number of characters that can be added is 30. In most cases, 30 characters will fit on two lines of the key.

For more information and the SCPI command, see Edit Register Names under the Save, State function.

Key Path	Recall, State
Mode	All
Dependencies	N9060A-7FP or N9060B-2FP license required to edit the register names. When the feature is not licensed, sending the SCPI command generates an error, -221, "Settings conflict;Option not available"
Initial S/W Revision	A.11.00

Register 1 thru Register 16

Selecting any one of these register keys causes the State of the mode from the specified Register to be recalled. Each of the register keys annotates whether it is empty or at what date and time it was last

modified. In addition, you can use the Edit Register Names key under Save, State to enter custom names for each register.

Registers are shared by all modes, so recalling from any one of the registers will cause a mode switch to the mode that was active when the save to the Register occurred.

Although these 16 registers are the only registers available from the front panel, there are 128 state registers available in the instrument. Registers 17–128 are only available from the SCPI interface, using the *RCL command.

After the recall completes, the message "Register <register number> recalled" appears in the message bar. If you are in the Spectrum Analyzer Mode, and you are recalling a register that was saved in the Spectrum Analyzer Mode, then after the recall, you will still be in the Recall Register menu. If the Recall causes you to switch modes, then after the Recall, you will be in the Frequency menu.

If a requested register is empty an error is generated.

Key Path	Recall, State
Example	*RCL 1
Range	1–16 from front panel, 1–128 from SCPI
Readback	Date and time with seconds resolution are displayed on the key OR A custom name of up to 30 characters entered using the Save, State, Edit Register Names key OR “(empty)” if no prior save operation has been performed to this register.
Initial S/W Revision	Prior to A.02.00
Modified at S/W Revision	Prior to A.11.00

Register 1 thru Register 16

Selecting any one of these register keys causes the State of the mode from the specified Register to be recalled. Each of the register keys annotates whether it is empty or at what date and time it was last modified. In addition, you can use the Edit Register Names key under Save, State to enter custom names for each register.

Registers are shared by all modes, so recalling from any one of the registers will cause a mode switch to the mode that was active when the save to the Register occurred.

Although these 16 registers are the only registers available from the front panel, there are 128 state registers available in the instrument. Registers 17–128 are only available from the SCPI interface, using the *RCL command.

After the recall completes, the message "Register <register number> recalled" appears in the message bar. If you are in the Spectrum Analyzer Mode, and you are recalling a register that was saved in the Spectrum Analyzer Mode, then after the recall, you will still be in the Recall Register menu. If the Recall causes you to switch modes, then after the Recall, you will be in the Frequency menu.

If a requested register is empty an error is generated.

Key Path	Recall, State
Example	*RCL 1
Range	1-16 from front panel, 1-128 from SCPI
Readback	Date and time with seconds resolution are displayed on the key OR A custom name of up to 30 characters entered using the Save, State,Edit Register Names key OR “(empty)” if no prior save operation has been performed to this register.
Initial S/W Revision	Prior to A.02.00
Modified at S/W Revision	Prior to A.11.00

Data (Import)

Importing a data file loads data that was previously saved from the current measurement or from other measurements and/or modes that produce compatible data files. The Import Menu only contains Data Types that are supported by the current measurement.

Since the commonly exported data files are in .csv format, the data can be edited by the user prior to importing. This allows you to export a data file, manipulate the data in Excel (the most common PC Application for manipulating .csv files) and then import it.

Importing Data loads measurement data from the specified file into the specified or default destination, depending on the data type selected. Selecting an Import Data menu key will not actually cause the importing to occur, since the analyzer still needs to know from where to get the data. Pressing the Open key in this menu brings up the Open dialog and Open menu that provides you with the options from where to recall the data. Once a filename has been selected or entered in the Open menu, the recall occurs as soon as the Open button is pressed.

Key Path	Recall
Mode	All
Notes	The menu is built from whatever data types are available for the mode. Some keys will be missing completely, so the key locations in the sub-menu will vary. No SCPI command directly controls the Data Type that this key controls. The Data Type is included in the MMEM:LOAD commands.
Dependencies	If a file type is not used by a certain measurement, it is grayed out for that measurement. The key for a file type will not show at all if there are no measurements in the Mode that support it.
Preset	Is not affected by Preset or shutdown, but is reset during Restore Mode Defaults
Readback	The data type that is currently selected
Initial S/W Revision	Prior to A.02.00

Masks

This key enables you to recall a preset mask file from the list. It is only available in SEM measurement under the Data menu: Limit Mask. Limit Mask enables setting a preset limit mask for 802.11p 5MHz and 10MHz system.

You cannot change or create the preset mask file since it is a binary file. This key is valid for the Spectrum Emission Mask measurement.

File location: "My Documents\WLAN\data.masks"

Note that "**My Documents**" is an alias to a directory and its location depends on which user is logged in. At XSA start up, all of the limit mask files in the current user's "My Documents\WLAN\data.masks" directory are overwritten.

File type: Binary

Filename:

11p_5MHz_A.mask

11p_5MHz_B.mask

11p_5MHz_C.mask

11p_5MHz_D.mask

11p_10MHz_A.mask

11p_10MHz_B.mask

11p_10MHz_C.mask

11p_10MHz_D.mask

File extension: .mask

Selecting OPEN under the Import Data menu, opens the above directory enabling you to select a mask file.

Example:

File Location: My Documents/WLAN/data/masks

File Name: 11p_5MHz_A.mask

Key Path	Recall, Data
Mode	WLAN
Remote Command	MMEMoRY:LOAD:MASK <string>
Example	MMEM:LOAD:MASK "11p_5MHz_A.mask"
Initial S/W Revision	A.11.00

Capture Buffer

Capture buffer functionality is only available when measurement is Mod Accuracy and radio standard is not 802.11ac 80+80MHz. The captured data is raw data which is not processed.

Key Path	Recall, Data
Mode	WLAN
Example	MMEM:LOAD:CAPT "MyCaptureData.bin" This loads the file of capture data (on the default file directory path) into the instrument.
Dependencies	Capture buffer data is only available when measurement is Mod Accuracy and radio standard is not 802.11ac 80+80MHz. In other situation, this key is grayed out.
Initial S/W Revision	A.11.00

Open...

When you press "Open", the analyzer brings up a Windows dialog and a menu entitled "File Open." This menu allows you to navigate to the various fields in the Windows dialog without using a keyboard or mouse. The Tab and Arrow keys can also be used for dialog navigation.

See "[From File...](#)" on page 2263 in Recall, State, for a full description of this dialog and menu.

Key Path	Recall, Data
Notes	The key location is mode-dependent and will vary. Brings up Open dialog for recalling a <mode specific> Save Type
Initial S/W Revision	Prior to A.02.00

Restart

The Restart function restarts the current sweep, or measurement, or set of averaged/held sweeps or measurements. If you are Paused, pressing Restart does a Resume.

The Restart function is accessed in several ways:

- Pressing the Restart key
- Sending the remote command INIT:IMMEDIATE
- Sending the remote command INIT:RESTART

See "[More Information](#)" on page 1647

Key Path	Front-panel key
Remote Command	:INITiate[:IMMEDIATE] :INITiate:RESTART
Example	:INIT:IMM :INIT:REST
Notes	:INITiate:RESTART and :INITiate:IMMEDIATE perform exactly the same function.
Couplings	Resets average/hold count k. For the first sweep overwrites all active (update=on) traces with new current data. For application modes, it resets other parameters as required by the measurement.
Status Bits/OPC dependencies	This is an Overlapped command. The STATUS:OPERation register bits 0 through 8 are cleared. The STATUS:QUESTIONable register bit 9 (INTEgrity sum) is cleared. The SWEEPING bit is set. The MEASURING bit is set.
Backwards Compatibility Notes	For Spectrum Analysis mode in ESA and PSA, the Restart hardkey and the INITiate:RESTART command restart trace averages (displayed average count reset to 1) for a trace in Clear Write, but did not restart Max Hold and Min Hold. In the X-Series, the Restart hardkey and the INITiate:RESTART command restart not only Trace Average, but MaxHold and MinHold traces as well. For wireless comms modes in ESA and PSA, the Restart hardkey and the INITiate:RESTART command restart every measurement, which includes all traces and numeric results. There is no change to this operation.
Initial S/W Revision	Prior to A.02.00

More Information

The **Restart** function first aborts the current sweep/measurement as quickly as possible. It then resets the sweep and trigger systems, sets up the measurement and initiates a new data measurement sequence with a new data acquisition (sweep) taken once the trigger condition is met.

If the analyzer is in the process of aligning when **Restart** is executed, the alignment finishes before the restart function is performed.

Even when set for Single operation, multiple sweeps may be taken when Restart is pressed (for example, when averaging/holding is on). Thus when we say that **Restart** "restarts a measurement," we may mean:

- It restarts the current sweep
- It restarts the current measurement
- It restarts the current set of sweeps if any trace is in Trace Average, Max Hold or Min Hold
- It restarts the current set of measurements if Averaging, or Max Hold, or Min Hold is on for the measurement
- depending on the current settings.

With **Average/Hold Number** (in **Meas Setup** menu) set to 1, or Averaging off, or no trace in Trace Average or Hold, a single sweep is equivalent to a single measurement. A single sweep is taken after the trigger condition is met; and the analyzer stops sweeping once that sweep has completed. However, with **Average/Hold Number** >1 and at least one trace set to **Trace Average, Max Hold, or Min Hold (SA Measurement)** or **Averaging on (most other measurements)**, multiple sweeps/data acquisitions are taken for a single measurement. The trigger condition must be met prior to each sweep. The sweep is stopped when the average count k equals the number N set for **Average/Hold Number**. A measurement average usually applies to all traces, marker results, and numeric results; but sometimes it only applies to the numeric results.

Once the full set of sweeps has been taken, the analyzer will go to idle state. To take one more sweep without resetting the average count, increment the average count by 1, by pressing the step up key while **Average/Hold Number** is the active function, or sending the remote command `CALC:AVER:TCON UP`.

Save

The Save menu lets you choose what you want to save and where you want to save it. Among the types of files you can save are **States**, **Traces**, and **Screen Images**. In addition, an Export (Data) option lets you save a number of data types as CSV files for easy import into Excel and other spreadsheet programs.

Key Path	Front-panel key
Mode	All
Notes	No remote command for this key specifically, but the :MMEM:STORe command is available for specific file types. An example is :MMEM:STOR:STATe <filename>.
Initial S/W Revision	Prior to A.02.00

State

The Save State menu lets you choose a register or file for saving the state.

The content of a state file includes all of the settings and data required to return the analyzer as closely as possible to the Mode it was in, with the exact settings which were in place, when the save occurred. The Mode settings in each state file include the settings that are affected by Mode Preset, as well as the additional settings affected by Restore Mode Defaults; all of the Mode's settings. In addition, all of the settings of the Input/Output system are included, even though they are outside of the Mode's state, because they are needed to restore the complete setup. Persistent System settings (for example, Verbose SCPI) are not affected by either Mode Preset or Restore Mode Defaults, nor are they included in a saved State file.

After the save completes, the message "File <filename> saved" or "State Register <register number> saved" is displayed.

For rapid saving, the State menu lists 16 registers to save to. Pressing a Register key initiates the save. You can also select a file to save to.

The default path for all State Files is:

My Documents\<>mode name>\state

where <mode name> is the parameter used to select the mode with the INST:SEL command (for example, SA for the Spectrum Analyzer).

Key Path	Save
Mode	All
Remote Command	:MMEMory:STORe:STATe <filename>
Example	MMEM:STOR:STATe "MyStateFile.state" This stores the current instrument state data in the file MyStateFile.state in the default directory.
Notes	Both single and double quotes are supported for any filename parameter over remote. After saving to a register, that register's menu key is updated with the date the time, unless a custom label has been entered for that key. After saving to a register, you remain in the Save State menu, so that you can see the Register key

	update. After saving to a file, the analyzer automatically returns to the previous menu and any Save As dialog goes away.
Backwards Compatibility SCPI	:MMEMory:STORe:STATe 1,<filename>
Initial S/W Revision	Prior to A.02.00

To File . . .

When you press “To File”, the analyzer brings up a Windows dialog and a menu entitled “Save As.” This menu allows you to navigate to the various fields in the Windows dialog without using a keyboard or mouse. The Tab and Arrow keys can also be used for dialog navigation.

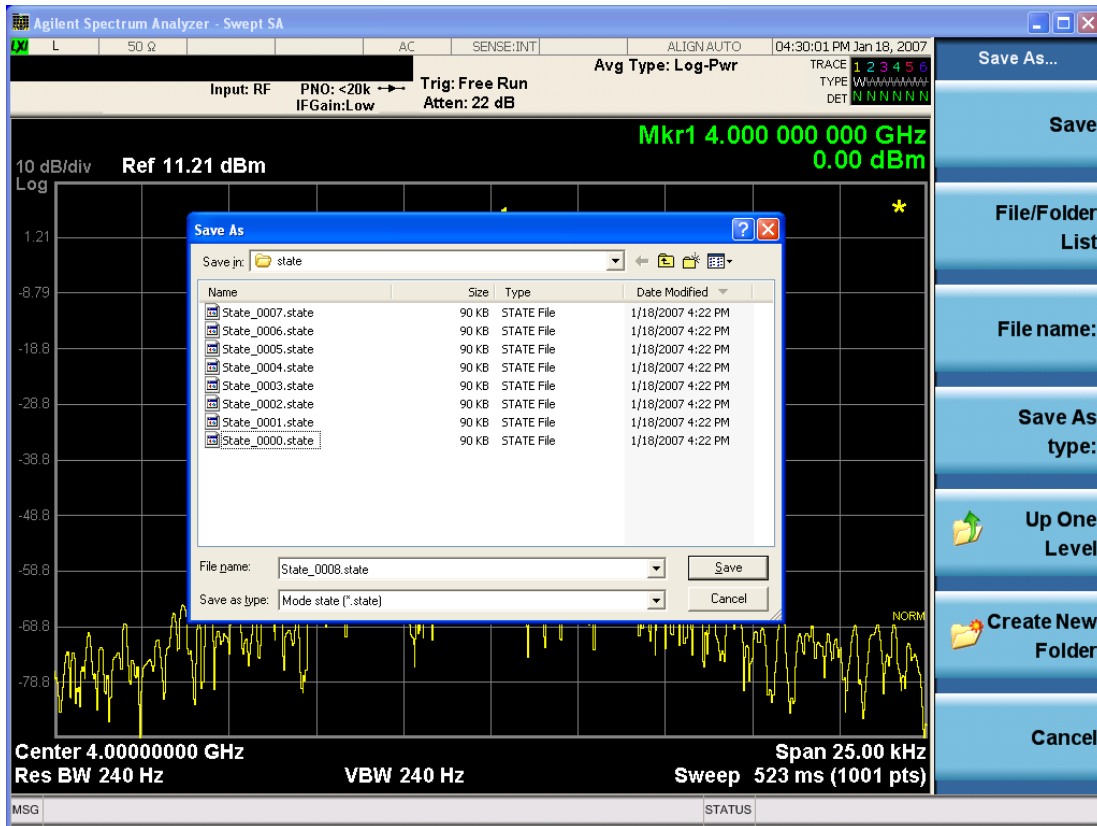

The Listed below

are the functions of the various fields in the dialog, and the corresponding softkeys:

Save

Performs the save to the specified file of the selected type. If the file already exists, a dialog will appear that allows you to replace the existing file by selecting OK, or you can Cancel the request. If you select OK, the file will be overwritten. Using the C: drive is strongly discouraged, since it runs the risk of being overwritten during an instrument software upgrade.

While the save is being performed, the floppy icon appears briefly in the Meas bar.

File/Folder List

Enables you to navigate to the center of the dialog that contains the list of files and folders. Once here you can get information about the file and use the tab keys to navigate to the other fields in the dialog, such as Save In.

Save In

The Save In field shows the path to which the file will be saved and allows you to change the path using the up and down arrow keys to navigate to other paths; the Enter key to open a directory; and the Backspace key to go back one directory. The **Save In field** defaults to the default path for this type of file and remembers the last path you used to save this type of file. There is no softkey for directly navigating to the Save In field but you can use left tab to get here from the File/Folder List.

User specified paths are remembered when you leave and return to a Mode and are reset back to the default using Restore Mode Defaults.

File Name

The File Name field is initially loaded with an automatically generated filename specific to the appropriate Save Type. The automatically generated filename is guaranteed not to conflict with any filename currently in the directory. You may replace or modify this filename using the File Name key. See the ["Quick Save " on page 2259](#) documentation for more on the automatic file naming algorithm.

When you press the File Name key the analyzer displays the Alpha Editor. Use the knob to choose the letter to add and the front-panel Enter key to add the letter to the file name. The BK character moves you back and the FW character moves you forward in the filename. The Select key on the front panel generates a space character. When you are done entering the filename press the Done softkey. This returns back to the **File Open** dialog and menu, but does not cause the save to occur.

Save As Type

This field shows the file suffix for the type of file you have selected to save. For example, if you navigated here while saving State, "Mode state (*.state)" is in the field. If you navigated here from saving Trace, ""Mode state (*.trace)" is in the field. If you navigated here while exporting a trace data file, "Trace Data (*.csv)" is in the field. For some file types, there is more than one choice in the dropdown, which you can select by using the up and down arrow keys and Enter.

Up One Level

This key corresponds to the icon of a folder with the up arrow that is in the tool bar of the dialog. When pressed, it causes the file and folder list to navigate up one level in the directory structure. The Backspace key does the same thing.

Create New Folder

This key corresponds to the icon of a folder with the "*" that is in the tool bar of the dialog. When pressed, a new folder is created in the current directory with the name **New Folder** and you can enter a new folder name using the Alpha Editor.

Cancel

This key corresponds to the Cancel selection in the dialog. It causes the current **Save As** request to be cancelled. The ESC key does the same thing.

Key Path	Save, State
Mode	All
Notes	Brings up Save As dialog for saving a State Save Type
Initial S/W Revision	Prior to A.02.00

Edit Register Names

You may enter a custom name on any of the Register keys, to help you remember what you are using that state to save. To do this, press the Edit Register Names key, choose the register whose name you wish to edit, and then enter the desired label using the Alpha Editor or an external PC keyboard.

The maximum number of characters that can be added is 30. In most cases, 30 characters will fit on two lines of the key.

See ["More Information" on page 1652](#)

Key Path	Save, State
Mode	All
Remote Command	:MMEMory:REGister:STATe:LABel <reg number>,"label" :MMEMory:REGister:STATe:LABel? <reg number>
Example	:MMEM:REG:STAT:LAB 1,"my label"
Notes	<reg number> is an integer from 1 to 16. If the SCPI specifies an invalid register number an error message is generated, -222,"Data out of range;Invalid register label number" "label" is a string from 0 to 30 characters in length. If a label exceeds 30 characters, an error message is generated, -150,"String data error;Label clipped to 30 characters" "label" of length 0 erases the custom label and restores the default (time and date) label. E.g.: :MMEM:REG:STAT:LAB 1,""
Dependencies	N9060A-7FP or N9060B-2FP license required to edit the register names. When the feature is not licensed, sending this command generates an error, -221,"Settings conflict;Option not available"
Preset	The names are unaffected by Preset or power cycle but are set to the default label (time and date) on a "Restore System Defaults->Misc"
Initial S/W Revision	A.11.00

More Information

When you edit one of the register names, the time and date field will be replaced by the custom name.

If you delete all the characters in the custom name, it restores the default (time and date).

The register names are stored within the state files, but they are not part of the instrument state; that is, once you have edited a register name, loading a new state will not change that register name. Another consequence of this is that the names will be persistent through a power cycle. Also, if a named state file is transferred to another analyzer, it will bring its custom name along with it.

If you try to edit the name of an empty register, the analyzer will first save the state to have a file to put the name in. If you load a named state file into an analyzer with older firmware it will ignore the metadata.

The *SAV and *RCL commands will not be affected by the custom register names, nor will the MMEM commands.

Register 1 thru Register 16

Selecting any one of these register menu keys causes the State of the currently active mode to be saved to the specified Register. The registers are provided for rapid saving and recalling, since you do not need to specify a filename or navigate to a file. Each of the register menu keys annotates whether it is empty or at what date and time it was last modified. In addition, you can use the Edit Register Names key to enter custom names for each register.

Although these 16 registers are the only registers available from the front panel, there are 128 state registers available in the instrument. Registers 17–128 are only available from the SCPI interface, using the *SAV command.

There is one set of 128 state registers in the instrument, not one set for each Mode. When a state is saved, the Mode it was saved from is saved with it; then when it is recalled, the instrument switches to that Mode.

After the save completes, the corresponding register menu key annotation is updated with the date and time and the message "Register <register number> saved" is displayed.

Key Path	Save, State
Mode	All
Example	*SAV 1
Range	1–16 from front panel, 1–128 from SCPI
Readback	Date and time with seconds resolution are displayed on the key OR A custom name of up to 30 characters entered using the Edit Register Names key OR “(empty)” if no prior save operation has been performed to this register.
Initial S/W Revision	Prior to A.02.00
Modified at S/W Revision	A.11.00

Register 1 thru Register 16

Selecting any one of these register menu keys causes the State of the currently active mode to be saved to the specified Register. The registers are provided for rapid saving and recalling, since you do not need to specify a filename or navigate to a file. Each of the register menu keys annotates whether it is empty or at what date and time it was last modified. In addition, you can use the Edit Register Names key to enter custom names for each register.

Although these 16 registers are the only registers available from the front panel, there are 128 state registers available in the instrument. Registers 17–128 are only available from the SCPI interface, using the *SAV command.

There is one set of 128 state registers in the instrument, not one set for each Mode. When a state is saved, the Mode it was saved from is saved with it; then when it is recalled, the instrument switches to that Mode.

After the save completes, the corresponding register menu key annotation is updated with the date and time and the message "Register <register number> saved" is displayed.

Key Path	Save, State
Mode	All
Example	*SAV 1
Range	1-16 from front panel, 1-128 from SCPI
Readback	Date and time with seconds resolution are displayed on the key OR A custom name of up to 30 characters entered using the Edit Register Names key OR "(empty)" if no prior save operation has been performed to this register.
Initial S/W Revision	Prior to A.02.00
Modified at S/W Revision	A.11.00

Data (Export)

Exporting a data file stores data from the current measurement to mass storage files. The Export Menu only contains data types that are supported by the current measurement.

Since the commonly exported data files are in .csv format, the data can be edited by you prior to importing. This allows you to export a data file, manipulate the data in Excel (the most common PC Application for manipulating .csv files) and then import it.

Selecting an Export Data menu key will not actually cause the exporting to occur, since the analyzer still needs to know where you wish to save the data. Pressing the Save As key in this menu brings up the Save As dialog and Save As menu that allows you to specify the destination file and directory. Once a filename has been selected or entered in the Open menu, the export will occur as soon as the Save key is pressed.

Key Path	Save
Mode	All
Notes	The menu is built from whatever data types are available for the mode. So the key locations in the sub menu will vary. No SCPI command directly controls the Data Type that this key controls. The Data Type is included in the MMEM:STORe commands.
Dependencies	If a file type is not used by a certain measurement, that type is grayed out for that measurement. The key for a file type will not show at all if there are no measurements in the Mode that support it.
Preset	Is not affected by a Preset or shutdown, but is reset during Restore Mode Defaults
Readback	The data type that is currently selected
Initial S/W Revision	Prior to A.02.00

Meas Results

Key Path	Save, Data
Mode	WLAN
Example	MMEM:STOR:RES "MyResultsFile.csv" This stores the measurement results data in the file MyResultsFile.xml in the default directory.
Initial S/W Revision	A.11.00

Capture Buffer

Capture buffer functionality is only available when measurement is Mod Accuracy and radio standard is not 802.11ac 80+80MHz. The captured data is raw data which is not processed.

Key Path	Save, Data
Mode	WLAN
Example	MMEM:STOR:CAPT "MyCaptureData.bin" This stores the capture data in the file MyCaptureData.bin in the default directory.
Dependencies	Capture buffer data is only available when measurement is Mod Accuracy and radio standard is not 802.11ac 80+80MHz. In other measurements, this key is grayed out.
Initial S/W Revision	A.11.00

Save As . . .

When you press "Save As", the analyzer brings up a Windows dialog and a menu entitled "**Save As.**" This menu allows you to navigate to the various fields in the Windows dialog without using a keyboard or mouse. The Tab and Arrow keys can also be used for dialog navigation.

See "[To File . . .](#)" on page 2273 in Save, State for a full description of this dialog and menu.

The default path for saving files is:

For all of the Trace Data Files:

My Documents\`<mode name>`\data\traces

For all of the Limit Data Files:

My Documents\`<mode name>`\data\limits

For all of the Measurement Results Data Files:

My Documents\`<mode name>`\data\`<measurement name>`\results

For all of the Capture Buffer Data Files:

My Documents\`<mode name>`\data\captureBuffer

Key Path	Save, Data
Mode	All
Notes	The key location is mode-dependent and will vary. Brings up the Save As dialog for saving a <mode specific> Save Type. The save is performed immediately and does not wait until the measurement is complete.
Initial S/W Revision	Prior to A.02.00

Screen Image

Pressing Screen Image accesses a menu of functions that enable you to specify a format and location for the saved screen image. It brings up a menu that allows you to specify the color scheme of the Screen Image (Themes) or navigate to the Save As dialog to perform the actual save.

Screen Image files contain an exact representation of the analyzer display. They cannot be loaded back onto the analyzer, but they can be loaded into your PC for use in many popular applications.

The image to be saved is actually captured when the Save front panel key is pressed, and kept in temporary storage to be used if you ask for a Screen Image save. When the Screen Image key is pressed, a "thumbnail" of the captured image is displayed, as shown below:

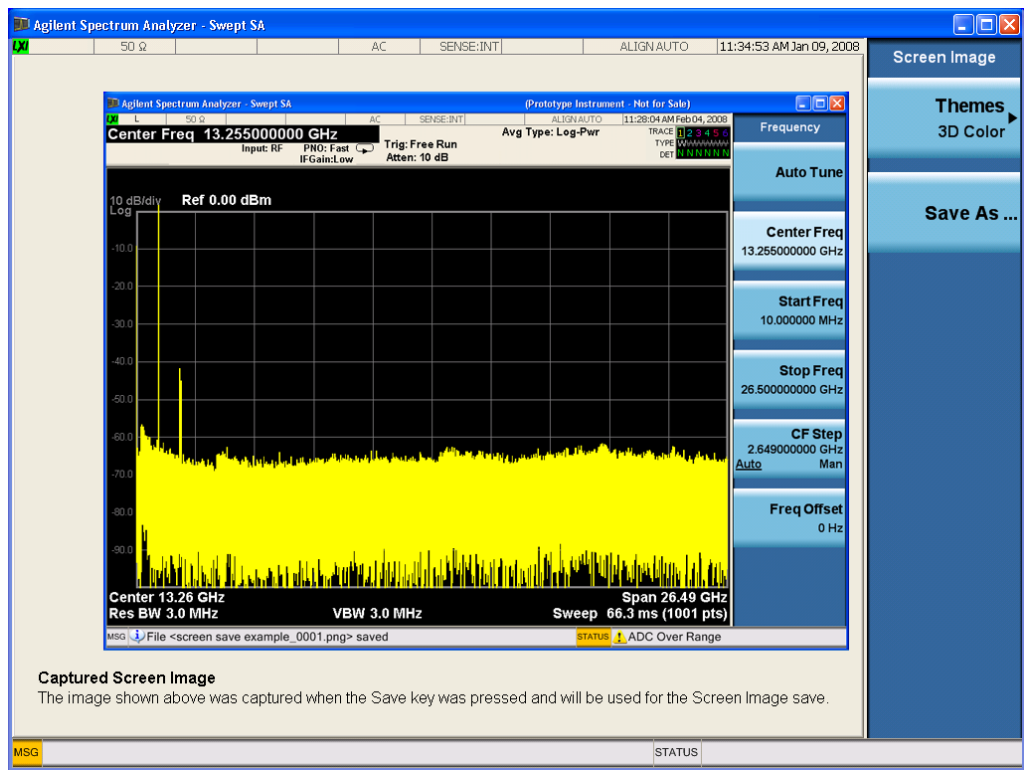

When you continue on into the Save As menu and complete the Screen Image save, the image depicted in the thumbnail is the one that gets saved, showing the menus that were on the screen before going into the Save menus. The save is performed immediately and does not wait until the measurement is complete.

After you have completed the save, the Quick Save front-panel key lets you quickly repeat the last save performed, using an auto-named file, with the current screen data.

NOTE

For versions previous to A.01.55, if you initiate a screen image save by navigating through the Save menus, the image that is saved will contain the Save menu softkeys, not the menus and the active function that were on the screen when you first pressed the Save front panel key.

Key Path	Save
Mode	All
Remote Command	:MMEMory:STORe:SCReem <filename>
Example	:MMEM:STOR:SCR "myScreen.png" This stores the current screen image in the file MyScreenFile.png in the default directory.
Initial S/W Revision	Prior to A.02.00

Themes

Accesses a menu of functions that enable you to choose the theme to be used when saving the screen image.

The **Themes** option is the same as the **Themes** option under the **Display** and **Page Setup** dialogs. It allows you to choose between themes to be used when saving the screen image.

Key Path	Save, Screen Image
Remote Command	:MMEMory:STORe:SCReem:THEMe TDColor TDMonochrome FCOLOR FMONochrome :MMEMory:STORe:SCReem:THEMe?
Example	:MMEM:STOR:SCR:THEM TDM
Preset	3D Color; Is not part of Preset, but is reset by Restore Misc Defaults or Restore System Defaults All and survives subsequent running of the modes.
Readback	3D Color 3D Mono Flat Color Flat Mono
Backwards Compatibility Notes	In ESA and PSA we offer the choice of "Reverse Bitmap" or "Reverse Metafile" when saving screen images. This is much like the "Flat Color" theme available in X-Series. Also, if you selected Reverse Bitmap AND a black & white screen image, that would be much like "Flat Monochrome". In other words, each of the X-Series themes has a similar screen image type in ESA/PSA. But they are not identical.
Initial S/W Revision	Prior to A.02.00

3D Color

Selects a standard color theme with each object filled, shaded and colored as designed.

Key Path	Save, Screen Image, Themes
Example	MMEM:STOR:SCR:THEM TDC

Readback	3D Color
Initial S/W Revision	Prior to A.02.00

3D Monochrome

Selects a format that is like 3D color but shades of gray are used instead of colors.

Key Path	Save, Screen Image, Themes
Example	MMEM:STOR:SCR:THEM TDM
Readback	3D Mono
Initial S/W Revision	Prior to A.02.00

Flat Color

Selects a format that is best when the screen is to be printed on an ink printer.

Key Path	Save, Screen Image, Themes
Example	MMEM:STOR:SCR:THEM FCOL
Readback	Flat Color
Initial S/W Revision	Prior to A.02.00

Flat Monochrome

Selects a format that is like Flat Color. But only black is used (no colors, not even gray), and no fill.

Key Path	Save, Screen Image, Themes
Example	MMEM:STOR:SCR:THEM FMON
Readback	Flat Mono
Initial S/W Revision	Prior to A.02.00

Save As...

When you press "Save As", the analyzer brings up a Windows dialog and a menu entitled "**Save As.**" This menu allows you to navigate to the various fields in the Windows dialog without using a keyboard or mouse. The Tab and Arrow keys can also be used for dialog navigation.

See "[To File . . .](#)" on page 2273 in Save, State for a full description of this dialog and menu.

The default path for Screen Images is

My Documents\`<mode name>`\screen.

where <mode name> is the parameter used to select the mode with the INST:SEL command (for example, SA for the Spectrum Analyzer).

Key Path	Save, Screen Image
Notes	Brings up Save As dialog for saving a Screen Image Save Type
Initial S/W Revision	Prior to A.02.00

Mass Storage Catalog (Remote Command Only)

Key path	SCPI Only
Remote Command	:MMEMory:CATalog? [<directory_name>]
Notes	<p>The string must be a valid logical path.</p> <p>Queries disk usage information (drive capacity, free space available) and obtains a list of files and directories in a specified directory in the following format: <numeric_value>,<numeric_value>,{<file_entry>}</p> <p>It returns two numeric parameters and as many strings as there are files and directories. The first parameter indicates the total amount of storage currently used in bytes. The second parameter indicates the total amount of storage available, also in bytes. The <file_entry> is a string. Each <file_entry> indicates the name, type, and size of one file in the directory list: <file_name>,<file_type>,<file_size></p> <p>As the windows file system has an extension that indicates file type, <file_type> is always empty. <file_size> provides the size of the file in bytes. For directories, <file_entry> is surrounded by square brackets and both <file_type> and <file_size> are empty</p>
Initial S/W Revision	Prior to A.02.00

Mass Storage Change Directory (Remote Command Only)

Key path	SCPI Only
Remote Command	:MMEMory:CDIRectory [<directory_name>] :MMEMory:CDIRectory?
Notes	<p>The string must be a valid logical path.</p> <p>Changes the default directory for a mass memory file system. The <directory_name> parameter is a string. If no parameter is specified, the directory is set to the *RST value.</p> <p>At *RST, this value is set to the default user data storage area, that is defined as System.Environment.SpecialFolder.Personal.</p> <p>Query returns full path of the default directory.</p>
Initial S/W Revision	Prior to A.02.00

Mass Storage Copy (Remote Command Only)

Key path	SCPI Only
Remote Command	:MMEMory:COpy <string>,<string>[,<string>,<string>]
Notes	<p>The string must be a valid logical path.</p> <p>Copies an existing file to a new file or an existing directory to a new directory.</p> <p>Two forms of parameters are allowed. The first form has two parameters. In this form, the first parameter specifies the source, and the second parameter specifies the destination.</p> <p>The second form has four parameters. In this form, the first and third parameters specify the source. The second and fourth parameters specify the directories. The first pair of parameters specifies the source. The second pair specifies the destination. An error is generated if the source doesn't exist or the destination file already exists.</p> <p>This command will generate an "access denied" error if the destination is a restricted folder (e.g., C:\Windows) and the current user does not have Power User or Administrator privileges.</p>

Mass Storage Device Copy (Remote Command Only)

This command transfers data to/from a file and a peripheral device.

Key path	SCPI Only
Remote Command	:MMEMory:COpy:DEvice <source_string>,<dest_string>
Notes	<p>The strings must be a valid logical path or a valid device keyword. If the dest_string is a device keyword, the data is copied from the source file to the device. If the source_string is a device keyword, the data is copied to the source file from the device.</p> <p>Valid device keywords are:</p> <p>SNS (smart noise source)</p> <p>An error is generated if the file or device is not found.</p>

Mass Storage Delete (Remote Command Only)

Key path	SCPI Only
Remote Command	:MMEMory:DElete <file_name>[,<directory_name>]
Notes	<p>The string must be a valid logical path.</p> <p>Removes a file from the specified directory. The <file_name> parameter specifies the file name to be removed. This command will generate an "access denied" error if the file is in a restricted folder (e.g., C:\Windows) and the current user does not have Power User or Administrator privileges.</p>
Initial S/W Revision	Prior to A.02.00

Mass Storage Data (Remote Command Only)

Creates a file containing the specified data OR queries the data from an existing file.

Key path	SCPI Only
Remote Command	:MMEMory:DATA <file_name>, <data> :MMEMory:DATA? <file_name>
Notes	The string must be a valid logical path. The command form is MMEMory:DATA <file_name>,<data>. It loads <data> into the file <file_name>. <data> is in 488.2 block format. <file_name> is string data. The query form is MMEMory:DATA? <file_name> with the response being the associated <data> in block format.
Initial S/W Revision	Prior to A.02.00

Mass Storage Make Directory (Remote Command Only)

Key path	SCPI Only
Remote Command	:MMEMory:MDIRectory <directory_name>
Notes	The string must be a valid logical path. Creates a new directory. The <directory_name> parameter specifies the name to be created. This command will generate an “access denied” error if the new directory would be in a restricted folder (e.g., C:\Windows) and the current user does not have Power User or Administrator privileges.
Initial S/W Revision	Prior to A.02.00

Mass Storage Move (Remote Command Only)

Key path	SCPI Only
Remote Command	:MMEMory:MOVE <string>,<string>[,<string>,<string>]
Notes	The string must be a valid logical path. Moves an existing file to a new file or an existing directory to a new directory. Two forms of parameters are allowed. The first form has two parameters. In this form, the first parameter specifies the source, and the second parameter specifies the destination. The second form has four parameters. In this form, the first and third parameters specify the source. The second and fourth parameters specify the directories. The first pair of parameters specifies the source. The second pair specifies the destination. An error is generated if the source doesn't exist or the destination file already exists. This command will generate an “access denied” error if the destination is a restricted folder (e.g., C:\Windows) and the current user does not have Power User or Administrator privileges.
Initial S/W Revision	Prior to A.02.00

Mass Storage Remove Directory (Remote Command Only)

Key path	SCPI Only
Remote Command	<code>:MMEMory:RDIRectory <directory_name></code>
Notes	<p>The string must be a valid logical path.</p> <p>Removes a directory. The <directory_name> parameter specifies the directory name to be removed. All files and directories under the specified directory shall also be removed.</p> <p>This command will generate an “access denied” error if the folder is a restricted folder (e.g., C:\Windows) or is in a restricted folder and the current user does not have Power User or Administrator privileges.</p>
Initial S/W Revision	Prior to A.02.00

Single (Single Measurement/Sweep)

Sets the analyzer for Single measurement operation. The single/continuous state is Meas Global, so the setting will affect all the measurements. If you are Paused, pressing Single does a Resume.

See "[More Information](#)" on page 1663

Key Path	Front-panel key
Example	:INIT:CONT OFF
Notes	See Cont key description.
Backwards Compatibility Notes	<p>For Spectrum Analysis mode in ESA and PSA, the Single hardkey and the INITiate:IMM switched from continuous measurement to single measurement and restarted sweeps and averages (displayed average count reset to 1), but did not restart Max Hold and Min Hold. In the X-Series, the Single hardkey and the INITiate:IMM command initiate a sweep/ measurement/ average sequence/hold sequence including MaxHold and MinHold.</p> <p>For Spectrum Analysis mode in ESA and PSA, the Single hardkey restarted the sweep regardless of whether or not you were in an active sweep or sweep sequence. In the X-Series, Restart does this but Single only restarts the sweep or sweep sequence if you are in the idle state.</p> <p>INIT[:IMM] in ESA & PSA Spectrum Analysis Mode does an implied ABORT. In some other PSA Modes, INIT[:IMM] is ignored if not in the idle state. . The X-Series follows the ESA/PSA SA Mode model, which may cause some Modes to have compatibility problems.</p>
Initial S/W Revision	Prior to A.02.00

More Information

See "[Restart](#)" on page 2270 for details on the INIT:IMMEDIATE (Restart) function.

If you are already in single sweep, the INIT:CONT OFF command has no effect.

If you are already in Single Sweep, then pressing the Single key in the middle of a sweep does not restart the sweep or sequence. Similarly, pressing the Single key does not restart the sweep or sequence if the sweep is not in the idle state (for example, if you are taking a very slow sweep, or the analyzer is waiting for a trigger). Instead, it results in a message. "Already in Single, press Restart to initiate a new sweep or sequence". Even though pressing the Single key in the middle of a sweep does not restart the sweep, sending INIT:IMMEDIATE does reset it.

To take one more sweep without resetting the average count, increment the average count by 1, by pressing the step up key while **Average/Hold Number** is the active function, or sending the remote command CALC:AVER:TCON UP.

Source

There is no Source control functionality for this measurement. When this key is pressed, the screen either displays a blank menu, or the previously-selected menu remains unchanged.

Key Path	Front-panel key
----------	-----------------

SPAN X Scale

Accesses the SPAN/X Scale menu that allows you to set the desired horizontal scale settings.

Key Path	Front-panel key
Initial S/W Revision	A.10.01

Ref Value

Allows you to set the display X reference value.

Key Path	SPAN X Scale
Mode	WLAN
Remote Command	:DISPlay:FLATness:VIEW[1]:WINDow[1]:TRACe:X[:SCALe]:RLEVel <real> :DISPlay:FLATness:VIEW[1]:WINDow[1]:TRACe:X[:SCALe]:RLEVel?
Example	DISP:FLAT:VIEW:WIND:TRAC:X:RLEV 1 DISP:FLAT:VIEW:WIND:TRAC:X:RLEV?
Notes	Default value is coupled with Radio Std.
Couplings	If Auto Scaling is On, this value is automatically determined by the measurement result. When a value is set manually, Auto Scaling is automatically set to Off.
Preset	If Radio Std is 802.11a/g-ERP-OFDM/g-DSSS-OFDM: -26 Carr If Radio Std is 802.11n is 64: -28 Carr If Radio Std is 802.11n is 128: -58 Carr If Radio Std is 802.11ac is 64: -28 Carr If Radio Std is 802.11ac is 128: -58 Carr If Radio Std is 802.11ac is 256: -122 Carr If Radio Std is 802.11ac is 512: -250 Carr
State Saved	Saved in instrument state.
Min	-512.0 carriers
Max	512.0 carriers
Initial S/W Revision	A.10.01

Scale/Div

Allows you to set the display X scale/division value.

Key Path	SPAN X Scale
Mode	WLAN
Remote Command	:DISPlay:FLATness:VIEW[1]:WINDow[1]:TRACe:X[:SCALe]:PDIVision <real> :DISPlay:FLATness:VIEW[1]:WINDow[1]:TRACe:X[:SCALe]:PDIVision?

Example	DISP:FLAT:VIEW:WIND:TRAC:X:PDIV 1 DISP:FLAT:VIEW:WIND:TRAC:X:PDIV?
Notes	Default value is coupled with Radio Std and FFT Size
Couplings	If Auto Scaling is set to On, this value is automatically determined by the measurement result. When a value is set manually, Auto Scaling is automatically set to Off.
Preset	If Radio Std is 802.11a/g-ERP-OFDM/g-DSSS-OFDM: 5.2 Carr If Radio Std is 802.11n and FFT Size is 64: 5.6 Carr If Radio Std is 802.11n and FFT Size is 128: 11.6 Carr If Radio Std is 802.11ac and FFT Size is 64: 5.6 Carr If Radio Std is 802.11ac and FFT Size is 128: 11.6 Carr If Radio Std is 802.11ac and FFT Size is 256: 24.4 Carr If Radio Std is 802.11ac and FFT Size is 512: 50.0 Carr
State Saved	Saved in instrument state.
Min	0.1 carriers
Max	51.2 carriers
Initial S/W Revision	A.10.01

Ref Position

Allows you to set the X reference position to the left, center, or right of the display.

Key Path	SPAN X Scale
Mode	WLAN
Remote Command	:DISPlay:FLATness:VIEW[1]:WINDow[1]:TRACe:X[:SCALE]:RPOSition LEFT CENTER RIGHT :DISPlay:FLATness:VIEW[1]:WINDow[1]:TRACe:X[:SCALE]:RPOSition?
Example	DISP:FLAT:VIEW:WIND:TRAC:X:RPOS LEFT DISP:FLAT:VIEW:WIND:TRAC:X:RPOS?
Preset	LEFT
State Saved	Saved in instrument state.
Range	Left Ctr Right
Initial S/W Revision	A.10.01

Auto Scaling

Allows you to toggle the X Auto Scaling function between On and Off.

Key Path	SPAN X Scale
Mode	WLAN

Remote Command	:DISPlay:FLATness:VIEW[1]:WINDow[1]:TRACe:X[:SCALe]:COUPle 0 1 OFF ON :DISPlay:FLATness:VIEW[1]:WINDow[1]:TRACe:X[:SCALe]:COUPle?
Example	DISP:FLAT:VIEW:WIND:TRAC:X:COUP OFF DISP:FLAT:VIEW:WIND:TRAC:X:COUP?
Couplings	Upon pressing the Restart front-panel key, the scale coupling function automatically determines the scale per division and reference values, based on the measurement results, if this parameter is set to On. When you manually set a value to either Rel Value or Scale/Div, X Auto Scaling is automatically set to Off.
Preset	ON
State Saved	Saved in instrument state.
Range	On Off
Initial S/W Revision	A.10.01

Sweep/Control

Accesses a menu that allows you to select parameters that affect the sweep of the displayed measurement signal.

Only the Pause/Resume key is available.

See "[Sweep/Control](#)" on page 2291 for more information.

Key Path	Front-panel key
Initial S/W Revision	A.10.01

Pause/Resume

Pauses a measurement after the current data acquisition is complete.

When Paused, the label on the key changes to Resume. Pressing Resume un-pauses the measurement. When you are Paused, pressing Restart, Single or Cont does a Resume.

Key Path	Sweep/Control
Remote Command	:INITiate:PAUSE
Dependencies	Grayed out in Measurements that do not support Pausing. Blanked in Modes that do not support Pausing.
Initial S/W Revision	Prior to A.02.00

Key Path	Sweep/Control
Remote Command	:INITiate:RESume
Dependencies	Grayed out in Measurements that do not support Pausing. Blanked in Modes that do not support Pausing.
Initial S/W Revision	Prior to A.02.00

System

See "System" on page 353

Trace/Detector

There is no local functionality for Trace/Detector.

Key Path	Front-panel key
Initial S/W Revision	A.10.01

Trigger

See ["Trigger" on page 428](#)

Free Run

See ["Free Run " on page 435](#)

Video

See ["Video \(IF Envelope\) " on page 436](#)

Trigger Level

See ["Trigger Level " on page 436](#)

Trig Slope

See ["Trig Slope " on page 437](#)

Trig Delay

See ["Trig Delay " on page 438](#)

Line

See ["Line " on page 2105](#)

Trig Slope

See ["Trig Slope " on page 2105](#)

Trig Delay

See ["Trig Delay " on page 440](#)

External 1

See ["External 1 " on page 2118](#)

Trigger Level

See ["Trigger Level " on page 2118](#)

Trig Slope

See ["Trig Slope " on page 2119](#)

Trig Delay

See ["Trig Delay " on page 443](#)

Zero Span Delay Comp

See ["Zero Span Delay Comp On/Off" on page 2107](#)

External 2

See ["External 2 "](#) on page 2120

Trigger Level

See ["Trigger Level "](#) on page 2120

Trig Slope

See ["Trig Slope "](#) on page 2121

Trig Delay

See ["Trig Delay "](#) on page 445

Zero Span Delay Comp

See ["Zero Span Delay Comp On/Off"](#) on page 2109

RF Burst

See ["RF Burst "](#) on page 2121

Absolute Trigger

See ["Absolute Trigger Level"](#) on page 2122

Relative Trigger

See ["Relative Trigger Level"](#) on page 2111

Trig Slope

See ["Trigger Slope "](#) on page 2123

Trig Delay

See ["Trig Delay "](#) on page 450

Periodic Timer

See ["Periodic Timer \(Frame Trigger\) "](#) on page 2113

Period

See ["Period "](#) on page 2114

Offset

See ["Offset "](#) on page 2115

Offset Adjust (Remote Command Only)

See ["Offset Adjust \(Remote Command Only\)"](#) on page 2116

Reset Offset Display

See "Reset Offset Display " on page 2117

Sync Source

See "Sync Source " on page 2117

Off

See "Off " on page 2118

External 1

See "External 1 " on page 2118

Trigger Level

See "Trigger Level " on page 2118

Trig Slope

See "Trig Slope " on page 2119

External 2

See "External 2 " on page 2120

Trigger Level

See "Trigger Level " on page 2120

Trig Slope

See "Trig Slope " on page 2121

RF Burst

See "RF Burst " on page 2121

Absolute Trigger

See "Absolute Trigger Level" on page 2122

Trig Slope

See "Trigger Slope " on page 2123

Trig Delay

See "Trig Delay" on page 460

Auto/Holdoff

See "Auto/Holdoff " on page 461

Auto Trig

See "Auto Trig " on page 461

14 Spectral Flatness Measurement
Trigger

Trig Holdoff

See "Trig Holdoff" on page 462

Holdoff Type

See ___ on page X

User Preset

Accesses a menu that gives you the following three choices:

- User Preset – recalls a state previously saved using the Save User Preset function.
- User Preset All Modes – presets all of the modes in the analyzer
- Save User Preset– saves the current state for the current mode

Key Path	Front-panel key
Backwards Compatibility Notes	<p>User Preset is actually loading a state, and in legacy analyzers, it was possible to load a state without affecting the trace data, limit lines or correction data. Similarly it was possible to do a User Preset without affecting the trace data, limit lines or correction data.</p> <p>In the X-Series, “state” always includes all of this data; so whenever state is loaded, or User Preset is executed, all of the traces, limit lines and corrections are affected. Although this differs from previous behavior, it is desirable behavior, and should not cause adverse issues for users.</p> <p>On ESA and PSA, User Preset affected the entire instrument’s state. In the X-Series, User Preset only recalls the state for the active mode. There is a User Preset file for each mode. User Preset can never cause a mode switch as it can in legacy analyzers. If you want to recall all modes to their user preset file state, you will need to do a User Preset after mode switching into each mode.</p> <p>User Preset recalls mode state which can now include data like traces; whereas on ESA and PSA, User Preset did not affect data.</p>
Initial S/W Revision	Prior to A.02.00

User Preset

User Preset sets the state of the currently active mode back to the state that was previously saved for this mode using the Save User Preset menu key or the SCPI command, SYST:PRES:USER:SAV. It not only recalls the Mode Preset settings, but it also recalls all of the mode persistent settings, and the Input/Output system setting that existed at the time Save User Preset was executed.

If a Save User Preset has not been done at any time, User Preset recalls the default user preset file for the currently active mode. The default user preset files are created if, at power-on, a mode detects there is no user preset file. There will never be a scenario when there is no user preset file to restore. For each mode, the default user preset state is the same state that would be saved if a Save User Preset is performed in each mode right after doing a Restore Mode Default and after a Restore Input/Output Defaults.

The User Preset function does the following:

- Aborts the currently running measurement.
- Sets the mode State to the values defined by Save User Preset.
- Makes the saved measurement for the currently running mode the active measurement.
- Brings up the saved menu for the power-on mode.
- Clears the input and output buffers.
- Sets the Status Byte to 0.

Key Path	User Preset
Remote Command	:SYSTem:PRESet:USER
Example	:SYST:PRES:USER:SAVE:SYST:PRES:USER
Notes	:SYST:PRES:USER:SAVE is used to save the current state as the user preset state. Clears all pending OPC bits. The Status Byte is set to 0. Pressing the User Preset front-panel key while already in the User Preset menu will cause the User Preset to get executed
Couplings	A user preset will cause the currently running measurement to be aborted and cause the saved measurement to be active. Recalling a User Preset file has the same issues that recalling a Save State file has. Some settings may need to be limited and therefore re-coupled, since the capabilities of the mode may have changes when the User Preset file was last saved.
Initial S/W Revision	Prior to A.02.00

User Preset All Modes

Recalls all of the User Preset files for each mode, switches to the power-on mode, and activates the saved measurement from the power-on mode User Preset file.

NOTE

When the instrument is secured, all of the user preset files are converted back to their default user preset files.

The User Preset function does the following:

- Aborts the currently running measurement.
- Switches the Mode to the power-on mode.
- Restores the User Preset files for each mode.
- Makes the saved measurement for the power-on mode the active measurement.
- Brings up the saved menu for the power-on mode.
- Clears the input and output buffers.
- Sets the Status Byte to 0.

Key Path	User Preset
Remote Command	:SYSTem:PRESet:USER:ALL
Example	:SYST:PRES:USER:SAVE:SYST:PRES:USER:ALL
Notes	Clears all pending OPC bits. The Status Byte is set to 0. :SYST:PRES:USER:SAVE is used to save the current state as the user preset state.
Couplings	A user preset will cause the currently running measurement to be aborted, cause a mode switch to the power-on mode, and cause the saved measurement to be active in the power-on mode. Recalling a User Preset file has the same issues that recalling a Save State file has. Some settings may need to be limited and therefore re-coupled, since the capabilities of the mode may have changes when the User Preset file was last saved.
Initial S/W Revision	Prior to A.02.00

Save User Preset

Saves the currently active mode and its State. You can recall this User Preset file by pressing the User Preset menu key or sending the SYST:PRES:USER remote command. This same state is also saved by the Save State function.

Key Path	User Preset
Remote Command	:SYSTem:PRESet:USER:SAVE
Example	:SYST:PRES:USER:SAVE
Notes	:SYST:PRES:SAVE creates the same file as if the user requested a *SAV or a MMEM:STOR:STAT, except User Preset Save does not allow the user to specify the filename or the location of the file.
Initial S/W Revision	Prior to A.02.00

View/Display

Accesses the View/Display menu for the current measurement. This menu includes the Display key which allows you to access parameters that control the display. All softkeys in the “View/Display” menu work regardless of which result window currently has the focus.

Key Path	Front-panel key
Initial S/W Revision	A.10.01

This measurement consists of one view, and only one window.

Flatness window

Marker Operation	Yes
Corresponding Trace	Corrected measured trace (n=1)

Display

The Display menu is common to most measurements, and is used for configuring items on the display. Some Display menu settings apply to all the measurements in a mode, and some only to the current measurement. Those under the System Display Settings key apply to all measurements in all modes.

Key Path	Display
Key Path	View/Display
Initial S/W Revision	Prior to A.02.00

Annotation

Turns on and off various parts of the display annotation. The annotation is divided up into four categories:

1. Meas Bar: This is the measurement bar at the top of the screen. It does not include the settings panel or the Active Function. Turning off the Meas Bar turns off the settings panel and the Active Function. When the Meas Bar is off, the graticule area expands to fill the area formerly occupied by the Meas Bar.
2. Screen Annotation: this is the annotation and annunciation around the graticule, including any annotation on lines (such as the display line, the threshold line, etc.) This does NOT include the marker number or the N dB result. When off, the graticule expands to fill the entire graticule area.
3. Trace annotation: these are the labels on the traces, showing their detector (or their math mode).
4. Active Function annotation: this is the active function display in the meas bar, and all of the active function values displayed on softkeys.

See the figure below. Each type of annotation can be turned on and off individually.

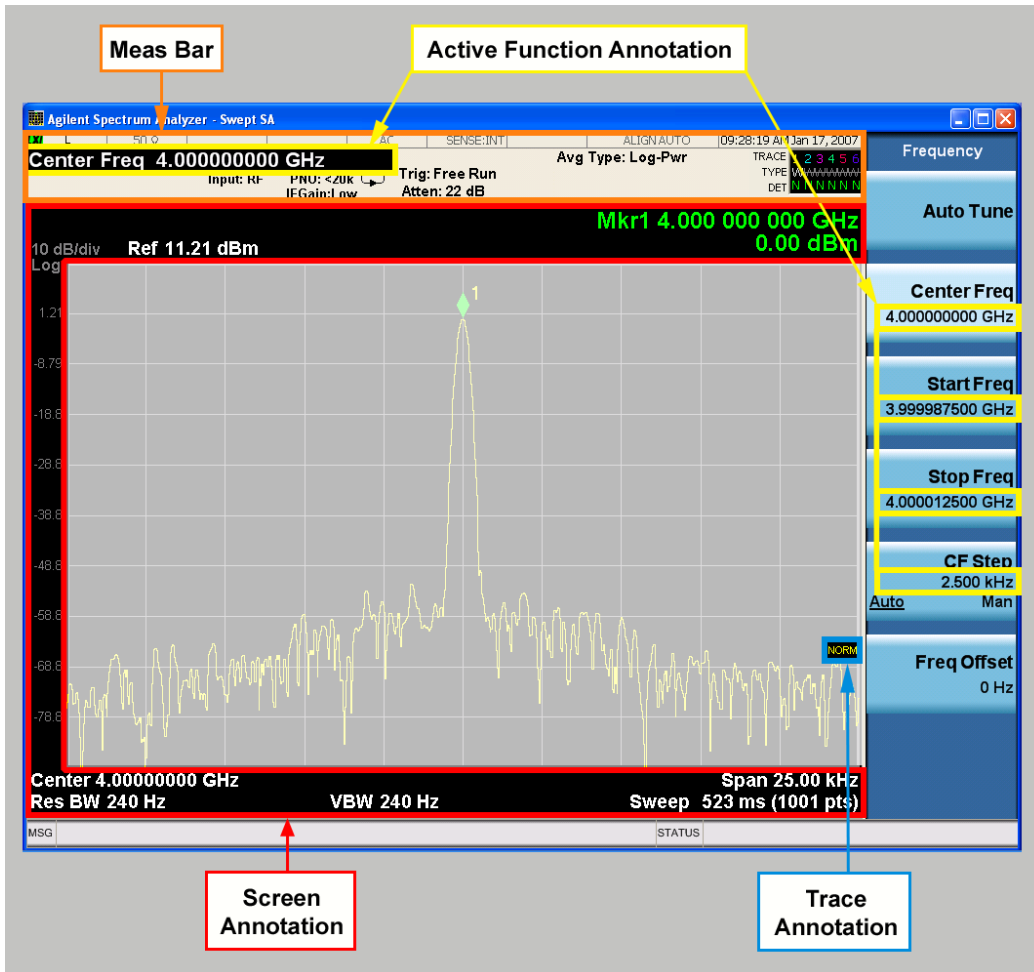

Key Path	View/Display, Display
Initial S/W Revision	Prior to A.02.00

Meas Bar On/Off

This function turns the Measurement Bar on and off, including the settings panel. When off, the graticule area expands to fill the area formerly occupied by the Measurement Bar.

Key Path	View/Display, Display, Annotation
Remote Command	:DISPlay:ANNotation:MBAR[:STATE] OFF ON 0 1 :DISPlay:ANNotation:MBAR[:STATE]?
Example	DISP:ANN:MBAR OFF
Dependencies	Grayed out and forced to OFF when System Display Settings, Annotation is set to Off.
Preset	On This should remain Off through a Preset when System DisplaySettings, Annotation is set to Off.
State Saved	Saved in instrument state.
Initial S/W Revision	Prior to A.02.00

Screen

This controls the display of the annunciation and annotation around the graticule, including any annotation on lines (such as the display line, the threshold line, etc.) and the y-axis annotation. This does NOT include marker annotation (or the N dB result). When off, the graticule expands to fill the entire graticule area, leaving only the 1.5% gap above the graticule as described in the Trace/Detector chapter.

Key Path	View/Display, Display, Annotation
Remote Command	:DISPlay:ANNotation:SCReen[:STATe] OFF ON 0 1 :DISPlay:ANNotation:SCReen[:STATe]?
Example	DISP:ANN:SCR OFF
Dependencies	Grayed-out and forced to OFF when System Display Settings, Annotation is set to Off.
Preset	On This should remain Off through a Preset when System DisplaySettings, Annotation is set to Off
State Saved	Saved in instrument state.
Initial S/W Revision	Prior to A.02.00

Active Function Values On/Off

Turns on and off the active function display in the Meas Bar, and all of the active function values displayed on the softkeys.

Note that all of the softkeys that have active functions have these numeric values blanked when this function is on. This is a security feature..



Key Path	View/Display, Display, Annotation
Remote Command	:DISPlay:ACTivefunc[:STATE] ON OFF 1 0 :DISPlay:ACTivefunc[:STATE]?
Example	DISP:ACT OFF
Dependencies	Grayed out and forced to OFF when System Display Settings, Annotation is set to Off.
Preset	On This should remain Off through a Preset when System DisplaySettings, Annotation is set to Off
State Saved	Saved in instrument state.
Initial S/W Revision	Prior to A.02.00

Title

Displays menu keys that enable you to change or clear a title on your display.

Key Path	View/Display, Display
Initial S/W Revision	Prior to A.02.00

Change Title

Writes a title into the "measurement name" field in the banner, for example, "Swept SA".

Press Change Title to enter a new title through the alpha editor. Press Enter or Return to complete the entry. Press ESC to cancel the entry and preserve your existing title.

The display title will replace the measurement name. It remains for this measurement until you press Change Title again, or you recall a state, or a Preset is performed. A title can also be cleared by pressing Title, Clear Title.

NOTE

Notice the inclusion of the <measurement> parameter in the command below. Because each measurement remembers the Display Title, the command must be qualified with the measurement name. For the Swept SA measurement this is not the case; no <measurement> parameter is used when changing the Display Title for the Swept SA measurement.

Key Path	View/Display, Display, Title
Mode	All
Remote Command	:DISPlay:<measurement>:ANNotation:TITLe:DATA <string> :DISPlay:<measurement>:ANNotation:TITLe:DATA?
Example	DISP:ANN:TITL:DATA "This Is My Title" This example is for the Swept SA measurement in the Spectrum Analyzer mode. The SANalyzer <measurement> name is not used. DISP:ACP:ANN:TITL:DATA "This Is My Title" This example is for Measurements other than Swept SA. Both set the title to: This Is My Title
Notes	Pressing this key cancels any active function. When a title is edited the previous title remains intact (it is not cleared) and the cursor goes at the end so that characters can be added or BKSP can be used to go back over previous characters.
Preset	No title (measurement name instead)
State Saved	Saved in instrument state.
Initial S/W Revision	Prior to A.02.00

Clear Title

Clears a title from the front-panel display. Once cleared, the title cannot be retrieved. After the title is cleared, the current Measurement Name replaces it in the title bar.

Key Path	View/Display, Display, Title
Example	The following commands clear the title and restore the measurement's original title: DISP:ANN:TITL:DATA "" This example is for the Swept SA measurement in the Spectrum Analyzer mode. The SANalyzer <measurement> name is not used. DISP:ACP:ANN:TITL:DATA "" This example is for ACP; in measurements other than Swept SA the measurement name is required.
Notes	Uses the :DISPlay:<measurement>:ANNotation:TITLe:DATA <string> command with an empty string (in the Swept SA, the <measurement> is omitted).
Preset	Performed on Preset.
Initial S/W Revision	Prior to A.02.00

Graticule

Pressing Graticule turns the display graticule On or Off. It also turns the graticule y-axis annotation on and off.

Key Path	View/Display, Display
Remote Command	:DISPlay:WINDow[1]:TRACe:GRATicule:GRID[:STATe] OFF ON 0 1 :DISPlay:WINDow[1]:TRACe:GRATicule:GRID[:STATe]?
Example	DISP:WIND:TRAC:GRAT:GRID OFF
Notes	The graticule is the set of horizontal and vertical lines that make up the grid/divisions for the x-axis and y-axis.
Preset	On
State Saved	Saved in instrument state
Initial S/W Revision	Prior to A.02.00

System Display Settings

These settings are "Mode Global" – they affect all modes and measurements and are reset only by Restore Misc Defaults or Restore System Defaults under System.

Key Path	View/Display, Display
Initial S/W Revision	Prior to A.02.00

Annotation Local Settings

This is a Mode Global override of the meas local annotation settings. When it is All Off, it forces ScreenAnnotation, Meas Bar, Trace, and Active Function Values settings to be OFF for all measurements in all modes. This provides the security based "annotation off" function of previous analyzers; hence it uses the legacy SCPI command.

When it is All Off, the Screen, Meas Bar, Trace, and Active Function Values keys under the Display, Annotation menu are grayed out and forced to Off. When Local Settings is selected, you are able to set the local annotation settings on a measurement by measurement basis.

Key Path	View/Display, Display, System Display Settings
Remote Command	:DISPlay:WINDow[1]:ANNOtation[:ALL] OFF ON 0 1 :DISPlay:WINDow[1]:ANNOtation[:ALL]?
Example	:DISP:WIND:ANN OFF
Preset	On (Set by Restore Misc Defaults)
State Saved	Not saved in instrument state.
Backwards Compatibility Notes	The WINDow parameter and optional subopcode is included for backwards compatibility but ignored – all windows are equally affected.
Initial S/W Revision	Prior to A.02.00

Themes

Accesses a menu of functions that enable you to choose the theme to be used when saving the screen image.

The **Themes** option is the same as the **Themes** option under the **Display** and **Page Setup** dialogs. It allows you to choose between themes to be used when saving the screen image.

Key Path	Save, Screen Image
Remote Command	:MMEMory:STORe:SCReen:THEMe TDColor TDMonochrome FCOLor FMONochrome :MMEMory:STORe:SCReen:THEMe?
Example	:MMEM:STOR:SCR:THEM TDM
Preset	3D Color; Is not part of Preset, but is reset by Restore Misc Defaults or Restore System Defaults All and survives subsequent running of the modes.
Readback	3D Color 3D Mono Flat Color Flat Mono
Backwards Compatibility Notes	In ESA and PSA we offer the choice of "Reverse Bitmap" or "Reverse Metafile" when saving screen images. This is much like the "Flat Color" theme available in X-Series. Also, if you selected Reverse Bitmap AND a black & white screen image, that would be much like "Flat Monochrome". In other words, each of the X-Series themes has a similar screen image type in ESA/PSA. But they are not identical.
Initial S/W Revision	Prior to A.02.00

3D Color

Selects a standard color theme with each object filled, shaded and colored as designed.

Key Path	Save, Screen Image, Themes
Example	MMEM:STOR:SCR:THEM TDC
Readback	3D Color
Initial S/W Revision	Prior to A.02.00

3D Monochrome

Selects a format that is like 3D color but shades of gray are used instead of colors.

Key Path	Save, Screen Image, Themes
Example	MMEM:STOR:SCR:THEM TDM
Readback	3D Mono
Initial S/W Revision	Prior to A.02.00

Flat Color

Selects a format that is best when the screen is to be printed on an ink printer.

Key Path	Save, Screen Image, Themes
Example	MMEM:STOR:SCR:THEM FCOL
Readback	Flat Color
Initial S/W Revision	Prior to A.02.00

Flat Monochrome

Selects a format that is like Flat Color. But only black is used (no colors, not even gray), and no fill.

Key Path	Save, Screen Image, Themes
Example	MMEM:STOR:SCR:THEM FMON
Readback	Flat Mono
Initial S/W Revision	Prior to A.02.00

Backlight

Accesses the display backlight on/off keys. This setting may interact with settings under the Windows "Power" menu.

When the backlight is off, pressing ESC, TAB, SPACE, ENTER, UP, DOWN, LEFT, RIGHT, DEL, BKSP, CTRL, or ALT turns the backlight on without affecting the application. Pressing any other key will turn backlight on and could potentially perform the action as well.

Key Path	View/Display, Display, System Display Settings
Remote Command	:DISPlay:BACKlight ON OFF :DISPlay:BACKlight?
Preset	ON (Set by Restore Misc Defaults)
Initial S/W Revision	Prior to A.02.00

Backlight Intensity

An active function used to set the backlight intensity. It goes from 0 to 100 where 100 is full on and 0 is off. This value is independent of the values set under the Backlight on/off key.

Key Path	View/Display, Display, System Display Settings
Remote Command	:DISPlay:BACKlight:INTensity <integer> :DISPlay:BACKlight:INTensity?
Example	DISP:BACK:INT 50

Preset	100 (Set by Restore Misc Defaults)
Min	0
Max	100
Initial S/W Revision	Prior to A.02.00

Limit Line

This key allows you to toggle the limit line on the view

Key Path	View/Display
Mode	WLAN
Remote Command	:DISPlay:FLATness:LLINe ON OFF 1 0 :DISPlay:FLATness:LLINe?
Example	DISP:FLAT:LLIN ON DISP:FLAT:LLIN?
Preset	ON
State Saved	Saved in instrument state.
Range	On Off
Initial S/W Revision	A.10.01

15 WLAN Modulation Analysis measurement

This section contains the following two topics

["Measurement Commands for Modulation Analysis" on page 1688](#)

["Remote Command Results for Modulation Analysis Measurement" on page 1689](#)

Measurement Commands for Modulation Analysis

The following commands are used to retrieve the measurement results:

:CONFigure:EVM

:CONFigure:EVM:NDEFault

:INITiate:EVM

:FETCh:EVM[n]?

:READ:EVM[n]?

:MEASure:EVM[n]?

For more measurement related commands, see the SENSE subsystem, and the section "[Remote Measurement Functions](#)" on page 2213.

Remote Command Results for Modulation Analysis Measurement

When Radio Std is 802.11ac 80+80MHz, these measurement results are also for one channel. Using SCPI “:CALCulte:EVM:SEGM” to specify that these contents are the first segment results or the second segment results.

If selects Radio Std 802.11a/g (OFDM), 801.11g (DSSS-OFDM), 802.11n (20 MHz), 802.11n (40 MHz), 802.11ac(20MHz), 802.11ac(40MHz), 802.11ac(80MHz), 802.11ac(80+80MHz), 802.11ac(160MHz):

Index: n	Results Returned
<Mnemonic>	
0	Returns unprocessed I/Q trace data of Capture Interval, as a series of trace point values. The I values are listed first in each pair, using the 0 through even-indexed values. The Q values are the odd-indexed values.
1 (or not specified)	<p>Returns the following 43 comma-separated scalar results, results 41 and 42 will be -999, they are reserved for 802.11b/g (DSSS/CCK/PBCC):</p> <p>“Avg” means the average of the individual measurements when averaging is on. “Max” means the maximum of the individual measurements when averaging is on.</p> <ol style="list-style-type: none"> 1. RMS EVM Max (dB) 2. RMS EVM Avg (dB) 3. Peak EVM Max (dB) 4. Peak EVM Avg (dB) 5. Max Peak EVM Index 6. Peak EVM Index*** 7. Frequency Error Max (Hz) 8. Frequency Error Avg (Hz) 9. Frequency Error Max (ppm) * 10. Frequency Error Avg (ppm) * 11. Symbol Clock Error Max (ppm) 12. Symbol Clock Error Avg (ppm) 13. I/Q Origin Offset Max (dB) 14. I/Q Origin Offset Avg (dB) 15. Gain Imbalance Max 16. Gain Imbalance Avg 17. Quadrature error Max (degrees) 18. Quadrature error Avg (degrees) 19. Avg Burst Power Max (dBm)

-
- 20. Avg Burst Power Avg (dBm)
 - 21. Peak Burst Power Max (dBm)
 - 22. Peak Burst Power Avg (dBm)
 - 23. Peak-to-Avg Burst Power Ratio Max
 - 24. Peak-to-Avg Burst Power Ratio Avg
 - 25. Data Modulation Format **
 - 26. Data Bit Rate (Mbits/s)
 - 27. Pilot EVM Max (dB)
 - 28. Pilot EVM Avg (dB)
 - 29. Data EVM Max (dB)
 - 30. Data EVM Avg (dB)
 - 31. IQ timing skew Max (for 802.11a/g, return -999.0)
 - 32. IQ timing skew Avg (for 802.11a/g, return -999.0)
 - 33. RMS EVM Max (%)
 - 34. RMS EVM Avg (%)
 - 35. Peak EVM Max (%)
 - 36. Peak EVM Avg (%)
 - 37. Pilot EVM Max (%)
 - 38. Pilot EVM Avg (%)
 - 39. Data EVM Max (%)
 - 40. Data EVM Avg (%)
 - 41. Reserved for 802.11b, return -999.0
 - 42. Reserved for 802.11b, return -999.0
 - 43. Burst Number analyzed in the last acquisition.

2		EVM vs. Symbol trace . vs. Symbol trace of Capture Interval. The first number is the symbol 0 decision point.
3		EVM vs. Carrier trace . vs. Carrier trace of Capture Interval.
7		Corrected measured trace . , when the IQ Normalize is turned on. The first number is the in-phase (I) sample and the second is the quadrature-phase (Q) sample.
8		Returns Demod Bits

9	<p>Returns 4 comma-separated scalar values of the pass/fail (0.0 = passed, or 1.0 = failed) results determined by testing the following items.</p> <p>802.11 standard (OFDM) specifies that EVM / IQ offset pass fail test should use average value.</p> <ol style="list-style-type: none"> 1. Test result of RMS EVM(Avg) 2. Test result of Frequency Error (Max) 3. Test result of symbol clock error(Max) 4. Test result of I/Q Origin Offset(Avg)
10	<p>If radio stand is 11n, return the decode bits of HT-SIG Signal.</p> <p>If radio stand is 11ac, return the decode bits of VHT-SIG-A and VHT_SIG_B Signal. the length of it depend on radio standard.</p> <p>For 11ac 20M, trace length is 48 + 26;</p> <p>For 11ac 40M, trace length is 48 + 27;</p> <p>For 11ac 80M,160M, 80+80M, trace length is 48 + 29;</p>
11	<p>Return the decode bits of L-SIG Signal.</p>
12	<p>Preamble Freq Error vs. Time, the total frequency error during the preamble portion of the OFDM burst.</p>
19	<p>IQ gain imbalance vs. Carrier trace .</p>
20	<p>IQ quadrature error vs.</p>

Carrier trace .

21

22

* when the input is BBIQ, this number will be -999.0.

** This result will return integer numbers, 0 represents BPSK, 1 represents QPSK, 2 represents 16-QAM, 3 represents 64-QAM, 4 represents 256-QAM.

*** Peak EVM Index is an instant value. While Average Number great than 1, Peak EVM Index is the last measurement's results in the average cycle.

If the Radio Std selects 802.11b/g (DSSS/CCK/PBCC)

Index: n <Mnemonic>	Results Returned
0	Returns unprocessed I/Q trace data of Capture Interval, as a series of trace point values. The I values are listed first in each pair, using the 0 through even-indexed values. The Q values are the odd-indexed values.
1 (or not specified)	Returns the following 42 comma-separated scalar results: "Avg" means the average of the individual measurements when averaging is on. "Max" means the maximum of the individual measurements when averaging is on. "Min" means the minimum of the individual measurements when averaging is on. 1. RMS EVM Max (%) 2. RMS EVM Avg (%) 3. Peak EVM Max (%) 4. Peak EVM Avg (%) 5. Max Peak EVM Index 6. Peak EVM Index*** 7. Frequency Error Max (Hz) 8. Frequency Error Avg (Hz) 9. Frequency Error Max (ppm) * 10. Frequency Error Avg (ppm) * 11. Chip Clock Error Max (ppm) 12. Chip Clock Error Avg (ppm) 13. I/Q Origin Offset Max (dB) 14. I/Q Origin Offset Avg (dB) 15. Gain Imbalance Max 16. Gain Imbalance Avg 17. Quadrature error Max (degrees) 18. Quadrature error Avg (degrees) 19. 1000 chips Peak EVM (802.11-2007) Max (%)

-
- 20. 1000 chips Peak EVM (802.11-2007) Avg (%)
 - 21. RMS Magnitude Error Max (%)
 - 22. RMS Magnitude Error Avg (%)
 - 23. Peak Magnitude Error Max (%)
 - 24. Peak Magnitude Error Avg (%)
 - 25. Max Peak Magnitude Error Index
 - 26. Peak Magnitude Error Index***
 - 27. RMS Phase Error Max (degrees)
 - 28. RMS Phase Error Avg (degrees)
 - 29. Peak Phase Error Max (degrees)
 - 30. Peak Phase Error Avg (degrees)
 - 31. Max Peak Phase Error Index
 - 32. Peak Phase Error Index***
 - 33. Carrier suppression Min (dB)
 - 34. Carrier suppression Avg (dB)**
 - 35. Avg Burst Power Max (dBm)
 - 36. Avg Burst Power Avg (dBm)**
 - 37. Peak Burst Power Max(dBm)
 - 38. Peak Burst Power Avg(dBm)**
 - 39. Peak-to-Avg Burst Power Ratio Max
 - 40. Peak-to-Avg Burst Power Ratio Avg
 - 41. Data Modulation Format **
 - 42. Data Bit Rate (Mbits/s)
 - 43. Burst Number analyzed in the last acquisition.**

4	EVM trace . the EVM value for each chip in the measurement interval.
5	Magnitude error trace . the magnitude error value for each chip in the measurement interval.
6	Phase error trace . the phase error value for each chip in the measurement interval.
7	Corrected measured trace . , when the IQ Normalize is turned on. The first number is the in-phase (I) sample of chip 0 decision point and the second is the quadrature-phase (Q) sample of chip 0 decision point
8	Returns Demod Bits
9	Returns 5 comma-separated scalar values of the pass/fail (0.0 = passed, or 1.0 = failed) results determined by testing the following items.

	802.11 standard (OFDA) specifies that EVM / IQ offset pass fail test should use average value. To keep consistent in one mode, also change 802.11b EVM / carrier suppression pass fail test to use average value. 1. Test result of RMS EVM (Avg) 2. Test result of 1000 Chips EVM (Avg) 3. Test result of Frequency Error (Max) 4. Test result of RF Carrier Suppression (Min) 5. Test result of Chip clock error (Avg)
10	Return the demod bits of PLCP Preamble.
11	Return the demod bits of PLCP Header.

* when the input is BBIQ, this number will be -999.0

** this result will return integer numbers, 0 represents DSSS1, 1 represents DSSS2, 2 represents CCK5.5, 3 represents CCK11, 4 represents PBCC5.5, 5 represents PBCC11, 6 represents PBCC22, 7 represents PBCC33.

*** Peak EVM Index, Peak Magnitude Error Index and Peak Phase Error Index are instant value. While Average Number great than 1, they keep the last measurement's results in the average cycle.

Selects the Modulation Analysis measurement.

Key Path	Meas
Initial S/W Revision	A.10.01

AMPTD Y Scale

Accesses the AMPTD Y Scale menu that allows you to set desired vertical scale settings.

Key Path	Front-panel key
Initial S/W Revision	A.10.01

Ref Value

Y Ref Value sets the reference value for the y-axis of the windows listed below, which are explained in greater detail in the following sections. NOTE: The settings available vary depending on the active window displayed. Scroll down for more information.

Key Path	AMPTD Y Scale
Initial S/W Revision	A.10.01

SCPI command information is available for the following measurement results display Windows:

- Ref Value (EVM vs Symbol or EVM vs Carrier Window)
- Ref Value (Mag Error or EVM Error Window)
- Ref Value (Phase Error Window)
- Ref Value(IQ Gain Imbalance vs Carrier Window)
- Ref Value(IQ Quadrature Skew vs Carrier Window)
- Ref Value(IQ Time Skew vs Carrier Window)

Ref Value (EVM vs. Symbol or EVM vs. Carrier Window)

Sets the relative power reference.

Key Path	AMPTD Y Scale
Mode	WLAN
Remote Command	:DISPlay:EVM:VIEW3:WINDow[1] 2:TRACe:Y[:SCALe]:RLEVel <rel_ampl> :DISPlay:EVM:VIEW3:WINDow[1] 2:TRACe:Y[:SCALe]:RLEVel?
Example	DISP:EVM:VIEW3:WIND:TRAC:Y:RLEV 5db DISP:EVM:VIEW3:WIND:TRAC:Y:RLEV?
Couplings	When Auto Scaling is set to On, this value is automatically determined by the measurement result. When you set this value manually, Auto Scaling is automatically set to Off.
Preset	0
State Saved	Saved in instrument state.
Min	-250.0

Max	250.0
Initial S/W Revision	A.10.01

Ref Value (Mag Error or EVM Window)

Sets the relative power reference.

Key Path	AMPTD Y Scale
Mode	WLAN
Remote Command	:DISPlay:EVM:VIEW2:WINDow[1] 3:TRACe:Y[:SCALe]:RLEVel <real> :DISPlay:EVM:VIEW2:WINDow[1] 3:TRACe:Y[:SCALe]:RLEVel?
Example	DISP:EVM:VIEW2:WIND:TRAC:Y:RLEV 1.5 DISP:EVM:VIEW2:WIND:TRAC:Y:RLEV?
Couplings	When Auto Scaling is set to On, this value is automatically determined by the measurement result. When you set this value manually, Auto Scaling is automatically set to Off.
Preset	0
State Saved	Saved in instrument state.
Min	-500.0
Max	500.0
Initial S/W Revision	A.10.01

Ref Value (Phase Error Window)

Sets the relative power reference.

Key Path	AMPTD Y Scale
Mode	WLAN
Remote Command	:DISPlay:EVM:VIEW2:WINDow2:TRACe:Y[:SCALe]:RLEVel <real> :DISPlay:EVM:VIEW2:WINDow2:TRACe:Y[:SCALe]:RLEVel?
Example	DISP:EVM:VIEW2:WIND2:TRAC:Y:RLEV 125 DISP:EVM:VIEW2:WIND2:TRAC:Y:RLEV?
Couplings	When Auto Scaling is set to On, this value is automatically determined by the measurement result. When you set this value manually, Auto Scaling is automatically set to Off.
Preset	0
State Saved	Saved in instrument state.
Min	-36000.0°
Max	36000.0°
Initial S/W Revision	A.10.01

Ref Value (Preamble Freq Error vs. Time)

Sets the relative power reference.

Key Path	AMPTD Y Scale
Mode	WLAN
Remote Command	:DISPlay:EVM:VIEW7:WINDow[1]:TRACe:Y[:SCALe]:RLEVel <real> :DISPlay:EVM:VIEW7:WINDow[1]:TRACe:Y[:SCALe]:RLEVel?
Example	DISP:EVM:VIEW7:WIND1:TRAC:Y:RLEV 125 DISP:EVM:VIEW7:WIND1:TRAC:Y:RLEV?
Couplings	When Auto Scaling is set to On, this value is automatically determined by the measurement result. When you set this value manually, Auto Scaling is automatically set to Off.
Preset	0
State Saved	Saved in instrument state.
Min	-5kHz
Max	5kHz
Initial S/W Revision	A.10.01

Ref Value (IQ Gain Imbalance vs. Carrier Window)

Set the Ref Value in IQ Gain Imbalance vs. Carrier Window.

Key Path	AMPTD Y Scale
Mode	WLAN
Remote Command	:DISPlay:EVM:VIEW8:WINDow[1]:TRACe:Y[:SCALe]:RLEVel <rel_ampl> :DISPlay:EVM:VIEW8:WINDow[1]:TRACe:Y[:SCALe]:RLEVel?
Example	DISP:EVM:VIEW8:WIND:TRAC:Y:RLEV 5db DISP:EVM:VIEW8:WIND:TRAC:Y:RLEV?
Couplings	When Auto Scaling is set to On, this value is automatically determined by the measurement result. When you set this value manually, Auto Scaling is automatically set to Off.
Preset	0
State Saved	Saved in instrument state.
Min	-250.0
Max	250.0
Initial S/W Revision	A.14.01

Ref Value (IQ Quadrature Skew vs. Carrier Window)

Set the Ref Value in IQ Quadrature Skew vs. Carrier Window.

Key Path	AMPTD Y Scale
Mode	WLAN
Remote Command	:DISPlay:EVM:VIEW8:WINDow2:TRACe:Y[:SCALe]:RLEVel <real> :DISPlay:EVM:VIEW8:WINDow2:TRACe:Y[:SCALe]:RLEVel?
Example	DISP:EVM:VIEW8:WIND2:TRAC:Y:RLEV 125 DISP:EVM:VIEW8:WIND2:TRAC:Y:RLEV?
Couplings	When Auto Scaling is set to On, this value is automatically determined by the measurement result. When you set this value manually, Auto Scaling is automatically set to Off.
Preset	0
State Saved	Saved in instrument state.
Min	-36000.0°
Max	36000.0°
Initial S/W Revision	A.14.01

Ref Value (EVM vs. Carrier Window)

Sets the relative power reference.

Key Path	AMPTD Y Scale
Mode	WLAN
Remote Command	:DISPlay:EVM:VIEW8:WINDow3:TRACe:Y[:SCALe]:RLEVel <rel_ampl> :DISPlay:EVM:VIEW8:WINDow3:TRACe:Y[:SCALe]:RLEVel?
Example	DISP:EVM:VIEW8:WIND3:TRAC:Y:RLEV 5db DISP:EVM:VIEW8:WIND3:TRAC:Y:RLEV?
Couplings	When Auto Scaling is set to On, this value is automatically determined by the measurement result. When you set this value manually, Auto Scaling is automatically set to Off.
Preset	0
State Saved	Saved in instrument state.
Min	-250.0
Max	250.0
Initial S/W Revision	A.14.01

Attenuation

This menu controls the attenuator functions and interactions between the attenuation system components.

There are two attenuator configurations in the X-Series. One is a dual attenuator configuration consisting of a mechanical attenuator and an optional electronic attenuator. The other configuration uses a single

attenuator with combined mechanical and electronic sections that controls all the attenuation functions. Different models in the X-Series come with different configurations.

See ["Dual Attenuator Configurations:" on page 1699](#)

See ["Single Attenuator Configuration:" on page 1700](#)

Most Attenuation settings are the same for all measurements – they do not change as you change measurements. Settings like these are called “Meas Global” and are unaffected by Meas Preset.

Key Path	AMPTD Y Scale
Scope	Meas Global
Dependencies	In measurements that support the I/Q inputs, this key is unavailable when I/Q is the selected input, and is replaced by the Range key in that case.
Readback Line	Contains a summary in [] brackets of the current total attenuation. See the descriptions of the , " (Mech) Atten " on page 2160, and " Enable Elec Atten " on page 2162 keys for more detail on the contributors to the total attenuation. Note that when "Pre-Adjust for Min Clip" is on, this value can change at the start of every measurement.
Initial S/W Revision	Prior to A.02.00
Modified at S/W Revision	A.03.00

Dual Attenuator Configurations:

Configuration 1: Mechanical attenuator + optional electronic attenuator

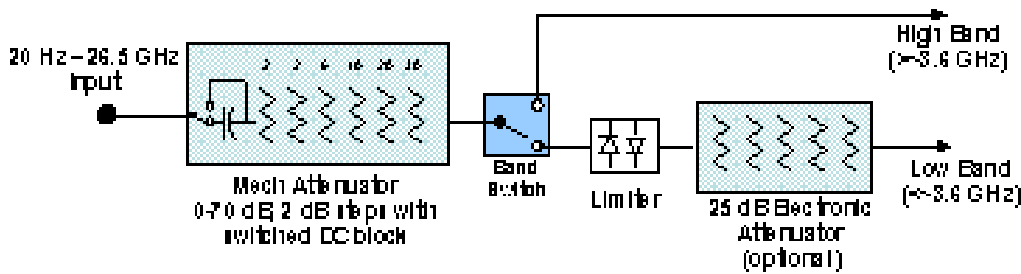

Configuration 2: Mechanical attenuator, no optional electronic attenuator

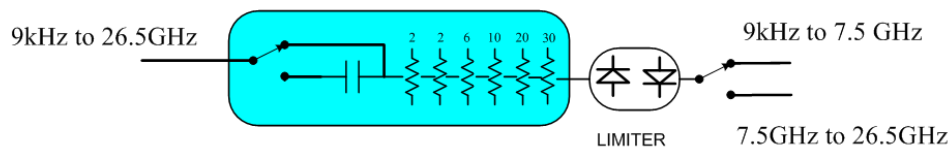

(note that Configuration 2 is not strictly speaking a dual-section attenuator, since there is no electronic section available. However, it behaves exactly like Configuration 1 without the Electronic Attenuator option EA3, therefore for the sake of this document it is grouped into the “Dual Attenuator” configuration)

Single Attenuator Configuration:

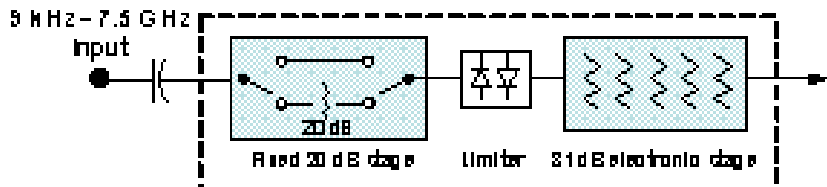

You can tell which attenuator configuration you have by pressing the Attenuation key, which (in most Modes) opens the Attenuation menu. If the first key in the Attenuation menu says Mech Atten you have the dual attenuator configuration. If the first key says Atten you have the single attenuator configuration.

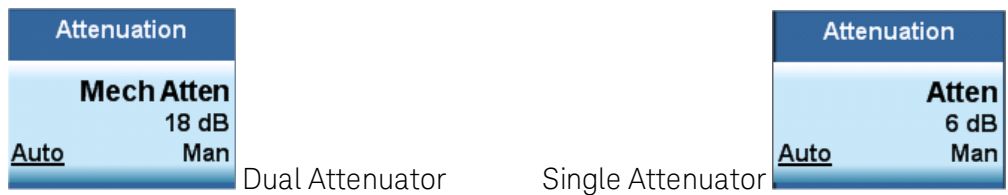

In the single attenuator configuration, you control the attenuation with a single control, as the fixed stage has only two states. In the dual attenuator configuration, both stages have significant range so you are given separate control of the mechanical and electronic attenuator stages.

When you have the dual attenuator configuration, you may still have only a single attenuator, because unless option EA3 (the Electronic Attenuator option) is available, and you purchase it, you will have only the mechanical attenuator.

(Mech) Atten

This key is labeled Mech Atten in dual attenuator models and Atten in single attenuator models. In the dual attenuator configuration, this key only affects the mechanical attenuator.

This key lets you modify the attenuation applied to the RF input signal path. This value is normally auto coupled to the Ref Level, the Internal Preamp Gain, any External Gain that is entered, and the Max Mixer Level, as described in the table below.

See ["Attenuator Configurations and Auto/Man" on page 1702](#)

Key Path	AMPTD Y Scale, Attenuation
Remote Command	<pre>[:SENSE] : POWer [:RF] : ATTenuation <rel_ampl> [:SENSE] : POWer [:RF] : ATTenuation? [:SENSE] : POWer [:RF] : ATTenuation : AUTO OFF ON 0 1 [:SENSE] : POWer [:RF] : ATTenuation : AUTO?</pre>
Example	<p>POW:ATT 20</p> <p>Dual attenuator configuration: sets the mechanical attenuator to 20 dB</p> <p>Single attenuator mode: sets the main attenuation to 20 dB (see below for definition of “main” attenuation).</p> <p>If the attenuator was in Auto, it sets it to Manual.</p>
Dependencies	Some measurements do not support the Auto setting of (Mech) Atten. In these measurements, the

Auto/Man selection is not available, and the Auto/Man line on the key disappears.

In dual attenuator configurations, when the electronic attenuator is enabled, the mechanical attenuator has no auto setting and the Auto/Man line on the key disappears. The state of Auto/Man is remembered and restored when the electronic attenuator is once again disabled. This is described in more detail in the "[Enable Elec Atten](#)" on page 2162 key description.

See "[Attenuator Configurations and Auto/Man](#)" on page 1702 for more information on the Auto/Man functionality of Attenuation.

Couplings

When (Mech) Atten is in Auto, it uses the following algorithm to determine a value:
If the USB Preamp is connected to USB, use 0 dB.
Otherwise, $Atten = ReferenceLevel + PreAmpGain + ExternalGain - RefLevelOffset - MaxMixerLevel + IF\ Gain$.
Limit this value to be between 6 dB and the Max value. No value below 6 dB can ever be chosen by Auto.
The resulting value is rounded up to the largest value possible given the attenuation step setting. That is, 50.01 dB would change to 60 dB (for a 10 dB attenuation step).
The "IF Gain" term in the equation above is either 0 dB or +10 dB, depending on the settings of FFT IF Gain, Swept IF Gain, max Ref Level and the Auto/Man setting of Mech Atten.
In External Mixing and BBIQ, where the Attenuator is not in the signal path, the Attenuator setting changes as described above when (Mech) Atten is in Auto, but no changes are made to the actual attenuator hardware setting until the input is changed back to the RF Input.

Preset The preset for Mech Attenuation is "Auto."
The Auto value of attenuation is:
CXA, EXA, MXA and PXA: 10 dB

State Saved Saved in instrument state

Min 0 dB
The attenuation set by this key cannot be decreased below 6 dB with the knob or step keys. To get to a value below 6 dB it has to be directly entered from the keypad or via SCPI. This protects from adjusting the attenuation to a dangerously small value which can put the instrument at risk of damage to input circuitry. However, if the current mechanical attenuation is below 6 dB it can be increased with the knob and step keys, but not decreased.

Max CXA N9000A-503/507: 50 dB
CXA N9000A-513/526: 70dB
EXA: 60 dB
MXA and PXA: 70 dB
In the single attenuator configuration, the total of ATT and EATT cannot exceed 50 dB, so if the EATT is set to 24 dB first, the main attenuation cannot be greater than 26 dB and will be reduced accordingly; if the main attenuator is set to 40 dB first, EATT cannot be greater than 10 dB.

Initial S/W Revision Prior to A.02.00

Modified at S/W Revision A.03.00

Attenuator Configurations and Auto/Man

As described in the Attenuation key description, there are two distinct attenuator configurations available in the X-Series, the single attenuator and dual attenuator configurations. In dual attenuator configurations, we have the mechanical attenuation and the electronic attenuation, and the current total attenuation is the sum of the electronic + mechanical attenuation. In single attenuator configurations, we refer to the attenuation set using the (Mech) Atten key (or POW:ATT SCPI) as the “main” attenuation; and the attenuation that is set by the SCPI command POW:EATT as the “soft” attenuation (the POW:EATT command is honored even in the single attenuator configuration, for compatibility purposes). Then the current total attenuation is the sum of the main + soft attenuation. See the Elec Atten key description for more on “soft” attenuation.

In the dual attenuator configuration, when the electronic attenuator is enabled, there is no Auto/Man functionality for the mechanical attenuator, and the third line of the key label (the Auto/Man line) disappears:

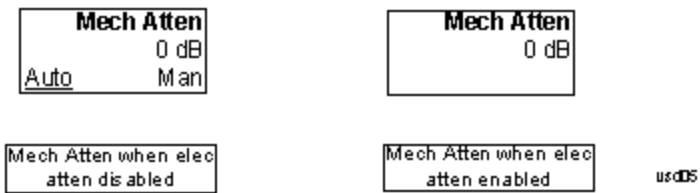

Enable Elec Atten

Enables the Electronic Attenuator.

The electronic attenuator offers finer steps than the mechanical attenuator, has no acoustical noise, is faster, and is less subject to wear. These advantages primarily aid in remote operation and are negligible for front panel use. See ["Using the Electronic Attenuator: Pros and Cons" on page 1704](#) for a detailed discussion of the pros and cons of using the electronic attenuator.

For the single attenuator configuration, for SCPI backwards compatibility, the “soft” attenuation feature replaces the dual attenuator configuration’s electronic attenuator. All the same couplings and limitations apply. See ["Attenuator Configurations and Auto/Man" on page 2162](#)

See ["More Information" on page 1703](#)

Key Path	AMPTD Y Scale, Attenuation
Remote Command	[:SENSe] : POWer [:RF] : EATTenuation : STATE OFF ON 0 1 [:SENSe] : POWer [:RF] : EATTenuation : STATE ?
Example	POW:EATT:STAT ON
Dependencies	This key only appears in Dual Attenuator models with an Electronic Attenuator installed. It does not appear in models with the Single Attenuator configuration, as in the single attenuator configuration there is no “electronic attenuator” there is only a single integrated attenuator (which has both a mechanical and electronic stage). However, in the single attenuator configuration, EATT SCPI commands are accepted for compatibility with other X-series instruments and set a “soft” attenuation as described in "Attenuator Configurations and Auto/Man" on page 2162 . The electronic attenuator (and the “soft” attenuation function provided in single attenuator configurations) is unavailable above 3.6 GHz. Therefore, if the Stop Frequency of the analyzer is > 3.6 GHz then the Enable Elec Atten key will be OFF and grayed out.

	<p>If the Internal Preamp is on, meaning it is set to Low Band or Full, the electronic attenuator (and the “soft” attenuation function provided in single attenuator configurations) is unavailable. In this case the Enable Elec Atten key will be OFF and grayed out.</p> <p>If either of the above is true, if the SCPI command is sent, an error indicating that the electronic attenuator is unavailable will be sent.</p> <p>If the electronic/soft Attenuator is enabled, then the Stop Freq of the analyzer is limited to 3.6 GHz and the Internal Preamp is unavailable.</p> <p>The SCPI-only “soft” electronic attenuation for the single-attenuator configuration is not available in all measurements; in particular, it is not available in the Swept SA measurement.</p>
Couplings	Enabling and disabling the Electronic Attenuator affects the setting of the Mechanical Attenuator (in dual attenuator configurations). This is described in more detail below this table.
Preset	OFF for Swept SA measurement; ON for all other measurements that support the electronic attenuator
State Saved	Saved in instrument state
Initial S/W Revision	Prior to A.02.00
Modified at S/W Revision	A.03.00

More Information

Mechanical Attenuator Transition Rules

When the Electronic Attenuator is enabled, the Mechanical Attenuator transitions to a state that has no Auto function. Below are the rules for transitioning the Mechanical Attenuator. NOTE that the information below ONLY applies to the dual attenuator configurations, and ONLY when the Electronic Attenuator is installed:

When the Electronic Attenuation is enabled from a disabled state:

- The Mechanical Attenuator is initialized to 10 dB (this is its optimal performance setting). You can then set it as desired with SCPI, numeric keypad, step keys, or knob, and it behaves as it normally would in manual mode
- The Auto/Man state of (Mech) Atten is saved
- The Auto/Man line on the (Mech) Atten key disappears and the auto rules are disabled
- The Electronic Attenuator is set to 10 dB less than the previous value of the Mechanical Attenuator, within the limitation that it must stay within the range of 0 to 24 dB of attenuation.

Examples in the dual attenuator configuration:

- Mech Atten at 20 dB. Elec Atten enabled, Mech Atten set to 10 dB, and Elec Atten set to 10 dB. New total attenuation equals the value before Elec Atten enabled.
- Mech Atten at 0 dB. Elec Atten enabled, Mech Atten set to 10 dB, and Elec Atten set to 0 dB. New total attenuation does not equal the value before Elec Atten enabled.
- Mech Atten at 40 dB. Elec Atten enabled, Mech Atten set to 10 dB, and Elec Atten set to 24 dB. New total attenuation does not equal the value before Elec Atten enabled.

When the Electronic Attenuation is disabled from an enabled state:

- The Elec Atten key is grayed out
- The Auto/Man state of (Mech) Atten is restored
- If now in Auto, (Mech) Atten recouples
- If now in Man, (Mech) Atten is set to the value of total attenuation that existed before the Elec Atten was disabled. The resulting value is rounded up to the smallest value possible given the (Mech) Atten Step setting - (That is, 57 dB changes to 58 dB when (Mech) Atten Step is 2 dB.)

Using the Electronic Attenuator: Pros and Cons

The electronic attenuator offers finer steps than the mechanical attenuator, has no acoustical noise, is faster, and is less subject to wear.

The “finer steps” advantage of the electronic attenuator is beneficial in optimizing the alignment of the analyzer dynamic range to the signal power in the front panel as well as remote use. Thus, you can achieve improved relative signal measurement accuracy. Compared to a mechanical attenuator with 2 dB steps, the 1 dB resolution of the electronic attenuator only gives better resolution when the odd-decibel steps are used. Those odd-decibel steps are less accurately calibrated than the even-decibel steps, so one tradeoff for this superior relative accuracy is reduced absolute amplitude accuracy.

Another disadvantage of the electronic attenuator is that the spectrum analyzer loses its “Auto” setting, making operation less convenient.

Also, the relationship between the dynamic range specifications (TOI, SHI, compression and noise) and instrument performance are less well-known with the electrical attenuator. With the mechanical attenuator, TOI, SHI and compression threshold levels increase dB-for-dB with increasing attenuation, and the noise floor does as well. With the electronic attenuator, there is an excess attenuation of about 1 to 3 dB between 0 and 3.6 GHz, making the effective TOI, SHI, and so forth, less well known. Excess attenuation is the actual attenuation relative to stated attenuation. Excess attenuation is accounted for in the analyzer calibration

Elec Atten

Controls the Electronic Attenuator in dual attenuator configurations. This key does not appear in single attenuator configurations, as the control of both the mechanical and electronic stages of the single attenuator is integrated into the single Atten key.

Key Path	AMPTD Y Scale, Attenuation
Remote Command	[:SENSe] :POWer [:RF] :EATTenuation <rel_ampl> [:SENSe] :POWer [:RF] :EATTenuation?
Notes	Electronic Attenuation’s specification is defined only when Mechanical Attenuation is 6 dB.
Dependencies	This key only appears in Dual Attenuator models with an Electronic Attenuator installed. It does not appear in models with the Single Attenuator configuration, as in the single attenuator configuration there is no “electronic attenuator” there is only a single integrated attenuator (which has both a mechanical and electronic stage). However, in the single attenuator configuration, EATT SCPI commands are accepted for compatibility with other X-series instruments and set a “soft” attenuation as described in "Attenuator Configurations and Auto/Man" on page 2162 . The “soft” attenuation is treated as an addition to the “main” attenuation value set by the Atten softkey or the

	POW:ATT SCPI command and affects the total attenuation displayed on the Attenuation key and the Meas Bar. When Enable Elec Atten is off or grayed out, the Elec Atten key is grayed out.
Preset	0 dB
State Saved	Saved in instrument state
Min	0 dB
Max	Dual attenuator configuration: 24 dB Single attenuator configuration: the total of ATT and EATT cannot exceed 50 dB, so if the EATT is set to 24 dB first, the main attenuation cannot be greater than 26 dB and will be reduced accordingly; if the main attenuator is set to 40 dB first, EATT cannot be greater than 10 dB
Initial S/W Revision	Prior to A.02.00
Modified at S/W Revision	A.03.00

Adjust Atten for Min Clip

Sets the combination of mechanical and electronic attenuation and gain based on the current measured signal level so that clipping will be at a minimum.

This is an "immediate action" function, that is, it executes once, when the key is pressed.

This key is grayed out in measurements that do not support this functionality. The spectrum analyzer measurement, Swept SA, does not support this functionality.

Key Path	AMPTD Y Scale, Attenuation
Remote Command	[:SENSe] :POWer [:RF] :RANGe:OPTimize IMMEDIATE
Initial S/W Revision	Prior to A.02.00
Modified at S/W Revision	A.03.00

Pre-Adjust for Min Clip

If this function is on, it does the adjustment described under "[Adjust Atten for Min Clip](#)" on page 2165 each time a measurement restarts. Therefore, in Continuous measurement mode, it only executes before the first measurement.

In dual attenuator models, you can set Elec+Mech Atten, in which case both attenuators participate in the autoranging, or Elec Atten Only, in which case the mechanical attenuator does not participate in the autoranging. This latter case results in less wear on the mechanical attenuator and is usually faster.

This key is grayed out in measurements that do not support this functionality. The spectrum analyzer measurement, Swept SA, does not support this functionality.

Key Path	AMPTD Y Scale, Attenuation
Remote Command	[:SENSe] :POWer [:RF] :RANGe:OPTimize:ATTenuation OFF ELECTRical COMBined

	<code>[:SENSe] :POWer [:RF] :RANGe:OPTimize:ATTenuation?</code>
Notes	The SCPI parameter ELECtrical sets this function to On in single attenuator models. The SCPI parameter COMBined is mapped to ELECtrical in single attenuator models; if you send COMBined, it sets the function to On and returns ELEC to a query.
Dependencies	This key only appears in Dual Attenuator models with an Electronic Attenuator installed. In instruments with Dual Attenuator model, when Enable Elec Atten is off or grayed out, the Pre-Adjust for Min Clip key is grayed out.
Preset	OFF for Swept SA measurement; ON for all other measurements that support Pre-Adjust for Min Clip
State Saved	Saved in instrument state
Range	Dual attenuator models: Off Elec Atten Only Mech + Elec Atten Single attenuator models: Off On
Initial S/W Revision	Prior to A.02.00
Modified at S/W Revision	A.03.00

Remote Command	<code>[:SENSe] :POWer [:RF] :RANGe:AUTO ON OFF 1 0</code> <code>[:SENSe] :POWer [:RF] :RANGe:AUTO?</code>
Notes	ON aliases to "Elec Atten Only" (:POW:RANG:OPT:ATT ELEC) OFF aliases to "Off" (:POW:RANG:OPT:ATT OFF) The query :POW:RANG:AUTO? returns true if :POW:RANG:OPT:ATT is not "Off"
Initial S/W Revision	Prior to A.02.00

Off

Turns Pre-Adjust for Min Clip off. This is the default setting.

This key is grayed out in measurements that do not support this functionality. The spectrum analyzer measurement, Swept SA, does not support this functionality.

Key Path	AMPTD Y Scale, Attenuation, Pre-Adjust for Min Clip
Example	:POW:RANGe:OPT:ATT OFF
Initial S/W Revision	Prior to A.02.00

Elec Atten Only

Selects only the electric attenuator to participate in auto ranging. This offers less wear on the mechanical attenuator and is usually faster.

This key is grayed out in measurements that do not support this functionality. The spectrum analyzer measurement, Swept SA, does not support this functionality.

Key Path	AMPTD Y Scale, Attenuation, Pre-Adjust for Min Clip
Example	:POW:RANGe:OPT:ATT ELEC
Initial S/W Revision	Prior to A.02.00

Mech + Elec Atten

In dual attenuator models, this selects both attenuators participate in the autoranging.

This key is grayed out in measurements that do not support this functionality. The spectrum analyzer measurement, Swept SA, does not support this functionality.

Key Path	AMPTD Y Scale, Attenuation, Pre-Adjust for Min Clip
Example	:POW:RANGe:OPT:ATT COMB
Initial S/W Revision	Prior to A.02.00

(Mech) Atten Step

This controls the step size used when making adjustments to the input attenuation.

This key is labeled Mech Atten Step in dual attenuator models and Atten Step in single attenuator models. In the dual attenuator configuration, this key only affects the step size of the mechanical attenuator.

Key Path	AMPTD Y Scale, Attenuation
Remote Command	[:SENSe] :POWer [:RF] :ATTenuation :STEP [:INCRement] 10 dB 2 dB [:SENSe] :POWer [:RF] :ATTenuation :STEP [:INCRement] ?
Example	POW:ATT:STEP 2
Notes	Note this feature works like a 1-N choice from the front panel, but it takes a specific value (in dB) when used remotely. The only valid values are 2 and 10.
Dependencies	Blanked in CXA and EXA if option FSA (2 dB steps) is not present. If blanked, attempts to set it via SCPI will yield an error.
Couplings	When the attenuation step size changes, the current mechanical attenuation value is adjusted (if necessary) to be quantized to the new step size. That is, if step is set to 10 dB, mech atten is increased if necessary so it is a multiple of 10 dB
Preset	PXA and MXA: 2 dB EXA and CXA: 10 dB (2 dB with option FSA)
State Saved	Saved in instrument state
Initial S/W Revision	Prior to A.02.00
Modified at S/W Revision	A.03.00

Scale/Div

Sets the logarithmic units per vertical graticule division in the display for the windows listed below, which are explained in greater detail in the following sections. When Auto Scaling is On, the Scale/Div is automatically determined by the measurement result. When you set a value manually, Auto Scaling is automatically toggled to Off.

Key Path	AMPTD Y Scale
Initial S/W Revision	A.10.01

Scale/Div (EVM vs. Symbol or EVM vs. Carrier Window)

Key Path	AMPTD Y Scale
Mode	WLAN
Remote Command	:DISPlay:EVM:VIEW3:WINDow[1] 2:TRACe:Y[:SCALe]:PDIVision <rel_ampl> :DISPlay:EVM:VIEW3:WINDow[1] 2:TRACe:Y[:SCALe]:PDIVision?
Example	DISP:EVM:VIEW3:WIND:TRAC:Y:PDIV 10dB DISP:EVM:VIEW3:WIND:TRAC:Y:PDIV?
Couplings	When the Auto Scaling is set to On, this value is automatically determined by the measurement result. When you set a value manually, Auto Scaling is automatically set to Off.
Preset	10.00 dB
State Saved	Saved in instrument state.
Min	0.1 dB
Max	20.0 dB
Initial S/W Revision	A.10.01

Scale/Div (Mag Error or EVM Window)

Key Path	AMPTD Y Scale
Mode	WLAN
Remote Command	:DISPlay:EVM:VIEW2:WINDow[1] 3:TRACe:Y[:SCALe]:PDIVision <percent> :DISPlay:EVM:VIEW2:WINDow[1] 3:TRACe:Y[:SCALe]:PDIVision?
Example	DISP:EVM:VIEW2:WIND:TRAC:Y:PDIV 5.0 DISP:EVM:VIEW2:WIND:TRAC:Y:PDIV?
Couplings	When the Auto Scaling is set to On, this value is automatically determined by the measurement result. When you set a value manually, Auto Scaling is automatically set to Off.
Preset	Mag Error Window: 3.00% EVM Error Window: 1.50%
State Saved	Saved in instrument state.

Min	0.1%
Max	50.0%
Initial S/W Revision	A.10.01

Scale/Div (Phase Error Window)

Key Path	AMPTD Y Scale
Mode	WLAN
Remote Command	:DISPlay:EVM:VIEW2:WINDow2:TRACe:Y[:SCALe]:PDIVision <real> :DISPlay:EVM:VIEW2:WINDow2:TRACe:Y[:SCALe]:PDIVision?
Example	DISP:EVM:VIEW2:WIND2:TRAC:Y:PDIV 45 DISP:EVM:VIEW2:WIND2:TRAC:Y:PDIV?
Couplings	When the Auto Scaling is set to On, this value is automatically determined by the measurement result. When you set a value manually, Auto Scaling is automatically set to Off.
Preset	7.50 °
State Saved	Saved in instrument state.
Min	0.01°
Max	3600.00°
Initial S/W Revision	A.10.01

Scale/Div (Preamble Freq Error vs. Time)

Key Path	AMPTD Y Scale
Mode	WLAN
Remote Command	:DISPlay:EVM:VIEW7:WINDow[1]:TRACe:Y[:SCALe]:PDIVision <real> :DISPlay:EVM:VIEW7:WINDow[1]:TRACe:Y[:SCALe]:PDIVision?
Example	DISP:EVM:VIEW7:WIND1:TRAC:Y:PDIV 45 DISP:EVM:VIEW7:WIND1:TRAC:Y:PDIV?
Couplings	When the Auto Scaling is set to On, this value is automatically determined by the measurement result. When you set a value manually, Auto Scaling is automatically set to Off.
Preset	1 kHz
State Saved	Saved in instrument state.
Min	-5kHz
Max	5kHz
Initial S/W Revision	A.10.01

Scale/Div (IQ Gain Imbalance vs. Carrier Window)

Set the vertical scale by changing a value per division in IQ Gain Imbalance vs. Carrier Window.

Key Path	AMPTD Y Scale
Mode	WLAN
Remote Command	:DISPlay:EVM:VIEW8:WINDow[1]:TRACe:Y[:SCALe]:PDIVision <rel_ampl> :DISPlay:EVM:VIEW8:WINDow[1]:TRACe:Y[:SCALe]:PDIVision?
Example	DISP:EVM:VIEW8:WIND:TRAC:Y:PDIV 10dB DISP:EVM:VIEW8:WIND:TRAC:Y:PDIV?
Couplings	When the Auto Scaling is set to On, this value is automatically determined by the measurement result. When you set a value manually, Auto Scaling is automatically set to Off.
Preset	10.00 dB
State Saved	Saved in instrument state.
Min	0.1 dB
Max	20.0 dB
Initial S/W Revision	A.14.01

Scale/Div (IQ Quadrature Skew vs. Carrier Window)

Set the vertical scale by changing a value per division in IQ Quadrature Skew vs. Carrier Window.

Key Path	AMPTD Y Scale
Mode	WLAN
Remote Command	:DISPlay:EVM:VIEW8:WINDow2:TRACe:Y[:SCALe]:PDIVision <real> :DISPlay:EVM:VIEW8:WINDow2:TRACe:Y[:SCALe]:PDIVision?
Example	DISP:EVM:VIEW8:WIND2:TRAC:Y:PDIV 10 DISP:EVM:VIEW8:WIND2:TRAC:Y:PDIV?
Couplings	When the Auto Scaling is set to On, this value is automatically determined by the measurement result. When you set a value manually, Auto Scaling is automatically set to Off.
Preset	7.50°
State Saved	Saved in instrument state.
Min	0.01°
Max	3600.00°
Initial S/W Revision	A.14.01

Scale/Div (EVM vs. Carrier Window)

Key Path	AMPTD Y Scale
----------	---------------

Mode	WLAN
Remote Command	:DISPlay:EVM:VIEW8:WINDow3:TRACe:Y[:SCALe]:PDIVision <rel_ampl> :DISPlay:EVM:VIEW8:WINDow3:TRACe:Y[:SCALe]:PDIVision?
Example	DISP:EVM:VIEW8:WIND3:TRAC:Y:PDIV 10dB DISP:EVM:VIEW8:WIND3:TRAC:Y:PDIV?
Couplings	When the Auto Scaling is set to On, this value is automatically determined by the measurement result. When you set a value manually, Auto Scaling is automatically set to Off.
Preset	10.00 dB
State Saved	Saved in instrument state.
Min	0.1 dB
Max	20.0 dB
Initial S/W Revision	A.14.01

Presel Center

When this key is pressed, the centering of the preselector filter is adjusted to optimize the amplitude accuracy at the frequency of the selected marker. If the selected marker is not on when Presel Center is pressed, the analyzer will turn on the selected marker, perform a peak search, and then perform centering on the marker's center frequency. If the selected marker is already on and between the start and stop frequencies of the analyzer, the analyzer performs the preselector calibration on that marker's frequency. If the selected marker is already on, but outside the frequency range between Start Freq and Stop Freq, the analyzer will first perform a peak search, and then perform centering on the marker's center frequency.

The value displayed on the Presel Adjust key will change to reflect the new preselector tuning (see Presel Adjust).

A number of considerations should be observed to ensure proper operation. See "[Proper Preselector Operation](#)" on page 1712.

Key Path	AMPTD Y Scale
Remote Command	[:SENSe]:POWer[:RF]:PCENter
Example	POW:PCEN
Notes	Note that the rules outlined above under the key description apply for the remote command as well as the key. The result of the command is dependent on marker position, and so forth. Any message shown by the key press is also shown in response to the remote command.
Dependencies	<ul style="list-style-type: none"> • Grayed out if the microwave preselector is off.) • If the selected marker's frequency is below Band 1, advisory message 0.5001 is generated and no action is taken. • Grayed out if entirely in Band 0. • Blank in models that do not include a preselector, such as option 503. If the SCPI is sent in these instruments, it is accepted without error, and the query always returns 0. • Grayed out in the Spectrogram View.

Couplings	The active marker position determines where the centering will be attempted. If the analyzer is in a measurement such as averaging when centering is initiated, the act of centering the preselector will restart averaging but the first average trace will not be taken until the centering is completed.
Status Bits/OPC dependencies	When centering the preselector, *OPC will not return true until the process is complete and a subsequent measurement has completed, nor will results be returned to a READ or MEASURE command. The Measuring bit should remain set while this command is operating and should not go false until the subsequent sweep/measurement has completed.
Initial S/W Revision	Prior to A.02.00
Modified at S/W Revision	A.03.00

Proper Preselector Operation

A number of considerations should be observed to ensure proper operation:

1. If the selected marker is off, the analyzer will turn on a marker, perform a peak search, and adjust the preselector using the selected marker's frequency. It uses the "highest peak" peak search method unqualified by threshold or excursion, so that there is no chance of a 'no peak found' error. It continues with that peak, even if it is the peak of just noise. Therefore, for this operation to work properly, there should be a signal on screen in a preselected range for the peak search to find.
2. If the selected marker is already on, the analyzer will attempt the centering at that marker's frequency. There is no preselector for signals below about 3.6 GHz, therefore if the marker is on a signal below 3.6 GHz, no centering will be attempted and an advisory message generated.
3. In some models, the preselector can be bypassed. If it is bypassed, no centering will be attempted in that range and a message will be generated.

Preselector Adjust

Allows you to manually adjust the preselector filter frequency to optimize its response to the signal of interest. This function is only available when "[Presel Center](#)" on page 2168 is available.

For general purpose signal analysis, using Presel Center is recommended. Centering the filter minimizes the impact of long-term preselector drift. Presel Adjust can be used instead to manually optimize the preselector. One application of manual optimization would be to peak the preselector response, which both optimizes the signal-to-noise ratio and minimizes amplitude variations due to small (short-term) preselector drifting.

Key Path	AMPTD Y Scale
Scope	Meas Global
Remote Command	[:SENSe] :POWer [:RF] :PADJust <freq> [:SENSe] :POWer [:RF] :PADJust?
Example	POW:PADJ 100KHz

	POW:PADJ?
Notes	The value on the key reads out to 0.1 MHz resolution.
Dependencies	<ul style="list-style-type: none"> • Grayed out if microwave preselector is off.) • Grayed out if entirely in Band 0. • Blank in models that do not include a preselector, such as option 503. If the SCPI is sent in these instruments, it is accepted without error, and the query always returns 0. • Grayed out in the Spectrogram View.
Preset	0 MHz
State Saved	The Presel Adjust value set by Presel Center, or by manually adjusting Presel Adjust, is not saved in instrument state, and does not survive a Preset or power cycle.
Min	-500 MHz
Max	500 MHz
Default Unit	Hz
Backwards Compatibility SCPI	<pre>[:SENSe] : POWer [:RF] : MW : PADJust</pre> <pre>[:SENSe] : POWer [:RF] : MMW : PADJust</pre> <p>PSA had multiple preselectors, but the X-Series has only one. These commands simply alias to [:SENSe] : POWer [:RF] : PADJust</p>
Initial S/W Revision	Prior to A.02.00
Modified at S/W Revision	A.03.00

Remote Command	<pre>[:SENSe] : POWer [:RF] : PADJust : PRESelector MWAVE MMWave EXTERNAL</pre> <pre>[:SENSe] : POWer [:RF] : PADJust : PRESelector?</pre>
Notes	<p>PSA had multiple preselectors, and you could select which preselector to adjust. Since the X-Series has only one mm/uW preselector, the preselector selection softkey is no longer available. However, to provide backward compatibility, we accept the legacy remote commands.</p> <p>The command form has no effect, the query always returns MWAVE</p>
Initial S/W Revision	Prior to A.02.00

μW Path Control

Sets the μW Path Control function to Auto, standard path, μW Preselector Bypass (Option MPB) and Low Noise Path (Option LNP).

Key Path	AMPTD/Y Scale
Initial S/W Revision	A.14.50

μW Path Control Auto

Activates the auto rules for μW Path Control. When Auto is active, the μW Path Control is set to Preselector Bypass in modulation analysis and spectral flatness measurement; it is set to standard path in other measurements.

Key Path	AMPTD/Y Scale
Remote Command	[:SENSe] :POWer [:RF] :MW:PATH:AUTO ON OFF 1 0 [:SENSe] :POWer [:RF] :MW:PATH:AUTO?
Example	POW:MW:PATH:AUTO ON POW:MW:PATH:AUTO?
Couplings	When Auto is active, the μW Path Control is set to μW Preselector Bypass in IQ measurements (IQ waveform, CCDF, PVT, EVM, Spetrum flatness and WLS); it is set to standard path in other measurements.
Preset	ON
Range	Off On
Initial S/W Revision	A.14.50

Standard Path

This path gives the best remote-control throughput, minimizes acoustic noise from switching and minimizes the risk of wear in the hardware switches, particularly in remote test scenarios where both low band and high band setups will follow in rapid succession.

In this path, the bypass of the low band/high band switch and microwave preamp is never activated, which can cause some noise degradation but preserves the life of the bypass switch.

Key Path	AMPTD Y Scale, μW Path Control
Example	:POW:MW:PATH STD
Readback Text	Standard Path
Initial S/W Revision	A.04.00

Low Noise Path Enable

You may choose Low Noise Path Enable, which gives a lower noise floor under some circumstances, particularly when operating in the 21–26.5 GHz region. With the Low Noise Path enabled, the low band/high band switch and microwave preamp are bypassed whenever all of the following are true:

- The analyzer is not in the Low Band, meaning:
- the start frequency is above 3.5 GHz and
- the stop frequency is above 3.6 GHz.
- the internal preamp is not installed or (if installed) is set to Off or Low Band

Note that this means that, when any part of a sweep is done in Low Band, the Low Noise Path is not used, whether or not the Low Noise Path Enable is selected in the user interface. Also, if the preamp is turned on, the Low Noise Path is not used, whether or not the Low Noise Path Enable is selected in the user interface. The only time the Low Noise Path is used is when Low Noise Path Enable is selected, the sweep is completely in High Band (> 3.6 GHz) and no preamp is in use.

See "[More Information](#)" on page 1715

Key Path	AMPTD Y Scale, μ W Path Control
Measurement	Swept SA
Example	:POW:MW:PATH LNP
Notes	<p>For measurements that use IQ acquisition, the low noise path is used when the Center Frequency is in High Band (> 3.6 GHz) and no preamp is in use.</p> <p>In other words, the rules above are modified to use only the center frequency to qualify which path to switch in.</p> <p>This is not the case for FFT's in the Swept SA measurement; they use the same rules as swept measurements.</p>
Dependencies	<p>Key is blanked if current mode does not support it.</p> <p>Key is grayed out if mode supports it but current measurement does not support it.</p> <p>Unless Option LNP is present and licensed, key is blank and if SCPI command sent, error -241, "Hardware missing; Option not installed" is generated.</p>
Readback Text	Low Noise Path Enable
Initial S/W Revision	A.04.00

More Information

The user should understand that the Low Noise Path, while giving improved DANL, has the disadvantage of decreased TOI performance and decreased gain compression performance relative to the standard path.

The user should also understand that the bypass switch is a mechanical switch and has finite life, so if the Low Noise Path is enabled, it is possible to cause frequent cycling of this switch by frequently changing analyzer settings such that the above conditions hold true only some of the time. A user making tests of this nature should consider opting for the Standard Path, which will never throw the bypass switch, at the expense of some degraded noise performance.

The low noise path is useful for situations where the signal level is so low that the analyzer performance is dominated by noise even with 0 dB attenuation, but still high enough that the preamp option would have excessive third-order intermodulation or compression. The preamp, if purchased and used, gives better noise floor than does the "Low Noise Path." However, its compression threshold and third-order intercept are much poorer than that of the non-preamp path. There are some applications, typically for signals around -30 dBm, for which the third-order dynamic range of the standard path is good enough, but the noise floor is not low enough even with 0 dB input attenuation. When the third-order dynamic range of the preamp path is too little and the noise floor of the standard path is too high, the Low Noise Path can provide the best dynamic range

The graph below illustrates the concept. It shows, in red, the performance of an analyzer at different attenuation settings, both with the preamp on and off, in a measurement that is affected by both analyzer

noise and analyzer TOI. The green shows the best available dynamic range, offset by 0.5 dB for clarity. The blue shows how the best available dynamic range improves for moderate signal levels with the low noise path switched in. In this illustration, the preamp improves the noise floor by 15 dB while degrading the third-order intercept by 30 dB, and the low noise path reduces loss by 8 dB. The attenuator step size is 2 dB.

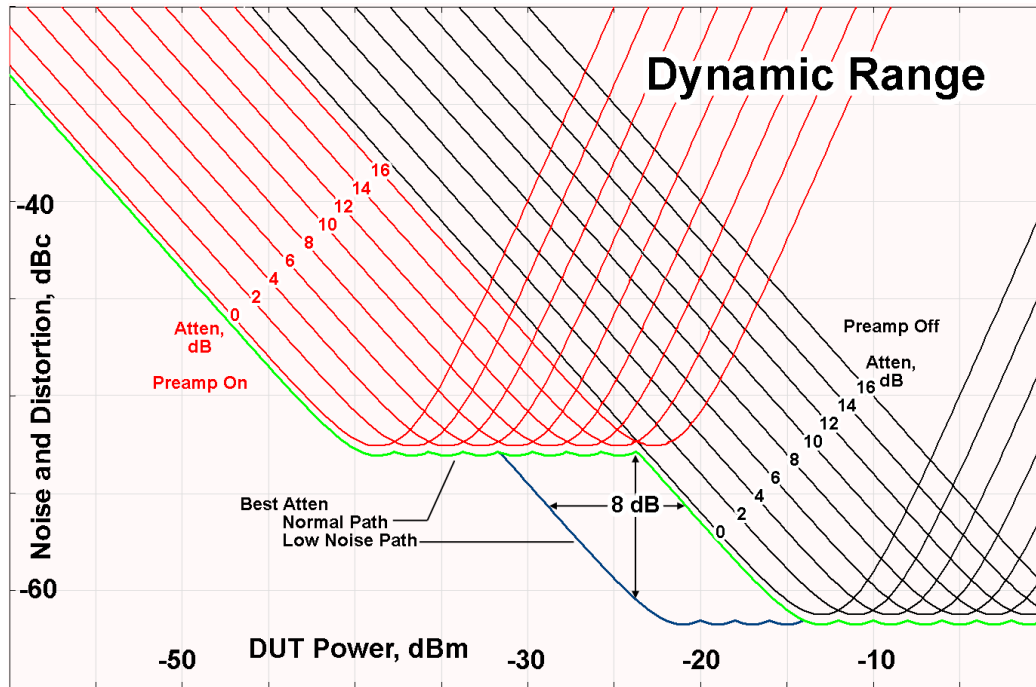

There are other times where selecting the low noise path improves performance, too. Compression-limited measurements such as finding the nulls in a pulsed-RF spectrum can profit from the low noise path in a way similar to the TOI-limited measurement illustrated. Accuracy can be improved when the low noise path allows the optimum attenuation to increase from a small amount like 0, 2 or 4 dB to a larger amount, giving better return loss at the analyzer input. Harmonic measurements, such as second and third harmonic levels, are much improved using the low noise path because of the superiority of that path for harmonic (though not intermodulation) distortion performance.

μW Preselector Bypass

This key toggles the preselector bypass switch for band 1 and higher. When the microwave preselector is on, the signal path is preselected. When the microwave preselector is off, the signal path is not preselected. The preselected path is the normal path for the analyzer.

The preselector is a tunable bandpass filter which prevents signals away from the frequency of interest from combining in the mixer to generate in-band spurious signals (images). The consequences of using a preselector filter are its limited bandwidth, the amplitude and phase ripple in its passband, and any amplitude and phase instability due to center frequency drift.

Option MPB or pre-selector bypass provides an unpreselected input mixer path for certain X-Series signal analyzers with frequency ranges above 3.6 GHz. This signal path allows a wider bandwidth and less amplitude variability, which is an advantage when doing modulation analysis and broadband signal analysis. The disadvantage is that, without the preselector, image signals will be displayed. Another disadvantage of bypassing the preselector is increased LO emission levels at the front panel input port.

Image responses are separated from the real signal by twice the 1st IF. For IF Paths of 10 MHz and 25 MHz, the 1st IF is 322.5 MHz, so the image response and the real signal will be separated by 645 MHz. The 1st IF will be different for other IF Path settings. When viewing a real signal and its corresponding image response in internal mixing, the image response will be to the left of the real signal.

Also, the image response and the real signal typically have the same amplitude and exhibit the same shape factor.

However, if Option FS1, Fast Sweep Capability, is enabled, the image response in the Swept SA measurement will appear lower in amplitude and have a much wider shape factor compared to the real signal.

Key Path	AMPTD Y Scale, μ W Path Control
Example	:POW:MW:PATH MPB
Dependencies	Key is blanked if current mode does not support it. Key is grayed out if mode supports it but current measurement does not support it. Key is blank unless Option MPB is present and licensed. If SCPI command sent when MPB not present, error -241, "Hardware missing; Option not installed" is generated.
Readback Text	μ W Preselector Bypass
Initial S/W Revision	A.04.00

Remote Command	[:SENSe] :POWer [:RF] :MW:PRESelector [:STATe] ON OFF 0 1 [:SENSe] :POWer [:RF] :MW:PRESelector [:STATe] ?
Example	:POW:MW:PRES OFF Bypasses the microwave preselector
Notes	The ON parameter sets the STD path (:POW:MW:PATH STD) The OFF parameter sets path MPB (:POW:MW:PATH MPB)
Preset	ON

Internal Preamp

Accesses a menu of keys that control the internal preamps. Turning on the preamp gives a better noise figure, but a poorer TOI to noise floor dynamic range. You can optimize this setting for your particular measurement.

The instrument takes the preamp gain into account as it sweeps. If you sweep outside of the range of the preamp the instrument will also account for that. The displayed result will always reflect the correct gain.

For some measurements, when the preamp is on and any part of the displayed frequency range is below the lowest frequency for which the preamp has specifications, a warning condition message appears in the status line. For example ,for a preamp with a 9 kHz lowest specified frequency: "Preamp: Accy unspec'd below 9 kHz".

Key Path	AMPTD Y Scale
----------	---------------

Scope	Meas Global
Remote Command	<code>[:SENSe] :POWeR [:RF] :GAIN [:STATe] OFF ON 0 1</code> <code>[:SENSe] :POWeR [:RF] :GAIN [:STATe] ?</code>
Dependencies	Preamp is not available on all hardware platforms. If the preamp is not present or is unlicensed, the key is not shown. The preamp is not available when the electronic/soft attenuator is enabled.
Couplings	The act of connecting the U7227A USB Preamplifier to one of the analyzer's USB ports will cause the Internal Preamp to be switched on. When this happens an informational message will be generated: "Internal Preamp turned on for optimal operation with USB Preamp." Note that if the Internal Preamp was already on, there will be no change to the setting, but if it was Off it will be switched On, to Full Range. Note that this same action occurs when the SA mode is selected while the USB Preamp is connected to one of the analyzer's USB ports, if it is the first time that the SA mode has run since powerup, or if the last time the SA mode was running the USB Preamp was NOT connected. Subsequently disconnecting the USB Preamp from USB does not change the Internal Preamp setting nor restore the previous setting.
Preset	OFF
State Saved	Saved in instrument state
Initial S/W Revision	Prior to A.02.00
Modified at S/W Revision	A.14.00

Key Path	AMPTD Y Scale, Internal Preamp
Scope	Meas Global
Remote Command	<code>[:SENSe] :POWeR [:RF] :GAIN :BAND LOW FULL</code> <code>[:SENSe] :POWeR [:RF] :GAIN :BAND ?</code>
Dependencies	Preamp is not available on all hardware platforms. If the preamp is not present or is unlicensed, the key is not shown. If a POW:GAIN:BAND FULL command is sent when a low band preamp is available, the preamp band parameter is to LOW instead of FULL, and an "Option not installed" message is generated.
Preset	LOW
State Saved	Saved in instrument state
Initial S/W Revision	Prior to A.02.00

Off

Turns the internal preamp off

Key Path	AMPTD Y Scale, Internal Preamp
----------	--------------------------------

Example	:POW:GAIN OFF
Readback	Off
Initial S/W Revision	Prior to A.02.00

Low Band

Sets the internal preamp to use only the low band.

The frequency range of the installed (optional) low-band preamp is displayed in square brackets on the Low Band key label.

Key Path	AMPTD Y Scale, Internal Preamp
Example	:POW:GAIN ON :POW:GAIN:BAND LOW
Readback	Low Band
Initial S/W Revision	Prior to A.02.00

Full Range

Sets the internal preamp to use its full range. The low band (0–3.6 GHz or 0–3GHz, depending on the model) is supplied by the low band preamp and the frequencies above low band are supplied by the high band preamp.

The frequency range of the installed (optional) preamp is displayed in square brackets on the Full Range key label. If the high band option is not installed the Full Range key does not appear.

Key Path	AMPTD Y Scale, Internal Preamp
Example	:POW:GAIN ON :POW:GAIN:BAND FULL
Readback	Full Range
Initial S/W Revision	Prior to A.02.00

Ref Position

Sets the reference position of the y-axis to the top, center, or bottom in the display of the following view windows, which are explained in greater detail in the following sections. Changing the reference position does not affect the reference level value.

Key Path	AMPTD Y Scale
Initial S/W Revision	A.10.01

Ref Position (EVM vs. Symbol or EVM vs. Carrier Window)

Key Path	AMPTD Y Scale
Mode	WLAN
Remote Command	:DISPlay:EVM:VIEW3:WINDow[1] 2:TRACe:Y[:SCALE]:RPOSition TOP CENTer BOTTOm :DISPlay:EVM:VIEW3:WINDow[1] 2:TRACe:Y[:SCALE]:RPOSition?
Example	DISP:EVM:VIEW3:WIND:TRAC:Y:RPOS CENT DISP:EVM:VIEW3:WIND:TRAC:Y:RPOS?
Preset	TOP
State Saved	Saved in instrument state.
Range	Top Ctr Bot
Initial S/W Revision	A.10.01

Ref Position (Mag Error or EVM Window)

Key Path	AMPTD Y Scale
Mode	WLAN
Remote Command	:DISPlay:EVM:VIEW2:WINDow[1] 3:TRACe:Y[:SCALE]:RPOSition TOP CENTer BOTTOm :DISPlay:EVM:VIEW2:WINDow[1] 3:TRACe:Y[:SCALE]:RPOSition?
Example	DISP:EVM:VIEW2:WIND:TRAC:Y:RPOS CENT DISP:EVM:VIEW2:WIND:TRAC:Y:RPOS?
Preset	Mag Error Windor: CENT Evm Error Window: BOTTOm
State Saved	Saved in instrument state.
Range	Top Ctr Bot
Initial S/W Revision	A.10.01

Ref Position (Phase Error Window)

Key Path	AMPTD Y Scale
Mode	WLAN
Remote Command	:DISPlay:EVM:VIEW2:WINDow2:TRACe:Y[:SCALE]:RPOSition TOP CENTer BOTTOm :DISPlay:EVM:VIEW2:WINDow2:TRACe:Y[:SCALE]:RPOSition?
Example	DISP:EVM:VIEW2:WIND2:TRAC:Y:RPOS CENT DISP:EVM:VIEW2:WIND2:TRAC:Y:RPOS?
Preset	CENT

State Saved	Saved in instrument state.
Range	Top Ctr Bot
Initial S/W Revision	A.10.01

Ref Position (Preamble Freq Error vs. Time)

Key Path	AMPTD Y Scale
Mode	WLAN
Remote Command	:DISPlay:EVM:VIEW7:WINDow[1]:TRACe:Y[:SCALe]:RPOSition TOP CENTer BOTTom :DISPlay:EVM:VIEW7:WINDow[1]:TRACe:Y[:SCALe]:RPOSition?
Example	DISP:EVM:VIEW7:WIND1:TRAC:Y:RPOS CENT DISP:EVM:VIEW7:WIND1:TRAC:Y:RPOS?
Preset	CENT
State Saved	Saved in instrument state.
Range	Top Ctr Bot
Initial S/W Revision	A.10.01

Ref Position (IQ Gain Imbalance vs. Carrier Window and EVM vs. Carrier window)

Set the reference position of the Y axis in IQ Gain Imbalance vs. Carrier Window.

Key Path	AMPTD Y Scale
Mode	WLAN
Remote Command	:DISPlay:EVM:VIEW8:WINDow[1] 3:TRACe:Y[:SCALe]:RPOSition TOP CENTer BOTTom :DISPlay:EVM:VIEW8:WINDow[1] 3:TRACe:Y[:SCALe]:RPOSition?
Example	DISP:EVM:VIEW8:WIND:TRAC:Y:RPOS CENT DISP:EVM:VIEW8:WIND:TRAC:Y:RPOS?
Preset	TOP
State Saved	Saved in instrument state.
Range	Top Ctr Bot
Initial S/W Revision	A.14.01

Ref Position (IQ Quadrature Skew vs. Carrier Window)

Set the reference position of the Y axis in IQ Quadrature Skew vs. Carrier Window.

Key Path	AMPTD Y Scale
Mode	WLAN
Remote Command	:DISPlay:EVM:VIEW8:WINDow2:TRACe:Y[:SCALe]:RPOSition TOP CENTer BOTTom :DISPlay:EVM:VIEW8:WINDow2:TRACe:Y[:SCALe]:RPOSition?
Example	DISP:EVM:VIEW8:WIND2:TRAC:Y:RPOS CENT DISP:EVM:VIEW8:WIND2:TRAC:Y:RPOS?
Preset	CENTer
State Saved	Saved in instrument state.
Range	Top Ctr Bot
Initial S/W Revision	A.14.01

Auto Scaling

Toggles the Auto Scaling function between On and Off in the windows listed below, which are explained in greater detail in the following sections. Upon pressing the Restart front-panel key or Restart softkey in the Meas Control menu, the Auto Scaling function automatically determines the scale per division and reference values based on the measurement results.

Key Path	AMPTD Y Scale
Initial S/W Revision	A.10.01

Auto Scaling (EVM vs. Symbol or EVM vs. Carrier Window)

Key Path	AMPTD Y Scale
Mode	WLAN
Remote Command	:DISPlay:EVM:VIEW3:WINDow[1] 2:TRACe:Y[:SCALe]:COUPle 0 1 OFF ON :DISPlay:EVM:VIEW3:WINDow[1] 2:TRACe:Y[:SCALe]:COUPle?
Example	DISP:EVM:VIEW3:WIND:TRAC:Y:COUP 0 DISP:EVM:VIEW3:WIND:TRAC:Y:COUP?
Couplings	When Auto Scaling is On and you press the Restart front-panel key, this function automatically determines the scale per division and reference values based on the measurement results. When you manually set a value for the Rel Value or Scale/Div , this parameter is automatically set to Off.
Preset	OFF
State Saved	Saved in instrument state.
Range	On Off
Initial S/W Revision	A.10.01

Auto Scaling (Mag Error or EVM Window)

Key Path	AMPTD Y Scale
Mode	WLAN
Remote Command	:DISPlay:EVM:VIEW2:WINDow[1]:3:TRACe:Y[:SCALE]:COUPle 0 1 OFF ON :DISPlay:EVM:VIEW2:WINDow[1]:3:TRACe:Y[:SCALE]:COUPle?
Example	DISP:EVM:VIEW2:WIND:TRAC:Y:COUP 0 DISP:EVM:VIEW2:WIND:TRAC:Y:COUP?
Couplings	When Auto Scaling is On and you press the Restart front-panel key, this function automatically determines the scale per division and reference values based on the measurement results. When you manually set a value for the Rel Value or Scale/Div , this parameter is automatically set to Off.
Preset	ON
State Saved	Saved in instrument state.
Range	On Off
Initial S/W Revision	A.10.01

Auto Scaling (Phase Error Window)

Key Path	AMPTD Y Scale
Mode	WLAN
Remote Command	:DISPlay:EVM:VIEW2:WINDow2:TRACe:Y[:SCALE]:COUPle 0 1 OFF ON :DISPlay:EVM:VIEW2:WINDow2:TRACe:Y[:SCALE]:COUPle?
Example	DISP:EVM:VIEW2:WIND2:TRAC:Y:COUP 0 DISP:EVM:VIEW2:WIND2:TRAC:Y:COUP?
Couplings	When Auto Scaling is On and you press the Restart front-panel key, this function automatically determines the scale per division and reference values based on the measurement results. When you manually set a value for the Rel Value or Scale/Div , this parameter is automatically set to Off.
Preset	ON
State Saved	Saved in instrument state.
Range	On Off
Initial S/W Revision	A.10.01

Auto Scaling (Preamble Freq Error vs. Time)

Key Path	AMPTD Y Scale
Mode	WLAN
Remote Command	:DISPlay:EVM:VIEW7:WINDow[1]:TRACe:Y[:SCALE]:COUPle 0 1 OFF ON :DISPlay:EVM:VIEW7:WINDow[1]:TRACe:Y[:SCALE]:COUPle?
Example	DISP:EVM:VIEW7:WIND:TRAC:Y:COUP 0

	DISP:EVM:VIEW7:WIND:TRAC:Y:COUP?
Couplings	When Auto Scaling is On and you press the Restart front-panel key, this function automatically determines the scale per division and reference values based on the measurement results. When you manually set a value for the Rel Value or Scale/Div , this parameter is automatically set to Off.
Preset	ON
State Saved	Saved in instrument state.
Range	On Off
Initial S/W Revision	A.10.01

Auto Scaling (IQ Gain Imbalance vs Carrier Window, IQ Quadrature Skew vs Carrier Window and EVM vs. Carrier Window)

When Auto Scaling is On, and the Restart front panel key is pressed, this function automatically displays the scale per division and reference value results in I/Q impairments view.

Key Path	AMPTD Y Scale
Mode	WLAN
Remote Command	:DISPlay:EVM:VIEW8:WINDow[1] 2 3:TRACe:Y[:SCALe]:COUPle 0 1 OFF ON :DISPlay:EVM:VIEW8:WINDow[1] 2 3:TRACe:Y[:SCALe]:COUPle?
Example	DISP:EVM:VIEW8:WIND:TRAC:Y:COUP 0 DISP:EVM:VIEW8:WIND:TRAC:Y:COUP?
Couplings	When Auto Scaling is On and you press the Restart front-panel key, this function automatically determines the scale per division and reference values based on the measurement results. When you manually set a value for the Rel Value or Scale/Div , this parameter is automatically set to Off.
Preset	ON
State Saved	Saved in instrument state.
Range	On Off
Initial S/W Revision	A.14.01

Auto Couple

The Auto Couple feature provides a quick and convenient way to automatically couple multiple instrument settings. This helps ensure accurate measurements and optimum dynamic range. When the Auto Couple feature is activated, either from the front panel or remotely, all parameters of the current measurement that have an Auto/Manual mode are set to Auto mode and all measurement settings dependent on (or coupled to) the Auto/Man parameters are automatically adjusted for optimal performance.

However, the Auto Couple key actions are confined to the current measurement only. It does not affect other measurements in the mode, and it does not affect markers, marker functions, or trace or display attributes.

See "[More Information](#)" on page 1725

Key Path	Front-panel key
Remote Command	:COUPle ALL NONE
Example	:COUP ALL
Notes	:COUPle ALL puts all Auto/Man parameters in Auto mode (equivalent to pressing the Auto Couple key). :COUPLE NONE puts all Auto/Man parameters in manual mode. It decouples all the coupled instrument parameters and is not recommended for making measurements.
Initial S/W Revision	Prior to A.02.00

More Information

There are two types of functions that have Auto/Manual modes.

Auto/Man Active Function keys

An Auto/Man toggle key controls the binary state associated with an instrument parameter by toggling between Auto (where the parameter is automatically coupled to the other parameters it is dependent upon) and Man (where the parameter is controlled independent of the other parameters), as well as making the parameter the active function. The current mode is indicated on the softkey with either Auto or Man underlined as illustrated below.



Auto/Man 1-of-N keys

An Auto/Man 1-of-N key allows you to manually pick from a list of parameter values, or place the function in Auto, in which case the value is automatically selected (and indicated) as shown below. If in Auto, Auto is underlined on the calling key. If in manual operation, manual is indicated on the calling key. But the calling key does not actually toggle the function, it simply opens the menu.

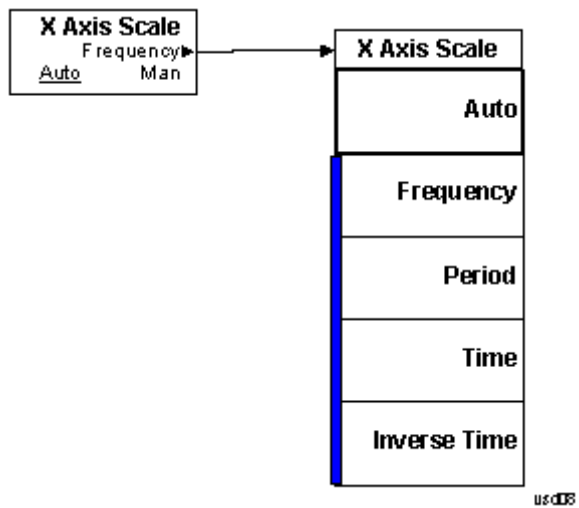

BW

Accesses a menu that allows you to control bandwidth settings.

Key Path	Front-panel key
Initial S/W Revision	A.10.01

Info BW

Activates the Info BW active function, which allows you to manually set the information bandwidth (Info BW) of the analyzer.

Key Path	BW
Mode	WLAN
Remote Command	<code>[:SENSe] :EVM: BANDwidth [:RESolution] <bandwidth></code> <code>[:SENSe] :EVM: BANDwidth [:RESolution] ?</code>
Example	EVM: BAND 20e6 EVM: BAND?
Couplings	Info BW is coupled with Subcarrier Spacing
Preset	Hardware Dependent: B25 = 25 MHz B40: if Radio Std is 802.11a/b/g = 25MHz if Radio Std is 802.11n-20M = 25MHz if Radio Std is 802.11n-40M = 40MHz if Radio Std is 802.11ac-20M = 25MHz if Radio Std is 802.11ac-40M = 40MHz B1X: if Radio Std is 802.11ac-80M / 80M+ 80M = 80MHz B1Y: if Radio Std is 802.11ac-160M = 160MHz
State Saved	Saved in instrument state.
Min	1 kHz
Max	Hardware Dependent: B25 = 25 MHz WB (40 MHz or wider) = Hardware Option Limit
Backwards Compatibility SCPI	<code>[:SENSe] :EVM: I FBW</code>
Initial S/W Revision	A.10.01

Cont (Continuous Measurement/Sweep)

Sets the analyzer for Continuous measurement operation. The single/continuous state is Meas Global so the setting will affect all measurements. If you are Paused, pressing Cont does a Resume.

Key Path	Front-panel key
Remote Command	:INITiate:CONTinuous OFF ON 0 1 :INITiate:CONTinuous?
Example	:INIT:CONT 0 puts analyzer in Single measurement operation. :INIT:CONT 1 puts analyzer in Continuous measurement operation
Preset	ON (Note that SYST:PRESet sets INIT:CONT to ON but *RST sets INIT:CONT to OFF)
State Saved	Saved in instrument state
Backwards Compatibility Notes	For Spectrum Analysis mode in ESA and PSA, there is no Cont hardkey, instead there is a Sweep Single/Cont key. In these analyzers, switching the Sweep Single/Cont key from Single to Cont restarts averages (displayed average count reset to 1), but does not restart Max Hold and Min Hold. The X-Series has Single and Cont keys in place of the SweepSingleCont key. In the X-Series, if in single measurement, the Cont key (and INIT:CONT ON) switches to continuous measurement, but never restarts a measurement and never resets a sweep.
Initial S/W Revision	Prior to A.02.00

In Swept SA Measurement (Spectrum Analysis Mode):

The analyzer takes repetitive sweeps, averages, measurements, etc., when in Continuous mode. When the average count reaches the Average/Hold Number the count stops incrementing, but the analyzer keeps sweeping. See the Trace/Detector section for the averaging formula used both before and after the Average/Hold Number is reached. The trigger condition must be met prior to each sweep. The type of trace processing for multiple sweeps, is set under the Trace/Detector key, with choices of Trace Average, Max Hold, or Min Hold.

In Other Measurements/Modes:

With Avg/Hold Num (in the Meas Setup menu) set to Off or set to On with a value of 1, a sweep is taken after the trigger condition is met; and the analyzer continues to take new sweeps after the current sweep has completed and the trigger condition is again met. However, with Avg/Hold Num set to On with a value >1, multiple sweeps (data acquisitions) are taken for the measurement. The trigger condition must be met prior to each sweep. The sweep is not stopped when the average count k equals the number N set for Avg/Hold Num is reached, but the number k stops incrementing. A measurement average usually applies to all traces, marker results, and numeric results. But sometimes it only applies to the numeric results.

If the analyzer is in Single measurement, pressing the Cont key does not change k and does not cause the sweep to be reset; the only action is to put the analyzer into Continuous measurement operation.

If it is already in continuous sweep:

the INIT:CONT 1 command has no effect

the INIT:CONT 0 command will place the analyzer in Single Sweep but will have no effect on the current sequence until $k = N$, at which point the current sequence will stop and the instrument will go to the idle state.

15 WLAN Modulation Analysis measurement
File

File

See "File" on page 348

FREQ Channel

Accesses a menu of keys that allow you to control the Frequency and Channel parameters of the instrument.

Some features in the Frequency menu are the same for all measurements – they do not change as you change measurements. Settings like these are called “Meas Global” and are unaffected by Meas Preset. For example, the Center Freq setting is the same for all measurements – it does not change as you change measurements.

Key Path	Front-panel key
Initial S/W Revision	Prior to A.02.00

Center Freq

Sets the frequency that corresponds to the horizontal center of the graticule (when frequency Scale Type is set to linear). While adjusting the Center Frequency the Span is held constant, which means that both Start Frequency and Stop Frequency will change.

Pressing Center Freq also sets the frequency entry mode to Center/Span. In Center/Span mode, the center frequency and span values are displayed below the graticule, and the default active function in the Frequency menu is Center Freq.

The center frequency setting is the same for all measurements within a mode, that is, it is Meas Global. Some modes are also able to share a Mode Global center frequency value. If this is the case, the Mode will have a Global Settings key in its Mode Setup menu.

The Center Freq function sets (and queries) the Center Frequency for the currently selected input. If your analyzer has multiple inputs, and you select another input, the Center Freq changes to the value for that input. SCPI commands are available to directly set the Center Freq for a specific input.

Center Freq is remembered as you go from input to input. Thus you can set a Center Freq of 10 GHz with the RF Input selected, change to BBIQ and set a Center Freq of 20 MHz, then switch to External Mixing and set a Center Freq of 60 GHz, and when you go back to the RF Input the Center Freq will go back to 10 GHz; back to BBIQ and it is 20 MHz; back to External Mixing and it is 60 GHz.

See ["RF Center Freq" on page 1734](#)

See [Ext Mix Center Freq](#)

See ["I/Q Center Freq" on page 1736](#)

See ["Center Frequency Presets" on page 1732](#)

Key Path	FREQ Channel
Scope	Meas Global
Remote Command	[:SENSe] :FREQuency :CENTer <freq> [:SENSe] :FREQuency :CENTer?

Example	FREQ:CENT 50 MHz FREQ:CENT UP changes the center frequency to 150 MHz if you use FREQ:CENT:STEP 100 MHz to set the center frequency step size to 100 MHz FREQ:CENT?
Notes	This command sets either the RF or I/Q Center Frequency depending on the selected input. For RF input it is equivalent to FREQ:RF:CENT For I/Q input it is equivalent to FREQ:IQ:CENT Preset and Max values are dependent on Hardware Options (5xx) If no terminator (e.g. MHz) is sent the terminator Hz is used. If a terminator with unit other than Frequency is used, an invalid suffix error message is generated.
Dependencies	The Center Frequency can be limited by Start or Stop Freq limits, if the Span is so large that Start or Stop reach their limit.
Couplings	When operating in "swept span", any value of the Center Frequency or Span that is within the frequency range of the analyzer is allowed when the value is being set through the front panel numeric key pad or the SCPI command. The other parameter is forced to a different value if needed, to keep the Start and the Stop Frequencies within the analyzer's frequency range
Preset	Depends on instrument maximum frequency, mode, measurement, and selected input. See "Center Frequency Presets" on page 1732 and "RF Center Freq" on page 1734 and Ext Mix Center Freq and "I/Q Center Freq" on page 1736 .
State Saved	Saved in instrument state
Min	Depends on instrument maximum frequency, mode, measurement, and selected input.. See "Center Frequency Presets" on page 1732 and "RF Center Freq" on page 1734 and "I/Q Center Freq" on page 1736 .
Max	Depends on instrument maximum frequency, mode, measurement, and selected input.. See "Center Frequency Presets" on page 1732 and "RF Center Freq" on page 1734 and "I/Q Center Freq" on page 1736 .
Default Unit	Hz
Status Bits/OPC	Non-overlapped
Dependencies	
Initial S/W Revision	Prior to A.02.00

Center Frequency Presets

The following table provides the Center Frequency Presets for the Spectrum Analyzer mode, and the Max Freq, for the various frequency options:

Freq Option	CF after Mode Preset	Stop Freq after Mode Preset	Max Freq (can't tune)

			above)
503 (all but N9000A)	1.805 GHz	3.6 GHz	3.7 GHz
503 (N9000A)	1.505 GHz	3.0 GHz	3.08 GHz
507 (all but N9000A)	3.505 GHz	7.0 GHz	7.1 GHz
507 (N9000A)	3.755 GHz	7.5 GHz	7.58 GHz
508 (all but N9038A)	1.805 GHz	3.6 GHz	8.5 GHz
508 (N9038A)	4.205 GHz	8.4 GHz	8.5 GHz
513	6.805 GHz	13.6 GHz	13.8 GHz
526 (all but N9000A and N9038A)	13.255 GHz	26.5 GHz	27.0 GHz
526 (N9000A)	13.255 GHz	26.5 GHz	26.55 GHz
526 (N9038A)	1.805 GHz	3.6 GHz	27.0 GHz
532	16.005 GHz	32.0 GHz	32.5 GHz
543	21.505 GHz	43.0 GHz	TBD
544	22.005 GHz	44.0 GHz	44.5 GHz
550	25.005 GHz	50.0 GHz	51 GHz

Input 2:

Model	CF after Mode Preset	Stop Freq after Mode Preset	Max Freq (can't tune above)
N9000A opt C75	0.7505GHz	1.5 GHz	1.58 GHz
N9038A	505 MHz	1 GHz	1.000025 GHz

Tracking Generator Frequency Limits (N9000A only):

Tracking Generator Option	Min Freq (clips to this freq when turn TG on and	If above this Freq, Stop Freq clipped to this Freq when	Max Freq (can't tune above) while TG

	can't tune below while TG on)	TG turned on	on
T03	9 kHz	3.0 GHz	3.08 GHz
T06	9 kHz	6.0 GHz	6.05 GHz

The following table shows the Center Frequency Presets for modes other than Spectrum Analyzer:

Mode	CF Preset for RF
WCDMA	1 GHz
WIMAXOFDMA,	1 GHz
BASIC	1 GHz
ADEMOD	1 GHz
VSA	1 GHz
TDSCDMA	1 GHz
PNOISE	1 GHz
LTE	1 GHz
LTETDD	1 GHz
MSR	1 GHz
GSM	935.2 MHz
NFIGURE	1.505 GHz

RF Center Freq

SCPI command for specifying the RF Center Frequency. This command will set the Center Frequency to be used when the RF input is selected, even if the RF input is not the input that is selected at the time the command is sent. Note that the Center Freq function in the Frequency menu on the front panel always applies to the currently selected input.

Scope	Meas Global
Remote Command	<code>[:SENSe] :FREQuency:RF:CENTer <freq></code> <code>[:SENSe] :FREQuency:RF:CENTer?</code>
Example	FREQ:RF:CENT 30 MHz
Notes	This command is the same in all modes, but the parameter is Measurement Global. So the value is independent in each mode and common across all the measurements in the mode.
Dependencies	If the electronic/soft attenuator is enabled, any attempt to set Center Frequency such that the Stop Frequency would be >3.6 GHz fails and results in an advisory message. If the equivalent SCPI command is sent, this same message is generated as part of a “-221, Settings conflict” warning. If Source Mode is set to Tracking, and the Max or Min Center Freq is therefore limited by the limits of the source, a warning message is generated, “Data out of range;clipped to source max/min” if these limits are exceeded. Note that for an external source, these limits can be affected by the settings of

	Source Numerator, Source Denominator and Power Sweep.
Preset	See table above
State Saved	Saved in instrument state.
Min	-79.999995 MHz, unless Source Mode is set to Tracking, in which case it is limited by the minimum frequency of the Source
Max	See table above. Basically instrument maximum frequency - 5 Hz. Note that, if the Source Mode is set to Tracking, the effective instrument maximum frequency may be limited by the source maximum frequency. If the knob or step keys are being used, also depends on the value of the other three interdependent parameters Span, Start Frequency and Stop Frequency
Initial S/W Revision	Prior to A.02.00
Modified at S/W Revision	A.03.00

Ext Mix Center Freq

SCPI command for specifying the External Mixer Center Frequency. This command will set the Center Frequency to be used when the External Mixer is selected, even if the External Mixer input is not the input which is selected at the time the command is sent. Note that the Center Freq function in the Frequency menu on the front panel always applies to the currently selected input.

Scope	Meas Global
Remote Command	<code>[:SENSe] :FREQuency:EMIXer:CENTer <freq></code> <code>[:SENSe] :FREQuency:EMIXer:CENTer?</code>
Example	<code>:FREQ:EMIX:CENT 60 GHz</code> <code>:FREQ:EMIX:CENT?</code>
Notes	This command is the same in all modes, but the parameter is Measurement Global. So the value is independent in each mode and common across all the measurements in the mode.
Couplings	When returning to External Mixing after having been switched to one of the other inputs (e.g., RF), you will come back into the settings that you had when you left External Mixing. So you will come back to the band you were in with the Center Frequency that you had. However, Span is not an input-dependent parameter, therefore you will bring the span over from the other input. Therefore, the analyzer comes back with the span from the previous input, limited as necessary by the current mixer setup.
Preset	When a Mode Preset is performed while in External Mixing, the Start frequency of the current Mode is set to the nominal Min Freq of the lowest harmonic range in the Harmonic Table for the current mixer setup. Similarly, the Stop frequency of the current Mode is set to the nominal Max Freq of the highest harmonic range in the Harmonic Table. The Center Freq thus presets to the point arithmetically equidistant from these two frequencies. If the current measurement has a limited Span available to it, and cannot achieve the Span shown in the table ($\text{Span} = \text{Stop Freq} - \text{Start Freq}$), the analyzer uses the maximum Span the measurement allows, and still sets the Center Freq to the midpoint of the Start and Stop Freq values in the Harmonic Table.

	<p>When Restore Input/Output Defaults is performed, the mixer presets to the 11970A, whose Start and Stop frequencies are 26.5 and 40 GHz respectively. The center of these two frequencies is 33.25 GHz.</p> <p>Therefore, after a Restore Input/Output Defaults, if you go into External Mixing and do a Mode Preset while in the Spectrum Analyzer Mode, the resulting Center Freq is 33.25 GHz.</p>
State Saved	Saved in instrument state.
Min	The minimum frequency in the currently selected mixer band + 5 Hz
Max	<p>The maximum frequency in the currently selected mixer band – 5 Hz</p> <p>If the knob or step keys are being used, also depends on the value of the other three interdependent parameters Span, Start Frequency and Stop Frequency</p>
Initial S/W Revision	A.08.01

I/Q Center Freq

SCPI command for specifying the I/Q Center Frequency. This command will set the Center Frequency to be used when the I/Q input is selected, even if the I/Q input is not the input which is selected at the time the command is sent. Note that the Center Freq function in the Frequency menu on the front panel always applies to the currently selected input.

Scope	Meas Global
Remote Command	<pre>[:SENSe] :FREQuency:IQ:CENTer <freq></pre> <pre>[:SENSe] :FREQuency:IQ:CENTer?</pre>
Example	FREQ:IQ:CENT: 30 MHz
Notes	This command is the same in all modes, but the parameter is Measurement Global. So the value is independent in each mode and common across all the measurements in the mode.
Preset	0 Hz
State Saved	Saved in instrument state.
Min	-40.049995 MHz
Max	40.049995 MHz
Initial S/W Revision	Prior to A.02.00

CF Step

Changes the step size for the center frequency and start and stop frequency functions. Once a step size has been selected and the center frequency function is active, the step keys (and the UP|DOWN parameters for Center Frequency from remote commands) change the center frequency by the step-size value. The step size function is useful for finding harmonics and sidebands beyond the current frequency span of the analyzer.

Note that the start and stop frequencies also step by the CF Step value.

Key Path	FREQ Channel
Remote Command	[:SENSe] :FREQuency:CENTer:STEP [:INCRement] <freq> [:SENSe] :FREQuency:CENTer:STEP [:INCRement] ? [:SENSe] :FREQuency:CENTer:STEP:AUTO OFF ON 0 1 [:SENSe] :FREQuency:CENTer:STEP:AUTO?
Example	FREQ:CENT:STEP:AUTO ON FREQ:CENT:STEP 500 MHz FREQ:CENT UP increases the current center frequency value by 500 MHz FREQ:CENT:STEP? FREQ:CENT:STEP:AUTO?
Notes	Preset and Max values are depending on Hardware Options (503, 507, 508, 513, 526)
Notes	Preset and Max values are dependent on Hardware Options (5xx)
Dependencies	Freq Offset is not available in External Mixing. In this case the Freq Offset key is grayed out and shows a value of zero. It will once again be available, and show the previously set value, when you return to the RF Input.
Dependencies	Span, RBW, Center frequency If the electronic/soft attenuator is enabled, any attempt to change the value of the center frequency >3.6 GHz by pressing the Up-arrow key, fails and results in an advisory message. If the equivalent SCPI command is sent, this same message is generated as part of a “-221, Settings conflict” warning.
Couplings	When auto-coupled in a non-zero span, the center frequency step size is set to 10% of the span. When auto-coupled in zero span, the center frequency step size is set to the equivalent -3 dB RBW value.
Preset	Auto ADEMOD: 1 MHz ON
State Saved	Saved in instrument state
Min	– (the maximum frequency of the instrument). That is, 27 GHz max freq instrument has a CF step range of +/- 27 GHz. Note that this is the maximum frequency given the current settings of the instrument, so in External Mixing, for example, it is the maximum frequency of the current mixer band.
Max	The maximum frequency of the instrument. That is, 27 GHz max freq instrument has a CF step range of +/- 27 GHz. Note that this is the maximum frequency given the current settings of the instrument, so in External Mixing, for example, it is the maximum frequency of the current mixer band.
Default Unit	Hz
Status Bits/OPC dependencies	non-overlapped
Initial S/W Revision	Prior to A.02.00
Modified at S/W Revision	A.03.00

15 WLAN Modulation Analysis measurement
Input/Output

Input/Output

See ["Input/Output" on page 194](#)

Marker

Accesses a menu that enables you to select, set up and control the markers for the current measurement.

Key Path	Front-panel key
Initial S/W Revision	A.10.01

Select Marker

Displays 12 markers available for selection.

Key Path	Marker
Initial S/W Revision	A.10.01

Marker Type

Sets the marker control mode. If the selected marker is Off, pressing Marker sets it to Normal and places it at the center of the screen on the trace determined by the Marker Trace rules. At the same time, reference value of the selected marker appears on the Active Function area.

Active Function Display:

Marker index at I/Q Measured Polar Vector graph

Marker X-axis value at other graphs

Default Active Function: the active function for the selected marker's current control mode. If the current control mode is Off, there is no active function and the active function is turned off.

The marker X axis value entered in the active function area displays the marker value to its full entered precision.

Key Path	Marker
Mode	WLAN
Remote Command	:CALCulate:EVM:MARKer[1] 2 ... 12:MODE POSition DELTA OFF :CALCulate:EVM:MARKer[1] 2 ... 12:MODE?
Example	CALC:EVM:MARK:MODE POS CALC:EVM:MARK:MODE?
Notes	If the selected marker is Off, pressing Marker sets it to Normal and places it at the center of the screen on the trace determined by the Marker Trace rules. At the same time, Marker X Axis Value appears on the Active Function area. Default Active Function: The active function for the selected marker's current control mode. If the current control mode is Off, there is no active function and the active function is turned off. Active Function Display:

- the marker index for the IQ Measured Polar Vector graph
 - the marker X axis value for any other graph
 The value entered in the active function area displays the marker value to its full entered precision.

Preset	OFF
State Saved	Saved in instrument state.
Range	Normal Delta Off
Initial S/W Revision	A.10.01

Properties

Accesses a menu that enables you to select a reference marker and marker trace.

Key Path	Marker
Initial S/W Revision	A.10.01

Select Marker

Displays 12 markers available for selection.

Key Path	Marker
Initial S/W Revision	A.10.01

Relative To

Selects the marker that the selected marker is relative to (its reference marker).

Key Path	Marker, Properties
Mode	WLAN
Remote Command	:CALCulate:EVM:MARKer[1] 2 ... 12:REFerence <integer> :CALCulate:EVM:MARKer[1] 2 ... 12:REFerence?
Example	CALC:EVM:MARK:REF 3 CALC:EVM:MARK:REF?
Notes	A marker cannot be relative to itself so that choice is grayed out, and if sent from SCPI generates error -221: "Settings conflict; marker cannot be relative to itself." When queried, a single value is returned (the specified marker number's relative marker).
Preset	2 3 4 5 6 7 8 9 10 11 12 1
State Saved	Saved in instrument state.
Min	1

Max	12
Initial S/W Revision	A.10.01

Marker Trace

Assigns the specified marker to the designated trace.

Key Path	Marker
Mode	WLAN
Remote Command	:CALCulate:EVM:MARKer[1] 2 ... 12:TRACe POLar EVM MERRor PERRor EVMS EVMC PFERRor IQGain IQQuad IQTime :CALCulate:EVM:MARKer[1] 2 ... 12:TRACe?
Example	CALC:EVM:MARK2:TRAC EVM CALC:EVM:MARK:TRACE?
Couplings	EVM, MERRor, PERRor, PFERRor will be available if the Radio Std is 802.11b/g (DSSS/CCK/PBCC), otherwise they are grayed out EVMS and EVMC will be available if the Radio Std is 802.11a/g (OFDM), 801.11g (DSSS-OFDM), 802.11n (20 MHz) or 802.11n (40 MHz), otherwise they are grayed out IQGain, IQQuad, and IQTime will be available if the Radio Std is 802.11n and 802.11ac, otherwise they are grayed out.
Preset	POLar
State Saved	Saved in instrument state.
Range	EVM Mag Err Phase Err EVM vs Symbol EVM vs Carrier IQ Polar
Initial S/W Revision	A.10.01

Marker Trace

Accesses a menu that enables you to assign a specified marker to the designated trace.

Symbol Traces means that three traces for I/Q polar, Symbol Error Carrier, Symbol Error Symbol, Symbol Power Carrier, and Symbol Power Symbol can be assigned. If used, a marker pointer is placed on each trace. In this case, the three pointers will move at the same time, as coupled markers, whenever the X position of the Symbol Traces changes.

Key Path	Marker
Mode	WIMAXOFDMA
Remote Command	:CALCulate:EVM:MARKer[1] 2 ... 12:TRACe SYMBol POLar EVCarrier RECarrier EVSymbol RESymbol PCARrier RPCarrier PSYMBOL RPSymbol FLATness DFFlatness PVT SPECTrum :CALCulate:EVM:MARKer[1] 2 ... 12:TRACe?

Example	CALC:EVM:MARK:TRAC SYMB CALC:EVM:MARK:TRAC?
Preset	SYMB
State Saved	Saved in instrument state.
Range	Symbol Traces IQ Measured Polar ConstIn Error Vector Carrier RMS Error Vector Carrier Error Vector Symbol RMS Error Vector Symbol Symbol Power Carrier RMS Symbol Power Carrier Symbol Power Symbol RMS Symbol Power Symbol PvT Spectrum
Initial S/W Revision	Prior to A.02.00

Couple Markers

Toggles the state of the markers to be coupled On or Off. When this function is true (On), moving any marker causes an “equal X Axis movement” of every other marker which is active. By “equal X Axis movement” we mean that we preserve the difference between each marker’s X Axis value (in the fundamental x-axis units of the trace that marker is on) and the X Axis value of the marker being moved (in the same fundamental x-axis units).

This may result in markers going offscreen.

Key Path	Marker
Mode	WLAN
Remote Command	:CALCulate:EVM:MARKer:COUPle[:STATE] ON OFF 1 0 :CALCulate:EVM:MARKer:COUPle[:STATE]?
Example	CALC:EVM:MARK:COUP ON CALC:EVM:MARK:COUP?
Preset	OFF
State Saved	Saved in instrument state.
Range	On Off
Initial S/W Revision	A.10.01

All Markers Off

Turns off all markers.

Key Path	Marker
Mode	WLAN
Remote Command	:CALCulate:EVM:MARKer:AOFF
Example	CALC:EVM:MARK:AOFF
Initial S/W Revision	A.10.01

Marker X Axis Value (Remote Command only)

Sets the marker X Axis value in the current marker X Axis Scale unit. It has no effect if the control mode is Off, but is the SCPI equivalent of entering an X value if the control mode is Normal or Delta.

Mode	WLAN
Remote Command	:CALCulate:EVM:MARKer[1] 2 ... 12:X <real> :CALCulate:EVM:MARKer[1] 2 ... 12:X?
Example	CALC:EVM:MARK3:X 0 CALC:EVM:MARK3:X?
Notes	If no suffix is sent, it will use the fundamental units for the current marker X Axis Scale. If a suffix is sent that does not match the current marker X Axis Scale unit, an "Invalid suffix" error will be generated. The query returns the marker's absolute X Axis value if the control mode is Normal, or the offset from the marker's reference marker if the control mode is Delta. The query is returned in the fundamental units for the current marker X Axis scale: Hz for Frequency and Inverse Time, seconds for Period and Time. If the marker is Off the response is not a number (NAN).
Preset	After a preset, all markers are set to Off, so a Marker X Axis Value query will return a not a number (NAN).
State Saved	Saved in instrument state.
Min	-9.9E+37
Max	9.9E+37.
Initial S/W Revision	A.10.01

Marker X Axis Position (Remote Command only)

Sets the marker X position in trace points. It has no effect if the control mode is Off, but is the SCPI equivalent of entering a value if the control mode is Normal or Delta - except in trace points rather than X Axis Scale units. The entered value is immediately translated into the current X Axis Scale units for setting the value of the marker.

Mode	WLAN
Remote Command	:CALCulate:EVM:MARKer[1] 2 ... 12:X:POSition <real> :CALCulate:EVM:MARKer[1] 2 ... 12:X:POSition?
Example	CALC:EVM:MARK10:X:POS 10 CALC:EVM:MARK10:X:POS?
Notes	The query returns the marker's absolute X Axis value in trace points if the control mode is Normal, or the offset from the marker's reference marker in trace points, if the control mode is Delta. The value is returned as a real number, not an integer, corresponding to the translation from X Axis Scale units to trace points. If the marker is Off the response is not a number(NAN).
Preset	After a preset, all markers are set to Off, so Marker X Axis Position query will return a not a number (NAN).
State Saved	Saved in instrument state.

Min	-9.9E+37
Max	9.9E+37
Initial S/W Revision	A.10.01

Marker Y Axis Value (Remote Command only)

Queries the marker Y Axis value in the current marker Y Axis unit.

Mode	WLAN
Remote Command	:CALCulate:EVM:MARKer[1] 2 ... 12:Y?
Example	CALC:EVM:MARK11:Y?
Notes	The query returns the marker Y-axis result if the control mode is Normal or Delta. If the marker is Off the response is not a number (NAN) Query results depend on the selected Marker Trace as follows: I/Q Measured Polar: I, Q (In normalized voltage) EVM vs. Symbol: EVM(dB) EVM vs. Carrier: EVM(dB) Mag Error: Mag Err(%) Phase Error: Phase Err(°) EVM: EVM(%)
Preset	Result dependant on Markers setup and signal source
State Saved	No
Initial S/W Revision	A.10.01

Backward Compatibility SCPI Commands

Sets or queries the state of a marker. Setting a marker which is Off to On, or 1, puts it in Normal mode and places it at the center of the screen.

Mode	WLAN
Remote Command	:CALCulate:EVM:MARKer[1] 2 ... 12:STATE OFF ON 0 1 :CALCulate:EVM:MARKer[1] 2 ... 12:STATE?
Example	CALC:EVM:MARK3:STAT ON CALC:EVM:MARK3:STAT?
Preset	OFF
State Saved	Saved in instrument state.
Range	On Off
Initial S/W Revision	A.10.01

Marker Function

There are no 'Marker Functions' supported in Mod Analysis so this front-panel key will display a blank softkey when pressed.

Key Path	Front-panel key
Initial S/W Revision	A.10.01

Marker To

There is no 'Marker To' functionality supported in Mod Analysis so this front-panel key will display a blank softkey when pressed.

Key Path	Front-panel key
Initial S/W Revision	A.10.01

Meas

The information in this section is common to all measurements. For key and remote command information for a specific measurement, refer to the section that describes the measurement of interest.

Measurements available under the Meas key are specific to the current Mode.

When viewing Help for measurements, note the following:

NOTE

Operation for some keys differs between measurements. The information displayed in Help pertains to the current measurement. To see how a key operates in a different measurement, exit Help (press the Cancel Esc key), select the measurement, then reenter Help (press the Help key) and press that key.

Key Path	Front-panel key
Initial S/W Revision	Prior to A.02.00

Remote Measurement Functions

This section contains the following topics:

"Measurement Group of Commands" on page 2214

"Current Measurement Query (Remote Command Only)" on page 2216

"Limit Test Current Results (Remote Command Only)" on page 2216

"Data Query (Remote Command Only)" on page 2216

"Calculate/Compress Trace Data Query (Remote Command Only)" on page 2217

"Calculate Peaks of Trace Data (Remote Command Only)" on page 2222

"Hardware-Accelerated Fast Power Measurement (Remote Command Only)" on page 2223

"Format Data: Numeric Data (Remote Command Only)" on page 2237

"Format Data: Byte Order (Remote Command Only)" on page 2238

Initial S/W Revision	Prior to A.02.00
----------------------	------------------

Measurement Group of Commands

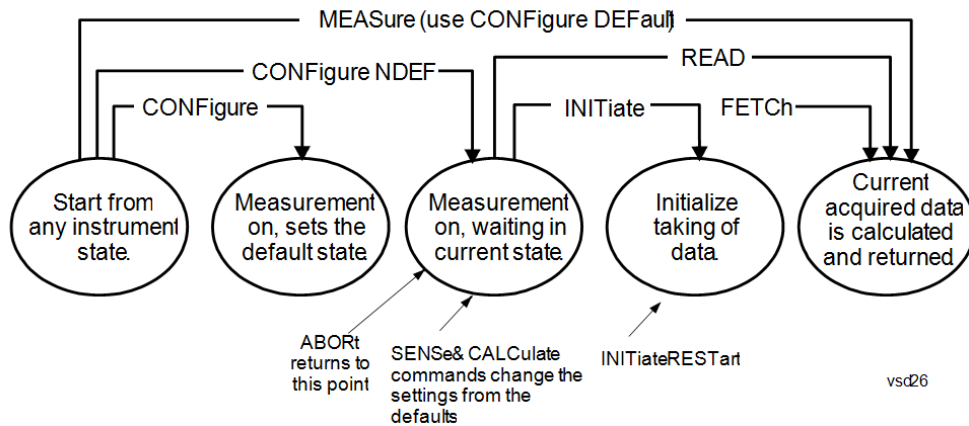

Measure Commands:

:MEASure:<measurement>[n]?

This is a fast single-command way to make a measurement using the factory default instrument settings. These are the settings and units that conform to the Mode Setup settings (e.g. radio standard) that you have currently selected.

- Stops the current measurement (if any) and sets up the instrument for the specified measurement using the factory defaults
- Initiates the data acquisition for the measurement
- Blocks other SCPI communication, waiting until the measurement is complete before returning results.
- If the function does averaging, it is turned on and the number of averages is set to 10.
- After the data is valid it returns the scalar results, or the trace data, for the specified measurement. The type of data returned may be defined by an [n] value that is sent with the command.
- The scalar measurement results will be returned if the optional [n] value is not included, or is set to 1. If the [n] value is set to a value other than 1, the selected trace data results will be returned. See each command for details of what types of scalar results or trace data results are available.
- ASCII is the default format for the data output. (Older versions of Spectrum Analysis and Phase Noise mode measurements only use ASCII.) The binary data formats should be used for handling large blocks of data since they are smaller and faster than the ASCII format. Refer to the FORMat:DATA command for more information.

If you need to change some of the measurement parameters from the factory default settings you can set up the measurement with the CONFigure command. Use the commands in the SENSE:<measurement> and CALCulate:<measurement> subsystems to change the settings. Then you can use the READ? command to initiate the measurement and query the results.

If you need to repeatedly make a given measurement with settings other than the factory defaults, you can use the commands in the SENSE:<measurement> and CALCulate:<measurement> subsystems to set up the measurement. Then use the READ? command to initiate the measurement and query results.

Measurement settings persist if you initiate a different measurement and then return to a previous one. Use READ:<measurement>? if you want to use those persistent settings. If you want to go back to the default settings, use MEASure:<measurement>?.

Configure Commands:

:CONFigure:<measurement>

This command stops the current measurement (if any) and sets up the instrument for the specified measurement using

the factory default instrument settings. It does not initiate the taking of measurement data unless INIT:CONTinuous is ON. If you change any measurement settings after using the CONFigure command, the READ command can be used to initiate a measurement without changing the settings back to their defaults.

In the Swept SA measurement in Spectrum Analyzer mode the CONFigure command also turns the averaging function on and sets the number of averages to 10 for all measurements.

:CONFigure: <measurement>: NDEFault stops the current measurement and changes to the specified measurement. It does not change the settings to the defaults. It does not initiate the taking of measurement data unless INIT:CONTinuous is ON.

The CONFigure? query returns the current measurement name.

The CONFigure:CATalog? query returns a quoted string of all licensed measurement names in the current mode. For example, "SAN, CHP, OBW, ACP, PST, TXP, SPUR, SEM, LIST".

Fetch Commands:

:FETCh:<measurement>[n]?

This command puts selected data from the most recent measurement into the output buffer. Use FETCh if you have already made a good measurement and you want to return several types of data (different [n] values, for example, both scalars and trace data) from a single measurement. FETCh saves you the time of re-making the measurement. You can only FETCh results from the measurement that is currently active, it will not change to a different measurement. An error message is reported if a measurement other than the current one is specified.

If you need to get new measurement data, use the READ command, which is equivalent to an INITiate followed by a FETCh.

The scalar measurement results will be returned if the optional [n] value is not included, or is set to 1. If the [n] value is set to a value other than 1, the selected trace data results will be returned. See each command for details of what types of scalar results or trace data results are available. The binary data formats should be used for handling large blocks of data since they are smaller and transfer faster than the ASCII format. (FORMat:DATA)

FETCh may be used to return results other than those specified with the original READ or MEASure command that you sent.

INITiate Commands:

:INITiate:<measurement>

This command is not available for measurements in all the instrument modes:

- Initiates a trigger cycle for the specified measurement, but does not output any data. You must then use the FETCh<meas> command to return data. If a measurement other than the current one is specified, the instrument will switch to that measurement and then initiate it.
- For example, suppose you have previously initiated the ACP measurement, but now you are running the channel power measurement. If you send INIT:ACP? it will change from channel power to ACP and will initiate an ACP measurement.
- Does not change any of the measurement settings. For example, if you have previously started the ACP measurement and you send INIT:ACP? it will initiate a new ACP measurement using the same instrument settings as the last time ACP was run.
- If your selected measurement is currently active (in the idle state) it triggers the measurement, assuming the trigger conditions are met. Then it completes one trigger cycle. Depending upon the measurement and the number of averages, there may be multiple data acquisitions, with multiple trigger events, for one full trigger cycle. It also holds off additional commands on GPIB until the acquisition is complete.

READ Commands:

:READ:<measurement>[n]?

- Does not preset the measurement to the factory default settings. For example, if you have previously initiated the ACP
-

measurement and you send READ:ACP? it will initiate a new measurement using the same instrument settings.

- Initiates the measurement and puts valid data into the output buffer. If a measurement other than the current one is specified, the instrument will switch to that measurement before it initiates the measurement and returns results.
 - For example, suppose you have previously initiated the ACP measurement, but now you are running the channel power measurement. Then you send READ:ACP? It will change from channel power back to ACP and, using the previous ACP settings, will initiate the measurement and return results.
 - Blocks other SCPI communication, waiting until the measurement is complete before returning the results
 - If the optional [n] value is not included, or is set to 1, the scalar measurement results will be returned. If the [n] value is set to a value other than 1, the selected trace data results will be returned. See each command for details of what types of scalar results or trace data results are available. The binary data formats should be used when handling large blocks of data since they are smaller and faster than the ASCII format. (FORMat:DATA)
-

Initial S/W Revision	Prior to A.02.00
----------------------	------------------

Current Measurement Query (Remote Command Only)

This command returns the name of the measurement that is currently running.

Remote Command	:CONFigure?
-----------------------	-------------

Example	CONF?
----------------	-------

Initial S/W Revision	Prior to A.02.00
----------------------	------------------

Limit Test Current Results (Remote Command Only)

Queries the status of the current measurement limit testing. It returns a 0 if the measured results pass when compared with the current limits. It returns a 1 if the measured results fail any limit tests.

Remote Command	:CALCulate:CLIMits:FAIL?
-----------------------	--------------------------

Example	CALC:CLIM:FAIL? queries the current measurement to see if it fails the defined limits. Returns a 0 or 1: 0 it passes, 1 it fails.
----------------	--

Initial S/W Revision	Prior to A.02.00
----------------------	------------------

Data Query (Remote Command Only)

Returns the designated measurement data for the currently selected measurement and subopcode.

n = any valid subopcode for the current measurement. See the measurement command results table for your current measurement, for information about what data is returned for the subopcodes.

This command uses the data setting specified by the FORMat:BORDER and FORMat:DATA commands and can return real or ASCII data. (See the format command descriptions under Input/Output in the Analyzer Setup section.)

Remote Command	:CALCulate:DATA[n]?
Notes	The return trace depends on the measurement. In CALCulate:<meas>:DATA[n], n is any valid subopcode for the current measurement. It returns the same data as the FETCH:<measurement>? query where <measurement> is the current measurement.
Initial S/W Revision	Prior to A.02.00

Calculate/Compress Trace Data Query (Remote Command Only)

Returns compressed data for the currently selected measurement and sub-opcode [n].

n = any valid sub-opcode for that measurement. See the MEASure:<measurement>? command description of your specific measurement for information on the data that can be returned.

The data is returned in the current Y Axis Unit of the analyzer. The command is used with a sub-opcode <n> (default=1) to specify the trace. With trace queries, it is best if the analyzer is not sweeping during the query. Therefore, it is generally advisable to be in Single Sweep, or Update=Off.

This command is used to compress or decimate a long trace to extract and return only the desired data. A typical example would be to acquire N frames of GSM data and return the mean power of the first burst in each frame. The command can also be used to identify the best curve fit for the data.

Remote Command	:CALCulate:DATA<n>:COMPress? BLOCk CFIT MAXimum MINimum MEAN DMEan RMS RMSCubed SAMPlE SDEVIation PPHase [,<soffset> [,<length>[,<roffset>[,<rlimit>]]]]
Example	To query the mean power of a set of GSM bursts: Supply a signal that is a set of GSM bursts. Select the IQ Waveform measurement (in IQ Analyzer Mode). Set the sweep time to acquire at least one burst. Set the triggers such that acquisition happens at a known position relative to a burst. Then query the mean burst levels using, CALC:DATA2:COMP? MEAN, 24e-6, 526e-6 (These parameter values correspond to GSM signals, where 526e-6 is the length of the burst in the slot and you just want 1 burst.)
Notes	The command supports 5 parameters. Note that the last 4 (<soffset>, <length>, <roffset>, <rlimit>) are optional. But these optional parameters must be entered in the specified order. For example, if you want to specify <length>, then you must also specify <soffset>. See details below for a definition of each of these parameters. This command uses the data in the format specified by FORMat:DATA, returning either binary or ASCII data.
Initial S/W Revision	Prior to A.02.00

- BLOCk or block data - returns all the data points from the region of the trace data that you specify. For example, it could be used to return the data points of an input signal over several timeslots, excluding the portions of the trace data that you do not want. (This is x,y pairs for trace data and I,Q pairs for complex data.)

- CFIT or curve fit - applies curve fitting routines to the data. <soffset> and <length> are required to define the data that you want. <roffset> is an optional parameter for the desired order of the curve equation. The query will return the following values: the x-offset (in seconds) and the curve coefficients ((order + 1) values).

MIN, MAX, MEAN, DME, RMS, RMSC, SAMP, SDEV and PPH return one data value for each specified region (or <length>) of trace data, for as many regions as possible until you run out of trace data (using <roffset> to specify regions). Or they return the number of regions you specify (using <rlimit>) ignoring any data beyond that.

- MINimum - returns the minimum data point (y value) for the specified region(s) of trace data. For I/Q trace data, the minimum magnitude of the I/Q pairs is returned.
- MAXimum - returns the maximum data point (y value) for the specified region(s) of trace data. For I/Q trace data, the maximum magnitude of the I/Q pairs is returned.
- MEAN - returns a single value that is the arithmetic mean of the data point values (in dB/ dBm) for the specified region(s) of trace data. For I/Q trace data, the mean of the magnitudes of the I/Q pairs is returned. See the following equations.

NOTE If the original trace data is in dB, this function returns the arithmetic mean of those log values, not log of the mean power which is a more useful value. The mean of the log is the better measurement technique when measuring CW signals in the presence of noise. The mean of the power, expressed in dB, is useful in power measurements such as Channel Power. To achieve the mean of the power, use the RMS option.

Equation 1

Mean Value of Data Points for Specified Region(s)

$$\text{MEAN} = \frac{1}{n} \sum_{X_i \in \text{region}(s)} X_i$$

where X_i is a data point value, and n is the number of data points in the specified region(s).

Equation 2

Mean Value of I/Q Data Pairs for Specified Region(s)

$$\text{MEAN} = \frac{1}{n} \sum_{X_i \in \text{region}(s)} |X_i|$$

where $|X_i|$ is the magnitude of an I/Q pair, and n is the number of I/Q pairs in the specified region(s).

- DMEan - returns a single value that is the mean power (in dB/ dBm) of the data point values for the specified region(s) of trace data. See the following equation:

Equation 3

DMEan Value of Data Points for Specified Region(s)

$$\text{DME} = 10 \times \log_{10} \left(\frac{1}{n} \sum_{X_i \in \text{region}(s)} 10^{\frac{X_i}{10}} \right)$$

- RMS - returns a single value that is the average power on a root-mean-squared voltage scale (arithmetic rms) of the data point values for the specified region(s) of trace data. See the following equation.

NOTE For I/Q trace data, the rms of the magnitudes of the I/Q pairs is returned. See the following equation. This function is very useful for I/Q trace data. However, if the original trace data is in dB, this function returns the rms of the log values which is not usually needed.

Equation 4

RMS Value of Data Points for Specified Region(s)

$$\text{RMS} = \sqrt{\frac{1}{n} \sum_{X_i \in \text{region}(s)} X_i^2}$$

where X_i is a data point value, and n is the number of data points in the specified region(s).

Equation 5

RMS Value of I/Q Data Pairs for Specified Region(s)

$$\text{RMS} = \sqrt{\frac{1}{n} \sum_{X_i \in \text{region}(s)} X_i X_i^*}$$

where X_i is the complex value representation of an I/Q pair, X_i^* its conjugate complex number, and n is the number of I/Q pairs in the specified region(s).

Once you have the rms value for a region of trace data (linear or I/Q), you may want to calculate the mean power. You must convert this rms value (peak volts) to power in dBm:

$$10 \times \log[10 \times (\text{rms value})^2]$$

- SAMPLe - returns the first data value (x,y pair) for the specified region(s) of trace data. For I/Q trace data, the first I/Q pair is returned.
- SDEViation - returns a single value that is the arithmetic standard deviation for the data point values for the specified region(s) of trace data. See the following equation.
- For I/Q trace data, the standard deviation of the magnitudes of the I/Q pairs is returned. See the following equation.

Equation 6

Standard Deviation of Data Point Values for Specified Region(s)

$$\text{SDEV} = \sqrt{\frac{1}{n} \sum_{X_i \in \text{region}(s)} (X_i - \bar{X})^2}$$

where X_i is a data point value, \bar{X} is the arithmetic mean of the data point values for the specified region (s), and n is the number of data points in the specified region(s).

$$\text{SDEV} = \sqrt{\frac{1}{n} \sum_{X_i \in \text{region}(s)} (|X_i| - \bar{X})^2}$$

where $|X_i|$ is the magnitude of an I/Q pair, \bar{X} is the mean of the magnitudes for the specified region(s), and n is the number of data points in the specified region(s).

- PPHase - returns the x,y pairs of both rms power (dBm) and arithmetic mean phase (radian) for every specified region and frequency offset (Hz). The number of pairs is defined by the specified number of regions. This parameter can be used for I/Q vector ($n=0$) in Waveform (time domain) measurement and all parameters are specified by data point in PPHase.

The rms power of the specified region may be expressed as:

$$\text{Power} = 10 \times \log [10 \times (\text{RMS I/Q value})] + 10.$$

The RMS I/Q value (peak volts) is:

$$\sqrt{\frac{1}{n} \sum_{X_i \in \text{region}} X_i X_i^*}$$

where X_i is the complex value representation of an I/Q pair, X_i^* its conjugate complex number, and n is the number of I/Q pairs in the specified region.

The arithmetic mean phase of the specified region may be expressed as:

$$\frac{1}{n} \sum_{Y_i \in \text{region}} Y_i$$

where Y_i is the unwrapped phase of I/Q pair with applying frequency correction and n is the number of I/Q pairs in the specified region.

The frequency correction is made by the frequency offset calculated by the arithmetic mean of every specified region's frequency offset. Each frequency offset is calculated by the least square method against the unwrapped phase of I/Q pair.

Sample Trace Data - Constant Envelope

(See below for explanation of variables.)

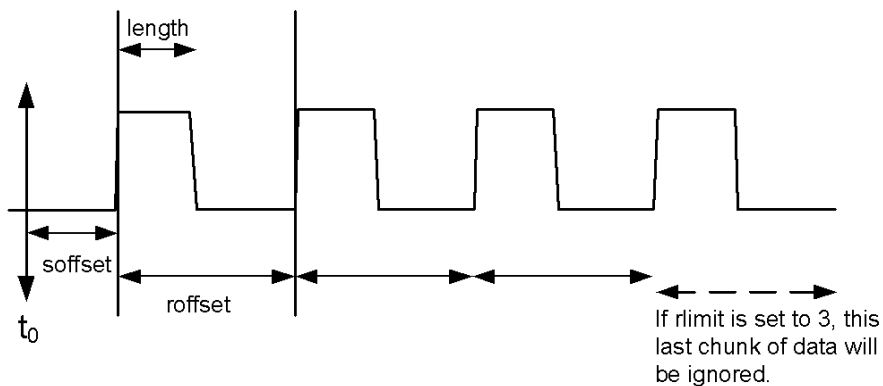

Sample Trace Data - Not Constant Envelope

(See below for explanation of variables.)



<soffset> - start offset is an optional real number. (It is in seconds for time-domain traces, and is a dimensionless index 0 to Npoints - 1, for frequency-domain traces). It specifies the amount of data at the beginning of the trace that will be ignored before the decimation process starts. It is the time or frequency change from the start of the trace to the point where you want to start using the data. The default value is zero.

<length> - is an optional real number. (It is in seconds for time-domain traces, and is a dimensionless index 0 to Npoints - 1, for frequency-domain traces). It defines how much data will be compressed into one value. This parameter has a default value equal to the current trace length.

<roffset> - repeat offset is an optional real number. (It is in seconds for time-domain traces, and is a dimensionless index 0 to Npoints - 1, for frequency-domain traces). It defines the beginning of the next field of trace elements to be compressed. This is relative to the beginning of the previous field. This parameter has a default value equal to the <length> variable. Note that this parameter is used for a completely different purpose when curve fitting (see CFIT above).

<rlimit> - repeat limit is an optional integer. It specifies the number of data items that you want returned. It will ignore any additional items beyond that number. You can use the Start offset and the Repeat limit to pick out exactly what part of the data you want to use. The default value is all the data.

Calculate Peaks of Trace Data (Remote Command Only)

Returns a list of all the peaks for the currently selected measurement and sub-opcode [n]. The peaks must meet the requirements of the peak threshold and excursion values.

n = any valid sub-opcode for the current measurement. See the MEASure:<measurement> command description of your specific measurement for information on the data that can be returned.

The command can only be used with specific sub-opcodes with measurement results that are trace data. Both real and complex traces can be searched, but complex traces are converted to magnitude in dBm. In many measurements the sub-opcode n=0, is the raw trace data which cannot be searched for peaks. And Sub-opcode n=1, is often calculated results values which also cannot be searched for peaks.

This command uses the data setting specified by the FORMat:BORDER and FORMat:DATA commands and can return real or ASCII data. If the format is set to INT,32, it returns REAL,32 data.

The command has four types of parameters:

- Threshold (in dBm)
- Excursion (in dB)
- Sorting order (amplitude, frequency, time)
- Optional in some measurements: Display line use (all, > display line, < display line)

Remote Command	<p>For Swept SA measurement:</p> <pre>:CALCulate:DATA[1] 2 ... 6:PEAKs? <threshold>,<excursion>[,AMPLitude FREQuency TIME[,ALL GTDLLine LTDLine]]</pre> <p>For most other measurements:</p> <pre>:CALCulate:DATA[1] 2 ... 6:PEAKs? <threshold>,<excursion>[,AMPLitude FREQuency TIME]</pre>
-----------------------	---

Example	<p>Example for Swept SA measurement in Spectrum Analyzer Mode:</p> <p>CALC:DATA4:PEAK? -40, 10, FREQ, GTDL This will identify the peaks of trace 4 that are above -40 dBm, with excursions of at least 10 dB. The peaks are returned in order of increasing frequency, starting with the lowest frequency. Only the peaks that are above the display line are returned.</p> <p>Query Results 1:</p> <p>With FORMat:DATA REAL, 32 selected, it returns a list of floating-point numbers. The first value in the list is the number of peak points that are in the following list. A peak point consists of two values: a peak amplitude followed by its corresponding frequency (or time).</p> <p>If no peaks are found the peak list will consist of only the number of peaks, (0).</p>
----------------	---

Notes	<p><n> - is the trace that will be used</p> <p><threshold> - is the level below which trace data peaks are ignored. Note that the threshold value is required and is always used as a peak criterion. To effectively disable the threshold criterion for this command, provide a substantially low threshold value such as -200 dBm. Also note that the threshold value used in this command is independent of and has no effect on the threshold value stored under the Peak Criteria menu.</p> <p><excursion> - is the minimum amplitude variation (rise and fall) required for a signal to be identified as peak. Note that the excursion value is required and is always used as a peak criterion. To effectively disable the excursion criterion for this command, provide the minimum value of 0.0 dB. Also note that the excursion value used in this command is independent of and has no effect on the</p>
--------------	---

excursion value stored under the Peak Criteria menu.

Values must be provided for threshold and excursion. The sorting and display line parameters are optional (defaults are AMPLitude and ALL).

Note that there is always a Y-axis value for the display line, regardless of whether the display line state is on or off. It is the current Y-axis value of the display line which is used by this command to determine whether a peak should be reported

Sorting order:

AMPLitude - lists the peaks in order of descending amplitude, with the highest peak first (default if optional parameter not sent)

FREQuency - lists the peaks in order of occurrence, left to right across the x-axis.

TIME - lists the peaks in order of occurrence, left to right across the x-axis.

Peaks vs. Display Line:

ALL - lists all of the peaks found (default if optional parameter not sent).

GTDLine (greater than display line) - lists all of the peaks found above the display line.

LTDLine (less than display line) - lists all of the peaks found below the display line.

Initial S/W Revision	Prior to A.02.00
----------------------	------------------

Hardware-Accelerated Fast Power Measurement (Remote Command Only)

The Fast Power option (FP2) enables very fast channel power measurements for instruments with the prerequisite hardware (DP2 and/or B40). It accomplishes this by performing real-time overlapped FFTs at the hardware layer, using software for basic post-processing before returning the result to the user. The upshot of this approach is improved throughput for user applications that require many sequential power measurements.

The analysis bandwidth of FP2 is limited by the licenses in the instrument, but its maximum overall analysis bandwidth per acquisition is 40 MHz.

FP2 is remote-only, which means the instrument does not switch to any particular mode or measurement. FP2 commands can be sent while another application is in use on the front panel.

Each Fast Power measurement can be predefined using an array index, and up to 1,000 measurements can be stored. In the following documentation, instances of [1,2,...,999] can be substituted with a particular measurement index, e.g. CALC:FPOW:POW1?, CALC:FPOW:POW2?, CALC:FPOW:POW134?. In this way, power measurements can be defined one time in a batch, and then executed multiple times without having to redefine them, similar to “list mode” on other measurements.

In addition to basic channel power measurements, there are a number of other measurement “functions” for each channel, including peak power, peak frequency, and power spectral density. See the Function parameter for more information.

Reset Fast Power Measurement (Remote Command Only)

Resets the measurement configuration to the defaults.

Mode	All
Remote Command	:CALCulate:FPOWer:POWer[1,2,...,999]:RESet
Example	:CALC:FPOW:POW1:RES

Notes	Option FP2 is required.
Initial S/W Revision	A.14.00

Define Fast Power Measurement (Remote Command Only)

Fast Power acquisitions are configured using the DEFine command. This command accepts a comma-delimited string of configuration parameters and their appropriate values, which are all specified in the subsection below.

Mode	All
Remote Command	:CALCulate:FPOWER:POWer[1,2,...,999]:DEFine "configuration string"
Example	:CALC:FPOW:POW1:DEF "CenterFrequency=2e9, AcquisitionTime=0.005"
Notes	See below for a list of measurement variables that can be defined in the configuration string.
Initial S/W Revision	A.14.00

Acquisition Time

Value	Time (s)
Range	0 s to 1 s
Preset	0.001 s
Example	CALC:FPOW:POW1:DEF "AcquisitionTime=0.002"
Notes	The acquisition time parameter sets the time in which the entire spectrum is measured. An increase in the acquisition time yields an improvement in measurement repeatability.
Initial S/W Revision	A.14.00

Center Frequency

Value	Frequency (Hz)
Range	0 Hz to maximum instrument frequency
Preset	1 GHz
Example	CALC:FPOW:POW1:DEF "CenterFrequency=2e9"
Notes	The center frequency parameter sets the frequency in which the measurement is centered around. The OffsetFrequency parameter is calculated relative to the center frequency.
Initial S/W Revision	A.14.00

DC Coupled

Value	Boolean
Range	True (DC Coupled) or False (AC Coupled)
Preset	False
Example	CALC:FPOW:POW1:DEF "DCCoupled=True"
Notes	The DC coupled parameter allows the user to specify whether the DC blocking capacitor is utilized. Set parameter to true when measuring frequencies below 10 MHz.
Initial S/W Revision	A.14.00

DetectorType

Example	CALC:FPOW:POW1:DEF "DetectorType=Peak"
Notes	Option FP2 is required. The detector type parameter allows the user to choose whether a RMS average or peak value is used during the measurement.
Preset	RmsAverage
Range	RmsAverage, Peak
Initial S/W Revision	A.14.00

Do Noise Correction

Value	Boolean
Range	True (enable noise correction) or False (disable noise correction)
Preset	False
Example	CALC:FPOW:POW1:DEF "DoNoiseCorrection=True"
Notes	When noise correction is enabled, the linear noise power contributed by the analyzer is subtracted from all measurements. This effectively lowers the noise floor of the analyzer. When noise correction is enabled, the first measurement for a given set of input parameters will take extra time. This is because the analyzer takes an extra acquisition with the RF input disconnected from the analyzer's front end to measure the noise of just the analyzer. The measured noise floor is stored in a cache so the noise acquisition will occur only once for the same state settings. In other words, if noise correction was turned on and the analyzer made an acquisition at frequency A, then frequency B, and back again to frequency A, the hidden initial noise floor acquisition would only occur for the first acquisition at frequency A and the cached noise floor would be used the second time frequency A was measured.
Initial S/W Revision	A.14.00

Do Spur Suppression

Value	Boolean
Range	True (enable spur suppression) or False (disable spur suppression)
Preset	False
Example	CALC:FPOW:POW1:DEF "DoSpurSuppression=True"
Notes	<p>When measuring very low level signals, or when large out-of-band inputs are input into the analyzer, sometimes unwanted spurs and residuals can appear in the measured spectrum. Spur suppression is a method to help minimize the levels of these internally generated spurs and residuals.</p> <p>When spur suppression is enabled, the analyzer will automatically take two acquisitions using two different internal analog LO frequencies. The FFT spectrums from both acquisitions are combined by taking the minimum power between both traces on a per FFT bin basis. External signals will have the same amplitude for both traces and therefore will return the expected amplitudes. However, low level spurs and residuals generated internally to the analyzer tend to move to different FFT bins depending on the internal analog LO frequency used, and therefore tend to be suppressed using this spur suppression method.</p> <p>Because two acquisitions, rather than a single acquisition, are made when spur suppression is enabled, the measurement time will always be slower when spur suppression is enabled.</p>
Initial S/W Revision	A.14.00

Electronic Attenuator Bypass

Value	Boolean
Range	True (bypass electronic attenuator) or False (use electronic attenuator)
Preset	True
Example	CALC:FPOW:POW1:DEF "ElecAttBypass =False"
Notes	The electronic attenuation bypass parameter allows the user to either utilize or bypass the electronic attenuator. The electronic attenuator is only available for frequencies up to 3.6 GHz. Set parameter to true when using frequencies above 3.6 GHz and set the parameter to false when using the preamp.
Initial S/W Revision	A.14.00

Electronic Attenuation

Value	dB
Range	0 - 24 dB (1 dB steps)
Preset	0 dB
Example	CALC:FPOW:POW1:DEF "ElecAttenuation=10"
Notes	<p>Option EA3 is required.</p> <p>The electronic attenuation value parameter sets the amount of electrical attenuation from 0 to 24 dB (1 dB steps).</p>

Set "ElecAttBypass=False" to make sure the electronic attenuator path is enabled.

Initial S/W Revision	A.14.00
-------------------------	---------

IF Gain

Value	dB
Range	-6 - 16 dB (1 dB steps)
Preset	0 dB
Example	CALC:FPOW:POW1:DEF "IFGain=10"
Notes	The IF gain parameter allows the user to specify the gain at the IF stage anywhere from -6 to 16 dB (1 dB steps). This is an advanced feature, and for most cases this should remain at its default value of 0 dB.
Initial S/W Revision	A.14.00

IF Type

Example	CALC:FPOW:POW1:DEF "IFType=B25M"
Notes	The IF type parameter allows the user to select between different IF paths. For example, if the signal is less than 25 MHz wide, then the user can select the B25M path to take advantage of additional filtering on this analog IF path.
Preset	B40M
Range	B10M, B25M, B40M
Initial S/W Revision	A.14.00

Include Power Spectrum

Value	Boolean
Range	True (return both channel power and full power spectrum) or False (returns only channel power)
Preset	False
Example	CALC:FPOW:POW1:DEF "IncludePowerSpectrum=True"
Notes	The power spectrum parameter allows the user to read data on the entire spectrum for diagnostic purposes. It is not recommended for production use. See CALC:FPOW:POW[n]:READ2? for details on the binary format of the response.
Initial S/W Revision	A.14.00

Mechanical Attenuation

Value	dB
Range	0 – 70 dB (2 dB steps)
Preset	0 dB
Example	CALC:FPOW:POW1:DEF "MechAttenuation=10"
Notes	The mechanical attenuation value parameter sets the amount of mechanical attenuation anywhere from 0 to 70 dB (2 dB steps).
Initial S/W Revision	A.14.00

Preamp Mode

Example	CALC:FPOW:POW1:DEF "PreAmpMode=Low"
Notes	The license for the appropriate preamp is required. The preamp mode parameter specifies whether the preamps are being utilized. Low allows any preamps up to 3.6 GHz, and Full allows all licensed preamps. Set "ElecAttBypass=True" in order to utilize any preamps.
Preset	Off
Range	Off, Low, Full
Initial S/W Revision	A.14.00

Resolution Bandwidth Mode

Example	CALC:FPOW:POW1:DEF "PreAmpMode=Low"
Notes	The resolution bandwidth mode parameter allows the user to choose whether the RBW filter is automatically or manually set. The BestSpeed value minimizes measurement time, while the Narrowest value minimizes RBW size (minimum of two FFT bins per RBW). To manually specify an RBW, set this parameter to Explicit, and set the ResolutionBW parameter to the desired value.
Preset	BestSpeed
Range	BestSpeed, Narrowest, Explicit
Initial S/W Revision	A.14.00

Resolution Bandwidth

Value	Hz
Preset	0 Hz

Example	CALC:FPOW:POW1:DEF "ResolutionBW=25e3"
Notes	The resolution bandwidth parameter sets the 3-dB bandwidth of the RBW filter. The ResolutionBWMode parameter must be set to Explicit in order to manually set the RBW.
Initial S/W Revision	A.14.00

Trigger Delay

Value	Seconds
Range	0 – 1 s
Preset	0 s
Example	CALC:FPOW:POW1:DEF "TriggerDelay=0.025"
Notes	The trigger delay parameter sets the time after an external trigger is detected until the measurement is performed.
Initial S/W Revision	A.14.00

Trigger Level

Value	Volts
Range	-5 to 5 V
Preset	1.2 V
Example	CALC:FPOW:POW1:DEF "TriggerLevel=2"
Notes	The trigger level parameter sets the voltage value at which an external trigger is detected.
Initial S/W Revision	A.14.00

Trigger Slope

Example	CALC:FPOW:POW1:DEF "TriggerSlope=Negative"
Notes	The trigger slope parameter indicates the direction of the edge trigger voltage for detection.
Preset	Positive
Range	Positive, Negative
Initial S/W Revision	A.14.00

Trigger Source

Example	CALC:FPOW:POW1:DEF "TriggerSource=Ext1 "
Notes	The trigger source parameter allows the user to choose between measurement's triggering freely or controlled by an external input. Ext1 and Ext2 correspond to Trigger 1 In and Trigger 2 In, respectively.
Preset	Free
Range	Free, Ext1, Ext2
Initial S/W Revision	A.14.00

Trigger Timeout

Value	Seconds
Range	0 - 1 s
Preset	1 s
Example	CALC:FPOW:POW1:DEF "TriggerTimeout=0.1"
Notes	The trigger timeout parameter sets the time in which the analyzer will wait for a trigger before automatically performing the measurement.
Initial S/W Revision	A.14.00

Signal Input

Example	CALC:FPOW:POW1:DEF "SignalInput=Fp50MHzCW"
Notes	The signal input parameter allows the user to select between using the main RF input or the internal analyzer reference CW signal of 50 MHz.
Preset	FpMainRf
Range	FpMainRf, Fp50MHzCW
Initial S/W Revision	A.14.00

Use Preselector

Value	Boolean
Range	True (use preselector above 3.6 GHz), or False (preselector bypassed)
Preset	False
Example	CALC:FPOW:POW1:DEF "UsePreSelector=True"
Notes	The preselector parameter allows the user to either utilize or bypass the front end tunable filter at frequencies above 3.6 GHz. For frequencies below 3.6 GHz, the preselector is automatically

bypassed, so you do not need to set this parameter to False in those cases.

Initial S/W Revision	A.14.00
----------------------	---------

Channel Bandwidth Array

Value	Hz
Range	0 to 40 MHz
Preset	[1 e6]
Example	CALC:FPOW:POW1:DEF "Bandwidth=[3.84e6, 5e6, 3.84e6]"
Notes	The bandwidth parameter array defines the bandwidth of each channel that will be measured. All array parameters should have the same number of elements. Alternatively, if all the elements are the same value, a single number with no square brackets can be used to define the parameter.
Initial S/W Revision	A.14.00

Channel Filter Type Array

Example	CALC:FPOW:POW1:DEF "FilterType=[RRC, IBW, RRC]"
Notes	The filter type parameter allows the user to choose between an integration bandwidth (IBW) filter or a root-raised-cosine (RRC) filter. The integration bandwidth filter weighs all frequencies within the bandwidth equally. The root-raised-cosine filter has an associated shape parameter, defined by the FilterAlpha parameter. All array parameters should have the same number of elements. Alternatively, if all the elements are the same value, a single value with no square brackets can be used to define the parameter.
Preset	[IBW]
Range	IBW, RRC
Initial S/W Revision	A.14.00

Channel Filter Alpha Array

Example	CALC:FPOW:POW1:DEF "FilterAlpha=[0.5, 0.0, 0.5]"
Notes	The filter alpha parameter allows the user to adjust the alpha value associated with the root-raised-cosine (RRC) filter type. Set FilterType to RRC in order to utilize this parameter. All array parameters should have the same number of elements. Alternatively, if all the elements are the same value, a single number with no square brackets can be used to define the parameter.
Preset	[0.22]
Range	0.0 - 1.0
Initial S/W Revision	A.14.00

Channel Measurement Function Array

Example	CALC:FPOW:POW1:DEF "Function=[BandPower, PeakPower, BandPower]"
Notes	<p>This parameter array defines what measurement is being made for each individually-specified channel:</p> <p>BandPower: Total power within the specified bandwidth of the channel (dBm)</p> <p>BandDensity: Total power density within the specified bandwidth of the channel (dBm/Hz)</p> <p>PeakPower: The peak power value within the specified bandwidth of the channel (dBm)</p> <p>PeakFrequency: The frequency which corresponds to the peak power value within the specified bandwidth of the channel. This frequency is relative to the center frequency (Hz)</p> <p>XdBBandwidth: The half power (-3.01 dB) bandwidth of the highest amplitude signal that resides within the channel (Hz), dB is configurable using XdBBandwidth parameter</p> <p>OccupiedBandwidth: The bandwidth at which 99% of the total power resides within the channel (Hz), percentage configurable using OccupiedBandwidthPercent parameter</p> <p>All array parameters should have the same number of elements. Alternatively, if all the elements are the same value, a single value with no square brackets can be used to define the parameter.</p>
Preset	[BandPower]
Range	BandPower, BandDensity, PeakPower, PeakFrequency, XdBBandwidth, OccupiedBandwidth
Initial S/W Revision	A.14.00

Channel Offset Frequency Array

Value	Hz
Range	0 to 20 MHz
Preset	[0]
Example	CALC:FPOW:POW1:DEF "OffsetFrequency=[-5e6, 0, 5e6]"
Notes	<p>The offset frequency parameter array defines the difference between the center frequency to the center frequency of each channel.</p> <p>All array parameters should have the same number of elements.</p>
Initial S/W Revision	A.14.00

Channel Occupied Bandwidth Percent Array

Example	CALC:FPOW:POW1:DEF "OccupiedBandwidthPercent =[0.95, 0.95, 0.95]"
Notes	<p>This parameter only applies for channels whose Function is set to OccupiedBandwidth. The occupied bandwidth percent parameter specifies the percent of total power in these channels. The valid range for this parameter is 0.0 to 1.0, where 1.0 represents 100%. The default for this parameter is 0.99, which will return the bandwidth that contains 99% of the total channel power.</p>

Preset	[0.99]
Range	0 – 1.0
Initial S/W Revision	A.14.00

Channel x-dB Bandwidth Array

Value	dB
Range	-200 to 0 dB
Preset	[-3.01]
Example	CALC:FPOW:POW1:DEF " XdBBandwidth =[-6.02, -3.01, -1.0]"
Notes	This parameter only applies for channels whose Function is set to XdBBandwidth. The X dB bandwidth parameter is used to specify the power relative to the peak channel power over which the bandwidth is calculated. The parameter value must be a negative number.
Initial S/W Revision	A.14.00

Define Fast Power Measurement Query (Remote Command Only)

The DEFine? command is used to retrieve a list of all defined parameters in an ASCII string format

M o d e	All
R e m o t e	:CALCulate:FPOWER:POWER[1,2,...,999]:DEFine?
C o m m a n d	
E x a m p l e	:CALC:FPOW:POW1:DEF?

```

p
l
e
N This command query is used to retrieve a list of all defined parameters in an ASCII format.
o The following is an example of the returned results:
t "DCCoupled=False,ElecAttBypass=True,ElecAttenuation=0,IFGain=0,MechAttenuation=0,PreAmpMode=Off,PreSelectorOffset
e =0,UsePreSelector=False,ExternalReferenceFrequency=10000000,FrequencyReferenceSource=AutoExternalFrequencyRefer
s ence,IFType=B40M,LOMode=SLW,SignalInput=FpMainRf,AcquisitionTime=0.001,CenterFrequency=1000000000,Resolution
BW=0,ResolutionBWMode=BestSpeed,DetectorType=RmsAverage,Bandwidth=[1000000],OffsetFrequency=[0],Function=
[BandPower],FilterType=[IBW],FilterAlpha=[0.22],OccupiedBandwidthPercent=[0.99],XdBBandwidth=[-
3.01],DoNoiseCorrection=False,DoSpurSuppression=False,MeasurementMethod=HardwareFFT,IncludePowerSpectrum=False
e,TriggerDelay=0,TriggerLevel=1.2,TriggerSlope=Positive,TriggerSource=Free,TriggerTimeout=1 "
I A.14.00
n
i
t
i
a
l
S
/
W
R
e
v
i
s
i
o
n

```

Configure Fast Power Measurement (Remote Command Only)

The configure command begins hardware setup and returns immediately, with no acquisition made. This can be used in parallel with other hardware operations to effectively hide the hardware setup time.

Mode	All
Remote Command	:CALCulate:FPOWer:POWer[1,2,...,999]:CONFigure
Example	:CALC:FPOW:POW1:CONF
Notes	Option FP2 is required.
Initial S/W Revision	A.14.00

Initiate Fast Power Measurement (Remote Command Only)

The INITiate command begins an acquisition and returns immediately. The results of the measurement can be retrieved using FETCh.

Mode	All
Remote Command	:CALCulate:FPOWer:POWer [1, 2, ..., 999] :INITiate
Example	:CALC:FPOW:POW1:INIT
Notes	Option FP2 is required.
Initial S/W Revision	A.14.00

Fetch Fast Power Measurement (Remote Command Only)

The FETCh command query is used to retrieve the results of an acquisition initiated by the INIT command. The returned results are in ASCII string format. The string begins and ends with quotation marks.

Mode	All
Remote Command	:CALCulate:FPOWer:POWer [1, 2, ..., 999] :FETCh?
Example	:CALC:FPOW:POW1:FETC?
Notes	Option FP2 is required. Returns m comma-separated ASCII values, where m corresponds to the number of bandwidths defined. 1. Declared function return in the 1st specified channel 2. Declared function return in the 2nd specified channel ... m. Declared function return in the last specified channel The INIT and FETC? command sequence performs the same functionality of a single CALC:FPOW:POW[n]? query. Units of the returned values are dependent on the Function parameter for each channel.
Initial S/W Revision	A.14.00

Execute Fast Power Measurement (Remote Command Only)

This command query is used as shorthand for an INIT command immediately followed by a FETC? command. The returned results are in ASCII string format. The string begins and ends with quotation marks.

Mode	All
Remote Command	:CALCulate:FPOWer:POWer [1, 2, ..., 999] ?
Example	:CALC:FPOW:POW1?
Notes	Option FP2 is required. See notes for Fast Power Fetch for return format.
Initial S/W Revision	A.14.00

Binary Read Fast Power Measurement (Remote Command Only)

This command query is used as shorthand for an INIT command immediately followed by a FETC? command. The returned results are in a binary format.

Mode	All
Remote Command	:CALCulate:FPOWER:POWER[1,2,...,999]:READ? :CALCulate:FPOWER:POWER[1,2,...,999]:READ1?
Example	:CALC:FPOW:POW1:READ? :CALC:FPOW:POW1:READ1?
Notes	Option FP2 is required. Returns m 4 byte floating point binary values (Little-Endian), where m corresponds to the number of bandwidths defined.
Initial S/W Revision	A.14.00

Diagnostic Binary Read Fast Power Measurement (Remote Command Only)

This command query is used as shorthand for an INIT command immediately followed by a FETC? command. The returned results are in a binary format. This command is used primarily for diagnostic purposes to test for ADC overloads and to visibly inspect the spectrum.

Mode	All
Remote Command	:CALCulate:FPOWER:POWER[1,2,...,999]:READ2?
Example	:CALC:FPOW:POW1:READ2?
Notes	Option FP2 is required. Note: Spectrum data is only returned if the IncludePowerSpectrum parameter is set to True. If IncludePowerSpectrum is False, the number of spectrum points will be zero (0). Units of the returned values are dependent on the Function parameter per channel (e.g. dBm for BandPower, Hz for PeakFrequency). Returns binary data (Little-Endian) that contains information on m amount of channels, along with ADC over range and full spectrum data. The following is the binary format of the response. Bandwidth Return Value 1. Number of channels specified, m [4 byte int] 2. Declared function result for the 1st specified channel [4 byte float] 3. Declared function result for the 2nd specified channel [4 byte float] ... (m + 1). Declared function result for the last (mth) specified channel [4 byte float] ADC Over Range 1. ADC over-range occurred (1: true, 0: false) [2 byte short]

	<p>Spectrum Data</p> <ol style="list-style-type: none"> 1. Number of points in the spectrum data, k [4 byte int] 2. Start frequency of spectrum data (Hz) [8 byte double] 3. Step frequency of spectrum data (Hz) [8 byte double] 4. FFT bin at 1st point (dBm) [4 byte float] 5. FFT bin at 2nd point (dBm) [4 byte float] <p>...</p> <p>(k + 3). FFT bin at last (kth) point (dBm) [4 byte float]</p>
Initial S/W Revision	A.14.00

Format Data: Numeric Data (Remote Command Only)

This command specifies the format of the trace data input and output. It specifies the formats used for trace data during data transfer across any remote port. It affects only the data format for setting and querying trace data for the :TRACe[:DATA], TRACe[:DATA]?, :CALCulate:DATA[n]? and FETCh:SANalyzer[n]? commands and queries.

Remote Command	<pre>:FORMat[:TRACe][:DATA] ASCii INTeger,32 REAL,32 REAL,64 :FORMat[:TRACe][:DATA]?</pre>
Notes	<p>The query response is:</p> <pre>ASCii: ASC,8 REAL,32: REAL,32 REAL,64: REAL,64 INTeger,32: INT,32</pre> <p>When the numeric data format is REAL or ASCii, data is output in the current Y Axis unit. When the data format is INTeger, data is output in units of m dBm (.001 dBm).</p> <p>The INT,32 format returns binary 32-bit integer values in internal units (m dBm), in a definite length block.</p>
Dependencies	<p>Sending a data format spec with an invalid number (for example, INT,48) generates no error. The analyzer simply uses the default (8 for ASCii, 32 for INTeger, 32 for REAL).</p> <p>Sending data to the analyzer which does not conform to the current FORMat specified, results in an error. Sending ASCII data when a definite block is expected generates message -161 "Invalid Block Data" and sending a definite block when ASCII data is expected generates message -121 "Invalid Character in Number".</p>
Preset	ASCii
Backwards Compatibility Notes	Note that the INT,32 format is only applicable to the command, TRACe:DATA. This preserves backwards compatibility for the Swept SA measurement. For all other commands/queries which honor FORMat:DATA, if INT,32 is sent the analyzer will behave as though it were set to REAL,32.
Initial S/W Revision	Prior to A.02.00

The specs for each output type follow:

AScii - Amplitude values are in ASCII, in the current Y Axis Unit, one ASCII character per digit, values separated by commas, each value in the form:

SX.YYYYYEsZZ

Where:

S = sign (+ or -)

X = one digit to left of decimal point

Y = 5 digits to right of decimal point

E = E, exponent header

s = sign of exponent (+ or -)

ZZ = two digit exponent

REAL,32 - Binary 32-bit real values in the current Y Axis Unit, in a definite length block.

REAL,64 - Binary 64-bit real values in the current Y Axis Unit, in a definite length block.

Format Data: Byte Order (Remote Command Only)

This command selects the binary data byte order for data transfer and other queries. It controls whether binary data is transferred in normal or swapped mode. This command affects only the byte order for setting and querying trace data for the :TRACe[:DATA], TRACe[:DATA]? , :CALCulate:DATA[n]? and FETCh:SANalyzer[n]? commands and queries.

By definition any command that says it uses FORMat:DATA uses any format supported by FORMat:DATA.

The NORMal order is a byte sequence that begins with the most significant byte (MSB) first, and ends with the least significant byte (LSB) last in the sequence: 1|2|3|4. SWAPped order is when the byte sequence begins with the LSB first, and ends with the MSB last in the sequence: 4|3|2|1.

Remote Command	:FORMat:BORDER NORMAL SWAPped :FORMat:BORDER?
Preset	NORMal
Initial S/W Revision	Prior to A.02.00

Meas Setup

Accesses the measurement setup menu for the current measurement.

Key Path	Front-panel key
Initial S/W Revision	A.10.01

Avg/Burst Number

Used to specify the number of data acquisitions that are averaged. After the specified number of average counts, the averaging mode (termination control) setting determines the averaging action.

Avg number is the number of bursts, is NOT the number of data acquisition. If search length is large enough to include all the bursts, acquisition will only execute once (single mode). If the bursts number include in one capture is smaller than average number, multi capture and measurement is necessary.

- On – Sets measurement averaging on.
- Off – Sets measurement averaging off.

Key Path	Meas Setup
Mode	WLAN
Remote Command	[:SENSe]:EVM:AVERage:COUNT <integer> [:SENSe]:EVM:AVERage:COUNT? [:SENSe]:EVM:AVERage[:STATe] OFF ON 0 1 [:SENSe]:EVM:AVERage[:STATe]?
Example	EVM:AVER:COUN 1 EVM:AVER:COUN? EVM:AVER OFF EVM:AVER?
Preset	10 ON
State Saved	Saved in instrument state.
Min	1
Max	10000
Initial S/W Revision	A.10.01

Avg Mode

Selects the type of termination control used for the averaging function. This determines the averaging action after the specified number of data acquisitions (average count) is reached.

KEY:Exponential	After the average count is reached, each successive data acquisition is exponentially
-----------------	---

SCPI:EXPOnential	weighted and combined with the existing average.
KEY:Repeat	After reaching the average count, the averaging is reset and a new average is started.
SCPI:REPeat	The default value is Exp.

Key Path	Meas Setup
Mode	WLAN
Remote Command	[:SENSe] :EVM:AVERage:TCONtrol EXPOnential REPeat [:SENSe] :EVM:AVERage:TCONtrol?
Example	EVM:AVER:TCON REP EVM:AVER:TCON?
Preset	EXP
State Saved	Saved in instrument state.
Range	Exp Repeat
Initial S/W Revision	A.10.01

Meas Time

Accesses the meas time menu for the current measurement.

Key Path	Meas Setup
Initial S/W Revision	A.10.01

Search Length

Sets the length of time to acquire the input signal. This defines the length of time that the burst search is performed.

The analyzer searches within the specified search length, find all burst positions within this search length, and demodulates burst one by one if average state is on and average number is still not reached. If one acquisition does not include total required bursts, multi capture is needed. So if want to get results for continues bursts, make sure search length is large enough to include all the bursts. Otherwise multi acquisitions will be performed.

Key Path	Meas Setup, Meas Time
Mode	WLAN
Remote Command	[:SENSe] :EVM:TIME:SLENgth <time> [:SENSe] :EVM:TIME:SLENgth? [:SENSe] :EVM:TIME:SEARchlength <real> [:SENSe] :EVM:TIME:SEARchlength?

Example	EVM:TIME:SLEN 1ms EVM:TIME:SLEN?
Notes	Min Value is coupled with Radio Std, Result Length, Guard Interval and Subcarrier Spacing Max Value is coupled with Radio Std, Info BW
Preset	1.0 ms
State Saved	Saved in instrument state.
Min	<p>If Radio Std is 802.11a/g (OFDM) or 801.11g (DSSS-OFDM) If Result Length is set to Man, Min Value will be: $1.17 * (\text{Result Length} + 9) * (1 + \text{Guard Interval}) / \text{Subcarrier Spacing s}$ If Result Length is set to Auto, Min Value will be: $1.17 * (\text{Max Result Length} + 9) * (1 + \text{Guard Interval}) / \text{Subcarrier Spacing}$</p> <p>If Radio Std is 802.11n (20 MHz)/(40 MHz): If Result Length is set to Man, Min Value will be: $1.17 * (\text{Result Length} + 13) * (1 + \text{Guard Interval}) / \text{Subcarrier Spacing s}$ If Result Length is set to Auto, Min Value will be: $1.17 * (\text{Max Result Length} + 13) * (1 + \text{Guard Interval}) / \text{Subcarrier Spacing}$</p> <p>If Radio Std is 802.11ac (20 MHz/40 MHz/80MHz/80M+80MHz/160Hz): If Result Length is set to Man, Min Value will be: $1.17 * (\text{Result Length} + 13) * (1 + \text{Guard Interval}) / \text{Subcarrier Spacing s}$ If Result Length is set to Auto, Min Value will be: $1.17 * (\text{Max Result Length} + 13) * (1 + \text{Guard Interval}) / \text{Subcarrier Spacing}$</p> <p>If Radio Std is 802.11b/g (DSSS/CCK/PBCC): If Result Length is set to Man, Min Value will be: Ceil (Result Length/Chip Rate) usec If Result Length is set to Auto, Min Value will be: Ceil (Max Result Length/Chip Rate) usec</p>
Max	<p>Hardware Dependent: 4000000 / Sampling Rate B25: Sampling Rate = 45M (when info BW is 25MHz); WB (B40 or Wider): Sampling Rate = Info BW * 1.25</p>
Backwards Compatibility SCPI	[:SENSe] :EVM:TIME:SEARCHlength
Initial S/W Revision	A.10.01

Meas Interval

For standard 802.11a/g (OFDM), 801.11g (DSSS-OFDM), 802.11n (20 MHz), 802.11n (40 MHz), 802.11ac (20 MHz), 802.11ac (40 MHz), 802.11ac (80 MHz), 802.11ac (80 + 80 MHz) or 802.11ac(160M):

This parameter specifies the measurement interval (length), in symbol times, of the portion of the OFDM burst that will be analyzed. This analyzed portion of the OFDM burst starts at a measurement offset specified by Meas Offset.

Key Path	Meas Setup, Meas Time
Mode	WLAN
Remote Command	[:SENSe] :EVM:TIME:INTerval <integer> [:SENSe] :EVM:TIME:INTerval?
Example	EVM:TIME:INT 15 EVM:TIME:INT?
Couplings	Default value, Min/Max value, will be coupled with Radio Std
Preset	802.11a/g (OFDM), 801.11g (DSSS-OFDM), 802.11n (20 MHz) , 802.11n (40 MHz) , 802.11ac (20 MHz), 802.11ac (40 MHz), 802.11ac (80 MHz), 802.11ac (80+ 80 MHz) or 802.11ac(160M): 60 symbols 802.11b/g (DSSS/CCK/PBCC): 2794 chips
State Saved	Saved in instrument state.
Min	802.11a/g (OFDM), 801.11g (DSSS-OFDM), 802.11n (20 MHz) or 802.11n (40 MHz) , 802.11ac (20 MHz), 802.11ac (40 MHz), 802.11ac (80 MHz), 802.11ac (80+ 80 MHz) or 802.11ac(160M): 1 symbols 802.11b/g (DSSS/CCK/PBCC): 1 chips
Max	802.11a/g (OFDM), 801.11g (DSSS-OFDM): 1367 symbols 802.11n (20 MHz) or 802.11n (40 MHz) , 802.11ac (20 MHz), 802.11ac (40 MHz), 802.11ac (80 MHz), 802.11ac (80+ 80 MHz) or 802.11ac(160M): 21848 symbols 802.11b/g (DSSS/CCK/PBCC): 96360 chips Max value is also limited by Hardware capability.
Initial S/W Revision	A.10.01

Meas Offset

802.11a/g (OFDM), 801.11g (DSSS-OFDM), 802.11n (20 MHz) or 802.11n (40 MHz):

This parameter specifies the measurement offset, in symbol times, of the portion of the OFDM burst that will be analyzed. The length of this analyzed portion of the OFDM burst is specified by Meas Interval.

802.11b/g (DSSS/CCK/PBCC):

Used to set the measurement offset, in chips, of the portion of the WLAN burst that will be analyzed. The length of this analyzed portion of the WLAN burst is specified by Meas Interval. If the specified measurement offset is less than zero, a value of zero is used instead.

The measurement interval and offset are relative to the ideal starting point of the PLCP preamble portion of the burst. For a signal that uses the long PLCP format, the ideal starting point of the PLCP preamble is exactly 128 symbol times (128*11 chip times) before the start of the SFD sync pattern. For a signal that

uses the short PLCP format, the ideal starting point of the PLCP preamble is exactly 56 symbol times (56*11 chip times) before the start of the SFD sync pattern.

Key Path	Meas Setup, Meas Time
Mode	WLAN
Remote Command	[:SENSe] :EVM:TIME:OFFSet <integer> [:SENSe] :EVM:TIME:OFFSet?
Example	EVM:TIME:OFFS 15 EVM:TIME:OFFS?
Couplings	Default value, Min/Max value, will be coupled with Radio Std and Result Length
Preset	802.11a/g (OFDM), 801.11g (DSSS-OFDM), 802.11n (20 MHz) or 802.11n (40 MHz) , 802.11ac (20 MHz), 802.11ac (40 MHz), 802.11ac (80 MHz), 802.11ac (80+ 80 MHz) or 802.11ac(160M): 0 symbols 802.11b/g (DSSS/CCK/PBCC): 22 chips
State Saved	Saved in instrument state.
Min	802.11a/g (OFDM), 801.11g (DSSS-OFDM), 802.11n (20 MHz) or 802.11n (40 MHz) , 802.11ac (20 MHz), 802.11ac (40 MHz), 802.11ac (80 MHz), 802.11ac (80+ 80 MHz) or 802.11ac(160M): 0 symbols 802.11b/g (DSSS/CCK/PBCC): 0 chips
Max	If Result Length is Auto, then the specified measurement offset will be clipped to be less than or equal to the value of Max Result Length – Meas Interval. If Result Length is Man, then the specified measurement offset will be clipped to be less than or equal to the value of Result Length – Meas Interval.
Initial S/W Revision	A.10.01

Result Length

For 802.11a/g (OFDM) and 801.11g (DSSS-OFDM), when Result Length is Auto, the length of the burst is auto-detected. The result length is determined from the decoded SIGNAL symbol. The value of Max Result Length specifies the maximum result length for the burst; any burst longer than that will be treated as though that were the length of the burst.

When Result Length is Man, you can specify the result length of the burst regardless of the actual length of the burst.

- For 802.11n, if From HT-Sig is On:

The result length is detected from the High Throughput Signal Field. It compares the decode length information to the Max Result Length parameter and uses the smaller value as the measurement result length.

- For 802.11n, if From HT-Sig is Off:

When Result Length is Auto, the analyzer automatically determines the measurement result length by burst search. It compares the detected result length to the Max Result Length parameter and uses the smaller value as the measurement result length.

When Result Length is Man, it compares the input result length to the Result Length parameter and uses the smaller value as the measurement.

Key Path	Meas Setup, Meas Time
Mode	WLAN
Remote Command	[:SENSe]:EVM:TIME:RESult:LENGth <integer> [:SENSe]:EVM:TIME:RESult:LENGth? [:SENSe]:EVM:TIME:RESult[:STATe]:AUTO OFF ON 0 1 [:SENSe]:EVM:TIME:RESult[:STATe]:AUTO?
Example	EVM:TIME:RES:LENG 10 EVM:TIME:RES:LENG? EVM:TIME:RES:AUTO ON EVM:TIME:RES:AUTO?
Couplings	Default value, Min/Max value, will be coupled with Radio Std
Preset	802.11a/g (OFDM), 801.11g (DSSS-OFDM), 802.11n (20 MHz) or 802.11n (40 MHz), 802.11ac (20 MHz), 802.11ac (40 MHz), 802.11ac (80 MHz), 802.11ac (80+ 80 MHz) or 802.11ac(160M): 60 symbols 802.11b/g (DSSS/CCK/PBCC): 2816 chips ON
State Saved	Saved in instrument state.
Min	802.11a/g (OFDM), 801.11g (DSSS-OFDM), 802.11n (20 MHz) or 802.11n (40 MHz), 802.11ac (20 MHz), 802.11ac (40 MHz), 802.11ac (80 MHz), 802.11ac (80+ 80 MHz) or 802.11ac(160M): 2 symbols 802.11b/g (DSSS/CCK/PBCC): 150 chips
Max	802.11a/g (OFDM), 801.11g (DSSS-OFDM): 1367 symbols 802.11n (20 MHz) or 802.11n (40 MHz), 802.11ac (20 MHz), 802.11ac (40 MHz), 802.11ac (80 MHz), 802.11ac (80+ 80 MHz) or 802.11ac(160M): 21848 symbols 802.11b/g (DSSS/CCK/PBCC): 96360 chips Max value is also limited by Hardware capability
Initial S/W Revision	A.10.01

Max Result Length

Max Result Length specifies a maximum result length.

If the auto-detected length is greater than the specified maximum result length, the maximum result length is used instead.

The actual results returned will be for a subset of this maximum, as specified by the Meas Interval and Meas Offset, and will be further limited to the auto-detected result length if that is shorter than the maximum result length.

Key Path	Meas Setup, Meas Time
Mode	WLAN
Remote Command	[:SENSe] :EVM:TIME:RESult:MAX <integer> [:SENSe] :EVM:TIME:RESult:MAX?
Example	EVM:TIME:RES:MAX 45 EVM:TIME:RES:MAX?
Couplings	Default value, Min/Max value, will be coupled with Radio Std
Preset	802.11a/g (OFDM), 801.11g (DSSS-OFDM), 802.11n (20 MHz) or 802.11n (40 MHz) , 802.11ac (20 MHz), 802.11ac (40 MHz), 802.11ac (80 MHz), 802.11ac (80+ 80 MHz) or 802.11ac(160M): 60 symbols 802.11b/g (DSSS/CCK/PBCC): 2816 chips
State Saved	Saved in instrument state.
Min	802.11a/g (OFDM), 801.11g (DSSS-OFDM), 802.11n (20 MHz) or 802.11n (40 MHz) , 802.11ac (20 MHz), 802.11ac (40 MHz), 802.11ac (80 MHz), 802.11ac (80+ 80 MHz) or 802.11ac(160M): 2 symbols 802.11b/g (DSSS/CCK/PBCC): 150 chips
Max	802.11a/g (OFDM), 801.11g (DSSS-OFDM): 1367 symbols 802.11n (20 MHz) or 802.11n (40 MHz) , 802.11ac (20 MHz), 802.11ac (40 MHz), 802.11ac (80 MHz), 802.11ac (80+ 80 MHz) or 802.11ac(160M): 21848 symbols 802.11b/g (DSSS/CCK/PBCC): 96360 chips Max value is also limited by Hardware capability
Backwards Compatibility SCPI	[:SENSe] :EVM:TIME:RESMax <integer> [:SENSe] :EVM:TIME:RESMax?
Initial S/W Revision	A.10.01

From SIG Symbols

- For 802.11n, if From SIG Syms is On:

The result length is detected from the High Throughput Signal Field. It compares the decoded length information to the Max Result Length parameter and uses the smaller value as the measurement result length.

- For 802.11n, if From SIG Syms Off:

When Result Length is Auto, the analyzer automatically determines the measurement result length by burst search. It compares the detected result length to Max Result Length parameter and uses the smaller value as the measurement result length.

When Result Length is Man, it compares the input result length to the Result Length parameter and uses the smaller value as the measurement.

Key Path	Meas Setup, Meas Time
Mode	WLAN
Remote Command	[:SENSe] :EVM:TIME:RESult:SIG OFF ON 0 1 [:SENSe] :EVM:TIME:RESult:SIG?
Example	EVM:TIME:RES:SIG ON EVM:TIME:RES:SIG?
Notes	If Radio Std is not 802.11n (20 MHz)/(40 MHz), it will be grayed out. The result length is determined by decoding the HT-SIG symbols and using the HT Length field. The value of Max Result Length specifies a maximum result length for the pulse; any pulse longer than that will be treated as though that were the length of the pulse.
Dependencies	The key is NOT available when Radio Std is 802.11b/g (DSSS/CCK/PBCC).
Preset	OFF
State Saved	Saved in instrument state.
Range	On Off
Initial S/W Revision	A.10.01

Subcarrier

This parameter specifies whether the demodulation results are for all subcarriers in the signal, or for a single subcarrier , or for just the pilot subcarriers.

Key Path	Meas Setup
Mode	WLAN
Remote Command	:CALCulate:EVM:SUBCarrier ALL PILOt SINGLE :CALCulate:EVM:SUBCarrier?
Example	CALC:EVM:SUBC ALL CALC:EVM:SUBC?
Notes	Only effective in OFDM demodulation, if Radio Std is 802.11b/g (DSSS/CCK/PBCC), this key will be NOT available.
Preset	ALL
State Saved	Saved in instrument state.
Range	All Pilot Single
Readback Text	All Pilot subcarrier number (in integer format, like "Subcarrier 2")
Initial S/W Revision	A.10.01

Subcarrier Number

This parameter specifies the demodulation results are for which subcarrier. When Subcarrier selects "Single", this number will indicate which subcarrier is used to do demodulation.

Key Path	Meas Setup
Mode	WLAN
Remote Command	:CALCulate:EVM:SUBCarrier:COUNT <integer> :CALCulate:EVM:SUBCarrier:COUNT
Example	CALC:EVM:SUBC:COUN 2 CALC:EVM:SUBC:COUN?
Notes	Only be available as in OFDM demodulation and Subcarrier is selected as Single, otherwise this key will be grayed out. For Radio Std 802.11a/g (OFDM), 801.11g (DSSS-OFDM), 802.11n (20 MHz) , 802.11ac (20 MHz) if the value was set to 0, it will change to 1. For Radio Std 802.11n (40MHz), 802.11ac (40MHz), 802.11ac (80MHz) or 802.11ac (80 + 80MHz) , if the value was set to 0, it will be change to 2. For Radio Std 802.11ac (160MHz), if the value was set to 0, it will be change to 6.
Dependencies	Only effective in OFDM demodulation, if Radio Std is 802.11b/g (DSSS/CCK/PBCC), this key will be NOT available.
Couplings	Valid only when Subcarrier selects "Single". Min and Max Value is coupled with Radio Std.
Preset	Radio Std 802.11 ac (160MHz): 6 Others : 2
State Saved	Saved in instrument state.
Min	-26: if Radio Std is 802.11a/g (OFDM), 801.11g (DSSS-OFDM) -28: if Radio Std is 802.11n (20 MHz), 802.11ac (20 MHz). -58: if Radio Std is 802.11n (40 MHz), 802.11ac (40 MHz). -122: if Radio std is 802.11ac (80MHz), 802.11ac (80+80MHz) -250: if Radio std is 802.11ac (160MHz)
Max	26: if Radio Std is 802.11a/g (OFDM), 801.11g (DSSS-OFDM) 28: if Radio Std is 802.11n (20 MHz), 802.11ac (20 MHz). 58: if Radio Std is 802.11n (40 MHz), 802.11ac (40 MHz). 58: if Radio Std is 802.11n (40 MHz), 802.11ac (40 MHz). 122: if Radio std is 802.11ac (80MHz), 802.11ac (80+80MHz) 250: if Radio std is 802.11ac (160MHz)
Initial S/W Revision	A.10.01

Optimize EVM

This is an "immediate action" function. It is used to set the combination of preamp, mechanical and electronic attenuation and IF gain value based on measured signal peak level. Its purpose is to get better EVM results by improving SNR and avoid ADC over load at the same time.

This key is not visible for B25 IF bandwidth option. This key will be gray out if radio standard is 11ac 80+80MHz. and it will not be visible if radio standard is 11b/g.

After this key pressed, Pre adjust for min clip will be changed to off, IF gain auto will be changed to Manu.

Key Path	Meas Setup
Remote Command	[:SENSe] :EVM:OPTimize
Initial S/W Revision	A.14.01

Subcarrier I/Q Estimation

This parameter allows turn On or Off the estimation for IQ Gain Imbalance vs. subcarrier, IQ Quadrature Error vs. subcarrier in the input signal.

Key Path	Meas Setup, Advanced
Mode	WLAN
Remote Command	:CALCulate:EVM:IQEstimation OFF ON 0 1 :CALCulate:EVM:IQEstimation?
Example	CALC:EVM: IQES ON CALC:EVM: IQES?
Notes	The accuracy of the IQ gain imbalance and quadrature error estimation is affected by the receiver's ability to determine the correct ideal reference constellation points for each symbol in the modulated signal. Large IQ impairments may result in incorrect determination of reference points, which will lead to incorrect estimates for the IQ errors. Generally, the receiver can provide correct IQ estimation with greater levels of IQ impairment for lower-order modulation such as QPSK than for higher-order modulation such as 64QAM.
Preset	OFF
State Saved	Saved in instrument state.
Range	On Off
Initial S/W Revision	A.14.01

Limits

Accesses the Limits menu allows you to set the fail/pass criteria of the limit check

Key Path	Meas Setup
Initial S/W Revision	A.10.01

BPSK-1/2 RMS EVM

Sets BPSK coding rate 1/2 RMS EVM limit to warn you if the measured average RMS EVM value exceeds a limit.

Key Path	Meas Setup, Limits
Mode	WLAN

Remote Command	:CALCulate:EVM:LIMit:RMS:BPSK:R1B2 <rel_ampl> :CALCulate:EVM:LIMit:RMS:BPSK:R1B2
Example	CALC:EVM:LIM:RMS:BPSK:R1B2 -20 CALC:EVM:LIM:RMS:BPSK:R1B2?
Notes	This limit value is used in 802.11n and 802.11ac
Preset	-5.00 dB
State Saved	Saved in instrument state.
Min	-1000.00
Max	0
Initial S/W Revision	A.10.01

QPSK-1/2 RMS EVM

Sets QPSK coding rate 1/2 RMS EVM limit to warn you if the measured average RMS EVM value exceeds a limit.

Key Path	Meas Setup, Limits
Mode	WLAN
Remote Command	:CALCulate:EVM:LIMit:RMS:QPSK:R1B2 <rel_ampl> :CALCulate:EVM:LIMit:RMS:QPSK:R1B2
Example	CALC:EVM:LIM:RMS:QPSK:R1B2 -20 CALC:EVM:LIM:RMS:QPSK:R1B2?
Notes	This limit value is used in 802.11n and 802.11ac
Preset	-10.00 dB
State Saved	Saved in instrument state.
Min	-1000.00
Max	0
Initial S/W Revision	A.10.01

QPSK-3/4 RMS EVM

Sets QPSK coding rate 3/4 RMS EVM limit to warn you if the measured average RMS EVM value exceeds a limit.

Key Path	Meas Setup, Limits
Mode	WLAN
Remote Command	:CALCulate:EVM:LIMit:RMS:QPSK:R3B4 <rel_ampl> :CALCulate:EVM:LIMit:RMS:QPSK:R3B4
Example	CALC:EVM:LIM:RMS:QPSK:R3B4 -20

	CALC:EVM:LIM:RMS:QPSK:R3B4?
Notes	This limit value is used in 802.11n and 802.11ac
Preset	-13.00 dB
State Saved	Saved in instrument state.
Min	-1000.00
Max	0
Initial S/W Revision	A.10.01

16QAM-1/2 RMS EVM

Sets 16QAM coding rate 1/2 RMS EVM limit to warn you if the measured average RMS EVM value exceeds a limit.

Key Path	Meas Setup, Limits
Mode	WLAN
Remote Command	:CALCulate:EVM:LIMit:RMS:QA16:R1B2 <rel_ampl> :CALCulate:EVM:LIMit:RMS:QA16:R1B2
Example	CALC:EVM:LIM:RMS:QA16:R1B2 -20 CALC:EVM:LIM:RMS:QA16:R1B2?
Notes	This limit value is used in 802.11n and 802.11ac
Preset	-16.00 dB
State Saved	Saved in instrument state.
Min	-1000.00
Max	0
Initial S/W Revision	A.10.01

16QAM-3/4 RMS EVM

Sets 16QAM coding rate 3/4 RMS EVM limit to warn you if the measured average RMS EVM value exceeds a limit.

Key Path	Meas Setup, Limits
Mode	WLAN
Remote Command	:CALCulate:EVM:LIMit:RMS:QA16:R3B4 <rel_ampl> :CALCulate:EVM:LIMit:RMS:QA16:R3B4?
Example	CALC:EVM:LIM:RMS:QA16:R3B4 -20 CALC:EVM:LIM:RMS:QA16:R3B4?
Notes	This limit value is used in 802.11n and 802.11ac

Preset	-19.00 dB
State Saved	Saved in instrument state.
Min	-1000.00
Max	0
Initial S/W Revision	A.10.01

64QAM-2/3 RMS EVM

Sets 64QAM coding rate 2/3 RMS EVM limit to warn you if the measured average RMS EVM value exceeds a limit.

Key Path	Meas Setup, Limits
Mode	WLAN
Remote Command	:CALCulate:EVM:LIMit:RMS:QA64:R2B3 <rel_ampl> :CALCulate:EVM:LIMit:RMS:QA64:R2B3?
Example	CALC:EVM:LIM:RMS:QA64:R2B3 -20 CALC:EVM:LIM:RMS:QA64:R2B3?
Notes	This limit value is used in 802.11n and 802.11ac
Preset	-22.00 dB
State Saved	Saved in instrument state.
Min	-1000.00
Max	0
Initial S/W Revision	A.10.01

64QAM-3/4 RMS EVM

Sets 64QAM coding rate 3/4 RMS EVM limit to warn you if the measured average RMS EVM value exceeds a limit.

Key Path	Meas Setup, Limits
Mode	WLAN
Remote Command	:CALCulate:EVM:LIMit:RMS:QA64:R3B4 <rel_ampl> :CALCulate:EVM:LIMit:RMS:QA64:R3B4
Example	CALC:EVM:LIM:RMS:QA64:R3B4 -20 CALC:EVM:LIM:RMS:QA64:R3B4?
Notes	This limit value is used in 802.11n and 802.11ac
Preset	-25.00 dB
State Saved	Saved in instrument state.

Min	-1000.00
Max	0
Initial S/W Revision	A.10.01

64QAM-5/6 RMS EVM

Sets 64QAM coding rate 5/6 RMS EVM limit to warn you if the measured average RMS EVM value exceeds a limit.

Key Path	Meas Setup, Limits
Mode	WLAN
Remote Command	:CALCulate:EVM:LIMit:RMS:QA64:R5B6 <rel_ampl> :CALCulate:EVM:LIMit:RMS:QA64:R5B6
Example	CALC:EVM:LIM:RMS:QA64:R5B6 -20 CALC:EVM:LIM:RMS:QA64:R5B6?
Notes	This limit value is used in 802.11n and 802.11ac
Preset	-27.00 dB
State Saved	Saved in instrument state.
Min	-1000.00
Max	0
Initial S/W Revision	A.10.01

256QAM-3/4 RMS EVM

Sets 256QAM coding rate 3/4 RMS EVM limit to warn you if the measured average RMS EVM value exceeds a limit. When the average RMS EVM result exceeds the limit, a red FAIL indicator appears in the PASS/FAIL indication. When the average RMS EVM result is less than the limit, a green PASS indicator appears in the PASS/FAIL indication.

Key Path	Meas Setup, Limits
Mode	WLAN
Remote Command	:CALCulate:EVM:LIMit:RMS:QA256:R3B4 <rel_ampl> :CALCulate:EVM:LIMit:RMS:QA256:R3B4
Example	CALC:EVM:LIM:RMS:QA256:R3B4 -20 CALC:EVM:LIM:RMS:QA256:R3B4?
Notes	This limit value is used in 802.11ac
Preset	-30.00 dB
State Saved	Saved in instrument state.
Min	-1000.00

Max	0
Initial S/W Revision	A.11.01

256QAM-5/6 RMS EVM

Sets 256QAM coding rate 5/6 RMS EVM limit to warn you if the measured average RMS EVM value exceeds a limit. When the average RMS EVM result exceeds the limit, a red FAIL indicator appears in the PASS/FAIL indication. When the average RMS EVM result is less than the limit, a green PASS indicator appears in the PASS/FAIL indication.

Key Path	Meas Setup, Limits
Mode	WLAN
Remote Command	:CALCulate:EVM:LIMit:RMS:QA256:R5B6 <rel_ampl> :CALCulate:EVM:LIMit:RMS:QA256:R5B6
Example	CALC:EVM:LIM:RMS:QA256:R5B6 -20 CALC:EVM:LIM:RMS:QA256:R5B6?
Notes	This limit value is used in 802.11ac
Preset	-32.00 dB
State Saved	Saved in instrument state.
Min	-1000.00
Max	0
Initial S/W Revision	A.11.01

Freq Error

Sets a frequency error limit to warn you if the measured maximum frequency error value exceeds the limit.

Key Path	Meas Setup, Limits
Mode	WLAN
Remote Command	:CALCulate:EVM:LIMit:FERRor <real> :CALCulate:EVM:LIMit:FERRor ?
Example	CALC:EVM:LIM:FERR 15 CALC:EVM:LIM:FERR?
Couplings	If Radio Std is 802.11n (20 MHz) or 802.11n (40 MHz) and Center Frequency is above 5GHz, freq error limit will be coupled to 20.0ppm
Preset	If Radio Std is 802.11a/g (OFDM), 801.11g (DSSS-OFDM), 802.11ac (20 MHz), 802.11ac (40 MHz), 802.11ac (80 MHz), 802.11ac (80 + 80 MHz) or 802.11ac (160MHz): 20.00 ppm If Radio Std is 802.11b/g (DSSS/CCK/PBCC): 25.00 ppm If Radio Std is 802.11n (20 MHz) or 802.11n (40 MHz) : 25.0ppm

State Saved	Saved in instrument state.
Min	0
Max	500 ppm
Initial S/W Revision	A.10.01

Clock Error

Sets a clock error limit to warn you if the measured maximum clock error value exceeds the limit.

Key Path	Meas Setup, Limits
Mode	WLAN
Remote Command	:CALCulate:EVM:LIMit:CLKerror <real> :CALCulate:EVM:LIMit:CLKerror ?
Example	CALC:EVM:LIM:CLK 15 CALC:EVM:LIM:CLK?
Couplings	If Radio Std is 802.11n (20 MHz) or 802.11n (40 MHz) and Center Frequency is above 5GHz, freq error limit will be coupled to 20.0ppm
Preset	If Radio Std is 802.11a/g (OFDM), 801.11g (DSSS-OFDM), 802.11ac (20 MHz), 802.11ac (40 MHz), 802.11ac (80 MHz), 802.11ac (80 + 80 MHz) or 802.11ac (160MHz): 20.00 ppm If Radio Std is 802.11b/g (DSSS/CCK/PBCC): 25.00 ppm If Radio Std is 802.11n (20 MHz) or 802.11n (40 MHz) : 25.0ppm
State Saved	Saved in instrument state.
Min	0
Max	100 ppm
Initial S/W Revision	A.10.01

Center Freq Leakage

Sets Center Freq Leakage limit to warn you if the measured average Center Freq Leakage exceeds the limit.

Key Path	Meas Setup, Limits
Mode	WLAN
Remote Command	:CALCulate:EVM:LIMit:CFLeakage <rel_ampl> :CALCulate:EVM:LIMit: CFLeakage?
Example	CALC:EVM:LIM:CFL -15 CALC:EVM:LIM:CFL?
Preset	If Radio Std is 802.11a/g (OFDM), 801.11g (DSSS-OFDM), 802.11n (20 MHz): -15dB If Radio Std is 802.11n (40 MHz): -20 dB

	If Radio Std is 802.11ac: $-10\log_{10}(N)$ (N is fft length) 11ac20M: -18dB 11ac40M: -21dB 11ac80M: -24dB 11ac160M: -27dB
State Saved	Saved in instrument state.
Min	-100
Max	0
Backwards Compatibility SCPI	:CALCulate:EVM:LIMit:IQOffset <rel_ampl>
Initial S/W Revision	A.10.01

48 Mbits/s RMS EVM

Sets 48 Mbits/s RMS EVM limit to warn you if the measured average RMS EVM value exceeds a limit.

Key Path	Meas Setup, Limits
Mode	WLAN
Remote Command	:CALCulate:EVM:LIMit:RMS:M48 <rel_ampl> :CALCulate:EVM:LIMit:RMS:M48?
Example	CALC:EVM:LIM:RMS:M48 -20 CALC:EVM:LIM:RMS:M48?
Notes	This limit value is used in 802.11a/g (OFDM), 801.11g (DSSS-OFDM)
Preset	-22.00 dB
State Saved	Saved in instrument state.
Min	-1000.00
Max	0
Initial S/W Revision	A.10.01

54 Mbits/s RMS EVM

Sets 54 Mbits/s RMS EVM limit to warn you if the measured average RMS EVM value exceeds a limit.

Key Path	Meas Setup, Limits
Mode	WLAN
Remote Command	:CALCulate:EVM:LIMit:RMS:M54 <rel_ampl> :CALCulate:EVM:LIMit:RMS:M54?
Example	CALC:EVM:LIM:RMS:M54 -20 CALC:EVM:LIM:RMS:M54?

Notes	This limit value is used in 802.11a/g (OFDM), 801.11g (DSSS-OFDM)
Preset	-25.00 dB
State Saved	Saved in instrument state.
Min	-1000.00
Max	0
Initial S/W Revision	A.10.01

RMS EVM

Sets an RMS EVM limit to warn you if the measured average RMS EVM value exceeds a limit.

Key Path	Meas Setup, Limits
Mode	WLAN
Remote Command	:CALCulate:EVM:LIMit:RMS <percent> :CALCulate:EVM:LIMit:RMS?
Example	CALC:EVM:LIM:RMS 20 CALC:EVM:LIM:RMS?
Notes	This limit value is used in 802.11b/g (DSSS/CCK/PBCC)
Preset	16.0 %
State Saved	Saved in instrument state.
Min	0
Max	100.0 %
Initial S/W Revision	A.10.01

1000 Chips EVM

Sets an 1000 Chips EVM limit to warn you if the measured average 1000 Chips value exceeds a limit.

Key Path	Meas Setup, Limits
Mode	WLAN
Remote Command	:CALCulate:EVM:LIMit:CHIP <percent> :CALCulate:EVM:LIMit:CHIP?
Example	CALC:EVM:LIM:CHIP 20 CALC:EVM:LIM:CHIP?
Notes	This limit value is used in 802.11b/g (DSSS/CCK/PBCC)
Preset	35.0 %
State Saved	Saved in instrument state.
Min	0

Max	100.0 %
Initial S/W Revision	A.10.01

RF Carrier Suppression

Sets an RF Carrier Suppression limit to warn you if the measured average RF Carrier Suppression value is less than a limit.

Key Path	Meas Setup, More, Limits
Mode	WLAN
Remote Command	:CALCulate:EVM:LIMit:CARRier <rel_ampl> :CALCulate:EVM:LIMit:CARRier?
Example	CALC:EVM:LIM:CARR 20 CALC:EVM:LIM:CARR?
Notes	This limit value is used in 802.11b/g (DSSS/CCK/PBCC)
Preset	15.00
State Saved	Saved in instrument state.
Min	0
Max	100.00
Initial S/W Revision	A.10.01

6 Mbits/s RMS EVM

Sets 6 Mbits/s RMS EVM limit to warn you if the measured average RMS EVM value exceeds a limit.

Key Path	Meas Setup, Limits
Mode	WLAN
Remote Command	:CALCulate:EVM:LIMit:RMS:M6 <rel_ampl> :CALCulate:EVM:LIMit:RMS:M6?
Example	CALC:EVM:LIM:RMS:M6 -20 CALC:EVM:LIM:RMS:M6?
Notes	This limit value is used in 802.11a/g (OFDM), 801.11g (DSSS-OFDM)
Preset	-5.00 dB
State Saved	Saved in instrument state.
Min	-1000.00
Max	0
Initial S/W Revision	A.10.01

9 Mbits/s RMS EVM

Sets 9 Mbits/s RMS EVM limit to warn you if the measured average RMS EVM value exceeds a limit.

Key Path	Meas Setup, Limits
Mode	WLAN
Remote Command	:CALCulate:EVM:LIMit:RMS:M9 <rel_ampl> :CALCulate:EVM:LIMit:RMS:M9?
Example	CALC:EVM:LIM:RMS:M9 -20 CALC:EVM:LIM:RMS:M9?
Notes	This limit value is used in 802.11a/g (OFDM), 801.11g (DSSS-OFDM)
Preset	-8.00 dB
State Saved	Saved in instrument state.
Min	-1000.00
Max	0
Initial S/W Revision	A.10.01

12 Mbits/s RMS EVM

Sets 12 Mbits/s RMS EVM limit to warn you if the measured average RMS EVM value exceeds a limit.

Key Path	Meas Setup, Limits
Mode	WLAN
Remote Command	:CALCulate:EVM:LIMit:RMS:M12 <rel_ampl> :CALCulate:EVM:LIMit:RMS:M12?
Example	CALC:EVM:LIM:RMS:M12 -20 CALC:EVM:LIM:RMS:M12?
Notes	This limit value is used in 802.11a/g (OFDM), 801.11g (DSSS-OFDM)
Preset	-10.00 dB
State Saved	Saved in instrument state.
Min	-1000.00
Max	0
Initial S/W Revision	A.10.01

18 Mbits/s RMS EVM

Sets 18 Mbits/s RMS EVM limit to warn you if the measured average RMS EVM value exceeds a limit.

Key Path	Meas Setup, Limits
----------	--------------------

Mode	WLAN
Remote Command	:CALCulate:EVM:LIMit:RMS:M18 <rel_ampl> :CALCulate:EVM:LIMit:RMS:M18?
Example	CALC:EVM:LIM:RMS:M18 -20 CALC:EVM:LIM:RMS:M18?
Notes	This limit value is used in 802.11a/g (OFDM), 801.11g (DSSS-OFDM)
Preset	-13.00 dB
State Saved	Saved in instrument state.
Min	-1000.00
Max	0
Initial S/W Revision	A.10.01

24 Mbits/s RMS EVM

Sets 24 Mbits/s RMS EVM limit to warn you if the measured average RMS EVM value exceeds a limit.

Key Path	Meas Setup, Limits
Mode	WLAN
Remote Command	:CALCulate:EVM:LIMit:RMS:M24 <rel_ampl> :CALCulate:EVM:LIMit:RMS:M24?
Example	CALC:EVM:LIM:RMS:M24 -20 CALC:EVM:LIM:RMS:M24?
Notes	This limit value is used in 802.11a/g (OFDM), 801.11g (DSSS-OFDM)
Preset	-16.00 dB
State Saved	Saved in instrument state.
Min	-1000.00
Max	0
Initial S/W Revision	A.10.01

36 Mbits/s RMS EVM

Sets 36 Mbits/s RMS EVM limit to warn you if the measured average RMS EVM value exceeds a limit.

Key Path	Meas Setup, Limits
Mode	WLAN
Remote Command	:CALCulate:EVM:LIMit:RMS:M36 <rel_ampl> :CALCulate:EVM:LIMit:RMS:M36?
Example	CALC:EVM:LIM:RMS:M36 -20

	CALC:EVM:LIM:RMS:M36?
Notes	This limit value is used in 802.11a/g (OFDM), 801.11g (DSSS-OFDM)
Preset	-19.00 dB
State Saved	Saved in instrument state.
Min	-1000.00
Max	0
Initial S/W Revision	A.10.01

Advanced

Accesses advanced features. These features are recommended for use only by advanced users.

Key Path	Meas Setup
Initial S/W Revision	A.10.01

Symbol Timing Adjust

This parameter Symbol Timing Adjust controls how far the FFT part of the symbol is adjusted away from the end of the symbol time. The value is in terms of percent of the used (FFT) part of the symbol time.

Key Path	Meas Setup, Advanced
Mode	WLAN
Remote Command	[:SENSe] :EVM:SYMBol:ADJust <percent> [:SENSe] :EVM:SYMBol:ADJust?
Example	EVM:SYMB:ADJ -3.125 EVM:SYMB:ADJ?
Notes	Only be available in 802.11a/g (OFDM), 801.11g (DSSS-OFDM), 802.11n (20 MHz) or 802.11n (40 MHz), 802.11ac (20 MHz), 802.11ac (40 MHz), 802.11ac (80 MHz), 802.11ac (80 + 80 MHz) or 802.11ac (160MHz) measurement
Couplings	The Min Value of Symbol Timing Adjust is $-100.0 * \text{Guard Interval}$. The value of Symbol Timing Adjust clipped to times of 1/128. (For 11n, Bebob 's support can be clipped to 1/256, to keep simple, we use 1/128 also).
Preset	-3.125%
State Saved	Saved in instrument state.
Min	$-100.0 * \text{Guard Interval}$
Max	0.0
Backwards Compatibility SCPI	[:SENSe] :EVM:TADJust <percent> [:SENSe] :EVM:TADJust?
Initial S/W Revision	A.10.01

Pilot Tracking

802.11 OFDM performs demodulation relative to the data in pilot carriers embedded in the signal. These pilot carriers replace data-carrying elements of the signal and allow some kinds of impairments to be removed or “tracked out”.

Many impairments will be common to all pilot carriers and can be measured and displayed as “common pilot error”.

In addition, several specific tracking functions can be individually switched on and off in the demodulation performed by this measurement. This is a very useful troubleshooting approach, since modulation errors can be examined with and without the benefit of particular types of pilot tracking.

Key Path	Meas Setup, Advanced
Initial S/W Revision	A.10.01

Track Amplitude

Track Amplitude specifies whether the analyzer tracks amplitude changes in the pilot subcarriers. When Track Amplitude is selected, the analyzer applies pilot subcarrier amplitude error correction to the pilot and data subcarriers. This is in addition to Track Phase and Track Timing error correction, if selected.

Key Path	Meas Setup, Advanced, Pilot Track
Mode	WLAN
Remote Command	:CALCulate:EVM:PIlot:TRACk:AMPLitude OFF ON 0 1 :CALCulate:EVM:PIlot:TRACk:AMPLitude?
Example	CALC:EVM:PIL:TRAC:AMPL 1 CALC:EVM:PIL:TRAC:AMPL?
Notes	Only used in 802.11a/g (OFDM), 801.11g (DSSS-OFDM), 802.11n (20 MHz) or 802.11n (40 MHz), 802.11ac (20 MHz), 802.11ac (40 MHz), 802.11ac (80 MHz), 802.11ac (80 + 80 MHz) or 802.11ac (160MHz) measurement
Preset	OFF
State Saved	Saved in instrument state.
Range	On Off
Backwards Compatibility SCPI	[:SENSe] :EVM:TRACk:AMP OFF ON 0 1 [:SENSe] :EVM:TRACk:AMP?
Initial S/W Revision	A.10.01

Track Phase

The Track Phase parameter specifies whether the analyzer tracks phase changes in the pilot subcarriers. When Track Phase is selected, the analyzer applies pilot subcarrier phase error correction to the pilot and data subcarriers. This is in addition to Track Amplitude and Track Timing error correction if selected.

Key Path	Meas Setup, Advanced, Pilot Track
Mode	WLAN
Remote Command	:CALCulate:EVM:PILot:TRACk:PHASe OFF ON 0 1 :CALCulate:EVM:PILot:TRACk:PHASe?
Example	CALC:EVM:PIL:TRAC:PHAS 0 CALC:EVM:PIL:TRAC:PHAS?
Notes	Only used in 802.11a/g (OFDM), 801.11g (DSSS-OFDM), 802.11n (20 MHz) or 802.11n (40 MHz), 802.11ac (20 MHz), 802.11ac (40 MHz), 802.11ac (80 MHz), 802.11ac (80 + 80 MHz) or 802.11ac (160MHz) measurement
Preset	ON
State Saved	Saved in instrument state.
Range	On Off
Initial S/W Revision	A.10.01

Track Timing

The Track Timing parameter specifies whether the analyzer tracks timing changes in the pilot subcarriers. When Track Timing is selected the analyzer applies pilot subcarrier timing error correction (frequency offset correction) to the pilot and data subcarriers. This is in addition to Track Amplitude and Track Phase error correction if selected.

Key Path	Meas Setup, Advanced, Pilot Track
Mode	WLAN
Remote Command	:CALCulate:EVM:PILot:TRACk:TIMing OFF ON 0 1 :CALCulate:EVM:PILot:TRACk:TIMing?
Example	CALC:EVM:PIL:TRAC:TIM 1 CALC:EVM:PIL:TRAC:TIM?
Notes	Only used in 802.11a/g (OFDM), 801.11g (DSSS-OFDM), 802.11n (20 MHz) or 802.11n (40 MHz), 802.11ac (20 MHz), 802.11ac (40 MHz), 802.11ac (80 MHz), 802.11ac (80 + 80 MHz) or 802.11ac (160MHz) measurement
Preset	OFF
State Saved	Saved in instrument state.
Range	On Off
Backwards Compatibility SCPI	[:SENSe] :EVM:TRACk:TIMing
Initial S/W Revision	A.10.01

Sync Training Sequence

This parameter specifies synchronization method to use when synchronizing to the start of the OFDM burst.

A value of Short means to search for and synchronize to an 802.11a/g (OFDM) preamble short symbol sequence.

A value of Long means to search for and synchronize to an 802.11a/g (OFDM) preamble long symbol sequence (also called the channel estimation sequence).

Key Path	Meas Setup, More, Advanced
Mode	WLAN
Remote Command	[:SENSe] :EVM:STSequence LONG SHORT [:SENSe] :EVM:STSequence?
Example	EVM:STS LONG EVM:STS?
Notes	Only used in 802.11a/g (OFDM), 801.11g (DSSS-OFDM) measurement, otherwise it will be grayed out. Forceful message “-221 Setting Conflict, Sync Training Sequence is not available for current Radio Setting”
Preset	SHORT
State Saved	Saved in instrument state.
Backwards Compatibility SCPI	[:SENSe] :EVM:SYNCseq LONG SHORT [:SENSe] :EVM:SYNCseq?
Initial S/W Revision	A.10.01

Equalizer Training

This specifies how the equalizer is initialized, or “trained”. The valid values are Channel Estimation Seq Only and Channel Estimation Seq & Data. The value Channel Estimation Seq Only, which is the default, specifies that the equalizer is trained using only the channel estimation sequence (also called the “long sync”) portion of the burst preamble. The 802.11a/g/n standards imply that the equalizer should be implemented this way when measuring EVM, and this matches how a real receiver would probably implement an equalizer.

The value and Channel Estimation Seq & Data specifies that the equalizer should be trained using both the channel estimation sequence and the entire data portion of the burst. This usually gives a more accurate estimate of the equalizer response. It also typically lowers the EVM by between one and three dB.

Key Path	Meas Setup, Advanced
Mode	WLAN
Remote Command	:CALCulate:EVM:EQUalizer:TMODe SEquence SDATa :CALCulate:EVM:EQUalizer:TMODe?
Example	CALC:EVM:EQU:TMOD SDAT CALC:EVM:EQU:TMOD?

Notes	Only used in 802.11a/g (OFDM), 801.11g (DSSS-OFDM), 802.11n (20 MHz) or 802.11n (40 MHz), 802.11ac (20 MHz), 802.11ac (40 MHz), 802.11ac (80 MHz), 802.11ac (80 + 80 MHz) or 802.11ac (160MHz) measurement
Preset	SEQ
State Saved	Saved in instrument state.
Range	Channel Est Seq Only Channel Est Seq&Data
Readback Text	Channel Est Seq Only Channel Est Seq & Data
Backwards Compatibility SCPI	[[:SENSE]:EVM:EQualizer:TRaining SEquence SDATA [:SENSE]:EVM:EQualizer:TRaining?
Initial S/W Revision	A.10.01

I/Q Normalize

This parameter specifies if the I/Q signals will be normalized.

Key Path	Meas Setup, Advanced
Mode	WLAN
Remote Command	:CALCulate:EVM:IQNorm OFF ON 0 1 :CALCulate:EVM:IQNorm?
Example	CALC:EVM:IQN ON CALC:EVM:IQN?
Preset	ON
State Saved	Saved in instrument state.
Range	On Off
Backwards Compatibility SCPI	[[:SENSE]:EVM:IQNorm OFF ON 0 1 [:SENSE]:EVM:IQNorm?
Initial S/W Revision	A.10.01

I/Q Compensation

This parameter allows to turn On or Off the compensation for IQ Gain Imbalance, IQ Quadrature Error, and IQ Timing Skew found in the input signal.

Key Path	Meas Setup, Advanced, More
Mode	WLAN
Remote Command	[[:SENSe]:EVM:COMPensate OFF ON 0 1 [:SENSe]:EVM:COMPensate?
Example	EVM:COMP ON EVM:COMP?

Notes	If the Radio Std is not 802.11n, it will be grayed out .Forceful message “-221 Setting conflict, IQ Compensation is not available for current Radio Setting”
Preset	Off
State Saved	Saved in instrument state.
Range	On Off
Initial S/W Revision	A.10.01

IF Gain

Accesses the menu that sets ranging in the digital IF when acquiring an I/Q time record.

See "[More Information about IF Gain](#)" on page 1799.

Key Path	Meas Setup, Advanced
Initial S/W Revision	A.10.01

More Information about IF Gain

To take full advantage of the RF dynamic range of the analyzer, you can manually turn on or turn off a switched digital IF amplifier. When it is turned on, the signal will get approximately 10 dB of gain.

- Setting IF Gain to Man and selecting High Gain will turn on the digital IF amplifier and get an extra 10 dB gain.
- Setting IF Gain to Auto will activate the Auto rules for IF Gain.

These settings affect sensitivity and IF overloads.

IF Gain Auto

Activates the Auto Rules for IF Gain. When Auto is active, the IF Gain is set to High Gain under any of the following conditions:

- the input attenuator is set to 0 dB
- the preamp is turned On
- the Max Mixer Level is -20 dBm or lower

For other settings, Auto sets IF Gain to Off.

Key Path	Meas Setup, More, Advanced, More
Mode	WLAN
Remote Command	[:SENSe] :EVM:IF:GAIN:AUTO [:STATe] ON OFF 1 0 [:SENSe] :EVM:IF:GAIN:AUTO [:STATe] ?
Example	EVM:IF:GAIN:AUTO ON EVM:IF:GAIN:AUTO?

Couplings	When either the auto attenuation is active (for example, with an electrical attenuator), or the optimize mechanical attenuator range is requested, the IF Gain setting is changed using the following rule. The Auto selection sets IF Gain On under any of the following conditions: the input attenuator is set to 0 dB the preamp is turned on, the Max Mixer Level is -20 dBm or lower. For other settings, Auto sets IF Gain to Off.
Preset	OFF
State Saved	Saved in instrument state.
Range	Auto Man
Initial S/W Revision	A.10.01

Other

This specifies the IF gain value. When IF gain is set to Other, this value will be used.

Key Path	Meas Setup, More, Advanced , More,IF Gain
Mode	WLAN
Remote Command	[:SENSe] :EVM:IF:GAIN:LEVel <rel_ampl > [:SENSe] :EVM:IF:GAIN:LEVel?
Example	EVM:IF:GINT:VAL -10 EVM:IF:GINT:VAL?
Couplings	It is not available for B25 IF bandwidth option. It would be changed after pressing optimize EVM.
Preset	0
State Saved	Saved in instrument state.
Min	-12
Max	12
Initial S/W Revision	A.14.01

IF Gain Select

Selects the range of IF gain.

- High gain: set 10dB IF gain for better noise level measurements.
- Low gain: set 0dB IF gain for large signals.
- Other: allow to set arbitrary IF gain value within -12dB to 12dB. This selection is not available for B25 If bandwidth option.

When this parameter is changed, IF Gain Auto will become Man.

Key Path	Meas Setup, More, Advanced , More,IF Gain
Mode	WLAN
Remote Command	[:SENSe] :EVM:IF:GAIN:SElect LOW HIGH OTHer [:SENSe] :EVM:IF:GAIN:SElect?
Example	EVM:IF:GINT:LEV LOW EVM:IF:GINT:LEV?
Notes	“Other” selection will be invisible for B25 IF bandwidth option.
Preset	LOW
State Saved	Saved in instrument state.
Range	Low High Other
Initial S/W Revision	A.14.01

Mode	WLAN
Remote Command	[:SENSe] :EVM:IF:GAIN[:STATe] ON OFF 1 0 [:SENSe] :EVM:IF:GAIN[:STATe] ?
Notes	ON aliases to "IF Gain High" (:EVM:IF:GINT:LEV HIGH) OFF aliases to "IF Gain Low" (:EVM:IF:GINT:LEV LOW)
Initial S/W Revision	A.10.01

Spectrum

Sets a spectrum to either normal or to inverted for demodulation related measurements. If set to INVert, the upper and lower spectrums are swapped.

The invert function conjugates the spectrum, which is equivalent to taking the negative of the quadrature component in demodulation. The correct setting (Normal or Invert) depends on whether the signal at the input of the instrument has a high or a low side mix.

Key Path	Meas Setup, Advanced, More
Mode	WLAN
Remote Command	:CALCulate:EVM:SPECTrum INVert NORMal :CALCuate:EVM:SPECTrum?
Example	CALC:EVM:SPEC INV CALC:EVM:SPEC?
Preset	NORMal
State Saved	Saved in instrument state.
Range	Normal Invert
Backwards Compatibility SCPI	[:SENSe] :EVM:MIRRorspec OFF ON 0 1 [:SENSe] :EVM:MIRRorspec?
Initial S/W Revision	A.10.01

PhNoise Opt

The Phase Noise Optimization setting affects the phase noise distribution on the analyzer's LO.

Key Path	Meas Setup, Advanced
Mode	WLAN
Remote Command	[:SENSe] :EVM:FREQuency:SYNThesis [:STATe] 1 2 3 [:SENSe] :EVM:FREQuency:SYNThesis [:STATe] ?
Example	EVM:FREQ:SYNT 1 EVM:FREQ:SYNT?
Notes	<p>Parameter:</p> <p>1: Best Close-in Φ Noise, optimizes phase noise for small frequency offsets from the carrier.</p> <p>2: Best Wide-offset Φ Noise, optimizes phase noise for wide frequency offsets from the carrier.</p> <p>3: Fast Tuning, optimizes LO for tuning speed</p> <p>The actual behavior varies somewhat depending on model number and option; you always get fast tuning by choosing #3, but in some models, the “Fast Tuning” choice is identical to the “Best Close-In” choice. Specifically:</p> <ul style="list-style-type: none"> • Models with option EP1 (for example PXA), have a two-loop local oscillator, which switches to a single loop for fast tuning • Models with option EP2 (available, for example, for MXA), use a different loop bandwidth for the fast-tuning choice, which is a compromise between tuning speed and phase noise, giving good tuning speed at all offsets, although not as good as for Close-In; this is useful when you have to look across a wide range of spans <p>In all other cases, Fast Tuning is the same as Best Close-In.</p>
Dependencies	Does not appear in all models. The key is blank in those models, but the SCPI command is accepted for compatibility (although no action is taken).
Preset	Default value is different depend on hardware configuration. Models with option EP2 (available, for example, for MXA), default value is 3; For other cases, default value is 2.
State Saved	Saved in instrument state.
Readback Text	Close-in Wide-offset Fast Tuning

PhNoise Opt

Selects the LO (local oscillator) phase noise behavior for various desired operating conditions.

Key Path	Meas Setup
Remote Command	[:SENSe] :FREQuency:SYNThesis [:STATe] 1 2 3 [:SENSe] :FREQuency:SYNThesis [:STATe] ?
Example	FREQ:SYNT 2 selects optimization for best wide offset phase noise
Notes	Parameter:

	<p>1: optimizes phase noise for small frequency offsets from the carrier.</p> <p>2: optimizes phase noise for wide frequency offsets from the carrier.</p> <p>3: optimizes LO for tuning speed</p> <p>The actual behavior varies somewhat depending on model number and option; you always get fast tuning by choosing #3, but in some models, the “Fast Tuning” choice is identical to the “Best Close-In” choice. Specifically:</p> <ul style="list-style-type: none"> • Models with option EP1 (for example PXA), have a two-loop local oscillator, which switches to a single loop for fast tuning • Models with option EP2 (available, for example, for MXA), use a different loop bandwidth for the fast-tuning choice, which is a compromise between tuning speed and phase noise, giving good tuning speed at all offsets, although not as good as for Close-In; this is useful when you have to look across a wide range of spans • In all other cases, Fast Tuning is the same as Best Close-In.
Dependencies	Does not appear in all models. The key is blank in those models, but the SCPI command is accepted for compatibility (although no action is taken).
Preset	Because this function is in Auto after preset, and because Span after preset > 314.16 kHz (see Auto rules, next section) the state of this function after Preset will be 2
Initial S/W Revision	Prior to A.02.00
Modified at S/W Revision	A.12.00

Best Close-in Φ Noise

The LO phase noise is optimized for smaller offsets from the carrier, at the expense of phase noise farther out.

The actual frequency offset within which noise is optimized is shown with in square brackets, as this can vary depending on the hardware set in use. For example, in some analyzers this annotation appears as [offset <20 kHz]

Key Path	Meas Setup, PhNoise Opt
Example	FREQ:SYNT 1
Couplings	<p>The frequency below which the phase noise is optimized is model dependent:</p> <p>PXA with option EP1: [offset <140 kHz]</p> <p>Models with option EP2: [offset <70 kHz]</p> <p>CXA with option EP4: [offset <90 kHz]</p> <p>CXA without option EP4: n/a</p> <p>All other models: [offset <20 kHz]</p>
Readback	<p>Close-in.</p> <p>If manually selected the “Man” will be underlined.</p>
Initial S/W Revision	Prior to A.02.00
Modified at S/W Revision	A.12.00

Best Wide-offset Φ Noise

The LO phase noise is optimized for wider offsets from the carrier. Optimization is especially improved for offsets from 70 kHz to 300 kHz. Closer offsets are compromised and the throughput of measurements (especially remote measurements where the center frequency is changing rapidly), is reduced.

The actual frequency offset beyond which noise is optimized is shown with in square brackets, as this can vary depending on the hardware set in use. For example, in some analyzers this annotation appears as [offset >30 kHz]

Key Path	Meas Setup, PhNoise Opt
Example	FREQ:SYNT 2
Couplings	The frequency below which the phase noise is optimized is model dependent: PXA with option EP1: [offset >160 kHz] Models with option EP2: [offset >100 kHz] CXA with option EP4: [offset >130 kHz] CXA without option EP4: n/a All other models: [offset >30 kHz]
Readback	Wide-offset. If manually selected the “Man” will be underlined.
Initial S/W Revision	Prior to A.02.00
Modified at S/W Revision	A.12.00

Fast Tuning

In this mode, the LO behavior compromises phase noise at many offsets from the carrier in order to allow rapid measurement throughput when changing the center frequency or span. The term “fast tuning” refers to the time it takes to move the local oscillator to the start frequency and begin a sweep; this setting does not impact the actual sweep time in any way.

In this mode in PXA, the LO behavior compromises phase noise at offsets below 4 MHz in order to improve measurement throughput. The throughput is especially affected when moving the LO more than 2.5 MHz and up to 10 MHz from the stop frequency to the next start frequency.

(In models whose hardware does not provide for a fast tuning option, the settings for Best Close-in Φ Noise are used if Fast Tuning is selected. This gives the fastest possible tuning for that hardware set.)

Key Path	Meas Setup, PhNoise Opt
Example	FREQ:SYNT 3
Couplings	The Fast Tuning details are model dependent: CXA without option EP4: n/a PXA with option EP1: [single loop] Models with option EP2: [medium loop bandwidth] All other models: [same as Close-in]
State Saved	Saved in instrument state.

Readback	Fast Tuning. If manually selected the “Man” will be underlined.
Initial S/W Revision	Prior to A.02.00
Modified at S/W Revision	A.12.00

Chip Rate

This specifies the fundamental chip rate of the signal to be analyzed. The value should be positive and default is 11 MHz, which matches the chip rate of 802.11b/g.

The only special case is the optional 802.11g 33Mbit PBCC mode. In this mode, the chip rate of the transmitted signal starts at 11 MHz, but changes to 16.5 MHz in the middle of the burst. For signals of this type, the CHIP_RATE should still be specified as 11 MHz, and the measurement will automatically switch to 16.5 MHz at the appropriate place in the burst.

Key Path	Meas Setup, Advanced
Mode	WLAN
Remote Command	[:SENSe] :EVM:CRATe <frequency> [:SENSe] :EVM:CRATe?
Example	EVM:CRAT 11MHz EVM:CRAT?
Notes	Only used in 802.11b/g (DSSS/CCK/PBCC) measurement
Preset	11.0 MHz
State Saved	Saved in instrument state.
Min	1.0 MHz
Max	25.0 MHz
Backwards Compatibility SCPI	[:SENSe] :EVM:CHPRate <frequency> [:SENSe] :EVM:CHPRate?
Initial S/W Revision	A.10.01

Clock Adjust

In a normal measurement, the signal is synchronized to the chip timing. In unusual cases, it is possible for the synchronization to be off slightly. This parameter allows the user to specify a timing offset which is added to the chip timing detected. This parameter should only be used when trying to debug unusual signals.

The maximum valid value for this parameter is 0.5 chips, and the minimum valid value is -0.5 chips.

Key Path	Meas Setup, Advanced
Mode	WLAN

Remote Command	<code>[:SENSe] :EVM :CADJust <real></code> <code>[:SENSe] :EVM :CADJust ?</code>
Example	<code>EVM :CADJ -0.1</code> <code>EVM :CADJ ?</code>
Notes	Only used in 802.11b/g (DSSS/CCK/PBCC) measurement
Preset	0 chips
State Saved	Saved in instrument state.
Min	-0.50 chips
Max	0.50 chips
Initial S/W Revision	A.10.01

Equalizer

This parameter specifies the total length of the equalizer filter's impulse response, in chips.

The minimum valid value for Equalizer Len is 3. The maximum valid value is 99, and also must be less than either Max Result Length or Result Length. The value must be an odd number. The impulse response is centered, so that it extends $(EQ_FILT_LEN-1)/2$ chips on either side of $t=0$.

Key Path	Meas Setup, Advanced
Mode	WLAN
Remote Command	<code>[:SENSe] :EVM :EQualizer :LENGth <integer></code> <code>[:SENSe] :EVM :EQualizer :LENGth ?</code> <code>[:SENSe] :EVM :EQualizer [:STATe] OFF ON 0 1</code> <code>[:SENSe] :EVM :EQualizer [:STATe] ?</code>
Example	<code>EVM :EQU :LENG 23</code> <code>EVM :EQU :LENG ?</code> <code>EVM :EQU ON</code> <code>EVM :EQU ?</code>
Notes	Only used in 802.11b/g (DSSS/CCK/PBCC) measurement
Couplings	Max Value is coupled with Result Length and Max Result Length
Preset	21 chips OFF
State Saved	Saved in instrument state.
Min	3
Max	If Result Length Sel is set to Auto, Min (99, Max Result Length) If Result Length Sel is set to Man, Min (99, Result Length)
Initial S/W Revision	A.10.01

Descramble

This parameter specifies what type of descrambling to do when producing bit vector results. The valid values are: All, None, Preamble Only, Preamble & Header Only. None means no descrambling is done at all. Preamble Only means only the PLCP preamble is descrambled. Preamble & Header Only means that the PLCP preamble and PLCP header are descrambled. All means that all parts of the burst are descrambled.

Normally, an 802.11b/g signal has all bits scrambled before transmission, so normally you would want to descramble all of the bitvector results. However, when debugging an 802.11b/g transmitter, it is sometimes helpful to disable scrambling in the transmitter, in which case you would disable descrambling.

Key Path	Meas Setup, Advanced
Mode	WLAN
Remote Command	[:SENSe] :EVM:DESCramble ALL NONE PONLy PHONLy [:SENSe] :EVM:DESCramble?
Example	EVM:DESC NONE EVM:DESC?
Notes	Only used in 802.11b/g (DSSS/CCK/PBCC) measurement
Preset	ALL
State Saved	Saved in instrument state.
Range	All None Preamble Only Preamble & Header Only
Readback Text	All None Preamble Pre. & Header
Backwards Compatibility SCPI	[:SENSe] :EVM:PREamble ALL NONE PONLy PHONLy [:SENSe] :EVM:PREamble?
Initial S/W Revision	A.10.01

Track Phase

This parameter specifies whether to perform phase tracking, to track carrier frequency changes during the course of the WLAN burst. The default is FALSE, because the 802.11b/g standards do not appear to call for phase tracking. If this parameter is TRUE, phase tracking is performed after all frequency/phase/timing synchronization, and before any equalization or computation of EVM.

Key Path	Meas Setup, Advanced
Mode	WLAN
Remote Command	:CALCulate:EVM:TRACk:PHASe OFF ON 0 1 :CALCulate:EVM:TRACk:PHASe?
Example	CALC:EVM:TRAC:PHAS ON CALC:EVM:TRAC:PHAS?
Notes	Only used in 802.11b/g (DSSS/CCK/PBCC) measurement
Preset	OFF

State Saved	Saved in instrument state.
Range	On Off
Initial S/W Revision	A.10.01

Meas Preset

Returns parameters for the current measurement to those set by the factory.

Key Path	Meas Setup, More
Mode	WLAN
Remote Command	:CONFigure:EVM
Example	CONF:EVM
Initial S/W Revision	A.10.01

Filter

Accesses Filter settings. These settings are used only for 802.11b/g (DSSS/CCK/PBCC) standard.

Key Path	Meas Setup
Initial S/W Revision	A.10.01

Reference Filter

This parameter controls the reference filter type used when computing the reference data for computing EVM

Key Path	Meas Setup, Filter
Remote Command	[:SENSe] :EVM :FILTer :REFerence :TYPE GAUSSian RECT RC [:SENSe] :EVM :FILTer :REFerence :TYPE?
Example	EVM:FILT:REF:TYPE GAUS EVM:FILT:REF:TYPE?
Notes	Only used in 802.11b/g (DSSS/CCK/PBCC) measurement
Preset	RECT
State Saved	Saved in instrument state.
Range	Gaussian Rect Raised Cosine
Readback Text	Gaussian Rect Raised Cosine
Initial S/W Revision	A.10.01

Alpha/BT

This parameter is used only when the Reference Filter is set to “GAUSSIAN” or “Raised Cosine”, or the Measurement filter is set to “RRC”. In these cases, this parameter controls the bT value for the Gaussian filter and alpha values for Raised Cosine and RRC filters.

Key Path	Meas Setup, Filter
Mode	WLAN
Remote Command	<code>[:SENSe] :EVM:FILTer:ALPHa <real></code> <code>[:SENSe] :EVM:FILTer:ALPHa?</code>
Example	<code>EVM:FILT:ALPH 0.5</code> <code>EVM:FILT:ALPH?</code>
Notes	Only be available in 802.11 b/g (DSSS/CCK/PBCC) measurement
Couplings	Max Value is coupled with Reference Filter
Preset	0.50
State Saved	Saved in instrument state.
Min	0.05
Max	When Reference Filter is set to Gaussian:100.00 When Reference Filter is set to Raised Cosine: 1.00
Backwards Compatibility SCPI	<code>[:SENSe] :EVM:FILTer:BT <real></code> <code>[:SENSe] :EVM:FILTer:BT?</code>
Initial S/W Revision	A.10.01

Measurement Filter

This parameter controls the measurement filter type used for computing EVM.

Key Path	Meas Setup, Filter
Mode	WLAN
Remote Command	<code>[:SENSe] :EVM:FILTer:MEASurement:TYPE NONE RRC</code> <code>[:SENSe] :EVM:FILTer:MEASurement:TYPE?</code>
Example	<code>EVM:FILT:MEAS:TYPE RRC</code> <code>EVM:FILT:MEAS:TYPE?</code>
Notes	Only be available in 802.11 b/g (DSSS/CCK/PBCC) measurement
State Saved	Saved in instrument state.
Range	None RRC
Initial S/W Revision	A.10.01

15 WLAN Modulation Analysis measurement
Mode

Mode

See "[Mode](#)" on page 288

Mode Preset

Returns the active mode to a known state.

Mode Preset does the following for the currently active mode:

- Aborts the currently running measurement.
- Brings up the default menu for the mode, with no active function.
- Sets measurement Global settings to their preset values for the active mode only.
- Activates the default measurement.
- Brings up the default menu for the mode.
- Clears the input and output buffers.
- Sets Status Byte to 0.

Mode Preset does not:

- Cause a mode switch
- Affect mode persistent settings
- Affect system settings
- See "[How-To Preset](#)" on page 1812 for more information.

Key Path	Front-panel key
Remote Command	:SYSTem:PRESet
Example	:SYST:PRES
Notes	*RST is preferred over :SYST:PRES for remote operation. *RST does a Mode Preset, as done by the :SYST:PRES command, and it sets the measurement mode to Single measurement rather than Continuous for optimal remote control throughput. Clears all pending OPC bits. The Status Byte is set to 0.
Couplings	A Mode Preset aborts the currently running measurement, activates the default measurement, and gets the mode to a consistent state with all of the default couplings set.
Backwards Compatibility Notes	In the X-Series, the legacy "Factory Preset" has been replaced with Mode Preset, which only presets the currently active mode, not the entire instrument. In the X-Series, the way to preset the entire instrument is by using System, Restore System Defaults All, which behaves essentially the same way as restore System Defaults does on ESA and PSA. There is also no "Preset Type" as there is on the PSA. There is a green Mode Preset front-panel key that does a Mode Preset and a white-with-green-letters User Preset front-panel key that does a User Preset. The old PRESet:TYPE command is ignored (without generating an error), and SYST:PRES without a parameter does a Mode Preset, which should cover most backward code compatibility issues. The settings and correction data under the Input/Output front-panel key (examples: Input Z Corr, Ext Amp Gain, etc.) are no longer part of any Mode, so they will not be preset by a Mode Preset. They are preset using Restore Input/Output Defaults, Restore System Defaults All. Note that because User Preset does a Recall State, and all of these settings are saved in State, they ARE recalled when using

	User Preset.
Initial S/W Revision	Prior to A.02.00

How-To Preset

The table below shows all possible presets, their corresponding SCPI commands and front-panel access (key paths). Instrument settings depend on the current measurement context. Some settings are local to the current measurement, some are global (common) across all the measurements in the current mode, and some are global to all the available modes. In a similar way, restoring the settings to their preset state can be done within the different contexts.

Auto Couple - is a measurement local key. It sets all Auto/Man parameter couplings in the measurement to Auto. Any Auto/Man selection that is local to other measurements in the mode will not be affected.

Meas Preset - is a measurement local key. Meas Preset resets all the variables local to the current measurement except the persistent ones.

Mode Preset - resets all the current mode's measurement local and measurement global variables except the persistent ones.

Restore Mode Defaults - resets ALL the Mode variables (and all the Meas global and Meas local variables), including the persistent ones.

Type Of Preset	SCPI Command	Front Panel Access
Auto Couple	:COUPle ALL	Auto Couple front-panel key
Meas Preset	:CONFigure:<Measurement>	Meas Setup Menu
Mode Preset	:SYSTem:PRESet	Mode Preset (green key)
Restore Mode Defaults	:INSTrument:DEFault	Mode Setup Menu
Restore All Mode Defaults	:SYSTem:DEFault MODes	System Menu; Restore System Default Menu
*RST	*RST	not possible (Mode Preset with Single)
Restore Input/Output Defaults	:SYSTem:DEFault INPUt	System Menu; Restore System Default Menu
Restore Power On Defaults	:SYSTem:DEFault PON	System Menu; Restore System Default Menu
Restore Alignment Defaults	:SYSTem:DEFault ALIGN	System Menu; Restore System Default Menu
Restore Miscellaneous Defaults	:SYSTem:DEFault MISC	System Menu; Restore System Default Menu
Restore All System Defaults	:SYSTem:DEFault [ALL] :SYSTem:PRESet:PERsistent	System Menu; Restore System Default Menu
User Preset	:SYSTem:PRESet:USER	User Preset Menu
User Preset All Modes	:SYSTem:PRESet:USER:ALL	User Preset Menu

Power On Mode Preset	:SYSTem:PON:TYPE MODE	System Menu
Power On User Preset	:SYSTem:PON:TYPE USER	System Menu
Power On Last State	:SYSTem:PON:TYPE LAST	System Menu

Mode Setup

See "[Mode Setup](#)" on page 320

Peak Search

Displays the Peak Search menu and places the selected marker on the trace point with the maximum y-axis value for that marker's trace.

Key Path	Peak Search
Mode	WIMAXOFDMA
Remote Command	:CALCulate:EVM:MARKer [1] 2 . . . 12:MAXimum
Example	CALC:EVM:MARK2:MAX
Initial S/W Revision	Prior to A.02.00

Next Peak

Moves the selected marker to the peak that has the next highest amplitude that is less than the marker's current value.

Key Path	Peak Search
Mode	WIMAXOFDMA
Remote Command	:CALCulate:EVM:MARKer [1] 2 . . . 12:MAXimum:NEXT
Example	CALC:EVM:MARK2:MAX:NEXT
Initial S/W Revision	Prior to A.02.00

Next Pk Right

Moves the selected marker to the next peak to the right of the current marker.

Key Path	Peak Search
Mode	WIMAXOFDMA
Remote Command	:CALCulate:EVM:MARKer [1] 2 . . . 12:MAXimum:RIGHT
Example	CALC:EVM:MARK2:MAX:RIGH
Initial S/W Revision	Prior to A.02.00

Next Pk Left

Moves the selected marker to the next peak to the left of the current marker.

Key Path	Peak Search
Mode	WIMAXOFDMA
Remote Command	:CALCulate:EVM:MARKer [1] 2 . . . 12:MAXimum:LEFT
Example	CALC:EVM:MARK2:MAX:LEFT
Initial S/W Revision	Prior to A.02.00

Marker Delta

Performs the same function as the Delta 1-of-N selection key in the Marker menu. This sets the control mode for the selected marker to Delta mode. The softkey enables you to conveniently perform a peak search and change the marker's control mode to Delta without having to access two separate menus.

Key Path	Peak Search
Initial S/W Revision	Prior to A.02.00

Pk-Pk Search

Finds and displays the amplitude and frequency (or time, if in zero span) differences between the highest and lowest y-axis value.

Key Path	Peak Search, More
Mode	WIMAXOFDMA
Remote Command	:CALCulate:EVM:MARKer[1] 2 ...12:PTPeak
Example	CALC:EVM:MARK:PTP
Notes	Turns on the Marker Δ active function.
Dependencies	This key is not available when Coupled Markers is on.
Initial S/W Revision	Prior to A.02.00

Min Search

Moves the selected marker to the minimum y-axis value of the current trace.

Key Path	Peak Search, More
Mode	WIMAXOFDMA
Remote Command	:CALCulate:EVM:MARKer[1] 2 ...12:MINimum
Example	CALC:EVM:MARK:MIN
Initial S/W Revision	Prior to A.02.00

Print

See ["Print" on page 352](#)

Quick Save

The Quick Save front-panel key repeats the most recent save that was performed from the Save menu, with the following exceptions:

- Register saves are not remembered as Saves for the purpose of the Quick Save function
- If the current measurement does not support the last non-register save that was performed, an informational message is generated, “File type not supported for this measurement”

Quick Save repeats the last type of qualified save (that is, a save qualified by the above criteria) in the last save directory by creating a unique filename using the Auto File Naming algorithm described below.

If Quick Save is pressed after startup and before any qualified Save has been performed, the Quick Save function performs a Screen Image save using the current settings for Screen Image saves (current theme, current directory), which then becomes the “last save” for the purpose of subsequent Quick Saves.

The Auto File Naming feature automatically generates a file name for use when saving a file. The filename consists of a prefix and suffix separated by a dot, as is standard for the Windows® file system. A default prefix exists for each of the available file types:

Type	Default Prefix	Menu
State	State_	(Save/Recall)
Trace + State	State_	(Save/Recall)
Screen	Screen_	(Save/Recall)
Amplitude Corrections	Ampcor_	(Import/Export)
Traces	Trace_	(Import/Export)
Limit Lines	LLine_	(Import/Export)
Measurement Result	MeasR_	(Import/Export)
Capture Buffer	CapBuf_	(Import/Export)

A four digit number is appended to the prefix to create a unique file name. The numbering sequence starts at 0000 within each Mode for each file type and updates incrementally to 9999, then wraps to 0000 again. It remembers where it was through a Mode Preset and when leaving and returning to the Mode. It is reset by Restore Misc Defaults and Restore System Defaults and subsequent running of the instrument application. So, for example, the first auto file name generated for State files is State_0000.state. The next is State_0001, and so forth.

One of the key features of Auto File Name is that we guarantee that the Auto File Name will never conflict with an existing file. The algorithm looks for the next available number. If it gets to 9999, then it looks for holes. If it find no holes, that is no more numbers are available, it gives an error.

For example, if when we get to State_0010.state there is already a State_0010.state file in the current directory, it advances the counter to State_0011.state to ensure that no conflict will exist (and then it verifies that State_0011.state also does not exist in the current directory and advances again if it does, and so forth).

If you enter a file name for a given file type, then the prefix becomes the filename you entered instead of the default prefix, followed by an underscore. The last four letters (the suffix) are the 4-digit number.

For example, if you save a measurement results file as “fred.csv”, then the next auto file name chosen for a measurement results save will be fred_0000.csv.

NOTE Although 0000 is used in the example above, the number that is used is actually the current number in the Meas Results sequence, that is, the number that would have been used if you had not entered your own file name.

NOTE If the filename you entered ends with _dddd, where d=any number, making it look just like an auto file name, then the next auto file name picks up where you left off with the suffix being dddd + 1.

Key Path	Front-panel key
Notes	No remote command for this key specifically.
Initial S/W Revision	Prior to A.02.00

Recall

The Recall menu lets you choose what you want to recall, and where you want to recall it from. Among the types of files you can recall are **States and Traces**. In addition, an Import (Data) option lets you recall a number of data types stored in CSV files (as used by Excel and other spreadsheet programs).

The default paths for Recall are data type dependent and are the same as for the Save key.

Key Path	Front-panel key
Notes	<p>No remote command for this key specifically, but the :MMEM:LOAD command is available for specific file types. An example is :MMEM:LOAD:STATe <filename>.</p> <p>If you try to recall a State file for a mode that is not licensed or not available in the instrument, an error message will occur and the state will not change.</p>
Backwards Compatibility Notes	<p>In legacy analyzers, it was possible to load a state without affecting the trace data, limit lines or correction data. Similarly (since User Preset is actually loading a state), it was possible to do a User Preset without affecting the trace data, limit lines or correction data.</p> <p>In the X-Series, “state” always includes all of this data; so whenever state is loaded, all of the traces, limit lines and corrections are affected. Although this differs from previous behavior, it is desirable behavior, and should not cause adverse issues for users.</p>
Backwards Compatibility Notes	<p>Recall for the X-Series supports backward compatibility in the sense that you can recall a state file from any X-Series model number and any version of X-Series software. This is only possible if part of the recalling process goes through a limiting step after recalling the mode settings, at least for settings that may vary with version number, model number, option and license differences. If you try to recall a state file onto an instrument with less capability than what was available on the instrument during the save, the recall will ignore the state it doesn't support and it will limit the recalled setting to what it allows.</p> <p>Example: if the saved state includes preamp ON, but the recalling instrument does not have a preamp; the preamp is limited to OFF. Conversely, if you save a state without a preamp, the preamp is OFF in the state file. When this saved file is recalled on an instrument with a licensed preamp, the preamp is changed to OFF. Another example is if the saved state has center frequency set to 20 GHz, but the instrument recalling the saved state is a different model and only supports 13.5 GHz. In this case, the center frequency is limited along with any other frequency based settings. Since the center frequency can't be preserved in this case, the recall limiting tries to at least preserve span to keep the measurement setup as intact as possible.</p> <p>It may be appropriate to issue a warning if the state is limited on the recall; warnings do not go out to SCPI so this would only affect the manual user.</p> <p>Note that there is no state file compatibility outside of the X-Series. For example, you cannot recall a state file from ESA or PSA.</p>
Initial S/W Revision	Prior to A.02.00

State

The Recall State menu lets you choose a register or file from which to recall the state.

The content of a state file includes all of the settings and data required to return the analyzer as closely as possible to the Mode it was in, with the exact settings that were in place, when the save occurred. The Mode settings in each state file include the settings that are affected by Mode Preset, as well as the

additional settings affected by Restore Mode Defaults; all of the Mode’s settings. In addition, all of the settings of the Input/Output system are included, even though they are outside of the Mode’s state, because they are needed to restore the complete setup. Persistent System settings (for example, GPIB address) are not affected by either a Mode Preset or Restore Mode Defaults, nor are they included in a saved State file.

Since each state file is only for one Mode, the settings for other Modes are unaffected when it is loaded. Recall State will cause a mode switch if the state being recalled is not from the current active mode.

After the recall completes, the message "File <filename> recalled" or “Recalled State Register <register number>” is displayed.

For rapid recalls, the State menu lists 16 registers that you can choose from to recall. Pressing a Register key initiates the recall. You can also select a file from which to recall.

The default path for all State Files is:

My Documents\<<mode name>\state

where <mode name> is the parameter used to select the mode with the INST:SEL command (for example, SA for the Spectrum Analyzer).

See "[More Information](#)" on page 1822.

Key Path	Recall
Mode	All
Remote Command	:MMEMory:LOAD:STATe <filename>
Example	:MMEM:LOAD:STAT "myState.state" This recalls the file myState.state on the default path
Example	MMEM:LOAD:STAT "MyStateFile.state" This loads the state file data (on the default file directory path) into the instrument state.
Notes	<p>When you pick a file to recall, the analyzer first verifies that the file is recallable in the current instrument by checking the software version and model number of the instrument. If everything matches, a full recall proceeds by aborting the currently running measurement, clearing any pending operations, and then loading the State from the saved state file. You can open state files from any mode, so recalling a State file switches to the mode that was active when the save occurred. After switching to the mode of the saved state file, mode settings and data (if any for the mode) are loaded with values from the saved file. The saved measurement of the mode becomes the newly active measurement and the data relevant to the measurement (if there is any) is recalled.</p> <ul style="list-style-type: none"> • If there is a mismatch between file version or model number or instrument version or model number, the recall function tries to recall as much as possible and returns a warning message. It may limit settings that differ based on model number, licensing or version number. <p>After recalling the state, the Recall State function does the following:</p> <ul style="list-style-type: none"> • Makes the saved measurement for the mode the active measurement. • Clears the input and output buffers. • Status Byte is set to 0. • Executes a *CLS <p>If the file specified is empty an error is generated. If the specified file does not exist, another error is generated. If there is a mismatch between the file and the proper file type, an error is generated. If</p>

	there is a mismatch between file version or model number or instrument version or model number, a warning is displayed. Then it returns to the State menu and File Open dialog goes away. After the Recall, the analyzer exits the Recall menu and returns to the previous menu.
Backwards Compatibility SCPI	:MMEMory:LOAD:STATe 1,<filename> For backwards compatibility, the above syntax is supported. The "1" is simply ignored.
Initial S/W Revision	Prior to A.02.00

More Information

In measurements that support saving Traces, for example, Swept SA, the Trace data is saved along with the State in the State file. When recalling the State, the Trace data is recalled as well. Traces are recalled exactly as they were stored, including the writing mode and update and display modes. If a Trace was updating and visible when the State was saved, it will come back updating and visible, and its data will be rewritten right away. When you use State to save and recall traces, any trace whose data must be preserved should be placed in View or Blank mode before saving.

The following table describes the Trace Save and Recall possibilities:

You want to recall state and one trace's data, leaving other traces unaffected.	Save Trace+State from 1 trace. Make sure that no other traces are updating (they should all be in View or Blank mode) when the save is performed.	On Recall, specify the trace you want to load the one trace's data into. This trace will load in View. All other traces' data will be unaffected, although their trace mode will be as it was when the state save was performed.
You want to recall all traces	Save Trace+State from ALL traces.	On Recall, all traces will come back in View (or Blank if they were in Blank or Background when saved)
You want all traces to load exactly as they were when saved.	Save State	On recall, all traces' mode and data will be exactly as they were when saved. Any traces that were updating will have their data immediately overwritten.

From File...

When you press "From File", the analyzer brings up a Windows dialog and a menu entitled "File Open." This menu allows you to navigate to the various fields in the Windows dialog without using a keyboard or mouse. The Tab and Arrow keys can also be used for dialog navigation.

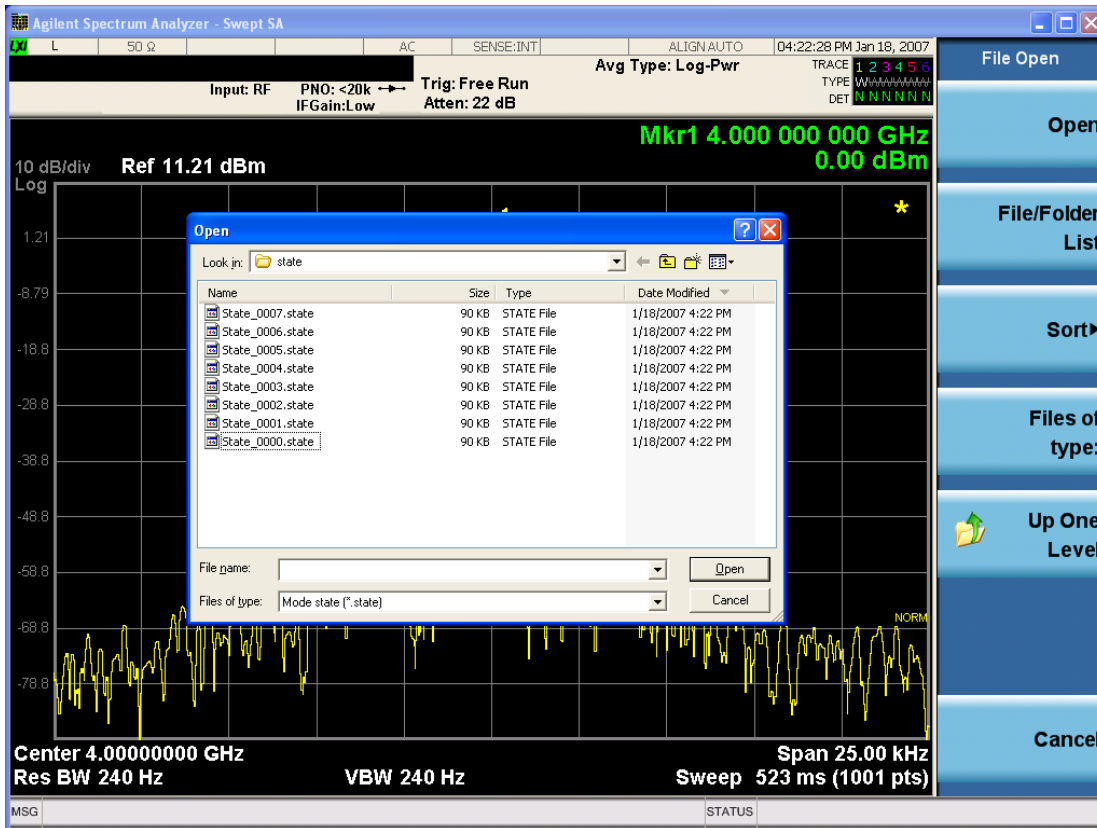

Listed below are the functions of the various fields in the dialog, and the corresponding softkeys:

Open

Performs the recall of the specified file. While the recall is being performed, the floppy icon appears briefly in the Meas bar.

File/Folder List

Enables you to navigate to the center of the dialog that contains the list of files and folders. Once here you can get information about the file and use the tab keys to navigate to the other fields in the dialog, such as Look In.

Look In

The Look In field shows the path from which the file will be recalled and allows you to change the path using the up and down arrow keys to navigate to other paths; the Enter key to open a directory; and the Backspace key to go back one directory. The **Look In field** first uses the last path from the Save As dialog **Save In:** path for that same file type. There is no softkey for directly navigating to the Look In field, but you can use the left tab to get here from the File/Folder List.

User specified paths are remembered when you leave and return to a Mode and are reset back to the default using Restore Mode Defaults.

Sort

Accesses a menu that enables you to sort the files within the File Open dialog. Only one sorting type can be selected at a time and the sorting happens immediately. The sorting types are By Date, By Name, By extension, and By Size.

Files of Type

This field shows the file suffix for the type of file you have selected to recall. For example, if you navigated here while recalling State, "Mode state (*.state)" is in the field. If you navigated here while recalling Trace, ""Mode state (*.trace)" is in the field. If you navigated here while importing a trace data file, "Trace Data (*.csv)" is in the field. For some file types, there is more than one choice in the dropdown menu, which you can select by using the up and down arrow keys and Enter.

Up One Level

This key corresponds to the icon of a folder with the up arrow that is in the tool bar of the dialog. When pressed, it causes the file and folder list to navigate up one level in the directory structure. The Backspace key does the same thing.

Cancel

This key corresponds to the Cancel selection in the dialog. It causes the current **Open** request to be cancelled. The ESC key does the same thing.

Key Path	Recall, State
Notes	Brings up the Open dialog for recalling a State Save Type
Initial S/W Revision	Prior to A.02.00

Edit Register Names

You may enter a custom name on any of the Register keys, to help you remember what you are using that state to save. To do this, press the Edit Register Names key, choose the register whose name you wish to edit, and then enter the desired label using the Alpha Editor or an external PC keyboard.

The maximum number of characters that can be added is 30. In most cases, 30 characters will fit on two lines of the key.

For more information and the SCPI command, see Edit Register Names under the Save, State function.

Key Path	Recall, State
Mode	All
Dependencies	N9060A-7FP or N9060B-2FP license required to edit the register names. When the feature is not licensed, sending the SCPI command generates an error, -221, "Settings conflict;Option not available"
Initial S/W Revision	A.11.00

Register 1 thru Register 16

Selecting any one of these register keys causes the State of the mode from the specified Register to be recalled. Each of the register keys annotates whether it is empty or at what date and time it was last

modified. In addition, you can use the Edit Register Names key under Save, State to enter custom names for each register.

Registers are shared by all modes, so recalling from any one of the registers will cause a mode switch to the mode that was active when the save to the Register occurred.

Although these 16 registers are the only registers available from the front panel, there are 128 state registers available in the instrument. Registers 17–128 are only available from the SCPI interface, using the *RCL command.

After the recall completes, the message "Register <register number> recalled" appears in the message bar. If you are in the Spectrum Analyzer Mode, and you are recalling a register that was saved in the Spectrum Analyzer Mode, then after the recall, you will still be in the Recall Register menu. If the Recall causes you to switch modes, then after the Recall, you will be in the Frequency menu.

If a requested register is empty an error is generated.

Key Path	Recall, State
Example	*RCL 1
Range	1–16 from front panel, 1–128 from SCPI
Readback	Date and time with seconds resolution are displayed on the key OR A custom name of up to 30 characters entered using the Save, State, Edit Register Names key OR “(empty)” if no prior save operation has been performed to this register.
Initial S/W Revision	Prior to A.02.00
Modified at S/W Revision	Prior to A.11.00

Register 1 thru Register 16

Selecting any one of these register keys causes the State of the mode from the specified Register to be recalled. Each of the register keys annotates whether it is empty or at what date and time it was last modified. In addition, you can use the Edit Register Names key under Save, State to enter custom names for each register.

Registers are shared by all modes, so recalling from any one of the registers will cause a mode switch to the mode that was active when the save to the Register occurred.

Although these 16 registers are the only registers available from the front panel, there are 128 state registers available in the instrument. Registers 17–128 are only available from the SCPI interface, using the *RCL command.

After the recall completes, the message "Register <register number> recalled" appears in the message bar. If you are in the Spectrum Analyzer Mode, and you are recalling a register that was saved in the Spectrum Analyzer Mode, then after the recall, you will still be in the Recall Register menu. If the Recall causes you to switch modes, then after the Recall, you will be in the Frequency menu.

If a requested register is empty an error is generated.

Key Path	Recall, State
Example	*RCL 1
Range	1-16 from front panel, 1-128 from SCPI
Readback	Date and time with seconds resolution are displayed on the key OR A custom name of up to 30 characters entered using the Save, State, Edit Register Names key OR “(empty)” if no prior save operation has been performed to this register.
Initial S/W Revision	Prior to A.02.00
Modified at S/W Revision	Prior to A.11.00

Data (Import)

Importing a data file loads data that was previously saved from the current measurement or from other measurements and/or modes that produce compatible data files. The Import Menu only contains Data Types that are supported by the current measurement.

Since the commonly exported data files are in .csv format, the data can be edited by the user prior to importing. This allows you to export a data file, manipulate the data in Excel (the most common PC Application for manipulating .csv files) and then import it.

Importing Data loads measurement data from the specified file into the specified or default destination, depending on the data type selected. Selecting an Import Data menu key will not actually cause the importing to occur, since the analyzer still needs to know from where to get the data. Pressing the Open key in this menu brings up the Open dialog and Open menu that provides you with the options from where to recall the data. Once a filename has been selected or entered in the Open menu, the recall occurs as soon as the Open button is pressed.

Key Path	Recall
Mode	All
Notes	The menu is built from whatever data types are available for the mode. Some keys will be missing completely, so the key locations in the sub-menu will vary. No SCPI command directly controls the Data Type that this key controls. The Data Type is included in the MMEM:LOAD commands.
Dependencies	If a file type is not used by a certain measurement, it is grayed out for that measurement. The key for a file type will not show at all if there are no measurements in the Mode that support it.
Preset	Is not affected by Preset or shutdown, but is reset during Restore Mode Defaults
Readback	The data type that is currently selected
Initial S/W Revision	Prior to A.02.00

Masks

This key enables you to recall a preset mask file from the list. It is only available in SEM measurement under the Data menu: Limit Mask. Limit Mask enables setting a preset limit mask for 802.11p 5MHz and 10MHz system.

You cannot change or create the preset mask file since it is a binary file. This key is valid for the Spectrum Emission Mask measurement.

File location: "My Documents\WLAN\data.masks"

Note that "**My Documents**" is an alias to a directory and its location depends on which user is logged in. At XSA start up, all of the limit mask files in the current user's "My Documents\WLAN\data.masks" directory are overwritten.

File type: Binary

Filename:

11p_5MHz_A.mask

11p_5MHz_B.mask

11p_5MHz_C.mask

11p_5MHz_D.mask

11p_10MHz_A.mask

11p_10MHz_B.mask

11p_10MHz_C.mask

11p_10MHz_D.mask

File extension: .mask

Selecting OPEN under the Import Data menu, opens the above directory enabling you to select a mask file.

Example:

File Location: My Documents/WLAN/data/masks

File Name: 11p_5MHz_A.mask

Key Path	Recall, Data
Mode	WLAN
Remote Command	MMEMoRY:LOAD:MASK <string>
Example	MMEM:LOAD:MASK "11p_5MHz_A.mask"
Initial S/W Revision	A.11.00

Capture Buffer

Capture buffer functionality is only available when measurement is Mod Accuracy and radio standard is not 802.11ac 80+80MHz. The captured data is raw data which is not processed.

Key Path	Recall, Data
Mode	WLAN
Example	MMEM:LOAD:CAPT "MyCaptureData.bin" This loads the file of capture data (on the default file directory path) into the instrument.
Dependencies	Capture buffer data is only available when measurement is Mod Accuracy and radio standard is not 802.11ac 80+80MHz. In other situation, this key is grayed out.
Initial S/W Revision	A.11.00

Open...

When you press "Open", the analyzer brings up a Windows dialog and a menu entitled "File Open." This menu allows you to navigate to the various fields in the Windows dialog without using a keyboard or mouse. The Tab and Arrow keys can also be used for dialog navigation.

See "[From File...](#)" on page 2263 in Recall, State, for a full description of this dialog and menu.

Key Path	Recall, Data
Notes	The key location is mode-dependent and will vary. Brings up Open dialog for recalling a <mode specific> Save Type
Initial S/W Revision	Prior to A.02.00

Restart

The Restart function restarts the current sweep, or measurement, or set of averaged/held sweeps or measurements. If you are Paused, pressing Restart does a Resume.

The Restart function is accessed in several ways:

- Pressing the Restart key
- Sending the remote command INIT:IMMEDIATE
- Sending the remote command INIT:RESTART

See "[More Information](#)" on page 1829

Key Path	Front-panel key
Remote Command	:INITiate[:IMMEDIATE] :INITiate:RESTART
Example	:INIT:IMM :INIT:REST
Notes	:INITiate:RESTART and :INITiate:IMMEDIATE perform exactly the same function.
Couplings	Resets average/hold count k. For the first sweep overwrites all active (update=on) traces with new current data. For application modes, it resets other parameters as required by the measurement.
Status Bits/OPC dependencies	This is an Overlapped command. The STATUS:OPERation register bits 0 through 8 are cleared. The STATUS:QUESTIONable register bit 9 (INTEgrity sum) is cleared. The SWEEPING bit is set. The MEASURING bit is set.
Backwards Compatibility Notes	For Spectrum Analysis mode in ESA and PSA, the Restart hardkey and the INITiate:RESTART command restart trace averages (displayed average count reset to 1) for a trace in Clear Write, but did not restart Max Hold and Min Hold. In the X-Series, the Restart hardkey and the INITiate:RESTART command restart not only Trace Average, but MaxHold and MinHold traces as well. For wireless comms modes in ESA and PSA, the Restart hardkey and the INITiate:RESTART command restart every measurement, which includes all traces and numeric results. There is no change to this operation.
Initial S/W Revision	Prior to A.02.00

More Information

The **Restart** function first aborts the current sweep/measurement as quickly as possible. It then resets the sweep and trigger systems, sets up the measurement and initiates a new data measurement sequence with a new data acquisition (sweep) taken once the trigger condition is met.

If the analyzer is in the process of aligning when **Restart** is executed, the alignment finishes before the restart function is performed.

Even when set for Single operation, multiple sweeps may be taken when Restart is pressed (for example, when averaging/holding is on). Thus when we say that **Restart** "restarts a measurement," we may mean:

- It restarts the current sweep
- It restarts the current measurement
- It restarts the current set of sweeps if any trace is in Trace Average, Max Hold or Min Hold
- It restarts the current set of measurements if Averaging, or Max Hold, or Min Hold is on for the measurement
- depending on the current settings.

With **Average/Hold Number** (in **Meas Setup** menu) set to 1, or Averaging off, or no trace in Trace Average or Hold, a single sweep is equivalent to a single measurement. A single sweep is taken after the trigger condition is met; and the analyzer stops sweeping once that sweep has completed. However, with **Average/Hold Number** >1 and at least one trace set to **Trace Average, Max Hold, or Min Hold (SA Measurement)** or **Averaging on (most other measurements)**, multiple sweeps/data acquisitions are taken for a single measurement. The trigger condition must be met prior to each sweep. The sweep is stopped when the average count k equals the number N set for **Average/Hold Number**. A measurement average usually applies to all traces, marker results, and numeric results; but sometimes it only applies to the numeric results.

Once the full set of sweeps has been taken, the analyzer will go to idle state. To take one more sweep without resetting the average count, increment the average count by 1, by pressing the step up key while **Average/Hold Number** is the active function, or sending the remote command `CALC:AVER:TCON UP`.

Save

The Save menu lets you choose what you want to save and where you want to save it. Among the types of files you can save are **States**, **Traces**, and **Screen Images**. In addition, an Export (Data) option lets you save a number of data types as CSV files for easy import into Excel and other spreadsheet programs.

Key Path	Front-panel key
Mode	All
Notes	No remote command for this key specifically, but the :MMEM:STORe command is available for specific file types. An example is :MMEM:STOR:STATe <filename>.
Initial S/W Revision	Prior to A.02.00

State

The Save State menu lets you choose a register or file for saving the state.

The content of a state file includes all of the settings and data required to return the analyzer as closely as possible to the Mode it was in, with the exact settings which were in place, when the save occurred. The Mode settings in each state file include the settings that are affected by Mode Preset, as well as the additional settings affected by Restore Mode Defaults; all of the Mode's settings. In addition, all of the settings of the Input/Output system are included, even though they are outside of the Mode's state, because they are needed to restore the complete setup. Persistent System settings (for example, Verbose SCPI) are not affected by either Mode Preset or Restore Mode Defaults, nor are they included in a saved State file.

After the save completes, the message "File <filename> saved" or "State Register <register number> saved" is displayed.

For rapid saving, the State menu lists 16 registers to save to. Pressing a Register key initiates the save. You can also select a file to save to.

The default path for all State Files is:

My Documents\<<mode name>\state

where <mode name> is the parameter used to select the mode with the INST:SEL command (for example, SA for the Spectrum Analyzer).

Key Path	Save
Mode	All
Remote Command	:MMEMory:STORe:STATe <filename>
Example	MMEM:STOR:STATe "MyStateFile.state" This stores the current instrument state data in the file MyStateFile.state in the default directory.
Notes	Both single and double quotes are supported for any filename parameter over remote. After saving to a register, that register's menu key is updated with the date the time, unless a custom label has been entered for that key. After saving to a register, you remain in the Save State menu, so that you can see the Register key

	update. After saving to a file, the analyzer automatically returns to the previous menu and any Save As dialog goes away.
Backwards Compatibility SCPI	:MMEMory:STORe:STATe 1,<filename>
Initial S/W Revision	Prior to A.02.00

To File . . .

When you press “To File”, the analyzer brings up a Windows dialog and a menu entitled “Save As.” This menu allows you to navigate to the various fields in the Windows dialog without using a keyboard or mouse. The Tab and Arrow keys can also be used for dialog navigation.

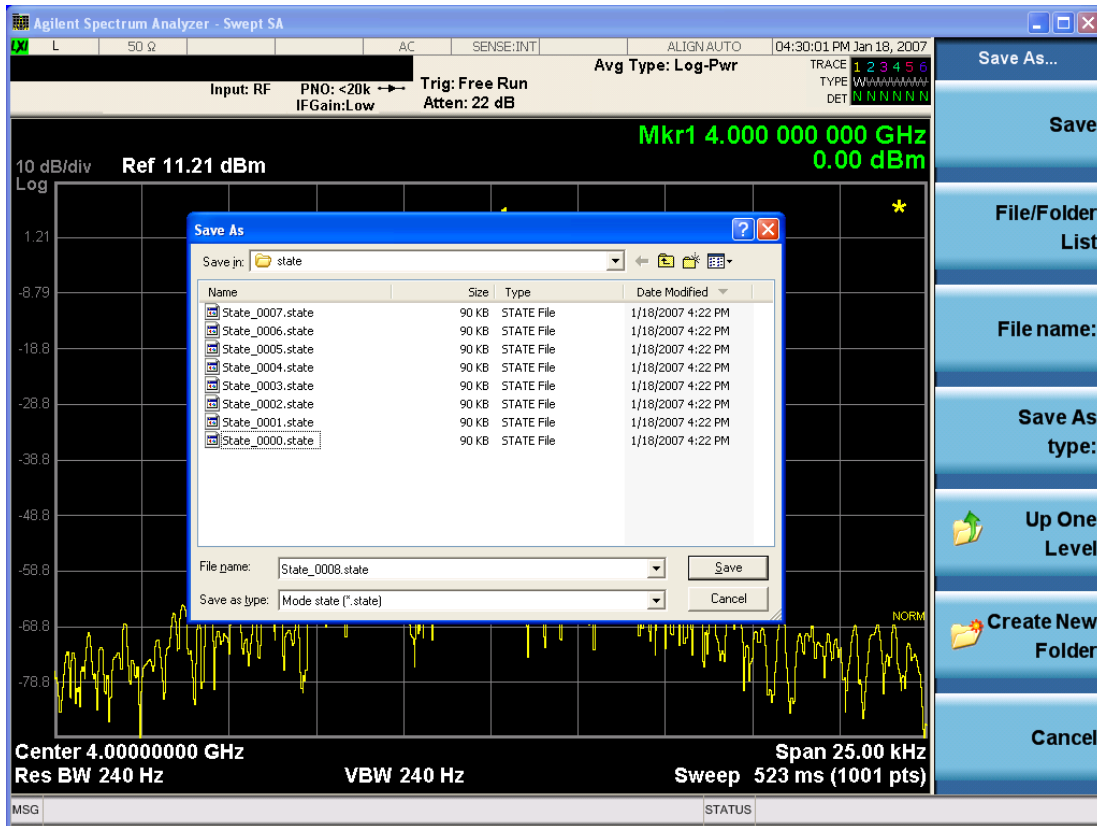

The Listed below

are the functions of the various fields in the dialog, and the corresponding softkeys:

Save

Performs the save to the specified file of the selected type. If the file already exists, a dialog will appear that allows you to replace the existing file by selecting OK, or you can Cancel the request. If you select OK, the file will be overwritten. Using the C: drive is strongly discouraged, since it runs the risk of being overwritten during an instrument software upgrade.

While the save is being performed, the floppy icon appears briefly in the Meas bar.

File/Folder List

Enables you to navigate to the center of the dialog that contains the list of files and folders. Once here you can get information about the file and use the tab keys to navigate to the other fields in the dialog, such as Save In.

Save In

The Save In field shows the path to which the file will be saved and allows you to change the path using the up and down arrow keys to navigate to other paths; the Enter key to open a directory; and the Backspace key to go back one directory. The **Save In field** defaults to the default path for this type of file and remembers the last path you used to save this type of file. There is no softkey for directly navigating to the Save In field but you can use left tab to get here from the File/Folder List.

User specified paths are remembered when you leave and return to a Mode and are reset back to the default using Restore Mode Defaults.

File Name

The File Name field is initially loaded with an automatically generated filename specific to the appropriate Save Type. The automatically generated filename is guaranteed not to conflict with any filename currently in the directory. You may replace or modify this filename using the File Name key. See the ["Quick Save " on page 2259](#) documentation for more on the automatic file naming algorithm.

When you press the File Name key the analyzer displays the Alpha Editor. Use the knob to choose the letter to add and the front-panel Enter key to add the letter to the file name. The BK character moves you back and the FW character moves you forward in the filename. The Select key on the front panel generates a space character. When you are done entering the filename press the Done softkey. This returns back to the **File Open** dialog and menu, but does not cause the save to occur.

Save As Type

This field shows the file suffix for the type of file you have selected to save. For example, if you navigated here while saving State, "Mode state (*.state)" is in the field. If you navigated here from saving Trace, ""Mode state (*.trace)" is in the field. If you navigated here while exporting a trace data file, "Trace Data (*.csv)" is in the field. For some file types, there is more than one choice in the dropdown, which you can select by using the up and down arrow keys and Enter.

Up One Level

This key corresponds to the icon of a folder with the up arrow that is in the tool bar of the dialog. When pressed, it causes the file and folder list to navigate up one level in the directory structure. The Backspace key does the same thing.

Create New Folder

This key corresponds to the icon of a folder with the "*" that is in the tool bar of the dialog. When pressed, a new folder is created in the current directory with the name **New Folder** and you can enter a new folder name using the Alpha Editor.

Cancel

This key corresponds to the Cancel selection in the dialog. It causes the current **Save As** request to be cancelled. The ESC key does the same thing.

Key Path	Save, State
Mode	All
Notes	Brings up Save As dialog for saving a State Save Type
Initial S/W Revision	Prior to A.02.00

Edit Register Names

You may enter a custom name on any of the Register keys, to help you remember what you are using that state to save. To do this, press the Edit Register Names key, choose the register whose name you wish to edit, and then enter the desired label using the Alpha Editor or an external PC keyboard.

The maximum number of characters that can be added is 30. In most cases, 30 characters will fit on two lines of the key.

See ["More Information" on page 1834](#)

Key Path	Save, State
Mode	All
Remote Command	:MMEMory:REGister:STATe:LABel <reg number>,"label" :MMEMory:REGister:STATe:LABel? <reg number>
Example	:MMEM:REG:STAT:LAB 1,"my label"
Notes	<reg number> is an integer from 1 to 16. If the SCPI specifies an invalid register number an error message is generated, -222,"Data out of range;Invalid register label number" "label" is a string from 0 to 30 characters in length. If a label exceeds 30 characters, an error message is generated, -150,"String data error;Label clipped to 30 characters" "label" of length 0 erases the custom label and restores the default (time and date) label. E.g.: :MMEM:REG:STAT:LAB 1,""
Dependencies	N9060A-7FP or N9060B-2FP license required to edit the register names. When the feature is not licensed, sending this command generates an error, -221,"Settings conflict;Option not available"
Preset	The names are unaffected by Preset or power cycle but are set to the default label (time and date) on a "Restore System Defaults->Misc"
Initial S/W Revision	A.11.00

More Information

When you edit one of the register names, the time and date field will be replaced by the custom name.

If you delete all the characters in the custom name, it restores the default (time and date).

The register names are stored within the state files, but they are not part of the instrument state; that is, once you have edited a register name, loading a new state will not change that register name. Another consequence of this is that the names will be persistent through a power cycle. Also, if a named state file is transferred to another analyzer, it will bring its custom name along with it.

If you try to edit the name of an empty register, the analyzer will first save the state to have a file to put the name in. If you load a named state file into an analyzer with older firmware it will ignore the metadata.

The *SAV and *RCL commands will not be affected by the custom register names, nor will the MMEM commands.

Register 1 thru Register 16

Selecting any one of these register menu keys causes the State of the currently active mode to be saved to the specified Register. The registers are provided for rapid saving and recalling, since you do not need to specify a filename or navigate to a file. Each of the register menu keys annotates whether it is empty or at what date and time it was last modified. In addition, you can use the Edit Register Names key to enter custom names for each register.

Although these 16 registers are the only registers available from the front panel, there are 128 state registers available in the instrument. Registers 17–128 are only available from the SCPI interface, using the *SAV command.

There is one set of 128 state registers in the instrument, not one set for each Mode. When a state is saved, the Mode it was saved from is saved with it; then when it is recalled, the instrument switches to that Mode.

After the save completes, the corresponding register menu key annotation is updated with the date and time and the message "Register <register number> saved" is displayed.

Key Path	Save, State
Mode	All
Example	*SAV 1
Range	1–16 from front panel, 1–128 from SCPI
Readback	Date and time with seconds resolution are displayed on the key OR A custom name of up to 30 characters entered using the Edit Register Names key OR “(empty)” if no prior save operation has been performed to this register.
Initial S/W Revision	Prior to A.02.00
Modified at S/W Revision	A.11.00

Register 1 thru Register 16

Selecting any one of these register menu keys causes the State of the currently active mode to be saved to the specified Register. The registers are provided for rapid saving and recalling, since you do not need to specify a filename or navigate to a file. Each of the register menu keys annotates whether it is empty or at what date and time it was last modified. In addition, you can use the Edit Register Names key to enter custom names for each register.

Although these 16 registers are the only registers available from the front panel, there are 128 state registers available in the instrument. Registers 17–128 are only available from the SCPI interface, using the *SAV command.

There is one set of 128 state registers in the instrument, not one set for each Mode. When a state is saved, the Mode it was saved from is saved with it; then when it is recalled, the instrument switches to that Mode.

After the save completes, the corresponding register menu key annotation is updated with the date and time and the message "Register <register number> saved" is displayed.

Key Path	Save, State
Mode	All
Example	*SAV 1
Range	1-16 from front panel, 1-128 from SCPI
Readback	Date and time with seconds resolution are displayed on the key OR A custom name of up to 30 characters entered using the Edit Register Names key OR “(empty)” if no prior save operation has been performed to this register.
Initial S/W Revision	Prior to A.02.00
Modified at S/W Revision	A.11.00

Data (Export)

Exporting a data file stores data from the current measurement to mass storage files. The Export Menu only contains data types that are supported by the current measurement.

Since the commonly exported data files are in .csv format, the data can be edited by you prior to importing. This allows you to export a data file, manipulate the data in Excel (the most common PC Application for manipulating .csv files) and then import it.

Selecting an Export Data menu key will not actually cause the exporting to occur, since the analyzer still needs to know where you wish to save the data. Pressing the Save As key in this menu brings up the Save As dialog and Save As menu that allows you to specify the destination file and directory. Once a filename has been selected or entered in the Open menu, the export will occur as soon as the Save key is pressed.

Key Path	Save
Mode	All
Notes	The menu is built from whatever data types are available for the mode. So the key locations in the sub menu will vary. No SCPI command directly controls the Data Type that this key controls. The Data Type is included in the MMEM:STORe commands.
Dependencies	If a file type is not used by a certain measurement, that type is grayed out for that measurement. The key for a file type will not show at all if there are no measurements in the Mode that support it.
Preset	Is not affected by a Preset or shutdown, but is reset during Restore Mode Defaults
Readback	The data type that is currently selected
Initial S/W Revision	Prior to A.02.00

Meas Results

Key Path	Save, Data
Mode	WLAN
Example	MMEM:STOR:RES "MyResultsFile.csv" This stores the measurement results data in the file MyResultsFile.xml in the default directory.
Initial S/W Revision	A.11.00

Capture Buffer

Capture buffer functionality is only available when measurement is Mod Accuracy and radio standard is not 802.11ac 80+80MHz. The captured data is raw data which is not processed.

Key Path	Save, Data
Mode	WLAN
Example	MMEM:STOR:CAPT "MyCaptureData.bin" This stores the capture data in the file MyCaptureData.bin in the default directory.
Dependencies	Capture buffer data is only available when measurement is Mod Accuracy and radio standard is not 802.11ac 80+80MHz. In other measurements, this key is grayed out.
Initial S/W Revision	A.11.00

Save As . . .

When you press "Save As", the analyzer brings up a Windows dialog and a menu entitled "**Save As.**" This menu allows you to navigate to the various fields in the Windows dialog without using a keyboard or mouse. The Tab and Arrow keys can also be used for dialog navigation.

See "[To File . . .](#)" on page 2273 in Save, State for a full description of this dialog and menu.

The default path for saving files is:

For all of the Trace Data Files:

My Documents\`<mode name>`\data\traces

For all of the Limit Data Files:

My Documents\`<mode name>`\data\limits

For all of the Measurement Results Data Files:

My Documents\`<mode name>`\data\`<measurement name>`\results

For all of the Capture Buffer Data Files:

My Documents\`<mode name>`\data\captureBuffer

Key Path	Save, Data
Mode	All
Notes	The key location is mode-dependent and will vary. Brings up the Save As dialog for saving a <mode specific> Save Type. The save is performed immediately and does not wait until the measurement is complete.
Initial S/W Revision	Prior to A.02.00

Screen Image

Pressing Screen Image accesses a menu of functions that enable you to specify a format and location for the saved screen image. It brings up a menu that allows you to specify the color scheme of the Screen Image (Themes) or navigate to the Save As dialog to perform the actual save.

Screen Image files contain an exact representation of the analyzer display. They cannot be loaded back onto the analyzer, but they can be loaded into your PC for use in many popular applications.

The image to be saved is actually captured when the Save front panel key is pressed, and kept in temporary storage to be used if you ask for a Screen Image save. When the Screen Image key is pressed, a "thumbnail" of the captured image is displayed, as shown below:

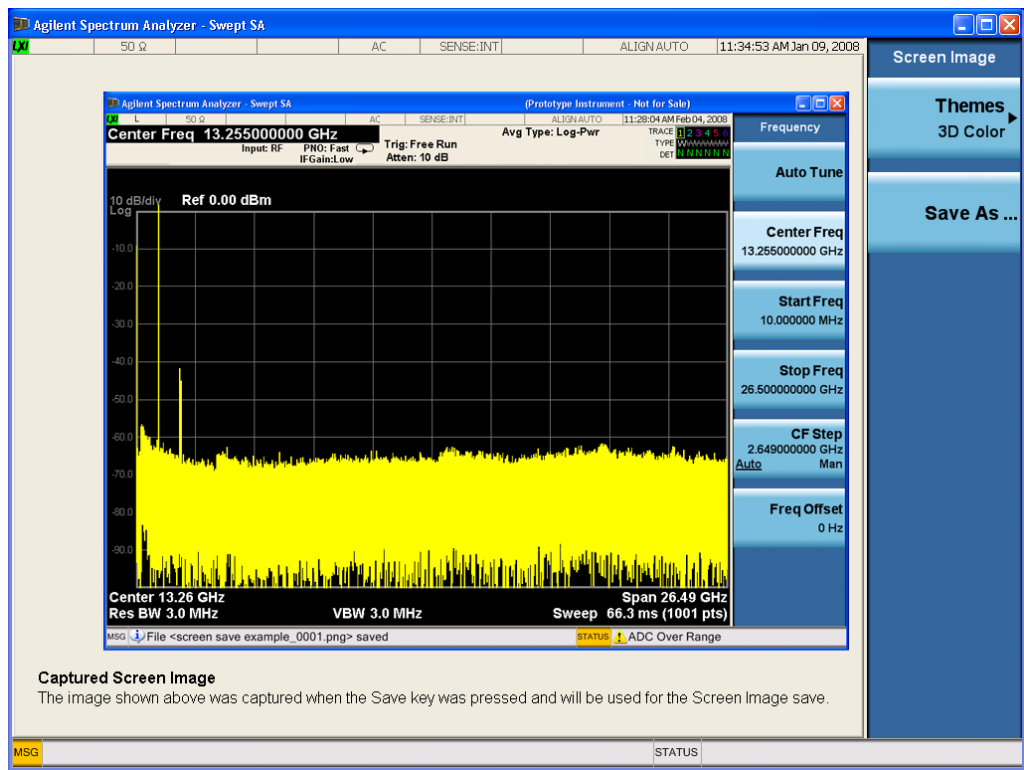

When you continue on into the Save As menu and complete the Screen Image save, the image depicted in the thumbnail is the one that gets saved, showing the menus that were on the screen before going into the Save menus. The save is performed immediately and does not wait until the measurement is complete.

After you have completed the save, the Quick Save front-panel key lets you quickly repeat the last save performed, using an auto-named file, with the current screen data.

NOTE

For versions previous to A.01.55, if you initiate a screen image save by navigating through the Save menus, the image that is saved will contain the Save menu softkeys, not the menus and the active function that were on the screen when you first pressed the Save front panel key.

Key Path	Save
Mode	All
Remote Command	:MMEMory:STORe:SCReem <filename>
Example	:MMEM:STOR:SCR "myScreen.png" This stores the current screen image in the file MyScreenFile.png in the default directory.
Initial S/W Revision	Prior to A.02.00

Themes

Accesses a menu of functions that enable you to choose the theme to be used when saving the screen image.

The **Themes** option is the same as the **Themes** option under the **Display** and **Page Setup** dialogs. It allows you to choose between themes to be used when saving the screen image.

Key Path	Save, Screen Image
Remote Command	:MMEMory:STORe:SCReem:THEME TDColor TDMonochrome FCOLOR FMONochrome :MMEMory:STORe:SCReem:THEMe?
Example	:MMEM:STOR:SCR:THEM TDM
Preset	3D Color; Is not part of Preset, but is reset by Restore Misc Defaults or Restore System Defaults All and survives subsequent running of the modes.
Readback	3D Color 3D Mono Flat Color Flat Mono
Backwards Compatibility Notes	In ESA and PSA we offer the choice of "Reverse Bitmap" or "Reverse Metafile" when saving screen images. This is much like the "Flat Color" theme available in X-Series. Also, if you selected Reverse Bitmap AND a black & white screen image, that would be much like "Flat Monochrome". In other words, each of the X-Series themes has a similar screen image type in ESA/PSA. But they are not identical.
Initial S/W Revision	Prior to A.02.00

3D Color

Selects a standard color theme with each object filled, shaded and colored as designed.

Key Path	Save, Screen Image, Themes
Example	MMEM:STOR:SCR:THEM TDC

Readback	3D Color
Initial S/W Revision	Prior to A.02.00

3D Monochrome

Selects a format that is like 3D color but shades of gray are used instead of colors.

Key Path	Save, Screen Image, Themes
Example	MMEM:STOR:SCR:THEM TDM
Readback	3D Mono
Initial S/W Revision	Prior to A.02.00

Flat Color

Selects a format that is best when the screen is to be printed on an ink printer.

Key Path	Save, Screen Image, Themes
Example	MMEM:STOR:SCR:THEM FCOL
Readback	Flat Color
Initial S/W Revision	Prior to A.02.00

Flat Monochrome

Selects a format that is like Flat Color. But only black is used (no colors, not even gray), and no fill.

Key Path	Save, Screen Image, Themes
Example	MMEM:STOR:SCR:THEM FMON
Readback	Flat Mono
Initial S/W Revision	Prior to A.02.00

Save As...

When you press "Save As", the analyzer brings up a Windows dialog and a menu entitled "**Save As.**" This menu allows you to navigate to the various fields in the Windows dialog without using a keyboard or mouse. The Tab and Arrow keys can also be used for dialog navigation.

See "[To File . . .](#)" on page 2273 in Save, State for a full description of this dialog and menu.

The default path for Screen Images is

My Documents\`<mode name>`\screen.

where <mode name> is the parameter used to select the mode with the INST:SEL command (for example, SA for the Spectrum Analyzer).

Key Path	Save, Screen Image
Notes	Brings up Save As dialog for saving a Screen Image Save Type
Initial S/W Revision	Prior to A.02.00

Mass Storage Catalog (Remote Command Only)

Key path	SCPI Only
Remote Command	:MMEMory:CATalog? [<directory_name>]
Notes	<p>The string must be a valid logical path.</p> <p>Queries disk usage information (drive capacity, free space available) and obtains a list of files and directories in a specified directory in the following format: <numeric_value>,<numeric_value>,{<file_entry>}</p> <p>It returns two numeric parameters and as many strings as there are files and directories. The first parameter indicates the total amount of storage currently used in bytes. The second parameter indicates the total amount of storage available, also in bytes. The <file_entry> is a string. Each <file_entry> indicates the name, type, and size of one file in the directory list: <file_name>,<file_type>,<file_size></p> <p>As the windows file system has an extension that indicates file type, <file_type> is always empty. <file_size> provides the size of the file in bytes. For directories, <file_entry> is surrounded by square brackets and both <file_type> and <file_size> are empty</p>
Initial S/W Revision	Prior to A.02.00

Mass Storage Change Directory (Remote Command Only)

Key path	SCPI Only
Remote Command	:MMEMory:CDIRectory [<directory_name>] :MMEMory:CDIRectory?
Notes	<p>The string must be a valid logical path.</p> <p>Changes the default directory for a mass memory file system. The <directory_name> parameter is a string. If no parameter is specified, the directory is set to the *RST value.</p> <p>At *RST, this value is set to the default user data storage area, that is defined as System.Environment.SpecialFolder.Personal.</p> <p>Query returns full path of the default directory.</p>
Initial S/W Revision	Prior to A.02.00

Mass Storage Copy (Remote Command Only)

Key path	SCPI Only
Remote Command	:MMEMory:COpy <string>,<string>[,<string>,<string>]
Notes	<p>The string must be a valid logical path.</p> <p>Copies an existing file to a new file or an existing directory to a new directory.</p> <p>Two forms of parameters are allowed. The first form has two parameters. In this form, the first parameter specifies the source, and the second parameter specifies the destination.</p> <p>The second form has four parameters. In this form, the first and third parameters specify the source. The second and fourth parameters specify the directories. The first pair of parameters specifies the source. The second pair specifies the destination. An error is generated if the source doesn't exist or the destination file already exists.</p> <p>This command will generate an "access denied" error if the destination is a restricted folder (e.g., C:\Windows) and the current user does not have Power User or Administrator privileges.</p>

Mass Storage Device Copy (Remote Command Only)

This command transfers data to/from a file and a peripheral device.

Key path	SCPI Only
Remote Command	:MMEMory:COpy:DEvice <source_string>,<dest_string>
Notes	<p>The strings must be a valid logical path or a valid device keyword. If the dest_string is a device keyword, the data is copied from the source file to the device. If the source_string is a device keyword, the data is copied to the source file from the device.</p> <p>Valid device keywords are:</p> <p>SNS (smart noise source)</p> <p>An error is generated if the file or device is not found.</p>

Mass Storage Delete (Remote Command Only)

Key path	SCPI Only
Remote Command	:MMEMory:DElete <file_name>[,<directory_name>]
Notes	<p>The string must be a valid logical path.</p> <p>Removes a file from the specified directory. The <file_name> parameter specifies the file name to be removed. This command will generate an "access denied" error if the file is in a restricted folder (e.g., C:\Windows) and the current user does not have Power User or Administrator privileges.</p>
Initial S/W Revision	Prior to A.02.00

Mass Storage Data (Remote Command Only)

Creates a file containing the specified data OR queries the data from an existing file.

Key path	SCPI Only
Remote Command	:MMEMory:DATA <file_name>, <data> :MMEMory:DATA? <file_name>
Notes	The string must be a valid logical path. The command form is MMEMory:DATA <file_name>,<data>. It loads <data> into the file <file_name>. <data> is in 488.2 block format. <file_name> is string data. The query form is MMEMory:DATA? <file_name> with the response being the associated <data> in block format.
Initial S/W Revision	Prior to A.02.00

Mass Storage Make Directory (Remote Command Only)

Key path	SCPI Only
Remote Command	:MMEMory:MDIRectory <directory_name>
Notes	The string must be a valid logical path. Creates a new directory. The <directory_name> parameter specifies the name to be created. This command will generate an “access denied” error if the new directory would be in a restricted folder (e.g., C:\Windows) and the current user does not have Power User or Administrator privileges.
Initial S/W Revision	Prior to A.02.00

Mass Storage Move (Remote Command Only)

Key path	SCPI Only
Remote Command	:MMEMory:MOVE <string>,<string>[,<string>,<string>]
Notes	The string must be a valid logical path. Moves an existing file to a new file or an existing directory to a new directory. Two forms of parameters are allowed. The first form has two parameters. In this form, the first parameter specifies the source, and the second parameter specifies the destination. The second form has four parameters. In this form, the first and third parameters specify the source. The second and fourth parameters specify the directories. The first pair of parameters specifies the source. The second pair specifies the destination. An error is generated if the source doesn't exist or the destination file already exists. This command will generate an “access denied” error if the destination is a restricted folder (e.g., C:\Windows) and the current user does not have Power User or Administrator privileges.
Initial S/W Revision	Prior to A.02.00

Mass Storage Remove Directory (Remote Command Only)

Key path	SCPI Only
Remote Command	:MMEMory:RDIRectory <directory_name>
Notes	<p>The string must be a valid logical path.</p> <p>Removes a directory. The <directory_name> parameter specifies the directory name to be removed. All files and directories under the specified directory shall also be removed.</p> <p>This command will generate an “access denied” error if the folder is a restricted folder (e.g., C:\Windows) or is in a restricted folder and the current user does not have Power User or Administrator privileges.</p>
Initial S/W Revision	Prior to A.02.00

Single (Single Measurement/Sweep)

Sets the analyzer for Single measurement operation. The single/continuous state is Meas Global, so the setting will affect all the measurements. If you are Paused, pressing Single does a Resume.

See "[More Information](#)" on page 1845

Key Path	Front-panel key
Example	:INIT:CONT OFF
Notes	See Cont key description.
Backwards Compatibility Notes	<p>For Spectrum Analysis mode in ESA and PSA, the Single hardkey and the INITiate:IMM switched from continuous measurement to single measurement and restarted sweeps and averages (displayed average count reset to 1), but did not restart Max Hold and Min Hold. In the X-Series, the Single hardkey and the INITiate:IMM command initiate a sweep/ measurement/ average sequence/hold sequence including MaxHold and MinHold.</p> <p>For Spectrum Analysis mode in ESA and PSA, the Single hardkey restarted the sweep regardless of whether or not you were in an active sweep or sweep sequence. In the X-Series, Restart does this but Single only restarts the sweep or sweep sequence if you are in the idle state.</p> <p>INIT[:IMM] in ESA & PSA Spectrum Analysis Mode does an implied ABORT. In some other PSA Modes, INIT[:IMM] is ignored if not in the idle state. . The X-Series follows the ESA/PSA SA Mode model, which may cause some Modes to have compatibility problems.</p>
Initial S/W Revision	Prior to A.02.00

More Information

See "[Restart](#)" on page 2270 for details on the INIT:IMMEDIATE (Restart) function.

If you are already in single sweep, the INIT:CONT OFF command has no effect.

If you are already in Single Sweep, then pressing the Single key in the middle of a sweep does not restart the sweep or sequence. Similarly, pressing the Single key does not restart the sweep or sequence if the sweep is not in the idle state (for example, if you are taking a very slow sweep, or the analyzer is waiting for a trigger). Instead, it results in a message. "Already in Single, press Restart to initiate a new sweep or sequence". Even though pressing the Single key in the middle of a sweep does not restart the sweep, sending INIT:IMMEDIATE does reset it.

To take one more sweep without resetting the average count, increment the average count by 1, by pressing the step up key while **Average/Hold Number** is the active function, or sending the remote command CALC:AVER:TCON UP.

Source

There is no Source control functionality for this measurement. When this key is pressed, the screen either displays a blank menu, or the previously-selected menu remains unchanged.

Key Path	Front-panel key
----------	-----------------

SPAN X Scale

Accesses the SPAN/X Scale menu that allows you to set the desired horizontal scale settings.

Key Path	Front-panel key
Initial S/W Revision	A.10.01

Sweep/Control

Accesses a menu that allows you to select parameters that affect the sweep of the displayed measurement signal.

Only the Pause/Resume key is available.

See "[Sweep/Control](#)" on page 2291 for more information.

Key Path	Front-panel key
Initial S/W Revision	A.10.01

Pause/Resume

Pauses a measurement after the current data acquisition is complete.

When Paused, the label on the key changes to Resume. Pressing Resume un-pauses the measurement. When you are Paused, pressing Restart, Single or Cont does a Resume.

Key Path	Sweep/Control
Remote Command	:INITiate:PAUSE
Dependencies	Grayed out in Measurements that do not support Pausing. Blanked in Modes that do not support Pausing.
Initial S/W Revision	Prior to A.02.00

Key Path	Sweep/Control
Remote Command	:INITiate:RESume
Dependencies	Grayed out in Measurements that do not support Pausing. Blanked in Modes that do not support Pausing.
Initial S/W Revision	Prior to A.02.00

System

See "System" on page 353

Trace/Detector

There is no 'Trace/Detector' functionality supported in Modulation Analysis so this front-panel key will display a blank softkey when pressed.

Key Path	Front-panel key
Initial S/W Revision	A.10.01

Trigger

See ["Trigger" on page 428](#)

Free Run

See ["Free Run " on page 435](#)

Video

See ["Video \(IF Envelope\) " on page 436](#)

Trigger Level

See ["Trigger Level " on page 436](#)

Trig Slope

See ["Trig Slope " on page 437](#)

Trig Delay

See ["Trig Delay " on page 438](#)

Line

See ["Line " on page 2105](#)

Trig Slope

See ["Trig Slope " on page 2105](#)

Trig Delay

See ["Trig Delay " on page 440](#)

External 1

See ["External 1 " on page 2118](#)

Trigger Level

See ["Trigger Level " on page 2118](#)

Trig Slope

See ["Trig Slope " on page 2119](#)

Trig Delay

See ["Trig Delay " on page 443](#)

Zero Span Delay Comp

See ["Zero Span Delay Comp On/Off" on page 2107](#)

External 2

See ["External 2 "](#) on page 2120

Trigger Level

See ["Trigger Level "](#) on page 2120

Trig Slope

See ["Trig Slope "](#) on page 2121

Trig Delay

See ["Trig Delay "](#) on page 445

Zero Span Delay Comp

See ["Zero Span Delay Comp On/Off"](#) on page 2109

RF Burst

See ["RF Burst "](#) on page 2121

Absolute Trigger

See ["Absolute Trigger Level"](#) on page 2122

Relative Trigger

See ["Relative Trigger Level"](#) on page 2111

Trig Slope

See ["Trigger Slope "](#) on page 2123

Trig Delay

See ["Trig Delay "](#) on page 450

Periodic Timer

See ["Periodic Timer \(Frame Trigger\) "](#) on page 2113

Period

See ["Period "](#) on page 2114

Offset

See ["Offset "](#) on page 2115

Offset Adjust (Remote Command Only)

See ["Offset Adjust \(Remote Command Only\)"](#) on page 2116

Reset Offset Display

See "Reset Offset Display " on page 2117

Sync Source

See "Sync Source " on page 2117

Off

See "Off " on page 2118

External 1

See "External 1 " on page 2118

Trigger Level

See "Trigger Level " on page 2118

Trig Slope

See "Trig Slope " on page 2119

External 2

See "External 2 " on page 2120

Trigger Level

See "Trigger Level " on page 2120

Trig Slope

See "Trig Slope " on page 2121

RF Burst

See "RF Burst " on page 2121

Absolute Trigger

See "Absolute Trigger Level" on page 2122

Trig Slope

See "Trigger Slope " on page 2123

Trig Delay

See "Trig Delay" on page 460

Auto/Holdoff

See "Auto/Holdoff " on page 461

Auto Trig

See "Auto Trig " on page 461

15 WLAN Modulation Analysis measurement
Trigger

Trig Holdoff

See "Trig Holdoff" on page 462

Holdoff Type

See ___ on page X

User Preset

Accesses a menu that gives you the following three choices:

- User Preset – recalls a state previously saved using the Save User Preset function.
- User Preset All Modes – presets all of the modes in the analyzer
- Save User Preset– saves the current state for the current mode

Key Path	Front-panel key
Backwards Compatibility Notes	<p>User Preset is actually loading a state, and in legacy analyzers, it was possible to load a state without affecting the trace data, limit lines or correction data. Similarly it was possible to do a User Preset without affecting the trace data, limit lines or correction data.</p> <p>In the X-Series, “state” always includes all of this data; so whenever state is loaded, or User Preset is executed, all of the traces, limit lines and corrections are affected. Although this differs from previous behavior, it is desirable behavior, and should not cause adverse issues for users.</p> <p>On ESA and PSA, User Preset affected the entire instrument’s state. In the X-Series, User Preset only recalls the state for the active mode. There is a User Preset file for each mode. User Preset can never cause a mode switch as it can in legacy analyzers. If you want to recall all modes to their user preset file state, you will need to do a User Preset after mode switching into each mode.</p> <p>User Preset recalls mode state which can now include data like traces; whereas on ESA and PSA, User Preset did not affect data.</p>
Initial S/W Revision	Prior to A.02.00

User Preset

User Preset sets the state of the currently active mode back to the state that was previously saved for this mode using the Save User Preset menu key or the SCPI command, SYST:PRES:USER:SAV. It not only recalls the Mode Preset settings, but it also recalls all of the mode persistent settings, and the Input/Output system setting that existed at the time Save User Preset was executed.

If a Save User Preset has not been done at any time, User Preset recalls the default user preset file for the currently active mode. The default user preset files are created if, at power-on, a mode detects there is no user preset file. There will never be a scenario when there is no user preset file to restore. For each mode, the default user preset state is the same state that would be saved if a Save User Preset is performed in each mode right after doing a Restore Mode Default and after a Restore Input/Output Defaults.

The User Preset function does the following:

- Aborts the currently running measurement.
- Sets the mode State to the values defined by Save User Preset.
- Makes the saved measurement for the currently running mode the active measurement.
- Brings up the saved menu for the power-on mode.
- Clears the input and output buffers.
- Sets the Status Byte to 0.

Key Path	User Preset
Remote Command	:SYSTem:PRESet:USER
Example	:SYST:PRES:USER:SAVE:SYST:PRES:USER
Notes	:SYST:PRES:USER:SAVE is used to save the current state as the user preset state. Clears all pending OPC bits. The Status Byte is set to 0. Pressing the User Preset front-panel key while already in the User Preset menu will cause the User Preset to get executed
Couplings	A user preset will cause the currently running measurement to be aborted and cause the saved measurement to be active. Recalling a User Preset file has the same issues that recalling a Save State file has. Some settings may need to be limited and therefore re-coupled, since the capabilities of the mode may have changes when the User Preset file was last saved.
Initial S/W Revision	Prior to A.02.00

User Preset All Modes

Recalls all of the User Preset files for each mode, switches to the power-on mode, and activates the saved measurement from the power-on mode User Preset file.

NOTE

When the instrument is secured, all of the user preset files are converted back to their default user preset files.

The User Preset function does the following:

- Aborts the currently running measurement.
- Switches the Mode to the power-on mode.
- Restores the User Preset files for each mode.
- Makes the saved measurement for the power-on mode the active measurement.
- Brings up the saved menu for the power-on mode.
- Clears the input and output buffers.
- Sets the Status Byte to 0.

Key Path	User Preset
Remote Command	:SYSTem:PRESet:USER:ALL
Example	:SYST:PRES:USER:SAVE:SYST:PRES:USER:ALL
Notes	Clears all pending OPC bits. The Status Byte is set to 0. :SYST:PRES:USER:SAVE is used to save the current state as the user preset state.
Couplings	A user preset will cause the currently running measurement to be aborted, cause a mode switch to the power-on mode, and cause the saved measurement to be active in the power-on mode. Recalling a User Preset file has the same issues that recalling a Save State file has. Some settings may need to be limited and therefore re-coupled, since the capabilities of the mode may have changes when the User Preset file was last saved.
Initial S/W Revision	Prior to A.02.00

Save User Preset

Saves the currently active mode and its State. You can recall this User Preset file by pressing the User Preset menu key or sending the SYST:PRES:USER remote command. This same state is also saved by the Save State function.

Key Path	User Preset
Remote Command	:SYSTem:PRESet:USER:SAVE
Example	:SYST:PRES:USER:SAVE
Notes	:SYST:PRES:SAVE creates the same file as if the user requested a *SAV or a MMEM:STOR:STAT, except User Preset Save does not allow the user to specify the filename or the location of the file.
Initial S/W Revision	Prior to A.02.00

View/Display

Accesses a menu that allows you to select from the following measurement view and display settings.

Key Path	Front-panel key
Initial S/W Revision	A.10.01

This topic contains the following sections:

["Understanding Front Panel Results to Use Remote Commands" on page 1858](#)

["Front Panel Results" on page 1858](#)

["View Selection by Name" on page 1859](#)

["View Selection by number \(SCPI Only\)" on page 1860](#)

NOTE

The view setting options depend on the measurement view that is active.

Understanding Front Panel Results to Use Remote Commands

WLAN Modulation Analysis measurement has 7 views. They can be selected both by the front-panel and remotely (SCPI commands). View # and Window # in the table below are also used as subops of :DISPlay subsets, for example:

:DISPlay:EVM:VIEW2:WINDow3:TRACe:X:SCALE:PDIVision?

Denotes X Scale/Div value query of EVM trace (View # = 2, Window # = 3).

Front Panel Results

View #	View	Number of Windows	Window #	Window
[1]	I/Q Measured Polar Graph	2	[1]	Numeric Results
			2	I/Q Measured Polar Vector
2	I/Q Error (Quad View)	4	[1]	Magnitude Error
			2	Phase Error
			3	EVM
			4	Numeric Results
3	OFDM EVM (Quad View)	4	[1]	RMS EVM vs. Symbol
			2	RMS EVM vs. Carrier
			3	I/Q Measured Polar Vector
			4	Numeric Results

4	Demod Bits	1	[1]	Demod Bits
5	Result Metrics	1	[1]	Result Metrics
6	Burst Info & HT-L Sig Info	2	[1]	Burst Info
			2	HT-Sig Info
7	Preamble Freq Error Vs. Time	1	[1]	Preamble Freq Error vs. Time
8	I/Q Impairments	3	[1]	IQ Gain Imbalance vs. Carrier
			2	IQ Quadrature Skew vs. Carrier
			3	IQ Time Skew vs. Carrier

- POLar(1): I/Q Measured Polar Graph – Provides a combination view of an I/Q Measured Polar Vector graph and the Numeric Results data.
- IQERror(2): I/Q Error (Quad View) – Provides a combination view of a Magnitude Error, Phase Error, EVM window and Numeric Results for Direct Spread Freq Modulation
- OFDM(3): OFDM EVM (Quad View) – Provides a combination view of a RMS EVM vs. Subcarrier graph, RMS EVM vs. Symbol graph, I/Q Measured Polar Vector graph, and Numeric Results graph.
- DBITs(4): – Provides a window of demod bits
- NRESults(5): Result Metrics – Provides a summary for the measurement result and information
- BHTSiginfo (6): Burst Info Graph and HT-Sig Info Graph. Provides a summary view on Burst Info , HT-Sig Info and L-Sig Info.
- PFERror(7): Provides a Preamble Freq Error vs. Time graph, shows the total frequency error in Hz during the preamble part of the burst.
- IQIMpair (8): IQ Impairments (Triple View) – Provides a combination view of a IQ Gain Imbalance vs. Carrier graph IQ Quadrature Skew vs. Carrier graph and IQ Time Skew vs. Carrier graph.

View Selection by Name

Selects the current active view

KEY:IQ Measured Polar Graph SCPI:POLar	To view I/Q Symbol Constellation graph and the summary data
KEY:I/Q Error SCPI:IQERror	To view Magnitude Error, Phase Error, EVM and Numeric Summary data
KEY:OFDM EVM SCPI:OFDM	To view RMS EVM vs. Symbol, RMS EVM vs. Carrier, I/Q Measured Polar Vector and Numeric Summary data
KEY:Demod Bits SCPI:DBITs	To view all the demoded bits of data

KEY:Numeric Results SCPI:NRESults	To view a summary for the measurement result and information
KEY:Burst Info & HT-Sig Info SCPI:BHTSiginfo	To view a summary on Burst Info, HT-Sig Info and L-Sig Info.
KEY:Preamble Freq Error vs. Time SCPI:PFERror	To view the total frequency error in the preamble part of the burst.
KEY:IQ Impairments SCPI:IQIMpair	To view the IQ impairments

Key Path	View/Display
Mode	WLAN
Remote Command	:DISPlay:EVM:VIEW[:SElect] POLar IQERror OFDM DBITs NRESults BHTSiginfo PFERror IQIMpair :DISPlay:EVM:VIEW[:SElect]?
Example	DISP:EVM:VIEW POL DISP:EVM:VIEW?
Couplings	If Radio Std is 802.11a/g (OFDM), 801.11g (DSSS-OFDM), 802.11n (20 MHz), 802.11n or 802.11ac IQ Error View will be grayed out, and if the customer selects this view by SCPI, an error “-211 Setting Conflict, I/Q Error is not available for current Radio Setting.” will be provided. If there is option x9077A-3FP or x9077A-4FP and Radio Std is not 802.11n or 802.11ac, Burst Info and HT-Sig Info will be grayed out, and if the customer selects this view by SCPI, an error “-211 Setting Conflict, Burst Info is not available for current Radio Setting.” Will be provided.
Preset	POLar
State Saved	Saved in instrument state.
Range	POLar IQERror OFDM DBITs NRESults BHTSiginfo PFERror IQIMpair
Initial S/W Revision	A.10.01

View Selection by number (SCPI Only)

The following remote command allows you to select the desired measurement view by number.

Mode	WLAN
Remote Command	:DISPlay:EVM:VIEW:NSElect <integer> :DISPlay:EVM:VIEW:NSElect?
Example	DISP:EVM:VIEW:NSEL 1 DISP:EVM:VIEW:NSEL?

Couplings	<p>:DISP:EVM:VIEW[:SEL] and :DISP:EVM:VIEW:NSEL shall be synchronized with each other.</p> <p>If Radio Std is 802.11a/g (OFDM), 801.11g (DSSS-OFDM), 802.11n or 802.11ac, View2 (I/Q Error) will be grayed out, and if the customer selects this view by SCPI, an error “-211 Setting Conflict, I/Q Error is not available for current Radio Setting.” will be prompted.</p> <p>If Radio Std is NOT 802.11n or 802.11ac, View6 (Burst Info & HT-Sig Info) will be grayed out, and if the customer selects this view by SCPI, an error “-211 Setting Conflict, Burst Info is not available for current Radio Setting.” Will be prompted.</p> <p>If Radio Std is NOT 802.11n or 802.11ac, View8 (I/Q Impairments) will be grayed out, and if the customer selects this view by SCPI, an error “-211 Setting Conflict, I/Q Impairments is not available for current Radio Setting.” will be returned.</p>
Preset	1
State Saved	Saved in instrument state.
Min	1
Max	8
Initial S/W Revision	A.10.01

Display

The Display menu is common to most measurements, and is used for configuring items on the display. Some Display menu settings apply to all the measurements in a mode, and some only to the current measurement. Those under the System Display Settings key apply to all measurements in all modes.

Key Path	Display
Key Path	View/Display
Initial S/W Revision	Prior to A.02.00

Annotation

Turns on and off various parts of the display annotation. The annotation is divided up into four categories:

1. Meas Bar: This is the measurement bar at the top of the screen. It does not include the settings panel or the Active Function. Turning off the Meas Bar turns off the settings panel and the Active Function. When the Meas Bar is off, the graticule area expands to fill the area formerly occupied by the Meas Bar.
2. Screen Annotation: this is the annotation and annunciation around the graticule, including any annotation on lines (such as the display line, the threshold line, etc.) This does NOT include the marker number or the N dB result. When off, the graticule expands to fill the entire graticule area.
3. Trace annotation: these are the labels on the traces, showing their detector (or their math mode).
4. Active Function annotation: this is the active function display in the meas bar, and all of the active function values displayed on softkeys.

See the figure below. Each type of annotation can be turned on and off individually.

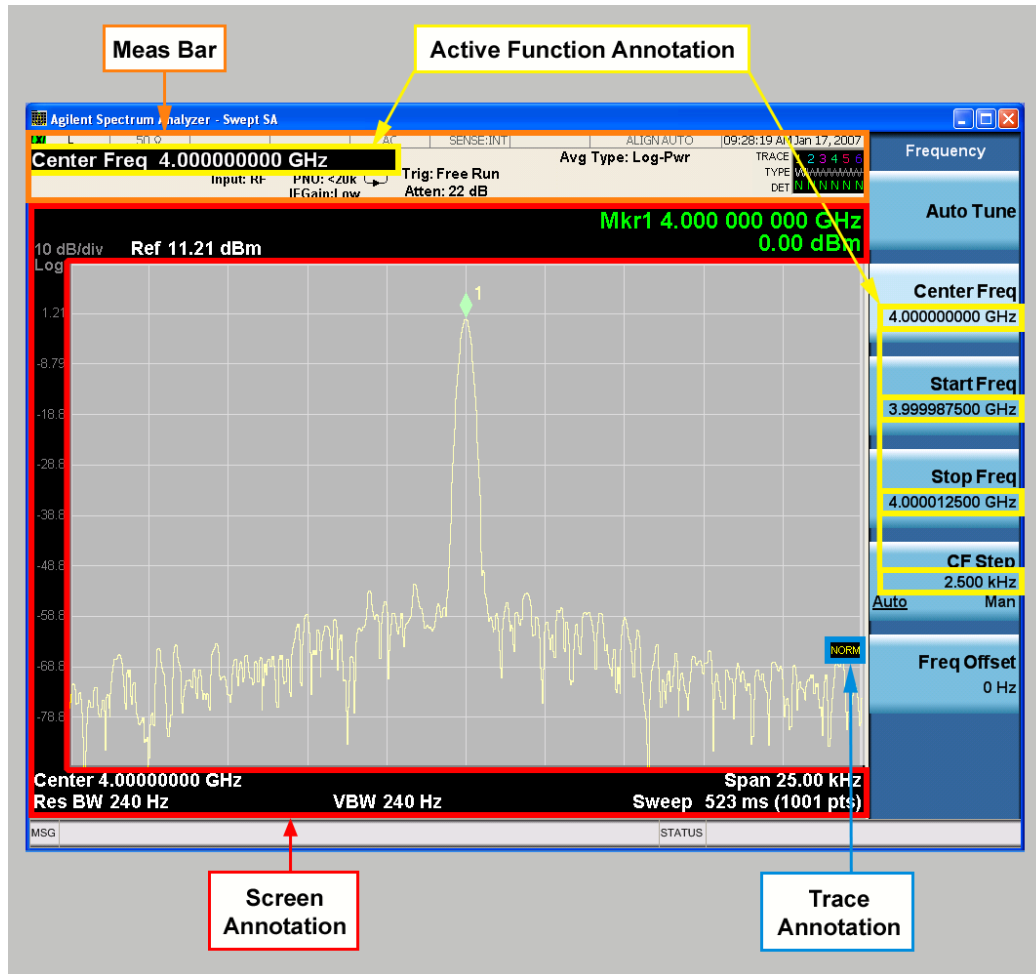

Key Path	View/Display, Display
Initial S/W Revision	Prior to A.02.00

Meas Bar On/Off

This function turns the Measurement Bar on and off, including the settings panel. When off, the graticule area expands to fill the area formerly occupied by the Measurement Bar.

Key Path	View/Display, Display, Annotation
Remote Command	:DISPlay:ANNOtation:MBAR[:STATe] OFF ON 0 1 :DISPlay:ANNOtation:MBAR[:STATe]?
Example	DISP:ANN:MBAR OFF
Dependencies	Grayed out and forced to OFF when System Display Settings, Annotation is set to Off.
Preset	On This should remain Off through a Preset when System DisplaySettings, Annotation is set to Off.
State Saved	Saved in instrument state.
Initial S/W Revision	Prior to A.02.00

Screen

This controls the display of the annunciation and annotation around the graticule, including any annotation on lines (such as the display line, the threshold line, etc.) and the y-axis annotation. This does NOT include marker annotation (or the N dB result). When off, the graticule expands to fill the entire graticule area, leaving only the 1.5% gap above the graticule as described in the Trace/Detector chapter.

Key Path	View/Display, Display, Annotation
Remote Command	:DISPlay:ANNotation:SCReen[:STATe] OFF ON 0 1 :DISPlay:ANNotation:SCReen[:STATe]?
Example	DISP:ANN:SCR OFF
Dependencies	Grayed-out and forced to OFF when System Display Settings, Annotation is set to Off.
Preset	On This should remain Off through a Preset when System DisplaySettings, Annotation is set to Off
State Saved	Saved in instrument state.
Initial S/W Revision	Prior to A.02.00

Active Function Values On/Off

Turns on and off the active function display in the Meas Bar, and all of the active function values displayed on the softkeys.

Note that all of the softkeys that have active functions have these numeric values blanked when this function is on. This is a security feature..

15 WLAN Modulation Analysis measurement
View/Display

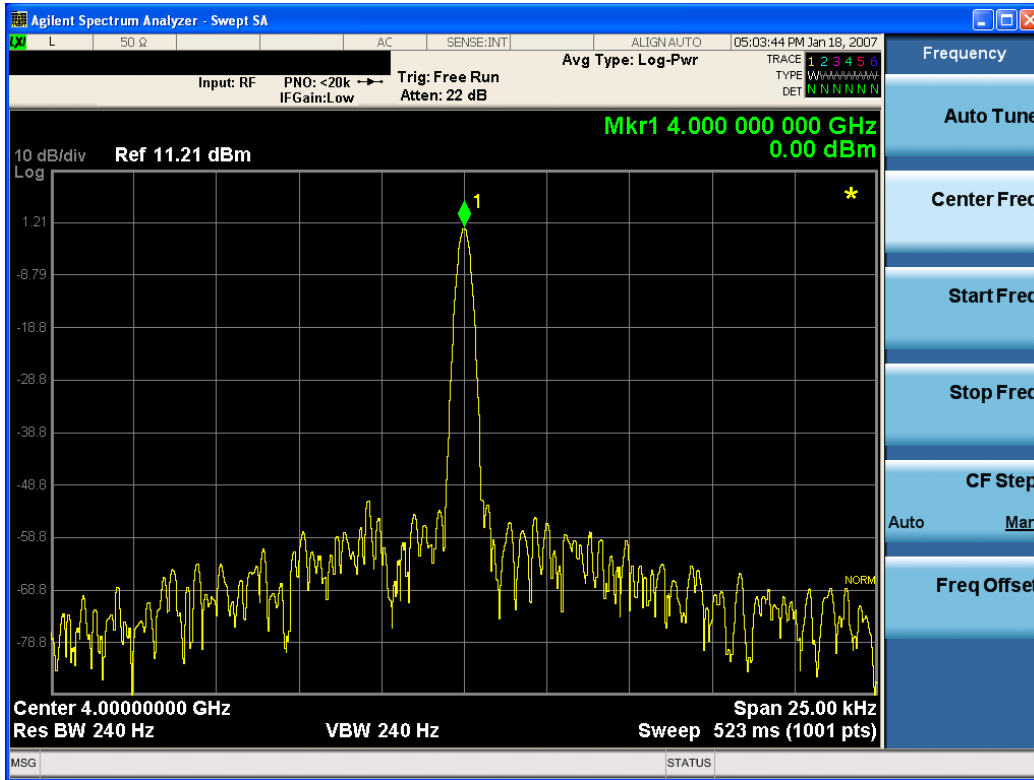

Key Path	View/Display, Display, Annotation
Remote Command	:DISPlay:ACTivefunc[:STATE] ON OFF 1 0 :DISPlay:ACTivefunc[:STATE] ?
Example	DISP:ACT OFF
Dependencies	Grayed out and forced to OFF when System Display Settings, Annotation is set to Off.
Preset	On This should remain Off through a Preset when System DisplaySettings, Annotation is set to Off
State Saved	Saved in instrument state.
Initial S/W Revision	Prior to A.02.00

Title

Displays menu keys that enable you to change or clear a title on your display.

Key Path	View/Display, Display
Initial S/W Revision	Prior to A.02.00

Change Title

Writes a title into the "measurement name" field in the banner, for example, "Swept SA".

Press Change Title to enter a new title through the alpha editor. Press Enter or Return to complete the entry. Press ESC to cancel the entry and preserve your existing title.

The display title will replace the measurement name. It remains for this measurement until you press Change Title again, or you recall a state, or a Preset is performed. A title can also be cleared by pressing Title, Clear Title.

NOTE

Notice the inclusion of the <measurement> parameter in the command below. Because each measurement remembers the Display Title, the command must be qualified with the measurement name. For the Swept SA measurement this is not the case; no <measurement> parameter is used when changing the Display Title for the Swept SA measurement.

Key Path	View/Display, Display, Title
Mode	All
Remote Command	:DISPlay:<measurement>:ANNotation:TITLe:DATA <string> :DISPlay:<measurement>:ANNotation:TITLe:DATA?
Example	DISP:ANN:TITL:DATA "This Is My Title" This example is for the Swept SA measurement in the Spectrum Analyzer mode. The SANalyzer <measurement> name is not used. DISP:ACP:ANN:TITL:DATA "This Is My Title" This example is for Measurements other than Swept SA. Both set the title to: This Is My Title
Notes	Pressing this key cancels any active function. When a title is edited the previous title remains intact (it is not cleared) and the cursor goes at the end so that characters can be added or BKSP can be used to go back over previous characters.
Preset	No title (measurement name instead)
State Saved	Saved in instrument state.
Initial S/W Revision	Prior to A.02.00

Clear Title

Clears a title from the front-panel display. Once cleared, the title cannot be retrieved. After the title is cleared, the current Measurement Name replaces it in the title bar.

Key Path	View/Display, Display, Title
Example	The following commands clear the title and restore the measurement's original title: DISP:ANN:TITL:DATA "" This example is for the Swept SA measurement in the Spectrum Analyzer mode. The SANalyzer <measurement> name is not used. DISP:ACP:ANN:TITL:DATA "" This example is for ACP; in measurements other than Swept SA the measurement name is required.
Notes	Uses the :DISPlay:<measurement>:ANNotation:TITLe:DATA <string> command with an empty string (in the Swept SA, the <measurement> is omitted).
Preset	Performed on Preset.
Initial S/W Revision	Prior to A.02.00

Graticule

Pressing Graticule turns the display graticule On or Off. It also turns the graticule y-axis annotation on and off.

Key Path	View/Display, Display
Remote Command	:DISPlay:WINDow[1]:TRACe:GRATicule:GRID[:STATe] OFF ON 0 1 :DISPlay:WINDow[1]:TRACe:GRATicule:GRID[:STATe]?
Example	DISP:WIND:TRAC:GRAT:GRID OFF
Notes	The graticule is the set of horizontal and vertical lines that make up the grid/divisions for the x-axis and y-axis.
Preset	On
State Saved	Saved in instrument state
Initial S/W Revision	Prior to A.02.00

System Display Settings

These settings are "Mode Global" – they affect all modes and measurements and are reset only by Restore Misc Defaults or Restore System Defaults under System.

Key Path	View/Display, Display
Initial S/W Revision	Prior to A.02.00

Annotation Local Settings

This is a Mode Global override of the meas local annotation settings. When it is All Off, it forces ScreenAnnotation, Meas Bar, Trace, and Active Function Values settings to be OFF for all measurements in all modes. This provides the security based "annotation off" function of previous analyzers; hence it uses the legacy SCPI command.

When it is All Off, the Screen, Meas Bar, Trace, and Active Function Values keys under the Display, Annotation menu are grayed out and forced to Off. When Local Settings is selected, you are able to set the local annotation settings on a measurement by measurement basis.

Key Path	View/Display, Display, System Display Settings
Remote Command	:DISPlay:WINDow[1]:ANNotation[:ALL] OFF ON 0 1 :DISPlay:WINDow[1]:ANNotation[:ALL]?
Example	:DISP:WIND:ANN OFF
Preset	On (Set by Restore Misc Defaults)
State Saved	Not saved in instrument state.
Backwards Compatibility Notes	The WINDow parameter and optional subopcode is included for backwards compatibility but ignored – all windows are equally affected.
Initial S/W Revision	Prior to A.02.00

Themes

Accesses a menu of functions that enable you to choose the theme to be used when saving the screen image.

The **Themes** option is the same as the **Themes** option under the **Display** and **Page Setup** dialogs. It allows you to choose between themes to be used when saving the screen image.

Key Path	Save, Screen Image
Remote Command	:MMEMory:STORe:SCReen:THEMe TDColor TDMonochrome FCOlor FMONochrome :MMEMory:STORe:SCReen:THEMe?
Example	:MMEM:STOR:SCR:THEM TDM
Preset	3D Color; Is not part of Preset, but is reset by Restore Misc Defaults or Restore System Defaults All and survives subsequent running of the modes.
Readback	3D Color 3D Mono Flat Color Flat Mono
Backwards Compatibility Notes	In ESA and PSA we offer the choice of "Reverse Bitmap" or "Reverse Metafile" when saving screen images. This is much like the "Flat Color" theme available in X-Series. Also, if you selected Reverse Bitmap AND a black & white screen image, that would be much like "Flat Monochrome". In other words, each of the X-Series themes has a similar screen image type in ESA/PSA. But they are not identical.
Initial S/W Revision	Prior to A.02.00

3D Color

Selects a standard color theme with each object filled, shaded and colored as designed.

Key Path	Save, Screen Image, Themes
Example	MMEM:STOR:SCR:THEM TDC
Readback	3D Color
Initial S/W Revision	Prior to A.02.00

3D Monochrome

Selects a format that is like 3D color but shades of gray are used instead of colors.

Key Path	Save, Screen Image, Themes
Example	MMEM:STOR:SCR:THEM TDM
Readback	3D Mono
Initial S/W Revision	Prior to A.02.00

Flat Color

Selects a format that is best when the screen is to be printed on an ink printer.

Key Path	Save, Screen Image, Themes
Example	MMEM:STOR:SCR:THEM FCOL
Readback	Flat Color
Initial S/W Revision	Prior to A.02.00

Flat Monochrome

Selects a format that is like Flat Color. But only black is used (no colors, not even gray), and no fill.

Key Path	Save, Screen Image, Themes
Example	MMEM:STOR:SCR:THEM FMON
Readback	Flat Mono
Initial S/W Revision	Prior to A.02.00

Backlight

Accesses the display backlight on/off keys. This setting may interact with settings under the Windows "Power" menu.

When the backlight is off, pressing ESC, TAB, SPACE, ENTER, UP, DOWN, LEFT, RIGHT, DEL, BKSP, CTRL, or ALT turns the backlight on without affecting the application. Pressing any other key will turn backlight on and could potentially perform the action as well.

Key Path	View/Display, Display, System Display Settings
Remote Command	:DISPlay:BACKlight ON OFF :DISPlay:BACKlight?
Preset	ON (Set by Restore Misc Defaults)
Initial S/W Revision	Prior to A.02.00

Backlight Intensity

An active function used to set the backlight intensity. It goes from 0 to 100 where 100 is full on and 0 is off. This value is independent of the values set under the Backlight on/off key.

Key Path	View/Display, Display, System Display Settings
Remote Command	:DISPlay:BACKlight:INTensity <integer> :DISPlay:BACKlight:INTensity?
Example	DISP:BACK:INT 50

Preset	100 (Set by Restore Misc Defaults)
Min	0
Max	100
Initial S/W Revision	Prior to A.02.00

IQ Measured Polar Vector

The following figure shows I/Q Measured Polar Vector view image. The window 2 (left window) shows metrics summary and the window 1 (right) shows I/Q measured polar vector graph.

The view consists of the following windows:

["I/Q Polar Vec/ConstIn" on page 1873](#)

["I/Q Symbol Constellation Window" on page 1870](#)

If Radio Standard is 802.11a/g (OFDM), 801.11g (DSSS-OFDM), 802.11n or 802.11ac:

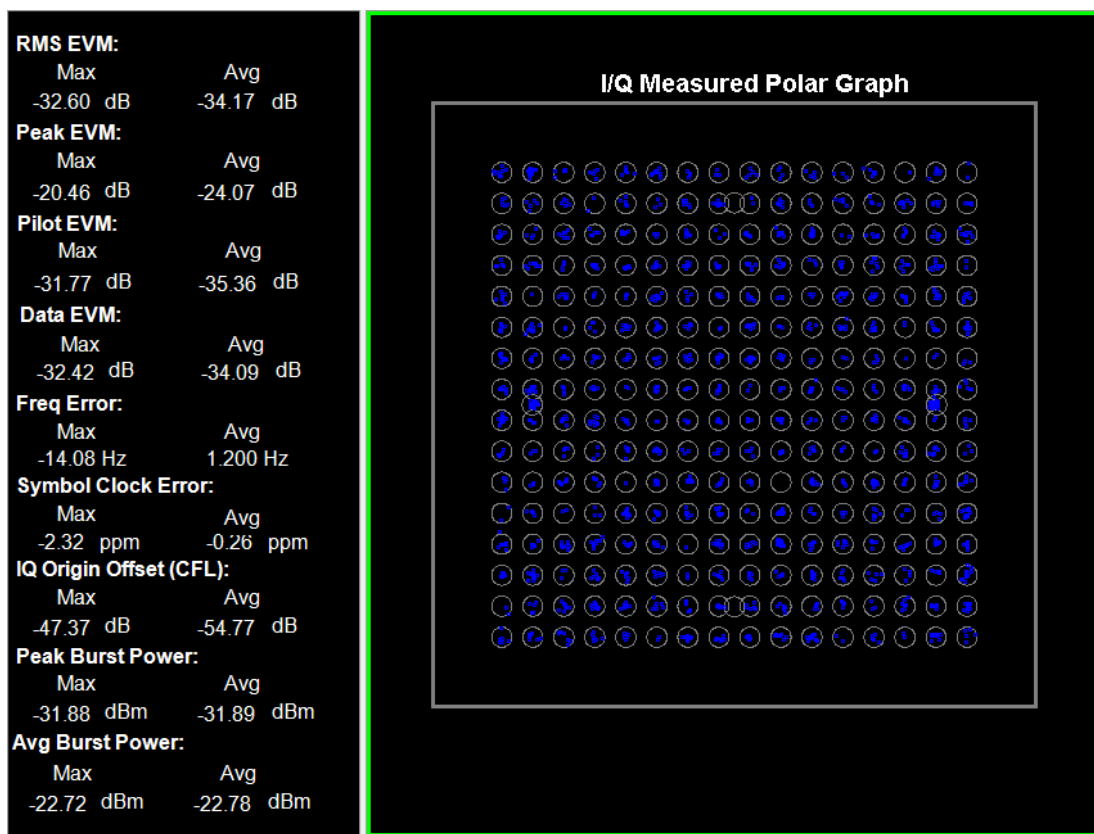

If Radio Standard is 802.11b/g:

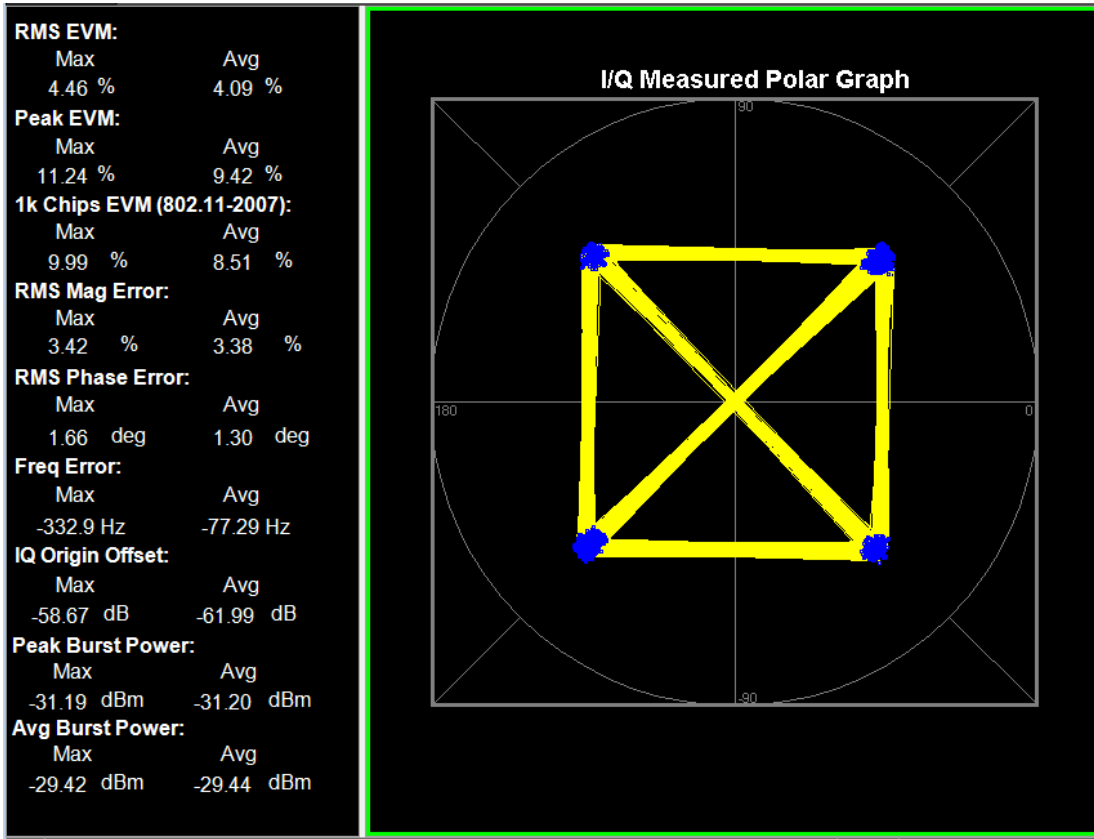

Numeric Results Window

“Avg” means the average of the individual measurements when averaging is on.
 “Max” means the maximum of the individual measurements when averaging is on.
 “Min” means the minimum of the individual measurements when averaging is on.

I/Q Symbol Constellation Window

Marker Operation	Yes [Symbol or Chip - (X,Y)]
Corresponding Trace	Corrected measured trace (n=7) This trace is affected by I/Q Meas Polar view setting parameters.

When Radio Std is 802.11a/g (OFDM), 801.11g (DSSS-OFDM), 802.11n (20 MHz), 802.11n (40 MHz)

Name	Corresponding Results	Description	Unit	Format
RMS EVM Max	n=1 1st	RMS EVM over the measurement area	dB	##.## dB
RMS EVM Avg	n=1 2nd		dB	##.## dB
Peak EVM Max	n=1 3rd	peak EVM in the	dB	##.## dB

measurement area.				
Peak EVM Avg	n=1 4th		dB	###.## dB
Max Peak EVM Index	n=1 5th		None	##
Peak EVM Index	n=1 6th		None	##
Frequency Error Max	n=1 7th	the frequency error in the measured signal.	Hz	###.## Hz
Frequency Error Avg	n=1 8th		Hz	###.## Hz
Symbol Clock Error Max	n=1 11th	symbol clock error	ppm	###.## ppm
Symbol Clock Error Avg	n=1 12th		ppm	###.## ppm
I/Q Origin Offset Max	n=1 13th	the I and Q error (magnitude squared) offset from the origin.	dB	###.## dB
I/Q Origin Offset Avg	n=1 14th		dB	###.## dB
Gain Imbalance Max	n=1 15th	the I/Q gain imbalance of the input signal	None	###.##
Gain Imbalance Avg	n=1 16th		None	###.##
Quadrature error Max	n=1 17th	the I/Q quadrature error of the input signal	degrees	###.## degrees
Quadrature error Avg	n=1 18th		degrees	###.## degrees
Avg Burst Power	n=1 19th		dBm	###.## dBm
Peak Burst Power	n=1 20th		dBm	###.## dBm
Peak-to-Avg Burst Power Ratio	n=1 21st		None	###.##

When Radio Std is 802.11b/g (DSSS/CCK/PBCC):

Name	Corresponding Results	Description	Unit	Format
RMS EVM Max	n=1 1st	RMS EVM over the measurement area	%	###.## %
RMS EVM Avg	n=1 2nd		%	###.## %
Peak EVM Max	n=1 3rd	peak EVM in the	%	###.## %

measurement area.				
Peak EVM Avg	n=1 4th		%	##.## %
1000chips Peak EVM (802.11- 2007) Max	n=1 19th	1000 chips peak EVM in the measurement area.	%	##.## %
1000 chips Peak EVM (802.11- 2007) Avg	n=1 20th		%	##.## %
RMS Magnitude Error Max	n=1 21st	RMS magnitude error over the measurement area	%	##.## %
RMS Magnitude Error Avg	n=1 22nd		%	##.## %
Peak Magnitude Error Max	n=1 23rd	peak magnitude error over the measurement area	%	##.## %
Peak Magnitude Error Avg	n=1 24th		%	##.## %
RMS Phase Error Max	n=1 27th	RMS phase error over the measurement area	%	##.## %
RMS Phase Error Avg	n=1 28th		%	##.## %
Peak Phase Error Max	n=1 29th	peak phase error over the measurement area	%	##.## %
Peak Phase Error Avg	n=1 30th		%	##.## %
Frequency Error Max	n=1 7th	the frequency error in the measured signal.	Hz	##.## Hz
Frequency Error Avg	n=1 8th		Hz	##.## Hz
Chip clock error Max	n=1 11th	Chip clock error	ppm	##.## ppm
Chip clock error Avg	n=1 12th		ppm	##.## ppm
I/Q Origin Offset Max	n=1 13th	the I and Q error (magnitude squared) offset from the origin.	dB	##.## dB
I/Q Origin Offset Avg	n=1 14th		dB	##.## dB
Gain	n=1 15th	the I/Q gain imbalance of	None	##.##

Imbalance Max		the input signal		
Gain Imbalance Avg	n=1 16th		None	###.##
Quadrature error Max	n=1 17th	the I/Q quadrature error of the input signal	degrees	###.## degrees
Quadrature error Avg	n=1 18th		degrees	###.## degrees
Carrier suppression Min	n=1 33th	RF Carrier Suppression	dB	###.## dB
Carrier suppression Avg	n=1 34th	RF Carrier Suppression	dB	###.## dB
Avg Burst Power	n=1 35th		dBm	###.## dBm
Peak Burst Power	n=1 36th		dBm	###.## dBm
Peak-to-Avg Burst Power Ratio	n=1 37th		None	###.##

Key Path	View/Display
Initial S/W Revision	A.10.01

I/Q Polar Vec/ConstIn

Specifies the format of the Polar Vector graph display. You can select one of the following formats:

- Vec ConstIn (Vector and Constellation)
- Vector (Vector only)
- Constellation (Constellation only)

Key Path	View/Display, I/Q Measured Polar Graph
Mode	WLAN
Remote Command	:DISPlay:EVM:VIEW[1]:WINDow[1]:TRACe:POLar VC VECTor CONSTIn :DISPlay:EVM:VIEW[1]:WINDow[1]:TRACe:POLar?
Example	DISP:EVM:VIEW:WIND:TRAC:POL CONS DISP:EVM:VIEW:WIND:TRAC:POL?
Notes	Default Value is coupled with Radio Std
Dependencies	If Radio Std is 802.11a/g (OFDM), 801.11g (DSSS-OFDM), 802.11n (20 MHz), 802.11n (40 MHz) ,

	802.11ac(20 MHz), 802.11ac (40 MHz), 802.11ac(80 MHz), 802.11ac (80 + 80 MHz), 802.11ac (160MHz): ,Vec&Constln and Vector keys are gray out Forceful message “-224 Illegal parameter, Vect&Constn is not available for current Radio Setting”, “-224 Illegal parameter, Vector is not available for current Radio Setting”
Preset	If Radio Std is 802.11a/g (OFDM), 801.11g (DSSS-OFDM), 802.11n (20 MHz), 802.11n (40 MHz), 802.11ac(20 MHz), 802.11ac (40 MHz), 802.11ac(80 MHz), 802.11ac (80 + 80 MHz), 802.11ac (160MHz): CONS If Radio Std is 802.11b/g (DSSS/CCK/PBCC): VC
State Saved	Saved in instrument state.
Range	Vec & Constln Vector Constellation
Initial S/W Revision	A.10.01

I/Q Points

Specifies the number of I/Q Points displayed for the I/Q measured polar graph.

Key Path	View/Display, I/Q Measured Polar Graph
Mode	WLAN
Remote Command	:DISPlay:EVM:VIEW[1]:WINDow[1]:TRACe:IQPoints <integer> :DISPlay:EVM:VIEW[1]:WINDow[1]:TRACe:IQPoints?
Example	DISP:EVM:VIEW:WIND:TRAC:IQP 10 DISP:EVM:VIEW:WIND:TRAC:IQP?
Notes	Default, Max values are coupled with Radio Std and Meas Interval
Couplings	Change the Meas Interval will set the I/Q Points as the same number as Meas Interval when Meas Interval is no bigger than 24564, otherwise, it will be clipped to 24564
Preset	If Raidd Std is 802.11a/g (OFDM), 801.11g (DSSS-OFDM), 802.11n (20 MHz), 802.11n (40 MHz) , 802.11ac(20 MHz), 802.11ac (40 MHz), 802.11ac(80 MHz), 802.11ac (80 + 80 MHz), 802.11ac (160MHz): 60 symbols If Raidd Std is 802.11b/g (DSSS/CCK/PBCC): 2794 chips
State Saved	Saved in instrument state.
Min	1
Max	Meas Interval, when Meas Interval <= 24564 24564, when Meas Interval > 24564
Initial S/W Revision	A.10.01

I/Q Points Offset

Specifies the number of points offset from the first one in the Meas Interval.

Key Path	View/Display, I/Q Measured Polar Graph
Mode	WLAN
Remote Command	:DISPlay:EVM:VIEW[1]:WINDow[1]:TRACe:IQOFfset <integer> :DISPlay:EVM:VIEW[1]:WINDow[1]:TRACe:IQOFfset?
Example	DISP:EVM:VIEW:WIND:TRAC:IQOF 10 DISP:EVM:VIEW:WIND:TRAC:IQOF?
Notes	Max Value is coupled with Meas Interval and I/Q Points
Couplings	Change of Meas Interval will set the I/Q Points Offset to be 0
Preset	0
State Saved	Saved in instrument state.
Min	0
Max	Meas Interval - I/Q Points
Initial S/W Revision	A.10.01

I/Q Rotation

Toggles the display rotation function between On and Off. If set to On, the I/Q polar vector or I/Q polar constellation graph is rotated from 0 to 359.5 degrees.

Key Path	View/Display, I/Q Measured Polar Graph
Mode	WLAN
Remote Command	:DISPlay:EVM:VIEW[1]:WINDow[1]:TRACe:ROTation <real> :DISPlay:EVM:VIEW[1]:WINDow[1]:TRACe:ROTation? :DISPlay:EVM:VIEW[1]:WINDow[1]:TRACe:ROTation:STATe 0 1 OFF ON :DISPlay:EVM:VIEW[1]:WINDow1:TRACe:ROTation:STATe?
Example	DISP:EVM:VIEW:WIND:TRAC:ROT 45 DISP:EVM:VIEW:WIND:TRAC:ROT?
Preset	45.0 ° OFF
State Saved	Saved in instrument state.
Min	0 °
Max	359.5 °
Initial S/W Revision	A.10.01

Full Vector

Toggles the full vector display function between On and Off. If set to On, the full vector traces, that are shown in gray, are displayed in the background of the polar vector solid traces, which are shown in yellow. Both traces can be interpolated by using the Interpolation key.

Key Path	View/Display, I/Q Measured Polar Graph
Mode	WLAN
Remote Command	:DISPlay:EVM:VIEW[1]:WINDow[1]:TRACe:FVECTor[:STATe] 0 1 OFF ON :DISPlay:EVM:VIEW[1]:WINDow[1]:TRACe:FVECTor[:STATe] ?
Example	DISP:EVM:VIEW:WIND:TRAC:FVEC ON DISP:EVM:VIEW:WIND:TRAC:FVEC?
Dependencies	Grayed out if the selected view is I/Q Measured Polar Graph and the selected I/Q Polar Vec/Constn is Constellation. Forceful message"-221 Setting conflict;Full vector is not available for Constellation only"
Preset	OFF
State Saved	Saved in instrument state.
Range	On Off
Initial S/W Revision	A.10.01

I/Q Error (Quad View)

The I/Q Error (Quad View) view consists of 4 windows.

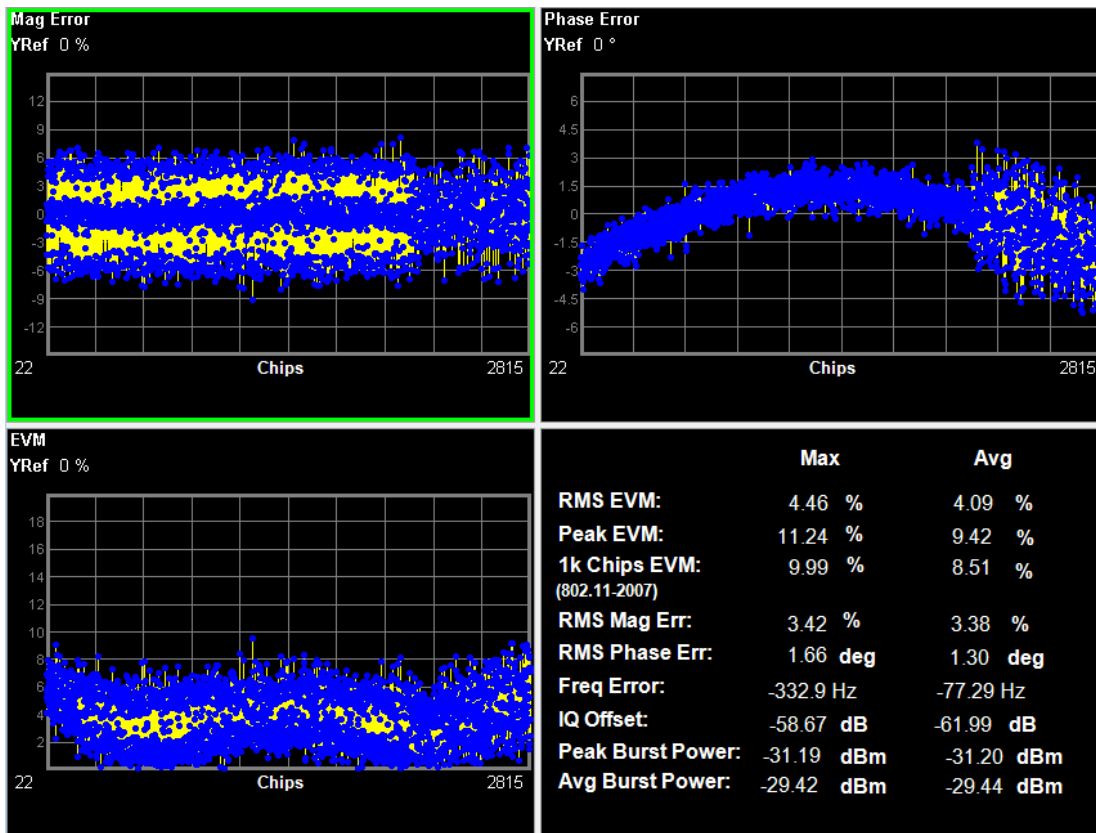

"Mag Error Window" on page 1877

"Phase Error Window" on page 1877

"EVM Window" on page 1877

"Numeric Results Window" on page 1877

Mag Error Window

Marker Operation	Yes (Chips - Magnitude)
Corresponding Trace	n=5 Magnitude Error Trace

Phase Error Window

Marker Operation	Yes (Chips - Phase)
Corresponding Trace	n=6 Phase Error Trace

EVM Window

Marker Operation	Yes (Chips - EVM)
Corresponding Trace	n=4 EVM trace

Numeric Results Window

Marker Operation	No
Corresponding Trace	None.

Key Path	View/Display
Initial S/W Revision	A.10.01

OFDM EVM View

The OFDM EVM (Quad View) view consists of 4 windows.

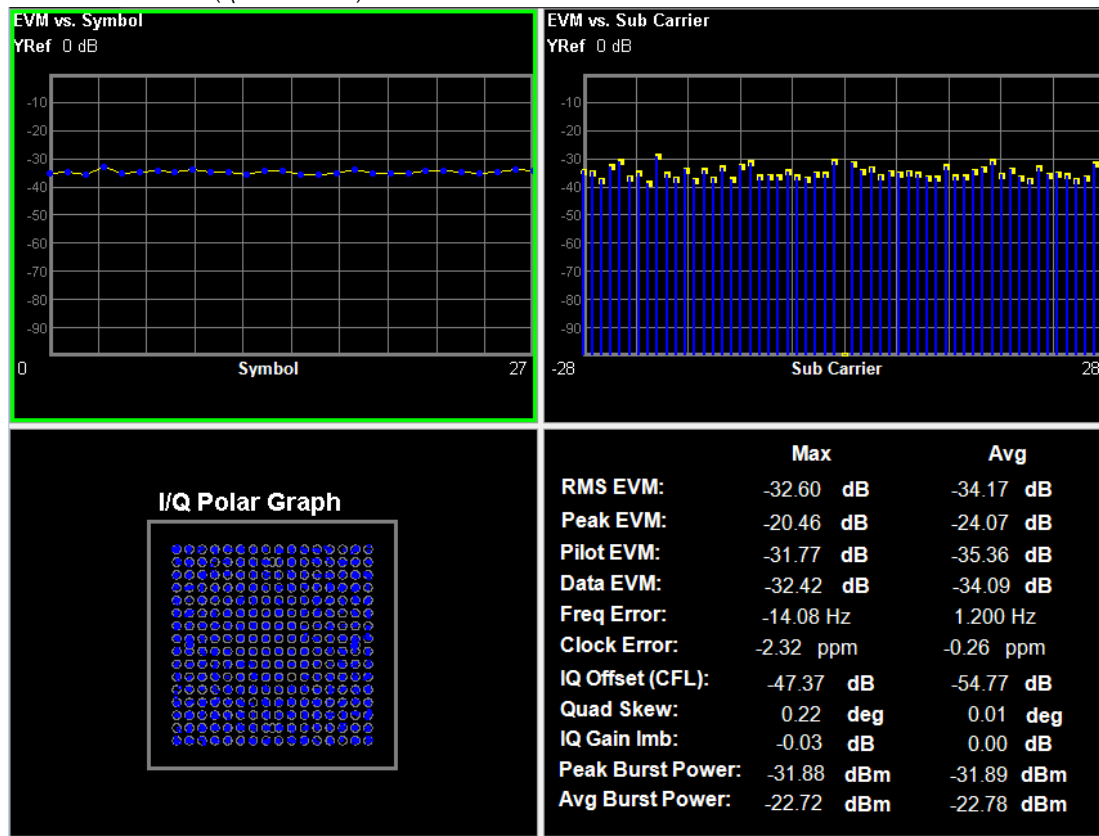

EVM vs. Symbol Window

EVM vs. Carrier Window

IQ Measured Polar Window

Numeric Results Window

EVM vs. Symbol

Provides Magnitude EVM vs. Symbol results.

Marker Operation	Yes (Symbol – Magnitude EVM)
Corresponding Trace	n=2 EVM vs. Symbol Trace

EVM vs. Carrier

Provides Magnitude EVM vs. Carrier results.

Marker Operation	Yes (Subcarrier – Magnitude EVM)
Corresponding Trace	n=3 EVM vs. Carrier Trace

I/Q Measured Polar

Marker Operation	Yes {Symbol or Chip – (X,Y)}
Corresponding Trace	Corrected measured trace (n=7) This trace is affected by I/Q Meas Polar view setting parameters.

Numeric Results Window

Marker Operation	No
Corresponding Trace	None.

Key Path	View/Display
Initial S/W Revision	A.10.01

I/Q Error

Selects the I/Q Error view.

There are four windows in this view:

- 1 "MER/EVM vs. Sub-carrier/Frequency Window" on page 1880 (top left)
- 2 "Logical Channel Window" on page 1884 (top right)
- 3 "Polar Graph Window" on page 1884 (bottom left)
- 4 "Result Metrics Window" on page 1885 (bottom right)

The Reference Value, Units per Division, and Reference Position of X or Y Axis in the trace graph can be adjusted by selecting SPAN X Scale or AMPTD Y Scale.

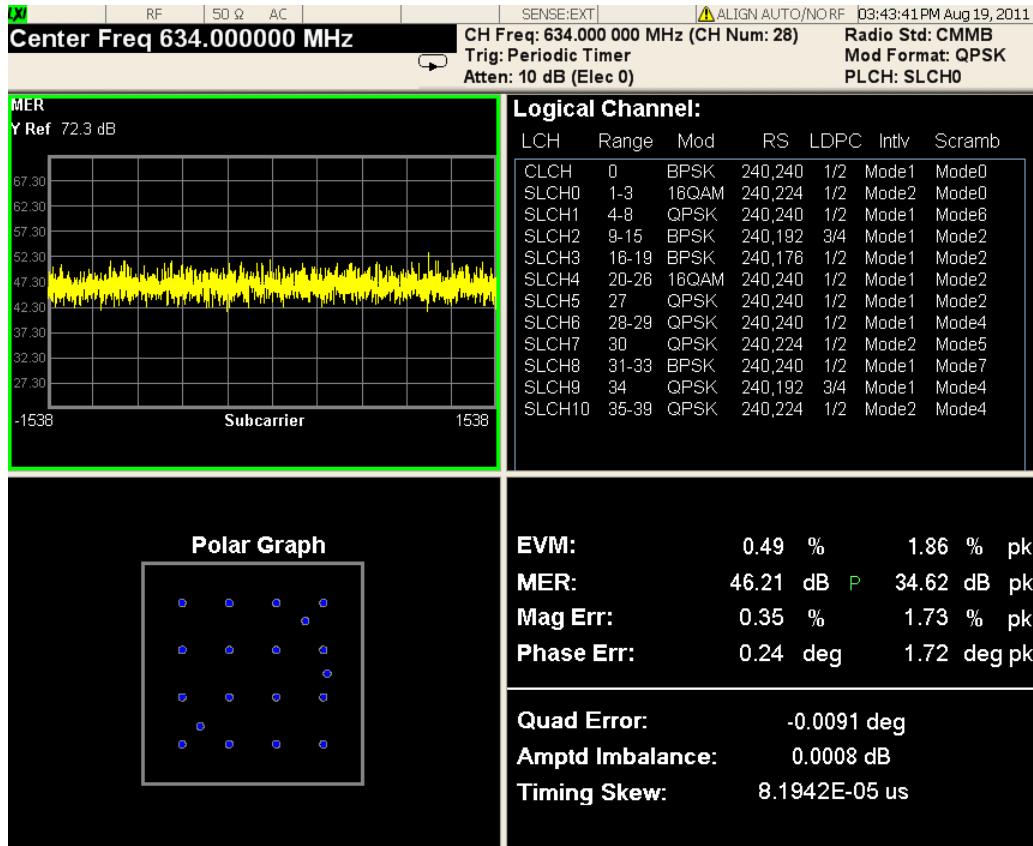

Figure - I/Q Error View of Modulation Accuracy Measurement

MER/EVM vs. Sub-carrier/Frequency Window

This window provides MER/EVM vs. Sub-carrier/Frequency results. It comprises the MER/EVM value of each sub-carrier/frequency in order to give the users a panorama of MER/EVM results. There are 3077 points in 8MHz mode.

Marker Trace	Yes
Corresponding Trace	MER/EVM vs. Sub-carrier/Frequency trace (n=3)

The top left window will be changed by Y Scale Type and X Scale Type.

If Y Scale Type is MER and X Scale Type is Carrier,

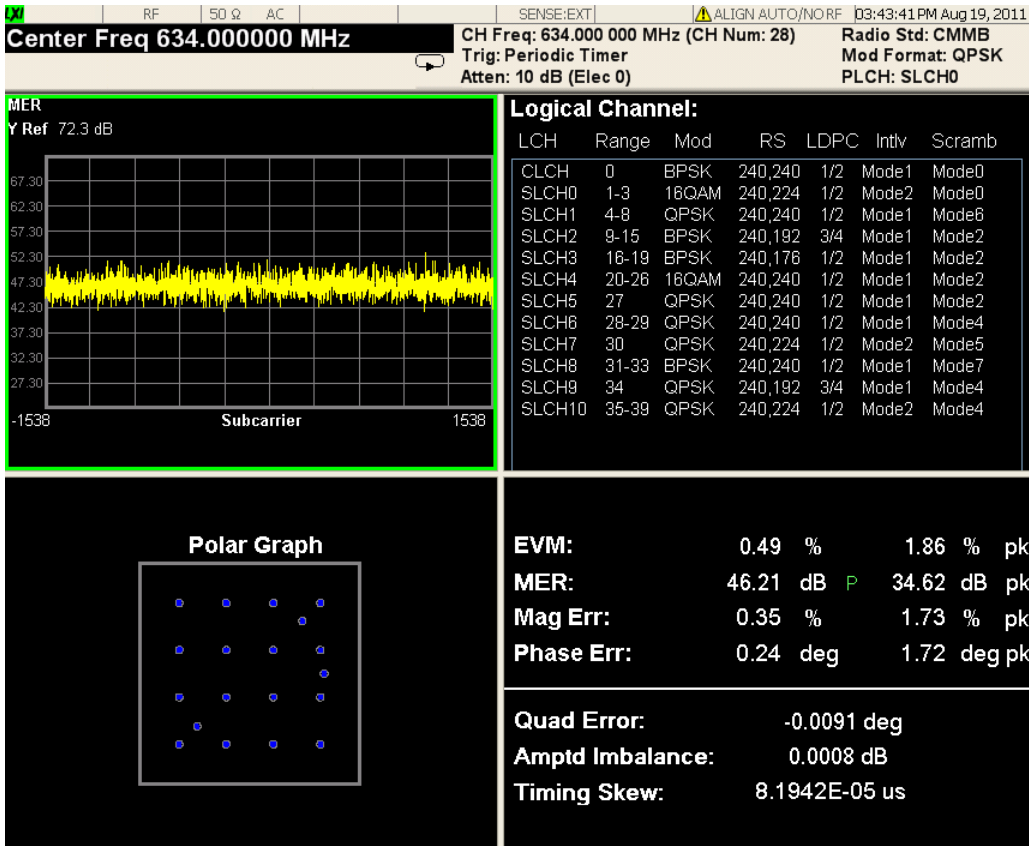

If Y Scale Type is EVM and X Scale Type is Carrier,

15 WLAN Modulation Analysis measurement
View/Display

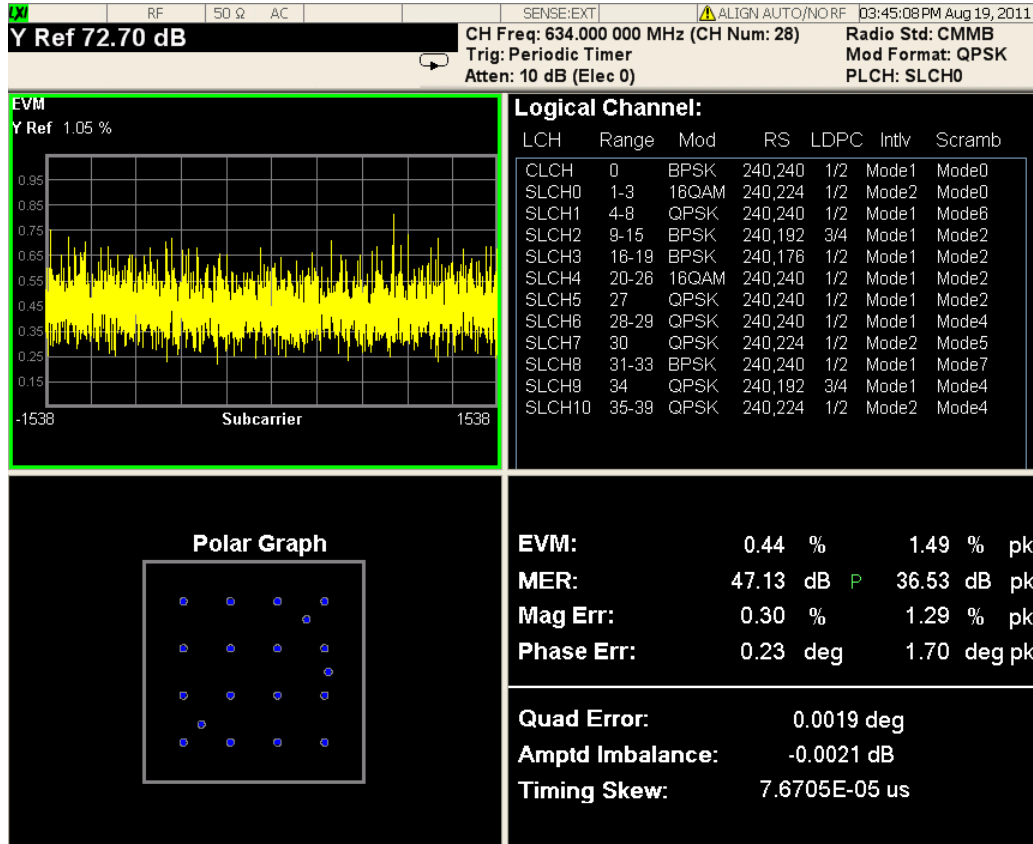

If Y Scale Type is MER and X Scale Type is Freq,

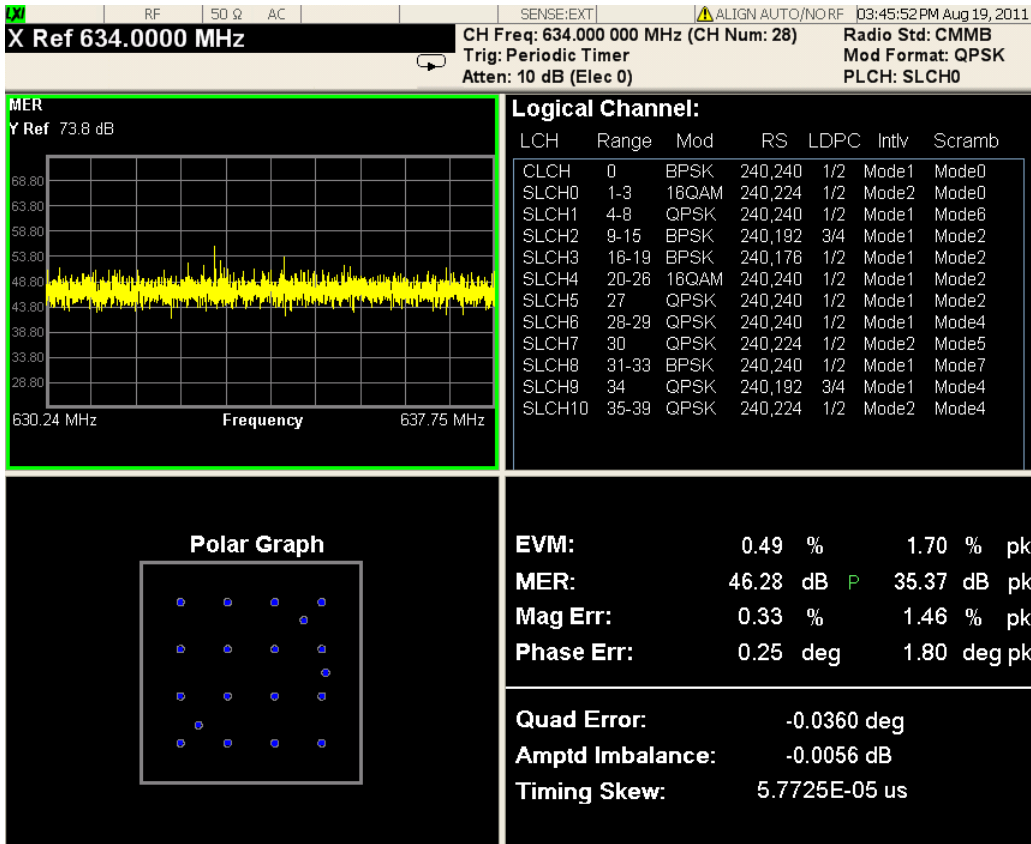

If Y Scale Type is EVM and X Scale Type is Freq,

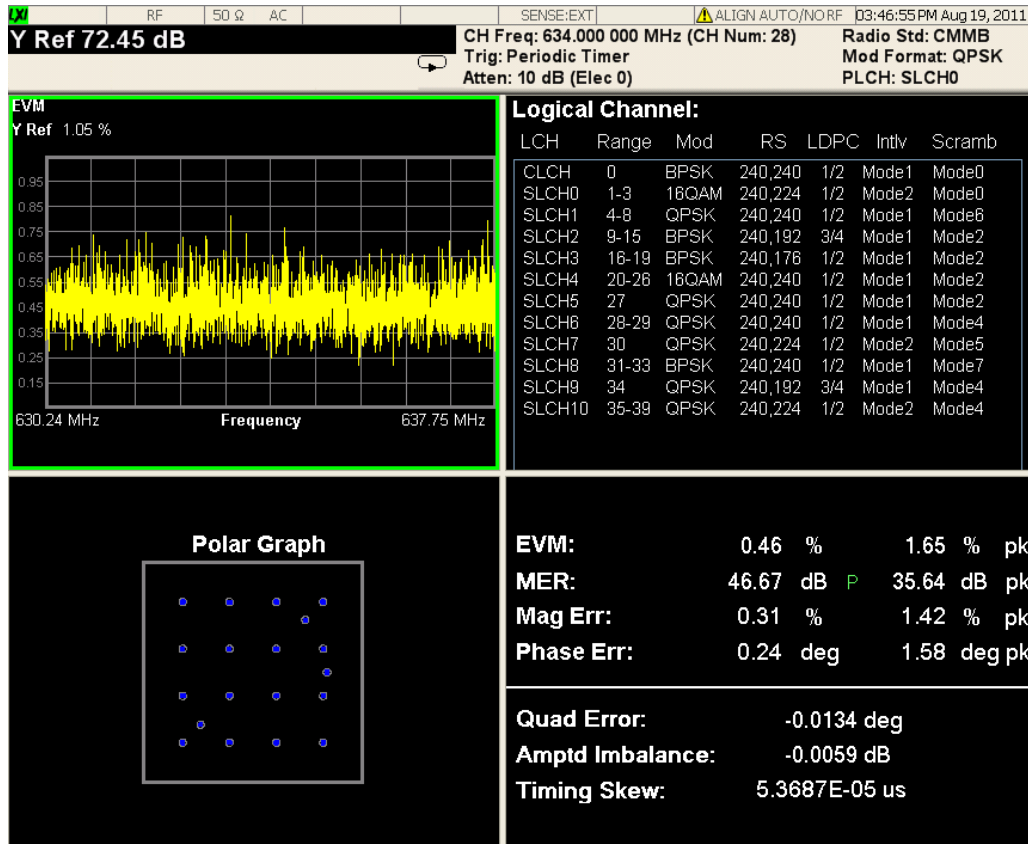

Logical Channel Window

This window provides Logical Channel graph. It gives the TSO decoding results.

Name	Corresponding Results	Format
LCH	Physical Logical Channel (PLCH) type and index. PLCH includes one Control Logical Channel (CLCH) and multiple Service Logical Channels (SLCH).	
Range	Start timeslot and end timeslot for corresponding PLCH	
Mod	Modulation format for corresponding PLCH	BPSK, QPSK, 16QAM
RS	RS code rate for corresponding PLCH	(240, 240), (240, 224), (240,192), (240, 176)
LDPC	LDPC code rate for corresponding PLCH	1/2, 3/4
Intlv	Byte interleaving type for corresponding PLCH	Mode 1, Mode 2, Mode 3
Scramb	Scrambling type for corresponding PLCH	Mode 0, Mode 1, Mode 2, Mode 3, Mode 4, Mode 5, Mode 6, Mode 7

Polar Graph Window

This window provides Polar Graph.

Name	Corresponding Trace	Format
Constellation	The I/Q polar trace of measured input data. The length displayed is defined by I/Q Points.(n=2)	Constellation

Result Metrics Window

This window provides Modulation Accuracy result metrics.

Name	Corresponding Results	Format
EVM	n=1 1st EVM of the current symbols	99.99 %
Peak EVM	n=1 2nd Peak EVM of the current symbols	99.99 %
MER	n=1 4th MER of the current symbols	99.99 dB
Peak MER	n=1 5th Peak MER of the current symbols	99.99 dB
Mag Error	n=1 7th Mag Error of the current symbols	99.99 %
Peak Mag Error	n=1 8th Peak Mag Error of the current symbols	99.99 %
Phase Error	n=1 10th Phase Error of the current symbols	99.99 deg
Peak Phase Error	n=1 11th Peak Phase Error of the current symbols	99.99 deg
Amptd Imbalance	n=1 14th Amplitude imbalance of the current symbols	99.9999 dB
Quad Err	n=1 15th Quadrature error of the current symbols	99.9999 deg
Timing Skew	n=1 16th Timing skew of the current symbols	9.9999E9 s

Key Path	View/Display
Example	:DISPlay:EVM:VIEW IQERror :DISPlay:EVM:VIEW?
Initial S/W Revision	A.03.00

Prev Page

Moves the display one page back to the previous page of the Logical Channel window.

Key Path	View/Display, I/Q Error
Mode	CMMB
Initial S/W Revision	A.03.00

Next Page

Moves the display one page forward to the next page of the Logical Channel window.

Key Path	View/Display, I/Q Error
Mode	CMMB
Initial S/W Revision	A.03.00

Scroll Up

Moves one line upward from the current line of the Logical Channel window.

Pressing the up arrow hard key has the same effect as this function, if no active function is shown. If an active function is shown, the up arrow hard key controls the active function, but has no effect on line movement.

Key Path	View/Display, I/Q Error
Mode	CMMB
Initial S/W Revision	A.03.00

Scroll Down

Moves one line downward from the current line of the Logical Channel window.

Pressing the down arrow hard key has the same effect as this function, if no active function is shown. If an active function is shown, the down arrow hard key controls the active function, but has no effect on line movement.

Key Path	View/Display, I/Q Error
Mode	CMMB
Initial S/W Revision	A.03.00

First Page

Moves the display to the first page of the Logical Channel window.

Key Path	View/Display, I/Q Error
Mode	CMMB
Initial S/W Revision	A.03.00

Last Page

Moves the display to the last page of the Logical Channel window.

Key Path	View/Display, I/Q Error
Mode	CMMB
Initial S/W Revision	A.03.00

Result Metrics

Show following OFDM numeric results view if radio standard is 802.11a/g (OFDM), 801.11g (DSSS-OFDM), 802.11n (20 MHz), 802.11n (40 MHz), 802.11ac(20MHz), 802.11ac(40MHz), 802.11ac(80MHz), 802.11ac (80+80MHz), 802.11ac(160MHz):

	Max		Avg	Limit
RMS EVM:	-27.97 dB		-29.16 dB	-30.00 dB
	3.99 %		3.49 %	
Peak EVM:	-15.19 dB	at sym 6	-19.65 dB	N/A
	17.39 %		10.41 %	
Pilot EVM:	-27.01 dB		-29.62 dB	N/A
	4.46 %		3.31 %	
Data EVM:	-27.93 dB		-29.14 dB	N/A
	4.02 %		3.49 %	
Freq Error:	-0.06 ppm		0.00 ppm	20.00 ppm
Symbol Clock Error:	8.46 ppm		1.03 ppm	20.00 ppm
IQ Origin Offset (CFL):	-45.96 dB		-53.34 dB	-24.00 dB
Quadrature Skew:	-0.22 deg		-0.04 deg	N/A
IQ Gain Imb:	-0.04 dB		0.00 dB	N/A
IQ Time Skew:	-93.77 ps		-69.88 ps	N/A
<hr/>				
Avg Burst Power:	-31.23 dBm		-31.24 dBm	
Peak Burst Power:	-20.05 dBm		-20.20 dBm	
Peak-to-Avg Pwr Ratio:	11.2 dB		11.0 dB	
Modulation Format:	256QAM	Bit Rate:	351.0 Mbps	

Show following DSSS numeric results view if radio standard is 802.11b\g (DSSS/CCK/PBCC).

	Max (Min)	Avg	Limit
RMS EVM:	3.92 %	3.92 %	16.0 %
Peak EVM:	9.21 % at chip 2387	9.21 %	N/A
1k Chips EVM (802.11-2007):	7.86 %	7.86 %	35.0 %
RMS Magnitude Error:	3.54 %	3.54 %	N/A
Peak Magnitude Error:	8.56 % at chip 2112	8.56 %	N/A
RMS Phase Error:	0.97 deg	0.97 deg	N/A
Peak Phase Error:	-5.10 deg at chip 2387	-5.10 deg	N/A
Freq Error:	0.00 ppm	0.00 ppm	25.00 ppm
Chip Clock Error:	0.01 ppm	0.01 ppm	25.00 ppm
IQ Origin Offset:	-54.56 dB	-54.56 dB	N/A
Quadrature Skew:	-0.16 deg	-0.16 deg	N/A
IQ Gain Imb:	-0.05 dB	-0.05 dB	N/A
Carrier Suppression:	45.56 dB	45.56 dB	15.00 dB
Avg Burst Power:	-31.36 dBm	-31.36 dBm	
Peak Burst Power:	-29.42 dBm	-29.42 dBm	
Peak-to-Avg Pwr Ratio:	1.9 dB	1.9 dB	
Modulation Format:	CCK11	Bit Rate: 11.0 Mbps	

Marker Operation	No
Corresponding Trace	n=1 Results Metrics trace

Key Path	View/Display
Initial S/W Revision	A.10.01

Burst Info & HT-Sig Info

The following figure shows Burst Info & HT-Sig Info view image. The window Burst Info shows the information about the analysed burst. The window HT-Sig Info shows the decode info on HT-Sig and L-Sig.

OFDM Data Burst Info:					
Burst Info Type	Mod Format	Len(sym)	Pwr(dBm)	EVM(dB)	Format: 20 MHz HT-mixed
L-STF	QPSK	2	-11.67	-999.00	Stream: 1
L-LTF	BPSK	2	-11.67	-999.00	HT-SIG: CRCPassed
L-SIG	BPSK	1	-11.47	-7.02	L-SIG: HdrStatErrBits
HT-SIG	BPSK	2	-11.66	-7.36	
HT-STF	QPSK	1	-11.46	-999.00	
HT-LTF	BPSK	1	-11.82	-999.00	
HT-Data	16QAM	60	-12.00	-2.73	
Total	Unknown	69	-11.95	-2.87	

OFDM HT-Sig Info								
MCS:	3	CBW:	20MHz	HTLen:	1058	Smooth: N	NotSnd: Y	
Reserved:	1	Aggreg:	N	STBC:	0	FECCode: BCC	ShortGI: N	
ExtStreams:	0	CRC:	0x8a	Tail:	0x0			
OFDM L-Sig Info								
Rate:	48	MBits/s	Reserved:	1	Len:	1312	Parity: 0	Tail: 0x1

Key Path	View/Display
Initial S/W Revision	A.10.01

Burst Info Content

Name	Description	Unit	Format
Burst Info Type	<p>It indicates the type of this piece of the input signal. It has 10 different values.</p> <p>L-STF/ HT-GF-STF: The first two symbols of any valid IEEE 802.11n signal will be an L-STF or HT-GF-STF.</p> <p>L-LTF: The second two symbols of a Non-HT (Legacy) Mode or HT-mixed Mode 802.11n signal will be an L-LTF.</p> <p>L-SIG: The fifth symbol of a Non-HT (Legacy) Mode or HT-mixed Mode 802.11n signal will be an L-SIG symbol.</p> <p>L-Data: A Non-HT (Legacy) Mode 802.11n signal contains L-Data symbols.</p> <p>HT-STF: An HT-mixed Mode 802.11n signal contains an HT-STF symbol.</p> <p>HT-LTF: HT-mixed Mode and HT-greenfield 802.11n signals both contain HT-LTF symbols, but they are found in different places in the</p>	None	None

	<p>preamble.</p> <p>HT-SIG: HT-mixed Mode and HT-greenfield 802.11n signals both contain HT-SIG symbols, but they are found in different places in the preamble.</p> <p>HT-Data: HT-mixed Mode and HT-greenfield 802.11n signals both contain HT-Data symbols.</p> <p>Unknown: This means that the give information about a chunk of the input signal of unknown type</p> <p>All: This means that the give information that summaries the entire input signal.</p>		
Mod Format	BPSK, QPSK, 16QAM, 64QAM, 256QAM, Unknown	None	None
Len	It is an integer used to description the symbol length the signal field or data field.	None	None
Pwr	It gives the average power level.	dBm	##.## dBm
Evm	<p>It gives the RMS EVM level, dB, of the piece of the input signal that is described by the Burst Info Type.</p> <p>The EVM level is not defined on the training symbols of the preamble, so it is set to -999.0 if the burst info type L-STF, L-LTF, HT-STF HT-LTF and Unknown.</p>	dB	##.## dB
Format	<p>This specifies which OFDM11n standard signal format was detected.</p> <p>20 MHz Non-HT: A Non-HT (Legacy) 20 MHz IEEE 802.11a signal was found.</p> <p>20 MHz HT-greenfield: An IEEE 802.11n HT-greenfield 20 MHz signal was found.</p> <p>20 MHz HT-mixed: An IEEE 802.11n HT-mixed Mode 20 MHz signal was found.</p> <p>40 MHz HT-greenfield: An IEEE 802.11n HT-greenfield 40 MHz signal was found.</p> <p>40 MHz HT-mixed: An IEEE 802.11n HT-mixed Mode 40 MHz signal was found.</p> <p>40 MHz Non-HT Duplicate: An IEEE 802.11n Non-HT Duplicate 40 MHz signal was found.</p> <p>Unknown: An invalid mode was detected.</p>	None	None
Stream	This gives the actual number of data streams that were analyzed.	None	None
HT-Sig	<p>The measurement demodulates and decodes the HT-SIG symbols found before the start of the data in many 802.11n signal formats, and this output variable gives the status of the HT-SIG demodulation. Possible values are:</p> <p>None: There aren't any HT-SIG symbols. This would happen if the input signal is a Non-HT (Legacy) or Non-HT Duplicate format signal.</p> <p>Unknown: Nothing is known about the HT-SIG symbols. This would happen if the input vector is so small that there is no data where the HT-SIG symbols are supposed to be.</p>		

	<p>CRCFail: The HT-SIG symbols were found and decoded, but the resulting checksum (CRC) fails.</p> <p>CRCPassed: The HT-SIG symbols were found and decoded, and the resulting checksum (CRC) passed, and no other obvious problems were found.</p>		
L-Sig	<p>The measurement demodulates and decodes the L-SIG symbol found before the start of the data in Non-HT Duplicate and HT-mixed Mode signals, and this output variable gives the status of the L-SIG demodulation. Possible values are:</p> <p>None: There is no L-SIG symbol. This would happen if the input signal is an HT-greenfield format signal.</p> <p>Unknown: Nothing is known about the L-SIG symbols. This would happen if the input vector is so small that there is no data where the L-SIG symbol is supposed to be.</p> <p>ParityWrong: The L-SIG symbol was found and decoded, but the resulting parity bit is incorrect.</p> <p>ParityOk: The L-SIG symbol was found and decoded, and the resulting parity bit is correct, and no other obvious problems were found.</p>	None	None

HT-Sig Content

MCS	<p>The Modulation and Coding Scheme (MCS) is a value that determines the modulation, coding and number of spatial channels. It is a compact representation that is carried in the HT SIGNAL field. Rate dependent parameters for the full set of modulation and coding schemes (MCS)</p>	None	None
CBW	20 MHz, 40 MHz, Unknown (Invalid data.)	None	None
HTLen	The number of octets of data in the PSDU in the range 0–65535.	None	None
Smooth	<p>Y indicates that channel estimate smoothing is recommended.</p> <p>N indicates that only per-carrier independent (unsmoothed) channel estimate is recommended.</p> <p>Unknown indicates invalid data.</p>	None	None
NotSnd	<p>Y indicates that the PPDU is not a sounding PPDU.</p> <p>N indicates that the PPDU is a sounding PPDU</p> <p>Unknown indicates invalid data.</p>	None	None
Reserved	<p>1: Reserved.</p> <p>0: Non reserved.</p> <p>-999: Invalid fatd.</p>	None	None
STBC	<p>Set to a non-zero number, to indicate the difference between the number of space time streams () and the number of spatial streams () indicated by the MCS.</p> <p>-999 indicate invalid data.</p>	None	None

RECCode	LDPC:1 BCC: 0 Unknown indicates invalid data.	None	None
ShortGI	Y N Unknown indicates invalid data.	None	None
ExtStreams	Indicates the Number of extension spatial streams ().	None	None
CRC	Its format is HEX.	None	None
Tail	Used to terminate the trellis of the convolution coder. Its format is HEX.	None	None

L-Sig Content

Rate	Data Rate.	MBits/s	## MBits/s
Reserved	1 or 0.	None	None
Len	It indicates the number of octets in the PSDU.	None	None
Parity	Its format is Hex.		
Tail	Used to terminate the trellis of the convolution coder. The PLCP tail bit field shall be produced by replacing six scrambled “zero” bits following the message end with six no scrambled “zero” bits. Its format is Hex.		

Preamble Freq Error vs. Time

Frequency error is the difference between the measured center frequency of the transmitted signal and the setting center frequency. This trace shows how the measured center frequency drifts during the preamble part of the burst. The units of this trace are in Hz. This includes the constant frequency error in addition to any time-varying frequency error.

Preamble Frequency Error is sampled at 64 times the subcarrier spacing for 802.11a/g (OFDM), 801.11g (DSSS-OFDM), 802.11n (20 MHz), and 128 times the subcarrier spacing for 802.11n (40 MHz).

The view will be looked like below:

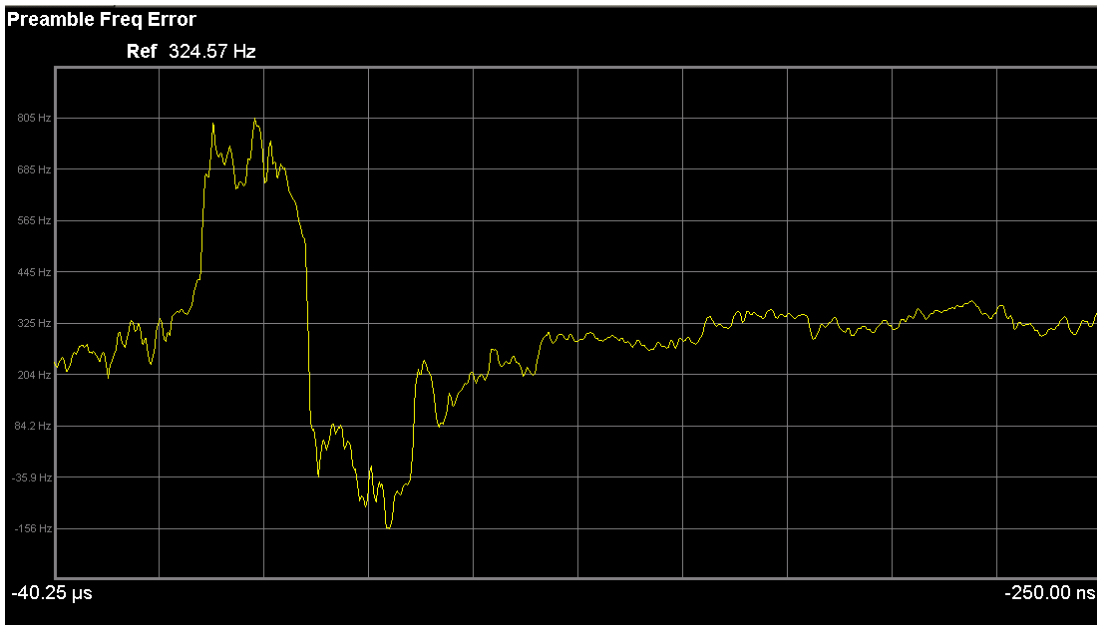

For 802.11a/g (OFDM) signal, the trace length is coupled with Sync Training Sequence. When Sync Training Sequence is set to Short, Preamble Frequency Error covers both the short training sequence and the long training sequence(channel estimation sequence), the length will be 16us. When the Sync type parameter is set to Long (Channel Estimation Sequence), Preamble Frequency Error covers only the channel estimation sequence, the length will be 8us.

For 802.11g (DSSS-OFDM), it can only use Long Sync Training Sequence, since it does not contain the short training sequence

For 802.11n signal, the trace length is auto determined by signals.

For HT-mixed signals, the Preamble Frequency Error covers only the Legacy Short Training Field (L-STF) and Legacy Long Training Field (L-LTF) parts of the preamble. This is the initial 16 us of the burst.

For HT-greenfield signals, the Preamble Frequency Error covers only the Legacy Short Training Field (L-STF) and the First High Throughput Long Training Field (HT-LTF1) parts of the preamble. This is the initial 16 us of the burst.

Key Path	View/Display
Initial S/W Revision	A.10.01

I/Q Impairments

The I/Q Impairments (Triple View) view consists of 3 windows.

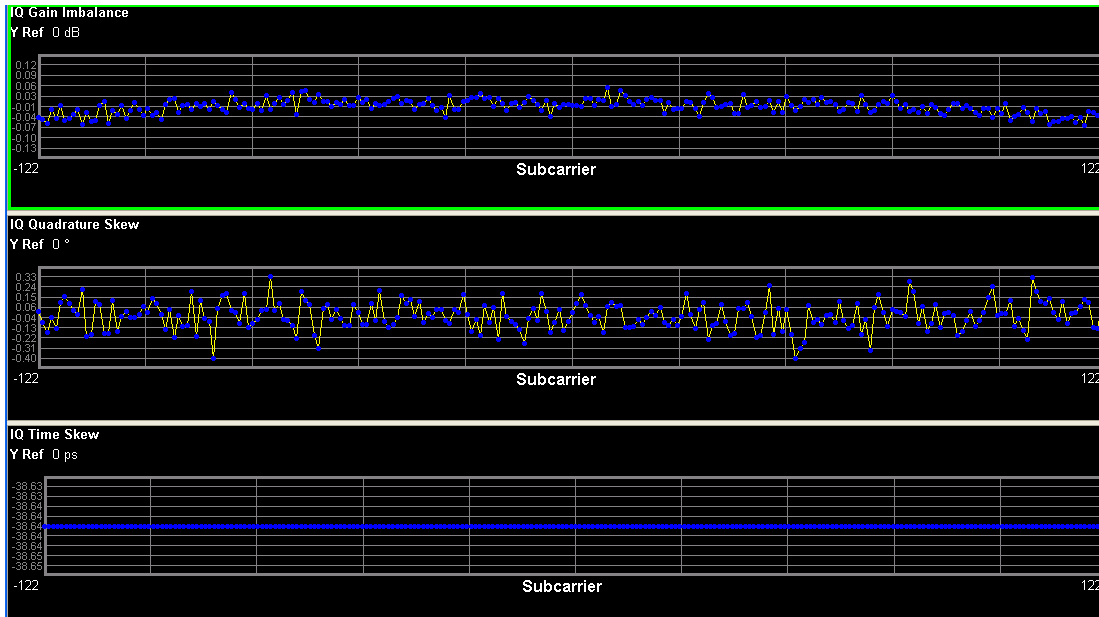

IQ Gain Imbalance vs. Carrier

Provides IQ Gain Imbalance vs. Carrier results.

Marker Operation	Yes (Subcarrier – IQ Gain Imbalance)
Corresponding Trace	n=19 IQ gain imbalance vs. Carrier trace

IQ Quadrature Skew vs. Carrier Window

Provides IQ Quadrature Skew vs. Carrier results.

Marker Operation	Yes (Subcarrier – IQ Quadrature Skew)
Corresponding Trace	n=20 IQ quadrature error vs. Carrier trace

EVM vs. Carrier

Provides Magnitude EVM vs. Carrier results.

Marker Operation	Yes (Subcarrier – Magnitude EVM)
Corresponding Trace	n=3 EVM vs. Carrier Trace

Key Path	View/Display
----------	--------------

Segment Number

This is a new section. It should be added as section 2.26.3 Segment Number.

Select Segment 1 or Segment 2 for 802.11ac 80+80MHz signals.

Segment Number is used to specify which channel results should be displayed in views or queried by SCPI. If Segm1 is selected, the contents both in views and queried by SCPI are the results of the first Segment ; If Segm2 is selected, the contents both in views and queried by SCPI are the results of the second Segment.

Key Path	View/Display
Mode	WLAN
Remote Command	:CALCulate:EVM:SEGMent SEGM1 SEGM2 :CALCulate:EVM:SEGMent?
Example	:CALC:EVM:SEGM SEGM2 :CALC:EVM:SEGM?
Couplings	If option N9077A-4fP is not available, this key will be blanked. If option N9077A-4fP is installed, but standard is not 802.11ac 80+80MHz, this key will be gray out.
Preset	SEGM1
State Saved	Saved in instrument state.
Range	Segment1 Segment2

16 WLAN List Sequence Measurement

List Sequence WLAN (WLS) is to perform sequence measurement mimic EXT and this measurement is only available on M/EXA with B40 option. WLS will make multiple acquisitions to acquire multiple WLAN bursts which have different frequency, different radio standard (one of 802.11a/g, 802.11b/g, 802.11n, 802.11ac), different power range, different trigger type, then make Transmit power, Transmit output spectrum (SEM), modulation accuracy and spectral flatness for each burst. This measurement is focused on manufacturing use cases.

This topic contains the following sections:

["Measurement Commands for WLAN Sequence" on page 1898](#)

["Remote Command Results for Combined WLAN Measurement" on page 1899](#)

Measurement Commands for WLAN Sequence

CONFigure:WLSequence

CONFigure:WLSequence:NDEFault

FETCh:WLSequence [n] ?

INITiate:WLSequence

MEASure:WLSequence [n] ?

READ:WLSequence [n] ?

For more measurement related commands, see the SENSE subsystem, and the section "[Remote Measurement Functions](#)" on page 2213.

Remote Command Results for Combined WLAN Measurement

n=	Results Returned
0	Because raw data is huge for entire sequence, no data is returned.
1	<p>Measurement Result Values</p> <p>Total result length is variable and dependent on how many bursts are measured..</p> <p>The sequence of results is all results of burst 1 which includes TxPower results , EVM results and SEM results, then all results of burst 2 ... all results of burst N. The following (1)(2)... mean the sequence of the remote results.</p> <p>(1)The number of the total results.</p> <p>Burst 1:</p> <p>TxPower results: (Length = 3)</p> <p>(2) Channel Power (dBm) (burst 1)</p> <p>(3) PeakDensityPerMHz.(dBm/MHz) (burst 1)</p> <p>(4) Overall_PassFail(Pass: 0; Fail:1) (burst1)</p> <p>EVM results (Length = 19)</p> <p>If (Radio std = WLAN11bg)</p> <p>{</p> <p>(5) FreqErr(Hz) (burst1)</p> <p>(6) FreqErrPassFail(Pass:0; Fail:1) (burst 1)</p> <p>(7) SymbolClockErr(not available, 9.91e37)(burst 1)</p> <p>(8) SymbolClockErrPassFail(always pass:0)(burst 1)</p> <p>(9) ChipClockErr(ppm) (burst 1)</p> <p>(10) ChipClockErrPassFail(Pass:0; Fail:1) (burst 1)</p> <p>(11) IQOffset(dB)(burst 1)</p> <p>(12)IQOffsetPassFail(Pass:0; Fail:1) (burst 1)</p> <p>(13) SpectralFlatnessPassFail(always pass:0)(burst 1)</p> <p>(14) CarrierSuppression(dB)(burst 1)</p> <p>(15)CarrierSuppressionPassFail(Pass:0; Fail:1) (burst 1)</p> <p>(16) RMSEVM%(burst 1)</p> <p>(17) RMSEVMPassFail(Pass:0; Fail:1) (burst 1)</p> <p>(18) PeakEVM%(burst1)</p> <p>(19)Chips1kPeakEVM%(burst 1)</p> <p>(20) Chips1kPeakEVMPassFail(Pass:0; Fail:1) (burst 1)</p> <p>(21) IQGainImbalance(dB)(burst 1)</p> <p>(22) IQQuadErr(degree)(burst 1)</p> <p>(23) Overall_PassFail(Pass: 0; Fail:1) (burst1)</p> <p>}</p> <p>Else //OFDM standard(11a/g, DSSS-OFDM, 11n/20/40M, 11ac/20/40M)</p> <p>{</p> <p>(5)FreqErr(Hz) (burst1)</p>

```

(6)FreqErrPassFail( Pass:0; Fail:1) (burst 1)
(7)SymbolClockErr(ppm)(burst 1)
(8)SymbolClockErrPassFail( pass:0, Fail:1)(burst 1)
(9)ChipClockErr(Not available, 9.91e37) (burst 1)
(10)ChipClockErrPassFail( always Pass:0) (burst 1)
(11)IQOffset(dB)(burst 1)
(12)IQOffsetPassFail( Pass:0; Fail:1) (burst 1)
(13)SpectralFlatnessPassFail(pass:0;Fail:1)(burst 1)
(14)CarrierSuppression(Not available 9.91e37)(burst 1)
(15)CarrierSuppressionPassFail( always Pass:0) (burst 1)
(16)RMSEVM(dB)(burst 1)
(17)RMSEVMPassFail( Pass:0; Fail:1) (burst 1)
(18)PeakEVM(dB)(burst1)
(19)Chips1kPeakEVM(Not available, 9.91e37)(burst 1)
(20)Chips1kPeakEVMPassFail( always Pass:0) (burst 1)
(21)IQGainImbalance(dB)(burst 1)
(22)IQQuadErr(degree)(burst 1)
(23)Overall_PassFail( Pass: 0; Fail:1) (burst1 )
}
SEM results (Length = 46)
(24)Overall_PassFail( Pass:0; Fail:1) (burst 1)
(25)Total_Ref_Pwr,(dBm)(burst 1)
(26)Spectrum_Peak_Ref(dBm/Hz)(burst 1),
(27)Peak_Freq_Ref,(Hz)(burst 1)
(28)Lower_OffsetA_Abs_Int_Pwr,(dBm)(burst 1)
(29)Lower_OffsetA_Rel_Int_Pwr,(dB)(burst 1)
(30)Lower_OffsetA_Abs_Peak_Pwr,(dBm) (burst 1)
(31)Lower_OffsetA_Rel_Peak_Pwr,(dB)(burst 1)
(32)Lower_OffsetA_Peak_Freq,(Hz)(burst 1)
(33)Lower_OffsetA_Limit_Delta,(dB)(burst 1)
(34)Lower_OffsetA_Limit_PassFail, ( Pass:0; Fail:1) (burst 1)
(35)Upper_OffsetA_Abs_Int_Pwr, ,(dBm)(burst 1)
(36)Upper_OffsetA_Rel_Int_Pwr, (dB)(burst 1)
(37)Upper_OffsetA_Abs_Peak_Pwr, ,(dBm)(burst 1)
(38)Upper_OffsetA_Rel_Peak_Pwr, (dB)(burst 1)
(39)Upper_OffsetA_Peak_Freq, ,(Hz)(burst 1)
(40)Upper_OffsetA_Limit_Delta, (dB)(burst 1)
(41)Upper_OffsetA_Limit_PassFail, ( Pass:0; Fail:1) (burst 1)
(42)Lower_OffsetB_Abs_Int_Pwr, (dBm)(burst 1)
(43)Lower_OffsetB_Rel_Int_Pwr, (dB)(burst 1)
(44)Lower_OffsetB_Abs_Peak_Pwr,(dBm)(burst 1)

```

(45)Lower_OffsetB_Rel_Peak_Pwr, (dB)(burst 1)
 (46)Lower_OffsetB_Peak_Freq, ,(Hz)(burst 1)
 (47)Lower_OffsetB_Limit_Delta, (dB)(burst 1)
 (48)Lower_OffsetB_Limit_PassFail, (Pass:0; Fail:1) (burst 1)
 (49)Upper_OffsetB_Abs_Int_Pwr, (dBm)(burst 1)
 (50)Upper_OffsetB_Rel_Int_Pwr, (dB)(burst 1)
 (51)Upper_OffsetB_Abs_Peak_Pwr, (dBm)(burst 1)
 (52)Upper_OffsetB_Rel_Peak_Pwr, (dB)(burst 1)
 (53)Upper_OffsetB_Peak_Freq, ,(Hz)(burst 1)
 (54)Upper_OffsetB_Limit_Delta, (dB)(burst 1)
 (55)Upper_OffsetB_Limit_PassFail, (Pass:0; Fail:1) (burst 1)
 (56)Lower_OffsetC_Abs_Int_Pwr, (dBm)(burst 1)
 (57)Lower_OffsetC_Rel_Int_Pwr, (dB)(burst 1)
 (58)Lower_OffsetC_Abs_Peak_Pwr, (dBm)(burst 1)
 (59)Lower_OffsetC_Rel_Peak_Pwr, (dB)(burst 1)
 (60)Lower_OffsetC_Peak_Freq, ,(Hz)(burst 1)
 (61)Lower_OffsetC_Limit_Delta, (dB)(burst 1)
 (62)Lower_OffsetC_Limit_PassFail, (Pass:0; Fail:1) (burst 1)
 (63)Upper_OffsetC_Abs_Int_Pwr, (dBm)(burst 1)
 (64)Upper_OffsetC_Rel_Int_Pwr, (dB)(burst 1)
 (65)Upper_OffsetC_Abs_Peak_Pwr, (dBm)(burst 1)
 (66)Upper_OffsetC_Rel_Peak_Pwr, (dB)(burst 1)
 (67)Upper_OffsetC_Peak_Freq, ,(Hz)(burst 1)
 (68)Upper_OffsetC_Limit_Delta, (dB)(burst 1)
 (69)Upper_OffsetC_Limit_PassFail(Pass:0; Fail:1) (burst 1)
 ...
 ...
 ...
 Burst N (index is from 1, ResultsPerBurst = 3 +19+46 = 68, offset = (N-1)*
 ResultsPerBurst)
 TxPower results: (Length = 3)
 (offset + 2) Channel Power (dBm) (burst N)
 (offset + 3) PeakDensityPerMHz.(dBm/MHz) (burst N)
 (offset + 4) Overall_PassFail(Pass: 0; Fail:1) (burst N)
 EVM results (Length = 19)
 If (Radio std = WLAN11bg)
 {
 (offset + 5) FreqErr(Hz) (burst N)
 (offset + 6) FreqErrPassFail(Pass:0; Fail:1) (burst N)
 (offset + 7) SymbolClockErr(not available, 9.91e37)(burst N)
 (offset + 8) SymbolClockErrPassFail(always pass:0)(burst N)

```

(offset + 9) ChipClockErr(ppm) (burst N)
(offset + 10) ChipClockErrPassFail( Pass:0; Fail:1) (burst N)
(offset + 11) IQOffset(dB)(burst N)
(offset + 12)IQOffsetPassFail( Pass:0; Fail:1) (burst N)
(offset + 13) SpectralFlatnessPassFail(always pass:0)(burst N)
(offset + 14) CarrierSuppression(dB)(burst N)
(offset + 15)CarrierSuppressionPassFail( Pass:0; Fail:1) (burst N)
(offset + 16) RMSEVM(%)(burst N)
(offset + 17) RMSEVMPassFail( Pass:0; Fail:1) (burst N)
(offset + 18) PeakEVM(%)(burst N)
(offset + 19)Chips1kPeakEVM(%)(burst N)
(offset + 20) Chips1kPeakEVMPassFail( Pass:0; Fail:1) (burst N)
(offset + 21) IQGainImbalance(dB)(burst N)
(offset + 22) IQQuadErr(degree)(burst N)
(offset + 23) Overall_PassFail( Pass: 0; Fail:1) (burst N )
}
Else //OFDM standard( 11a/g, DSSS-OFDM, 11n/20/40M, 11ac/20/40M)
{
(offset + 5)FreqErr(Hz) (burst N)
(offset + 6)FreqErrPassFail( Pass:0; Fail:1) (burst N)
(offset + 7)SymbolClockErr(ppm)(burst N)
(offset + 8)SymbolClockErrPassFail( pass:0, Fail:1)(burst N)
(offset + 9)ChipClockErr(Not available, 9.91 e37) (burst N)
(offset + 10)ChipClockErrPassFail( always Pass:0) (burst N)
(offset + 11)IQOffset(dB)(burst N)
(offset + 12)IQOffsetPassFail( Pass:0; Fail:1) (burst N)
(offset + 13)SpectralFlatnessPassFail(pass:0;Fail:1)(burst N)
(offset + 14)CarrierSuppression(Not available 9.91 e37)(burst N)
(offset + 15)CarrierSuppressionPassFail( always Pass:0) (burst N)
(offset + 16)RMSEVM(dB)(burst N)
(offset + 17)RMSEVMPassFail( Pass:0; Fail:1) (burst N)
(offset + 18)PeakEVM(dB)(burst N)
(offset + 19)Chips1kPeakEVM(Not available, 9.91 e37)(burst N)
(offset + 20)Chips1kPeakEVMPassFail( always Pass:0) (burst N)
(offset + 21)IQGainImbalance(dB)(burst N)
(offset + 22)IQQuadErr(degree)(burst N)
(offset + 23) Overall_PassFail( Pass: 0; Fail:1) (burst N )
}
SEM results (Length = 46)
(offset + 24)Overall_PassFail( Pass:0; Fail:1) (burst N)
(offset + 25)Total_Ref_Pwr,(dBm)(burst N)

```

(offset + 26)Spectrum_Peak_Ref(dBm/Hz)(burst N)
 (offset + 27)Peak_Freq_Ref,(Hz)(burst N)
 (offset + 28)Lower_OffsetA_Abs_Int_Pwr,(dBm)(burst N)
 (offset + 29)Lower_OffsetA_Rel_Int_Pwr,(dB)(burst N)
 (offset + 30)Lower_OffsetA_Abs_Peak_Pwr,(dBm) (burst N)
 (offset + 31)Lower_OffsetA_Rel_Peak_Pwr,(dB)(burst N)
 (offset + 32)Lower_OffsetA_Peak_Freq,(Hz)(burst N)
 (offset + 33)Lower_OffsetA_Limit_Delta,(dB)(burst N)
 (offset + 34)Lower_OffsetA_Limit_PassFail, (Pass:0; Fail:1) (burst N)
 (offset + 35)Upper_OffsetA_Abs_Int_Pwr, ,(dBm)(burst N)
 (offset + 36)Upper_OffsetA_Rel_Int_Pwr, (dB)(burst N)
 (offset + 37)Upper_OffsetA_Abs_Peak_Pwr, ,(dBm)(burst N)
 (offset + 38)Upper_OffsetA_Rel_Peak_Pwr, (dB)(burst N)
 (offset + 39)Upper_OffsetA_Peak_Freq, ,(Hz)(burst N)
 (offset + 40)Upper_OffsetA_Limit_Delta, (dB)(burst N)
 (offset + 41)Upper_OffsetA_Limit_PassFail, (Pass:0; Fail:1) (burst N)
 (offset + 42)Lower_OffsetB_Abs_Int_Pwr, (dBm)(burst N)
 (offset + 43)Lower_OffsetB_Rel_Int_Pwr, (dB)(burst N)
 (offset + 44)Lower_OffsetB_Abs_Peak_Pwr,(dBm)(burst N)
 (offset + 45)Lower_OffsetB_Rel_Peak_Pwr, (dB)(burst N)
 (offset + 46)Lower_OffsetB_Peak_Freq, ,(Hz)(burst N)
 (offset + 47)Lower_OffsetB_Limit_Delta, (dB)(burst N)
 (offset + 48)Lower_OffsetB_Limit_PassFail, (Pass:0; Fail:1) (burst N)
 (offset + 49)Upper_OffsetB_Abs_Int_Pwr, (dBm)(burst N)
 (offset + 50)Upper_OffsetB_Rel_Int_Pwr, (dB)(burst N)
 (offset + 51)Upper_OffsetB_Abs_Peak_Pwr, (dBm)(burst N)
 (offset + 52)Upper_OffsetB_Rel_Peak_Pwr, (dB)(burst N)
 (offset + 53)Upper_OffsetB_Peak_Freq, ,(Hz)(burst N)
 (offset + 54)Upper_OffsetB_Limit_Delta, (dB)(burst N)
 (offset + 55)Upper_OffsetB_Limit_PassFail, (Pass:0; Fail:1) (burst N)
 (offset + 56)Lower_OffsetC_Abs_Int_Pwr, (dBm)(burst N)
 (offset + 57)Lower_OffsetC_Rel_Int_Pwr, (dB)(burst N)
 (offset + 58)Lower_OffsetC_Abs_Peak_Pwr, (dBm)(burst N)
 (offset + 59)Lower_OffsetC_Rel_Peak_Pwr, (dB)(burst N)
 (offset + 60)Lower_OffsetC_Peak_Freq, ,(Hz)(burst N)
 (offset + 61)Lower_OffsetC_Limit_Delta, (dB)(burst N)
 (offset + 62)Lower_OffsetC_Limit_PassFail, (Pass:0; Fail:1) (burst N)
 (offset + 63)Upper_OffsetC_Abs_Int_Pwr, (dBm)(burst N)
 (offset + 64)Upper_OffsetC_Rel_Int_Pwr, (dB)(burst N)
 (offset + 65)Upper_OffsetC_Abs_Peak_Pwr, (dBm)(burst N)
 (offset + 66)Upper_OffsetC_Rel_Peak_Pwr, (dB)(burst N)

(offset + 67)Upper_OffsetC_Peak_Freq, ,(Hz)(burst N)
(offset + 68)Upper_OffsetC_Limit_Delta, (dB)(burst N)
(offset + 69)Upper_OffsetC_Limit_PassFail(Pass:0; Fail:1) (burst N)

Key Path	Meas
Initial S/W Revision	A.11.00

AMPTD Y Scale

This function is not supported in this measurement.

The Attenuation setting is controlled by the Measurement setup.

Preselector settings are controlled automatically by software.

Key Path	Front Panel key
Initial S/W Revision	A.11.00

BW

This function is not supported in this measurement.

The IFBW will be determined automatically by software based on radio standards. The coupling relationship is as below:

	IFBW
802.11a/g OFDM	20MHz
802.11b DSSS/CCK/PBCC	22MHz
802.11g DSSS-OFDM	20MHz
802.11n 20MHz	20MHz
802.11n 40MHz	40MHz
802.11ac 20MHz	20MHz
802.11ac 40MHz	40MHz

Key Path	Front Panel key
Initial S/W Revision	A.11.00

FREQ Channel

This function is not supported in this measurement.

Frequency of each burst can be set in meas setup.

Key Path	Front Panel key
Initial S/W Revision	A.11.00

Marker

This function is not supported in this measurement because there is no any trace display in this measurement.

Key Path	Front Panel key
Initial S/W Revision	A.11.00

Marker Fctn

This function is not supported in this measurement because there is no any trace display in this measurement.

Key Path	Front Panel key
Initial S/W Revision	A.11.00

Marker To

This function is not supported in this measurement because there is no any trace display in this measurement.

Key Path	Front Panel key
Initial S/W Revision	A.11.00

Meas Setup

Allows you to change the capture setting and the measurement settings of TX Power, TX Output Spectrum and Mod Accuracy. Each measurement can be enabled or disabled by toggling on/off, while all measurements are disabled/off, warning message “no measurement is selected” will be shown.

NOTE

There is no menu displayed under Meas Setup. All the settings under Meas Setup are SCPI only.

Key Path	Front Panel key
Initial S/W Revision	A.11.00

General Setting Commands

Allows you to set the general parameters which work on entire sequence. These parameters are : Trigger Timeout, Abort On Limit Fail , Abort On Error ,Input Trigger Setup.

Initial S/W Revision	A.11.00
----------------------	---------

Trigger Timeout

This parameter sets the timeout for trigger events that occur throughout a sequence. It can effectively be used as a measurement timeout. If all acquisition triggers are set to Free Run, then this parameter is not active. It should be set to a value greater than the trigger arming period (that is, the time expected between a previous acquisition completing and the trigger occurring). This value applies to all non-Free Run triggers in a sequence. When the STATE is set to ON and the trigger arming period is less than the trig timeout value, then the measurement continues and the trig timeout is activated on the next non-Free Run trigger in the sequence. No timeout error is thrown for that trigger event.

If the trigger arming period is greater than the trig timeout value then a trigger timeout error is thrown, and the integrity value for that acquisition is returned as “trigger error”. The measurement is only aborted if “Abort on Error” is enabled. Otherwise the measurement continues to wait for a trigger, and if a trigger event occurs, the measurement proceeds and trigger timeout is activated on the next non-Free Run trigger in the sequence.

When the STATE is set to OFF, then no trigger timeout error is thrown, and this parameter is disabled.

Remote Command

```
[ :SENSe ] :WLSequence:TIMEout:TRIGger <time>
[ :SENSe ] :WLSequence:TIMEout:TRIGger?
[ :SENSe ] :WLSequence:TIMEout:TRIGger:STATe OFF|ON| 0|1
[ :SENSe ] :WLSequence:TIMEout:TRIGger:STATe?
```

Example	WLS:TIM:TRIG 500ms
Couplings	The measurement is only aborted if “Abort on Error” is enabled. Coupled to the integrity indicator “Trigger Error”.
Preset	2 s

	OFF
State Saved	Saved in instrument state.
Range	1 us to 4 ks
Min	1 us
Max	4 ks
Initial S/W Revision	A.11.00

Abort on Limit Fail

This parameter is used to toggle abort on a limit failing while a sequence measurement is being made. When set to ON, if any of the selected measurements on an analysis step fails its pass/fail limits, the sequence aborts at the current point and fails to complete the full sequence if any more acquisitions or measurements have still to be made. When set to OFF, if any measurements fail their limits, then the sequence acquisitions and measurements carry on regardless. This only applies to measurements that have their respective limit test parameters enabled.

Remote Command	[:SENSe] :WLSSequence:ABORt:LIMit:FAIL[:STATe] ON OFF 1 0 [:SENSe] :WLSSequence:ABORt:LIMit:FAIL[:STATe] ?
Example	WLS:ABOR:LIM:FAIL ON WLS:ABOR:LIM:FAIL?
Preset	OFF
State Saved	Saved in instrument state.
Range	ON OFF 1 0
Initial S/W Revision	A.11.00

Abort on Error

When this parameter is set to ON, if any of the errors occur, the sequence aborts at the current point, and fails to complete the full sequence if any more acquisitions or measurements have still to be made. When set to OFF, if any integrity errors occur, then the sequence acquisitions and measurements carry on regardless.

NOTE

When set to ON, if any errors are in the error queue then the measurement aborts immediately. To avoid this, send *CLS or clear the error queue prior to starting the measurement.

Mode	SEQA
Remote Command	[:SENSe] :WLSSequence:ABORt:ERRor[:STATe] ON OFF 1 0 [:SENSe] :WLSSequence:ABORt:ERRor[:STATe] ?
Example	WLS:ABOR:ERR ON WLS:ABOR:ERR?

Preset	OFF
State Saved	Saved in instrument state.
Range	ON OFF 1 0
Initial S/W Revision	A.11.00

Input Trigger Setup

This sets the input trigger parameters that cannot be set within the acquisition parameters. These are set for the entire Sequence. Please note the trigger parameters are not sharing with other measurements such as OBW, CCDF, Monitor spectrum etc.

Initial S/W Revision	A.11.00
----------------------	---------

RF Burst Trig Slope

This parameter controls the trigger polarity for the RF Burst trigger. It is set positive to trigger on a rising edge, and negative to trigger on a falling edge.

Remote Command	:TRIGger:WLSequence:RFBurst:SLOPe POSitive NEGative :TRIGger:WLSequencer:RFBurst:SLOPe?
Example	TRIG:WLS:RFB:SLOP NEG TRIG:WLS:RFB:SLOP?
Preset	POSitive
State Saved	Saved in instrument state.
Initial S/W Revision	A.11.00

Video Trig Slope

This parameter controls the trigger polarity for the Video trigger. It is set positive to trigger on a rising edge, and negative to trigger on a falling edge.

Remote Command	:TRIGger:WLSequence:VIDeo:SLOPe POSitive NEGative :TRIGger:WLSequence:VIDeo:SLOPe?
Example	TRIG:WLS:VID:SLOP NEG TRIG:WLS:VID:SLOP?
Preset	POSitive
State Saved	Saved in instrument state.
Initial S/W Revision	A.11.00

External 1 Trig Slope

This parameter controls the trigger polarity for the External 1 trigger. It is set positive to trigger on a rising edge, and negative to trigger on a falling edge.

Remote Command	:TRIGger:WLSequence:EXTErnal1:SLOPe POSitive NEGative :TRIGger:WLSequence:EXTErnal1:SLOPe?
Example	TRIG:WLS:EXT1:SLOP NEG TRIG:WLS:EXT1:SLOP?
Preset	POSitive
State Saved	Saved in instrument state.
Initial S/W Revision	A.11.00

External 1 Trigger Level

Sets the voltage level for the External 1 trigger.

Remote Command	:TRIGger:WLSequence:EXTErnal1:LEVel <level> :TRIGger:WLSequence:EXTErnal1:LEVel?
Example	TRIG:WLS:EXT1:LEV 1.0 TRIG:WLS:EXT1:LEV?
Dependencies	This parameter is used for Ext1 trigger only.
Preset	1.2 V
State Saved	Saved in instrument state.
Min	-5 V
Max	5 V
Initial S/W Revision	A.11.00

External 2 Trig Slope

This parameter controls the trigger polarity for the External 2 trigger. It is set positive to trigger on a rising edge, and negative to trigger on a falling edge.

Remote Command	:TRIGger:WLSequence:EXTErnal2:SLOPe POSitive NEGative :TRIGger:WLSequence:EXTErnal2:SLOPe?
Example	TRIG:WLS:EXT2:SLOP NEG TRIG:WLS:EXT2:SLOP?
Preset	POSitive
Initial S/W Revision	A.11.00

External 2 Trigger Level

Sets the voltage level for the External 2 trigger.

Remote Command	:TRIGger:WLSquence:EXTernal2:LEVel <level> :TRIGger:WLSquence:EXTernal2:LEVel?
Example	TRIG:WLS:EXT2:LEV 1.0 TRIG:WLS:EXT2:LEV?
Dependencies	This parameter is used for Ext2 trigger only.
Preset	1.2 V
State Saved	Saved in instrument state.
Min	-5 V
Max	5 V
Initial S/W Revision	A.11.00

Use Preselector

This parameter is used to set using preselector or bypassing preselector.

Remote Command	[:SENSe] :WLSquence:POWer [:RF] :PRESelector:STATe ON OFF 1 0 [:SENSe] :WLSquence:POWer [:RF] :PRESelector:STATe?
Example	WLS:POW:PRES:STAT OFF WLS:POW:PRES:STAT?
Preset	OFF
State Saved	Saved in instrument state.
Range	ON OFF 1 0
Initial S/W Revision	A.11.00

Auto Range Setup

Allows you to set the parameters related to auto range which work on entire sequence. These parameters are : Auto Rules, Mech Atten,,Min Signal to Noise Ratio Margin,,Peak Power Margin.

Initial S/W Revision	A.11.00
-----------------------------	---------

Auto Rules

In WLAN List Sequence measurement, Auto Range feature is always “auto”, that means E-Atten, Preamp Gain and IF Gain can be set automatically by Auto Range algorithm. Regarding Mech-Atten, in order to avoid frequently switching Mech- Atten, auto range algorithm can select excluding or including Mech Atten, but because E-Atten can not be available above 3.6GHz and the signal of WLAN sequence can be

above 3.6G and lower 3.6GHz, in order to assure range is right for entire sequence, we select include M-Atten as default, it will lead to Range algorithm to change Mech Atten during calculation.

Remote Command	<code>[:SENSe] :WLSquence:ASRLevels:ARULes EMAT IMAT</code> <code>[:SENSe] :WLSquence:ASRLevels:ARULes?</code>
Example	<code>:WLS:ASRL:ARUL IMAT</code>
Preset	IMAT
State Saved	Saved in instrument state.
Initial S/W Revision	A.11.00

Exclude Mech Atten

Selects the Exclude Mech Atten setting for Auto Set RF Levels.

Example	<code>WLS:ASRL:ARUL EMAT</code>
State Saved	Saved in instrument state.
Initial S/W Revision	A.11.00

Include Mech Atten

Selects the Include Mech Atten setting for Auto Set RF Levels.

Example	<code>WLS:ASRL:ARUL IMAT</code>
State Saved	Saved in instrument state.
Initial S/W Revision	A.11.00

Mech Atten

This parameter is set for the entire Sequence. It cannot be changed from one acquisition to the next within the same sequence.

The Mech Atten value, range 0 – 70 dB in 2 dB steps, cannot be switched during a Sequence run; it must be set before the Sequence is initiated. There is no restriction to the Mechanical Atten value with either the Electronic Attenuation value or the preamp state. If Auto Rules is set to Include Mech Atten, the Mech Atten parameter will be the value calculated by algorithm instead of value from manual setting.

If Auto Rules is set to Exclude Mech Atten, the Mech Atten parameter defaults to 0 dB but is enabled for you to change.

Remote Command	<code>[:SENSe] :WLSquence:POWer[:RF]:ATTenuation <rel_amp1></code> <code>[:SENSe] :WLSquence:POWer[:RF]:ATTenuation?</code>
Example	<code>:WLS:POW:ATT 4</code>
Couplings	While Auto Rules is set to Include Mech Atten, this parameter will be updated by measurement

	algorithm automatically.
Preset	0 dB
State Saved	Saved in instrument state.
Range	0 dB to 70 dB
Min	0 dB
Max	70 dB
Initial S/W Revision	A.11.00

Min Signal To Noise Ratio Margin

This parameter is fed into the auto set RF levels algorithm. It sets how far from the analyzer noise floor (DANL) the ranging will go. This is best described as a Signal to Noise Ratio (SNR) Margin. In communication systems this value is set to allow the data to be fully demodulated with minimum error. A default value of 15 dB is used. This assumes a capture length of 1 ms. The longer the capture, the more averaging is performed, which impacts the SNR required.

Remote Command	<code>[:SENSe] :WLSquence:ASRLevels:MSNRatio <rel_amp1></code> <code>[:SENSe] :WLSquence:ASRLevels:MSNRatio?</code>
Example	<code>:WLS:ASRL:MSNR 10</code>
Preset	15
State Saved	Saved in instrument state.
Range	0 dB to 70 dB
Min	0 dB
Max	70 dB
Initial S/W Revision	A.11.00

Peak Power Margin

This parameter is fed into the auto set RF levels algorithm. It specifies a difference between expected peak power and full scale, after the ranging is done. This margin is intended to accommodate the output power uncertainty of the DUT. A default value of 5 dB is used. That means if the Auto RF level ranging is finished successfully, you won't get an overload warning if the actual power is less than (the Peak Power setting + 5 dB). Increasing the margin may cause the test set to increase its attenuation.

Key Path	Meas setup, Auto Set RF Levels
Remote Command	<code>[:SENSe] :WLSquence:ASRLevels:PPMargin <rel_amp1></code> <code>[:SENSe] :WLSquence:ASRLevels:PPMargin?</code>
Example	<code>:WLS:ASRL:PPM 5</code>
Preset	5

State Saved	Saved in instrument state.
Range	0 dB to 10 dB
Min	0 dB
Max	10 dB
Initial S/W Revision	A.11.00

Max Mixer Level

This parameter is fed into the auto set RF levels algorithm. It specifies a high limit of power range at Mixer.

Remote Command	<code>SERvice[:PRODUCTION]:WLSequence:ASRLevels:MMLevel <rel_ampl></code> <code>SERvice[:PRODUCTION]:WLSequence:ASRLevels:MMLevel?</code>
Example	<code>SERvice:WLSequence:ASRLevels:MMLevel -15</code>
Preset	-15 dBm
State Saved	Saved in instrument state.
Range	-50 dBm to -10 dBm
Min	-50 dBm
Max	-10 dBm
Initial S/W Revision	A.11.00

Capture Setup

Allows you to set the parameters related to each burst acquisition.

Initial S/W Revision	A.11.00
----------------------	---------

Number of Bursts

This parameter is used to define the number of current active Acquisitions.

Remote Command	<code>[:SENSe]:WLSequence:CAPture:BURSt:NUMBer <integer></code> <code>[:SENSe]:WLSequence:CAPture:BURSt:NUMBer?</code>
Example	<code>:WLS:CAPT:BURSt:NUMB 15</code>
Notes	This parameter shows the exact number of bursts customers want to measure but it is not the exact number of busts captured in software. If Tx output spectrum is on/enabled, actual number of bursts captured are 3* Number of Bursts. If Tx output spectrum is off/disabled, the captured bursts equals to Number of Bursts.
Preset	1
State Saved	Saved in instrument state.
Range	If Tx output spectrum is on/enabled: 1 to 45

Min	1
Max	If Tx output spectrum is on/enabled: 45
Initial S/W Revision	A.11.00

Radio Standard

This parameter sets the Radio Standard for the current burst.

Supported Radio Standards are:

- 802.11a/g OFDM
- 802.11b DSSS/CCK/PBCC
- 802.11g DSSS-OFDM
- 802.11n 20MHz
- 802.11n 40MHz
- 802.11ac 20MHz
- 802.11ac 40MHz

Remote Command	<code>[:SENSe] :WLSSequence:CAPTure:BURSt:RADio <enum>, <enum>, <enum>, ...</code> <code>[:SENSe] :WLSSequence:CAPTure:BURSt:RADio?</code>
Example	<code>:WLS:CAPT:BURSt:RAD AG, BG, GDO, AG, N20</code> <code>:WLS:CAPT:BURSt:RAD?</code>
Preset	AG
State Saved	Saved in instrument state.
Range	802.11a/g (OFDM) 802.11b/g (DSSS/CCK/PBCC) 802.11g (DSSS-OFDM) 802.11n (20 M) 802.11n (40 M) 802.11ac(20M) 802.11ac(40M) AG BG GDO N20 N40 AC20 AC40
Initial S/W Revision	A.11.00

Frequency

This parameter sets the frequency for the current Burst.

Remote Command	<code>[:SENSe] :WLSSequence:CAPTure:BURSt:FREQuency <freq>, <freq>, <freq>, ...</code> <code>[:SENSe] :WLSSequence:CAPTure:BURSt:FREQuency?</code>
Example	<code>:WLS:CAPT:BURSt:FREQ 1GHz, 2.412 GHz, 5GHz</code> <code>:WLS:CAPT:BURSt:FREQ?</code>
Preset	2.412 GHz

State Saved	Saved in instrument state.
Range	-80 MHz to 7.1 GHz
Min	-80 MHz
Max	7.1 GHz
Initial S/W Revision	A.11.00

Peak Power

This parameter sets the peak power for the acquisition which is used for the Auto Range algorithm.

Remote Command	<code>[:SENSe] :WLSequence:CAPTURE:BURSt:POWer:PEAK <ampl>, <ampl>, <ampl>, ...</code> <code>[:SENSe] :WLSequence:CAPTURE:BURSt:POWer:PEAK?</code>
Example	<code>:WLS:CAPT:BURSt:POW:PEAK 0DBM, -20DBM</code> <code>:WLS:CAPT:BURSt:POW:PEAK?</code>
Notes	.
Preset	0 dBm
State Saved	Saved in instrument state.
Min	-100 dBm
Max	100 dBm
Initial S/W Revision	A.11.00

Expected Power at DUT Output

For each burst, there are 3 measurements to be executed, TX power, TX Output Spectrum and Mod accuracy. For each measurement, right power level will be set to assure the good performance. This parameter is the minimal expected power in 3 measurements. The RF input range is determined by the Auto Set RF Level algorithm. In this algorithm, peak power together with this Expected power value are used.

Remote Command	<code>[:SENSe] :WLSequence:CAPTURE:BURSt:POWer:EXPeCted <ampl>, <ampl>, <ampl>, ...</code> <code>[:SENSe] :WLSequence:CAPTURE:BURSt:POWer:EXPeCted?</code>
Example	<code>:WLS:CAPT:BURSt:POW:EXP 0DBM, 5DBM</code> <code>:WLS:CAPT:BURSt:POW:EXP?</code>
Notes	.
Preset	0 dBm
State Saved	Saved in instrument state.
Min	-100 dBm
Max	100 dBm
Initial S/W Revision	A.11.00

Burst Length

This parameter is used to set the actual burst length of the WLAN burst customer sends. The actual acquisition duration will be Burst Length + Prefix - Pre trigger. Please note, here Prefix value is positive, pre-trigger is input trigger delay and is negative.

Remote Command	[:SENSe] :WLSequence:CAPTure:BURSt:LENGth <time>, <time>, <time>, ... [:SENSe] :WLSequence:CAPTure:BURSt:LENGth?
Example	:WLS:CAPT:BURSt:LENG 1ms, 2ms :WLS:CAPT:BURSt:LENG?
Notes	.
Preset	1 ms
State Saved	Saved in instrument state.
Range	0 to 50 m s
Min	0
Max	50 ms
Initial S/W Revision	A.11.00

Prefix

In general, trigger point is not the start point of ramp up of burst, Prefix is used to assure the acquisition interval must include a complete ramp up of burst. Actually, Prefix has the same functionality as pre-trigger, Prefix is an additional timing offset based on pre-trigger. It is good practice to set a 2us Prefix. This allows the RF front input circuitry time to ramp up.

Data capture is actually on during Prefix time, yet the system excludes this data from being processed. This parameter indicates the searching window length from which the ramp on and down is searched. If it is set shorter than actual ramp time, the ramp may be lost.

Remote Command	[:SENSe] :WLSequence:CAPTure:BURSt:TIME:PREFix <time>, <time>, <time>, ... [:SENSe] :WLSequence:CAPTure:BURSt:TIME:PREFix
Example	:WLS:CAPT:BURSt:TIME:PREF 1us, 1us, 1us :WLS:CAPT:BURSt:TIME:PREF?
Notes	.
Preset	2.0 us
State Saved	Saved in instrument state.
Range	0 to 1.0 m s
Min	0
Max	1.0 ms
Initial S/W Revision	A.11.00

Transition Time

This parameter sets the amount of time that is required for any changes in Acquisition Parameters that occur between Acquisitions (this allows time for transition between Frequency and or Power range changes). This time applies to the acquisition after the acquisition duration.

Remote Command	<code>[:SENSe] :WLSquence :CAPTure :BURSt :TIME :TRANSition <time>, <time>, <time>, ... [:SENSe] :WLSquence :CAPTure :BURSt :TIME :TRANSition</code>
Example	<code>:WLS:CAPT:BURSt:TIME:TRAN 1us,1us,1us :WLS:CAPT:BURSt:TIME:TRAN?</code>
Notes	. The times set here are dependent on what Acquisition parameters are changing between acquisitions. For accurate measurements the following setup rules should apply. Frequency changes: Within same Frequency Band switching: 300us Different Frequency Band switching: 1 ms Note: Frequency Band 1: -0.08GHz to 0.6075GHz Frequency Band 2: 0.5075GHz to 2.1775GHz Frequency Band 3: 2.0775GHz to 3.6GHz Frequency Band4: above 3.6GHz
Preset	1000us
State Saved	Saved in instrument state.
Range	1 us to 4 ks
Min	0 s
Max	4 ks
Initial S/W Revision	A.11.00

Input Trigger Type

This parameter sets the Trigger input for the current acquisition.

Remote Command	<code>[:SENSe] :WLSquence :CAPTure :BURSt :TRIGger :TYPE <enum>, <enum>, <enum>, ... [:SENSe] :WLSquence :CAPTure :BURSt : TRIGger :TYPE</code>
Example	<code>:WLS:CAPT:BURSt:TRIG:TYPE EXT1 :WLS:CAPT:BURSt:TRIG:TYPE?</code>
Notes	. <ul style="list-style-type: none"> • Free Run • RF burst (wideband) • External 1/2.

Preset	RF Burst
State Saved	Saved in instrument state.
Range	IMMediate RFBurst VIDeo EXTernal1 External2
Initial S/W Revision	A.11.00

Input Trigger Level

This parameter sets the trigger level of Video trigger for the current Acquisition.

Remote Command	<code>[:SENSe] :WLSequence:CAPTure:BURSt:TRIGger:LEVel <amp > , <ampl> , <ampl> , ...</code> <code>[:SENSe] :WLSequence:CAPTure:BURSt: TRIGger:LEVel</code>
Example	<code>:WLS:CAPT:BURSt:TRIG:LEVel -20Dbm</code> <code>:WLS:CAPT:BURSt:TRIG:LEVel?</code>
Notes	. This parameter are used for Video trigger and RF burst Trigger, if the trigger type of this burst is Video trigger, then the level is for Video trigger; if the trigger type of this burst is RF Burst trigger, then the level is for RF Burst trigger.
Dependencies	.
Preset	-20 dBm
State Saved	Saved in instrument state.
Min	-100 dBm
Max	100 dBm
Initial S/W Revision	A.11.00

Input Trigger Delay

This parameter allows you to set the trigger delay for the current Acquisition.

Remote Command	<code>[:SENSe] :WLSequence:CAPTure:BURSt:TRIGger:DELay <time > , <time> , <time> , ...</code> <code>[:SENSe] :WLSequence:CAPTure:BURSt: TRIGger:DELay</code>
Example	<code>:WLS:CAPT:BURSt:TRIG:DEL 0</code> <code>:WLS:CAPT:BURSt:TRIG:DEL?</code>
Notes	. Positive values act as a trigger delay. A negative number acts as a pre-trigger. For example, if set to -200 us, the signal will be captured from start of 200 us prior to the trigger event.
Preset	0 s
State Saved	Saved in instrument state.
Range	-150 ms to 500 ms

Min	-150 ms
Max	500 ms
Initial S/W Revision	A.11.00

TX Power Setup

Settings for Transmit Power.

Initial S/W Revision	A.11.00
----------------------	---------

TX Power

Allows you to enable or disable the TX Power measurement.

Remote Command	<code>[:SENSe] :WLSequence:TXPower [:ENABle] OFF ON 0 1</code> <code>[:SENSe] :WLSequence:TXPower [:ENABle] ?</code>
Example	WLS:TXP ON WLS:TXP?
Preset	ON
State Saved	Saved in instrument state.
Initial S/W Revision	A.11.00

Display Range

Settings for Display Range.

Initial S/W Revision	A.11.00
----------------------	---------

Start Burst

Allows you to display the results of the specific bursts from Start Burst to Stop Burst.

Start Burst must be equal to or less than the Burst Number.

Remote Command	<code>:CALCulate:WLSequence:TXPower:BURSt:STARt <Integer></code> <code>:CALCulate:WLSequence:TXPower:BURSt:STARt ?</code>
Example	:CALC:WLS:TXP:BURS:STAR 2 :CALC:WLS:TXP:BURS:STAR?
Couplings	Max value of Start Burst is equal to the value of Burst Number.

Preset	1
State Saved	Saved in instrument state.
Min	1
Max	Burst Number
Initial S/W Revision	A.11.00

Stop Burst

Allows you to display the results of the specific bursts from Start Burst to Stop Burst.

Stop Burst must be equal to or less than the Burst Number.

Remote Command	:CALCulate:WLSequence:TXPower:BURSt:STOP <Integer> :CALCulate:WLSequence:TXPower:BURSt:STOP ?
Example	:CALC:WLS:TXP:BURS:STOP 5 :CALC:WLS:TXP:BURS:STOP?
Couplings	Max value of Start Burst is equal to the value of Burst Number.
Preset	1
State Saved	Saved in instrument state.
Min	1
Max	Burst Number
Initial S/W Revision	A.11.00

Limits

Settings for Limits.

Initial S/W Revision	A.11.00
----------------------	---------

Limits State

This command switches the limits test for TX Power measurement on or off This parameter is for all bursts.

That means if this state is off, measured power and peak density will not compare with limit, then pass/fail of each burst is always pass; if the state is on, power and peak density of each burst will compare with each limit, then each burst has its own pass/fail.

Remote Command	:CALCulate:WLSequence:TXPower:LIMit:STATe OFF ON 0 1 :CALCulate:WLSequence:TXPower:LIMit:STATe?
Example	:CALC:WLS:TXP:LIM:STAT ON

	:CALC:WLS:TXP:LIM:STAT?
Preset	ON
State Saved	Saved in instrument state.
Range	On Off
Initial S/W Revision	A.11.00

Limits Fail

This command is used to check the pass/fail of each burst in Tx Power measurement. The criteria of pass/fail for each burst is pass if power and peak density are both pass and fail if either power or peak density is fail.

Remote Command	:CALCulate:WLSequence:TXPower:LIMit:FAIL?
Example	:CALC:WLS:TXP:LIM:FAIL?
Notes	This is query only command. It will return 45 values which are pass /fail for 45 bursts. The return value 0 means pass and 1 means fail.
Notes	The return value 0 means pass and 1 means fail.
State Saved	Saved in instrument state.
Range	0 1
Initial S/W Revision	A.11.00

Transmit Power Limit

Allow a user to set the transmit power limits for 7 different standards. They are:

- 1: 802.11a/g OFDM
- 2: 802.11b DSSS/CCK/PBCC
- 3: 802.11g DSSS-OFDM
- 4: 802.11n 20MHz
- 5: 802.11n 40MHz
- 6: 802.11ac 20MHz
- 7: 802.11ac 40MHz

Although up to 45 bursts can be supported, because each burst can belong to 1 of 7 standards, in order to reduce SCPI size, each standard can be set a power limit, all bursts which belong to this standard will use the same power limit.

Remote Command	:CALCulate:WLSequence:TXPower:LIMit:STANdard[1] 2 ...7:TPOWER <ampl> :CALCulate:WLSequence:TXPower:LIMit:STANdard[1] 2 ...7:TPOWER?
Example	CALC:WLS:TXP:LIM:STAN:TPOW -10

CALC:WLS:TXP:LIM:STAN:TPOW?	
Notes	In SCPI command, the sub op codes mean different radio standard: 1: 802.11a/g OFDM 2: 802.11b DSSS/CCK/PBCC 3: 802.11g DSSS-OFDM 4: 802.11n 20MHz 5: 802.11n 40MHz 6: 802.11ac 20MHz 7: 802.11ac 40MHz
Preset	16 dBm 16 dBm 16 dBm 16 dBm 16 dBm 16 dBm 16 dBm
State Saved	Saved in instrument state.
Min	-100 dBm
Max	30 dBm
Initial S/W Revision	A.11.00

Peak Power Spectral Density

Allow a user to set the Peak Power Spectral Density limit for 7 different standards. They are:

- 1: 802.11a/g OFDM
- 2: 802.11b DSSS/CCK/PBCC
- 3: 802.11g DSSS-OFDM
- 4: 802.11n 20MHz
- 5: 802.11n 40MHz
- 6: 802.11ac 20MHz
- 7: 802.11ac 40MHz

Although up to 45 bursts can be supported, because each burst can belong to 1 of 7 standards, in order to reduce SCPI size, each standard can be set a Peak Power Spectral Density limit, all bursts which belong to this standard will use the same Peak Power Spectral Density limit

Remote Command	:CALCulate:WLSequence:TXPower:LIMit:STANdard[1] 2 ...7:PSDensity <real> :CALCulate:WLSequence:TXPower:LIMit:STANdard[1] 2 ...7:PSDensity?
Example	CALC:WLS:TXP:LIM:STAN:PSD -10 CALC:WLS:TXP:LIM:STAN:PSD?
Notes	In SCPI command, the sub op codes mean different radio standard: 1: 802.11a/g OFDM 2: 802.11b DSSS/CCK/PBCC 3: 802.11g DSSS-OFDM

	4: 802.11n 20MHz
	5: 802.11n 40MHz
	6: 802.11ac 20MHz
	7: 802.11ac 40MHz
Preset	4.0 4.0 4.0 4.0 4.0 4.0 4.0
State Saved	Saved in instrument state.
Min	-100 dBm/MHz
Max	30 dBm/MHz
Initial S/W Revision	A.11.00

TX Output Spectrum Setup

Settings for TX Output Spectrum.

Initial S/W Revision	A.11.00
----------------------	---------

TX Output Spectrum

Allows you to enable or disable the TX Output Spectrum measurement.

Remote Command	[:SENSe] :WLSequence :TOSpectrum [:ENABle] OFF ON 0 1 [:SENSe] :WLSequence :TOSpectrum [:ENABle] ?
Example	WLS:TOSP ON WLS:TOSP?
Preset	ON
State Saved	Saved in instrument state.
Range	Off On
Initial S/W Revision	A.11.00

Display Range

Settings for Display Range.

Initial S/W Revision	A.11.00
----------------------	---------

Start Burst

Allows you to display the results of the specific bursts from Start Burst to Stop Burst.

Start Burst must be equal to or less than the Burst Number.

Remote Command	:CALCulate:WLSequence:TOSpectrum:BURSt:STARt <Integer> :CALCulate:WLSequence:TOSpectrum:BURSt:STARt ?
Example	:CALC:WLS:TOSP:BURS:STAR 2 :CALC:WLS:TOSP:BURS:STAR?
Couplings	Max value of Start Burst is equal to the value of Burst Number.
Preset	1
State Saved	Saved in instrument state.
Min	1
Max	Burst Number
Initial S/W Revision	A.11.00

Stop Burst

Allows you to display the results of the specific bursts from Start Burst to Stop Burst.

Stop Burst must be equal to or less than the Burst Number.

Remote Command	:CALCulate:WLSequence:TOSpectrum:BURSt:STOP <Integer> :CALCulate:WLSequence:TOSpectrum:BURSt:STOP ?
Example	:CALC:WLS:TOSP:BURS:STOP 5 :CALC:WLS:TOSP:BURS:STOP?
Couplings	Max value of Start Burst is equal to the value of Burst Number.
Preset	1
State Saved	Saved in instrument state.
Min	1
Max	Burst Number
Initial S/W Revision	A.11.00

Offset/Limits

Settings for Offset/Limits.

Initial S/W Revision	A.11.00
-----------------------------	---------

Limits State

This command switches the relative limit test for TX Output Spectrum measurement to on or off

This parameter is for all bursts. That means if this state is off, measured relative power density will not compare with limit, then pass/fail of each burst is always pass; if the state is on, measured relative power density of each burst will compare with each limit, then each burst has its own pass/fail.

Remote Command	:CALCulate:WLSequence:TOSpectrum:LIMit:STATe OFF ON 0 1 :CALCulate:WLSequence:TOSpectrum:LIMit:STATe?
Example	CALC:WLS:TOSP:LIM:STAT ON CALC:WLS:TOSP:LIM:STAT?
Preset	ON
State Saved	Saved in instrument state.
Range	On Off
Initial S/W Revision	A.11.00

Limits Fail

This command is used to check the pass/fail of each burst in Tx Output Spectrum measurement. The criteria of pass/fail for each burst is pass if all offsets are pass and fail if one of offset is fail.

Remote Command	:CALCulate:WLSequence:TOSpectrum:LIMit:FAIL?
Example	:CALC:WLS:TOSP:LIM:FAIL?
Notes	This is query only command. It will return 45 values which are pass /fail for 45 bursts. The return value 0 means pass and 1 means fail.
State Saved	Saved in instrument state.
Range	0 1
Initial S/W Revision	A.11.00

Limits Level

Allows you to set Transmit Output Spectrum Limit Line of Offset A, B, C, D. The table below shows the different offsets and relative level for 802.11a, 802.11b,802.11g DSSS-OFDM,80211n 20M, 802.11n 40M, 802.11ac 20M and 802.11ac 40M.

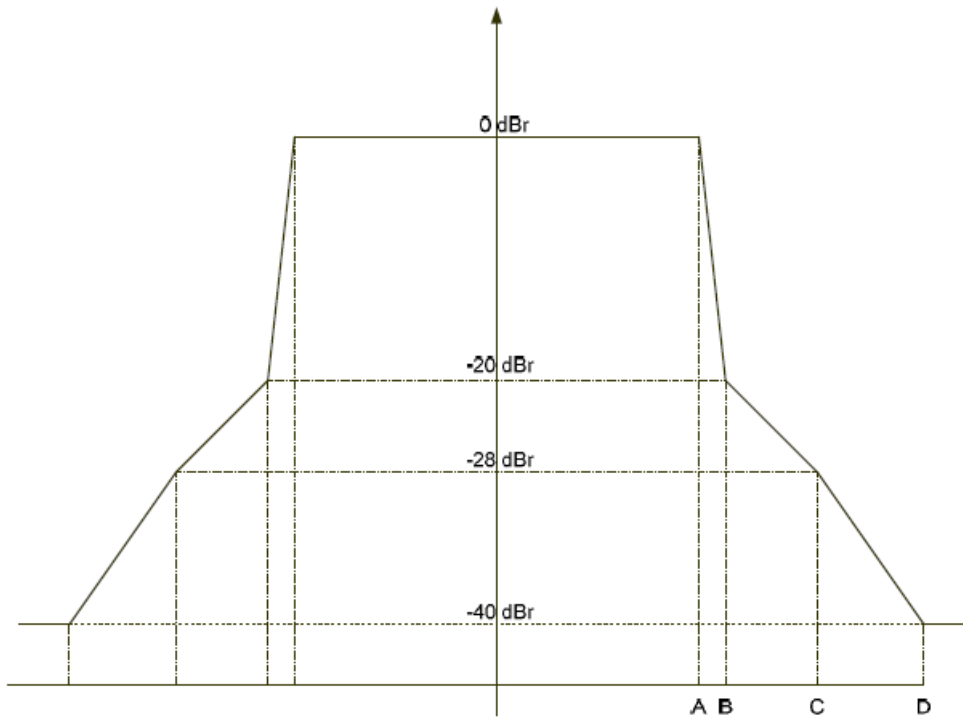

Radio standard	Channel size	Point A	Point B	Point C	Point D				
802.11a	20MHz	9MHz	0dBm	11MHz	-20dBm	20MHz	-28dBm	30MHz	-40dBm
802.11b	22MHz	11MHz	-30dBm	22MHz	-50dBm	-	-50dBm	-	-
802.11g DSSS-OFDM	20MHz	9MHz	0dBm	11MHz	-20dBm	20MHz	-28dBm	30MHz	-40dBm
802.11n 20M	20MHz	9MHz	0dBm	11MHz	-20dBm	20MHz	-28dBm	30MHz	Max(-45dBm,--53dBm/MHz)
802.11n 40M	40MHz	19MHz	0dBm	21MHz	-20dBm	40MHz	-28dBm	60MHz	Max(-45dBm,--56dBm/MHz)
802.11ac 20M	20MHz	9MHz	0dBm	11MHz	-20dBm	20MHz	-28dBm	30MHz	Max(-40dBm,--53dBm/MHz)
802.11ac 40M	40MHz	19MHz	0dBm	21MHz	-20dBm	40MHz	-28dBm	60MHz	Max(-40dBm,--56dBm/MHz)

Remote Command This is used for setting the limit of one offset for one standard at a time:
:CALCulate:WLSequence:TOSpectrum:LIMit:STANdard[1]|2|...7: :OFFSet[1]

	<pre> 2 ...4:DATA <real ></pre> <pre>:CALCulate:WLSequence:TOSpectrum:LIMit:STANdard[1] 2 ...7: :OFFSet[1]</pre> <pre> 2 ...4:DATA?</pre> <p>This is used for setting the limit values as an array for one standard:</p> <pre>:CALCulate:WLSequence:TOSpectrum:LIMit:STANdard[1] 2 ...7: DATA <real</pre> <pre>>,<real>,<real>,<real></pre> <pre>:CALCulate:WLSequence:TOSpectrum:LIMit:STANdard[1] 2 ...7: DATA?</pre>
Example	<pre>CALC:WLS:TOSP:LIM:STAN2:OFFS3:DATA -10</pre> <pre>CALC:WLS:TOSP:LIM:STAN2:OFFS3:DATA?</pre> <pre>CALC:WLS:TOSP:LIM:STAN2:DATA -10, -20, -20, -20</pre> <pre>CALC:WLS:TOSP:LIM:STAN2:DATA?</pre>
Notes	<p>In SCPI command, the sub op codes mean different radio standard::</p> <ul style="list-style-type: none"> 1: 802.11a/g OFDM 2: 802.11b DSSS/CCK/PBCC 3: 802.11g DSSS-OFDM 4: 802.11n 20MHz 5: 802.11n 40MHz 6: 802.11ac 20MHz 7: 802.11ac 40MHz <p>For 11ac and 11n, this SCPI can set relative limit, however, absolute limit is needed at 30MHz for 20M and 60MHz for 40M, then absolute limit, -53dBm/MHz and -56dBm/MHz are fixed and can not be changed.</p>
Preset	<pre>0, -20, -28, -40 (802.11a, 802.11g-OFDM, 802.11ac 20M and 802.11ac 40M)</pre> <pre>-30, -50, -50, -50(802.11b, 802.11g-DSSS)</pre> <pre>0, -20, -28, -45 (802.11n 20M and 802.11n40M)</pre>
State Saved	Saved in instrument state.
Min	-200
Max	50
Initial S/W Revision	A.11.00

Mod Accuracy Setup

Settings for Mod Accuracy.

Initial S/W Revision	A.11.00
-----------------------------	---------

Modulation Accuracy

Allows you to set the On/Off status of the Modulation Accuracy measurement.

Remote Command	<pre>[:SENSe] :WLSequence:EVM[:ENABLe] OFF ON 0 1</pre>
-----------------------	---

	<code>[:SENSe] :WLSequence:EVM[:ENABle] ?</code>
Example	WLS:EVMON WLS:EVM?
Preset	ON
State Saved	Saved in instrument state.
Range	Off On
Initial S/W Revision	A.11.00

Display Range

Settings for Display Range.

Initial S/W Revision	A.11.00
----------------------	---------

Start Burst

Allows you to display the results of the specific bursts from Start Burst to Stop Burst.

Start Burst must be equal to or less than the Burst Number.

Remote Command	<code>:CALCulate:WLSequence:EVM:BURSt:STARt <Integer></code> <code>:CALCulate:WLSequence:EVM:BURSt:STARt ?</code>
Example	<code>:CALC:WLS:EVM:BURS:STAR 2</code> <code>:CALC:WLS:EVM:BURS:STAR?</code>
Couplings	Max value of Start Burst is equal to the value of Burst Number.
Preset	1
State Saved	Saved in instrument state.
Min	1
Max	Burst Number
Initial S/W Revision	A.11.00

Stop Burst

Allows you to display the results of the specific bursts from Start Burst to Stop Burst.

Stop Burst must be equal to or less than the Burst Number.

Remote Command	<code>:CALCulate:WLSequence:EVM:BURSt:STOP <Integer></code> <code>:CALCulate:WLSequence:EVM:BURSt:STOP ?</code>
Example	<code>:CALC:WLS:EVM:BURS:STOP 5</code>

	:CALC:WLS:EVM:BURS:STOP?
Couplings	Max value of Start Burst is equal to the value of Burst Number.
Preset	1
State Saved	Saved in instrument state.
Min	1
Max	Burst Number
Initial S/W Revision	A.11.00

Mod Accuracy /Limits

Settings for Mod Accuracy/Limits.

Initial S/W Revision	A.11.00
----------------------	---------

Limits State

This command switches the limit test for Mod Accuracy measurement on or off This parameter is for all bursts.

Each standard has its own limit to compare with. Which standard the limit parameter will apply to will be addressed in note section of each parameter.

Remote Command	:CALCulate:WLSequence:EVM:LIMit:STATe OFF ON 0 1 :CALCulate:WLSequence:EVM:LIMit:STATe?
Example	CALC:WLS:EVM:LIM:STAT ON CALC:WLS:EVM:LIM:STAT?
Preset	ON
State Saved	Saved in instrument state.
Range	On Off
Initial S/W Revision	A.11.00

Limits Fail

This command is used to check the EVM measurement limits results.

Remote Command	:CALCulate:WLSequence:EVM:LIMit:FAIL?
Notes	This is query only command. It will return 45 values which are pass /fail for 45 bursts. The return value 0 means pass and 1 means fail.
State Saved	Saved in instrument state.
Range	0 1
Initial S/W Revision	A.11.00

Freq Error

The command is used to set a frequency error limit value to warn you if the measured frequency error exceeds the limit value.

Remote Command

```
:CALCulate:WLSequence:EVM:LIMit:STANdard[1]|2|...7:FERRor <real>
:CALCulate:WLSequence:EVM:LIMit:STANdard[1]|2|...7:FERRor?
```

Example

```
CALC:WLS:EVM:LIM:STAN:FERR 2
CALC:WLS:EVM:LIM:STAN:FERR?
```

Notes

In SCPI command, the sub op codes mean different radio standard:

- 1: 802.11a/g OFDM
- 2: 802.11b DSSS/CCK/PBCC
- 3: 802.11g DSSS-OFDM
- 4: 802.11n 20MHz
- 5: 802.11n 40MHz
- 6: 802.11ac 20MHz
- 7: 802.11ac 40MHz

Preset	20 25 20 20 20 20 20
--------	----------------------

State Saved	Saved in instrument state.
-------------	----------------------------

Min	0
-----	---

Max	500
-----	-----

Initial S/W Revision	A.11.00
----------------------	---------

Symbol Clock Error

The command is used to set a symbol clock error limit value to warn you if the measured symbol clock error exceeds the limit value.

Remote Command

```
:CALCulate:WLSequence:EVM:LIMit:STANdard[1]|2|...7:SCLKerror <real>
:CALCulate:WLSequence:EVM:LIMit:STANdard[1]|2|...7:SCLKerror?
```

Example

```
CALC:WLS:EVM:LIM:STAN:SCLK 2
CALC:WLS:EVM:LIM:STAN:SCLK?
```

Notes

In SCPI command, the sub op codes mean different radio standard:

- 1: 802.11a/g OFDM
 - 2: 802.11b DSSS/CCK/PBCC
-

	3: 802.11g DSSS-OFDM
	4: 802.11n 20MHz
	5: 802.11n 40MHz
	6: 802.11ac 20MHz
	7: 802.11ac 40MHz

Preset	20 20 20 20 20 20 20
State Saved	Saved in instrument state.
Min	0
Max	100
Initial S/W Revision	A.11.00

Center Freq Leakage

The command is used to set a center frequency leakage limit value to warn you if the measured center frequency leakage exceeds the limit value.

Remote Command :CALCulate:WLSequence:EVM:LIMit:STANdard[1]|2|...7:CFLeakage <rel_ampl>
:CALCulate:WLSequence:EVM:LIMit:STANdard[1]|2|...7:CFLeakage?

Example CALC:WLS:EVM:LIM:STAN:CFL -10dB
CALC:WLS:EVM:LIM:STAN:CFL?

Notes

In SCPI command, the sub op codes mean different radio standard::

- 1: 802.11a/g OFDM
- 2: 802.11b DSSS/CCK/PBCC
- 3: 802.11g DSSS-OFDM
- 4: 802.11n 20MHz
- 5: 802.11n 40MHz
- 6: 802.11ac 20MHz
- 7: 802.11ac 40MHz

Preset	-15dB -15dB -15dB -15dB -24dB -15dB -24dB
State Saved	Saved in instrument state.
Min	-100 dB
Max	0 dB
Initial S/W Revision	A.11.00

6 Mbits/s RMS EVM

Sets RMS EVM limit at the 6 Mbits/s data rate for 802.11a and 802.11g/DSSS--OFDM Radio Std.

Remote Command	:CALCulate:WLSequence:EVM:LIMit:STANdard[1] 2 ...7:RMS:D6Mbits <rel_ ampl> :CALCulate:WLSequence:EVM:LIMit:STANdard[1] 2 ...7:RMS:D6Mbits?
Example	CALC:WLS:EVM:LIM:STAN:RMS:D6MB 2 CALC:WLS:EVM:LIM:STAN:RMS:D6MB?
Notes	In SCPI command, the sub op codes mean different radio standard: 1: 802.11a/g OFDM 2: 802.11b DSSS/CCK/PBCC 3: 802.11g DSSS-OFDM 4: 802.11n 20MHz 5: 802.11n 40MHz 6: 802.11ac 20MHz 7: 802.11ac 40MHz
Preset	-5 dB -5dB -5 dB -5dB -5 dB -5dB -5dB
State Saved	Saved in instrument state.
Min	-100 dB
Max	0 dB
Initial S/W Revision	A.11.00

9 Mbits/s RMS EVM

Sets RMS EVM limit at the 9 Mbits/s data rate for 802.11a and 802.11g-OFDM Radio Std.

Remote Command	:CALCulate:WLSequence:EVM:LIMit:STANdard[1] 2 ...7:RMS:D9Mbits <rel_ ampl> :CALCulate:WLSequence:EVM:LIMit:STANdard[1] 2 ...7:RMS:D9Mbits?
Example	CALC:WLS:EVM:LIM:STAN:RMS:D9MB 2 CALC:WLS:EVM:LIM:STAN:RMS:D9MB?
Notes	In SCPI command, the sub op codes mean different radio standard: 1: 802.11a/g OFDM 2: 802.11b DSSS/CCK/PBCC 3: 802.11g DSSS-OFDM 4: 802.11n 20MHz 5: 802.11n 40MHz 6: 802.11ac 20MHz 7: 802.11ac 40MHz

Preset	-8 dB -8dB -8dB -8dB -8dB -8dB -8dB
State Saved	Saved in instrument state.
Min	-100 dB
Max	0 dB
Initial S/W Revision	A.11.00

12 Mbits/s RMS EVM

Sets RMS EVM limit at the 12 Mbits/s data rate for 802.11a and 802.11g-OFDM Radio Std.

Remote Command	:CALCulate:WLSequence:EVM:LIMit:STANdard[1] 2 ...7:RMS:D12Mbits <rel_ ampl> :CALCulate:WLSequence:EVM:LIMit:STANdard[1] 2 ...7:RMS:D12Mbits?
Example	CALC:WLS:EVM:LIM:STAN:RMS:D12MB 2 CALC:WLS:EVM:LIM:STAN:RMS:D12MB?

Notes

In SCPI command, the sub op codes mean different radio standard::

- 1: 802.11a/g OFDM
- 2: 802.11b DSSS/CCK/PBCC
- 3: 802.11g DSSS-OFDM
- 4: 802.11n 20MHz
- 5: 802.11n 40MHz
- 6: 802.11ac 20MHz
- 7: 802.11ac 40MHz

Preset	-10 dB -10dB -10dB -10dB -10dB -10dB -10dB
State Saved	Saved in instrument state.
Min	-100 dB
Max	0 dB
Initial S/W Revision	A.11.00

18 Mbits/s RMS EVM

Sets RMS EVM limit at the 18 Mbits/s data rate for 802.11a and 802.11g-OFDM Radio Std.

Remote Command	:CALCulate:WLSequence:EVM:LIMit:STANdard[1] 2 ...7:RMS:D18Mbits <rel_ ampl> :CALCulate:WLSequence:EVM:LIMit:STANdard[1] 2 ...7:RMS:D18Mbits?
Example	CALC:WLS:EVM:LIM:STAN:RMS:D18MB 2 CALC:WLS:EVM:LIM:STAN:RMS:D18MB?

Notes

In SCPI command, the sub op codes mean different radio standard::

- 1: 802.11a/g OFDM
- 2: 802.11b DSSS/CCK/PBCC
- 3: 802.11g DSSS-OFDM
- 4: 802.11n 20MHz
- 5: 802.11n 40MHz
- 6: 802.11ac 20MHz
- 7: 802.11ac 40MHz

Preset	-13 dB -13dB -13dB -13dB -13dB -13dB -13dB
State Saved	Saved in instrument state.
Min	-100 dB
Max	0 dB
Initial S/W Revision	A.11.00

24 Mbits/s RMS EVM

Sets RMS EVM limit at the 24 Mbits/s data rate for 802.11a and 802.11g-OFDM Radio Std.

Remote Command	:CALCulate:WLSequence:EVM:LIMit:STANdard[1] 2 ...7:RMS:D24Mbits <rel_ ampl> :CALCulate:WLSequence:EVM:LIMit:STANdard[1] 2 ...7:RMS:D24Mbits?
Example	CALC:WLS:EVM:LIM:STAN:RMS:D24MB 2 CALC:WLS:EVM:LIM:STAN:RMS:D24MB?

Notes

In SCPI command, the sub op codes mean different radio standard::

- 1: 802.11a/g OFDM
- 2: 802.11b DSSS/CCK/PBCC
- 3: 802.11g DSSS-OFDM
- 4: 802.11n 20MHz
- 5: 802.11n 40MHz
- 6: 802.11ac 20MHz
- 7: 802.11ac 40MHz

Preset	-16 dB -16dB -16dB -16dB -16dB -16dB -16dB
State Saved	Saved in instrument state.
Min	-100 dB
Max	0 dB
Initial S/W Revision	A.11.00

36 Mbits/s RMS EVM

Sets RMS EVM limit at the 36 Mbits/s data rate for 802.11a and 802.11g-OFDM Radio Std.

Remote Command	<code>:CALCulate:WLSequence:EVM:LIMit:STANdard[1] 2 ...7:RMS:D36Mbits <rel_ ampl></code> <code>:CALCulate:WLSequence:EVM:LIMit:STANdard[1] 2 ...7:RMS:D36Mbits?</code>
-----------------------	---

Example	<code>CALC:WLS:EVM:LIM:STAN:RMS:D36MB 2</code> <code>CALC:WLS:EVM:LIM:STAN:RMS:D36MB?</code>
----------------	---

Notes	In SCPI command, the sub op codes mean different radio standard: 1: 802.11a/g OFDM 2: 802.11b DSSS/CCK/PBCC 3: 802.11g DSSS-OFDM 4: 802.11n 20MHz 5: 802.11n 40MHz 6: 802.11ac 20MHz 7: 802.11ac 40MHz
--------------	---

Preset	-19 dB -19dB -19dB -19dB -19dB -19dB -19dB
State Saved	Saved in instrument state.
Min	-100 dB
Max	0 dB
Initial S/W Revision	A.11.00

48 Mbits/s RMS EVM

Sets RMS EVM limit at the 48 Mbits/s data rate for 802.11a and 802.11g-OFDM Radio Std.

Remote Command	<code>:CALCulate:WLSequence:EVM:LIMit:STANdard[1] 2 ...7:RMS:D48Mbits <rel_ ampl></code> <code>:CALCulate:WLSequence:EVM:LIMit:STANdard[1] 2 ...7:RMS:D48Mbits?</code>
-----------------------	---

Example	<code>CALC:WLS:EVM:LIM:STAN:RMS:D48MB 2</code> <code>CALC:WLS:EVM:LIM:STAN:RMS:D48MB?</code>
----------------	---

Notes	In SCPI command, the sub op codes mean different radio standard: 1: 802.11a/g OFDM 2: 802.11b DSSS/CCK/PBCC 3: 802.11g DSSS-OFDM 4: 802.11n 20MHz 5: 802.11n 40MHz
--------------	---

	6: 802.11ac 20MHz 7: 802.11ac 40MHz
Preset	-22 dB -22dB -22dB -22dB -22dB -22dB -22dB
State Saved	Saved in instrument state.
Min	-100 dB
Max	0 dB
Initial S/W Revision	A.11.00

54 Mbits/s RMS EVM

Sets RMS EVM limit at the 54 Mbits/s data rate for 802.11a and 802.11g-OFDM Radio Std.

Remote Command	:CALCulate:WLSequence:EVM:LIMit:STANdard[1] 2 ...7:RMS:D54Mbits <rel_ ampl> :CALCulate:WLSequence:EVM:LIMit:STANdard[1] 2 ...7:RMS:D54Mbits?
Example	CALC:WLS:EVM:LIM:STAN:RMS:D54MB 2 CALC:WLS:EVM:LIM:STAN:RMS:D54MB?

Notes

In SCPI command, the sub op codes mean different radio standard::

- 1: 802.11a/g OFDM
- 2: 802.11b DSSS/CCK/PBCC
- 3: 802.11g DSSS-OFDM
- 4: 802.11n 20MHz
- 5: 802.11n 40MHz
- 6: 802.11ac 20MHz
- 7: 802.11ac 40MHz

Preset	-25 dB -25dB -25dB -25dB -25dB -25dB -25dB
State Saved	Saved in instrument state.
Min	-100
Max	0
Initial S/W Revision	A.11.00

BPSK-1/2 RMS EVM

Sets BPSK coding rate 1/2 RMS EVM limit to warn you if the measured average RMS EVM value exceeds a limit.

Remote Command	:CALCulate:WLSequence:EVM:LIMit:STANdard[1] 2 ...7:RMS:BPSK:R1B2 <rel_ ampl>
-----------------------	---

	ampl>
	:CALCulate:WLSequence:EVM:LIMit:STANdard[1] 2 ...7:RMS:BPSK:R1B2
Example	CALC:WLS:EVM:LIM:STAN:RMS:BPSK:R1B2 -20 CALC:WLS:EVM:LIM:STAN:RMS:BPSK:R1B2?
Notes	In SCPI command, the sub op codes mean different radio standard:: 1: 802.11a/g OFDM 2: 802.11b DSSS/CCK/PBCC 3: 802.11g DSSS-OFDM 4: 802.11n 20MHz 5: 802.11n 40MHz 6: 802.11ac 20MHz 7: 802.11ac 40MHz
Preset	-5.00 dB -5.00dB -5.00dB -5.00dB -5.00dB -5.00dB -5.00dB
State Saved	Saved in instrument state.
Min	-1000.00
Max	0
Initial S/W Revision	A.11.00

QPSK-1/2 RMS EVM

Sets QPSK coding rate 1/2 RMS EVM limit to warn you if the measured average RMS EVM value exceeds a limit. When the average RMS EVM result exceeds the limit, a red FAIL indicator appears in the PASS/FAIL indication. When the average RMS EVM result is less than the limit, a green PASS indicator appears in the PASS/FAIL indication.

Remote Command	:CALCulate:WLSequence:EVM:LIMit:STANdard[1] 2 ...7:RMS:QPSK:R1B2 <rel_ ampl> :CALCulate:WLSequence:EVM:LIMit:STANdard[1] 2 ...7:RMS:QPSK:R1B2
Example	CALC:WLS:EVM:LIM:STAN:RMS:QPSK:R1B2 -20 CALC:WLS:EVM:LIM:STAN:RMS:QPSK:R1B2?
Notes	In SCPI command, the sub op codes mean different radio standard:: 1: 802.11a/g OFDM 2: 802.11b DSSS/CCK/PBCC 3: 802.11g DSSS-OFDM 4: 802.11n 20MHz 5: 802.11n 40MHz 6: 802.11ac 20MHz 7: 802.11ac 40MHz

Preset	-10.00 dB -10.00dB -10.00dB -10.00dB -10.00dB -10.00dB -10.00dB
State Saved	Saved in instrument state.
Min	-1000.00
Max	0
Initial S/W Revision	A.11.00

QPSK-3/4 RMS EVM

Sets QPSK coding rate 3/4 RMS EVM limit to warn you if the measured average RMS EVM value exceeds a limit. When the average RMS EVM result exceeds the limit, a red FAIL indicator appears in the PASS/FAIL indication. When the average RMS EVM result is less than the limit, a green PASS indicator appears in the PASS/FAIL indication.

Remote Command	:CALCulate:WLSequence:EVM:LIMit:STANdard[1] 2 ...7:RMS:QPSK:R3B4 <rel_ ampl> :CALCulate:WLSequence:EVM:LIMit:STANdard[1] 2 ...7:RMS:QPSK:R3B4
Example	CALC:WLSequence:EVM:LIM:STAN:RMS:QPSK:R3B4 -20 CALC:WLSequence:EVM:LIM:STAN:RMS:QPSK:R3B4?

Notes

In SCPI command, the sub op codes mean different radio standard::

- 1: 802.11a/g OFDM
- 2: 802.11b DSSS/CCK/PBCC
- 3: 802.11g DSSS-OFDM
- 4: 802.11n 20MHz
- 5: 802.11n 40MHz
- 6: 802.11ac 20MHz
- 7: 802.11ac 40MHz

Preset	-13.00 dB -13.00dB -13.00dB -13.00dB -13.00dB -13.00dB -13.00dB
State Saved	Saved in instrument state.
Min	-1000.00
Max	0
Initial S/W Revision	A.11.00

16QAM-1/2 RMS EVM

Sets 16QAM coding rate 1/2 RMS EVM limit to warn you if the measured average RMS EVM value exceeds a limit. When the average RMS EVM result exceeds the limit, a red FAIL indicator appears in the PASS/FAIL indication. When the average RMS EVM result is less than the limit, a green PASS indicator appears in the PASS/FAIL indication.

Remote Command	:CALCulate:WLSequence:EVM:LIMit:STANdard[1] 2 ...7:RMS:QA16:R1B2 <rel_ ampl> :CALCulate:WLSequence:EVM:LIMit:STANdard[1] 2 ...7:RMS:QA16:R1B2
Example	CALC:WLS:EVM:LIM:STAN:RMS:QA16:R1B2 -20 CALC:WLS:EVM:LIM:STAN:RMS:QA16:R1B2?
Notes	In SCPI command, the sub op codes mean different radio standard: 1: 802.11a/g OFDM 2: 802.11b DSSS/CCK/PBCC 3: 802.11g DSSS-OFDM 4: 802.11n 20MHz 5: 802.11n 40MHz 6: 802.11ac 20MHz 7: 802.11ac 40MHz
Preset	-16.00 dB -16.00dB -16.00dB -16.00dB -16.00dB -16.00dB -16.00dB
State Saved	Saved in instrument state.
Min	-1000.00
Max	0
Initial S/W Revision	A.11.00

16QAM-3/4 RMS EVM

Sets 16QAM coding rate 3/4 RMS EVM limit to warn you if the measured average RMS EVM value exceeds a limit.

Remote Command	:CALCulate:WLSequence:EVM:LIMit:STANdard[1] 2 ...7:RMS:QA16:R3B4 <rel_ ampl> :CALCulate:WLSequence:EVM:LIMit:STANdard[1] 2 ...7:RMS:QA16:R3B4?
Example	CALC:WLS:EVM:LIM:STAN:RMS:QA16:R3B4 -20 CALC:WLS:EVM:LIM:STAN:RMS:QA16:R3B4?
Notes	In SCPI command, the sub op codes mean different radio standard: 1: 802.11a/g OFDM 2: 802.11b DSSS/CCK/PBCC 3: 802.11g DSSS-OFDM 4: 802.11n 20MHz 5: 802.11n 40MHz 6: 802.11ac 20MHz 7: 802.11ac 40MHz

Preset	-19.00 dB -19.00dB -19.00dB -19.00dB -19.00dB -19.00dB -19.00dB
State Saved	Saved in instrument state.
Min	-1000.00
Max	0
Initial S/W Revision	A.11.00

64QAM-2/3 RMS EVM

Sets 64QAM coding rate 2/3 RMS EVM limit to warn you if the measured average RMS EVM value exceeds a limit. When the average RMS EVM result exceeds the limit, a red FAIL indicator appears in the PASS/FAIL indication. When the average RMS EVM result is less than the limit, a green PASS indicator appears in the PASS/FAIL indication.

Remote Command	:CALCulate:WLSequence:EVM:LIMit:STANdard[1] 2 ...7:RMS:QA64:R2B3 <rel_ ampl> :CALCulate:WLSequence:EVM:LIMit:STANdard[1] 2 ...7:RMS:QA64:R2B3?
Example	CALC:WLSequence:EVM:LIM:STAN:RMS:QA64:R2B3 -20 CALC:WLSequence:EVM:LIM:STAN:RMS:QA64:R2B3?

Notes

In SCPI command, the sub op codes mean different radio standard::

- 1: 802.11a/g OFDM
- 2: 802.11b DSSS/CCK/PBCC
- 3: 802.11g DSSS-OFDM
- 4: 802.11n 20MHz
- 5: 802.11n 40MHz
- 6: 802.11ac 20MHz
- 7: 802.11ac 40MHz

Preset	-22.00 dB -22.00dB -22.00dB -22.00dB -22.00dB -22.00dB -22.00dB
State Saved	Saved in instrument state.
Min	-1000.00
Max	0
Initial S/W Revision	A.11.00

64QAM-3/4 RMS EVM

Sets 64QAM coding rate 3/4 RMS EVM limit to warn you if the measured average RMS EVM value exceeds a limit.

Remote Command	:CALCulate:WLSequence:EVM:LIMit:STANdard[1] 2 ...7:RMS:QA64:R3B4 <rel_ ampl>
-----------------------	--

	:CALCulate:WLSequence:EVM:LIMit:STANdard[1] 2 ...7:RMS:QA64:R3B4
Example	CALC:WLSequence:EVM:LIM:STAN:RMS:QA64:R3B4 -20 CALC:WLSequence:EVM:LIM:STAN:RMS:QA64:R3B4?
Notes	In SCPI command, the sub op codes mean different radio standard: 1: 802.11a/g OFDM 2: 802.11b DSSS/CCK/PBCC 3: 802.11g DSSS-OFDM 4: 802.11n 20MHz 5: 802.11n 40MHz 6: 802.11ac 20MHz 7: 802.11ac 40MHz
Preset	-25.00 dB -25.00dB -25.00dB -25.00dB -25.00dB -25.00dB -25.00dB
State Saved	Saved in instrument state.
Min	-1000.00
Max	0
Initial S/W Revision	A.11.00

64QAM-5/6 RMS EVM

Sets 64QAM coding rate 5/6 RMS EVM limit to warn you if the measured average RMS EVM value exceeds a limit. .

Remote Command	:CALCulate:WLSequence:EVM:LIMit:STANdard[1] 2 ...7:RMS:QA64:R5B6 <rel_ ampl> :CALCulate:WLSequence:EVM:LIMit:STANdard[1] 2 ...7:RMS:QA64:R5B6
Example	CALC:WLSequence:EVM:LIM:STAN:RMS:QA64:R5B6 -20 CALC:WLSequence:EVM:LIM:STAN:RMS:QA64:R5B6?
Notes	In SCPI command, the sub op codes mean different radio standard: 1: 802.11a/g OFDM 2: 802.11b DSSS/CCK/PBCC 3: 802.11g DSSS-OFDM 4: 802.11n 20MHz 5: 802.11n 40MHz 6: 802.11ac 20MHz 7: 802.11ac 40MHz
Preset	-28.00 dB -28.00dB -28.00dB -28.00dB -28.00dB -28.00dB -28.00dB

State Saved	Saved in instrument state.
Min	-1000.00
Max	0
Initial S/W Revision	A.11.00

256QAM-3/4 RMS EVM

Sets 256QAM coding rate 3/4 RMS EVM limit to warn you if the measured average RMS EVM value exceeds a limit.

Remote Command	:CALCulate:WLSequence:EVM:LIMit:STANdard[1] 2 ...7:RMS:QA256:R3B4 <rel_ ampl> :CALCulate:WLSequence:EVM:LIMit:STANdard[1] 2 ...7:RMS:QA256:R3B4
-----------------------	--

Example	CALC:WLS:EVM:LIM:STAN:RMS:QA256:R3B4 -20 CALC:WLS:EVM:LIM:STAN:RMS:QA256:R3B4?
----------------	---

Notes	In SCPI command, the sub op codes mean different radio standard: 1: 802.11a/g OFDM 2: 802.11b DSSS/CCK/PBCC 3: 802.11g DSSS-OFDM 4: 802.11n 20MHz 5: 802.11n 40MHz 6: 802.11ac 20MHz 7: 802.11ac 40MHz
-------	---

Preset	-30.00 dB -30.00dB -30.00dB -30.00dB -30.00dB -30.00dB -30.00dB
State Saved	Saved in instrument state.
Min	-1000.00
Max	0
Initial S/W Revision	A.11.00

256QAM-5/6 RMS EVM

Sets 256QAM coding rate 5/6 RMS EVM limit to warn you if the measured average RMS EVM value exceeds a limit.

Remote Command	:CALCulate:WLSequence:EVM:LIMit:STANdard[1] 2 ...7:RMS:QA256:R5B6 <rel_ ampl> :CALCulate:WLSequence:EVM:LIMit:STANdard[1] 2 ...7:RMS:QA256:R5B6
-----------------------	--

Example	CALC:WLS:EVM:LIM:STAN:RMS:QA256:R5B6 -20 CALC:WLS:EVM:LIM:STAN:RMS:QA256:R5B6?
----------------	---

Notes

In SCPI command, the sub op codes mean different radio standard::
 1: 802.11a/g OFDM
 2: 802.11b DSSS/CCK/PBCC
 3: 802.11g DSSS-OFDM
 4: 802.11n 20MHz
 5: 802.11n 40MHz
 6: 802.11ac 20MHz
 7: 802.11ac 40MHz

Preset	-32.00 dB -32.00dB -32.00dB -32.00dB -32.00dB -32.00dB -32.00dB
State Saved	Saved in instrument state.
Min	-1000.00
Max	0
Initial S/W Revision	A.11.00

Chip Clock Error

The command is used to set a chip clock error limit value to warn you if the measured chip clock error exceeds the limit value.

Remote Command	:CALCulate:WLSequence:EVM:LIMit:STANdard[1] 2 ...7:CCLkError <real> :CALCulate:WLSequence:EVM:LIMit:STANdard[1] 2 ...7:CCLkError?
Example	CALC:WLS:EVM:LIM:STAN:CCLK 2 CALC:WLS:EVM:LIM:STAN:CCLK?
Preset	25
State Saved	Saved in instrument state.
Min	0
Max	100
Initial S/W Revision	A.11.00

RF Carrier Suppression

Sets an RF Carrier Suppression limit to warn you if the measured RF Carrier Suppression value is less than a limit

Remote Command	:CALCulate:WLSequence:EVM:LIMit:CSUPpression <rel_ampl> :CALCulate:WLSequence:EVM:LIMit:CSUPpression?
Example	CALC:WLS:EVM:LIM:CSUP 10 CALC:WLS:EVM:LIM:CSUP?

Preset	15 dB
State Saved	Saved in instrument state.
Min	0
Max	100
Initial S/W Revision	A.11.00

RMS EVM

Sets an RMS EVM limit to warn you if the measured average RMS EVM value exceeds a limit. When the average RMS

Remote Command	:CALCulate:WLSequence:EVM:LIMit:RMS <percent> :CALCulate:WLSequence:EVM:LIMit:RMS?
Example	CALC:WLS:EVM:LIM:RMS 20 CALC:WLS:EVM:LIM:RMS?
Preset	16.0 %
State Saved	Saved in instrument state.
Min	0
Max	100.0 %
Initial S/W Revision	A.11.00

1000 Chips EVM

Sets an 1000 Chips EVM limit to warn you if the measured average 1000 Chips value exceeds a limit

Remote Command	:CALCulate:WLSequence:EVM:LIMit:CHIP <percent> :CALCulate:WLSequence:EVM:LIMit:CHIP?
Example	CALC:WLS:EVM:LIM:CHIP 20 CALC:WLS:EVM:LIM:CHIP?
Preset	35.0 %
State Saved	Saved in instrument state.
Min	0
Max	100.0 %
Initial S/W Revision	A.11.00

Flatness Limits

For IEEE 802.11a/g-ERP-OFDM/g-DSSS-OFDM specification, Segment 1 includes the carriers -16...-1 and 1...16, Segment 2 includes -26...-17 and 17... 26.

For IEEE 802.11n, 20MHz specification, Segment 1 includes the carriers -16...-1 and 1...16, Segment 2 includes -28...-17 and 17... 28.

For IEEE 802.11n, 40MHz transmission specification (excluding HT duplicate and Non-HT Duplicate), Segment 1 includes the carriers -42...-2 and 2...42, while Segment 2 includes -58...-43 and 43... 58.

For IEEE 802.11n, 40MHz Duplicate mode (including HT and Non-HT duplicate) , Segment 1 includes the carriers -42 to -33, -31 to -6, +6 to +31, and +33 to +42, while Segment 2 includes -58...-43 and 43... 58.

For IEEE 802.11ac, 20MHz specification, Segment 1 includes the carriers -16...-1 and 1...16, Segment 2 includes -28...-17 and 17... 28.

For IEEE 802.11ac, 40MHz transmission specification , Segment 1 includes the carriers -42...-2 and 2...42, while Segment 2 includes -58...-43 and 43... 58.

For IEEE 802.11ac, 40MHz Non-HT duplicate mode , Segment 1 includes the carriers -42 to -33, -31 to -6, +6 to +31, and +33 to +42, while Segment 2 includes -58...-43 and 43... 58.

Initial S/W Revision	A.11.00
----------------------	---------

Upper Limit Segment 1

This parameter allows you to specify upper deviation limit (dB) of the segment 1

Remote Command	:CALCulate:WLSequence:FLATness:LIMit:STANdard[1] 2 ...7:UPPer:SEG1 <rel_amp> :CALCulate:WLSequence:FLATness:LIMit:STANdard[1] 2 ...7:UPPer:SEG1?
-----------------------	--

Example	CALC:WLS:FLAT:LIM:STAN:UPP:SEG1 2.0 CALC:WLS:FLAT:LIM:STAN:UPP:SEG1?
----------------	---

Notes

In SCPI command, the sub op codes mean different radio standard::
 1: 802.11a/g OFDM
 2: 802.11b DSSS/CCK/PBCC
 3: 802.11g DSSS-OFDM
 4: 802.11n 20MHz
 5: 802.11n 40MHz
 6: 802.11ac 20MHz
 7: 802.11ac 40MHz

Preset	2.00 2.00 2.00 2.00 2.00 2.00 2.00
--------	------------------------------------

State Saved	Saved in instrument state.
-------------	----------------------------

Min	0.10
-----	------

Max	10.00
-----	-------

Initial S/W Revision	A.11.00
----------------------	---------

Lower Limit Segment 1

This parameter allows you to specify lower deviation limit (dB) of the segment 1

Key Path	Meas Setup, Limit
Mode	WLAN
Remote Command	:CALCulate:WLSequence:FLATness:LIMit:STANdard[1] 2 ...7:LOWer:SEG1 <rel_amp> :CALCulate:WLSequence:FLATness:LIMit:STANdard[1] 2 ...7:LOWer:SEG1?
Example	CALC:WLS:FLAT:LIM:STAN:LOW:SEG1 -2.0 CALC:WLS:FLAT:LIM:STAN:LOW:SEG1?
Notes	In SCPI command, the sub op codes mean different radio standard: 1: 802.11a/g OFDM 2: 802.11b DSSS/CCK/PBCC 3: 802.11g DSSS-OFDM 4: 802.11n 20MHz 5: 802.11n 40MHz 6: 802.11ac 20MHz 7: 802.11ac 40MHz
Preset	-2.00 -2.00 -2.00 -2.00 -2.00 -2.00 -2.00
State Saved	Saved in instrument state.
Min	-10.00
Max	-0.10
Initial S/W Revision	A.11.00

Upper Limit Segment 2

This parameter allows you to specify upper deviation limit (dB) of the segment 2

Remote Command	:CALCulate:WLSequence:FLATness:LIMit:STANdard[1] 2 ...7:UPPer:SEG2 <rel_amp> :CALCulate:WLSequence:FLATness:LIMit:STANdard[1] 2 ...7:UPPer:SEG2?
Example	CALC:WLSequence:FLAT:LIM:STAN:UPP:SEG2 2.0 CALC:WLSequence:FLAT:LIM:STAN:UPP:SEG2?
Notes	In SCPI command, the sub op codes mean different radio standard: 1: 802.11a/g OFDM 2: 802.11b DSSS/CCK/PBCC 3: 802.11g DSSS-OFDM 4: 802.11n 20MHz

	5: 802.11n 40MHz
	6: 802.11ac 20MHz
	7: 802.11ac 40MHz

Preset	2.00 2.00 2.00 2.00 2.00 2.00 2.00
State Saved	Saved in instrument state.
Min	0.10
Max	10.00
Initial S/W Revision	A.11.00

Lower Limit Segment 2

This parameter allows you to specify lower deviation limit (dB) of the segment 2

Remote Command	:CALCulate:WLSequence:FLATness:LIMit:STANdard[1] 2 ...7:LOWer:SEG2 <rel_amp> :CALCulate:WLSequence:FLATness:LIMit:STANdard[1] 2 ...7:LOWer:SEG2?
Example	CALC:WLS:FLAT:LIM:STAN:LOW:SEG2 -2.0 CALC:WLS:FLAT:LIM:STAN:LOW:SEG2?

Notes

In SCPI command, the sub op codes mean different radio standard::

- 1: 802.11a/g OFDM
- 2: 802.11b DSSS/CCK/PBCC
- 3: 802.11g DSSS-OFDM
- 4: 802.11n 20MHz
- 5: 802.11n 40MHz
- 6: 802.11ac 20MHz
- 7: 802.11ac 40MHz

Preset	-4.00 -4.00 -4.00 -4.00 -4.00 -4.00 -4.00
State Saved	Saved in instrument state.
Min	-10.00
Max	-0.10
Initial S/W Revision	A.11.00

Meas Interval

This parameter specifies the measurement interval (length), in symbol times for the portion of the OFDM burst or chips for the portion if 802.11b burst to be analyzed.

Because analyzing all symbols or chips in one burst can consume a lot of time, Meas Interval is part of whole symbols or chips in one burst, then only measuring Meas interval can speed up measurement.

The total symbols or chips in one burst can be determined automatically by software, named Max result length, so the maximum of Meas Interval is Max result length.

Remote Command	<code>[:SENSe] :WLSquence:EVM:STANdard[1] 2 ...7:TIME:INTerval <integer></code> <code>[:SENSe] :WLSquence:EVM:STANdard[1] 2 ...7:TIME:INTerval?</code>
Example	WLS:EVM:STAN:TIME:INT 15 WLS:EVM:STAN:TIME:INT?
Notes	The total symbols or chips in one burst can be determined automatically by software, named Max result length, so the maximum of Meas Interval is Max result length. If the Meas Interval manually set is bigger than Max result length, software will just give results on symbols/chips of Max result length In SCPI command, the sub op codes mean different radio standard: 1: 802.11a/g OFDM 2: 802.11b DSSS/CCK/PBCC 3: 802.11g DSSS-OFDM 4: 802.11n 20MHz 5: 802.11n 40MHz 6: 802.11ac 20MHz 7: 802.11ac 40MHz
Couplings	Default value, Min/Max value, will be coupled with Radio Std
Preset	60 2794 60 60 60 60 60
State Saved	Saved in instrument state.
Min	1
Max	802.11a/g OFDM : 1367 802.11b DSSS/CCK/PBCC: 96360 802.11g DSSS-OFDM: 1367 802.11n 20MHz: 21848 802.11n 40MHz: 21848 802.11ac 20MHz: 21848 802.11ac 40MHz: 21848
Initial S/W Revision	A.11.00

Subcarrier

Settings for Subcarrier.

Initial S/W Revision	A.11.00
-----------------------------	---------

Subcarrier Spacing

This parameter specifies the subcarrier frequency spacing of the input signal. This parameter must match the actual subcarrier frequency spacing of the input signal, otherwise demodulation will fail. The default 312.5 kHz matches the 802.11a/g/n/ac standards.

Remote Command	<code>[:SENSe] :WLSquence :EVM :STANdard [1] 2 . . . 7 :SUBCarrier :SPACing <freq></code> <code>[:SENSe] :WLSquence :EVM :STANdard [1] 2 . . . 7 :SUBCarrier :SPACing ?</code>
Example	<code>WLS:EVM:STAN:SUBC:SPAC 312.5 kHz</code> <code>WLS:EVM:STAN:SUBC:SPAC?</code>
Notes	Only used in 802.11a/g (OFDM), 801.11g (DSSS-OFDM) 802.11n and 802.11ac radio standard. In SCPI command, the sub op codes mean different radio standard: 1: 802.11a/g OFDM 2: 802.11b DSSS/CCK/PBCC 3: 802.11g DSSS-OFDM 4: 802.11n 20MHz 5: 802.11n 40MHz 6: 802.11ac 20MHz 7: 802.11ac 40MHz
Preset	312.5 kHz 312.5 kHz 312.5 kHz 312.5 kHz 312.5 kHz 312.5 kHz 312.5 kHz
State Saved	Saved in instrument state.
Min	78.125 kHz
Max	1.25 MHz
Initial S/W Revision	A.11.00

Guard Interval

This specifies the guard interval (also called cyclic extension) length for each symbol time, as a fraction of the FFT length. The value must match the guard interval length actually used in the input signal in order for demodulation to work properly. The value should be between zero and one, and values outside that range are clipped to be within the range. The value is rounded to the nearest 1/128th.

Remote Command	<code>[:SENSe] :WLSquence :EVM :STANdard [1] 2 . . . 7 :GINTerval :LENGth <real></code> <code>[:SENSe] :WLSquence :EVM :STANdard [1] 2 . . . 7 :GINTerval :LENGth ?</code>
Example	<code>WLS:EVM:STAN:GINT:LENG 0.25</code> <code>WLS:EVM:STAN:GINT:LENG?</code>
Notes	Only used in 802.11a/g (OFDM), 801.11g (DSSS-OFDM) 802.11n and 802.11ac radio standard. In SCPI command, the sub op codes mean different radio standard: 1: 802.11a/g OFDM 2: 802.11b DSSS/CCK/PBCC 3: 802.11g DSSS-OFDM

	4: 802.11n 20MHz 5: 802.11n 40MHz 6: 802.11ac 20MHz 7: 802.11ac 40MHz
Preset	0.25 0.25 0.25 0.25 0.25 0.25
State Saved	Saved in instrument state.
Min	0.0078125
Max	1
Initial S/W Revision	A.11.00

Reference Filter

This parameter controls the reference filter type used when computing the reference data for computing EVM

Remote Command	[:SENSe] :WLSquence:EVM:FILTer:REFerence:TYPE GAUSSian RECT RC [:SENSe] :WLSquence:EVM:FILTer:REFerence:TYPE?
Example	WLS:EVM:FILT:REF:TYPE GAUS WLS:EVM:FILT:REF:TYPE?
Notes	Only used in 802.11b/g (DSSS/CCK/PBCC) radio standard.
Preset	RECT
State Saved	Saved in instrument state.
Range	Gaussian Rect Raised Cosine
Initial S/W Revision	A.11.00

Alpha/BT

This parameter is used only when the Reference Filter is set to “GAUSSIAN” or “Raised Cosine”, or the Measurement filter is set to “RRC”. In these cases, this parameter controls the bT value for the Gaussian filter and alpha values for Raised Cosine and RRC filters.

Remote Command	[:SENSe] :WLSquence:EVM:FILTer:ALPHa <real> [:SENSe] :WLSquence:EVM:FILTer:ALPHa?
Example	WLS:EVM:FILT:ALPH 0.5 WLS:EVM:FILT:ALPH?
Notes	Only be available in 802.11b/g (DSSS/CCK/PBCC) radio standard.
Preset	0.50
State Saved	Saved in instrument state.

Min	0.05
Max	100
Initial S/W Revision	A.11.00

Measurement Filter

This parameter controls the measurement filter type used for computing EVM.

Remote Command	<code>[:SENSe] :WLSquence:EVM:FILTer:MEASurement:TYPE NONE RRC</code> <code>[:SENSe] :WLSquence:EVM:FILTer:MEASurement:TYPE?</code>
Example	<code>WLS:EVM:FILT:MEAS:TYPE RRC</code> <code>WLS:EVM:FILT:MEAS:TYPE?</code>
Notes	Only be available in 802.11 b/g (DSSS/CCK/PBCC) radio standard
State Saved	Saved in instrument state.
Range	None RRC
Initial S/W Revision	A.11.00

Symbol Timing Adjust

This parameter Symbol Timing Adjust controls how far the FFT part of the symbol is adjusted away from the end of the symbol time. The value is in terms of percent of the used (FFT) part of the symbol time.

Remote Command	<code>[:SENSe] :WLSquence:EVM:STANdard[1] 2 ...7:SYMBol:ADJust <real></code> <code>[:SENSe] :WLSquence:EVM:STANdard[1] 2 ...7:SYMBol:ADJust?</code>
Example	<code>WLS:EVM:STAN:SYMB:ADJ -3.125</code> <code>WLS:EVM:STAN:SYMB:ADJ?</code>
Notes	Only be available in 802.11 a/g (OFDM), 801.11g (DSSS-OFDM), 802.11n and 802.11ac radio standard. In SCPI command, the sub op codes mean different radio standard: 1: 802.11a/g OFDM 2: 802.11b DSSS/CCK/PBCC 3: 802.11g DSSS-OFDM 4: 802.11n 20MHz 5: 802.11n 40MHz 6: 802.11ac 20MHz 7: 802.11ac 40MHz
Preset	-3.125 -3.125 -3.125 -3.125 -3.125 -3.125 -3.125
State Saved	Saved in instrument state.

Min	-100.0
Max	0.0
Initial S/W Revision	A.11.00

Sync Training Sequence

This parameter specifies synchronization method to use when synchronizing to the start of the OFDM burst.

A value of Short means to search for and synchronize to an 802.11a/g (OFDM) preamble short symbol sequence.

A value of Long means to search for and synchronize to an 802.11a/g (OFDM) preamble long symbol sequence (also called the channel estimation sequence).

Remote Command	<code>[:SENSe]:WLSequence:EVM:STANdard[1] 2 ...7:STSequence LONG SHORT</code> <code>[:SENSe]:WLSequence:EVM:STANdard[1] 2 ...7:STSequence?</code>
Example	<code>WLS:EVM:STAN:STS LONG</code> <code>WLS:EVM:STAN:STS?</code>
Notes	Only used in 802.11a/g (OFDM), 801.11g (DSSS-OFDM) radio standard. In SCPI command, the sub op codes mean different radio standard: 1: 802.11a/g OFDM 2: 802.11b DSSS/CCK/PBCC 3: 802.11g DSSS-OFDM 4: 802.11n 20MHz 5: 802.11n 40MHz 6: 802.11ac 20MHz 7: 802.11ac 40MHz
Preset	<code>SHORT SHORT SHORT SHORT SHORT SHORT SHORT</code>
State Saved	Saved in instrument state.
Initial S/W Revision	A.11.00

Track Amplitude

Track Amplitude specifies whether the analyzer tracks amplitude changes in the pilot subcarriers. When Track Amplitude is selected, the analyzer applies pilot subcarrier amplitude error correction to the pilot and data subcarriers. This is in addition to Track Phase and Track Timing error correction, if selected.

Remote Command	<code>:CALCulate:WLSequence:EVM:STANdard[1] 2 ...7:PILot:TRACk:AMPLitude OFF</code> <code> ON 0 1</code> <code>:CALCulate:WLSequence:EVM:STANdard[1] 2 ...7:PILot:TRACk:AMPLitude?</code>
-----------------------	--

Example	CALC:WLS:EVM:STAN:PIL:TRAC:AMPL 1 CALC:WLS:EVM:STAN:PIL:TRAC:AMPL?
Notes	Only used in 802.11a/g (OFDM), 801.11g (DSSS-OFDM), 802.11n and 802.11ac. In SCPI command, the sub op codes mean different radio standard:: 1: 802.11a/g OFDM 2: 802.11b DSSS/CCK/PBCC 3: 802.11g DSSS-OFDM 4: 802.11n 20MHz 5: 802.11n 40MHz 6: 802.11ac 20MHz 7: 802.11ac 40MHz
Preset	OFF OFF OFF OFF OFF OFF
State Saved	Saved in instrument state.
Range	On Off
Initial S/W Revision	A.11.00

Track Phase

The Track Phase parameter specifies whether the analyzer tracks phase changes in the pilot subcarriers. When Track Phase is selected, the analyzer applies pilot subcarrier phase error correction to the pilot and data subcarriers. This is in addition to Track Amplitude and Track Timing error correction if selected.

Mode	WLAN
Remote Command	:CALCulate:WLSequence:EVM:STANdard[1] 2 ... 7:PILOt:TRACk:PHASe OFF ON 0 1 :CALCulate:WLSequence:EVM:STANdard[1] 2 ... 7:PILOt:TRACk:PHASe?
Example	CALC:WLS:EVM:STAN:PIL:TRAC:PHAS 0 CALC:WLS:EVM:STAN:PIL:TRAC:PHAS?
Notes	Only used in 802.11a/g (OFDM), 801.11g (DSSS-OFDM), 802.11n and 802.11ac radio standard. In SCPI command, the sub op codes mean different radio standard:: 1: 802.11a/g OFDM 2: 802.11b DSSS/CCK/PBCC 3: 802.11g DSSS-OFDM 4: 802.11n 20MHz 5: 802.11n 40MHz 6: 802.11ac 20MHz 7: 802.11ac 40MHz
Preset	ON ON ON ON ON ON ON

State Saved	Saved in instrument state.
Range	On Off
Initial S/W Revision	A.11.00

Track Timing

The Track Timing parameter specifies whether the analyzer tracks timing changes in the pilot subcarriers. When Track Timing is selected the analyzer applies pilot subcarrier timing error correction (frequency offset correction) to the pilot and data subcarriers. This is in addition to Track Amplitude and Track Phase error correction if selected.

Remote Command	:CALCulate:WLSequence:EVM:STANdard[1] 2 ...7:PILot:TRACk:TIMing OFF ON 0 1 :CALCulate:WLSequence:EVM:STANdard[1] 2 ...7:PILot:TRACk:TIMing?
Example	CALC:WLS:EVM:STAN:PIL:TRAC:TIM 1 CALC:WLS:EVM:STAN:PIL:TRAC:TIM?
Notes	Only used in 802.11a/g (OFDM), 801.11g (DSSS-OFDM), 802.11n and 802.11ac radio standard. In SCPI command, the sub op codes mean different radio standard: 1: 802.11a/g OFDM 2: 802.11b DSSS/CCK/PBCC 3: 802.11g DSSS-OFDM 4: 802.11n 20MHz 5: 802.11n 40MHz 6: 802.11ac 20MHz 7: 802.11ac 40MHz
Preset	OFF OFF OFF OFF OFF OFF OFF
State Saved	Saved in instrument state.
Range	On Off
Initial S/W Revision	A.11.00

Equalizer Training

This specifies how the equalizer is initialized, or “trained”. The valid values are Channel Estimation Seq Only and Channel Estimation Seq & Data. The value Channel Estimation Seq Only, which is the default, specifies that the equalizer is trained using only the channel estimation sequence (also called the “long sync”) portion of the burst preamble. The 802.11a/g/n standards imply that the equalizer should be implemented this way when measuring EVM, and this matches how a real receiver would probably implement an equalizer.

The value and Channel Estimation Seq & Data specifies that the equalizer should be trained using both the channel estimation sequence and the entire data portion of the burst. This usually gives a more accurate estimate of the equalizer response. It also typically lowers the EVM by between one and three dB.

Remote Command	:CALCulate:WLSequence:EVM:STANdard[1] 2 ...7:EQualizer:TMODe SEQuence SDATa :CALCulate:WLSequence:EVM:STANdard[1] 2 ...7:EQualizer:TMODe?
Example	CALC:WLS:EVM:STAN:EQU:TMOD SDAT CALC:WLS:EVM:STAN:EQU:TMOD?
Notes	Only used in 802.11a/g (OFDM), 801.11g (DSSS-OFDM), 802.11n and 802.11ac. In SCPI command, the sub op codes mean different radio standard:: 1: 802.11a/g OFDM 2: 802.11b DSSS/CCK/PBCC 3: 802.11g DSSS-OFDM 4: 802.11n 20MHz 5: 802.11n 40MHz 6: 802.11ac 20MHz 7: 802.11ac 40MHz
Preset	SEQ SEQ SEQ SEQ SEQ SEQ SEQ
State Saved	Saved in instrument state.
Range	Channel Est Seq Only Channel Est Seq&Data
Initial S/W Revision	A.11.00

I/Q Normalize

This parameter specifies if the I/Q signals will be normalized.

Remote Command	:CALCulate:WLSequence:EVM:STANdard[1] 2 ...7:IQNorm OFF ON 0 1 :CALCulate:WLSequence:EVM:STANdard[1] 2 ...7:IQNorm?
Example	CALC:WLS:EVM:STAN:IQN ON CALC:WLS:EVM:STAN:IQN?
Notes	used in all radio standards In SCPI command, the sub op codes mean different radio standard:: 1: 802.11a/g OFDM 2: 802.11b DSSS/CCK/PBCC 3: 802.11g DSSS-OFDM 4: 802.11n 20MHz 5: 802.11n 40MHz 6: 802.11ac 20MHz 7: 802.11ac 40MHz

Preset	ON ON ON ON ON ON ON
State Saved	Saved in instrument state.
Range	On Off
Initial S/W Revision	A.11.00

I/Q Compensation

This parameter allows to turn On or Off the compensation for IQ Gain Imbalance, IQ Quadrature Error, and IQ Timing Skew found in the input signal.

Remote Command	[:SENSe] :WLSSequence:EVM:STANdard[1] 2 ...7:COMPensate OFF ON 0 1 [:SENSe] :WLSSequence:EVM:STANdard[1] 2 ...7:COMPensate?
Example	WLS:EVM:STAN:COMP ON WLS:EVM:STAN:COMP?
Notes	Only used in 802.11n and 802.11ac In SCPI command, the sub op codes mean different radio standard: 1: 802.11a/g OFDM 2: 802.11b DSSS/CCK/PBCC 3: 802.11g DSSS-OFDM 4: 802.11n 20MHz 5: 802.11n 40MHz 6: 802.11ac 20MHz 7: 802.11ac 40MHz
Preset	OFF OFF OFF OFF OFF OFF OFF
State Saved	Saved in instrument state.
Range	On Off
Initial S/W Revision	A.11.00

Spectrum

Sets a spectrum to either normal or to inverted for demodulation related measurements. If set to INVert, the upper and lower spectrums are swapped.

The invert function conjugates the spectrum, which is equivalent to taking the negative of the quadrature component in demodulation. The correct setting (Normal or Invert) depends on whether the signal at the input of the instrument has a high or a low side mix.

Remote Command	:CALCulate:WLSSequence:EVM:STANdard[1] 2 ...7:SPECTrum INVert NORMal :CALCualte:WLSSequence:EVM:STANdard[1] 2 ...7:SPECTrum?
Example	CALC:WLS:EVM:STAN:SPEC INV

	CALC:WLS:EVM:STAN:SPEC?
Notes	Used in all radio standards. In SCPI command, the sub op codes mean different radio standard:: 1: 802.11a/g OFDM 2: 802.11b DSSS/CCK/PBCC 3: 802.11g DSSS-OFDM 4: 802.11n 20MHz 5: 802.11n 40MHz 6: 802.11ac 20MHz 7: 802.11ac 40MHz
Preset	NORMal NORMal NORMal NORMal NORMal NORMal NORMal
State Saved	Saved in instrument state.
Range	Normal Invert
Initial S/W Revision	A.11.00

Chip Rate

This specifies the fundamental chip rate of the signal to be analyzed. The value should be positive and default is 11 MHz, which matches the chip rate of 802.11b/g.

The only special case is the optional 802.11g 33Mbit PBCC mode. In this mode, the chip rate of the transmitted signal starts at 11 MHz, but changes to 16.5 MHz in the middle of the burst. For signals of this type, the CHIP_RATE should still be specified as 11 MHz, and the measurement will automatically switch to 16.5 MHz at the appropriate place in the burst.

Remote Command	[:SENSe] :WLS:equence:EVM:CRATe <frequency> [:SENSe] :WLS:equence:EVM:CRATe?
Example	WLS:EVM:CRAT 11MHz WLS:EVM:CRAT?
Notes	Only used in 802.11b/g (DSSS/CCK/PBCC) radio standard.
Preset	11.0 MHz
State Saved	Saved in instrument state.
Min	1.0 MHz
Max	25.0 MHz
Initial S/W Revision	A.11.00

Clock Adjust

In a normal measurement, the signal is synchronized to the chip timing. In unusual cases, it is possible for the synchronization to be off slightly. This parameter allows the user to specify a timing offset which is

added to the chip timing detected. This parameter should only be used when trying to debug unusual signals.

The maximum valid value for this parameter is 0.5 chips, and the minimum valid value is -0.5 chips.

Remote Command	<code>[:SENSe] :WLSequence:EVM:CADJust <real></code> <code>[:SENSe] :WLSequence:EVM:CADJust?</code>
Example	<code>WLS:EVM:CADJ -0.1</code> <code>WLS:EVM:CADJ?</code>
Notes	Only used in 802.11b/g (DSSS/CCK/PBCC) radio standard.
Preset	0 chips
State Saved	Saved in instrument state.
Min	-0.50 chips
Max	0.50 chips
Initial S/W Revision	A.11.00

Equalizer

This parameter specifies the total length of the equalizer filter's impulse response, in chips.

Remote Command	<code>[:SENSe] :WLSequence:EVM:EQUalizer:LENGth <integer></code> <code>[:SENSe] :WLSequence:EVM:EQUalizer:LENGth?</code> <code>[:SENSe] :WLSequence:EVM:EQUalizer[:STATe] OFF ON 0 1</code> <code>[:SENSe] :WLSequence:EVM:EQUalizer[:STATe]?</code>
Example	<code>WLS:EVM:EQU:LENG 23</code> <code>WLS:EVM:EQU:LENG?</code> <code>WLS:EVM:EQU ON</code> <code>WLS:EVM:EQU?</code>
Notes	Only used in 802.11b/g (DSSS/CCK/PBCC) radio standard.
Preset	21 chips OFF
State Saved	Saved in instrument state.
Min	3
Max	99
Initial S/W Revision	A.11.00

Descramble

This parameter specifies what type of descrambling to do when producing bit vector results. The valid values are: All, None, Preamble Only, Preamble & Header Only. None means no descrambling is done at all. Preamble Only means only the PLCP preamble is descrambled. Preamble & Header Only means that

the PLCP preamble and PLCP header are descrambled. All means that all parts of the burst are descrambled.

Normally, an 802.11b/g signal has all bits scrambled before transmission, so normally you would want to descramble all of the bitvector results. However, when debugging an 802.11b/g transmitter, it is sometimes helpful to disable scrambling in the transmitter, in which case you would disable descrambling.

Mode	WLAN
Remote Command	[:SENSe] :WLSequence :EVM :DESCramble ALL NONE PONLy PHONLy [:SENSe] :WLSequence :EVM :DESCramble?
Example	WLS:EVM:DESC NONE WLS:EVM:DESC?
Notes	Only used in 802.11b/g (DSSS/CCK/PBCC) radio standard.
Preset	ALL
State Saved	Saved in instrument state.
Range	All None Preamble Only Preamble & Header Only
Initial S/W Revision	A.11.00

Remote Setup

Settings for Remote Setup.

Initial S/W Revision	A.11.00
-----------------------------	---------

Programming Acquisitions Via SCPI

The SCPI command used to configure the Acquisition and Analysis Meas Setup parameters is detailed in the table below. The SCPI is defined so that you send one command per Acquisition or Analysis Step, with the Acquisition or Analysis Step number being specified as a sub op code of the SCPI command. Each command includes all the settings for the Acquisition or Analysis Step. As an analysis step is set up, the values entered are run through several levels of validation.

Initial S/W Revision	A.11.00
-----------------------------	---------

Acquisition Setup using SCPI

Settings for Acquisition.

Remote Command	[:SENSe] :WLSequence :ACQuire [1] 2 ... 4 . 45 :SETup AG BG GDO N20 N40 AC20 AC40, <real>, <ampl>, <ampl>, <time>, <time>, <time>, IMMEDIATE VIDeo RFBurst EXT1 EXT2, <ampl>, <time> [:SENSe] :WLSequence :ACQuire [1] 2 ... 4 . 45 :SETup?
Example	:WLS:ACQ1:SETUP AG, 2.412e9, 0dBm, -10dBm, 5us, 500us, 5ms, RFB, -10dBm, 0

	:WLS:ACQ1:SETUP?
Notes	<p>The parameters are:</p> <p><enum> - specifies the Radio Standard for the Acquisition.</p> <p><real> - specifies the Frequency for the Acquisition.</p> <p><ampl> - specifies the peak expected power in dB for the Acquisition.</p> <p><ampl> - specifies the Expected Power at DUT Output for the Analysis Step.</p> <p><time> - specifies the Prefix Time for the Acquisition.</p> <p><time> - specifies the Transition Time for the Acquisition.</p> <p><time> - specifies the duration of the Acquisition, here it is burst length.</p> <p><enum> - specifies the Input Trigger Type for the Acquisition.</p> <p><ampl> - specifies the Input Trigger Level for the Acquisition.</p> <p><time> - specifies the Input Trigger Delay for the Acquisition.</p>
Dependencies	<p>The range of sub op code values is determined by the number of Bursts you have configured.</p> <p>If you attempt to remotely set or query a sub op code that is out of range, this results in an error message.</p>
Initial S/W Revision	A.11.00

Validation and Setup dependencies

The validation checks prior to run time are listed below:

Validation Errors:

1. Range checking for all parameters.
2. Acquisition overlap pre-trigger error (acquisitions cannot overlap in time).

Validation Warnings/Advisories:

- Transition Time is not long enough for the Acquisition change.
- If the file passes this test, errors may be generated at run time for the Sequence. In this case, the error messages are sent to the error queue. The Sequence may or may not stop when an error is detected, depending on whether you have selected "Abort on error". Additionally, the error message contains the Burst Number where the error occurred.

Settings for Setup.

Initial S/W Revision	A.11.00
----------------------	---------

Peak Search

This function is not supported in this measurement.

Key Path	Front Panel key
Initial S/W Revision	A.11.00

SPAN X Scale

This function is not supported in this measurement.

Key Path	Front Panel key
Initial S/W Revision	A.11.00

Trigger

See ___ on page X

View/Display

The View/Display key opens the Display Menu (common to most measurements) and the View menu for the current measurement.

Only two views are available for the List Sequencer measurement: the Results Metric View, and the RF envelope view. The RF envelope view is only available when basic IQ data is captured in Sequence Analyzer mode.

Key Path	Front-panel key
Initial S/W Revision	A.05.00

Display

The Display menu is common to most measurements, and is used for configuring items on the display. Some Display menu settings apply to all the measurements in a mode, and some only to the current measurement. Those under the System Display Settings key apply to all measurements in all modes.

Key Path	Display
Key Path	View/Display
Initial S/W Revision	Prior to A.02.00

Annotation

Turns on and off various parts of the display annotation. The annotation is divided up into four categories:

1. Meas Bar: This is the measurement bar at the top of the screen. It does not include the settings panel or the Active Function. Turning off the Meas Bar turns off the settings panel and the Active Function. When the Meas Bar is off, the graticule area expands to fill the area formerly occupied by the Meas Bar.
2. Screen Annotation: this is the annotation and annunciation around the graticule, including any annotation on lines (such as the display line, the threshold line, etc.) This does NOT include the marker number or the N dB result. When off, the graticule expands to fill the entire graticule area.
3. Trace annotation: these are the labels on the traces, showing their detector (or their math mode).
4. Active Function annotation: this is the active function display in the meas bar, and all of the active function values displayed on softkeys.

See the figure below. Each type of annotation can be turned on and off individually.

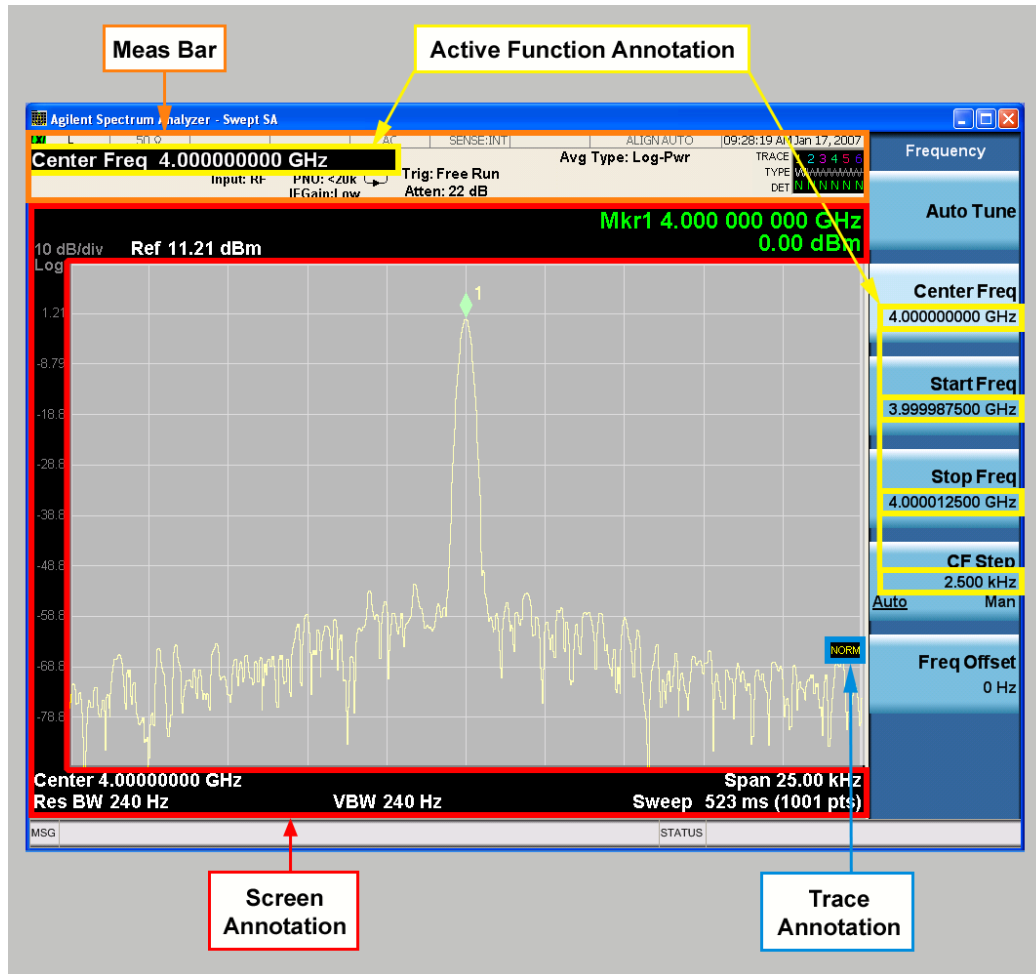

Key Path	View/Display, Display
Initial S/W Revision	Prior to A.02.00

Meas Bar On/Off

This function turns the Measurement Bar on and off, including the settings panel. When off, the graticule area expands to fill the area formerly occupied by the Measurement Bar.

Key Path	View/Display, Display, Annotation
Remote Command	:DISPlay:ANNOtation:MBAR[:STATe] OFF ON 0 1 :DISPlay:ANNOtation:MBAR[:STATe]?
Example	DISP:ANN:MBAR OFF
Dependencies	Grayed out and forced to OFF when System Display Settings, Annotation is set to Off.
Preset	On This should remain Off through a Preset when System DisplaySettings, Annotation is set to Off.
State Saved	Saved in instrument state.
Initial S/W Revision	Prior to A.02.00

Screen

This controls the display of the annunciation and annotation around the graticule, including any annotation on lines (such as the display line, the threshold line, etc.) and the y-axis annotation. This does NOT include marker annotation (or the N dB result). When off, the graticule expands to fill the entire graticule area, leaving only the 1.5% gap above the graticule as described in the Trace/Detector chapter.

Key Path	View/Display, Display, Annotation
Remote Command	:DISPlay:ANNotation:SCReen[:STATe] OFF ON 0 1 :DISPlay:ANNotation:SCReen[:STATe]?
Example	DISP:ANN:SCR OFF
Dependencies	Grayed-out and forced to OFF when System Display Settings, Annotation is set to Off.
Preset	On This should remain Off through a Preset when System DisplaySettings, Annotation is set to Off
State Saved	Saved in instrument state.
Initial S/W Revision	Prior to A.02.00

Active Function Values On/Off

Turns on and off the active function display in the Meas Bar, and all of the active function values displayed on the softkeys.

Note that all of the softkeys that have active functions have these numeric values blanked when this function is on. This is a security feature..

16 WLAN List Sequence Measurement
View/Display

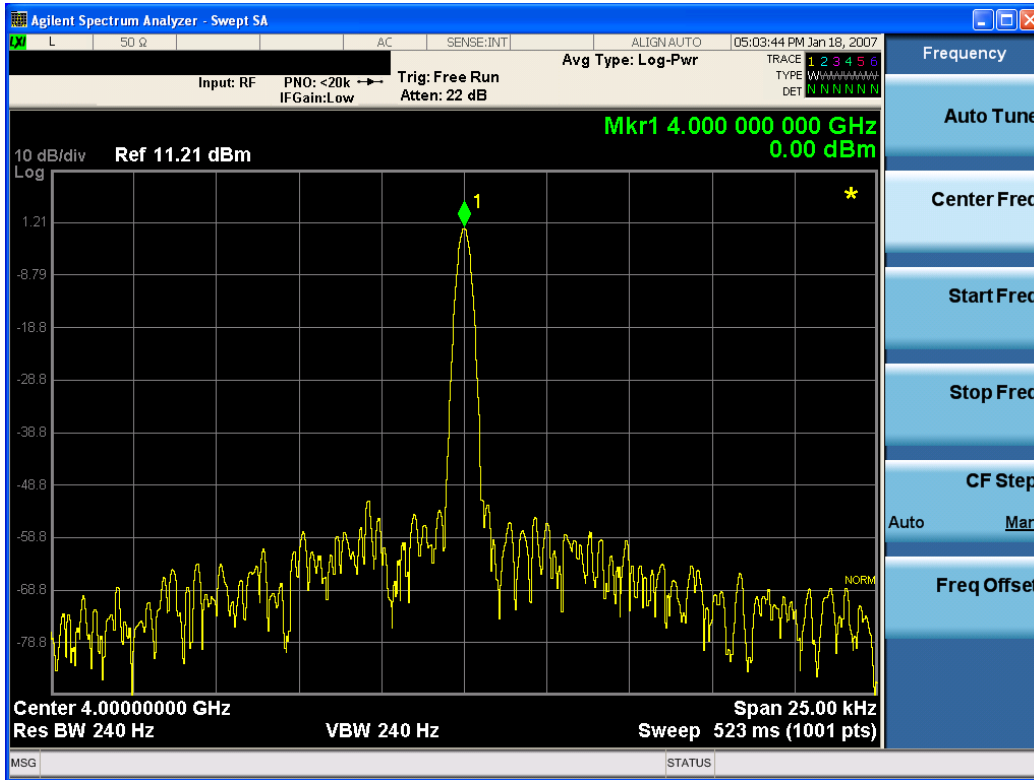

Key Path	View/Display, Display, Annotation
Remote Command	:DISPlay:ACTivefunc[:STATE] ON OFF 1 0 :DISPlay:ACTivefunc[:STATE]?
Example	DISP:ACT OFF
Dependencies	Grayed out and forced to OFF when System Display Settings, Annotation is set to Off.
Preset	On This should remain Off through a Preset when System DisplaySettings, Annotation is set to Off
State Saved	Saved in instrument state.
Initial S/W Revision	Prior to A.02.00

Title

Displays menu keys that enable you to change or clear a title on your display.

Key Path	View/Display, Display
Initial S/W Revision	Prior to A.02.00

Change Title

Writes a title into the "measurement name" field in the banner, for example, "Swept SA".

Press Change Title to enter a new title through the alpha editor. Press Enter or Return to complete the entry. Press ESC to cancel the entry and preserve your existing title.

The display title will replace the measurement name. It remains for this measurement until you press Change Title again, or you recall a state, or a Preset is performed. A title can also be cleared by pressing Title, Clear Title.

NOTE

Notice the inclusion of the <measurement> parameter in the command below. Because each measurement remembers the Display Title, the command must be qualified with the measurement name. For the Swept SA measurement this is not the case; no <measurement> parameter is used when changing the Display Title for the Swept SA measurement.

Key Path	View/Display, Display, Title
Mode	All
Remote Command	:DISPlay:<measurement>:ANNotation:TITLe:DATA <string> :DISPlay:<measurement>:ANNotation:TITLe:DATA?
Example	DISP:ANN:TITL:DATA "This Is My Title" This example is for the Swept SA measurement in the Spectrum Analyzer mode. The SANalyzer <measurement> name is not used. DISP:ACP:ANN:TITL:DATA "This Is My Title" This example is for Measurements other than Swept SA. Both set the title to: This Is My Title
Notes	Pressing this key cancels any active function. When a title is edited the previous title remains intact (it is not cleared) and the cursor goes at the end so that characters can be added or BKSP can be used to go back over previous characters.
Preset	No title (measurement name instead)
State Saved	Saved in instrument state.
Initial S/W Revision	Prior to A.02.00

Clear Title

Clears a title from the front-panel display. Once cleared, the title cannot be retrieved. After the title is cleared, the current Measurement Name replaces it in the title bar.

Key Path	View/Display, Display, Title
Example	The following commands clear the title and restore the measurement's original title: DISP:ANN:TITL:DATA "" This example is for the Swept SA measurement in the Spectrum Analyzer mode. The SANalyzer <measurement> name is not used. DISP:ACP:ANN:TITL:DATA "" This example is for ACP; in measurements other than Swept SA the measurement name is required.
Notes	Uses the :DISPlay:<measurement>:ANNotation:TITLe:DATA <string> command with an empty string (in the Swept SA, the <measurement> is omitted).
Preset	Performed on Preset.
Initial S/W Revision	Prior to A.02.00

Graticule

Pressing Graticule turns the display graticule On or Off. It also turns the graticule y-axis annotation on and off.

Key Path	View/Display, Display
Remote Command	:DISPlay:WINDow[1]:TRACe:GRATicule:GRID[:STATe] OFF ON 0 1 :DISPlay:WINDow[1]:TRACe:GRATicule:GRID[:STATe]?
Example	DISP:WIND:TRAC:GRAT:GRID OFF
Notes	The graticule is the set of horizontal and vertical lines that make up the grid/divisions for the x-axis and y-axis.
Preset	On
State Saved	Saved in instrument state
Initial S/W Revision	Prior to A.02.00

System Display Settings

These settings are "Mode Global" – they affect all modes and measurements and are reset only by Restore Misc Defaults or Restore System Defaults under System.

Key Path	View/Display, Display
Initial S/W Revision	Prior to A.02.00

Annotation Local Settings

This is a Mode Global override of the meas local annotation settings. When it is All Off, it forces ScreenAnnotation, Meas Bar, Trace, and Active Function Values settings to be OFF for all measurements in all modes. This provides the security based "annotation off" function of previous analyzers; hence it uses the legacy SCPI command.

When it is All Off, the Screen, Meas Bar, Trace, and Active Function Values keys under the Display, Annotation menu are grayed out and forced to Off. When Local Settings is selected, you are able to set the local annotation settings on a measurement by measurement basis.

Key Path	View/Display, Display, System Display Settings
Remote Command	:DISPlay:WINDow[1]:ANNotation[:ALL] OFF ON 0 1 :DISPlay:WINDow[1]:ANNotation[:ALL]?
Example	:DISP:WIND:ANN OFF
Preset	On (Set by Restore Misc Defaults)
State Saved	Not saved in instrument state.
Backwards Compatibility Notes	The WINDow parameter and optional subopcode is included for backwards compatibility but ignored – all windows are equally affected.
Initial S/W Revision	Prior to A.02.00

Themes

Accesses a menu of functions that enable you to choose the theme to be used when saving the screen image.

The **Themes** option is the same as the **Themes** option under the **Display** and **Page Setup** dialogs. It allows you to choose between themes to be used when saving the screen image.

Key Path	Save, Screen Image
Remote Command	:MMEMory:STORe:SCReen:THEMe TDColor TDMonochrome FCOLor FMONochrome :MMEMory:STORe:SCReen:THEMe?
Example	:MMEM:STOR:SCR:THEM TDM
Preset	3D Color; Is not part of Preset, but is reset by Restore Misc Defaults or Restore System Defaults All and survives subsequent running of the modes.
Readback	3D Color 3D Mono Flat Color Flat Mono
Backwards Compatibility Notes	In ESA and PSA we offer the choice of "Reverse Bitmap" or "Reverse Metafile" when saving screen images. This is much like the "Flat Color" theme available in X-Series. Also, if you selected Reverse Bitmap AND a black & white screen image, that would be much like "Flat Monochrome". In other words, each of the X-Series themes has a similar screen image type in ESA/PSA. But they are not identical.
Initial S/W Revision	Prior to A.02.00

3D Color

Selects a standard color theme with each object filled, shaded and colored as designed.

Key Path	Save, Screen Image, Themes
Example	MMEM:STOR:SCR:THEM TDC
Readback	3D Color
Initial S/W Revision	Prior to A.02.00

3D Monochrome

Selects a format that is like 3D color but shades of gray are used instead of colors.

Key Path	Save, Screen Image, Themes
Example	MMEM:STOR:SCR:THEM TDM
Readback	3D Mono
Initial S/W Revision	Prior to A.02.00

Flat Color

Selects a format that is best when the screen is to be printed on an ink printer.

Key Path	Save, Screen Image, Themes
Example	MMEM:STOR:SCR:THEM FCOL
Readback	Flat Color
Initial S/W Revision	Prior to A.02.00

Flat Monochrome

Selects a format that is like Flat Color. But only black is used (no colors, not even gray), and no fill.

Key Path	Save, Screen Image, Themes
Example	MMEM:STOR:SCR:THEM FMON
Readback	Flat Mono
Initial S/W Revision	Prior to A.02.00

Backlight

Accesses the display backlight on/off keys. This setting may interact with settings under the Windows "Power" menu.

When the backlight is off, pressing ESC, TAB, SPACE, ENTER, UP, DOWN, LEFT, RIGHT, DEL, BKSP, CTRL, or ALT turns the backlight on without affecting the application. Pressing any other key will turn backlight on and could potentially perform the action as well.

Key Path	View/Display, Display, System Display Settings
Remote Command	:DISPlay:BACKlight ON OFF :DISPlay:BACKlight?
Preset	ON (Set by Restore Misc Defaults)
Initial S/W Revision	Prior to A.02.00

Backlight Intensity

An active function used to set the backlight intensity. It goes from 0 to 100 where 100 is full on and 0 is off. This value is independent of the values set under the Backlight on/off key.

Key Path	View/Display, Display, System Display Settings
Remote Command	:DISPlay:BACKlight:INTensity <integer> :DISPlay:BACKlight:INTensity?
Example	DISP:BACK:INT 50

Preset	100 (Set by Restore Misc Defaults)
Min	0
Max	100
Initial S/W Revision	Prior to A.02.00

Parameter List view

This view shows name, remote command and value of available commands for this measurement. You can verify and change values by using the menu, the front panel keys or by using a mouse and keyboard.

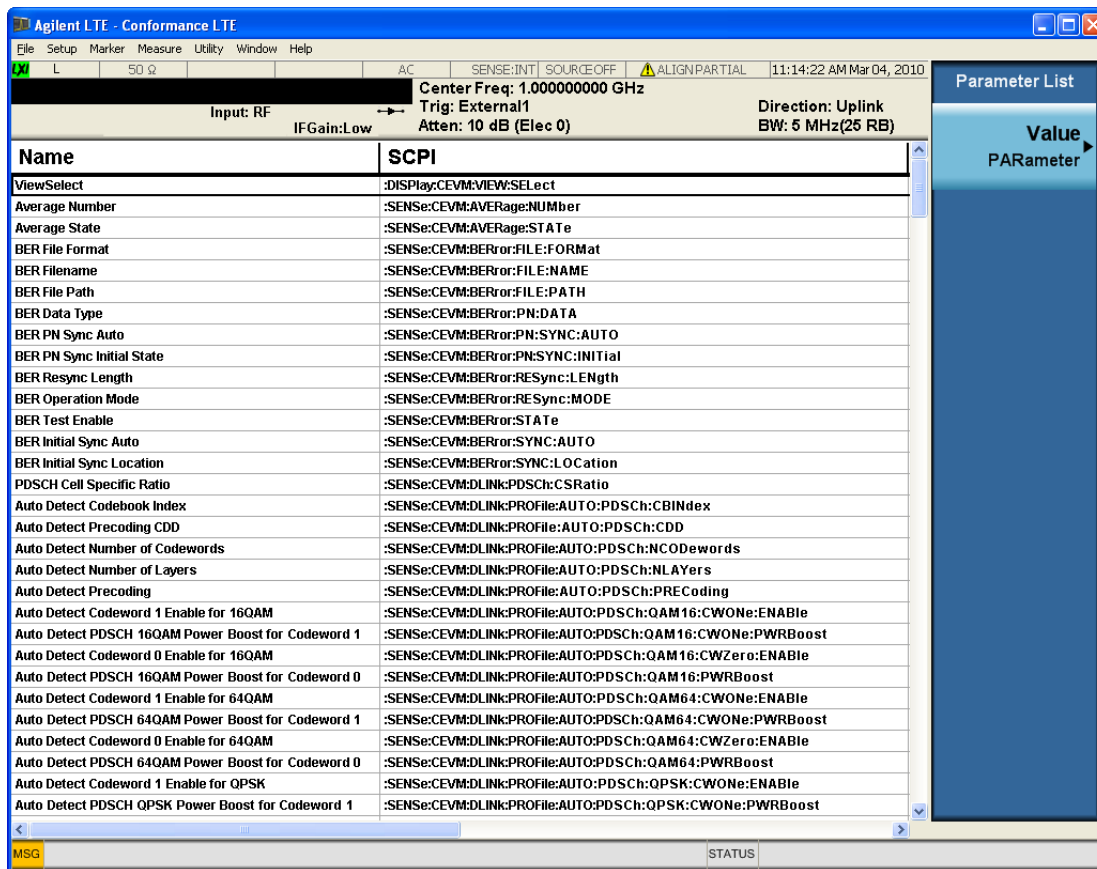

Figure - Parameter List view

Key Path	View/Display
Initial S/W Revision	A.06.30

Value

Allows you to refer to and modify the value on the selected row.

Key Path	View/Display, Parameter List
Initial S/W Revision	A.06.30

17 Monitor Spectrum Measurement

The monitor spectrum measurement is used as a quick, convenient means of looking at the entire spectrum. While the look and feel are similar to the Spectrum Analyzer mode, the functionality is greatly reduced for easy operation. The main purpose of the measurement is to show the spectrum. The default span should cover an appropriate frequency range of the application.

For measurement results and views, see ["View/Display" on page 2142](#).

This topic contains the following sections:

["Measurement Commands for Monitor Spectrum" on page 1980](#)

["Remote Command Results for Monitor Spectrum Measurement" on page 1981](#)

Measurement Commands for Monitor Spectrum

The following commands can be used to retrieve the measurement results:

`:CONFigure:MONitor`

`:CONFigure:MONitor:NDEFault`

`:INITiate:MONitor`

`:FETCh:MONitor[n]?`

`:READ:MONitor[n]?`

`:MEASure:MONitor[n]?`

For more measurement related commands, see the SENSE subsystem, and the section "[Remote Measurement Functions](#)" on page 2213.

Remote Command Results for Monitor Spectrum Measurement

The following table describes the results returned by the queries listed above, according to the index value n .

n	Results Returned
1 (or not specified)	Returns trace1 data with comma separated floating numbers
2	Returns trace2 data with comma separated floating numbers
3	Returns trace3 data with comma separated floating numbers

Key Path	Meas
Initial S/W Revision	Prior to A.02.00

AMPTD Y Scale

Accesses a menu of functions that enable you to set the vertical scale parameters. These functions control how data on the vertical (Y) axis is displayed and control instrument settings that affect the vertical axis.

Key Path	Front-panel key
Initial S/W Revision	Prior to A.02.00

Ref Value

Sets the absolute power reference value. However, since Auto Scaling defaults to On, this value is automatically determined by the measurement result. When you set a value manually, Auto Scaling automatically changes to Off.

Key Path	AMPTD Y Scale
Mode	All except SA and BASIC
Remote Command	:DISPlay:MONitor:VIEW[1]:WINDow[1]:TRACe:Y[:SCALe]:RLEVel <real> :DISPlay:MONitor:VIEW[1]:WINDow[1]:TRACe:Y[:SCALe]:RLEVel?
Example	DISP:MON:VIEW:WIND:TRAC:Y:RLEV 2.0 DISP:MON:VIEW:WIND:TRAC:Y:RLEV?
Couplings	When the Auto Scaling is On, this value is automatically determined by the measurement result. When you set a value manually, Auto Scaling automatically changes to Off.
Preset	10.00 dBm
State Saved	Saved in instrument state.
Min	-250.00 dBm
Max	250.00 dBm
Initial S/W Revision	Prior to A.02.00

Attenuation

This menu controls the attenuator functions and interactions between the attenuation system components.

There are two attenuator configurations in the X-Series. One is a dual attenuator configuration consisting of a mechanical attenuator and an optional electronic attenuator. The other configuration uses a single attenuator with combined mechanical and electronic sections that controls all the attenuation functions. Different models in the X-Series come with different configurations.

See ["Dual Attenuator Configurations:" on page 1983](#)

See ["Single Attenuator Configuration:" on page 1983](#)

Most Attenuation settings are the same for all measurements – they do not change as you change measurements. Settings like these are called “Meas Global” and are unaffected by Meas Preset.

Key Path	AMPTD Y Scale
Scope	Meas Global
Dependencies	In measurements that support the I/Q inputs, this key is unavailable when I/Q is the selected input, and is replaced by the Range key in that case.
Readback Line	Contains a summary in [] brackets of the current total attenuation. See the descriptions of the , " (Mech) Atten " on page 2160, and "Enable Elec Atten" on page 2162 keys for more detail on the contributors to the total attenuation. Note that when "Pre-Adjust for Min Clip" is on, this value can change at the start of every measurement.
Initial S/W Revision	Prior to A.02.00
Modified at S/W Revision	A.03.00

Dual Attenuator Configurations:

Configuration 1: Mechanical attenuator + optional electronic attenuator

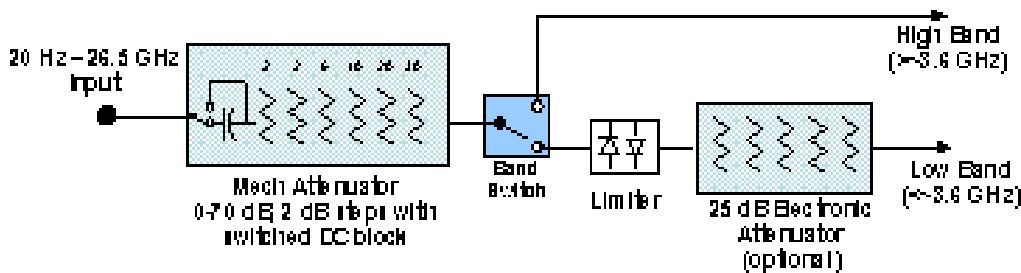

Configuration 2: Mechanical attenuator, no optional electronic attenuator

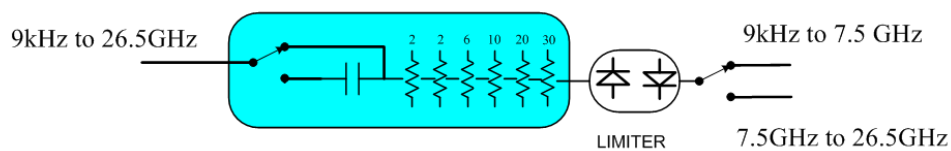

(note that Configuration 2 is not strictly speaking a dual-section attenuator, since there is no electronic section available. However, it behaves exactly like Configuration 1 without the Electronic Attenuator option EA3, therefore for the sake of this document it is grouped into the "Dual Attenuator" configuration)

Single Attenuator Configuration:

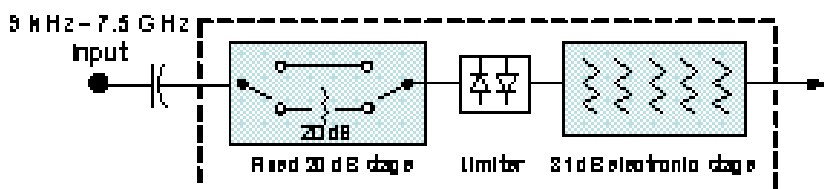

You can tell which attenuator configuration you have by pressing the Attenuation key, which (in most Modes) opens the Attenuation menu. If the first key in the Attenuation menu says Mech Atten you have the dual attenuator configuration. If the first key says Atten you have the single attenuator configuration.

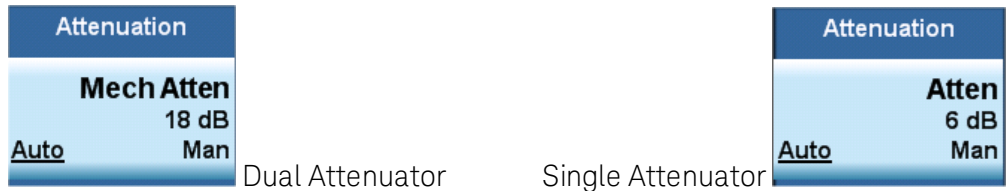

In the single attenuator configuration, you control the attenuation with a single control, as the fixed stage has only two states. In the dual attenuator configuration, both stages have significant range so you are given separate control of the mechanical and electronic attenuator stages.

When you have the dual attenuator configuration, you may still have only a single attenuator, because unless option EA3 (the Electronic Attenuator option) is available, and you purchase it, you will have only the mechanical attenuator.

(Mech) Atten

This key is labeled Mech Atten in dual attenuator models and Atten in single attenuator models. In the dual attenuator configuration, this key only affects the mechanical attenuator.

This key lets you modify the attenuation applied to the RF input signal path. This value is normally auto coupled to the Ref Level, the Internal Preamp Gain, any External Gain that is entered, and the Max Mixer Level, as described in the table below.

See "[Attenuator Configurations and Auto/Man](#)" on page 1985

Key Path	AMPTD Y Scale, Attenuation
Remote Command	[:SENSe]:POWer[:RF]:ATTenuation <rel_amp1> [:SENSe]:POWer[:RF]:ATTenuation? [:SENSe]:POWer[:RF]:ATTenuation:AUTO OFF ON 0 1 [:SENSe]:POWer[:RF]:ATTenuation:AUTO?
Example	POW:ATT 20 Dual attenuator configuration: sets the mechanical attenuator to 20 dB Single attenuator mode: sets the main attenuation to 20 dB (see below for definition of "main" attenuation). If the attenuator was in Auto, it sets it to Manual.
Dependencies	Some measurements do not support the Auto setting of (Mech) Atten. In these measurements, the Auto/Man selection is not available, and the Auto/Man line on the key disappears. In dual attenuator configurations, when the electronic attenuator is enabled, the mechanical attenuator has no auto setting and the Auto/Man line on the key disappears. The state of Auto/Man is remembered and restored when the electronic attenuator is once again disabled. This is described in more detail in the " Enable Elec Atten " on page 2162 key description. See " Attenuator Configurations and Auto/Man " on page 1985 for more information on the Auto/Man functionality of Attenuation.

Couplings

	<p>When (Mech) Atten is in Auto, it uses the following algorithm to determine a value: If the USB Preamp is connected to USB, use 0 dB. Otherwise, Atten = ReferenceLevel + PreAmpGain + ExternalGain – RefLevelOffset - MaxMixerLevel + IF Gain. Limit this value to be between 6 dB and the Max value. No value below 6 dB can ever be chosen by Auto. The resulting value is rounded up to the largest value possible given the attenuation step setting. That is, 50.01 dB would change to 60 dB (for a 10 dB attenuation step). The “IF Gain” term in the equation above is either 0 dB or +10 dB, depending on the settings of FFT IF Gain, Swept IF Gain, max Ref Level and the Auto/Man setting of Mech Atten. In External Mixing and BBIQ, where the Attenuator is not in the signal path, the Attenuator setting changes as described above when (Mech) Atten is in Auto, but no changes are made to the actual attenuator hardware setting until the input is changed back to the RF Input.</p>
Preset	<p>The preset for Mech Attenuation is “Auto.” The Auto value of attenuation is: CXA, EXA, MXA and PXA: 10 dB</p>
State Saved	<p>Saved in instrument state</p>
Min	<p>0 dB The attenuation set by this key cannot be decreased below 6 dB with the knob or step keys. To get to a value below 6 dB it has to be directly entered from the keypad or via SCPI. This protects from adjusting the attenuation to a dangerously small value which can put the instrument at risk of damage to input circuitry. However, if the current mechanical attenuation is below 6 dB it can be increased with the knob and step keys, but not decreased.</p>
Max	<p>CXA N9000A–503/507: 50 dB CXA N9000A–513/526: 70dB EXA: 60 dB MXA and PXA: 70 dB In the single attenuator configuration, the total of ATT and EATT cannot exceed 50 dB, so if the EATT is set to 24 dB first, the main attenuation cannot be greater than 26 dB and will be reduced accordingly; if the main attenuator is set to 40 dB first, EATT cannot be greater than 10 dB.</p>
Initial S/W Revision	<p>Prior to A.02.00</p>
Modified at S/W Revision	<p>A.03.00</p>

Attenuator Configurations and Auto/Man

As described in the Attenuation key description, there are two distinct attenuator configurations available in the X-Series, the single attenuator and dual attenuator configurations. In dual attenuator configurations, we have the mechanical attenuation and the electronic attenuation, and the current total attenuation is the sum of the electronic + mechanical attenuation. In single attenuator configurations, we refer to the attenuation set using the (Mech) Atten key (or POW:ATT SCPI) as the “main” attenuation; and the attenuation that is set by the SCPI command POW:EATT as the “soft” attenuation (the POW:EATT command is honored even in the single attenuator configuration, for compatibility purposes). Then the

current total attenuation is the sum of the main + soft attenuation. See the Elec Atten key description for more on “soft” attenuation.

In the dual attenuator configuration, when the electronic attenuator is enabled, there is no Auto/Man functionality for the mechanical attenuator, and the third line of the key label (the Auto/Man line) disappears:



Enable Elec Atten

Enables the Electronic Attenuator.

The electronic attenuator offers finer steps than the mechanical attenuator, has no acoustical noise, is faster, and is less subject to wear. These advantages primarily aid in remote operation and are negligible for front panel use. See ["Using the Electronic Attenuator: Pros and Cons" on page 1988](#) for a detailed discussion of the pros and cons of using the electronic attenuator.

For the single attenuator configuration, for SCPI backwards compatibility, the “soft” attenuation feature replaces the dual attenuator configuration’s electronic attenuator. All the same couplings and limitations apply. See ["Attenuator Configurations and Auto/Man" on page 2162](#)

See ["More Information" on page 1987](#)

Key Path	AMPTD Y Scale, Attenuation
Remote Command	[:SENSE] :POWER [:RF] :EATTenuation :STATe OFF ON 0 1 [:SENSE] :POWER [:RF] :EATTenuation :STATe ?
Example	POW:EATT:STAT ON
Dependencies	<p>This key only appears in Dual Attenuator models with an Electronic Attenuator installed. It does not appear in models with the Single Attenuator configuration, as in the single attenuator configuration there is no “electronic attenuator” there is only a single integrated attenuator (which has both a mechanical and electronic stage). However, in the single attenuator configuration, EATT SCPI commands are accepted for compatibility with other X-series instruments and set a “soft” attenuation as described in "Attenuator Configurations and Auto/Man" on page 2162.</p> <p>The electronic attenuator (and the “soft” attenuation function provided in single attenuator configurations) is unavailable above 3.6 GHz. Therefore, if the Stop Frequency of the analyzer is > 3.6 GHz then the Enable Elec Atten key will be OFF and grayed out.</p> <p>If the Internal Preamp is on, meaning it is set to Low Band or Full, the electronic attenuator (and the “soft” attenuation function provided in single attenuator configurations) is unavailable. In this case the Enable Elec Atten key will be OFF and grayed out.</p> <p>If either of the above is true, if the SCPI command is sent, an error indicating that the electronic attenuator is unavailable will be sent.</p> <p>If the electronic/soft Attenuator is enabled, then the Stop Freq of the analyzer is limited to 3.6 GHz and the Internal Preamp is unavailable.</p> <p>The SCPI-only “soft” electronic attenuation for the single-attenuator configuration is not available in</p>

	all measurements; in particular, it is not available in the Swept SA measurement.
Couplings	Enabling and disabling the Electronic Attenuator affects the setting of the Mechanical Attenuator (in dual attenuator configurations). This is described in more detail below this table.
Preset	OFF for Swept SA measurement; ON for all other measurements that support the electronic attenuator
State Saved	Saved in instrument state
Initial S/W Revision	Prior to A.02.00
Modified at S/W Revision	A.03.00

More Information

Mechanical Attenuator Transition Rules

When the Electronic Attenuator is enabled, the Mechanical Attenuator transitions to a state that has no Auto function. Below are the rules for transitioning the Mechanical Attenuator. NOTE that the information below ONLY applies to the dual attenuator configurations, and ONLY when the Electronic Attenuator is installed:

When the Electronic Attenuation is enabled from a disabled state:

- The Mechanical Attenuator is initialized to 10 dB (this is its optimal performance setting). You can then set it as desired with SCPI, numeric keypad, step keys, or knob, and it behaves as it normally would in manual mode
- The Auto/Man state of (Mech) Atten is saved
- The Auto/Man line on the (Mech) Atten key disappears and the auto rules are disabled
- The Electronic Attenuator is set to 10 dB less than the previous value of the Mechanical Attenuator, within the limitation that it must stay within the range of 0 to 24 dB of attenuation.

Examples in the dual attenuator configuration:

- Mech Atten at 20 dB. Elec Atten enabled, Mech Atten set to 10 dB, and Elec Atten set to 10 dB. New total attenuation equals the value before Elec Atten enabled.
- Mech Atten at 0 dB. Elec Atten enabled, Mech Atten set to 10 dB, and Elec Atten set to 0 dB. New total attenuation does not equal the value before Elec Atten enabled.
- Mech Atten at 40 dB. Elec Atten enabled, Mech Atten set to 10 dB, and Elec Atten set to 24 dB. New total attenuation does not equal the value before Elec Atten enabled.

When the Electronic Attenuation is disabled from an enabled state:

- The Elec Atten key is grayed out
- The Auto/Man state of (Mech) Atten is restored
- If now in Auto, (Mech) Atten recouples

- If now in Man, (Mech) Atten is set to the value of total attenuation that existed before the Elec Atten was disabled. The resulting value is rounded up to the smallest value possible given the (Mech) Atten Step setting - (That is, 57 dB changes to 58 dB when (Mech) Atten Step is 2 dB.)

Using the Electronic Attenuator: Pros and Cons

The electronic attenuator offers finer steps than the mechanical attenuator, has no acoustical noise, is faster, and is less subject to wear.

The “finer steps” advantage of the electronic attenuator is beneficial in optimizing the alignment of the analyzer dynamic range to the signal power in the front panel as well as remote use. Thus, you can achieve improved relative signal measurement accuracy. Compared to a mechanical attenuator with 2 dB steps, the 1 dB resolution of the electronic attenuator only gives better resolution when the odd-decibel steps are used. Those odd-decibel steps are less accurately calibrated than the even-decibel steps, so one tradeoff for this superior relative accuracy is reduced absolute amplitude accuracy.

Another disadvantage of the electronic attenuator is that the spectrum analyzer loses its “Auto” setting, making operation less convenient.

Also, the relationship between the dynamic range specifications (TOI, SHI, compression and noise) and instrument performance are less well-known with the electrical attenuator. With the mechanical attenuator, TOI, SHI and compression threshold levels increase dB-for-dB with increasing attenuation, and the noise floor does as well. With the electronic attenuator, there is an excess attenuation of about 1 to 3 dB between 0 and 3.6 GHz, making the effective TOI, SHI, and so forth, less well known. Excess attenuation is the actual attenuation relative to stated attenuation. Excess attenuation is accounted for in the analyzer calibration

Elec Atten

Controls the Electronic Attenuator in dual attenuator configurations. This key does not appear in single attenuator configurations, as the control of both the mechanical and electronic stages of the single attenuator is integrated into the single Atten key.

Key Path	AMPTD Y Scale, Attenuation
Remote Command	<code>[:SENSe] :POWer [:RF] :EATTenuation <rel_amp1></code> <code>[:SENSe] :POWer [:RF] :EATTenuation?</code>
Notes	Electronic Attenuation's specification is defined only when Mechanical Attenuation is 6 dB.
Dependencies	This key only appears in Dual Attenuator models with an Electronic Attenuator installed. It does not appear in models with the Single Attenuator configuration, as in the single attenuator configuration there is no “electronic attenuator” there is only a single integrated attenuator (which has both a mechanical and electronic stage). However, in the single attenuator configuration, EATT SCPI commands are accepted for compatibility with other X-series instruments and set a “soft” attenuation as described in "Attenuator Configurations and Auto/Man" on page 2162 . The “soft” attenuation is treated as an addition to the “main” attenuation value set by the Atten softkey or the POW:ATT SCPI command and affects the total attenuation displayed on the Attenuation key and the Meas Bar. When Enable Elec Atten is off or grayed out, the Elec Atten key is grayed out.
Preset	0 dB
State Saved	Saved in instrument state

Min	0 dB
Max	Dual attenuator configuration: 24 dB Single attenuator configuration: the total of ATT and EATT cannot exceed 50 dB, so if the EATT is set to 24 dB first, the main attenuation cannot be greater than 26 dB and will be reduced accordingly; if the main attenuator is set to 40 dB first, EATT cannot be greater than 10 dB
Initial S/W Revision	Prior to A.02.00
Modified at S/W Revision	A.03.00

Adjust Atten for Min Clip

Sets the combination of mechanical and electronic attenuation and gain based on the current measured signal level so that clipping will be at a minimum.

This is an "immediate action" function, that is, it executes once, when the key is pressed.

This key is grayed out in measurements that do not support this functionality. The spectrum analyzer measurement, Swept SA, does not support this functionality.

Key Path	AMPTD Y Scale, Attenuation
Remote Command	<code>[:SENSe] :POWer [:RF] :RANGe:OPTimize IMMEDIATE</code>
Initial S/W Revision	Prior to A.02.00
Modified at S/W Revision	A.03.00

Pre-Adjust for Min Clip

If this function is on, it does the adjustment described under ["Adjust Atten for Min Clip" on page 2165](#) each time a measurement restarts. Therefore, in Continuous measurement mode, it only executes before the first measurement.

In dual attenuator models, you can set Elec+Mech Atten, in which case both attenuators participate in the autoranging, or Elec Atten Only, in which case the mechanical attenuator does not participate in the autoranging. This latter case results in less wear on the mechanical attenuator and is usually faster.

This key is grayed out in measurements that do not support this functionality. The spectrum analyzer measurement, Swept SA, does not support this functionality.

Key Path	AMPTD Y Scale, Attenuation
Remote Command	<code>[:SENSe] :POWer [:RF] :RANGe:OPTimize:ATTenuation OFF ELECTrical COMBined</code> <code>[:SENSe] :POWer [:RF] :RANGe:OPTimize:ATTenuation?</code>
Notes	The SCPI parameter ELECTrical sets this function to On in single attenuator models. The SCPI parameter COMBined is mapped to ELECTrical in single attenuator models; if you send COMBined, it sets the function to On and returns ELEC to a query.
Dependencies	This key only appears in Dual Attenuator models with an Electronic Attenuator installed.

	In instruments with Dual Attenuator model, when Enable Elec Atten is off or grayed out, the Pre-Adjust for Min Clip key is grayed out.
Preset	OFF for Swept SA measurement; ON for all other measurements that support Pre-Adjust for Min Clip
State Saved	Saved in instrument state
Range	Dual attenuator models: Off Elec Atten Only Mech + Elec Atten Single attenuator models: Off On
Initial S/W Revision	Prior to A.02.00
Modified at S/W Revision	A.03.00

Remote Command	<code>[:SENSe] :POWer [:RF] :RANGe :AUTO ON OFF 1 0</code> <code>[:SENSe] :POWer [:RF] :RANGe :AUTO ?</code>
Notes	ON aliases to "Elec Atten Only" (:POW:RANG:OPT:ATT ELEC) OFF aliases to "Off" (:POW:RANG:OPT:ATT OFF) The query :POW:RANG:AUTO? returns true if :POW:RANG:OPT:ATT is not "Off"
Initial S/W Revision	Prior to A.02.00

Off

Turns Pre-Adjust for Min Clip off. This is the default setting.

This key is grayed out in measurements that do not support this functionality. The spectrum analyzer measurement, Swept SA, does not support this functionality.

Key Path	AMPTD Y Scale, Attenuation, Pre-Adjust for Min Clip
Example	:POW:RANG:OPT:ATT OFF
Initial S/W Revision	Prior to A.02.00

Elec Atten Only

Selects only the electric attenuator to participate in auto ranging. This offers less wear on the mechanical attenuator and is usually faster.

This key is grayed out in measurements that do not support this functionality. The spectrum analyzer measurement, Swept SA, does not support this functionality.

Key Path	AMPTD Y Scale, Attenuation, Pre-Adjust for Min Clip
Example	:POW:RANG:OPT:ATT ELEC
Initial S/W Revision	Prior to A.02.00

Mech + Elec Atten

In dual attenuator models, this selects both attenuators participate in the autoranging.

This key is grayed out in measurements that do not support this functionality. The spectrum analyzer measurement, Swept SA, does not support this functionality.

Key Path	AMPTD Y Scale, Attenuation, Pre-Adjust for Min Clip
Example	:POW:RANGe:OPT:ATT COMB
Initial S/W Revision	Prior to A.02.00

(Mech) Atten Step

This controls the step size used when making adjustments to the input attenuation.

This key is labeled Mech Atten Step in dual attenuator models and Atten Step in single attenuator models. In the dual attenuator configuration, this key only affects the step size of the mechanical attenuator.

Key Path	AMPTD Y Scale, Attenuation
Remote Command	<code>[:SENSe] :POWer [:RF] :ATTenuation :STEP [:INCRement] 10 dB 2 dB</code> <code>[:SENSe] :POWer [:RF] :ATTenuation :STEP [:INCRement] ?</code>
Example	POW:ATT:STEP 2
Notes	Note this feature works like a 1-N choice from the front panel, but it takes a specific value (in dB) when used remotely. The only valid values are 2 and 10.
Dependencies	Blanked in CXA and EXA if option FSA (2 dB steps) is not present. If blanked, attempts to set it via SCPI will yield an error.
Couplings	When the attenuation step size changes, the current mechanical attenuation value is adjusted (if necessary) to be quantized to the new step size. That is, if step is set to 10 dB, mech atten is increased if necessary so it is a multiple of 10 dB
Preset	PXA and MXA: 2 dB EXA and CXA: 10 dB (2 dB with option FSA)
State Saved	Saved in instrument state
Initial S/W Revision	Prior to A.02.00
Modified at S/W Revision	A.03.00

Scale/Div

Sets the logarithmic units per vertical graticule division on the display. However, since the Auto Scaling defaults to On, this value is automatically determined by the measurement result. When you set a value manually, Auto Scaling automatically changes to Off.

Key Path	AMPTD Y Scale
Mode	All except SA and BASIC
Remote Command	:DISPlay:MONitor:VIEW[1]:WINDow[1]:TRACe:Y[:SCALe]:PDIVision <rel_ampl> :DISPlay:MONitor:VIEW[1]:WINDow[1]:TRACe:Y[:SCALe]:PDIVision?
Example	DISP:MON:VIEW:WIND:TRAC:Y:PDIV 5.0 dB DISP:MON:VIEW:WIND:TRAC:Y:PDIV?
Couplings	When the Auto Scaling is On, this value is automatically determined by the measurement result. When you set a value manually, Auto Scaling automatically changes to Off.
Preset	10.00 dB
State Saved	Saved in instrument state.
Min	0.10 dB
Max	20.00 dB
Initial S/W Revision	Prior to A.02.00

Presel Center

When this key is pressed, the centering of the preselector filter is adjusted to optimize the amplitude accuracy at the frequency of the selected marker. If the selected marker is not on when Presel Center is pressed, the analyzer will turn on the selected marker, perform a peak search, and then perform centering on the marker's center frequency. If the selected marker is already on and between the start and stop frequencies of the analyzer, the analyzer performs the preselector calibration on that marker's frequency. If the selected marker is already on, but outside the frequency range between Start Freq and Stop Freq, the analyzer will first perform a peak search, and then perform centering on the marker's center frequency.

The value displayed on the Presel Adjust key will change to reflect the new preselector tuning (see Presel Adjust).

A number of considerations should be observed to ensure proper operation. See ["Proper Preselector Operation" on page 1993](#).

Key Path	AMPTD Y Scale
Remote Command	[:SENSe]:POWer[:RF]:PCENter
Example	POW:PCEN
Notes	Note that the rules outlined above under the key description apply for the remote command as well as the key. The result of the command is dependent on marker position, and so forth. Any message shown by the key press is also shown in response to the remote command.
Dependencies	<ul style="list-style-type: none"> • Grayed out if the microwave preselector is off.) • If the selected marker's frequency is below Band 1, advisory message 0.5001 is generated and no action is taken. • Grayed out if entirely in Band 0. • Blank in models that do not include a preselector, such as option 503. If the SCPI is sent in these instruments, it is accepted without error, and the query always returns 0.

- Grayed out in the Spectrogram View.

Couplings	The active marker position determines where the centering will be attempted. If the analyzer is in a measurement such as averaging when centering is initiated, the act of centering the preselector will restart averaging but the first average trace will not be taken until the centering is completed.
Status Bits/OPC dependencies	When centering the preselector, *OPC will not return true until the process is complete and a subsequent measurement has completed, nor will results be returned to a READ or MEASURE command. The Measuring bit should remain set while this command is operating and should not go false until the subsequent sweep/measurement has completed.
Initial S/W Revision	Prior to A.02.00
Modified at S/W Revision	A.03.00

Proper Preselector Operation

A number of considerations should be observed to ensure proper operation:

1. If the selected marker is off, the analyzer will turn on a marker, perform a peak search, and adjust the preselector using the selected marker's frequency. It uses the "highest peak" peak search method unqualified by threshold or excursion, so that there is no chance of a 'no peak found' error. It continues with that peak, even if it is the peak of just noise. Therefore, for this operation to work properly, there should be a signal on screen in a preselected range for the peak search to find.
2. If the selected marker is already on, the analyzer will attempt the centering at that marker's frequency. There is no preselector for signals below about 3.6 GHz, therefore if the marker is on a signal below 3.6 GHz, no centering will be attempted and an advisory message generated
3. In some models, the preselector can be bypassed. If it is bypassed, no centering will be attempted in that range and a message will be generated.

Preselector Adjust

Allows you to manually adjust the preselector filter frequency to optimize its response to the signal of interest. This function is only available when "Presel Center" on page 2168 is available.

For general purpose signal analysis, using Presel Center is recommended. Centering the filter minimizes the impact of long-term preselector drift. Presel Adjust can be used instead to manually optimize the preselector. One application of manual optimization would be to peak the preselector response, which both optimizes the signal-to-noise ratio and minimizes amplitude variations due to small (short-term) preselector drifting.

Key Path	AMPTD Y Scale
Scope	Meas Global
Remote Command	<code>[:SENSe] :POWer [:RF] :PADJust <freq></code>

	<code>[:SENSe] : POWer [:RF] : PADJust ?</code>
Example	POW:PADJ 100KHz POW:PADJ?
Notes	The value on the key reads out to 0.1 MHz resolution.
Dependencies	<ul style="list-style-type: none"> • Grayed out if microwave preselector is off.) • Grayed out if entirely in Band 0. • Blank in models that do not include a preselector, such as option 503. If the SCPI is sent in these instruments, it is accepted without error, and the query always returns 0. • Grayed out in the Spectrogram View.
Preset	0 MHz
State Saved	The Presel Adjust value set by Presel Center, or by manually adjusting Presel Adjust, is not saved in instrument state, and does not survive a Preset or power cycle.
Min	-500 MHz
Max	500 MHz
Default Unit	Hz
Backwards Compatibility SCPI	<code>[:SENSe] : POWer [:RF] : MW : PADJust</code> <code>[:SENSe] : POWer [:RF] : MMW : PADJust</code> PSA had multiple preselectors, but the X-Series has only one. These commands simply alias to <code>[:SENSe] : POWer [:RF] : PADJust</code>
Initial S/W Revision	Prior to A.02.00
Modified at S/W Revision	A.03.00

Remote Command	<code>[:SENSe] : POWer [:RF] : PADJust : PRESelector MWAVE MMWave EXTernal</code> <code>[:SENSe] : POWer [:RF] : PADJust : PRESelector ?</code>
Notes	PSA had multiple preselectors, and you could select which preselector to adjust. Since the X-Series has only one mm/uW preselector, the preselector selection softkey is no longer available. However, to provide backward compatibility, we accept the legacy remote commands. The command form has no effect, the query always returns MWAVE
Initial S/W Revision	Prior to A.02.00

μW Path Control

Sets the μW Path Control function to Auto, standard path, μW Preselector Bypass (Option MPB) and Low Noise Path (Option LNP).

Key Path	AMPTD/Y Scale
Initial S/W Revision	A.14.50

μW Path Control Auto

Activates the auto rules for μW Path Control. When Auto is active, the μW Path Control is set to Preselector Bypass in modulation analysis and spectral flatness measurement; it is set to standard path in other measurements.

Key Path	AMPTD/Y Scale
Remote Command	[:SENSe] :POWer [:RF] :MW:PATH:AUTO ON OFF 1 0 [:SENSe] :POWer [:RF] :MW:PATH:AUTO?
Example	POW:MW:PATH:AUTO ON POW:MW:PATH:AUTO?
Couplings	When Auto is active, the μW Path Control is set to μW Preselector Bypass in IQ measurements (IQ waveform, CCDF, PVT, EVM, Spetrum flatness and WLS); it is set to standard path in other measurements.
Preset	ON
Range	Off On
Initial S/W Revision	A.14.50

Standard Path

This path gives the best remote-control throughput, minimizes acoustic noise from switching and minimizes the risk of wear in the hardware switches, particularly in remote test scenarios where both low band and high band setups will follow in rapid succession.

In this path, the bypass of the low band/high band switch and microwave preamp is never activated, which can cause some noise degradation but preserves the life of the bypass switch.

Key Path	AMPTD Y Scale, μW Path Control
Example	:POW:MW:PATH STD
Readback Text	Standard Path
Initial S/W Revision	A.04.00

Low Noise Path Enable

You may choose Low Noise Path Enable, which gives a lower noise floor under some circumstances, particularly when operating in the 21–26.5 GHz region. With the Low Noise Path enabled, the low band/high band switch and microwave preamp are bypassed whenever all of the following are true:

- The analyzer is not in the Low Band, meaning:
- the start frequency is above 3.5 GHz and
- the stop frequency is above 3.6 GHz.
- the internal preamp is not installed or (if installed) is set to Off or Low Band

Note that this means that, when any part of a sweep is done in Low Band, the Low Noise Path is not used, whether or not the Low Noise Path Enable is selected in the user interface. Also, if the preamp is turned on, the Low Noise Path is not used, whether or not the Low Noise Path Enable is selected in the user interface. The only time the Low Noise Path is used is when Low Noise Path Enable is selected, the sweep is completely in High Band (> 3.6 GHz) and no preamp is in use.

See "[More Information](#)" on page 1996

Key Path	AMPTD Y Scale, μ W Path Control
Measurement	Swept SA
Example	:POW:MW:PATH LNP
Notes	<p>For measurements that use IQ acquisition, the low noise path is used when the Center Frequency is in High Band (> 3.6 GHz) and no preamp is in use.</p> <p>In other words, the rules above are modified to use only the center frequency to qualify which path to switch in.</p> <p>This is not the case for FFT's in the Swept SA measurement; they use the same rules as swept measurements.</p>
Dependencies	<p>Key is blanked if current mode does not support it.</p> <p>Key is grayed out if mode supports it but current measurement does not support it.</p> <p>Unless Option LNP is present and licensed, key is blank and if SCPI command sent, error -241, "Hardware missing; Option not installed" is generated.</p>
Readback Text	Low Noise Path Enable
Initial S/W Revision	A.04.00

More Information

The user should understand that the Low Noise Path, while giving improved DANL, has the disadvantage of decreased TOI performance and decreased gain compression performance relative to the standard path.

The user should also understand that the bypass switch is a mechanical switch and has finite life, so if the Low Noise Path is enabled, it is possible to cause frequent cycling of this switch by frequently changing analyzer settings such that the above conditions hold true only some of the time. A user making tests of this nature should consider opting for the Standard Path, which will never throw the bypass switch, at the expense of some degraded noise performance.

The low noise path is useful for situations where the signal level is so low that the analyzer performance is dominated by noise even with 0 dB attenuation, but still high enough that the preamp option would have excessive third-order intermodulation or compression. The preamp, if purchased and used, gives better noise floor than does the "Low Noise Path." However, its compression threshold and third-order intercept are much poorer than that of the non-preamp path. There are some applications, typically for signals around -30 dBm, for which the third-order dynamic range of the standard path is good enough, but the noise floor is not low enough even with 0 dB input attenuation. When the third-order dynamic range of the preamp path is too little and the noise floor of the standard path is too high, the Low Noise Path can provide the best dynamic range

The graph below illustrates the concept. It shows, in red, the performance of an analyzer at different attenuation settings, both with the preamp on and off, in a measurement that is affected by both analyzer

noise and analyzer TOI. The green shows the best available dynamic range, offset by 0.5 dB for clarity. The blue shows how the best available dynamic range improves for moderate signal levels with the low noise path switched in. In this illustration, the preamp improves the noise floor by 15 dB while degrading the third-order intercept by 30 dB, and the low noise path reduces loss by 8 dB. The attenuator step size is 2 dB.

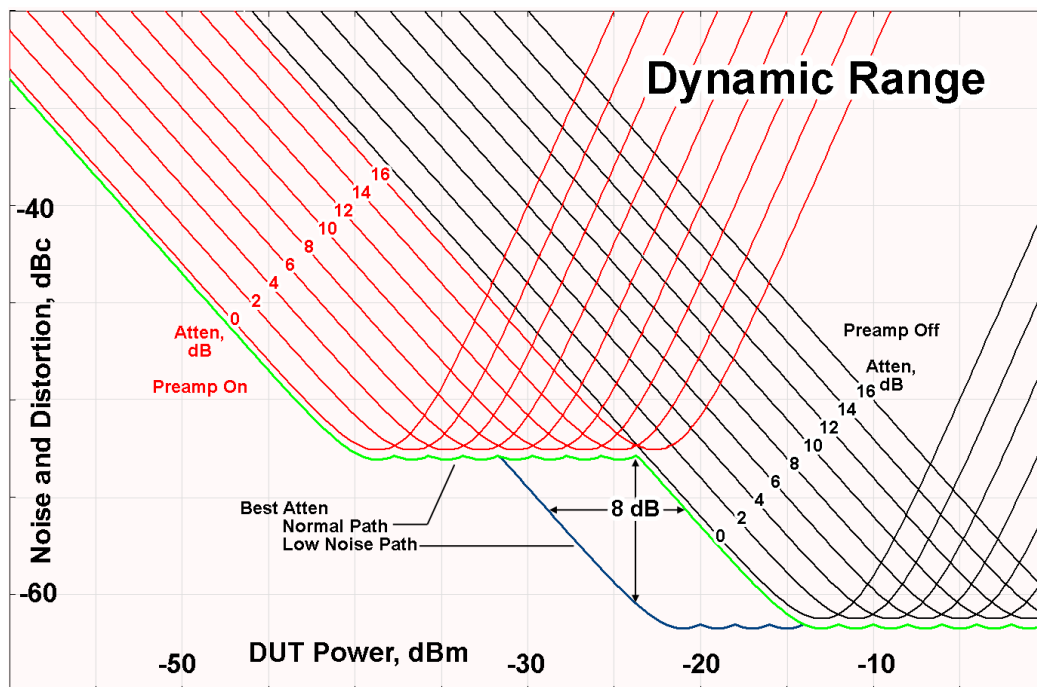

There are other times where selecting the low noise path improves performance, too. Compression-limited measurements such as finding the nulls in a pulsed-RF spectrum can profit from the low noise path in a way similar to the TOI-limited measurement illustrated. Accuracy can be improved when the low noise path allows the optimum attenuation to increase from a small amount like 0, 2 or 4 dB to a larger amount, giving better return loss at the analyzer input. Harmonic measurements, such as second and third harmonic levels, are much improved using the low noise path because of the superiority of that path for harmonic (though not intermodulation) distortion performance.

μ W Preselector Bypass

This key toggles the preselector bypass switch for band 1 and higher. When the microwave preselector is on, the signal path is preselected. When the microwave preselector is off, the signal path is not preselected. The preselected path is the normal path for the analyzer.

The preselector is a tunable bandpass filter which prevents signals away from the frequency of interest from combining in the mixer to generate in-band spurious signals (images). The consequences of using a preselector filter are its limited bandwidth, the amplitude and phase ripple in its passband, and any amplitude and phase instability due to center frequency drift.

Option MPB or pre-selector bypass provides an unpreselected input mixer path for certain X-Series signal analyzers with frequency ranges above 3.6 GHz. This signal path allows a wider bandwidth and less amplitude variability, which is an advantage when doing modulation analysis and broadband signal analysis. The disadvantage is that, without the preselector, image signals will be displayed. Another disadvantage of bypassing the preselector is increased LO emission levels at the front panel input port.

Image responses are separated from the real signal by twice the 1st IF. For IF Paths of 10 MHz and 25 MHz, the 1st IF is 322.5 MHz, so the image response and the real signal will be separated by 645 MHz. The 1st IF will be different for other IF Path settings. When viewing a real signal and its corresponding image response in internal mixing, the image response will be to the left of the real signal.

Also, the image response and the real signal typically have the same amplitude and exhibit the same shape factor.

However, if Option FS1, Fast Sweep Capability, is enabled, the image response in the Swept SA measurement will appear lower in amplitude and have a much wider shape factor compared to the real signal.

Key Path	AMPTD Y Scale, μ W Path Control
Example	:POW:MW:PATH MPB
Dependencies	Key is blanked if current mode does not support it. Key is grayed out if mode supports it but current measurement does not support it. Key is blank unless Option MPB is present and licensed. If SCPI command sent when MPB not present, error -241, "Hardware missing; Option not installed" is generated.
Readback Text	μ W Preselector Bypass
Initial S/W Revision	A.04.00

Remote Command	[:SENSe] :POWer [:RF] :MW:PRESelector [:STATe] ON OFF 0 1 [:SENSe] :POWer [:RF] :MW:PRESelector [:STATe] ?
Example	:POW:MW:PRES OFF Bypasses the microwave preselector
Notes	The ON parameter sets the STD path (:POW:MW:PATH STD) The OFF parameter sets path MPB (:POW:MW:PATH MPB)
Preset	ON

Internal Preamp

Accesses a menu of keys that control the internal preamps. Turning on the preamp gives a better noise figure, but a poorer TOI to noise floor dynamic range. You can optimize this setting for your particular measurement.

The instrument takes the preamp gain into account as it sweeps. If you sweep outside of the range of the preamp the instrument will also account for that. The displayed result will always reflect the correct gain.

For some measurements, when the preamp is on and any part of the displayed frequency range is below the lowest frequency for which the preamp has specifications, a warning condition message appears in the status line. For example, for a preamp with a 9 kHz lowest specified frequency: "Preamp: Accy unspec'd below 9 kHz".

Key Path	AMPTD Y Scale
-----------------	---------------

Scope	Meas Global
Remote Command	[:SENSe] :POWer [:RF] :GAIN [:STATe] OFF ON 0 1 [:SENSe] :POWer [:RF] :GAIN [:STATe] ?
Dependencies	Preamp is not available on all hardware platforms. If the preamp is not present or is unlicensed, the key is not shown. The preamp is not available when the electronic/soft attenuator is enabled.
Couplings	The act of connecting the U7227A USB Preamplifier to one of the analyzer's USB ports will cause the Internal Preamp to be switched on. When this happens an informational message will be generated: "Internal Preamp turned on for optimal operation with USB Preamp." Note that if the Internal Preamp was already on, there will be no change to the setting, but if it was Off it will be switched On, to Full Range. Note that this same action occurs when the SA mode is selected while the USB Preamp is connected to one of the analyzer's USB ports, if it is the first time that the SA mode has run since powerup, or if the last time the SA mode was running the USB Preamp was NOT connected. Subsequently disconnecting the USB Preamp from USB does not change the Internal Preamp setting nor restore the previous setting.
Preset	OFF
State Saved	Saved in instrument state
Initial S/W Revision	Prior to A.02.00
Modified at S/W Revision	A.14.00

Key Path	AMPTD Y Scale, Internal Preamp
Scope	Meas Global
Remote Command	[:SENSe] :POWer [:RF] :GAIN :BAND LOW FULL [:SENSe] :POWer [:RF] :GAIN :BAND ?
Dependencies	Preamp is not available on all hardware platforms. If the preamp is not present or is unlicensed, the key is not shown. If a POW:GAIN:BAND FULL command is sent when a low band preamp is available, the preamp band parameter is to LOW instead of FULL, and an "Option not installed" message is generated.
Preset	LOW
State Saved	Saved in instrument state
Initial S/W Revision	Prior to A.02.00

Off

Turns the internal preamp off

Key Path	AMPTD Y Scale, Internal Preamp
----------	--------------------------------

Example	:POW:GAIN OFF
Readback	Off
Initial S/W Revision	Prior to A.02.00

Low Band

Sets the internal preamp to use only the low band.

The frequency range of the installed (optional) low-band preamp is displayed in square brackets on the Low Band key label.

Key Path	AMPTD Y Scale, Internal Preamp
Example	:POW:GAIN ON :POW:GAIN:BAND LOW
Readback	Low Band
Initial S/W Revision	Prior to A.02.00

Full Range

Sets the internal preamp to use its full range. The low band (0–3.6 GHz or 0–3GHz, depending on the model) is supplied by the low band preamp and the frequencies above low band are supplied by the high band preamp.

The frequency range of the installed (optional) preamp is displayed in square brackets on the Full Range key label. If the high band option is not installed the Full Range key does not appear.

Key Path	AMPTD Y Scale, Internal Preamp
Example	:POW:GAIN ON :POW:GAIN:BAND FULL
Readback	Full Range
Initial S/W Revision	Prior to A.02.00

Ref Position

Positions the reference level at the top, center or bottom of the Y Scale display. Changing the reference position does not change the reference level value.

Key Path	AMPTD Y Scale
Mode	All except SA and BASIC
Remote Command	:DISPlay:MONitor:VIEW[1]:WINDow[1]:TRACe:Y[:SCALe]:RPOsition TOP CENTer BOTTom :DISPlay:MONitor:VIEW[1]:WINDow[1]:TRACe:Y[:SCALe]:RPOsition?

Example	DISP:MON:VIEW:WIND:TRAC:Y:RPOS CENT DISP:MON:VIEW:WIND:TRAC:Y:RPOS?
Preset	TOP
State Saved	Saved in instrument state.
Range	Top Ctr Bot
Initial S/W Revision	Prior to A.02.00

Auto Scaling

Toggles the Auto Scaling function between On and Off.

Key Path	AMPTD Y Scale
Mode	All except SA and BASIC
Remote Command	:DISPlay:MONitor:VIEW[1]:WINDow[1]:TRACe:Y[:SCALe]:COUPLe 0 1 OFF ON :DISPlay:MONitor:VIEW[1]:WINDow[1]:TRACe:Y[:SCALe]:COUPLe?
Example	DISP:MON:VIEW:WIND:TRAC:Y:COUP ON DISP:MON:VIEW:WIND:TRAC:Y:COUP?
Couplings	When Auto Scaling is On, and the Restart front-panel key is pressed, this function automatically determines the scale per division and reference values based on the measurement results. When you set a value to either Scale/Div or Ref Value manually, Auto Scaling automatically changes to Off.
Preset	ON
State Saved	Saved in instrument state.
Range	On Off
Initial S/W Revision	Prior to A.02.00

Auto Couple

The Auto Couple feature provides a quick and convenient way to automatically couple multiple instrument settings. This helps ensure accurate measurements and optimum dynamic range. When the Auto Couple feature is activated, either from the front panel or remotely, all parameters of the current measurement that have an Auto/Manual mode are set to Auto mode and all measurement settings dependent on (or coupled to) the Auto/Man parameters are automatically adjusted for optimal performance.

However, the Auto Couple key actions are confined to the current measurement only. It does not affect other measurements in the mode, and it does not affect markers, marker functions, or trace or display attributes.

See ["More Information" on page 2002](#)

Key Path	Front-panel key
Remote Command	:COUPLe ALL NONE
Example	:COUP ALL
Notes	:COUPLe ALL puts all Auto/Man parameters in Auto mode (equivalent to pressing the Auto Couple key). :COUPLE NONE puts all Auto/Man parameters in manual mode. It decouples all the coupled instrument parameters and is not recommended for making measurements.
Initial S/W Revision	Prior to A.02.00

More Information

There are two types of functions that have Auto/Manual modes.

Auto/Man Active Function keys

An Auto/Man toggle key controls the binary state associated with an instrument parameter by toggling between Auto (where the parameter is automatically coupled to the other parameters it is dependent upon) and Man (where the parameter is controlled independent of the other parameters), as well as making the parameter the active function. The current mode is indicated on the softkey with either Auto or Man underlined as illustrated below.



Auto/Man 1-of-N keys

An Auto/Man 1-of-N key allows you to manually pick from a list of parameter values, or place the function in Auto, in which case the value is automatically selected (and indicated) as shown below. If in Auto, Auto is underlined on the calling key. If in manual operation, manual is indicated on the calling key. But the calling key does not actually toggle the function, it simply opens the menu.

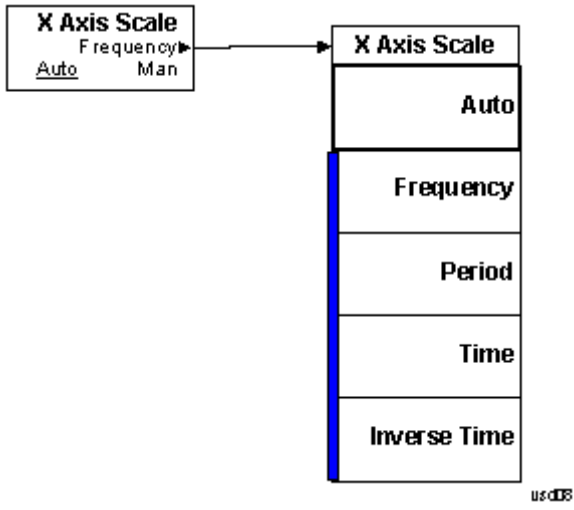

BW

Accesses a menu that enables you to specify the resolution bandwidth functions that control the bandwidth and filter selection.

Key Path	Front-panel key
Initial S/W Revision	Prior to A.02.00

Res BW

Sets the resolution bandwidth for the current measurement. If an unavailable bandwidth is entered with the numeric keypad, the closest available bandwidth is selected.

Key Path	BW
Mode	All except SA and BASIC
Remote Command	[:SENSe]:MONitor:BANDwidth[:RESolution] <freq> [:SENSe]:MONitor:BANDwidth[:RESolution]? [:SENSe]:MONitor:BANDwidth[:RESolution]:AUTO OFF ON 0 1 [:SENSe]:MONitor:BANDwidth[:RESolution]:AUTO?
Example	MON:BAND 2.4 MHz MON:BAND? MON:BAND:AUTO ON MON:BAND:AUTO?
Preset	WCDMA: Automatically calculated WIMAX OFDMA: 100kHz C2K: Automatically calculated BLUETOOTH: Automatically calculated PN: Automatically calculated GSM/EDGE: Automatically calculated TD-SCDMA: Automatically calculated 1xEVDO: 30kHz DVB-T/H: 3.9kHz DTMB (CTTB): 3.9kHz ISDB-T: 3.9kHz CMMB: 3.9kHz LTE: 100 kHz LTETDD: 100 kHz Digital Cable TV: 3.9kHz WLAN: 100 kHz MSR: Automatically calculated LTEAFDD, LTEATDD: 100kHz

	WCDMA: ON
	WIMAX: OFF
	C2K: ON
	BLUETOOTH: ON
	PN: ON
	GSM/EDGE: ON
	TD-SCDMA: ON
	1xEVDO: ON
	DVB-T/H: OFF
	DTMB (CTTB): OFF
	ISDB-T: OFF
	CMMB: OFF
	LTE:OFF
	LTETDD: OFF
	Digital Cable TV: OFF
	WLAN: OFF
	MSR: ON
	LTEAFDD, LTEATDD: OFF
State Saved	Saved in instrument state.
Min	1.0 Hz
Max	8.0 MHz
Backwards Compatibility SCPI	<code>[:SENSe] :MONitor :BWIDth [:RESolution]</code>
Initial S/W Revision	Prior to A.02.00
Modified at S/W Revision	A.02.00
Modified at S/W Revision	A.03.00

Video BW

Changes the analyzer post-detection filter.

Key Path	BW
Mode	All except SA and BASIC
Remote Command	<code>[:SENSe] :MONitor :BANDwidth :VIDeo <bandwidth></code> <code>[:SENSe] :MONitor :BANDwidth :VIDeo?</code> <code>[:SENSe] :MONitor :BANDwidth :VIDeo :AUTO ON OFF 1 0</code> <code>[:SENSe] :MONitor :BANDwidth :VIDeo :AUTO?</code>
Example	MON:BAND:VID 10 MHz MON:BAND:VID? MON:BAND:VID:AUTO OFF

	MON:BAND:VID:AUTO?
Preset	WCDMA: Automatically calculated WIMAX OFDMA: 1 MHz C2K: Automatically calculated BLUETOOTH: Automatically calculated PN: Automatically calculated GSM/EDGE: Automatically calculated TD-SCDMA: Automatically calculated 1xEVDO: 300kHz DVB-T/H: 39kHz DTMB (CTTB): 39kHz ISDB-T: 39kHz CMMB: 39kHz LTE: 1 MHz LTETDD: 1 MHz Digital Cable TV: 39kHz WLAN: 1 MHz MSR: Automatically calculated LTEAFDD, LTEATDD:1 MHz WCDMA: ON WIMAX: OFF C2K: ON BLUETOOTH: ON PN: ON GSM/EDGE: ON TD-SCDMA: ON 1xEVDO: ON DVB-T/H: OFF DTMB (CTTB): OFF ISDB-T: OFF CMMB: OFF LTE:OFF LTETDD:OFF Digital Cable TV: OFF WLAN: OFF MSR: ON LTEAFDD, LTEATDD: OFF
State Saved	Saved in instrument state.
Min	1 Hz
Max	50 MHz

Backwards Compatibility SCPI	<code>[:SENSe] :MONitor :BWIDth :VIDeo</code>
Initial S/W Revision	Prior to A.02.00
Modified at S/W Revision	A.02.00
Modified at S/W Revision	A.03.00

VBW:3dB RBW

Selects the ratio between the video bandwidth and the equivalent 3 dB resolution bandwidth to be used for setting the VBW when VBW is in Auto.

Key Path	BW
Mode	All except SA and BASIC
Remote Command	<code>[:SENSe] :MONitor :BANDwidth :VIDeo :RATio <real></code> <code>[:SENSe] :MONitor :BANDwidth :VIDeo :RATio?</code> <code>[:SENSe] :MONitor :BANDwidth :VIDeo :RATio :AUTO OFF ON 0 1</code> <code>[:SENSe] :MONitor :BANDwidth :VIDeo :RATio :AUTO?</code>
Example	MON:BAND:VID:RAT 2 MON:BAND:VID:RAT? MON:BAND:VID:RAT:AUTO 0 MON:BAND:VID:RAT:AUTO?
Preset	1 ON
State Saved	Saved in instrument state.
Min	0.00001
Max	3000000
Backwards Compatibility SCPI	<code>[:SENSe] :MONitor :BWIDth :VIDeo :RATio</code>
Initial S/W Revision	Prior to A.02.00

Span:3dB RBW

Selects the ratio between span and resolution bandwidth.

The default setting is Auto with a Span:3 dB RBW ratio of 106:1. You can manually change this ratio by pressing the key, entering a new value, and pressing Enter.

Key Path	BW
Mode	All except SA and BASIC
Remote Command	<code>[:SENSe] :MONitor :FREQuency :SPAN :BANDwidth [:RESolution] :RATio <integer></code>

	<code>[:SENSe] :MONitor:FREQuency:SPAN:BANDwidth[:RESolution]:RATio?</code>
	<code>[:SENSe] :MONitor:FREQuency:SPAN:BANDwidth[:RESolution]:RATio:AUTO OFF ON 0 1</code>
	<code>[:SENSe] :MONitor:FREQuency:SPAN:BANDwidth[:RESolution]:RATio:AUTO?</code>
Example	<code>MON:FREQ:SPAN:BAND:RAT 200</code> <code>MON:FREQ:SPAN:BAND:RAT?</code> <code>MON:FREQ:SPAN:BAND:RAT:AUTO ON</code> <code>MON:FREQ:SPAN:BAND:RAT:AUTO?</code>
Preset	106 ON
State Saved	Saved in instrument state.
Min	2
Max	10000
Backwards Compatibility SCPI	<code>[:SENSe] :MONitor:FREQuency:SPAN:BWIDth[:RESolution]:RATio</code>
Initial S/W Revision	Prior to A.02.00
Modified at S/W Revision	A.04.00

Cont (Continuous Measurement/Sweep)

Sets the analyzer for Continuous measurement operation. The single/continuous state is Meas Global so the setting will affect all measurements. If you are Paused, pressing Cont does a Resume.

Key Path	Front-panel key
Remote Command	:INITiate:CONTinuous OFF ON 0 1 :INITiate:CONTinuous?
Example	:INIT:CONT 0 puts analyzer in Single measurement operation. :INIT:CONT 1 puts analyzer in Continuous measurement operation
Preset	ON (Note that SYST:PRESet sets INIT:CONT to ON but *RST sets INIT:CONT to OFF)
State Saved	Saved in instrument state
Backwards Compatibility Notes	For Spectrum Analysis mode in ESA and PSA, there is no Cont hardkey, instead there is a Sweep Single/Cont key. In these analyzers, switching the Sweep Single/Cont key from Single to Cont restarts averages (displayed average count reset to 1), but does not restart Max Hold and Min Hold. The X-Series has Single and Cont keys in place of the SweepSingleCont key. In the X-Series, if in single measurement, the Cont key (and INIT:CONT ON) switches to continuous measurement, but never restarts a measurement and never resets a sweep.
Initial S/W Revision	Prior to A.02.00

In Swept SA Measurement (Spectrum Analysis Mode):

The analyzer takes repetitive sweeps, averages, measurements, etc., when in Continuous mode. When the average count reaches the Average/Hold Number the count stops incrementing, but the analyzer keeps sweeping. See the Trace/Detector section for the averaging formula used both before and after the Average/Hold Number is reached. The trigger condition must be met prior to each sweep. The type of trace processing for multiple sweeps, is set under the Trace/Detector key, with choices of Trace Average, Max Hold, or Min Hold.

In Other Measurements/Modes:

With Avg/Hold Num (in the Meas Setup menu) set to Off or set to On with a value of 1, a sweep is taken after the trigger condition is met; and the analyzer continues to take new sweeps after the current sweep has completed and the trigger condition is again met. However, with Avg/Hold Num set to On with a value >1, multiple sweeps (data acquisitions) are taken for the measurement. The trigger condition must be met prior to each sweep. The sweep is not stopped when the average count k equals the number N set for Avg/Hold Num is reached, but the number k stops incrementing. A measurement average usually applies to all traces, marker results, and numeric results. But sometimes it only applies to the numeric results.

If the analyzer is in Single measurement, pressing the Cont key does not change k and does not cause the sweep to be reset; the only action is to put the analyzer into Continuous measurement operation.

If it is already in continuous sweep:

the INIT:CONT 1 command has no effect

17 Monitor Spectrum Measurement
Cont (Continuous Measurement/Sweep)

the INIT:CONT 0 command will place the analyzer in Single Sweep but will have no effect on the current sequence until $k = N$, at which point the current sequence will stop and the instrument will go to the idle state.

File

See "File" on page 348

FREQ Channel

Accesses a menu of keys that allow you to control the Frequency and Channel parameters of the instrument.

Some features in the Frequency menu are the same for all measurements – they do not change as you change measurements. Settings like these are called “Meas Global” and are unaffected by Meas Preset. For example, the Center Freq setting is the same for all measurements - it does not change as you change measurements.

Key Path	Front-panel key
Initial S/W Revision	Prior to A.02.00

Center Freq

Sets the frequency that corresponds to the horizontal center of the graticule (when frequency Scale Type is set to linear). While adjusting the Center Frequency the Span is held constant, which means that both Start Frequency and Stop Frequency will change.

Pressing Center Freq also sets the frequency entry mode to Center/Span. In Center/Span mode, the center frequency and span values are displayed below the graticule, and the default active function in the Frequency menu is Center Freq.

The center frequency setting is the same for all measurements within a mode, that is, it is Meas Global. Some modes are also able to share a Mode Global center frequency value. If this is the case, the Mode will have a Global Settings key in its Mode Setup menu.

The Center Freq function sets (and queries) the Center Frequency for the currently selected input. If your analyzer has multiple inputs, and you select another input, the Center Freq changes to the value for that input. SCPI commands are available to directly set the Center Freq for a specific input.

Center Freq is remembered as you go from input to input. Thus you can set a Center Freq of 10 GHz with the RF Input selected, change to BBIQ and set a Center Freq of 20 MHz, then switch to External Mixing and set a Center Freq of 60 GHz, and when you go back to the RF Input the Center Freq will go back to 10 GHz; back to BBIQ and it is 20 MHz; back to External Mixing and it is 60 GHz.

See ["RF Center Freq" on page 2015](#)

See [Ext Mix Center Freq](#)

See ["I/Q Center Freq" on page 2017](#)

See ["Center Frequency Presets" on page 2013](#)

Key Path	FREQ Channel
Scope	Meas Global
Remote Command	<code>[:SENSe] :FREQuency:CENTer <freq></code> <code>[:SENSe] :FREQuency:CENTer?</code>

Example	FREQ:CENT 50 MHz FREQ:CENT UP changes the center frequency to 150 MHz if you use FREQ:CENT:STEP 100 MHz to set the center frequency step size to 100 MHz FREQ:CENT?
Notes	This command sets either the RF or I/Q Center Frequency depending on the selected input. For RF input it is equivalent to FREQ:RF:CENT For I/Q input it is equivalent to FREQ:IQ:CENT Preset and Max values are dependent on Hardware Options (5xx) If no terminator (e.g. MHz) is sent the terminator Hz is used. If a terminator with unit other than Frequency is used, an invalid suffix error message is generated.
Dependencies	The Center Frequency can be limited by Start or Stop Freq limits, if the Span is so large that Start or Stop reach their limit.
Couplings	When operating in “swept span”, any value of the Center Frequency or Span that is within the frequency range of the analyzer is allowed when the value is being set through the front panel numeric key pad or the SCPI command. The other parameter is forced to a different value if needed, to keep the Start and the Stop Frequencies within the analyzer’s frequency range
Preset	Depends on instrument maximum frequency, mode, measurement, and selected input. See "Center Frequency Presets" on page 2013 and "RF Center Freq" on page 2015 and Ext Mix Center Freq and "I/Q Center Freq" on page 2017 .
State Saved	Saved in instrument state
Min	Depends on instrument maximum frequency, mode, measurement, and selected input.. See "Center Frequency Presets" on page 2013 and "RF Center Freq" on page 2015 and "I/Q Center Freq" on page 2017 .
Max	Depends on instrument maximum frequency, mode, measurement, and selected input.. See "Center Frequency Presets" on page 2013 and "RF Center Freq" on page 2015 and "I/Q Center Freq" on page 2017 .
Default Unit	Hz
Status Bits/OPC	Non-overlapped
Dependencies	
Initial S/W Revision	Prior to A.02.00

Center Frequency Presets

The following table provides the Center Frequency Presets for the Spectrum Analyzer mode, and the Max Freq, for the various frequency options:

Freq Option	CF after Mode Preset	Stop Freq after Mode Preset	Max Freq (can't tune)

17 Monitor Spectrum Measurement
FREQ Channel

			above)
503 (all but N9000A)	1.805 GHz	3.6 GHz	3.7 GHz
503 (N9000A)	1.505 GHz	3.0 GHz	3.08 GHz
507 (all but N9000A)	3.505 GHz	7.0 GHz	7.1 GHz
507 (N9000A)	3.755 GHz	7.5 GHz	7.58 GHz
508 (all but N9038A)	1.805 GHz	3.6 GHz	8.5 GHz
508 (N9038A)	4.205 GHz	8.4 GHz	8.5 GHz
513	6.805 GHz	13.6 GHz	13.8 GHz
526 (all but N9000A and N9038A)	13.255 GHz	26.5 GHz	27.0 GHz
526 (N9000A)	13.255 GHz	26.5 GHz	26.55 GHz
526 (N9038A)	1.805 GHz	3.6 GHz	27.0 GHz
532	16.005 GHz	32.0 GHz	32.5 GHz
543	21.505 GHz	43.0 GHz	TBD
544	22.005 GHz	44.0 GHz	44.5 GHz
550	25.005 GHz	50.0 GHz	51 GHz

Input 2:

Model	CF after Mode Preset	Stop Freq after Mode Preset	Max Freq (can't tune above)
N9000A opt C75	0.7505GHz	1.5 GHz	1.58 GHz
N9038A	505 MHz	1 GHz	1.000025 GHz

Tracking Generator Frequency Limits (N9000A only):

Tracking Generator Option	Min Freq (clips to this freq when turn TG on and	If above this Freq, Stop Freq clipped to this Freq when	Max Freq (can't tune above) while TG

	can't tune below while TG on)	TG turned on	on
T03	9 kHz	3.0 GHz	3.08 GHz
T06	9 kHz	6.0 GHz	6.05 GHz

The following table shows the Center Frequency Presets for modes other than Spectrum Analyzer:

Mode	CF Preset for RF
WCDMA	1 GHz
WIMAXOFDMA,	1 GHz
BASIC	1 GHz
ADEMOD	1 GHz
VSA	1 GHz
TDSCDMA	1 GHz
PNOISE	1 GHz
LTE	1 GHz
LTETDD	1 GHz
MSR	1 GHz
GSM	935.2 MHz
NFIGURE	1.505 GHz

RF Center Freq

SCPI command for specifying the RF Center Frequency. This command will set the Center Frequency to be used when the RF input is selected, even if the RF input is not the input that is selected at the time the command is sent. Note that the Center Freq function in the Frequency menu on the front panel always applies to the currently selected input.

Scope	Meas Global
Remote Command	<code>[:SENSe] :FREQuency:RF:CENTer <freq></code> <code>[:SENSe] :FREQuency:RF:CENTer?</code>
Example	FREQ:RF:CENT 30 MHz
Notes	This command is the same in all modes, but the parameter is Measurement Global. So the value is independent in each mode and common across all the measurements in the mode.
Dependencies	If the electronic/soft attenuator is enabled, any attempt to set Center Frequency such that the Stop Frequency would be >3.6 GHz fails and results in an advisory message. If the equivalent SCPI command is sent, this same message is generated as part of a “-221, Settings conflict” warning. If Source Mode is set to Tracking, and the Max or Min Center Freq is therefore limited by the limits of the source, a warning message is generated, “Data out of range;clipped to source max/min” if these limits are exceeded. Note that for an external source, these limits can be affected by the settings of

	Source Numerator, Source Denominator and Power Sweep.
Preset	See table above
State Saved	Saved in instrument state.
Min	-79.999995 MHz, unless Source Mode is set to Tracking, in which case it is limited by the minimum frequency of the Source
Max	See table above. Basically instrument maximum frequency – 5 Hz. Note that, if the Source Mode is set to Tracking, the effective instrument maximum frequency may be limited by the source maximum frequency. If the knob or step keys are being used, also depends on the value of the other three interdependent parameters Span, Start Frequency and Stop Frequency
Initial S/W Revision	Prior to A.02.00
Modified at S/W Revision	A.03.00

Ext Mix Center Freq

SCPI command for specifying the External Mixer Center Frequency. This command will set the Center Frequency to be used when the External Mixer is selected, even if the External Mixer input is not the input which is selected at the time the command is sent. Note that the Center Freq function in the Frequency menu on the front panel always applies to the currently selected input.

Scope	Meas Global
Remote Command	<code>[:SENSe] :FREQuency:EMIXer:CENTer <freq></code> <code>[:SENSe] :FREQuency:EMIXer:CENTer?</code>
Example	<code>:FREQ:EMIX:CENT 60 GHz</code> <code>:FREQ:EMIX:CENT?</code>
Notes	This command is the same in all modes, but the parameter is Measurement Global. So the value is independent in each mode and common across all the measurements in the mode.
Couplings	When returning to External Mixing after having been switched to one of the other inputs (e.g., RF), you will come back into the settings that you had when you left External Mixing. So you will come back to the band you were in with the Center Frequency that you had. However, Span is not an input-dependent parameter, therefore you will bring the span over from the other input. Therefore, the analyzer comes back with the span from the previous input, limited as necessary by the current mixer setup.
Preset	When a Mode Preset is performed while in External Mixing, the Start frequency of the current Mode is set to the nominal Min Freq of the lowest harmonic range in the Harmonic Table for the current mixer setup. Similarly, the Stop frequency of the current Mode is set to the nominal Max Freq of the highest harmonic range in the Harmonic Table. The Center Freq thus presets to the point arithmetically equidistant from these two frequencies. If the current measurement has a limited Span available to it, and cannot achieve the Span shown in the table (Span=Stop Freq – Start Freq), the analyzer uses the maximum Span the measurement allows, and still sets the Center Freq to the midpoint of the Start and Stop Freq values in the Harmonic Table.

	When Restore Input/Output Defaults is performed, the mixer presets to the 11970A, whose Start and Stop frequencies are 26.5 and 40 GHz respectively. The center of these two frequencies is 33.25 GHz. Therefore, after a Restore Input/Output Defaults, if you go into External Mixing and do a Mode Preset while in the Spectrum Analyzer Mode, the resulting Center Freq is 33.25 GHz.
State Saved	Saved in instrument state.
Min	The minimum frequency in the currently selected mixer band + 5 Hz
Max	The maximum frequency in the currently selected mixer band – 5 Hz If the knob or step keys are being used, also depends on the value of the other three interdependent parameters Span, Start Frequency and Stop Frequency
Initial S/W Revision	A.08.01

I/Q Center Freq

SCPI command for specifying the I/Q Center Frequency. This command will set the Center Frequency to be used when the I/Q input is selected, even if the I/Q input is not the input which is selected at the time the command is sent. Note that the Center Freq function in the Frequency menu on the front panel always applies to the currently selected input.

Scope	Meas Global
Remote Command	[:SENSe] :FREQuency:IQ:CENTer <freq> [:SENSe] :FREQuency:IQ:CENTer?
Example	FREQ:IQ:CENT: 30 MHz
Notes	This command is the same in all modes, but the parameter is Measurement Global. So the value is independent in each mode and common across all the measurements in the mode.
Preset	0 Hz
State Saved	Saved in instrument state.
Min	-40.049995 MHz
Max	40.049995 MHz
Initial S/W Revision	Prior to A.02.00

CF Step

Changes the step size for the center frequency and start and stop frequency functions. Once a step size has been selected and the center frequency function is active, the step keys (and the UP|DOWN parameters for Center Frequency from remote commands) change the center frequency by the step-size value. The step size function is useful for finding harmonics and sidebands beyond the current frequency span of the analyzer.

Note that the start and stop frequencies also step by the CF Step value.

Key Path	FREQ Channel
Remote Command	[:SENSe]:FREQuency:CENTer:STEP[:INCRement] <freq> [:SENSe]:FREQuency:CENTer:STEP[:INCRement]? [:SENSe]:FREQuency:CENTer:STEP:AUTO OFF ON 0 1 [:SENSe]:FREQuency:CENTer:STEP:AUTO?
Example	FREQ:CENt:STEP:AUTO ON FREQ:CENt:STEP 500 MHz FREQ:CENt UP increases the current center frequency value by 500 MHz FREQ:CENt:STEP? FREQ:CENt:STEP:AUTO?
Notes	Preset and Max values are depending on Hardware Options (503, 507, 508, 513, 526)
Notes	Preset and Max values are dependent on Hardware Options (5xx)
Dependencies	Freq Offset is not available in External Mixing. In this case the Freq Offset key is grayed out and shows a value of zero. It will once again be available, and show the previously set value, when you return to the RF Input.
Dependencies	Span, RBW, Center frequency If the electronic/soft attenuator is enabled, any attempt to change the value of the center frequency >3.6 GHz by pressing the Up-arrow key, fails and results in an advisory message. If the equivalent SCPI command is sent, this same message is generated as part of a “-221, Settings conflict” warning.
Couplings	When auto-coupled in a non-zero span, the center frequency step size is set to 10% of the span. When auto-coupled in zero span, the center frequency step size is set to the equivalent -3 dB RBW value.
Preset	Auto ADEMOD: 1 MHz ON
State Saved	Saved in instrument state
Min	– (the maximum frequency of the instrument). That is, 27 GHz max freq instrument has a CF step range of +/- 27 GHz. Note that this is the maximum frequency given the current settings of the instrument, so in External Mixing, for example, it is the maximum frequency of the current mixer band.
Max	The maximum frequency of the instrument. That is, 27 GHz max freq instrument has a CF step range of +/- 27 GHz. Note that this is the maximum frequency given the current settings of the instrument, so in External Mixing, for example, it is the maximum frequency of the current mixer band.
Default Unit	Hz
Status Bits/OPC dependencies	non-overlapped
Initial S/W Revision	Prior to A.02.00
Modified at S/W Revision	A.03.00

Input/Output

See "Input/Output" on page 194

Marker

Accesses a menu that enables you to select, set up and control the markers for the current measurement. For remote-only commands associated with Marker functionality, see:

- "Marker X Axis Value (Remote Command only)" on page 2023
- "Marker X Axis Position (Remote Command only)" on page 2023
- "Marker Y Axis Value (Remote Command only)" on page 2024

Key Path	Front-panel key
Initial S/W Revision	Prior to A.02.00

Select Marker

Displays 12 markers available for selection.

Key Path	Marker
Initial S/W Revision	Prior to A.02.00

Marker Type

Sets the marker control mode to Normal, Delta or Off. If the selected marker is Off, pressing Marker sets it to Normal and places a single marker at the center of the display. At the same time, Marker X Axis Value appears on the Active Function area.

Key Path	Marker
Mode	All except SA and BASIC
Remote Command	:CALCulate:MONitor:MARKer[1] 2 ... 12:MODE POSITION DELTa OFF :CALCulate:MONitor:MARKer[1] 2 ... 12:MODE?
Example	CALC:MON:MARK:MODE POS CALC:MON:MARK:MODE?
Notes	If the selected marker is Off, pressing Marker sets it to Normal and places it at the center of the screen on the trace determined by the Marker Trace rules. At the same time, Marker X Axis Value appears on the Active Function area. Default Active Function: the active function for the selected marker's current control mode. If the current control mode is Off, there is no active function and the active function is turned off. Active Function Display: the marker X axis value entered in the active function area displays the marker value to its full entered precision.
Preset	OFF
State Saved	Saved in instrument state.
Range	Normal Delta Off
Initial S/W Revision	Prior to A.02.00

Properties

Accesses a menu that enables you to select the active marker, the reference marker and the trace for the current measurement.

Key Path	Marker
Initial S/W Revision	Prior to A.02.00

Select Marker

Displays 12 markers available for selection.

Key Path	Marker
Initial S/W Revision	Prior to A.02.00

Relative To

Selects the desired marker. The selected marker is relative to its reference marker.

Key Path	Marker, Properties
Mode	All except SA and BASIC
Remote Command	<code>:CALCulate:MONitor:MARKer[1] 2 ... 12:REFerence <integer></code> <code>:CALCulate:MONitor:MARKer[1] 2 ... 12:REFerence?</code>
Example	CALC:MON:MARK2:REF 1 CALC:MON:MARK2:REF?
Notes	A marker cannot be relative to itself so that choice is grayed out, and if sent from SCPI generates error -221: "Settings conflict; marker cannot be relative to itself." When queried a single value is returned (the specified marker number's relative marker).
Preset	2 3 4 5 6 7 8 9 10 11 12 1
State Saved	Saved in instrument state.
Min	1
Max	12
Initial S/W Revision	Prior to A.02.00

Marker Trace

Assigns the specified marker to the designated trace.

Key Path	Marker, Properties
Mode	All except SA and BASIC

Remote Command	:CALCulate:MONitor:MARKer[1] 2 ... 12:TRACe <integer> :CALCulate:MONitor:MARKer[1] 2 ... 12:TRACe?
Example	CALC:MON:MARK:TRAC 1 CALC:MON:MARK:TRAC?
Preset	1
State Saved	Saved in instrument state.
Min	1
Max	3
Initial S/W Revision	Prior to A.02.00

Couple Markers

When this function is true, moving any marker causes an equal X Axis movement of every other marker that is not Off. By “equal X Axis movement” we mean that we preserve the difference between each marker’s X Axis value (in the fundamental x-axis units of the trace that marker is on) and the X Axis value of the marker being moved (in the same fundamental x-axis units).

Key Path	Marker
Mode	All except SA and BASIC
Remote Command	:CALCulate:MONitor:MARKer:COUPle[:STATe] ON OFF 1 0 :CALCulate:MONitor:MARKer:COUPle[:STATe]?
Example	CALC:MON:MARK:COUP ON CALC:MON:MARK:COUP?
Preset	OFF
State Saved	Saved in instrument state.
Range	On Off
Initial S/W Revision	Prior to A.02.00

All Markers Off

Turns off all markers on the current measurement.

Key Path	Marker
Mode	All except SA and BASIC
Remote Command	:CALCulate:MONitor:MARKer:AOff
Example	CALC:MON:MARK:AOff
Initial S/W Revision	Prior to A.02.00

Marker X Axis Value (Remote Command only)

Sets the marker X Axis value in the current marker X Axis Scale unit. It has no effect if the control mode is Off, but is the SCPI equivalent of entering an X value if the control mode is Normal or Delta.

Mode	All except SA and BASIC
Remote Command	:CALCulate:MONitor:MARKer[1] 2 ... 12:X <freq> :CALCulate:MONitor:MARKer[1] 2 ... 12:X?
Example	CALC:MON:MARK3:X 0 CALC:MON:MARK3:X?
Notes	If no suffix is sent, uses the fundamental units for the current marker X Axis Scale. If a suffix is sent that does not match the current marker X Axis Scale unit, an error "Invalid suffix" is generated. The query returns the marker's absolute X Axis value if the control mode is Normal, or the offset from the marker's reference marker if the control mode is Delta. The query is returned in the fundamental units for the current marker X Axis scale: Hz for Frequency and Inverse Time, seconds for Period and Time. If the marker is Off the response is not a number.
Preset	After a preset, all markers are turned OFF, so Marker X Axis Value query returns a not a number (NAN).
State Saved	No
Min	-9.9E+37
Max	9.9E+37
Initial S/W Revision	Prior to A.02.00

Marker X Axis Position (Remote Command only)

Sets the marker X position in trace points. It has no effect if the control mode is Off, but is the SCPI equivalent of entering a value if the control mode is Normal or Delta – except in trace points rather than X Axis Scale units. The entered value is immediately translated into the current X Axis Scale units for setting the value of the marker.

Mode	All except SA and BASIC
Remote Command	:CALCulate:MONitor:MARKer[1] 2 ... 12:X:POSition <real> :CALCulate:MONitor:MARKer[1] 2 ... 12:X:POSition?
Example	CALC:MON:MARK:X:POS 0 CALC:MON:MARK:X:POS?
Notes	The query returns the marker's absolute X Axis value in trace points if the control mode is Normal, or the offset from the marker's reference marker in trace points if the control mode is Delta. The value is returned as a real number, not an integer, corresponding to the translation from X Axis Scale units to trace points. If the marker is Off the response is not a number.
Preset	After a preset, all markers are turned OFF, so Marker X Axis Value query returns a not a number (NAN).
State Saved	No
Min	-9.9E+37

Max	9.9E+37
Initial S/W Revision	Prior to A.02.00

Marker Y Axis Value (Remote Command only)

Returns the marker Y Axis value in the current marker.

Mode	All except SA and BASIC
Remote Command	:CALCulate:MONitor:MARKer[1] 2 ... 12:Y?
Example	CALC:MON:MARK11:Y?
Preset	Result dependent on markers setup and signal source
Backwards Compatibility SCPI	:CALCulate:MONitor:MARKer[1] 2 ... 12:FUNCTion:RESult?
Initial S/W Revision	Prior to A.02.00

Marker Function

Accesses special marker functions such as marker noise, and power in a specified bandwidth or time interval.

Key Path	Front-panel key
Initial S/W Revision	Prior to A.02.00

Select Marker

Displays 12 markers available for selection.

Key Path	Marker
Initial S/W Revision	Prior to A.02.00

Marker Function Type

Sets the marker control function type to one of the following:

NOISe	Marker Noise
BPOWer	Band/Interval Power
BDENsity	Band Interval Density
OFF	Marker Function Off

Key Path	Marker Function
Mode	All except SA and BASIC
Remote Command	:CALCulate:MONitor:MARKer[1] 2 ... 12:FUNCtion NOISe BPOWer BDENsity OFF :CALCulate:MONitor:MARKer[1] 2 ... 12:FUNCtion?
Example	CALC:MON:MARK:FUNC NOISCALC:MON:MARK:FUNC?
Preset	OFF
State Saved	Saved in instrument state.
Range	Marker Noise Band/Interval Power Band Interval Density Marker Function Off
Initial S/W Revision	Prior to A.02.00

Band Adjust

Accesses a menu that enables you to set the frequency span width and the left and right edge, or time values, for the band or interval of the selected marker.

Key Path	Marker Function
Initial S/W Revision	Prior to A.02.00

Band/Interval Span for Frequency Domain

Sets the width of the frequency span for the selected marker.

Key Path	Marker Function
Mode	All except SA and BASIC
Remote Command	:CALCulate:MONitor:MARKer[1] 2 ... 12:FUNction:BAND:SPAN <freq> :CALCulate:MONitor:MARKer[1] 2 ... 12:FUNction:BAND:SPAN?
Example	CALC:MON:MARK12:FUNC:BAND:SPAN 20 MHz CALC:MON:MARK12:FUNC:BAND:SPAN?
Couplings	Changing the Band/Interval Span necessarily changes the Band/Interval Left and Band/Interval Right values.
Preset	Depends on X axis range of selected Trace.
State Saved	Saved in instrument state.
Min	-9.9E+37
Max	9.9E+37
Initial S/W Revision	Prior to A.02.00

Band/Interval Left for Frequency Domain

Sets the left edge frequency or time value for the band of the selected marker.

Key Path	Marker Function
Mode	All except SA and BASIC
Remote Command	:CALCulate:MONitor:MARKer[1] 2 ... 12:FUNction:BAND:LEFT <freq> :CALCulate:MONitor:MARKer[1] 2 ... 12:FUNction:BAND:LEFT?
Example	CALC:MON:MARK12:FUNC:BAND:LEFT 20 GHz CALC:MON:MARK12:FUNC:BAND:LEFT?
Couplings	Changing the Band/Interval Left necessarily changes the Band/Interval Span value.
Preset	Depends on X axis range of selected Trace.
State Saved	Saved in instrument state.
Min	-9.9E+37
Max	9.9E+37
Initial S/W Revision	Prior to A.02.00

Band/Interval Right for Frequency Domain

Sets the right edge frequency or time value for the band of the selected marker.

Key Path	Marker Function
Mode	All except SA and BASIC
Remote Command	:CALCulate:MONitor:MARKer[1] 2 ... 12:FUNCtion:BAND:RIGHT <freq> :CALCulate:MONitor:MARKer[1] 2 ... 12:FUNCtion:BAND:RIGHT?
Example	CALC:MON:MARK12:FUNC:BAND:RIGH 20 GHz CALC:MON:MARK12:FUNC:BAND:RIGH?
Couplings	Changing the Band/Interval Right necessarily changes the Band/Interval Span value.
Preset	Depends on X axis range of selected Trace.
State Saved	Saved in instrument state.
Min	-9.9E+37
Max	9.9E+37
Initial S/W Revision	Prior to A.02.00

Marker To

There is no 'Marker To' functionality supported in Monitor Spectrum. The front-panel key displays a blank menu when pressed.

Key Path	Front-panel key
Initial S/W Revision	Prior to A.02.00

Meas

The information in this section is common to all measurements. For key and remote command information for a specific measurement, refer to the section that describes the measurement of interest.

Measurements available under the Meas key are specific to the current Mode.

When viewing Help for measurements, note the following:

NOTE

Operation for some keys differs between measurements. The information displayed in Help pertains to the current measurement. To see how a key operates in a different measurement, exit Help (press the Cancel Esc key), select the measurement, then reenter Help (press the Help key) and press that key.

Key Path	Front-panel key
Initial S/W Revision	Prior to A.02.00

Remote Measurement Functions

This section contains the following topics:

"Measurement Group of Commands" on page 2214

"Current Measurement Query (Remote Command Only)" on page 2216

"Limit Test Current Results (Remote Command Only)" on page 2216

"Data Query (Remote Command Only)" on page 2216

"Calculate/Compress Trace Data Query (Remote Command Only)" on page 2217

"Calculate Peaks of Trace Data (Remote Command Only)" on page 2222

"Hardware-Accelerated Fast Power Measurement (Remote Command Only)" on page 2223

"Format Data: Numeric Data (Remote Command Only)" on page 2237

"Format Data: Byte Order (Remote Command Only)" on page 2238

Initial S/W Revision	Prior to A.02.00
----------------------	------------------

Measurement Group of Commands

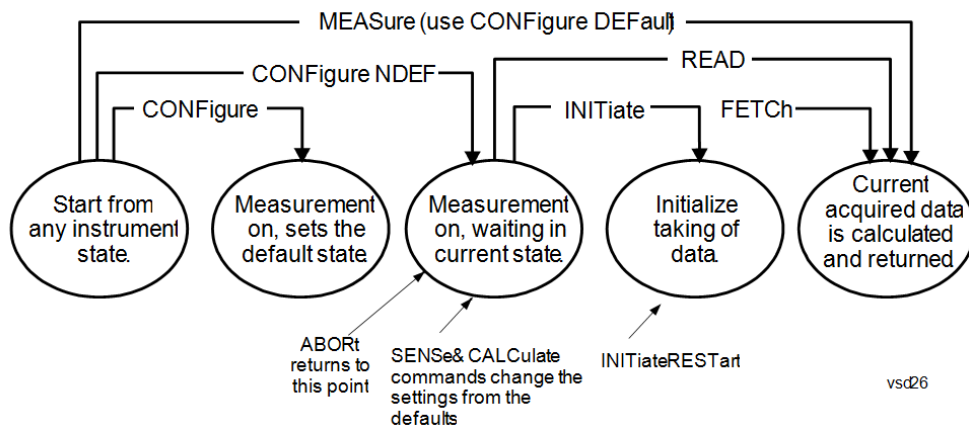

Measure Commands:

:MEASure:<measurement>[n]?

This is a fast single-command way to make a measurement using the factory default instrument settings. These are the settings and units that conform to the Mode Setup settings (e.g. radio standard) that you have currently selected.

- Stops the current measurement (if any) and sets up the instrument for the specified measurement using the factory defaults
- Initiates the data acquisition for the measurement
- Blocks other SCPI communication, waiting until the measurement is complete before returning results.
- If the function does averaging, it is turned on and the number of averages is set to 10.
- After the data is valid it returns the scalar results, or the trace data, for the specified measurement. The type of data returned may be defined by an [n] value that is sent with the command.
- The scalar measurement results will be returned if the optional [n] value is not included, or is set to 1. If the [n] value is set to a value other than 1, the selected trace data results will be returned. See each command for details of what types of scalar results or trace data results are available.
- ASCII is the default format for the data output. (Older versions of Spectrum Analysis and Phase Noise mode measurements only use ASCII.) The binary data formats should be used for handling large blocks of data since they are smaller and faster than the ASCII format. Refer to the FORMat:DATA command for more information.

If you need to change some of the measurement parameters from the factory default settings you can set up the measurement with the CONFIgure command. Use the commands in the SENSe:<measurement> and CALCulate:<measurement> subsystems to change the settings. Then you can use the READ? command to initiate the measurement and query the results.

If you need to repeatedly make a given measurement with settings other than the factory defaults, you can use the commands in the SENSe:<measurement> and CALCulate:<measurement> subsystems to set up the measurement. Then use the READ? command to initiate the measurement and query results.

Measurement settings persist if you initiate a different measurement and then return to a previous one. Use READ:<measurement>? if you want to use those persistent settings. If you want to go back to the default settings, use MEASure:<measurement>?.

Configure Commands:

:CONFIgure:<measurement>

This command stops the current measurement (if any) and sets up the instrument for the specified measurement using

the factory default instrument settings. It does not initiate the taking of measurement data unless INIT:CONTInuous is ON. If you change any measurement settings after using the CONFigure command, the READ command can be used to initiate a measurement without changing the settings back to their defaults.

In the Swept SA measurement in Spectrum Analyzer mode the CONFigure command also turns the averaging function on and sets the number of averages to 10 for all measurements.

:CONFigure: <measurement>: NDEFault stops the current measurement and changes to the specified measurement. It does not change the settings to the defaults. It does not initiate the taking of measurement data unless INIT:CONTInuous is ON.

The CONFigure? query returns the current measurement name.

The CONFigure:CATalog? query returns a quoted string of all licensed measurement names in the current mode. For example, "SAN, CHP, OBW, ACP, PST, TXP, SPUR, SEM, LIST".

Fetch Commands:

:FETCh:<measurement>[n]?

This command puts selected data from the most recent measurement into the output buffer. Use FETCh if you have already made a good measurement and you want to return several types of data (different [n] values, for example, both scalars and trace data) from a single measurement. FETCh saves you the time of re-making the measurement. You can only FETCh results from the measurement that is currently active, it will not change to a different measurement. An error message is reported if a measurement other than the current one is specified.

If you need to get new measurement data, use the READ command, which is equivalent to an INITiate followed by a FETCh.

The scalar measurement results will be returned if the optional [n] value is not included, or is set to 1. If the [n] value is set to a value other than 1, the selected trace data results will be returned. See each command for details of what types of scalar results or trace data results are available. The binary data formats should be used for handling large blocks of data since they are smaller and transfer faster than the ASCII format. (FORMat:DATA)

FETCh may be used to return results other than those specified with the original READ or MEASure command that you sent.

INITiate Commands:

:INITiate:<measurement>

This command is not available for measurements in all the instrument modes:

- Initiates a trigger cycle for the specified measurement, but does not output any data. You must then use the FETCh<meas> command to return data. If a measurement other than the current one is specified, the instrument will switch to that measurement and then initiate it.
 - For example, suppose you have previously initiated the ACP measurement, but now you are running the channel power measurement. If you send INIT:ACP? it will change from channel power to ACP and will initiate an ACP measurement.
 - Does not change any of the measurement settings. For example, if you have previously started the ACP measurement and you send INIT:ACP? it will initiate a new ACP measurement using the same instrument settings as the last time ACP was run.
 - If your selected measurement is currently active (in the idle state) it triggers the measurement, assuming the trigger conditions are met. Then it completes one trigger cycle. Depending upon the measurement and the number of averages, there may be multiple data acquisitions, with multiple trigger events, for one full trigger cycle. It also holds off additional commands on GPIB until the acquisition is complete.
-

READ Commands:

:READ:<measurement>[n]?

- Does not preset the measurement to the factory default settings. For example, if you have previously initiated the ACP
-

measurement and you send READ:ACP? it will initiate a new measurement using the same instrument settings.

- Initiates the measurement and puts valid data into the output buffer. If a measurement other than the current one is specified, the instrument will switch to that measurement before it initiates the measurement and returns results.
 - For example, suppose you have previously initiated the ACP measurement, but now you are running the channel power measurement. Then you send READ:ACP? It will change from channel power back to ACP and, using the previous ACP settings, will initiate the measurement and return results.
 - Blocks other SCPI communication, waiting until the measurement is complete before returning the results
 - If the optional [n] value is not included, or is set to 1, the scalar measurement results will be returned. If the [n] value is set to a value other than 1, the selected trace data results will be returned. See each command for details of what types of scalar results or trace data results are available. The binary data formats should be used when handling large blocks of data since they are smaller and faster than the ASCII format. (FORMat:DATA)
-

Initial S/W Revision	Prior to A.02.00
----------------------	------------------

Current Measurement Query (Remote Command Only)

This command returns the name of the measurement that is currently running.

Remote Command	:CONFigure?
-----------------------	-------------

Example	CONF?
----------------	-------

Initial S/W Revision	Prior to A.02.00
----------------------	------------------

Limit Test Current Results (Remote Command Only)

Queries the status of the current measurement limit testing. It returns a 0 if the measured results pass when compared with the current limits. It returns a 1 if the measured results fail any limit tests.

Remote Command	:CALCulate:CLIMits:FAIL?
-----------------------	--------------------------

Example	CALC:CLIM:FAIL? queries the current measurement to see if it fails the defined limits. Returns a 0 or 1: 0 it passes, 1 it fails.
----------------	--

Initial S/W Revision	Prior to A.02.00
----------------------	------------------

Data Query (Remote Command Only)

Returns the designated measurement data for the currently selected measurement and subopcode.

n = any valid subopcode for the current measurement. See the measurement command results table for your current measurement, for information about what data is returned for the subopcodes.

This command uses the data setting specified by the FORMat:BORDER and FORMat:DATA commands and can return real or ASCII data. (See the format command descriptions under Input/Output in the Analyzer Setup section.)

Remote Command	:CALCulate:DATA[n]?
Notes	The return trace depends on the measurement. In CALCulate:<meas>:DATA[n], n is any valid subopcode for the current measurement. It returns the same data as the FETCH:<measurement>? query where <measurement> is the current measurement.
Initial S/W Revision	Prior to A.02.00

Calculate/Compress Trace Data Query (Remote Command Only)

Returns compressed data for the currently selected measurement and sub-opcode [n].

n = any valid sub-opcode for that measurement. See the MEASure:<measurement>? command description of your specific measurement for information on the data that can be returned.

The data is returned in the current Y Axis Unit of the analyzer. The command is used with a sub-opcode <n> (default=1) to specify the trace. With trace queries, it is best if the analyzer is not sweeping during the query. Therefore, it is generally advisable to be in Single Sweep, or Update=Off.

This command is used to compress or decimate a long trace to extract and return only the desired data. A typical example would be to acquire N frames of GSM data and return the mean power of the first burst in each frame. The command can also be used to identify the best curve fit for the data.

Remote Command	:CALCulate:DATA<n>:COMPRESS? BLOCK CFIT MAXimum MINimum MEAN DMEan RMS RMSCubed SAMPLE SDEVIation PPHase [,<soffset> [,<length>[,<roffset>[,<rlimit>]]]]
Example	To query the mean power of a set of GSM bursts: Supply a signal that is a set of GSM bursts. Select the IQ Waveform measurement (in IQ Analyzer Mode). Set the sweep time to acquire at least one burst. Set the triggers such that acquisition happens at a known position relative to a burst. Then query the mean burst levels using, CALC:DATA2:COMP? MEAN, 24e-6, 526e-6 (These parameter values correspond to GSM signals, where 526e-6 is the length of the burst in the slot and you just want 1 burst.)
Notes	The command supports 5 parameters. Note that the last 4 (<soffset>, <length>, <roffset>, <rlimit>) are optional. But these optional parameters must be entered in the specified order. For example, if you want to specify <length>, then you must also specify <soffset>. See details below for a definition of each of these parameters. This command uses the data in the format specified by FORMat:DATA, returning either binary or ASCII data.
Initial S/W Revision	Prior to A.02.00

- BLOCK or block data - returns all the data points from the region of the trace data that you specify. For example, it could be used to return the data points of an input signal over several timeslots, excluding the portions of the trace data that you do not want. (This is x,y pairs for trace data and I,Q pairs for complex data.)

- CFIT or curve fit - applies curve fitting routines to the data. <soffset> and <length> are required to define the data that you want. <roffset> is an optional parameter for the desired order of the curve equation. The query will return the following values: the x-offset (in seconds) and the curve coefficients ((order + 1) values).

MIN, MAX, MEAN, DME, RMS, RMSC, SAMP, SDEV and PPH return one data value for each specified region (or <length>) of trace data, for as many regions as possible until you run out of trace data (using <roffset> to specify regions). Or they return the number of regions you specify (using <rlimit>) ignoring any data beyond that.

- MINimum - returns the minimum data point (y value) for the specified region(s) of trace data. For I/Q trace data, the minimum magnitude of the I/Q pairs is returned.
- MAXimum - returns the maximum data point (y value) for the specified region(s) of trace data. For I/Q trace data, the maximum magnitude of the I/Q pairs is returned.
- MEAN - returns a single value that is the arithmetic mean of the data point values (in dB/ dBm) for the specified region(s) of trace data. For I/Q trace data, the mean of the magnitudes of the I/Q pairs is returned. See the following equations.

NOTE If the original trace data is in dB, this function returns the arithmetic mean of those log values, not log of the mean power which is a more useful value. The mean of the log is the better measurement technique when measuring CW signals in the presence of noise. The mean of the power, expressed in dB, is useful in power measurements such as Channel Power. To achieve the mean of the power, use the RMS option.

Equation 1

Mean Value of Data Points for Specified Region(s)

$$MEAN = \frac{1}{n} \sum_{X_i \in \text{region}(s)} X_i$$

where X_i is a data point value, and n is the number of data points in the specified region(s).

Equation 2

Mean Value of I/Q Data Pairs for Specified Region(s)

$$MEAN = \frac{1}{n} \sum_{X_i \in \text{region}(s)} |X_i|$$

where $|X_i|$ is the magnitude of an I/Q pair, and n is the number of I/Q pairs in the specified region(s).

- DMEan - returns a single value that is the mean power (in dB/ dBm) of the data point values for the specified region(s) of trace data. See the following equation:

Equation 3

DMEan Value of Data Points for Specified Region(s)

$$\text{DME} = 10 \times \log_{10} \left(\frac{1}{n} \sum_{X_i \in \text{region}(s)} 10^{\frac{X_i}{10}} \right)$$

- RMS - returns a single value that is the average power on a root-mean-squared voltage scale (arithmetic rms) of the data point values for the specified region(s) of trace data. See the following equation.

NOTE

For I/Q trace data, the rms of the magnitudes of the I/Q pairs is returned. See the following equation. This function is very useful for I/Q trace data. However, if the original trace data is in dB, this function returns the rms of the log values which is not usually needed.

Equation 4

RMS Value of Data Points for Specified Region(s)

$$\text{RMS} = \sqrt{\frac{1}{n} \sum_{X_i \in \text{region}(s)} X_i^2}$$

where X_i is a data point value, and n is the number of data points in the specified region(s).

Equation 5

RMS Value of I/Q Data Pairs for Specified Region(s)

$$\text{RMS} = \sqrt{\frac{1}{n} \sum_{X_i \in \text{region}(s)} X_i X_i^*}$$

where X_i is the complex value representation of an I/Q pair, X_i^* its conjugate complex number, and n is the number of I/Q pairs in the specified region(s).

Once you have the rms value for a region of trace data (linear or I/Q), you may want to calculate the mean power. You must convert this rms value (peak volts) to power in dBm:

$$10 \times \log[10 \times (\text{rms value})^2]$$

- SAMPLe - returns the first data value (x,y pair) for the specified region(s) of trace data. For I/Q trace data, the first I/Q pair is returned.
- SDEViation - returns a single value that is the arithmetic standard deviation for the data point values for the specified region(s) of trace data. See the following equation.
- For I/Q trace data, the standard deviation of the magnitudes of the I/Q pairs is returned. See the following equation.

Equation 6

Standard Deviation of Data Point Values for Specified Region(s)

$$\text{SDEV} = \sqrt{\frac{1}{n} \sum_{X_i \in \text{region}(s)} (X_i - \bar{X})^2}$$

where X_i is a data point value, \bar{X} is the arithmetic mean of the data point values for the specified region (s), and n is the number of data points in the specified region(s).

$$\text{SDEV} = \sqrt{\frac{1}{n} \sum_{X_i \in \text{region}(s)} (|X_i| - \bar{X})^2}$$

where $|X_i|$ is the magnitude of an I/Q pair, \bar{X} is the mean of the magnitudes for the specified region(s), and n is the number of data points in the specified region(s).

- PPHase - returns the x,y pairs of both rms power (dBm) and arithmetic mean phase (radian) for every specified region and frequency offset (Hz). The number of pairs is defined by the specified number of regions. This parameter can be used for I/Q vector ($n=0$) in Waveform (time domain) measurement and all parameters are specified by data point in PPHase.

The rms power of the specified region may be expressed as:

$$\text{Power} = 10 \times \log [10 \times (\text{RMS I/Q value})] + 10.$$

The RMS I/Q value (peak volts) is:

$$\sqrt{\frac{1}{n} \sum_{X_i \in \text{region}} X_i X_i^*}$$

where X_i is the complex value representation of an I/Q pair, X_i^* its conjugate complex number, and n is the number of I/Q pairs in the specified region.

The arithmetic mean phase of the specified region may be expressed as:

$$\frac{1}{n} \sum_{Y_i \in \text{region}} Y_i$$

where Y_i is the unwrapped phase of I/Q pair with applying frequency correction and n is the number of I/Q pairs in the specified region.

The frequency correction is made by the frequency offset calculated by the arithmetic mean of every specified region's frequency offset. Each frequency offset is calculated by the least square method against the unwrapped phase of I/Q pair.

Sample Trace Data - Constant Envelope

(See below for explanation of variables.)

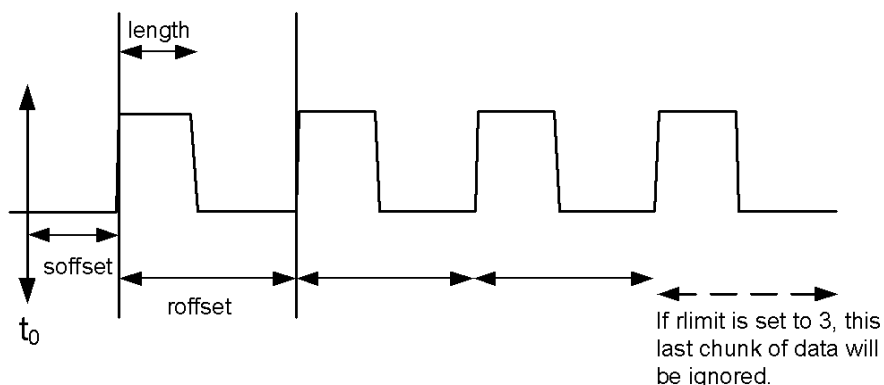

Sample Trace Data - Not Constant Envelope

(See below for explanation of variables.)

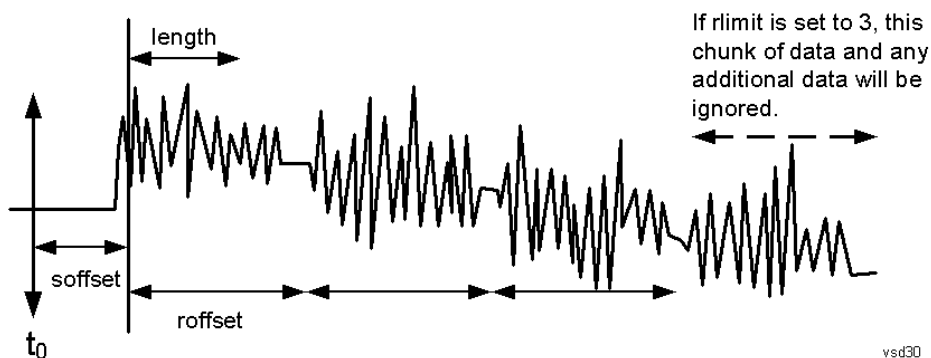

<soffset> - start offset is an optional real number. (It is in seconds for time-domain traces, and is a dimensionless index 0 to Npoints - 1, for frequency-domain traces). It specifies the amount of data at the beginning of the trace that will be ignored before the decimation process starts. It is the time or frequency change from the start of the trace to the point where you want to start using the data. The default value is zero.

<length> - is an optional real number. (It is in seconds for time-domain traces, and is a dimensionless index 0 to Npoints - 1, for frequency-domain traces). It defines how much data will be compressed into one value. This parameter has a default value equal to the current trace length.

<roffset> - repeat offset is an optional real number. (It is in seconds for time-domain traces, and is a dimensionless index 0 to Npoints - 1, for frequency-domain traces). It defines the beginning of the next field of trace elements to be compressed. This is relative to the beginning of the previous field. This parameter has a default value equal to the <length> variable. Note that this parameter is used for a completely different purpose when curve fitting (see CFIT above).

<rlimit> - repeat limit is an optional integer. It specifies the number of data items that you want returned. It will ignore any additional items beyond that number. You can use the Start offset and the Repeat limit to pick out exactly what part of the data you want to use. The default value is all the data.

Calculate Peaks of Trace Data (Remote Command Only)

Returns a list of all the peaks for the currently selected measurement and sub-opcode [n]. The peaks must meet the requirements of the peak threshold and excursion values.

n = any valid sub-opcode for the current measurement. See the MEASure:<measurement> command description of your specific measurement for information on the data that can be returned.

The command can only be used with specific sub-opcodes with measurement results that are trace data. Both real and complex traces can be searched, but complex traces are converted to magnitude in dBm. In many measurements the sub-opcode n=0, is the raw trace data which cannot be searched for peaks. And Sub-opcode n=1, is often calculated results values which also cannot be searched for peaks.

This command uses the data setting specified by the FORMat:BORDER and FORMat:DATA commands and can return real or ASCII data. If the format is set to INT,32, it returns REAL,32 data.

The command has four types of parameters:

- Threshold (in dBm)
- Excursion (in dB)
- Sorting order (amplitude, frequency, time)
- Optional in some measurements: Display line use (all, > display line, < display line)

Remote Command	<p>For Swept SA measurement:</p> <pre>:CALCulate:DATA[1] 2 ... 6:PEAKs? <threshold>,<excursion>[,AMPLitude FREQuency TIME[,ALL GTDLine LTDLine]]</pre> <p>For most other measurements:</p> <pre>:CALCulate:DATA[1] 2 ... 6:PEAKs? <threshold>,<excursion>[,AMPLitude FREQuency TIME]</pre>
-----------------------	--

Example	<p>Example for Swept SA measurement in Spectrum Analyzer Mode:</p> <p>CALC:DATA4:PEAK? -40, 10, FREQ, GTDL This will identify the peaks of trace 4 that are above -40 dBm, with excursions of at least 10 dB. The peaks are returned in order of increasing frequency, starting with the lowest frequency. Only the peaks that are above the display line are returned.</p> <p>Query Results 1:</p> <p>With FORMat:DATA REAL, 32 selected, it returns a list of floating-point numbers. The first value in the list is the number of peak points that are in the following list. A peak point consists of two values: a peak amplitude followed by its corresponding frequency (or time).</p> <p>If no peaks are found the peak list will consist of only the number of peaks, (0).</p>
----------------	---

Notes	<p><n> - is the trace that will be used</p> <p><threshold> - is the level below which trace data peaks are ignored. Note that the threshold value is required and is always used as a peak criterion. To effectively disable the threshold criterion for this command, provide a substantially low threshold value such as -200 dBm. Also note that the threshold value used in this command is independent of and has no effect on the threshold value stored under the Peak Criteria menu.</p> <p><excursion> - is the minimum amplitude variation (rise and fall) required for a signal to be identified as peak. Note that the excursion value is required and is always used as a peak criterion. To effectively disable the excursion criterion for this command, provide the minimum value of 0.0 dB. Also note that the excursion value used in this command is independent of and has no effect on the</p>
--------------	---

excursion value stored under the Peak Criteria menu.

Values must be provided for threshold and excursion. The sorting and display line parameters are optional (defaults are AMPLitude and ALL).

Note that there is always a Y-axis value for the display line, regardless of whether the display line state is on or off. It is the current Y-axis value of the display line which is used by this command to determine whether a peak should be reported

Sorting order:

AMPLitude - lists the peaks in order of descending amplitude, with the highest peak first (default if optional parameter not sent)

FREQUENCY - lists the peaks in order of occurrence, left to right across the x-axis.

TIME - lists the peaks in order of occurrence, left to right across the x-axis.

Peaks vs. Display Line:

ALL - lists all of the peaks found (default if optional parameter not sent).

GTDLine (greater than display line) - lists all of the peaks found above the display line.

LTDLine (less than display line) - lists all of the peaks found below the display line.

Initial S/W Revision	Prior to A.02.00
----------------------	------------------

Hardware-Accelerated Fast Power Measurement (Remote Command Only)

The Fast Power option (FP2) enables very fast channel power measurements for instruments with the prerequisite hardware (DP2 and/or B40). It accomplishes this by performing real-time overlapped FFTs at the hardware layer, using software for basic post-processing before returning the result to the user. The upshot of this approach is improved throughput for user applications that require many sequential power measurements.

The analysis bandwidth of FP2 is limited by the licenses in the instrument, but its maximum overall analysis bandwidth per acquisition is 40 MHz.

FP2 is remote-only, which means the instrument does not switch to any particular mode or measurement. FP2 commands can be sent while another application is in use on the front panel.

Each Fast Power measurement can be predefined using an array index, and up to 1,000 measurements can be stored. In the following documentation, instances of [1,2,...,999] can be substituted with a particular measurement index, e.g. CALC:FPOW:POW1?, CALC:FPOW:POW2?, CALC:FPOW:POW134?. In this way, power measurements can be defined one time in a batch, and then executed multiple times without having to redefine them, similar to “list mode” on other measurements.

In addition to basic channel power measurements, there are a number of other measurement “functions” for each channel, including peak power, peak frequency, and power spectral density. See the Function parameter for more information.

Reset Fast Power Measurement (Remote Command Only)

Resets the measurement configuration to the defaults.

Mode	All
Remote Command	:CALCulate:FPOWer:POWer[1,2,...,999]:RESet
Example	:CALC:FPOW:POW1:RES

Notes	Option FP2 is required.
Initial S/W Revision	A.14.00

Define Fast Power Measurement (Remote Command Only)

Fast Power acquisitions are configured using the DEFine command. This command accepts a comma-delimited string of configuration parameters and their appropriate values, which are all specified in the subsection below.

Mode	All
Remote Command	:CALCulate:FPOWER:POWer[1,2,...,999]:DEFine "configuration string"
Example	:CALC:FPOW:POW1:DEF "CenterFrequency=2e9, AcquisitionTime=0.005"
Notes	See below for a list of measurement variables that can be defined in the configuration string.
Initial S/W Revision	A.14.00

Acquisition Time

Value	Time (s)
Range	0 s to 1 s
Preset	0.001 s
Example	CALC:FPOW:POW1:DEF "AcquisitionTime=0.002"
Notes	The acquisition time parameter sets the time in which the entire spectrum is measured. An increase in the acquisition time yields an improvement in measurement repeatability.
Initial S/W Revision	A.14.00

Center Frequency

Value	Frequency (Hz)
Range	0 Hz to maximum instrument frequency
Preset	1 GHz
Example	CALC:FPOW:POW1:DEF "CenterFrequency=2e9"
Notes	The center frequency parameter sets the frequency in which the measurement is centered around. The OffsetFrequency parameter is calculated relative to the center frequency.
Initial S/W Revision	A.14.00

DC Coupled

Value	Boolean
Range	True (DC Coupled) or False (AC Coupled)
Preset	False
Example	CALC:FPOW:POW1:DEF "DCCoupled=True"
Notes	The DC coupled parameter allows the user to specify whether the DC blocking capacitor is utilized. Set parameter to true when measuring frequencies below 10 MHz.
Initial S/W Revision	A.14.00

DetectorType

Example	CALC:FPOW:POW1:DEF "DetectorType=Peak"
Notes	Option FP2 is required. The detector type parameter allows the user to choose whether a RMS average or peak value is used during the measurement.
Preset	RmsAverage
Range	RmsAverage, Peak
Initial S/W Revision	A.14.00

Do Noise Correction

Value	Boolean
Range	True (enable noise correction) or False (disable noise correction)
Preset	False
Example	CALC:FPOW:POW1:DEF "DoNoiseCorrection=True"
Notes	When noise correction is enabled, the linear noise power contributed by the analyzer is subtracted from all measurements. This effectively lowers the noise floor of the analyzer. When noise correction is enabled, the first measurement for a given set of input parameters will take extra time. This is because the analyzer takes an extra acquisition with the RF input disconnected from the analyzer's front end to measure the noise of just the analyzer. The measured noise floor is stored in a cache so the noise acquisition will occur only once for the same state settings. In other words, if noise correction was turned on and the analyzer made an acquisition at frequency A, then frequency B, and back again to frequency A, the hidden initial noise floor acquisition would only occur for the first acquisition at frequency A and the cached noise floor would be used the second time frequency A was measured.
Initial S/W Revision	A.14.00

Do Spur Suppression

Value	Boolean
Range	True (enable spur suppression) or False (disable spur suppression)
Preset	False
Example	CALC:FPOW:POW1:DEF "DoSpurSuppression=True"
Notes	<p>When measuring very low level signals, or when large out-of-band inputs are input into the analyzer, sometimes unwanted spurs and residuals can appear in the measured spectrum. Spur suppression is a method to help minimize the levels of these internally generated spurs and residuals.</p> <p>When spur suppression is enabled, the analyzer will automatically take two acquisitions using two different internal analog LO frequencies. The FFT spectrums from both acquisitions are combined by taking the minimum power between both traces on a per FFT bin basis. External signals will have the same amplitude for both traces and therefore will return the expected amplitudes. However, low level spurs and residuals generated internally to the analyzer tend to move to different FFT bins depending on the internal analog LO frequency used, and therefore tend to be suppressed using this spur suppression method.</p> <p>Because two acquisitions, rather than a single acquisition, are made when spur suppression is enabled, the measurement time will always be slower when spur suppression is enabled.</p>
Initial S/W Revision	A.14.00

Electronic Attenuator Bypass

Value	Boolean
Range	True (bypass electronic attenuator) or False (use electronic attenuator)
Preset	True
Example	CALC:FPOW:POW1:DEF "ElecAttBypass =False"
Notes	The electronic attenuation bypass parameter allows the user to either utilize or bypass the electronic attenuator. The electronic attenuator is only available for frequencies up to 3.6 GHz. Set parameter to true when using frequencies above 3.6 GHz and set the parameter to false when using the preamp.
Initial S/W Revision	A.14.00

Electronic Attenuation

Value	dB
Range	0 - 24 dB (1 dB steps)
Preset	0 dB
Example	CALC:FPOW:POW1:DEF "ElecAttenuation=10"
Notes	<p>Option EA3 is required.</p> <p>The electronic attenuation value parameter sets the amount of electrical attenuation from 0 to 24 dB (1 dB steps).</p>

Set "ElecAttBypass=False" to make sure the electronic attenuator path is enabled.

Initial S/W Revision	A.14.00
-------------------------	---------

IF Gain

Value	dB
Range	-6 - 16 dB (1 dB steps)
Preset	0 dB
Example	CALC:FPOW:POW1:DEF "IFGain=10"
Notes	The IF gain parameter allows the user to specify the gain at the IF stage anywhere from -6 to 16 dB (1 dB steps). This is an advanced feature, and for most cases this should remain at its default value of 0 dB.
Initial S/W Revision	A.14.00

IF Type

Example	CALC:FPOW:POW1:DEF "IFType=B25M"
Notes	The IF type parameter allows the user to select between different IF paths. For example, if the signal is less than 25 MHz wide, then the user can select the B25M path to take advantage of additional filtering on this analog IF path.
Preset	B40M
Range	B10M, B25M, B40M
Initial S/W Revision	A.14.00

Include Power Spectrum

Value	Boolean
Range	True (return both channel power and full power spectrum) or False (returns only channel power)
Preset	False
Example	CALC:FPOW:POW1:DEF "IncludePowerSpectrum=True"
Notes	The power spectrum parameter allows the user to read data on the entire spectrum for diagnostic purposes. It is not recommended for production use. See CALC:FPOW:POW[n]:READ2? for details on the binary format of the response.
Initial S/W Revision	A.14.00

Mechanical Attenuation

Value	dB
Range	0 – 70 dB (2 dB steps)
Preset	0 dB
Example	CALC:FPOW:POW1:DEF "MechAttenuation=10"
Notes	The mechanical attenuation value parameter sets the amount of mechanical attenuation anywhere from 0 to 70 dB (2 dB steps).
Initial S/W Revision	A.14.00

Preamp Mode

Example	CALC:FPOW:POW1:DEF "PreAmpMode=Low"
Notes	The license for the appropriate preamp is required. The preamp mode parameter specifies whether the preamps are being utilized. Low allows any preamps up to 3.6 GHz, and Full allows all licensed preamps. Set "ElecAttBypass=True" in order to utilize any preamps.
Preset	Off
Range	Off, Low, Full
Initial S/W Revision	A.14.00

Resolution Bandwidth Mode

Example	CALC:FPOW:POW1:DEF "PreAmpMode=Low"
Notes	The resolution bandwidth mode parameter allows the user to choose whether the RBW filter is automatically or manually set. The BestSpeed value minimizes measurement time, while the Narrowest value minimizes RBW size (minimum of two FFT bins per RBW). To manually specify an RBW, set this parameter to Explicit, and set the ResolutionBW parameter to the desired value.
Preset	BestSpeed
Range	BestSpeed, Narrowest, Explicit
Initial S/W Revision	A.14.00

Resolution Bandwidth

Value	Hz
Preset	0 Hz

Example	CALC:FPOW:POW1:DEF "ResolutionBW=25e3"
Notes	The resolution bandwidth parameter sets the 3-dB bandwidth of the RBW filter. The ResolutionBWMode parameter must be set to Explicit in order to manually set the RBW.
Initial S/W Revision	A.14.00

Trigger Delay

Value	Seconds
Range	0 – 1 s
Preset	0 s
Example	CALC:FPOW:POW1:DEF "TriggerDelay=0.025"
Notes	The trigger delay parameter sets the time after an external trigger is detected until the measurement is performed.
Initial S/W Revision	A.14.00

Trigger Level

Value	Volts
Range	-5 to 5 V
Preset	1.2 V
Example	CALC:FPOW:POW1:DEF "TriggerLevel=2"
Notes	The trigger level parameter sets the voltage value at which an external trigger is detected.
Initial S/W Revision	A.14.00

Trigger Slope

Example	CALC:FPOW:POW1:DEF "TriggerSlope=Negative"
Notes	The trigger slope parameter indicates the direction of the edge trigger voltage for detection.
Preset	Positive
Range	Positive, Negative
Initial S/W Revision	A.14.00

Trigger Source

Example	CALC:FPOW:POW1:DEF "TriggerSource=Ext1 "
Notes	The trigger source parameter allows the user to choose between measurement's triggering freely or controlled by an external input. Ext1 and Ext2 correspond to Trigger 1 In and Trigger 2 In, respectively.
Preset	Free
Range	Free, Ext1, Ext2
Initial S/W Revision	A.14.00

Trigger Timeout

Value	Seconds
Range	0 - 1 s
Preset	1 s
Example	CALC:FPOW:POW1:DEF "TriggerTimeout=0.1"
Notes	The trigger timeout parameter sets the time in which the analyzer will wait for a trigger before automatically performing the measurement.
Initial S/W Revision	A.14.00

Signal Input

Example	CALC:FPOW:POW1:DEF "SignalInput=Fp50MHzCW"
Notes	The signal input parameter allows the user to select between using the main RF input or the internal analyzer reference CW signal of 50 MHz.
Preset	FpMainRf
Range	FpMainRf, Fp50MHzCW
Initial S/W Revision	A.14.00

Use Preselector

Value	Boolean
Range	True (use preselector above 3.6 GHz), or False (preselector bypassed)
Preset	False
Example	CALC:FPOW:POW1:DEF "UsePreSelector=True"
Notes	The preselector parameter allows the user to either utilize or bypass the front end tunable filter at frequencies above 3.6 GHz. For frequencies below 3.6 GHz, the preselector is automatically

bypassed, so you do not need to set this parameter to False in those cases.

Initial S/W Revision A.14.00

Channel Bandwidth Array

Value	Hz
Range	0 to 40 MHz
Preset	[1 e6]
Example	CALC:FPOW:POW1:DEF "Bandwidth=[3.84e6, 5e6, 3.84e6]"
Notes	The bandwidth parameter array defines the bandwidth of each channel that will be measured. All array parameters should have the same number of elements. Alternatively, if all the elements are the same value, a single number with no square brackets can be used to define the parameter.
Initial S/W Revision	A.14.00

Channel Filter Type Array

Example	CALC:FPOW:POW1:DEF "FilterType=[RRC, IBW, RRC]"
Notes	The filter type parameter allows the user to choose between an integration bandwidth (IBW) filter or a root-raised-cosine (RRC) filter. The integration bandwidth filter weighs all frequencies within the bandwidth equally. The root-raised-cosine filter has an associated shape parameter, defined by the FilterAlpha parameter. All array parameters should have the same number of elements. Alternatively, if all the elements are the same value, a single value with no square brackets can be used to define the parameter.
Preset	[IBW]
Range	IBW, RRC
Initial S/W Revision	A.14.00

Channel Filter Alpha Array

Example	CALC:FPOW:POW1:DEF "FilterAlpha=[0.5, 0.0, 0.5]"
Notes	The filter alpha parameter allows the user to adjust the alpha value associated with the root-raised-cosine (RRC) filter type. Set FilterType to RRC in order to utilize this parameter. All array parameters should have the same number of elements. Alternatively, if all the elements are the same value, a single number with no square brackets can be used to define the parameter.
Preset	[0.22]
Range	0.0 – 1.0
Initial S/W Revision	A.14.00

Channel Measurement Function Array

Example	CALC:FPOW:POW1:DEF "Function=[BandPower, PeakPower, BandPower]"
Notes	<p>This parameter array defines what measurement is being made for each individually-specified channel:</p> <p>BandPower: Total power within the specified bandwidth of the channel (dBm)</p> <p>BandDensity: Total power density within the specified bandwidth of the channel (dBm/Hz)</p> <p>PeakPower: The peak power value within the specified bandwidth of the channel (dBm)</p> <p>PeakFrequency: The frequency which corresponds to the peak power value within the specified bandwidth of the channel. This frequency is relative to the center frequency (Hz)</p> <p>XdBBandwidth: The half power (-3.01 dB) bandwidth of the highest amplitude signal that resides within the channel (Hz), dB is configurable using XdBBandwidth parameter</p> <p>OccupiedBandwidth: The bandwidth at which 99% of the total power resides within the channel (Hz), percentage configurable using OccupiedBandwidthPercent parameter</p> <p>All array parameters should have the same number of elements. Alternatively, if all the elements are the same value, a single value with no square brackets can be used to define the parameter.</p>
Preset	[BandPower]
Range	BandPower, BandDensity, PeakPower, PeakFrequency, XdBBandwidth, OccupiedBandwidth
Initial S/W Revision	A.14.00

Channel Offset Frequency Array

Value	Hz
Range	0 to 20 MHz
Preset	[0]
Example	CALC:FPOW:POW1:DEF "OffsetFrequency=[-5e6, 0, 5e6]"
Notes	<p>The offset frequency parameter array defines the difference between the center frequency to the center frequency of each channel.</p> <p>All array parameters should have the same number of elements.</p>
Initial S/W Revision	A.14.00

Channel Occupied Bandwidth Percent Array

Example	CALC:FPOW:POW1:DEF "OccupiedBandwidthPercent =[0.95, 0.95, 0.95]"
Notes	<p>This parameter only applies for channels whose Function is set to OccupiedBandwidth. The occupied bandwidth percent parameter specifies the percent of total power in these channels. The valid range for this parameter is 0.0 to 1.0, where 1.0 represents 100%. The default for this parameter is 0.99, which will return the bandwidth that contains 99% of the total channel power.</p>

Preset	[0.99]
Range	0 – 1.0
Initial S/W Revision	A.14.00

Channel x-dB Bandwidth Array

Value	dB
Range	-200 to 0 dB
Preset	[-3.01]
Example	CALC:FPOW:POW1:DEF "XdBBandwidth =[-6.02, -3.01, -1.0]"
Notes	This parameter only applies for channels whose Function is set to XdBBandwidth. The X dB bandwidth parameter is used to specify the power relative to the peak channel power over which the bandwidth is calculated. The parameter value must be a negative number.
Initial S/W Revision	A.14.00

Define Fast Power Measurement Query (Remote Command Only)

The DEFine? command is used to retrieve a list of all defined parameters in an ASCII string format

M All
o
d
e

R :CALCulate:FPOWER:POWer [1,2,...,999]:DEFine?

e
m
o
t
e

C
o
m
m
a
n
d

E :CALC:FPOW:POW1:DEF?

x
a
m

```

p
l
e
-----
N This command query is used to retrieve a list of all defined parameters in an ASCII format.
o The following is an example of the returned results:
t "DCCoupled=False,ElecAttBypass=True,ElecAttenuation=0,IFGain=0,MechAttenuation=0,PreAmpMode=Off,PreSelectorOffset
e =0,UsePreSelector=False,ExternalReferenceFrequency=10000000,FrequencyReferenceSource=AutoExternalFrequencyRefer
s ence,IFType=B40M,LOMode=SLW,SignalInput=FpMainRf,AcquisitionTime=0.001,CenterFrequency=1000000000,Resolution
BW=0,ResolutionBWMode=BestSpeed,DetectorType=RmsAverage,Bandwidth=[1000000],OffsetFrequency=[0],Function=
[BandPower],FilterType=[IBW],FilterAlpha=[0.22],OccupiedBandwidthPercent=[0.99],XdBBandwidth=[-
3.01],DoNoiseCorrection=False,DoSpurSuppression=False,MeasurementMethod=HardwareFFT,IncludePowerSpectrum=False
e,TriggerDelay=0,TriggerLevel=1.2,TriggerSlope=Positive,TriggerSource=Free,TriggerTimeout=1 "
-----
I A.14.00
n
i
t
i
a
l

S
/
W

R
e
v
i
s
i
o
n

```

Configure Fast Power Measurement (Remote Command Only)

The configure command begins hardware setup and returns immediately, with no acquisition made. This can be used in parallel with other hardware operations to effectively hide the hardware setup time.

Mode	All
Remote Command	:CALCulate:FPOWER:POWER[1,2,...,999]:CONFigure
Example	:CALC:FPOW:POW1:CONF
Notes	Option FP2 is required.
Initial S/W Revision	A.14.00

Initiate Fast Power Measurement (Remote Command Only)

The INITiate command begins an acquisition and returns immediately. The results of the measurement can be retrieved using FETCh.

Mode	All
Remote Command	:CALCulate:FPOWER:POWER[1,2,...,999]:INITiate
Example	:CALC:FPOW:POW1:INIT
Notes	Option FP2 is required.
Initial S/W Revision	A.14.00

Fetch Fast Power Measurement (Remote Command Only)

The FETCh command query is used to retrieve the results of an acquisition initiated by the INIT command. The returned results are in ASCII string format. The string begins and ends with quotation marks.

Mode	All
Remote Command	:CALCulate:FPOWER:POWER[1,2,...,999]:FETCh?
Example	:CALC:FPOW:POW1:FETC?
Notes	Option FP2 is required. Returns m comma-separated ASCII values, where m corresponds to the number of bandwidths defined. 1. Declared function return in the 1st specified channel 2. Declared function return in the 2nd specified channel ... m. Declared function return in the last specified channel The INIT and FETC? command sequence performs the same functionality of a single CALC:FPOW:POW[n]? query. Units of the returned values are dependent on the Function parameter for each channel.
Initial S/W Revision	A.14.00

Execute Fast Power Measurement (Remote Command Only)

This command query is used as shorthand for an INIT command immediately followed by a FETC? command. The returned results are in ASCII string format. The string begins and ends with quotation marks.

Mode	All
Remote Command	:CALCulate:FPOWER:POWER[1,2,...,999]?
Example	:CALC:FPOW:POW1?
Notes	Option FP2 is required. See notes for Fast Power Fetch for return format.
Initial S/W Revision	A.14.00

Binary Read Fast Power Measurement (Remote Command Only)

This command query is used as shorthand for an INIT command immediately followed by a FETC? command. The returned results are in a binary format.

Mode	All
Remote Command	:CALCulate:FPOWER:POWER[1,2,...,999]:READ? :CALCulate:FPOWER:POWER[1,2,...,999]:READ1?
Example	:CALC:FPOW:POW1:READ? :CALC:FPOW:POW1:READ1?
Notes	Option FP2 is required. Returns m 4 byte floating point binary values (Little-Endian), where m corresponds to the number of bandwidths defined.
Initial S/W Revision	A.14.00

Diagnostic Binary Read Fast Power Measurement (Remote Command Only)

This command query is used as shorthand for an INIT command immediately followed by a FETC? command. The returned results are in a binary format. This command is used primarily for diagnostic purposes to test for ADC overloads and to visibly inspect the spectrum.

Mode	All
Remote Command	:CALCulate:FPOWER:POWER[1,2,...,999]:READ2?
Example	:CALC:FPOW:POW1:READ2?
Notes	Option FP2 is required. Note: Spectrum data is only returned if the IncludePowerSpectrum parameter is set to True. If IncludePowerSpectrum is False, the number of spectrum points will be zero (0). Units of the returned values are dependent on the Function parameter per channel (e.g. dBm for BandPower, Hz for PeakFrequency). Returns binary data (Little-Endian) that contains information on m amount of channels, along with ADC over range and full spectrum data. The following is the binary format of the response. Bandwidth Return Value 1. Number of channels specified, m [4 byte int] 2. Declared function result for the 1st specified channel [4 byte float] 3. Declared function result for the 2nd specified channel [4 byte float] ... (m + 1). Declared function result for the last (mth) specified channel [4 byte float] ADC Over Range 1. ADC over-range occurred (1: true, 0: false) [2 byte short]

	<p>Spectrum Data</p> <ol style="list-style-type: none"> 1. Number of points in the spectrum data, k [4 byte int] 2. Start frequency of spectrum data (Hz) [8 byte double] 3. Step frequency of spectrum data (Hz) [8 byte double] 4. FFT bin at 1st point (dBm) [4 byte float] 5. FFT bin at 2nd point (dBm) [4 byte float] <p>...</p> <p>(k + 3). FFT bin at last (kth) point (dBm) [4 byte float]</p>
Initial S/W Revision	A.14.00

Format Data: Numeric Data (Remote Command Only)

This command specifies the format of the trace data input and output. It specifies the formats used for trace data during data transfer across any remote port. It affects only the data format for setting and querying trace data for the :TRACe[:DATA], TRACe[:DATA]?, :CALCulate:DATA[n]? and FETCh:SANalyzer[n]? commands and queries.

Remote Command	<pre>:FORMat[:TRACe][:DATA] ASCii INTeger,32 REAL,32 REAL,64 :FORMat[:TRACe][:DATA]?</pre>
Notes	<p>The query response is:</p> <pre>ASCii: ASC,8 REAL,32: REAL,32 REAL,64: REAL,64 INTeger,32: INT,32</pre> <p>When the numeric data format is REAL or ASCii, data is output in the current Y Axis unit. When the data format is INTeger, data is output in units of m dBm (.001 dBm).</p> <p>The INT,32 format returns binary 32-bit integer values in internal units (m dBm), in a definite length block.</p>
Dependencies	<p>Sending a data format spec with an invalid number (for example, INT,48) generates no error. The analyzer simply uses the default (8 for ASCii, 32 for INTeger, 32 for REAL).</p> <p>Sending data to the analyzer which does not conform to the current FORMat specified, results in an error. Sending ASCII data when a definite block is expected generates message -161 "Invalid Block Data" and sending a definite block when ASCII data is expected generates message -121 "Invalid Character in Number".</p>
Preset	ASCii
Backwards Compatibility Notes	Note that the INT,32 format is only applicable to the command, TRACe:DATA. This preserves backwards compatibility for the Swept SA measurement. For all other commands/queries which honor FORMat:DATA, if INT,32 is sent the analyzer will behave as though it were set to REAL,32.
Initial S/W Revision	Prior to A.02.00

The specs for each output type follow:

AScii - Amplitude values are in ASCII, in the current Y Axis Unit, one ASCII character per digit, values separated by commas, each value in the form:

SX.YYYYYEsZZ

Where:

S = sign (+ or -)

X = one digit to left of decimal point

Y = 5 digits to right of decimal point

E = E, exponent header

s = sign of exponent (+ or -)

ZZ = two digit exponent

REAL,32 - Binary 32-bit real values in the current Y Axis Unit, in a definite length block.

REAL,64 - Binary 64-bit real values in the current Y Axis Unit, in a definite length block.

Format Data: Byte Order (Remote Command Only)

This command selects the binary data byte order for data transfer and other queries. It controls whether binary data is transferred in normal or swapped mode. This command affects only the byte order for setting and querying trace data for the :TRACe[:DATA], TRACe[:DATA]? , :CALCulate:DATA[n]? and FETCh:SANalyzer[n]? commands and queries.

By definition any command that says it uses FORMat:DATA uses any format supported by FORMat:DATA.

The NORMal order is a byte sequence that begins with the most significant byte (MSB) first, and ends with the least significant byte (LSB) last in the sequence: 1|2|3|4. SWAPped order is when the byte sequence begins with the LSB first, and ends with the MSB last in the sequence: 4|3|2|1.

Remote Command	:FORMat:BORDER NORMal SWAPped :FORMat:BORDER?
Preset	NORMal
Initial S/W Revision	Prior to A.02.00

Meas Setup

Displays the setup menu for the current measurement. The measurement setup parameters include the number of measurement averages used to calculate the measurement result and the averaging mode. The setup menu also includes the option to reset the measurement settings to their factory defaults.

Key Path	Front-panel key
Initial S/W Revision	Prior to A.02.00

Avg/Hold Num

Specifies the number of measurement averages used when calculating the measurement result. The average is displayed at the end of each sweep.

After the specified number of average counts, the averaging mode (terminal control) setting determines the averaging action.

Key Path	Meas Setup
Mode	All except SA and BASIC
Remote Command	[:SENSe]:MONitor:AVERage:COUNT <integer> [:SENSe]:MONitor:AVERage:COUNT? [:SENSe]:MONitor:AVERage[:STATe] OFF ON 0 1 [:SENSe]:MONitor:AVERage[:STATe]?
Example	MON:AVER:COUN 25 MON:AVER:COUN? MON:AVER ON MON:AVER?
Preset	10 OFF
State Saved	Saved in instrument state.
Min	1
Max	1000
Initial S/W Revision	Prior to A.02.00

Avg Mode

Toggles the average mode between exponential (Exp) and Repeat.

- **Exp**– continues measurement averaging, using the specified number of averages to compute each averaged value. The average is displayed at the end of each sweep.
- **Repeat**– causes the measurement to reset the average counter each time the specified number of averages is reached.

Key Path	Meas Setup
Mode	All except SA and BASIC
Remote Command	<code>[:SENSe] :MONitor :AVERage :TCONtrol EXPonential REPEAT</code> <code>[:SENSe] :MONitor :AVERage :TCONtrol ?</code>
Example	MON:AVER:TCON EXP MON:AVER:TCON?
Preset	EXPonential
State Saved	Saved in instrument state.
Range	ExpRepeat
Initial S/W Revision	Prior to A.02.00

Meas Preset

Restores all the measurement parameters to their default values.

Key Path	Meas Setup
Mode	All except SA and BASIC
Remote Command	<code>:CONFigure :MONitor</code>
Example	CONF:MON
Initial S/W Revision	Prior to A.02.00

Mode

See "Mode" on page 288

Mode Preset

Returns the active mode to a known state.

Mode Preset does the following for the currently active mode:

- Aborts the currently running measurement.
- Brings up the default menu for the mode, with no active function.
- Sets measurement Global settings to their preset values for the active mode only.
- Activates the default measurement.
- Brings up the default menu for the mode.
- Clears the input and output buffers.
- Sets Status Byte to 0.

Mode Preset does not:

- Cause a mode switch
- Affect mode persistent settings
- Affect system settings
- See "[How-To Preset](#)" on page 2059 for more information.

Key Path	Front-panel key
Remote Command	:SYSTem:PRESet
Example	:SYST:PRES
Notes	*RST is preferred over :SYST:PRES for remote operation. *RST does a Mode Preset, as done by the :SYST:PRES command, and it sets the measurement mode to Single measurement rather than Continuous for optimal remote control throughput. Clears all pending OPC bits. The Status Byte is set to 0.
Couplings	A Mode Preset aborts the currently running measurement, activates the default measurement, and gets the mode to a consistent state with all of the default couplings set.
Backwards Compatibility Notes	In the X-Series, the legacy "Factory Preset" has been replaced with Mode Preset, which only presets the currently active mode, not the entire instrument. In the X-Series, the way to preset the entire instrument is by using System, Restore System Defaults All, which behaves essentially the same way as restore System Defaults does on ESA and PSA. There is also no "Preset Type" as there is on the PSA. There is a green Mode Preset front-panel key that does a Mode Preset and a white-with-green-letters User Preset front-panel key that does a User Preset. The old PRESet:TYPE command is ignored (without generating an error), and SYST:PRES without a parameter does a Mode Preset, which should cover most backward code compatibility issues. The settings and correction data under the Input/Output front-panel key (examples: Input Z Corr, Ext Amp Gain, etc.) are no longer part of any Mode, so they will not be preset by a Mode Preset. They are preset using Restore Input/Output Defaults, Restore System Defaults All. Note that because User Preset does a Recall State, and all of these settings are saved in State, they ARE recalled when using

	User Preset.
Initial S/W Revision	Prior to A.02.00

How-To Preset

The table below shows all possible presets, their corresponding SCPI commands and front-panel access (key paths). Instrument settings depend on the current measurement context. Some settings are local to the current measurement, some are global (common) across all the measurements in the current mode, and some are global to all the available modes. In a similar way, restoring the settings to their preset state can be done within the different contexts.

Auto Couple - is a measurement local key. It sets all Auto/Man parameter couplings in the measurement to Auto. Any Auto/Man selection that is local to other measurements in the mode will not be affected.

Meas Preset - is a measurement local key. Meas Preset resets all the variables local to the current measurement except the persistent ones.

Mode Preset - resets all the current mode's measurement local and measurement global variables except the persistent ones.

Restore Mode Defaults - resets ALL the Mode variables (and all the Meas global and Meas local variables), including the persistent ones.

Type Of Preset	SCPI Command	Front Panel Access
Auto Couple	:COUPlE ALL	Auto Couple front-panel key
Meas Preset	:CONFIgure:<Measurement>	Meas Setup Menu
Mode Preset	:SYSTem:PRESet	Mode Preset (green key)
Restore Mode Defaults	:INSTrument:DEFault	Mode Setup Menu
Restore All Mode Defaults	:SYSTem:DEFault MODEs	System Menu; Restore System Default Menu
*RST	*RST	not possible (Mode Preset with Single)
Restore Input/Output Defaults	:SYSTem:DEFault INPut	System Menu; Restore System Default Menu
Restore Power On Defaults	:SYSTem:DEFault PON	System Menu; Restore System Default Menu
Restore Alignment Defaults	:SYSTem:DEFault ALIGn	System Menu; Restore System Default Menu
Restore Miscellaneous Defaults	:SYSTem:DEFault MISC	System Menu; Restore System Default Menu
Restore All System Defaults	:SYSTem:DEFault [ALL] :SYSTem:PRESet:PERSistent	System Menu; Restore System Default Menu
User Preset	:SYSTem:PRESet:USER	User Preset Menu
User Preset All Modes	:SYSTem:PRESet:USER:ALL	User Preset Menu

17 Monitor Spectrum Measurement
Mode Preset

Power On Mode Preset	:SYSTem:PON:TYPE MODE	System Menu
Power On User Preset	:SYSTem:PON:TYPE USER	System Menu
Power On Last State	:SYSTem:PON:TYPE LAST	System Menu

Mode Setup

See ["Mode Setup" on page 320](#)

Peak Search

Places the selected marker on the trace point with the maximum y-axis value for that marker's trace. Pressing Peak Search with the selected marker off causes the selected marker to be set to Normal, then a peak search is immediately performed.

Key Path	Front-panel key
Mode	All except SA and BASIC
Remote Command	:CALCulate:MONitor:MARKer[1] 2 ... 12:MAXimum
Example	CALC:MON:MARK2:MAX
Initial S/W Revision	Prior to A.02.00

Print

See "Print" on page 352

Quick Save

The Quick Save front-panel key repeats the most recent save that was performed from the Save menu, with the following exceptions:

- Register saves are not remembered as Saves for the purpose of the Quick Save function
- If the current measurement does not support the last non-register save that was performed, an informational message is generated, “File type not supported for this measurement”

Quick Save repeats the last type of qualified save (that is, a save qualified by the above criteria) in the last save directory by creating a unique filename using the Auto File Naming algorithm described below.

If Quick Save is pressed after startup and before any qualified Save has been performed, the Quick Save function performs a Screen Image save using the current settings for Screen Image saves (current theme, current directory), which then becomes the “last save” for the purpose of subsequent Quick Saves.

The Auto File Naming feature automatically generates a file name for use when saving a file. The filename consists of a prefix and suffix separated by a dot, as is standard for the Windows® file system. A default prefix exists for each of the available file types:

Type	Default Prefix	Menu
State	State_	(Save/Recall)
Trace + State	State_	(Save/Recall)
Screen	Screen_	(Save/Recall)
Amplitude Corrections	Ampcor_	(Import/Export)
Traces	Trace_	(Import/Export)
Limit Lines	LLine_	(Import/Export)
Measurement Result	MeasR_	(Import/Export)
Capture Buffer	CapBuf_	(Import/Export)

A four digit number is appended to the prefix to create a unique file name. The numbering sequence starts at 0000 within each Mode for each file type and updates incrementally to 9999, then wraps to 0000 again. It remembers where it was through a Mode Preset and when leaving and returning to the Mode. It is reset by Restore Misc Defaults and Restore System Defaults and subsequent running of the instrument application. So, for example, the first auto file name generated for State files is State_0000.state. The next is State_0001, and so forth.

One of the key features of Auto File Name is that we guarantee that the Auto File Name will never conflict with an existing file. The algorithm looks for the next available number. If it gets to 9999, then it looks for holes. If it find no holes, that is no more numbers are available, it gives an error.

For example, if when we get to State_0010.state there is already a State_0010.state file in the current directory, it advances the counter to State_0011.state to ensure that no conflict will exist (and then it verifies that State_0011.state also does not exist in the current directory and advances again if it does, and so forth).

If you enter a file name for a given file type, then the prefix becomes the filename you entered instead of the default prefix, followed by an underscore. The last four letters (the suffix) are the 4-digit number.

For example, if you save a measurement results file as “fred.csv”, then the next auto file name chosen for a measurement results save will be fred_0000.csv.

NOTE

Although 0000 is used in the example above, the number that is used is actually the current number in the Meas Results sequence, that is, the number that would have been used if you had not entered your own file name.

NOTE

If the filename you entered ends with _dddd, where d=any number, making it look just like an auto file name, then the next auto file name picks up where you left off with the suffix being dddd + 1.

Key Path	Front-panel key
Notes	No remote command for this key specifically.
Initial S/W Revision	Prior to A.02.00

Recall

The Recall menu lets you choose what you want to recall, and where you want to recall it from. Among the types of files you can recall are **States and Traces**. In addition, an Import (Data) option lets you recall a number of data types stored in CSV files (as used by Excel and other spreadsheet programs).

The default paths for Recall are data type dependent and are the same as for the Save key.

Key Path	Front-panel key
Notes	<p>No remote command for this key specifically, but the :MMEM:LOAD command is available for specific file types. An example is :MMEM:LOAD:STATe <filename>.</p> <p>If you try to recall a State file for a mode that is not licensed or not available in the instrument, an error message will occur and the state will not change.</p>
Backwards Compatibility Notes	<p>In legacy analyzers, it was possible to load a state without affecting the trace data, limit lines or correction data. Similarly (since User Preset is actually loading a state), it was possible to do a User Preset without affecting the trace data, limit lines or correction data.</p> <p>In the X-Series, “state” always includes all of this data; so whenever state is loaded, all of the traces, limit lines and corrections are affected. Although this differs from previous behavior, it is desirable behavior, and should not cause adverse issues for users.</p>
Backwards Compatibility Notes	<p>Recall for the X-Series supports backward compatibility in the sense that you can recall a state file from any X-Series model number and any version of X-Series software. This is only possible if part of the recalling process goes through a limiting step after recalling the mode settings, at least for settings that may vary with version number, model number, option and license differences. If you try to recall a state file onto an instrument with less capability than what was available on the instrument during the save, the recall will ignore the state it doesn't support and it will limit the recalled setting to what it allows.</p> <p>Example: if the saved state includes preamp ON, but the recalling instrument does not have a preamp; the preamp is limited to OFF. Conversely, if you save a state without a preamp, the preamp is OFF in the state file. When this saved file is recalled on an instrument with a licensed preamp, the preamp is changed to OFF. Another example is if the saved state has center frequency set to 20 GHz, but the instrument recalling the saved state is a different model and only supports 13.5 GHz. In this case, the center frequency is limited along with any other frequency based settings. Since the center frequency can't be preserved in this case, the recall limiting tries to at least preserve span to keep the measurement setup as intact as possible.</p> <p>It may be appropriate to issue a warning if the state is limited on the recall; warnings do not go out to SCPI so this would only affect the manual user.</p> <p>Note that there is no state file compatibility outside of the X-Series. For example, you cannot recall a state file from ESA or PSA.</p>
Initial S/W Revision	Prior to A.02.00

State

The Recall State menu lets you choose a register or file from which to recall the state.

The content of a state file includes all of the settings and data required to return the analyzer as closely as possible to the Mode it was in, with the exact settings that were in place, when the save occurred. The Mode settings in each state file include the settings that are affected by Mode Preset, as well as the

additional settings affected by Restore Mode Defaults; all of the Mode's settings. In addition, all of the settings of the Input/Output system are included, even though they are outside of the Mode's state, because they are needed to restore the complete setup. Persistent System settings (for example, GPIB address) are not affected by either a Mode Preset or Restore Mode Defaults, nor are they included in a saved State file.

Since each state file is only for one Mode, the settings for other Modes are unaffected when it is loaded. Recall State will cause a mode switch if the state being recalled is not from the current active mode.

After the recall completes, the message "File <filename> recalled" or "Recalled State Register <register number>" is displayed.

For rapid recalls, the State menu lists 16 registers that you can choose from to recall. Pressing a Register key initiates the recall. You can also select a file from which to recall.

The default path for all State Files is:

My Documents\<<mode name>\state

where <mode name> is the parameter used to select the mode with the INST:SEL command (for example, SA for the Spectrum Analyzer).

See "[More Information](#)" on page 2068.

Key Path	Recall
Mode	All
Remote Command	:MMEMory:LOAD:STATe <filename>
Example	:MMEM:LOAD:STAT "myState.state" This recalls the file myState.state on the default path
Example	MMEM:LOAD:STAT "MyStateFile.state" This loads the state file data (on the default file directory path) into the instrument state.
Notes	<p>When you pick a file to recall, the analyzer first verifies that the file is recallable in the current instrument by checking the software version and model number of the instrument. If everything matches, a full recall proceeds by aborting the currently running measurement, clearing any pending operations, and then loading the State from the saved state file. You can open state files from any mode, so recalling a State file switches to the mode that was active when the save occurred. After switching to the mode of the saved state file, mode settings and data (if any for the mode) are loaded with values from the saved file. The saved measurement of the mode becomes the newly active measurement and the data relevant to the measurement (if there is any) is recalled.</p> <ul style="list-style-type: none"> • If there is a mismatch between file version or model number or instrument version or model number, the recall function tries to recall as much as possible and returns a warning message. It may limit settings that differ based on model number, licensing or version number. <p>After recalling the state, the Recall State function does the following:</p> <ul style="list-style-type: none"> • Makes the saved measurement for the mode the active measurement. • Clears the input and output buffers. • Status Byte is set to 0. • Executes a *CLS <p>If the file specified is empty an error is generated. If the specified file does not exist, another error is generated. If there is a mismatch between the file and the proper file type, an error is generated. If</p>

	there is a mismatch between file version or model number or instrument version or model number, a warning is displayed. Then it returns to the State menu and File Open dialog goes away. After the Recall, the analyzer exits the Recall menu and returns to the previous menu.
Backwards Compatibility SCPI	:MMEMory:LOAD:STATe 1,<filename> For backwards compatibility, the above syntax is supported. The "1" is simply ignored.
Initial S/W Revision	Prior to A.02.00

More Information

In measurements that support saving Traces, for example, Swept SA, the Trace data is saved along with the State in the State file. When recalling the State, the Trace data is recalled as well. Traces are recalled exactly as they were stored, including the writing mode and update and display modes. If a Trace was updating and visible when the State was saved, it will come back updating and visible, and its data will be rewritten right away. When you use State to save and recall traces, any trace whose data must be preserved should be placed in View or Blank mode before saving.

The following table describes the Trace Save and Recall possibilities:

You want to recall state and one trace's data, leaving other traces unaffected.	Save Trace+State from 1 trace. Make sure that no other traces are updating (they should all be in View or Blank mode) when the save is performed.	On Recall, specify the trace you want to load the one trace's data into. This trace will load in View. All other traces' data will be unaffected, although their trace mode will be as it was when the state save was performed.
You want to recall all traces	Save Trace+State from ALL traces.	On Recall, all traces will come back in View (or Blank if they were in Blank or Background when saved)
You want all traces to load exactly as they were when saved.	Save State	On recall, all traces' mode and data will be exactly as they were when saved. Any traces that were updating will have their data immediately overwritten.

From File...

When you press "From File", the analyzer brings up a Windows dialog and a menu entitled "File Open." This menu allows you to navigate to the various fields in the Windows dialog without using a keyboard or mouse. The Tab and Arrow keys can also be used for dialog navigation.



Listed below are the functions of the various fields in the dialog, and the corresponding softkeys:

Open

Performs the recall of the specified file. While the recall is being performed, the floppy icon appears briefly in the Meas bar.

File/Folder List

Enables you to navigate to the center of the dialog that contains the list of files and folders. Once here you can get information about the file and use the tab keys to navigate to the other fields in the dialog, such as Look In.

Look In

The Look In field shows the path from which the file will be recalled and allows you to change the path using the up and down arrow keys to navigate to other paths; the Enter key to open a directory; and the Backspace key to go back one directory. The **Look In field** first uses the last path from the Save As dialog **Save In:** path for that same file type. There is no softkey for directly navigating to the Look In field, but you can use the left tab to get here from the File/Folder List.

User specified paths are remembered when you leave and return to a Mode and are reset back to the default using Restore Mode Defaults.

Sort

Accesses a menu that enables you to sort the files within the File Open dialog. Only one sorting type can be selected at a time and the sorting happens immediately. The sorting types are By Date, By Name, By extension, and By Size.

Files of Type

This field shows the file suffix for the type of file you have selected to recall. For example, if you navigated here while recalling State, "Mode state (*.state)" is in the field. If you navigated here while recalling Trace, ""Mode state (*.trace)" is in the field. If you navigated here while importing a trace data file, "Trace Data (*.csv)" is in the field. For some file types, there is more than one choice in the dropdown menu, which you can select by using the up and down arrow keys and Enter.

Up One Level

This key corresponds to the icon of a folder with the up arrow that is in the tool bar of the dialog. When pressed, it causes the file and folder list to navigate up one level in the directory structure. The Backspace key does the same thing.

Cancel

This key corresponds to the Cancel selection in the dialog. It causes the current **Open** request to be cancelled. The ESC key does the same thing.

Key Path	Recall, State
Notes	Brings up the Open dialog for recalling a State Save Type
Initial S/W Revision	Prior to A.02.00

Edit Register Names

You may enter a custom name on any of the Register keys, to help you remember what you are using that state to save. To do this, press the Edit Register Names key, choose the register whose name you wish to edit, and then enter the desired label using the Alpha Editor or an external PC keyboard.

The maximum number of characters that can be added is 30. In most cases, 30 characters will fit on two lines of the key.

For more information and the SCPI command, see Edit Register Names under the Save, State function.

Key Path	Recall, State
Mode	All
Dependencies	N9060A-7FP or N9060B-2FP license required to edit the register names. When the feature is not licensed, sending the SCPI command generates an error, -221, "Settings conflict;Option not available"
Initial S/W Revision	A.11.00

Register 1 thru Register 16

Selecting any one of these register keys causes the State of the mode from the specified Register to be recalled. Each of the register keys annotates whether it is empty or at what date and time it was last

modified. In addition, you can use the Edit Register Names key under Save, State to enter custom names for each register.

Registers are shared by all modes, so recalling from any one of the registers will cause a mode switch to the mode that was active when the save to the Register occurred.

Although these 16 registers are the only registers available from the front panel, there are 128 state registers available in the instrument. Registers 17–128 are only available from the SCPI interface, using the *RCL command.

After the recall completes, the message "Register <register number> recalled" appears in the message bar. If you are in the Spectrum Analyzer Mode, and you are recalling a register that was saved in the Spectrum Analyzer Mode, then after the recall, you will still be in the Recall Register menu. If the Recall causes you to switch modes, then after the Recall, you will be in the Frequency menu.

If a requested register is empty an error is generated.

Key Path	Recall, State
Example	*RCL 1
Range	1–16 from front panel, 1–128 from SCPI
Readback	Date and time with seconds resolution are displayed on the key OR A custom name of up to 30 characters entered using the Save, State, Edit Register Names key OR “(empty)” if no prior save operation has been performed to this register.
Initial S/W Revision	Prior to A.02.00
Modified at S/W Revision	Prior to A.11.00

Register 1 thru Register 16

Selecting any one of these register keys causes the State of the mode from the specified Register to be recalled. Each of the register keys annotates whether it is empty or at what date and time it was last modified. In addition, you can use the Edit Register Names key under Save, State to enter custom names for each register.

Registers are shared by all modes, so recalling from any one of the registers will cause a mode switch to the mode that was active when the save to the Register occurred.

Although these 16 registers are the only registers available from the front panel, there are 128 state registers available in the instrument. Registers 17–128 are only available from the SCPI interface, using the *RCL command.

After the recall completes, the message "Register <register number> recalled" appears in the message bar. If you are in the Spectrum Analyzer Mode, and you are recalling a register that was saved in the Spectrum Analyzer Mode, then after the recall, you will still be in the Recall Register menu. If the Recall causes you to switch modes, then after the Recall, you will be in the Frequency menu.

If a requested register is empty an error is generated.

Key Path	Recall, State
Example	*RCL 1
Range	1-16 from front panel, 1-128 from SCPI
Readback	Date and time with seconds resolution are displayed on the key OR A custom name of up to 30 characters entered using the Save, State, Edit Register Names key OR “(empty)” if no prior save operation has been performed to this register.
Initial S/W Revision	Prior to A.02.00
Modified at S/W Revision	Prior to A.11.00

Data (Import)

Importing a data file loads data that was previously saved from the current measurement or from other measurements and/or modes that produce compatible data files. The Import Menu only contains Data Types that are supported by the current measurement.

Since the commonly exported data files are in .csv format, the data can be edited by the user prior to importing. This allows you to export a data file, manipulate the data in Excel (the most common PC Application for manipulating .csv files) and then import it.

Importing Data loads measurement data from the specified file into the specified or default destination, depending on the data type selected. Selecting an Import Data menu key will not actually cause the importing to occur, since the analyzer still needs to know from where to get the data. Pressing the Open key in this menu brings up the Open dialog and Open menu that provides you with the options from where to recall the data. Once a filename has been selected or entered in the Open menu, the recall occurs as soon as the Open button is pressed.

Key Path	Recall
Mode	All
Notes	The menu is built from whatever data types are available for the mode. Some keys will be missing completely, so the key locations in the sub-menu will vary. No SCPI command directly controls the Data Type that this key controls. The Data Type is included in the MMEM:LOAD commands.
Dependencies	If a file type is not used by a certain measurement, it is grayed out for that measurement. The key for a file type will not show at all if there are no measurements in the Mode that support it.
Preset	Is not affected by Preset or shutdown, but is reset during Restore Mode Defaults
Readback	The data type that is currently selected
Initial S/W Revision	Prior to A.02.00

Masks

This key enables you to recall a preset mask file from the list. It is only available in SEM measurement under the Data menu: Limit Mask. Limit Mask enables setting a preset limit mask for 802.11p 5MHz and 10MHz system.

You cannot change or create the preset mask file since it is a binary file. This key is valid for the Spectrum Emission Mask measurement.

File location: “My Documents\WLAN\data.masks”

Note that “**My Documents**” is an alias to a directory and its location depends on which user is logged in. At XSA start up, all of the limit mask files in the current user’s “My Documents\WLAN\data.masks” directory are overwritten.

File type: Binary

Filename:

11p_5MHz_A.mask

11p_5MHz_B.mask

11p_5MHz_C.mask

11p_5MHz_D.mask

11p_10MHz_A.mask

11p_10MHz_B.mask

11p_10MHz_C.mask

11p_10MHz_D.mask

File extension: .mask

Selecting OPEN under the Import Data menu, opens the above directory enabling you to select a mask file.

Example:

File Location: My Documents/WLAN/data/masks

File Name: 11p_5MHz_A.mask

Key Path	Recall, Data
Mode	WLAN
Remote Command	MMEMoRY:LOAD:MASK <string>
Example	MMEM:LOAD:MASK “11p_5MHz_A.mask”
Initial S/W Revision	A.11.00

Capture Buffer

Capture buffer functionality is only available when measurement is Mod Accuracy and radio standard is not 802.11ac 80+80MHz. The captured data is raw data which is not processed.

Key Path	Recall, Data
Mode	WLAN
Example	MMEM:LOAD:CAPT "MyCaptureData.bin" This loads the file of capture data (on the default file directory path) into the instrument.
Dependencies	Capture buffer data is only available when measurement is Mod Accuracy and radio standard is not 802.11ac 80+80MHz. In other situation, this key is grayed out.
Initial S/W Revision	A.11.00

Open...

When you press "Open", the analyzer brings up a Windows dialog and a menu entitled "File Open." This menu allows you to navigate to the various fields in the Windows dialog without using a keyboard or mouse. The Tab and Arrow keys can also be used for dialog navigation.

See "[From File...](#)" on page 2263 in Recall, State, for a full description of this dialog and menu.

Key Path	Recall, Data
Notes	The key location is mode-dependent and will vary. Brings up Open dialog for recalling a <mode specific> Save Type
Initial S/W Revision	Prior to A.02.00

Restart

The Restart function restarts the current sweep, or measurement, or set of averaged/held sweeps or measurements. If you are Paused, pressing Restart does a Resume.

The Restart function is accessed in several ways:

- Pressing the Restart key
- Sending the remote command INIT:IMMEDIATE
- Sending the remote command INIT:RESTART

See "[More Information](#)" on page 2075

Key Path	Front-panel key
Remote Command	:INITiate[:IMMEDIATE] :INITiate:RESTART
Example	:INIT:IMM :INIT:REST
Notes	:INITiate:RESTART and :INITiate:IMMEDIATE perform exactly the same function.
Couplings	Resets average/hold count k. For the first sweep overwrites all active (update=on) traces with new current data. For application modes, it resets other parameters as required by the measurement.
Status Bits/OPC dependencies	This is an Overlapped command. The STATUS:OPERation register bits 0 through 8 are cleared. The STATUS:QUESTIONable register bit 9 (INTEgrity sum) is cleared. The SWEEPING bit is set. The MEASURING bit is set.
Backwards Compatibility Notes	For Spectrum Analysis mode in ESA and PSA, the Restart hardkey and the INITiate:RESTART command restart trace averages (displayed average count reset to 1) for a trace in Clear Write, but did not restart Max Hold and Min Hold. In the X-Series, the Restart hardkey and the INITiate:RESTART command restart not only Trace Average, but MaxHold and MinHold traces as well. For wireless comms modes in ESA and PSA, the Restart hardkey and the INITiate:RESTART command restart every measurement, which includes all traces and numeric results. There is no change to this operation.
Initial S/W Revision	Prior to A.02.00

More Information

The **Restart** function first aborts the current sweep/measurement as quickly as possible. It then resets the sweep and trigger systems, sets up the measurement and initiates a new data measurement sequence with a new data acquisition (sweep) taken once the trigger condition is met.

If the analyzer is in the process of aligning when **Restart** is executed, the alignment finishes before the restart function is performed.

Even when set for Single operation, multiple sweeps may be taken when Restart is pressed (for example, when averaging/holding is on). Thus when we say that **Restart** "restarts a measurement," we may mean:

- It restarts the current sweep
- It restarts the current measurement
- It restarts the current set of sweeps if any trace is in Trace Average, Max Hold or Min Hold
- It restarts the current set of measurements if Averaging, or Max Hold, or Min Hold is on for the measurement
- depending on the current settings.

With **Average/Hold Number** (in **Meas Setup** menu) set to 1, or Averaging off, or no trace in Trace Average or Hold, a single sweep is equivalent to a single measurement. A single sweep is taken after the trigger condition is met; and the analyzer stops sweeping once that sweep has completed. However, with **Average/Hold Number** >1 and at least one trace set to **Trace Average, Max Hold, or Min Hold (SA Measurement)** or **Averaging on (most other measurements)**, multiple sweeps/data acquisitions are taken for a single measurement. The trigger condition must be met prior to each sweep. The sweep is stopped when the average count k equals the number N set for **Average/Hold Number**. A measurement average usually applies to all traces, marker results, and numeric results; but sometimes it only applies to the numeric results.

Once the full set of sweeps has been taken, the analyzer will go to idle state. To take one more sweep without resetting the average count, increment the average count by 1, by pressing the step up key while **Average/Hold Number** is the active function, or sending the remote command `CALC:AVER:TCON UP`.

Save

The Save menu lets you choose what you want to save and where you want to save it. Among the types of files you can save are **States**, **Traces**, and **Screen Images**. In addition, an Export (Data) option lets you save a number of data types as CSV files for easy import into Excel and other spreadsheet programs.

Key Path	Front-panel key
Mode	All
Notes	No remote command for this key specifically, but the :MMEM:STORe command is available for specific file types. An example is :MMEM:STOR:STATe <filename>.
Initial S/W Revision	Prior to A.02.00

State

The Save State menu lets you choose a register or file for saving the state.

The content of a state file includes all of the settings and data required to return the analyzer as closely as possible to the Mode it was in, with the exact settings which were in place, when the save occurred. The Mode settings in each state file include the settings that are affected by Mode Preset, as well as the additional settings affected by Restore Mode Defaults; all of the Mode's settings. In addition, all of the settings of the Input/Output system are included, even though they are outside of the Mode's state, because they are needed to restore the complete setup. Persistent System settings (for example, Verbose SCPI) are not affected by either Mode Preset or Restore Mode Defaults, nor are they included in a saved State file.

After the save completes, the message "File <filename> saved" or "State Register <register number> saved" is displayed.

For rapid saving, the State menu lists 16 registers to save to. Pressing a Register key initiates the save. You can also select a file to save to.

The default path for all State Files is:

My Documents\<<mode name>\state

where <mode name> is the parameter used to select the mode with the INST:SEL command (for example, SA for the Spectrum Analyzer).

Key Path	Save
Mode	All
Remote Command	:MMEMory:STORe:STATe <filename>
Example	MMEM:STOR:STATe "MyStateFile.state" This stores the current instrument state data in the file MyStateFile.state in the default directory.
Notes	Both single and double quotes are supported for any filename parameter over remote. After saving to a register, that register's menu key is updated with the date the time, unless a custom label has been entered for that key. After saving to a register, you remain in the Save State menu, so that you can see the Register key

	update. After saving to a file, the analyzer automatically returns to the previous menu and any Save As dialog goes away.
Backwards Compatibility SCPI	:MMEMory:STORe:STATe 1,<filename> For backwards compatibility, the above syntax is supported. The "1" is simply ignored. The command is sequential.
Initial S/W Revision	Prior to A.02.00

To File . . .

When you press “To File”, the analyzer brings up a Windows dialog and a menu entitled “Save As.” This menu allows you to navigate to the various fields in the Windows dialog without using a keyboard or mouse. The Tab and Arrow keys can also be used for dialog navigation.

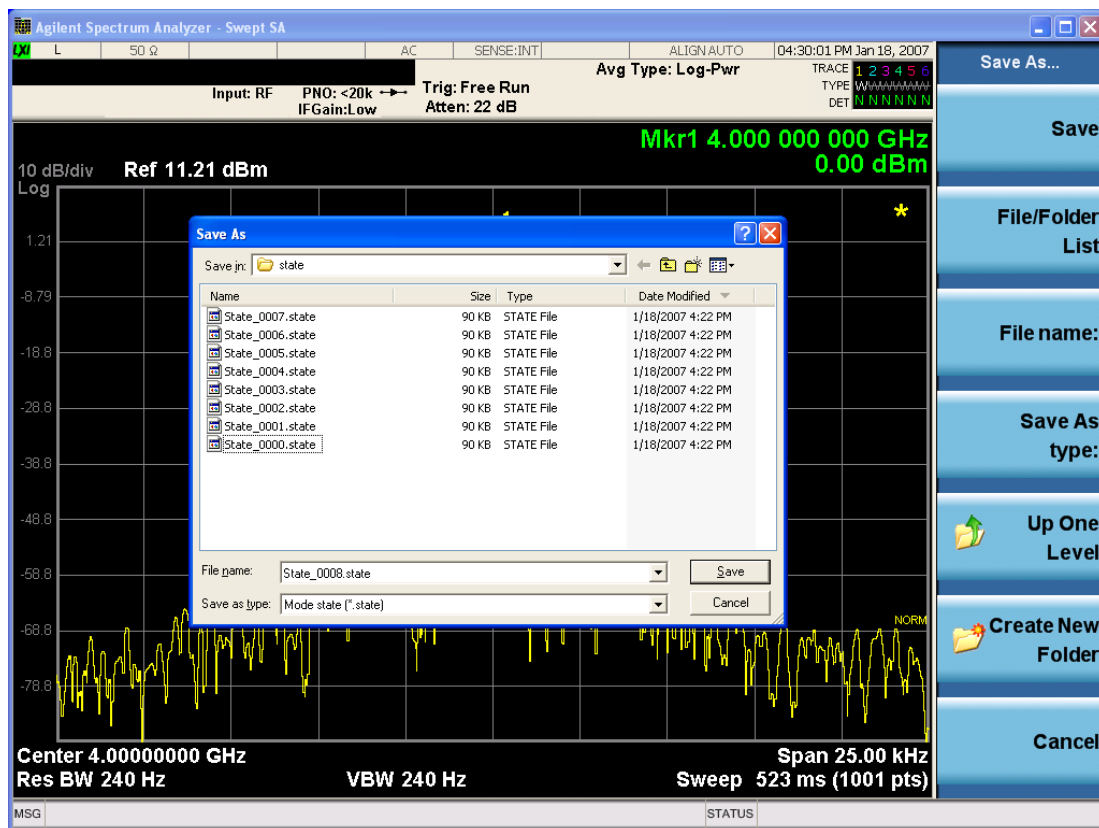

The Listed below

are the functions of the various fields in the dialog, and the corresponding softkeys:

Save

Performs the save to the specified file of the selected type. If the file already exists, a dialog will appear that allows you to replace the existing file by selecting OK, or you can Cancel the request. If you select OK, the file will be overwritten. Using the C: drive is strongly discouraged, since it runs the risk of being overwritten during an instrument software upgrade.

While the save is being performed, the floppy icon appears briefly in the Meas bar.

File/Folder List

Enables you to navigate to the center of the dialog that contains the list of files and folders. Once here you can get information about the file and use the tab keys to navigate to the other fields in the dialog, such as Save In.

Save In

The Save In field shows the path to which the file will be saved and allows you to change the path using the up and down arrow keys to navigate to other paths; the Enter key to open a directory; and the Backspace key to go back one directory. The **Save In field** defaults to the default path for this type of file and remembers the last path you used to save this type of file. There is no softkey for directly navigating to the Save In field but you can use left tab to get here from the File/Folder List.

User specified paths are remembered when you leave and return to a Mode and are reset back to the default using Restore Mode Defaults.

File Name

The File Name field is initially loaded with an automatically generated filename specific to the appropriate Save Type. The automatically generated filename is guaranteed not to conflict with any filename currently in the directory. You may replace or modify this filename using the File Name key. See the ["Quick Save " on page 2259](#) documentation for more on the automatic file naming algorithm.

When you press the File Name key the analyzer displays the Alpha Editor. Use the knob to choose the letter to add and the front-panel Enter key to add the letter to the file name. The BK character moves you back and the FW character moves you forward in the filename. The Select key on the front panel generates a space character. When you are done entering the filename press the Done softkey. This returns back to the **File Open** dialog and menu, but does not cause the save to occur.

Save As Type

This field shows the file suffix for the type of file you have selected to save. For example, if you navigated here while saving State, "Mode state (*.state)" is in the field. If you navigated here from saving Trace, ""Mode state (*.trace)" is in the field. If you navigated here while exporting a trace data file, "Trace Data (*.csv)" is in the field. For some file types, there is more than one choice in the dropdown, which you can select by using the up and down arrow keys and Enter.

Up One Level

This key corresponds to the icon of a folder with the up arrow that is in the tool bar of the dialog. When pressed, it causes the file and folder list to navigate up one level in the directory structure. The Backspace key does the same thing.

Create New Folder

This key corresponds to the icon of a folder with the "*" that is in the tool bar of the dialog. When pressed, a new folder is created in the current directory with the name **New Folder** and you can enter a new folder name using the Alpha Editor.

Cancel

This key corresponds to the Cancel selection in the dialog. It causes the current **Save As** request to be cancelled. The ESC key does the same thing.

Key Path	Save, State
Mode	All
Notes	Brings up Save As dialog for saving a State Save Type
Initial S/W Revision	Prior to A.02.00

Edit Register Names

You may enter a custom name on any of the Register keys, to help you remember what you are using that state to save. To do this, press the Edit Register Names key, choose the register whose name you wish to edit, and then enter the desired label using the Alpha Editor or an external PC keyboard.

The maximum number of characters that can be added is 30. In most cases, 30 characters will fit on two lines of the key.

See ["More Information" on page 2080](#)

Key Path	Save, State
Mode	All
Remote Command	:MMEMory:REGister:STATe:LABel <reg number>,"label" :MMEMory:REGister:STATe:LABel? <reg number>
Example	:MMEM:REG:STAT:LAB 1,"my label"
Notes	<reg number> is an integer from 1 to 16. If the SCPI specifies an invalid register number an error message is generated, -222,"Data out of range;Invalid register label number" "label" is a string from 0 to 30 characters in length. If a label exceeds 30 characters, an error message is generated, -150,"String data error;Label clipped to 30 characters" "label" of length 0 erases the custom label and restores the default (time and date) label. E.g.: :MMEM:REG:STAT:LAB 1,""
Dependencies	N9060A-7FP or N9060B-2FP license required to edit the register names. When the feature is not licensed, sending this command generates an error, -221,"Settings conflict;Option not available"
Preset	The names are unaffected by Preset or power cycle but are set to the default label (time and date) on a "Restore System Defaults->Misc"
Initial S/W Revision	A.11.00

More Information

When you edit one of the register names, the time and date field will be replaced by the custom name.

If you delete all the characters in the custom name, it restores the default (time and date).

The register names are stored within the state files, but they are not part of the instrument state; that is, once you have edited a register name, loading a new state will not change that register name. Another consequence of this is that the names will be persistent through a power cycle. Also, if a named state file is transferred to another analyzer, it will bring its custom name along with it.

If you try to edit the name of an empty register, the analyzer will first save the state to have a file to put the name in. If you load a named state file into an analyzer with older firmware it will ignore the metadata.

The *SAV and *RCL commands will not be affected by the custom register names, nor will the MMEM commands.

Register 1 thru Register 16

Selecting any one of these register menu keys causes the State of the currently active mode to be saved to the specified Register. The registers are provided for rapid saving and recalling, since you do not need to specify a filename or navigate to a file. Each of the register menu keys annotates whether it is empty or at what date and time it was last modified. In addition, you can use the Edit Register Names key to enter custom names for each register.

Although these 16 registers are the only registers available from the front panel, there are 128 state registers available in the instrument. Registers 17–128 are only available from the SCPI interface, using the *SAV command.

There is one set of 128 state registers in the instrument, not one set for each Mode. When a state is saved, the Mode it was saved from is saved with it; then when it is recalled, the instrument switches to that Mode.

After the save completes, the corresponding register menu key annotation is updated with the date and time and the message "Register <register number> saved" is displayed.

Key Path	Save, State
Mode	All
Example	*SAV 1
Range	1–16 from front panel, 1–128 from SCPI
Readback	Date and time with seconds resolution are displayed on the key OR A custom name of up to 30 characters entered using the Edit Register Names key OR “(empty)” if no prior save operation has been performed to this register.
Initial S/W Revision	Prior to A.02.00
Modified at S/W Revision	A.11.00

Register 1 thru Register 16

Selecting any one of these register menu keys causes the State of the currently active mode to be saved to the specified Register. The registers are provided for rapid saving and recalling, since you do not need to specify a filename or navigate to a file. Each of the register menu keys annotates whether it is empty or at what date and time it was last modified. In addition, you can use the Edit Register Names key to enter custom names for each register.

Although these 16 registers are the only registers available from the front panel, there are 128 state registers available in the instrument. Registers 17–128 are only available from the SCPI interface, using the *SAV command.

There is one set of 128 state registers in the instrument, not one set for each Mode. When a state is saved, the Mode it was saved from is saved with it; then when it is recalled, the instrument switches to that Mode.

After the save completes, the corresponding register menu key annotation is updated with the date and time and the message "Register <register number> saved" is displayed.

Key Path	Save, State
Mode	All
Example	*SAV 1
Range	1-16 from front panel, 1-128 from SCPI
Readback	Date and time with seconds resolution are displayed on the key OR A custom name of up to 30 characters entered using the Edit Register Names key OR “(empty)” if no prior save operation has been performed to this register.
Initial S/W Revision	Prior to A.02.00
Modified at S/W Revision	A.11.00

Data (Export)

Exporting a data file stores data from the current measurement to mass storage files. The Export Menu only contains data types that are supported by the current measurement.

Since the commonly exported data files are in .csv format, the data can be edited by you prior to importing. This allows you to export a data file, manipulate the data in Excel (the most common PC Application for manipulating .csv files) and then import it.

Selecting an Export Data menu key will not actually cause the exporting to occur, since the analyzer still needs to know where you wish to save the data. Pressing the Save As key in this menu brings up the Save As dialog and Save As menu that allows you to specify the destination file and directory. Once a filename has been selected or entered in the Open menu, the export will occur as soon as the Save key is pressed.

Key Path	Save
Mode	All
Notes	The menu is built from whatever data types are available for the mode. So the key locations in the sub menu will vary. No SCPI command directly controls the Data Type that this key controls. The Data Type is included in the MMEM:STORe commands.
Dependencies	If a file type is not used by a certain measurement, that type is grayed out for that measurement. The key for a file type will not show at all if there are no measurements in the Mode that support it.
Preset	Is not affected by a Preset or shutdown, but is reset during Restore Mode Defaults
Readback	The data type that is currently selected
Initial S/W Revision	Prior to A.02.00

Meas Results

Key Path	Save, Data
Mode	WLAN
Example	MMEM:STOR:RES "MyResultsFile.csv" This stores the measurement results data in the file MyResultsFile.xml in the default directory.
Initial S/W Revision	A.11.00

Capture Buffer

Capture buffer functionality is only available when measurement is Mod Accuracy and radio standard is not 802.11ac 80+80MHz. The captured data is raw data which is not processed.

Key Path	Save, Data
Mode	WLAN
Example	MMEM:STOR:CAPT "MyCaptureData.bin" This stores the capture data in the file MyCaptureData.bin in the default directory.
Dependencies	Capture buffer data is only available when measurement is Mod Accuracy and radio standard is not 802.11ac 80+80MHz. In other measurements, this key is grayed out.
Initial S/W Revision	A.11.00

Save As . . .

When you press "Save As", the analyzer brings up a Windows dialog and a menu entitled "**Save As.**" This menu allows you to navigate to the various fields in the Windows dialog without using a keyboard or mouse. The Tab and Arrow keys can also be used for dialog navigation.

See "[To File . . .](#)" on page 2273 in Save, State for a full description of this dialog and menu.

The default path for saving files is:

For all of the Trace Data Files:

My Documents\`<mode name>`\data\traces

For all of the Limit Data Files:

My Documents\`<mode name>`\data\limits

For all of the Measurement Results Data Files:

My Documents\`<mode name>`\data\`<measurement name>`\results

For all of the Capture Buffer Data Files:

My Documents\`<mode name>`\data\captureBuffer

Key Path	Save, Data
Mode	All
Notes	The key location is mode-dependent and will vary. Brings up the Save As dialog for saving a <mode specific> Save Type. The save is performed immediately and does not wait until the measurement is complete.
Initial S/W Revision	Prior to A.02.00

Screen Image

Pressing Screen Image accesses a menu of functions that enable you to specify a format and location for the saved screen image. It brings up a menu that allows you to specify the color scheme of the Screen Image (Themes) or navigate to the Save As dialog to perform the actual save.

Screen Image files contain an exact representation of the analyzer display. They cannot be loaded back onto the analyzer, but they can be loaded into your PC for use in many popular applications.

The image to be saved is actually captured when the Save front panel key is pressed, and kept in temporary storage to be used if you ask for a Screen Image save. When the Screen Image key is pressed, a "thumbnail" of the captured image is displayed, as shown below:

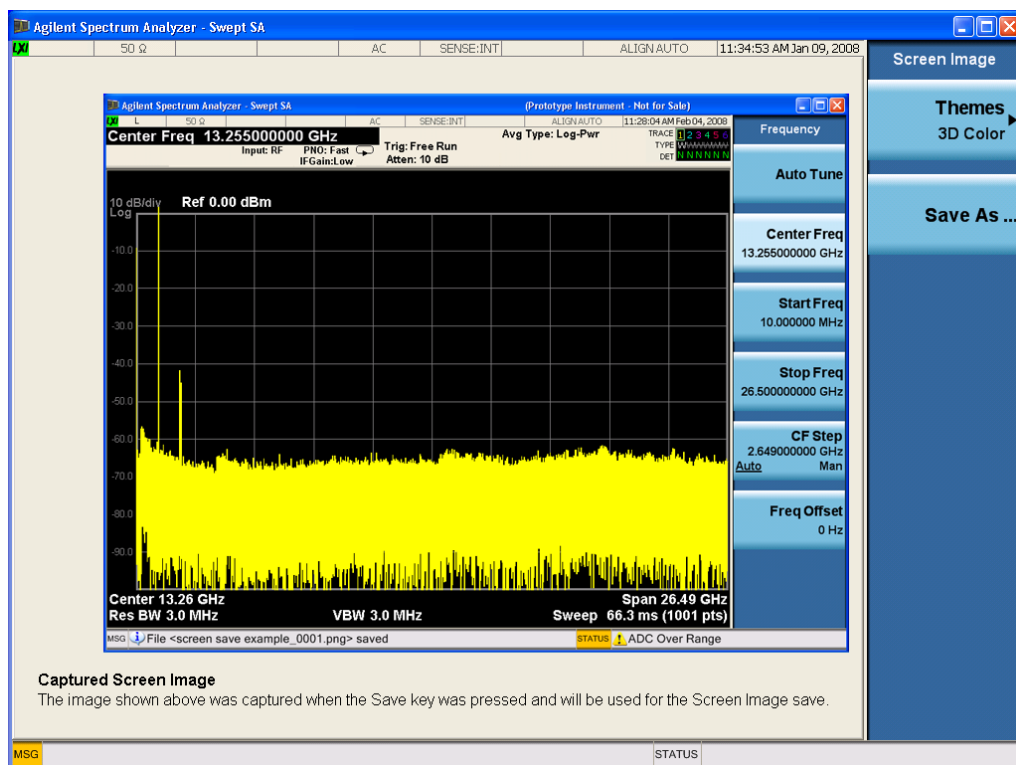

When you continue on into the Save As menu and complete the Screen Image save, the image depicted in the thumbnail is the one that gets saved, showing the menus that were on the screen before going into the Save menus. The save is performed immediately and does not wait until the measurement is complete.

After you have completed the save, the Quick Save front-panel key lets you quickly repeat the last save performed, using an auto-named file, with the current screen data.

NOTE

For versions previous to A.01.55, if you initiate a screen image save by navigating through the Save menus, the image that is saved will contain the Save menu softkeys, not the menus and the active function that were on the screen when you first pressed the Save front panel key.

Key Path	Save
Mode	All
Remote Command	:MMEMory:STORe:SCReem <filename>
Example	:MMEM:STOR:SCR "myScreen.png" This stores the current screen image in the file MyScreenFile.png in the default directory.
Initial S/W Revision	Prior to A.02.00

Themes

Accesses a menu of functions that enable you to choose the theme to be used when saving the screen image.

The **Themes** option is the same as the **Themes** option under the **Display** and **Page Setup** dialogs. It allows you to choose between themes to be used when saving the screen image.

Key Path	Save, Screen Image
Remote Command	:MMEMory:STORe:SCReem:THEMe TDColor TDMonochrome FCOLOR FMONochrome :MMEMory:STORe:SCReem:THEMe?
Example	:MMEM:STOR:SCR:THEM TDM
Preset	3D Color; Is not part of Preset, but is reset by Restore Misc Defaults or Restore System Defaults All and survives subsequent running of the modes.
Readback	3D Color 3D Mono Flat Color Flat Mono
Backwards Compatibility Notes	In ESA and PSA we offer the choice of "Reverse Bitmap" or "Reverse Metafile" when saving screen images. This is much like the "Flat Color" theme available in X-Series. Also, if you selected Reverse Bitmap AND a black & white screen image, that would be much like "Flat Monochrome". In other words, each of the X-Series themes has a similar screen image type in ESA/PSA. But they are not identical.
Initial S/W Revision	Prior to A.02.00

3D Color

Selects a standard color theme with each object filled, shaded and colored as designed.

Key Path	Save, Screen Image, Themes
Example	MMEM:STOR:SCR:THEM TDC

Readback	3D Color
Initial S/W Revision	Prior to A.02.00

3D Monochrome

Selects a format that is like 3D color but shades of gray are used instead of colors.

Key Path	Save, Screen Image, Themes
Example	MMEM:STOR:SCR:THEM TDM
Readback	3D Mono
Initial S/W Revision	Prior to A.02.00

Flat Color

Selects a format that is best when the screen is to be printed on an ink printer.

Key Path	Save, Screen Image, Themes
Example	MMEM:STOR:SCR:THEM FCOL
Readback	Flat Color
Initial S/W Revision	Prior to A.02.00

Flat Monochrome

Selects a format that is like Flat Color. But only black is used (no colors, not even gray), and no fill.

Key Path	Save, Screen Image, Themes
Example	MMEM:STOR:SCR:THEM FMON
Readback	Flat Mono
Initial S/W Revision	Prior to A.02.00

Save As...

When you press "Save As", the analyzer brings up a Windows dialog and a menu entitled "**Save As.**" This menu allows you to navigate to the various fields in the Windows dialog without using a keyboard or mouse. The Tab and Arrow keys can also be used for dialog navigation.

See "[To File . . .](#)" on page 2273 in Save, State for a full description of this dialog and menu.

The default path for Screen Images is

My Documents\<<mode name>\screen.

where <mode name> is the parameter used to select the mode with the INST:SEL command (for example, SA for the Spectrum Analyzer).

Key Path	Save, Screen Image
Notes	Brings up Save As dialog for saving a Screen Image Save Type
Initial S/W Revision	Prior to A.02.00

Mass Storage Catalog (Remote Command Only)

Key path	SCPI Only
Remote Command	:MMEMory:CATalog? [<directory_name>]
Notes	<p>The string must be a valid logical path.</p> <p>Queries disk usage information (drive capacity, free space available) and obtains a list of files and directories in a specified directory in the following format: <numeric_value>,<numeric_value>,{<file_entry>}</p> <p>It returns two numeric parameters and as many strings as there are files and directories. The first parameter indicates the total amount of storage currently used in bytes. The second parameter indicates the total amount of storage available, also in bytes. The <file_entry> is a string. Each <file_entry> indicates the name, type, and size of one file in the directory list: <file_name>,<file_type>,<file_size></p> <p>As the windows file system has an extension that indicates file type, <file_type> is always empty. <file_size> provides the size of the file in bytes. For directories, <file_entry> is surrounded by square brackets and both <file_type> and <file_size> are empty</p>
Initial S/W Revision	Prior to A.02.00

Mass Storage Change Directory (Remote Command Only)

Key path	SCPI Only
Remote Command	:MMEMory:CDIRectory [<directory_name>] :MMEMory:CDIRectory?
Notes	<p>The string must be a valid logical path.</p> <p>Changes the default directory for a mass memory file system. The <directory_name> parameter is a string. If no parameter is specified, the directory is set to the *RST value.</p> <p>At *RST, this value is set to the default user data storage area, that is defined as System.Environment.SpecialFolder.Personal.</p> <p>Query returns full path of the default directory.</p>
Initial S/W Revision	Prior to A.02.00

Mass Storage Copy (Remote Command Only)

Key path	SCPI Only
Remote Command	:MMEMory:COpy <string>,<string>[,<string>,<string>]
Notes	<p>The string must be a valid logical path.</p> <p>Copies an existing file to a new file or an existing directory to a new directory.</p> <p>Two forms of parameters are allowed. The first form has two parameters. In this form, the first parameter specifies the source, and the second parameter specifies the destination.</p> <p>The second form has four parameters. In this form, the first and third parameters specify the source. The second and fourth parameters specify the directories. The first pair of parameters specifies the source. The second pair specifies the destination. An error is generated if the source doesn't exist or the destination file already exists.</p> <p>This command will generate an "access denied" error if the destination is a restricted folder (e.g., C:\Windows) and the current user does not have Power User or Administrator privileges.</p>

Mass Storage Device Copy (Remote Command Only)

This command transfers data to/from a file and a peripheral device.

Key path	SCPI Only
Remote Command	:MMEMory:COpy:DEvice <source_string>,<dest_string>
Notes	<p>The strings must be a valid logical path or a valid device keyword. If the dest_string is a device keyword, the data is copied from the source file to the device. If the source_string is a device keyword, the data is copied to the source file from the device.</p> <p>Valid device keywords are:</p> <p>SNS (smart noise source)</p> <p>An error is generated if the file or device is not found.</p>

Mass Storage Delete (Remote Command Only)

Key path	SCPI Only
Remote Command	:MMEMory:DElete <file_name>[,<directory_name>]
Notes	<p>The string must be a valid logical path.</p> <p>Removes a file from the specified directory. The <file_name> parameter specifies the file name to be removed. This command will generate an "access denied" error if the file is in a restricted folder (e.g., C:\Windows) and the current user does not have Power User or Administrator privileges.</p>
Initial S/W Revision	Prior to A.02.00

Mass Storage Data (Remote Command Only)

Creates a file containing the specified data OR queries the data from an existing file.

Key path	SCPI Only
Remote Command	:MMEMory:DATA <file_name>, <data> :MMEMory:DATA? <file_name>
Notes	The string must be a valid logical path. The command form is MMEMory:DATA <file_name>,<data>. It loads <data> into the file <file_name>. <data> is in 488.2 block format. <file_name> is string data. The query form is MMEMory:DATA? <file_name> with the response being the associated <data> in block format.
Initial S/W Revision	Prior to A.02.00

Mass Storage Make Directory (Remote Command Only)

Key path	SCPI Only
Remote Command	:MMEMory:MDIRectory <directory_name>
Notes	The string must be a valid logical path. Creates a new directory. The <directory_name> parameter specifies the name to be created. This command will generate an “access denied” error if the new directory would be in a restricted folder (e.g., C:\Windows) and the current user does not have Power User or Administrator privileges.
Initial S/W Revision	Prior to A.02.00

Mass Storage Move (Remote Command Only)

Key path	SCPI Only
Remote Command	:MMEMory:MOVE <string>,<string>[,<string>,<string>]
Notes	The string must be a valid logical path. Moves an existing file to a new file or an existing directory to a new directory. Two forms of parameters are allowed. The first form has two parameters. In this form, the first parameter specifies the source, and the second parameter specifies the destination. The second form has four parameters. In this form, the first and third parameters specify the source. The second and fourth parameters specify the directories. The first pair of parameters specifies the source. The second pair specifies the destination. An error is generated if the source doesn't exist or the destination file already exists. This command will generate an “access denied” error if the destination is a restricted folder (e.g., C:\Windows) and the current user does not have Power User or Administrator privileges.
Initial S/W Revision	Prior to A.02.00

Mass Storage Remove Directory (Remote Command Only)

Key path	SCPI Only
Remote Command	<code>:MMEMory:RDIRectory <directory_name></code>
Notes	<p>The string must be a valid logical path.</p> <p>Removes a directory. The <directory_name> parameter specifies the directory name to be removed. All files and directories under the specified directory shall also be removed.</p> <p>This command will generate an “access denied” error if the folder is a restricted folder (e.g., C:\Windows) or is in a restricted folder and the current user does not have Power User or Administrator privileges.</p>
Initial S/W Revision	Prior to A.02.00

Single (Single Measurement/Sweep)

Sets the analyzer for Single measurement operation. The single/continuous state is Meas Global, so the setting will affect all the measurements. If you are Paused, pressing Single does a Resume.

See ["More Information" on page 2091](#)

Key Path	Front-panel key
Example	:INIT:CONT OFF
Notes	See Cont key description.
Backwards Compatibility Notes	<p>For Spectrum Analysis mode in ESA and PSA, the Single hardkey and the INITiate:IMM switched from continuous measurement to single measurement and restarted sweeps and averages (displayed average count reset to 1), but did not restart Max Hold and Min Hold. In the X-Series, the Single hardkey and the INITiate:IMM command initiate a sweep/ measurement/ average sequence/hold sequence including MaxHold and MinHold.</p> <p>For Spectrum Analysis mode in ESA and PSA, the Single hardkey restarted the sweep regardless of whether or not you were in an active sweep or sweep sequence. In the X-Series, Restart does this but Single only restarts the sweep or sweep sequence if you are in the idle state.</p> <p>INIT[:IMM] in ESA & PSA Spectrum Analysis Mode does an implied ABORT. In some other PSA Modes, INIT[:IMM] is ignored if not in the idle state. . The X-Series follows the ESA/PSA SA Mode model, which may cause some Modes to have compatibility problems.</p>
Initial S/W Revision	Prior to A.02.00

More Information

See ["Restart" on page 2270](#) for details on the INIT:IMMEDIATE (Restart) function.

If you are already in single sweep, the INIT:CONT OFF command has no effect.

If you are already in Single Sweep, then pressing the Single key in the middle of a sweep does not restart the sweep or sequence. Similarly, pressing the Single key does not restart the sweep or sequence if the sweep is not in the idle state (for example, if you are taking a very slow sweep, or the analyzer is waiting for a trigger). Instead, it results in a message. "Already in Single, press Restart to initiate a new sweep or sequence". Even though pressing the Single key in the middle of a sweep does not restart the sweep, sending INIT:IMMEDIATE does reset it.

To take one more sweep without resetting the average count, increment the average count by 1, by pressing the step up key while **Average/Hold Number** is the active function, or sending the remote command CALC:AVER:TCON UP.

Source

There is no Source control functionality for this measurement. When this key is pressed, the screen either displays a blank menu, or the previously-selected menu remains unchanged.

Key Path	Front-panel key
----------	-----------------

Span X Scale

Accesses a menu of functions that enable you to set the horizontal scale parameters.

Key Path	Front-panel key
Initial S/W Revision	Prior to A.02.00

Span

Changes the frequency range symmetrically about the center frequency.

For details of WiDEN preset values, see ["IDEN Mode Span Preset for Monitor Spectrum" on page 2094](#).

Key Path	Span X Scale
Mode	All except SA, BASIC
Remote Command	[:SENSe] :MONitor:FREQuency:SPAN <freq> [:SENSe] :MONitor:FREQuency:SPAN?
Example	MON:FREQ:SPAN 1 MHz MON:FREQ:SPAN?
Couplings	Changing the span causes the resolution bandwidth to change automatically, and affects data acquisition time.
Preset	WCDMA: 10.0 MHz WIMAX OFDMA: 50.0 MHz C2K: 2.5MHz PN: 1.0 MHz GSM/EDGE: 1.0 MHz TD-SCDMA: 3.2 MHz 1xEVDO: 2.0MHz DVB-T/H: 10.0MHz DTMB (CTTB): 10.0MHz ISDB-T: 10.0MHz CMMB: 10.0MHz LTE: 50 MHz LTETDD: 50 MHz IDEN: See the table below Digital Cable TV: 10.0MHz WLAN: If Radio Std is 802.11a/b/g 802.11n(20MHz) 802.11ac(20MHz): 25 MHz If Radio Std is 802.11n(40MHz), 802.11 ac (40MHz): 50 MHz If Radio Std is 802.11ac(80MHz): 100MHz If Radio Std is 802.11ac(160MHz): 200MHz

	MSR: 20.0 MHz LTEAFDD, LTEATDD: 20.0MHz
State Saved	Saved in instrument state.
Min	10 Hz
Max	Hardware Dependent: Option 503 = 3.7 GHz Option 507 = 7.1GHz Option 508 = 8.5 GHz Option 513 = 13.8 GHz Option 526 = 27.0 GHz
Initial S/W Revision	Prior to A.02.00
Modified at S/W Revision	A.02.00
Modified at S/W Revision	A.03.00

IDEN Mode Span Preset for Monitor Spectrum

iDEN Slot Format	WiDEN Slot Format 25kHz	WiDEN Slot Format 50kHz	WiDEN Slot Format 75kHz	WiDEN Slot Format 100kHz	WiDEN Slot Format 50kHz Out
60kHz	60kHz	85kHz	110kHz	135kHz	135kHz

Full Span

Changes the Span to show the full frequency range of the analyzer.

Key Path	Span X Scale
Mode	All except SA and BASIC
Remote Command	[:SENSe] :MONitor:FREQuency:SPAN:FULL
Example	MON:FREQ:SPAN:FULL
Couplings	Sets the span to the full frequency range, and adjusts the center frequency accordingly.
Initial S/W Revision	Prior to A.02.00

Last Span

Changes the measurement span to the span setting of the previous measurement. If there is no existing previous span value, then the span remains unchanged.

Key Path	Span X Scale
----------	--------------

Mode	All except SA and BASIC
Remote Command	[:SENSe] :MONitor :FREQuency :SPAN :PREVious
Example	MON:FREQ:SPAN:PREV
Couplings	Selecting last span changes the measurement span value.
Initial S/W Revision	Prior to A.02.00

Sweep/Control

Access a menu of functions that enable you to set up and control the sweep time for the current measurement

Key Path	Front-panel key
Initial S/W Revision	Prior to A.02.00

Sweep Time

Selects the length of time in which the spectrum analyzer sweeps the displayed frequency span. Additional overhead time is required by the analyzer. It impacts the sweep rate, but is not calculated as part of the sweep time. Reducing the sweep time increases the rate of sweeps.

Key Path	Sweep/Control
Mode	All except SA and BASIC
Remote Command	[:SENSe]:MONitor:SWEep:TIME <time> [:SENSe]:MONitor:SWEep:TIME? [:SENSe]:MONitor:SWEep:TIME:AUTO OFF ON 0 1 [:SENSe]:MONitor:SWEep:TIME:AUTO?
Example	MON:SWE:TIME 100 ms MON:SWE:TIME? MON:SWE:TIME:AUTO ON MON:SWE:TIME:AUTO?
Preset	Automatically Calculated
State Saved	Saved in instrument state.
Min	1 ms
Max	4000 s
Initial S/W Revision	Prior to A.02.00
MIN/MAX/DEF Support	Yes

Pause

Pauses a measurement after the current data acquisition is complete.

When Paused, the label on the key changes to Resume. Pressing Resume continues the measurement at the point where it had been paused.

See "[Pause/Resume](#)" on page 2291 under Sweep/Control for more information.

Key Path	Sweep/Control
Initial S/W Revision	Prior to A.02.00

Gate

Accesses a menu that enables you to control the gating function. The Gate functionality is used to view signals best viewed by qualifying them with other events.

Gate setup parameters are the same for all measurements – they do not change as you change measurements. Settings like these are called “Meas Global” and are unaffected by Meas Preset.

Note that Sweep Time autocoupling rules and annotation are changed by Gate being on.

Key Path	Sweep/Control
Scope	Meas Global
Readback	The state and method of Gate, as [Off, LO] or [On, Video]. Note that for measurements that only support gated LO, the method is nonetheless read back, but always as LO.
Initial S/W Revision	Prior to A.02.00

Gate On/Off

Turns the gate function on and off.

When the Gate Function is on, the selected Gate Method is used along with the gate settings and the signal at the gate source to control the sweep and video system with the gate signal. Not all measurements allow every type of Gate Methods.

When Gate is on, the annunciation in the measurement bar reflects that it is on and what method is used, as seen in the following "Gate: LO" annunciator graphic.

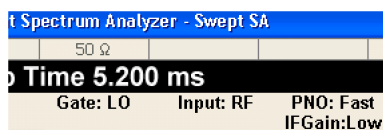

Key Path	Sweep/Control, Gate
Remote Command	[:SENSe] :SWEep:EGATe [:STATe] OFF ON 0 1 [:SENSe] :SWEep:EGATe [:STATe] ?
Example	SWE:EGAT ON SWE:EGAT?
Dependencies	The function is unavailable (grayed out) and Off when:

- Gate Method is LO or Video and FFT Sweep Type is manually selected.
- Gate Method is FFT and Swept Sweep Type is manually selected.
- Marker Count is ON.

The following are unavailable whenever Gate is on:

- FFT under Sweep Type when Method=LO or Video or Swept under Sweep Type when Method=FFT
- Marker Count

While Gate is on, the Auto Rules for Sweep Type are modified so that the choice agrees with the Gate Method: i.e., FFT for Method = FFT and Swept for Method = LO or Video.

The Gate softkey and all SCPI under the [:SENSe]:SWEep:EGATe SCPI node are grayed out when Source Mode is Tracking with an external source. This is because the Gate circuitry is used to sync the external source. If the Tracking Source is turned on, the Gate is turned off.

When in the ACP measurement:

- When Meas Method is RBW or FAST, this function is unavailable and the key is grayed out.
- Whenever Gate is on, Meas Method, RBW or FAST is unavailable and keys for those are grayed out.
- When Gate is on, Offset Res BW and Offset Video BW are ignored (if you set these values) and the measurement works as if all Offset Res BW and all Offset Video BW are coupled with the Res BW and the Video BW under the BW menu. When Gate is on, the Offset BW key in the Offset/Limit menu is grayed out.

Preset	Off LTETDD: On
State Saved	Saved in instrument state
Range	On Off
Backwards Compatibility SCPI	[:SENSe]:SWEep:TIME:GATE[:STATe] ESA compatibility
Backwards Compatibility Notes	In ESA, Trig Delay (On) and Gate (On) could not be active at the same time.. This dependency does not exist in PSA or in the X-Series.
Initial S/W Revision	Prior to A.02.00

Gate View On/Off

Turning on Gate View in the Swept SA measurement provides a single-window gate view display..

Turning on Gate View in other measurements shows the split-screen Gate View. In these measurements, when the Gate View is on, the regular view of the current measurement traces and results are reduced vertically to about 70% of the regular height. The Zero Span window, showing the positions of the Gate, is shown between the Measurement Bar and the reduced measurement window. By reducing the height of the measurement window, some of the annotation on the Data Display may not fit and is not shown.

Key Path	Sweep/Control, Gate
Remote Command	[:SENSe]:SWEep:EGATe:VIEW ON OFF 1 0 [:SENSe]:SWEep:EGATe:VIEW?

Example	SWE:EGAT:VIEW ON turns on the gate view.
Dependencies	<p>In the Swept SA measurement:</p> <p>In Gate View, the regular Sweep Time key is grayed out . When pressed, the grayed out key puts up the informational message "Use Gate View Sweep Time in the Gate menu."</p> <p>In the other measurements:</p> <p>When you turn Gate View on, the lower window takes on the current state of the instrument. Upon leaving Gate View, the instrument takes on the state of the lower window.</p> <p>When you turn Gate View on, the upper window Sweep Time is set to the gate view sweep time.</p>
Couplings	<p>These couplings apply to the Swept SA measurement:</p> <ul style="list-style-type: none"> • When Gate View is turned on, the instrument is set to Zero Span. • Gate View automatically turns off whenever a Span other than Zero is selected. • Gate View automatically turns off if you press the Last Span key while in Gate View, and the instrument returns to the Span it was in before entering Gate View (even if that is Zero Span). • When Gate View is turned on, the sweep time used is the gate view sweep time. This is set according to the rules in section "Gate View Setup" on page 2101 • When Gate View is turned off, Sweep Time is set to the normal Swept SA measurement sweep time. • If Gate View is on and Gate is off, then turning on Gate turns off Gate View.
Preset	OFF
State Saved	Saved in instrument state
Range	On Off
Initial S/W Revision	Prior to A.02.00

A sample of the Gate View screen in the Swept SA measurement is shown in the following graphic :

17 Monitor Spectrum Measurement Sweep/Control

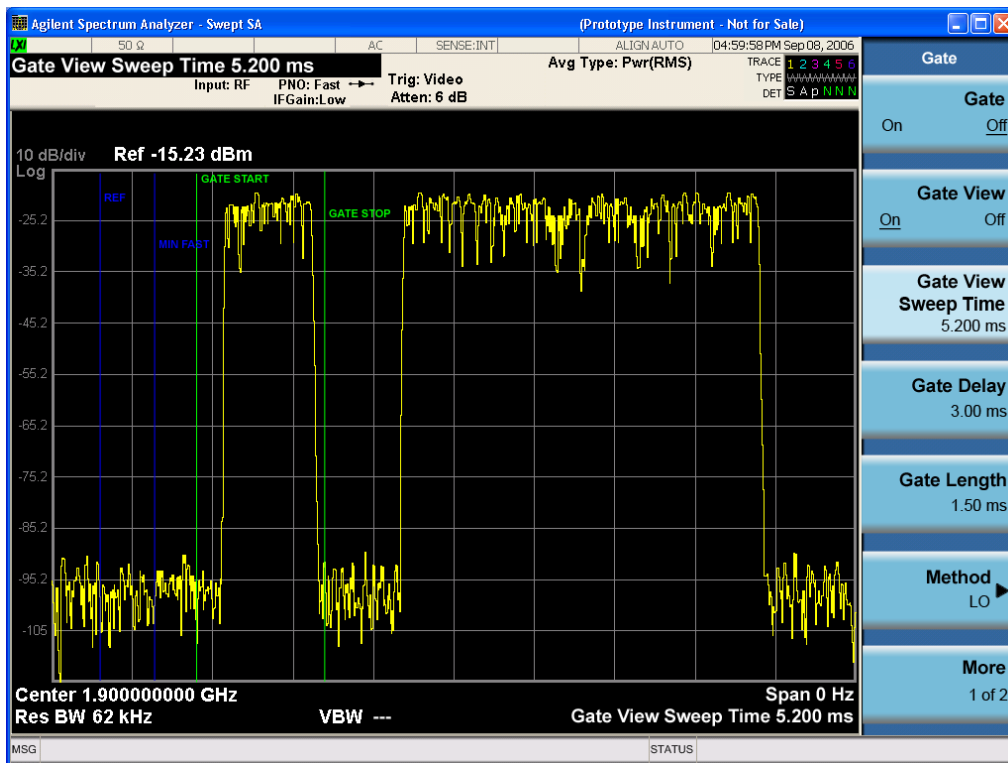

A sample of the Gate View screen in other measurements is shown in the following graphic. This example is for the ACP measurement:

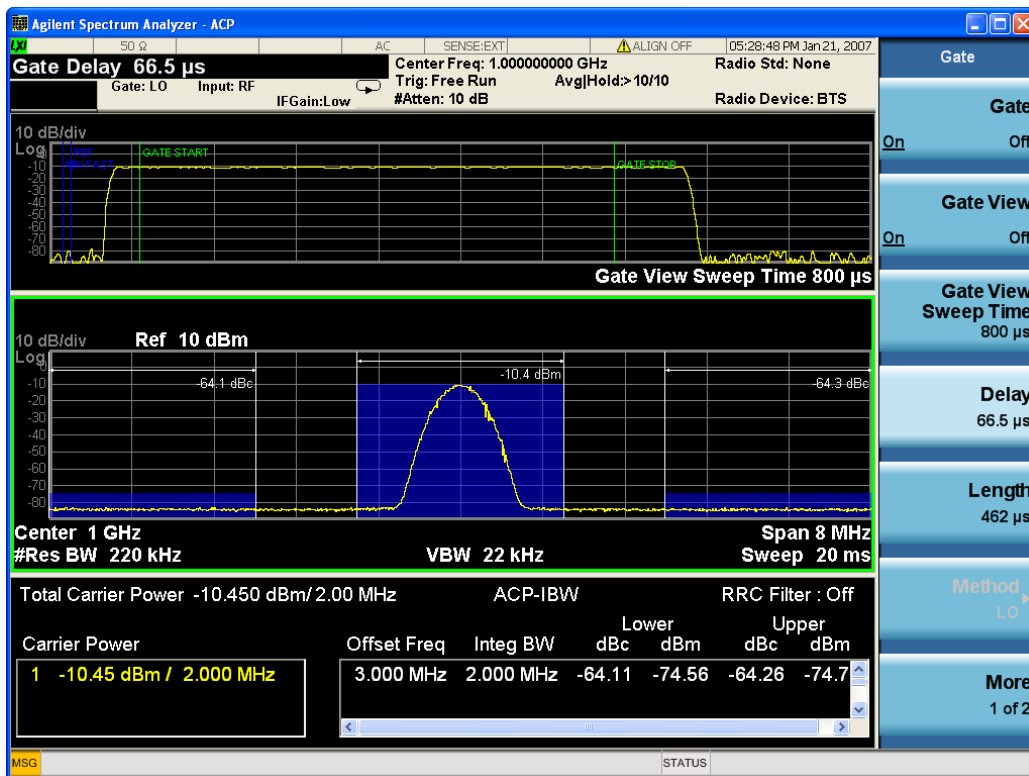

Turning Gate View off returns the analyzer to the Normal measurement view.

In the Swept SA, the normal measurement view is the single-window Swept SA view. When returning to this view, the Swept SA measurement returns to the Span it was in before entering **Gate View** (even if that is Zero Span).

The **Gate View** window is triggered from the Gate Source, with zero trigger delay. Also, when updating the **Gate View** window, the Gate itself must not operate. So it is internally shut off while the gate view window is being updated. For the Swept SA measurement, this means that the Gate is internally shut off whenever the gate view window is displayed. The measurement bar and softkeys continue to show the Trigger source for the main sweep window and give no indication that the Gate is shut off or that the Gate View window is triggered from the Gate Source.

When in **Gate View**, vertical lines are displayed in the Gate View window as follows:

- Green lines are displayed at the gate edges as follows: in Edge Gate, a line is shown for Delay and one for the end of the Gate period, defined by Length. In Level Gate a line is shown only for Delay. You can adjust the position of the green lines by adjusting the gate length and the gate delay. These lines update in the Gate View window as the active function changes, even if the window is not being updated. In Gated LO and Gated Video, these lines are positioned relative to the delay reference line (not relative to 0 time). In Gated FFT, their location is relative to the left edge of the screen.
- A blue line is displayed showing the delay reference, that is, the reference point for the Gate Delay within the Zero Span window. The blue line represents where (in time) the effective location of the gate start would be if the gate were programmed to zero delay.
-
- The second blue line is labeled "MIN FAST" as shown in the figure above because it represents the minimum Gate Delay for fast Gated LO operation. This line is only displayed in Gated LO. You cannot scroll (knob) or decrement (down key) the Gate Delay to less than that represented by the position of this line, it can only be set below this position manually, although once there it can be moved freely with the knob while below the line.
- A yellow line in the Gated Video case only, is displayed at Blength, where Blength is the display point (bucket) length for the swept trace, which is given by the sweep time for that trace divided by number of Points - 1. So it is referenced to 0 time, not to the delay reference. This line is labeled NEXT PT (it is not shown in the figure above because the figure above is for Gated LO).
- The yellow line represents the edge of a display point (bucket). Normally in Gated Video, the bucket length must be selected so that it exceeds the off time of the burst. There is another way to use the analyzer in Gated Video measurements, and that is to set the bucket width much shorter than the off time of the burst. Then use the Max Hold trace function to fill in "missing" buckets more slowly. This allows you to see some of the patterns of the Gated Video results earlier, though seeing a completely filled-in spectrum later.

Gate View Setup

Accesses a menu that enables you to setup parameters relevant to the Gate View

Key Path	Sweep/Control, Gate
Scope	Meas Global
Initial S/W Revision	A.10.00

Gate View Sweep Time

Controls the sweep time in the Gate View window. To provide an optimal view of the gate signal, the analyzer initializes Gate View Sweep Time based on the current settings of Gate Delay and Gate Length.

Key Path	Sweep/Control, Gate, Gate View Setup
Remote Command	[:SENSe] :SWEep:EGATe:TIME <time> [:SENSe] :SWEep:EGATe:TIME?
Example	SWE:EGAT:TIME 500 ms
Dependencies	Gate View Sweep Time is initialized: <ul style="list-style-type: none"> • On Preset (after initializing delay and length). • Every time the Gate Method is set/changed. <p>Additionally, in the Swept SA measurement, whenever you do a Preset, or leave Gate View, the analyzer remembers the Gate Delay and Gate Length settings. Then, when returning to Gate View, if the current Gate Delay and/or Gate Length do not match the remembered values Gate View Sweep Time is re-initialized.</p> <ol style="list-style-type: none"> 1. Compute the location of the "gate stop" line, which you know is at time $t = t_{min} + \text{GateDelay} + \text{GateLength}$.
Preset	519.3 μ s WiMAX OFDMA: 5 ms GSM/EDGE: 1 ms
State Saved	Saved in instrument state
Max	6000 s
Initial S/W Revision	Prior to A.02.00

Gate View Start Time

Controls the time at the left edge of the Gate View.

Key Path	Sweep/Control, Gate, Gate View Setup
Remote Command	[:SENSe] :SWEep:EGATe:VIEW:START <time> [:SENSe] :SWEep:EGATe:VIEW:START?
Example	SWE:EGAT:VIEW:STAR 10ms
Notes	Units of time are required or no units; otherwise an invalid suffix error message will be generated. See error -131.
Preset	0 ms
State Saved	Saved in instrument state
Min	0
Max	500 ms
Initial S/W Revision	A.10.00

Gate Delay

Controls the length of time from the time the gate condition goes True until the gate is turned on.

Key Path	Sweep/Control, Gate
Remote Command	[:SENSe] :SWEep:EGATe:DELay <time> [:SENSe] :SWEep:EGATe:DELay?
Example	SWE:EGAT:DELay 500ms SWE:EGAT:DELay?
Notes	Units of time are required or no units; otherwise an invalid suffix error message will be generated.
Preset	57.7 us WiMAX OFDMA: 71 us GSM/EDGE: 600 us WLAN: 500 us
State Saved	Saved in instrument state
Min	0.0 us
Max	100 s
Backwards Compatibility SCPI	[:SENSe] :SWEep:TIME:GATE:DELay ESA compatibility
Initial S/W Revision	Prior to A.02.00

Gate Length

Controls the length of time that the gate is on after it opens.

Key Path	Sweep/Control, Gate
Remote Command	[:SENSe] :SWEep:EGATe:LENGth <time> [:SENSe] :SWEep:EGATe:LENGth?
Example	SWE:EGAT:LENG 1 SWE:EGAT:LENG?
Notes	Units of time are required or no units; otherwise an invalid suffix error message will be generated.
Dependencies	<p>Grayed out when Gate Method is set to FFT in which case the label changes to that shown below.</p> <div style="border: 1px solid black; padding: 5px; display: inline-block;"> <p>Gate Length (=1.83/RBW) 2.8 ms</p> </div> <p style="margin-left: 20px;">vsd 39-1</p> <p>The key is also grayed out if Gate Control = Level.</p>
Preset	461.6 us

	WiMAX OFDMA: 50 us GSM/EDGE: 200 us WLAN: 1.54 ms
State Saved	Saved in instrument state
Min	100 ns
Max	5 s
Backwards Compatibility SCPI	[:SENSe] :SWEep:TIME:GATE:LENGth ESA compatibility
Initial S/W Revision	Prior to A.02.00

Gate Source

The menus under the Gate Source key are the same as those under the Trigger key, with the exception that neither Free Run nor Video are available as Gate Source selections. However, a different SCPI command is used to select the Gate Source (see table below) because you may independently set the Gate Source and the Trigger Source.

Any changes to the settings in the setup menus under each Gate Source selection key (for example: Trigger Level, Trigger Delay, etc.) also affect the corresponding settings under the Trigger menu keys. The SCPI commands used for these are the same for Trigger and Gate, since there is only one setting which affects both Gate and Trigger. Example: to set the Trigger Level for External 1 you use the command :TRIG:EXT1:LEV regardless of whether you are using External 1 as a Trigger Source or a Gate Source.

Key Path	Sweep/Control, Gate
Remote Command	[:SENSe] :SWEep:EGATE:SOURce EXTernal1 EXTernal2 LINE FRAMe RFBurst [:SENSe] :SWEep:EGATE:SOURce?
Dependencies	In some models, there is no second External input. In these models, the External 2 key is blanked and the EXTernal2 parameter will generate a "Hardware missing; Not available for this model number" error.
Preset	EXTernal 1 GSM/EDGE, MSR: FRAMe LTETDD: EXTernal 1When Direction is Downlink, FRAMe when Direction is Uplink.
Backwards Compatibility Notes	In ESA, there is a single Gate input port. In PSA, the Gate Source may be taken from one of two specified input ports. In the X-Series, any Trigger Source can be a Gate Source.
Initial S/W Revision	Prior to A.02.00
Modified at S/W Revision	A.03.00, A.14.00

Line

Pressing this key, when it is not selected, selects the line signal as the trigger. A new sweep/measurement will start synchronized with the next cycle of the line voltage. Pressing this key, when it is already selected, access the line trigger setup menu.

Key Path	Trigger
Example	TRIG:SOUR LINE Swept SA measurement TRIG:<meas>:SOUR LINE Measurements other than Swept SA
Dependencies	Line trigger is not available when operating from a "dc power source", for example, when the instrument is powered from batteries.
State Saved	Saved in instrument state
Status Bits/OPC dependencies	The Status Operation Register bit 5 "Waiting for Trigger" is set at the same time as the Sweeping or Measuring bit is set. It is cleared when the trigger actually occurs (that is, after the trigger event occurs and all the applicable trigger criteria have been met). A corresponding pop-up message ("Waiting for trigger") is generated if no trigger signal appears after approximately 2 sec. This message goes away when a trigger signal appears.
Initial S/W Revision	Prior to A.02.00

Trig Slope

Controls the trigger polarity. It is set positive to trigger on a rising edge and negative to trigger on a falling edge.

Key Path	Trigger, Line
Remote Command	:TRIGger[:SEQuence]:LINE:SLOPe POSitive NEGative :TRIGger[:SEQuence]:LINE:SLOPe?
Example	TRIG:LINE:SLOP NEG
Preset	POSitive
State Saved	Saved in instrument state
Backwards Compatibility Notes	The legacy :TRIGger[:SEQuence]:SLOPe command affects the slopes for the VID, LINE, EXT1, EXT2, and RFB triggers.
Initial S/W Revision	Prior to A.02.00

External 1

Pressing this key, when it is not selected, selects an external input signal as the trigger. A new sweep/measurement will start when the external trigger condition is met using the external 1 input connector on the rear panel.

Pressing this key, when it is already selected, accesses the external 1 trigger setup menu.

Key Path	Trigger
Example	TRIG:SOUR EXT1 Swept SA measurement TRIG:<meas>:SOUR EXT1 Measurements other than Swept SA
Dependencies	Grayed out if in use by Point Trigger in the Source Setup menu. Forced to Free Run if already selected and Point Trigger is set to External 1.
State Saved	Saved in instrument state
Status Bits/OPC dependencies	The Status Operation Register bit 5 "Waiting for Trigger" is set at the same time as the Sweeping or Measuring bit is set. It is cleared when the trigger actually occurs (that is, after the trigger event occurs and all the applicable trigger criteria have been met). A corresponding pop-up message ("Waiting for trigger") is generated if no trigger signal appears after approximately 2 sec. This message goes away when a trigger signal appears.
Initial S/W Revision	Prior to A.02.00

Trigger Level

Sets the value where the external 1 trigger input will trigger a new sweep/measurement.

Key Path	Trigger, External 1
Remote Command	:TRIGger[:SEquence]:EXTernal1:LEVel <level> :TRIGger[:SEquence]:EXTernal1:LEVel?
Example	TRIG:EXT1:LEV 0.4 V
Couplings	This same level is used for the Ext1 trigger source in the Trigger menu, for the Ext1 selection in the Periodic Timer sync source (in the Trigger menu and in the Gate Source menu), and also for the Ext1 selection in the Gate Source menu.
Preset	1.2 V
State Saved	Saved in instrument state
Min	-5 V
Max	5 V
Default Unit	V
Backwards Compatibility SCPI	:TRIGger[:SEquence]:EXTernal:LEVel For backward compatibility, the parameter EXTernal is mapped to EXTernal1
Backwards Compatibility SCPI	:TRIGger[:SEquence]:FRAMe:EXTernal1:LEVel
Initial S/W Revision	Prior to A.02.00

Trig Slope

Controls the trigger polarity. It is set positive to trigger on a rising edge and negative to trigger on a falling edge.

Key Path	Trigger, External 1
Remote Command	:TRIGger[:SEQuence]:EXTernal1:SLOPe POSitive NEGative :TRIGger[:SEQuence]:EXTernal1:SLOPe?
Example	TRIG:EXT1:SLOP NEG
Couplings	This same slope is used in the Ext1 selection for the trigger source in the Trigger menu and for the period timer sync source (in the Trigger menu and in the Gate Source menu).
Preset	POSitive
State Saved	Saved in instrument state
Backwards Compatibility SCPI	:TRIGger[:SEQuence]:EXTernal:SLOPe For backward compatibility, the parameter EXTernal is mapped to EXTernal1
Backwards Compatibility SCPI	:TRIGger[:SEQuence]:FRAMe:EXTernal1:SLOPe
Backwards Compatibility Notes	The legacy :TRIGger[:SEQuence]:SLOPe command affects the slopes for the VID, LINE, EXT1, EXT2, and RFB triggers.
Initial S/W Revision	Prior to A.02.00

Zero Span Delay Comp On/Off

In zero span, there is a natural delay in the signal path, which comes from the RBW filter. This is usually desirable, as it allows you to trigger on events and also see those events, because the signal is delayed from the trigger event. However, in some cases it is desirable to eliminate this delay, so that trigger events line up exactly with the zero time point in zero span. You can use the Zero Span Delay Comp On/Off feature to enable or disable zero span delay compensation.

Key Path	Trigger, External 1
Remote Command	:TRIGger[:SEQuence]:EXTernal1:DELAy:COMPensation OFF ON 0 1 :TRIGger[:SEQuence]:EXTernal1:DELAy:COMPensation?
Example	TRIG:EXT1:DEL:COMP ON
Dependencies	No effect except in zero-span, but not locked out in nonzero spans. Blanked in modes that do not support zero-span measurements. If the SCPI command is sent when the key is blanked, an error is returned: -221, "Settings conflict; Feature not supported for this measurement" In analyzers shipping N9060A, this feature requires N9060A-7FP.
Preset	OFF
State Saved	Saved in instrument state
Initial S/W Revision	A.11.00

External 2

Pressing this key, when it is not selected, selects an external input signal as the trigger. A new sweep/measurement will start when the external trigger condition is met using the external 2 input

connector. The external trigger 2 input connector is on the rear panel.

Pressing this key, when it is already selected, accesses the external 2 trigger setup menu.

Key Path	Trigger
Example	TRIG:SOUR EXT2 Swept SA measurement TRIG:<meas>:SOUR EXT2 Measurements other than Swept SA
Dependencies	In some models, there is no second External input. In these models, the External 2 key is blanked and the EXTernal2 parameter will generate a "Hardware missing; Not available for this model number" message. Grayed out if in use by Point Trigger in the Source Setup menu. Forced to Free Run if already selected and Point Trigger is set to External 2.
State Saved	Saved in instrument state
Status Bits/OPC dependencies	The Status Operation Register bit 5 "Waiting for Trigger" is set at the same time as the Sweeping or Measuring bit is set. It is cleared when the trigger actually occurs (that is, after the trigger event occurs and all the applicable trigger criteria have been met). A corresponding pop-up message ("Waiting for trigger") is generated if no trigger signal appears after approximately 2 sec. This message goes away when a trigger signal appears.
Initial S/W Revision	Prior to A.02.00
Modified at S/W Revision	A.03.00

Trigger Level

Sets the value where the external 2 trigger input will trigger a new sweep/measurement.

Key Path	Trigger, External 2
Remote Command	:TRIGger[:SEquence]:EXTernal2:LEVel :TRIGger[:SEquence]:EXTernal2:LEVel?
Example	TRIG:EXT2:LEV 1.1 V
Couplings	This same level is used for the Ext2 trigger source in the Trigger menu, for the Ext2 selection in the Periodic Timer sync source (in the Trigger menu and in the Gate Source menu), and also for the Ext2 selection in the Gate Source menu.
Preset	1.2 V
State Saved	Saved in instrument state
Min	-5 V
Max	5 V
Default Unit	V
Backwards Compatibility SCPI	:TRIGger[:SEquence]:FRAMe:EXTernal2:LEVel
Initial S/W Revision	Prior to A.02.00

Trig Slope

Controls the trigger polarity. It is set positive to trigger on a rising edge and negative to trigger on a falling edge.

Key Path	Trigger, External 2
Remote Command	:TRIGger[:SEquence]:EXTernal2:SLOPe POSitive NEGative :TRIGger[:SEquence]:EXTernal2:SLOPe?
Example	TRIG:EXT2:SLOP NEG
Couplings	This same slope is used in the Ext2 selection for the trigger source in the Trigger menu and for the period timer sync source (in the Trigger menu and in the Gate Source menu).
Preset	POSitive
State Saved	Saved in instrument state
Backwards Compatibility SCPI	:TRIGger[:SEquence]:FRAMe:EXTernal2:SLOPe
Backwards Compatibility Notes	The legacy :TRIGger[:SEquence]:SLOPe command affects the slopes for the VID, LINE, EXT1, EXT2, and RFB triggers.
Initial S/W Revision	Prior to A.02.00

Zero Span Delay Comp On/Off

In zero span, there is a natural delay in the signal path, which comes from the RBW filter. This is usually desirable, as it allows you to trigger on events and also see those events, because the signal is delayed from the trigger event. However, in some cases it is desirable to eliminate this delay, so that trigger events line up exactly with the zero time point in zero span. You can use the Zero Span Delay Comp On/Off feature to enable or disable zero span delay compensation.

Key Path	Trigger, External 2
Remote Command	:TRIGger[:SEquence]:EXTernal2:DELAy:COMPensation OFF ON 0 1 :TRIGger[:SEquence]:EXTernal2:DELAy:COMPensation?
Example	TRIG:EXT2:DEL:COMP ON
Dependencies	No effect except in zero-span, but not locked out in nonzero spans. Blanked in modes that do not support zero-span measurements. If the SCPI command is sent when the key is blanked, an error is returned: -221, "Settings conflict; Feature not supported for this measurement" In analyzers shipping N9060A, this feature requires N9060A-7FP.
Preset	OFF
State Saved	Saved in instrument state
Initial S/W Revision	A.11.00

RF Burst

Pressing this key, when it is not selected, selects the RF Burst as the trigger. A new sweep/measurement will start when an RF burst envelope signal is identified from the signal at the RF Input connector. Pressing this key, when it is already selected, accesses the RF Burst trigger setup menu.

In some models, a variety of burst trigger circuitry is available, resulting in various available burst trigger bandwidths. The analyzer automatically chooses the appropriate trigger path based on the hardware configuration and other settings of the analyzer.

Key Path	Trigger
Example	TRIG:SOUR RFB Swept SA measurement TRIG:< meas>:SOUR RFB Measurements other than Swept SA
State Saved	Saved in instrument state
Status Bits/OPC dependencies	The Status Operation Register bit 5 "Waiting for Trigger" is set at the same time as the Sweeping or Measuring bit is set. It is cleared when the trigger actually occurs (that is, after the trigger event occurs and all the applicable trigger criteria have been met). A corresponding pop-up message ("Waiting for trigger") is generated if no trigger signal appears after approximately 2 sec. This message goes away when a trigger signal appears.
Backwards Compatibility Notes	The legacy command: :TRIGger[:SEQuence]:RFBurst:FSElectivity[:STATe] OFF ON 0 1 is not supported in the X-Series, as the hardware to do Frequency Selective burst triggers does not exist in X-Series.
Initial S/W Revision	Prior to A.02.00
Modified at S/W Revision	A.04.00

Absolute Trigger Level

Sets the absolute trigger level for the RF burst envelope.

When using the External Mixing path, the Absolute Trigger Level is uncalibrated because the factory default was set to accommodate the expected IF levels for the RF path.

Key Path	Trigger, RF Burst
Scope	Meas Global
Remote Command	:TRIGger[:SEQuence]:RFBurst:LEVel:ABSolute <ampl> :TRIGger[:SEQuence]:RFBurst:LEVel:ABSolute?
Example	TRIG:RFB:LEV:ABS 10 dBm sets the trigger level of the RF burst envelope signal to the absolute level of 10 dBm
Notes	Sending this command does not switch the setting from relative to absolute; to switch it you need to send the :TRIGger[:SEQuence]:RFBurst:LEVel:TYPE command, below. Amplitude Corrections are not taken into account by the Absolute Trigger Level. For example, if you have given yourself effective gain with an amplitude correction factor, the Absolute Trigger will not fire until you have set the trigger level that far below the displayed signal level, rather than simply to

	the displayed signal level. This is only true for Amplitude Corrections, not External Gain or Ref Level Offset functions. If mode is Bluetooth, the default value is -50 dBm.
Couplings	This same level is used for the RF Burst trigger source in the Trigger menu, for the RF Burst selection in the Periodic Timer sync source (in the Trigger menu and in the Gate Source menu), and also for the RF Burst selection in the Gate Source menu
Preset	-20 dBm
State Saved	Saved in instrument state
Min	-200 dBm
Max	100 dBm
Default Unit	depends on the current selected Y-Axis unit
Backwards Compatibility SCPI	:TRIGger[:SEquence]:FRAMe:RFBurst:LEVel:ABSolute
Initial S/W Revision	Prior to A.02.00
Modified at S/W Revision	A.04.00

Key Path	Trigger, RF Burst
Remote Command	:TRIGger[:SEquence]:RFBurst:LEVel:TYPE ABSolute RELative :TRIGger[:SEquence]:RFBurst:LEVel:TYPE?
Example	TRIG:RFB:LEV:TYPE REL sets the trigger level type of the RF burst trigger to Relative.
Preset	ABSolute
State Saved	Saved in instrument state
Initial S/W Revision	Prior to A.02.00
Modified at S/W Revision	A.04.00

Relative Trigger Level

Sets the relative trigger level for the RF burst envelope.

In some models, the relative burst trigger function is implemented in hardware. In other models, without the advanced triggering hardware required, the relative burst trigger function is implemented in software in some measurements, and is unavailable in other measurements.

When implemented in software, the relative RF Burst trigger function is implemented as follows:

1. The measurement starts with the absolute RF Burst trigger setting. If it cannot get a trigger with that level, auto trigger fires and the acquisition starts anyway. After the acquisition, the measurement searches for the peak in the acquired waveform and saves it.

2. Now, in the next cycle of the measurement, the measurement determines a new absolute RF Burst level based on the peak value from the first measurement and the Relative RF Burst Trigger Level (always 0 or negative dB) set by the user. The following formula is used:
 3. absolute RF Burst level = peak level of the previous acquisition + relative RF Burst level
 4. If the new absolute RF Burst level differs from the previous by more than 0.5 dB, the new level is sent to the hardware; otherwise it is not updated (to avoid slowing down the acquisition)
- Steps 2 and 3 repeat for subsequent measurements.

Key Path	Trigger, RF Burst
Scope	Meas Global
Remote Command	:TRIGger[:SEquence]:RFBurst:LEVel:RELative <rel_ampl> :TRIGger[:SEquence]:RFBurst:LEVel:RELative?
Example	TRIG:RFB:LEV:REL -10 dB sets the trigger level of the RF burst envelope signal to the relative level of -10 dB
Notes	Sending this command does not switch the setting from absolute to relative; to switch it you need to send the :TRIGger[:SEquence]:RFBurst:LEVel:TYPE command, above. The relative trigger level is not available in some measurements. In those measurements the RELative parameter, and the :TRIGger[:SEquence]:RFBurst:LEVel:TYPE command (above), will generate an error if sent.
Dependencies	This key is grayed out and Absolute Trigger Level selected if the required hardware is not present in your analyzer and the current measurement does not support Relative triggering.
Preset	-6 dB GSM: -25 dB
State Saved	Saved in instrument state
Min	-45 dB
Max	0 dB
Default Unit	dB or dBc
Backwards Compatibility SCPI	:TRIGger[:SEquence]:RFBurst:LEVel This legacy command is aliased to :TRIGger[:SEquence]:RFBurst:LEVel:RELative because the PSA had ONLY relative burst triggering
Initial S/W Revision	Prior to A.02.00
Modified at S/W Revision	A.04.00

Trigger Slope

It is set positive to trigger on a rising edge and negative to trigger on a falling edge.

Key Path	Trigger, RF Burst
Remote Command	:TRIGger[:SEquence]:RFBurst:SLOPe POSitive NEGative :TRIGger[:SEquence]:RFBurst:SLOPe?

Example	TRIG:RFB:SLOP NEG
Couplings	This same slope is used in the RF Burst selection for the trigger source in the Trigger menu and for the period timer sync source (in the Trigger menu and in the Gate Source menu).
Preset	POSitive
State Saved	Saved in instrument state
Backwards Compatibility SCPI	:TRIGger[:SEQuence]:FRAMe:RFBurst:SLOPe
Backwards Compatibility Notes	The legacy :TRIGger[:SEQuence]:SLOPe command affects the slopes for the VID, LINE, EXT1, EXT2, and RFB triggers.
Initial S/W Revision	Prior to A.02.00

Periodic Timer (Frame Trigger)

Pressing this key, when it is not selected, selects the internal periodic timer signal as the trigger. Triggering occurrences are set by the **Period** parameter, which is modified by the **Sync Source** and **Offset**. Pressing this key, when it is already selected, accesses the periodic timer trigger setup functions.

If you do not have a sync source selected (it is Off), then the internal timer will not be synchronized with any external timing events.

Key Path	Trigger
Example	TRIG:SOUR FRAM Swept SA measurement TRIG:<meas>:SOUR FRAM Measurements other than Swept SA
State Saved	Saved in instrument state
Readback	[Sync: <value of Sync Source>], for example, [Sync: External 1]
Status Bits/OPC dependencies	The Status Operation Register bit 5 "Waiting for Trigger" is set at the same time as the Sweeping or Measuring bit is set. It is cleared when the trigger actually occurs (that is, after the trigger event occurs and all the applicable trigger criteria have been met). A corresponding pop-up message ("Waiting for trigger") is generated if no trigger signal appears after approximately 2 sec. This message goes away when a trigger signal appears.
Initial S/W Revision	Prior to A.02.00

Periodic Timer Triggering:

This feature selects the internal periodic timer signal as the trigger. Trigger occurrences are set by the **Periodic Timer** parameter, which is modified by the **Sync Source** and **Offset**.

The figure below shows the action of the periodic timer trigger. Before reviewing the figure, we'll explain some uses for the periodic trigger.

A common application is measuring periodic burst RF signals for which a trigger signal is not easily available. For example, we might be measuring a TDMA radio which bursts every 20 ms. Let's assume that the 20 ms period is very consistent. Let's also assume that we do not have an external trigger source

available that is synchronized with the period, and that the signal-to-noise ratio of the signal is not high enough to provide a clean RF burst trigger at all of the analysis frequencies. For example, we might want to measure spurious transmissions at an offset from the carrier that is larger than the bandwidth of the RF burst trigger. In this application, we can set the Periodic Timer to a 20.00 ms period and adjust the offset from that timer to position our trigger just where we want it. If we find that the 20.00 ms is not exactly right, we can adjust the period slightly to minimize the drift between the period timer and the signal to be measured.

A second way to use this feature would be to use **Sync Source** temporarily, instead of **Offset**. In this case, we might tune to the signal in a narrow span and use the RF Burst trigger to synchronize the periodic timer. Then we would turn the sync source off so that it would not miss-trigger. Miss-triggering can occur when we are tuned so far away from the RF burst trigger that it is no longer reliable.

A third example would be to synchronize to a signal that has a reference time element of much longer period than the period of interest. In some CDMA applications, it is useful to look at signals with a short periodicity, by synchronizing that periodicity to the "even-second clock" edge that happens every two seconds. Thus, we could connect the even-second clock trigger to Ext1 and use then Ext1 as the sync source for the periodic timer.

The figure below illustrates this third example. The top trace represents the even-second clock. It causes the periodic timer to synchronize with the leading edge shown. The analyzer trigger occurs at a time delayed by the accumulated offset from the period trigger event. The periodic timer continues to run, and triggers continue to occur, with a periodicity determined by the analyzer time base. The timer output (labeled "late event") will drift away from its ideal time due to imperfect matching between the time base of the signal being measured and the time base of the analyzer, and also because of imperfect setting of the period parameter. But the synchronization is restored on the next even-second clock event. ("Accumulated offset" is described in the in the **Offset** function section.)

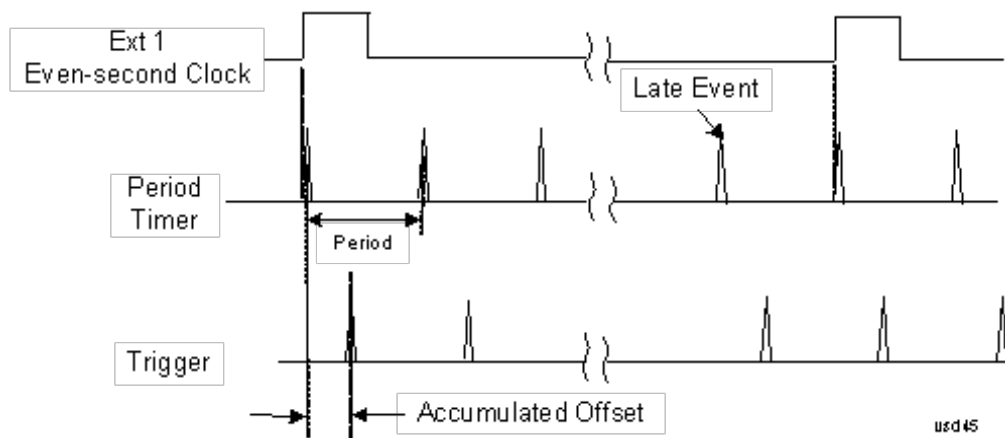

Period

Sets the period of the internal periodic timer clock. For digital communications signals, this is usually set to the frame period of your current input signal. In the case that sync source is not set to OFF, and the external sync source rate is changed for some reason, the periodic timer is synchronized at the every external synchronization pulse by resetting the internal state of the timer circuit.

Key Path	Trigger, Periodic Timer
Remote Command	:TRIGger[:SEquence]:FRAME:PERiod <time>

	:TRIGger[:SEquence]:FRAMe:PERiod?
Example	TRIG:FRAM:PER 100 ms
Dependencies	The invalid data indicator turns on when the period is changed, until the next sweep/measurement completes.
Couplings	The same period is used in the Gate Source selection of the period timer.
Preset	20 ms GSM: 4.615383
State Saved	Saved in instrument state
Min	100.000 ns
Max	559.0000 ms
Default Unit	S
Initial S/W Revision	Prior to A.02.00

Offset

Adjusts the accumulated offset between the periodic timer events and the trigger event. Adjusting the accumulated offset is different than setting an offset, and requires explanation.

The periodic timer is usually not synchronized with any external events, so the timing of its output events has no absolute meaning. Since the timing relative to external events (RF signals) is important, you need to be able to adjust (offset) it. However, you have no direct way to see when the periodic timer events occur. All that you can see is the trigger timing. When you want to adjust the trigger timing, you will be changing the internal offset between the periodic timer events and the trigger event. Because the absolute value of that internal offset is unknown, we will just call that the accumulated offset. Whenever the Offset parameter is changed, you are changing that accumulated offset. You can reset the displayed offset using Reset Offset Display. Changing the display does not change the value of the accumulated offset, and you can still make additional changes to accumulated offset.

To avoid ambiguity, we define that an increase in the "offset" parameter, either from the knob or the SCPI adjust command, serves to delay the timing of the trigger event.

Key Path	Trigger, Periodic Timer
Remote Command	:TRIGger[:SEquence]:FRAMe:OFFSet <time> :TRIGger[:SEquence]:FRAMe:OFFSet?
Example	TRIG:FRAM:OFFS 1.2 ms
Notes	The front panel interface (for example, the knob), and this command, adjust the accumulated offset, which is shown on the active function display. However, the actual amount sent to the hardware each time the offset is updated is the delta value, that is, the current accumulated offset value minus the previous accumulated offset value. Note that the accumulated offset value is essentially arbitrary; it represents the accumulated offset from the last time the offset was zeroed (with the Reset Offset Display key). Note that this command does not change the period of the trigger waveform. Note also that Offset is used only when the sync source is set to OFF, otherwise delay is used, see section "Trig Delay" on page 460.

	An increase in the "offset" parameter, either from the knob or the SCPI adjust command, serves to delay the timing of the trigger event.
Notes	When the SCPI command is sent the value shown on the key (and the Active Function, if this happens to be the active function) is updated with the new value. However, the actual amount sent to the hardware is the delta value, that is, the current accumulated offset value minus the previous accumulated offset value. The SCPI query simply returns the value currently showing on the key.
Dependencies	The invalid data indicator turns on when the offset is changed, until the next sweep/measurement completes.
Couplings	The same offset is used in the Gate Source selection of the period timer.
Preset	0 s
State Saved	Saved in instrument state
Min	-10.000 s
Max	10.000 s
Default Unit	S
Initial S/W Revision	Prior to A.02.00

Offset Adjust (Remote Command Only)

This remote command does not work at all like the related front panel keys. This command lets you advance the phase of the frame trigger by the amount you specify.

It does not change the period of the trigger waveform. If the command is sent multiple times, it advances the phase of the frame trigger an additional amount each time it is sent. Negative numbers are permitted.

Remote Command	:TRIGger[:SEquence]:FRAMe:ADJust <time>
Example	TRIG:FRAM:ADJ 1.2 ms
Notes	Note also that Offset is used only when the sync source is set to OFF, otherwise delay is used, see section "Trig Delay" on page 460 An increase in the "offset" parameter, either from the knob or the SCPI adjust command, serves to delay the timing of the trigger event.
Notes	The front panel interface (for example, the knob) and the :TRIG:FRAM:OFFS command adjust the accumulated offset, which is shown on the active function display. However, the actual amount sent to the hardware is the delta value, that is, the current offset value minus the previous offset value. When the SCPI command is sent the value shown on the key (and the Active Function, if this happens to be the active function) is updated by increasing it (or decreasing it if the value sent is negative) by the amount specified in the SCPI command. This is a "command only" SCPI command, with no query.
Dependencies	The invalid data indicator turns on when the offset is changed, until the next sweep/measurement completes.
Couplings	The same offset is used in the Gate Source selection of the period timer.
Preset	0 s

State Saved	Saved in instrument state
Min	-10.000 s
Max	10.000 s
Default Unit	S
Initial S/W Revision	Prior to A.02.00

Reset Offset Display

Resets the value of the periodic trigger offset display setting to 0.0 seconds. The current displayed trigger location may include an offset value defined with the Offset key. Pressing this key redefines the currently displayed trigger location as the new trigger point that is 0.0 s offset. The Offset key can then be used to add offset relative to this new timing.

Key Path	Trigger, Periodic Timer
Remote Command	:TRIGger[:SEquence]:FRAMe:OFFSet:DISPlay:RESet
Example	TRIG:FRAM:OFFS:DISP:RES
Initial S/W Revision	Prior to A.02.00

Sync Source

Selects a signal source for you to synchronize your periodic timer trigger to, otherwise you are triggering at some arbitrary location in the frame. Synchronization reduces the precision requirements on the setting of the period.

For convenience you may adjust the level and slope of the selected sync source in a conditional branch setup menu accessed from the Sync Source menu. Note that these settings match those in the **Trigger** and **Gate Source** menus; that is, each trigger source has only one value of level and slope, regardless of which menu it is accessed from.

Key Path	Trigger, Periodic Timer
Remote Command	:TRIGger[:SEquence]:FRAMe:SYNC EXTernal1 EXTernal2 RFBurst OFF :TRIGger[:SEquence]:FRAMe:SYNC?
Example	TRIG:FRAM:SYNC EXT2
Dependencies	In some models, there is no second External input. In these models, the External 2 key is blanked and the EXTernal2 parameter will generate a "Hardware missing; Not available for this model number" message.
Preset	Off GSM/EDGE, MSR,LTE,LTETDD: RFBurst
State Saved	Saved in instrument state
Readback	The current setting is read back to this key and it is also Readback to the previous Periodic Timer trigger key.

Backwards Compatibility SCPI	:TRIGger[:SEquence]:FRAMe:SYNC EXTernal
Initial S/W Revision	Prior to A.02.00
Modified at S/W Revision	A.03.00, A.14.00

Off

Turns off the sync source for your periodic trigger. With the sync source off, the timing will drift unless the signal source frequency is locked to the analyzer frequency reference.

Key Path	Trigger, Periodic Timer, Sync Source
Example	TRIG:FRAM:SYNC OFF
Readback	Off
Initial S/W Revision	Prior to A.02.00

External 1

Pressing this key, when it is not selected, selects an external input signal as the trigger. A new sweep/measurement will start when the external trigger condition is met using the external 1 input connector on the rear panel.

Pressing this key, when it is already selected, accesses the external 1 trigger setup menu.

Key Path	Trigger
Example	TRIG:SOUR EXT1 Swept SA measurement TRIG:<meas>:SOUR EXT1 Measurements other than Swept SA
Dependencies	Grayed out if in use by Point Trigger in the Source Setup menu. Forced to Free Run if already selected and Point Trigger is set to External 1.
State Saved	Saved in instrument state
Status Bits/OPC dependencies	The Status Operation Register bit 5 "Waiting for Trigger" is set at the same time as the Sweeping or Measuring bit is set. It is cleared when the trigger actually occurs (that is, after the trigger event occurs and all the applicable trigger criteria have been met). A corresponding pop-up message ("Waiting for trigger") is generated if no trigger signal appears after approximately 2 sec. This message goes away when a trigger signal appears.
Initial S/W Revision	Prior to A.02.00

Trigger Level

Sets the value where the external 1 trigger input will trigger a new sweep/measurement.

Key Path	Trigger, External 1
Remote Command	:TRIGger[:SEquence]:EXTernal1:LEVel <level> :TRIGger[:SEquence]:EXTernal1:LEVel?
Example	TRIG:EXT1:LEV 0.4 V
Couplings	This same level is used for the Ext1 trigger source in the Trigger menu, for the Ext1 selection in the Periodic Timer sync source (in the Trigger menu and in the Gate Source menu), and also for the Ext1 selection in the Gate Source menu.
Preset	1.2 V
State Saved	Saved in instrument state
Min	-5 V
Max	5 V
Default Unit	V
Backwards Compatibility SCPI	:TRIGger[:SEquence]:EXTernal:LEVel For backward compatibility, the parameter EXTernal is mapped to EXTernal1
Backwards Compatibility SCPI	:TRIGger[:SEquence]:FRAMe:EXTernal1:LEVel
Initial S/W Revision	Prior to A.02.00

Trig Slope

Controls the trigger polarity. It is set positive to trigger on a rising edge and negative to trigger on a falling edge.

Key Path	Trigger, External 1
Remote Command	:TRIGger[:SEquence]:EXTernal1:SLOPe POSitive NEGative :TRIGger[:SEquence]:EXTernal1:SLOPe?
Example	TRIG:EXT1:SLOP NEG
Couplings	This same slope is used in the Ext1 selection for the trigger source in the Trigger menu and for the period timer sync source (in the Trigger menu and in the Gate Source menu).
Preset	POSitive
State Saved	Saved in instrument state
Backwards Compatibility SCPI	:TRIGger[:SEquence]:EXTernal:SLOPe For backward compatibility, the parameter EXTernal is mapped to EXTernal1
Backwards Compatibility SCPI	:TRIGger[:SEquence]:FRAMe:EXTernal1:SLOPe
Backwards Compatibility Notes	The legacy :TRIGger[:SEquence]:SLOPe command affects the slopes for the VID, LINE, EXT1, EXT2, and RFB triggers.
Initial S/W Revision	Prior to A.02.00

External 2

Pressing this key, when it is not selected, selects an external input signal as the trigger. A new sweep/measurement will start when the external trigger condition is met using the external 2 input connector. The external trigger 2 input connector is on the rear panel.

Pressing this key, when it is already selected, accesses the external 2 trigger setup menu.

Key Path	Trigger
Example	TRIG:SOUR EXT2 Swept SA measurement TRIG:<meas>:SOUR EXT2 Measurements other than Swept SA
Dependencies	In some models, there is no second External input. In these models, the External 2 key is blanked and the EXTERNAL2 parameter will generate a "Hardware missing; Not available for this model number" message. Grayed out if in use by Point Trigger in the Source Setup menu. Forced to Free Run if already selected and Point Trigger is set to External 2.
State Saved	Saved in instrument state
Status Bits/OPC dependencies	The Status Operation Register bit 5 "Waiting for Trigger" is set at the same time as the Sweeping or Measuring bit is set. It is cleared when the trigger actually occurs (that is, after the trigger event occurs and all the applicable trigger criteria have been met). A corresponding pop-up message ("Waiting for trigger") is generated if no trigger signal appears after approximately 2 sec. This message goes away when a trigger signal appears.
Initial S/W Revision	Prior to A.02.00
Modified at S/W Revision	A.03.00

Trigger Level

Sets the value where the external 2 trigger input will trigger a new sweep/measurement.

Key Path	Trigger, External 2
Remote Command	:TRIGger[:SEquence]:EXTernal2:LEVel :TRIGger[:SEquence]:EXTernal2:LEVel?
Example	TRIG:EXT2:LEV 1.1 V
Couplings	This same level is used for the Ext2 trigger source in the Trigger menu, for the Ext2 selection in the Periodic Timer sync source (in the Trigger menu and in the Gate Source menu), and also for the Ext2 selection in the Gate Source menu.
Preset	1.2 V
State Saved	Saved in instrument state
Min	-5 V
Max	5 V
Default Unit	V
Backwards Compatibility SCPI	:TRIGger[:SEquence]:FRAME:EXTernal2:LEVel
Initial S/W Revision	Prior to A.02.00

Trig Slope

Controls the trigger polarity. It is set positive to trigger on a rising edge and negative to trigger on a falling edge.

Key Path	Trigger, External 2
Remote Command	:TRIGger[:SEquence]:EXTernal2:SLOPe POSitive NEGative :TRIGger[:SEquence]:EXTernal2:SLOPe?
Example	TRIG:EXT2:SLOP NEG
Couplings	This same slope is used in the Ext2 selection for the trigger source in the Trigger menu and for the period timer sync source (in the Trigger menu and in the Gate Source menu).
Preset	POSitive
State Saved	Saved in instrument state
Backwards Compatibility SCPI	:TRIGger[:SEquence]:FRAMe:EXTernal2:SLOPe
Backwards Compatibility Notes	The legacy :TRIGger[:SEquence]:SLOPe command affects the slopes for the VID, LINE, EXT1, EXT2, and RFB triggers.
Initial S/W Revision	Prior to A.02.00

RF Burst

Pressing this key, when it is not selected, selects the RF Burst as the trigger. A new sweep/measurement will start when an RF burst envelope signal is identified from the signal at the RF Input connector. Pressing this key, when it is already selected, accesses the RF Burst trigger setup menu.

In some models, a variety of burst trigger circuitry is available, resulting in various available burst trigger bandwidths. The analyzer automatically chooses the appropriate trigger path based on the hardware configuration and other settings of the analyzer.

Key Path	Trigger
Example	TRIG:SOUR RFB Swept SA measurement TRIG:<meas>:SOUR RFB Measurements other than Swept SA
State Saved	Saved in instrument state
Status Bits/OPC dependencies	The Status Operation Register bit 5 "Waiting for Trigger" is set at the same time as the Sweeping or Measuring bit is set. It is cleared when the trigger actually occurs (that is, after the trigger event occurs and all the applicable trigger criteria have been met). A corresponding pop-up message ("Waiting for trigger") is generated if no trigger signal appears after approximately 2 sec. This message goes away when a trigger signal appears.
Backwards Compatibility Notes	The legacy command: :TRIGger[:SEquence]:RFBurst:FSElectivity[:STATe] OFF ON 0 1 is not supported in the X-Series, as the hardware to do Frequency Selective burst triggers does not exist in X-Series.

Initial S/W Revision	Prior to A.02.00
Modified at S/W Revision	A.04.00

Absolute Trigger Level

Sets the absolute trigger level for the RF burst envelope.

When using the External Mixing path, the Absolute Trigger Level is uncalibrated because the factory default was set to accommodate the expected IF levels for the RF path.

Key Path	Trigger, RF Burst
Scope	Meas Global
Remote Command	:TRIGger[:SEquence]:RFBurst:LEVel:ABSolute <ampl> :TRIGger[:SEquence]:RFBurst:LEVel:ABSolute?
Example	TRIG:RFB:LEV:ABS 10 dBm sets the trigger level of the RF burst envelope signal to the absolute level of 10 dBm
Notes	Sending this command does not switch the setting from relative to absolute; to switch it you need to send the :TRIGger[:SEquence]:RFBurst:LEVel:TYPE command, below. Amplitude Corrections are not taken into account by the Absolute Trigger Level. For example, if you have given yourself effective gain with an amplitude correction factor, the Absolute Trigger will not fire until you have set the trigger level that far below the displayed signal level, rather than simply to the displayed signal level. This is only true for Amplitude Corrections, not External Gain or Ref Level Offset functions. If mode is Bluetooth, the default value is -50 dBm.
Couplings	This same level is used for the RF Burst trigger source in the Trigger menu, for the RF Burst selection in the Periodic Timer sync source (in the Trigger menu and in the Gate Source menu), and also for the RF Burst selection in the Gate Source menu
Preset	-20 dBm
State Saved	Saved in instrument state
Min	-200 dBm
Max	100 dBm
Default Unit	depends on the current selected Y-Axis unit
Backwards Compatibility SCPI	:TRIGger[:SEquence]:FRAME:RFBurst:LEVel:ABSolute
Initial S/W Revision	Prior to A.02.00
Modified at S/W Revision	A.04.00

Key Path	Trigger, RF Burst
Remote Command	:TRIGger[:SEquence]:RFBurst:LEVel:TYPE ABSolute RELative :TRIGger[:SEquence]:RFBurst:LEVel:TYPE?

Example	TRIG:RFB:LEV:TYPE REL sets the trigger level type of the RF burst trigger to Relative.
Preset	ABSolute
State Saved	Saved in instrument state
Initial S/W Revision	Prior to A.02.00
Modified at S/W Revision	A.04.00

Trigger Slope

It is set positive to trigger on a rising edge and negative to trigger on a falling edge.

Key Path	Trigger, RF Burst
Remote Command	:TRIGger[:SEquence]:RFBurst:SLOPe POSitive NEGative :TRIGger[:SEquence]:RFBurst:SLOPe?
Example	TRIG:RFB:SLOP NEG
Couplings	This same slope is used in the RF Burst selection for the trigger source in the Trigger menu and for the period timer sync source (in the Trigger menu and in the Gate Source menu).
Preset	POSitive
State Saved	Saved in instrument state
Backwards Compatibility SCPI	:TRIGger[:SEquence]:FRAME:RFBurst:SLOPe
Backwards Compatibility Notes	The legacy :TRIGger[:SEquence]:SLOPe command affects the slopes for the VID, LINE, EXT1, EXT2, and RFB triggers.
Initial S/W Revision	Prior to A.02.00

Sync Holdoff

Sync Holdoff specifies the duration that the sync source signal must be kept false before the transition to true to be recognized as the sync timing. The periodic timer phase is aligned when the sync source signal becomes true, after the Holdoff time is satisfied.

A holdoff of 2 ms will work with most WiMAX signals, but there may be cases where the burst off duration is less than 1 ms and this value will need to be changed.

Key Path	Trigger, Periodic Timer
Remote Command	:TRIGger[:SEquence]:FRAME:SYNC:HOLDoff <time> :TRIGger[:SEquence]:FRAME:SYNC:HOLDoff? :TRIGger[:SEquence]:FRAME:SYNC:HOLDoff:STATe OFF ON 0 1 :TRIGger[:SEquence]:FRAME:SYNC:HOLDoff:STATe?
Preset	On, 1.000 ms

State Saved	Saved in instrument state
Min	0 ms
Max	+500 ms
Default Unit	s
Initial S/W Revision	Prior to A.02.00

Control Edge/Level

Sets the method of controlling the gating function from the gating signal.

Edge

In Edge triggering, the gate opens (after the Delay) on the selected edge (for example, positive) of the gate signal and closes on the alternate edge (for example, negative).

Level

In Level triggering, the gate opens (after the Delay) when the gate signal has achieved a certain level and stays open as long as that level is maintained.

Key Path	Sweep/Control, Gate
Remote Command	[:SENSe] :SWEp:EGATe:CONTRol EDGE LEVe1 [:SENSe] :SWEp:EGATe:CONTRol?
Example	SWE:EGAT:CONT EDGE
Dependencies	If the Gate Method is FFT the Control key is grayed out and Edge is selected. If the Gate Source is TV, Frame or Line, the Control key is grayed out and Edge is selected.
Preset	EDGE
State Saved	Saved in instrument state
Backwards Compatibility SCPI	[:SENSe] :SWEp:TIME:GATE:TYPE ESA Compatibility
Initial S/W Revision	Prior to A.02.00

Gate Holdoff

Lets you increase or decrease the wait time after a gate event ends before the analyzer will respond to the next gate signal.

After any Gate event finishes, the analyzer must wait for the sweep system to settle before it can respond to another Gate signal. The analyzer calculates a "wait time," taking into account a number of factors, including RBW and Phase Noise Optimization settings. The goal is to achieve the same accuracy when gated as in ungated operation. The figure below illustrates this concept:

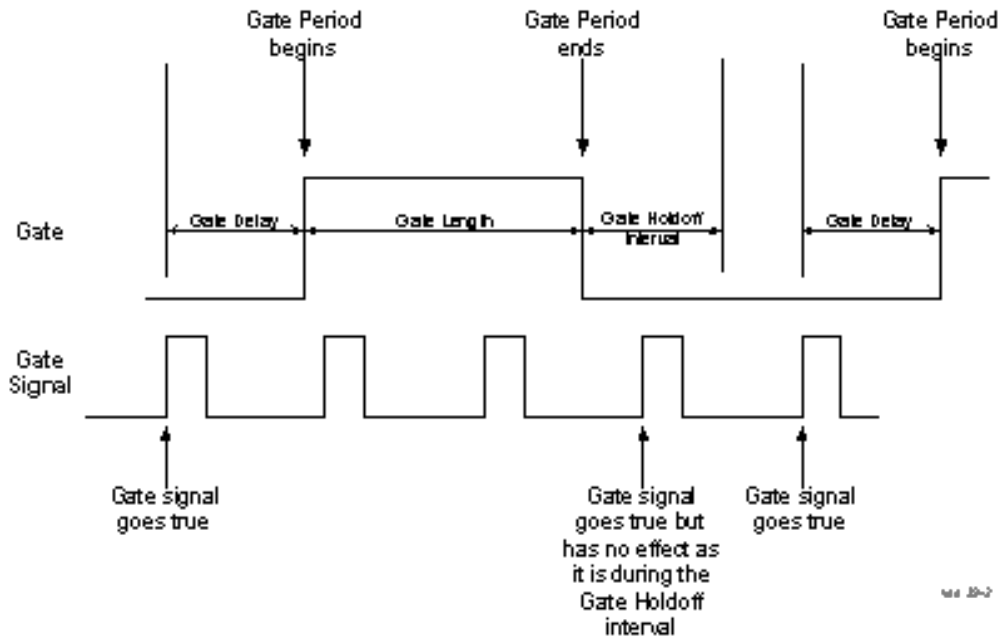

When Gate Holdoff is in Auto, the wait time calculated by the analyzer is used. When Gate Time is in Manual, the user may adjust the wait time, usually decreasing it in order to achieve greater speed, but at the risk of decreasing accuracy.

When the Method key is set to Video or FFT, the Gate Holdoff function has no effect.

In measurements that do not support Auto, the value shown when Auto is selected is “---” and the manually set holdoff is returned to a query.

Key Path	Sweep/Control, Gate
Remote Command	<pre>[:SENSe] :SWEep:EGATe:HOLDoff <time> [:SENSe] :SWEep:EGATe:HOLDoff? [:SENSe] :SWEep:EGATe:HOLDoff:AUTO OFF ON 0 1 [:SENSe] :SWEep:EGATe:HOLDoff:AUTO?</pre>
Example	<pre>SWE:EGAT:HOLD 0.0002 SWE:EGAT:HOLD? SWE:EGAT:HOLD:AUTO ON SWE:EGAT:HOLD:AUTO?</pre>
Couplings	<p>When Gate Holdoff is Auto, the Gate Holdoff key shows the value calculated by the analyzer for the wait time.</p> <p>Pressing the Gate Holdoff key while it is in Auto and not selected, causes the key to become selected and allows the user to adjust the value. If the value is adjusted, the setting changes to Man.</p> <p>Pressing the Gate Holdoff key, while it is in Auto and selected, does not change the value of Gate Holdoff, but causes the setting to change to Man. Now the user can adjust the value.</p> <p>Pressing the key while it is in Man and selected, cause the value to change back to Auto.</p> <p>Pressing the key while it is in Man and not selected, causes the key to become selected and allows the user to adjust the value.</p>

	When Method is set to Video or FFT, the Gate Holdoff function has no effect.
Preset	Auto Auto/On
State Saved	Saved in instrument state
Min	1 µsec
Max	1 sec
Initial S/W Revision	Prior to A.02.00

Gate Delay Compensation

This function allows you to select an RBW-dependent value by which to adjust the gate delay, to compensate for changes in the delay caused by RBW effects.

You can select between uncompensated operation and two types of compensation, Delay Until RBW Settled and Compensate for RBW Group Delay.

See "[More Information](#)" on page 2127

Key Path	Sweep/Control, Gate
Scope	Meas Global
Remote Command	[:SENSe] :SWEep:EGATe:DELay:COMPensation:TYPE OFF SETTled GDELay [:SENSe] :SWEep:EGATe:DELay:COMPensation:TYPE?
Example	SWE:EGAT:DEL:COMP:TYPE SETT SWE:EGAT:DEL:COMP:TYPE?
Notes	Although this function is Meas Global, there are some measurements that do not support this function. In those measurements the operation will be Uncompensated. Going into one of those measurements will not change the Meas Global selection; it will simply display the grayed-out menu key with "Uncompensated" showing as the selection. This is a non-forceful grayout, so the SCPI command is still accepted. If Gate Delay Compensation is not supported at all within a particular mode, the key is not displayed, and if the SCPI command is sent while in a measurement within that mode, an "Undefined Header" message is generated. Measurements that do not support this function include: Swept SA
Preset	TD-SCDMA mode: Compensate for RBW Group Delay All other modes: Delay Until RBW Settled
State Saved	Saved in instrument state
Range	Uncompensated Delay Until RBW Settled Compensate for RBW Group Delay
Readback text	Uncompensated Settled Group Delay
Initial S/W Revision	Prior to A.02.00
Modified at S/W Revision	A.11.0

More Information

Selecting Uncompensated means that the actual gate delay is as you sets it.

Selecting Delay Until RBW Settled causes the gate delay to be increased above the user setting by an amount equal to $3.06/\text{RBW}$. This compensated delay causes the GATE START and GATE STOP lines on the display to move by the compensation amount, and the actual hardware gate delay to be increased by the same amount. All the other gate lines (for example, MIN FAST) are unaffected. If the RBW subsequently changes, the compensation is readjusted for the new RBW. The value shown on the Gate Delay key does NOT change.

Delay Until RBW Settled allows excellent measurements of gated signals, by allowing the IF to settle following any transient that affects the burst. Excellent measurements also require that the analysis region not extend into the region affected by the falling edge of the burst. Thus, excellent measurements can only be made over a width that declines with narrowing RBWs, which is achieved by decreasing the gate length below the user setting by an amount equal to $2.53/\text{RBW}$. Therefore, for general purpose compensation, you will still want to change the gate length with changes in RBW even if the gate delay is compensated. The compensated Gate Length is limited by the analyzer so that it will never go below 10% of the value shown on the Gate Length key, as otherwise the sweep times could get very long. Anytime the Gate Length and RBW values combine in such a way that this limiting takes place, a warning is displayed. For measurements which contain multiple sweeps with different RBW like SEM and SPUR, the smallest RBW is used for this limiting.

Selecting Compensate for RBW Group Delay causes the gate delay to be increased above the user setting by an amount equal to $1.81/\text{RBW}$. This compensated delay causes the GATE START, GATE STOP lines on the display to move by the compensation amount, and the actual hardware gate delay to be increased by the same amount. All the other gate lines (for example, MIN FAST) are unaffected. If the RBW subsequently changes, the compensation is readjusted for the new RBW. The value shown on the Gate Delay key does NOT change. Compensate for RBW Group Delay also includes gate length compensation; the gate length itself is adjusted as necessary to attempt to compensate for delay effects imposed by the RBW.

Compensate for RBW Group Delay is similar to Delay Until RBW Settled, but compensates for the group delay of the RBW filter, rather than the filter settling time. As the RBW gets narrow, this can allow the settling tail of the RBW to affect the beginning part of the gated measurement, and allow the beginning of the RBW settling transient to affect the end of the gated measurement. These two effects are symmetric because the RBW response is symmetric. Because the gate length is not automatically compensated, some users might find this compensation to be more intuitive than compensation for RBW settling.

Min Fast Position Query (Remote Command Only)

This command queries the position of the MIN FAST line, relative to the delay reference (REF) line. See section "[Gate View On/Off](#)" on page 2098. If this query is sent while not in gate view, the MinFast calculation is performed based on the current values of the appropriate parameters and the result is returned. Knowing this value lets you set an optimal gate delay value for the current measurement setup.

Remote Command	[:SENSe] :SWEep:EGATe:MINFast?
Example	SWE:EGAT:MIN?
Initial S/W Revision	Prior to A.02.00

Gate Preset (Remote Command Only)

Presets the time-gated spectrum analysis capability.

This command sets gate parameter values to the ESA preset values, as follows:

Gate trigger type = edge

Gate polarity = positive

Gate delay = 1 us

Gate length = 1 us

Remote Command	<code>[:SENSe]:SWEep:TIME:GATE:PRESet</code> ESA Compatibility
Initial S/W Revision	Prior to A.02.00

Gate Level (Remote Command Only)

Sets the gate input transition point level for the external TRIGGER inputs on the front and rear panel. This is a legacy command for PSA compatibility. It is simply an alias to the equivalent trigger level command.

Remote Command	<code>[:SENSe]:SWEep:EGATE:EXTErnal[1] 2:LEVel <voltage></code> <code>[:SENSe]:SWEep:EGATE:EXTErnal[1] 2:LEVel?</code>
Notes	This command is simply an alias to <code>:TRIGger[:SEQuence]:EXTErnal[1] 2:LEVel</code> For details refer
Initial S/W Revision	Prior to A.02.00

Gate Polarity (Remote Command Only)

Sets the polarity for the gate signal. This setup is now done using the gate trigger's slope setting.

When Positive (Pos) is selected, a positive-going edge (Edge) or a high voltage (Level) will satisfy the gate condition, after the delay set with the Gate Delay key. When Negative (Neg) is selected, a negative-going edge (Edge) or a low voltage (Level) will satisfy the gate condition after the delay.

Remote Command	<code>[:SENSe]:SWEep:EGATE:POLarity</code> NEGative POSitive <code>[:SENSe]:SWEep:EGATE:POLarity?</code>
Example	<code>SWE:EGAT:POL</code> NEG <code>SWE:EGAT:POL?</code>
Preset	POSitive
State Saved	Saved in instrument state
Backwards Compatibility SCPI	<code>[:SENSe]:SWEep:TIME:GATE:POLarity</code> ESA compatibility
Initial S/W Revision	Prior to A.02.00

Remote Command	[:SENSe] :SWEep:TIME:GATE:LEVel HIGH LOW [:SENSe] :SWEep:TIME:GATE:LEVel? ESA compatibility
Preset	HIGH
Initial S/W Revision	Prior to A.02.00

Points

Sets the number of points per sweep. The resolution of setting the sweep time depends on the number of points selected. If Preset is selected, the number of points per sweep defaults to 1001. The current value of points is displayed parenthetically, next to the sweep time in the lower right corner of the display.

Key Path	Sweep/Control
Mode	All except SA and BASIC
Remote Command	[:SENSe] :MONitor:SWEep:POINts <integer> [:SENSe] :MONitor:SWEep:POINts?
Example	:MON:SWE:POIN 1000 :MON:SWE:POIN?
Couplings	Whenever the number of sweep points changes, the sweep time is re-quantized.
Preset	1001
State Saved	Saved in instrument state.
Range	1 to 20001
Min	1
Max	20001
Initial S/W Revision	Prior to A.02.00

System

See "[System](#)" on page 353

Trace/Detector

Accesses a menu that enables you to control the display, storage, detection and manipulation of trace data. Each trace is comprised of a series of data points in which X and Y axis information is stored. The analyzer updates the information for the active trace with each sweep of the current measurement.

Key Path	Front-panel key
Initial S/W Revision	Prior to A.02.00

Select Trace

Allows you to select which trace you want to use for the current measurement. You can select one of three traces. Monitor Spectrum supports 3 traces, numbered 1 through 3.

Key Path	Trace/Detector
Mode	All except SA and BASIC
Preset	Trace 1
State Saved	The number of the selected trace is saved in Instrument State
Initial S/W Revision	Prior to A.02.00

Trace Type

Allows you to select the type of trace you want to use for the current measurement. You can assign a trace type to one of the three available traces.

The first page of this menu contains a 1–of–N selection of the trace type for the selected trace:

WRITe	Clear Write
AVERage	Average
MAXHold	Max Hold
MINHold	Min Hold

Key Path	Trace/Detector
Mode	All except SA and BASIC
Remote Command	:TRACe[1] 2 3:MONitor:TYPE WRITe AVERage MAXHold MINHold :TRACe[1] 2 3:MONitor:TYPE?
Example	TRAC:MON:TYPE WRIT TRAC:MON:TYPE?
Preset	WRITe
State Saved	Saved in instrument state.

Range	WRITE AVERage MAXHold MINHold for traces 1 through 3
Backwards Compatibility SCPI	:DISPlay:MONitor:VIEW:WINDow:TRACe[1] 2 3:TYPE
Initial S/W Revision	Prior to A.02.00

Update

Toggles a trace state between Update and Off. The Off selection makes the trace inactive (or a *stored trace*). This does not affect whether the trace is visible or not. To change the trace visibility, see ["Display" on page 2132](#).

Key Path	Trace/Detector
Mode	All except SA and BASIC
Remote Command	:TRACe[1] 2 3:MONitor:UPDate[:STATe] ON OFF 0 1 :TRACe[1] 2 3:MONitor:UPDate[:STATe]?
Example	TRAC3:MON:UPD OFF TRAC3:MON:UPD?
Preset	ON
State Saved	Saved in instrument state.
Range	On Off(View)
Initial S/W Revision	Prior to A.02.00

Display

Controls the visibility of a trace. When set to Blank, traces do not display nor appear on printouts but are otherwise unaffected. They may be queried and markers may be placed on them.

Key Path	Trace/Detector
Mode	All except SA and BASIC
Remote Command	:TRACe[1] 2 3:MONitor:DISPlay[:STATe] ON OFF 0 1 :TRACe[1] 2 3:MONitor:DISPlay[:STATe]?
Example	TRAC:MON:DISP ON TRAC:MON:DISP?
Preset	ON OFF OFF
State Saved	Saved in instrument state.
Range	Show Blank
Initial S/W Revision	Prior to A.02.00

Detector

Accesses a menu of functions that enable you to control the detectors for the current measurement. The following choices are available:

- **Auto** – the detector selected depends on marker functions, trace functions, average type, and the trace averaging function. See ["Auto" on page 2134](#).
- **Normal** – the detector determines the peak of the CW-like signals, and it yields alternating maximums and minimums of noise-like signals. This is also referred to as Rosenfell detection.
- **Average** – the detector determines the average of the signal within the sweep points. The averaging method depends upon the Average Type selection (voltage, power or log scales).
- **Peak** – the detector determines the maximum of the signal within the sweep points.
- **Sample** – the detector indicates the instantaneous level of the signal at the center of the sweep points represented by each display point.
- **Negative Peak** – the detector determines the minimum of the signal within the sweep points.

In swept analysis, the time interval of the data collection for the display sweep points also represents a frequency interval. In FFT analysis, the sweep points represent just a frequency interval. The detector determines the relationship between the spectrum computed by the FFT and the single data point displayed for the sweep points.

Key Path	Trace/Detector
Mode	All except SA and BASIC
Remote Command	[:SENSe]:MONitor:DETEctor:TRACe AVERage NEGative NORMal POSitive SAMPlE [:SENSe]:MONitor:DETEctor:TRACe?
Example	MON:DET:TRAC NORM MON:DET:TRAC?
Notes	The query returns a name that corresponds to the detector type as shown below. String Returned - Definition <ul style="list-style-type: none"> • NORM - Normal • AVER - Average • POS - Peak • SAMP - Sample • NEG - Negative Peak
Couplings	When the Detector choice is Auto, the detector selected depends on average type.
Preset	NORMAL
State Saved	Saved in instrument state.
Range	Normal Average(RMS) Peak Sample Negative Peak
Backwards Compatibility SCPI	[:SENSe]:MONitor:DETEctor[:FUNction]
Initial S/W Revision	Prior to A.02.00

Auto

Sets the detector for the currently selected trace to Auto. When the detector choice is Auto, the analyzer selects the detector. The selected detector depends on marker functions, trace functions, and trace averaging functions for the current measurement.

Key Path	Trace/DetectorTrace/Detector, Detector
Mode	All except SA and BASIC
Remote Command	<code>[:SENSe] :MONitor:DETECTOR:AUTO ON OFF 1 0</code> <code>[:SENSe] :MONitor:DETECTOR:AUTO?</code>
Example	MON:DET:AUTO OFF MON:DET:AUTO?
Couplings	When the Detector choice is Auto, the detector selected depends on average state and trace type.
Preset	ON
State Saved	Saved in instrument state.
Range	Auto Man
Initial S/W Revision	Prior to A.02.00

Clear Trace

Clears the selected trace from the display.

Key Path	Trace/Detector
Mode	All except SA and BASIC
Remote Command	<code>:TRACe:MONitor:CLEAr [TRACE1] TRACE2 TRACE3</code>
Example	TRAC:MON:CLE
Initial S/W Revision	Prior to A.02.00

Mode	All except SA and BASIC
Remote Command	<code>:DISPlay:MONitor:VIEW:WINDow:TRACe [1] 2 3:CLEAr</code>
Example	DISP:MON:VIEW:WIND:TRAC:CLE
Initial S/W Revision	Prior to A.02.00

Clear All Traces

Clears all traces from the display.

Key Path	Trace/Detector
Mode	All except SA and BASIC

Remote Command	:TRACe:MONitor:CLEar:ALL
Example	TRAC:MON:CLE:ALL
Backwards Compatibility SCPI	:DISPlay:MONitor:VIEW:WINDow:TRACe:CLEar:ALL
Initial S/W Revision	Prior to A.02.00

Trigger

See ["Trigger" on page 428](#)

Free Run

See ["Free Run " on page 435](#)

Video

See ["Video \(IF Envelope\) " on page 436](#)

Trigger Level

See ["Trigger Level " on page 436](#)

Trig Slope

See ["Trig Slope " on page 437](#)

Trig Delay

See ["Trig Delay " on page 438](#)

Line

See ["Line " on page 2105](#)

Trig Slope

See ["Trig Slope " on page 2105](#)

Trig Delay

See ["Trig Delay " on page 440](#)

External 1

See ["External 1 " on page 2118](#)

Trigger Level

See ["Trigger Level " on page 2118](#)

Trig Slope

See ["Trig Slope " on page 2119](#)

Trig Delay

See ["Trig Delay " on page 443](#)

Zero Span Delay Comp

See ["Zero Span Delay Comp On/Off" on page 2107](#)

External 2

See ["External 2 "](#) on page 2120

Trigger Level

See ["Trigger Level "](#) on page 2120

Trig Slope

See ["Trig Slope "](#) on page 2121

Trig Delay

See ["Trig Delay "](#) on page 445

Zero Span Delay Comp

See ["Zero Span Delay Comp On/Off"](#) on page 2109

RF Burst

See ["RF Burst "](#) on page 2121

Absolute Trigger

See ["Absolute Trigger Level"](#) on page 2122

Relative Trigger

See ["Relative Trigger Level"](#) on page 2111

Trig Slope

See ["Trigger Slope "](#) on page 2123

Trig Delay

See ["Trig Delay "](#) on page 450

Periodic Timer

See ["Periodic Timer \(Frame Trigger\) "](#) on page 2113

Period

See ["Period "](#) on page 2114

Offset

See ["Offset "](#) on page 2115

Reset Offset Display

See ["Reset Offset Display "](#) on page 2117

Sync Source

See ["Sync Source "](#) on page 2117

Off

See ["Off "](#) on page 2118

External 1

See ["External 1 "](#) on page 2118

Trigger Level

See ["Trigger Level "](#) on page 2118

Trig Slope

See ["Trig Slope "](#) on page 2119

External 2

See ["External 2 "](#) on page 2120

Trigger Level

See ["Trigger Level "](#) on page 2120

Trig Slope

See ["Trig Slope "](#) on page 2121

RF Burst

See ["RF Burst "](#) on page 2121

Absolute Trigger

See ["Absolute Trigger Level"](#) on page 2122

Trig Slope

See ["Trigger Slope "](#) on page 2123

Trig Delay

See ["Trig Delay"](#) on page 460

Auto/Holdoff

See ["Auto/Holdoff "](#) on page 461

Auto Trig

See ["Auto Trig "](#) on page 461

Trig Holdoff

See ["Trig Holdoff "](#) on page 462

User Preset

Accesses a menu that gives you the following three choices:

- User Preset – recalls a state previously saved using the Save User Preset function.
- User Preset All Modes – presets all of the modes in the analyzer
- Save User Preset– saves the current state for the current mode

Key Path	Front-panel key
Backwards Compatibility Notes	<p>User Preset is actually loading a state, and in legacy analyzers, it was possible to load a state without affecting the trace data, limit lines or correction data. Similarly it was possible to do a User Preset without affecting the trace data, limit lines or correction data.</p> <p>In the X-Series, “state” always includes all of this data; so whenever state is loaded, or User Preset is executed, all of the traces, limit lines and corrections are affected. Although this differs from previous behavior, it is desirable behavior, and should not cause adverse issues for users.</p> <p>On ESA and PSA, User Preset affected the entire instrument’s state. In the X-Series, User Preset only recalls the state for the active mode. There is a User Preset file for each mode. User Preset can never cause a mode switch as it can in legacy analyzers. If you want to recall all modes to their user preset file state, you will need to do a User Preset after mode switching into each mode.</p> <p>User Preset recalls mode state which can now include data like traces; whereas on ESA and PSA, User Preset did not affect data.</p>
Initial S/W Revision	Prior to A.02.00

User Preset

User Preset sets the state of the currently active mode back to the state that was previously saved for this mode using the Save User Preset menu key or the SCPI command, SYST:PRES:USER:SAV. It not only recalls the Mode Preset settings, but it also recalls all of the mode persistent settings, and the Input/Output system setting that existed at the time Save User Preset was executed.

If a Save User Preset has not been done at any time, User Preset recalls the default user preset file for the currently active mode. The default user preset files are created if, at power-on, a mode detects there is no user preset file. There will never be a scenario when there is no user preset file to restore. For each mode, the default user preset state is the same state that would be saved if a Save User Preset is performed in each mode right after doing a Restore Mode Default and after a Restore Input/Output Defaults.

The User Preset function does the following:

- Aborts the currently running measurement.
- Sets the mode State to the values defined by Save User Preset.
- Makes the saved measurement for the currently running mode the active measurement.
- Brings up the saved menu for the power-on mode.
- Clears the input and output buffers.
- Sets the Status Byte to 0.

Key Path	User Preset
Remote Command	:SYSTem:PRESet:USER
Example	:SYST:PRES:USER:SAVE:SYST:PRES:USER
Notes	:SYST:PRES:USER:SAVE is used to save the current state as the user preset state. Clears all pending OPC bits. The Status Byte is set to 0. Pressing the User Preset front-panel key while already in the User Preset menu will cause the User Preset to get executed
Couplings	A user preset will cause the currently running measurement to be aborted and cause the saved measurement to be active. Recalling a User Preset file has the same issues that recalling a Save State file has. Some settings may need to be limited and therefore re-coupled, since the capabilities of the mode may have changes when the User Preset file was last saved.
Initial S/W Revision	Prior to A.02.00

User Preset All Modes

Recalls all of the User Preset files for each mode, switches to the power-on mode, and activates the saved measurement from the power-on mode User Preset file.

NOTE

When the instrument is secured, all of the user preset files are converted back to their default user preset files.

The User Preset function does the following:

- Aborts the currently running measurement.
- Switches the Mode to the power-on mode.
- Restores the User Preset files for each mode.
- Makes the saved measurement for the power-on mode the active measurement.
- Brings up the saved menu for the power-on mode.
- Clears the input and output buffers.
- Sets the Status Byte to 0.

Key Path	User Preset
Remote Command	:SYSTem:PRESet:USER:ALL
Example	:SYST:PRES:USER:SAVE:SYST:PRES:USER:ALL
Notes	Clears all pending OPC bits. The Status Byte is set to 0. :SYST:PRES:USER:SAVE is used to save the current state as the user preset state.
Couplings	A user preset will cause the currently running measurement to be aborted, cause a mode switch to the power-on mode, and cause the saved measurement to be active in the power-on mode. Recalling a User Preset file has the same issues that recalling a Save State file has. Some settings may need to be limited and therefore re-coupled, since the capabilities of the mode may have changes when the User Preset file was last saved.
Initial S/W Revision	Prior to A.02.00

Save User Preset

Saves the currently active mode and its State. You can recall this User Preset file by pressing the User Preset menu key or sending the SYST:PRES:USER remote command. This same state is also saved by the Save State function.

Key Path	User Preset
Remote Command	:SYSTem:PRESet:USER:SAVE
Example	:SYST:PRES:USER:SAVE
Notes	:SYST:PRES:SAVE creates the same file as if the user requested a *SAV or a MMEM:STOR:STAT, except User Preset Save does not allow the user to specify the filename or the location of the file.
Initial S/W Revision	Prior to A.02.00

View/Display

Accesses a menu of functions that enable you to control certain functions related to the display of the analyzer.

The available views and related commands depend on the currently-selected mode. This section includes the following topics:

- ["View for all modes except MSR, 1xEV-DO, LTE-Advanced FDD/TDD" on page 2142](#), LTE-Advanced FDD/TDD
- ["1xEV-DO Mode View" on page 2143](#)
- ["MSR and LTE-Advanced FDD/TDD Mode Views" on page 2143](#)
- ["View Selection by Name \(MSR and LTE-Advanced FDD/TDD mode only\)" on page 2144](#)
- ["View Selection by Number \(MSR and LTE-Advanced FDD/TDD mode only\)" on page 2144](#)

View for all modes except MSR, 1xEV-DO, LTE-Advanced FDD/TDD

When the current mode is **not** MSR, LTE-Advanced FDD/TDD or 1xEV-DO, there is a single trace view for this measurement, as shown below:

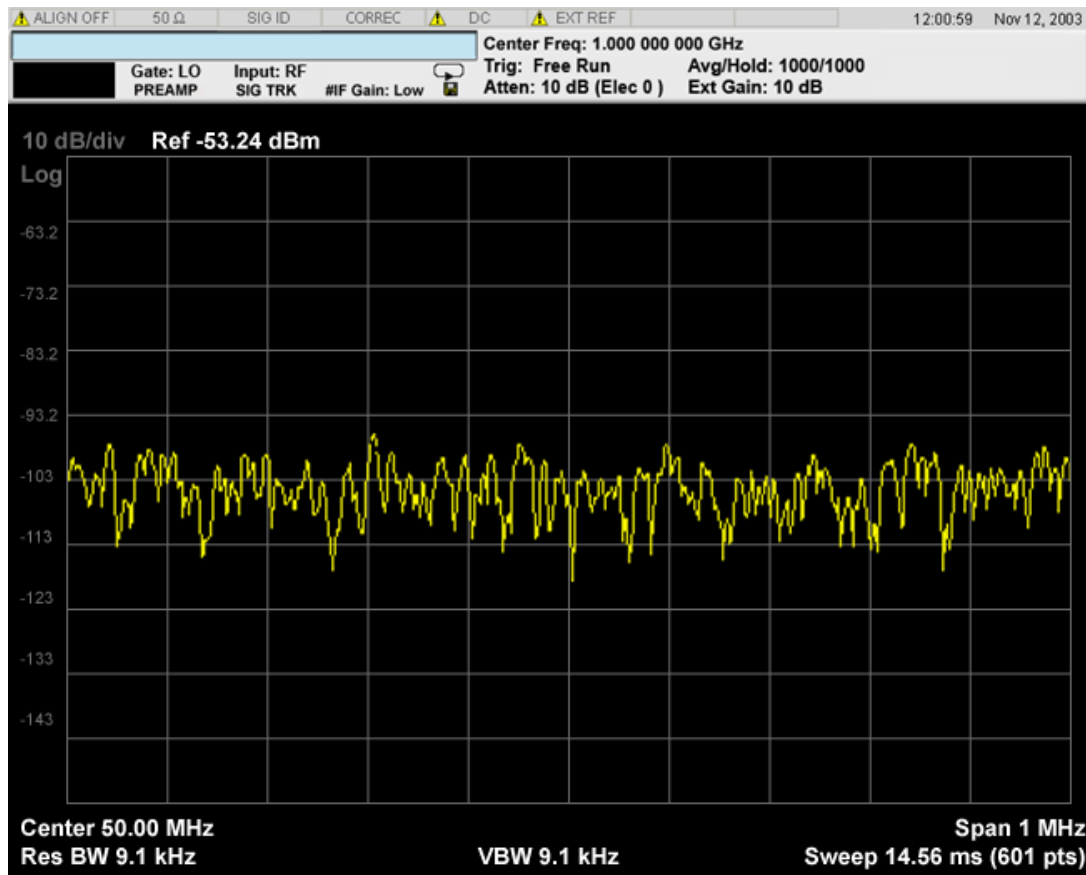

1xEV-DO Mode View

When the current mode is 1xEV-DO, a single view is available, as shown in the example below:

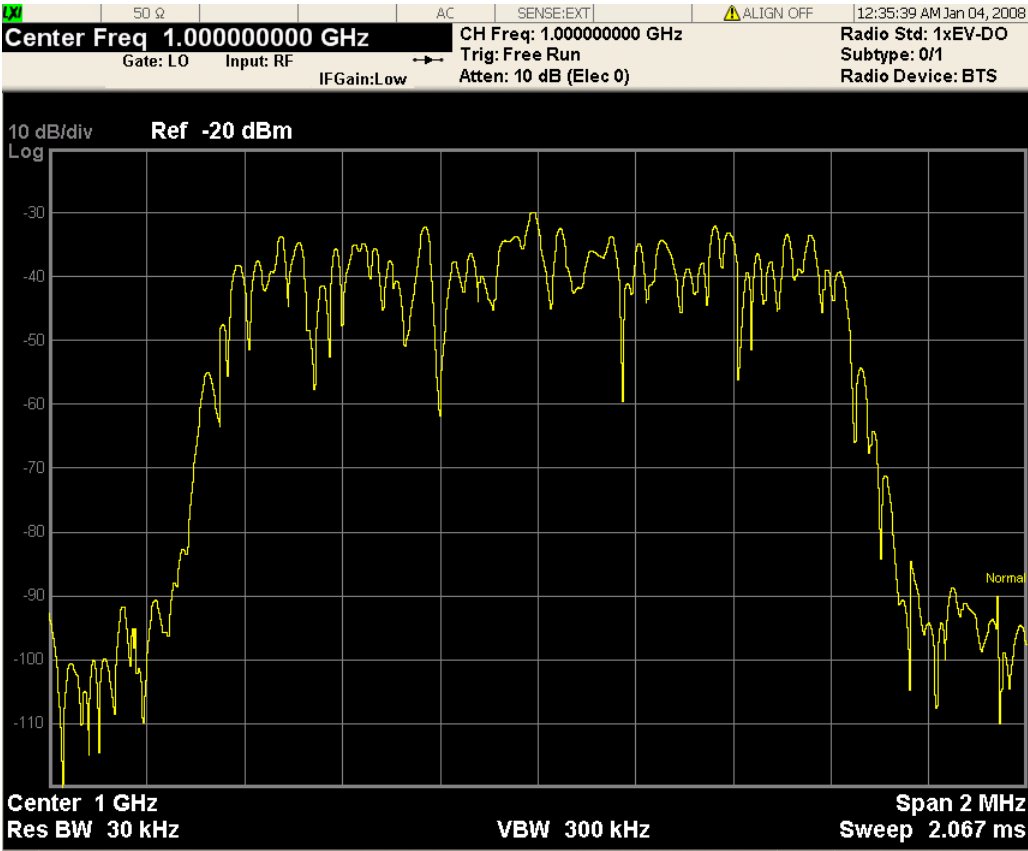

The measurement has no results, but has a number of features that make it flexible and simple to use.

MSR and LTE-Advanced FDD/TDD Mode Views

When the current mode is MSR and LTE-Advanced FDD/TDD, there are two views, Result Trace and Carrier Info, as described in the table below. The Result Trace view is the same as the common Monitor Spectrum view in other modes. Carrier Info is available on the spectrum trace.

Result Trace	The spectrum trace and power bars are displayed in the upper window. Carrier and offset powers are summarized in the lower window. For more details, see Result Trace (MSR and LTE-Advanced FDD/TDD mode only) .
Carrier Info	Carrier center frequency can be displayed in either offset or absolute frequency depending on Carrier Freq. The table can be scrolled by Select Carrier in the Config Carriers menu. The highlighted row changes as Select Carrier is changed. The highlighted row and Select Carrier are not coupled. For more details, see Carrier Info (MSR and LTE-Advanced FDD/TDD mode only) .

View Selection by Name (MSR and LTE-Advanced FDD/TDD mode only)

Key Path	Display
Mode	MSR, LTEAFDD, LTEATDD
Remote Command	:DISPlay:MONitor:VIEW[:SElect] RTRace CINformation :DISPlay:MONitor:VIEW[:SElect]?
Example	DISP:MON:VIEW RTR DISP:MON:VIEW?
Preset	RTRace
State Saved	Saved in instrument state
Range	Power Results Carrier Info
Initial S/W Revision	A.10.00

View Selection by Number (MSR and LTE-Advanced FDD/TDD mode only)

Key Path	DISP:MON:VIEW
Mode	MSR, LTEAFDD, LTEATDD
Remote Command	:DISPlay:MONitor:VIEW:NSElect <integer> :DISPlay:MONitor:VIEW:NSElect?
Example	DISP:MON:VIEW:NSEL 1 DISP:MON:VIEW:NSEL?
Preset	1
State Saved	Saved in instrument state
Min	1
Max	2
Initial S/W Revision	A.10.00

Key Path	Front-panel key
Initial S/W Revision	Prior to A.02.00

Display

The Display menu is common to most measurements, and is used for configuring items on the display. Some Display menu settings apply to all the measurements in a mode, and some only to the current measurement. Those under the System Display Settings key apply to all measurements in all modes.

Key Path	Display
Key Path	View/Display
Initial S/W Revision	Prior to A.02.00

Annotation

Turns on and off various parts of the display annotation. The annotation is divided up into four categories:

1. Meas Bar: This is the measurement bar at the top of the screen. It does not include the settings panel or the Active Function. Turning off the Meas Bar turns off the settings panel and the Active Function. When the Meas Bar is off, the graticule area expands to fill the area formerly occupied by the Meas Bar.
2. Screen Annotation: this is the annotation and annunciation around the graticule, including any annotation on lines (such as the display line, the threshold line, etc.) This does NOT include the marker number or the N dB result. When off, the graticule expands to fill the entire graticule area.
3. Trace annotation: these are the labels on the traces, showing their detector (or their math mode).
4. Active Function annotation: this is the active function display in the meas bar, and all of the active function values displayed on softkeys.

See the figure below. Each type of annotation can be turned on and off individually.

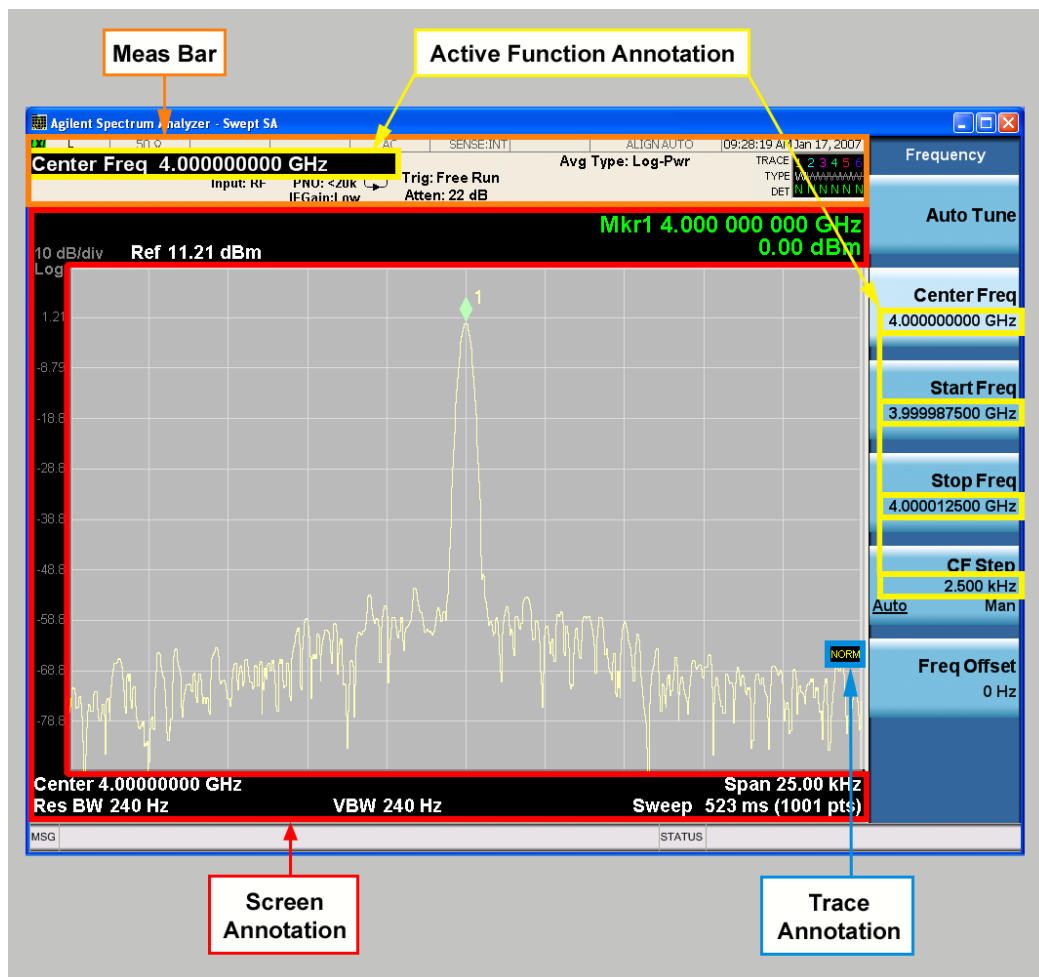

Key Path View/Display, Display

Initial S/W Revision Prior to A.02.00

Meas Bar On/Off

This function turns the Measurement Bar on and off, including the settings panel. When off, the graticule area expands to fill the area formerly occupied by the Measurement Bar.

Key Path	View/Display, Display, Annotation
Remote Command	:DISPlay:ANNOtation:MBAR[:STATe] OFF ON 0 1 :DISPlay:ANNOtation:MBAR[:STATe]?
Example	DISP:ANN:MBAR OFF
Dependencies	Grayed out and forced to OFF when System Display Settings, Annotation is set to Off.
Preset	On This should remain Off through a Preset when System DisplaySettings, Annotation is set to Off.
State Saved	Saved in instrument state.
Initial S/W Revision	Prior to A.02.00

Screen

This controls the display of the annunciation and annotation around the graticule, including any annotation on lines (such as the display line, the threshold line, etc.) and the y-axis annotation. This does NOT include marker annotation (or the N dB result). When off, the graticule expands to fill the entire graticule area, leaving only the 1.5% gap above the graticule as described in the Trace/Detector chapter.

Key Path	View/Display, Display, Annotation
Remote Command	:DISPlay:ANNOtation:SCREen[:STATe] OFF ON 0 1 :DISPlay:ANNOtation:SCREen[:STATe]?
Example	DISP:ANN:SCR OFF
Dependencies	Grayed-out and forced to OFF when System Display Settings, Annotation is set to Off.
Preset	On This should remain Off through a Preset when System DisplaySettings, Annotation is set to Off
State Saved	Saved in instrument state.
Initial S/W Revision	Prior to A.02.00

Active Function Values On/Off

Turns on and off the active function display in the Meas Bar, and all of the active function values displayed on the softkeys.

Note that all of the softkeys that have active functions have these numeric values blanked when this function is on. This is a security feature..

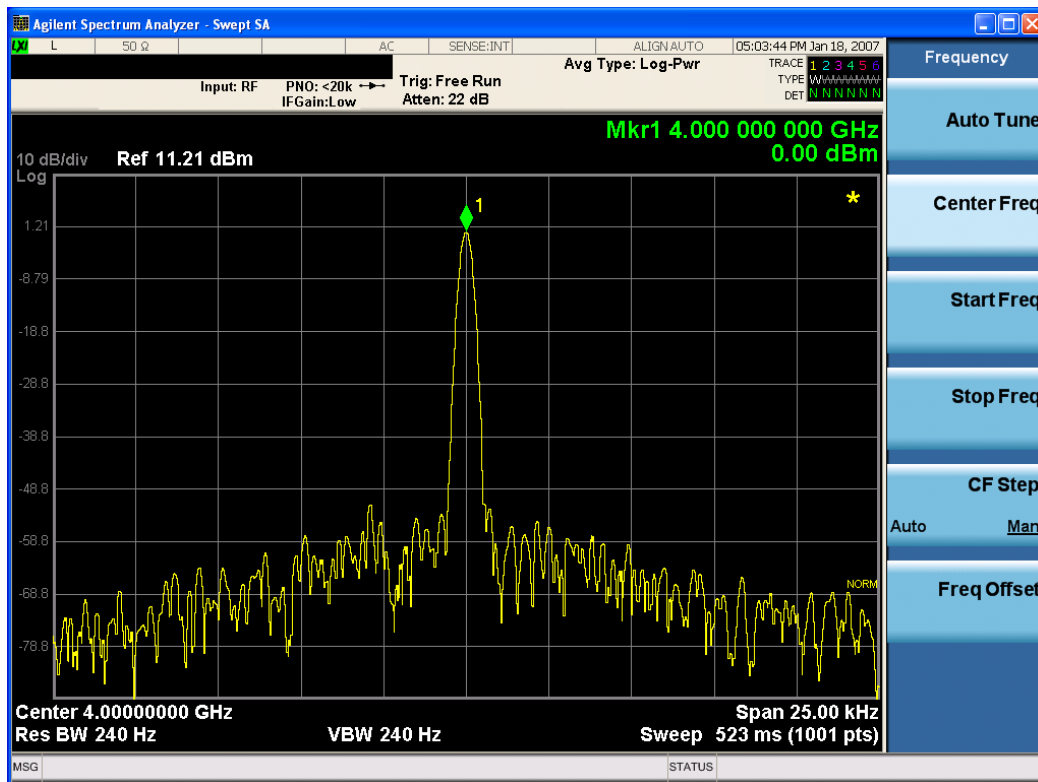

Key Path	View/Display, Display, Annotation
Remote Command	:DISPlay:ACTivefunc[:STATE] ON OFF 1 0 :DISPlay:ACTivefunc[:STATE]?
Example	DISP:ACT OFF
Dependencies	Grayed out and forced to OFF when System Display Settings, Annotation is set to Off.
Preset	On This should remain Off through a Preset when System DisplaySettings, Annotation is set to Off
State Saved	Saved in instrument state.
Initial S/W Revision	Prior to A.02.00

Title

Displays menu keys that enable you to change or clear a title on your display.

Key Path	View/Display, Display
Initial S/W Revision	Prior to A.02.00

Change Title

Writes a title into the "measurement name" field in the banner, for example, "Swept SA".

Press Change Title to enter a new title through the alpha editor. Press Enter or Return to complete the entry. Press ESC to cancel the entry and preserve your existing title.

The display title will replace the measurement name. It remains for this measurement until you press Change Title again, or you recall a state, or a Preset is performed. A title can also be cleared by pressing Title, Clear Title.

NOTE

Notice the inclusion of the <measurement> parameter in the command below. Because each measurement remembers the Display Title, the command must be qualified with the measurement name. For the Swept SA measurement this is not the case; no <measurement> parameter is used when changing the Display Title for the Swept SA measurement.

Key Path	View/Display, Display, Title
Mode	All
Remote Command	:DISPlay:<measurement>:ANNotation:TITLe:DATA <string> :DISPlay:<measurement>:ANNotation:TITLe:DATA?
Example	DISP:ANN:TITL:DATA "This Is My Title" This example is for the Swept SA measurement in the Spectrum Analyzer mode. The SANalyzer <measurement> name is not used. DISP:ACP:ANN:TITL:DATA "This Is My Title" This example is for Measurements other than Swept SA. Both set the title to: This Is My Title
Notes	Pressing this key cancels any active function. When a title is edited the previous title remains intact (it is not cleared) and the cursor goes at the end so that characters can be added or BKSP can be used to go back over previous characters.
Preset	No title (measurement name instead)
State Saved	Saved in instrument state.
Initial S/W Revision	Prior to A.02.00

Clear Title

Clears a title from the front-panel display. Once cleared, the title cannot be retrieved. After the title is cleared, the current Measurement Name replaces it in the title bar.

Key Path	View/Display, Display, Title
Example	The following commands clear the title and restore the measurement's original title: DISP:ANN:TITL:DATA "" This example is for the Swept SA measurement in the Spectrum Analyzer mode. The SANalyzer <measurement> name is not used. DISP:ACP:ANN:TITL:DATA "" This example is for ACP; in measurements other than Swept SA the measurement name is required.
Notes	Uses the :DISPlay:<measurement>:ANNotation:TITLe:DATA <string> command with an empty string (in the Swept SA, the <measurement> is omitted).
Preset	Performed on Preset.
Initial S/W Revision	Prior to A.02.00

Graticule

Pressing Graticule turns the display graticule On or Off. It also turns the graticule y-axis annotation on and off.

Key Path	View/Display, Display
Remote Command	:DISPlay:WINDow[1]:TRACe:GRATicule:GRID[:STATe] OFF ON 0 1 :DISPlay:WINDow[1]:TRACe:GRATicule:GRID[:STATe]?
Example	DISP:WIND:TRAC:GRAT:GRID OFF
Notes	The graticule is the set of horizontal and vertical lines that make up the grid/divisions for the x-axis and y-axis.
Preset	On
State Saved	Saved in instrument state
Initial S/W Revision	Prior to A.02.00

System Display Settings

These settings are "Mode Global" – they affect all modes and measurements and are reset only by Restore Misc Defaults or Restore System Defaults under System.

Key Path	View/Display, Display
Initial S/W Revision	Prior to A.02.00

Annotation Local Settings

This is a Mode Global override of the meas local annotation settings. When it is All Off, it forces ScreenAnnotation, Meas Bar, Trace, and Active Function Values settings to be OFF for all measurements in all modes. This provides the security based "annotation off" function of previous analyzers; hence it uses the legacy SCPI command.

When it is All Off, the Screen, Meas Bar, Trace, and Active Function Values keys under the Display, Annotation menu are grayed out and forced to Off. When Local Settings is selected, you are able to set the local annotation settings on a measurement by measurement basis.

Key Path	View/Display, Display, System Display Settings
Remote Command	:DISPlay:WINDow[1]:ANNOtation[:ALL] OFF ON 0 1 :DISPlay:WINDow[1]:ANNOtation[:ALL]?
Example	:DISP:WIND:ANN OFF
Preset	On (Set by Restore Misc Defaults)
State Saved	Not saved in instrument state.
Backwards Compatibility Notes	The WINDow parameter and optional subopcode is included for backwards compatibility but ignored – all windows are equally affected.
Initial S/W Revision	Prior to A.02.00

Themes

Accesses a menu of functions that enable you to choose the theme to be used when saving the screen image.

The **Themes** option is the same as the **Themes** option under the **Display** and **Page Setup** dialogs. It allows you to choose between themes to be used when saving the screen image.

Key Path	Save, Screen Image
Remote Command	:MMEMory:STORe:SCReen:THEMe TDColor TDMonochrome FCOLor FMONochrome :MMEMory:STORe:SCReen:THEMe?
Example	:MMEM:STOR:SCR:THEM TDM
Preset	3D Color; Is not part of Preset, but is reset by Restore Misc Defaults or Restore System Defaults All and survives subsequent running of the modes.
Readback	3D Color 3D Mono Flat Color Flat Mono
Backwards Compatibility Notes	In ESA and PSA we offer the choice of "Reverse Bitmap" or "Reverse Metafile" when saving screen images. This is much like the "Flat Color" theme available in X-Series. Also, if you selected Reverse Bitmap AND a black & white screen image, that would be much like "Flat Monochrome". In other words, each of the X-Series themes has a similar screen image type in ESA/PSA. But they are not identical.
Initial S/W Revision	Prior to A.02.00

3D Color

Selects a standard color theme with each object filled, shaded and colored as designed.

Key Path	Save, Screen Image, Themes
Example	MMEM:STOR:SCR:THEM TDC
Readback	3D Color
Initial S/W Revision	Prior to A.02.00

3D Monochrome

Selects a format that is like 3D color but shades of gray are used instead of colors.

Key Path	Save, Screen Image, Themes
Example	MMEM:STOR:SCR:THEM TDM
Readback	3D Mono
Initial S/W Revision	Prior to A.02.00

Flat Color

Selects a format that is best when the screen is to be printed on an ink printer.

Key Path	Save, Screen Image, Themes
Example	MMEM:STOR:SCR:THEM FCOL
Readback	Flat Color
Initial S/W Revision	Prior to A.02.00

Flat Monochrome

Selects a format that is like Flat Color. But only black is used (no colors, not even gray), and no fill.

Key Path	Save, Screen Image, Themes
Example	MMEM:STOR:SCR:THEM FMON
Readback	Flat Mono
Initial S/W Revision	Prior to A.02.00

Backlight

Accesses the display backlight on/off keys. This setting may interact with settings under the Windows "Power" menu.

When the backlight is off, pressing ESC, TAB, SPACE, ENTER, UP, DOWN, LEFT, RIGHT, DEL, BKSP, CTRL, or ALT turns the backlight on without affecting the application. Pressing any other key will turn backlight on and could potentially perform the action as well.

Key Path	View/Display, Display, System Display Settings
Remote Command	:DISPlay:BACKlight ON OFF :DISPlay:BACKlight?
Preset	ON (Set by Restore Misc Defaults)
Initial S/W Revision	Prior to A.02.00

Backlight Intensity

An active function used to set the backlight intensity. It goes from 0 to 100 where 100 is full on and 0 is off. This value is independent of the values set under the Backlight on/off key.

Key Path	View/Display, Display, System Display Settings
Remote Command	:DISPlay:BACKlight:INTensity <integer> :DISPlay:BACKlight:INTensity?
Example	DISP:BACK:INT 50

17 Monitor Spectrum Measurement
View/Display

Preset	100 (Set by Restore Misc Defaults)
Min	0
Max	100
Initial S/W Revision	Prior to A.02.00

18 Waveform Measurement

The waveform measurement is a generic measurement for viewing the input signal waveforms in the time domain. This measurement represents how the instrument performs the zero span functionality found in traditional spectrum analyzers. For more details, see ["Waveform Measurement Description" on page 2156](#) below.

This topic contains the following sections:

["Measurement Commands for Waveform" on page 2154](#)

["Remote Command Results for the Waveform Measurement" on page 2155](#)

Measurement Commands for Waveform

The general functionality of CONFigure, INITiate, FETCh, MEASure, and READ are described at this section.

:CONFigure:WAVeform

:CONFigure:WAVeform:NDEFault

:INITiate:WAVeform

:FETCh:WAVeform[n]?

:MEASure:WAVeform[n]?

:READ:WAVeform[n]?

For more measurement related commands, see the SENSE subsystem, and the section ["Remote Measurement Functions" on page 2213](#).

Remote Command Results for the Waveform Measurement

The following table denotes the returned results from the FETCh|MEASure|READ commands:

n	Results Returned
0	Returns unprocessed I/Q trace data, as a series of trace point values, in volts. The I values are listed first in each pair, using the 0 through even-indexed values. The Q values are the odd-indexed values.
1	<p>Returns the following scalar results:</p> <ol style="list-style-type: none"> 1. Sample Time is a floating point number representing the time between samples when using the trace queries (n=0, 2, and so forth). 2. Mean Power is the mean power (in dBm). This is the power across the entire trace. If averaging is on, the power is for the latest acquisition. 3. Mean Power Averaged is the power (in dBm) for N averages, if averaging is on. This is the power across the entire trace. If averaging is on, the power is for the latest acquisition. If averaging is off, the value of the mean power averaged is the same as the value of the mean power. 4. Number of samples is the number of data points in the captured signal. This number is useful when performing a query on the signal (i.e. when n=0, 2, etc.). 5. Peak-to-mean ratio has units of dB. This is the ratio of the maximum signal level to the mean power. Valid values are only obtained with averaging turned off. If averaging is on, the peak-to-mean ratio is calculated using the highest peak value, rather than the displayed average peak value. 6. Maximum value is the maximum of the most recently acquired data (in dBm). 7. Minimum value is the minimum of the most recently acquired data (in dBm).
2	Returns trace point values of the entire captured signal envelope trace data. These data points are floating point numbers representing the power of the signal (in dBm). There are N data points, where N is the number of samples. The period between the samples is defined by the sample time.

Waveform Measurement Description

Also available under the basic Waveform measurement is an I/Q window, which shows the I and Q signal waveforms in parameters of voltage versus time to disclose the voltages that comprise the complex modulated waveform of a digital signal.

The waveform measurement can also be used to perform general purpose power measurements to a high degree of accuracy.

Key Path	Front-panel key
Initial S/W Revision	Prior to A.02.00

AMPTD Y Scale

Accesses a menu of functions that enable you to set the vertical scale parameters.

Key Path	Front-panel key
Initial S/W Revision	Prior to A.02.00

Ref Value

Sets the absolute power reference value. However, since Auto Scaling is defaulted to On, this value is automatically determined by the measurement result. When you set a value manually, Auto Scaling automatically changes to Off.

This functionality depends on the selected view:

- [Ref Value \(RF Envelope View\)](#)
- [Ref Value \(I/Q Waveform View\)](#)

Scale/Div

Sets the units per division of vertical scale in the logarithmic display. However, since Auto Scaling is defaulted to On, this value is automatically determined by the measurement result. When you set a value manually, Auto Scaling automatically changes to Off.

This functionality depends on the selected view:

- ["Scale/Div \(RF Envelope View\)" on page 2157](#)
- ["Scale/Div \(I/Q Waveform View\)" on page 2158](#)

Scale/Div (RF Envelope View)

Sets the scale per division for the RF Envelope result waveform (time domain) measurements in the graph window.

Key Path	AMPTD Y Scale
Mode	BASIC, PNOISE, WCDMA, C2K, GSM, WIMAXOFDMA, TDSCDMA, 1XEVDO, DVB, DTMB, ISDBT, CMMB, LTE, LTETDD, DCATV, WLAN, LTEATDD, LTEAFDD
Remote Command	:DISPlay:WAVeform:VIEW[1]:WINDow[1]:TRACe:Y[:SCALe]:PDIVision <rel_ ampl> :DISPlay:WAVeform:VIEW[1]:WINDow[1]:TRACe:Y[:SCALe]:PDIVision?
Example	DISP:WAV:VIEW:WIND:TRAC:Y:PDIV 5 DISP:WAV:VIEW:WIND:TRAC:Y:PDIV?
Notes	You must be in a mode that includes the Waveform measurement to use this command. Use INSTRument:SElect to set the mode.
Couplings	When Auto Scaling is On, this value is automatically determined by the measurement result. When you set a value manually, Auto Scaling automatically changes to Off.

Preset	10.00 dB
State Saved	Saved in instrument state.
Range	0.10 dB to 20.00 dB
Min	0.10 dB
Max	20.00 dB
Initial S/W Revision	Prior to A.02.00
Modified at S/W Revision	A.03.00

Scale/Div (I/Q Waveform View)

Sets the scale per division for the I/Q signal waveform graph.

Key Path	AMPTD Y Scale
Mode	BASIC, PNOISE, WCDMA, C2K, GSM, WIMAXOFDMA, TDSCDMA, 1XEVD0, DVB, DTMB, ISDBT, CMMB, LTE, LTETDD, DCATV, WLAN, LTEATDD, LTEAFDD
Remote Command	:DISPlay:WAVeform:VIEW2:WINDow[1]:TRACe:Y[:SCALE]:PDIVision <voltage> :DISPlay:WAVeform:VIEW2:WINDow[1]:TRACe:Y[:SCALE]:PDIVision?
Example	DISP:WAV:VIEW2:WIND:TRAC:Y:PDIV 25mV DISP:WAV:VIEW2:WIND:TRAC:Y:PDIV?
Notes	You must be in a mode that includes the Waveform measurement to use this command. Use INSTRument:SElect to set the mode.
Couplings	When Auto Scaling is On, this value is automatically determined by the measurement result. When you set a value manually, Auto Scaling automatically changes to Off.
Preset	100.0 mV
State Saved	Saved in instrument state.
Min	1.0 nV
Max	20 V
Initial S/W Revision	Prior to A.02.00
Modified at S/W Revision	A.03.00

Attenuation

This menu controls the attenuator functions and interactions between the attenuation system components.

There are two attenuator configurations in the X-Series. One is a dual attenuator configuration consisting of a mechanical attenuator and an optional electronic attenuator. The other configuration uses a single attenuator with combined mechanical and electronic sections that controls all the attenuation functions. Different models in the X-Series come with different configurations.

See "[Dual Attenuator Configurations:](#)" on page 2159

See "Single Attenuator Configuration:" on page 2160

Most Attenuation settings are the same for all measurements – they do not change as you change measurements. Settings like these are called “Meas Global” and are unaffected by Meas Preset.

Key Path	AMPTD Y Scale
Scope	Meas Global
Dependencies	In measurements that support the I/Q inputs, this key is unavailable when I/Q is the selected input, and is replaced by the Range key in that case.
Readback Line	Contains a summary in [] brackets of the current total attenuation. See the descriptions of the , " (Mech) Atten " on page 2160, and " Enable Elec Atten " on page 2162 keys for more detail on the contributors to the total attenuation. Note that when "Pre-Adjust for Min Clip" is on, this value can change at the start of every measurement.
Initial S/W Revision	Prior to A.02.00
Modified at S/W Revision	A.03.00

Dual Attenuator Configurations:

Configuration 1: Mechanical attenuator + optional electronic attenuator

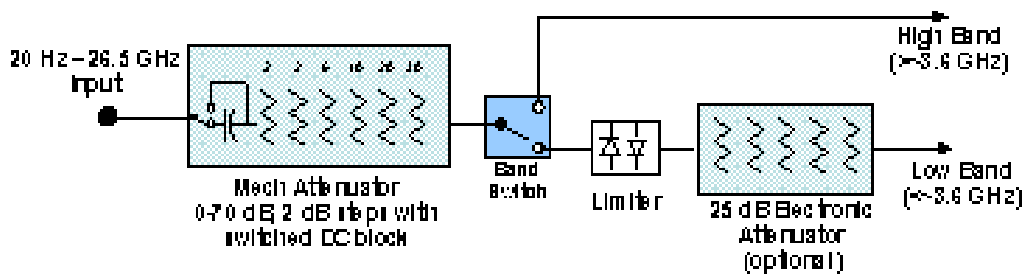

Configuration 2: Mechanical attenuator, no optional electronic attenuator

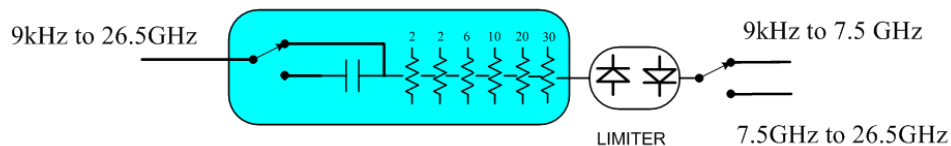

(note that Configuration 2 is not strictly speaking a dual-section attenuator, since there is no electronic section available. However, it behaves exactly like Configuration 1 without the Electronic Attenuator option EA3, therefore for the sake of this document it is grouped into the “Dual Attenuator” configuration)

Single Attenuator Configuration:

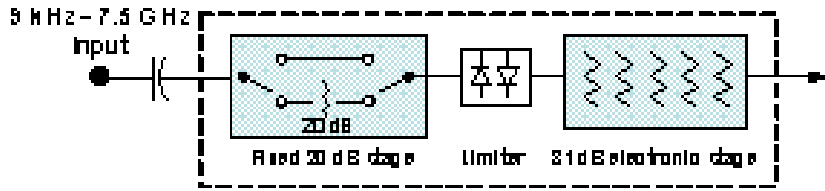

You can tell which attenuator configuration you have by pressing the Attenuation key, which (in most Modes) opens the Attenuation menu. If the first key in the Attenuation menu says Mech Atten you have the dual attenuator configuration. If the first key says Atten you have the single attenuator configuration.

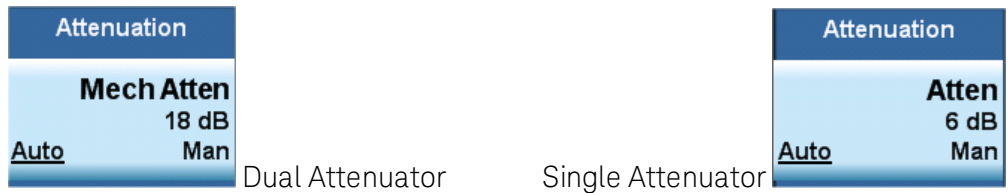

In the single attenuator configuration, you control the attenuation with a single control, as the fixed stage has only two states. In the dual attenuator configuration, both stages have significant range so you are given separate control of the mechanical and electronic attenuator stages.

When you have the dual attenuator configuration, you may still have only a single attenuator, because unless option EA3 (the Electronic Attenuator option) is available, and you purchase it, you will have only the mechanical attenuator.

(Mech) Atten

This key is labeled Mech Atten in dual attenuator models and Atten in single attenuator models. In the dual attenuator configuration, this key only affects the mechanical attenuator.

This key lets you modify the attenuation applied to the RF input signal path. This value is normally auto coupled to the Ref Level, the Internal Preamp Gain, any External Gain that is entered, and the Max Mixer Level, as described in the table below.

See ["Attenuator Configurations and Auto/Man" on page 2162](#)

Key Path	AMPTD Y Scale, Attenuation
Remote Command	<pre>[:SENSe]:POWeR[:RF]:ATTenuation <rel_ampl> [:SENSe]:POWeR[:RF]:ATTenuation? [:SENSe]:POWeR[:RF]:ATTenuation:AUTO OFF ON 0 1 [:SENSe]:POWeR[:RF]:ATTenuation:AUTO?</pre>
Example	<p>POW:ATT 20</p> <p>Dual attenuator configuration: sets the mechanical attenuator to 20 dB</p> <p>Single attenuator mode: sets the main attenuation to 20 dB (see below for definition of “main” attenuation).</p> <p>If the attenuator was in Auto, it sets it to Manual.</p>
Dependencies	Some measurements do not support the Auto setting of (Mech) Atten. In these measurements, the

Auto/Man selection is not available, and the Auto/Man line on the key disappears.

In dual attenuator configurations, when the electronic attenuator is enabled, the mechanical attenuator has no auto setting and the Auto/Man line on the key disappears. The state of Auto/Man is remembered and restored when the electronic attenuator is once again disabled. This is described in more detail in the ["Enable Elec Atten" on page 2162](#) key description.

See ["Attenuator Configurations and Auto/Man" on page 2162](#) for more information on the Auto/Man functionality of Attenuation.

Couplings

When (Mech) Atten is in Auto, it uses the following algorithm to determine a value:
 If the USB Preamp is connected to USB, use 0 dB.
 Otherwise, $Atten = ReferenceLevel + PreAmpGain + ExternalGain - RefLevelOffset - MaxMixerLevel + IF\ Gain$.
 Limit this value to be between 6 dB and the Max value. No value below 6 dB can ever be chosen by Auto.
 The resulting value is rounded up to the largest value possible given the attenuation step setting. That is, 50.01 dB would change to 60 dB (for a 10 dB attenuation step).
 The "IF Gain" term in the equation above is either 0 dB or +10 dB, depending on the settings of FFT IF Gain, Swept IF Gain, max Ref Level and the Auto/Man setting of Mech Atten.
 In External Mixing and BBIQ, where the Attenuator is not in the signal path, the Attenuator setting changes as described above when (Mech) Atten is in Auto, but no changes are made to the actual attenuator hardware setting until the input is changed back to the RF Input.

Preset The preset for Mech Attenuation is "Auto."
 The Auto value of attenuation is:
 CXA, EXA, MXA and PXA: 10 dB

State Saved Saved in instrument state

Min 0 dB
 The attenuation set by this key cannot be decreased below 6 dB with the knob or step keys. To get to a value below 6 dB it has to be directly entered from the keypad or via SCPI. This protects from adjusting the attenuation to a dangerously small value which can put the instrument at risk of damage to input circuitry. However, if the current mechanical attenuation is below 6 dB it can be increased with the knob and step keys, but not decreased.

Max CXA N9000A-503/507: 50 dB
 CXA N9000A-513/526: 70dB
 EXA: 60 dB
 MXA and PXA: 70 dB
 In the single attenuator configuration, the total of ATT and EATT cannot exceed 50 dB, so if the EATT is set to 24 dB first, the main attenuation cannot be greater than 26 dB and will be reduced accordingly; if the main attenuator is set to 40 dB first, EATT cannot be greater than 10 dB.

Initial S/W Revision Prior to A.02.00

Modified at S/W Revision A.03.00

Attenuator Configurations and Auto/Man

As described in the Attenuation key description, there are two distinct attenuator configurations available in the X-Series, the single attenuator and dual attenuator configurations. In dual attenuator configurations, we have the mechanical attenuation and the electronic attenuation, and the current total attenuation is the sum of the electronic + mechanical attenuation. In single attenuator configurations, we refer to the attenuation set using the (Mech) Atten key (or POW:ATT SCPI) as the “main” attenuation; and the attenuation that is set by the SCPI command POW:EATT as the “soft” attenuation (the POW:EATT command is honored even in the single attenuator configuration, for compatibility purposes). Then the current total attenuation is the sum of the main + soft attenuation. See the Elec Atten key description for more on “soft” attenuation.

In the dual attenuator configuration, when the electronic attenuator is enabled, there is no Auto/Man functionality for the mechanical attenuator, and the third line of the key label (the Auto/Man line) disappears:

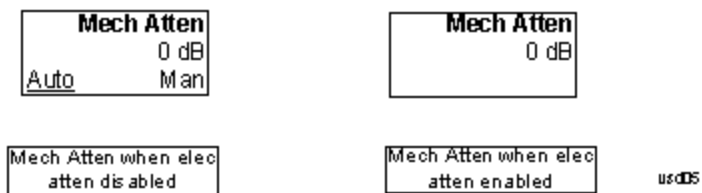

Enable Elec Atten

Enables the Electronic Attenuator.

The electronic attenuator offers finer steps than the mechanical attenuator, has no acoustical noise, is faster, and is less subject to wear. These advantages primarily aid in remote operation and are negligible for front panel use. See ["Using the Electronic Attenuator: Pros and Cons" on page 2164](#) for a detailed discussion of the pros and cons of using the electronic attenuator.

For the single attenuator configuration, for SCPI backwards compatibility, the “soft” attenuation feature replaces the dual attenuator configuration’s electronic attenuator. All the same couplings and limitations apply. See ["Attenuator Configurations and Auto/Man" on page 2162](#)

See ["More Information" on page 2163](#)

Key Path	AMPTD Y Scale, Attenuation
Remote Command	[:SENSe] :POWer [:RF] :EATTenuation :STATe OFF ON 0 1 [:SENSe] :POWer [:RF] :EATTenuation :STATe ?
Example	POW:EATT:STAT ON
Dependencies	This key only appears in Dual Attenuator models with an Electronic Attenuator installed. It does not appear in models with the Single Attenuator configuration, as in the single attenuator configuration there is no “electronic attenuator” there is only a single integrated attenuator (which has both a mechanical and electronic stage). However, in the single attenuator configuration, EATT SCPI commands are accepted for compatibility with other X-series instruments and set a “soft” attenuation as described in "Attenuator Configurations and Auto/Man" on page 2162 . The electronic attenuator (and the “soft” attenuation function provided in single attenuator configurations) is unavailable above 3.6 GHz. Therefore, if the Stop Frequency of the analyzer is > 3.6 GHz then the Enable Elec Atten key will be OFF and grayed out.

	<p>If the Internal Preamp is on, meaning it is set to Low Band or Full, the electronic attenuator (and the “soft” attenuation function provided in single attenuator configurations) is unavailable. In this case the Enable Elec Atten key will be OFF and grayed out.</p> <p>If either of the above is true, if the SCPI command is sent, an error indicating that the electronic attenuator is unavailable will be sent.</p> <p>If the electronic/soft Attenuator is enabled, then the Stop Freq of the analyzer is limited to 3.6 GHz and the Internal Preamp is unavailable.</p> <p>The SCPI-only “soft” electronic attenuation for the single-attenuator configuration is not available in all measurements; in particular, it is not available in the Swept SA measurement.</p>
Couplings	Enabling and disabling the Electronic Attenuator affects the setting of the Mechanical Attenuator (in dual attenuator configurations). This is described in more detail below this table.
Preset	OFF for Swept SA measurement; ON for all other measurements that support the electronic attenuator
State Saved	Saved in instrument state
Initial S/W Revision	Prior to A.02.00
Modified at S/W Revision	A.03.00

More Information

Mechanical Attenuator Transition Rules

When the Electronic Attenuator is enabled, the Mechanical Attenuator transitions to a state that has no Auto function. Below are the rules for transitioning the Mechanical Attenuator. NOTE that the information below ONLY applies to the dual attenuator configurations, and ONLY when the Electronic Attenuator is installed:

When the Electronic Attenuation is enabled from a disabled state:

- The Mechanical Attenuator is initialized to 10 dB (this is its optimal performance setting). You can then set it as desired with SCPI, numeric keypad, step keys, or knob, and it behaves as it normally would in manual mode
- The Auto/Man state of (Mech) Atten is saved
- The Auto/Man line on the (Mech) Atten key disappears and the auto rules are disabled
- The Electronic Attenuator is set to 10 dB less than the previous value of the Mechanical Attenuator, within the limitation that it must stay within the range of 0 to 24 dB of attenuation.

Examples in the dual attenuator configuration:

- Mech Atten at 20 dB. Elec Atten enabled, Mech Atten set to 10 dB, and Elec Atten set to 10 dB. New total attenuation equals the value before Elec Atten enabled.
- Mech Atten at 0 dB. Elec Atten enabled, Mech Atten set to 10 dB, and Elec Atten set to 0 dB. New total attenuation does not equal the value before Elec Atten enabled.
- Mech Atten at 40 dB. Elec Atten enabled, Mech Atten set to 10 dB, and Elec Atten set to 24 dB. New total attenuation does not equal the value before Elec Atten enabled.

When the Electronic Attenuation is disabled from an enabled state:

- The Elec Atten key is grayed out
- The Auto/Man state of (Mech) Atten is restored
- If now in Auto, (Mech) Atten recouples
- If now in Man, (Mech) Atten is set to the value of total attenuation that existed before the Elec Atten was disabled. The resulting value is rounded up to the smallest value possible given the (Mech) Atten Step setting - (That is, 57 dB changes to 58 dB when (Mech) Atten Step is 2 dB.)

Using the Electronic Attenuator: Pros and Cons

The electronic attenuator offers finer steps than the mechanical attenuator, has no acoustical noise, is faster, and is less subject to wear.

The “finer steps” advantage of the electronic attenuator is beneficial in optimizing the alignment of the analyzer dynamic range to the signal power in the front panel as well as remote use. Thus, you can achieve improved relative signal measurement accuracy. Compared to a mechanical attenuator with 2 dB steps, the 1 dB resolution of the electronic attenuator only gives better resolution when the odd-decibel steps are used. Those odd-decibel steps are less accurately calibrated than the even-decibel steps, so one tradeoff for this superior relative accuracy is reduced absolute amplitude accuracy.

Another disadvantage of the electronic attenuator is that the spectrum analyzer loses its “Auto” setting, making operation less convenient.

Also, the relationship between the dynamic range specifications (TOI, SHI, compression and noise) and instrument performance are less well-known with the electrical attenuator. With the mechanical attenuator, TOI, SHI and compression threshold levels increase dB-for-dB with increasing attenuation, and the noise floor does as well. With the electronic attenuator, there is an excess attenuation of about 1 to 3 dB between 0 and 3.6 GHz, making the effective TOI, SHI, and so forth, less well known. Excess attenuation is the actual attenuation relative to stated attenuation. Excess attenuation is accounted for in the analyzer calibration

Elec Atten

Controls the Electronic Attenuator in dual attenuator configurations. This key does not appear in single attenuator configurations, as the control of both the mechanical and electronic stages of the single attenuator is integrated into the single Atten key.

Key Path	AMPTD Y Scale, Attenuation
Remote Command	<code>[:SENSe] :POWer [:RF] :EATTenuation <rel_ampl></code> <code>[:SENSe] :POWer [:RF] :EATTenuation?</code>
Notes	Electronic Attenuation’s specification is defined only when Mechanical Attenuation is 6 dB.
Dependencies	This key only appears in Dual Attenuator models with an Electronic Attenuator installed. It does not appear in models with the Single Attenuator configuration, as in the single attenuator configuration there is no “electronic attenuator” there is only a single integrated attenuator (which has both a mechanical and electronic stage). However, in the single attenuator configuration, EATT SCPI commands are accepted for compatibility with other X-series instruments and set a “soft” attenuation as described in "Attenuator Configurations and Auto/Man" on page 2162 . The “soft” attenuation is treated as an addition to the “main” attenuation value set by the Atten softkey or the

	POW:ATT SCPI command and affects the total attenuation displayed on the Attenuation key and the Meas Bar. When Enable Elec Atten is off or grayed out, the Elec Atten key is grayed out.
Preset	0 dB
State Saved	Saved in instrument state
Min	0 dB
Max	Dual attenuator configuration: 24 dB Single attenuator configuration: the total of ATT and EATT cannot exceed 50 dB, so if the EATT is set to 24 dB first, the main attenuation cannot be greater than 26 dB and will be reduced accordingly; if the main attenuator is set to 40 dB first, EATT cannot be greater than 10 dB
Initial S/W Revision	Prior to A.02.00
Modified at S/W Revision	A.03.00

Adjust Atten for Min Clip

Sets the combination of mechanical and electronic attenuation and gain based on the current measured signal level so that clipping will be at a minimum.

This is an "immediate action" function, that is, it executes once, when the key is pressed.

This key is grayed out in measurements that do not support this functionality. The spectrum analyzer measurement, Swept SA, does not support this functionality.

Key Path	AMPTD Y Scale, Attenuation
Remote Command	<code>[:SENSe] :POWer [:RF] :RANGe:OPTimize IMMEDIATE</code>
Initial S/W Revision	Prior to A.02.00
Modified at S/W Revision	A.03.00

Pre-Adjust for Min Clip

If this function is on, it does the adjustment described under "[Adjust Atten for Min Clip](#)" on page 2165 each time a measurement restarts. Therefore, in Continuous measurement mode, it only executes before the first measurement.

In dual attenuator models, you can set Elec+Mech Atten, in which case both attenuators participate in the autoranging, or Elec Atten Only, in which case the mechanical attenuator does not participate in the autoranging. This latter case results in less wear on the mechanical attenuator and is usually faster.

This key is grayed out in measurements that do not support this functionality. The spectrum analyzer measurement, Swept SA, does not support this functionality.

Key Path	AMPTD Y Scale, Attenuation
Remote Command	<code>[:SENSe] :POWer [:RF] :RANGe:OPTimize:ATTenuation OFF ELECTRical COMBined</code>

	<code>[:SENSe] :POWer [:RF] :RANGe:OPTimize:ATTenuation?</code>
Notes	The SCPI parameter ELECtrical sets this function to On in single attenuator models. The SCPI parameter COMBined is mapped to ELECtrical in single attenuator models; if you send COMBined, it sets the function to On and returns ELEC to a query.
Dependencies	This key only appears in Dual Attenuator models with an Electronic Attenuator installed. In instruments with Dual Attenuator model, when Enable Elec Atten is off or grayed out, the Pre-Adjust for Min Clip key is grayed out.
Preset	OFF for Swept SA measurement; ON for all other measurements that support Pre-Adjust for Min Clip
State Saved	Saved in instrument state
Range	Dual attenuator models: Off Elec Atten Only Mech + Elec Atten Single attenuator models: Off On
Initial S/W Revision	Prior to A.02.00
Modified at S/W Revision	A.03.00

Remote Command	<code>[:SENSe] :POWer [:RF] :RANGe:AUTO ON OFF 1 0</code> <code>[:SENSe] :POWer [:RF] :RANGe:AUTO?</code>
Notes	ON aliases to "Elec Atten Only" (:POW:RANG:OPT:ATT ELEC) OFF aliases to "Off" (:POW:RANG:OPT:ATT OFF) The query :POW:RANG:AUTO? returns true if :POW:RANG:OPT:ATT is not "Off"
Initial S/W Revision	Prior to A.02.00

Off

Turns Pre-Adjust for Min Clip off. This is the default setting.

This key is grayed out in measurements that do not support this functionality. The spectrum analyzer measurement, Swept SA, does not support this functionality.

Key Path	AMPTD Y Scale, Attenuation, Pre-Adjust for Min Clip
Example	:POW:RANGe:OPT:ATT OFF
Initial S/W Revision	Prior to A.02.00

Elec Atten Only

Selects only the electric attenuator to participate in auto ranging. This offers less wear on the mechanical attenuator and is usually faster.

This key is grayed out in measurements that do not support this functionality. The spectrum analyzer measurement, Swept SA, does not support this functionality.

Key Path	AMPTD Y Scale, Attenuation, Pre-Adjust for Min Clip
Example	:POW:RANGe:OPT:ATT ELEC
Initial S/W Revision	Prior to A.02.00

Mech + Elec Atten

In dual attenuator models, this selects both attenuators participate in the autoranging.

This key is grayed out in measurements that do not support this functionality. The spectrum analyzer measurement, Swept SA, does not support this functionality.

Key Path	AMPTD Y Scale, Attenuation, Pre-Adjust for Min Clip
Example	:POW:RANGe:OPT:ATT COMB
Initial S/W Revision	Prior to A.02.00

(Mech) Atten Step

This controls the step size used when making adjustments to the input attenuation.

This key is labeled Mech Atten Step in dual attenuator models and Atten Step in single attenuator models. In the dual attenuator configuration, this key only affects the step size of the mechanical attenuator.

Key Path	AMPTD Y Scale, Attenuation
Remote Command	[:SENSe] :POWer [:RF] :ATTenuation :STEP [:INCRement] 10 dB 2 dB [:SENSe] :POWer [:RF] :ATTenuation :STEP [:INCRement] ?
Example	POW:ATT:STEP 2
Notes	Note this feature works like a 1-N choice from the front panel, but it takes a specific value (in dB) when used remotely. The only valid values are 2 and 10.
Dependencies	Blanked in CXA and EXA if option FSA (2 dB steps) is not present. If blanked, attempts to set it via SCPI will yield an error.
Couplings	When the attenuation step size changes, the current mechanical attenuation value is adjusted (if necessary) to be quantized to the new step size. That is, if step is set to 10 dB, mech atten is increased if necessary so it is a multiple of 10 dB
Preset	PXA and MXA: 2 dB EXA and CXA: 10 dB (2 dB with option FSA)
State Saved	Saved in instrument state
Initial S/W Revision	Prior to A.02.00
Modified at S/W Revision	A.03.00

Presel Center

When this key is pressed, the centering of the preselector filter is adjusted to optimize the amplitude accuracy at the frequency of the selected marker. If the selected marker is not on when Presel Center is pressed, the analyzer will turn on the selected marker, perform a peak search, and then perform centering on the marker's center frequency. If the selected marker is already on and between the start and stop frequencies of the analyzer, the analyzer performs the preselector calibration on that marker's frequency. If the selected marker is already on, but outside the frequency range between Start Freq and Stop Freq, the analyzer will first perform a peak search, and then perform centering on the marker's center frequency.

The value displayed on the Presel Adjust key will change to reflect the new preselector tuning (see Presel Adjust).

A number of considerations should be observed to ensure proper operation. See ["Proper Preselector Operation" on page 2168](#).

Key Path	AMPTD Y Scale
Remote Command	[:SENSe] :POWer [:RF] :PCENter
Example	POW:PCEN
Notes	Note that the rules outlined above under the key description apply for the remote command as well as the key. The result of the command is dependent on marker position, and so forth. Any message shown by the key press is also shown in response to the remote command.
Dependencies	<ul style="list-style-type: none"> • Grayed out if the microwave preselector is off.) • If the selected marker's frequency is below Band 1, advisory message 0.5001 is generated and no action is taken. • Grayed out if entirely in Band 0. • Blank in models that do not include a preselector, such as option 503. If the SCPI is sent in these instruments, it is accepted without error, and the query always returns 0. • Grayed out in the Spectrogram View.
Couplings	<p>The active marker position determines where the centering will be attempted.</p> <p>If the analyzer is in a measurement such as averaging when centering is initiated, the act of centering the preselector will restart averaging but the first average trace will not be taken until the centering is completed.</p>
Status Bits/OPC dependencies	<p>When centering the preselector, *OPC will not return true until the process is complete and a subsequent measurement has completed, nor will results be returned to a READ or MEASure command.</p> <p>The Measuring bit should remain set while this command is operating and should not go false until the subsequent sweep/measurement has completed.</p>
Initial S/W Revision	Prior to A.02.00
Modified at S/W Revision	A.03.00

Proper Preselector Operation

A number of considerations should be observed to ensure proper operation:

1. If the selected marker is off, the analyzer will turn on a marker, perform a peak search, and adjust the preselector using the selected marker's frequency. It uses the "highest peak" peak search method unqualified by threshold or excursion, so that there is no chance of a 'no peak found' error. It continues with that peak, even if it is the peak of just noise. Therefore, for this operation to work properly, there should be a signal on screen in a preselected range for the peak search to find.
2. If the selected marker is already on, the analyzer will attempt the centering at that marker's frequency. There is no preselector for signals below about 3.6 GHz, therefore if the marker is on a signal below 3.6 GHz, no centering will be attempted and an advisory message generated
3. In some models, the preselector can be bypassed. If it is bypassed, no centering will be attempted in that range and a message will be generated.

Preselector Adjust

Allows you to manually adjust the preselector filter frequency to optimize its response to the signal of interest. This function is only available when "Presel Center" on page 2168 is available.

For general purpose signal analysis, using Presel Center is recommended. Centering the filter minimizes the impact of long-term preselector drift. Presel Adjust can be used instead to manually optimize the preselector. One application of manual optimization would be to peak the preselector response, which both optimizes the signal-to-noise ratio and minimizes amplitude variations due to small (short-term) preselector drifting.

Key Path	AMPTD Y Scale
Scope	Meas Global
Remote Command	[:SENSe] :POWer [:RF] :PADJust <freq> [:SENSe] :POWer [:RF] :PADJust?
Example	POW:PADJ 100KHz POW:PADJ?
Notes	The value on the key reads out to 0.1 MHz resolution.
Dependencies	<ul style="list-style-type: none"> • Grayed out if microwave preselector is off.) • Grayed out if entirely in Band 0. • Blank in models that do not include a preselector, such as option 503. If the SCPI is sent in these instruments, it is accepted without error, and the query always returns 0. • Grayed out in the Spectrogram View.
Preset	0 MHz
State Saved	The Presel Adjust value set by Presel Center, or by manually adjusting Presel Adjust, is not saved in instrument state, and does not survive a Preset or power cycle.
Min	-500 MHz
Max	500 MHz
Default Unit	Hz
Backwards Compatibility SCPI	[:SENSe] :POWer [:RF] :MW:PADJust [:SENSe] :POWer [:RF] :MMW:PADJust

	PSA had multiple preselectors, but the X-Series has only one. These commands simply alias to [:SENSe]:POWer[:RF]:PADJust
Initial S/W Revision	Prior to A.02.00
Modified at S/W Revision	A.03.00

Remote Command	[:SENSe]:POWer[:RF]:PADJust:PRESelector MWAVE MMWave EXTERNAL [:SENSe]:POWer[:RF]:PADJust:PRESelector?
Notes	PSA had multiple preselectors, and you could select which preselector to adjust. Since the X-Series has only one mm/uW preselector, the preselector selection softkey is no longer available. However, to provide backward compatibility, we accept the legacy remote commands. The command form has no effect, the query always returns MWAVE
Initial S/W Revision	Prior to A.02.00

μW Path Control

Sets the μW Path Control function to Auto, standard path, μW Preselector Bypass (Option MPB) and Low Noise Path(Option LNP).

Key Path	AMPTD/Y Scale
Initial S/W Revision	A.14.50

μW Path Control Auto

Activates the auto rules for μW Path Control. When Auto is active, the μW Path Control is set to Preselector Bypass in modulation analysis and spectral flatness measurement; it is set to standard path in other measurements.

Key Path	AMPTD/Y Scale
Remote Command	[:SENSe]:POWer[:RF]:MW:PATH:AUTO ON OFF 1 0 [:SENSe]:POWer[:RF]:MW:PATH:AUTO?
Example	POW:MW:PATH:AUTO ON POW:MW:PATH:AUTO?
Couplings	When Auto is active, the μW Path Control is set to μW Preselector Bypass in IQ measurements (IQ waveform, CCDF, PVT, EVM, Spetrum flatness and WLS); it is set to standard path in other measurements.
Preset	ON
Range	Off On
Initial S/W Revision	A.14.50

Standard Path

This path gives the best remote-control throughput, minimizes acoustic noise from switching and minimizes the risk of wear in the hardware switches, particularly in remote test scenarios where both low band and high band setups will follow in rapid succession.

In this path, the bypass of the low band/high band switch and microwave preamp is never activated, which can cause some noise degradation but preserves the life of the bypass switch.

Key Path	AMPTD Y Scale, μ W Path Control
Example	:POW:MW:PATH STD
Readback Text	Standard Path
Initial S/W Revision	A.04.00

Low Noise Path Enable

You may choose Low Noise Path Enable, which gives a lower noise floor under some circumstances, particularly when operating in the 21–26.5 GHz region. With the Low Noise Path enabled, the low band/high band switch and microwave preamp are bypassed whenever all of the following are true:

- The analyzer is not in the Low Band, meaning:
- the start frequency is above 3.5 GHz and
- the stop frequency is above 3.6 GHz.
- the internal preamp is not installed or (if installed) is set to Off or Low Band

Note that this means that, when any part of a sweep is done in Low Band, the Low Noise Path is not used, whether or not the Low Noise Path Enable is selected in the user interface. Also, if the preamp is turned on, the Low Noise Path is not used, whether or not the Low Noise Path Enable is selected in the user interface. The only time the Low Noise Path is used is when Low Noise Path Enable is selected, the sweep is completely in High Band (> 3.6 GHz) and no preamp is in use.

See "[More Information](#)" on page 2172

Key Path	AMPTD Y Scale, μ W Path Control
Measurement	Swept SA
Example	:POW:MW:PATH LNP
Notes	<p>For measurements that use IQ acquisition, the low noise path is used when the Center Frequency is in High Band (> 3.6 GHz) and no preamp is in use.</p> <p>In other words, the rules above are modified to use only the center frequency to qualify which path to switch in.</p> <p>This is not the case for FFT's in the Swept SA measurement; they use the same rules as swept measurements.</p>
Dependencies	<p>Key is blanked if current mode does not support it.</p> <p>Key is grayed out if mode supports it but current measurement does not support it.</p> <p>Unless Option LNP is present and licensed, key is blank and if SCPI command sent, error -241,</p>

	"Hardware missing; Option not installed" is generated.
Readback Text	Low Noise Path Enable
Initial S/W Revision	A.04.00

More Information

The user should understand that the Low Noise Path, while giving improved DANL, has the disadvantage of decreased TOI performance and decreased gain compression performance relative to the standard path.

The user should also understand that the bypass switch is a mechanical switch and has finite life, so if the Low Noise Path is enabled, it is possible to cause frequent cycling of this switch by frequently changing analyzer settings such that the above conditions hold true only some of the time. A user making tests of this nature should consider opting for the Standard Path, which will never throw the bypass switch, at the expense of some degraded noise performance.

The low noise path is useful for situations where the signal level is so low that the analyzer performance is dominated by noise even with 0 dB attenuation, but still high enough that the preamp option would have excessive third-order intermodulation or compression. The preamp, if purchased and used, gives better noise floor than does the "Low Noise Path." However, its compression threshold and third-order intercept are much poorer than that of the non-preamp path. There are some applications, typically for signals around -30 dBm, for which the third-order dynamic range of the standard path is good enough, but the noise floor is not low enough even with 0 dB input attenuation. When the third-order dynamic range of the preamp path is too little and the noise floor of the standard path is too high, the Low Noise Path can provide the best dynamic range

The graph below illustrates the concept. It shows, in red, the performance of an analyzer at different attenuation settings, both with the preamp on and off, in a measurement that is affected by both analyzer noise and analyzer TOI. The green shows the best available dynamic range, offset by 0.5 dB for clarity. The blue shows how the best available dynamic range improves for moderate signal levels with the low noise path switched in. In this illustration, the preamp improves the noise floor by 15 dB while degrading the third-order intercept by 30 dB, and the low noise path reduces loss by 8 dB. The attenuator step size is 2 dB.

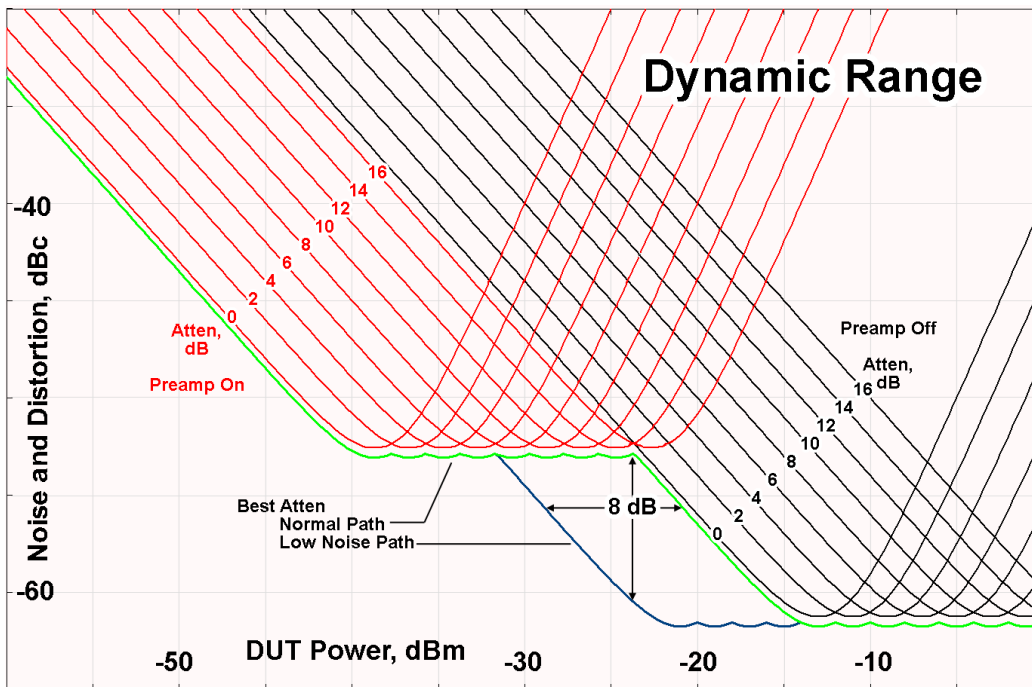

There are other times where selecting the low noise path improves performance, too. Compression-limited measurements such as finding the nulls in a pulsed-RF spectrum can profit from the low noise path in a way similar to the TOI-limited measurement illustrated. Accuracy can be improved when the low noise path allows the optimum attenuation to increase from a small amount like 0, 2 or 4 dB to a larger amount, giving better return loss at the analyzer input. Harmonic measurements, such as second and third harmonic levels, are much improved using the low noise path because of the superiority of that path for harmonic (though not intermodulation) distortion performance.

μ W Preselector Bypass

This key toggles the preselector bypass switch for band 1 and higher. When the microwave preselector is on, the signal path is preselected. When the microwave preselector is off, the signal path is not preselected. The preselected path is the normal path for the analyzer.

The preselector is a tunable bandpass filter which prevents signals away from the frequency of interest from combining in the mixer to generate in-band spurious signals (images). The consequences of using a preselector filter are its limited bandwidth, the amplitude and phase ripple in its passband, and any amplitude and phase instability due to center frequency drift.

Option MPB or pre-selector bypass provides an unpreselected input mixer path for certain X-Series signal analyzers with frequency ranges above 3.6 GHz. This signal path allows a wider bandwidth and less amplitude variability, which is an advantage when doing modulation analysis and broadband signal analysis. The disadvantage is that, without the preselector, image signals will be displayed. Another disadvantage of bypassing the preselector is increased LO emission levels at the front panel input port.

Image responses are separated from the real signal by twice the 1st IF. For IF Paths of 10 MHz and 25 MHz, the 1st IF is 322.5 MHz, so the image response and the real signal will be separated by 645 MHz. The 1st IF will be different for other IF Path settings. When viewing a real signal and its corresponding image response in internal mixing, the image response will be to the left of the real signal.

Also, the image response and the real signal typically have the same amplitude and exhibit the same shape factor.

However, if Option FS1, Fast Sweep Capability, is enabled, the image response in the Swept SA measurement will appear lower in amplitude and have a much wider shape factor compared to the real signal.

Key Path	AMPTD Y Scale, μ W Path Control
Example	:POW:MW:PATH MPB
Dependencies	Key is blanked if current mode does not support it. Key is grayed out if mode supports it but current measurement does not support it. Key is blank unless Option MPB is present and licensed. If SCPI command sent when MPB not present, error -241, "Hardware missing; Option not installed" is generated.
Readback Text	μ W Preselector Bypass
Initial S/W Revision	A.04.00

Remote Command	[:SENSe] :POWer [:RF] :MW:PRESelector [:STATe] ON OFF 0 1 [:SENSe] :POWer [:RF] :MW:PRESelector [:STATe] ?
Example	:POW:MW:PRES OFF Bypasses the microwave preselector
Notes	The ON parameter sets the STD path (:POW:MW:PATH STD) The OFF parameter sets path MPB (:POW:MW:PATH MPB)
Preset	ON

Internal Preamp

Accesses a menu of keys that control the internal preamps. Turning on the preamp gives a better noise figure, but a poorer TOI to noise floor dynamic range. You can optimize this setting for your particular measurement.

The instrument takes the preamp gain into account as it sweeps. If you sweep outside of the range of the preamp the instrument will also account for that. The displayed result will always reflect the correct gain.

For some measurements, when the preamp is on and any part of the displayed frequency range is below the lowest frequency for which the preamp has specifications, a warning condition message appears in the status line. For example, for a preamp with a 9 kHz lowest specified frequency: "Preamp: Accy unspec'd below 9 kHz".

Key Path	AMPTD Y Scale
Scope	Meas Global
Remote Command	[:SENSe] :POWer [:RF] :GAIN [:STATe] OFF ON 0 1 [:SENSe] :POWer [:RF] :GAIN [:STATe] ?
Dependencies	Preamp is not available on all hardware platforms. If the preamp is not present or is unlicensed, the

key is not shown.
The preamp is not available when the electronic/soft attenuator is enabled.

Couplings	<p>The act of connecting the U7227A USB Preamplifier to one of the analyzer's USB ports will cause the Internal Preamp to be switched on. When this happens an informational message will be generated: "Internal Preamp turned on for optimal operation with USB Preamp." Note that if the Internal Preamp was already on, there will be no change to the setting, but if it was Off it will be switched On, to Full Range.</p> <p>Note that this same action occurs when the SA mode is selected while the USB Preamp is connected to one of the analyzer's USB ports, if it is the first time that the SA mode has run since powerup, or if the last time the SA mode was running the USB Preamp was NOT connected.</p> <p>Subsequently disconnecting the USB Preamp from USB does not change the Internal Preamp setting nor restore the previous setting.</p>
Preset	OFF
State Saved	Saved in instrument state
Initial S/W Revision	Prior to A.02.00
Modified at S/W Revision	A.14.00

Key Path	AMPTD Y Scale, Internal Preamp
Scope	Meas Global
Remote Command	<pre>[:SENSe] :POWer [:RF] :GAIN:BAND LOW FULL [:SENSe] :POWer [:RF] :GAIN:BAND?</pre>
Dependencies	<p>Preamp is not available on all hardware platforms. If the preamp is not present or is unlicensed, the key is not shown.</p> <p>If a POW:GAIN:BAND FULL command is sent when a low band preamp is available, the preamp band parameter is to LOW instead of FULL, and an "Option not installed" message is generated.</p>
Preset	LOW
State Saved	Saved in instrument state
Initial S/W Revision	Prior to A.02.00

Off

Turns the internal preamp off

Key Path	AMPTD Y Scale, Internal Preamp
Example	:POW:GAIN OFF
Readback	Off
Initial S/W Revision	Prior to A.02.00

Low Band

Sets the internal preamp to use only the low band.

The frequency range of the installed (optional) low-band preamp is displayed in square brackets on the Low Band key label.

Key Path	AMPTD Y Scale, Internal Preamp
Example	:POW:GAIN ON :POW:GAIN:BAND LOW
Readback	Low Band
Initial S/W Revision	Prior to A.02.00

Full Range

Sets the internal preamp to use its full range. The low band (0–3.6 GHz or 0–3GHz, depending on the model) is supplied by the low band preamp and the frequencies above low band are supplied by the high band preamp.

The frequency range of the installed (optional) preamp is displayed in square brackets on the Full Range key label. If the high band option is not installed the Full Range key does not appear.

Key Path	AMPTD Y Scale, Internal Preamp
Example	:POW:GAIN ON :POW:GAIN:BAND FULL
Readback	Full Range
Initial S/W Revision	Prior to A.02.00

Ref Position

Positions the reference level at the top, center or bottom of the Y Scale display. Changing the reference position does not change the reference level value.

This functionality depends on the selected view:

- [Ref Position \(RF Envelope View\)](#)
- [Ref Position \(I/Q Waveform View\)](#)

Auto Scaling

Toggles the Auto Scaling function between On and Off. When the Restart front-panel key is pressed, this function automatically determines the scale per division and reference values based on the measurement results.

Key Path	AMPTD Y Scale
----------	---------------

Mode	BASIC, PNOISE, WCDMA, C2K, GSM, WIMAXOFDMA, TDSCDMA, 1XEVD0, DVB, DTMB, ISDBT, CMMB, LTE, LTEFDD, DCATV, WLAN,LTEATDD, LTEAFDD
Remote Command	:DISPlay:WAVeform:VIEW[1] 2:WINDow[1]:TRACe:Y[:SCALe]:COUPle 0 1 OFF ON :DISPlay:WAVeform:VIEW[1] 2:WINDow[1]:TRACe:Y[:SCALe]:COUPle?
Example	DISP:WAV:VIEW:WIND:TRAC:Y:COUP OFF DISP:WAV:VIEW:WIND:TRAC:Y:COUP?
Notes	You must be in a mode that includes the Waveform measurement to use this command. Use INSTRument:SElect to set the mode.
Couplings	When Auto Scaling is On, upon pressing the Restart front-panel key, this function automatically switches the scale per division and reference values into the defaults. When you set a value to either Scale/Div or Ref Value manually, Auto Scaling automatically changes to Off.
Preset	OFF
State Saved	Saved in instrument state.
Range	On Off
Initial S/W Revision	Prior to A.02.00
Modified at S/W Revision	A.03.00

Auto Couple

The Auto Couple feature provides a quick and convenient way to automatically couple multiple instrument settings. This helps ensure accurate measurements and optimum dynamic range. When the Auto Couple feature is activated, either from the front panel or remotely, all parameters of the current measurement that have an Auto/Manual mode are set to Auto mode and all measurement settings dependent on (or coupled to) the Auto/Man parameters are automatically adjusted for optimal performance.

However, the Auto Couple key actions are confined to the current measurement only. It does not affect other measurements in the mode, and it does not affect markers, marker functions, or trace or display attributes.

See ["More Information" on page 2178](#)

Key Path	Front-panel key
Remote Command	:COUPLe ALL NONE
Example	:COUP ALL
Notes	:COUPLe ALL puts all Auto/Man parameters in Auto mode (equivalent to pressing the Auto Couple key). :COUPLE NONE puts all Auto/Man parameters in manual mode. It decouples all the coupled instrument parameters and is not recommended for making measurements.
Initial S/W Revision	Prior to A.02.00

More Information

There are two types of functions that have Auto/Manual modes.

Auto/Man Active Function keys

An Auto/Man toggle key controls the binary state associated with an instrument parameter by toggling between Auto (where the parameter is automatically coupled to the other parameters it is dependent upon) and Man (where the parameter is controlled independent of the other parameters), as well as making the parameter the active function. The current mode is indicated on the softkey with either Auto or Man underlined as illustrated below.



Auto/Man 1-of-N keys

An Auto/Man 1-of-N key allows you to manually pick from a list of parameter values, or place the function in Auto, in which case the value is automatically selected (and indicated) as shown below. If in Auto, Auto is underlined on the calling key. If in manual operation, manual is indicated on the calling key. But the calling key does not actually toggle the function, it simply opens the menu.

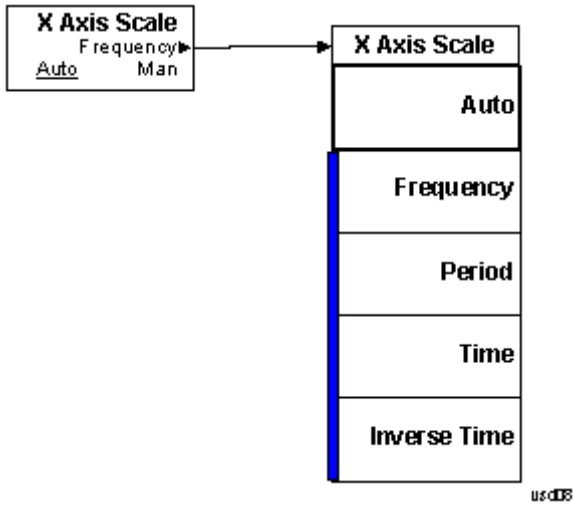

BW

Accesses a menu that enables you to control the information bandwidth functions of the instrument. You can also select the filter type for the measurement.

Key Path	Front-panel key
Initial S/W Revision	Prior to A.02.00

Digital IF BW

Enables you to set the Digital IF (formerly Info BW) bandwidth of the instrument.

Key Path	BW
Mode	BASIC, PNOISE, WCDMA, C2K, GSM, WIMAXOFDMA, TD-SCDMA, 1XEVD0, DVB, DTMB, ISDBT, CMMB, LTE, LTETDD, DCATV, WLAN, MSR,LTEATDD, LTEAFDD
Remote Command	[:SENSe] :WAVeform:DIF:BA NDwidth <freq> [:SENSe] :WAVeform:DIF:BA NDwidth?
Example	WAV:DIF:BA ND 1kHz WAV:DIF:BA ND?
Notes	Max value depends on the IF Path Selection
Remote Command Notes	You must be in a mode that includes the Waveform measurements to use this command. Use INSTRument:SElect to set the mode.
Dependencies	For applications that have the IF Path Selection menu such as the BASIC mode, if IF Path Auto is OFF, the maximum value depends on which IF Path is currently selected. If 10 MHz, 25 MHz, 40 MHz, 85 MHz, 125 MHz, 140 MHz or 160 MHz paths are selected, the maximum value of this parameter will be 10, 25, 40, 85, 125, 140 or 160 MHz, respectively. If IF Path Auto is ON, the maximum value will be the maximum Digital IF BW available in the instrument regardless of the current IF Path Selection. For example, if the instrument has the options B25, B40, and B1X installed, the maximum available Digital IF BW of the instrument is 140 MHz. Thus, if IF Path Auto is ON and IF Path Selection is 25 MHz, the maximum Digital IF BW is not limited to 25 MHz but is 140 MHz.
Preset	All except the following list: 100 kHz GSM/EDGE: 510 kHz TDSCDMA: 1.3 MHz 1xEVD0: 1.3 MHz DVB-T/H: 8.0 MHz DTMB (CTTB): 8.0 MHz ISDB-T: 6.0 MHz CMMB: 8.0 MHz Digital Cable TV: 8 MHz LTEAFDD, LTEATDD: 6 MHz LTETDD: 6 MHz

	<p>WLAN: Hardware Dependent</p> <p>No option = 10 MHz</p> <p>Option B25 = 25 MHz</p> <p>Option B40:</p> <p>if Radio Std is 802.11a/b/g/n(20MHz) = 25 MHz</p> <p>if Radio Std is 802.11n(40MHz) = 40 MHz</p> <p>if Radio Std is 802.11ac(20MHz) = 25 MHz</p> <p>if Radio Std is 802.11ac(40MHz) = 40 MHz</p> <p>Option B1X:</p> <p>if Radio Std is 802.11ac(80MHz) = 80 MHz</p> <p>Option B1Y:</p> <p>if Radio Std is 802.11ac(160MHz) = 160 MHz</p>
State Saved	Saved in instrument state.
Min	10 Hz
Max	<p>Hardware Dependent:</p> <p>RF Input:</p> <p>No Option = 10 MHz</p> <p>Option B25 = 25 MHz</p> <p>Option B40 = 40 MHz</p> <p>Option B85 = 85.0 MHz</p> <p>Option B1A = 125.0 MHz</p> <p>Option B1X = 140 MHz</p> <p>Option B1Y = 160 MHz</p> <p>I/Q Input:</p> <p>No Option = 10 MHz per channel (20 MHz for I+jQ)</p> <p>Option B25 = 25 MHz per channel (50 MHz for I+jQ)</p> <p>Option S40 = 40 MHz per channel (80 MHz for I+jQ)</p>
Backwards Compatibility SCPI	<code>[:SENSe] :WAVeform :BANDwidth [:RESolution]</code>
	<code>[:SENSe] :WAVeform :BWIDth [:RESolution]</code>
Initial S/W Revision	Prior to A.02.00
Modified at S/W Revision	A.03.00, A.13.00

Filter Type

Selects the type of bandwidth filter that is used.

Besides the Gaussian filter shape, a variety of other filter types are available with variable alpha settings for maximum control over the filter shape..

Key Path	BW
Mode	BASIC, PNOISE, WCDMA, C2K, GSM, WIMAXOFDMA, TDSCDMA, 1XEVD0, DVB, DTMB, ISDBT,

	CMMB, LTE, LTETDD, DCATV, WLAN, MSR,,LTEATDD, LTEAFDD
Remote Command	[:SENSe]:WAVeform:DIF:FILTer:TYPE GAUSSian FLATtop [:SENSe]:WAVeform:DIF:FILTer:TYPE? (With DIF40 and/or WBDIF) [:SENSe]:WAVeform:DIF:FILTer:TYPE GAUSSian FLATtop SNYQuist RSNYquist RCOSine RRCosine [:SENSe]:WAVeform:DIF:FILTer:TYPE?
Example	WAV:DIF:FILT:TYPE GAUS WAV:DIF:FILT:TYPE?
Remote Command Notes	You must be in a mode that includes the Waveform measurements to use this command. Use INSTRument:SElect to set the mode.
Dependencies	Gaussian and Flattop are available in all DIF configurations. For the other filter types, the filters are only available when Option DP2, B40, or wider IF Bandwidth option is installed.
Preset	BASIC with DP2, B40, or wider IF Bandwidth option: FLATtop All other apps: GAUSSian
State Saved	Saved in instrument state.
Range	Gaussian FlatTop When Option DP2, B40, or wider IF Bandwidth option is installed, the range is as follows. Gaussian Flattop Short nyquist Root Short Nquist Raised Cosine Root RaisedCosine
Backwards Compatibility SCPI	[:SENSe]:WAVeform:BANDwidth:SHAPE [:SENSe]:WAVeform:BWIDth:SHAPE [:SENSe]:WAVeform:BANDwidth BWIDth[:RESolution]:TYPE
Initial S/W Revision	Prior to A.02.00
Modified at S/W Revision	A.03.00, A.13.00

Filter BW

This feature is only available when Option DP2, B40, or wider IF Bandwidth option is installed.

Key Path	BW
Mode	BASIC
Remote Command	[:SENSe]:WAVeform:DIF:FILTer:BANDwidth <freq> [:SENSe]:WAVeform:DIF:FILTer:BANDwidth? [:SENSe]:WAVeform:DIF:FILTer:BANDwidth:AUTO ON OFF 1 0 [:SENSe]:WAVeform:DIF:FILTer:BANDwidth:AUTO?
Example	WAV:DIF:FILT:BAND 1MHz WAV:DIF:FILT:BAND? WAV:DIF:FILT:BAND:AUTO 0

	WAV:DIF:FILT:BAND:AUTO?
Notes	You must be in the IQ Analyzer (Basic) mode to use this command. Use INSTRUMENT:SElect to set the mode.
Dependencies	This feature is only available when Option DP2, B40, or wider IF Bandwidth option is installed.
Couplings	Sets the same value as the current Digital IF BW value upon a preset or when Channel Filter Bandwidth Auto is ON.
Preset	Same value as Digital IF BW ON
State Saved	Saved in instrument state.
Min	10 Hz
Max	Clipped to the current Digital IF BW value.
Initial S/W Revision	A.04.00, A.13.00

Filter Alpha

Sets the filter alpha for the DIF filter. This feature is only available when Option DP2, B40, or wider IF Bandwidth option is installed.

Key Path	BW
Mode	BASIC
Remote Command	[:SENSe] :WAVeform:DIF:FILTer:ALPHa <real> [:SENSe] :WAVeform:DIF:FILTer:ALPHa?
Example	WAV:DIF:FILT:ALPH 0.5 WAV:DIF:FILT:ALPH?
Notes	You must be in the IQ Analyzer (Basic) mode to use this command. Use INSTRUMENT:SElect to set the mode.
Dependencies	This feature is only available when Option DP2, B40, or wider IF Bandwidth option is installed.
Preset	0.2
State Saved	Saved in instrument state.
Min	0.01
Max	1.00
Backwards Compatibility SCPI	[:SENSe] :WAVeform:WBIF:FILTer:ALPHa
Modified at S/W Revision	A.13.00

Filter Type Bwcc

This parameter is strictly for Bwcc purposes.

Remote Command	<code>[:SENSe] :WAVeform:WBIF:FILTer[:TYPE] GAUSSian NONE NYQuist RNYQuist RCOSine RRCosine</code> <code>[:SENSe] :WAVeform:WBIF:FILTer[:TYPE] ?</code>
Preset	BASIC with Option DP2, B40, or wider IF Bandwidth option: FLATtop All other apps: GAUSSian

Gaussian

When Option DP2, B40, or wider IF Bandwidth option is installed, the capability for arbitrary Digital IF bandwidths is available. However, for instruments without DP2, B40, or wider IF Bandwidth option, the selectable Gaussian filter bandwidths are predetermined as shown in the following list. There are 160 Info BWs (RBWs) arranged in a 24-per-decade sequence from 1 Hz through 3 MHz, plus the 4, 5, 6 and 8 MHz settings.

The following table list all 160 Gaussian filter types

Gaussian filters

Normal (-3 dB)	-6 dB	Noise	Impulse
1.0 Hz	1.41 Hz	1.06 Hz	1.49 Hz
1.1 Hz	1.55 Hz	1.16 Hz	1.63 Hz
1.2 Hz	1.69 Hz	1.27 Hz	1.77 Hz
1.3 Hz	1.83 Hz	1.37 Hz	1.92 Hz
1.5 Hz	2.11 Hz	1.59 Hz	2.22 Hz
1.6 Hz	2.25 Hz	1.69 Hz	2.37 Hz
1.8 Hz	2.53 Hz	1.90 Hz	2.66 Hz
2.0 Hz	2.81 Hz	2.12 Hz	2.96 Hz
2.2 Hz	3.09 Hz	2.33 Hz	3.25 Hz
2.4 Hz	3.38 Hz	2.54 Hz	3.55 Hz
2.7 Hz	3.80 Hz	2.86 Hz	3.99 Hz
3.0 Hz	4.22 Hz	3.17 Hz	4.44 Hz
3.3 Hz	4.64 Hz	3.49 Hz	4.88 Hz
3.6 Hz	5.06 Hz	3.81 Hz	5.32 Hz
3.9 Hz	5.49 Hz	4.12 Hz	5.77 Hz
4.3 Hz	6.05 Hz	4.55 Hz	6.36 Hz
4.7 Hz	6.61 Hz	4.97 Hz	6.95 Hz
5.1 Hz	7.17 Hz	5.39 Hz	7.54 Hz
5.6 Hz	7.87 Hz	5.92 Hz	8.27 Hz
6.2 Hz	8.72 Hz	6.56 Hz	9.17 Hz

6.8 Hz	9.55 Hz	7.18 Hz	10.0 Hz
7.5 Hz	10.5 Hz	7.93 Hz	11.1 Hz
8.2 Hz	11.5 Hz	8.66 Hz	12.1 Hz
9.1 Hz	12.8 Hz	9.64 Hz	13.5 Hz
10 Hz	14.0 Hz	10.6 Hz	14.8 Hz
11 Hz	15.4 Hz	11.6 Hz	16.2 Hz
12 Hz	16.9 Hz	12.7 Hz	17.7 Hz
13 Hz	18.3 Hz	13.7 Hz	19.2 Hz
15 Hz	21.1 Hz	15.9 Hz	22.2 Hz
16 Hz	22.5 Hz	16.9 Hz	23.7 Hz
18 Hz	25.3 Hz	19.1 Hz	26.6 Hz
20 Hz	28.1 Hz	21.1 Hz	29.5 Hz
22 Hz	30.9 Hz	23.2 Hz	32.5 Hz
24 Hz	33.8 Hz	25.4 Hz	35.5 Hz
27 Hz	38.0 Hz	28.6 Hz	40.0 Hz
30 Hz	42.3 Hz	31.8 Hz	44.5 Hz
33 Hz	46.3 Hz	34.8 Hz	48.7 Hz
36 Hz	50.7 Hz	38.1 Hz	53.3 Hz
39 Hz	54.9 Hz	41.3 Hz	57.7 Hz
43 Hz	60.5 Hz	45.5 Hz	63.6 Hz
47 Hz	66.1 Hz	49.7 Hz	69.5 Hz
51 Hz	71.7 Hz	53.9 Hz	75.3 Hz
56 Hz	78.9 Hz	59.3 Hz	83.0 Hz
62 Hz	87.3 Hz	65.6 Hz	91.7 Hz
68 Hz	95.5 Hz	71.8 Hz	100 Hz
75 Hz	106 Hz	79.4 Hz	111 Hz
82 Hz	115 Hz	86.8 Hz	121 Hz
91 Hz	128 Hz	96.4 Hz	135 Hz
100 Hz	141 Hz	106 Hz	148 Hz
110 Hz	154 Hz	116 Hz	162 Hz
120 Hz	169 Hz	127 Hz	178 Hz
130 Hz	183 Hz	137 Hz	192 Hz
150 Hz	211 Hz	159 Hz	222 Hz
160 Hz	225 Hz	169 Hz	237 Hz
180 Hz	253 Hz	190 Hz	266 Hz
200 Hz	281 Hz	211 Hz	295 Hz
220 Hz	309 Hz	232 Hz	325 Hz

240 Hz	337 Hz	254 Hz	355 Hz
270 Hz	380 Hz	286 Hz	400 Hz
300 Hz	422 Hz	317 Hz	444 Hz
330 Hz	463 Hz	348 Hz	487 Hz
360 Hz	507 Hz	381 Hz	533 Hz
390 Hz	550 Hz	413 Hz	578 Hz
430 Hz	605 Hz	455 Hz	636 Hz
470 Hz	662 Hz	498 Hz	696 Hz
510 Hz	718 Hz	540 Hz	755 Hz
560 Hz	789 Hz	593 Hz	829 Hz
620 Hz	872 Hz	655 Hz	916 Hz
680 Hz	958 Hz	720 Hz	1.01 kHz
750 Hz	1.06 kHz	794 Hz	1.11 kHz
820 Hz	1.15 kHz	866 Hz	1.21 kHz
910 Hz	1.28 kHz	964 Hz	1.35 kHz
1.0 kHz	1.41 kHz	1.06 kHz	1.48 kHz
1.1 kHz	1.55 kHz	1.17 kHz	1.63 kHz
1.2 kHz	1.69 kHz	1.27 kHz	1.78 kHz
1.3 kHz	1.83 kHz	1.38 kHz	1.93 kHz
1.5 kHz	2.11 kHz	1.59 kHz	2.22 kHz
1.6 kHz	2.26 kHz	1.70 kHz	2.37 kHz
1.8 kHz	2.54 kHz	1.91 kHz	2.67 kHz
2.0 kHz	2.82 kHz	2.12 kHz	2.96 kHz
2.2 kHz	3.10 kHz	2.33 kHz	3.26 kHz
2.4 kHz	3.38 kHz	2.54 kHz	3.56 kHz
2.7 kHz	3.80 kHz	2.86 kHz	4.00 kHz
3.0 kHz	4.23 kHz	3.18 kHz	4.44 kHz
3.3 kHz	4.65 kHz	3.49 kHz	4.89 kHz
3.6 kHz	5.06 kHz	3.81 kHz	5.32 kHz
3.9 kHz	5.48 kHz	4.12 kHz	5.76 kHz
4.3 kHz	6.07 kHz	4.56 kHz	6.38 kHz
4.7 kHz	6.62 kHz	4.98 kHz	6.96 kHz
5.1 kHz	7.16 kHz	5.38 kHz	7.53 kHz
5.6 kHz	7.87 kHz	5.92 kHz	8.27 kHz
6.2 kHz	8.74 kHz	6.57 kHz	9.18 kHz
6.8 kHz	9.58 kHz	7.20 kHz	10.1 kHz
7.5 kHz	10.5 kHz	7.92 kHz	11.1 kHz

8.2 kHz	11.5 kHz	8.66 kHz	12.1 kHz
9.1 kHz	12.8 kHz	9.64 kHz	13.5 kHz
10 kHz	14.1 kHz	10.6 kHz	14.8 kHz
11 kHz	15.4 kHz	11.6 kHz	16.2 kHz
12 kHz	16.9 kHz	12.7 kHz	17.8 kHz
13 kHz	18.3 kHz	13.7 kHz	19.2 kHz
15 kHz	21.2 kHz	15.9 kHz	22.3 kHz
16 kHz	22.4 kHz	16.8 kHz	23.5 kHz
18 kHz	25.2 kHz	19.0 kHz	26.5 kHz
20 kHz	28.4 kHz	21.3 kHz	29.8 kHz
22 kHz	31.2 kHz	23.4 kHz	32.8 kHz
24 kHz	33.8 kHz	25.4 kHz	35.6 kHz
27 kHz	38.1 kHz	28.7 kHz	40.1 kHz
30 kHz	42.1 kHz	31.7 kHz	44.3 kHz
33 kHz	46.8 kHz	35.2 kHz	49.2 kHz
36 kHz	50.1 kHz	37.7 kHz	52.7 kHz
39 kHz	54.8 kHz	41.2 kHz	57.6 kHz
43 kHz	61.1 kHz	46.0 kHz	64.3 kHz
47 kHz	66.2 kHz	49.8 kHz	69.6 kHz
51 kHz	72.3 kHz	54.3 kHz	76.0 kHz
56 kHz	79.5 kHz	59.8 kHz	83.6 kHz
62 kHz	86.3 kHz	64.9 kHz	90.8 kHz
68 kHz	96.5 kHz	72.6 kHz	101 kHz
75 kHz	106 kHz	79.7 kHz	111 kHz
82 kHz	114 kHz	86.0 kHz	120 kHz
91 kHz	129 kHz	97.3 kHz	136 kHz
100 kHz	140 kHz	105 kHz	147 kHz
110 kHz	154 kHz	116 kHz	162 kHz
120 kHz	169 kHz	127 kHz	178 kHz
130 kHz	182 kHz	137 kHz	192 kHz
150 kHz	210 kHz	158 kHz	221 kHz
160 kHz	223 kHz	168 kHz	235 kHz
180 kHz	253 kHz	190 kHz	266 kHz
200 kHz	280 kHz	211 kHz	295 kHz
220 kHz	308 kHz	232 kHz	324 kHz
240 kHz	336 kHz	253 kHz	353 kHz
270 kHz	380 kHz	286 kHz	400 kHz

300 kHz	420 kHz	316 kHz	441 kHz
330 kHz	467 kHz	352 kHz	491 kHz
360 kHz	506 kHz	380 kHz	532 kHz
390 kHz	550 kHz	414 kHz	578 kHz
430 kHz	599 kHz	451 kHz	629 kHz
470 kHz	660 kHz	497 kHz	693 kHz
510 kHz	715 kHz	538 kHz	750 kHz
560 kHz	786 kHz	592 kHz	826 kHz
620 kHz	867 kHz	653 kHz	912 kHz
680 kHz	952 kHz	717 kHz	1.00 MHz
750 kHz	1.05 MHz	791 kHz	1.10 MHz
820 kHz	1.14 MHz	859 kHz	1.19 MHz
910 kHz	1.27 MHz	960 kHz	1.34 MHz
1.0 MHz	1.40 MHz	1.06 MHz	1.47 MHz
1.1 MHz	1.53 MHz	1.15 MHz	1.61 MHz
1.2 MHz	1.66 MHz	1.26 MHz	1.75 MHz
1.3 MHz	1.80 MHz	1.36 MHz	1.89 MHz
1.5 MHz	2.06 MHz	1.56 MHz	2.17 MHz
1.6 MHz	2.19 MHz	1.66 MHz	2.29 MHz
1.8 MHz	2.51 MHz	1.91 MHz	2.63 MHz
2.0 MHz	2.75 MHz	2.10 MHz	2.88 MHz
2.2 MHz	3.00 MHz	2.30 MHz	3.14 MHz
2.4 MHz	3.30 MHz	2.54 MHz	3.45 MHz
2.7 MHz	3.63 MHz	2.81 MHz	3.78 MHz
3.0 MHz	4.09 MHz	3.18 MHz	4.22 MHz
4 MHz	5.30 MHz	4.23 MHz	5.30 MHz
5 MHz	5.78 MHz	4.81 MHz	5.41 MHz
6 MHz	6.31 MHz	5.50 MHz	5.82 MHz
8 MHz	8.07 MHz	7.21 MHz	6.90 MHz

Flattop

When Option DP2, B40, or wider IF Bandwidth option is installed, the capability for arbitrary Digital IF bandwidths is available. However, for instruments without Option DP2, B40 or wider IF Bandwidth option, the selectable Flattop filter bandwidths are predefined as shown in the following table. There are 134 Digital IF BWs (RBWs).

The table in the section "[Flattop Filters](#)" on page 2189 lists all 134 Flattop filter types.

Flattop Filters

3.0 Hz	3.3 Hz	3.6 Hz	3.9 Hz
4.3 Hz	4.7 Hz	5.1 Hz	5.6 Hz
6.2 Hz	6.8 Hz	7.5 Hz	8.2 Hz
9.1 Hz	10 Hz	11 Hz	12 Hz
13 Hz	15 Hz	16 Hz	18 Hz
20 Hz	22 Hz	24 Hz	27 Hz
30 Hz	33 Hz	36 Hz	39 Hz
43 Hz	47 Hz	51 Hz	56 Hz
62 Hz	68 Hz	75 Hz	82 Hz
91 Hz	100 Hz	110 Hz	120 Hz
130 Hz	150 Hz	160 Hz	180 Hz
200 Hz	220 Hz	240 Hz	270 Hz
300 Hz	330 Hz	360 Hz	390 Hz
430 Hz	470 Hz	510 Hz	560 Hz
620 Hz	680 Hz	750 Hz	820 Hz
910 Hz	1.0 kHz	1.1 kHz	1.2 kHz
1.3 kHz	1.5 kHz	1.6 kHz	1.8 kHz
2.0 kHz	2.2 kHz	2.4 kHz	2.7 kHz
3.0 kHz	3.3 kHz	3.6 kHz	3.9 kHz
4.3 kHz	4.7 kHz	5.1 kHz	5.6 kHz
6.2 kHz	6.8 kHz	7.5 kHz	8.2 kHz
9.1 kHz	10 kHz	11 kHz	12 kHz
13 kHz	15 kHz	16 kHz	18 kHz
20 kHz	22 kHz	24 kHz	27 kHz
30 kHz	33 kHz	36 kHz	39 kHz
43 kHz	47 kHz	51 kHz	56 kHz
62 kHz	68 kHz	75 kHz	82 kHz
91 kHz	100 kHz	110 kHz	120 kHz
130 kHz	150 kHz	160 kHz	180 kHz
200 kHz	220 kHz	240 kHz	270 kHz
300 kHz	330 kHz	390 kHz	430 kHz
510 kHz	620 kHz	750 kHz	1.0 MHz
1.5 MHz	3.0 MHz	4 MHz	5 MHz
6 MHz	8 MHz		

Channel Filter Bandwidth Bwcc (Remote Command Only)

This is the backward compatibility command for Channel Filter Bandwidth.

Mode	BASIC
Remote Command	<code>[:SENSe] :WAVeform:WBIF:FILTer:BANDwidth <real></code> <code>[:SENSe] :WAVeform:WBIF:FILTer:BANDwidth?</code>
Example	WAV:WBIF:FILT:BAND 0.3 WAV:WBIF:FILT:BAND?
Notes	You must be in the IQ Analyzer (Basic) mode to use this command. Use INSTRUMENT:SElect to set the mode.
Dependencies	This feature is only available when Option DP2, B40, or wider IF Bandwidth option is installed.
Couplings	The value is determined by the following equation. $\text{ChannelFilterBwBwcc} = (\text{ChannelFilterBw} / (\text{DigitalIFBw} * \text{OverSampleRatio}))$
Preset	0.8
State Saved	Saved in instrument state.
Min	0.01
Max	1.0
Initial S/W Revision	A.04.00
Modified at S/W Revision	A.13.00

Cont (Continuous Measurement/Sweep)

Sets the analyzer for Continuous measurement operation. The single/continuous state is Meas Global so the setting will affect all measurements. If you are Paused, pressing Cont does a Resume.

Key Path	Front-panel key
Remote Command	:INITiate:CONTinuous OFF ON 0 1 :INITiate:CONTinuous?
Example	:INIT:CONT 0 puts analyzer in Single measurement operation. :INIT:CONT 1 puts analyzer in Continuous measurement operation
Preset	ON (Note that SYST:PRESet sets INIT:CONT to ON but *RST sets INIT:CONT to OFF)
State Saved	Saved in instrument state
Backwards Compatibility Notes	For Spectrum Analysis mode in ESA and PSA, there is no Cont hardkey, instead there is a Sweep Single/Cont key. In these analyzers, switching the Sweep Single/Cont key from Single to Cont restarts averages (displayed average count reset to 1), but does not restart Max Hold and Min Hold. The X-Series has Single and Cont keys in place of the SweepSingleCont key. In the X-Series, if in single measurement, the Cont key (and INIT:CONT ON) switches to continuous measurement, but never restarts a measurement and never resets a sweep.
Initial S/W Revision	Prior to A.02.00

In Swept SA Measurement (Spectrum Analysis Mode):

The analyzer takes repetitive sweeps, averages, measurements, etc., when in Continuous mode. When the average count reaches the Average/Hold Number the count stops incrementing, but the analyzer keeps sweeping. See the Trace/Detector section for the averaging formula used both before and after the Average/Hold Number is reached. The trigger condition must be met prior to each sweep. The type of trace processing for multiple sweeps, is set under the Trace/Detector key, with choices of Trace Average, Max Hold, or Min Hold.

In Other Measurements/Modes:

With Avg/Hold Num (in the Meas Setup menu) set to Off or set to On with a value of 1, a sweep is taken after the trigger condition is met; and the analyzer continues to take new sweeps after the current sweep has completed and the trigger condition is again met. However, with Avg/Hold Num set to On with a value >1, multiple sweeps (data acquisitions) are taken for the measurement. The trigger condition must be met prior to each sweep. The sweep is not stopped when the average count k equals the number N set for Avg/Hold Num is reached, but the number k stops incrementing. A measurement average usually applies to all traces, marker results, and numeric results. But sometimes it only applies to the numeric results.

If the analyzer is in Single measurement, pressing the Cont key does not change k and does not cause the sweep to be reset; the only action is to put the analyzer into Continuous measurement operation.

If it is already in continuous sweep:

the INIT:CONT 1 command has no effect

18 Waveform Measurement
Cont (Continuous Measurement/Sweep)

the INIT:CONT 0 command will place the analyzer in Single Sweep but will have no effect on the current sequence until $k = N$, at which point the current sequence will stop and the instrument will go to the idle state.

File

See "File" on page 348

FREQ Channel

Accesses a menu of keys that allow you to control the Frequency and Channel parameters of the instrument.

Some features in the Frequency menu are the same for all measurements – they do not change as you change measurements. Settings like these are called “Meas Global” and are unaffected by Meas Preset. For example, the Center Freq setting is the same for all measurements - it does not change as you change measurements.

Key Path	Front-panel key
Initial S/W Revision	Prior to A.02.00

Center Freq

Sets the frequency that corresponds to the horizontal center of the graticule (when frequency Scale Type is set to linear). While adjusting the Center Frequency the Span is held constant, which means that both Start Frequency and Stop Frequency will change.

Pressing Center Freq also sets the frequency entry mode to Center/Span. In Center/Span mode, the center frequency and span values are displayed below the graticule, and the default active function in the Frequency menu is Center Freq.

The center frequency setting is the same for all measurements within a mode, that is, it is Meas Global. Some modes are also able to share a Mode Global center frequency value. If this is the case, the Mode will have a Global Settings key in its Mode Setup menu.

The Center Freq function sets (and queries) the Center Frequency for the currently selected input. If your analyzer has multiple inputs, and you select another input, the Center Freq changes to the value for that input. SCPI commands are available to directly set the Center Freq for a specific input.

Center Freq is remembered as you go from input to input. Thus you can set a Center Freq of 10 GHz with the RF Input selected, change to BBIQ and set a Center Freq of 20 MHz, then switch to External Mixing and set a Center Freq of 60 GHz, and when you go back to the RF Input the Center Freq will go back to 10 GHz; back to BBIQ and it is 20 MHz; back to External Mixing and it is 60 GHz.

See ["RF Center Freq" on page 2197](#)

See [Ext Mix Center Freq](#)

See ["I/Q Center Freq" on page 2199](#)

See ["Center Frequency Presets" on page 2195](#)

Key Path	FREQ Channel
Scope	Meas Global
Remote Command	<code>[:SENSe] :FREQuency:CENTer <freq></code> <code>[:SENSe] :FREQuency:CENTer?</code>

Example	FREQ:CENT 50 MHz FREQ:CENT UP changes the center frequency to 150 MHz if you use FREQ:CENT:STEP 100 MHz to set the center frequency step size to 100 MHz FREQ:CENT?
Notes	This command sets either the RF or I/Q Center Frequency depending on the selected input. For RF input it is equivalent to FREQ:RF:CENT For I/Q input it is equivalent to FREQ:IQ:CENT Preset and Max values are dependent on Hardware Options (5xx) If no terminator (e.g. MHz) is sent the terminator Hz is used. If a terminator with unit other than Frequency is used, an invalid suffix error message is generated.
Dependencies	The Center Frequency can be limited by Start or Stop Freq limits, if the Span is so large that Start or Stop reach their limit.
Couplings	When operating in “swept span”, any value of the Center Frequency or Span that is within the frequency range of the analyzer is allowed when the value is being set through the front panel numeric key pad or the SCPI command. The other parameter is forced to a different value if needed, to keep the Start and the Stop Frequencies within the analyzer’s frequency range
Preset	Depends on instrument maximum frequency, mode, measurement, and selected input. See "Center Frequency Presets" on page 2195 and "RF Center Freq" on page 2197 and Ext Mix Center Freq and "I/Q Center Freq" on page 2199 .
State Saved	Saved in instrument state
Min	Depends on instrument maximum frequency, mode, measurement, and selected input.. See "Center Frequency Presets" on page 2195 and "RF Center Freq" on page 2197 and "I/Q Center Freq" on page 2199 .
Max	Depends on instrument maximum frequency, mode, measurement, and selected input.. See "Center Frequency Presets" on page 2195 and "RF Center Freq" on page 2197 and "I/Q Center Freq" on page 2199 .
Default Unit	Hz
Status Bits/OPC	Non-overlapped
Dependencies	
Initial S/W Revision	Prior to A.02.00

Center Frequency Presets

The following table provides the Center Frequency Presets for the Spectrum Analyzer mode, and the Max Freq, for the various frequency options:

Freq Option	CF after Mode Preset	Stop Freq after Mode Preset	Max Freq (can't tune)

			above)
503 (all but N9000A)	1.805 GHz	3.6 GHz	3.7 GHz
503 (N9000A)	1.505 GHz	3.0 GHz	3.08 GHz
507 (all but N9000A)	3.505 GHz	7.0 GHz	7.1 GHz
507 (N9000A)	3.755 GHz	7.5 GHz	7.58 GHz
508 (all but N9038A)	1.805 GHz	3.6 GHz	8.5 GHz
508 (N9038A)	4.205 GHz	8.4 GHz	8.5 GHz
513	6.805 GHz	13.6 GHz	13.8 GHz
526 (all but N9000A and N9038A)	13.255 GHz	26.5 GHz	27.0 GHz
526 (N9000A)	13.255 GHz	26.5 GHz	26.55 GHz
526 (N9038A)	1.805 GHz	3.6 GHz	27.0 GHz
532	16.005 GHz	32.0 GHz	32.5 GHz
543	21.505 GHz	43.0 GHz	TBD
544	22.005 GHz	44.0 GHz	44.5 GHz
550	25.005 GHz	50.0 GHz	51 GHz

Input 2:

Model	CF after Mode Preset	Stop Freq after Mode Preset	Max Freq (can't tune above)
N9000A opt C75	0.7505GHz	1.5 GHz	1.58 GHz
N9038A	505 MHz	1 GHz	1.000025 GHz

Tracking Generator Frequency Limits (N9000A only):

Tracking Generator Option	Min Freq (clips to this freq when turn TG on and	If above this Freq, Stop Freq clipped to this Freq when	Max Freq (can't tune above) while TG

	can't tune below while TG on)	TG turned on	on
T03	9 kHz	3.0 GHz	3.08 GHz
T06	9 kHz	6.0 GHz	6.05 GHz

The following table shows the Center Frequency Presets for modes other than Spectrum Analyzer:

Mode	CF Preset for RF
WCDMA	1 GHz
WIMAXOFDMA,	1 GHz
BASIC	1 GHz
ADEMOD	1 GHz
VSA	1 GHz
TDSCDMA	1 GHz
PNOISE	1 GHz
LTE	1 GHz
LTETDD	1 GHz
MSR	1 GHz
GSM	935.2 MHz
NFIGURE	1.505 GHz

RF Center Freq

SCPI command for specifying the RF Center Frequency. This command will set the Center Frequency to be used when the RF input is selected, even if the RF input is not the input that is selected at the time the command is sent. Note that the Center Freq function in the Frequency menu on the front panel always applies to the currently selected input.

Scope	Meas Global
Remote Command	<code>[:SENSe] :FREQuency:RF:CENTer <freq></code> <code>[:SENSe] :FREQuency:RF:CENTer?</code>
Example	FREQ:RF:CENT 30 MHz
Notes	This command is the same in all modes, but the parameter is Measurement Global. So the value is independent in each mode and common across all the measurements in the mode.
Dependencies	If the electronic/soft attenuator is enabled, any attempt to set Center Frequency such that the Stop Frequency would be >3.6 GHz fails and results in an advisory message. If the equivalent SCPI command is sent, this same message is generated as part of a “-221, Settings conflict” warning. If Source Mode is set to Tracking, and the Max or Min Center Freq is therefore limited by the limits of the source, a warning message is generated, “Data out of range;clipped to source max/min” if these limits are exceeded. Note that for an external source, these limits can be affected by the settings of

	Source Numerator, Source Denominator and Power Sweep.
Preset	See table above
State Saved	Saved in instrument state.
Min	-79.999995 MHz, unless Source Mode is set to Tracking, in which case it is limited by the minimum frequency of the Source
Max	See table above. Basically instrument maximum frequency – 5 Hz. Note that, if the Source Mode is set to Tracking, the effective instrument maximum frequency may be limited by the source maximum frequency. If the knob or step keys are being used, also depends on the value of the other three interdependent parameters Span, Start Frequency and Stop Frequency
Initial S/W Revision	Prior to A.02.00
Modified at S/W Revision	A.03.00

Ext Mix Center Freq

SCPI command for specifying the External Mixer Center Frequency. This command will set the Center Frequency to be used when the External Mixer is selected, even if the External Mixer input is not the input which is selected at the time the command is sent. Note that the Center Freq function in the Frequency menu on the front panel always applies to the currently selected input.

Scope	Meas Global
Remote Command	<code>[:SENSe] :FREQuency:EMIXer:CENTer <freq></code> <code>[:SENSe] :FREQuency:EMIXer:CENTer?</code>
Example	<code>:FREQ:EMIX:CENT 60 GHz</code> <code>:FREQ:EMIX:CENT?</code>
Notes	This command is the same in all modes, but the parameter is Measurement Global. So the value is independent in each mode and common across all the measurements in the mode.
Couplings	When returning to External Mixing after having been switched to one of the other inputs (e.g., RF), you will come back into the settings that you had when you left External Mixing. So you will come back to the band you were in with the Center Frequency that you had. However, Span is not an input-dependent parameter, therefore you will bring the span over from the other input. Therefore, the analyzer comes back with the span from the previous input, limited as necessary by the current mixer setup.
Preset	When a Mode Preset is performed while in External Mixing, the Start frequency of the current Mode is set to the nominal Min Freq of the lowest harmonic range in the Harmonic Table for the current mixer setup. Similarly, the Stop frequency of the current Mode is set to the nominal Max Freq of the highest harmonic range in the Harmonic Table. The Center Freq thus presets to the point arithmetically equidistant from these two frequencies. If the current measurement has a limited Span available to it, and cannot achieve the Span shown in the table (Span=Stop Freq – Start Freq), the analyzer uses the maximum Span the measurement allows, and still sets the Center Freq to the midpoint of the Start and Stop Freq values in the Harmonic Table.

	When Restore Input/Output Defaults is performed, the mixer presets to the 11970A, whose Start and Stop frequencies are 26.5 and 40 GHz respectively. The center of these two frequencies is 33.25 GHz. Therefore, after a Restore Input/Output Defaults, if you go into External Mixing and do a Mode Preset while in the Spectrum Analyzer Mode, the resulting Center Freq is 33.25 GHz.
State Saved	Saved in instrument state.
Min	The minimum frequency in the currently selected mixer band + 5 Hz
Max	The maximum frequency in the currently selected mixer band – 5 Hz If the knob or step keys are being used, also depends on the value of the other three interdependent parameters Span, Start Frequency and Stop Frequency
Initial S/W Revision	A.08.01

I/Q Center Freq

SCPI command for specifying the I/Q Center Frequency. This command will set the Center Frequency to be used when the I/Q input is selected, even if the I/Q input is not the input which is selected at the time the command is sent. Note that the Center Freq function in the Frequency menu on the front panel always applies to the currently selected input.

Scope	Meas Global
Remote Command	<code>[:SENSe] :FREQuency:IQ:CENTer <freq></code> <code>[:SENSe] :FREQuency:IQ:CENTer?</code>
Example	FREQ:IQ:CENT: 30 MHz
Notes	This command is the same in all modes, but the parameter is Measurement Global. So the value is independent in each mode and common across all the measurements in the mode.
Preset	0 Hz
State Saved	Saved in instrument state.
Min	-40.049995 MHz
Max	40.049995 MHz
Initial S/W Revision	Prior to A.02.00

CF Step

Changes the step size for the center frequency and start and stop frequency functions. Once a step size has been selected and the center frequency function is active, the step keys (and the UP|DOWN parameters for Center Frequency from remote commands) change the center frequency by the step-size value. The step size function is useful for finding harmonics and sidebands beyond the current frequency span of the analyzer.

Note that the start and stop frequencies also step by the CF Step value.

Key Path	FREQ Channel
Remote Command	<pre>[:SENSe] :FREQuency:CENTer:STEP [:INCRement] <freq> [:SENSe] :FREQuency:CENTer:STEP [:INCRement] ? [:SENSe] :FREQuency:CENTer:STEP:AUTO OFF ON 0 1 [:SENSe] :FREQuency:CENTer:STEP:AUTO?</pre>
Example	<pre>FREQ:CENT:STEP:AUTO ON FREQ:CENT:STEP 500 MHz FREQ:CENT UP increases the current center frequency value by 500 MHz FREQ:CENT:STEP? FREQ:CENT:STEP:AUTO?</pre>
Notes	Preset and Max values are depending on Hardware Options (503, 507, 508, 513, 526)
Notes	Preset and Max values are dependent on Hardware Options (5xx)
Dependencies	Freq Offset is not available in External Mixing. In this case the Freq Offset key is grayed out and shows a value of zero. It will once again be available, and show the previously set value, when you return to the RF Input.
Dependencies	Span, RBW, Center frequency If the electronic/soft attenuator is enabled, any attempt to change the value of the center frequency >3.6 GHz by pressing the Up-arrow key, fails and results in an advisory message. If the equivalent SCPI command is sent, this same message is generated as part of a “-221, Settings conflict” warning.
Couplings	When auto-coupled in a non-zero span, the center frequency step size is set to 10% of the span. When auto-coupled in zero span, the center frequency step size is set to the equivalent -3 dB RBW value.
Preset	Auto ADEM0D: 1 MHz ON
State Saved	Saved in instrument state
Min	– (the maximum frequency of the instrument). That is, 27 GHz max freq instrument has a CF step range of +/- 27 GHz. Note that this is the maximum frequency given the current settings of the instrument, so in External Mixing, for example, it is the maximum frequency of the current mixer band.
Max	The maximum frequency of the instrument. That is, 27 GHz max freq instrument has a CF step range of +/- 27 GHz. Note that this is the maximum frequency given the current settings of the instrument, so in External Mixing, for example, it is the maximum frequency of the current mixer band.
Default Unit	Hz
Status Bits/OPC dependencies	non-overlapped
Initial S/W Revision	Prior to A.02.00
Modified at S/W Revision	A.03.00

Input/Output

See "Input/Output" on page 194

Marker

Accesses a menu that enables you to select, set up and control the markers for the current measurement.

Key Path	Front-panel key
Initial S/W Revision	Prior to A.02.00

Select Marker

Displays 12 markers available for selection.

Key Path	Marker
Initial S/W Revision	Prior to A.02.00

Marker Type

Sets the marker control mode to Normal, Delta, Fixed or Off. All interactions and dependencies detailed under the key description are enforced when the remote command is sent. If the selected marker is Off, pressing Marker sets it to Normal and places it at the center of the screen on the trace determined by the Marker Trace rules. At the same time, the Marker X Axis Value appears on the Active Function area.

The default active function is the active function for the currently selected marker control mode. If the current control mode is Off, there is no active function and the active function is turned off.

Key Path	Marker
Mode	BASIC, PNOISE, WCDMA, C2K, GSM, WIMAXOFDMA, TDSCDMA, 1XEVD0, DVB, DTMB, ISDBT, CMMB, LTE, LTETDD, DCATV, WLAN,,LTEATDD, LTEAFDD
Remote Command	:CALCulate:WAVeform:MARKer[1] 2 ... 12:MODE POSition DELTa OFF :CALCulate:WAVeform:MARKer[1] 2 ... 12:MODE?
Example	CALC:WAV:MARK:MODE OFF CALC:WAV:MARK:MODE?
Notes	If the selected marker is Off, pressing Marker sets it to Normal and places it at the center of the screen on the trace determined by the Marker Trace rules. At the same time, Marker X Axis Value appears on the Active Function area. Default Active Function: the active function for the selected marker's current control mode. If the current control mode is Off, there is no active function and the active function is turned off. Active Function Display: the marker X axis value entered in the active function area displays the marker value to its full entered precision. You must be in a mode that includes the Waveform measurement to use this command. Use INSTRument:SElect to set the mode.
Preset	OFF
State Saved	Saved in instrument state.

Range	Normal Delta Off
Initial S/W Revision	Prior to A.02.00
Modified at S/W Revision	A.03.00

Properties

Accesses the marker properties menu.

Key Path	Marker
Initial S/W Revision	Prior to A.02.00

Select Marker

Displays 12 markers available for selection.

Key Path	Marker
Initial S/W Revision	Prior to A.02.00

Relative To

Selects the marker that the selected marker is relative to (*its reference marker*).

Key Path	Marker, Properties
Mode	BASIC, PNOISE, WCDMA, C2K, GSM, WIMAXOFDMA, TDSCDMA, 1XEVD0, DVB, DTMB, ISDBT, CMMB, LTE, LTEADD, DCATV, WLAN,,LTEATDD, LTEAFDD
Remote Command	:CALCulate:WAVEform:MARKer[1] 2 ... 12:REFerence <integer> :CALCulate:WAVEform:MARKer[1] 2 ... 12:REFerence?
Example	CALC:WAV:MARK:REF 8 CALC:WAV:MARK:REF?
Notes	A marker cannot be relative to itself so that choice is grayed out, and if sent from SCPI generates error -221: "Settings conflict; marker cannot be relative to itself." When queried a single value is returned (the specified marker numbers relative marker). You must be in a mode that includes the Waveform measurement to use this command. Use INSTRument:SElect to set the mode.
Preset	2 3 4 5 6 7 8 9 10 11 12 1
State Saved	Saved in instrument state.
Min	1
Max	12
Initial S/W Revision	Prior to A.02.00
Modified at S/W Revision	A.03.00

Marker Trace

Assigns the specified marker to the designated trace.

Key Path	Marker
Mode	BASIC, PNOISE, WCDMA, C2K, GSM, WIMAXOFDMA, TDSCDMA, 1XEVD0, DVB, DTMB, ISDBT, CMMB, LTE, LTETDD, DCATV, WLAN,,LTEATDD, LTEAFDD
Remote Command	:CALCulate:WAVeform:MARKer[1] 2 ... 12:TRACe RFENvelope I Q IQ :CALCulate:WAVeform:MARKer[1] 2 ... 12:TRACe?
Example	CALC:WAV:MARK:TRAC RFEN CALC:WAV:MARK:TRAC?
Notes	Assigns the specified marker to the designated trace. The IQ selection is for backward compatibility purposes. It is recommended that the users use the I and/or Q selection instead. You must be in a mode that includes the Waveform measurement to use this command. Use INSTRument:SElect to set the mode.
Preset	RFEN
State Saved	Saved in instrument state.
Range	RF Envelope I Q IQ
Initial S/W Revision	Prior to A.02.00
Modified at S/W Revision	A.03.00

Couple Markers

Toggles the state of the markers to be coupled On or Off. When this function is true (On), moving any marker causes an equal X-axis movement of every other marker which is not Off. "Equal X-axis movement" refers to the difference between each marker's X-Axis value (in the fundamental x-axis units of the trace that marker is on) and the X-Axis value of the marker being moved (in the same fundamental x-axis units) are preserved.

Key Path	Marker
Mode	BASIC, PNOISE, WCDMA, C2K, GSM, WIMAXOFDMA, TDSCDMA, 1XEVD0, DVB, DTMB, ISDBT, CMMB, LTE, LTETDD, DCATV, WLAN,,LTEATDD, LTEAFDD
Remote Command	:CALCulate:WAVeform:MARKer:COUPle[:STATe] ON OFF 1 0 :CALCulate:WAVeform:MARKer:COUPle[:STATe]?
Example	CALC:WAV:MARK:COUP ON CALC:WAV:MARK:COUP ON
Notes	You must be in a mode that includes the Waveform measurement to use this command. Use INSTRument:SElect to set the mode.
Preset	OFF

State Saved	Saved in instrument state.
Range	On Off
Initial S/W Revision	Prior to A.02.00
Modified at S/W Revision	A.03.00

All Markers Off

Turns off all markers.

Key Path	Marker
Mode	BASIC, PNOISE, WCDMA, C2K, GSM, WIMAXOFDMA, TDSCDMA, 1XEVD0, DVB, DTMB, ISDBT, CMMB, LTE, LTETDD, DCATV, WLAN,LTEATDD, LTEAFDD
Remote Command	:CALCulate:WAVeform:MARKer:AOFF
Example	CALC:WAV:MARK:AOFF
Notes	You must be in a mode that includes the Waveform measurement to use this command. Use INSTRument:SElect to set the mode.
Initial S/W Revision	Prior to A.02.00
Modified at S/W Revision	A.03.00

Marker X Axis Value (Remote Command Only)

Sets the marker X Axis value in the current marker X Axis Scale unit. It has no effect if the control mode is Off, but is the SCPI equivalent of entering an X value if the control mode is Normal or Delta.

Mode	BASIC, PNOISE, WCDMA, C2K, GSM, WIMAXOFDMA, TDSCDMA, 1XEVD0, DVB, DTMB, ISDBT, CMMB, LTE, LTETDD, DCATV, WLAN,,LTEATDD, LTEAFDD
Remote Command	:CALCulate:WAVeform:MARKer[1] 2 ... 12:X <time> :CALCulate:WAVeform:MARKer[1] 2 ... 12:X?
Example	CALC:WAV:MARK:X 50 ms CALC:WAV:MARK:X?
Notes	If no suffix is sent, uses the fundamental units for the current marker X Axis Scale. If a suffix is sent that does not match the current marker X Axis Scale unit, an error "Invalid suffix" is generated. If the specified marker is Fixed and a Marker Function is on, error -221 "Settings conflict; cannot adjust Fixed marker while Marker Function is on" is generated. The query returns the marker's absolute X Axis value if the control mode is Normal, or the offset from the marker's reference marker if the control mode is Delta. The query is returned in the fundamental units for the current marker X Axis scale: Hz for Frequency and Inverse Time, seconds for Period and Time. If the marker is Off the response is not a number. You must be in a mode that includes the Waveform measurement to use this command. Use INSTRument:SElect to set the mode.
Preset	0

Preset	After a preset, all markers are turned OFF, so Marker X Axis Value query returns a not a number (NAN).
State Saved	No
Min	(9.9E+37
Max	9.9E+37
Initial S/W Revision	Prior to A.02.00
Modified at S/W Revision	A.03.00

Marker X Axis Position (Remote Command Only)

Sets the marker X position in trace points. It has no effect if the control mode is Off, but is the SCPI equivalent of entering a value if the control mode is Normal or Delta. The entered value is immediately translated into the current X Axis Scale units for setting the value of the marker.

Mode	BASIC, PNOISE, WCDMA, C2K, GSM, WIMAXOFDMA, TDSCDMA, 1XEVD0, DVB, DTMB, ISDBT, CMMB, LTE, LTETDD, DCATV, WLAN,,LTEATDD, LTEAFDD
Remote Command	:CALCulate:WAVeform:MARKer[1] 2 ... 12:X:POSition <real> :CALCulate:WAVeform:MARKer[1] 2 ... 12:X:POSition?
Example	CALC:WAV:MARK:X:POS 500 CALC:WAV:MARK:X:POS?
Notes	The query returns the marker's absolute X Axis value in trace points if the control mode is Normal or the offset from the marker's reference marker in trace points if the control mode is Delta. The value is returned as a real number, not an integer, corresponding to the translation from X Axis Scale units to trace points. You must be in a mode that includes the Waveform measurement to use this command. Use INSTRument:SElect to set the mode.
Preset	0
Preset	After a preset, all markers are turned OFF, so Marker X Axis Value query returns a not a number (NAN).
State Saved	No
Min	(9.9E+37
Max	9.9E+37
Initial S/W Revision	Prior to A.02.00
Modified at S/W Revision	A.03.00

Marker Y Axis Value (Remote Command Only)

Queries the marker Y Axis value in the current marker Y Axis unit.

Mode	BASIC, PNOISE, WCDMA, C2K, GSM, WIMAXOFDMA, TDSCDMA, 1XEVD0, DVB, DTMB, ISDBT, CMMB, LTE, LTETDD, DCATV, WLAN,,LTEATDD, LTEAFDD
------	---

Remote Command	:CALCulate:WAVeform:MARKer[1] 2 ... 12:Y?
Example	CALC:WAV:MARK11:Y?
Notes	<p>When the marker is on, IQ waveform returns I and Q values.</p> <p>Case #1 - Trace RF, I or Q: returns a single double value.</p> <p>>:CALC:WAV:MARK1:Y? -2.402406506109E+001</p> <p>Case #2 - Trace IQ: returns a double array of two values, the first is I, and the second is Q.</p> <p>>:CALC:WAV:MARK1:Y? -3.006944493834E-003,+9.9870666467354E-004</p> <p>The IQ selection is for backward compatibility purposes. It is recommended that the users use the I and/or Q selection instead.</p> <p>You must be in a mode that includes the Waveform measurement to use this command. Use INSTRument:SElect to set the mode.</p>
Preset	Result dependent on the marker setup and signal source.
State Saved	No
Backwards Compatibility SCPI	:CALCulate:WAVeform:MARKer[1] 2 ... 12:FUNCTion:RESult?
Initial S/W Revision	Prior to A.02.00
Modified at S/W Revision	A.03.00

Backward Compatibility SCPI Commands

Sets or queries the state of a marker. Setting a marker that is OFF to state ON or 1 puts it in Normal mode and places it at the center of the screen.

Mode	BASIC, PNOISE, WCDMA, CDMA2K, EDGE GSM, WIMAX OFDMA, TDSCDMA, CDMA1XEV, DVB, DTMB, ISDBT, CMMB, LTE, LTETDD, DCATV, WLAN
Remote Command	:CALCulate:WAVeform:MARKer[1] 2 ... 12:STATe OFF ON 0 1 :CALCulate:WAVeform:MARKer[1] 2 ... 12:STATe?
Example	CALC:WAV:MARK:STAT ON CALC:WAV:MARK:STAT?
Notes	You must be in a mode that includes the Waveform measurement to use this command. Use INSTRument:SElect to set the mode.
Preset	OFF
State Saved	Saved in instrument state.
Range	On Off
Initial S/W Revision	Prior to A.02.00
Modified at S/W Revision	A.03.00

Marker ->

There is no 'Marker ->' functionality supported in Waveform measurements. The front-panel key displays a blank menu when pressed.

Key Path	Front-panel key
Initial S/W Revision	Prior to A.02.00

Marker Function

Accesses a menu of marker functions that perform post-processing operations on markers based on the measurement specifications. Marker functions are distinct from measurement functions, which automatically perform complex sequences of setup, data acquisition, and display operations in order to measure specified signal characteristics. Marker Functions are specified for each individual marker and may be turned on individually for each marker.

The Marker Function menu controls which marker functions are turned on and allows you to adjust the setup parameters for each function. These parameters include the following, but only one parameter can be assigned to a given marker:

- Marker Noise
- BandInterval Power
- Band/Interval Density
- Marker Function Off

Key Path	Front-panel key
Initial S/W Revision	Prior to A.02.00

Select Marker

Displays 12 markers available for selection.

Key Path	Marker
Initial S/W Revision	Prior to A.02.00

Marker Function Type

Sets the marker control function type to, Marker Noise, Band/Interval Power, Band Interval Density, or Marker Function Off

Key Path	Marker Function
Mode	BASIC, PNOISE, WCDMA, C2K, GSM, WIMAXOFDMA, TDSCDMA, 1XEVD0, DVB, DTMB, ISDBT, CMMB, LTE, LTETDD, DCATV, WLAN,,LTEATDD, LTEAFDD
Remote Command	:CALCulate:WAVeform:MARKer[1] 2 ... 12:FUNctIon BPOwer BDENsity OFF :CALCulate:WAVeform:MARKer[1] 2 ... 12:FUNctIon?
Example	CALC:WAV:MARK:FUNC BPOW CALC:WAV:MARK:FUNC?
Notes	You must be in a mode that includes the Waveform measurement to use this command. Use INSTRument:SElect to set the mode.
Preset	OFF

State Saved	Saved in instrument state.
Range	Band/Interval Power Band Interval Density Marker Function Off
Initial S/W Revision	Prior to A.02.00
Modified at S/W Revision	A.03.00

Band Adjust

Accesses a menu that enables you to set the frequency span width and the left and right edge, or time values, for the band or interval of the selected marker.

Key Path	Marker Function
Initial S/W Revision	Prior to A.02.00

Band/Interval Span for Time Domain

Sets the width of the frequency span for the selected marker.

Key Path	Marker Function
Mode	BASIC, PNOISE, WCDMA, C2K, GSM, WIMAXOFDMA, TDSCDMA, 1XEVD0, DVB, DTMB, ISDBT, CMMB, LTE, LTETDD, DCATV, WLAN,LTEATDD, LTEAFDD
Remote Command	:CALCulate:WAVEform:MARKer[1] 2 ... 12:FUNCtion:BAND:SPAN <time> :CALCulate:WAVEform:MARKer[1] 2 ... 12:FUNCtion:BAND:SPAN?
Example	CALC:WAV:MARK:FUNC:BAND:SPAN 20 ms CALC:WAV:MARK:FUNC:BAND:SPAN?
Notes	You must be in a mode that includes the Waveform measurement to use this command. Use INSTRument:SElect to set the mode.
Couplings	Changing the Band/Interval Span necessarily changes the Band/Interval Left and Band/Interval Right values
Preset	0
Preset	10% of Meas Time
State Saved	Saved in instrument state.
Min	0
Max	100 s
Backwards Compatibility SCPI	:CALCulate:WAVEform:MARKer[1] 2 ... 4:X:SPAN
Initial S/W Revision	Prior to A.02.00
Modified at S/W Revision	A.03.00

Band/Interval Left for Time Domain

Sets the left edge frequency or time value for the band of the selected marker.

Key Path	Marker Function
Mode	BASIC, PNOISE, WCDMA, C2K, GSM, WIMAXOFDMA, TDSCDMA, 1XEVD0, DVB, DTMB, ISDBT, CMMB, LTE, LTETDD, DCATV, WLAN,,LTEATDD, LTEAFDD
Remote Command	:CALCulate:WAVeform:MARKer[1] 2 ... 12:FUNction:BAND:LEFT <time> :CALCulate:WAVeform:MARKer[1] 2 ... 12:FUNction:BAND:LEFT?
Example	CALC:WAV:MARK12:FUNC:BAND:LEFT 1 s CALC:WAV:MARK12:FUNC:BAND:LEFT?
Notes	You must be in a mode that includes the Waveform measurement to use this command. Use INSTRument:SElect to set the mode.
Couplings	Changing the Band/Interval Left necessarily changes the Band/Interval Span and Band/Interval Right values
Preset	0
Preset	5% of Meas Time
State Saved	Saved in instrument state.
Min	0
Max	100 s
Initial S/W Revision	Prior to A.02.00
Modified at S/W Revision	A.03.00

Band/Interval Right for Time Domain

Sets the right edge frequency or time value for the band of the selected marker.

Key Path	Marker Function
Mode	BASIC, PNOISE, WCDMA, C2K, GSM, WIMAXOFDMA, TDSCDMA, 1XEVD0, DVB, DTMB, ISDBT, CMMB, LTE, LTETDD, DCATV, WLAN,,LTEATDD, LTEAFDD
Remote Command	:CALCulate:WAVeform:MARKer[1] 2 ... 12:FUNction:BAND:RIGHT <time> :CALCulate:WAVeform:MARKer[1] 2 ... 12:FUNction:BAND:RIGHT?
Example	CALC:WAV:MARK12:FUNC:BAND:RIGH 1 s CALC:WAV:MARK12:FUNC:BAND:RIGH?
Notes	You must be in a mode that includes the Waveform measurement to use this command. Use INSTRument:SElect to set the mode.
Couplings	Changing the Band/Interval Left necessarily changes the Band/Interval Span and Band/Interval Right values
Preset	0
Preset	5% of Meas Time
State Saved	Saved in instrument state.

18 Waveform Measurement
Marker Function

Min	0
Max	100 s
Initial S/W Revision	Prior to A.02.00
Modified at S/W Revision	A.03.00

Meas

The information in this section is common to all measurements. For key and remote command information for a specific measurement, refer to the section that describes the measurement of interest.

Measurements available under the Meas key are specific to the current Mode.

When viewing Help for measurements, note the following:

NOTE

Operation for some keys differs between measurements. The information displayed in Help pertains to the current measurement. To see how a key operates in a different measurement, exit Help (press the Cancel Esc key), select the measurement, then reenter Help (press the Help key) and press that key.

Key Path	Front-panel key
Initial S/W Revision	Prior to A.02.00

Remote Measurement Functions

This section contains the following topics:

["Measurement Group of Commands" on page 2214](#)

["Current Measurement Query \(Remote Command Only\)" on page 2216](#)

["Limit Test Current Results \(Remote Command Only\)" on page 2216](#)

["Data Query \(Remote Command Only\)" on page 2216](#)

["Calculate/Compress Trace Data Query \(Remote Command Only\)" on page 2217](#)

["Calculate Peaks of Trace Data \(Remote Command Only\)" on page 2222](#)

["Hardware-Accelerated Fast Power Measurement \(Remote Command Only\)" on page 2223](#)

["Format Data: Numeric Data \(Remote Command Only\)" on page 2237](#)

["Format Data: Byte Order \(Remote Command Only\)" on page 2238](#)

Initial S/W Revision	Prior to A.02.00
----------------------	------------------

Measurement Group of Commands

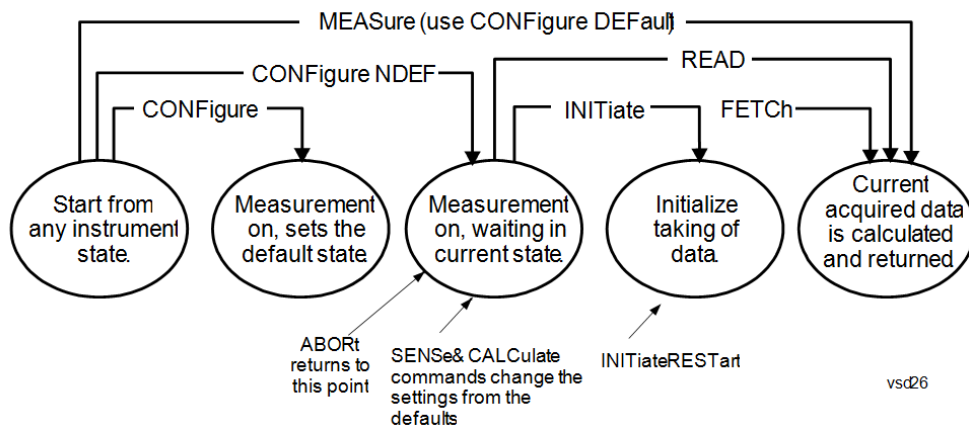

Measure Commands:

:MEASure:<measurement>[n]?

This is a fast single-command way to make a measurement using the factory default instrument settings. These are the settings and units that conform to the Mode Setup settings (e.g. radio standard) that you have currently selected.

- Stops the current measurement (if any) and sets up the instrument for the specified measurement using the factory defaults
- Initiates the data acquisition for the measurement
- Blocks other SCPI communication, waiting until the measurement is complete before returning results.
- If the function does averaging, it is turned on and the number of averages is set to 10.
- After the data is valid it returns the scalar results, or the trace data, for the specified measurement. The type of data returned may be defined by an [n] value that is sent with the command.
- The scalar measurement results will be returned if the optional [n] value is not included, or is set to 1. If the [n] value is set to a value other than 1, the selected trace data results will be returned. See each command for details of what types of scalar results or trace data results are available.
- ASCII is the default format for the data output. (Older versions of Spectrum Analysis and Phase Noise mode measurements only use ASCII.) The binary data formats should be used for handling large blocks of data since they are smaller and faster than the ASCII format. Refer to the FORMat:DATA command for more information.

If you need to change some of the measurement parameters from the factory default settings you can set up the measurement with the CONFigure command. Use the commands in the SENSE:<measurement> and CALCulate:<measurement> subsystems to change the settings. Then you can use the READ? command to initiate the measurement and query the results.

If you need to repeatedly make a given measurement with settings other than the factory defaults, you can use the commands in the SENSE:<measurement> and CALCulate:<measurement> subsystems to set up the measurement. Then use the READ? command to initiate the measurement and query results.

Measurement settings persist if you initiate a different measurement and then return to a previous one. Use READ:<measurement>? if you want to use those persistent settings. If you want to go back to the default settings, use MEASure:<measurement>?.

Configure Commands:

:CONFigure:<measurement>

This command stops the current measurement (if any) and sets up the instrument for the specified measurement using

the factory default instrument settings. It does not initiate the taking of measurement data unless INIT:CONTInuous is ON. If you change any measurement settings after using the CONFigure command, the READ command can be used to initiate a measurement without changing the settings back to their defaults.

In the Swept SA measurement in Spectrum Analyzer mode the CONFigure command also turns the averaging function on and sets the number of averages to 10 for all measurements.

:CONFigure: <measurement>: NDEFault stops the current measurement and changes to the specified measurement. It does not change the settings to the defaults. It does not initiate the taking of measurement data unless INIT:CONTInuous is ON.

The CONFigure? query returns the current measurement name.

The CONFigure:CATalog? query returns a quoted string of all licensed measurement names in the current mode. For example, "SAN, CHP, OBW, ACP, PST, TXP, SPUR, SEM, LIST".

Fetch Commands:

:FETCh:<measurement>[n]?

This command puts selected data from the most recent measurement into the output buffer. Use FETCh if you have already made a good measurement and you want to return several types of data (different [n] values, for example, both scalars and trace data) from a single measurement. FETCh saves you the time of re-making the measurement. You can only FETCh results from the measurement that is currently active, it will not change to a different measurement. An error message is reported if a measurement other than the current one is specified.

If you need to get new measurement data, use the READ command, which is equivalent to an INITiate followed by a FETCh.

The scalar measurement results will be returned if the optional [n] value is not included, or is set to 1. If the [n] value is set to a value other than 1, the selected trace data results will be returned. See each command for details of what types of scalar results or trace data results are available. The binary data formats should be used for handling large blocks of data since they are smaller and transfer faster than the ASCII format. (FORMat:DATA)

FETCh may be used to return results other than those specified with the original READ or MEASure command that you sent.

INITiate Commands:

:INITiate:<measurement>

This command is not available for measurements in all the instrument modes:

- Initiates a trigger cycle for the specified measurement, but does not output any data. You must then use the FETCh<meas> command to return data. If a measurement other than the current one is specified, the instrument will switch to that measurement and then initiate it.
 - For example, suppose you have previously initiated the ACP measurement, but now you are running the channel power measurement. If you send INIT:ACP? it will change from channel power to ACP and will initiate an ACP measurement.
 - Does not change any of the measurement settings. For example, if you have previously started the ACP measurement and you send INIT:ACP? it will initiate a new ACP measurement using the same instrument settings as the last time ACP was run.
 - If your selected measurement is currently active (in the idle state) it triggers the measurement, assuming the trigger conditions are met. Then it completes one trigger cycle. Depending upon the measurement and the number of averages, there may be multiple data acquisitions, with multiple trigger events, for one full trigger cycle. It also holds off additional commands on GPIB until the acquisition is complete.
-

READ Commands:

:READ:<measurement>[n]?

- Does not preset the measurement to the factory default settings. For example, if you have previously initiated the ACP
-

measurement and you send READ:ACP? it will initiate a new measurement using the same instrument settings.

- Initiates the measurement and puts valid data into the output buffer. If a measurement other than the current one is specified, the instrument will switch to that measurement before it initiates the measurement and returns results.
 - For example, suppose you have previously initiated the ACP measurement, but now you are running the channel power measurement. Then you send READ:ACP? It will change from channel power back to ACP and, using the previous ACP settings, will initiate the measurement and return results.
 - Blocks other SCPI communication, waiting until the measurement is complete before returning the results
 - If the optional [n] value is not included, or is set to 1, the scalar measurement results will be returned. If the [n] value is set to a value other than 1, the selected trace data results will be returned. See each command for details of what types of scalar results or trace data results are available. The binary data formats should be used when handling large blocks of data since they are smaller and faster than the ASCII format. (FORMat:DATA)
-

Initial S/W Revision	Prior to A.02.00
----------------------	------------------

Current Measurement Query (Remote Command Only)

This command returns the name of the measurement that is currently running.

Remote Command	:CONFigure?
-----------------------	-------------

Example	CONF?
----------------	-------

Initial S/W Revision	Prior to A.02.00
----------------------	------------------

Limit Test Current Results (Remote Command Only)

Queries the status of the current measurement limit testing. It returns a 0 if the measured results pass when compared with the current limits. It returns a 1 if the measured results fail any limit tests.

Remote Command	:CALCulate:CLIMits:FAIL?
-----------------------	--------------------------

Example	CALC:CLIM:FAIL? queries the current measurement to see if it fails the defined limits. Returns a 0 or 1: 0 it passes, 1 it fails.
----------------	--

Initial S/W Revision	Prior to A.02.00
----------------------	------------------

Data Query (Remote Command Only)

Returns the designated measurement data for the currently selected measurement and subopcode.

n = any valid subopcode for the current measurement. See the measurement command results table for your current measurement, for information about what data is returned for the subopcodes.

This command uses the data setting specified by the FORMat:BORDER and FORMat:DATA commands and can return real or ASCII data. (See the format command descriptions under Input/Output in the Analyzer Setup section.)

Remote Command	:CALCulate:DATA[n]?
Notes	The return trace depends on the measurement. In CALCulate:<meas>:DATA[n], n is any valid subopcode for the current measurement. It returns the same data as the FETCH:<measurement>? query where <measurement> is the current measurement.
Initial S/W Revision	Prior to A.02.00

Calculate/Compress Trace Data Query (Remote Command Only)

Returns compressed data for the currently selected measurement and sub-opcode [n].

n = any valid sub-opcode for that measurement. See the MEASure:<measurement>? command description of your specific measurement for information on the data that can be returned.

The data is returned in the current Y Axis Unit of the analyzer. The command is used with a sub-opcode <n> (default=1) to specify the trace. With trace queries, it is best if the analyzer is not sweeping during the query. Therefore, it is generally advisable to be in Single Sweep, or Update=Off.

This command is used to compress or decimate a long trace to extract and return only the desired data. A typical example would be to acquire N frames of GSM data and return the mean power of the first burst in each frame. The command can also be used to identify the best curve fit for the data.

Remote Command	:CALCulate:DATA<n>:COMPRESS? BLOCK CFIT MAXimum MINimum MEAN DMEan RMS RMSCubed SAMPLE SDEVIation PPHase [,<soffset> [,<length>[,<roffset>[,<rlimit>]]]]
Example	To query the mean power of a set of GSM bursts: Supply a signal that is a set of GSM bursts. Select the IQ Waveform measurement (in IQ Analyzer Mode). Set the sweep time to acquire at least one burst. Set the triggers such that acquisition happens at a known position relative to a burst. Then query the mean burst levels using, CALC:DATA2:COMP? MEAN, 24e-6, 526e-6 (These parameter values correspond to GSM signals, where 526e-6 is the length of the burst in the slot and you just want 1 burst.)
Notes	The command supports 5 parameters. Note that the last 4 (<soffset>, <length>, <roffset>, <rlimit>) are optional. But these optional parameters must be entered in the specified order. For example, if you want to specify <length>, then you must also specify <soffset>. See details below for a definition of each of these parameters. This command uses the data in the format specified by FORMat:DATA, returning either binary or ASCII data.
Initial S/W Revision	Prior to A.02.00

- BLOCK or block data - returns all the data points from the region of the trace data that you specify. For example, it could be used to return the data points of an input signal over several timeslots, excluding the portions of the trace data that you do not want. (This is x,y pairs for trace data and I,Q pairs for complex data.)

- CFIT or curve fit - applies curve fitting routines to the data. <soffset> and <length> are required to define the data that you want. <roffset> is an optional parameter for the desired order of the curve equation. The query will return the following values: the x-offset (in seconds) and the curve coefficients ((order + 1) values).

MIN, MAX, MEAN, DME, RMS, RMSC, SAMP, SDEV and PPH return one data value for each specified region (or <length>) of trace data, for as many regions as possible until you run out of trace data (using <roffset> to specify regions). Or they return the number of regions you specify (using <rlimit>) ignoring any data beyond that.

- MINimum - returns the minimum data point (y value) for the specified region(s) of trace data. For I/Q trace data, the minimum magnitude of the I/Q pairs is returned.
- MAXimum - returns the maximum data point (y value) for the specified region(s) of trace data. For I/Q trace data, the maximum magnitude of the I/Q pairs is returned.
- MEAN - returns a single value that is the arithmetic mean of the data point values (in dB/ dBm) for the specified region(s) of trace data. For I/Q trace data, the mean of the magnitudes of the I/Q pairs is returned. See the following equations.

NOTE If the original trace data is in dB, this function returns the arithmetic mean of those log values, not log of the mean power which is a more useful value. The mean of the log is the better measurement technique when measuring CW signals in the presence of noise. The mean of the power, expressed in dB, is useful in power measurements such as Channel Power. To achieve the mean of the power, use the RMS option.

Equation 1

Mean Value of Data Points for Specified Region(s)

$$MEAN = \frac{1}{n} \sum_{X_i \in \text{region}(s)} X_i$$

where X_i is a data point value, and n is the number of data points in the specified region(s).

Equation 2

Mean Value of I/Q Data Pairs for Specified Region(s)

$$MEAN = \frac{1}{n} \sum_{X_i \in \text{region}(s)} |X_i|$$

where $|X_i|$ is the magnitude of an I/Q pair, and n is the number of I/Q pairs in the specified region(s).

- DMEan - returns a single value that is the mean power (in dB/ dBm) of the data point values for the specified region(s) of trace data. See the following equation:

Equation 3

DMEan Value of Data Points for Specified Region(s)

$$\text{DME} = 10 \times \log_{10} \left(\frac{1}{n} \sum_{X_i \in \text{region}(s)} 10^{\frac{X_i}{10}} \right)$$

- RMS - returns a single value that is the average power on a root-mean-squared voltage scale (arithmetic rms) of the data point values for the specified region(s) of trace data. See the following equation.

NOTE For I/Q trace data, the rms of the magnitudes of the I/Q pairs is returned. See the following equation. This function is very useful for I/Q trace data. However, if the original trace data is in dB, this function returns the rms of the log values which is not usually needed.

Equation 4

RMS Value of Data Points for Specified Region(s)

$$\text{RMS} = \sqrt{\frac{1}{n} \sum_{X_i \in \text{region}(s)} X_i^2}$$

where X_i is a data point value, and n is the number of data points in the specified region(s).

Equation 5

RMS Value of I/Q Data Pairs for Specified Region(s)

$$\text{RMS} = \sqrt{\frac{1}{n} \sum_{X_i \in \text{region}(s)} X_i X_i^*}$$

where X_i is the complex value representation of an I/Q pair, X_i^* its conjugate complex number, and n is the number of I/Q pairs in the specified region(s).

Once you have the rms value for a region of trace data (linear or I/Q), you may want to calculate the mean power. You must convert this rms value (peak volts) to power in dBm:

$$10 \times \log[10 \times (\text{rms value})^2]$$

- SAMPLe - returns the first data value (x,y pair) for the specified region(s) of trace data. For I/Q trace data, the first I/Q pair is returned.
- SDEViation - returns a single value that is the arithmetic standard deviation for the data point values for the specified region(s) of trace data. See the following equation.
- For I/Q trace data, the standard deviation of the magnitudes of the I/Q pairs is returned. See the following equation.

Equation 6

Standard Deviation of Data Point Values for Specified Region(s)

$$\text{SDEV} = \sqrt{\frac{1}{n} \sum_{X_i \in \text{region}(s)} (X_i - \bar{X})^2}$$

where X_i is a data point value, \bar{X} is the arithmetic mean of the data point values for the specified region (s), and n is the number of data points in the specified region(s).

$$\text{SDEV} = \sqrt{\frac{1}{n} \sum_{X_i \in \text{region}(s)} (|X_i| - \bar{X})^2}$$

where $|X_i|$ is the magnitude of an I/Q pair, \bar{X} is the mean of the magnitudes for the specified region(s), and n is the number of data points in the specified region(s).

- PPHase - returns the x,y pairs of both rms power (dBm) and arithmetic mean phase (radian) for every specified region and frequency offset (Hz). The number of pairs is defined by the specified number of regions. This parameter can be used for I/Q vector ($n=0$) in Waveform (time domain) measurement and all parameters are specified by data point in PPHase.

The rms power of the specified region may be expressed as:

$$\text{Power} = 10 \times \log [10 \times (\text{RMS I/Q value})] + 10.$$

The RMS I/Q value (peak volts) is:

$$\sqrt{\frac{1}{n} \sum_{X_i \in \text{region}} X_i X_i^*}$$

where X_i is the complex value representation of an I/Q pair, X_i^* its conjugate complex number, and n is the number of I/Q pairs in the specified region.

The arithmetic mean phase of the specified region may be expressed as:

$$\frac{1}{n} \sum_{Y_i \in \text{region}} Y_i$$

where Y_i is the unwrapped phase of I/Q pair with applying frequency correction and n is the number of I/Q pairs in the specified region.

The frequency correction is made by the frequency offset calculated by the arithmetic mean of every specified region's frequency offset. Each frequency offset is calculated by the least square method against the unwrapped phase of I/Q pair.

Sample Trace Data - Constant Envelope

(See below for explanation of variables.)

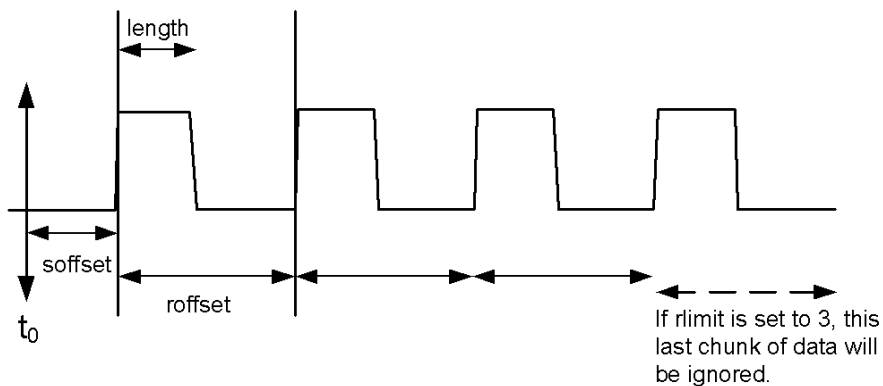

Sample Trace Data - Not Constant Envelope

(See below for explanation of variables.)



<soffset> - start offset is an optional real number. (It is in seconds for time-domain traces, and is a dimensionless index 0 to Npoints - 1, for frequency-domain traces). It specifies the amount of data at the beginning of the trace that will be ignored before the decimation process starts. It is the time or frequency change from the start of the trace to the point where you want to start using the data. The default value is zero.

<length> - is an optional real number. (It is in seconds for time-domain traces, and is a dimensionless index 0 to Npoints - 1, for frequency-domain traces). It defines how much data will be compressed into one value. This parameter has a default value equal to the current trace length.

<roffset> - repeat offset is an optional real number. (It is in seconds for time-domain traces, and is a dimensionless index 0 to Npoints - 1, for frequency-domain traces). It defines the beginning of the next field of trace elements to be compressed. This is relative to the beginning of the previous field. This parameter has a default value equal to the <length> variable. Note that this parameter is used for a completely different purpose when curve fitting (see CFIT above).

<rlimit> - repeat limit is an optional integer. It specifies the number of data items that you want returned. It will ignore any additional items beyond that number. You can use the Start offset and the Repeat limit to pick out exactly what part of the data you want to use. The default value is all the data.

Calculate Peaks of Trace Data (Remote Command Only)

Returns a list of all the peaks for the currently selected measurement and sub-opcode [n]. The peaks must meet the requirements of the peak threshold and excursion values.

n = any valid sub-opcode for the current measurement. See the MEASure:<measurement> command description of your specific measurement for information on the data that can be returned.

The command can only be used with specific sub-opcodes with measurement results that are trace data. Both real and complex traces can be searched, but complex traces are converted to magnitude in dBm. In many measurements the sub-opcode n=0, is the raw trace data which cannot be searched for peaks. And Sub-opcode n=1, is often calculated results values which also cannot be searched for peaks.

This command uses the data setting specified by the FORMat:BORDER and FORMat:DATA commands and can return real or ASCII data. If the format is set to INT,32, it returns REAL,32 data.

The command has four types of parameters:

- Threshold (in dBm)
- Excursion (in dB)
- Sorting order (amplitude, frequency, time)
- Optional in some measurements: Display line use (all, > display line, < display line)

Remote Command	<p>For Swept SA measurement:</p> <pre>:CALCulate:DATA[1] 2 ... 6:PEAKs? <threshold>,<excursion>[,AMPLitude FREQuency TIME[,ALL GTDLine LTDLine]]</pre> <p>For most other measurements:</p> <pre>:CALCulate:DATA[1] 2 ... 6:PEAKs? <threshold>,<excursion>[,AMPLitude FREQuency TIME]</pre>
-----------------------	--

Example	<p>Example for Swept SA measurement in Spectrum Analyzer Mode:</p> <p>CALC:DATA4:PEAK? -40, 10, FREQ, GTDL This will identify the peaks of trace 4 that are above -40 dBm, with excursions of at least 10 dB. The peaks are returned in order of increasing frequency, starting with the lowest frequency. Only the peaks that are above the display line are returned.</p> <p>Query Results 1:</p> <p>With FORMat:DATA REAL, 32 selected, it returns a list of floating-point numbers. The first value in the list is the number of peak points that are in the following list. A peak point consists of two values: a peak amplitude followed by its corresponding frequency (or time).</p> <p>If no peaks are found the peak list will consist of only the number of peaks, (0).</p>
----------------	---

Notes	<p><n> - is the trace that will be used</p> <p><threshold> - is the level below which trace data peaks are ignored. Note that the threshold value is required and is always used as a peak criterion. To effectively disable the threshold criterion for this command, provide a substantially low threshold value such as -200 dBm. Also note that the threshold value used in this command is independent of and has no effect on the threshold value stored under the Peak Criteria menu.</p> <p><excursion> - is the minimum amplitude variation (rise and fall) required for a signal to be identified as peak. Note that the excursion value is required and is always used as a peak criterion. To effectively disable the excursion criterion for this command, provide the minimum value of 0.0 dB. Also note that the excursion value used in this command is independent of and has no effect on the</p>
--------------	---

excursion value stored under the Peak Criteria menu.

Values must be provided for threshold and excursion. The sorting and display line parameters are optional (defaults are AMPLitude and ALL).

Note that there is always a Y-axis value for the display line, regardless of whether the display line state is on or off. It is the current Y-axis value of the display line which is used by this command to determine whether a peak should be reported. Sorting order:

AMPLitude - lists the peaks in order of descending amplitude, with the highest peak first (default if optional parameter not sent)

FREQUENCY - lists the peaks in order of occurrence, left to right across the x-axis.

TIME - lists the peaks in order of occurrence, left to right across the x-axis.

Peaks vs. Display Line:

ALL - lists all of the peaks found (default if optional parameter not sent).

GTDLine (greater than display line) - lists all of the peaks found above the display line.

LTDLine (less than display line) - lists all of the peaks found below the display line.

Initial S/W Revision	Prior to A.02.00
----------------------	------------------

Hardware-Accelerated Fast Power Measurement (Remote Command Only)

The Fast Power option (FP2) enables very fast channel power measurements for instruments with the prerequisite hardware (DP2 and/or B40). It accomplishes this by performing real-time overlapped FFTs at the hardware layer, using software for basic post-processing before returning the result to the user. The upshot of this approach is improved throughput for user applications that require many sequential power measurements.

The analysis bandwidth of FP2 is limited by the licenses in the instrument, but its maximum overall analysis bandwidth per acquisition is 40 MHz.

FP2 is remote-only, which means the instrument does not switch to any particular mode or measurement. FP2 commands can be sent while another application is in use on the front panel.

Each Fast Power measurement can be predefined using an array index, and up to 1,000 measurements can be stored. In the following documentation, instances of [1,2,...,999] can be substituted with a particular measurement index, e.g. CALC:FPOW:POW1?, CALC:FPOW:POW2?, CALC:FPOW:POW134?. In this way, power measurements can be defined one time in a batch, and then executed multiple times without having to redefine them, similar to “list mode” on other measurements.

In addition to basic channel power measurements, there are a number of other measurement “functions” for each channel, including peak power, peak frequency, and power spectral density. See the Function parameter for more information.

Reset Fast Power Measurement (Remote Command Only)

Resets the measurement configuration to the defaults.

Mode	All
Remote Command	:CALCulate:FPOWer:POWer[1,2,...,999]:RESet
Example	:CALC:FPOW:POW1:RES

Notes	Option FP2 is required.
Initial S/W Revision	A.14.00

Define Fast Power Measurement (Remote Command Only)

Fast Power acquisitions are configured using the DEFine command. This command accepts a comma-delimited string of configuration parameters and their appropriate values, which are all specified in the subsection below.

Mode	All
Remote Command	:CALCulate:FPOWER:POWer[1,2,...,999]:DEFine "configuration string"
Example	:CALC:FPOW:POW1:DEF "CenterFrequency=2e9, AcquisitionTime=0.005"
Notes	See below for a list of measurement variables that can be defined in the configuration string.
Initial S/W Revision	A.14.00

Acquisition Time

Value	Time (s)
Range	0 s to 1 s
Preset	0.001 s
Example	CALC:FPOW:POW1:DEF "AcquisitionTime=0.002"
Notes	The acquisition time parameter sets the time in which the entire spectrum is measured. An increase in the acquisition time yields an improvement in measurement repeatability.
Initial S/W Revision	A.14.00

Center Frequency

Value	Frequency (Hz)
Range	0 Hz to maximum instrument frequency
Preset	1 GHz
Example	CALC:FPOW:POW1:DEF "CenterFrequency=2e9"
Notes	The center frequency parameter sets the frequency in which the measurement is centered around. The OffsetFrequency parameter is calculated relative to the center frequency.
Initial S/W Revision	A.14.00

DC Coupled

Value	Boolean
Range	True (DC Coupled) or False (AC Coupled)
Preset	False
Example	CALC:FPOW:POW1:DEF "DCCoupled=True"
Notes	The DC coupled parameter allows the user to specify whether the DC blocking capacitor is utilized. Set parameter to true when measuring frequencies below 10 MHz.
Initial S/W Revision	A.14.00

DetectorType

Example	CALC:FPOW:POW1:DEF "DetectorType=Peak"
Notes	Option FP2 is required. The detector type parameter allows the user to choose whether a RMS average or peak value is used during the measurement.
Preset	RmsAverage
Range	RmsAverage, Peak
Initial S/W Revision	A.14.00

Do Noise Correction

Value	Boolean
Range	True (enable noise correction) or False (disable noise correction)
Preset	False
Example	CALC:FPOW:POW1:DEF "DoNoiseCorrection=True"
Notes	When noise correction is enabled, the linear noise power contributed by the analyzer is subtracted from all measurements. This effectively lowers the noise floor of the analyzer. When noise correction is enabled, the first measurement for a given set of input parameters will take extra time. This is because the analyzer takes an extra acquisition with the RF input disconnected from the analyzer's front end to measure the noise of just the analyzer. The measured noise floor is stored in a cache so the noise acquisition will occur only once for the same state settings. In other words, if noise correction was turned on and the analyzer made an acquisition at frequency A, then frequency B, and back again to frequency A, the hidden initial noise floor acquisition would only occur for the first acquisition at frequency A and the cached noise floor would be used the second time frequency A was measured.
Initial S/W Revision	A.14.00

Do Spur Suppression

Value	Boolean
Range	True (enable spur suppression) or False (disable spur suppression)
Preset	False
Example	CALC:FPOW:POW1:DEF "DoSpurSuppression=True"
Notes	<p>When measuring very low level signals, or when large out-of-band inputs are input into the analyzer, sometimes unwanted spurs and residuals can appear in the measured spectrum. Spur suppression is a method to help minimize the levels of these internally generated spurs and residuals.</p> <p>When spur suppression is enabled, the analyzer will automatically take two acquisitions using two different internal analog LO frequencies. The FFT spectrums from both acquisitions are combined by taking the minimum power between both traces on a per FFT bin basis. External signals will have the same amplitude for both traces and therefore will return the expected amplitudes. However, low level spurs and residuals generated internally to the analyzer tend to move to different FFT bins depending on the internal analog LO frequency used, and therefore tend to be suppressed using this spur suppression method.</p> <p>Because two acquisitions, rather than a single acquisition, are made when spur suppression is enabled, the measurement time will always be slower when spur suppression is enabled.</p>
Initial S/W Revision	A.14.00

Electronic Attenuator Bypass

Value	Boolean
Range	True (bypass electronic attenuator) or False (use electronic attenuator)
Preset	True
Example	CALC:FPOW:POW1:DEF "ElecAttBypass =False"
Notes	The electronic attenuation bypass parameter allows the user to either utilize or bypass the electronic attenuator. The electronic attenuator is only available for frequencies up to 3.6 GHz. Set parameter to true when using frequencies above 3.6 GHz and set the parameter to false when using the preamp.
Initial S/W Revision	A.14.00

Electronic Attenuation

Value	dB
Range	0 - 24 dB (1 dB steps)
Preset	0 dB
Example	CALC:FPOW:POW1:DEF "ElecAttenuation=10"
Notes	<p>Option EA3 is required.</p> <p>The electronic attenuation value parameter sets the amount of electrical attenuation from 0 to 24 dB (1 dB steps).</p>

Set "ElecAttBypass=False" to make sure the electronic attenuator path is enabled.

Initial S/W Revision	A.14.00
-------------------------	---------

IF Gain

Value	dB
Range	-6 - 16 dB (1 dB steps)
Preset	0 dB
Example	CALC:FPOW:POW1:DEF "IFGain=10"
Notes	The IF gain parameter allows the user to specify the gain at the IF stage anywhere from -6 to 16 dB (1 dB steps). This is an advanced feature, and for most cases this should remain at its default value of 0 dB.
Initial S/W Revision	A.14.00

IF Type

Example	CALC:FPOW:POW1:DEF "IFType=B25M"
Notes	The IF type parameter allows the user to select between different IF paths. For example, if the signal is less than 25 MHz wide, then the user can select the B25M path to take advantage of additional filtering on this analog IF path.
Preset	B40M
Range	B10M, B25M, B40M
Initial S/W Revision	A.14.00

Include Power Spectrum

Value	Boolean
Range	True (return both channel power and full power spectrum) or False (returns only channel power)
Preset	False
Example	CALC:FPOW:POW1:DEF "IncludePowerSpectrum=True"
Notes	The power spectrum parameter allows the user to read data on the entire spectrum for diagnostic purposes. It is not recommended for production use. See CALC:FPOW:POW[n]:READ2? for details on the binary format of the response.
Initial S/W Revision	A.14.00

Mechanical Attenuation

Value	dB
Range	0 – 70 dB (2 dB steps)
Preset	0 dB
Example	CALC:FPOW:POW1:DEF "MechAttenuation=10"
Notes	The mechanical attenuation value parameter sets the amount of mechanical attenuation anywhere from 0 to 70 dB (2 dB steps).
Initial S/W Revision	A.14.00

Preamp Mode

Example	CALC:FPOW:POW1:DEF "PreAmpMode=Low"
Notes	The license for the appropriate preamp is required. The preamp mode parameter specifies whether the preamps are being utilized. Low allows any preamps up to 3.6 GHz, and Full allows all licensed preamps. Set "ElecAttBypass=True" in order to utilize any preamps.
Preset	Off
Range	Off, Low, Full
Initial S/W Revision	A.14.00

Resolution Bandwidth Mode

Example	CALC:FPOW:POW1:DEF "PreAmpMode=Low"
Notes	The resolution bandwidth mode parameter allows the user to choose whether the RBW filter is automatically or manually set. The BestSpeed value minimizes measurement time, while the Narrowest value minimizes RBW size (minimum of two FFT bins per RBW). To manually specify an RBW, set this parameter to Explicit, and set the ResolutionBW parameter to the desired value.
Preset	BestSpeed
Range	BestSpeed, Narrowest, Explicit
Initial S/W Revision	A.14.00

Resolution Bandwidth

Value	Hz
Preset	0 Hz

Example	CALC:FPOW:POW1:DEF "ResolutionBW=25e3"
Notes	The resolution bandwidth parameter sets the 3-dB bandwidth of the RBW filter. The ResolutionBWMode parameter must be set to Explicit in order to manually set the RBW.
Initial S/W Revision	A.14.00

Trigger Delay

Value	Seconds
Range	0 – 1 s
Preset	0 s
Example	CALC:FPOW:POW1:DEF "TriggerDelay=0.025"
Notes	The trigger delay parameter sets the time after an external trigger is detected until the measurement is performed.
Initial S/W Revision	A.14.00

Trigger Level

Value	Volts
Range	-5 to 5 V
Preset	1.2 V
Example	CALC:FPOW:POW1:DEF "TriggerLevel=2"
Notes	The trigger level parameter sets the voltage value at which an external trigger is detected.
Initial S/W Revision	A.14.00

Trigger Slope

Example	CALC:FPOW:POW1:DEF "TriggerSlope=Negative"
Notes	The trigger slope parameter indicates the direction of the edge trigger voltage for detection.
Preset	Positive
Range	Positive, Negative
Initial S/W Revision	A.14.00

Trigger Source

Example	CALC:FPOW:POW1:DEF "TriggerSource=Ext1 "
Notes	The trigger source parameter allows the user to choose between measurement's triggering freely or controlled by an external input. Ext1 and Ext2 correspond to Trigger 1 In and Trigger 2 In, respectively.
Preset	Free
Range	Free, Ext1, Ext2
Initial S/W Revision	A.14.00

Trigger Timeout

Value	Seconds
Range	0 - 1 s
Preset	1 s
Example	CALC:FPOW:POW1:DEF "TriggerTimeout=0.1"
Notes	The trigger timeout parameter sets the time in which the analyzer will wait for a trigger before automatically performing the measurement.
Initial S/W Revision	A.14.00

Signal Input

Example	CALC:FPOW:POW1:DEF "SignalInput=Fp50MHzCW"
Notes	The signal input parameter allows the user to select between using the main RF input or the internal analyzer reference CW signal of 50 MHz.
Preset	FpMainRf
Range	FpMainRf, Fp50MHzCW
Initial S/W Revision	A.14.00

Use Preselector

Value	Boolean
Range	True (use preselector above 3.6 GHz), or False (preselector bypassed)
Preset	False
Example	CALC:FPOW:POW1:DEF "UsePreSelector=True"
Notes	The preselector parameter allows the user to either utilize or bypass the front end tunable filter at frequencies above 3.6 GHz. For frequencies below 3.6 GHz, the preselector is automatically

bypassed, so you do not need to set this parameter to False in those cases.

Initial S/W Revision A.14.00

Channel Bandwidth Array

Value	Hz
Range	0 to 40 MHz
Preset	[1 e6]
Example	CALC:FPOW:POW1:DEF "Bandwidth=[3.84e6, 5e6, 3.84e6]"
Notes	The bandwidth parameter array defines the bandwidth of each channel that will be measured. All array parameters should have the same number of elements. Alternatively, if all the elements are the same value, a single number with no square brackets can be used to define the parameter.
Initial S/W Revision	A.14.00

Channel Filter Type Array

Example	CALC:FPOW:POW1:DEF "FilterType=[RRC, IBW, RRC]"
Notes	The filter type parameter allows the user to choose between an integration bandwidth (IBW) filter or a root-raised-cosine (RRC) filter. The integration bandwidth filter weighs all frequencies within the bandwidth equally. The root-raised-cosine filter has an associated shape parameter, defined by the FilterAlpha parameter. All array parameters should have the same number of elements. Alternatively, if all the elements are the same value, a single value with no square brackets can be used to define the parameter.
Preset	[IBW]
Range	IBW, RRC
Initial S/W Revision	A.14.00

Channel Filter Alpha Array

Example	CALC:FPOW:POW1:DEF "FilterAlpha=[0.5, 0.0, 0.5]"
Notes	The filter alpha parameter allows the user to adjust the alpha value associated with the root-raised-cosine (RRC) filter type. Set FilterType to RRC in order to utilize this parameter. All array parameters should have the same number of elements. Alternatively, if all the elements are the same value, a single number with no square brackets can be used to define the parameter.
Preset	[0.22]
Range	0.0 – 1.0
Initial S/W Revision	A.14.00

Channel Measurement Function Array

Example	CALC:FPOW:POW1:DEF "Function=[BandPower, PeakPower, BandPower]"
Notes	<p>This parameter array defines what measurement is being made for each individually-specified channel:</p> <p>BandPower: Total power within the specified bandwidth of the channel (dBm)</p> <p>BandDensity: Total power density within the specified bandwidth of the channel (dBm/Hz)</p> <p>PeakPower: The peak power value within the specified bandwidth of the channel (dBm)</p> <p>PeakFrequency: The frequency which corresponds to the peak power value within the specified bandwidth of the channel. This frequency is relative to the center frequency (Hz)</p> <p>XdBBandwidth: The half power (-3.01 dB) bandwidth of the highest amplitude signal that resides within the channel (Hz), dB is configurable using XdBBandwidth parameter</p> <p>OccupiedBandwidth: The bandwidth at which 99% of the total power resides within the channel (Hz), percentage configurable using OccupiedBandwidthPercent parameter</p> <p>All array parameters should have the same number of elements. Alternatively, if all the elements are the same value, a single value with no square brackets can be used to define the parameter.</p>
Preset	[BandPower]
Range	BandPower, BandDensity, PeakPower, PeakFrequency, XdBBandwidth, OccupiedBandwidth
Initial S/W Revision	A.14.00

Channel Offset Frequency Array

Value	Hz
Range	0 to 20 MHz
Preset	[0]
Example	CALC:FPOW:POW1:DEF "OffsetFrequency=[-5e6, 0, 5e6]"
Notes	<p>The offset frequency parameter array defines the difference between the center frequency to the center frequency of each channel.</p> <p>All array parameters should have the same number of elements.</p>
Initial S/W Revision	A.14.00

Channel Occupied Bandwidth Percent Array

Example	CALC:FPOW:POW1:DEF "OccupiedBandwidthPercent =[0.95, 0.95, 0.95]"
Notes	<p>This parameter only applies for channels whose Function is set to OccupiedBandwidth. The occupied bandwidth percent parameter specifies the percent of total power in these channels. The valid range for this parameter is 0.0 to 1.0, where 1.0 represents 100%. The default for this parameter is 0.99, which will return the bandwidth that contains 99% of the total channel power.</p>

Preset	[0.99]
Range	0 – 1.0
Initial S/W Revision	A.14.00

Channel x-dB Bandwidth Array

Value	dB
Range	-200 to 0 dB
Preset	[-3.01]
Example	CALC:FPOW:POW1:DEF " XdBBandwidth =[-6.02, -3.01, -1.0]"
Notes	This parameter only applies for channels whose Function is set to XdBBandwidth. The X dB bandwidth parameter is used to specify the power relative to the peak channel power over which the bandwidth is calculated. The parameter value must be a negative number.
Initial S/W Revision	A.14.00

Define Fast Power Measurement Query (Remote Command Only)

The DEFine? command is used to retrieve a list of all defined parameters in an ASCII string format

M o d e	All
R e m o t e	:CALCulate:FPOWER:POWer [1,2,...,999]:DEFine?
C o m m a n d	
E x a m p l e	:CALC:FPOW:POW1:DEF?

```

p
l
e
N This command query is used to retrieve a list of all defined parameters in an ASCII format.
o The following is an example of the returned results:
t "DCCoupled=False,ElecAttBypass=True,ElecAttenuation=0,IFGain=0,MechAttenuation=0,PreAmpMode=Off,PreSelectorOffset
e =0,UsePreSelector=False,ExternalReferenceFrequency=10000000,FrequencyReferenceSource=AutoExternalFrequencyRefer
s ence,IFType=B40M,LOMode=SLW,SignalInput=FpMainRf,AcquisitionTime=0.001,CenterFrequency=1000000000,Resolution
BW=0,ResolutionBWMode=BestSpeed,DetectorType=RmsAverage,Bandwidth=[1000000],OffsetFrequency=[0],Function=
[BandPower],FilterType=[IBW],FilterAlpha=[0.22],OccupiedBandwidthPercent=[0.99],XdBBandwidth=[-
3.01],DoNoiseCorrection=False,DoSpurSuppression=False,MeasurementMethod=HardwareFFT,IncludePowerSpectrum=False,
e,TriggerDelay=0,TriggerLevel=1.2,TriggerSlope=Positive,TriggerSource=Free,TriggerTimeout=1 "
I A.14.00
n
i
t
i
a
l
S
/
W
R
e
v
i
s
i
o
n

```

Configure Fast Power Measurement (Remote Command Only)

The configure command begins hardware setup and returns immediately, with no acquisition made. This can be used in parallel with other hardware operations to effectively hide the hardware setup time.

Mode	All
Remote Command	:CALCulate:FPOWer:POWer[1,2,...,999]:CONFigure
Example	:CALC:FPOW:POW1:CONF
Notes	Option FP2 is required.
Initial S/W Revision	A.14.00

Initiate Fast Power Measurement (Remote Command Only)

The INITiate command begins an acquisition and returns immediately. The results of the measurement can be retrieved using FETCh.

Mode	All
Remote Command	:CALCulate:FPOWER:POWER[1,2,...,999]:INITiate
Example	:CALC:FPOW:POW1:INIT
Notes	Option FP2 is required.
Initial S/W Revision	A.14.00

Fetch Fast Power Measurement (Remote Command Only)

The FETCh command query is used to retrieve the results of an acquisition initiated by the INIT command. The returned results are in ASCII string format. The string begins and ends with quotation marks.

Mode	All
Remote Command	:CALCulate:FPOWER:POWER[1,2,...,999]:FETCh?
Example	:CALC:FPOW:POW1:FETC?
Notes	Option FP2 is required. Returns m comma-separated ASCII values, where m corresponds to the number of bandwidths defined. 1. Declared function return in the 1st specified channel 2. Declared function return in the 2nd specified channel ... m. Declared function return in the last specified channel The INIT and FETC? command sequence performs the same functionality of a single CALC:FPOW:POW[n]? query. Units of the returned values are dependent on the Function parameter for each channel.
Initial S/W Revision	A.14.00

Execute Fast Power Measurement (Remote Command Only)

This command query is used as shorthand for an INIT command immediately followed by a FETC? command. The returned results are in ASCII string format. The string begins and ends with quotation marks.

Mode	All
Remote Command	:CALCulate:FPOWER:POWER[1,2,...,999]?
Example	:CALC:FPOW:POW1?
Notes	Option FP2 is required. See notes for Fast Power Fetch for return format.
Initial S/W Revision	A.14.00

Binary Read Fast Power Measurement (Remote Command Only)

This command query is used as shorthand for an INIT command immediately followed by a FETC? command. The returned results are in a binary format.

Mode	All
Remote Command	:CALCulate:FPOWER:POWER[1,2,...,999]:READ? :CALCulate:FPOWER:POWER[1,2,...,999]:READ1?
Example	:CALC:FPOW:POW1:READ? :CALC:FPOW:POW1:READ1?
Notes	Option FP2 is required. Returns m 4 byte floating point binary values (Little-Endian), where m corresponds to the number of bandwidths defined.
Initial S/W Revision	A.14.00

Diagnostic Binary Read Fast Power Measurement (Remote Command Only)

This command query is used as shorthand for an INIT command immediately followed by a FETC? command. The returned results are in a binary format. This command is used primarily for diagnostic purposes to test for ADC overloads and to visibly inspect the spectrum.

Mode	All
Remote Command	:CALCulate:FPOWER:POWER[1,2,...,999]:READ2?
Example	:CALC:FPOW:POW1:READ2?
Notes	Option FP2 is required. Note: Spectrum data is only returned if the IncludePowerSpectrum parameter is set to True. If IncludePowerSpectrum is False, the number of spectrum points will be zero (0). Units of the returned values are dependent on the Function parameter per channel (e.g. dBm for BandPower, Hz for PeakFrequency). Returns binary data (Little-Endian) that contains information on m amount of channels, along with ADC over range and full spectrum data. The following is the binary format of the response. Bandwidth Return Value 1. Number of channels specified, m [4 byte int] 2. Declared function result for the 1st specified channel [4 byte float] 3. Declared function result for the 2nd specified channel [4 byte float] ... (m + 1). Declared function result for the last (mth) specified channel [4 byte float] ADC Over Range 1. ADC over-range occurred (1: true, 0: false) [2 byte short]

	<p>Spectrum Data</p> <ol style="list-style-type: none"> 1. Number of points in the spectrum data, k [4 byte int] 2. Start frequency of spectrum data (Hz) [8 byte double] 3. Step frequency of spectrum data (Hz) [8 byte double] 4. FFT bin at 1st point (dBm) [4 byte float] 5. FFT bin at 2nd point (dBm) [4 byte float] <p>...</p> <p>(k + 3). FFT bin at last (kth) point (dBm) [4 byte float]</p>
Initial S/W Revision	A.14.00

Format Data: Numeric Data (Remote Command Only)

This command specifies the format of the trace data input and output. It specifies the formats used for trace data during data transfer across any remote port. It affects only the data format for setting and querying trace data for the :TRACe[:DATA], TRACe[:DATA]?, :CALCulate:DATA[n]? and FETCh:SANalyzer[n]? commands and queries.

Remote Command	<pre>:FORMat[:TRACe][:DATA] ASCii INTeger,32 REAL,32 REAL,64 :FORMat[:TRACe][:DATA]?</pre>
Notes	<p>The query response is:</p> <pre>ASCii: ASC,8 REAL,32: REAL,32 REAL,64: REAL,64 INTeger,32: INT,32</pre> <p>When the numeric data format is REAL or ASCii, data is output in the current Y Axis unit. When the data format is INTeger, data is output in units of m dBm (.001 dBm).</p> <p>The INT,32 format returns binary 32-bit integer values in internal units (m dBm), in a definite length block.</p>
Dependencies	<p>Sending a data format spec with an invalid number (for example, INT,48) generates no error. The analyzer simply uses the default (8 for ASCii, 32 for INTeger, 32 for REAL).</p> <p>Sending data to the analyzer which does not conform to the current FORMat specified, results in an error. Sending ASCII data when a definite block is expected generates message -161 "Invalid Block Data" and sending a definite block when ASCII data is expected generates message -121 "Invalid Character in Number".</p>
Preset	ASCii
Backwards Compatibility Notes	Note that the INT,32 format is only applicable to the command, TRACe:DATA. This preserves backwards compatibility for the Swept SA measurement. For all other commands/queries which honor FORMat:DATA, if INT,32 is sent the analyzer will behave as though it were set to REAL,32.
Initial S/W Revision	Prior to A.02.00

The specs for each output type follow:

AScii - Amplitude values are in ASCII, in the current Y Axis Unit, one ASCII character per digit, values separated by commas, each value in the form:

SX.YYYYYEsZZ

Where:

S = sign (+ or -)

X = one digit to left of decimal point

Y = 5 digits to right of decimal point

E = E, exponent header

s = sign of exponent (+ or -)

ZZ = two digit exponent

REAL,32 - Binary 32-bit real values in the current Y Axis Unit, in a definite length block.

REAL,64 - Binary 64-bit real values in the current Y Axis Unit, in a definite length block.

Format Data: Byte Order (Remote Command Only)

This command selects the binary data byte order for data transfer and other queries. It controls whether binary data is transferred in normal or swapped mode. This command affects only the byte order for setting and querying trace data for the :TRACe[:DATA], TRACe[:DATA]? , :CALCulate:DATA[n]? and FETCh:SANalyzer[n]? commands and queries.

By definition any command that says it uses FORMat:DATA uses any format supported by FORMat:DATA.

The NORMal order is a byte sequence that begins with the most significant byte (MSB) first, and ends with the least significant byte (LSB) last in the sequence: 1|2|3|4. SWAPped order is when the byte sequence begins with the LSB first, and ends with the MSB last in the sequence: 4|3|2|1.

Remote Command	:FORMat:BORDER NORMAL SWAPped :FORMat:BORDER?
Preset	NORMal
Initial S/W Revision	Prior to A.02.00

Meas Setup

Displays the setup menu keys that enable you to control the parameters for the current measurement.

Key Path	Front-panel key
Initial S/W Revision	Prior to A.02.00

Average/Hold Num

Sets the number of sweeps (average counts) that are averaged. After the specified number of sweeps, the averaging mode (terminal control) setting determines the averaging action.

Key Path	Meas Setup
Mode	BASIC, PNOISE, WCDMA, C2K, GSM, WIMAXOFDMA, TDSCDMA, 1XEVD0, DVB, DTMB, ISDBT, CMMB, LTE, LTETDD, DCATV, WLAN, MSR, LTEATDD, LTEAFDD
Remote Command	[:SENSe]:WAVeform:AVERAge:COUNT <integer> [:SENSe]:WAVeform:AVERAge:COUNT? [:SENSe]:WAVeform:AVERAge[:STATe] OFF ON 0 1 [:SENSe]:WAVeform:AVERAge[:STATe]?
Example	WAV:AVER:COUN 1001 WAV:AVER:COUN? WAV:AVER ON WAV:AVER?
Notes	You must be in a mode that includes the Waveform measurement to use this command. Use INSTRument:SElect to set the mode.
Preset	10 OFF
State Saved	Saved in instrument state.
Min	1
Max	20001
Initial S/W Revision	Prior to A.02.00
Modified at S/W Revision	A.03.00

Avg Mode

Enables you to set the averaging mode.

- When set to Exponential (Exp) the measurement averaging continues using the specified number of averages to compute each averaged value. The average is displayed at the end of each sweep.
- When set to Repeat, the measurement resets the average counter each time the specified number of averages is reached.

Key Path	Meas Setup
Mode	BASIC, PNOISE, WCDMA, C2K, GSM, WIMAXOFDMA, TDSCDMA, 1XEVD0, DVB, DTMB, ISDBT, CMMB, LTE, LTETDD, DCATV, WLAN, MSR,LTEATDD, LTEAFDD
Remote Command	<code>[:SENSe] :WAVeform:AVErAge:TCONtrol EXPonential REPeat</code> <code>[:SENSe] :WAVeform:AVErAge:TCONtrol?</code>
Example	WAV:AVER:TCON REP WAV:AVER:TCON?
Notes	You must be in a mode that includes the Waveform measurement to use this command. Use INSTRUMENT:SElect to set the mode.
Preset	EXPonential
State Saved	Saved in instrument state.
Range	Exp Repeat
Initial S/W Revision	Prior to A.02.00
Modified at S/W Revision	A.03.00

Avg Type

Selects the type of averaging.

Key Path	Meas Setup
Mode	BASIC, PNOISE, WCDMA, C2K, GSM, WIMAXOFDMA, TDSCDMA, 1XEVD0, DVB, DTMB, ISDBT, CMMB, LTE, LTETDD, DCATV, WLAN, MSR,LTEATDD, LTEAFDD
Remote Command	<code>[:SENSe] :WAVeform:AVErAge:TYPE LOG MAXimum MINimum RMS SCALar</code> <code>[:SENSe] :WAVeform:AVErAge:TYPE?</code>
Example	WAV:AVER:TYPE RMS WAV:AVER:TYPE?
Notes	The SCPI selection of MAX and MIN are kept for BWCC, but they are removed from the front panel access because they are not an Average function. You must be in a mode that includes the Waveform measurement to use this command. Use INSTRUMENT:SElect to set the mode.
Preset	RMS
State Saved	Saved in instrument state.
Range	Pwr Avg(RMS) Log-Pwr Avg(Video) Voltage Avg
Initial S/W Revision	Prior to A.02.00
Modified at S/W Revision	A.03.00

Time Avg Num

Sets the number of HW averages to be executed per each data acquisition.

Key Path	Meas Setup
Mode	BASIC
Remote Command	[:SENSe] :WAVeform:AVERage:TACount <integer> [:SENSe] :WAVeform:AVERage:TACount?
Example	WAV:AVER:TAC 10WAV:AVER:TAC?
Notes	This feature is only available when Option DP2, B40, or wider IF Bandwidth option is installed.
Preset	1
State Saved	Saved in instrument state
Min	1
Max	65535
Default Unit	Enter

Meas Time

Sets how long the measurement is performed. X Scale only changes the representation of the display.

Key Path	Meas Setup
Mode	BASIC, PNOISE, WCDMA, C2K, GSM, WIMAXOFDMA, TDSCDMA, 1XEVD0, DVB, DTMB, ISDBT, CMMB, LTE, LTEADD, DCATV, WLAN, MSR,LTEATDD, LTEAFDD
Remote Command	[:SENSe] :WAVeform:SWEep:TIME <time> [:SENSe] :WAVeform:SWEep:TIME?
Example	WAV:SWE:TIME 50 ms WAV:SWE:TIME?
Notes	Specifies and returns how long the measurement is performed. It is the time record length of the measurement waveform. The Max time may be reduced when the sample frequency is high due to the memory limitation. You must be in a mode that includes the Waveform measurement to use this command. Use INSTRument:SElect to set the mode.
Preset	All except the following list: 2.000000 ms LTEAFDD, LTEATDD: 10 ms LTETDD: 10 ms
State Saved	Saved in instrument state.
Range	1.000 (s to 100.00 s
Min	1.000 us
Max	3200 s
Initial S/W Revision	Prior to A.02.00
Modified at S/W Revision	A.03.00, A.14.00

Sample Rate

Enables you to set an arbitrary sample rate for the acquired data to be processed.

Key Path	Meas Setup
Mode	BASIC
Remote Command	[:SENSe] :WAVeform:SRATe <freq> [:SENSe] :WAVeform:SRATe?
Example	WAV:SRAT 1.3636 MHz
Notes	Command and query available when Option DP2, B40, or wider IF Bandwidth option is installed. For other configuration, only query is available.
Couplings	The coupling between Sample Rate and IF BW depends on Physics implementation.
Preset	125.0 kHz
Min	12.5 Hz
Max	<ul style="list-style-type: none"> • (For Option DP2, B40 or wider IF Bandwidth option) • Digital IF 10 MHz path: 12.5 MHz • Digital IF 25 MHz path: 31.25 MHz • Digital IF 40 MHz path: 50 MHz • Option B85 85 MHz path: 106.25 MHz • Option B1A 125 MHz path: 156.25 MHz • Option B1X 140 MHz path: 175 MHz • Option B1Y 160 MHz path: 200 MHz • (For all other configuration) • 10 MHz path: 15 MHz • Option B25 25 MHz path: 45 MHz
Modified at S/W Revision	13.00

PhNoise Opt

Selects the LO (local oscillator) phase noise behavior for various desired operating conditions.

Key Path	Meas Setup
Remote Command	[:SENSe] :WAVeform:FREQuency:SYNThesis [:STATe] 1 2 3 [:SENSe] :WAVeform:FREQuency:SYNThesis [:STATe] ?
Example	WAV:FREQ:SYNT 2 Selects optimization for best wide offset phase noise
Notes	Parameter: 1 optimizes phase noise for small frequency offsets from the carrier. 2 optimizes phase noise for wide frequency offsets from the carrier. 3 optimizes LO for tuning speed

	(In PXA, the local oscillator hardware provides for extra-low phase noise at the expense of some speed.)
Dependencies	Does not appear in all models. The key is blank in those models, but the SCPI command is accepted for compatibility (although no action is taken).
Preset	Because this function is in Auto after preset, and because Digital IF BW after preset < 150 kHz for MXA/EXA and > 400 kHz for PXA the state of this function after Preset will be 1 for MXA/EXA and 2 for PXA.
State Saved	Saved in instrument state.
Min	1
Min	1
Max	3
Initial S/W Revision	Prior to A.07.00
Modified at S/W Revision	A.07.00

Auto

Selects the LO (local oscillator) phase noise behavior to optimize dynamic range and speed for various instrument operating conditions.

The X-Series has two grades of LO; a high performance LO that gives the best phase noise performance; and a medium-performance LO that gives excellent performance.

In models with the high performance LO, Auto will choose:

	Best Close in Phase Noise	Best Wide-offset Phase Noise
Filter BW	≤ 400 kHz	> 400 kHz

In models with the medium-performance LO, Auto will choose:

	Best Close in Phase Noise	Best Wide-offset Phase Noise
Filter BW	≤ 150 kHz	>150 kHz

Note that Fast Tuning will not be selected when in Auto.

Key Path	Meas Setup, PhNoise Opt
Remote Command	<code>[:SENSe] :WAVeform:FREQuency:SYNThesis:AUTO[:STATe] OFF ON 0 1</code> <code>[:SENSe] :WAVeform:FREQuency:SYNThesis:AUTO[:STATe] ?</code>
Example	WAV:FREQ:SYNT:AUTO ON
Preset	ON
State Saved	Saved in instrument state.
Initial S/W Revision	Prior to A.07.00

Best Close-in P Noise

The LO phase noise is optimized for smaller offsets from the carrier, at the expense of phase noise farther out.

Key Path	Meas Setup, PhNoise Opt
Example	WAV:FREQ:SYNT 1
Couplings	<p>The frequency below which the phase noise is optimized is model dependent:</p> <ul style="list-style-type: none"> • CXA: n/a • EXA: [offset \leq150 kHz] • MXA: [offset \leq150 kHz] • PXA: [offset \leq400 kHz]
Readback	<p>Close-in.</p> <p>If manually selected, “Man” will be underlined. The actual frequency offset within which noise is optimized is shown with in square brackets, as this can vary depending on the hardware set in use. For example, in some analyzers this annotation appears as [offset < 150 kHz]</p>
Initial S/W Revision	Prior to A.07.00

Best Wide-offset P Noise

The LO phase noise is optimized for wider offsets from the carrier. Closer offsets are compromised and the throughput of measurements (especially remote measurements where the center frequency is changing rapidly), is reduced.

Key Path	Meas Setup, PhNoise Opt
Example	WAV:FREQ:SYNT 2
Couplings	<p>The frequency below which the phase noise is optimized is model dependent:</p> <p>CXA: n/a</p> <p>EXA: [offset >150 kHz]</p> <p>MXA: [offset >150 kHz]</p> <p>PXA: [offset >400 kHz]</p>
Readback	<p>Wide-offset.</p> <p>If manually selected, “Man” will be underlined. The actual frequency offset beyond which noise is optimized is shown with in square brackets, as this can vary depending on the hardware set in use. For example, in some analyzers this annotation appears as [offset > 150 kHz]</p>
Initial S/W Revision	Prior to A.07.00

Fast Tuning

In this mode, the LO behavior compromises phase noise at many offsets from the carrier in order to allow rapid measurement throughput when changing the center frequency. The term “fast tuning” refers to the time it takes to move the local oscillator to the start frequency and begin a capture; this setting does not impact the actual measurement time in any way.

Key Path	Meas Setup, PhNoise Opt
Example	WAV:FREQ:SYNT 3
State Saved	Saved in instrument state.
Readback	Fast Tuning. If manually selected the “Man” will be underlined.
Initial S/W Revision	Prior to A.07.00

Advanced

Accesses a menu of advanced functions that are used for specific applications. These settings should not be changed for most measurements.

Key Path	Meas Setup
Initial S/W Revision	Prior to A.02.00

ADC Dither

Accesses the ADC Dither control menu.

Key Path	Meas Setup, Advanced
Initial S/W Revision	Prior to A.02.00

ADC Dither Auto

Sets ADC dithering to automatically select whether dithering is needed.

Key Path	Meas Setup, Advanced, ADC Dither
Mode	BASIC, PNOISE, WCDMA, C2K, GSM, WIMAXOFDMA, TDSCDMA, 1XEVD0, DVB, DTMB, ISDBT, CMMB, LTE, LTETDD, DCATV, WLAN, MSR,LTEATDD, LTEAFDD
Remote Command	[:SENSe] :WAVeform:ADC:DITHer:AUTO [:STATe] OFF ON 0 1 [:SENSe] :WAVeform:ADC:DITHer:AUTO [:STATe] ?
Example	WAV:ADC:DITH:AUTO ON WAV:ADC:DITH:AUTO?
Notes	The dither function improves linearity for low level signals, at the expense of a higher noise floor. You must be in a mode that includes the Waveform measurement to use this command. Use

	INSTRument:SElect to set the mode.
Preset	OFF
State Saved	Saved in instrument state.
Range	On Off
Initial S/W Revision	Prior to A.02.00
Modified at S/W Revision	A.03.00

ADC Dither

Toggles the dither function On and Off. The dither function improves linearity for low level signals, at the expense of a higher noise floor.

The reduced clipping-to-noise ratio results in higher noise, because the clipping level of the ADC relative to the front terminals remains unchanged with the introduction of dither. The enhanced linearity is mostly improved scale fidelity.

With dither on, the third-order distortions are usually invisible for mixer levels below -35 dBm. With dither off, these distortions can be visible, with typical power levels of -110 dBm referred to the mixer. Detection nonlinearity can reach 1 dB for dither off at mixer levels around -70 dBm and lower, while the specified nonlinearity is many times smaller with dither on.

Key Path	Meas Setup, Advanced, ADC Dither
Mode	BASIC, PNOISE, WCDMA, C2K, GSM, WIMAXOFDMA, TDSCDMA, 1XEVD0, DVB, DTMB, ISDBT, CMMB, LTE, LTETDD, DCATV, WLAN, MSR,LTEATDD, LTEAFDD
Remote Command	[:SENSe] :WAVeform:ADC:DITHer [:STATe] OFF ON 0 1 [:SENSe] :WAVeform:ADC:DITHer [:STATe] ?
Example	WAV:ADC:DITH ON WAV:ADC:DITH?
Notes	The dither function improves linearity for low level signals, at the expense of a higher noise floor. . You must be in a mode that includes the Waveform measurement to use this command. Use INSTRument:SElect to set the mode.
Preset	OFF
State Saved	Saved in instrument state.
Range	Auto Man
Backwards Compatibility SCPI	[:SENSe] :WAVeform:WBIF:ADC:DITHer [:SENSe] :WAVeform:PDITHer
Initial S/W Revision	Prior to A.02.00
Modified at S/W Revision	A.03.00

IF Gain

Accesses the keys to select the IF Gain settings.

When in Autorange mode, the IF checks its range once for data acquisition, to provide the best signal to noise ratio. You can specify the range for the best speed, and optimize for noise or for large signals.

When the IF Gain is set to Autorange, the IF Gain is set to High initially for each chunk of data. The data is then acquired. If the IF overloads, then the IF Gain is set to Low and the data is re-acquired. Because of this operation, the Autorange setting uses more measurement time as the instrument checks/resets its range. You can get faster measurement speed by forcing the range to either the high or low gain setting. But you must know that your measurement conditions will not overload the IF (in the high gain range) and that your signals are well above the noise floor (for the low gain range), and that the signals are not changing.

When Digital Bus Out (under the Input/Output menu) is ON, the IF Gain State Autorange selection is not allowed. Thus, in this case, IF Gain State will be set to Low.

This only applies to the RF input. It does not apply to baseband I/Q input.

Key Path	Meas Setup, Advanced
Initial S/W Revision	Prior to A.02.00

IF Gain Auto

Activates the auto rules for IF Gain

Key Path	Meas Setup, Advanced, IF Gain
Mode	BASIC, PNOISE, WCDMA, C2K, GSM, WIMAXOFDMA, TDSCDMA, 1XEVD0, DVB, DTMB, ISDBT, CMMB, LTE, LTE-TDD, DCATV, WLAN, MSR, LTE-TDD, LTE-AFDD
Remote Command	[:SENSe] :WAVeform:IF:GAIN:AUTO [:STATe] ON OFF 1 0 [:SENSe] :WAVeform:IF:GAIN:AUTO [:STATe] ?
Example	WAV:IF:GAIN:AUTO ON WAV:IF:GAIN:AUTO?
Notes	This only applies to the RF input. It does not apply to baseband I/Q input. You must be in a mode that includes the Waveform measurement to use this command. Use INSTRument:SElect to set the mode.
Preset	ON
State Saved	Saved in instrument state.
Range	On Off
Initial S/W Revision	Prior to A.02.00
Modified at S/W Revision	A.03.00

IF Gain State

Selects the range of IF gain.

Key Path	Meas Setup, Advanced, IF Gain
Mode	BASIC, PNOISE, WCDMA, C2K, GSM, WIMAXOFDMA, TDSCDMA, 1XEVD0, DVB, DTMB, ISDBT, CMMB, LTE, LTETDD, DCATV, WLAN, MSR,LTEATDD, LTEAFDD
Remote Command	[:SENSe] :WAVeform:IF:GAIN [:STATe] AUTOrange LOW HIGH [:SENSe] :WAVeform:IF:GAIN [:STATe] ?
Example	WAV:IF:GAIN HIGH WAV:IF:GAIN?
Notes	This only applies to the RF input and does not apply to baseband I/Q input. You must be in a mode that includes the Waveform measurement to use this command. Use INSTRument:SElect to set the mode. If the user tries to select Autorange while Digital Bus Out is ON, an error message -221 "Settings conflict; "IF Gain Autorange not allowed when Digital Bus Out is ON" is displayed.
Couplings	If the user tries to select Autorange via SCPI while Digital Bus Out is ON, an error message - 224, "Illegal parameter value; "IF Gain Autorange not allowed when Digital Bus Out is on" is displayed. If the user tries to select Autorange via front panel while Digital Bus Out is ON, an advisory message "IF Gain Autorange not allowed when Digital Bus Out is on" is displayed.
Preset	LOW
State Saved	Saved in instrument state.
Range	Autorange (Slower Follows Signals) Low (Best for Large Signals) High (Best Noise Level)
Readback Text	Autorange Low High
Initial S/W Revision	Prior to A.02.00
Modified at S/W Revision	A.03.00

IF Gain Offset

Sets the IF Gain offset in 2 dB step from -6 dB to +6 dB. Increasing the gain can increase the amplitude of small signals as long as you do not overdrive the hardware. Wideband gain should usually be adjusted after setting the input attenuation.

Internally, the IF Gain value will change based on the current configuration of the hardware. If you choose to offset this value, you may do so with this parameter. The value specified is not an absolute value but relative to the current internal IF Gain setting.

For example:

IF Gain Low + IF Gain Offset +4 dB = Total IF Gain of +4 dB (0 + 4 = 4)

IF Gain High + IF Gain Offset +4 dB = Total IF Gain of +14 dB (10 + 4 = 14)

IF Gain Low + IF Gain Offset -6 dB = Total IF Gain of -6 dB (0 - 6 = -6)

IF Gain High + IF Gain Offset -6 dB = Total IF Gain of +6 dB (10 - 6 = 4)

The total IF Gain range when IF Gain Offset is available is a minimum of $0 - 6 = -6$ dB and a maximum of $10 + 6 = 16$ dB. The available IF Gain depends on the IF Path and center frequency. The maximum IF Gain may not be achievable at all times depending on the configuration.

Key Path	Meas Setup, Advanced
Remote Command	[:SENSe] :WAVeform:IF:GAIN:OFFSet <rel_ampl > [:SENSe] :WAVeform:IF:GAIN:OFFSet?
Example	WAV:IF:GAIN:OFFS 2 Sets the IF Gain offset to 2
Preset	0
State Saved	Saved in instrument state.
Min	-6
Max	+6
Default Unit	dB

Meas Preset

Restores all the measurement parameters to their default values.

Key Path	Meas Setup
Mode	BASIC, PNOISE, WCDMA, C2K, GSM, WIMAXOFDMA, TDSCDMA, 1XEVD0, DVB, DTMB, ISDBT, CMMB, LTE, LTE4DD, DCATV, WLAN, MSR,LTEATDD, LTEAFDD
Remote Command	:CONFigure:WAVeform
Example	CONF:WAV
Notes	Restore default values of all parameters. You must be in a mode that includes the Waveform measurement to use this command. Use INSTRument:SElect to set the mode.
Initial S/W Revision	Prior to A.02.00
Modified at S/W Revision	A.03.00

HW Averaging

Changes the number of time averages is to be made using hardware. This averaging is much faster than the standard averaging done in software. The hardware averaging is done on the complex voltage time trace data before any measurement application averaging is done. Both types of averaging (HW and SW) can be done on the same measurement data.

When time averaging is being done in HW, each trace update represents N fresh data acquisitions averaged together, where N is the number of averages. You cannot access the individual time data. Note that in the spectrum measurement this averaging is done prior to the standard averaging done within the application. Thus the yellow trace in this measurement shows the result of the time averaging. Subsequent averaging is orthogonal to this hardware based time averaging and its result is seen as the blue trace in this and other applications.

So it is possible to turn off the averaging within the application but still have the HW averaging set to a certain number. In other words, turning averaging off within the measurement will not affect HW averaging. If HW averaging needs to be turned off, simply set the HW Averaging parameter to 1.

Since it is time averaging, a trigger source something other than Free Run should be used to avoid cancelling out the signal to be measured. It is most useful for a periodic signal with known periods.

Time Avg Num

Sets the number of HW averages to be executed per each data acquisition.

Key Path	Meas Setup
Mode	BASIC
Remote Command	[:SENSe] :WAVeform:AVErAge:TACount <integer> [:SENSe] :WAVeform:AVErAge:TACount?
Example	WAV:AVER:TAC 10WAV:AVER:TAC?
Notes	This feature is only available when Option DP2, B40, or wider IF Bandwidth option is installed.
Preset	1
State Saved	Saved in instrument state
Min	1
Max	65535
Default Unit	Enter

Sample Period (Aperture) Setting (Remote Command Only)

Returns the time between samples (sample period or aperture).

Mode	BASIC
Remote Command	[:SENSe] :WAVeform:APERture?
Example	WAV:APER?
Notes	Query only.
Couplings	Coupled to Sample Rate by the following equation. Sample Period = 1/(Sample Rate)
Preset	1/(Sample Rate Default)
Min	1/(Max Sample Rate)
Max	1/(Min Sample Rate)

Mode

See "Mode" on page 288

Mode Preset

Returns the active mode to a known state.

Mode Preset does the following for the currently active mode:

- Aborts the currently running measurement.
- Brings up the default menu for the mode, with no active function.
- Sets measurement Global settings to their preset values for the active mode only.
- Activates the default measurement.
- Brings up the default menu for the mode.
- Clears the input and output buffers.
- Sets Status Byte to 0.

Mode Preset does not:

- Cause a mode switch
- Affect mode persistent settings
- Affect system settings
- See "[How-To Preset](#)" on page 2253 for more information.

Key Path	Front-panel key
Remote Command	:SYSTem:PRESet
Example	:SYST:PRES
Notes	*RST is preferred over :SYST:PRES for remote operation. *RST does a Mode Preset, as done by the :SYST:PRES command, and it sets the measurement mode to Single measurement rather than Continuous for optimal remote control throughput. Clears all pending OPC bits. The Status Byte is set to 0.
Couplings	A Mode Preset aborts the currently running measurement, activates the default measurement, and gets the mode to a consistent state with all of the default couplings set.
Backwards Compatibility Notes	In the X-Series, the legacy "Factory Preset" has been replaced with Mode Preset, which only presets the currently active mode, not the entire instrument. In the X-Series, the way to preset the entire instrument is by using System, Restore System Defaults All, which behaves essentially the same way as restore System Defaults does on ESA and PSA. There is also no "Preset Type" as there is on the PSA. There is a green Mode Preset front-panel key that does a Mode Preset and a white-with-green-letters User Preset front-panel key that does a User Preset. The old PRESet:TYPE command is ignored (without generating an error), and SYST:PRES without a parameter does a Mode Preset, which should cover most backward code compatibility issues. The settings and correction data under the Input/Output front-panel key (examples: Input Z Corr, Ext Amp Gain, etc.) are no longer part of any Mode, so they will not be preset by a Mode Preset. They are preset using Restore Input/Output Defaults, Restore System Defaults All. Note that because User Preset does a Recall State, and all of these settings are saved in State, they ARE recalled when using

	User Preset.
Initial S/W Revision	Prior to A.02.00

How-To Preset

The table below shows all possible presets, their corresponding SCPI commands and front-panel access (key paths). Instrument settings depend on the current measurement context. Some settings are local to the current measurement, some are global (common) across all the measurements in the current mode, and some are global to all the available modes. In a similar way, restoring the settings to their preset state can be done within the different contexts.

Auto Couple - is a measurement local key. It sets all Auto/Man parameter couplings in the measurement to Auto. Any Auto/Man selection that is local to other measurements in the mode will not be affected.

Meas Preset - is a measurement local key. Meas Preset resets all the variables local to the current measurement except the persistent ones.

Mode Preset - resets all the current mode's measurement local and measurement global variables except the persistent ones.

Restore Mode Defaults - resets ALL the Mode variables (and all the Meas global and Meas local variables), including the persistent ones.

Type Of Preset	SCPI Command	Front Panel Access
Auto Couple	:COUPlE ALL	Auto Couple front-panel key
Meas Preset	:CONFIgure:<Measurement>	Meas Setup Menu
Mode Preset	:SYSTem:PRESet	Mode Preset (green key)
Restore Mode Defaults	:INSTrument:DEFault	Mode Setup Menu
Restore All Mode Defaults	:SYSTem:DEFault MODEs	System Menu; Restore System Default Menu
*RST	*RST	not possible (Mode Preset with Single)
Restore Input/Output Defaults	:SYSTem:DEFault INPut	System Menu; Restore System Default Menu
Restore Power On Defaults	:SYSTem:DEFault PON	System Menu; Restore System Default Menu
Restore Alignment Defaults	:SYSTem:DEFault ALIGn	System Menu; Restore System Default Menu
Restore Miscellaneous Defaults	:SYSTem:DEFault MISC	System Menu; Restore System Default Menu
Restore All System Defaults	:SYSTem:DEFault [ALL] :SYSTem:PRESet:PERSistent	System Menu; Restore System Default Menu
User Preset	:SYSTem:PRESet:USER	User Preset Menu
User Preset All Modes	:SYSTem:PRESet:USER:ALL	User Preset Menu

18 Waveform Measurement
Mode Preset

Power On Mode Preset	:SYSTem:PON:TYPE MODE	System Menu
Power On User Preset	:SYSTem:PON:TYPE USER	System Menu
Power On Last State	:SYSTem:PON:TYPE LAST	System Menu

Mode Setup

See ["Mode Setup" on page 320](#)

Peak Search

Places the selected marker on the trace point with the maximum y-axis value for that marker's trace and accesses a menu that enables you to select to do a next peak or minimum peak search.

Key Path	Front-panel key
Mode	BASIC, PNOISE, WCDMA, C2K, GSM, WIMAXOFDMA, TDSCDMA, 1XEVD0, DVB, DTMB, ISDBT, CM MB, LTE, LTETDD, DCATV, WLAN, MSR,LTEATDD, LTEAFDD
Remote Command	:CALCulate:WAVEform:MARKer[1] 2 . . . 12:MAXimum
Example	CALC:WAV:MARK2:MAX
Notes	You must be in a mode that includes the Waveform measurement to use this command. Use INSTRument:SElect to set the mode.
Initial S/W Revision	Prior to A.02.00
Modified at S/W Revision	A.03.00

Next Peak

Moves the selected marker to the next highest local maximum with a value less than that of the current marker.

Key Path	Peak Search
Mode	BASIC, PNOISE, WCDMA, C2K, GSM, WIMAXOFDMA, TDSCDMA, 1XEVD0, DVB, DTMB, ISDBT, CM MB, LTE, LTETDD, DCATV, WLAN, MSR,LTEATDD, LTEAFDD
Remote Command	:CALCulate:WAVEform:MARKer[1] 2 . . . 12:MAXimum:NEXT
Example	CALC:WAV:MARK:MAX:NEXT
Notes	You must be in a mode that includes the Waveform measurement to use this command. Use INSTRument:SElect to set the mode.
Initial S/W Revision	Prior to A.02.00
Modified at S/W Revision	A.03.00

Min Search

Moves the selected marker to the minimum y-axis value on the current trace.

Key Path	Peak Search
Mode	BASIC, PNOISE, WCDMA, C2K, GSM, WIMAXOFDMA, TDSCDMA, 1XEVD0, DVB, DTMB, ISDBT, CM MB, LTE, LTETDD, DCATV, WLAN, MSR,LTEATDD, LTEAFDD
Remote Command	:CALCulate:WAVEform:MARKer[1] 2 . . . 12:MINimum
Example	CALC:WAV:MARK:MIN
Notes	You must be in a mode that includes the Waveform measurement to use this command. Use INSTRument:SElect to set the mode.

Initial S/W Revision	Prior to A.02.00
Modified at S/W Revision	A.03.00

18 Waveform Measurement
Print

Print

See ["Print" on page 352](#)

Quick Save

The Quick Save front-panel key repeats the most recent save that was performed from the Save menu, with the following exceptions:

- Register saves are not remembered as Saves for the purpose of the Quick Save function
- If the current measurement does not support the last non-register save that was performed, an informational message is generated, “File type not supported for this measurement”

Quick Save repeats the last type of qualified save (that is, a save qualified by the above criteria) in the last save directory by creating a unique filename using the Auto File Naming algorithm described below.

If Quick Save is pressed after startup and before any qualified Save has been performed, the Quick Save function performs a Screen Image save using the current settings for Screen Image saves (current theme, current directory), which then becomes the “last save” for the purpose of subsequent Quick Saves.

The Auto File Naming feature automatically generates a file name for use when saving a file. The filename consists of a prefix and suffix separated by a dot, as is standard for the Windows® file system. A default prefix exists for each of the available file types:

Type	Default Prefix	Menu
State	State_	(Save/Recall)
Trace + State	State_	(Save/Recall)
Screen	Screen_	(Save/Recall)
Amplitude Corrections	Ampcor_	(Import/Export)
Traces	Trace_	(Import/Export)
Limit Lines	LLine_	(Import/Export)
Measurement Result	MeasR_	(Import/Export)
Capture Buffer	CapBuf_	(Import/Export)

A four digit number is appended to the prefix to create a unique file name. The numbering sequence starts at 0000 within each Mode for each file type and updates incrementally to 9999, then wraps to 0000 again. It remembers where it was through a Mode Preset and when leaving and returning to the Mode. It is reset by Restore Misc Defaults and Restore System Defaults and subsequent running of the instrument application. So, for example, the first auto file name generated for State files is State_0000.state. The next is State_0001, and so forth.

One of the key features of Auto File Name is that we guarantee that the Auto File Name will never conflict with an existing file. The algorithm looks for the next available number. If it gets to 9999, then it looks for holes. If it find no holes, that is no more numbers are available, it gives an error.

For example, if when we get to State_0010.state there is already a State_0010.state file in the current directory, it advances the counter to State_0011.state to ensure that no conflict will exist (and then it verifies that State_0011.state also does not exist in the current directory and advances again if it does, and so forth).

If you enter a file name for a given file type, then the prefix becomes the filename you entered instead of the default prefix, followed by an underscore. The last four letters (the suffix) are the 4-digit number.

For example, if you save a measurement results file as “fred.csv”, then the next auto file name chosen for a measurement results save will be fred_0000.csv.

NOTE

Although 0000 is used in the example above, the number that is used is actually the current number in the Meas Results sequence, that is, the number that would have been used if you had not entered your own file name.

NOTE

If the filename you entered ends with _dddd, where d=any number, making it look just like an auto file name, then the next auto file name picks up where you left off with the suffix being dddd + 1.

Key Path	Front-panel key
Notes	No remote command for this key specifically.
Initial S/W Revision	Prior to A.02.00

Recall

The Recall menu lets you choose what you want to recall, and where you want to recall it from. Among the types of files you can recall are **States and Traces**. In addition, an Import (Data) option lets you recall a number of data types stored in CSV files (as used by Excel and other spreadsheet programs).

The default paths for Recall are data type dependent and are the same as for the Save key.

Key Path	Front-panel key
Notes	<p>No remote command for this key specifically, but the :MMEM:LOAD command is available for specific file types. An example is :MMEM:LOAD:STATe <filename>.</p> <p>If you try to recall a State file for a mode that is not licensed or not available in the instrument, an error message will occur and the state will not change.</p>
Backwards Compatibility Notes	<p>In legacy analyzers, it was possible to load a state without affecting the trace data, limit lines or correction data. Similarly (since User Preset is actually loading a state), it was possible to do a User Preset without affecting the trace data, limit lines or correction data.</p> <p>In the X-Series, “state” always includes all of this data; so whenever state is loaded, all of the traces, limit lines and corrections are affected. Although this differs from previous behavior, it is desirable behavior, and should not cause adverse issues for users.</p>
Backwards Compatibility Notes	<p>Recall for the X-Series supports backward compatibility in the sense that you can recall a state file from any X-Series model number and any version of X-Series software. This is only possible if part of the recalling process goes through a limiting step after recalling the mode settings, at least for settings that may vary with version number, model number, option and license differences. If you try to recall a state file onto an instrument with less capability than what was available on the instrument during the save, the recall will ignore the state it doesn't support and it will limit the recalled setting to what it allows.</p> <p>Example: if the saved state includes preamp ON, but the recalling instrument does not have a preamp; the preamp is limited to OFF. Conversely, if you save a state without a preamp, the preamp is OFF in the state file. When this saved file is recalled on an instrument with a licensed preamp, the preamp is changed to OFF. Another example is if the saved state has center frequency set to 20 GHz, but the instrument recalling the saved state is a different model and only supports 13.5 GHz. In this case, the center frequency is limited along with any other frequency based settings. Since the center frequency can't be preserved in this case, the recall limiting tries to at least preserve span to keep the measurement setup as intact as possible.</p> <p>It may be appropriate to issue a warning if the state is limited on the recall; warnings do not go out to SCPI so this would only affect the manual user.</p> <p>Note that there is no state file compatibility outside of the X-Series. For example, you cannot recall a state file from ESA or PSA.</p>
Initial S/W Revision	Prior to A.02.00

State

The Recall State menu lets you choose a register or file from which to recall the state.

The content of a state file includes all of the settings and data required to return the analyzer as closely as possible to the Mode it was in, with the exact settings that were in place, when the save occurred. The Mode settings in each state file include the settings that are affected by Mode Preset, as well as the

additional settings affected by Restore Mode Defaults; all of the Mode's settings. In addition, all of the settings of the Input/Output system are included, even though they are outside of the Mode's state, because they are needed to restore the complete setup. Persistent System settings (for example, GPIB address) are not affected by either a Mode Preset or Restore Mode Defaults, nor are they included in a saved State file.

Since each state file is only for one Mode, the settings for other Modes are unaffected when it is loaded. Recall State will cause a mode switch if the state being recalled is not from the current active mode.

After the recall completes, the message "File <filename> recalled" or "Recalled State Register <register number>" is displayed.

For rapid recalls, the State menu lists 16 registers that you can choose from to recall. Pressing a Register key initiates the recall. You can also select a file from which to recall.

The default path for all State Files is:

My Documents\<<mode name>\state

where <mode name> is the parameter used to select the mode with the INST:SEL command (for example, SA for the Spectrum Analyzer).

See ["More Information" on page 2263](#).

Key Path	Recall
Mode	All
Remote Command	:MMEMory:LOAD:STATe <filename>
Example	:MMEM:LOAD:STAT "myState.state" This recalls the file myState.state on the default path
Example	MMEM:LOAD:STAT "MyStateFile.state" This loads the state file data (on the default file directory path) into the instrument state.
Notes	<p>When you pick a file to recall, the analyzer first verifies that the file is recallable in the current instrument by checking the software version and model number of the instrument. If everything matches, a full recall proceeds by aborting the currently running measurement, clearing any pending operations, and then loading the State from the saved state file. You can open state files from any mode, so recalling a State file switches to the mode that was active when the save occurred. After switching to the mode of the saved state file, mode settings and data (if any for the mode) are loaded with values from the saved file. The saved measurement of the mode becomes the newly active measurement and the data relevant to the measurement (if there is any) is recalled.</p> <ul style="list-style-type: none"> • If there is a mismatch between file version or model number or instrument version or model number, the recall function tries to recall as much as possible and returns a warning message. It may limit settings that differ based on model number, licensing or version number. <p>After recalling the state, the Recall State function does the following:</p> <ul style="list-style-type: none"> • Makes the saved measurement for the mode the active measurement. • Clears the input and output buffers. • Status Byte is set to 0. • Executes a *CLS <p>If the file specified is empty an error is generated. If the specified file does not exist, another error is generated. If there is a mismatch between the file and the proper file type, an error is generated. If</p>

	there is a mismatch between file version or model number or instrument version or model number, a warning is displayed. Then it returns to the State menu and File Open dialog goes away. After the Recall, the analyzer exits the Recall menu and returns to the previous menu.
Backwards Compatibility SCPI	:MMEMory:LOAD:STATe 1,<filename> For backwards compatibility, the above syntax is supported. The "1" is simply ignored.
Initial S/W Revision	Prior to A.02.00

More Information

In measurements that support saving Traces, for example, Swept SA, the Trace data is saved along with the State in the State file. When recalling the State, the Trace data is recalled as well. Traces are recalled exactly as they were stored, including the writing mode and update and display modes. If a Trace was updating and visible when the State was saved, it will come back updating and visible, and its data will be rewritten right away. When you use State to save and recall traces, any trace whose data must be preserved should be placed in View or Blank mode before saving.

The following table describes the Trace Save and Recall possibilities:

You want to recall state and one trace's data, leaving other traces unaffected.	Save Trace+State from 1 trace. Make sure that no other traces are updating (they should all be in View or Blank mode) when the save is performed.	On Recall, specify the trace you want to load the one trace's data into. This trace will load in View. All other traces' data will be unaffected, although their trace mode will be as it was when the state save was performed.
You want to recall all traces	Save Trace+State from ALL traces.	On Recall, all traces will come back in View (or Blank if they were in Blank or Background when saved)
You want all traces to load exactly as they were when saved.	Save State	On recall, all traces' mode and data will be exactly as they were when saved. Any traces that were updating will have their data immediately overwritten.

From File...

When you press "From File", the analyzer brings up a Windows dialog and a menu entitled "File Open." This menu allows you to navigate to the various fields in the Windows dialog without using a keyboard or mouse. The Tab and Arrow keys can also be used for dialog navigation.

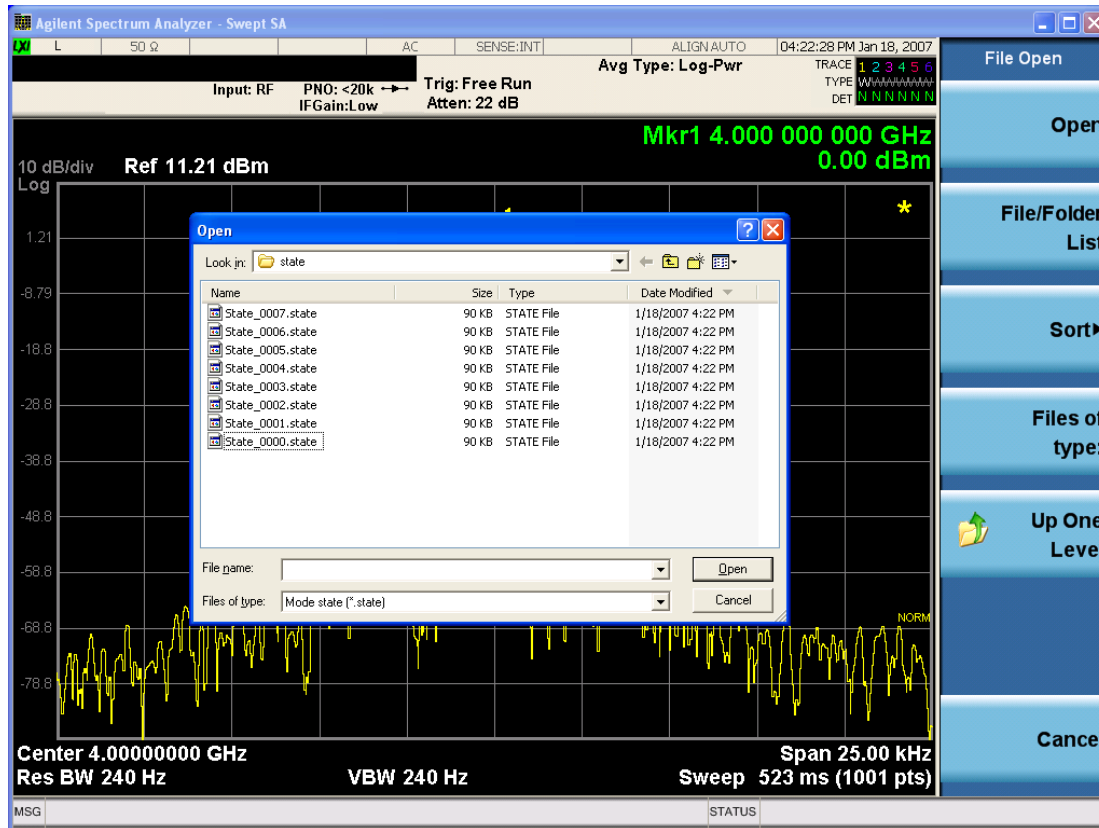

Listed below are the functions of the various fields in the dialog, and the corresponding softkeys:

Open

Performs the recall of the specified file. While the recall is being performed, the floppy icon appears briefly in the Meas bar.

File/Folder List

Enables you to navigate to the center of the dialog that contains the list of files and folders. Once here you can get information about the file and use the tab keys to navigate to the other fields in the dialog, such as Look In.

Look In

The Look In field shows the path from which the file will be recalled and allows you to change the path using the up and down arrow keys to navigate to other paths; the Enter key to open a directory; and the Backspace key to go back one directory. The **Look In field** first uses the last path from the Save As dialog **Save In:** path for that same file type. There is no softkey for directly navigating to the Look In field, but you can use the left tab to get here from the File/Folder List.

User specified paths are remembered when you leave and return to a Mode and are reset back to the default using Restore Mode Defaults.

Sort

Accesses a menu that enables you to sort the files within the File Open dialog. Only one sorting type can be selected at a time and the sorting happens immediately. The sorting types are By Date, By Name, By extension, and By Size.

Files of Type

This field shows the file suffix for the type of file you have selected to recall. For example, if you navigated here while recalling State, "Mode state (*.state)" is in the field. If you navigated here while recalling Trace, ""Mode state (*.trace)" is in the field. If you navigated here while importing a trace data file, "Trace Data (*.csv)" is in the field. For some file types, there is more than one choice in the dropdown menu, which you can select by using the up and down arrow keys and Enter.

Up One Level

This key corresponds to the icon of a folder with the up arrow that is in the tool bar of the dialog. When pressed, it causes the file and folder list to navigate up one level in the directory structure. The Backspace key does the same thing.

Cancel

This key corresponds to the Cancel selection in the dialog. It causes the current **Open** request to be cancelled. The ESC key does the same thing.

Key Path	Recall, State
Notes	Brings up the Open dialog for recalling a State Save Type
Initial S/W Revision	Prior to A.02.00

Edit Register Names

You may enter a custom name on any of the Register keys, to help you remember what you are using that state to save. To do this, press the Edit Register Names key, choose the register whose name you wish to edit, and then enter the desired label using the Alpha Editor or an external PC keyboard.

The maximum number of characters that can be added is 30. In most cases, 30 characters will fit on two lines of the key.

For more information and the SCPI command, see Edit Register Names under the Save, State function.

Key Path	Recall, State
Mode	All
Dependencies	N9060A-7FP or N9060B-2FP license required to edit the register names. When the feature is not licensed, sending the SCPI command generates an error, -221, "Settings conflict;Option not available"
Initial S/W Revision	A.11.00

Register 1 thru Register 16

Selecting any one of these register keys causes the State of the mode from the specified Register to be recalled. Each of the register keys annotates whether it is empty or at what date and time it was last

modified. In addition, you can use the Edit Register Names key under Save, State to enter custom names for each register.

Registers are shared by all modes, so recalling from any one of the registers will cause a mode switch to the mode that was active when the save to the Register occurred.

Although these 16 registers are the only registers available from the front panel, there are 128 state registers available in the instrument. Registers 17–128 are only available from the SCPI interface, using the *RCL command.

After the recall completes, the message "Register <register number> recalled" appears in the message bar. If you are in the Spectrum Analyzer Mode, and you are recalling a register that was saved in the Spectrum Analyzer Mode, then after the recall, you will still be in the Recall Register menu. If the Recall causes you to switch modes, then after the Recall, you will be in the Frequency menu.

If a requested register is empty an error is generated.

Key Path	Recall, State
Example	*RCL 1
Range	1–16 from front panel, 1–128 from SCPI
Readback	Date and time with seconds resolution are displayed on the key OR A custom name of up to 30 characters entered using the Save, State, Edit Register Names key OR “(empty)” if no prior save operation has been performed to this register.
Initial S/W Revision	Prior to A.02.00
Modified at S/W Revision	Prior to A.11.00

Register 1 thru Register 16

Selecting any one of these register keys causes the State of the mode from the specified Register to be recalled. Each of the register keys annotates whether it is empty or at what date and time it was last modified. In addition, you can use the Edit Register Names key under Save, State to enter custom names for each register.

Registers are shared by all modes, so recalling from any one of the registers will cause a mode switch to the mode that was active when the save to the Register occurred.

Although these 16 registers are the only registers available from the front panel, there are 128 state registers available in the instrument. Registers 17–128 are only available from the SCPI interface, using the *RCL command.

After the recall completes, the message "Register <register number> recalled" appears in the message bar. If you are in the Spectrum Analyzer Mode, and you are recalling a register that was saved in the Spectrum Analyzer Mode, then after the recall, you will still be in the Recall Register menu. If the Recall causes you to switch modes, then after the Recall, you will be in the Frequency menu.

If a requested register is empty an error is generated.

Key Path	Recall, State
Example	*RCL 1
Range	1–16 from front panel, 1–128 from SCPI
Readback	Date and time with seconds resolution are displayed on the key OR A custom name of up to 30 characters entered using the Save, State,Edit Register Names key OR “(empty)” if no prior save operation has been performed to this register.
Initial S/W Revision	Prior to A.02.00
Modified at S/W Revision	Prior to A.11.00

Data (Import)

Importing a data file loads data that was previously saved from the current measurement or from other measurements and/or modes that produce compatible data files. The Import Menu only contains Data Types that are supported by the current measurement.

Since the commonly exported data files are in .csv format, the data can be edited by the user prior to importing. This allows you to export a data file, manipulate the data in Excel (the most common PC Application for manipulating .csv files) and then import it.

Importing Data loads measurement data from the specified file into the specified or default destination, depending on the data type selected. Selecting an Import Data menu key will not actually cause the importing to occur, since the analyzer still needs to know from where to get the data. Pressing the Open key in this menu brings up the Open dialog and Open menu that provides you with the options from where to recall the data. Once a filename has been selected or entered in the Open menu, the recall occurs as soon as the Open button is pressed.

Key Path	Recall
Mode	All
Notes	The menu is built from whatever data types are available for the mode. Some keys will be missing completely, so the key locations in the sub-menu will vary. No SCPI command directly controls the Data Type that this key controls. The Data Type is included in the MMEM:LOAD commands.
Dependencies	If a file type is not used by a certain measurement, it is grayed out for that measurement. The key for a file type will not show at all if there are no measurements in the Mode that support it.
Preset	Is not affected by Preset or shutdown, but is reset during Restore Mode Defaults
Readback	The data type that is currently selected
Initial S/W Revision	Prior to A.02.00

Masks

This key enables you to recall a preset mask file from the list. It is only available in SEM measurement under the Data menu: Limit Mask. Limit Mask enables setting a preset limit mask for 802.11p 5MHz and 10MHz system.

You cannot change or create the preset mask file since it is a binary file. This key is valid for the Spectrum Emission Mask measurement.

File location: "My Documents\WLAN\data.masks"

Note that **"My Documents"** is an alias to a directory and its location depends on which user is logged in. At XSA start up, all of the limit mask files in the current user's "My Documents\WLAN\data.masks" directory are overwritten.

File type: Binary

Filename:

11p_5MHz_A.mask

11p_5MHz_B.mask

11p_5MHz_C.mask

11p_5MHz_D.mask

11p_10MHz_A.mask

11p_10MHz_B.mask

11p_10MHz_C.mask

11p_10MHz_D.mask

File extension: .mask

Selecting OPEN under the Import Data menu, opens the above directory enabling you to select a mask file.

Example:

File Location: My Documents/WLAN/data/masks

File Name: 11p_5MHz_A.mask

Key Path	Recall, Data
Mode	WLAN
Remote Command	MME ^M ory:LOAD:MASK <string>
Example	MMEM:LOAD:MASK "11p_5MHz_A.mask"
Initial S/W Revision	A.11.00

Capture Buffer

Capture buffer functionality is only available when measurement is Mod Accuracy and radio standard is not 802.11ac 80+80MHz. The captured data is raw data which is not processed.

Key Path	Recall, Data
Mode	WLAN
Example	MMEM:LOAD:CAPT "MyCaptureData.bin" This loads the file of capture data (on the default file directory path) into the instrument.
Dependencies	Capture buffer data is only available when measurement is Mod Accuracy and radio standard is not 802.11ac 80+80MHz. In other situation, this key is grayed out.
Initial S/W Revision	A.11.00

Open...

When you press "Open", the analyzer brings up a Windows dialog and a menu entitled "File Open." This menu allows you to navigate to the various fields in the Windows dialog without using a keyboard or mouse. The Tab and Arrow keys can also be used for dialog navigation.

See "[From File...](#)" on page 2263 in Recall, State, for a full description of this dialog and menu.

Key Path	Recall, Data
Notes	The key location is mode-dependent and will vary. Brings up Open dialog for recalling a <mode specific> Save Type
Initial S/W Revision	Prior to A.02.00

Restart

The Restart function restarts the current sweep, or measurement, or set of averaged/held sweeps or measurements. If you are Paused, pressing Restart does a Resume.

The Restart function is accessed in several ways:

- Pressing the Restart key
- Sending the remote command INIT:IMMEDIATE
- Sending the remote command INIT:RESTART

See "[More Information](#)" on page 2270

Key Path	Front-panel key
Remote Command	:INITiate[:IMMEDIATE] :INITiate:RESTART
Example	:INIT:IMM :INIT:REST
Notes	:INITiate:RESTART and :INITiate:IMMEDIATE perform exactly the same function.
Couplings	Resets average/hold count k. For the first sweep overwrites all active (update=on) traces with new current data. For application modes, it resets other parameters as required by the measurement.
Status Bits/OPC dependencies	This is an Overlapped command. The STATus:OPERation register bits 0 through 8 are cleared. The STATus:QUESTionable register bit 9 (INTEgrity sum) is cleared. The SWEEPING bit is set. The MEASURING bit is set.
Backwards Compatibility Notes	For Spectrum Analysis mode in ESA and PSA, the Restart hardkey and the INITiate:RESTART command restart trace averages (displayed average count reset to 1) for a trace in Clear Write, but did not restart Max Hold and Min Hold. In the X-Series, the Restart hardkey and the INITiate:RESTART command restart not only Trace Average, but MaxHold and MinHold traces as well. For wireless comms modes in ESA and PSA, the Restart hardkey and the INITiate:RESTART command restart every measurement, which includes all traces and numeric results. There is no change to this operation.
Initial S/W Revision	Prior to A.02.00

More Information

The **Restart** function first aborts the current sweep/measurement as quickly as possible. It then resets the sweep and trigger systems, sets up the measurement and initiates a new data measurement sequence with a new data acquisition (sweep) taken once the trigger condition is met.

If the analyzer is in the process of aligning when **Restart** is executed, the alignment finishes before the restart function is performed.

Even when set for Single operation, multiple sweeps may be taken when Restart is pressed (for example, when averaging/holding is on). Thus when we say that **Restart** "restarts a measurement," we may mean:

- It restarts the current sweep
- It restarts the current measurement
- It restarts the current set of sweeps if any trace is in Trace Average, Max Hold or Min Hold
- It restarts the current set of measurements if Averaging, or Max Hold, or Min Hold is on for the measurement
- depending on the current settings.

With **Average/Hold Number** (in **Meas Setup** menu) set to 1, or Averaging off, or no trace in Trace Average or Hold, a single sweep is equivalent to a single measurement. A single sweep is taken after the trigger condition is met; and the analyzer stops sweeping once that sweep has completed. However, with **Average/Hold Number** >1 and at least one trace set to **Trace Average, Max Hold, or Min Hold (SA Measurement)** or **Averaging on (most other measurements)**, multiple sweeps/data acquisitions are taken for a single measurement. The trigger condition must be met prior to each sweep. The sweep is stopped when the average count k equals the number N set for **Average/Hold Number**. A measurement average usually applies to all traces, marker results, and numeric results; but sometimes it only applies to the numeric results.

Once the full set of sweeps has been taken, the analyzer will go to idle state. To take one more sweep without resetting the average count, increment the average count by 1, by pressing the step up key while **Average/Hold Number** is the active function, or sending the remote command `CALC:AVER:TCON UP`.

Save

The Save menu lets you choose what you want to save and where you want to save it. Among the types of files you can save are **States**, **Traces**, and **Screen Images**. In addition, an Export (Data) option lets you save a number of data types as CSV files for easy import into Excel and other spreadsheet programs.

Key Path	Front-panel key
Mode	All
Notes	No remote command for this key specifically, but the :MMEM:STORe command is available for specific file types. An example is :MMEM:STOR:STATe <filename>.
Initial S/W Revision	Prior to A.02.00

State

The Save State menu lets you choose a register or file for saving the state.

The content of a state file includes all of the settings and data required to return the analyzer as closely as possible to the Mode it was in, with the exact settings which were in place, when the save occurred. The Mode settings in each state file include the settings that are affected by Mode Preset, as well as the additional settings affected by Restore Mode Defaults; all of the Mode's settings. In addition, all of the settings of the Input/Output system are included, even though they are outside of the Mode's state, because they are needed to restore the complete setup. Persistent System settings (for example, Verbose SCPI) are not affected by either Mode Preset or Restore Mode Defaults, nor are they included in a saved State file.

After the save completes, the message "File <filename> saved" or "State Register <register number> saved" is displayed.

For rapid saving, the State menu lists 16 registers to save to. Pressing a Register key initiates the save. You can also select a file to save to.

The default path for all State Files is:

My Documents\<<mode name>\state

where <mode name> is the parameter used to select the mode with the INST:SEL command (for example, SA for the Spectrum Analyzer).

Key Path	Save
Mode	All
Remote Command	:MMEMory:STORe:STATe <filename>
Example	MMEM:STOR:STATe "MyStateFile.state" This stores the current instrument state data in the file MyStateFile.state in the default directory.
Notes	Both single and double quotes are supported for any filename parameter over remote. After saving to a register, that register's menu key is updated with the date the time, unless a custom label has been entered for that key. After saving to a register, you remain in the Save State menu, so that you can see the Register key

update. After saving to a file, the analyzer automatically returns to the previous menu and any Save As dialog goes away.

Backwards Compatibility SCPI	:MMEMoRY:STORe:STATe 1,<filename>
Initial S/W Revision	Prior to A.02.00

To File . . .

When you press “To File”, the analyzer brings up a Windows dialog and a menu entitled “**Save As.**” This menu allows you to navigate to the various fields in the Windows dialog without using a keyboard or mouse. The Tab and Arrow keys can also be used for dialog navigation.

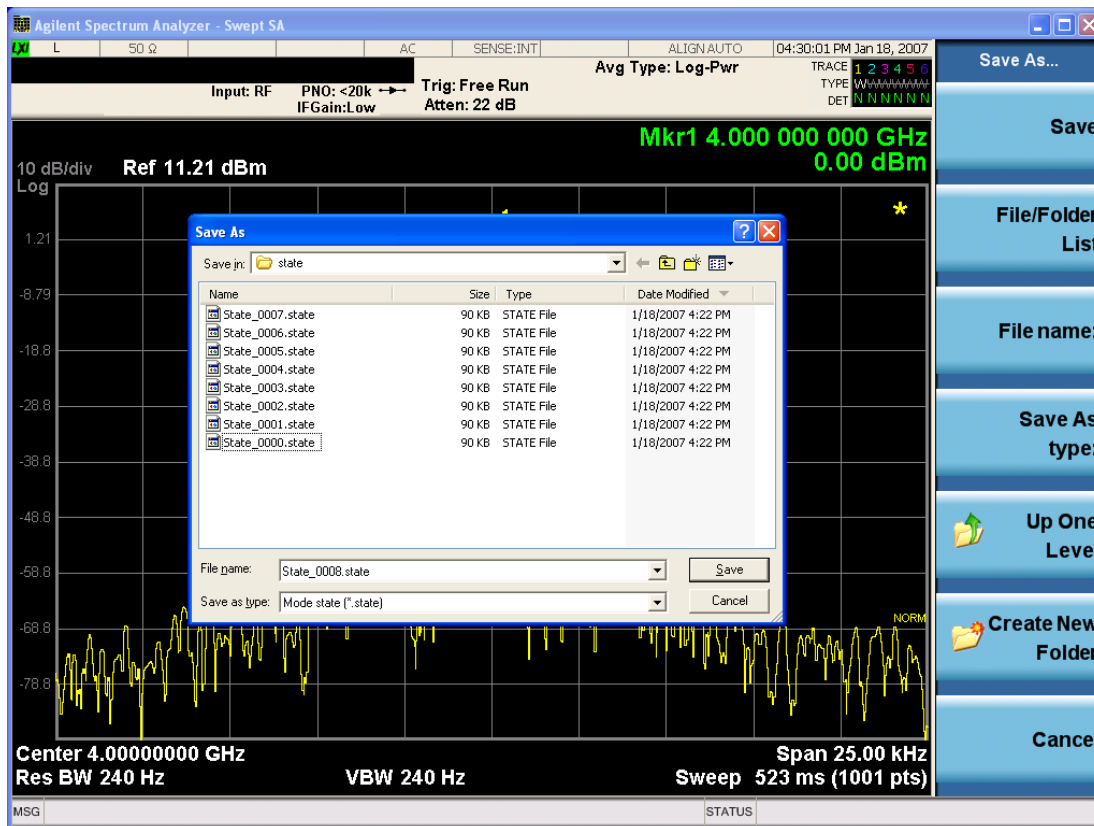

The Listed below

are the functions of the various fields in the dialog, and the corresponding softkeys:

Save

Performs the save to the specified file of the selected type. If the file already exists, a dialog will appear that allows you to replace the existing file by selecting OK, or you can Cancel the request. If you select OK, the file will be overwritten. Using the C: drive is strongly discouraged, since it runs the risk of being overwritten during an instrument software upgrade.

While the save is being performed, the floppy icon appears briefly in the Meas bar.

File/Folder List

Enables you to navigate to the center of the dialog that contains the list of files and folders. Once here you can get information about the file and use the tab keys to navigate to the other fields in the dialog, such as Save In.

Save In

The Save In field shows the path to which the file will be saved and allows you to change the path using the up and down arrow keys to navigate to other paths; the Enter key to open a directory; and the Backspace key to go back one directory. The **Save In field** defaults to the default path for this type of file and remembers the last path you used to save this type of file. There is no softkey for directly navigating to the Save In field but you can use left tab to get here from the File/Folder List.

User specified paths are remembered when you leave and return to a Mode and are reset back to the default using Restore Mode Defaults.

File Name

The File Name field is initially loaded with an automatically generated filename specific to the appropriate Save Type. The automatically generated filename is guaranteed not to conflict with any filename currently in the directory. You may replace or modify this filename using the File Name key. See the ["Quick Save " on page 2259](#) documentation for more on the automatic file naming algorithm.

When you press the File Name key the analyzer displays the Alpha Editor. Use the knob to choose the letter to add and the front-panel Enter key to add the letter to the file name. The BK character moves you back and the FW character moves you forward in the filename. The Select key on the front panel generates a space character. When you are done entering the filename press the Done softkey. This returns back to the **File Open** dialog and menu, but does not cause the save to occur.

Save As Type

This field shows the file suffix for the type of file you have selected to save. For example, if you navigated here while saving State, "Mode state (*.state)" is in the field. If you navigated here from saving Trace, ""Mode state (*.trace)" is in the field. If you navigated here while exporting a trace data file, "Trace Data (*.csv)" is in the field. For some file types, there is more than one choice in the dropdown, which you can select by using the up and down arrow keys and Enter.

Up One Level

This key corresponds to the icon of a folder with the up arrow that is in the tool bar of the dialog. When pressed, it causes the file and folder list to navigate up one level in the directory structure. The Backspace key does the same thing.

Create New Folder

This key corresponds to the icon of a folder with the "*" that is in the tool bar of the dialog. When pressed, a new folder is created in the current directory with the name **New Folder** and you can enter a new folder name using the Alpha Editor.

Cancel

This key corresponds to the Cancel selection in the dialog. It causes the current **Save As** request to be cancelled. The ESC key does the same thing.

Key Path	Save, State
Mode	All
Notes	Brings up Save As dialog for saving a State Save Type
Initial S/W Revision	Prior to A.02.00

Edit Register Names

You may enter a custom name on any of the Register keys, to help you remember what you are using that state to save. To do this, press the Edit Register Names key, choose the register whose name you wish to edit, and then enter the desired label using the Alpha Editor or an external PC keyboard.

The maximum number of characters that can be added is 30. In most cases, 30 characters will fit on two lines of the key.

See ["More Information" on page 2275](#)

Key Path	Save, State
Mode	All
Remote Command	:MMEMory:REGister:STATe:LABel <reg number>,"label" :MMEMory:REGister:STATe:LABel? <reg number>
Example	:MMEM:REG:STAT:LAB 1,"my label"
Notes	<reg number> is an integer from 1 to 16. If the SCPI specifies an invalid register number an error message is generated, -222,"Data out of range;Invalid register label number" "label" is a string from 0 to 30 characters in length. If a label exceeds 30 characters, an error message is generated, -150,"String data error;Label clipped to 30 characters" "label" of length 0 erases the custom label and restores the default (time and date) label. E.g.: :MMEM:REG:STAT:LAB 1,""
Dependencies	N9060A-7FP or N9060B-2FP license required to edit the register names. When the feature is not licensed, sending this command generates an error, -221,"Settings conflict;Option not available"
Preset	The names are unaffected by Preset or power cycle but are set to the default label (time and date) on a "Restore System Defaults->Misc"
Initial S/W Revision	A.11.00

More Information

When you edit one of the register names, the time and date field will be replaced by the custom name.

If you delete all the characters in the custom name, it restores the default (time and date).

The register names are stored within the state files, but they are not part of the instrument state; that is, once you have edited a register name, loading a new state will not change that register name. Another consequence of this is that the names will be persistent through a power cycle. Also, if a named state file is transferred to another analyzer, it will bring its custom name along with it.

If you try to edit the name of an empty register, the analyzer will first save the state to have a file to put the name in. If you load a named state file into an analyzer with older firmware it will ignore the metadata.

The *SAV and *RCL commands will not be affected by the custom register names, nor will the MMEM commands.

Register 1 thru Register 16

Selecting any one of these register menu keys causes the State of the currently active mode to be saved to the specified Register. The registers are provided for rapid saving and recalling, since you do not need to specify a filename or navigate to a file. Each of the register menu keys annotates whether it is empty or at what date and time it was last modified. In addition, you can use the Edit Register Names key to enter custom names for each register.

Although these 16 registers are the only registers available from the front panel, there are 128 state registers available in the instrument. Registers 17–128 are only available from the SCPI interface, using the *SAV command.

There is one set of 128 state registers in the instrument, not one set for each Mode. When a state is saved, the Mode it was saved from is saved with it; then when it is recalled, the instrument switches to that Mode.

After the save completes, the corresponding register menu key annotation is updated with the date and time and the message "Register <register number> saved" is displayed.

Key Path	Save, State
Mode	All
Example	*SAV 1
Range	1–16 from front panel, 1–128 from SCPI
Readback	Date and time with seconds resolution are displayed on the key OR A custom name of up to 30 characters entered using the Edit Register Names key OR “(empty)” if no prior save operation has been performed to this register.
Initial S/W Revision	Prior to A.02.00
Modified at S/W Revision	A.11.00

Register 1 thru Register 16

Selecting any one of these register menu keys causes the State of the currently active mode to be saved to the specified Register. The registers are provided for rapid saving and recalling, since you do not need to specify a filename or navigate to a file. Each of the register menu keys annotates whether it is empty or at what date and time it was last modified. In addition, you can use the Edit Register Names key to enter custom names for each register.

Although these 16 registers are the only registers available from the front panel, there are 128 state registers available in the instrument. Registers 17–128 are only available from the SCPI interface, using the *SAV command.

There is one set of 128 state registers in the instrument, not one set for each Mode. When a state is saved, the Mode it was saved from is saved with it; then when it is recalled, the instrument switches to that Mode.

After the save completes, the corresponding register menu key annotation is updated with the date and time and the message "Register <register number> saved" is displayed.

Key Path	Save, State
Mode	All
Example	*SAV 1
Range	1–16 from front panel, 1–128 from SCPI
Readback	Date and time with seconds resolution are displayed on the key OR A custom name of up to 30 characters entered using the Edit Register Names key OR “(empty)” if no prior save operation has been performed to this register.
Initial S/W Revision	Prior to A.02.00
Modified at S/W Revision	A.11.00

Data (Export)

Exporting a data file stores data from the current measurement to mass storage files. The Export Menu only contains data types that are supported by the current measurement.

Since the commonly exported data files are in .csv format, the data can be edited by you prior to importing. This allows you to export a data file, manipulate the data in Excel (the most common PC Application for manipulating .csv files) and then import it.

Selecting an Export Data menu key will not actually cause the exporting to occur, since the analyzer still needs to know where you wish to save the data. Pressing the Save As key in this menu brings up the Save As dialog and Save As menu that allows you to specify the destination file and directory. Once a filename has been selected or entered in the Open menu, the export will occur as soon as the Save key is pressed.

Key Path	Save
Mode	All
Notes	The menu is built from whatever data types are available for the mode. So the key locations in the sub menu will vary. No SCPI command directly controls the Data Type that this key controls. The Data Type is included in the MMEM:STORe commands.
Dependencies	If a file type is not used by a certain measurement, that type is grayed out for that measurement. The key for a file type will not show at all if there are no measurements in the Mode that support it.
Preset	Is not affected by a Preset or shutdown, but is reset during Restore Mode Defaults
Readback	The data type that is currently selected
Initial S/W Revision	Prior to A.02.00

Meas Results

Key Path	Save, Data
Mode	WLAN
Example	MMEM:STOR:RES "MyResultsFile.csv" This stores the measurement results data in the file MyResultsFile.xml in the default directory.
Initial S/W Revision	A.11.00

Capture Buffer

Capture buffer functionality is only available when measurement is Mod Accuracy and radio standard is not 802.11ac 80+80MHz. The captured data is raw data which is not processed.

Key Path	Save, Data
Mode	WLAN
Example	MMEM:STOR:CAPT "MyCaptureData.bin" This stores the capture data in the file MyCaptureData.bin in the default directory.
Dependencies	Capture buffer data is only available when measurement is Mod Accuracy and radio standard is not 802.11ac 80+80MHz. In other measurements, this key is grayed out.
Initial S/W Revision	A.11.00

Save As . . .

When you press "Save As", the analyzer brings up a Windows dialog and a menu entitled "**Save As.**" This menu allows you to navigate to the various fields in the Windows dialog without using a keyboard or mouse. The Tab and Arrow keys can also be used for dialog navigation.

See "[To File . . .](#)" on page 2273 in Save, State for a full description of this dialog and menu.

The default path for saving files is:

For all of the Trace Data Files:

My Documents\`<mode name>`\data\traces

For all of the Limit Data Files:

My Documents\`<mode name>`\data\limits

For all of the Measurement Results Data Files:

My Documents\`<mode name>`\data\`<measurement name>`\results

For all of the Capture Buffer Data Files:

My Documents\`<mode name>`\data\captureBuffer

Key Path	Save, Data
Mode	All
Notes	The key location is mode-dependent and will vary. Brings up the Save As dialog for saving a <mode specific> Save Type. The save is performed immediately and does not wait until the measurement is complete.
Initial S/W Revision	Prior to A.02.00

Screen Image

Pressing Screen Image accesses a menu of functions that enable you to specify a format and location for the saved screen image. It brings up a menu that allows you to specify the color scheme of the Screen Image (Themes) or navigate to the Save As dialog to perform the actual save.

Screen Image files contain an exact representation of the analyzer display. They cannot be loaded back onto the analyzer, but they can be loaded into your PC for use in many popular applications.

The image to be saved is actually captured when the Save front panel key is pressed, and kept in temporary storage to be used if you ask for a Screen Image save. When the Screen Image key is pressed, a "thumbnail" of the captured image is displayed, as shown below:

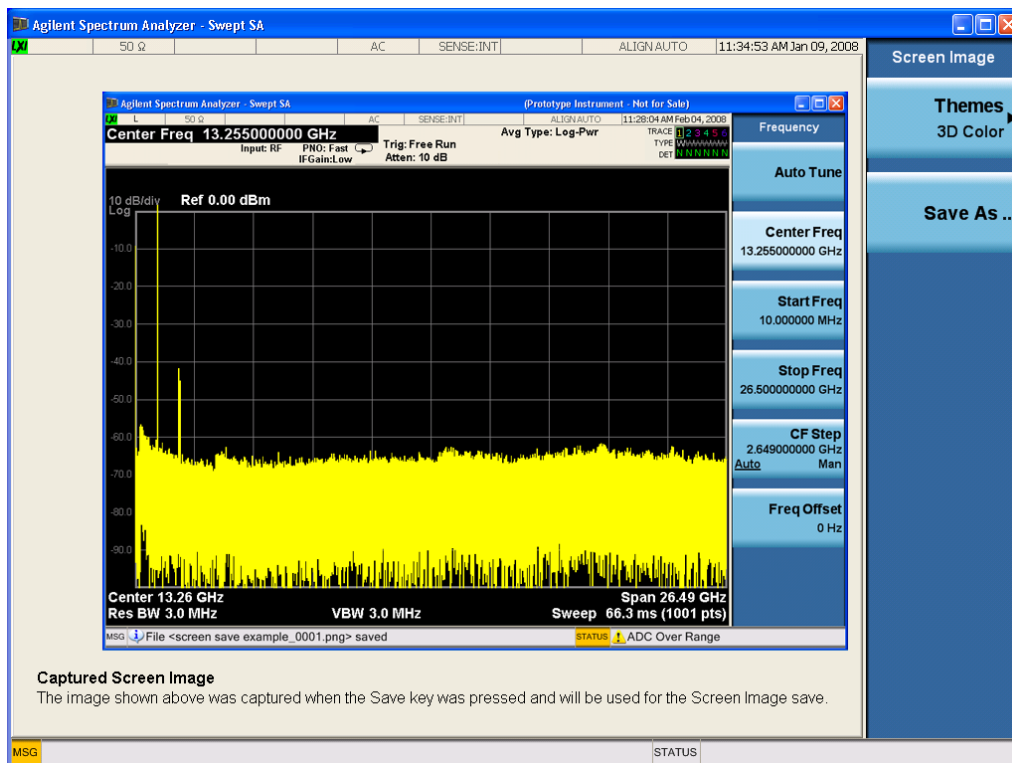

When you continue on into the Save As menu and complete the Screen Image save, the image depicted in the thumbnail is the one that gets saved, showing the menus that were on the screen before going into the Save menus. The save is performed immediately and does not wait until the measurement is complete.

After you have completed the save, the Quick Save front-panel key lets you quickly repeat the last save performed, using an auto-named file, with the current screen data.

NOTE

For versions previous to A.01.55, if you initiate a screen image save by navigating through the Save menus, the image that is saved will contain the Save menu softkeys, not the menus and the active function that were on the screen when you first pressed the Save front panel key.

Key Path	Save
Mode	All
Remote Command	:MMEMory:STORe:SCReem <filename>
Example	:MMEM:STOR:SCR "myScreen.png" This stores the current screen image in the file MyScreenFile.png in the default directory.
Initial S/W Revision	Prior to A.02.00

Themes

Accesses a menu of functions that enable you to choose the theme to be used when saving the screen image.

The **Themes** option is the same as the **Themes** option under the **Display** and **Page Setup** dialogs. It allows you to choose between themes to be used when saving the screen image.

Key Path	Save, Screen Image
Remote Command	:MMEMory:STORe:SCReem:THEMe TDColor TDMonochrome FCOLor FMONochrome :MMEMory:STORe:SCReem:THEMe?
Example	:MMEM:STOR:SCR:THEM TDM
Preset	3D Color; Is not part of Preset, but is reset by Restore Misc Defaults or Restore System Defaults All and survives subsequent running of the modes.
Readback	3D Color 3D Mono Flat Color Flat Mono
Backwards Compatibility Notes	In ESA and PSA we offer the choice of "Reverse Bitmap" or "Reverse Metafile" when saving screen images. This is much like the "Flat Color" theme available in X-Series. Also, if you selected Reverse Bitmap AND a black & white screen image, that would be much like "Flat Monochrome". In other words, each of the X-Series themes has a similar screen image type in ESA/PSA. But they are not identical.
Initial S/W Revision	Prior to A.02.00

3D Color

Selects a standard color theme with each object filled, shaded and colored as designed.

Key Path	Save, Screen Image, Themes
Example	MMEM:STOR:SCR:THEM TDC

Readback	3D Color
Initial S/W Revision	Prior to A.02.00

3D Monochrome

Selects a format that is like 3D color but shades of gray are used instead of colors.

Key Path	Save, Screen Image, Themes
Example	MMEM:STOR:SCR:THEM TDM
Readback	3D Mono
Initial S/W Revision	Prior to A.02.00

Flat Color

Selects a format that is best when the screen is to be printed on an ink printer.

Key Path	Save, Screen Image, Themes
Example	MMEM:STOR:SCR:THEM FCOL
Readback	Flat Color
Initial S/W Revision	Prior to A.02.00

Flat Monochrome

Selects a format that is like Flat Color. But only black is used (no colors, not even gray), and no fill.

Key Path	Save, Screen Image, Themes
Example	MMEM:STOR:SCR:THEM FMON
Readback	Flat Mono
Initial S/W Revision	Prior to A.02.00

Save As...

When you press "Save As", the analyzer brings up a Windows dialog and a menu entitled "**Save As.**" This menu allows you to navigate to the various fields in the Windows dialog without using a keyboard or mouse. The Tab and Arrow keys can also be used for dialog navigation.

See "[To File . . .](#)" on page 2273 in Save, State for a full description of this dialog and menu.

The default path for Screen Images is

My Documents\`<mode name>`\screen.

where <mode name> is the parameter used to select the mode with the INST:SEL command (for example, SA for the Spectrum Analyzer).

Key Path	Save, Screen Image
Notes	Brings up Save As dialog for saving a Screen Image Save Type
Initial S/W Revision	Prior to A.02.00

Mass Storage Catalog (Remote Command Only)

Key path	SCPI Only
Remote Command	:MMEMory:CATalog? [<directory_name>]
Notes	<p>The string must be a valid logical path.</p> <p>Queries disk usage information (drive capacity, free space available) and obtains a list of files and directories in a specified directory in the following format:</p> <p><numeric_value>,<numeric_value>,{<file_entry>}</p> <p>It returns two numeric parameters and as many strings as there are files and directories. The first parameter indicates the total amount of storage currently used in bytes. The second parameter indicates the total amount of storage available, also in bytes. The <file_entry> is a string. Each <file_entry> indicates the name, type, and size of one file in the directory list:</p> <p><file_name>,<file_type>,<file_size></p> <p>As the windows file system has an extension that indicates file type, <file_type> is always empty. <file_size> provides the size of the file in bytes. For directories, <file_entry> is surrounded by square brackets and both <file_type> and <file_size> are empty</p>
Initial S/W Revision	Prior to A.02.00

Mass Storage Change Directory (Remote Command Only)

Key path	SCPI Only
Remote Command	:MMEMory:CDIRectory [<directory_name>] :MMEMory:CDIRectory?
Notes	<p>The string must be a valid logical path.</p> <p>Changes the default directory for a mass memory file system. The <directory_name> parameter is a string. If no parameter is specified, the directory is set to the *RST value.</p> <p>At *RST, this value is set to the default user data storage area, that is defined as System.Environment.SpecialFolder.Personal.</p> <p>Query returns full path of the default directory.</p>
Initial S/W Revision	Prior to A.02.00

Mass Storage Copy (Remote Command Only)

Key path	SCPI Only
Remote Command	:MMEMory:COpy <string>,<string>[,<string>,<string>]
Notes	<p>The string must be a valid logical path.</p> <p>Copies an existing file to a new file or an existing directory to a new directory.</p> <p>Two forms of parameters are allowed. The first form has two parameters. In this form, the first parameter specifies the source, and the second parameter specifies the destination.</p> <p>The second form has four parameters. In this form, the first and third parameters specify the source. The second and fourth parameters specify the directories. The first pair of parameters specifies the source. The second pair specifies the destination. An error is generated if the source doesn't exist or the destination file already exists.</p> <p>This command will generate an "access denied" error if the destination is a restricted folder (e.g., C:\Windows) and the current user does not have Power User or Administrator privileges.</p>

Mass Storage Device Copy (Remote Command Only)

This command transfers data to/from a file and a peripheral device.

Key path	SCPI Only
Remote Command	:MMEMory:COpy:DEvice <source_string>,<dest_string>
Notes	<p>The strings must be a valid logical path or a valid device keyword. If the dest_string is a device keyword, the data is copied from the source file to the device. If the source_string is a device keyword, the data is copied to the source file from the device.</p> <p>Valid device keywords are:</p> <p>SNS (smart noise source)</p> <p>An error is generated if the file or device is not found.</p>

Mass Storage Delete (Remote Command Only)

Key path	SCPI Only
Remote Command	:MMEMory:DElete <file_name>[,<directory_name>]
Notes	<p>The string must be a valid logical path.</p> <p>Removes a file from the specified directory. The <file_name> parameter specifies the file name to be removed. This command will generate an "access denied" error if the file is in a restricted folder (e.g., C:\Windows) and the current user does not have Power User or Administrator privileges.</p>
Initial S/W Revision	Prior to A.02.00

Mass Storage Data (Remote Command Only)

Creates a file containing the specified data OR queries the data from an existing file.

Key path	SCPI Only
Remote Command	:MMEMory:DATA <file_name>, <data> :MMEMory:DATA? <file_name>
Notes	The string must be a valid logical path. The command form is MMEMory:DATA <file_name>,<data>. It loads <data> into the file <file_name>. <data> is in 488.2 block format. <file_name> is string data. The query form is MMEMory:DATA? <file_name> with the response being the associated <data> in block format.
Initial S/W Revision	Prior to A.02.00

Mass Storage Make Directory (Remote Command Only)

Key path	SCPI Only
Remote Command	:MMEMory:MDIRectory <directory_name>
Notes	The string must be a valid logical path. Creates a new directory. The <directory_name> parameter specifies the name to be created. This command will generate an “access denied” error if the new directory would be in a restricted folder (e.g., C:\Windows) and the current user does not have Power User or Administrator privileges.
Initial S/W Revision	Prior to A.02.00

Mass Storage Move (Remote Command Only)

Key path	SCPI Only
Remote Command	:MMEMory:MOVE <string>,<string>[,<string>,<string>]
Notes	The string must be a valid logical path. Moves an existing file to a new file or an existing directory to a new directory. Two forms of parameters are allowed. The first form has two parameters. In this form, the first parameter specifies the source, and the second parameter specifies the destination. The second form has four parameters. In this form, the first and third parameters specify the source. The second and fourth parameters specify the directories. The first pair of parameters specifies the source. The second pair specifies the destination. An error is generated if the source doesn't exist or the destination file already exists. This command will generate an “access denied” error if the destination is a restricted folder (e.g., C:\Windows) and the current user does not have Power User or Administrator privileges.
Initial S/W Revision	Prior to A.02.00

Mass Storage Remove Directory (Remote Command Only)

Key path	SCPI Only
Remote Command	<code>:MMEMory:RDIRECTory <directory_name></code>
Notes	<p>The string must be a valid logical path.</p> <p>Removes a directory. The <directory_name> parameter specifies the directory name to be removed. All files and directories under the specified directory shall also be removed.</p> <p>This command will generate an “access denied” error if the folder is a restricted folder (e.g., C:\Windows) or is in a restricted folder and the current user does not have Power User or Administrator privileges.</p>
Initial S/W Revision	Prior to A.02.00

Single (Single Measurement/Sweep)

Sets the analyzer for Single measurement operation. The single/continuous state is Meas Global, so the setting will affect all the measurements. If you are Paused, pressing Single does a Resume.

See ["More Information" on page 2286](#)

Key Path	Front-panel key
Example	:INIT:CONT OFF
Notes	See Cont key description.
Backwards Compatibility Notes	<p>For Spectrum Analysis mode in ESA and PSA, the Single hardkey and the INITiate:IMM switched from continuous measurement to single measurement and restarted sweeps and averages (displayed average count reset to 1), but did not restart Max Hold and Min Hold. In the X-Series, the Single hardkey and the INITiate:IMM command initiate a sweep/ measurement/ average sequence/hold sequence including MaxHold and MinHold.</p> <p>For Spectrum Analysis mode in ESA and PSA, the Single hardkey restarted the sweep regardless of whether or not you were in an active sweep or sweep sequence. In the X-Series, Restart does this but Single only restarts the sweep or sweep sequence if you are in the idle state.</p> <p>INIT[:IMM] in ESA & PSA Spectrum Analysis Mode does an implied ABORT. In some other PSA Modes, INIT[:IMM] is ignored if not in the idle state. . The X-Series follows the ESA/PSA SA Mode model, which may cause some Modes to have compatibility problems.</p>
Initial S/W Revision	Prior to A.02.00

More Information

See ["Restart" on page 2270](#) for details on the INIT:IMMEDIATE (Restart) function.

If you are already in single sweep, the INIT:CONT OFF command has no effect.

If you are already in Single Sweep, then pressing the Single key in the middle of a sweep does not restart the sweep or sequence. Similarly, pressing the Single key does not restart the sweep or sequence if the sweep is not in the idle state (for example, if you are taking a very slow sweep, or the analyzer is waiting for a trigger). Instead, it results in a message. "Already in Single, press Restart to initiate a new sweep or sequence". Even though pressing the Single key in the middle of a sweep does not restart the sweep, sending INIT:IMMEDIATE does reset it.

To take one more sweep without resetting the average count, increment the average count by 1, by pressing the step up key while **Average/Hold Number** is the active function, or sending the remote command CALC:AVER:TCON UP.

Source

There is no Source control functionality for this measurement. When this key is pressed, the screen either displays a blank menu, or the previously-selected menu remains unchanged.

Key Path	Front-panel key
----------	-----------------

Span X Scale

Accesses a menu of functions that enable you to set the horizontal scale parameters.

Key Path	Front-panel key
Initial S/W Revision	Prior to A.02.00

Ref Value

Sets the reference value for time on the horizontal axis. When Auto Scaling is set to On, the displayed plots use a Scale/Div value determined by the analyzer, based on the measurement result.

Key Path	SPAN X Scale
Mode	BASIC, PNOISE, WCDMA, C2K, GSM, WIMAXOFDMA, TDSCDMA, 1XEVD0, DVB, DTMB, ISDBT, CMMB, LTE, LTETDD, DCATV, WLAN, MSR,LTEATDD, LTEAFDD
Remote Command	:DISPlay:WAVeform:VIEW[1] 2:WINDow[1]:TRACe:X[:SCALE]:RLEVel <time> :DISPlay:WAVeform:VIEW[1] 2:WINDow[1]:TRACe:X[:SCALE]:RLEVel?
Example	DISP:WAV:VIEW:WIND:TRAC:X:RLEV 10 ms DISP:WAV:VIEW:WIND:TRAC:X:RLEV?
Notes	You must be in a mode that includes the Waveform measurement to use this command. Use INSTRument:SElect to set the mode.
Couplings	If Auto Scaling is set to On, this value is automatically determined by the measurement result. When you set this value manually, Auto Scaling automatically changes to Off.
Preset	0.00 s
State Saved	Saved in instrument state.
Min	-1.000 s
Max	10.00 s
Initial S/W Revision	Prior to A.02.00
Modified at S/W Revision	A.03.00

Scale/Div

Sets the horizontal scale by changing a time value per division.

Key Path	SPAN X Scale
Mode	BASIC, PNOISE, WCDMA, C2K, GSM, WIMAXOFDMA, TDSCDMA, 1XEVD0, DVB, DTMB, ISDBT, CMMB, LTE, LTETDD, DCATV, WLAN, MSR,LTEATDD, LTEAFDD
Remote Command	:DISPlay:WAVeform:VIEW[1] 2:WINDow[1]:TRACe:X[:SCALE]:PDIVision <time> :DISPlay:WAVeform:VIEW[1] 2:WINDow[1]:TRACe:X[:SCALE]:PDIVision?
Example	DISP:WAV:VIEW:WIND:TRAC:X:PDIV 500 us DISP:WAV:VIEW:WIND:TRAC:X:PDIV?

Notes	You must be in a mode that includes the Waveform measurement to use this command. Use INSTRUMENT:SElect to set the mode.
Couplings	If Auto Scaling is set to On, this value is automatically determined by the measurement result. When you set this value manually, Auto Scaling automatically changes to Off.
Preset	All except the following list: 200.0 us LTEAFDD, LTEATDD: 1.000 ms LTETDD: 1.000 ms
State Saved	Saved in instrument state.
Min	1.000 ns
Max	320 s
Initial S/W Revision	Prior to A.02.00
Modified at S/W Revision	A.03.00, A.14.00

Ref Position

Sets the reference position for the X axis to Left, Center or Right.

Key Path	SPAN X Scale
Mode	BASIC, PNOISE, WCDMA, C2K, GSM, WIMAXOFDMA, TDSCDMA, 1XEVD0, DVB, DTMB, ISDBT, CMMB, LTE, LTETDD, DCATV, WLAN, MSR,LTEATDD, LTEAFDD
Remote Command	:DISPlay:WAVeform:VIEW[1] 2:WINDow[1]:TRACe:X[:SCALe]:RPOSition LEFT CENTER RIGHT :DISPlay:WAVeform:VIEW[1] 2:WINDow[1]:TRACe:X[:SCALe]:RPOSition?
Example	DISP:WAV:VIEW:WIND:TRAC:X:RPOS LEFT DISP:WAV:VIEW:WIND:TRAC:X:RPOS?
Notes	Allows you to set the reference position to Left, Ctr (center) or Right. You must be in a mode that includes the Waveform measurement to use this command. Use INSTRUMENT:SElect to set the mode.
Preset	LEFT
State Saved	Saved in instrument state.
Range	Left Ctr Right
Initial S/W Revision	Prior to A.02.00
Modified at S/W Revision	A.03.00

Auto Scaling

Toggles the scale coupling function between On and Off.

Key Path	SPAN X Scale
Mode	BASIC, PNOISE, WCDMA, C2K, GSM, WIMAXOFDMA, TDSCDMA, 1XEVD0, DVB, DTMB, ISDBT, CM MB, LTE, LTETDD, DCATV, WLAN, MSR,LTEATDD, LTEAFDD
Remote Command	:DISPlay:WAVeform:VIEW[1] 2:WINDow[1]:TRACe:X[:SCALE]:COUPle 0 1 OFF ON :DISPlay:WAVeform:VIEW[1] 2:WINDow[1]:TRACe:X[:SCALE]:COUPle?
Example	DISP:WAV:VIEW:WIND:TRAC:X:COUP ON DISP:WAV:VIEW:WIND:TRAC:X:COUP?
Notes	You must be in a mode that includes the Waveform measurement to use this command. Use INSTRument:SElect to set the mode.
Couplings	When Auto Scaling is On and the Restart front-panel key is pressed, this function automatically determines the scale per division and reference values based on the measurement results. When you set a value to either Scale/Div or Ref Value manually, Auto Scaling automatically changes to Off.
Preset	1
State Saved	Saved in instrument state.
Range	On Off
Initial S/W Revision	Prior to A.02.00
Modified at S/W Revision	A.03.00

Sweep/Control

Accesses a menu that enables you to configure the Sweep and Control functions of the analyzer, such as Sweep Time and Gating.

Key Path	Front-panel key
Initial S/W Revision	Prior to A.02.00

Pause/Resume

Pauses a measurement after the current data acquisition is complete.

When Paused, the label on the key changes to Resume. Pressing Resume un-pauses the measurement. When you are Paused, pressing Restart, Single or Cont does a Resume.

Key Path	Sweep/Control
Remote Command	:INITiate:PAUSE
Dependencies	Grayed out in Measurements that do not support Pausing. Blanked in Modes that do not support Pausing.
Initial S/W Revision	Prior to A.02.00

Key Path	Sweep/Control
Remote Command	:INITiate:RESume
Dependencies	Grayed out in Measurements that do not support Pausing. Blanked in Modes that do not support Pausing.
Initial S/W Revision	Prior to A.02.00

Abort (Remote Command Only)

This command is used to stop the current measurement. It aborts the current measurement as quickly as possible, resets the sweep and trigger systems, and puts the measurement into an "idle" state. If the analyzer is in the process of aligning when ABORT is sent, the alignment finishes before the abort function is performed. So ABORT does not abort an alignment.

If the analyzer is set for Continuous measurement, it sets up the measurement and initiates a new data measurement sequence with a new data acquisition (sweep) taken once the trigger condition is met.

If the analyzer is set for Single measurement, it remains in the "idle" state until an :INIT:IMM command is received.

Remote Command	:ABORt
Example	:ABOR

Notes	If :INITiate:CONTInuous is ON, then a new continuous measurement will start immediately, with sweep (data acquisition) occurring once the trigger condition has been met. If :INITiate:CONTInuous is OFF, then :INITiate:IMMEDIATE is used to start a single measurement; with sweep (data acquisition) occurring once the trigger condition has been met.
Dependencies	For continuous measurement, ABORt is equivalent to the Restart key. Not all measurements support the abort command.
Status Bits/OPC dependencies	The STATus:OPERation register bits 0 through 8 are cleared. The STATus:QUEStionable register bit 9 (INTegrity sum) is cleared. Since all the bits that feed into OPC are cleared by the ABORt, the ABORt will cause the *OPC query to return true.
Initial S/W Revision	Prior to A.02.00

System

See "System" on page 353

Trace/Detector

There is no Trace/Detector functionality supported in the Waveform measurement. The front-panel key displays a blank menu when pressed.

Key Path	Front-panel key
Initial S/W Revision	Prior to A.02.00

Trigger

See ["Trigger" on page 428](#)

Free Run

See ["Free Run " on page 435](#)

Video

See ["Video \(IF Envelope\) " on page 436](#)

Trigger Level

See ["Trigger Level " on page 436](#)

Trig Slope

See ["Trig Slope " on page 437](#)

Trig Delay

See ["Trig Delay " on page 438](#)

Line

See ["Line " on page 2105](#)

Trig Slope

See ["Trig Slope " on page 2105](#)

Trig Delay

See ["Trig Delay " on page 440](#)

External 1

See ["External 1 " on page 2118](#)

Trigger Level

See ["Trigger Level " on page 2118](#)

Trig Slope

See ["Trig Slope " on page 2119](#)

Trig Delay

See ["Trig Delay " on page 443](#)

Zero Span Delay Comp

See ["Zero Span Delay Comp On/Off" on page 2107](#)

External 2

See ["External 2 "](#) on page 2120

Trigger Level

See ["Trigger Level "](#) on page 2120

Trig Slope

See ["Trig Slope "](#) on page 2121

Trig Delay

See ["Trig Delay "](#) on page 445

Zero Span Delay Comp

See ["Zero Span Delay Comp On/Off"](#) on page 2109

RF Burst

See ["RF Burst "](#) on page 2121

Absolute Trigger

See ["Absolute Trigger Level"](#) on page 2122

Relative Trigger

See ["Relative Trigger Level"](#) on page 2111

Trig Slope

See ["Trigger Slope "](#) on page 2123

Trig Delay

See ["Trig Delay "](#) on page 450

Periodic Timer

See ["Periodic Timer \(Frame Trigger\) "](#) on page 2113

Period

See ["Period "](#) on page 2114

Offset

See ["Offset "](#) on page 2115

Offset Adjust (Remote Command Only)

See ["Offset Adjust \(Remote Command Only\)"](#) on page 2116

Reset Offset Display

See "Reset Offset Display " on page 2117

Sync Source

See "Sync Source " on page 2117

Off

See "Off " on page 2118

External 1

See "External 1 " on page 2118

Trigger Level

See "Trigger Level " on page 2118

Trig Slope

See "Trig Slope " on page 2119

External 2

See "External 2 " on page 2120

Trigger Level

See "Trigger Level " on page 2120

Trig Slope

See "Trig Slope " on page 2121

RF Burst

See "RF Burst " on page 2121

Absolute Trigger

See "Absolute Trigger Level" on page 2122

Trig Slope

See "Trigger Slope " on page 2123

Trig Delay

See "Trig Delay" on page 460

Auto/Holdoff

See "Auto/Holdoff " on page 461

Auto Trig

See "Auto Trig " on page 461

18 Waveform Measurement
Trigger

Trig Holdoff

See "Trig Holdoff" on page 462

Holdoff Type

See ___ on page X

User Preset

Accesses a menu that gives you the following three choices:

- User Preset – recalls a state previously saved using the Save User Preset function.
- User Preset All Modes – presets all of the modes in the analyzer
- Save User Preset– saves the current state for the current mode

Key Path	Front-panel key
Backwards Compatibility Notes	<p>User Preset is actually loading a state, and in legacy analyzers, it was possible to load a state without affecting the trace data, limit lines or correction data. Similarly it was possible to do a User Preset without affecting the trace data, limit lines or correction data.</p> <p>In the X-Series, “state” always includes all of this data; so whenever state is loaded, or User Preset is executed, all of the traces, limit lines and corrections are affected. Although this differs from previous behavior, it is desirable behavior, and should not cause adverse issues for users.</p> <p>On ESA and PSA, User Preset affected the entire instrument’s state. In the X-Series, User Preset only recalls the state for the active mode. There is a User Preset file for each mode. User Preset can never cause a mode switch as it can in legacy analyzers. If you want to recall all modes to their user preset file state, you will need to do a User Preset after mode switching into each mode.</p> <p>User Preset recalls mode state which can now include data like traces; whereas on ESA and PSA, User Preset did not affect data.</p>
Initial S/W Revision	Prior to A.02.00

User Preset

User Preset sets the state of the currently active mode back to the state that was previously saved for this mode using the Save User Preset menu key or the SCPI command, SYST:PRES:USER:SAV. It not only recalls the Mode Preset settings, but it also recalls all of the mode persistent settings, and the Input/Output system setting that existed at the time Save User Preset was executed.

If a Save User Preset has not been done at any time, User Preset recalls the default user preset file for the currently active mode. The default user preset files are created if, at power-on, a mode detects there is no user preset file. There will never be a scenario when there is no user preset file to restore. For each mode, the default user preset state is the same state that would be saved if a Save User Preset is performed in each mode right after doing a Restore Mode Default and after a Restore Input/Output Defaults.

The User Preset function does the following:

- Aborts the currently running measurement.
- Sets the mode State to the values defined by Save User Preset.
- Makes the saved measurement for the currently running mode the active measurement.
- Brings up the saved menu for the power-on mode.
- Clears the input and output buffers.
- Sets the Status Byte to 0.

Key Path	User Preset
Remote Command	:SYSTem:PRESet:USER
Example	:SYST:PRES:USER:SAVE:SYST:PRES:USER
Notes	:SYST:PRES:USER:SAVE is used to save the current state as the user preset state. Clears all pending OPC bits. The Status Byte is set to 0. Pressing the User Preset front-panel key while already in the User Preset menu will cause the User Preset to get executed
Couplings	A user preset will cause the currently running measurement to be aborted and cause the saved measurement to be active. Recalling a User Preset file has the same issues that recalling a Save State file has. Some settings may need to be limited and therefore re-coupled, since the capabilities of the mode may have changes when the User Preset file was last saved.
Initial S/W Revision	Prior to A.02.00

User Preset All Modes

Recalls all of the User Preset files for each mode, switches to the power-on mode, and activates the saved measurement from the power-on mode User Preset file.

NOTE

When the instrument is secured, all of the user preset files are converted back to their default user preset files.

The User Preset function does the following:

- Aborts the currently running measurement.
- Switches the Mode to the power-on mode.
- Restores the User Preset files for each mode.
- Makes the saved measurement for the power-on mode the active measurement.
- Brings up the saved menu for the power-on mode.
- Clears the input and output buffers.
- Sets the Status Byte to 0.

Key Path	User Preset
Remote Command	:SYSTem:PRESet:USER:ALL
Example	:SYST:PRES:USER:SAVE:SYST:PRES:USER:ALL
Notes	Clears all pending OPC bits. The Status Byte is set to 0. :SYST:PRES:USER:SAVE is used to save the current state as the user preset state.
Couplings	A user preset will cause the currently running measurement to be aborted, cause a mode switch to the power-on mode, and cause the saved measurement to be active in the power-on mode. Recalling a User Preset file has the same issues that recalling a Save State file has. Some settings may need to be limited and therefore re-coupled, since the capabilities of the mode may have changes when the User Preset file was last saved.
Initial S/W Revision	Prior to A.02.00

Save User Preset

Saves the currently active mode and its State. You can recall this User Preset file by pressing the User Preset menu key or sending the SYST:PRES:USER remote command. This same state is also saved by the Save State function.

Key Path	User Preset
Remote Command	:SYSTem:PRESet:USER:SAVE
Example	:SYST:PRES:USER:SAVE
Notes	:SYST:PRES:SAVE creates the same file as if the user requested a *SAV or a MMEM:STOR:STAT, except User Preset Save does not allow the user to specify the filename or the location of the file.
Initial S/W Revision	Prior to A.02.00

View/Display

Accesses a menu of functions that enable you to set up and control the display parameters for the current measurement.

This topic contains the following sections:

["View Selection by name \(Remote Command Only\)" on page 2302](#)

["View Selection by number \(Remote Command Only\)" on page 2302](#)

View Selection by name (Remote Command Only)

Selects the results view.

Key Path	View/Display
Mode	BASIC, PNOISE, WCDMA, C2K, GSM, WIMAXOFDMA, TDSCDMA, 1XEVDO, DVB, DTMB, ISDBT, CMMB, LTE, LTETDD, DCATV, WLAN, MSR,LTEATDD, LTEAFDD
Remote Command	:DISPlay:WAVeform:VIEW[:SElect] RFENvelope IQ :DISPlay:WAVeform:VIEW[:SElect]?
Example	DISP:WAV:VIEW RFEN DISP:WAV:VIEW?
Notes	You must be in a mode that includes the Waveform measurement to use this command. Use INSTRument:SElect to set the mode.
Preset	RFENvelope
State Saved	Saved in instrument state.
Range	RF Envelope Q Waveform
Initial S/W Revision	Prior to A.02.00
Modified at S/W Revision	A.03.00

View Selection by number (Remote Command Only)

Displays the numeric values of the measurement results.

Mode	BASIC, PNOISE, WCDMA, C2K, GSM, WIMAXOFDMA, TDSCDMA, 1XEVDO, DVB, DTMB, ISDBT, CMMB, LTE, LTETDD, DCATV, WLAN, MSR,LTEATDD, LTEAFDD
Remote Command	:DISPlay:WAVeform:VIEW:NSElect <integer> :DISPlay:WAVeform:VIEW:NSElect?
Example	DISP:WAV:VIEW:NSEL 1 DISP:WAV:VIEW:NSEL?
Notes	You must be in a mode that includes the Waveform measurement to use this command. Use INSTRument:SElect to set the mode.
Preset	1
State Saved	Saved in instrument state.

Min	1
Max	2
Initial S/W Revision	Prior to A.02.00
Modified at S/W Revision	A.03.00

Key Path	Front-panel key
Initial S/W Revision	Prior to A.02.00

Display

The Display menu is common to most measurements, and is used for configuring items on the display. Some Display menu settings apply to all the measurements in a mode, and some only to the current measurement. Those under the System Display Settings key apply to all measurements in all modes.

Key Path	Display
Key Path	View/Display
Initial S/W Revision	Prior to A.02.00

Annotation

Turns on and off various parts of the display annotation. The annotation is divided up into four categories:

1. Meas Bar: This is the measurement bar at the top of the screen. It does not include the settings panel or the Active Function. Turning off the Meas Bar turns off the settings panel and the Active Function. When the Meas Bar is off, the graticule area expands to fill the area formerly occupied by the Meas Bar.
2. Screen Annotation: this is the annotation and annunciation around the graticule, including any annotation on lines (such as the display line, the threshold line, etc.) This does NOT include the marker number or the N dB result. When off, the graticule expands to fill the entire graticule area.
3. Trace annotation: these are the labels on the traces, showing their detector (or their math mode).
4. Active Function annotation: this is the active function display in the meas bar, and all of the active function values displayed on softkeys.

See the figure below. Each type of annotation can be turned on and off individually.

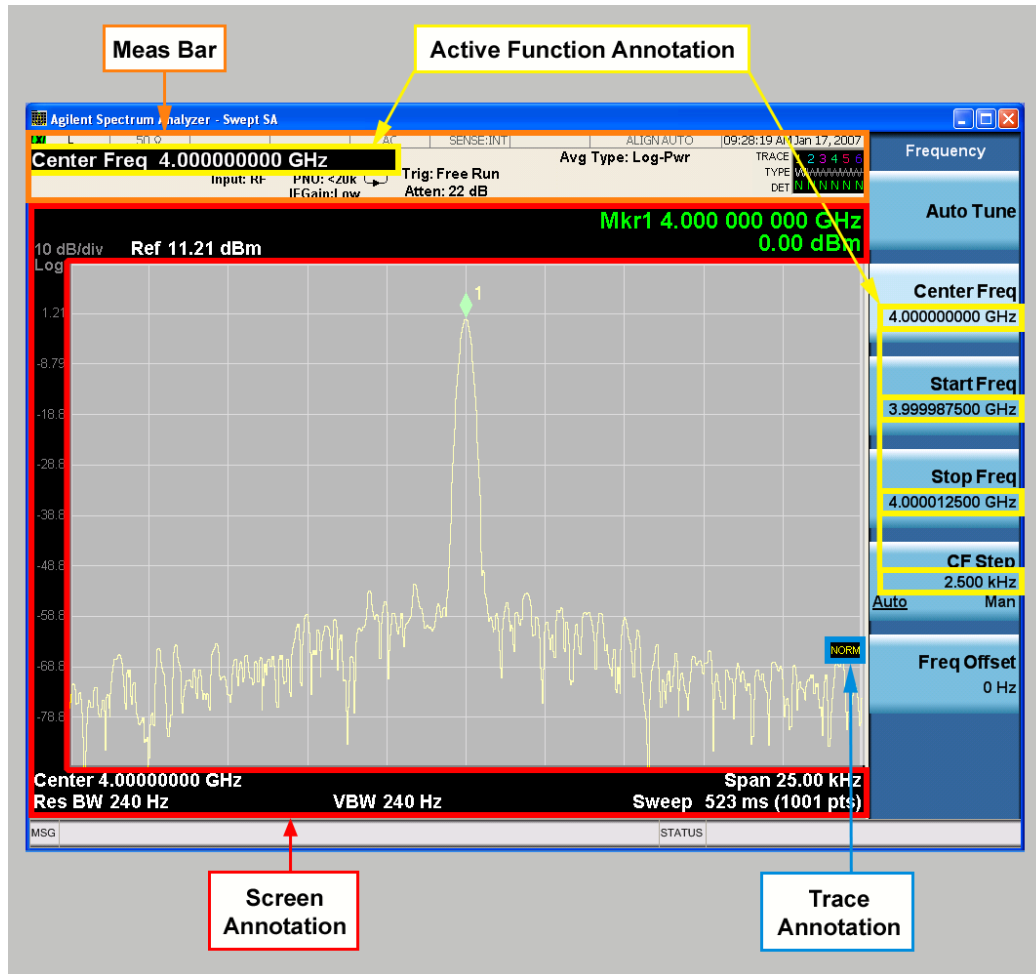

Key Path	View/Display, Display
Initial S/W Revision	Prior to A.02.00

Meas Bar On/Off

This function turns the Measurement Bar on and off, including the settings panel. When off, the graticule area expands to fill the area formerly occupied by the Measurement Bar.

Key Path	View/Display, Display, Annotation
Remote Command	:DISPlay:ANNOtation:MBAR[:STATe] OFF ON 0 1 :DISPlay:ANNOtation:MBAR[:STATe]?
Example	DISP:ANN:MBAR OFF
Dependencies	Grayed out and forced to OFF when System Display Settings, Annotation is set to Off.
Preset	On This should remain Off through a Preset when System DisplaySettings, Annotation is set to Off.
State Saved	Saved in instrument state.
Initial S/W Revision	Prior to A.02.00

Screen

This controls the display of the annunciation and annotation around the graticule, including any annotation on lines (such as the display line, the threshold line, etc.) and the y-axis annotation. This does NOT include marker annotation (or the N dB result). When off, the graticule expands to fill the entire graticule area, leaving only the 1.5% gap above the graticule as described in the Trace/Detector chapter.

Key Path	View/Display, Display, Annotation
Remote Command	:DISPlay:ANNotation:SCReen[:STATe] OFF ON 0 1 :DISPlay:ANNotation:SCReen[:STATe]?
Example	DISP:ANN:SCR OFF
Dependencies	Grayed-out and forced to OFF when System Display Settings, Annotation is set to Off.
Preset	On This should remain Off through a Preset when System DisplaySettings, Annotation is set to Off
State Saved	Saved in instrument state.
Initial S/W Revision	Prior to A.02.00

Active Function Values On/Off

Turns on and off the active function display in the Meas Bar, and all of the active function values displayed on the softkeys.

Note that all of the softkeys that have active functions have these numeric values blanked when this function is on. This is a security feature..

18 Waveform Measurement
View/Display

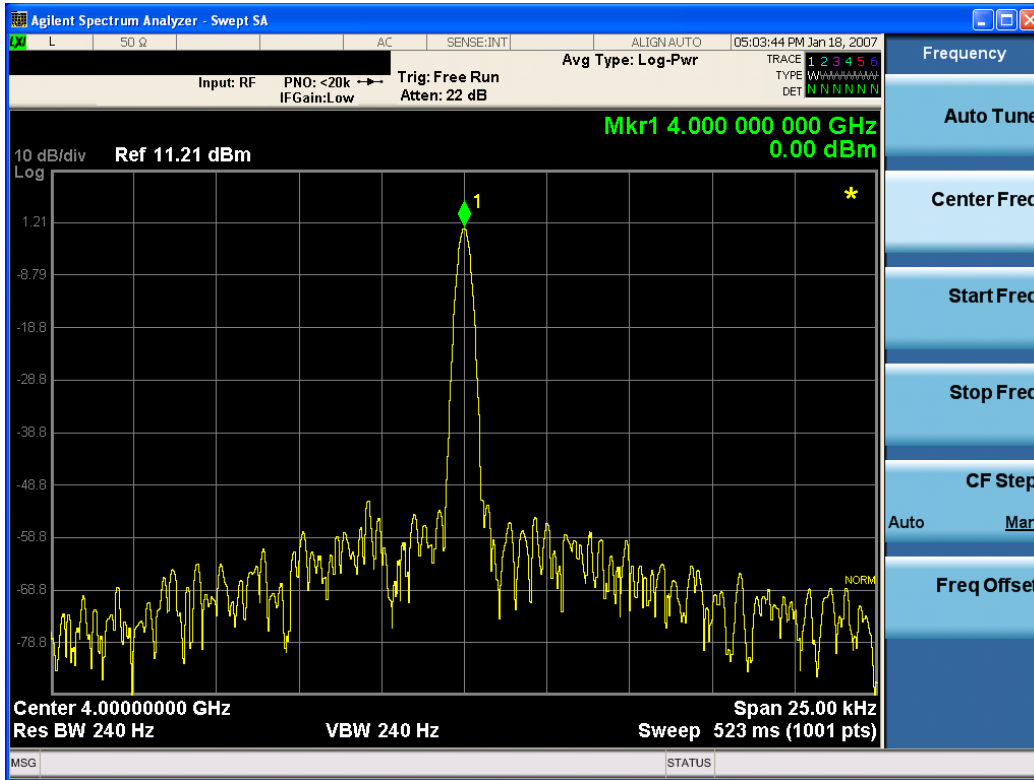

Key Path	View/Display, Display, Annotation
Remote Command	:DISPlay:ACTivefunc[:STATE] ON OFF 1 0 :DISPlay:ACTivefunc[:STATE]?
Example	DISP:ACT OFF
Dependencies	Grayed out and forced to OFF when System Display Settings, Annotation is set to Off.
Preset	On This should remain Off through a Preset when System DisplaySettings, Annotation is set to Off
State Saved	Saved in instrument state.
Initial S/W Revision	Prior to A.02.00

Title

Displays menu keys that enable you to change or clear a title on your display.

Key Path	View/Display, Display
Initial S/W Revision	Prior to A.02.00

Change Title

Writes a title into the "measurement name" field in the banner, for example, "Swept SA".

Press Change Title to enter a new title through the alpha editor. Press Enter or Return to complete the entry. Press ESC to cancel the entry and preserve your existing title.

The display title will replace the measurement name. It remains for this measurement until you press Change Title again, or you recall a state, or a Preset is performed. A title can also be cleared by pressing Title, Clear Title.

NOTE

Notice the inclusion of the <measurement> parameter in the command below. Because each measurement remembers the Display Title, the command must be qualified with the measurement name. For the Swept SA measurement this is not the case; no <measurement> parameter is used when changing the Display Title for the Swept SA measurement.

Key Path	View/Display, Display, Title
Mode	All
Remote Command	:DISPlay:<measurement>:ANNotation:TITLe:DATA <string> :DISPlay:<measurement>:ANNotation:TITLe:DATA?
Example	DISP:ANN:TITL:DATA "This Is My Title" This example is for the Swept SA measurement in the Spectrum Analyzer mode. The SANalyzer <measurement> name is not used. DISP:ACP:ANN:TITL:DATA "This Is My Title" This example is for Measurements other than Swept SA. Both set the title to: This Is My Title
Notes	Pressing this key cancels any active function. When a title is edited the previous title remains intact (it is not cleared) and the cursor goes at the end so that characters can be added or BKSP can be used to go back over previous characters.
Preset	No title (measurement name instead)
State Saved	Saved in instrument state.
Initial S/W Revision	Prior to A.02.00

Clear Title

Clears a title from the front-panel display. Once cleared, the title cannot be retrieved. After the title is cleared, the current Measurement Name replaces it in the title bar.

Key Path	View/Display, Display, Title
Example	The following commands clear the title and restore the measurement's original title: DISP:ANN:TITL:DATA "" This example is for the Swept SA measurement in the Spectrum Analyzer mode. The SANalyzer <measurement> name is not used. DISP:ACP:ANN:TITL:DATA "" This example is for ACP; in measurements other than Swept SA the measurement name is required.
Notes	Uses the :DISPlay:<measurement>:ANNotation:TITLe:DATA <string> command with an empty string (in the Swept SA, the <measurement> is omitted).
Preset	Performed on Preset.
Initial S/W Revision	Prior to A.02.00

Graticule

Pressing Graticule turns the display graticule On or Off. It also turns the graticule y-axis annotation on and off.

Key Path	View/Display, Display
Remote Command	:DISPlay:WINDow[1]:TRACe:GRATicule:GRID[:STATe] OFF ON 0 1 :DISPlay:WINDow[1]:TRACe:GRATicule:GRID[:STATe]?
Example	DISP:WIND:TRAC:GRAT:GRID OFF
Notes	The graticule is the set of horizontal and vertical lines that make up the grid/divisions for the x-axis and y-axis.
Preset	On
State Saved	Saved in instrument state
Initial S/W Revision	Prior to A.02.00

System Display Settings

These settings are "Mode Global" – they affect all modes and measurements and are reset only by Restore Misc Defaults or Restore System Defaults under System.

Key Path	View/Display, Display
Initial S/W Revision	Prior to A.02.00

Annotation Local Settings

This is a Mode Global override of the meas local annotation settings. When it is All Off, it forces ScreenAnnotation, Meas Bar, Trace, and Active Function Values settings to be OFF for all measurements in all modes. This provides the security based "annotation off" function of previous analyzers; hence it uses the legacy SCPI command.

When it is All Off, the Screen, Meas Bar, Trace, and Active Function Values keys under the Display, Annotation menu are grayed out and forced to Off. When Local Settings is selected, you are able to set the local annotation settings on a measurement by measurement basis.

Key Path	View/Display, Display, System Display Settings
Remote Command	:DISPlay:WINDow[1]:ANNotation[:ALL] OFF ON 0 1 :DISPlay:WINDow[1]:ANNotation[:ALL]?
Example	:DISP:WIND:ANN OFF
Preset	On (Set by Restore Misc Defaults)
State Saved	Not saved in instrument state.
Backwards Compatibility Notes	The WINDow parameter and optional subopcode is included for backwards compatibility but ignored – all windows are equally affected.
Initial S/W Revision	Prior to A.02.00

Themes

Accesses a menu of functions that enable you to choose the theme to be used when saving the screen image.

The **Themes** option is the same as the **Themes** option under the **Display** and **Page Setup** dialogs. It allows you to choose between themes to be used when saving the screen image.

Key Path	Save, Screen Image
Remote Command	:MMEMory:STORe:SCReen:THEMe TDColor TDMonochrome FCOlor FMONochrome :MMEMory:STORe:SCReen:THEMe?
Example	:MMEM:STOR:SCR:THEM TDM
Preset	3D Color; Is not part of Preset, but is reset by Restore Misc Defaults or Restore System Defaults All and survives subsequent running of the modes.
Readback	3D Color 3D Mono Flat Color Flat Mono
Backwards Compatibility Notes	In ESA and PSA we offer the choice of "Reverse Bitmap" or "Reverse Metafile" when saving screen images. This is much like the "Flat Color" theme available in X-Series. Also, if you selected Reverse Bitmap AND a black & white screen image, that would be much like "Flat Monochrome". In other words, each of the X-Series themes has a similar screen image type in ESA/PSA. But they are not identical.
Initial S/W Revision	Prior to A.02.00

3D Color

Selects a standard color theme with each object filled, shaded and colored as designed.

Key Path	Save, Screen Image, Themes
Example	MMEM:STOR:SCR:THEM TDC
Readback	3D Color
Initial S/W Revision	Prior to A.02.00

3D Monochrome

Selects a format that is like 3D color but shades of gray are used instead of colors.

Key Path	Save, Screen Image, Themes
Example	MMEM:STOR:SCR:THEM TDM
Readback	3D Mono
Initial S/W Revision	Prior to A.02.00

Flat Color

Selects a format that is best when the screen is to be printed on an ink printer.

Key Path	Save, Screen Image, Themes
Example	MMEM:STOR:SCR:THEM FCOL
Readback	Flat Color
Initial S/W Revision	Prior to A.02.00

Flat Monochrome

Selects a format that is like Flat Color. But only black is used (no colors, not even gray), and no fill.

Key Path	Save, Screen Image, Themes
Example	MMEM:STOR:SCR:THEM FMON
Readback	Flat Mono
Initial S/W Revision	Prior to A.02.00

Backlight

Accesses the display backlight on/off keys. This setting may interact with settings under the Windows "Power" menu.

When the backlight is off, pressing ESC, TAB, SPACE, ENTER, UP, DOWN, LEFT, RIGHT, DEL, BKSP, CTRL, or ALT turns the backlight on without affecting the application. Pressing any other key will turn backlight on and could potentially perform the action as well.

Key Path	View/Display, Display, System Display Settings
Remote Command	:DISPlay:BACKlight ON OFF :DISPlay:BACKlight?
Preset	ON (Set by Restore Misc Defaults)
Initial S/W Revision	Prior to A.02.00

Backlight Intensity

An active function used to set the backlight intensity. It goes from 0 to 100 where 100 is full on and 0 is off. This value is independent of the values set under the Backlight on/off key.

Key Path	View/Display, Display, System Display Settings
Remote Command	:DISPlay:BACKlight:INTensity <integer> :DISPlay:BACKlight:INTensity?
Example	DISP:BACK:INT 50

Preset	100 (Set by Restore Misc Defaults)
Min	0
Max	100
Initial S/W Revision	Prior to A.02.00

RF Envelope

This view shows an example of the RF Envelope result for the waveform (time domain) measurements in the graph window. The measured values for the mean power and peak-to-mean power are shown in the text window.

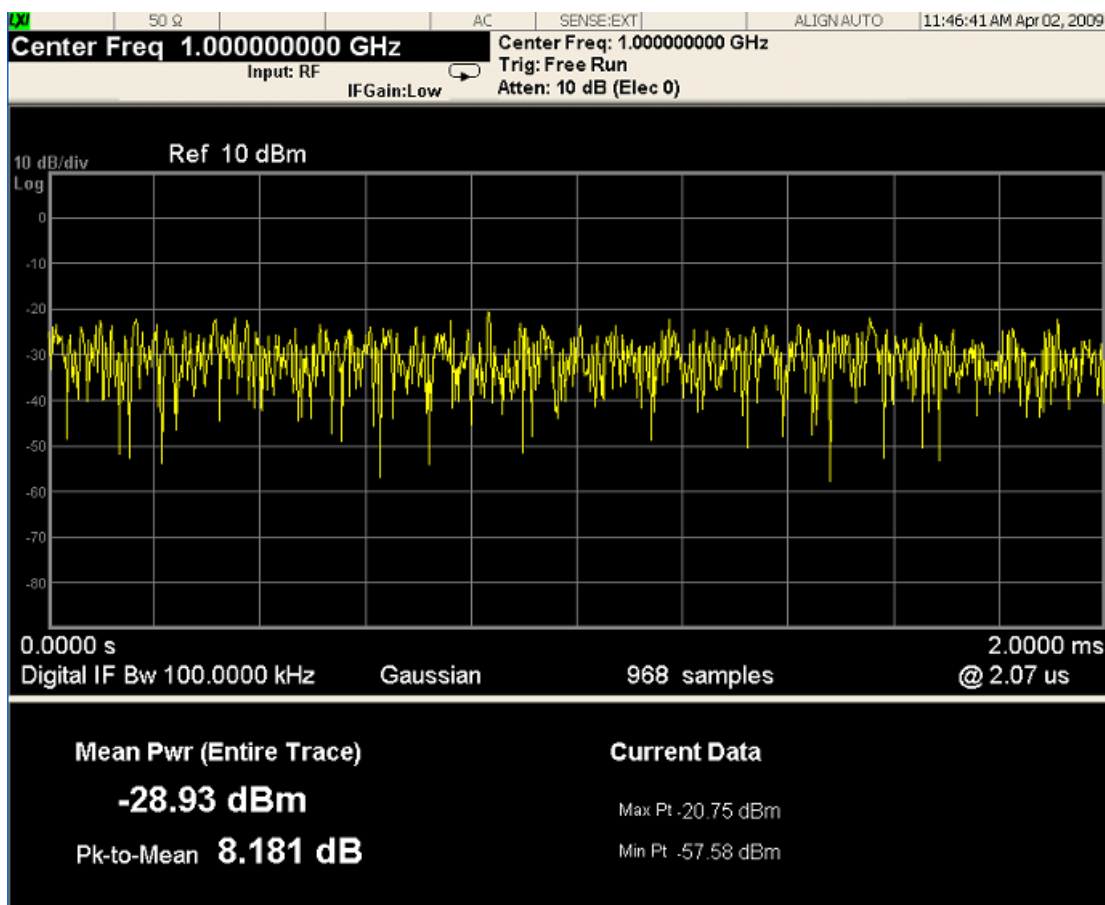

Numeric Results

Name	Type	Description	Unit	Format
Mean Pwr	Float64	The mean power (dBm). This is either the power across the entire trace, or the power between markers if the markers are enabled.	dBm	XX.XX dBm

Name	Type	Description	Unit	Format
Pk-to-Mean	Float64	This is the ratio of the maximum signal level to the mean power.	dB	XX.XX dB
Max Pt	Float64	The maximum of the most recently acquired data.	dBm	XX.XX dBm
Min Pt	Float64	The minimum of the most recently acquired data.	dBm	XX.XX dBm

Key Path	View/Display
Initial S/W Revision	Prior to A.02.00

I/Q Waveform

This view shows the I and Q signal waveforms in parameters of voltage versus time.

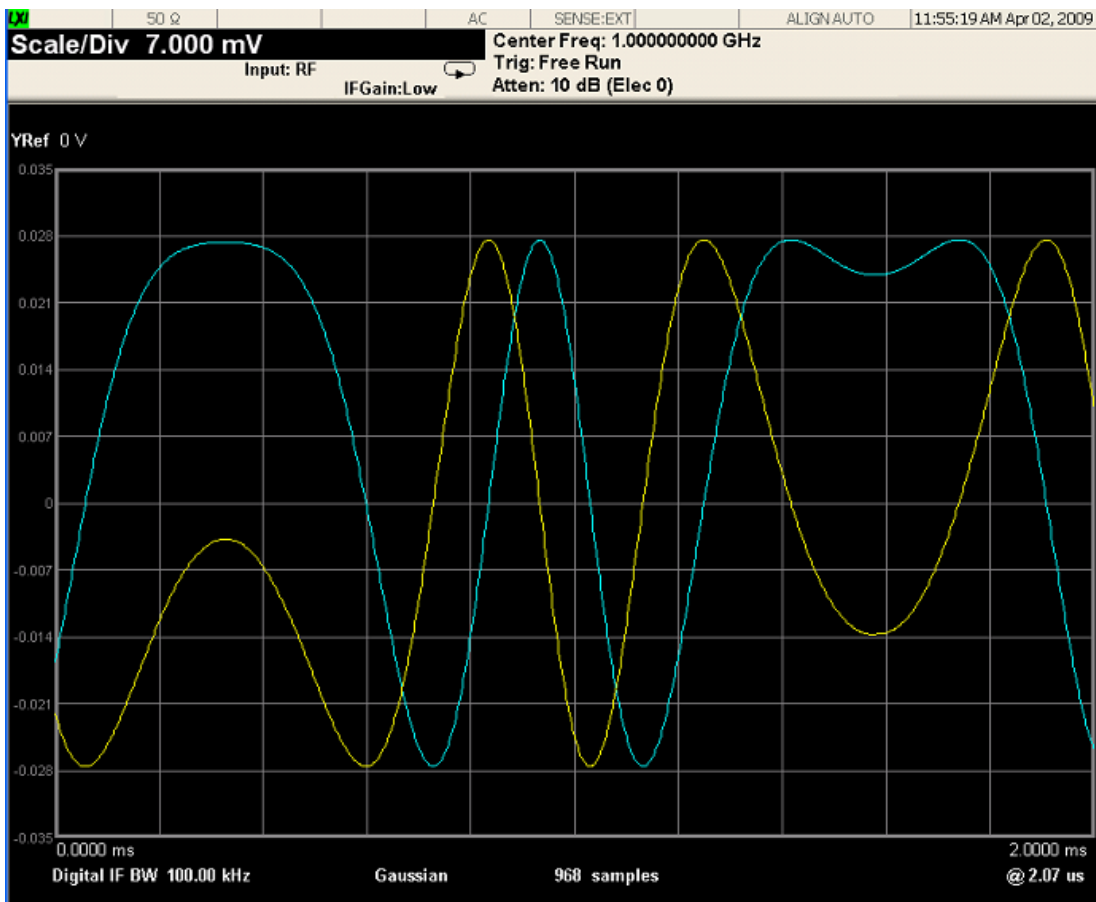

Key Path	View/Display
Initial S/W Revision	Prior to A.02.00

