

Keysight X-Series Signal Analyzer

This manual provides documentation for the following X-Series Analyzers:
PXA Signal Analyzer N9030A
MXA Signal Analyzer N9020A
EXA Signal Analyzer N9010A
CXA Signal Analyzer N9000A

Notice: This document contains references to Agilent. Please note that Agilent's Test and Measurement business has become Keysight Technologies. For more information, go to www.keysight.com.

N9082A & W9082A
LTE TDD
Measurement
Application User's &
Programmer's
Reference

Notices

© Keysight Technologies, Inc.
2008-2014

No part of this manual may be reproduced in any form or by any means (including electronic storage and retrieval or translation into a foreign language) without prior agreement and written consent from Keysight Technologies, Inc. as governed by United States and international copyright laws.

Acknowledgments

Adobe Acrobat® and Reader® are U.S. registered trademarks of Adobe Systems Incorporated.

Manual Part Number

N9082-90001

Edition

August 2014

Printed in USA

Keysight Technologies, Inc.
1400 Fountaingrove Parkway
Santa Rosa, CA 95403

Warranty

The material contained in this document is provided “as is,” and is subject to being changed, without notice, in future editions. Further, to the maximum extent permitted by applicable law, Keysight disclaims all warranties, either express or implied, with regard to this manual and any information contained herein, including but not limited to the implied warranties of merchantability and fitness for a particular purpose. Keysight shall not be liable for errors or for incidental or consequential

damages in connection with the furnishing, use, or performance of this document or of any information contained herein. Should Keysight and the user have a separate written agreement with warranty terms covering the material in this document that conflict with these terms, the warranty terms in the separate agreement shall control.

Technology Licenses

The hardware and/or software described in this document are furnished under a license and may be used or copied only in accordance with the terms of such license.

Restricted Rights

Legend

If software is for use in the performance of a U.S. Government prime contract or subcontract, Software is delivered and licensed as “Commercial computer software” as defined in DFAR 252.227-7014 (June 1995), or as a “commercial item” as defined in FAR 2.101(a) or as “Restricted computer software” as defined in FAR 52.227-19 (June 1987) or any equivalent agency regulation or contract clause. Use, duplication or disclosure of Software is subject to Keysight Technologies’ standard commercial license terms, and non-DOD Departments and Agencies of the U.S. Government will receive no greater than Restricted Rights as defined in FAR 52.227-19(c)(1-2) (June 1987). U.S. Government users will

receive no greater than Limited Rights as defined in FAR 52.227-14 (June 1987) or DFAR 252.227-7015 (b)(2) (November 1995), as applicable in any technical data.

Safety Notices

CAUTION

A CAUTION notice denotes a hazard. It calls attention to an operating procedure, practice, or the like that, if not correctly performed or adhered to, could result in damage to the product or loss of important data. Do not proceed beyond a CAUTION notice until the indicated conditions are fully understood and met.

WARNING

A WARNING notice denotes a hazard. It calls attention to an operating procedure, practice, or the like that, if not correctly performed or adhered to, could result in personal injury or death. Do not proceed beyond a WARNING notice until the indicated conditions are fully understood and met.

Table of Contents

N9082A & W9082A LTE TDD Measurement Application User's & Programmer's Reference	i
Table of Contents	iii
1 About the Analyzer	91
Installing Application Software	92
Viewing a License Key	92
Obtaining and Installing a License Key	92
Updating Measurement Application Software	92
X-Series Options and Accessories	94
Front-Panel Features	95
Display Annotations	96
Rear-Panel Features	97
Window Control Keys	98
Multi-Window	98
Zoom	98
Next Window	99
Full Screen	100
Display Enable (Remote Command Only)	100
Mouse and Keyboard Control	102
Right-Click	102
PC Keyboard	104
Instrument Security & Memory Volatility	107
2 About the LTE TDD Measurement Application	109
What Does the LTE TDD Application Do?	110
3 Programming the Analyzer	111
What Programming Information is Available?	112
List of SCPI Commands	113
STATus Subsystem	171
Detailed Description	173
What Are Status Registers	174
What Are Status Register SCPI Commands	174
How to Use the Status Registers	175
Using a Status Register	176
Using the Service Request (SRQ) Method	177
Generating a Service Request	177
Status Register System	178
The Status Byte Register	179
Standard Event Status Register	181
Operation and Questionable Status Registers	183
Operation Status Register	183
Questionable Status Register	183

STATus Subsystem Command Descriptions	184
Operation Register	184
Operation Condition Query	184
Operation Enable	185
Operation Event Query	185
Operation Negative Transition	185
Operation Positive Transition	186
Preset the Status Byte	186
Questionable Register	187
Questionable Condition	187
Questionable Enable	187
Questionable Event Query	188
Questionable Negative Transition	188
Questionable Positive Transition	188
Questionable Calibration Register	189
Questionable Calibration Condition	189
Questionable Calibration Enable	189
Questionable Calibration Event Query	190
Questionable Calibration Negative Transition	190
Questionable Calibration Positive Transition	191
Questionable Calibration Skipped Register	191
Questionable Calibration Skipped Condition	191
Questionable Calibration Skipped Enable	192
Questionable Calibration Skipped Event Query	192
Questionable Calibration Skipped Negative Transition	193
Questionable Calibration Skipped Positive Transition	193
Questionable Calibration Extended Failure Register	193
Questionable Calibration Extended Failure Condition	194
Questionable Calibration Extended Failure Enable	194
Questionable Calibration Extended Failure Event Query	194
Questionable Calibration Extended Failure Negative Transition	195
Questionable Calibration Extended Failure Positive Transition	195
Questionable Calibration Extended Needed Register	196
Questionable Calibration Extended Needed Condition	196
Questionable Calibration Extended Needed Enable	196
Questionable Calibration Extended Needed Event Query	197
Questionable Calibration Extended Needed Negative Transition	197
Questionable Calibration Extended Needed Positive Transition	198
Questionable Frequency Register	198
Questionable Frequency Condition	198
Questionable Frequency Enable	199
Questionable Frequency Event Query	199
Questionable Frequency Negative Transition	199

Questionable Frequency Positive Transition	200
Questionable Integrity Register	200
Questionable Integrity Condition	200
Questionable Integrity Enable	201
Questionable Integrity Event Query	201
Questionable Integrity Negative Transition	202
Questionable Integrity Positive Transition	202
Questionable Integrity Signal Register	202
Questionable Integrity Signal Condition	203
Questionable Integrity Signal Enable	203
Questionable Integrity Signal Event Query	204
Questionable Integrity Signal Negative Transition	204
Questionable Integrity Signal Positive Transition	204
Questionable Integrity Uncalibrated Register	205
Questionable Integrity Uncalibrated Condition	205
Questionable Integrity Uncalibrated Enable	205
Questionable Integrity Uncalibrated Event Query	206
Questionable Integrity Uncalibrated Negative Transition	206
Questionable Integrity Uncalibrated Positive Transition	207
Questionable Power Register	207
Questionable Power Condition	207
Questionable Power Enable	208
Questionable Power Event Query	208
Questionable Power Negative Transition	209
Questionable Power Positive Transition	209
Questionable Temperature Register	209
Questionable Temperature Condition	210
Questionable Temperature Enable	210
Questionable Temperature Event Query	210
Questionable Temperature Negative Transition	211
Questionable Temperature Positive Transition	211
IEEE 488.2 Common Commands	213
All	213
Clear Status	215
Standard Event Status Enable	215
Standard Event Status Register Query	216
Identification Query	216
Operation Complete	217
Query Instrument Options	218
Recall Instrument State	218
*RST (Remote Command Only)	219
Save Instrument State	219
Service Request Enable	219

Status Byte Query	220
Trigger	220
Self Test Query	220
Wait-to-Continue	221
4 Input/Output Functions	223
Input/Output	224
Input/Output variables - Preset behavior	225
RF Input	226
Input Z Correction	226
RF Coupling	227
External Mixer	228
More Information	229
Ext Mix Setup	231
Mixer Presets	236
Mixer Bias	241
Edit Harmonic Table	241
Cable IF Loss	244
I/Q	245
Baseband I/Q (Option BBA)	245
Baseband I/Q Remote Language Compatibility	247
I/Q Path	248
I+jQ	249
I Only	249
Q Only	250
I Setup	250
I Differential Input	250
I Input Z	251
I Skew	252
I Probe	252
Combined Differential/Input Z (Remote Command Only)	254
Q Setup	255
Q Same as I	255
Q Differential Input	256
Q Input Z	257
Q Skew	257
Q Probe	258
Reference Z	260
I/Q Cable Calibrate...	260
I/Q Probe Setup	261
Attenuation	261
Offset	262
Coupling	263
Calibrate	264

Clear Calibration	264
RF Calibrator	265
50 MHz	266
4.8 GHz	266
Off	266
External Gain	267
Ext Preamp	267
More Information	268
MS	269
BTS	270
I Ext Gain	271
Q Ext Gain	271
Restore Input/Output Defaults	272
Corrections	272
Select Correction	273
Correction On/Off	273
Properties	274
Select Correction	274
Antenna Unit	275
Frequency Interpolation	277
Description	279
Comment	279
Edit	279
Navigate	280
Frequency	281
Amplitude	281
Insert Point Below	281
Delete Point	281
Scale X Axis	281
Delete Correction	282
Apply Corrections	282
Delete All Corrections	283
Remote Correction Data Set Commands	283
Set (Replace) Data (Remote Command Only)	283
Merge Correction Data (Remote Command Only)	284
Freq Ref In	284
Sense	286
Internal	286
External	286
Ext Ref Freq	287
External Reference Lock BW	288
External Ref Coupling	288
Output Config	290

Trig Out	290
Polarity	291
Off	291
Sweeping (HSWP)	292
Measuring	292
Main Trigger	292
Gate Trigger	292
Gate	293
Source Point Trigger	293
Odd/Even Trace Point	293
Analog Out	293
More Information	294
Auto	294
Off	295
Screen Video	295
Log Video (RF Envelope, Ref=Mixer Level)	296
Linear Video (RF Envelope, Ref=Ref Level)	297
Demod Audio	297
Digital Bus	298
Bus Out On/Off	298
I/Q Cal Out	299
1 kHz Square Wave	299
250 kHz Square Wave	299
Off	300
Aux IF Out	300
Off	300
Second IF	301
Arbitrary IF	301
Fast Log Video	302
I/Q Guided Calibration	302
I/Q Isolation Calibration	303
Next	303
Exit	303
I/Q Isolation Calibration Time (Remote Command Only)	303
I/Q Cable Calibrate...	304
I Port	304
I-bar Port	305
Q Port	306
Q-bar Port	307
I/Q Cable Calibration Time (Remote Command Only)	308
I/Q Probe Calibration	308
I Port	309
I-bar Port	310

Q Port	312
Q-bar Port	313
Show Adapter Screen	314
I/Q Probe Calibration Time (Remote Command Only)	314
Exit Confirmation	314
5 Mode Functions	315
Mode	316
More Information	317
Spectrum Analyzer	318
Noise Figure	319
Vector Signal Analyzer (VXA)	319
Analog Demod	319
Phase Noise	320
CMMB	320
Combined WLAN	320
TD-SCDMA with HSPA/8PSK	321
IQ Analyzer (Basic)	321
GSM/EDGE/EDGE Evo	321
Combined Fixed WiMAX	322
W-CDMA with HSPA+	322
DVB-T/H with T2	322
EMI Receiver	322
802.16 OFDM (Fixed WiMAX)	323
WLAN	323
1xEV-DO	323
802.16 OFDMA (WiMAX/WiBro)	324
89601 VSA	324
MSR	325
cdma2000	325
Bluetooth	326
LTE	326
SCPI Language Compatibility	326
iDEN/WiDEN/MOTOTalk	327
ISDB-T	327
Digital Cable TV	327
LTE TDD	327
Remote Language Compatibility	328
DTMB (CTTB)	328
Application Mode Number Selection (Remote Command Only)	328
Application Mode Catalog Query (Remote Command Only)	330
Application Identification (Remote Commands Only)	330
Current Application Model	331
Current Application Revision	331

Current Application Options	331
Application Identification Catalog (Remote Commands Only)	332
Application Catalog Number of Entries	332
Application Catalog Model Numbers	332
Application Catalog Revision	332
Application Catalog Options	333
Detailed List of Modes	333
1xEV-DO	333
802.16 OFDMA (WiMAX/WiBro)	334
802.16 OFDM (Fixed WiMAX)	334
89601 VSA	334
Analog Demod	335
Bluetooth	335
cdma2000	336
CMMB	336
Combined WLAN	336
Combined Fixed WiMAX	337
Digital Cable TV	337
DTMB (CTTB)	337
DVB-T/H with T2	338
EMI Receiver	338
GSM/EDGE/EDGE Evo	338
iDEN/WiDEN/MOTOTalk	339
IQ Analyzer (Basic)	339
ISDB-T	339
LTE	339
LTE TDD	340
LTE-Advanced FDD	340
LTE-Advanced TDD	341
MSR	341
Noise Figure	341
Phase Noise	342
Real Time Spectrum Analyzer	342
Remote Language Compatibility	342
SCPI Language Compatibility	343
Spectrum Analyzer	343
TD-SCDMA with HSPA/8PSK	343
Vector Signal Analyzer (VXA)	344
W-CDMA with HSPA+	344
WLAN	344
Global Settings	345
Global Center Freq	345
Restore Defaults	346

Mode Setup	347
Radio	347
Direction	347
UL/DL Config	348
Dw/GP/Up Len	348
Pre-defined Parameters	349
Analysis Slot	349
Meas Interval	350
CP Length	350
Measure PRACH/SRS	351
Demod	351
Bandwidth	351
Spectrum	352
Fixed Equalization	352
Fixed EQ Mode	352
Freq Response Register	353
Preset to Standard	353
Noise Reduction	354
Noise Floor Extension	354
More Information	355
Restore Mode Defaults	356
Global Settings	356
Global Center Freq	356
Restore Defaults	357
6 System Functions	359
File	360
File Explorer	360
Page Setup	361
Print	362
Restore Down	362
Minimize	362
Exit	363
Print	363
Maximize/Restore Down	363
Maximize	363
Restore Down	364
Print	365
System	366
Show	366
Errors	366
Previous Page	367
Next Page	368
History	368

Verbose SCPI On/Off	368
Refresh	369
Clear Error Queue	369
Status	369
Input Overload Enable (Remote Command Only)	369
System	370
Show System contents (Remote Command Only)	371
Computer System description (Remote Command Only)	371
Hardware	371
LXI	372
Power On	372
Mode and Input/Output Defaults	373
User Preset	373
Last State	374
Power On Application	374
Configure Applications	375
Preloading Applications	376
Access to Configure Applications utility	376
Virtual memory usage	376
Select All	377
Deselect All	377
Move Up	377
Move Down	377
Select/Deselect	377
Save Changes and Exit	378
Exit Without Saving	378
Restore Power On Defaults	378
Configure Applications - Instrument boot-up	379
Configure Applications - Windows desktop	379
Configure Applications - Remote Commands	379
Configuration list (Remote Command Only)	380
Configuration Memory Available (Remote Command Only)	380
Configuration Memory Total (Remote Command Only)	380
Configuration Memory Used (Remote Command Only)	380
Configuration Application Memory (Remote Command Only)	381
Alignments	381
Auto Align	381
Normal	382
Partial	383
Off	383
All but RF	384
Alert	384
Execute Expired Alignments (Remote Command Only)	387

Align Now	388
All	388
All but RF	390
RF	391
External Mixer	392
Show Alignment Statistics	393
Restore Align Defaults	398
Backup or Restore Align Data...	398
Alignment Data Wizard	399
Perform Backup (Remote Command Only)	404
Perform Restore (Remote Command Only)	405
Advanced	405
Characterize Preselector	405
Characterize Reference Clock	406
Characterize Noise Floor	409
Timebase DAC	411
Calibrated	412
User	412
I/O Config	413
GPIB	413
GPIB Address	414
GPIB Controller	414
SCPI LAN	415
SCPI Telnet	415
SCPI Socket	416
SICL Server	416
HiSLIP Server	417
SCPI Socket Control Port (Remote Command Only)	417
Reset Web Password	418
LXI	418
LAN Reset	419
Device Identification (Remote Command Only)	419
System IDN Response	419
Factory	420
User	420
Query USB Connection (Remote Command Only)	420
USB Connection Status (Remote Command Only)	421
USB Packet Count (Remote Command Only)	421
Restore Defaults	422
Restore Input/Output Defaults	422
Restore Power On Defaults	422
Restore Align Defaults	423
Restore Misc Defaults	424

Restore Mode Defaults (All Modes)	425
All	426
Control Panel...	426
Licensing...	427
Security	429
USB	429
Read-Write	430
Read only	430
Diagnostics	430
Show Hardware Statistics	431
SCPI for Show Hardware Statistics (Remote Commands Only)	432
Internet Explorer...	433
System Remote Commands (Remote Commands Only)	433
System Powerdown (Remote Command Only)	434
List installed Options (Remote Command Only)	434
Lock the Front-panel keys (Remote Command Only)	434
List SCPI Commands (Remote Command Only)	435
SCPI Version Query (Remote Command Only)	435
Date (Remote Command Only)	435
Time (Remote Command Only)	436
7 Trigger Functions	437
Trigger	438
Trigger Source Presets	439
RF Trigger Source	442
I/Q Trigger Source	443
More Information	444
Free Run	445
Video (IF Envelope)	446
Trigger Level	446
Trig Slope	447
Trig Delay	448
Line	449
Trig Slope	450
Trig Delay	450
External 1	451
Trigger Level	451
Trig Slope	452
Trig Delay	453
Zero Span Delay Comp On/Off	453
External 2	454
Trigger Level	454
Trig Slope	455
Trig Delay	455

Zero Span Delay Comp On/Off	456
RF Burst	457
Absolute Trigger Level	457
Relative Trigger Level	458
Trigger Slope	459
Trig Delay	460
Periodic Timer (Frame Trigger)	461
Period	462
Offset	463
Reset Offset Display	464
Sync Source	464
Off	465
External 1	465
External 2	466
RF Burst	468
Trig Delay	470
Auto/Holdoff	471
Auto Trig	471
Trig Holdoff	472
Holdoff Type	472
8 Channel Power Measurement	475
AMPTD Y Scale	484
Ref Value	484
Attenuation	484
Dual Attenuator Configurations:	485
Single Attenuator Configuration:	486
(Mech) Atten	486
Attenuator Configurations and Auto/Man	488
Enable Elec Atten	488
More Information	489
Mechanical Attenuator Transition Rules	489
When the Electronic Attenuation is enabled from a disabled state:	489
Examples in the dual attenuator configuration:	489
When the Electronic Attenuation is disabled from an enabled state:	490
Using the Electronic Attenuator: Pros and Cons	490
Elec Atten	490
Adjust Atten for Min Clip	491
Pre-Adjust for Min Clip	491
Off	492
Elec Atten Only	492
Mech + Elec Atten	493
(Mech) Atten Step	493
Scale/Div	494

Presel Center	494
Proper Preselector Operation	495
Preselector Adjust	495
μW Path Control	497
Standard Path	498
Low Noise Path Enable	498
More Information	499
μW Preselector Bypass	500
Internal Preamp	501
Off	502
Low Band	503
Full Range	503
Ref Position	503
Auto Scaling	504
Auto Couple	505
More Information	505
Auto/Man Active Function keys	505
Auto/Man 1-of-N keys	505
BW	507
Res BW	507
Video BW	508
Filter Type	510
Cont (Continuous Measurement/Sweep)	511
File	513
FREQ Channel	514
Center Freq	514
Center Frequency Presets	515
RF Center Freq	517
Ext Mix Center Freq	518
I/Q Center Freq	519
CF Step	519
Input/Output	521
Marker	522
Select Marker	522
Marker Type	522
Properties	523
Select Marker	523
Relative To	523
All Markers Off	523
Marker X Axis Value (Remote Command Only)	524
Marker X Axis Position (Remote Command Only)	524
Marker Y Axis Value (Remote Command only)	525
Backward Compatibility SCPI Commands	525

Marker Function	527
Marker To	528
Meas	529
Remote Measurement Functions	529
Measurement Group of Commands	530
Current Measurement Query (Remote Command Only)	532
Limit Test Current Results (Remote Command Only)	532
Data Query (Remote Command Only)	532
Calculate/Compress Trace Data Query (Remote Command Only)	533
Calculate Peaks of Trace Data (Remote Command Only)	538
Format Data: Numeric Data (Remote Command Only)	539
Format Data: Byte Order (Remote Command Only)	540
Meas Setup	541
Avg/Hold Num	541
Avg Mode	542
Integ BW	543
PhNoise Opt	544
PhNoise Opt Auto	544
PhNoise Opt State	544
IF Gain	545
IF Gain Auto	546
IF Gain State	546
Method	547
Method	548
Filter Alpha	548
Filter BW	549
Limits	550
Power Limit	550
PSD Limit	551
Power Limit Fail (remote command only)	552
PSD Limit Fail (remote command only)	553
PSD Unit	553
Meas Preset	554
Mode	555
Mode Preset	556
How-To Preset	557
Preset Type (Remote Command Only)	558
Mode Setup	559
Peak Search	560
Print	561
Quick Save	562
Recall	564
State	564

Table of Contents

More Information	565
From File...	566
Edit Register Names	568
Register 1 thru Register 16	568
Register 1 thru Register 16	569
Recall	569
Import Trace Data	570
Data 1	570
Data 2	571
Data 3	571
Data 4	571
Data 5	571
Data 6	571
Display in Selected Trace	571
Signal Studio Setup	572
89601 VSA Setup	572
Masks	573
EVM Setup	574
Open...	575
Restart	576
More Information	576
Save	578
State	578
To File . . .	579
Edit Register Names	581
More Information	581
Register 1 thru Register 16	582
Register 1 thru Register 16	582
Data (Export)	583
Export Trace Data	584
Trace 1	584
Trace 2	585
Trace 3	585
Trace 4	585
Include Header	585
Measurement Results	585
Save As . . .	588
Screen Image	589
Themes	590
3D Color	590
3D Monochrome	591
Flat Color	591
Flat Monochrome	591

Save As...	591
Mass Storage Catalog (Remote Command Only)	592
Mass Storage Change Directory (Remote Command Only)	592
Mass Storage Copy (Remote Command Only)	593
Mass Storage Device Copy (Remote Command Only)	593
Mass Storage Delete (Remote Command Only)	593
Mass Storage Data (Remote Command Only)	593
Mass Storage Make Directory (Remote Command Only)	594
Mass Storage Move (Remote Command Only)	594
Mass Storage Remove Directory (Remote Command Only)	595
Single (Single Measurement/Sweep)	596
More Information	596
Source	597
Span X Scale	598
Span	598
Full Span	599
Last Span	600
Sweep/Control	601
Sweep Time	601
Sweep Setup	602
Auto Sweep Time Rules	602
Pause	603
Gate	603
Gate On/Off	603
Gate View On/Off	604
Gate View Setup	607
Gate View Sweep Time	608
Gate View Start Time	608
Gate Delay	609
Gate Length	609
Gate Source	610
Line	611
External 1	611
External 2	613
RF Burst	616
Periodic Timer (Frame Trigger)	619
Control Edge/Level	630
Gate Holdoff	630
Gate Delay Compensation	632
More Information	633
Min Fast Position Query (Remote Command Only)	633
Gate Preset (Remote Command Only)	634
Gate Level (Remote Command Only)	634

Gate Polarity (Remote Command Only)	634
Points	635
System	637
Trace/Detector	638
Trace Type	638
Detector	638
Auto	639
Detector Selection	639
Trigger	641
Free Run	641
Video	641
Trigger Level	641
Trig Slope	641
Trig Delay	641
Line	641
Trig Slope	641
Trig Delay	641
External 1	641
Trigger Level	641
Trig Slope	641
Trig Delay	641
Zero Span Delay Comp	641
External 2	642
Trigger Level	642
Trig Slope	642
Trig Delay	642
Zero Span Delay Comp	642
RF Burst	642
Absolute Trigger	642
Relative Trigger	642
Trig Slope	642
Trig Delay	642
Periodic Timer	642
Period	642
Offset	642
Reset Offset Display	642
Sync Source	643
Off	643
External 1	643
External 2	643
RF Burst	643
Trig Delay	643
Auto/Holdoff	643

Auto Trig	643
Trig Holdoff	643
Holdoff Type	644
User Preset	645
User Preset	645
User Preset All Modes	646
Save User Preset	647
View/Display	648
View selection by name (MSR and LTE-Advanced FDD/TDD only)	650
Selects the results view. The following SCPI command allows you to select the desired measurement view by enumeration.	650
Selects the results view. The following SCPI command allows you to select the desired measurement view by enumeration.	651
View selection by name (DTMB (CTTB), DVB-T/H only)	651
View selection by name (ISDB-T, CMMB only)	652
Display	652
Annotation	652
Meas Bar On/Off	653
Screen	654
Active Function Values On/Off	654
Title	655
Change Title	655
Clear Title	656
Graticule	657
System Display Settings	657
Annotation Local Settings	657
Themes	658
Backlight	659
Backlight Intensity	659
Bar Graph	660
9 Occupied Bandwidth Measurement	661
AMPTD Y Scale (Amplitude/Y Scale)	664
Ref Value	664
Attenuation	664
Dual Attenuator Configurations:	665
Single Attenuator Configuration:	666
(Mech) Atten	666
Attenuator Configurations and Auto/Man	668
Enable Elec Atten	668
More Information	669
Mechanical Attenuator Transition Rules	669
When the Electronic Attenuation is enabled from a disabled state:	669
Examples in the dual attenuator configuration:	669

When the Electronic Attenuation is disabled from an enabled state:	670
Using the Electronic Attenuator: Pros and Cons	670
Elec Atten	670
Adjust Atten for Min Clip	671
Pre-Adjust for Min Clip	671
Off	672
Elec Atten Only	672
Mech + Elec Atten	673
(Mech) Atten Step	673
Scale/Div	674
Presel Center	674
Proper Preselector Operation	675
Preselector Adjust	675
μ W Path Control	677
Standard Path	678
Low Noise Path Enable	678
More Information	679
μ W Preselector Bypass	680
Internal Preamp	681
Off	682
Low Band	683
Full Range	683
Ref Position	683
Auto Scaling	684
Auto Couple	685
More Information	685
Auto/Man Active Function keys	685
Auto/Man 1-of-N keys	685
BW	687
Res BW	687
Video BW	688
Filter Type	689
Cont (Continuous Measurement/Sweep)	691
File	693
FREQ Channel	694
Center Freq	694
Center Frequency Presets	695
RF Center Freq	697
Ext Mix Center Freq	698
I/Q Center Freq	699
CF Step	699
Input/Output	701
Marker	702

Select Marker	702
Select Marker	702
Marker Type	702
Properties	703
Select Marker	703
Select Marker	703
Relative To	703
All Markers Off	704
Marker X Axis Value (Remote Command Only)	704
Marker X Axis Position (Remote Command Only)	705
Marker Y Axis Value (Remote Command Only)	705
Backward Compatibility SCPI Commands	706
Marker Function	707
Marker To	708
Meas	709
Remote Measurement Functions	709
Measurement Group of Commands	710
Current Measurement Query (Remote Command Only)	712
Limit Test Current Results (Remote Command Only)	712
Data Query (Remote Command Only)	712
Calculate/Compress Trace Data Query (Remote Command Only)	713
Calculate Peaks of Trace Data (Remote Command Only)	718
Format Data: Numeric Data (Remote Command Only)	719
Format Data: Byte Order (Remote Command Only)	720
Meas Setup	721
Avg/Hold Num	721
Avg Mode	722
Occ BW % Pwr	722
x dB	723
IF Gain	724
IF Gain Auto	724
IF Gain State	724
Limit (for all modes except MSR and LTE-Advanced FDD/TDD)	725
Meas Preset	726
Max Hold (Remote Command Only)	727
Mode	728
Mode Preset	729
How-To Preset	730
Preset Type (Remote Command Only)	731
Mode Setup	732
Peak Search	733
Print	734
Quick Save	735

Table of Contents

Recall	737
State	737
More Information	738
From File...	739
Edit Register Names	741
Register 1 thru Register 16	741
Register 1 thru Register 16	742
Recall	742
Import Trace Data	743
Data 1	743
Data 2	744
Data 3	744
Data 4	744
Data 5	744
Data 6	744
Display in Selected Trace	744
Signal Studio Setup	745
89601 VSA Setup	745
Masks	746
EVM Setup	747
Open...	748
Restart	749
More Information	749
Save	751
State	751
To File . . .	752
Edit Register Names	754
More Information	754
Register 1 thru Register 16	755
Register 1 thru Register 16	755
Data (Export)	756
Export Trace Data	757
Trace 1	757
Trace 2	758
Trace 3	758
Trace 4	758
Include Header	758
Measurement Results	758
Meas Results File Definition	759
Meas Results File Example	760
Save As . . .	761
Screen Image	762
Themes	763

3D Color	763
3D Monochrome	764
Flat Color	764
Flat Monochrome	764
Save As...	764
Mass Storage Catalog (Remote Command Only)	765
Mass Storage Change Directory (Remote Command Only)	765
Mass Storage Copy (Remote Command Only)	766
Mass Storage Device Copy (Remote Command Only)	766
Mass Storage Delete (Remote Command Only)	766
Mass Storage Data (Remote Command Only)	766
Mass Storage Make Directory (Remote Command Only)	767
Mass Storage Move (Remote Command Only)	767
Mass Storage Remove Directory (Remote Command Only)	768
Single (Single Measurement/Sweep)	769
More Information	769
Source	770
Span X Scale	771
Span	771
Full Span	772
Last Span	772
Sweep/Control	774
Sweep Time	774
Sweep Setup	775
Auto Sweep Time Rules	775
Pause	776
Gate	776
Gate On/Off	776
Gate View On/Off	777
Gate View Setup	780
Gate View Sweep Time	781
Gate View Start Time	781
Gate Delay	782
Gate Length	782
Gate Source	783
Line	784
External 1	784
External 2	786
RF Burst	789
Periodic Timer (Frame Trigger)	792
Control Edge/Level	803
Gate Holdoff	803
Gate Delay Compensation	805

More Information	806
Min Fast Position Query (Remote Command Only)	806
Gate Preset (Remote Command Only)	807
Gate Level (Remote Command Only)	807
Gate Polarity (Remote Command Only)	807
Points	808
System	810
Trace/Detector	811
Trace Type	811
Detector	811
Auto	812
Detector Selection	812
Trigger	814
Free Run	814
Video	814
Trigger Level	814
Trig Slope	814
Trig Delay	814
Line	814
Trig Slope	814
Trig Delay	814
External 1	814
Trigger Level	814
Trig Slope	814
Trig Delay	814
Zero Span Delay Comp	814
External 2	815
Trigger Level	815
Trig Slope	815
Trig Delay	815
Zero Span Delay Comp	815
RF Burst	815
Absolute Trigger	815
Relative Trigger	815
Trig Slope	815
Trig Delay	815
Periodic Timer	815
Period	815
Offset	815
Reset Offset Display	815
Sync Source	816
Off	816
External 1	816

External 2	816
RF Burst	816
Trig Delay	816
Auto/Holdoff	816
Auto Trig	816
Trig Holdoff	816
Holdoff Type	817
User Preset	818
User Preset	818
User Preset All Modes	819
Save User Preset	820
View/Display	821
Spectrum View	821
Display	826
Annotation	826
Meas Bar On/Off	828
Screen	828
Active Function Values On/Off	828
Title	829
Change Title	829
Clear Title	830
Graticule	831
System Display Settings	831
Annotation Local Settings	831
Themes	832
Backlight	833
Backlight Intensity	833
10 ACP Measurement	835
AMPTD Y Scale	847
Ref Value	847
Attenuation	847
Dual Attenuator Configurations:	848
Single Attenuator Configuration:	849
(Mech) Atten	849
Attenuator Configurations and Auto/Man	851
Enable Elec Atten	851
More Information	852
Mechanical Attenuator Transition Rules	852
When the Electronic Attenuation is enabled from a disabled state:	852
Examples in the dual attenuator configuration:	852
When the Electronic Attenuation is disabled from an enabled state:	853
Using the Electronic Attenuator: Pros and Cons	853
Elec Atten	853

Table of Contents

Adjust Atten for Min Clip	854
Pre-Adjust for Min Clip	854
Off	855
Elec Atten Only	855
Mech + Elec Atten	856
(Mech) Atten Step	856
Scale/Div	857
Presel Center	857
Proper Preselector Operation	858
Preselector Adjust	858
μ W Path Control	860
Standard Path	861
Low Noise Path Enable	861
More Information	862
μ W Preselector Bypass	863
Internal Preamp	864
Off	865
Low Band	866
Full Range	866
Ref Position	866
Auto Scaling	867
Auto Couple	868
More Information	868
Auto/Man Active Function keys	868
Auto/Man 1-of-N keys	868
BW	870
Res BW	870
Video BW	871
RBW Control	873
Filter Type	873
Filter BW	874
Cont (Continuous Measurement/Sweep)	875
File	877
FREQ Channel	878
Center Freq	878
Center Frequency Presets	879
RF Center Freq	881
Ext Mix Center Freq	882
I/Q Center Freq	883
CF Step	883
Input/Output	885
Marker	886
Select Marker	886

Marker Type	886
Properties	887
Select Marker	887
Relative To	887
Marker Trace	888
Couple Markers	889
Marker All Off	889
Marker X Axis Value (Remote Command only)	889
Marker X Axis Position (Remote Command only)	890
Marker Y Axis Value (Remote Command only)	891
Backward Compatibility Remote Commands	891
Marker Function	892
Marker To	893
Meas	894
Remote Measurement Functions	894
Measurement Group of Commands	895
Current Measurement Query (Remote Command Only)	897
Limit Test Current Results (Remote Command Only)	897
Data Query (Remote Command Only)	897
Calculate/Compress Trace Data Query (Remote Command Only)	898
Calculate Peaks of Trace Data (Remote Command Only)	903
Format Data: Numeric Data (Remote Command Only)	904
Format Data: Byte Order (Remote Command Only)	905
Meas Setup	906
Average/Hold Number	906
Avg Mode	907
Carrier Setup (This menu is unavailable in MSR and LTE-Advanced FDD/TDD)	907
Carriers	907
Ref Carrier	908
Ref Car Freq	909
Power Ref	910
Total Power	910
PSD	911
Configure Carriers	912
Carrier	912
Carrier Pwr Present	913
Carrier Spacing	914
Measurement Noise Bandwidth	915
Method for Carrier	916
Carrier Coupling	918
Offset/Limits	919
Select Offset	919
Offset Freq	919

Table of Contents

Integ BW	921
Offset BW	922
Res BW	923
Video BW	924
RBW Control	925
Limits	927
Select Offset	927
Abs Limit	928
Rel Lim (Car)	929
Rel Limit (PSD)	932
Fail Mask	933
Offset Side	934
Method for Offset	935
Method for Offset	936
Offset Frequency Define	938
Carrier Result	938
PhNoise Opt	939
PhNoise Opt Auto	939
PhNoise Opt State	939
Meas Method	941
Meas Type	942
PSD Ref	943
Limit Test	943
Noise Correction	944
Meas Preset	945
Offset RRC Weighting (Backward Compatibility SCPI)	945
Offset Filter Alpha (Backward Compatibility SCPI)	946
Method for Carrier (Backward Compatibility SCPI)	947
Mode	949
Mode Preset	950
How-To Preset	951
Preset Type (Remote Command Only)	952
Mode Setup	953
Peak Search	954
Next Peak	954
Next Pk Right	954
Next Pk Left	955
Marker Delta	955
Pk-Pk Search	955
Min Search	955
Print	957
Quick Save	958
Recall	960

State	960
More Information	961
From File...	962
Edit Register Names	964
Register 1 thru Register 16	964
Register 1 thru Register 16	965
Recall	965
Import Trace Data	966
Data 1	966
Data 2	967
Data 3	967
Data 4	967
Data 5	967
Data 6	967
Display in Selected Trace	967
Signal Studio Setup	968
89601 VSA Setup	968
Masks	969
EVM Setup	970
Open...	971
Restart	972
More Information	972
Save	974
State	974
To File . . .	975
Edit Register Names	977
More Information	977
Register 1 thru Register 16	978
Register 1 thru Register 16	978
Data (Export)	979
Export Trace Data	980
Trace 1	980
Trace 2	981
Trace 3	981
Trace 4	981
Include Header	981
Measurement Results	981
Save As . . .	990
Screen Image	990
Themes	991
3D Color	992
3D Monochrome	992
Flat Color	992

Flat Monochrome	993
Save As...	993
Mass Storage Catalog (Remote Command Only)	993
Mass Storage Change Directory (Remote Command Only)	994
Mass Storage Copy (Remote Command Only)	994
Mass Storage Device Copy (Remote Command Only)	994
Mass Storage Delete (Remote Command Only)	995
Mass Storage Data (Remote Command Only)	995
Mass Storage Make Directory (Remote Command Only)	995
Mass Storage Move (Remote Command Only)	996
Mass Storage Remove Directory (Remote Command Only)	996
Single (Single Measurement/Sweep)	997
More Information	997
Source	998
SPAN X Scale	999
Span	999
Full Span	1000
Last Span	1000
Sweep/Control	1002
Sweep Time	1002
Sweep Setup	1003
Auto Sweep Time Rules	1004
Pause	1004
Gate	1004
Gate On/Off	1005
Gate View On/Off	1006
Gate View Setup	1009
Gate View Sweep Time	1009
Gate View Start Time	1010
Gate Delay	1010
Gate Length	1011
Gate Source	1011
Line	1012
External 1	1013
External 2	1015
RF Burst	1017
Periodic Timer (Frame Trigger)	1020
Control Edge/Level	1031
Gate Holdoff	1032
Gate Delay Compensation	1033
More Information	1034
Min Fast Position Query (Remote Command Only)	1035
Gate Preset (Remote Command Only)	1035

Gate Level (Remote Command Only)	1035
Gate Polarity (Remote Command Only)	1035
Points	1036
System	1038
Trace/Detector	1039
Select Trace (Front-panel Only)	1039
Trace Type	1039
View/Blank	1040
Detector	1041
Auto	1042
Detector Selection	1042
Trigger	1044
Free Run	1044
Video	1044
Trigger Level	1044
Trig Slope	1044
Trig Delay	1044
Line	1044
Trig Slope	1044
Trig Delay	1044
External 1	1044
Trigger Level	1044
Trig Slope	1044
Trig Delay	1044
Zero Span Delay Comp	1044
External 2	1045
Trigger Level	1045
Trig Slope	1045
Trig Delay	1045
Zero Span Delay Comp	1045
RF Burst	1045
Absolute Trigger	1045
Relative Trigger	1045
Trig Slope	1045
Trig Delay	1045
Periodic Timer	1045
Period	1045
Offset	1045
Reset Offset Display	1045
Sync Source	1046
Off	1046
External 1	1046
External 2	1046

RF Burst	1046
Trig Delay	1046
Auto/Holdoff	1046
Auto Trig	1046
Trig Holdoff	1046
Holdoff Type	1047
User Preset	1048
User Preset	1048
User Preset All Modes	1049
Save User Preset	1050
View/Display	1051
Spectrum Window	1053
Results Window	1053
Display	1056
Annotation	1056
Meas Bar On/Off	1057
Screen	1058
Active Function Values On/Off	1058
Title	1059
Change Title	1059
Clear Title	1060
Graticule	1061
System Display Settings	1061
Annotation Local Settings	1061
Themes	1062
Backlight	1063
Backlight Intensity	1063
Bar Graph	1064
11 Power Stat CCDF Measurement	1065
AMPTD Y Scale	1070
Attenuation	1070
Dual Attenuator Configurations:	1070
Single Attenuator Configuration:	1071
(Mech) Atten	1072
Attenuator Configurations and Auto/Man	1073
Enable Elec Atten	1073
More Information	1074
Mechanical Attenuator Transition Rules	1074
When the Electronic Attenuation is enabled from a disabled state:	1075
Examples in the dual attenuator configuration:	1075
When the Electronic Attenuation is disabled from an enabled state:	1075
Using the Electronic Attenuator: Pros and Cons	1075
Elec Atten	1076

Adjust Atten for Min Clip	1076
Pre-Adjust for Min Clip	1077
Off	1078
Elec Atten Only	1078
Mech + Elec Atten	1078
(Mech) Atten Step	1078
Presel Center	1079
Proper Preselector Operation	1080
Preselector Adjust	1080
μ W Path Control	1082
Standard Path	1083
Low Noise Path Enable	1083
More Information	1084
μ W Preselector Bypass	1085
Internal Preamp	1086
Off	1087
Low Band	1088
Full Range	1088
Range	1088
Range Auto/Man	1089
I Range	1090
1 V Peak	1091
0.5 V Peak	1091
0.25 V Peak	1091
0.125 V Peak	1091
Q Range Value	1092
Q Same as I	1093
1 V Peak	1093
0.5 V Peak	1093
0.25 V Peak	1094
0.125 V Peak	1094
I/Q Gain Ranges	1094
1 V Peak	1094
0.5 V Peak	1094
0.25 V Peak	1094
0.125 V Peak	1095
Presel Center	1095
Presel Adjust	1095
Auto Couple	1096
More Information	1096
Auto/Man Active Function keys	1096
Auto/Man 1-of-N keys	1096
BW	1098

Info BW	1098
Cont (Continuous Measurement/Sweep)	1100
File	1102
FREQ Channel	1103
Center Freq	1103
Center Frequency Presets	1104
RF Center Freq	1106
Ext Mix Center Freq	1107
I/Q Center Freq	1108
CF Step	1108
Input/Output	1110
Marker	1111
Select Marker	1111
Marker Type	1111
Properties	1112
Select Marker	1112
Relative To	1112
Marker Trace	1113
Couple Markers	1113
All Markers Off	1113
Marker X Axis Value (Remote Command Only)	1114
Marker Y Axis Value (Remote Command Only)	1114
Marker Function	1116
Marker To	1117
Meas	1118
Remote Measurement Functions	1118
Measurement Group of Commands	1119
Current Measurement Query (Remote Command Only)	1121
Limit Test Current Results (Remote Command Only)	1121
Data Query (Remote Command Only)	1121
Calculate/Compress Trace Data Query (Remote Command Only)	1122
Calculate Peaks of Trace Data (Remote Command Only)	1127
Format Data: Numeric Data (Remote Command Only)	1128
Format Data: Byte Order (Remote Command Only)	1129
Meas Setup	1130
Counts	1130
Meas Cycles	1130
Meas Interval (Not 1xEVDO)	1131
Meas Offset	1132
IF Gain	1132
IF Gain Auto	1132
IF Gain State	1133
Meas Preset	1134

Mode	1135
Mode Preset	1136
How-To Preset	1137
Preset Type (Remote Command Only)	1138
Mode Setup	1139
Peak Search	1140
Print	1141
Quick Save	1142
Recall	1144
State	1144
More Information	1145
From File...	1146
Edit Register Names	1148
Register 1 thru Register 16	1148
Register 1 thru Register 16	1149
Recall	1149
Import Trace Data	1150
Data 1	1150
Data 2	1151
Data 3	1151
Data 4	1151
Data 5	1151
Data 6	1151
Display in Selected Trace	1151
Signal Studio Setup	1152
89601 VSA Setup	1152
Masks	1153
EVM Setup	1154
Open...	1155
Restart	1156
More Information	1156
Save	1158
State	1158
To File . . .	1159
Edit Register Names	1161
More Information	1161
Register 1 thru Register 16	1162
Register 1 thru Register 16	1162
Data (Export)	1163
Export Trace Data	1164
Trace 1	1164
Trace 2	1165
Trace 3	1165

Trace 4	1165
Include Header	1165
Measurement Results	1165
Meas Results File Definition	1166
Meas Results File Example	1168
Save As . . .	1169
Screen Image	1170
Themes	1171
3D Color	1172
3D Monochrome	1172
Flat Color	1172
Flat Monochrome	1173
Save As...	1173
Mass Storage Catalog (Remote Command Only)	1173
Mass Storage Change Directory (Remote Command Only)	1174
Mass Storage Copy (Remote Command Only)	1174
Mass Storage Device Copy (Remote Command Only)	1174
Mass Storage Delete (Remote Command Only)	1175
Mass Storage Data (Remote Command Only)	1175
Mass Storage Make Directory (Remote Command Only)	1175
Mass Storage Move (Remote Command Only)	1176
Mass Storage Remove Directory (Remote Command Only)	1176
Single (Single Measurement/Sweep)	1177
More Information	1177
Source	1178
Span X Scale	1179
Scale/Div	1179
Sweep/Control	1180
Pause/Resume	1180
System	1181
Trace/Detector	1182
Store Ref Trace	1182
Ref Trace	1182
Gaussian Line	1183
Trigger	1184
Free Run	1184
Video	1184
Trigger Level	1184
Trig Slope	1184
Trig Delay	1184
Line	1184
Trig Slope	1184
Trig Delay	1184

External 1	1184
Trigger Level	1184
Trig Slope	1184
Trig Delay	1184
Zero Span Delay Comp	1184
External 2	1185
Trigger Level	1185
Trig Slope	1185
Trig Delay	1185
Zero Span Delay Comp	1185
RF Burst	1185
Absolute Trigger	1185
Relative Trigger	1185
Trig Slope	1185
Trig Delay	1185
Periodic Timer	1185
Period	1185
Offset	1185
Offset Adjust (Remote Command Only)	1185
Reset Offset Display	1186
Sync Source	1186
Off	1186
External 1	1186
External 2	1186
RF Burst	1186
Trig Delay	1186
Auto/Holdoff	1186
Auto Trig	1186
Trig Holdoff	1187
Holdoff Type	1187
Baseband I/Q	1187
I/Q Mag	1187
Trigger Level	1187
Trig Slope	1187
Trig Delay	1187
I	1187
Trigger Level	1187
Trig Slope	1187
Trig Delay	1187
Q	1187
Trigger Level	1187
Trig Slope	1187
Trig Delay	1188

Input I	1188
Trigger Level	1188
Trig Slope	1188
Trig Delay	1188
Input Q	1188
Trigger Level	1188
Trig Slope	1188
Trig Delay	1188
Aux Channel Center Freq	1188
Trigger Level	1188
Trig Slope	1188
Trig Delay	1188
Trigger Center Freq	1188
Trigger BW	1188
User Preset	1189
User Preset	1189
User Preset All Modes	1190
Save User Preset	1191
View/Display	1192
Display	1192
Annotation	1192
Meas Bar On/Off	1193
Screen	1194
Active Function Values On/Off	1194
Title	1195
Change Title	1195
Clear Title	1196
Graticule	1197
System Display Settings	1197
Annotation Local Settings	1197
Themes	1198
Backlight	1199
Backlight Intensity	1199
Slot View	1200
12 Spurious Emissions Measurement	1201
AMPTD Y Scale	1204
Ref Value	1204
Attenuation	1204
Dual Attenuator Configurations:	1205
Single Attenuator Configuration:	1206
(Mech) Atten	1206
Attenuator Configurations and Auto/Man	1208
Enable Elec Atten	1208

More Information	1209
Mechanical Attenuator Transition Rules	1209
When the Electronic Attenuation is enabled from a disabled state:	1209
Examples in the dual attenuator configuration:	1209
When the Electronic Attenuation is disabled from an enabled state:	1210
Using the Electronic Attenuator: Pros and Cons	1210
Elec Atten	1210
Adjust Atten for Min Clip	1211
Pre-Adjust for Min Clip	1211
Off	1212
Elec Atten Only	1212
Mech + Elec Atten	1213
(Mech) Atten Step	1213
Scale/Div	1214
Presel Center	1214
Proper Preselector Operation	1215
Preselector Adjust	1216
μ W Path Control	1217
Standard Path	1218
Low Noise Path Enable	1218
More Information	1219
μ W Preselector Bypass	1220
Internal Preamp	1221
Off	1222
Low Band	1223
Full Range	1223
Auto Scaling	1223
Auto Couple	1225
More Information	1225
Auto/Man Active Function keys	1225
Auto/Man 1-of-N keys	1225
BW	1227
Cont (Continuous Measurement/Sweep)	1228
File	1230
FREQ Channel	1231
Center Freq	1231
Center Frequency Presets	1232
RF Center Freq	1234
Ext Mix Center Freq	1235
I/Q Center Freq	1236
CF Step	1236
Input/Output	1238
Marker	1239

Select Marker	1239
Marker Type	1239
Properties	1240
Select Marker	1240
Relative To	1240
Couple Markers	1241
All Markers Off	1241
Marker X Axis Value (Remote Command only)	1242
Marker X Axis Position (Remote Command only)	1242
Marker Y Axis Value (Remote Command only)	1243
Marker Function	1244
Marker To	1245
Meas	1246
Remote Measurement Functions	1246
Measurement Group of Commands	1247
Current Measurement Query (Remote Command Only)	1249
Limit Test Current Results (Remote Command Only)	1249
Data Query (Remote Command Only)	1249
Calculate/Compress Trace Data Query (Remote Command Only)	1250
Calculate Peaks of Trace Data (Remote Command Only)	1255
Format Data: Numeric Data (Remote Command Only)	1256
Format Data: Byte Order (Remote Command Only)	1257
Meas Setup	1258
Avg/Hold Num	1258
Avg Mode	1258
Range Table	1259
Range	1259
Start Freq	1261
Stop Freq	1262
Res BW	1263
Video BW	1265
Filter Type	1266
Abs Start Limit	1267
Abs Stop Limit	1268
Peak Excursion	1270
Pk Threshold	1270
Attenuation	1271
Detector 1	1272
Detector 2	1273
Sweep Time	1274
Points	1274
IF Gain	1276
IF Gain Auto	1276

IF Gain State	1277
Meas Type	1277
Spur	1278
Spurious Report Mode	1279
Meas Preset	1279
Fast Spurious Meas (Remote Command only)	1280
Mode	1281
Mode Preset	1282
How-To Preset	1283
Preset Type (Remote Command Only)	1284
Mode Setup	1285
Peak Search	1286
Next Peak	1286
Next Pk Right	1286
Next Pk Left	1287
Marker Delta	1287
Pk-Pk Search	1287
Min Search	1287
Print	1289
Quick Save	1290
Recall	1292
State	1292
More Information	1293
From File...	1294
Edit Register Names	1296
Register 1 thru Register 16	1296
Register 1 thru Register 16	1297
Recall	1297
Import Trace Data	1298
Data 1	1298
Data 2	1299
Data 3	1299
Data 4	1299
Data 5	1299
Data 6	1299
Display in Selected Trace	1299
Signal Studio Setup	1300
89601 VSA Setup	1300
Masks	1301
EVM Setup	1302
Open...	1303
Restart	1304
More Information	1304

Save	1306
State	1306
To File . . .	1307
Edit Register Names	1309
More Information	1309
Register 1 thru Register 16	1310
Register 1 thru Register 16	1310
Data (Export)	1311
Export Trace Data	1312
Trace 1	1312
Trace 2	1313
Trace 3	1313
Trace 4	1313
Include Header	1313
Measurement Results	1313
Meas Results File Definition	1314
Meas Results File Example	1316
Save As . . .	1319
Screen Image	1320
Themes	1321
3D Color	1321
3D Monochrome	1322
Flat Color	1322
Flat Monochrome	1322
Save As...	1322
Mass Storage Catalog (Remote Command Only)	1323
Mass Storage Change Directory (Remote Command Only)	1323
Mass Storage Copy (Remote Command Only)	1324
Mass Storage Device Copy (Remote Command Only)	1324
Mass Storage Delete (Remote Command Only)	1324
Mass Storage Data (Remote Command Only)	1324
Mass Storage Make Directory (Remote Command Only)	1325
Mass Storage Move (Remote Command Only)	1325
Mass Storage Remove Directory (Remote Command Only)	1326
Single (Single Measurement/Sweep)	1327
More Information	1327
Source	1328
Span X Scale	1329
Sweep/Control	1330
Sweep Setup	1330
Auto Sweep Time Rules	1330
Sweep Type	1331
Pause	1331

Gate	1331
Gate On/Off	1332
Gate View On/Off	1333
Gate View Setup	1336
Gate View Sweep Time	1336
Gate View Start Time	1337
Gate Delay	1337
Gate Length	1338
Gate Source	1338
Line	1339
External 1	1340
External 2	1342
RF Burst	1344
Periodic Timer (Frame Trigger)	1347
Control Edge/Level	1358
Gate Holdoff	1359
Gate Delay Compensation	1360
More Information	1361
Min Fast Position Query (Remote Command Only)	1362
Gate Preset (Remote Command Only)	1362
Gate Level (Remote Command Only)	1362
Gate Polarity (Remote Command Only)	1362
Gate	1363
System	1364
Trace/Detector	1365
Trigger	1366
Free Run	1366
Video	1366
Trigger Level	1366
Trig Slope	1366
Trig Delay	1366
Line	1366
Trig Slope	1366
Trig Delay	1366
External 1	1366
Trigger Level	1366
Trig Slope	1366
Trig Delay	1366
Zero Span Delay Comp	1366
External 2	1367
Trigger Level	1367
Trig Slope	1367
Trig Delay	1367

Table of Contents

Zero Span Delay Comp	1367
RF Burst	1367
Absolute Trigger	1367
Relative Trigger	1367
Trig Slope	1367
Trig Delay	1367
Periodic Timer	1367
Period	1367
Offset	1367
Reset Offset Display	1367
Sync Source	1368
Off	1368
External 1	1368
External 2	1368
RF Burst	1368
Trig Delay	1368
Auto/Holdoff	1368
Auto Trig	1368
Trig Holdoff	1368
Holdoff Type	1369
User Preset	1370
User Preset	1370
User Preset All Modes	1371
Save User Preset	1372
View/Display	1373
Display	1373
Annotation	1373
Meas Bar On/Off	1374
Screen	1375
Active Function Values On/Off	1375
Title	1376
Change Title	1376
Clear Title	1377
Graticule	1378
System Display Settings	1378
Annotation Local Settings	1378
Themes	1379
Backlight	1380
Backlight Intensity	1380
View Selection	1381
Graph + Metrics	1381
Range Table	1382
All Ranges	1385

Range Table Selection (SCPI only command)	1386
13 Spectrum Emission Mask Measurement	1389
AMPTD Y Scale	1412
Ref Value	1412
Attenuation	1412
Dual Attenuator Configurations:	1413
Single Attenuator Configuration:	1414
(Mech) Atten	1414
Attenuator Configurations and Auto/Man	1416
Enable Elec Atten	1416
More Information	1417
Mechanical Attenuator Transition Rules	1417
When the Electronic Attenuation is enabled from a disabled state:	1417
Examples in the dual attenuator configuration:	1417
When the Electronic Attenuation is disabled from an enabled state:	1418
Using the Electronic Attenuator: Pros and Cons	1418
Elec Atten	1418
Adjust Atten for Min Clip	1419
Pre-Adjust for Min Clip	1419
Off	1420
Elec Atten Only	1420
Mech + Elec Atten	1421
(Mech) Atten Step	1421
Scale/Div	1422
Presel Center	1422
Proper Preselector Operation	1423
Preselector Adjust	1423
μ W Path Control	1425
Standard Path	1426
Low Noise Path Enable	1426
More Information	1427
μ W Preselector Bypass	1428
Internal Preamp	1429
Off	1430
Low Band	1431
Full Range	1431
Ref Position	1431
Auto Scaling	1432
Auto Couple	1433
More Information	1433
Auto/Man Active Function keys	1433
Auto/Man 1-of-N keys	1433
BW	1435

Filter Type	1435
Cont (Continuous Measurement/Sweep)	1436
File	1438
FREQ Channel	1439
Center Freq	1439
Center Frequency Presets	1440
RF Center Freq	1442
Ext Mix Center Freq	1443
I/Q Center Freq	1444
CF Step	1444
Input/Output	1446
Marker	1447
Select Marker	1447
Marker Type	1447
Couple Markers	1448
All Markers Off	1448
Marker X Axis Value (Remote Command Only)	1448
Marker X Axis Position (Remote Command Only)	1449
Marker Y Axis Value (Remote Command Only)	1450
Marker Function	1451
Marker To	1452
Meas	1453
Remote Measurement Functions	1453
Measurement Group of Commands	1454
Current Measurement Query (Remote Command Only)	1456
Limit Test Current Results (Remote Command Only)	1456
Data Query (Remote Command Only)	1456
Calculate/Compress Trace Data Query (Remote Command Only)	1457
Calculate Peaks of Trace Data (Remote Command Only)	1462
Format Data: Numeric Data (Remote Command Only)	1463
Format Data: Byte Order (Remote Command Only)	1464
Meas Setup	1465
Avg/Hold Num	1465
Meas Type	1465
Ref Channel	1466
Integ BW	1466
Span	1467
Sweep Time	1469
Res BW	1469
Video BW	1471
VBW/RBW	1472
Power Ref (for the modes except MSR and LTE-Advanced FDD/TDD)	1473
Total Power	1473

PSD	1474
Spectrum Peak	1475
Offset/Limits	1476
Select Offset	1476
Start Freq	1476
Stop Freq	1479
Sweep Time	1481
Offset Side	1482
Res BW	1483
Meas BW	1485
Video BW	1486
VBW/RBW	1487
Limits	1489
Select Offset	1489
Abs Start	1489
Abs Stop	1491
Rel Start	1494
Rel Stop	1496
Fail Mask	1498
Offset Freq Define	1500
Method	1502
Filter Alpha	1503
Meas Preset	1503
Mode	1505
Mode Preset	1506
How-To Preset	1507
Preset Type (Remote Command Only)	1508
Mode Setup	1509
Peak Search	1510
Print	1511
Quick Save	1512
Recall	1514
State	1514
More Information	1515
From File...	1516
Edit Register Names	1518
Register 1 thru Register 16	1518
Register 1 thru Register 16	1519
Recall	1519
Import Trace Data	1520
Data 1	1520
Data 2	1521
Data 3	1521

Table of Contents

Data 4	1521
Data 5	1521
Data 6	1521
Display in Selected Trace	1521
Signal Studio Setup	1522
89601 VSA Setup	1522
Masks	1523
EVM Setup	1524
Open...	1525
Restart	1526
More Information	1526
Save	1528
State	1528
To File . . .	1529
Edit Register Names	1531
More Information	1531
Register 1 thru Register 16	1532
Register 1 thru Register 16	1532
Data (Export)	1533
Export Trace Data	1534
Trace 1	1534
Trace 2	1535
Trace 3	1535
Trace 4	1535
Include Header	1535
Measurement Results	1535
Meas Results File Contents	1536
Save As . . .	1545
Screen Image	1546
Themes	1547
3D Color	1547
3D Monochrome	1548
Flat Color	1548
Flat Monochrome	1548
Save As...	1548
Mass Storage Catalog (Remote Command Only)	1549
Mass Storage Change Directory (Remote Command Only)	1549
Mass Storage Copy (Remote Command Only)	1550
Mass Storage Device Copy (Remote Command Only)	1550
Mass Storage Delete (Remote Command Only)	1550
Mass Storage Data (Remote Command Only)	1550
Mass Storage Make Directory (Remote Command Only)	1551
Mass Storage Move (Remote Command Only)	1551

Mass Storage Remove Directory (Remote Command Only)	1552
Single (Single Measurement/Sweep)	1553
More Information	1553
Source	1554
Span X Scale	1555
Ref Value	1555
Scale/Div	1555
Ref Position	1556
Auto Scaling	1556
Sweep/Control	1558
Pause	1558
Gate	1558
Gate On/Off	1558
Gate View On/Off	1559
Gate View Setup	1562
Gate View Sweep Time	1563
Gate View Start Time	1563
Gate Delay	1564
Gate Length	1564
Gate Source	1565
Line	1566
External 1	1566
External 2	1568
RF Burst	1571
Periodic Timer (Frame Trigger)	1574
Control Edge/Level	1585
Gate Holdoff	1585
Gate Delay Compensation	1587
More Information	1588
Min Fast Position Query (Remote Command Only)	1588
Gate Preset (Remote Command Only)	1589
Gate Level (Remote Command Only)	1589
Gate Polarity (Remote Command Only)	1589
System	1591
Trace/Detector	1592
Trace Type	1592
Chan Detector	1592
Chan Detector Auto	1593
Chan Detector Selection	1593
Offset Detector	1594
Offset Detector Auto	1594
Offset Detector Selection	1595
Trigger	1596

Table of Contents

Free Run	1596
Video	1596
Trigger Level	1596
Trig Slope	1596
Trig Delay	1596
Line	1596
Trig Slope	1596
Trig Delay	1596
External 1	1596
Trigger Level	1596
Trig Slope	1596
Trig Delay	1596
Zero Span Delay Comp	1596
External 2	1597
Trigger Level	1597
Trig Slope	1597
Trig Delay	1597
Zero Span Delay Comp	1597
RF Burst	1597
Absolute Trigger	1597
Relative Trigger	1597
Trig Slope	1597
Trig Delay	1597
Periodic Timer	1597
Period	1597
Offset	1597
Reset Offset Display	1597
Sync Source	1598
Off	1598
External 1	1598
External 2	1598
RF Burst	1598
Trig Delay	1598
Auto/Holdoff	1598
Auto Trig	1598
Trig Holdoff	1598
Holdoff Type	1599
User Preset	1600
User Preset	1600
User Preset All Modes	1601
Save User Preset	1602
View/Display	1603
View Selection by Name (Remote Command Only)	1603

Views Selection by Number (Remote Command only)	1604
Display	1604
Annotation	1605
Meas Bar On/Off	1606
Screen	1607
Active Function Values On/Off	1607
Title	1608
Change Title	1608
Clear Title	1609
Graticule	1610
System Display Settings	1610
Annotation Local Settings	1610
Themes	1611
Backlight	1612
Backlight Intensity	1612
Abs Pwr Freq	1613
Abs Peak Pwr & Freq (Total Pwr Ref)	1613
Trace Window	1615
Results Window	1615
Abs Peak Pwr & Freq (PSD Ref)	1615
Trace Window	1617
Results Window	1617
Abs Peak Pwr & Freq (Spectrum Pk Ref)	1617
Trace Window	1619
Results Window	1619
Rel Pwr Freq	1619
Rel Peak Pwr & Freq (Total Pwr Ref)	1619
Trace Window	1620
Results Window	1620
Rel Peak Pwr & Freq (PSD Ref)	1621
Trace Window	1621
Results Window	1622
Rel Peak Pwr & Freq (Spectrum Pk Ref)	1622
Trace Window	1623
Results Window	1623
Integrated Power	1624
Integrated Power (Total Pwr Ref)	1624
Trace Window	1626
Results Window	1626
Integrated Power (PSD Ref)	1627
Trace Window	1629
Results Window	1629
Integrated Power (Spectrum Pk Ref)	1630

Trace Window	1631
Results Window	1631
Limit Lines	1632
14 Transmit On/Off Power Measurement Functions	1633
Amplitude (AMPTD) Y Scale	1639
Ref Value	1639
Ref Value (Burst View)	1639
Ref Value (Rise & Fall view)	1639
Attenuation	1640
Dual Attenuator Configurations:	1640
Single Attenuator Configuration:	1641
(Mech) Atten	1642
Attenuator Configurations and Auto/Man	1643
Enable Elec Atten	1643
More Information	1644
Mechanical Attenuator Transition Rules	1644
When the Electronic Attenuation is enabled from a disabled state:	1645
Examples in the dual attenuator configuration:	1645
When the Electronic Attenuation is disabled from an enabled state:	1645
Using the Electronic Attenuator: Pros and Cons	1645
Elec Atten	1646
Adjust Atten for Min Clip	1646
Pre-Adjust for Min Clip	1647
Off	1648
Elec Atten Only	1648
Mech + Elec Atten	1648
(Mech) Atten Step	1648
Scale/Div	1649
Scale/Div(Burst View)	1649
Scale/Div (Rise & Fall view)	1650
Presel Center	1650
Proper Preselector Operation	1651
Preselector Adjust	1652
μ W Path Control	1653
Standard Path	1654
Low Noise Path Enable	1654
More Information	1655
μ W Preselector Bypass	1656
Internal Preamp	1657
Off	1658
Low Band	1659
Full Range	1659
Ref Position	1659

Ref Position(Burst View)	1659
Ref Position (Rise & Fall view)	1660
Auto Scale	1660
Auto Scale(Burst View)	1660
Auto Scale (Rise & Fall view)	1661
Auto Couple	1662
More Information	1662
Auto/Man Active Function keys	1662
Auto/Man 1-of-N keys	1662
BW	1664
Cont (Continuous Measurement/Sweep)	1666
File	1668
FREQ Channel	1669
Center Freq	1669
Center Frequency Presets	1670
RF Center Freq	1672
Ext Mix Center Freq	1673
I/Q Center Freq	1674
CF Step	1674
Input/Output	1676
Marker	1677
Select Marker	1677
Marker Type	1677
Properties	1678
Select Marker	1678
Relative To	1678
Marker Trace	1679
Couple Marker	1679
All Markers Off	1679
Marker X Axis Value (Remote Command Only)	1680
Marker X Axis Position (Remote Command only)	1680
Marker Y Axis Value (Remote Command only)	1681
Maker State (Remote Command Only)	1681
Marker Fctn	1683
Marker To	1684
Meas	1685
Remote Measurement Functions	1685
Measurement Group of Commands	1686
Current Measurement Query (Remote Command Only)	1688
Limit Test Current Results (Remote Command Only)	1688
Data Query (Remote Command Only)	1688
Calculate/Compress Trace Data Query (Remote Command Only)	1689
Calculate Peaks of Trace Data (Remote Command Only)	1694

Format Data: Numeric Data (Remote Command Only)	1695
Format Data: Byte Order (Remote Command Only)	1696
Meas Setup	1697
Avg/Hold Num	1697
Avg Mode	1697
Avg Type	1698
Ramp Time Length	1698
IF Gain	1699
More Information about IF Gain	1699
IF Gain Auto	1699
IF Gain State	1700
Limits	1701
Max Ramp Down Time	1701
Max Ramp Up Time	1701
Downlink Off Power	1702
Uplink Off Power	1702
Threshold	1703
Ramp Up Start Level	1703
Ramp Up End Level	1703
Ramp Down Start Level	1704
Ramp Down End Level	1704
Noise Correction	1705
Meas Preset	1705
Mode	1706
Mode Preset	1707
How-To Preset	1708
Preset Type (Remote Command Only)	1709
Mode Setup	1710
Peak Search	1711
Print	1712
Quick Save	1713
Recall	1715
State	1715
More Information	1716
From File...	1717
Edit Register Names	1719
Register 1 thru Register 16	1719
Register 1 thru Register 16	1720
Recall	1720
Import Trace Data	1721
Data 1	1721
Data 2	1722
Data 3	1722

Data 4	1722
Data 5	1722
Data 6	1722
Display in Selected Trace	1722
Signal Studio Setup	1723
89601 VSA Setup	1723
Masks	1724
EVM Setup	1725
Open...	1726
Restart	1727
More Information	1727
Save	1729
State	1729
To File . . .	1730
Edit Register Names	1732
More Information	1732
Register 1 thru Register 16	1733
Register 1 thru Register 16	1733
Data (Export)	1734
Export Trace Data	1735
Trace 1	1735
Trace 2	1736
Trace 3	1736
Trace 4	1736
Include Header	1736
Measurement Results	1736
Meas Results File Contents	1737
Marker Table	1737
Peak Table	1740
Spectrogram	1743
Save As . . .	1747
Screen Image	1748
Themes	1749
3D Color	1750
3D Monochrome	1750
Flat Color	1750
Flat Monochrome	1751
Save As...	1751
Mass Storage Catalog (Remote Command Only)	1751
Mass Storage Change Directory (Remote Command Only)	1752
Mass Storage Copy (Remote Command Only)	1752
Mass Storage Device Copy (Remote Command Only)	1752
Mass Storage Delete (Remote Command Only)	1753

Table of Contents

Mass Storage Data (Remote Command Only)	1753
Mass Storage Make Directory (Remote Command Only)	1753
Mass Storage Move (Remote Command Only)	1754
Mass Storage Remove Directory (Remote Command Only)	1754
Single (Single Measurement/Sweep)	1755
More Information	1755
Source	1756
SPAN X Scale	1757
Ref Value	1757
Ref Value(Burst View)	1757
Ref Value(Rise & Fall view)	1757
Scale/Div	1758
Scale/Div(Burst View)	1758
Scale/Div(Rise & Fall View)	1759
Ref Position	1759
Ref Position(Burst View)	1759
Ref Position(Rise & Fall View)	1760
Auto Scale	1760
Auto Scale(Burst View)	1760
Auto Scale(Rise & Fall View)	1761
Sweep/Control	1762
Abort (Remote Command Only)	1762
System	1763
Trace/Detector	1764
Max Hold Trace	1764
Min Hold Trace	1764
Trigger	1766
Free Run	1766
Video	1766
Trigger Level	1766
Trig Slope	1766
Trig Delay	1766
External 1	1766
Trigger Level	1766
Trig Slope	1766
Trig Delay	1766
Zero Span Delay Comp	1766
External 2	1766
Trigger Level	1766
Trig Slope	1766
Trig Delay	1767
Zero Span Delay Comp	1767
RF Burst	1767

Absolute Trigger	1767
Relative Trigger	1767
Trig Slope	1767
Trig Delay	1767
Periodic Timer	1767
Period	1767
Offset	1767
Offset Adjust (Remote Command Only)	1767
Reset Offset Display	1767
Sync Source	1767
Off	1767
External 1	1768
External 2	1768
RF Burst	1768
Trig Delay	1768
Auto/Holdoff	1768
Auto Trig	1768
Trig Holdoff	1768
Holdoff Type	1768
User Preset	1769
User Preset	1769
User Preset All Modes	1770
Save User Preset	1771
View/Display	1772
Display	1773
Annotation	1773
Meas Bar On/Off	1774
Screen	1775
Active Function Values On/Off	1775
Title	1776
Change Title	1776
Clear Title	1777
Graticule	1778
System Display Settings	1778
Annotation Local Settings	1778
Themes	1779
Backlight	1780
Backlight Intensity	1780
Burst View	1781
RF Envelope window	1781
Result Metrics window	1782
Trigger Lines	1784
Burst Lines	1784

Limit Mask	1785
Rise & Fall View	1785
Ramp Lines	1786
Scroll	1787
Prev Page	1787
Next Page	1787
Scroll Up	1787
Scroll Down	1788
First Page	1788
Last Page	1788
Display	1788
15 LTE Modulation Analysis Measurement	1789
AMPTD Y Scale (Amplitude)	1797
Y Auto Scale	1797
Range	1797
μ W Path Control	1798
Standard Path	1799
Low Noise Path Enable	1799
More Information	1800
μ W Preselector Bypass	1801
Select Trace	1802
Couple Ref to Range	1804
Y Reference Value	1804
Y Scale Per Division	1805
Y Reference: Position	1805
Reference Line	1806
Y Unit Preference	1806
Y Log Ratio	1807
Vector Horiz Center	1807
Copy Y Scale	1808
Auto Couple	1809
More Information	1809
Auto/Man Active Function keys	1809
Auto/Man 1-of-N keys	1809
BW (Bandwidth)	1811
FFT Window	1811
Cont (Continuous Measurement/Sweep)	1813
File	1815
FREQ Channel	1816
Center Freq	1816
Start Freq	1817
Stop Freq	1817
CF Step	1818

Input/Output	1819
Marker	1820
Select Marker	1820
Control Mode	1821
Marker Properties	1821
Select Marker	1821
Relative To	1822
Complex Format	1822
Marker Trace	1823
Marker Count	1824
Marker Table	1824
Marker Position	1825
Marker X	1825
SCPI only X position commands	1826
Marker Z	1827
Marker Y	1828
Marker Y Imag (Imaginary)	1830
Couple Markers	1830
All Markers Off	1831
Normal (Position)	1831
Delta	1832
Fixed	1833
Off	1833
Coupling of Delta and Reference Markers	1833
Marker -> (Marker To)	1835
Mkr -> CF (Center Frequency)	1835
Mkr -> CF Step	1835
Mkr -> Start	1836
Mkr -> Stop	1836
Mkr Delta -> Span	1836
Mkr -> Ref Lvl	1836
Counter -> CF (Center Frequency)	1837
Mkr Delta -> CF (Center Frequency)	1837
Marker Function	1838
Select Marker	1838
Band/Interval Power	1839
Frequency-domain data	1839
Time-domain data	1839
Band Power Calculation	1839
Band/Interval Density	1841
Frequency-domain data	1841
Time-domain data	1841
Band Density Calculation	1841

Band Adjust	1842
Band/Interval Center	1842
Band/Interval Span	1843
Band/Interval Left	1843
Band/Interval Right	1844
Band Power and Delta Markers	1844
Meas	1846
Remote Measurement Functions	1846
Measurement Group of Commands	1847
Current Measurement Query (Remote Command Only)	1849
Limit Test Current Results (Remote Command Only)	1849
Data Query (Remote Command Only)	1849
Calculate/Compress Trace Data Query (Remote Command Only)	1850
Calculate Peaks of Trace Data (Remote Command Only)	1855
Format Data: Numeric Data (Remote Command Only)	1856
Format Data: Byte Order (Remote Command Only)	1857
Meas Setup	1858
Avg Number	1858
Average Mode	1859
Average Setup	1859
Average Type	1860
Fast Average	1860
Update Rate	1861
Sync/Format Setup (Downlink)	1862
Sync/Format Setup (Downlink)	1862
Sync Type	1862
RS-PRS	1864
Cell ID	1865
Tx Antenna	1866
MIMO Decoding	1873
PDSCH Cell Specific Ratio	1875
Sync/Format Setup (Uplink)	1875
Sync Type (Uplink)	1876
Half Subcarrier Shift	1878
PUSCH DFT Swap	1878
Meas Time Setup	1879
Result Length	1879
Meas Offset Slot	1880
Meas Offset Symbol	1880
Meas Interval Slot	1881
Meas Interval Symbol	1881
Analysis Start Boundary	1882
Frame	1883

Half-Frame	1883
Subframe	1883
Slot	1883
Chan Profile Setup (Downlink)	1883
Chan Profile Setup (Downlink)	1884
Detection	1884
RB Auto Detect Mode	1885
Round to Standard Values	1887
Number of Expected DL Users	1888
Composite Include	1888
Include Channels	1889
Include Users (Downlink)	1895
Edit Control Channels	1898
Edit User Mapping (Downlink)	1939
Copy Auto -> Manual	2016
Chan Profile Setup (Uplink)	2017
Detection	2017
Auto Detect Power Levels	2018
Include Non Allocation	2018
Composite Include (Uplink)	2018
Include Users (Uplink)	2019
Edit User Mapping (Uplink)	2029
Copy Auto -> Manual	2185
Decode	2186
Decode Type	2186
PBCH Decoding	2186
PCFICH Decoding	2187
PDCCH Decoding	2187
PDSCH Decoding	2188
PUSCH Decoding	2189
PUCCH Decoding	2191
DCI Format Detection Include	2191
RNTI Range	2192
RA-RNTI Range Min Value	2192
RA-RNTI Range Max Value	2193
TPC-RNTI Range Min Value	2193
TPC-RNTI Range Max Value	2194
DCI Format 2 PMI Config	2195
Latest PMI Report on PUSCH using 1 Layer	2195
Latest PMI Report on PUSCH using 2 Layers	2196
Latest PMI Report on PUSCH using 3 Layers	2197
Latest PMI Report on PUSCH using 4 Layers	2197
PUSCH Decode Parameters	2197

Info Size parameter	2198
Offset Index parameter	2198
PUSCH HARQ-ACK	2198
PUSCH RI	2199
PUSCH CQI/PMI	2201
PUCCH Decode Parameters	2202
Info Size parameter	2202
PUCCH HARQ-ACK	2202
PUCCH CQI/PMI	2203
ACK/NACK Feedback Mode	2204
Advanced	2205
Cyclic Prefix Length (Downlink)	2205
Auto	2206
Normal	2206
Extended	2206
Cyclic Prefix Length (Uplink)	2206
Extended Freq Lock Range	2207
Equalizer Training	2208
Off	2210
RS	2210
RS + Data	2210
Moving Average Filter	2210
MIMO Channel Frequency Normalize	2211
Equalizer Training Mode	2212
Symbol Timing Adjust	2212
Max of EVM Window Start/End	2213
Min of EVM in Start/End	2213
EVM Window Start	2213
EVM Window End	2213
EVM Window Center	2214
% FFT Size	2214
EVM Window Length	2214
3GPP	2215
EVM Window Length Custom	2215
Result Format	2216
Report EVM in dB	2216
Report Relative Power Levels	2217
Power Boost Normalize	2218
UE-RS Weights	2218
Time Scale Factor	2220
Multi Carrier Filter	2221
Phase Noise Optimization	2221
Best Close-in Φ Noise	2222

Best Wide-offset Φ Noise	2222
Fast Tuning	2222
EVM Minimization	2223
EVM Minimization Items	2224
EVM Minimization by Timing	2224
EVM Minimization by Frequency/Phase	2225
EVM Minimization by Amplitude	2225
EVM Minimization by IQ Offset	2226
Exclude EVM Transient Time	2226
Opposite Direction Active	2227
Antenna Element Spacing	2227
Number of Antenna Elements	2228
Spectrum Flatness Mask	2228
Spectrum Flatness Mask	2228
Store Equalizer Channel Frequency Response	2231
Meas Preset	2231
Mode	2232
Mode Preset	2233
How-To Preset	2234
Preset Type (Remote Command Only)	2235
Mode Setup	2236
Peak Search	2237
Select Marker	2237
Next Peak (Next Lower Amptd)	2238
Next Higher Amptd	2238
Next Right	2239
Next Left	2239
Mkr -> CF (Center Frequency)	2239
Continuous Peak Search	2240
Min Search	2240
Mkr -> Ref Lvl (Reference Level)	2241
Print	2242
Quick Save	2243
Recall	2245
State	2245
More Information	2246
From File...	2247
Edit Register Names	2249
Register 1 thru Register 16	2249
Register 1 thru Register 16	2250
Recall	2250
Import Trace Data	2251
Data 1	2251

Table of Contents

Data 2	2252
Data 3	2252
Data 4	2252
Data 5	2252
Data 6	2252
Display in Selected Trace	2252
Signal Studio Setup	2253
89601 VSA Setup	2253
Masks	2254
EVM Setup	2255
Open...	2256
Restart	2257
More Information	2257
Save	2259
State	2259
To File . . .	2260
Edit Register Names	2262
More Information	2262
Register 1 thru Register 16	2263
Register 1 thru Register 16	2263
Data (Export)	2264
Export Trace Data	2265
Trace 1	2265
Trace 2	2266
Trace 3	2266
Trace 4	2266
Include Header	2266
Measurement Results	2266
Meas Results File Contents	2267
Marker Table	2267
Peak Table	2270
Spectrogram	2273
Save As . . .	2277
Screen Image	2278
Themes	2279
3D Color	2280
3D Monochrome	2280
Flat Color	2280
Flat Monochrome	2281
Save As...	2281
Mass Storage Catalog (Remote Command Only)	2281
Mass Storage Change Directory (Remote Command Only)	2282
Mass Storage Copy (Remote Command Only)	2282

Mass Storage Device Copy (Remote Command Only)	2282
Mass Storage Delete (Remote Command Only)	2283
Mass Storage Data (Remote Command Only)	2283
Mass Storage Make Directory (Remote Command Only)	2283
Mass Storage Move (Remote Command Only)	2284
Mass Storage Remove Directory (Remote Command Only)	2284
Single (Single Measurement/Sweep)	2285
More Information	2285
Source	2286
SPAN X Scale	2287
Span	2287
Full Span	2287
Select Trace	2288
X Scale	2289
X Reference Value	2289
X Width	2290
X Reference Position	2291
Freq Annotation	2291
All Frequency Points	2292
Copy X Scale	2292
Sweep/Control	2294
Pause / Resume	2294
System	2295
Trace/Detector	2296
Select Trace	2296
Data	2297
Pre Demod	2298
Spectrum	2298
Inst Spectrum	2299
Search Time	2299
Time	2299
Raw Main Time	2299
Statistical	2300
CCDF (Complementary, Cumulative Density Function)	2300
CDF (Cumulative Density Function)	2301
PDF (Probability Density Function)	2302
Demod	2302
IQ Meas	2303
IQ Ref	2303
IQ Meas Time	2303
IQ Ref Time	2304
IQ Freq Meas	2304
IQ Freq Ref	2304

Detected Allocations	2305
Demod Err (Error)	2305
Error Vector Time	2305
RMS Error Vector Time	2306
Error Vector Spectrum	2306
RMS Error Vector Spectrum	2306
Common Tracking Error	2307
RB Error Mag Spectrum	2307
RB Error Mag Time	2307
RB Power Spectrum	2308
RB Power vs Time	2308
Freq Err Per Slot	2308
IQ Offset Per Slot	2308
In-band Emissions	2309
Tables	2309
Error Summary	2309
Frame Summary	2312
Symbols	2316
Decoded Symbol Table	2317
DL Decode Info	2317
UL Decode Info	2317
UE-RS Weights	2318
Response	2318
Eq Ch Frequency Response	2319
Inst Eq Ch Freq Resp	2319
Eq Ch Freq Resp Diff	2319
Inst Eq Ch Freq Resp Diff	2319
Eq Impulse Response	2320
Eq Ch Freq Resp Per Slot	2320
MIMO	2320
Info Table	2321
Ch Freq Resp	2321
Ch Freq Resp Diff	2322
Eq Impulse Resp	2322
MIMO Common Tracking Error	2322
ACP	2322
ACP Summary for Trace 1	2323
ACP Summary for Trace 2	2323
ACP Summary for Trace 3	2323
ACP Summary for Trace 4	2323
OBW	2324
OBW Summary for Trace 1	2324
OBW Summary for Trace 2	2324

OBW Summary for Trace 3	2324
OBW Summary for Trace 4	2325
Register	2325
Data 1	2325
Data 2	2325
Data 3	2326
Data 4	2326
Data 5	2326
Data 6	2326
No Data	2327
Format	2327
Digital Demod Trace Setup	2328
Symbol Shape	2328
Ideal State Shape	2329
Ideal State Size	2329
Symbol Table Format	2330
Time Unit	2331
Freq Unit	2331
Eye Length	2332
Avg Line	2332
Copy to Data Register	2333
Phase/Delay Properties	2334
Phase/Trellis Offset	2334
Unwrap Phase Ref	2335
Group Delay Aperture	2335
ACP Setup	2336
ACP On/Off	2337
Carrier Freq	2338
Carrier Meas Noise BW	2338
Carrier RRC Weighting	2339
Carrier Filter Alpha	2339
Offsets	2340
Offsets	2340
RRC Weighting (All Offsets)	2343
OBW Setup (Occupied Bandwidth)	2344
OBW Power	2345
OBW Centroid > CF	2345
BW Limit	2346
Trace Indicator Info	2346
Limit Test (SCPI Only)	2347
Trigger	2348
Free Run	2348
Video	2348

Table of Contents

Trigger Level	2348
Trig Slope	2348
Trig Delay	2348
Line	2348
Trig Slope	2348
Trig Delay	2348
External 1	2348
Trigger Level	2348
Trig Slope	2348
Trig Delay	2348
External 2	2348
Trigger Level	2349
Trig Slope	2349
Trig Delay	2349
RF Burst	2349
Absolute Trigger	2349
Trig Slope	2349
Trig Delay	2349
Periodic Timer	2349
Period	2349
Offset	2349
Offset Adjust (Remote Command Only)	2349
Reset Offset Display	2349
Sync Source	2349
Off	2349
External 1	2350
External 2	2350
RF Burst	2350
Trig Delay	2350
Trig Reference Line	2350
Auto/Holdoff	2350
Auto Trig	2350
Trig Holdoff	2350
Holdoff Type	2350
User Preset	2351
User Preset	2351
User Preset All Modes	2352
Save User Preset	2353
View/Display	2354
Display	2354
Annotation	2354
Meas Bar On/Off	2355
Screen	2356

Active Function Values On/Off	2356
Title	2357
Change Title	2357
Clear Title	2358
Graticule	2359
System Display Settings	2359
Annotation Local Settings	2359
Themes	2360
Backlight	2361
Backlight Intensity	2361
Layout	2362
Preset View: Basic	2364
Preset View: Meas Summary	2365
Preset View: RB Slot Meas	2366
Preset View: Subcarrier Meas	2367
Preset View: MIMO Summary	2368
Preset View	2369
Preset View: Basic	2369
Preset View: Meas Summary	2370
Preset View: RB Slot Meas	2371
Preset View: Subcarrier Meas	2372
Preset View: MIMO Summary	2373
16 Monitor Spectrum Measurement	2375
AMPTD Y Scale	2378
Ref Value	2378
Attenuation	2378
Dual Attenuator Configurations:	2379
Single Attenuator Configuration:	2379
(Mech) Atten	2380
Attenuator Configurations and Auto/Man	2381
Enable Elec Atten	2382
More Information	2383
Mechanical Attenuator Transition Rules	2383
When the Electronic Attenuation is enabled from a disabled state:	2383
Examples in the dual attenuator configuration:	2383
When the Electronic Attenuation is disabled from an enabled state:	2383
Using the Electronic Attenuator: Pros and Cons	2384
Elec Atten	2384
Adjust Atten for Min Clip	2385
Pre-Adjust for Min Clip	2385
Off	2386
Elec Atten Only	2386
Mech + Elec Atten	2387

(Mech) Atten Step	2387
Scale/Div	2387
Presel Center	2388
Proper Preselector Operation	2389
Preselector Adjust	2389
μ W Path Control	2390
Standard Path	2392
Low Noise Path Enable	2392
More Information	2393
μ W Preselector Bypass	2394
Internal Preamp	2395
Off	2396
Low Band	2397
Full Range	2397
Ref Position	2397
Auto Scaling	2398
Auto Couple	2399
More Information	2399
Auto/Man Active Function keys	2399
Auto/Man 1-of-N keys	2399
BW	2401
Res BW	2401
Video BW	2402
VBW:3dB RBW	2404
Span:3dB RBW	2404
Cont (Continuous Measurement/Sweep)	2406
File	2408
FREQ Channel	2409
Center Freq	2409
Center Frequency Presets	2410
RF Center Freq	2412
Ext Mix Center Freq	2413
I/Q Center Freq	2414
CF Step	2414
Input/Output	2416
Marker	2417
Select Marker	2417
Marker Type	2417
Properties	2418
Select Marker	2418
Relative To	2418
Marker Trace	2418
Couple Markers	2419

All Markers Off	2419
Marker X Axis Value (Remote Command only)	2420
Marker X Axis Position (Remote Command only)	2420
Marker Y Axis Value (Remote Command only)	2421
Marker Function	2422
Select Marker	2422
Marker Function Type	2422
Band Adjust	2422
Band/Interval Span for Frequency Domain	2423
Band/Interval Left for Frequency Domain	2423
Band/Interval Right for Frequency Domain	2424
Marker To	2425
Meas	2426
Remote Measurement Functions	2426
Measurement Group of Commands	2427
Current Measurement Query (Remote Command Only)	2429
Limit Test Current Results (Remote Command Only)	2429
Data Query (Remote Command Only)	2429
Calculate/Compress Trace Data Query (Remote Command Only)	2430
Calculate Peaks of Trace Data (Remote Command Only)	2435
Format Data: Numeric Data (Remote Command Only)	2436
Format Data: Byte Order (Remote Command Only)	2437
Meas Setup	2438
Avg/Hold Num	2438
Avg Mode	2438
Meas Preset	2439
Mode	2440
Mode Preset	2441
How-To Preset	2442
Preset Type (Remote Command Only)	2443
Mode Setup	2444
Peak Search	2445
Print	2446
Quick Save	2447
Recall	2449
State	2449
More Information	2450
From File...	2451
Edit Register Names	2453
Register 1 thru Register 16	2453
Register 1 thru Register 16	2454
Recall	2454
Import Trace Data	2455

Table of Contents

Data 1	2455
Data 2	2456
Data 3	2456
Data 4	2456
Data 5	2456
Data 6	2456
Display in Selected Trace	2456
Signal Studio Setup	2457
89601 VSA Setup	2457
Masks	2458
EVM Setup	2459
Open...	2460
Restart	2461
More Information	2461
Save	2463
State	2463
To File . . .	2464
Edit Register Names	2466
More Information	2466
Register 1 thru Register 16	2467
Register 1 thru Register 16	2467
Data (Export)	2468
Export Trace Data	2469
Trace 1	2469
Trace 2	2470
Trace 3	2470
Trace 4	2470
Include Header	2470
Measurement Results	2470
Meas Results File Contents	2471
Marker Table	2471
Peak Table	2474
Spectrogram	2477
Save As . . .	2481
Screen Image	2482
Themes	2483
3D Color	2484
3D Monochrome	2484
Flat Color	2484
Flat Monochrome	2485
Save As...	2485
Mass Storage Catalog (Remote Command Only)	2485
Mass Storage Change Directory (Remote Command Only)	2486

Mass Storage Copy (Remote Command Only)	2486
Mass Storage Device Copy (Remote Command Only)	2486
Mass Storage Delete (Remote Command Only)	2487
Mass Storage Data (Remote Command Only)	2487
Mass Storage Make Directory (Remote Command Only)	2487
Mass Storage Move (Remote Command Only)	2488
Mass Storage Remove Directory (Remote Command Only)	2488
Single (Single Measurement/Sweep)	2489
More Information	2489
Source	2490
Span X Scale	2491
Span	2491
IDEN Mode Span Preset for Monitor Spectrum	2492
Full Span	2492
Last Span	2492
Sweep/Control	2494
Sweep Time	2494
Pause	2494
Gate	2495
Gate On/Off	2495
Gate View On/Off	2496
Gate View Setup	2499
Gate View Sweep Time	2500
Gate View Start Time	2500
Gate Delay	2501
Gate Length	2501
Gate Source	2502
Line	2503
External 1	2503
External 2	2505
RF Burst	2508
Periodic Timer (Frame Trigger)	2511
Control Edge/Level	2522
Gate Holdoff	2522
Gate Delay Compensation	2524
More Information	2525
Min Fast Position Query (Remote Command Only)	2525
Gate Preset (Remote Command Only)	2526
Gate Level (Remote Command Only)	2526
Gate Polarity (Remote Command Only)	2526
Points	2527
System	2528
Trace/Detector	2529

Table of Contents

Select Trace	2529
Trace Type	2529
Update	2530
Display	2530
Detector	2531
Auto	2532
Clear Trace	2532
Clear All Traces	2532
Trigger	2534
Free Run	2534
Video	2534
Trigger Level	2534
Trig Slope	2534
Trig Delay	2534
Line	2534
Trig Slope	2534
Trig Delay	2534
External 1	2534
Trigger Level	2534
Trig Slope	2534
Trig Delay	2534
Zero Span Delay Comp	2534
External 2	2535
Trigger Level	2535
Trig Slope	2535
Trig Delay	2535
Zero Span Delay Comp	2535
RF Burst	2535
Absolute Trigger	2535
Relative Trigger	2535
Trig Slope	2535
Trig Delay	2535
Periodic Timer	2535
Period	2535
Offset	2535
Reset Offset Display	2535
Sync Source	2536
Off	2536
External 1	2536
External 2	2536
RF Burst	2536
Trig Delay	2536
Auto/Holdoff	2536

Auto Trig	2536
Trig Holdoff	2536
Holdoff Type	2537
User Preset	2538
User Preset	2538
User Preset All Modes	2539
Save User Preset	2540
View/Display	2541
View for all modes except MSR, 1xEV-DO, LTE-Advanced FDD/TDD	2541
1xEV-DO Mode View	2542
MSR and LTE-Advanced FDD/TDD Mode Views	2542
View Selection by Name (MSR and LTE-Advanced FDD/TDD mode only)	2543
View Selection by Number (MSR and LTE-Advanced FDD/TDD mode only)	2543
Display	2543
Annotation	2544
Meas Bar On/Off	2545
Screen	2545
Active Function Values On/Off	2545
Title	2546
Change Title	2546
Clear Title	2547
Graticule	2548
System Display Settings	2548
Annotation Local Settings	2548
Themes	2549
Backlight	2550
Backlight Intensity	2550
17 Waveform Measurement	2553
AMPTD Y Scale	2557
Ref Value (RF Envelope View)	2557
Attenuation	2557
Dual Attenuator Configurations:	2558
Single Attenuator Configuration:	2559
(Mech) Atten	2559
Attenuator Configurations and Auto/Man	2561
Enable Elec Atten	2561
More Information	2562
Mechanical Attenuator Transition Rules	2562
When the Electronic Attenuation is enabled from a disabled state:	2562
Examples in the dual attenuator configuration:	2562
When the Electronic Attenuation is disabled from an enabled state:	2563
Using the Electronic Attenuator: Pros and Cons	2563
Elec Atten	2563

Table of Contents

Adjust Atten for Min Clip	2564
Pre-Adjust for Min Clip	2564
Off	2565
Elec Atten Only	2565
Mech + Elec Atten	2566
(Mech) Atten Step	2566
Scale/Div (RF Envelope View)	2567
Presel Center	2567
Proper Preselector Operation	2568
Preselector Adjust	2568
μ W Path Control	2570
Standard Path	2571
Low Noise Path Enable	2571
More Information	2572
μ W Preselector Bypass	2573
Internal Preamp	2574
Off	2575
Low Band	2576
Full Range	2576
Ref Position (RF Envelope View)	2576
Auto Scaling	2577
Range	2577
Range Auto/Man	2578
I Range	2579
1 V Peak	2580
0.5 V Peak	2580
0.25 V Peak	2580
0.125 V Peak	2580
Q Range Value	2581
Q Same as I	2582
1 V Peak	2582
0.5 V Peak	2582
0.25 V Peak	2583
0.125 V Peak	2583
I/Q Gain Ranges	2583
1 V Peak	2583
0.5 V Peak	2583
0.25 V Peak	2583
0.125 V Peak	2584
Ref Value	2584
Ref Value (RF Envelope View)	2584
Ref Value (I/Q Waveform View)	2585
Scale/Div	2585

Scale/Div (RF Envelope View)	2585
Scale/Div (I/Q Waveform View)	2586
Ref Position	2587
Ref Position (RF Envelope View)	2587
Ref Position (I/Q Waveform View)	2587
Auto Couple	2589
More Information	2589
Auto/Man Active Function keys	2589
Auto/Man 1-of-N keys	2589
BW	2591
Digital IF BW	2591
Filter Type	2592
Filter BW	2593
Filter Alpha	2594
Filter Type Bwcc	2594
Gaussian	2595
Gaussian filters	2595
Flattop	2599
Flattop Filters	2600
Channel Filter Bandwidth Bwcc (Remote Command Only)	2601
Cont (Continuous Measurement/Sweep)	2602
File	2604
FREQ Channel	2605
Center Freq	2605
Center Frequency Presets	2606
RF Center Freq	2608
Ext Mix Center Freq	2609
I/Q Center Freq	2610
CF Step	2610
Input/Output	2612
Marker	2613
Select Marker	2613
Marker Type	2613
Properties	2614
Select Marker	2614
Relative To	2614
Marker Trace	2615
Couple Markers	2615
All Markers Off	2616
Marker X Axis Value (Remote Command Only)	2616
Marker X Axis Position (Remote Command Only)	2617
Marker Y Axis Value (Remote Command Only)	2617
Backward Compatibility SCPI Commands	2618

Marker ->	2619
Marker Function	2620
Select Marker	2620
Marker Function Type	2620
Band Adjust	2621
Band/Interval Span for Time Domain	2621
Band/Interval Left for Time Domain	2622
Band/Interval Right for Time Domain	2622
Meas	2624
Remote Measurement Functions	2624
Measurement Group of Commands	2625
Current Measurement Query (Remote Command Only)	2627
Limit Test Current Results (Remote Command Only)	2627
Data Query (Remote Command Only)	2627
Calculate/Compress Trace Data Query (Remote Command Only)	2628
Calculate Peaks of Trace Data (Remote Command Only)	2633
Format Data: Numeric Data (Remote Command Only)	2634
Format Data: Byte Order (Remote Command Only)	2635
Meas Setup	2636
Average/Hold Num	2636
Avg Mode	2636
Avg Type	2637
Time Avg Num	2638
Meas Time	2638
Sample Rate	2639
PhNoise Opt	2639
Auto	2640
Best Close-in P Noise	2641
Best Wide-offset P Noise	2641
Fast Tuning	2642
Advanced	2642
ADC Dither	2642
ADC Dither Auto	2642
ADC Dither	2643
IF Gain	2644
IF Gain Auto	2644
IF Gain State	2644
IF Gain Offset	2645
Meas Preset	2646
HW Averaging	2646
Time Avg Num	2647
Sample Period (Aperture) Setting (Remote Command Only)	2647
Mode	2648

Mode Preset	2649
How-To Preset	2650
Preset Type (Remote Command Only)	2651
Mode Setup	2652
Peak Search	2653
Next Peak	2653
Min Search	2653
Print	2655
Quick Save	2656
Recall	2658
State	2658
More Information	2659
From File...	2660
Edit Register Names	2662
Register 1 thru Register 16	2662
Register 1 thru Register 16	2663
Recall	2663
Import Trace Data	2664
Data 1	2664
Data 2	2665
Data 3	2665
Data 4	2665
Data 5	2665
Data 6	2665
Display in Selected Trace	2665
Signal Studio Setup	2666
89601 VSA Setup	2666
Masks	2667
EVM Setup	2668
Open...	2669
Restart	2670
More Information	2670
Save	2672
State	2672
To File . . .	2673
Edit Register Names	2675
More Information	2675
Register 1 thru Register 16	2676
Register 1 thru Register 16	2676
Data (Export)	2677
Export Trace Data	2678
Trace 1	2678
Trace 2	2679

Trace 3	2679
Trace 4	2679
Include Header	2679
Measurement Results	2679
Meas Results File Contents	2680
Marker Table	2680
Peak Table	2683
Spectrogram	2686
Save As . . .	2690
Screen Image	2691
Themes	2692
3D Color	2693
3D Monochrome	2693
Flat Color	2693
Flat Monochrome	2694
Save As...	2694
Mass Storage Catalog (Remote Command Only)	2694
Mass Storage Change Directory (Remote Command Only)	2695
Mass Storage Copy (Remote Command Only)	2695
Mass Storage Device Copy (Remote Command Only)	2695
Mass Storage Delete (Remote Command Only)	2696
Mass Storage Data (Remote Command Only)	2696
Mass Storage Make Directory (Remote Command Only)	2696
Mass Storage Move (Remote Command Only)	2697
Mass Storage Remove Directory (Remote Command Only)	2697
Single (Single Measurement/Sweep)	2698
More Information	2698
Source	2699
Span X Scale	2700
Ref Value	2700
Scale/Div	2700
Ref Position	2701
Auto Scaling	2701
Sweep/Control	2703
Pause/Resume	2703
Abort (Remote Command Only)	2703
System	2705
Trace/Detector	2706
Trigger	2707
Free Run	2707
Video	2707
Trigger Level	2707
Trig Slope	2707

Trig Delay	2707
Line	2707
Trig Slope	2707
Trig Delay	2707
External 1	2707
Trigger Level	2707
Trig Slope	2707
Trig Delay	2707
Zero Span Delay Comp	2707
External 2	2708
Trigger Level	2708
Trig Slope	2708
Trig Delay	2708
Zero Span Delay Comp	2708
RF Burst	2708
Absolute Trigger	2708
Relative Trigger	2708
Trig Slope	2708
Trig Delay	2708
Periodic Timer	2708
Period	2708
Offset	2708
Offset Adjust (Remote Command Only)	2708
Reset Offset Display	2709
Sync Source	2709
Off	2709
External 1	2709
External 2	2709
RF Burst	2709
Trig Delay	2709
Auto/Holdoff	2709
Auto Trig	2709
Trig Holdoff	2710
Holdoff Type	2710
Baseband I/Q	2710
I/Q Mag	2710
Trigger Level	2710
Trig Slope	2710
Trig Delay	2710
I	2710
Trigger Level	2710
Trig Slope	2710
Trig Delay	2710

Q	2710
Trigger Level	2710
Trig Slope	2710
Trig Delay	2711
Input I	2711
Trigger Level	2711
Trig Slope	2711
Trig Delay	2711
Input Q	2711
Trigger Level	2711
Trig Slope	2711
Trig Delay	2711
Aux Channel Center Freq	2711
Trigger Level	2711
Trig Slope	2711
Trig Delay	2711
Trigger Center Freq	2711
Trigger BW	2711
User Preset	2712
User Preset	2712
User Preset All Modes	2713
Save User Preset	2714
View/Display	2715
View Selection by name (Remote Command Only)	2715
View Selection by number (Remote Command Only)	2715
Display	2716
Annotation	2716
Meas Bar On/Off	2717
Screen	2718
Active Function Values On/Off	2718
Title	2719
Change Title	2719
Clear Title	2720
Graticule	2721
System Display Settings	2721
Annotation Local Settings	2721
Themes	2722
Backlight	2723
Backlight Intensity	2723
RF Envelope	2724
I/Q Waveform	2725
18 Conformance EVM	2727
AMPTD Y Scale	2734

Attenuation	2734
Dual Attenuator Configurations:	2734
Single Attenuator Configuration:	2735
(Mech) Atten	2736
Attenuator Configurations and Auto/Man	2737
Enable Elec Atten	2737
More Information	2738
Mechanical Attenuator Transition Rules	2738
When the Electronic Attenuation is enabled from a disabled state:	2739
Examples in the dual attenuator configuration:	2739
When the Electronic Attenuation is disabled from an enabled state:	2739
Using the Electronic Attenuator: Pros and Cons	2739
Elec Atten	2740
Adjust Atten for Min Clip	2740
Pre-Adjust for Min Clip	2741
Off	2742
Elec Atten Only	2742
Mech + Elec Atten	2742
(Mech) Atten Step	2742
Presel Center	2743
Proper Preselector Operation	2744
Preselector Adjust	2744
μ W Path Control	2746
Standard Path	2747
Low Noise Path Enable	2747
More Information	2748
μ W Preselector Bypass	2749
Internal Preamp	2750
Off	2751
Low Band	2752
Full Range	2752
Auto Couple	2753
More Information	2753
Auto/Man Active Function keys	2753
Auto/Man 1-of-N keys	2753
BW	2755
Cont (Continuous Measurement/Sweep)	2756
File	2758
FREQ Channel	2759
Center Freq	2759
Center Frequency Presets	2760
RF Center Freq	2762
Ext Mix Center Freq	2763

I/Q Center Freq	2764
CF Step	2764
Input/Output	2766
Marker	2767
Marker > (Marker To)	2768
Marker Fctn	2769
Meas	2770
Remote Measurement Functions	2770
Measurement Group of Commands	2771
Current Measurement Query (Remote Command Only)	2773
Limit Test Current Results (Remote Command Only)	2773
Data Query (Remote Command Only)	2773
Calculate/Compress Trace Data Query (Remote Command Only)	2774
Calculate Peaks of Trace Data (Remote Command Only)	2779
Format Data: Numeric Data (Remote Command Only)	2780
Format Data: Byte Order (Remote Command Only)	2781
Meas Setup	2782
Meas Method (when 85 MHz or wider analysis bandwidth option is installed)	2782
Fast Mode Limitation	2782
Copy from Mod Analysis Measurement	2784
Meas Preset	2784
Mode	2786
Mode Preset	2787
How-To Preset	2788
Preset Type (Remote Command Only)	2789
Mode Setup	2790
Peak Search	2791
Print	2792
Quick Save	2793
Recall	2795
State	2795
More Information	2796
From File...	2797
Edit Register Names	2799
Register 1 thru Register 16	2799
Register 1 thru Register 16	2800
Recall	2800
Import Trace Data	2801
Data 1	2801
Data 2	2802
Data 3	2802
Data 4	2802
Data 5	2802

Data 6	2802
Display in Selected Trace	2802
Signal Studio Setup	2803
89601 VSA Setup	2803
Masks	2804
EVM Setup	2805
Open...	2806
Restart	2807
More Information	2807
Save	2809
State	2809
To File . . .	2810
Edit Register Names	2812
More Information	2812
Register 1 thru Register 16	2813
Register 1 thru Register 16	2813
Data (Export)	2814
Export Trace Data	2815
Trace 1	2815
Trace 2	2816
Trace 3	2816
Trace 4	2816
Include Header	2816
Measurement Results	2816
Meas Results File Contents	2817
Marker Table	2817
Peak Table	2820
Spectrogram	2823
Save As . . .	2827
Screen Image	2828
Themes	2829
3D Color	2830
3D Monochrome	2830
Flat Color	2830
Flat Monochrome	2831
Save As...	2831
Mass Storage Catalog (Remote Command Only)	2831
Mass Storage Change Directory (Remote Command Only)	2832
Mass Storage Copy (Remote Command Only)	2832
Mass Storage Device Copy (Remote Command Only)	2832
Mass Storage Delete (Remote Command Only)	2833
Mass Storage Data (Remote Command Only)	2833
Mass Storage Make Directory (Remote Command Only)	2833

Mass Storage Move (Remote Command Only)	2834
Mass Storage Remove Directory (Remote Command Only)	2834
Single (Single Measurement/Sweep)	2835
More Information	2835
Source	2836
SPAN X Scale	2837
Sweep/Control	2838
System	2839
Trace/Detector	2840
Trigger	2841
Free Run	2841
Video	2841
Trigger Level	2841
Trig Slope	2841
Trig Delay	2841
Line	2841
Trig Slope	2841
Trig Delay	2841
External 1	2841
Trigger Level	2841
Trig Slope	2841
Trig Delay	2841
Zero Span Delay Comp	2841
External 2	2842
Trigger Level	2842
Trig Slope	2842
Trig Delay	2842
Zero Span Delay Comp	2842
RF Burst	2842
Absolute Trigger	2842
Relative Trigger	2842
Trig Slope	2842
Trig Delay	2842
Periodic Timer	2842
Period	2842
Offset	2842
Offset Adjust (Remote Command Only)	2842
Reset Offset Display	2843
Sync Source	2843
Off	2843
External 1	2843
External 2	2843
RF Burst	2843

Trig Delay	2843
Auto/Holdoff	2843
Auto Trig	2843
Trig Holdoff	2844
Holdoff Type	2844
User Preset	2845
User Preset	2845
User Preset All Modes	2846
Save User Preset	2847
View/Display	2848
Display	2848
Annotation	2848
Meas Bar On/Off	2849
Screen	2850
Active Function Values On/Off	2850
Title	2851
Change Title	2851
Clear Title	2852
Graticule	2853
System Display Settings	2853
Annotation Local Settings	2853
Themes	2854
Backlight	2855
Backlight Intensity	2855
Measurement List view	2856
Show All Items	2856
Parameter List view	2857
Value	2857
Result Metrics view	2858
RF Envelope view	2858
19 Remote SCPI Commands and Data Queries	2861
:READ and :FETCh Commands	2862
:CALCulate:DATA	2865
:CALCulate:DATA:RAW	2867
:CALCulate:DATA:RAW:COMPLex	2868
:CALCulate:DATA:POINts commands	2869
:CALCulate:DATA:TABL commands	2870
Query Table Data as Number	2871
Query Table Data as String	2871
Query Table Names	2872
Query Table Units	2872
:CALCulate:DATA:HEADer commands	2874
Query Header Names	2874

Table of Contents

Query Header Type	2874
Query Header as String	2875
Query Numeric Header	2875
:CALC:CLIMits:FAIL?	2876
IQ Data Transfers	2877
Fast Capture Length	2878
Fast Capture Word Length	2878
Initiate Fast Capture	2879
Fast Capture Block	2879
Fast Capture Pointer	2880
Fetch Fast Capture	2880
Input Sample Rate Query	2881
Parameter Update Enable	2882

1 About the Analyzer

The X-Series signal analyzer measures and monitors complex RF and microwave signals. Analog baseband analysis is available on MXA. The analyzer integrates traditional spectrum measurements with advanced vector signal analysis to optimize speed, accuracy, and dynamic range. The analyzer has Windows 7[®] built in as an operating system, which expands its usability.

With a broad set of applications and demodulation capabilities, an intuitive user interface, outstanding connectivity and powerful one-button measurements, the analyzer is ideal for both R&D and manufacturing engineers working on cellular, emerging wireless communications, general purpose, aerospace and defense applications.

Installing Application Software

If you want to install a measurement application after your initial hardware purchase, you need only to license it. All of the available applications are loaded in your analyzer at the time of purchase.

Thus, when you purchase a new application, you will receive an entitlement certificate that you can use to obtain a license key for that application. To activate the new measurement application, enter the license key that you obtain into the Signal Analyzer.

For the latest information on Keysight Signal Analyzer measurement applications and upgrade kits, visit the following internet URL.

http://www.agilent.com/find/sa_upgrades

Viewing a License Key

Measurement applications that you purchased with your instrument have been installed and activated at the factory before shipment. The instrument requires a unique License Key for every measurement application purchased. The license key is a hexadecimal string that is specific to your measurement application, instrument model number and serial number. It enables you to install, or reactivate, that particular application.

Press **System, Show, System** to display the measurement applications that are currently licensed in your analyzer.

Go to the following location to view the license keys for the installed measurement applications:

C:\Program Files\Agilent\Licensing

You may want to keep a copy of your license key in a secure location. To do this, you can print out a copy of the display showing the license numbers. If you should lose your license key, call your nearest Keysight Technologies service or sales office for assistance.

Obtaining and Installing a License Key

If you purchase an additional application that requires installation, you will receive an "Entitlement Certificate", which may be redeemed for a license key for one instrument. To obtain your license key, follow the instructions that accompany the certificate.

Installing a license key for the selected application can be done automatically using a USB memory device. To do this, you copy the license file to the USB memory device, at the root level. Follow the instructions that come with your software installation kit.

Installing a license key can also be done manually using the built-in license management application, which may be found via the instrument front panel keys at **System, Licensing. . .**, or on-disk at:

C:\Programming Files\Agilent\Licensing

You can also use these procedures to reinstall a license key that has been accidentally deleted, or lost due to a memory failure.

Updating Measurement Application Software

All the software applications were loaded at the time of original instrument manufacture. It is a good idea to regularly update your software with the latest available version. This helps to ensure that you receive

any improvements and expanded functionality.

Because the software was loaded at the initial purchase, further additional measurement applications may now be available. If the application you are interested in licensing is not available, you will need to do a software update. (To display a list of installed applications, press **System, Show, System.**)

Check the appropriate page of the Keysight web site for the latest available software versions, according to the name of your instrument, as follows:

http://www.agilent.com/find/pxa_software

http://www.agilent.com/find/mxa_software

http://www.agilent.com/find/exa_software

http://www.agilent.com/find/cxa_software

You can load the updated software package into the analyzer from a USB drive, or directly from the internet. An automatic loading program is included with the files.

X-Series Options and Accessories

You can view an online list of available Options and Accessories for your instrument as follows:

1. Browse to one of the following URLs, according to the product name of your analyzer:

www.agilent.com/find/cxa

www.agilent.com/find/exa

www.agilent.com/find/mxa

www.agilent.com/find/pxa

2. The home page for your instrument appears (in some cases, you may see an initial splash screen containing a button named View the Webpage, which you should click to display the home page).
3. Locate the Options tab, as highlighted in the example below, which shows the home page for the MXA.



4. Click the Options tab, to display a list of available options and accessories for your instrument.

Front-Panel Features

The instrument's Front-panel features are fully detailed in the section "Front-Panel Features" (under the chapter "Front and Rear Panel Features") of the document:

[Getting Started Guide](#)

If you are viewing this information as a Help file in the instrument, then you can click on the link above to open the PDF document.

Display Annotations

Display Annotations are fully detailed under the chapter "Front and Rear Panel Features" of the document:

[Getting Started Guide](#)

If you are viewing this information as a Help file in the instrument, then you can click on the link above to open the PDF document.

Rear-Panel Features

The instrument's Rear-panel features are fully detailed in the section "Rear-Panel Features" (under the chapter "Front and Rear Panel Features") of the document:

[Getting Started Guide](#)

If you are viewing this information as a Help file in the instrument, then you can click on the link above to open the PDF document.

Window Control Keys

The instrument provides three front-panel keys for controlling windows. They are Multi Window, Zoom, and Next Window. These are all “immediate action” keys.

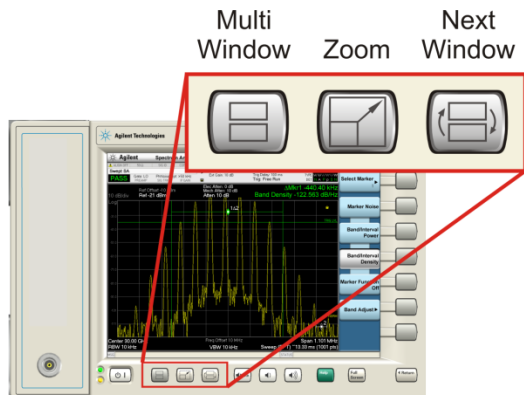

Multi-Window



The Multi Window front-panel key will toggle you back and forth between the Normal View and the last Multi Window View (Zone Span, Trace Zoom or Spectrogram) that you were in, when using the Swept SA measurement of the Spectrum Analyzer Mode. It remembers which View you were in through a Preset. This “previous view” is set to Zone Span on a Restore Mode Defaults.

Key Path	Front-panel key
Initial S/W Revision	Prior to A.02.00

Zoom

Zoom is a toggle function. Pressing this key once increases the size of the selected window. Pressing the key again returns the window to the original size.

When Zoom is on for a window, that window will get the entire primary display area. The zoomed window, since it is the selected window, is outlined in green.

Zoom is local to each Measurement. Each Measurement remembers its Zoom state. The Zoom state of each Measurement is part of the Mode’s state.

NOTE

Data acquisition and processing for the other windows continues while a window is zoomed, as does all SCPI communication with the other windows.

Remote Command	:DISPlay:WINDow:FORMat:ZOOM
----------------	-----------------------------

Remote Command	:DISPlay:WINDow:FORMat:TILE
Example	:DISP:WIND:FORM:ZOOM sets zoomed :DISP:WIND:FORM:TILE sets un-zoomed
Preset	TILE
Initial S/W Revision	Prior to A.02.00

Next Window

Selects the next window of the current view. When the Next Window key is pressed, the next window in the order of precedence becomes selected. If the selected window was zoomed, the next window will also be zoomed.

The window numbers are as follows. Note that these numbers also determine the order of precedence (that is, Next Window goes from 1 to 2, then 2 to 3, etc.):

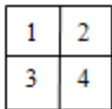

Four window display

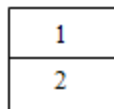

Two window display

RTSA measurements:

Only two windows are available in the Spectrogram view under the Spectrum measurement and up to three windows are available in the Power vs. Time measurement, depending on the view set up.

Remote Command	:DISPlay:WINDow[:SElect] <number> :DISPlay:WINDow[:SElect]?
Example	:DISP:WIND 1
Preset	1
Min	1
Max	If <number> is greater than the number of windows, limit to <number of windows>
Initial S/W Revision	Prior to A.02.00

One and only one window is always selected. The selected window has the focus; this means that all window-specific key presses apply only to that window. You can tell which window is selected by the thick green border around it. If a window is not selected, its boundary is gray.

If a window in a multi-window display is zoomed it is still outlined in green. If there is only one window, the green outline is not used. This allows the user to distinguish between a zoomed window and a display with only one window.

The selected window is local to each Measurement. Each Measurement remembers which window is selected. The selected window for each Measurement is remembered in Mode state.

NOTE

When this key is pressed in Help Mode, it toggles focus between the table of contents window and the topic pane window.

Full Screen

When Full Screen is pressed the measurement window expands horizontally over the entire instrument display. The screen graticule area expands to fill the available display area.

It turns off the display of the softkey labels, however the menus and active functions still work. (Though it would obviously be very hard to navigate without the key labels displayed.) Pressing Full Screen again while Full Screen is in effect cancels Full Screen.

Note that the banner and status lines are unaffected. You can get even more screen area for your data display by turning off the Meas Bar (in the Display menu) which also turns off the settings panel.

Full Screen is a Meas Global function. Therefore it is cancelled by the Preset key.

Key Path	Display
Remote Command	:DISPlay:FSCReen[:STAtE] OFF ON 0 1 :DISPlay:FSCReen[:STAtE]?
Preset	Unaffected by Preset but set to Off by Restore Misc Defaults or shutdown and restart
State Saved	Not saved in instrument state.
Backwards Compatibility SCPI	:DISPlay:MENU[:STAtE] OFF ON 0 1 This emulates ESA full screen functionality, which is the same as the FSCReen command in PSA except that the sense of on/off is reversed (that is, OFF means the menus are OFF, so Fullscreen is ON) and the default is ON (meaning Fullscreen is OFF).
Backwards Compatibility Notes	In ESA/PSA, Full Screen was turned on with a softkey, so pressing any other key turned Full Screen off. In the X-Series, because a hardkey is provided to turn this function on and off, pressing any other key no longer turns off Full Screen
Initial S/W Revision	Prior to A.02.00

Display Enable (Remote Command Only)

Turns the display on/off, including the display drive circuitry. The backlight stays lit so you can tell that the instrument is on. The display enable setting is mode global. The reasons for turning the display off are three:

- To increase speed as much as possible by freeing the instrument from having to update the display
- To reduce emissions from the display, drive circuitry
- For security purposes

If you have turned off the display:

- and you are in local operation, the display can be turned back on by pressing any key or by sending the SYSTem:DEFaults MISC command or the DISPlay:ENABle ON (neither *RST nor SYSTem:PRESet enable the display.)
- and you are in remote operation, the display can be turned back on by pressing the Local or Esc keys or by sending the SYSTem:DEFaults MISC command or the DISPlay:ENABle ON (neither *RST nor SYSTem:PRESet enable the display.)

and you are using either the SYSTem:KLOCK command or GPIB local lockout, then no front-panel key press will turn the display back on. You must turn it back on remotely.

Remote Command	:DISPlay:ENABle OFF ON 0 1 :DISPlay:ENABle?
Example	DISP:ENAB OFF
Couplings	DISP:ENAB OFF turns Backlight OFF and DISP:ENAB ON turns Backlight ON. However, settings of Backlight do not change the state of DISP:ENAB
Preset	On Set by SYST:DEF MISC, but Not affected by *RST or SYSTem:PRESet.
State Saved	Not saved in instrument state.
Backwards Compatibility Notes	SYST:PRES no longer turns on DISPlay:ENABle as it did in legacy analyzers
Initial S/W Revision	Prior to A.02.00

Mouse and Keyboard Control

If you do not have access to the instrument front-panel, there are several ways that a mouse and PC Keyboard can give you access to functions normally accessed using the front-panel keys.

Right-Click

If you plug in a mouse and right-click on the analyzer screen, a menu will appear as below:

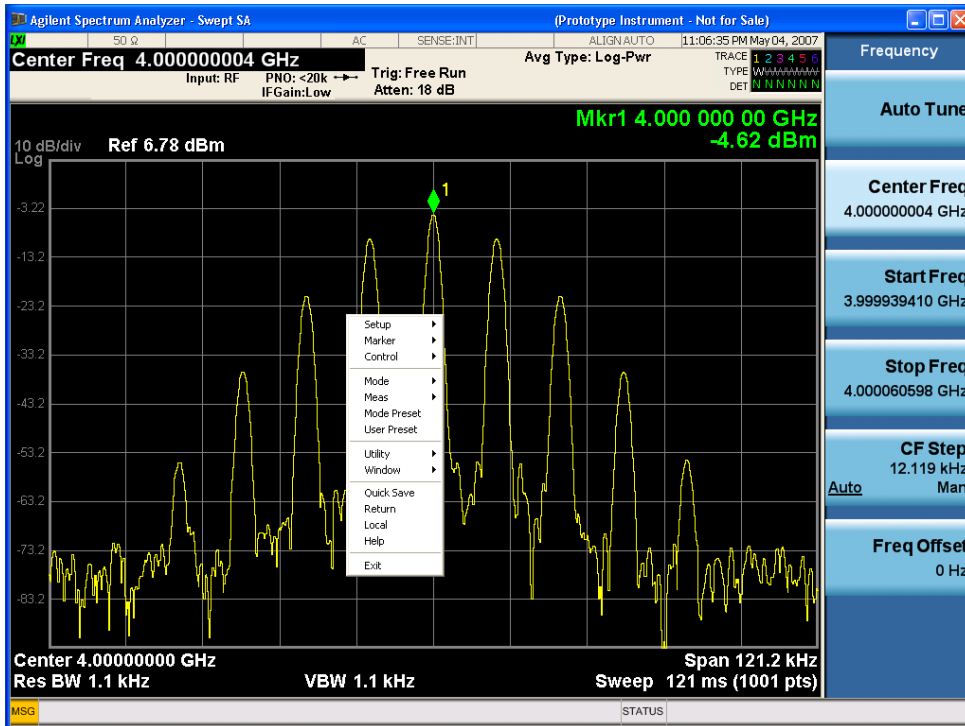

Placing the mouse on one of the rows marked with a right arrow symbol will cause that row to expand, as for example below where the mouse is hovered over the “Utility” row:

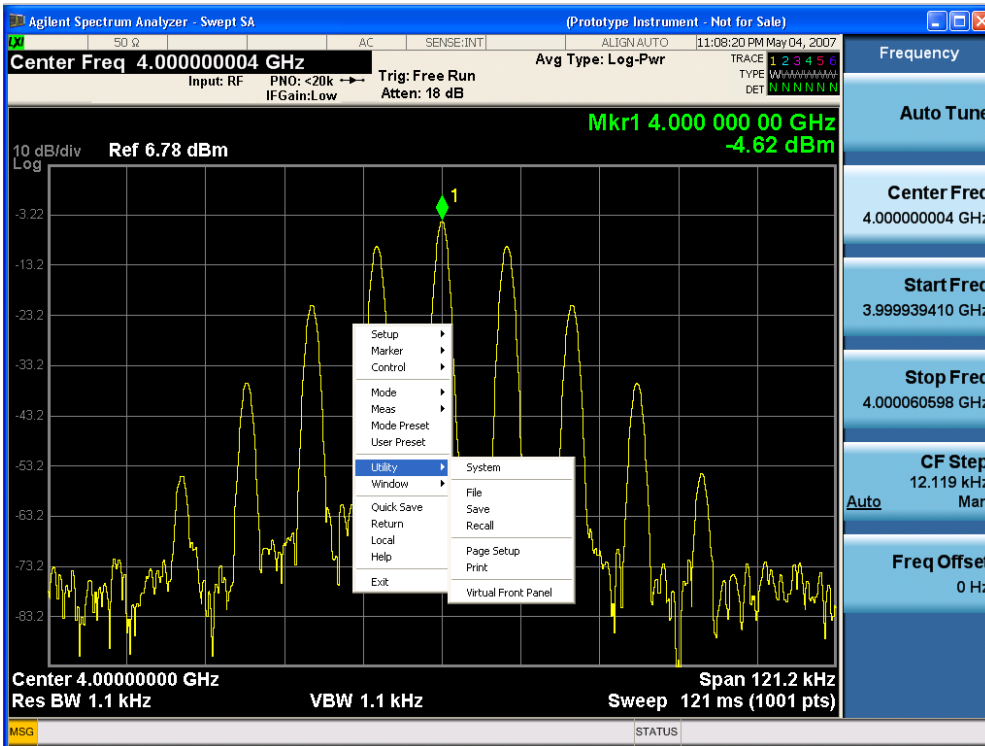

This method can be used to access any of the front-panel keys by using a mouse; as for example if you are accessing the instrument through Remote Desktop.

The array of keys thus available is shown below:

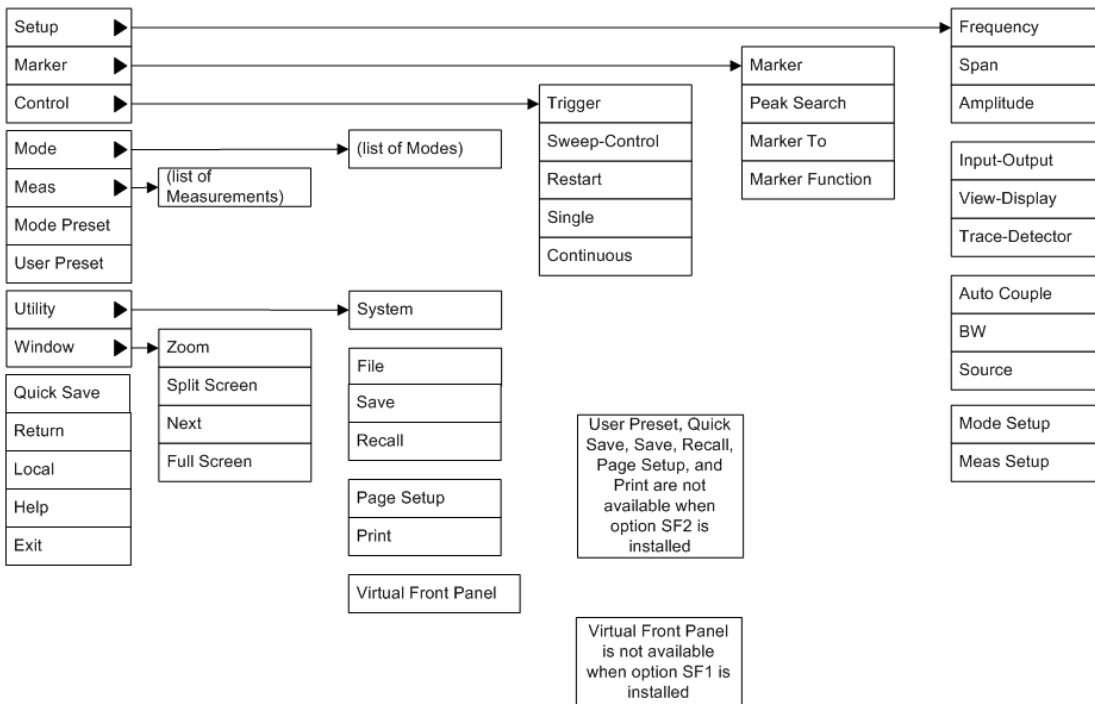

PC Keyboard

If you have a PC keyboard plugged in (or via Remote Desktop), certain key codes on the PC keyboard map to front-panel keys on the GPSA front panel. These key codes are shown below:

Front-panel key	Key code
Frequency	CTRL+SHIFT+F
Span	CTRL+SHIFT+S
Amplitude	CTRL+SHIFT+A
Input/Output	CTRL+SHIFT+O
View/Display	CTRL+SHIFT+V
Trace/Detector	CTRL+ALT+T
Auto Couple	CTRL+SHIFT+C
Bandwidth	CTRL+ALT+B
Source	CTRL+ALT-U
Marker	CTRL+ALT+K
Peak Search	CTRL+ALT+P
Marker To	CTRL+ALT+N
Marker Function	CTRL+ALT+F
System	CTRL+SHIFT+Y
Quick Save	CTRL+Q
Save	CTRL+S
Recall	CTRL+R
Mode Preset	CTRL+M
User Preset	CTRL+U
Print	CTRL+P
File	CTRL+SHIFT+L
Mode	CTRL+SHIFT+M
Measure	CTRL+ALT+M
Mode Setup	CTRL+SHIFT+E
Meas Setup	CTRL+ALT+E
Trigger	CTRL+SHIFT+T
Sweep/Control	CTRL+SHIFT+W
Restart	CTRL+ALT+R
Single	CTRL+ALT+S
Cont	CTRL+ALT+C
Zoom	CTRL+SHIFT+Z
Next Window	CTRL+SHIFT+N
Split Screen	CTRL+L

Front-panel key	Key code
Full Screen	CTRL+SHIFT+B
Return	CTRL+SHIFT+R
Mute	Mute
Inc Audio	Volume Up
Dec Audio	Volume Down
Help	F1
Control	CTRL
Alt	ALT
Enter	Return
Cancel	Esc
Del	Delete
Backspace	Backspace
Select	Space
Up Arrow	Up
Down Arrow	Down
Left Arrow	Left
Right Arrow	Right
Menu key 1	CTRL+SHIFT+F1
Menu key 2	CTRL+SHIFT+F2
Menu key 3	CTRL+SHIFT+F3
Menu key 4	CTRL+SHIFT+F4
Menu key 5	CTRL+SHIFT+F5
Menu key 6	CTRL+SHIFT+F6
Menu key 7	CTRL+SHIFT+F7
Backspace	BACKSPACE
Enter	ENTER
Tab	Tab
1	1
2	2
3	3
4	4
5	5
6	6
7	7
8	8
9	9
0	0

1 About the Analyzer
 Mouse and Keyboard Control

This is a pictorial view of the table:

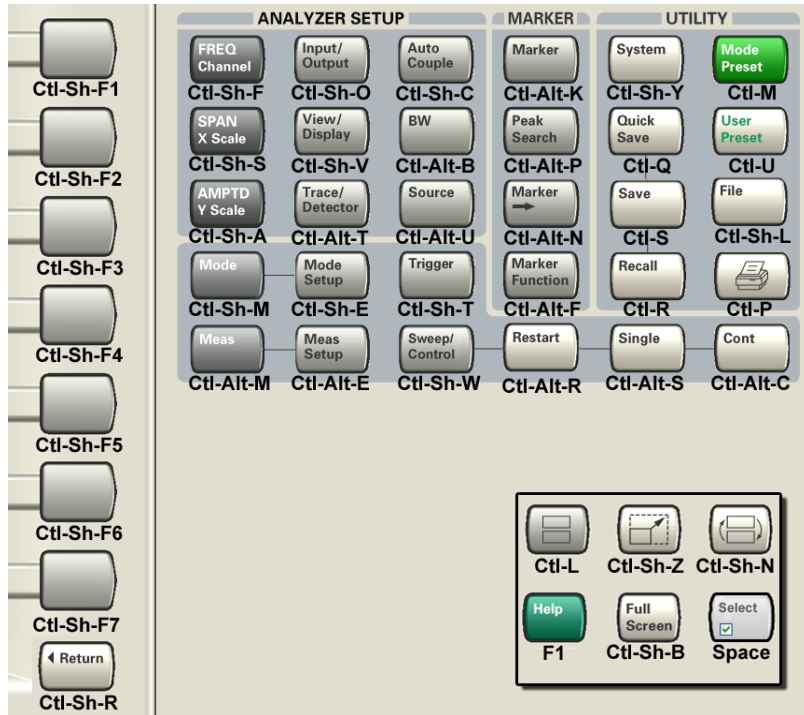

Instrument Security & Memory Volatility

If you are using the instrument in a secure environment, you may need details of how to clear or sanitize its memory, in compliance with published security standards of the United States Department of Defense, or other similar authorities.

For X-Series analyzers, this information is contained in the document "Security Features and Document of Volatility". This document is not included in the Documentation CD, or the instrument's on-disk library, but it may be downloaded from Keysight's web site.

To obtain a copy of the document, click on or browse to the following URL:

<http://www.agilent.com/find/security>

To locate and download the document, select Model Number "N9020A", then click "Submit". Then, follow the on-screen instructions to download the file.

2 About the LTE TDD Measurement Application

This chapter provides overall information on LTE TDD communications systems, and describes LTE TDD measurements made by the analyzer.

What Does the LTE TDD Application Do?

This analyzer can be used for testing a LTE TDD downlink and uplink signals complying with the standards listed below. Because they are continually changed, each release will support the most recent version of these standards:

- 3GPP TS 36.201 V9.1.0 (2010-03) Physical Layer General Description
- 3GPP TS 36.211 V9.1.0 (2010-03) Physical Channels and Modulation
- 3GPP TS 36.212 V9.4.0 (2011-09) Multiplexing and Channel Coding
- 3GPP TS 36.213 V9.3.0 (2010-10) Physical Layer Procedures
- 3GPP TS 36.214 V9.2.0 (2010-06) Physical Layer Measurements
- 3GPP TS 36.101 V9.12.0 (2012-07) UE Radio Transmission and Reception
- 3GPP TS 36.104 V9.12.0 (2012-07) BS Radio Transmission and Reception
- 3GPP TS 36.141 V9.10.0 (2012-07) BS Conformance Testing
- 3GPP TS 36.521-1 V9.8.0 (2012-03) UE Conformance Testing

The instrument automatically makes these measurements using the measurement methods and limits defined in the documents. The detailed results displayed by the measurements enable you to analyze LTE TDD signals performance. You may alter the measurement parameters for specific analysis.

This analyzer makes the following 10 measurements providing power measurements and modulation analysis for the LTE TDD signals:

- Modulation Analysis
- Channel Power
- Adjacent Channel Power (ACP)
- Spectrum Emission Mask
- Spurious Emissions
- Occupied BW
- Power Stat CCDF
- Monitor Spectrum
- IQ Waveform (Time Domain)
- Transmit On/Off Power
- Conformance EVM

3 Programming the Analyzer

This section provides introductory information about the programming documentation included with your product.

- ["What Programming Information is Available?" on page 112](#)
- ["STATus Subsystem " on page 171](#)
- ["IEEE 488.2 Common Commands" on page 213](#)

What Programming Information is Available?

The X-Series Documentation can be accessed through the Additional Documentation page in the instrument Help system and is included on the Documentation DVD shipped with the instrument. It can also be found online at: http://www.agilent.com/find/mxa_manuals.

The following resources are available to help you create programs for automating your X-Series measurements:

Resource	Description
X-Series Programmer's Guide	<p>Provides general SCPI programming information on the following topics:</p> <ul style="list-style-type: none">• Programming the X-Series Applications• Programming fundamentals• Programming examples <p>Note that SCPI command descriptions for measurement applications are not in this book, but are in the User's and Programmer's Reference.</p>
User's and Programmer's Reference manuals	<p>Describes all front-panel keys and softkeys, including SCPI commands for a measurement application. Note that:</p> <ul style="list-style-type: none">• Each measurement application has its own User's and Programmer's Reference.• The content in this manual is duplicated in the instrument's Help (the Help that you see for a key is identical to what you see in this manual).
Embedded Help in your instrument	<p>Describes all front-panel keys and softkeys, including SCPI commands, for a measurement application. Note that the content that you see in Help when you press a key is identical to what you see in the User's and Programmer's Reference.</p>
X-Series Getting Started Guide	<p>Provides valuable sections related to programming including:</p> <ul style="list-style-type: none">• Licensing New Measurement Application Software - After Initial Purchase• Configuring instrument LAN Hostname, IP Address, and Gateway Address• Using the Windows Remote Desktop to connect to the instrument remotely• Using the Embedded Web Server Telnet connection to communicate SCPI <p>This printed document is shipped with the instrument.</p>
Keysight Application Notes	<p>Printable PDF versions of pertinent application notes.</p>
Keysight VISA User's Guide	<p>Describes the Keysight Virtual Instrument Software Architecture (VISA) library and shows how to use it to develop I/O applications and instrument drivers on Windows PCs.</p>

List of SCPI Commands

```

*CAL?
*CLS
*ESE <integer>
*ESE?
*ESR?
*IDN?
*OPC
*OPC?
*OPT?
*RCL <register#>
*RST
*SAV <register#>
*SRE <integer>
*SRE?
*STB?
*TRG
*TST?
*WAI
ABORT
ABORT
CALC:EVM:DATA4:TABL:STR? "FreqErr"
CALCulate:<meas>:DATA[1] | 2 | ...4?[Y | X | XY[, OFF | ON | 0 | 1] | LL |
UL]
CALCulate:<meas>:DATA[1] | 2 | ...4:HEADer:NAMes?
CALCulate:<meas>:DATA[1] | 2 | ...4:HEADer[:NUMBer]? <string>
CALCulate:<meas>:DATA[1] | 2 | ...4:HEADer:STRing? <string>
CALCulate:<meas>:DATA[1] | 2 | ...4:HEADer:TYPE? <string>
CALCulate:<meas>:DATA[1] | 2 | ...4:NAMes?
CALCulate:<meas>:DATA[1] | 2 | ...4:POINts? [OFF | ON | 0 | 1]
CALCulate:<meas>:DATA[1] | 2 | ...4:RAW?
CALCulate:<meas>:DATA[1] | 2 | ...4:RAW:COMPLex?
CALCulate:<meas>:DATA[1] | 2 | ...4:RAW:POINts?
CALCulate:<meas>:DATA[1] | 2 | ...4:TABLE:NAMes?
CALCulate:<meas>:DATA[1] | 2 | ...4:TABLE[:NUMBer]? [<string>]
CALCulate:<meas>:DATA[1] | 2 | ...4:TABLE:STRing? [<string>]
CALCulate:<meas>:DATA[1] | 2 | ...4:TABLE:UNIT?
CALCulate:<meas>:MARKer:AOFF
CALCulate:<meas>:MARKer[1] | 2 | ...12:CFORmat RECTangular | POLar
CALCulate:<meas>:MARKer[1] | 2 | ...12:CFORmat?
CALCulate:<meas>:MARKer:COUple[:STATe] OFF | ON | 0 | 1
CALCulate:<meas>:MARKer:COUple[:STATe]?
CALCulate:<meas>:MARKer[1] | 2 | ...12:CPSeArch[:STATe] ON | OFF | 1 | 0
CALCulate:<meas>:MARKer[1] | 2 | ...12:CPSeArch[:STATe]?
CALCulate:<meas>:MARKer[1] | 2 | ...12:FCOunt[:STATe] OFF | ON | 0 | 1
CALCulate:<meas>:MARKer[1] | 2 | ...12:FCOunt[:STATe]?
CALCulate:<meas>:MARKer[1] | 2 | ...12:FCOunt:X?
CALCulate:<meas>:MARKer[1] | 2 | ...12:FUNCTion BPOWer | BDENSity | =OFF
CALCulate:<meas>:MARKer[1] | 2 | ...12:FUNCTion?
CALCulate:<meas>:MARKer[1] | 2 | ...12:FUNCTion:BAND:CENTer <real>
CALCulate:<meas>:MARKer[1] | 2 | ...12:FUNCTion:BAND:CENTer?

```

3 Programming the Analyzer

List of SCPI Commands

```

CALCulate:<meas>:MARKer[1]|2|...12:FUNction:BAND:LEFT <real>
CALCulate:<meas>:MARKer[1]|2|...12:FUNction:BAND:LEFT?
CALCulate:<meas>:MARKer[1]|2|...12:FUNction:BAND:RIGHT <real>
CALCulate:<meas>:MARKer[1]|2|...12:FUNction:BAND:RIGHT?
CALCulate:<meas>:MARKer[1]|2|...12:FUNction:BAND:SPAN <real>
CALCulate:<meas>:MARKer[1]|2|...12:FUNction:BAND:SPAN?
CALCulate:<meas>:MARKer[1]|2|...12:FUNction:BDENsity:CTYPe MEAN | RMS
CALCulate:<meas>:MARKer[1]|2|...12:FUNction:BDENsity:CTYPe?
CALCulate:<meas>:MARKer[1]|2|...12:FUNction:BPOWer:CTYPe MEAN | RMS
CALCulate:<meas>:MARKer[1]|2|...12:FUNction:BPOWer:CTYPe?
CALCulate:<meas>:MARKer[1]|2|...12:MAXimum
CALCulate:<meas>:MARKer[1]|2|...12:MAXimum:LEFT
CALCulate:<meas>:MARKer[1]|2|...12:MAXimum:NEXT
CALCulate:<meas>:MARKer[1]|2|...12:MAXimum:PREVious
CALCulate:<meas>:MARKer[1]|2|...12:MAXimum:RIGHT
CALCulate:<meas>:MARKer[1]|2|...12:MINimum
CALCulate:<meas>:MARKer[1]|2|...12:MODE POSition | DELTa | FIXed | =OFF
CALCulate:<meas>:MARKer[1]|2|...12:MODE?
CALCulate:<meas>:MARKer[1]|2|...12:REFerence <integer>
CALCulate:<meas>:MARKer[1]|2|...12:REFerence?
CALCulate:<meas>:MARKer:TABLE[:STATE] OFF | ON | 0 | 1
CALCulate:<meas>:MARKer:TABLE[:STATE]?
CALCulate:<meas>:MARKer[1]|2|...12:TRACe <integer>
CALCulate:<meas>:MARKer[1]|2|...12:TRACe?
CALCulate:<meas>:MARKer[1]|2|...12:X <real>
CALCulate:<meas>:MARKer[1]|2|...12:X?
CALCulate:<meas>:MARKer[1]|2|...12[:X]:POSition <real>
CALCulate:<meas>:MARKer[1]|2|...12[:X]:POSition?
CALCulate:<meas>:MARKer[1]|2|...12:X:UNIT?
CALCulate:<meas>:MARKer[1]|2|...12:Y:IMAGinary <real>
CALCulate:<meas>:MARKer[1]|2|...12:Y:IMAGinary?
CALCulate:<meas>:MARKer[1]|2|...12:Y[:REAL] <real>
CALCulate:<meas>:MARKer[1]|2|...12:Y[:REAL]?
CALCulate:<meas>:MARKer[1]|2|...12:Y:UNIT?
CALCulate:<meas>:MARKer[1]|2|...12:Z <real>
CALCulate:<meas>:MARKer[1]|2|...12:Z?
CALCulate:<meas>:MARKer[1]|2|...12:Z:UNIT?
CALCulate:<meas>:TRACe[1]
|2|...4:ACPower:CARRier:BANDwidth|BWIDth:INTegration <bandwidth>
CALCulate:<meas>:TRACe[1]
|2|...4:ACPower:CARRier:BANDwidth|BWIDth:INTegration?
CALCulate:<meas>:TRACe[1]|2|...4:ACPower:CARRier:FILTer:RRC:ALPHA <real>
CALCulate:<meas>:TRACe[1]|2|...4:ACPower:CARRier:FILTer:RRC:ALPHA?
CALCulate:<meas>:TRACe[1]|2|...4:ACPower:CARRier:FILTer:RRC:STATE OFF | ON
| 0 | 1
CALCulate:<meas>:TRACe[1]|2|...4:ACPower:CARRier:FILTer:RRC:STATE?
CALCulate:<meas>:TRACe[1]|2|...4:ACPower:CARRier:FREQuency <freq>
CALCulate:<meas>:TRACe[1]|2|...4:ACPower:CARRier:FREQuency?
CALCulate:<meas>:TRACe[1]|2|...4:ACPower:OFFSet:FILTer:RRC:STATE OFF | ON
| 0 | 1
CALCulate:<meas>:TRACe[1]|2|...4:ACPower:OFFSet:FILTer:RRC:STATE?

```

```

CALCulate:<meas>:TRACe[1]
|2|...4:ACPower:OFFSet:LIST:BANDwidth|BWIDth:INTEgration <bandwidth>, ...
CALCulate:<meas>:TRACe[1]
|2|...4:ACPower:OFFSet:LIST:BANDwidth|BWIDth:INTEgration?
CALCulate:<meas>:TRACe[1]|2|...4:ACPower:OFFSet:LIST:FILTEr:RRC:ALPHA
<real>, ...
CALCulate:<meas>:TRACe[1]|2|...4:ACPower:OFFSet:LIST:FILTEr:RRC:ALPHA?
CALCulate:<meas>:TRACe[1]|2|...4:ACPower:OFFSet:LIST:FREQuency <freq>, ...
CALCulate:<meas>:TRACe[1]|2|...4:ACPower:OFFSet:LIST:FREQuency?
CALCulate:<meas>:TRACe[1]|2|...4:ACPower:OFFSet:LIST:RCARrier <reall>, ...
CALCulate:<meas>:TRACe[1]|2|...4:ACPower:OFFSet:LIST:RCARrier?
CALCulate:<meas>:TRACe[1]|2|...4:ACPower:OFFSet:LIST:RCARrier:TEST OFF |
ON | 0 | 1, ...
CALCulate:<meas>:TRACe[1]|2|...4:ACPower:OFFSet:LIST:RCARrier:TEST?
CALCulate:<meas>:TRACe[1]|2|...4:ACPower:OFFSet:LIST:STATE OFF | ON | 0 |
1, ...
CALCulate:<meas>:TRACe[1]|2|...4:ACPower:OFFSet:LIST:STATE?
CALCulate:<meas>:TRACe[1]|2|...4:ACPower:STATE OFF | ON | 0 | 1
CALCulate:<meas>:TRACe[1]|2|...4:ACPower:STATE?
CALCulate:<meas>:TRACe[1]|2|...4:LIMit:VISible OFF | ON | 0 | 1
CALCulate:<meas>:TRACe[1]|2|...4:LIMit:VISible?
CALCulate:<meas>:TRACe[1]|2|...4:OBWidth:CENTroid?
CALCulate:<meas>:TRACe[1]|2|...4:OBWidth:LIMit:FBLimit <freq>
CALCulate:<meas>:TRACe[1]|2|...4:OBWidth:LIMit:FBLimit?
CALCulate:<meas>:TRACe[1]|2|...4:OBWidth:LIMit[:TEST] OFF | ON | 0 | 1
CALCulate:<meas>:TRACe[1]|2|...4:OBWidth:LIMit[:TEST]?
CALCulate:<meas>:TRACe[1]|2|...4:OBWidth:PERCent <real>
CALCulate:<meas>:TRACe[1]|2|...4:OBWidth:PERCent?
CALCulate:<meas>:TRACe[1]|2|...4:OBWidth:STATE OFF | ON | 0 | 1
CALCulate:<meas>:TRACe[1]|2|...4:OBWidth:STATE?
CALCulate:ACPower:LIMit:STATE OFF | ON | 0 | 1
CALCulate:ACPower:LIMit:STATE?
CALCulate:ACPower:MARKer:AOFF
CALCulate:ACPower:MARKer:COUple[:STATE] ON | OFF | 1 | 0
CALCulate:ACPower:MARKer:COUple[:STATE]?
CALCulate:ACPower:MARKer[1]|2|...|12:FUNCTion:RESult?
CALCulate:ACPower:MARKer[1]|2|...|12:MAXimum
CALCulate:ACPower:MARKer[1]|2|...|12:MAXimum:LEFT
CALCulate:ACPower:MARKer[1]|2|...|12:MAXimum:NEXT
CALCulate:ACPower:MARKer[1]|2|...|12:MAXimum:RIGHT
CALCulate:ACPower:MARKer[1]|2|...|12:MINimum
CALCulate:ACPower:MARKer[1]|2|...|12:MODE POSition | DELTA | OFF
CALCulate:ACPower:MARKer[1]|2|...|12:MODE?
CALCulate:ACPower:MARKer[1]|2|...|12:PTPeak
CALCulate:ACPower:MARKer[1]|2|...|12:REFerence <integer>
CALCulate:ACPower:MARKer[1]|2|...|12:REFerence?
CALCulate:ACPower:MARKer[1]|2|...|12:STATE OFF | ON | 0 | 1
CALCulate:ACPower:MARKer[1]|2|...|12:STATE?
CALCulate:ACPower:MARKer[1]|2|...|12:TRACe 1 | 2 | 3
CALCulate:ACPower:MARKer[1]|2|...|12:TRACe?
CALCulate:ACPower:MARKer[1]|2|...|12:X <freq>
CALCulate:ACPower:MARKer[1]|2|...|12:X?

```

```

CALCulate:ACPower:MARKer[1]|2|...|12:X:POSition <real>
CALCulate:ACPower:MARKer[1]|2|...|12:X:POSition?
CALCulate:ACPower:MARKer[1]|2|...|12:Y?
CALCulate:ACPower:OFFSet[:OUTer]:LIST:LIMit:NEGative[:UPPer]:DATA <real>,
...
CALCulate:ACPower:OFFSet[:OUTer]:LIST:LIMit:NEGative[:UPPer]:DATA?
CALCulate:ACPower:OFFSet[:OUTer]:LIST:LIMit:POSitive[:UPPer]:DATA <real>,
...
CALCulate:ACPower:OFFSet[:OUTer]:LIST:LIMit:POSitive[:UPPer]:DATA?
CALCulate:CHPower:LIMit:POWER <ampl>
CALCulate:CHPower:LIMit:POWER?
CALCulate:CHPower:LIMit:POWER:FAIL?
CALCulate:CHPower:LIMit:POWER:STATE OFF | ON | 0 | 1
CALCulate:CHPower:LIMit:POWER:STATE?
CALCulate:CHPower:LIMit:PSDensity <real>
CALCulate:CHPower:LIMit:PSDensity?
CALCulate:CHPower:LIMit:PSDensity:STATE OFF | ON | 0 | 1
CALCulate:CHPower:LIMit:PSDensity:STATE?
CALCulate:CHPower:LIMit:PSD:FAIL?
CALCulate:CHPower:MARKer:AOff
CALCulate:CHPower:MARKer[1]|2|...|12:MAXimum
CALCulate:CHPower:MARKer[1]|2|...|12:MODE POSition | DELTA | OFF
CALCulate:CHPower:MARKer[1]|2|...|12:MODE?
CALCulate:CHPower:MARKer[1]|2|...|12:REFerence <integer>
CALCulate:CHPower:MARKer[1]|2|...|12:REFerence?
CALCulate:CHPower:MARKer[1]|2|...|12:STATE OFF | ON | 0 | 1
CALCulate:CHPower:MARKer[1]|2|...|12:STATE?
CALCulate:CHPower:MARKer[1]|2|...|12:X <real>
CALCulate:CHPower:MARKer[1]|2|...|12:X?
CALCulate:CHPower:MARKer[1]|2|...|12:X:POSition <real>
CALCulate:CHPower:MARKer[1]|2|...|12:X:POSition?
CALCulate:CHPower:MARKer[1]|2|...|12:Y?
CALCulate:CLIMits:FAIL?
CALCulate:DATA<n>:COMPRESS? BLOCK | CFIT | MAXimum | MINimum | MEAN |
DMEan | RMS | RMSCubed | SAMPLE | SDEVIation | PPHase[, <soffset>[,
<length>[, <roffset>[, <rlimit>]]]]
CALCulate:DATA[n]?
CALCulate:DATA[1]|2|...|6:PEAKs? <threshold>, <excursion>[, AMPLitude |
FREQuency | TIME[, ALL | GTDLine | LTDLine]]
CALCulate:DATA[1]|2|...|6:PEAKs? <threshold>, <excursion>[, AMPLitude |
FREQuency | TIME]
CALCulate:DATA:REGister:ALL:REMove
CALCulate:DATA:REGister[1]|2|...6:EMPTy?
CALCulate:DATA:REGister[1]|2|...6:REMove
CALCulate:EVM:DATA<n>:TABLe:NAMes?
CALCulate:EVM:DATA<n>:TABLe:STRing?
CALCulate:EVM:DATA<n>:TABLe:UNIT?
CALCulate:MCPower:OFFSet:LIST:LIMit:NEGative[:UPPer]:DATA (PSAPowerSuite)
CALCulate:MCPower:OFFSet:LIST:LIMit:POSitive[:UPPer]:DATA (PSAPowerSuite)
CALCulate:MONitor:MARKer:AOff
CALCulate:MONitor:MARKer:COUPle[:STATe] ON | OFF | 1 | 0
CALCulate:MONitor:MARKer:COUPle[:STATe]?

```



```

CALCulate:MONitor:MARKer[1]|2|...|12:FUNCTION NOISe | BPOwer | BDENsity |
OFF
CALCulate:MONitor:MARKer[1]|2|...|12:FUNCTION?
CALCulate:MONitor:MARKer[1]|2|...|12:FUNCTION:BAND:LEFT <freq>
CALCulate:MONitor:MARKer[1]|2|...|12:FUNCTION:BAND:LEFT?
CALCulate:MONitor:MARKer[1]|2|...|12:FUNCTION:BAND:RIGHT <freq>
CALCulate:MONitor:MARKer[1]|2|...|12:FUNCTION:BAND:RIGHT?
CALCulate:MONitor:MARKer[1]|2|...|12:FUNCTION:BAND:SPAN <freq>
CALCulate:MONitor:MARKer[1]|2|...|12:FUNCTION:BAND:SPAN?
CALCulate:MONitor:MARKer[1]|2|...|12:FUNCTION:RESult?
CALCulate:MONitor:MARKer[1]|2|...|12:MAXimum
CALCulate:MONitor:MARKer[1]|2|...|12:MODE POSition | DELTa | OFF
CALCulate:MONitor:MARKer[1]|2|...|12:MODE?
CALCulate:MONitor:MARKer[1]|2|...|12:REFerence <integer>
CALCulate:MONitor:MARKer[1]|2|...|12:REFerence?
CALCulate:MONitor:MARKer[1]|2|...|12:TRACe <integer>
CALCulate:MONitor:MARKer[1]|2|...|12:TRACe?
CALCulate:MONitor:MARKer[1]|2|...|12:X <freq>
CALCulate:MONitor:MARKer[1]|2|...|12:X?
CALCulate:MONitor:MARKer[1]|2|...|12:X:POSition <real>
CALCulate:MONitor:MARKer[1]|2|...|12:X:POSition?
CALCulate:MONitor:MARKer[1]|2|...|12:Y?
CALCulate:OBwidth:LIMit:FBLimit <freq>
CALCulate:OBwidth:LIMit:FBLimit?
CALCulate:OBwidth:LIMit[:TEST] ON | OFF | 1 | 0
CALCulate:OBwidth:LIMit[:TEST]?
CALCulate:OBwidth:MARKer:AOFF
CALCulate:OBwidth:MARKer[1]|2|...|12:MAXimum
CALCulate:OBwidth:MARKer[1]|2|...|12:MODE POSition | DELTa | OFF
CALCulate:OBwidth:MARKer[1]|2|...|12:MODE?
CALCulate:OBwidth:MARKer[1]|2|...|12:REFerence <integer>
CALCulate:OBwidth:MARKer[1]|2|...|12:REFerence?
CALCulate:OBwidth:MARKer[1]|2|...|12:STATE OFF | ON | 0 | 1
CALCulate:OBwidth:MARKer[1]|2|...|12:STATE?
CALCulate:OBwidth:MARKer[1]|2|...|12:X <freq>
CALCulate:OBwidth:MARKer[1]|2|...|12:X?
CALCulate:OBwidth:MARKer[1]|2|...|12:X:POSition <real>
CALCulate:OBwidth:MARKer[1]|2|...|12:X:POSition?
CALCulate:OBwidth:MARKer[1]|2|...|12:Y?
CALCulate:PStatistic:MARKer:AOFF
CALCulate:PStatistic:MARKer[1]|2|...|12:FUNCTION:RESult?
CALCulate:PStatistic:MARKer[1]|2|...|12:MODE POSition | DELTa | OFF
CALCulate:PStatistic:MARKer[1]|2|...|12:MODE?
CALCulate:PStatistic:MARKer[1]|2|...|12:REFerence <integer>
CALCulate:PStatistic:MARKer[1]|2|...|12:REFerence?
CALCulate:PStatistic:MARKer[1]|2|...|12:TRACe MEASured | GAUSSian |
REFERENCE
CALCulate:PStatistic:MARKer[1]|2|...|12:TRACe?
CALCulate:PStatistic:MARKer[1]|2|...|12:X <rel_ampl>
CALCulate:PStatistic:MARKer[1]|2|...|12:X?
CALCulate:PStatistic:MARKer[1]|2|...|12:Y?
CALCulate:PStatistic:STORE:REFerence
CALCulate:PVTime:MARKer:AOFF

```

3 Programming the Analyzer

List of SCPI Commands

```
CALCulate:PVTIME:MARKER:COUPLE[:STATE] ON | OFF | 1 | 0
CALCulate:PVTIME:MARKER:COUPLE[:STATE]?
CALCulate:PVTIME:MARKER[1]|2|...|12:MAXimum
CALCulate:PVTIME:MARKER[1]|2|...|12:MODE POSITION | DELTA | OFF
CALCulate:PVTIME:MARKER[1]|2|...|12:MODE?
CALCulate:PVTIME:MARKER[1]|2|...|12:REFERENCE <integer>
CALCulate:PVTIME:MARKER[1]|2|...|12:REFERENCE?
CALCulate:PVTIME:MARKER[1]|2|...|12:STATE OFF | ON | 0 | 1
CALCulate:PVTIME:MARKER[1]|2|...|12:STATE?
CALCulate:PVTIME:MARKER[1]|2|...|12:TRACE RFENvelope | MAXHold | MINHold
CALCulate:PVTIME:MARKER[1]|2|...|12:TRACE?
CALCulate:PVTIME:MARKER[1]|2|...|12:X <real>
CALCulate:PVTIME:MARKER[1]|2|...|12:X?
CALCulate:PVTIME:MARKER[1]|2|...|12:X:POSITION <real>
CALCulate:PVTIME:MARKER[1]|2|...|12:X:POSITION?
CALCulate:PVTIME:MARKER[1]|2|...|12:Y?
CALCulate:SEMask:LLINE:STATE ON | OFF | 1 | 0
CALCulate:SEMask:LLINE:STATE?
CALCulate:SEMask:MARKER:AOFF
CALCulate:SEMask:MARKER:COUPLE[:STATE] ON | OFF | 1 | 0
CALCulate:SEMask:MARKER:COUPLE[:STATE]?
CALCulate:SEMask:MARKER[1]|2|...|12:FUNCTION:RESULT?
CALCulate:SEMask:MARKER[1]|2|...|12:MODE POSITION | OFF
CALCulate:SEMask:MARKER[1]|2|...|12:MODE?
CALCulate:SEMask:MARKER[1]|2|...|12:X <freq>
CALCulate:SEMask:MARKER[1]|2|...|12:X?
CALCulate:SEMask:MARKER[1]|2|...|12:X:POSITION <real>
CALCulate:SEMask:MARKER[1]|2|...|12:X:POSITION?
CALCulate:SEMask:MARKER[1]|2|...|12:Y?
CALCulate:SPURious:MARKER:AOFF
CALCulate:SPURious:MARKER:COUPLE[:STATE] ON | OFF | 1 | 0
CALCulate:SPURious:MARKER:COUPLE[:STATE]?
CALCulate:SPURious:MARKER[1]|2|...|12:MAXimum
CALCulate:SPURious:MARKER[1]|2|...|12:MAXimum:LEFT
CALCulate:SPURious:MARKER[1]|2|...|12:MAXimum:NEXT
CALCulate:SPURious:MARKER[1]|2|...|12:MAXimum:RIGHT
CALCulate:SPURious:MARKER[1]|2|...|12:MINimum
CALCulate:SPURious:MARKER[1]|2|...|12:MODE POSITION | DELTA | OFF
CALCulate:SPURious:MARKER[1]|2|...|12:MODE?
CALCulate:SPURious:MARKER[1]|2|...|12:PTPeak
CALCulate:SPURious:MARKER[1]|2|...|12:REFERENCE <integer>
CALCulate:SPURious:MARKER[1]|2|...|12:REFERENCE?
CALCulate:SPURious:MARKER[1]|2|...|12:X <freq>
CALCulate:SPURious:MARKER[1]|2|...|12:X?
CALCulate:SPURious:MARKER[1]|2|...|12:X:POSITION <integer>
CALCulate:SPURious:MARKER[1]|2|...|12:X:POSITION?
CALCulate:SPURious:MARKER[1]|2|...|12:Y?
CALCulate:SPURious[:RANGE][:LIST]:LIMIT:ABSolute[:UPPER]:DATA[:START]
<ampl>, ...
CALCulate:SPURious[:RANGE][:LIST]:LIMIT:ABSolute[:UPPER]:DATA[:START]?
CALCulate:SPURious[:RANGE][:LIST]:LIMIT:ABSolute[:UPPER]:DATA:STOP <ampl>,
...
CALCulate:SPURious[:RANGE][:LIST]:LIMIT:ABSolute[:UPPER]:DATA:STOP?
```

```

CALCulate:SPURious[:RANGE][:LIST]:LIMIT:ABSolute[:UPPer]:DATA:STOP:AUTO
OFF|ON|0|1, ...
CALCulate:SPURious[:RANGE][:LIST]:LIMIT:ABSolute[:UPPer]:DATA:STOP:AUTO?
CALCulate:WAVEform:MARKer:AOff
CALCulate:WAVEform:MARKer:COUPle[:STATE] ON | OFF | 1 | 0
CALCulate:WAVEform:MARKer:COUPle[:STATE]?
CALCulate:WAVEform:MARKer[1]|2|...|12:FUNCTION BPOwer | BDENsity | OFF
CALCulate:WAVEform:MARKer[1]|2|...|12:FUNCTION?
CALCulate:WAVEform:MARKer[1]|2|...|12:FUNCTION:BAND:LEFT <time>
CALCulate:WAVEform:MARKer[1]|2|...|12:FUNCTION:BAND:LEFT?
CALCulate:WAVEform:MARKer[1]|2|...|12:FUNCTION:BAND:RIGHT <time>
CALCulate:WAVEform:MARKer[1]|2|...|12:FUNCTION:BAND:RIGHT?
CALCulate:WAVEform:MARKer[1]|2|...|12:FUNCTION:BAND:SPAN <time>
CALCulate:WAVEform:MARKer[1]|2|...|12:FUNCTION:BAND:SPAN?
CALCulate:WAVEform:MARKer[1]|2|...|12:FUNCTION:RESult?
CALCulate:WAVEform:MARKer[1]|2|...|12:MAXimum
CALCulate:WAVEform:MARKer[1]|2|...|12:MAXimum:NEXT
CALCulate:WAVEform:MARKer[1]|2|...|12:MINimum
CALCulate:WAVEform:MARKer[1]|2|...|12:MODE POSition | DELTA | OFF
CALCulate:WAVEform:MARKer[1]|2|...|12:MODE?
CALCulate:WAVEform:MARKer[1]|2|...|12:REFerence <integer>
CALCulate:WAVEform:MARKer[1]|2|...|12:REFerence?
CALCulate:WAVEform:MARKer[1]|2|...|12:STATE OFF | ON | 0 | 1
CALCulate:WAVEform:MARKer[1]|2|...|12:STATE?
CALCulate:WAVEform:MARKer[1]|2|...|12:TRACe RFENvelope | I | Q | IQ
CALCulate:WAVEform:MARKer[1]|2|...|12:TRACe?
CALCulate:WAVEform:MARKer[1]|2|...|12:X <time>
CALCulate:WAVEform:MARKer[1]|2|...|12:X?
CALCulate:WAVEform:MARKer[1]|2|...|12:X:POSition <real>
CALCulate:WAVEform:MARKer[1]|2|...|12:X:POSition?
CALCulate:WAVEform:MARKer[1]|2|...|4:X:SPAN
CALCulate:WAVEform:MARKer[1]|2|...|12:Y?
CALibration[:ALL]
CALibration[:ALL]?
CALibration:AUTO ON | PARTial | OFF
CALibration:AUTO ALERT
CALibration:AUTO?
CALibration:AUTO:ALERT TEMPerature | DAY | WEEK | NONE
CALibration:AUTO:ALERT?
CALibration:AUTO:MODE ALL | NRF
CALibration:AUTO:MODE?
CALibration:AUTO:TIME:OFF?
CALibration:DATA:BACKUp <filename>
CALibration:DATA:DEFault
CALibration:DATA:REStore <filename>
CALibration:EMIXer
CALibration:EMIXer?
CALibration:EXPIred?
CALibration:FREQuency:REFerence:COARse <integer>
CALibration:FREQuency:REFerence:COARse
CALibration:FREQuency:REFerence:COARse?
CALibration:FREQuency:REFerence:FINE <integer>
CALibration:FREQuency:REFerence:FINE?

```

3 Programming the Analyzer

List of SCPI Commands

```
CALibration:FREQuency:REFeRence:MODE CALibrated | USER
CALibration:FREQuency:REFeRence:MODE?
CALibration:IQ:FLATness:I
CALibration:IQ:FLATness:IBAR
CALibration:IQ:FLATness:I|IBAR|Q|QBAR:TIME?
CALibration:IQ:FLATness:Q
CALibration:IQ:FLATness:QBAR
CALibration:IQ:ISOLation
CALibration:IQ:ISOLation:TIME?
CALibration:IQ:PROBE:I
CALibration:IQ:PROBE:IBar
CALibration:IQ:PROBE:I|IBAR|Q|QBAR:TIME?
CALibration:IQ:PROBE:I|Q:CLEAr
CALibration:IQ:PROBE:Q
CALibration:IQ:PROBE:QBar
CALibration:NFLoor
CALibration:NFLoor?
CALibration:NRF
CALibration:NRF?
CALibration:REFeRence:CLOCK?
CALibration:REFeRence:CLOCK:END?
CALibration:REFeRence:CLOCK:INITialize?
CALibration:RF
CALibration:RF?
CALibration:RFPSelector:SCHeduler:TIME:NEXT?
CALibration:SOURce:STATe OFF | ON | 0 | 1
CALibration:SOURce:STATe?
CALibration:TEMPerature:CURREnt?
CALibration:TEMPerature:LALL?
CALibration:TEMPerature:LPReselector?
CALibration:TEMPerature:LRF?
CALibration:TEMPerature:NFLoor?
CALibration:TEMPerature:RFPSelector:LCONducted?
CALibration:TEMPerature:RFPSelector:LRADiated?
CALibration:TIME:ELAPsed:NFLoor?
CALibration:TIME:LALL?
CALibration:TIME:LPReselector?
CALibration:TIME:LRF?
CALibration:TIME:NFLoor?
CALibration:TIME:REFeRence:CLOCK?
CALibration:TIME:RFPSelector:LCONducted?
CALibration:TIME:RFPSelector:LRADiated?
CALibration:YTF
CALibration:YTF?
CONF FSC
CONFigure?
CONFigure:ACP
CONFigure:ACP:NDEFault
CONFigure:ACPower
CONFigure:CEVM
CONFigure:CEVM:NDEFault
CONFigure:CHPower
CONFigure:CHPower
```

```

CONFigure:CHPower:NDEFault
CONFigure:EVM
CONFigure:MONitor
CONFigure:MONitor
CONFigure:MONitor:NDEFault
CONFigure:OBWidth
CONFigure:OBWidth
CONFigure:OBWidth:NDEFault
CONFigure:PStatistic
CONFigure:PStatistic
CONFigure:PStatistic:NDEFault
CONFigure:PVTime
CONFigure:PVTime
CONFigure:PVTime:NDEFault
CONFigure:SEMask
CONFigure:SEMask
CONFigure:SEMask:NDEFault
CONFigure:SPURious
CONFigure:SPURious
CONFigure:SPURious:NDEFault
CONFigure:VECTor
CONFigure:WAVEform
CONFigure:WAVEform
CONFigure:WAVEform:NDEFault
COUple ALL | NONE
DISPlay:<meas>:AFPoints OFF | ON | 0 | 1
DISPlay:<meas>:AFPoints?
DISPlay:<meas>:FANNotation CSPAN | SSTOP
DISPlay:<meas>:FANNotation?
DISPlay:<meas>:TRACe[1]|2|...4:COpy D1 | D2 | D3 | D4 | D5 | D6
DISPlay:<meas>:TRACe[1]|2|...4:DDEMod:ALIN?
DISPlay:<meas>:TRACe[1]|2|...4:DDEMod:ALINe OFF | ON | 0 | 1
DISPlay:<meas>:TRACe[1]|2|...4:DDEMod:EYE:COUNT <real>
DISPlay:<meas>:TRACe[1]|2|...4:DDEMod:EYE:COUNT?
DISPlay:<meas>:TRACe[1]|2|...4:DDEMod:SYMBOL BARS | DOTS | OFF
DISPlay:<meas>:TRACe[1]|2|...4:DDEMod:SYMBOL?
DISPlay:<meas>:TRACe[1]|2|...4:DDEMod:SYMBOL:FORMAt HEXadecimal | BINary
DISPlay:<meas>:TRACe[1]|2|...4:DDEMod:SYMBOL:FORMAt?
DISPlay:<meas>:TRACe[1]|2|...4:DDEMod:SYMBOL:SHAPE CIRCLE | CROSS | OFF
DISPlay:<meas>:TRACe[1]|2|...4:DDEMod:SYMBOL:SHAPE?
DISPlay:<meas>:TRACe[1]|2|...4:DDEMod:SYMBOL:SIZE <real>
DISPlay:<meas>:TRACe[1]|2|...4:DDEMod:SYMBOL:SIZE?
DISPlay:<meas>:TRACe[1]|2|...4:DDEMod:UNIT:FREQuency CARRIER | HZ
DISPlay:<meas>:TRACe[1]|2|...4:DDEMod:UNIT:FREQuency?
DISPlay:<meas>:TRACe[1]|2|...4:DDEMod:UNIT:TIME SEC | SYMBOL
DISPlay:<meas>:TRACe[1]|2|...4:DDEMod:UNIT:TIME?
DISPlay:<meas>:TRACe[1]|2|...4:FEED <string>
DISPlay:<meas>:TRACe[1]|2|...4:FEED?
DISPlay:<meas>:TRACe[1]|2|...4:FORMAt MLOG | MLINear | REAL | IMAGinary |
VECTor | CONS | PHASe | UPHase | IEYE | QEYE | TRELlis | GDELay |
MLGLinear
DISPlay:<meas>:TRACe[1]|2|...4:FORMAt?
DISPlay:<meas>:TRACe[1]|2|...4:FORMAt:DELay:APERture <real>

```

3 Programming the Analyzer

List of SCPI Commands

```
DISPlay:<meas>:TRACe[1]|2|...4:FORMat:DELay:APERture?
DISPlay:<meas>:TRACe[1]|2|...4:FORMat:PHASe:OFFSet <real>
DISPlay:<meas>:TRACe[1]|2|...4:FORMat:PHASe:OFFSet?
DISPlay:<meas>:TRACe[1]|2|...4:FORMat:PHASe:UNWRap:REFerence <real>
DISPlay:<meas>:TRACe[1]|2|...4:FORMat:PHASe:UNWRap:REFerence?
DISPlay:<meas>:TRACe[1]|2|...4:RLINE OFF | ON | 0 | 1:DISPlay:<meas>:TRACe
[1] | 2 | ...4:RLINE?
DISPlay:<meas>:TRACe[1]|2|...4:VHCenter <real>
DISPlay:<meas>:TRACe[1]|2|...4:VHCenter?
DISPlay:<meas>:TRACe[1]|2|...4:X[:SCALE]:COUple OFF | ON | 0 | 1
DISPlay:<meas>:TRACe[1]|2|...4:X[:SCALE]:COUple?
DISPlay:<meas>:TRACe[1]|2|...4:X[:SCALE]:RLEVel <real>
DISPlay:<meas>:TRACe[1]|2|...4:X[:SCALE]:RLEVel?
DISPlay:<meas>:TRACe[1]|2|...4:X[:SCALE]:RPOsition LEFT | CENTER | RIGHT
DISPlay:<meas>:TRACe[1]|2|...4:X[:SCALE]:RPOsition?
DISPlay:<meas>:TRACe[1]|2|...4:X[:SCALE]:SPAN <real>
DISPlay:<meas>:TRACe[1]|2|...4:X[:SCALE]:SPAN?
DISPlay:<meas>:TRACe[1]|2|...4:Y:LRATio <real>
DISPlay:<meas>:TRACe[1]|2|...4:Y:LRATio?
DISPlay:<meas>:TRACe[1]|2|...4:Y[:SCALE]:AUTO:ONCE
DISPlay:<meas>:TRACe[1]|2|...4:Y[:SCALE]:PDIVision <real>
DISPlay:<meas>:TRACe[1]|2|...4:Y[:SCALE]:PDIVision?
DISPlay:<meas>:TRACe[1]|2|...4:Y[:SCALE]:RLEVel <real>
DISPlay:<meas>:TRACe[1]|2|...4:Y[:SCALE]:RLEVel?
DISPlay:<meas>:TRACe[1]|2|...4:Y[:SCALE]:RLEVel:AUTO OFF | ON | 0 | 1
DISPlay:<meas>:TRACe[1]|2|...4:Y[:SCALE]:RLEVel:AUTO?
DISPlay:<meas>:TRACe[1]|2|...4:Y[:SCALE]:RPOsition TOP | CENTER | BOTTom
DISPlay:<meas>:TRACe[1]|2|...4:Y[:SCALE]:RPOsition?
DISPlay:<meas>:TRACe[1]|2|...4:Y:UNIT?
DISPlay:<meas>:TRACe[1]|2|...4:Y:UNIT:PREFerence AUTO | PEAK | RMS | POWer
| MRMS
DISPlay:<meas>:TRACe[1]|2|...4:Y:UNIT:PREFerence?
DISPlay:<meas>:WINDow:FORMat SINGLE | TWO | TRI | QUAD | GR2X3 | GR3X2
DISPlay:<meas>:WINDow:FORMat SINGLE | TWO | TRI | QUAD
DISPlay:<meas>:WINDow:FORMat?
DISPlay:<meas>:WINDow:FORMat?
DISPlay:<measurement>:ANNotation:TITLe:DATA <string>
DISPlay:<measurement>:ANNotation:TITLe:DATA?
DISPlay:ACPower:VIEW:NSElect <integer>
DISPlay:ACPower:VIEW:NSElect?
DISPlay:ACPower:VIEW[:SElect] PRESult | CINformation
DISPlay:ACPower:VIEW[:SElect]?
DISPlay:ACPower:VIEW[1]:WINDow[1]:BGRaph OFF | ON | 0 | 1
DISPlay:ACPower:VIEW[1]:WINDow[1]:BGRaph?
DISPlay:ACPower:VIEW[1]:WINDow[1]:TRACe:Y[:SCALE]:COUple 0 | 1 | OFF | ON
DISPlay:ACPower:VIEW[1]:WINDow[1]:TRACe:Y[:SCALE]:COUple?
DISPlay:ACPower:VIEW[1]:WINDow[1]:TRACe:Y[:SCALE]:PDIVision <rel_ampl>
DISPlay:ACPower:VIEW[1]:WINDow[1]:TRACe:Y[:SCALE]:PDIVision?
DISPlay:ACPower:VIEW[1]:WINDow[1]:TRACe:Y[:SCALE]:RLEVel <real>
DISPlay:ACPower:VIEW[1]:WINDow[1]:TRACe:Y[:SCALE]:RLEVel?
DISPlay:ACPower:VIEW[1]:WINDow[1]:TRACe:Y[:SCALE]:RPOsition TOP | CENTER |
BOTTom
```

```

DISPlay:ACPower:VIEW[1]:WINDow[1]:TRACe:Y[:SCALe]:RPOSition?
DISPlay:ACTivefunc[:STATe] ON | OFF | 1 | 0
DISPlay:ACTivefunc[:STATe]?
DISPlay:ANNotation:MBAR[:STATe] OFF | ON | 0 | 1
DISPlay:ANNotation:MBAR[:STATe]?
DISPlay:ANNotation:SCREen[:STATe] OFF | ON | 0 | 1
DISPlay:ANNotation:SCREen[:STATe]?
DISPlay:BACKlight ON | OFF
DISPlay:BACKlight?
DISPlay:BACKlight:INTensity <integer>
DISPlay:BACKlight:INTensity?
DISPlay:CEVM:VIEW[:SELEct] MLISt | PARAmeter | RESult | RFENvelope
DISPlay:CEVM:VIEW[:SELEct]?
DISPlay:CHPower:VIEW:NSELEct <integer>
DISPlay:CHPower:VIEW:NSELEct?
DISPlay:CHPower:VIEW[:SELEct] RFSpectrum | SHOULder | MASK
DISPlay:CHPower:VIEW[:SELEct] PRESult | CINformation
DISPlay:CHPower:VIEW[:SELEct] RFSpectrum | SHOULder
DISPlay:CHPower:VIEW[:SELEct]?
DISPlay:CHPower:VIEW[:SELEct]?
DISPlay:CHPower:VIEW[:SELEct]?
DISPlay:CHPower:VIEW[1]:WINDow[1]:BGRaph ON | OFF | 1 | 0
DISPlay:CHPower:VIEW[1]:WINDow[1]:BGRaph?
DISPlay:CHPower:VIEW[1]:WINDow[1]:TRACe:Y[:SCALe]:COUPlE 0 | 1 | OFF | ON
DISPlay:CHPower:VIEW[1]:WINDow[1]:TRACe:Y[:SCALe]:COUPlE?
DISPlay:CHPower:VIEW[1]:WINDow[1]:TRACe:Y[:SCALe]:PDIVision <rel_ampl>
DISPlay:CHPower:VIEW[1]:WINDow[1]:TRACe:Y[:SCALe]:PDIVision?
DISPlay:CHPower:VIEW[1]:WINDow[1]:TRACe:Y[:SCALe]:RLEVEl <real>
DISPlay:CHPower:VIEW[1]:WINDow[1]:TRACe:Y[:SCALe]:RLEVEl?
DISPlay:CHPower:VIEW[1]:WINDow[1]:TRACe:Y[:SCALe]:RPOSition TOP | CENTER |
BOTTom
DISPlay:CHPower:VIEW[1]:WINDow[1]:TRACe:Y[:SCALe]:RPOSition?
DISPlay:ENABle OFF | ON | 0 | 1
DISPlay:ENABle?
DISPlay:EVM:VIEW:PRESEt SUBCarrier
DISPlay:EVM:VIEW:PRESEt RBSLot
DISPlay:EVM:VIEW:PRESEt SUMMary
DISPlay:EVM:VIEW:PRESEt BASic
DISPlay:EVM:VIEW:PRESEt MIMO
DISPlay:EVM:VIEW:PRESEt BASic | SUMMary | RBSLot | SUBCarrier | MIMO
DISPlay:FSCREen[:STATe] OFF | ON | 0 | 1
DISPlay:FSCREen[:STATe]?
DISPlay:MENU[:STATe] OFF | ON | 0 | 1
DISPlay:MONitor:VIEW:NSELEct <integer>
DISPlay:MONitor:VIEW:NSELEct?
DISPlay:MONitor:VIEW[:SELEct] RTRace | CINformation
DISPlay:MONitor:VIEW[:SELEct]?
DISPlay:MONitor:VIEW:WINDow:TRACe[1]|2|3:CLEar
DISPlay:MONitor:VIEW:WINDow:TRACe:CLEar:ALL
DISPlay:MONitor:VIEW:WINDow:TRACe[1]|2|3:TYPE
DISPlay:MONitor:VIEW[1]:WINDow[1]:TRACe:Y[:SCALe]:COUPlE 0 | 1 | OFF | ON
DISPlay:MONitor:VIEW[1]:WINDow[1]:TRACe:Y[:SCALe]:COUPlE?
DISPlay:MONitor:VIEW[1]:WINDow[1]:TRACe:Y[:SCALe]:PDIVision <rel_ampl>

```

```

DISPlay:MONitor:VIEW[1]:WINDow[1]:TRACe:Y[:SCALE]:PDIVision?
DISPlay:MONitor:VIEW[1]:WINDow[1]:TRACe:Y[:SCALE]:RLEVel <real>
DISPlay:MONitor:VIEW[1]:WINDow[1]:TRACe:Y[:SCALE]:RLEVel?
DISPlay:MONitor:VIEW[1]:WINDow[1]:TRACe:Y[:SCALE]:RPOStition TOP | CENTer |
BOTTom
DISPlay:MONitor:VIEW[1]:WINDow[1]:TRACe:Y[:SCALE]:RPOStition?
DISPlay:OBWidth:VIEW[1]:WINDow[1]:TRACe:Y[:SCALE]:COUPle 0 | 1 | OFF | ON
DISPlay:OBWidth:VIEW[1]:WINDow[1]:TRACe:Y[:SCALE]:COUPle?
DISPlay:OBWidth:VIEW[1]:WINDow[1]:TRACe:Y[:SCALE]:PDIVision <rel_ampl>
DISPlay:OBWidth:VIEW[1]:WINDow[1]:TRACe:Y[:SCALE]:PDIVision?
DISPlay:OBWidth:VIEW[1]:WINDow[1]:TRACe:Y[:SCALE]:RLEVel <real>
DISPlay:OBWidth:VIEW[1]:WINDow[1]:TRACe:Y[:SCALE]:RLEVel?
DISPlay:OBWidth:VIEW[1]:WINDow[1]:TRACe:Y[:SCALE]:RPOStition TOP | CENTer |
BOTTom
DISPlay:OBWidth:VIEW[1]:WINDow[1]:TRACe:Y[:SCALE]:RPOStition?
DISPlay:PStatistic:GAUSSian[:STATE] OFF | ON | 0 | 1
DISPlay:PStatistic:GAUSSian[:STATE]?
DISPlay:PStatistic:RTRace[:STATE] OFF | ON | 0 | 1
DISPlay:PStatistic:RTRace[:STATE]?
DISPlay:PStatistic:VIEW[1]:WINDow2:TRACe:X[:SCALE]:PDIVision <rel_ampl>
DISPlay:PStatistic:VIEW[1]:WINDow2:TRACe:X[:SCALE]:PDIVision?
DISPlay:PStatistic:XSCale
DISPlay:PVTime:RAMP[:STATE] OFF | ON | 0 | 1
DISPlay:PVTime:RAMP[:STATE]?
DISPlay:PVTime:VIEW:NSElect <integer>
DISPlay:PVTime:VIEW:NSElect?
DISPlay:PVTime:VIEW[:SElect] ALL | BOTH
DISPlay:PVTime:VIEW[:SElect]?
DISPlay:PVTime:VIEW[1]:WINDow[1]:BLINes[:STATE] ON | OFF | 1 | 0
DISPlay:PVTime:VIEW[1]:WINDow[1]:BLINes[:STATE]?
DISPlay:PVTime:VIEW[1]:WINDow[1]:LIMit:MASK OFF | ON | 0 | 1
DISPlay:PVTime:VIEW[1]:WINDow[1]:LIMit:MASK?
DISPlay:PVTime:VIEW[1]:WINDow[1]:TRACe:MAXHold[:STATE] ON | OFF | 1 | 0
DISPlay:PVTime:VIEW[1]:WINDow[1]:TRACe:MAXHold[:STATE]?
DISPlay:PVTime:VIEW[1]:WINDow[1]:TRACe:MINHold[:STATE] ON | OFF | 1 | 0
DISPlay:PVTime:VIEW[1]:WINDow[1]:TRACe:MINHold[:STATE]?
DISPlay:PVTime:VIEW2:WINDow[1]|2:TRACe:X[:SCALE]:COUPle 0 | 1 | OFF | ON
DISPlay:PVTime:VIEW[1]:WINDow[1]:TRACe:X[:SCALE]:COUPle 0 | 1 | OFF | ON
DISPlay:PVTime:VIEW2:WINDow[1]|2:TRACe:X[:SCALE]:COUPle?
DISPlay:PVTime:VIEW[1]:WINDow[1]:TRACe:X[:SCALE]:COUPle?
DISPlay:PVTime:VIEW[1]:WINDow[1]:TRACe:X[:SCALE]:PDIVision <time>
DISPlay:PVTime:VIEW2:WINDow[1]|2:TRACe:X[:SCALE]:PDIVision <time>
DISPlay:PVTime:VIEW[1]:WINDow[1]:TRACe:X[:SCALE]:PDIVision?
DISPlay:PVTime:VIEW2:WINDow[1]|2:TRACe:X[:SCALE]:PDIVision?
DISPlay:PVTime:VIEW[1]:WINDow[1]:TRACe:X[:SCALE]:RLEVel <time>
DISPlay:PVTime:VIEW2:WINDow[1]|2:TRACe:X[:SCALE]:RLEVel <time>
DISPlay:PVTime:VIEW[1]:WINDow[1]:TRACe:X[:SCALE]:RLEVel?
DISPlay:PVTime:VIEW2:WINDow[1]|2:TRACe:X[:SCALE]:RLEVel?
DISPlay:PVTime:VIEW2:WINDow[1]|2:TRACe:X[:SCALE]:RPOStition LEFT | CENTer |
RIGHT
DISPlay:PVTime:VIEW[1]:WINDow[1]:TRACe:X[:SCALE]:RPOStition LEFT | CENTer |
RIGHT

```



```

DISPlay:PVTime:VIEW[1]:WINDow[1]:TRACe:X[:SCALe]:RPOSition?
DISPlay:PVTime:VIEW2:WINDow[1]|2:TRACe:X[:SCALe]:RPOSition?
DISPlay:PVTime:VIEW[1]:WINDow[1]:TRACe:Y[:SCALe]:COUPlE 0 | 1 | OFF | ON
DISPlay:PVTime:VIEW2:WINDow[1]|2:TRACe:Y[:SCALe]:COUPlE 0 | 1 | OFF | ON
DISPlay:PVTime:VIEW2:WINDow[1]|2:TRACe:Y[:SCALe]:COUPlE?
DISPlay:PVTime:VIEW[1]:WINDow[1]:TRACe:Y[:SCALe]:COUPlE?
DISPlay:PVTime:VIEW[1]:WINDow[1]:TRACe:Y[:SCALe]:PDIVision <rel_ampl>
DISPlay:PVTime:VIEW2:WINDow[1]|2:TRACe:Y[:SCALe]:PDIVision <rel_ampl>
DISPlay:PVTime:VIEW[1]:WINDow[1]:TRACe:Y[:SCALe]:PDIVision?
DISPlay:PVTime:VIEW2:WINDow[1]|2:TRACe:Y[:SCALe]:PDIVision?
DISPlay:PVTime:VIEW2:WINDow[1]|2:TRACe:Y[:SCALe]:RLEVel <real>
DISPlay:PVTime:VIEW[1]:WINDow[1]:TRACe:Y[:SCALe]:RLEVel <real>
DISPlay:PVTime:VIEW2:WINDow[1]|2:TRACe:Y[:SCALe]:RLEVel?
DISPlay:PVTime:VIEW[1]:WINDow[1]:TRACe:Y[:SCALe]:RLEVel?
DISPlay:PVTime:VIEW[1]:WINDow[1]:TRACe:Y[:SCALe]:RPOSition TOP | CENTer |
BOTTom
DISPlay:PVTime:VIEW2:WINDow[1]|2:TRACe:Y[:SCALe]:RPOSition TOP | CENTer |
BOTTom
DISPlay:PVTime:VIEW[1]:WINDow[1]:TRACe:Y[:SCALe]:RPOSition?
DISPlay:PVTime:VIEW2:WINDow[1]|2:TRACe:Y[:SCALe]:RPOSition?
DISPlay:PVTime:VIEW[1]:WINDow[1]:TRIGger[:STATe] ON | OFF | 1 | 0
DISPlay:PVTime:VIEW[1]:WINDow[1]:TRIGger[:STATe]?
DISPlay:SEMAsk:VIEW:NSElect <integer>
DISPlay:SEMAsk:VIEW:NSElect?
DISPlay:SEMAsk:VIEW[:SElect] APFReq | RPFReq | IPOWer | CINformation
DISPlay:SEMAsk:VIEW[:SElect]?
DISPlay:SEMAsk:VIEW[1]:WINDow[1]:TRACe:X[:SCALe]:COUPlE 0 | 1 | OFF | ON
DISPlay:SEMAsk:VIEW[1]:WINDow[1]:TRACe:X[:SCALe]:COUPlE?
DISPlay:SEMAsk:VIEW[1]:WINDow[1]:TRACe:X[:SCALe]:PDIVision ?
DISPlay:SEMAsk:VIEW[1]:WINDow[1]:TRACe:X[:SCALe]:PDIVision <freq>
DISPlay:SEMAsk:VIEW[1]:WINDow[1]:TRACe:X[:SCALe]:RLEVel <freq>
DISPlay:SEMAsk:VIEW[1]:WINDow[1]:TRACe:X[:SCALe]:RLEVel?
DISPlay:SEMAsk:VIEW[1]:WINDow[1]:TRACe:X[:SCALe]:RPOSition LEFT | CENTer |
RIGHT
DISPlay:SEMAsk:VIEW[1]:WINDow[1]:TRACe:X[:SCALe]:RPOSition?
DISPlay:SEMAsk:VIEW[1]:WINDow[1]:TRACe:Y[:SCALe]:COUPlE 0 | 1 | ON | OFF
DISPlay:SEMAsk:VIEW[1]:WINDow[1]:TRACe:Y[:SCALe]:COUPlE?
DISPlay:SEMAsk:VIEW[1]:WINDow[1]:TRACe:Y[:SCALe]:PDIVision <rel_ampl>
DISPlay:SEMAsk:VIEW[1]:WINDow[1]:TRACe:Y[:SCALe]:PDIVision?
DISPlay:SEMAsk:VIEW[1]:WINDow[1]:TRACe:Y[:SCALe]:RLEVel <real>
DISPlay:SEMAsk:VIEW[1]:WINDow[1]:TRACe:Y[:SCALe]:RLEVel?
DISPlay:SEMAsk:VIEW[1]:WINDow[1]:TRACe:Y[:SCALe]:RPOSition TOP | CENTer |
BOTTom
DISPlay:SEMAsk:VIEW[1]:WINDow[1]:TRACe:Y[:SCALe]:RPOSition?
DISPlay:SPURious:VIEW:RANGe[:SElect] <integer>
DISPlay:SPURious:VIEW:RANGe[:SElect]?
DISPlay:SPURious:VIEW:RANGe:TABLE <integer>
DISPlay:SPURious:VIEW:RANGe:TABLE?
DISPlay:SPURious:VIEW[:SElect] RESult | RANGe | ALL
DISPlay:SPURious:VIEW[:SElect]?
DISPlay:SPURious:VIEW[1]:WINDow[1]:TRACe:Y[:SCALe]:COUPlE 0 | 1 | OFF | ON
DISPlay:SPURious:VIEW[1]:WINDow[1]:TRACe:Y[:SCALe]:COUPlE?

```

3 Programming the Analyzer

List of SCPI Commands

```
DISPlay:SPURious:VIEW[1]:WINDow[1]:TRACe:Y[:SCALe]:PDIVision <rel_ampl>
DISPlay:SPURious:VIEW[1]:WINDow[1]:TRACe:Y[:SCALe]:PDIVision?
DISPlay:SPURious:VIEW[1]:WINDow[1]:TRACe:Y[:SCALe]:RLEVel <real>
DISPlay:SPURious:VIEW[1]:WINDow[1]:TRACe:Y[:SCALe]:RLEVel?
DISPlay:WAVEform:VIEW:NSElect <integer>
DISPlay:WAVEform:VIEW:NSElect?
DISPlay:WAVEform:VIEW[:SElect] RFENvelope | IQ
DISPlay:WAVEform:VIEW[:SElect]?
DISPlay:WAVEform:VIEW[1]|2:WINDow[1]:TRACe:X[:SCALe]:COUPlE 0 | 1 | OFF |
ON
DISPlay:WAVEform:VIEW[1]|2:WINDow[1]:TRACe:X[:SCALe]:COUPlE?
DISPlay:WAVEform:VIEW[1]|2:WINDow[1]:TRACe:X[:SCALe]:PDIVision <time>
DISPlay:WAVEform:VIEW[1]|2:WINDow[1]:TRACe:X[:SCALe]:PDIVision?
DISPlay:WAVEform:VIEW[1]|2:WINDow[1]:TRACe:X[:SCALe]:RLEVel <time>
DISPlay:WAVEform:VIEW[1]|2:WINDow[1]:TRACe:X[:SCALe]:RLEVel?
DISPlay:WAVEform:VIEW[1]|2:WINDow[1]:TRACe:X[:SCALe]:RPOSition LEFT |
CENTer | RIGHT
DISPlay:WAVEform:VIEW[1]|2:WINDow[1]:TRACe:X[:SCALe]:RPOSition?
DISPlay:WAVEform:VIEW[1]|2:WINDow[1]:TRACe:Y[:SCALe]:COUPlE 0 | 1 | OFF |
ON
DISPlay:WAVEform:VIEW[1]|2:WINDow[1]:TRACe:Y[:SCALe]:COUPlE?
DISPlay:WAVEform:VIEW2:WINDow[1]:TRACe:Y[:SCALe]:PDIVision <voltage>
DISPlay:WAVEform:VIEW[1]:WINDow[1]:TRACe:Y[:SCALe]:PDIVision <rel_ampl>
DISPlay:WAVEform:VIEW2:WINDow[1]:TRACe:Y[:SCALe]:PDIVision?
DISPlay:WAVEform:VIEW[1]:WINDow[1]:TRACe:Y[:SCALe]:PDIVision?
DISPlay:WAVEform:VIEW[1]:WINDow[1]:TRACe:Y[:SCALe]:RLEVel <ampl>
DISPlay:WAVEform:VIEW2:WINDow[1]:TRACe:Y[:SCALe]:RLEVel <voltage>
DISPlay:WAVEform:VIEW[1]:WINDow[1]:TRACe:Y[:SCALe]:RLEVel?
DISPlay:WAVEform:VIEW2:WINDow[1]:TRACe:Y[:SCALe]:RLEVel?
DISPlay:WAVEform:VIEW[1]:WINDow[1]:TRACe:Y[:SCALe]:RPOSition TOP | CENTer
| BOTTom
DISPlay:WAVEform:VIEW2:WINDow[1]:TRACe:Y[:SCALe]:RPOSition TOP | CENTer |
BOTTom
DISPlay:WAVEform:VIEW2:WINDow[1]:TRACe:Y[:SCALe]:RPOSition?
DISPlay:WAVEform:VIEW[1]:WINDow[1]:TRACe:Y[:SCALe]:RPOSition?
DISPlay:WINDow[1]:ANNotation[:ALL] OFF | ON | 0 | 1
DISPlay:WINDow[1]:ANNotation[:ALL]?
DISPlay:WINDow:FORMat:TILE
DISPlay:WINDow:FORMat:ZOOM
DISPlay:WINDow[:SElect] <number>
DISPlay:WINDow[:SElect]?
DISPlay:WINDow[1]:TRACe:GRATICule:GRID[:STATe] OFF | ON | 0 | 1
DISPlay:WINDow[1]:TRACe:GRATICule:GRID[:STATe]?
FETCh:<meas>[n]?
FETCh:ACP[n]?
FETCh:CEVM[n]?
FETCh:CHPower:CHPower?
FETCh:CHPower:DENSity?
FETCh:CHPower[n]?
FETCh:EVM[n]?
FETCh:FCAPture?
FETCh:MONitor[n]?
```

```

FETCh:OBWidth:FERRor?
FETCh:OBWidth[n]?
FETCh:OBWidth:OBWidth?
FETCh:OBWidth:XDB?
FETCh:PStatistic[n]?
FETCh:PVTime[n]?
FETCh:SEMask[n]?
FETCh:SPURious[n]?
FETCh:WAVEform[n]?
FORMat:BORDER NORMAl | SWAPped
FORMat:BORDER?
FORMat[:TRACe][:DATA] ASCii | INTeger, 32 | REAL, 32 | REAL, 64
FORMat[:TRACe][:DATA]?
GLOBal:DEFault
GLOBal:FREQUency:CENTer[:STATe] 1 | 0 | ON | OFF
GLOBal:FREQUency:CENTer[:STATe]?
HCOpy:ABORT
HCOpy[:IMMediate]
INITiate:ACP
INITiate:CEVM
INITiate:CHPower
INITiate:CONTinuous OFF | ON | 0 | 1
INITiate:CONTinuous?
INITiate:EVM
INITiate:FCAPture
INITiate[:IMMediate]
INITiate:MONitor
INITiate:OBWidth
INITiate:PAUSE
INITiate:PStatistic
INITiate:PVTime
INITiate:REStart
INITiate:RESume
INITiate:SEMask
INITiate:SPURious
INITiate:WAVEform
INPut:COUpling AC | DC
INPut:COUpling?
INPut:COUpling:I|Q DC | LFR1 | LFR2
INPut:COUpling:I|Q?
INPut:IMPedance:IQ U50 | B50 | U1M | B1M
INPut:IMPedance:IQ?
INPut:IMPedance:REFerence <integer>
INPut:IMPedance:REFerence?
INPut[1]:IQ:BALanced[:STATe] OFF | ON | 0 | 1
INPut[1]:IQ:BALanced[:STATe]?
INPut:IQ[:I]:DIFFerential OFF | ON | 0 | 1
INPut:IQ[:I]:DIFFerential?
INPut[1]:IQ[:I]:IMPedance LOW | HIGH
INPut[1]:IQ[:I]:IMPedance?
INPut:IQ:MIRRored OFF | ON | 0 | 1
INPut:IQ:MIRRored?
INPut:IQ:Q:DIFFerential OFF | ON | 0 | 1

```

3 Programming the Analyzer

List of SCPI Commands

```
INPut:IQ:Q:DIFFerential?
INPut[1]:IQ:Q:IMPedance LOW | HIGH
INPut[1]:IQ:Q:IMPedance?
INPut[1]:IQ:TYPE IQ | I | Q
INPut[1]:IQ:TYPE?
INPut:MIXer EXTernal | INTernal
INPut:MIXer?
INPut:OFFSet:I|Q <voltage>
INPut:OFFSet:I|Q?
INST:NSEL 105
INST:NSEL 102
INSTrument:CATalog?
INSTrument:COUPle:DEFault
INSTrument:COUPle:FREQuency:CENTer ALL | NONE
INSTrument:COUPle:FREQuency:CENTer?
INSTrument:DEFault
INSTrument:NSElect <integer>
INSTrument:NSElect?
INSTrument[:SElect] SA | RTSA | SEQAN | EMI | BASIC | WCDMA | EDGE GSM |
WIMAXOFDMA | VSA | PNOISE | NFIGure | ADEMOD | BTooth | TDSCDMA | CDMA2K |
CDMA1XEV | LTE | LTETDD | LTEAFDD | LTEATDD | MSR | DVB | DTMB | DCATV |
ISDBT | CMMB | WLAN | CWLAN | CWIMAXOFDM | WIMAXFIXED | IDEN | RLC |
SCPILC | VSA89601
INSTrument[:SElect] RECeiver
INSTrument[:SElect] SANalyzer
INSTrument[:SElect] GSM
INSTrument[:SElect] 'SA' | 'PNOISE' | 'EDGE' | 'GSM' | 'BASIC'
INSTrument[:SElect]?
INST:SEL LTE
INST:SEL SCPILC
INST:SEL LTETDD
INST:SEL EMI
LXI:IDENtify[:STATE] OFF | ON | 0 | 1
LXI:IDENtify[:STATE]?
MEASure:ACP[n]?
MEASure:CEVM[n]?
MEASure:CHPower:CHPower?
MEASure:CHPower:DENSity?
MEASure:CHPower[n]?
MEASure:EVM[n]?
MEASure:MONitor[n]?
MEASure:OBWidth:FERRor?
MEASure:OBWidth[n]?
MEASure:OBWidth:OBWidth?
MEASure:OBWidth:XDB?
MEASure:PStatistic[n]?
MEASure:PVTime[n]?
MEASure:SEMask[n]?
MEASure:SPURious[n]?
MEASure:WAVEform[n]?
MEMory:EVM:STORE:ECFResponse
MMEMory:CATalog? [<directory_name>]
```

```

MMEMory:CDIRectory [<directory_name>]
MMEMory:CDIRectory?
MMEMory:COpy <string>, <string>[, <string>, <string>]
MMEMory:COpy:DEvice <source_string>, <dest_string>
MMEMory:DATA <file_name>, <data>
MMEMory:DATA? <file_name>
MMEMory:DELeTe <file_name>[, <directory_name>]
MMEMory:LOAD:EVMSetup <string>
MMEMory:LOAD:MASK <string>
MMEMory:LOAD:SSSetup <string>
MMEMory:LOAD:STATE 1, <filename>
MMEMory:LOAD:STATE <filename>
MMEMory:LOAD:TRACe:DATA D1 | D2 | D3 | D4 | D5 | D6, <filename>[, CSV |
TXT | SDF | MAT4 | MAT | HDF5 | BIN]
MMEMory:LOAD:VSASetup <string>
MMEMory:MDIRectory <directory_name>
MMEMory:MOVE <string>, <string>[, <string>, <string>]
MMEMory:RDIRectory <directory_name>
MMEMory:REGister:STATe:LAbel <regnumber>, "label"
MMEMory:REGister:STATe:LAbel? <regnumber>
MMEMory:STORe:RESuLts <string>
MMEMory:STORe:RESuLts <string>
MMEMory:STORe:RESuLts <string>
MMEMory:STORe:RESuLts <string>
MMEMory:STORe:RESuLts <string>
MMEMory:STORe:RESuLts <string>
MMEMory:STORe:RESuLts:MTAbLe|PTAbLe|SPeCTrogram <filename>
MMEMory:STORe:SCReen <filename>
MMEMory:STORe:SCReen:THEME TDColor | TDMonochrome | FCOLor | FMONochrome
MMEMory:STORe:SCReen:THEME?
MMEMory:STORe:STATe <filename>
MMEMory:STORe:STATe 1, <filename>
MMEMory:STORe:TRACe:DATA TRACE1 | TRACE2 | TRACE3 | TRACE4 | TRACE5 |
TRACE6, "<filename>"[, CSV | TXT | SDF | MAT4 | MAT | HDF5 | BIN[, OFF |
ON | 0 | 1]]
OUTPut:ANALog OFF | SVIDeO | LOGVIdEO | LINVIdEO | DAUDIO
OUTPut:ANALog?
OUTPut:ANALog:AUTO OFF | ON | 0 | 1
OUTPut:ANALog:AUTO?
OUTPut:AUX SIF | AIF | LOGVIdEO | OFF
OUTPut:AUX?
OUTPut:AUX:AIF <value>
OUTPut:AUX:AIF?
OUTPut:DBUS[1][:STATe] ON | OFF | 1 | 0
OUTPut:DBUS[1][:STATe]?
OUTPut:IQ:OUTPut IQ1 | IQ250 | OFF
OUTPut:IQ:OUTPut?
READ:<meas>[n]?
READ:ACP[n]?
READ:CEVM[n]?
READ:CHPower:CHPower?
READ:CHPower:DENSity

```

```
READ:CHPower[n]?
READ:EVM[n]?
READ:MONitor[n]?
READ:OBwidth:FERRor?
READ:OBwidth[n]?
READ:OBwidth:OBwidth?
READ:OBwidth:XDB?
READ:PStatistic[n]?
READ:PVTime[n]?
READ:SEMask[n]?
READ:SPURious[n]?
READ:WAVEform[n]?
[:SENSe]:<meas>:AVERAge:COUNT <integer>
[:SENSe]:<meas>:AVERAge:COUNT?
[:SENSe]:<meas>:AVERAge:FAST OFF | ON | 0 | 1
[:SENSe]:<meas>:AVERAge:FAST?
[:SENSe]:<meas>:AVERAge:FAST:URATe <integer>
[:SENSe]:<meas>:AVERAge:FAST:URATe?
[:SENSe]:<meas>:AVERAge:FAST:URATe:AUTO OFF | ON | 0 | 1
[:SENSe]:<meas>:AVERAge:FAST:URATe:AUTO?
[:SENSe]:<meas>:AVERAge[:STATe] OFF | ON | 0 | 1
[:SENSe]:<meas>:AVERAge[:STATe]?
[:SENSe]:<meas>:AVERAge:TCONTRol EXPONential | REPeat
[:SENSe]:<meas>:AVERAge:TCONTRol?
[:SENSe]:<meas>:AVERAge:TYPE RMS | TIME | MAXimum
[:SENSe]:<meas>:AVERAge:TYPE?
[:SENSe]:<meas>:FFT:WINDow[:TYPE] UNIFORM | HANNing | GAUSSian | FLATtop
[:SENSe]:<meas>:FFT:WINDow[:TYPE]?
[:SENSe]:<meas>:PUPDate:ENABLE OFF | ON | 0 | 1
[:SENSe]:<meas>:PUPDate:ENABLE?
[:SENSe]:<meas>:SWEep:ISRATe?
[:SENSe]:<measurement>:TRIGger:SOURce IF
[:SENSe]:<measurement>:TRIGger:SOURce
[:SENSe]:ACPower:AVERAge:COUNT <integer>
[:SENSe]:ACPower:AVERAge:COUNT?
[:SENSe]:ACPower:AVERAge[:STATe] OFF | ON | 0 | 1
[:SENSe]:ACPower:AVERAge[:STATe]?
[:SENSe]:ACPower:AVERAge:TCONTRol EXPONential | REPeat
[:SENSe]:ACPower:AVERAge:TCONTRol?
[:SENSe]:ACPower:BANDwidth:INTegration
[:SENSe]:ACPower:BANDwidth[:RESolution] <freq>
[:SENSe]:ACPower:BANDwidth[:RESolution]?
[:SENSe]:ACPower:BANDwidth[:RESolution]:AUTO ON | OFF | 1 | 0
[:SENSe]:ACPower:BANDwidth[:RESolution]:AUTO?
[:SENSe]:ACPower:BANDwidth:SHAPE GAUSSian | FLATtop
[:SENSe]:ACPower:BANDwidth:SHAPE?
[:SENSe]:ACPower:BANDwidth:TYPE DB3 | DB6
[:SENSe]:ACPower:BANDwidth:TYPE?
[:SENSe]:ACPower:BANDwidth:VIDeo <freq>
[:SENSe]:ACPower:BANDwidth:VIDeo?
[:SENSe]:ACPower:BANDwidth:VIDeo:AUTO OFF | ON | 0 | 1
[:SENSe]:ACPower:BANDwidth:VIDeo:AUTO?
[:SENSe]:ACPower:BWIDth:INTegration
```

```

[:SENSe]:ACPower:BWIDth[:RESolution]
[:SENSe]:ACPower:BWIDth:SHAPE
[:SENSe]:ACPower:BWIDth:TYPE
[:SENSe]:ACPower:BWIDth:VIDeo
[:SENSe]:ACPower:CARRier[1]|2:AUTO[:STATE] OFF | ON | 0 | 1
[:SENSe]:ACPower:CARRier[1]|2:AUTO[:STATE]?
[:SENSe]:ACPower:CARRier[1]|2:COUNt <integer>
[:SENSe]:ACPower:CARRier[1]|2:COUNt?
[:SENSe]:ACPower:CARRier[1]|2:CPSD <real>
[:SENSe]:ACPower:CARRier[1]|2:CPSD?
[:SENSe]:ACPower:CARRier[1]|2:LIST:BANDwidth[:INTEgration] <freq>, ...
[:SENSe]:ACPower:CARRier[1]|2:LIST:BANDwidth[:INTEgration]?
[:SENSe]:ACPower:CARRier[1]|2:LIST:BWIDth[:INTEgration]
[:SENSe]:ACPower:CARRier[1]|2:LIST:COUPlE OFF|ON|0|1, ...
[:SENSe]:ACPower:CARRier[1]|2:LIST:COUPlE?
[:SENSe]:ACPower:CARRier[1]|2:LIST:FILTer:ALPHa <real>, ...
[:SENSe]:ACPower:CARRier[1]|2:LIST:FILTer:ALPHa?
[:SENSe]:ACPower:CARRier[1]|2:LIST:FILTer[:RRC][:STATE] ON|OFF|1|0, ...
[:SENSe]:ACPower:CARRier[1]|2:LIST:FILTer[:RRC][:STATE]?
[:SENSe]:ACPower:CARRier[1]|2:LIST:METHod IBW | RRC, ...
[:SENSe]:ACPower:CARRier[1]|2:LIST:METHod?
[:SENSe]:ACPower:CARRier[1]|2:LIST:PPResent YES|NO, ...
[:SENSe]:ACPower:CARRier[1]|2:LIST:PPResent?
[:SENSe]:ACPower:CARRier[1]|2:LIST:WIDTh <freq>, ...
[:SENSe]:ACPower:CARRier[1]|2:LIST:WIDTh?
[:SENSe]:ACPower:CARRier[1]|2[:POWER] <real>
[:SENSe]:ACPower:CARRier[1]|2[:POWER]?
[:SENSe]:ACPower:CARRier[1]|2:RCARRier <integer>
[:SENSe]:ACPower:CARRier[1]|2:RCARRier?
[:SENSe]:ACPower:CARRier[1]|2:RCARRier:AUTO OFF | ON | 0 | 1
[:SENSe]:ACPower:CARRier[1]|2:RCARRier:AUTO?
[:SENSe]:ACPower:CARRier[1]|2:RCFRequency <freq>
[:SENSe]:ACPower:CARRier[1]|2:RCFRequency?
[:SENSe]:ACPower:CARRier[1]|2:RCFRequency:AUTO OFF | ON | 0 | 1
[:SENSe]:ACPower:CARRier[1]|2:RCFRequency:AUTO?
[:SENSe]:ACPower:CORRection:NOISe[:AUTO] OFF | ON | 0 | 1
[:SENSe]:ACPower:CORRection:NOISe[:AUTO]?
[:SENSe]:ACPower:DETEctor:AUTO ON | OFF | 1 | 0
[:SENSe]:ACPower:DETEctor:AUTO?
[:SENSe]:ACPower:DETEctor[:FUNction] AVERAge | NEGAtive | NORMAl |
Positive | SAMPlE
[:SENSe]:ACPower:DETEctor[:FUNction]?
[:SENSe]:ACPower:FILTer[:RRC]:ALPHa <real>
[:SENSe]:ACPower:FILTer[:RRC]:ALPHa?
[:SENSe]:ACPower:FILTer[:RRC][:STATE] OFF | ON | 0 | 1
[:SENSe]:ACPower:FILTer[:RRC][:STATE]?
[:SENSe]:ACPower:FREQuency:SPAN <freq>
[:SENSe]:ACPower:FREQuency:SPAN?
[:SENSe]:ACPower:FREQuency:SPAN:FULL
[:SENSe]:ACPower:FREQuency:SPAN:PREVIOUS
[:SENSe]:ACPower:FREQuency:SYNThesis:AUTO[:STATE] OFF | ON | 0 | 1
[:SENSe]:ACPower:FREQuency:SYNThesis:AUTO[:STATE]?
[:SENSe]:ACPower:FREQuency:SYNThesis[:STATE] 1 | 2 | 3

```

3 Programming the Analyzer

List of SCPI Commands

```
[ :SENSe]:ACPower:FREQuency:SYNThesis[:STATe]?
[:SENSe]:ACPower:LIMit[:STATe]
[:SENSe]:ACPower:METHod IBW | IBWRange | FAST | RBW
[:SENSe]:ACPower:METHod?
[:SENSe]:ACPower:OFFSet[1]|2[:LIST:BWIDth[:INTEgration]
[:SENSe]:ACPower:OFFSet[1]|2[:LIST:BWIDth:RESolution
[:SENSe]:ACPower:OFFSet[1]|2[:LIST:BWIDth:SHAPE
[:SENSe]:ACPower:OFFSet[1]|2[:LIST:BWIDth:TYPE
[:SENSe]:ACPower:OFFSet[1]|2[:LIST:BWIDth:VIDeo
[:SENSe]:ACPower:OFFSet[1]|2[:OUTer]:LIST:ABSolute <real>, ...
[:SENSe]:ACPower:OFFSet[1]|2[:OUTer]:LIST:ABSolute?
[:SENSe]:ACPower:OFFSet[1]|2[:OUTer]:LIST:BANdwidth[:INTEgration] <freq>,
...
[:SENSe]:ACPower:OFFSet[1]|2[:OUTer]:LIST:BANdwidth[:INTEgration]?
[:SENSe]:ACPower:OFFSet[1]|2[:OUTer]:LIST:BANdwidth:RESolution <freq>, ...
[:SENSe]:ACPower:OFFSet[1]|2[:OUTer]:LIST:BANdwidth:RESolution?
[:SENSe]:ACPower:OFFSet[1]|2[:OUTer]:LIST:BANdwidth:RESolution:AUTO
ON|OFF|1|0, ...
[:SENSe]:ACPower:OFFSet[1]|2[:OUTer]:LIST:BANdwidth:RESolution:AUTO?
[:SENSe]:ACPower:OFFSet[1]|2[:OUTer]:LIST:BANdwidth:SHAPE
GAUSSian|FLATtop, ...
[:SENSe]:ACPower:OFFSet[1]|2[:OUTer]:LIST:BANdwidth:SHAPE?
[:SENSe]:ACPower:OFFSet[1]|2[:OUTer]:LIST:BANdwidth:TYPE DB3|DB6, ...
[:SENSe]:ACPower:OFFSet[1]|2[:OUTer]:LIST:BANdwidth:TYPE?
[:SENSe]:ACPower:OFFSet[1]|2[:OUTer]:LIST:BANdwidth:VIDeo <freq>, ...
[:SENSe]:ACPower:OFFSet[1]|2[:OUTer]:LIST:BANdwidth:VIDeo?
[:SENSe]:ACPower:OFFSet[1]|2[:OUTer]:LIST:BANdwidth:VIDeo:AUTO OFF|ON|0|1,
...
[:SENSe]:ACPower:OFFSet[1]|2[:OUTer]:LIST:BANdwidth:VIDeo:AUTO?
[:SENSe]:ACPower:OFFSet[1]|2[:OUTer]:LIST:FILTer:ALPHa <real>, ...
[:SENSe]:ACPower:OFFSet[1]|2[:OUTer]:LIST:FILTer:ALPHa?
[:SENSe]:ACPower:OFFSet[1]|2[:OUTer]:LIST:FILTer[:RRC][:STATe] ON|OFF|1|0,
...
[:SENSe]:ACPower:OFFSet[1]|2[:OUTer]:LIST:FILTer[:RRC][:STATe]?
[:SENSe]:ACPower:OFFSet[1]|2[:OUTer]:LIST[:FREQuency] <freq>, ...
[:SENSe]:ACPower:OFFSet[1]|2[:OUTer]:LIST[:FREQuency]?
[:SENSe]:ACPower:OFFSet[1]|2[:OUTer]:LIST:RCARrier <real>, ...
[:SENSe]:ACPower:OFFSet[1]|2[:OUTer]:LIST:RCARrier?
[:SENSe]:ACPower:OFFSet[1]|2[:OUTer]:LIST:RPSDensity <rel_ampl>, ...
[:SENSe]:ACPower:OFFSet[1]|2[:OUTer]:LIST:RPSDensity?
[:SENSe]:ACPower:OFFSet[1]|2[:OUTer]:LIST:SIDE NEGative|BOTH|POSitive, ...
[:SENSe]:ACPower:OFFSet[1]|2[:OUTer]:LIST:SIDE?
[:SENSe]:ACPower:OFFSet[1]|2[:OUTer]:LIST:STATe OFF|ON|0|1, ...
[:SENSe]:ACPower:OFFSet[1]|2[:OUTer]:LIST:STATe?
[:SENSe]:ACPower:OFFSet[1]|2[:OUTer]:LIST:TEST ABSolute|AND|OR|RELative,
...
[:SENSe]:ACPower:OFFSet[1]|2[:OUTer]:LIST:TEST?
[:SENSe]:ACPower:OFFSet[1]|2[:OUTer]:TYPE CTOCenter | CTOEdge | ETOCenter
| ETOEdge
[:SENSe]:ACPower:OFFSet[1]|2[:OUTer]:TYPE?
[:SENSe]:ACPower:SWEep:POINts <integer>
[:SENSe]:ACPower:SWEep:POINts?
```



```

[:SENSE]:ACPower:SWEEP:TIME <time>
[:SENSE]:ACPower:SWEEP:TIME?
[:SENSE]:ACPower:SWEEP:TIME:AUTO OFF | ON | 0 | 1
[:SENSE]:ACPower:SWEEP:TIME:AUTO?
[:SENSE]:ACPower:SWEEP:TIME:AUTO:RULES NORMAL | ACCURACY
[:SENSE]:ACPower:SWEEP:TIME:AUTO:RULES?
[:SENSE]:ACPower:TYPE TPRef | PSDRef
[:SENSE]:ACPower:TYPE?
[:SENSE]:ACPR:AVERAGE:COUNT
[:SENSE]:ACPR:AVERAGE:TCONTROL
[:SENSE]:ACPR:FILTER[:RRC]:ALPHA
[:SENSE]:ACPR:FILTER[:RRC][:STATE]
[:SENSE]:ACPR:OFFSET[1]|2:LIST:ABSOLUTE (PSAW-CDMA, PSACDMA2000)
[:SENSE]:ACPR:OFFSET[1]|2:LIST:BANDWIDTH
[:SENSE]:ACPR:OFFSET[1]|2:LIST:BWIDTh
[:SENSE]:ACPR:SWEEP:DETECTOR[:FUNCTION]
[:SENSE]:ACPR:SWEEP:TYPE
[:SENSE]:ACPR:TRIGGER:SOURCE
[:SENSE]:ACP:SWEEP:BANDWIDTH|BWIDTh[:RESOLUTION] (PSAW-CDMA, PSACDMA2000)
[:SENSE]:CEVM:EQUALIZER:TRAINING
[:SENSE]:CEVM:EVM:COPY[:IMMEDIATE]
[:SENSE]:CEVM:METHOd NORMAL | FAST
[:SENSE]:CEVM:METHOd?
[:SENSE]:CEVM:ULINK:PROFile:USER:HOPPING:GROUp
[:SENSE]:CEVM:ULINK:PROFile:USER1|50:HOPPING:SEQuence
[:SENSE]:CEVM:ULINK:PROFile:USER:PUSCh
[:SENSE]:CEVM:ULINK:PROFile:USER:PUSCh:ACTive
[:SENSE]:CEVM:ULINK:PROFile:USER:PUSCh:ADD:SLOT
[:SENSE]:CEVM:ULINK:PROFile:USER:PUSCh:DMRS
[:SENSE]:CEVM:ULINK:PROFile:USER:PUSCh:DMRS:ONE
[:SENSE]:CEVM:ULINK:PROFile:USER:PUSCh:DMRS:PARAmS
[:SENSE]:CEVM:ULINK:PROFile:USER:PUSCh:DMRS:TWO
[:SENSE]:CEVM:ULINK:PROFile:USER:PUSCh:DSS
[:SENSE]:CEVM:ULINK:PROFile:USER:PUSCh:FHOPping
[:SENSE]:CEVM:ULINK:PROFile:USER1|50:PUSCh:MODulation:TYPE
[:SENSE]:CEVM:ULINK:PROFile:USER:PUSCh:RB:END
[:SENSE]:CEVM:ULINK:PROFile:USER:PUSCh:RB:END:COUple
[:SENSE]:CEVM:ULINK:PROFile:USER:PUSCh:RB:START
[:SENSE]:CEVM:ULINK:PROFile:USER:PUSCh:RB:START:COUple
[:SENSE]:CEVM:ULINK:PROFile:USER:PUSCh:SSLot
[:SENSE]:CEVM:ULINK:PROFile:USER:PUSCh:SSLot:AUTO
[:SENSE]:CHPower:AVERAGE:COUNT <integer>
[:SENSE]:CHPower:AVERAGE:COUNT?
[:SENSE]:CHPower:AVERAGE[:STATE] ON | OFF | 1 | 0
[:SENSE]:CHPower:AVERAGE[:STATE]?
[:SENSE]:CHPower:AVERAGE:TCONTROL EXPONENTIAL | REPEAT
[:SENSE]:CHPower:AVERAGE:TCONTROL?
[:SENSE]:CHPower:BANDWIDTH:INTEgration <bandwidth>
[:SENSE]:CHPower:BANDWIDTH:INTEgration?
[:SENSE]:CHPower:BANDWIDTH[:RESOLUTION] <bandwidth>
[:SENSE]:CHPower:BANDWIDTH[:RESOLUTION]?
[:SENSE]:CHPower:BANDWIDTH[:RESOLUTION]:AUTO ON | OFF | 1 | 0
[:SENSE]:CHPower:BANDWIDTH[:RESOLUTION]:AUTO?

```

```

[:SENSe]:CHPower:BANDwidth:SHApe GAUSSian | FLATtop
[:SENSe]:CHPower:BANDwidth:SHApe?
[:SENSe]:CHPower:BANDwidth:VIDeo <bandwidth>
[:SENSe]:CHPower:BANDwidth:VIDeo?
[:SENSe]:CHPower:BANDwidth:VIDeo:AUTO ON | OFF | 1 | 0
[:SENSe]:CHPower:BANDwidth:VIDeo:AUTO?
[:SENSe]:CHPower:BWIDth[:RESolution]
[:SENSe]:CHPower:BWIDth:SHApe
[:SENSe]:CHPower:DETEctor:AUTO ON | OFF | 1 | 0
[:SENSe]:CHPower:DETEctor:AUTO?
[:SENSe]:CHPower:DETEctor[:FUNction] NORMal | AVERage | POSitive | SAMPlE
| NEGative
[:SENSe]:CHPower:DETEctor[:FUNction]?
[:SENSe]:CHPower:FILTEr[:RRC]:ALPHa <real>
[:SENSe]:CHPower:FILTEr[:RRC]:ALPHa?
[:SENSe]:CHPower:FILTEr[:RRC]:BANDwidth <real>
[:SENSe]:CHPower:FILTEr[:RRC]:BANDwidth?
[:SENSe]:CHPower:FILTEr[:RRC]:BWIDth
[:SENSe]:CHPower:FILTEr[:RRC][:STATE] OFF | ON | 0 | 1
[:SENSe]:CHPower:FILTEr[:RRC][:STATE]?
[:SENSe]:CHPower:FREQUency:SPAN <freq>
[:SENSe]:CHPower:FREQUency:SPAN?
[:SENSe]:CHPower:FREQUency:SPAN:FULL
[:SENSe]:CHPower:FREQUency:SPAN:PREVious
[:SENSe]:CHPower:FREQUency:SYNThesis:AUTO[:STATE] OFF | ON | 0 | 1
[:SENSe]:CHPower:FREQUency:SYNThesis:AUTO[:STATE]?
[:SENSe]:CHPower:FREQUency:SYNThesis[:STATE] 1 | 2 | 3
[:SENSe]:CHPower:FREQUency:SYNThesis[:STATE]?
[:SENSe]:CHPower:IF:GAIN:AUTO[:STATE] ON | OFF | 1 | 0
[:SENSe]:CHPower:IF:GAIN:AUTO[:STATE]?
[:SENSe]:CHPower:IF:GAIN[:STATE] ON | OFF | 1 | 0
[:SENSe]:CHPower:IF:GAIN[:STATE]?
[:SENSe]:CHPower:SWEep:POINts <integer>
[:SENSe]:CHPower:SWEep:POINts?
[:SENSe]:CHPower:SWEep:TIME <time>
[:SENSe]:CHPower:SWEep:TIME?
[:SENSe]:CHPower:SWEep:TIME:AUTO OFF | ON | 0 | 1
[:SENSe]:CHPower:SWEep:TIME:AUTO?
[:SENSe]:CHPower:SWEep:TIME:AUTO:RULEs NORMal | ACCuracy
[:SENSe]:CHPower:SWEep:TIME:AUTO:RULEs?
[:SENSe]:CORRection:BTS[:RF]:GAIN <rel_ampl>
[:SENSe]:CORRection:BTS[:RF]:GAIN?
[:SENSe]:CORRection:BTS[:RF]:LOSS <rel_ampl>
[:SENSe]:CORRection:BTS[:RF]:LOSS?
[:SENSe]:CORRection:CSET:ALL:DELEte
[:SENSe]:CORRection:CSET:ALL[:STATE] ON | OFF | 1 | 0
[:SENSe]:CORRection:CSET:ALL[:STATE]?
[:SENSe]:CORRection:CSET[1]:ANTenna[:UNIT] GAUSS | PTESla | UVM | UAM | UA
| NOConversion
[:SENSe]:CORRection:CSET[1]:ANTenna[:UNIT]?
[:SENSe]:CORRection:CSET[1]|2|...|8:COMMEnt "text"
[:SENSe]:CORRection:CSET[1]|2|...|8:COMMEnt?
[:SENSe]:CORRection:CSET[1]|2|...|8:DATA <freq>, <ampl>, ...

```

```

[:SENSE]:CORREction:CSET[1]|2|...|8:DATA?
[:SENSE]:CORREction:CSET[1]|2|...|8:DATA:MERGe <freq>, <ampl>, ...
[:SENSE]:CORREction:CSET[1]|2|...|6:DELeTe
[:SENSE]:CORREction:CSET[1]|2|...|8:DESCription "text"
[:SENSE]:CORREction:CSET[1]|2|...|8:DESCription?
[:SENSE]:CORREction:CSET[1]|2|...|8[:STATE] ON | OFF | 1 | 0
[:SENSE]:CORREction:CSET[1]|2|...|8[:STATE]?
[:SENSE]:CORREction:CSET[1]|2|...|8:X:SPACing LINear | LOGarithmic
[:SENSE]:CORREction:CSET[1]|2|...|8:X:SPACing?
[:SENSE]:CORREction:FEQualizer OFF | NORMal | INVert
[:SENSE]:CORREction:FEQualizer?
[:SENSE]:CORREction:FEQualizer:REGister D1 | D2 | D3 | D4 | D5 | D6
[:SENSE]:CORREction:FEQualizer:REGister?
[:SENSE]:CORREction:IMPedance[:INPut][:MAGNitude] 50 | 75
[:SENSE]:CORREction:IMPedance[:INPut][:MAGNitude]?
[:SENSE]:CORREction:IQ:I:GAIN <rel_ampl>
[:SENSE]:CORREction:IQ:I:GAIN?
[:SENSE]:CORREction:IQ:I|Q:ATTenuation <rel_ampl>
[:SENSE]:CORREction:IQ:I|Q:ATTenuation?
[:SENSE]:CORREction:IQ:I|Q:ATTenuation:RATio <real>
[:SENSE]:CORREction:IQ:I|Q:ATTenuation:RATio?
[:SENSE]:CORREction:IQ[:I]:SKEW <seconds>
[:SENSE]:CORREction:IQ[:I]:SKEW?
[:SENSE]:CORREction:IQ:Q:GAIN <rel_ampl>
[:SENSE]:CORREction:IQ:Q:GAIN?
[:SENSE]:CORREction:IQ:Q:SKEW <seconds>
[:SENSE]:CORREction:IQ:Q:SKEW?
[:SENSE]:CORREction:MS[:RF]:GAIN <rel_ampl>
[:SENSE]:CORREction:MS[:RF]:GAIN?
[:SENSE]:CORREction:MS[:RF]:LOSS <rel_ampl>
[:SENSE]:CORREction:MS[:RF]:LOSS?
[:SENSE]:CORREction:NOISe:FLOor ON | OFF | 1 | 0
[:SENSE]:CORREction:NOISe:FLOor?
[:SENSE]:CORREction:OFFSet[:MAGNitude]
[:SENSE]:CORREction:SA[:RF]:GAIN <rel_ampl>
[:SENSE]:CORREction:SA[:RF]:GAIN?
[:SENSE]:EBwidth:AVERage:COUNT
[:SENSE]:EBwidth:FREQuency:SPAN
[:SENSE]:EBwidth:MAXHold
[:SENSE]:EBwidth:XDB
[:SENSE]:EVM:DLINK:AENumber <integer>
[:SENSE]:EVM:DLINK:AENumber?
[:SENSE]:EVM:DLINK:AESpacing <double>
[:SENSE]:EVM:DLINK:AESpacing?
[:SENSE]:EVM:DLINK:DECode:DFINclude F1F1B | F1F1D | F1 | F1B | F1D
[:SENSE]:EVM:DLINK:DECode:DFINclude?
[:SENSE]:EVM:DLINK:DECode:DFTWo:PRFour <integer>
[:SENSE]:EVM:DLINK:DECode:DFTWo:PRFour?
[:SENSE]:EVM:DLINK:DECode:DFTWo:PRONe <integer>
[:SENSE]:EVM:DLINK:DECode:DFTWo:PRONe?
[:SENSE]:EVM:DLINK:DECode:DFTWo:PRTHree <integer>
[:SENSE]:EVM:DLINK:DECode:DFTWo:PRTHree?
[:SENSE]:EVM:DLINK:DECode:DFTWo:PRTWo <integer>

```

3 Programming the Analyzer

List of SCPI Commands

```
[ :SENSe ]:EVM:DLINK:DECode:DFTWo:PRTWo?
[ :SENSe ]:EVM:DLINK:DECode:PBCH NONE | DESCrambled | DRMatched | DECodeD
[ :SENSe ]:EVM:DLINK:DECode:PBCH?
[ :SENSe ]:EVM:DLINK:DECode:PCFich NONE | DESCrambled | DECodeD
[ :SENSe ]:EVM:DLINK:DECode:PCFich?
[ :SENSe ]:EVM:DLINK:DECode:PDCCh NONE | DEMapped | DINterleaved |
DESCrambled | DRMatched | DECodeD
[ :SENSe ]:EVM:DLINK:DECode:PDCCh?
[ :SENSe ]:EVM:DLINK:DECode:PDSCh NONE | DESCrambled | DRMatched | DCBLock |
DTBLock
[ :SENSe ]:EVM:DLINK:DECode:PDSCh?
[ :SENSe ]:EVM:DLINK:DECode:RNTI:MAXimum:RA <integer>
[ :SENSe ]:EVM:DLINK:DECode:RNTI:MAXimum:RA?
[ :SENSe ]:EVM:DLINK:DECode:RNTI:MAXimum:TPC <integer>
[ :SENSe ]:EVM:DLINK:DECode:RNTI:MAXimum:TPC?
[ :SENSe ]:EVM:DLINK:DECode:RNTI:MINimum:RA <integer>
[ :SENSe ]:EVM:DLINK:DECode:RNTI:MINimum:RA?
[ :SENSe ]:EVM:DLINK:DECode:RNTI:MINimum:TPC <integer>
[ :SENSe ]:EVM:DLINK:DECode:RNTI:MINimum:TPC?
[ :SENSe ]:EVM:DLINK:PDSCh:CSRatio R1 | PB0 | PB1 | PB2 | PB3
[ :SENSe ]:EVM:DLINK:PDSCh:CSRatio?
[ :SENSe ]:EVM:DLINK:PROFile:ADD:USER
[ :SENSe ]:EVM:DLINK:PROFile:AUTO[:DETECT]:CCPower OFF | ON | 0 | 1
[ :SENSe ]:EVM:DLINK:PROFile:AUTO[:DETECT]:CCPower?
[ :SENSe ]:EVM:DLINK:PROFile:AUTO[:DETECT]:MODE Power | DECodeD
[ :SENSe ]:EVM:DLINK:PROFile:AUTO[:DETECT]:MODE?
[ :SENSe ]:EVM:DLINK:PROFile:AUTO[:DETECT]:POWER OFF | ON | 0 | 1
[ :SENSe ]:EVM:DLINK:PROFile:AUTO[:DETECT]:POWER?
[ :SENSe ]:EVM:DLINK:PROFile:AUTO[:DETECT]:POWER:PMODE OFF | ON | 0 | 1
[ :SENSe ]:EVM:DLINK:PROFile:AUTO[:DETECT]:POWER:PMODE?
[ :SENSe ]:EVM:DLINK:PROFile:AUTO[:DETECT]:POWER:ROUND OFF | ON | 0 | 1
[ :SENSe ]:EVM:DLINK:PROFile:AUTO[:DETECT]:POWER:ROUND?
[ :SENSe ]:EVM:DLINK:PROFile:AUTO:PDSCh:CBIndex <integer>
[ :SENSe ]:EVM:DLINK:PROFile:AUTO:PDSCh:CBIndex?
[ :SENSe ]:EVM:DLINK:PROFile:AUTO:PDSCh:CDD WOCDD | LDCDD
[ :SENSe ]:EVM:DLINK:PROFile:AUTO:PDSCh:CDD?
[ :SENSe ]:EVM:DLINK:PROFile:AUTO:PDSCh:NCODEwords <integer>
[ :SENSe ]:EVM:DLINK:PROFile:AUTO:PDSCh:NCODEwords?
[ :SENSe ]:EVM:DLINK:PROFile:AUTO:PDSCh:NLAYers <integer>
[ :SENSe ]:EVM:DLINK:PROFile:AUTO:PDSCh:NLAYers?
[ :SENSe ]:EVM:DLINK:PROFile:AUTO:PDSCh:PRECoding OFF | TXDiversity |
SMULtiplex
[ :SENSe ]:EVM:DLINK:PROFile:AUTO:PDSCh:PRECoding?
[ :SENSe ]:EVM:DLINK:PROFile:AUTO:PDSCh:QAM64:CWONE:ENABLE ON | OFF | 0 | 1
[ :SENSe ]:EVM:DLINK:PROFile:AUTO:PDSCh:QAM16:CWONE:ENABLE ON | OFF | 0 | 1
[ :SENSe ]:EVM:DLINK:PROFile:AUTO:PDSCh:QAM16:CWONE:ENABLE?
[ :SENSe ]:EVM:DLINK:PROFile:AUTO:PDSCh:QAM64:CWONE:ENABLE?
[ :SENSe ]:EVM:DLINK:PROFile:AUTO:PDSCh:QAM16:CWONE:PWRBoost <rel_ampl>
[ :SENSe ]:EVM:DLINK:PROFile:AUTO:PDSCh:QAM64:CWONE:PWRBoost <rel_ampl>
[ :SENSe ]:EVM:DLINK:PROFile:AUTO:PDSCh:QAM64:CWONE:PWRBoost?
[ :SENSe ]:EVM:DLINK:PROFile:AUTO:PDSCh:QAM16:CWONE:PWRBoost?
[ :SENSe ]:EVM:DLINK:PROFile:AUTO:PDSCh:QAM64:CWZero:ENABLE ON | OFF | 0 | 1
```

```

[:SENSE]:EVM:DLINK:PROFile:AUTO:PDsch:QAM16:CWZero:ENABle ON | OFF | 0 | 1
[:SENSE]:EVM:DLINK:PROFile:AUTO:PDsch:QAM64:CWZero:ENABle?
[:SENSE]:EVM:DLINK:PROFile:AUTO:PDsch:QAM16:CWZero:ENABle?
[:SENSE]:EVM:DLINK:PROFile:AUTO:PDsch:QAM64:EPRE <rel_ampl>
[:SENSE]:EVM:DLINK:PROFile:AUTO:PDsch:QAM16:EPRE <rel_ampl>
[:SENSE]:EVM:DLINK:PROFile:AUTO:PDsch:QAM16:EPRE?
[:SENSE]:EVM:DLINK:PROFile:AUTO:PDsch:QAM64:EPRE?
[:SENSE]:EVM:DLINK:PROFile:AUTO:PDsch:QAM64:PWRBoost <rel_ampl>
[:SENSE]:EVM:DLINK:PROFile:AUTO:PDsch:QAM16:PWRBoost <rel_ampl>
[:SENSE]:EVM:DLINK:PROFile:AUTO:PDsch:QAM64:PWRBoost?
[:SENSE]:EVM:DLINK:PROFile:AUTO:PDsch:QAM16:PWRBoost?
[:SENSE]:EVM:DLINK:PROFile:AUTO:PDsch:QPSK:CWONe:ENABle ON | OFF | 0 | 1
[:SENSE]:EVM:DLINK:PROFile:AUTO:PDsch:QPSK:CWONe:ENABle?
[:SENSE]:EVM:DLINK:PROFile:AUTO:PDsch:QPSK:CWONe:PWRBoost <rel_ampl>
[:SENSE]:EVM:DLINK:PROFile:AUTO:PDsch:QPSK:CWONe:PWRBoost?
[:SENSE]:EVM:DLINK:PROFile:AUTO:PDsch:QPSK:CWZero:ENABle ON | OFF | 0 | 1
[:SENSE]:EVM:DLINK:PROFile:AUTO:PDsch:QPSK:CWZero:ENABle?
[:SENSE]:EVM:DLINK:PROFile:AUTO:PDsch:QPSK:EPRE <rel_ampl>
[:SENSE]:EVM:DLINK:PROFile:AUTO:PDsch:QPSK:EPRE?
[:SENSE]:EVM:DLINK:PROFile:AUTO:PDsch:QPSK:PWRBoost <rel_ampl>
[:SENSE]:EVM:DLINK:PROFile:AUTO:PDsch:QPSK:PWRBoost?
[:SENSE]:EVM:DLINK:PROFile:AUTO:PMCH:PWRBoost <rel_ampl>
[:SENSE]:EVM:DLINK:PROFile:AUTO:PMCH:PWRBoost?
[:SENSE]:EVM:DLINK:PROFile:CLear
[:SENSE]:EVM:DLINK:PROFile:COUNT?
[:SENSE]:EVM:DLINK:PROFile:EPRE:PANTenna OFF | ON | 0 | 1
[:SENSE]:EVM:DLINK:PROFile:EPRE:PANTenna?
[:SENSE]:EVM:DLINK:PROFile:EUSers:COUNT <integer>
[:SENSE]:EVM:DLINK:PROFile:EUSers:COUNT?
[:SENSE]:EVM:DLINK:PROFile:EXCLude:ALL
[:SENSE]:EVM:DLINK:PROFile:IGNore
[:SENSE]:EVM:DLINK:PROFile:INCLude:ALL
[:SENSE]:EVM:DLINK:PROFile:MBSFn INCLude | EXCLude
[:SENSE]:EVM:DLINK:PROFile:MBSFn?
[:SENSE]:EVM:DLINK:PROFile:MBSFn:ACTive OFF | ON | 0 | 1
[:SENSE]:EVM:DLINK:PROFile:MBSFn:ACTive?
[:SENSE]:EVM:DLINK:PROFile:MBSFn:AID <integer>
[:SENSE]:EVM:DLINK:PROFile:MBSFn:AID?
[:SENSE]:EVM:DLINK:PROFile:MBSFn:NMRLength <integer>
[:SENSE]:EVM:DLINK:PROFile:MBSFn:NMRLength?
[:SENSE]:EVM:DLINK:PROFile:MBSFn:PWRBoost <rel_ampl>
[:SENSE]:EVM:DLINK:PROFile:MBSFn:PWRBoost?
[:SENSE]:EVM:DLINK:PROFile:MBSFn:SUBFrame1:ACTive OFF | ON | 0 | 1
[:SENSE]:EVM:DLINK:PROFile:MBSFn:SUBFrame2:ACTive OFF | ON | 0 | 1
[:SENSE]:EVM:DLINK:PROFile:MBSFn:SUBFrame4:ACTive OFF | ON | 0 | 1
[:SENSE]:EVM:DLINK:PROFile:MBSFn:SUBFrame9:ACTive OFF | ON | 0 | 1
[:SENSE]:EVM:DLINK:PROFile:MBSFn:SUBFrame3:ACTive OFF | ON | 0 | 1
[:SENSE]:EVM:DLINK:PROFile:MBSFn:SUBFrame7:ACTive OFF | ON | 0 | 1
[:SENSE]:EVM:DLINK:PROFile:MBSFn:SUBFrame8:ACTive OFF | ON | 0 | 1
[:SENSE]:EVM:DLINK:PROFile:MBSFn:SUBFrame6:ACTive OFF | ON | 0 | 1
[:SENSE]:EVM:DLINK:PROFile:MBSFn:SUBFrame4:ACTive?
[:SENSE]:EVM:DLINK:PROFile:MBSFn:SUBFrame6:ACTive?
[:SENSE]:EVM:DLINK:PROFile:MBSFn:SUBFrame8:ACTive?

```

```
[ :SENSe ] :EVM:DLINK:PROFile:MBSFn:SUBFrame9:ACTive?
[ :SENSe ] :EVM:DLINK:PROFile:MBSFn:SUBFrame7:ACTive?
[ :SENSe ] :EVM:DLINK:PROFile:MBSFn:SUBFrame1:ACTive?
[ :SENSe ] :EVM:DLINK:PROFile:MBSFn:SUBFrame2:ACTive?
[ :SENSe ] :EVM:DLINK:PROFile:MBSFn:SUBFrame3:ACTive?
[ :SENSe ] :EVM:DLINK:PROFile:PBCH INCLude | EXCLude
[ :SENSe ] :EVM:DLINK:PROFile:PBCH?
[ :SENSe ] :EVM:DLINK:PROFile:PBCH:PWRBoost <rel_ampl>
[ :SENSe ] :EVM:DLINK:PROFile:PBCH:PWRBoost?
[ :SENSe ] :EVM:DLINK:PROFile:PCFich INCLude | EXCLude
[ :SENSe ] :EVM:DLINK:PROFile:PCFich?
[ :SENSe ] :EVM:DLINK:PROFile:PCFich:PWRBoost <rel_ampl>
[ :SENSe ] :EVM:DLINK:PROFile:PCFich:PWRBoost?
[ :SENSe ] :EVM:DLINK:PROFile:PDCCh INCLude | EXCLude
[ :SENSe ] :EVM:DLINK:PROFile:PDCCh?
[ :SENSe ] :EVM:DLINK:PROFile:PDCCh:ALLocation:AUTO[:DETECT] OFF | ON | 0 | 1
[ :SENSe ] :EVM:DLINK:PROFile:PDCCh:ALLocation:AUTO[:DETECT]?
[ :SENSe ] :EVM:DLINK:PROFile:PDCCh:ALLocation:CONSTant OFF | ON | 0 | 1
[ :SENSe ] :EVM:DLINK:PROFile:PDCCh:ALLocation:CONSTant?
[ :SENSe ] :EVM:DLINK:PROFile:PDCCh:ALLocation:SUBFrame2:SYMBOLs <integer>
[ :SENSe ] :EVM:DLINK:PROFile:PDCCh:ALLocation:SUBFrame9:SYMBOLs <integer>
[ :SENSe ] :EVM:DLINK:PROFile:PDCCh:ALLocation:SUBFrame4:SYMBOLs <integer>
[ :SENSe ] :EVM:DLINK:PROFile:PDCCh:ALLocation:SUBFrame6:SYMBOLs <integer>
[ :SENSe ] :EVM:DLINK:PROFile:PDCCh:ALLocation:SUBFrame3:SYMBOLs <integer>
[ :SENSe ] :EVM:DLINK:PROFile:PDCCh:ALLocation:SUBFrame8:SYMBOLs <integer>
[ :SENSe ] :EVM:DLINK:PROFile:PDCCh:ALLocation:SUBFrame7:SYMBOLs <integer>
[ :SENSe ] :EVM:DLINK:PROFile:PDCCh:ALLocation:SUBFrame0:SYMBOLs <integer>
[ :SENSe ] :EVM:DLINK:PROFile:PDCCh:ALLocation:SUBFrame5:SYMBOLs <integer>
[ :SENSe ] :EVM:DLINK:PROFile:PDCCh:ALLocation:SUBFrame1:SYMBOLs <integer>
[ :SENSe ] :EVM:DLINK:PROFile:PDCCh:ALLocation:SUBFrame1:SYMBOLs?
[ :SENSe ] :EVM:DLINK:PROFile:PDCCh:ALLocation:SUBFrame7:SYMBOLs?
[ :SENSe ] :EVM:DLINK:PROFile:PDCCh:ALLocation:SUBFrame0:SYMBOLs?
[ :SENSe ] :EVM:DLINK:PROFile:PDCCh:ALLocation:SUBFrame9:SYMBOLs?
[ :SENSe ] :EVM:DLINK:PROFile:PDCCh:ALLocation:SUBFrame4:SYMBOLs?
[ :SENSe ] :EVM:DLINK:PROFile:PDCCh:ALLocation:SUBFrame5:SYMBOLs?
[ :SENSe ] :EVM:DLINK:PROFile:PDCCh:ALLocation:SUBFrame6:SYMBOLs?
[ :SENSe ] :EVM:DLINK:PROFile:PDCCh:ALLocation:SUBFrame2:SYMBOLs?
[ :SENSe ] :EVM:DLINK:PROFile:PDCCh:ALLocation:SUBFrame8:SYMBOLs?
[ :SENSe ] :EVM:DLINK:PROFile:PDCCh:ALLocation:SUBFrame3:SYMBOLs?
[ :SENSe ] :EVM:DLINK:PROFile:PDCCh:PWRBoost <rel_ampl>
[ :SENSe ] :EVM:DLINK:PROFile:PDCCh:PWRBoost?
[ :SENSe ] :EVM:DLINK:PROFile:PDCCh:PWRBoost:STEP <rel_ampl>
[ :SENSe ] :EVM:DLINK:PROFile:PDCCh:PWRBoost:STEP?
[ :SENSe ] :EVM:DLINK:PROFile:PHICH INCLude | EXCLude
[ :SENSe ] :EVM:DLINK:PROFile:PHICH?
[ :SENSe ] :EVM:DLINK:PROFile:PHICH:ALLocation:RATio ADETECT | R1BY6 | R1BY2
| R1 | R2
[ :SENSe ] :EVM:DLINK:PROFile:PHICH:ALLocation:RATio?
[ :SENSe ] :EVM:DLINK:PROFile:PHICH:DESPread OFF | ON | 0 | 1
[ :SENSe ] :EVM:DLINK:PROFile:PHICH:DESPread?
[ :SENSe ] :EVM:DLINK:PROFile:PHICH:DURation ADETECT | NORMAl | EXTended
[ :SENSe ] :EVM:DLINK:PROFile:PHICH:DURation?
[ :SENSe ] :EVM:DLINK:PROFile:PHICH:MIDefinition STD | ETM
```

```

[:SENSe]:EVM:DLINK:PROFile:PHICH:MIDefinition?
[:SENSe]:EVM:DLINK:PROFile:PHICH:PWRBoost <rel_ampl>
[:SENSe]:EVM:DLINK:PROFile:PHICH:PWRBoost?
[:SENSe]:EVM:DLINK:PROFile:PHICH:PWRBoost:STEP <rel_ampl>+
[:SENSe]:EVM:DLINK:PROFile:PHICH:PWRBoost:STEP?
[:SENSe]:EVM:DLINK:PROFile:PMCH INCLude | EXCLude
[:SENSe]:EVM:DLINK:PROFile:PMCH?
[:SENSe]:EVM:DLINK:PROFile:PMCH:SUBFrame6:ACTive OFF | ON | 0 | 1
[:SENSe]:EVM:DLINK:PROFile:PMCH:SUBFrame2:ACTive OFF | ON | 0 | 1
[:SENSe]:EVM:DLINK:PROFile:PMCH:SUBFrame3:ACTive OFF | ON | 0 | 1
[:SENSe]:EVM:DLINK:PROFile:PMCH:SUBFrame4:ACTive OFF | ON | 0 | 1
[:SENSe]:EVM:DLINK:PROFile:PMCH:SUBFrame1:ACTive OFF | ON | 0 | 1
[:SENSe]:EVM:DLINK:PROFile:PMCH:SUBFrame7:ACTive OFF | ON | 0 | 1
[:SENSe]:EVM:DLINK:PROFile:PMCH:SUBFrame8:ACTive OFF | ON | 0 | 1
[:SENSe]:EVM:DLINK:PROFile:PMCH:SUBFrame9:ACTive OFF | ON | 0 | 1
[:SENSe]:EVM:DLINK:PROFile:PMCH:SUBFrame2:ACTive?
[:SENSe]:EVM:DLINK:PROFile:PMCH:SUBFrame1:ACTive?
[:SENSe]:EVM:DLINK:PROFile:PMCH:SUBFrame3:ACTive?
[:SENSe]:EVM:DLINK:PROFile:PMCH:SUBFrame6:ACTive?
[:SENSe]:EVM:DLINK:PROFile:PMCH:SUBFrame8:ACTive?
[:SENSe]:EVM:DLINK:PROFile:PMCH:SUBFrame7:ACTive?
[:SENSe]:EVM:DLINK:PROFile:PMCH:SUBFrame9:ACTive?
[:SENSe]:EVM:DLINK:PROFile:PMCH:SUBFrame4:ACTive?
[:SENSe]:EVM:DLINK:PROFile:PMCH:SUBFrame8:MODulation:TYPE QPSK | QAM16 |
QAM64
[:SENSe]:EVM:DLINK:PROFile:PMCH:SUBFrame7:MODulation:TYPE QPSK | QAM16 |
QAM64
[:SENSe]:EVM:DLINK:PROFile:PMCH:SUBFrame9:MODulation:TYPE QPSK | QAM16 |
QAM64
[:SENSe]:EVM:DLINK:PROFile:PMCH:SUBFrame2:MODulation:TYPE QPSK | QAM16 |
QAM64
[:SENSe]:EVM:DLINK:PROFile:PMCH:SUBFrame4:MODulation:TYPE QPSK | QAM16 |
QAM64
[:SENSe]:EVM:DLINK:PROFile:PMCH:SUBFrame1:MODulation:TYPE QPSK | QAM16 |
QAM64
[:SENSe]:EVM:DLINK:PROFile:PMCH:SUBFrame6:MODulation:TYPE QPSK | QAM16 |
QAM64
[:SENSe]:EVM:DLINK:PROFile:PMCH:SUBFrame3:MODulation:TYPE QPSK | QAM16 |
QAM64
[:SENSe]:EVM:DLINK:PROFile:PMCH:SUBFrame8:MODulation:TYPE?
[:SENSe]:EVM:DLINK:PROFile:PMCH:SUBFrame9:MODulation:TYPE?
[:SENSe]:EVM:DLINK:PROFile:PMCH:SUBFrame2:MODulation:TYPE?
[:SENSe]:EVM:DLINK:PROFile:PMCH:SUBFrame1:MODulation:TYPE?
[:SENSe]:EVM:DLINK:PROFile:PMCH:SUBFrame6:MODulation:TYPE?
[:SENSe]:EVM:DLINK:PROFile:PMCH:SUBFrame4:MODulation:TYPE?
[:SENSe]:EVM:DLINK:PROFile:PMCH:SUBFrame3:MODulation:TYPE?
[:SENSe]:EVM:DLINK:PROFile:PMCH:SUBFrame7:MODulation:TYPE?
[:SENSe]:EVM:DLINK:PROFile:PMCH:SUBFrame8:PWRBoost <rel_ampl>
[:SENSe]:EVM:DLINK:PROFile:PMCH:SUBFrame9:PWRBoost <rel_ampl>
[:SENSe]:EVM:DLINK:PROFile:PMCH:SUBFrame6:PWRBoost <rel_ampl>
[:SENSe]:EVM:DLINK:PROFile:PMCH:SUBFrame7:PWRBoost <rel_ampl>
[:SENSe]:EVM:DLINK:PROFile:PMCH:SUBFrame4:PWRBoost <rel_ampl>

```

3 Programming the Analyzer

List of SCPI Commands

```
[ :SENSe ] :EVM:DLINK:PROFile:PMCH:SUBFrame2:PWRBoost <rel_ampl>
[ :SENSe ] :EVM:DLINK:PROFile:PMCH:SUBFrame3:PWRBoost <rel_ampl>
[ :SENSe ] :EVM:DLINK:PROFile:PMCH:SUBFrame1:PWRBoost <rel_ampl>
[ :SENSe ] :EVM:DLINK:PROFile:PMCH:SUBFrame6:PWRBoost?
[ :SENSe ] :EVM:DLINK:PROFile:PMCH:SUBFrame9:PWRBoost?
[ :SENSe ] :EVM:DLINK:PROFile:PMCH:SUBFrame8:PWRBoost?
[ :SENSe ] :EVM:DLINK:PROFile:PMCH:SUBFrame7:PWRBoost?
[ :SENSe ] :EVM:DLINK:PROFile:PMCH:SUBFrame4:PWRBoost?
[ :SENSe ] :EVM:DLINK:PROFile:PMCH:SUBFrame2:PWRBoost?
[ :SENSe ] :EVM:DLINK:PROFile:PMCH:SUBFrame1:PWRBoost?
[ :SENSe ] :EVM:DLINK:PROFile:PMCH:SUBFrame3:PWRBoost?
[ :SENSe ] :EVM:DLINK:PROFile:PRS INCLude | EXCLude
[ :SENSe ] :EVM:DLINK:PROFile:PRS?
[ :SENSe ] :EVM:DLINK:PROFile:PRS:ACTive OFF | ON | 0 | 1
[ :SENSe ] :EVM:DLINK:PROFile:PRS:ACTive?
[ :SENSe ] :EVM:DLINK:PROFile:PRS:BANDwidth B1M4 | B3M | B5M | B10M | B15M |
B20M
[ :SENSe ] :EVM:DLINK:PROFile:PRS:BANDwidth?
[ :SENSe ] :EVM:DLINK:PROFile:PRS:INDex <integer>
[ :SENSe ] :EVM:DLINK:PROFile:PRS:INDex?
[ :SENSe ] :EVM:DLINK:PROFile:PRS:PWRBoost <rel_ampl>
[ :SENSe ] :EVM:DLINK:PROFile:PRS:PWRBoost?
[ :SENSe ] :EVM:DLINK:PROFile:PRS:SUBFrame:NUMBer N1 | N2 | N4 | N6
[ :SENSe ] :EVM:DLINK:PROFile:PRS:SUBFrame:NUMBer?
[ :SENSe ] :EVM:DLINK:PROFile:PSS INCLude | EXCLude
[ :SENSe ] :EVM:DLINK:PROFile:PSS?
[ :SENSe ] :EVM:DLINK:PROFile:PSS:PWRBoost <rel_ampl>
[ :SENSe ] :EVM:DLINK:PROFile:PSS:PWRBoost?
[ :SENSe ] :EVM:DLINK:PROFile:QAM64 INCLude | EXCLude
[ :SENSe ] :EVM:DLINK:PROFile:QAM16 INCLude | EXCLude
[ :SENSe ] :EVM:DLINK:PROFile:QAM16?
[ :SENSe ] :EVM:DLINK:PROFile:QAM64?
[ :SENSe ] :EVM:DLINK:PROFile:QAM64:RNTI <integer>
[ :SENSe ] :EVM:DLINK:PROFile:QAM16:RNTI <integer>
[ :SENSe ] :EVM:DLINK:PROFile:QAM16:RNTI?
[ :SENSe ] :EVM:DLINK:PROFile:QAM64:RNTI?
[ :SENSe ] :EVM:DLINK:PROFile:QAM64:UERS INCLude | EXCLude
[ :SENSe ] :EVM:DLINK:PROFile:QAM16:UERS INCLude | EXCLude
[ :SENSe ] :EVM:DLINK:PROFile:QAM16:UERS?
[ :SENSe ] :EVM:DLINK:PROFile:QAM64:UERS?
[ :SENSe ] :EVM:DLINK:PROFile:QAM16:UERS:ACTive OFF | ON | 0 | 1
[ :SENSe ] :EVM:DLINK:PROFile:QAM64:UERS:ACTive OFF | ON | 0 | 1
[ :SENSe ] :EVM:DLINK:PROFile:QAM16:UERS:ACTive?
[ :SENSe ] :EVM:DLINK:PROFile:QAM64:UERS:ACTive?
[ :SENSe ] :EVM:DLINK:PROFile:QAM64:UERS:PORT P5 | P7 | P8
[ :SENSe ] :EVM:DLINK:PROFile:QAM16:UERS:PORT P5 | P7 | P8
[ :SENSe ] :EVM:DLINK:PROFile:QAM64:UERS:PORT?
[ :SENSe ] :EVM:DLINK:PROFile:QAM16:UERS:PORT?
[ :SENSe ] :EVM:DLINK:PROFile:QAM64:UERS:PWRBoost <rel_ampl>
[ :SENSe ] :EVM:DLINK:PROFile:QAM16:UERS:PWRBoost <rel_ampl>
[ :SENSe ] :EVM:DLINK:PROFile:QAM64:UERS:PWRBoost?
[ :SENSe ] :EVM:DLINK:PROFile:QAM16:UERS:PWRBoost?
[ :SENSe ] :EVM:DLINK:PROFile:QAM16:UERS:SCID <integer>
```



```

[:SENSe]:EVM:DLINK:PROFile:QAM64:UERS:SCID <integer>
[:SENSe]:EVM:DLINK:PROFile:QAM64:UERS:SCID?
[:SENSe]:EVM:DLINK:PROFile:QAM16:UERS:SCID?
[:SENSe]:EVM:DLINK:PROFile:QPSK INCLude | EXCLude
[:SENSe]:EVM:DLINK:PROFile:QPSK?
[:SENSe]:EVM:DLINK:PROFile:QPSK:RNTI <integer>
[:SENSe]:EVM:DLINK:PROFile:QPSK:RNTI?
[:SENSe]:EVM:DLINK:PROFile:QPSK:UERS INCLude | EXCLude
[:SENSe]:EVM:DLINK:PROFile:QPSK:UERS?
[:SENSe]:EVM:DLINK:PROFile:QPSK:UERS:ACTive OFF | ON | 0 | 1
[:SENSe]:EVM:DLINK:PROFile:QPSK:UERS:ACTive?
[:SENSe]:EVM:DLINK:PROFile:QPSK:UERS:PORT P5 | P7 | P8
[:SENSe]:EVM:DLINK:PROFile:QPSK:UERS:PORT?
[:SENSe]:EVM:DLINK:PROFile:QPSK:UERS:PWRBoost <rel_ampl>
[:SENSe]:EVM:DLINK:PROFile:QPSK:UERS:PWRBoost?
[:SENSe]:EVM:DLINK:PROFile:QPSK:UERS:SCID <integer>
[:SENSe]:EVM:DLINK:PROFile:QPSK:UERS:SCID?
[:SENSe]:EVM:DLINK:PROFile:RS INCLude | EXCLude
[:SENSe]:EVM:DLINK:PROFile:RS?
[:SENSe]:EVM:DLINK:PROFile:RS:PWRBoost <rel_ampl>
[:SENSe]:EVM:DLINK:PROFile:RS:PWRBoost?
[:SENSe]:EVM:DLINK:PROFile:SSS INCLude | EXCLude
[:SENSe]:EVM:DLINK:PROFile:SSS?
[:SENSe]:EVM:DLINK:PROFile:SSS:PWRBoost <rel_ampl>
[:SENSe]:EVM:DLINK:PROFile:SSS:PWRBoost?
[:SENSe]:EVM:DLINK:PROFile:UPDate
[:SENSe]:EVM:DLINK:PROFile:USER<n>:DECoded:PDSCh INCLude | EXCLude
[:SENSe]:EVM:DLINK:PROFile:USER<n>:DECoded:PDSCh?
[:SENSe]:EVM:DLINK:PROFile:USER<n>:DECoded:PDSCh:CWOne:ENABle ON | OFF | 0
| 1
[:SENSe]:EVM:DLINK:PROFile:USER<n>:DECoded:PDSCh:CWOne:ENABle?
[:SENSe]:EVM:DLINK:PROFile:USER<n>:DECoded:PDSCh:CWOne:PWRBoost <rel_ampl>
[:SENSe]:EVM:DLINK:PROFile:USER<n>:DECoded:PDSCh:CWOne:PWRBoost?
[:SENSe]:EVM:DLINK:PROFile:USER<n>:DECoded:PDSCh:CWZero:ENABle ON | OFF |
0 | 1
[:SENSe]:EVM:DLINK:PROFile:USER<n>:DECoded:PDSCh:CWZero:ENABle?
[:SENSe]:EVM:DLINK:PROFile:USER<n>:DECoded:PDSCh:CWZero:PWRBoost <rel_
ampl>
[:SENSe]:EVM:DLINK:PROFile:USER<n>:DECoded:PDSCh:CWZero:PWRBoost?
[:SENSe]:EVM:DLINK:PROFile:USER<n>:DECoded:PDSCh:EPRE <rel_ampl>
[:SENSe]:EVM:DLINK:PROFile:USER<n>:DECoded:PDSCh:EPRE?
[:SENSe]:EVM:DLINK:PROFile:USER<n>:DELete
[:SENSe]:EVM:DLINK:PROFile:USER<n>:PDSCh INCLude | EXCLude
[:SENSe]:EVM:DLINK:PROFile:USER<n>:PDSCh?
[:SENSe]:EVM:DLINK:PROFile:USER<n>:PDSCh:ADD:ALLocation
[:SENSe]:EVM:DLINK:PROFile:USER<n>:PDSCh:ALLocation<m>:CWOne:MODulation:TY
PE QPSK | QAM16 | QAM64 (Maxvalueform=50andm=50)
[:SENSe]:EVM:DLINK:PROFile:USER<n>:PDSCh:ALLocation<m>:CWOne:PWRBoost
(Maxvalueform=50andm=50)
[:SENSe]:EVM:DLINK:PROFile:USER<n>:PDSCh:ALLocation<m>:DELete
(Maxvalueform=50andm=50)

```

```

[:SENSe]:EVM:DLINK:PROFile:USER<n>:PDSCh:ALLocation<m>:FINDex F0 | F1
(Maxvalueform=50andm=50)
[:SENSe]:EVM:DLINK:PROFile:USER<n>:PDSCh:ALLocation<m>:MODulation:TYPE
QPSK | QAM16 | QAM64 (Maxvalueform=50andm=50)
[:SENSe]:EVM:DLINK:PROFile:USER<n>:PDSCh:ALLocation<m>:PWRBoost
(Maxvalueform=50andm=50)
[:SENSe]:EVM:DLINK:PROFile:USER<n>:PDSCh:ALLocation<m>:RB:END
(Maxvalueform=50andm=50)
[:SENSe]:EVM:DLINK:PROFile:USER<n>:PDSCh:ALLocation<m>:RB:START
(Maxvalueform=50andm=50)
[:SENSe]:EVM:DLINK:PROFile:USER<n>:PDSCh:ALLocation<m>:SLOT:END
(Maxvalueform=50andm=50)
[:SENSe]:EVM:DLINK:PROFile:USER<n>:PDSCh:ALLocation<m>:SLOT:START
(Maxvalueform=50andm=50)
[:SENSe]:EVM:DLINK:PROFile:USER<n>:PDSCh:COUNT?
[:SENSe]:EVM:DLINK:PROFile:USER<n>:PDSCh:CWONe:MODulation:TYPE QPSK |
QAM16 | QAM64
[:SENSe]:EVM:DLINK:PROFile:USER<n>:PDSCh:CWONe:MODulation:TYPE?
[:SENSe]:EVM:DLINK:PROFile:USER<n>:PDSCh:CWONe:MODulation:TYPE:COUple OFF
| ON | 0 | 1
[:SENSe]:EVM:DLINK:PROFile:USER<n>:PDSCh:CWONe:MODulation:TYPE:COUple?
[:SENSe]:EVM:DLINK:PROFile:USER<n>:PDSCh:CWONe:PWRBoost <rel_ampl>
[:SENSe]:EVM:DLINK:PROFile:USER<n>:PDSCh:CWONe:PWRBoost?
[:SENSe]:EVM:DLINK:PROFile:USER<n>:PDSCh:CWONe:PWRBoost:COUple OFF | ON |
0 | 1
[:SENSe]:EVM:DLINK:PROFile:USER<n>:PDSCh:CWONe:PWRBoost:COUple?
[:SENSe]:EVM:DLINK:PROFile:USER<n>:PDSCh:EPRE <rel_ampl>
[:SENSe]:EVM:DLINK:PROFile:USER<n>:PDSCh:EPRE?
[:SENSe]:EVM:DLINK:PROFile:USER<n>:PDSCh:EPRE:COUple OFF | ON | 0 | 1
[:SENSe]:EVM:DLINK:PROFile:USER<n>:PDSCh:EPRE:COUple?
[:SENSe]:EVM:DLINK:PROFile:USER<n>:PDSCh:FINDex F0 | F1
[:SENSe]:EVM:DLINK:PROFile:USER<n>:PDSCh:FINDex?
[:SENSe]:EVM:DLINK:PROFile:USER<n>:PDSCh:FINDex:COUple OFF | ON | 0 | 1
[:SENSe]:EVM:DLINK:PROFile:USER<n>:PDSCh:FINDex:COUple?
[:SENSe]:EVM:DLINK:PROFile:USER<n>:PDSCh:MODulation:TYPE QPSK | QAM16 |
QAM64
[:SENSe]:EVM:DLINK:PROFile:USER<n>:PDSCh:MODulation:TYPE?
[:SENSe]:EVM:DLINK:PROFile:USER<n>:PDSCh:MODulation:TYPE:COUple OFF | ON |
0 | 1
[:SENSe]:EVM:DLINK:PROFile:USER<n>:PDSCh:MODulation:TYPE:COUple?
[:SENSe]:EVM:DLINK:PROFile:USER<n>:PDSCh:PWRBoost <rel_ampl>
[:SENSe]:EVM:DLINK:PROFile:USER<n>:PDSCh:PWRBoost?
[:SENSe]:EVM:DLINK:PROFile:USER<n>:PDSCh:PWRBoost:COUple OFF | ON | 0 | 1
[:SENSe]:EVM:DLINK:PROFile:USER<n>:PDSCh:PWRBoost:COUple?
[:SENSe]:EVM:DLINK:PROFile:USER<n>:PDSCh:RBALloc<m>:CWONe:MODulation:TYPE
QPSK | QAM16 | QAM64
[:SENSe]:EVM:DLINK:PROFile:USER<n>:PDSCh:RBALloc<m>:CWONe:MODulation:TYPE?

[:SENSe]:EVM:DLINK:PROFile:USER<n>:PDSCh:RBALloc<m>:CWONe:PWRBoost <rel_
ampl>
[:SENSe]:EVM:DLINK:PROFile:USER<n>:PDSCh:RBALloc<m>:CWONe:PWRBoost?
[:SENSe]:EVM:DLINK:PROFile:USER<n>:PDSCh:RBALloc<m>:DELete

```

```

[:SENSE]:EVM:DLINK:PROFile:USER<n>:PDSCh:RBALloc<m>:EPRE <rel_ampl>
[:SENSE]:EVM:DLINK:PROFile:USER<n>:PDSCh:RBALloc<m>:EPRE?
[:SENSE]:EVM:DLINK:PROFile:USER<n>:PDSCh:RBALloc<m>:FINDEx F0 | F1
[:SENSE]:EVM:DLINK:PROFile:USER<n>:PDSCh:RBALloc<m>:FINDEx?
[:SENSE]:EVM:DLINK:PROFile:USER<n>:PDSCh:RBALloc<m>:MODulation:TYPE QPSK |
QAM16 | QAM64
[:SENSE]:EVM:DLINK:PROFile:USER<n>:PDSCh:RBALloc<m>:MODulation:TYPE?
[:SENSE]:EVM:DLINK:PROFile:USER<n>:PDSCh:RBALloc<m>:PWRBoost <rel_ampl>
[:SENSE]:EVM:DLINK:PROFile:USER<n>:PDSCh:RBALloc<m>:PWRBoost?
[:SENSE]:EVM:DLINK:PROFile:USER<n>:PDSCh:RBALloc<m>:RB:END <integer>
[:SENSE]:EVM:DLINK:PROFile:USER<n>:PDSCh:RBALloc<m>:RB:END?
[:SENSE]:EVM:DLINK:PROFile:USER<n>:PDSCh:RBALloc<m>:RB:START <integer>
[:SENSE]:EVM:DLINK:PROFile:USER<n>:PDSCh:RBALloc<m>:RB:START?
[:SENSE]:EVM:DLINK:PROFile:USER<n>:PDSCh:RBALloc<m>:SLOT:END <integer>
[:SENSE]:EVM:DLINK:PROFile:USER<n>:PDSCh:RBALloc<m>:SLOT:END?
[:SENSE]:EVM:DLINK:PROFile:USER<n>:PDSCh:RBALloc<m>:SLOT:START <integer>
[:SENSE]:EVM:DLINK:PROFile:USER<n>:PDSCh:RBALloc<m>:SLOT:START?
[:SENSE]:EVM:DLINK:PROFile:USER<n>:RNTI <integer>
[:SENSE]:EVM:DLINK:PROFile:USER<n>:RNTI?
[:SENSE]:EVM:DLINK:PROFile:USER<n>:UERS INCLude | EXCLude
[:SENSE]:EVM:DLINK:PROFile:USER<n>:UERS?
[:SENSE]:EVM:DLINK:PROFile:USER<n>:UERS:ACTive OFF | ON | 0 | 1
[:SENSE]:EVM:DLINK:PROFile:USER<n>:UERS:ACTive?
[:SENSE]:EVM:DLINK:PROFile:USER<n>:UERS:PORT P5 | P7 | P8
[:SENSE]:EVM:DLINK:PROFile:USER<n>:UERS:PORT?
[:SENSE]:EVM:DLINK:PROFile:USER<n>:UERS:PWRBoost <rel_ampl>
[:SENSE]:EVM:DLINK:PROFile:USER<n>:UERS:PWRBoost?
[:SENSE]:EVM:DLINK:PROFile:USER<n>:UERS:SCID <integer>
[:SENSE]:EVM:DLINK:PROFile:USER<n>:UERS:SCID?
[:SENSE]:EVM:DLINK:PROFile:USER1|50:PDSCh:CBINdex <integer>
[:SENSE]:EVM:DLINK:PROFile:USER1|50:PDSCh:CBINdex?
[:SENSE]:EVM:DLINK:PROFile:USER1|50:PDSCh:CDD WOCDD | LDCDD
[:SENSE]:EVM:DLINK:PROFile:USER1|50:PDSCh:CDD?
[:SENSE]:EVM:DLINK:PROFile:USER1|50:PDSCh:CWONe:ENABle ON | OFF | 0 | 1
[:SENSE]:EVM:DLINK:PROFile:USER1|50:PDSCh:CWONe:ENABle?
[:SENSE]:EVM:DLINK:PROFile:USER1|50:PDSCh:CWZero:ENABle ON | OFF | 0 | 1
[:SENSE]:EVM:DLINK:PROFile:USER1|50:PDSCh:CWZero:ENABle?
[:SENSE]:EVM:DLINK:PROFile:USER1|50:PDSCh:NCODewords <integer>
[:SENSE]:EVM:DLINK:PROFile:USER1|50:PDSCh:NCODewords?
[:SENSE]:EVM:DLINK:PROFile:USER1|50:PDSCh:NLAYers <integer>
[:SENSE]:EVM:DLINK:PROFile:USER1|50:PDSCh:NLAYers?
[:SENSE]:EVM:DLINK:PROFile:USER1|50:PDSCh:PRECoding OFF | TXDiversity |
SMULtiplex
[:SENSE]:EVM:DLINK:PROFile:USER1|50:PDSCh:PRECoding?
[:SENSE]:EVM:DLINK:SYNC:ANTenna:DETECT:THReshold <rel_ampl>
[:SENSE]:EVM:DLINK:SYNC:ANTenna:DETECT:THReshold?
[:SENSE]:EVM:DLINK:SYNC:ANTenna:INACTive:PATHs INCLude | EXCLude
[:SENSE]:EVM:DLINK:SYNC:ANTenna:INACTive:PATHs?
[:SENSE]:EVM:DLINK:SYNC:ANTenna:NUMBer ANT1 | ANT2 | ANT4
[:SENSE]:EVM:DLINK:SYNC:ANTenna:NUMBer?
[:SENSE]:EVM:DLINK:SYNC:ANTenna:PORT P0 | P1 | P2 | P3
[:SENSE]:EVM:DLINK:SYNC:ANTenna:PORT?
[:SENSE]:EVM:DLINK:SYNC:ANTenna:PORT:AUTO OFF | ON | 0 | 1

```

```
[ :SENSe ]:EVM:DLINK:SYNC:ANTenna:PORT:AUTO?
[ :SENSe ]:EVM:DLINK:SYNC:CID <integer>
[ :SENSe ]:EVM:DLINK:SYNC:CID?
[ :SENSe ]:EVM:DLINK:SYNC:CID:AUTO OFF | ON | 0 | 1
[ :SENSe ]:EVM:DLINK:SYNC:CID:AUTO?
[ :SENSe ]:EVM:DLINK:SYNC:CPLength AUTO | NORMAl | EXTended
[ :SENSe ]:EVM:DLINK:SYNC:CPLength?
[ :SENSe ]:EVM:DLINK:SYNC:CPLength:AUTO OFF | ON | 0 | 1
[ :SENSe ]:EVM:DLINK:SYNC:CPLength:AUTO?
[ :SENSe ]:EVM:DLINK:SYNC:MIMO:DECoding NONE | GPPMimo
[ :SENSe ]:EVM:DLINK:SYNC:MIMO:DECoding?
[ :SENSe ]:EVM:DLINK:SYNC:RSPRs GPP | CUSTom
[ :SENSe ]:EVM:DLINK:SYNC:RSPRs?
[ :SENSe ]:EVM:DLINK:SYNC:SS:ANTenna:PORT P0 | P1 | P2 | P3 | APOrts
[ :SENSe ]:EVM:DLINK:SYNC:SS:ANTenna:PORT?
[ :SENSe ]:EVM:DLINK:SYNC:TYPE PSS | RS
[ :SENSe ]:EVM:DLINK:SYNC:TYPE?
[ :SENSe ]:EVM:DLINK:UERS:CFRCompen OFF | ON | 0 | 1
[ :SENSe ]:EVM:DLINK:UERS:CFRCompen?
[ :SENSe ]:EVM:DLINK:UERS:WEIGHTs:DISPlay PSUBcarrier | PRB | PUSer
[ :SENSe ]:EVM:DLINK:UERS:WEIGHTs:DISPlay?
[ :SENSe ]:EVM:DLINK:UERS:WEIGHTs:RIFormat OFF | ON | 0 | 1
[ :SENSe ]:EVM:DLINK:UERS:WEIGHTs:RIFormat?
[ :SENSe ]:EVM:EETTime OFF | ON | 0 | 1
[ :SENSe ]:EVM:EETTime?
[ :SENSe ]:EVM:EQUalizer:TRAINing OFF | RS | RSD
[ :SENSe ]:EVM:EQUalizer:TRAINing?
[ :SENSe ]:EVM:EQUalizer:TRAINing:MAFilter OFF | ON | 0 | 1
[ :SENSe ]:EVM:EQUalizer:TRAINing:MAFilter?
[ :SENSe ]:EVM:EQUalizer:TRAINing:MAFilter:LENGth <integer>
[ :SENSe ]:EVM:EQUalizer:TRAINing:MAFilter:LENGth?
[ :SENSe ]:EVM:EQUalizer:TRAINing:MCFNormalize OFF | ON | 0 | 1
[ :SENSe ]:EVM:EQUalizer:TRAINing:MCFNormalize?
[ :SENSe ]:EVM:EQUalizer:TRAINing:MODE ZFORcing | LSQuares
[ :SENSe ]:EVM:EQUalizer:TRAINing:MODE?
[ :SENSe ]:EVM:EVMMinimize OFF | GPP | TRACKing
[ :SENSe ]:EVM:EVMMinimize?
[ :SENSe ]:EVM:EVMMinimize:AMPLitude OFF | ON | 0 | 1
[ :SENSe ]:EVM:EVMMinimize:AMPLitude?
[ :SENSe ]:EVM:EVMMinimize:FREQuency OFF | ON | 0 | 1
[ :SENSe ]:EVM:EVMMinimize:FREQuency?
[ :SENSe ]:EVM:EVMMinimize:IQOFFset OFF | ON | 0 | 1
[ :SENSe ]:EVM:EVMMinimize:IQOFFset?
[ :SENSe ]:EVM:EVMMinimize:TIMing OFF | ON | 0 | 1
[ :SENSe ]:EVM:EVMMinimize:TIMing?
[ :SENSe ]:EVM:EXTended:FREQuency:LOCK:RANGE OFF | ON | 0 | 1
[ :SENSe ]:EVM:EXTended:FREQuency:LOCK:RANGE?
[ :SENSe ]:EVM:FREQuency:SYNThesis[:STATE] 1 | 2 | 3
[ :SENSe ]:EVM:FREQuency:SYNThesis[:STATE]?
[ :SENSe ]:EVM:MCFilter:STATE OFF | ON | 0 | 1
[ :SENSe ]:EVM:MCFilter:STATE?
[ :SENSe ]:EVM:ODActive OFF | ON | 0 | 1
[ :SENSe ]:EVM:ODActive?
```

```

[:SENSE]:EVM:PILOT:TRACK:AMPLITUDE
[:SENSE]:EVM:PILOT:TRACK:PHASE
[:SENSE]:EVM:PILOT:TRACK:TIMING
[:SENSE]:EVM:POWER:BOOST:NORMALIZE OFF | ON | 0 | 1
[:SENSE]:EVM:POWER:BOOST:NORMALIZE?
[:SENSE]:EVM:PROFILE:AUTO[:DETECT] OFF | ON | 0 | 1
[:SENSE]:EVM:PROFILE:AUTO[:DETECT]?
[:SENSE]:EVM:PROFILE:COPY[:IMMEDIATE]
[:SENSE]:EVM:PROFILE:MFXANALYSIS OFF | ON | 0 | 1
[:SENSE]:EVM:PROFILE:MFXANALYSIS?
[:SENSE]:EVM:PROFILE:NALLOCATION INCLUDE | EXCLUDE
[:SENSE]:EVM:PROFILE:NALLOCATION?
[:SENSE]:EVM:PROFILE:SMAPPING[:SELECT] F0 | F1
[:SENSE]:EVM:PROFILE:SMAPPING[:SELECT]?
[:SENSE]:EVM:REPORT:DB OFF | ON | 0 | 1
[:SENSE]:EVM:REPORT:DB?
[:SENSE]:EVM:REPORT:POWER:RELATIVE OFF | ON | 0 | 1
[:SENSE]:EVM:REPORT:POWER:RELATIVE?
[:SENSE]:EVM:SYMBOL:TIMING:ADJUST MAX | MIN | START | END | CENTER |
FFTSIZE
[:SENSE]:EVM:SYMBOL:TIMING:ADJUST?
[:SENSE]:EVM:SYMBOL:TIMING:ADJUST:USER <percent>
[:SENSE]:EVM:SYMBOL:TIMING:ADJUST:USER?
[:SENSE]:EVM:TIME:ASBOUNDARY FRAME | HALF | SUB | SLOT
[:SENSE]:EVM:TIME:ASBOUNDARY?
[:SENSE]:EVM:TIME:INTERVAL:SLOT <integer>
[:SENSE]:EVM:TIME:INTERVAL:SLOT?
[:SENSE]:EVM:TIME:INTERVAL:SYMBOL <integer>
[:SENSE]:EVM:TIME:INTERVAL:SYMBOL?
[:SENSE]:EVM:TIME:OFFSET:SLOT <integer>
[:SENSE]:EVM:TIME:OFFSET:SLOT?
[:SENSE]:EVM:TIME:OFFSET:SYMBOL <integer>
[:SENSE]:EVM:TIME:OFFSET:SYMBOL?
[:SENSE]:EVM:TIME:RESULT:LENGTH <integer>
[:SENSE]:EVM:TIME:RESULT:LENGTH?
[:SENSE]:EVM:TIME:SCALE:FACTOR <value>
[:SENSE]:EVM:TIME:SCALE:FACTOR?
[:SENSE]:EVM:ULINK:DECODE:ANFMODE MULTIPLEXING | BUNDLING
[:SENSE]:EVM:ULINK:DECODE:ANFMODE?
[:SENSE]:EVM:ULINK:DECODE:PUCCH NONE | DESCRAMBLED | DECODED
[:SENSE]:EVM:ULINK:DECODE:PUCCH?
[:SENSE]:EVM:ULINK:DECODE:PUCCH:CQI:ISIZE <integer>
[:SENSE]:EVM:ULINK:DECODE:PUCCH:CQI:ISIZE?
[:SENSE]:EVM:ULINK:DECODE:PUCCH:CQI:ISIZE:AUTO OFF | ON | 0 | 1
[:SENSE]:EVM:ULINK:DECODE:PUCCH:CQI:ISIZE:AUTO?
[:SENSE]:EVM:ULINK:DECODE:PUCCH:HARQ:ISIZE <integer>
[:SENSE]:EVM:ULINK:DECODE:PUCCH:HARQ:ISIZE?
[:SENSE]:EVM:ULINK:DECODE:PUCCH:HARQ:ISIZE:AUTO OFF | ON | 0 | 1
[:SENSE]:EVM:ULINK:DECODE:PUCCH:HARQ:ISIZE:AUTO?
[:SENSE]:EVM:ULINK:DECODE:PUSCH NONE | DESCRAMBLED | DRMATCHED | DCBLOCK |
DTBLOCK
[:SENSE]:EVM:ULINK:DECODE:PUSCH?
[:SENSE]:EVM:ULINK:DECODE:PUSCH:CQI:ISIZE <integer>

```

```
[ :SENSe ] :EVM:ULINK:DECode:PUSCh:CQI:ISIZe?
[ :SENSe ] :EVM:ULINK:DECode:PUSCh:CQI:ISIZe:AUTO OFF | ON | 0 | 1
[ :SENSe ] :EVM:ULINK:DECode:PUSCh:CQI:ISIZe:AUTO?
[ :SENSe ] :EVM:ULINK:DECode:PUSCh:CQI:OFFSet <integer>
[ :SENSe ] :EVM:ULINK:DECode:PUSCh:CQI:OFFSet?
[ :SENSe ] :EVM:ULINK:DECode:PUSCh:HARQ:ISIZe <integer>
[ :SENSe ] :EVM:ULINK:DECode:PUSCh:HARQ:ISIZe?
[ :SENSe ] :EVM:ULINK:DECode:PUSCh:HARQ:ISIZe:AUTO OFF | ON | 0 | 1
[ :SENSe ] :EVM:ULINK:DECode:PUSCh:HARQ:ISIZe:AUTO?
[ :SENSe ] :EVM:ULINK:DECode:PUSCh:HARQ:OFFSet <integer>
[ :SENSe ] :EVM:ULINK:DECode:PUSCh:HARQ:OFFSet?
[ :SENSe ] :EVM:ULINK:DECode:PUSCh:RI:ISIZe <integer>
[ :SENSe ] :EVM:ULINK:DECode:PUSCh:RI:ISIZe?
[ :SENSe ] :EVM:ULINK:DECode:PUSCh:RI:ISIZe:AUTO OFF | ON | 0 | 1
[ :SENSe ] :EVM:ULINK:DECode:PUSCh:RI:ISIZe:AUTO?
[ :SENSe ] :EVM:ULINK:DECode:PUSCh:RI:OFFSet <integer>
[ :SENSe ] :EVM:ULINK:DECode:PUSCh:RI:OFFSet?
[ :SENSe ] :EVM:ULINK:FLATness:CHANnel:CONDition NORMAL | EXTReMe
[ :SENSe ] :EVM:ULINK:FLATness:CHANnel:CONDition?
[ :SENSe ] :EVM:ULINK:FREQuency:CENTer <freq>
[ :SENSe ] :EVM:ULINK:FREQuency:CENTer?
[ :SENSe ] :EVM:ULINK:FREQuency:HIGH <freq>
[ :SENSe ] :EVM:ULINK:FREQuency:HIGH?
[ :SENSe ] :EVM:ULINK:FREQuency:LOW <freq>
[ :SENSe ] :EVM:ULINK:FREQuency:LOW?
[ :SENSe ] :EVM:ULINK:PROFile:ADD:USER
[ :SENSe ] :EVM:ULINK:PROFile:AUTO:CID <integer>
[ :SENSe ] :EVM:ULINK:PROFile:AUTO:CID?
[ :SENSe ] :EVM:ULINK:PROFile:AUTO[:DETeCt]:POWEr OFF | ON | 0 | 1
[ :SENSe ] :EVM:ULINK:PROFile:AUTO[:DETeCt]:POWEr?
[ :SENSe ] :EVM:ULINK:PROFile:AUTO:HOPPing:GROup OFF | ON | 0 | 1
[ :SENSe ] :EVM:ULINK:PROFile:AUTO:HOPPing:GROup?
[ :SENSe ] :EVM:ULINK:PROFile:AUTO:HOPPing:SEQuence OFF | ON | 0 | 1
[ :SENSe ] :EVM:ULINK:PROFile:AUTO:HOPPing:SEQuence?
[ :SENSe ] :EVM:ULINK:PROFile:AUTO:PRACH INCLude | EXCLude
[ :SENSe ] :EVM:ULINK:PROFile:AUTO:PRACH?
[ :SENSe ] :EVM:ULINK:PROFile:AUTO:PRACH:ACTive OFF | ON | 0 | 1
[ :SENSe ] :EVM:ULINK:PROFile:AUTO:PRACH:ACTive?
[ :SENSe ] :EVM:ULINK:PROFile:AUTO:PRACH:CINdex <integer>
[ :SENSe ] :EVM:ULINK:PROFile:AUTO:PRACH:CINdex?
[ :SENSe ] :EVM:ULINK:PROFile:AUTO:PRACH:CSSet UNReStRicted | REStRicted
[ :SENSe ] :EVM:ULINK:PROFile:AUTO:PRACH:CSSet?
[ :SENSe ] :EVM:ULINK:PROFile:AUTO:PRACH:LRsindex <integer>
[ :SENSe ] :EVM:ULINK:PROFile:AUTO:PRACH:LRsindex?
[ :SENSe ] :EVM:ULINK:PROFile:AUTO:PRACH:NCSConfig <integer>
[ :SENSe ] :EVM:ULINK:PROFile:AUTO:PRACH:NCSConfig?
[ :SENSe ] :EVM:ULINK:PROFile:AUTO:PRACH:NRAPrb <integer>
[ :SENSe ] :EVM:ULINK:PROFile:AUTO:PRACH:NRAPrb?
[ :SENSe ] :EVM:ULINK:PROFile:AUTO:PRACH:PINdex <integer>
[ :SENSe ] :EVM:ULINK:PROFile:AUTO:PRACH:PINdex?
[ :SENSe ] :EVM:ULINK:PROFile:AUTO:PRACH:PWRBoost <rel_ampl>
[ :SENSe ] :EVM:ULINK:PROFile:AUTO:PRACH:PWRBoost?
[ :SENSe ] :EVM:ULINK:PROFile:AUTO:PRACH:SRESource <integer>
```

```

[:SENSE]:EVM:ULINK:PROFile:AUTO:PRACH:SRESource?
[:SENSE]:EVM:ULINK:PROFile:AUTO:PUCCh INCLude | EXCLude
[:SENSE]:EVM:ULINK:PROFile:AUTO:PUCCh?
[:SENSE]:EVM:ULINK:PROFile:AUTO:PUCCh:ACTive OFF | ON | 0 | 1
[:SENSE]:EVM:ULINK:PROFile:AUTO:PUCCh:ACTive?
[:SENSE]:EVM:ULINK:PROFile:AUTO:PUCCh:CSHift <integer>
[:SENSE]:EVM:ULINK:PROFile:AUTO:PUCCh:CSHift?
[:SENSE]:EVM:ULINK:PROFile:AUTO:PUCCh:DMRS INCLude | EXCLude
[:SENSE]:EVM:ULINK:PROFile:AUTO:PUCCh:DMRS?
[:SENSE]:EVM:ULINK:PROFile:AUTO:PUCCh:DMRS:GROup <integer>
[:SENSE]:EVM:ULINK:PROFile:AUTO:PUCCh:DMRS:GROup?
[:SENSE]:EVM:ULINK:PROFile:AUTO:PUCCh:DMRS:PARams OFF | ON | 0 | 1
[:SENSE]:EVM:ULINK:PROFile:AUTO:PUCCh:DMRS:PARams?
[:SENSE]:EVM:ULINK:PROFile:AUTO:PUCCh:DMRS:PWRBoost <rel_ampl>
[:SENSE]:EVM:ULINK:PROFile:AUTO:PUCCh:DMRS:PWRBoost?
[:SENSE]:EVM:ULINK:PROFile:AUTO:PUCCh:FNpucch:AUTO OFF | ON | 0 | 1
[:SENSE]:EVM:ULINK:PROFile:AUTO:PUCCh:FNpucch:AUTO?
[:SENSE]:EVM:ULINK:PROFile:AUTO:PUCCh:FORMat T1 | T1A | T1B | T2 | T2A |
T2B | T1S | T1AS | T1BS
[:SENSE]:EVM:ULINK:PROFile:AUTO:PUCCh:FORMat?
[:SENSE]:EVM:ULINK:PROFile:AUTO:PUCCh:NCS:ONE <integer>
[:SENSE]:EVM:ULINK:PROFile:AUTO:PUCCh:NCS:ONE?
[:SENSE]:EVM:ULINK:PROFile:AUTO:PUCCh:N:ONE <integer>
[:SENSE]:EVM:ULINK:PROFile:AUTO:PUCCh:N:ONE?
[:SENSE]:EVM:ULINK:PROFile:AUTO:PUCCh:NRB:TWO <integer>
[:SENSE]:EVM:ULINK:PROFile:AUTO:PUCCh:NRB:TWO?
[:SENSE]:EVM:ULINK:PROFile:AUTO:PUCCh:N:TWO <integer>
[:SENSE]:EVM:ULINK:PROFile:AUTO:PUCCh:N:TWO?
[:SENSE]:EVM:ULINK:PROFile:AUTO:PUCCh:OS INDEx0 | INDEx1 | INDEx2
[:SENSE]:EVM:ULINK:PROFile:AUTO:PUCCh:OS?
[:SENSE]:EVM:ULINK:PROFile:AUTO:PUCCh:PWRBoost <rel_ampl>
[:SENSE]:EVM:ULINK:PROFile:AUTO:PUCCh:PWRBoost?
[:SENSE]:EVM:ULINK:PROFile:AUTO:PUCCh:RB <integer>
[:SENSE]:EVM:ULINK:PROFile:AUTO:PUCCh:RB?
[:SENSE]:EVM:ULINK:PROFile:AUTO:PUCCh:SHIFt <integer>
[:SENSE]:EVM:ULINK:PROFile:AUTO:PUCCh:SHIFt?
[:SENSE]:EVM:ULINK:PROFile:AUTO:PUCCh:SSLot <integer>
[:SENSE]:EVM:ULINK:PROFile:AUTO:PUCCh:SSLot?
[:SENSE]:EVM:ULINK:PROFile:AUTO:PUCCh:SSLot:AUTO OFF | ON | 0 | 1
[:SENSE]:EVM:ULINK:PROFile:AUTO:PUCCh:SSLot:AUTO?
[:SENSE]:EVM:ULINK:PROFile:AUTO:PUSCh INCLude | EXCLude
[:SENSE]:EVM:ULINK:PROFile:AUTO:PUSCh?
[:SENSE]:EVM:ULINK:PROFile:AUTO:PUSCh:ACTive OFF | ON | 0 | 1
[:SENSE]:EVM:ULINK:PROFile:AUTO:PUSCh:ACTive?
[:SENSE]:EVM:ULINK:PROFile:AUTO:PUSCh:DMRS INCLude | EXCLude
[:SENSE]:EVM:ULINK:PROFile:AUTO:PUSCh:DMRS?
[:SENSE]:EVM:ULINK:PROFile:AUTO:PUSCh:DMRS:CSHift <integer>
[:SENSE]:EVM:ULINK:PROFile:AUTO:PUSCh:DMRS:CSHift?
[:SENSE]:EVM:ULINK:PROFile:AUTO:PUSCh:DMRS:GROup <integer>
[:SENSE]:EVM:ULINK:PROFile:AUTO:PUSCh:DMRS:GROup?
[:SENSE]:EVM:ULINK:PROFile:AUTO:PUSCh:DMRS:ONE <integer>
[:SENSE]:EVM:ULINK:PROFile:AUTO:PUSCh:DMRS:ONE?
[:SENSE]:EVM:ULINK:PROFile:AUTO:PUSCh:DMRS:PARams OFF | ON | 0 | 1

```



```
[ :SENSe ]:EVM:ULINK:PROFile:AUTO:PUSCh:DMRS:PARAmS?
[ :SENSe ]:EVM:ULINK:PROFile:AUTO:PUSCh:DMRS:PWRBoost <rel_ampl>
[ :SENSe ]:EVM:ULINK:PROFile:AUTO:PUSCh:DMRS:PWRBoost?
[ :SENSe ]:EVM:ULINK:PROFile:AUTO:PUSCh:DMRS:SEQuence <integer>
[ :SENSe ]:EVM:ULINK:PROFile:AUTO:PUSCh:DMRS:SEQuence?
[ :SENSe ]:EVM:ULINK:PROFile:AUTO:PUSCh:DMRS:TWO <integer>
[ :SENSe ]:EVM:ULINK:PROFile:AUTO:PUSCh:DMRS:TWO?
[ :SENSe ]:EVM:ULINK:PROFile:AUTO:PUSCh:DSS <integer>
[ :SENSe ]:EVM:ULINK:PROFile:AUTO:PUSCh:DSS?
[ :SENSe ]:EVM:ULINK:PROFile:AUTO:PUSCh:FHOpping OFF | T1ISF00 | T1IISF00 |
T1ISF01 | T1IISF01 | T1ISF10 | T1IISF10 | T2ISF | T2IISF
[ :SENSe ]:EVM:ULINK:PROFile:AUTO:PUSCh:FHOpping?
[ :SENSe ]:EVM:ULINK:PROFile:AUTO:PUSCh:MODulation:TYPE QPSK | QAM16 | QAM64
[ :SENSe ]:EVM:ULINK:PROFile:AUTO:PUSCh:MODulation:TYPE?
[ :SENSe ]:EVM:ULINK:PROFile:AUTO:PUSCh:NRBHo <integer>
[ :SENSe ]:EVM:ULINK:PROFile:AUTO:PUSCh:NRBHo?
[ :SENSe ]:EVM:ULINK:PROFile:AUTO:PUSCh:NSB <integer>
[ :SENSe ]:EVM:ULINK:PROFile:AUTO:PUSCh:NSB?
[ :SENSe ]:EVM:ULINK:PROFile:AUTO:PUSCh:PWRBoost <rel_ampl>
[ :SENSe ]:EVM:ULINK:PROFile:AUTO:PUSCh:PWRBoost?
[ :SENSe ]:EVM:ULINK:PROFile:AUTO:PUSCh:RB:END <integer>
[ :SENSe ]:EVM:ULINK:PROFile:AUTO:PUSCh:RB:END?
[ :SENSe ]:EVM:ULINK:PROFile:AUTO:PUSCh:RB:START <integer>
[ :SENSe ]:EVM:ULINK:PROFile:AUTO:PUSCh:RB:START?
[ :SENSe ]:EVM:ULINK:PROFile:AUTO:PUSCh:SSLot <integer>
[ :SENSe ]:EVM:ULINK:PROFile:AUTO:PUSCh:SSLot?
[ :SENSe ]:EVM:ULINK:PROFile:AUTO:PUSCh:SSLot:AUTO OFF | ON | 0 | 1
[ :SENSe ]:EVM:ULINK:PROFile:AUTO:PUSCh:SSLot:AUTO?
[ :SENSe ]:EVM:ULINK:PROFile:AUTO:RNTI <integer>
[ :SENSe ]:EVM:ULINK:PROFile:AUTO:RNTI?
[ :SENSe ]:EVM:ULINK:PROFile:AUTO:SFNumber <integer>
[ :SENSe ]:EVM:ULINK:PROFile:AUTO:SFNumber?
[ :SENSe ]:EVM:ULINK:PROFile:AUTO:SRS INCLude | EXCLude
[ :SENSe ]:EVM:ULINK:PROFile:AUTO:SRS?
[ :SENSe ]:EVM:ULINK:PROFile:AUTO:SRS:ACTive OFF | ON | 0 | 1
[ :SENSe ]:EVM:ULINK:PROFile:AUTO:SRS:ACTive?
[ :SENSe ]:EVM:ULINK:PROFile:AUTO:SRS:BConfig <integer>
[ :SENSe ]:EVM:ULINK:PROFile:AUTO:SRS:BConfig?
[ :SENSe ]:EVM:ULINK:PROFile:AUTO:SRS:BWIDth <integer>
[ :SENSe ]:EVM:ULINK:PROFile:AUTO:SRS:BWIDth?
[ :SENSe ]:EVM:ULINK:PROFile:AUTO:SRS:CINdex <integer>
[ :SENSe ]:EVM:ULINK:PROFile:AUTO:SRS:CINdex?
[ :SENSe ]:EVM:ULINK:PROFile:AUTO:SRS:CShift <integer>
[ :SENSe ]:EVM:ULINK:PROFile:AUTO:SRS:CShift?
[ :SENSe ]:EVM:ULINK:PROFile:AUTO:SRS:FDPosition <integer>
[ :SENSe ]:EVM:ULINK:PROFile:AUTO:SRS:FDPosition?
[ :SENSe ]:EVM:ULINK:PROFile:AUTO:SRS:HBWidth <integer>
[ :SENSe ]:EVM:ULINK:PROFile:AUTO:SRS:HBWidth?
[ :SENSe ]:EVM:ULINK:PROFile:AUTO:SRS:MUPTs OFF | ON | 0 | 1
[ :SENSe ]:EVM:ULINK:PROFile:AUTO:SRS:MUPTs?
[ :SENSe ]:EVM:ULINK:PROFile:AUTO:SRS:NRA:SONe <integer>
[ :SENSe ]:EVM:ULINK:PROFile:AUTO:SRS:NRA:SONe?
[ :SENSe ]:EVM:ULINK:PROFile:AUTO:SRS:NRA:SSIX <integer>
```



```

[:SENSE]:EVM:ULINK:PROFile:AUTO:SRS:NRA:SSIX?
[:SENSE]:EVM:ULINK:PROFile:AUTO:SRS:PWRBoost <rel_ampl>
[:SENSE]:EVM:ULINK:PROFile:AUTO:SRS:PWRBoost?
[:SENSE]:EVM:ULINK:PROFile:AUTO:SRS:SFConfig <integer>
[:SENSE]:EVM:ULINK:PROFile:AUTO:SRS:SFConfig?
[:SENSE]:EVM:ULINK:PROFile:AUTO:SRS:SSLot <integer>
[:SENSE]:EVM:ULINK:PROFile:AUTO:SRS:SSLot?
[:SENSE]:EVM:ULINK:PROFile:AUTO:SRS:SSLot:AUTO OFF | ON | 0 | 1
[:SENSE]:EVM:ULINK:PROFile:AUTO:SRS:SSLot:AUTO?
[:SENSE]:EVM:ULINK:PROFile:AUTO:SRS:TCOMb <integer>
[:SENSE]:EVM:ULINK:PROFile:AUTO:SRS:TCOMb?
[:SENSE]:EVM:ULINK:PROFile:CLEAr
[:SENSE]:EVM:ULINK:PROFile:COUnT?
[:SENSE]:EVM:ULINK:PROFile:EXCLude:ALL
[:SENSE]:EVM:ULINK:PROFile:IGNore
[:SENSE]:EVM:ULINK:PROFile:INCLude:ALL
[:SENSE]:EVM:ULINK:PROFile:UPDate
[:SENSE]:EVM:ULINK:PROFile:USER<n>:CID <integer>
[:SENSE]:EVM:ULINK:PROFile:USER<n>:CID?
[:SENSE]:EVM:ULINK:PROFile:USER<n>:DELeTe
[:SENSE]:EVM:ULINK:PROFile:USER<n>:HOpping:GROup OFF | ON | 0 | 1
[:SENSE]:EVM:ULINK:PROFile:USER<n>:HOpping:GROup?
[:SENSE]:EVM:ULINK:PROFile:USER<n>:HOpping:SEQuence OFF | ON | 0 | 1
[:SENSE]:EVM:ULINK:PROFile:USER<n>:HOpping:SEQuence?
[:SENSE]:EVM:ULINK:PROFile:USER<n>:PRACH INCLude | EXCLude
[:SENSE]:EVM:ULINK:PROFile:USER<n>:PRACH?
[:SENSE]:EVM:ULINK:PROFile:USER<n>:PRACH:CINdex <integer>
[:SENSE]:EVM:ULINK:PROFile:USER<n>:PRACH:CINdex?
[:SENSE]:EVM:ULINK:PROFile:USER<n>:PRACH:CSSet UNREstricted | REStRicted
[:SENSE]:EVM:ULINK:PROFile:USER<n>:PRACH:CSSet?
[:SENSE]:EVM:ULINK:PROFile:USER<n>:PRACH:LRsindex <integer>
[:SENSE]:EVM:ULINK:PROFile:USER<n>:PRACH:LRsindex?
[:SENSE]:EVM:ULINK:PROFile:USER<n>:PRACH:NCsConfig <integer>
[:SENSE]:EVM:ULINK:PROFile:USER<n>:PRACH:NCsConfig?
[:SENSE]:EVM:ULINK:PROFile:USER<n>:PRACH:NRAPrb <integer>
[:SENSE]:EVM:ULINK:PROFile:USER<n>:PRACH:NRAPrb?
[:SENSE]:EVM:ULINK:PROFile:USER<n>:PRACH:PINdex <integer>
[:SENSE]:EVM:ULINK:PROFile:USER<n>:PRACH:PINdex?
[:SENSE]:EVM:ULINK:PROFile:USER<n>:PRACH:PWRBoost <rel_ampl>
[:SENSE]:EVM:ULINK:PROFile:USER<n>:PRACH:PWRBoost?
[:SENSE]:EVM:ULINK:PROFile:USER<n>:PRACH:SRESource <integer>
[:SENSE]:EVM:ULINK:PROFile:USER<n>:PRACH:SRESource?
[:SENSE]:EVM:ULINK:PROFile:USER<n>:PUCCh INCLude | EXCLude
[:SENSE]:EVM:ULINK:PROFile:USER<n>:PUCCh?
[:SENSE]:EVM:ULINK:PROFile:USER<n>:PUCCh:ADD:SLOT<integer>
[:SENSE]:EVM:ULINK:PROFile:USER<n>:PUCCh:COUnT?
[:SENSE]:EVM:ULINK:PROFile:USER<n>:PUCCh:CSHift <integer>
[:SENSE]:EVM:ULINK:PROFile:USER<n>:PUCCh:CSHift?
[:SENSE]:EVM:ULINK:PROFile:USER<n>:PUCCh:CSHift:COUPle OFF | ON | 0 | 1
[:SENSE]:EVM:ULINK:PROFile:USER<n>:PUCCh:CSHift:COUPle?
[:SENSE]:EVM:ULINK:PROFile:USER<n>:PUCCh:DMRS INCLude | EXCLude
[:SENSE]:EVM:ULINK:PROFile:USER<n>:PUCCh:DMRS?
[:SENSE]:EVM:ULINK:PROFile:USER<n>:PUCCh:DMRS:GROup <integer>

```

3 Programming the Analyzer

List of SCPI Commands

```
[ :SENSe ] :EVM:ULINK:PROFile:USER<n>:PUCCh:DMRS:GROup?
[ :SENSe ] :EVM:ULINK:PROFile:USER<n>:PUCCh:DMRS:GROup:COUPle OFF | ON | 0 | 1
[ :SENSe ] :EVM:ULINK:PROFile:USER<n>:PUCCh:DMRS:GROup:COUPle?
[ :SENSe ] :EVM:ULINK:PROFile:USER<n>:PUCCh:DMRS:PARAmS OFF | ON | 0 | 1
[ :SENSe ] :EVM:ULINK:PROFile:USER<n>:PUCCh:DMRS:PARAmS?
[ :SENSe ] :EVM:ULINK:PROFile:USER<n>:PUCCh:DMRS:PWRBoost <rel_ampl>
[ :SENSe ] :EVM:ULINK:PROFile:USER<n>:PUCCh:DMRS:PWRBoost?
[ :SENSe ] :EVM:ULINK:PROFile:USER<n>:PUCCh:DMRS:PWRBoost:COUPle OFF | ON | 0 | 1
[ :SENSe ] :EVM:ULINK:PROFile:USER<n>:PUCCh:DMRS:PWRBoost:COUPle?
[ :SENSe ] :EVM:ULINK:PROFile:USER<n>:PUCCh:FORMAt T1 | T1A | T1B | T2 | T2A | T2B | T1S | T1AS | T1BS
[ :SENSe ] :EVM:ULINK:PROFile:USER<n>:PUCCh:FORMAt?
[ :SENSe ] :EVM:ULINK:PROFile:USER<n>:PUCCh:FORMAt:COUPle OFF | ON | 0 | 1
[ :SENSe ] :EVM:ULINK:PROFile:USER<n>:PUCCh:FORMAt:COUPle?
[ :SENSe ] :EVM:ULINK:PROFile:USER<n>:PUCCh:NCS:ONE <integer>
[ :SENSe ] :EVM:ULINK:PROFile:USER<n>:PUCCh:NCS:ONE?
[ :SENSe ] :EVM:ULINK:PROFile:USER<n>:PUCCh:N:ONE <integer>
[ :SENSe ] :EVM:ULINK:PROFile:USER<n>:PUCCh:N:ONE?
[ :SENSe ] :EVM:ULINK:PROFile:USER<n>:PUCCh:N:ONE:COUPle OFF | ON | 0 | 1
[ :SENSe ] :EVM:ULINK:PROFile:USER<n>:PUCCh:N:ONE:COUPle?
[ :SENSe ] :EVM:ULINK:PROFile:USER<n>:PUCCh:NRB:TWO <integer>
[ :SENSe ] :EVM:ULINK:PROFile:USER<n>:PUCCh:NRB:TWO?
[ :SENSe ] :EVM:ULINK:PROFile:USER<n>:PUCCh:N:TWO <integer>
[ :SENSe ] :EVM:ULINK:PROFile:USER<n>:PUCCh:N:TWO?
[ :SENSe ] :EVM:ULINK:PROFile:USER<n>:PUCCh:OS INDeX0 | INDeX1 | INDeX2
[ :SENSe ] :EVM:ULINK:PROFile:USER<n>:PUCCh:OS?
[ :SENSe ] :EVM:ULINK:PROFile:USER<n>:PUCCh:OS:COUPle OFF | ON | 0 | 1
[ :SENSe ] :EVM:ULINK:PROFile:USER<n>:PUCCh:OS:COUPle?
[ :SENSe ] :EVM:ULINK:PROFile:USER<n>:PUCCh:PWRBoost <rel_ampl>
[ :SENSe ] :EVM:ULINK:PROFile:USER<n>:PUCCh:PWRBoost?
[ :SENSe ] :EVM:ULINK:PROFile:USER<n>:PUCCh:PWRBoost:COUPle OFF | ON | 0 | 1
[ :SENSe ] :EVM:ULINK:PROFile:USER<n>:PUCCh:PWRBoost:COUPle?
[ :SENSe ] :EVM:ULINK:PROFile:USER<n>:PUCCh:RB <integer>
[ :SENSe ] :EVM:ULINK:PROFile:USER<n>:PUCCh:RB?
[ :SENSe ] :EVM:ULINK:PROFile:USER<n>:PUCCh:RB:COUPle OFF | ON | 0 | 1
[ :SENSe ] :EVM:ULINK:PROFile:USER<n>:PUCCh:RB:COUPle?
[ :SENSe ] :EVM:ULINK:PROFile:USER<n>:PUCCh:SHIFt <integer>
[ :SENSe ] :EVM:ULINK:PROFile:USER<n>:PUCCh:SHIFt?
[ :SENSe ] :EVM:ULINK:PROFile:USER<n>:PUCCh:SLOT<m>:CSHift <integer>
[ :SENSe ] :EVM:ULINK:PROFile:USER<n>:PUCCh:SLOT<m>:CSHift?
[ :SENSe ] :EVM:ULINK:PROFile:USER<n>:PUCCh:SLOT<m>:DELeTe
[ :SENSe ] :EVM:ULINK:PROFile:USER<n>:PUCCh:SLOT<m>:DMRS:GROup <integer>
[ :SENSe ] :EVM:ULINK:PROFile:USER<n>:PUCCh:SLOT<m>:DMRS:GROup?
[ :SENSe ] :EVM:ULINK:PROFile:USER<n>:PUCCh:SLOT<m>:DMRS:PWRBoost <rel_ampl>
[ :SENSe ] :EVM:ULINK:PROFile:USER<n>:PUCCh:SLOT<m>:DMRS:PWRBoost?
[ :SENSe ] :EVM:ULINK:PROFile:USER<n>:PUCCh:SLOT<m>:FORMAt T1 | T1A | T1B | T2 | T2A | T2B | T1S | T1AS | T1BS
[ :SENSe ] :EVM:ULINK:PROFile:USER<n>:PUCCh:SLOT<m>:FORMAt?
[ :SENSe ] :EVM:ULINK:PROFile:USER<n>:PUCCh:SLOT<m>:N:ONE <integer>
[ :SENSe ] :EVM:ULINK:PROFile:USER<n>:PUCCh:SLOT<m>:N:ONE?
```

```

[:SENSe]:EVM:ULINK:PROFile:USER<n>:PUCCh:SLOT<m>:OS INDeX0 | INDeX1 |
INDeX2
[:SENSe]:EVM:ULINK:PROFile:USER<n>:PUCCh:SLOT<m>:OS?
[:SENSe]:EVM:ULINK:PROFile:USER<n>:PUCCh:SLOT<m>:POSition?
[:SENSe]:EVM:ULINK:PROFile:USER<n>:PUCCh:SLOT<m>:PWRBoost <rel_ampl>
[:SENSe]:EVM:ULINK:PROFile:USER<n>:PUCCh:SLOT<m>:PWRBoost?
[:SENSe]:EVM:ULINK:PROFile:USER<n>:PUCCh:SLOT<m>:RB <integer>
[:SENSe]:EVM:ULINK:PROFile:USER<n>:PUCCh:SLOT<m>:RB?
[:SENSe]:EVM:ULINK:PROFile:USER<n>:PUCCh:SSLot <integer>
[:SENSe]:EVM:ULINK:PROFile:USER<n>:PUCCh:SSLot?
[:SENSe]:EVM:ULINK:PROFile:USER<n>:PUCCh:SSLot:AUTO OFF | ON | 0 | 1
[:SENSe]:EVM:ULINK:PROFile:USER<n>:PUCCh:SSLot:AUTO?
[:SENSe]:EVM:ULINK:PROFile:USER<n>:PUSCh INCLude | EXCLude
[:SENSe]:EVM:ULINK:PROFile:USER<n>:PUSCh?
[:SENSe]:EVM:ULINK:PROFile:USER<n>:PUSCh:ADD:SLOT <integer>
[:SENSe]:EVM:ULINK:PROFile:USER<n>:PUSCh:COUNT?
[:SENSe]:EVM:ULINK:PROFile:USER<n>:PUSCh:CTNB EVEN | ODD
[:SENSe]:EVM:ULINK:PROFile:USER<n>:PUSCh:CTNB?
[:SENSe]:EVM:ULINK:PROFile:USER<n>:PUSCh:CTNB:COUPle OFF | ON | 0 | 1
[:SENSe]:EVM:ULINK:PROFile:USER<n>:PUSCh:CTNB:COUPle?
[:SENSe]:EVM:ULINK:PROFile:USER<n>:PUSCh:DMRS INCLude | EXCLude
[:SENSe]:EVM:ULINK:PROFile:USER<n>:PUSCh:DMRS?
[:SENSe]:EVM:ULINK:PROFile:USER<n>:PUSCh:DMRS:CSHift <integer>
[:SENSe]:EVM:ULINK:PROFile:USER<n>:PUSCh:DMRS:CSHift?
[:SENSe]:EVM:ULINK:PROFile:USER<n>:PUSCh:DMRS:CSHift:COUPle OFF | ON | 0 |
1
[:SENSe]:EVM:ULINK:PROFile:USER<n>:PUSCh:DMRS:CSHift:COUPle?
[:SENSe]:EVM:ULINK:PROFile:USER<n>:PUSCh:DMRS:GROup <integer>
[:SENSe]:EVM:ULINK:PROFile:USER<n>:PUSCh:DMRS:GROup?
[:SENSe]:EVM:ULINK:PROFile:USER<n>:PUSCh:DMRS:GROup:COUPle OFF | ON | 0 |
1
[:SENSe]:EVM:ULINK:PROFile:USER<n>:PUSCh:DMRS:GROup:COUPle?
[:SENSe]:EVM:ULINK:PROFile:USER<n>:PUSCh:DMRS:ONE <integer>
[:SENSe]:EVM:ULINK:PROFile:USER<n>:PUSCh:DMRS:ONE?
[:SENSe]:EVM:ULINK:PROFile:USER<n>:PUSCh:DMRS:PARAmS OFF | ON | 0 | 1
[:SENSe]:EVM:ULINK:PROFile:USER<n>:PUSCh:DMRS:PARAmS?
[:SENSe]:EVM:ULINK:PROFile:USER<n>:PUSCh:DMRS:PWRBoost <rel_ampl>
[:SENSe]:EVM:ULINK:PROFile:USER<n>:PUSCh:DMRS:PWRBoost?
[:SENSe]:EVM:ULINK:PROFile:USER<n>:PUSCh:DMRS:PWRBoost:COUPle
[:SENSe]:EVM:ULINK:PROFile:USER<n>:PUSCh:DMRS:PWRBoost:COUPle OFF | ON | 0
| 1
[:SENSe]:EVM:ULINK:PROFile:USER<n>:PUSCh:DMRS:SEQuence <integer>
[:SENSe]:EVM:ULINK:PROFile:USER<n>:PUSCh:DMRS:SEQuence?
[:SENSe]:EVM:ULINK:PROFile:USER<n>:PUSCh:DMRS:SEQuence:COUPle OFF | ON | 0
| 1
[:SENSe]:EVM:ULINK:PROFile:USER<n>:PUSCh:DMRS:SEQuence:COUPle?
[:SENSe]:EVM:ULINK:PROFile:USER<n>:PUSCh:DMRS:TWO <integer>
[:SENSe]:EVM:ULINK:PROFile:USER<n>:PUSCh:DMRS:TWO?
[:SENSe]:EVM:ULINK:PROFile:USER<n>:PUSCh:DSS <integer>
[:SENSe]:EVM:ULINK:PROFile:USER<n>:PUSCh:DSS?
[:SENSe]:EVM:ULINK:PROFile:USER<n>:PUSCh:FHOPping OFF | T1ISF00 | T1IISF00
| T1ISF01 | T1IISF01 | T1ISF10 | T1IISF10 | T2ISF | T2IISF

```

```

[:SENSe]:EVM:ULINK:PROFile:USER<n>:PUSCh:FHOPping?
[:SENSe]:EVM:ULINK:PROFile:USER<n>:PUSCh:MODulation:TYPE QPSK | QAM16 |
QAM64
[:SENSe]:EVM:ULINK:PROFile:USER<n>:PUSCh:MODulation:TYPE?
[:SENSe]:EVM:ULINK:PROFile:USER<n>:PUSCh:MODulation:TYPE:COUPle OFF | ON |
0 | 1
[:SENSe]:EVM:ULINK:PROFile:USER<n>:PUSCh:MODulation:TYPE:COUPle?
[:SENSe]:EVM:ULINK:PROFile:USER<n>:PUSCh:NRBHo?
[:SENSe]:EVM:ULINK:PROFile:USER<n>:PUSCh:NRBHo:<integer>
[:SENSe]:EVM:ULINK:PROFile:USER<n>:PUSCh:NSB <integer>
[:SENSe]:EVM:ULINK:PROFile:USER<n>:PUSCh:NSB?
[:SENSe]:EVM:ULINK:PROFile:USER<n>:PUSCh:PWRBoost <rel_ampl>
[:SENSe]:EVM:ULINK:PROFile:USER<n>:PUSCh:PWRBoost?
[:SENSe]:EVM:ULINK:PROFile:USER<n>:PUSCh:PWRBoost:COUPle
[:SENSe]:EVM:ULINK:PROFile:USER<n>:PUSCh:PWRBoost:COUPle OFF | ON | 0 | 1
[:SENSe]:EVM:ULINK:PROFile:USER<n>:PUSCh:RB:END <integer>
[:SENSe]:EVM:ULINK:PROFile:USER<n>:PUSCh:RB:END?
[:SENSe]:EVM:ULINK:PROFile:USER<n>:PUSCh:RB:END:COUPle OFF | ON | 0 | 1
[:SENSe]:EVM:ULINK:PROFile:USER<n>:PUSCh:RB:END:COUPle?
[:SENSe]:EVM:ULINK:PROFile:USER<n>:PUSCh:RB:START <integer>
[:SENSe]:EVM:ULINK:PROFile:USER<n>:PUSCh:RB:START?
[:SENSe]:EVM:ULINK:PROFile:USER<n>:PUSCh:RB:START:COUPle OFF | ON | 0 | 1
[:SENSe]:EVM:ULINK:PROFile:USER<n>:PUSCh:RB:START:COUPle?
[:SENSe]:EVM:ULINK:PROFile:USER<n>:PUSCh:SLOT<m>:CTNB OFF | ON | 0 | 1
[:SENSe]:EVM:ULINK:PROFile:USER<n>:PUSCh:SLOT<m>:CTNB?
[:SENSe]:EVM:ULINK:PROFile:USER<n>:PUSCh:SLOT<m>:DELeTe
[:SENSe]:EVM:ULINK:PROFile:USER<n>:PUSCh:SLOT<m>:DMRS:CSHift <integer>
[:SENSe]:EVM:ULINK:PROFile:USER<n>:PUSCh:SLOT<m>:DMRS:CSHift?
[:SENSe]:EVM:ULINK:PROFile:USER<n>:PUSCh:SLOT<m>:DMRS:GROUp <integer>
[:SENSe]:EVM:ULINK:PROFile:USER<n>:PUSCh:SLOT<m>:DMRS:GROUp?
[:SENSe]:EVM:ULINK:PROFile:USER<n>:PUSCh:SLOT<m>:DMRS:PWRBoost <rel_ampl>
[:SENSe]:EVM:ULINK:PROFile:USER<n>:PUSCh:SLOT<m>:DMRS:PWRBoost?
[:SENSe]:EVM:ULINK:PROFile:USER<n>:PUSCh:SLOT<m>:DMRS:SEQuence <integer>
[:SENSe]:EVM:ULINK:PROFile:USER<n>:PUSCh:SLOT<m>:DMRS:SEQuence?
[:SENSe]:EVM:ULINK:PROFile:USER<n>:PUSCh:SLOT<m>:MODulation:TYPE QPSK |
QAM16 | QAM64
[:SENSe]:EVM:ULINK:PROFile:USER<n>:PUSCh:SLOT<m>:MODulation:TYPE?
[:SENSe]:EVM:ULINK:PROFile:USER<n>:PUSCh:SLOT<m>:POSition?
[:SENSe]:EVM:ULINK:PROFile:USER<n>:PUSCh:SLOT<m>:PWRBoost <rel_ampl>
[:SENSe]:EVM:ULINK:PROFile:USER<n>:PUSCh:SLOT<m>:PWRBoost?
[:SENSe]:EVM:ULINK:PROFile:USER<n>:PUSCh:SLOT<m>:RB:END <integer>
[:SENSe]:EVM:ULINK:PROFile:USER<n>:PUSCh:SLOT<m>:RB:END?
[:SENSe]:EVM:ULINK:PROFile:USER<n>:PUSCh:SLOT<m>:RB:START <integer>
[:SENSe]:EVM:ULINK:PROFile:USER<n>:PUSCh:SLOT<m>:RB:START?
[:SENSe]:EVM:ULINK:PROFile:USER<n>:PUSCh:SSLot?
[:SENSe]:EVM:ULINK:PROFile:USER<n>:PUSCh:SSLot:<integer>
[:SENSe]:EVM:ULINK:PROFile:USER<n>:PUSCh:SSLot:AUTO OFF | ON | 0 | 1
[:SENSe]:EVM:ULINK:PROFile:USER<n>:PUSCh:SSLot:AUTO?
[:SENSe]:EVM:ULINK:PROFile:USER<n>:RNTI <integer>
[:SENSe]:EVM:ULINK:PROFile:USER<n>:RNTI?
[:SENSe]:EVM:ULINK:PROFile:USER<n>:SFNumber <integer>
[:SENSe]:EVM:ULINK:PROFile:USER<n>:SFNumber?

```

```

[:SENSe]:EVM:ULINK:PROFile:USER<n>:SRS INCLude | EXCLude
[:SENSe]:EVM:ULINK:PROFile:USER<n>:SRS?
[:SENSe]:EVM:ULINK:PROFile:USER<n>:SRS:BCONfig <integer>
[:SENSe]:EVM:ULINK:PROFile:USER<n>:SRS:BCONfig?
[:SENSe]:EVM:ULINK:PROFile:USER<n>:SRS:BWIDth <integer>
[:SENSe]:EVM:ULINK:PROFile:USER<n>:SRS:BWIDth?
[:SENSe]:EVM:ULINK:PROFile:USER<n>:SRS:CINdex <integer>
[:SENSe]:EVM:ULINK:PROFile:USER<n>:SRS:CINdex?
[:SENSe]:EVM:ULINK:PROFile:USER<n>:SRS:CSHift <integer>
[:SENSe]:EVM:ULINK:PROFile:USER<n>:SRS:CSHift?
[:SENSe]:EVM:ULINK:PROFile:USER<n>:SRS:FDPosition <integer>
[:SENSe]:EVM:ULINK:PROFile:USER<n>:SRS:FDPosition?
[:SENSe]:EVM:ULINK:PROFile:USER<n>:SRS:HBWidth <integer>
[:SENSe]:EVM:ULINK:PROFile:USER<n>:SRS:HBWidth?
[:SENSe]:EVM:ULINK:PROFile:USER<n>:SRS:MUPTs OFF | ON | 0 | 1
[:SENSe]:EVM:ULINK:PROFile:USER<n>:SRS:MUPTs?
[:SENSe]:EVM:ULINK:PROFile:USER<n>:SRS:NRA:SONe <integer>
[:SENSe]:EVM:ULINK:PROFile:USER<n>:SRS:NRA:SONe?
[:SENSe]:EVM:ULINK:PROFile:USER<n>:SRS:NRA:SSIX <integer>
[:SENSe]:EVM:ULINK:PROFile:USER<n>:SRS:NRA:SSIX?
[:SENSe]:EVM:ULINK:PROFile:USER<n>:SRS:PWRBoost <rel_ampl>
[:SENSe]:EVM:ULINK:PROFile:USER<n>:SRS:PWRBoost?
[:SENSe]:EVM:ULINK:PROFile:USER<n>:SRS:SFConfig <integer>
[:SENSe]:EVM:ULINK:PROFile:USER<n>:SRS:SFConfig?
[:SENSe]:EVM:ULINK:PROFile:USER<n>:SRS:SSLot <integer>
[:SENSe]:EVM:ULINK:PROFile:USER<n>:SRS:SSLot?
[:SENSe]:EVM:ULINK:PROFile:USER<n>:SRS:SSLot:AUTO OFF | ON | 0 | 1
[:SENSe]:EVM:ULINK:PROFile:USER<n>:SRS:SSLot:AUTO?
[:SENSe]:EVM:ULINK:PROFile:USER<n>:SRS:TCOMb <integer>
[:SENSe]:EVM:ULINK:PROFile:USER<n>:SRS:TCOMb?
[:SENSe]:EVM:ULINK:PROFile:USER1|50:PRACH:ACTive OFF | ON | 0 | 1
[:SENSe]:EVM:ULINK:PROFile:USER1|50:PRACH:ACTive?
[:SENSe]:EVM:ULINK:PROFile:USER1|50:PUCCh:ACTive OFF | ON | 0 | 1
[:SENSe]:EVM:ULINK:PROFile:USER1|50:PUCCh:ACTive?
[:SENSe]:EVM:ULINK:PROFile:USER1|50:PUSCh:ACTive OFF | ON | 0 | 1
[:SENSe]:EVM:ULINK:PROFile:USER1|50:PUSCh:ACTive?
[:SENSe]:EVM:ULINK:PROFile:USER1|50:PUSCh:CTNB EVEN | ODD
[:SENSe]:EVM:ULINK:PROFile:USER1|50:PUSCh:CTNB?
[:SENSe]:EVM:ULINK:PROFile:USER1|50:SRS:ACTive OFF | ON | 0 | 1
[:SENSe]:EVM:ULINK:PROFile:USER1|50:SRS:ACTive?
[:SENSe]:EVM:ULINK:SYNC:CPLength AUTO | NORMAl | EXTended
[:SENSe]:EVM:ULINK:SYNC:CPLength?
[:SENSe]:EVM:ULINK:SYNC:CPLength:AUTO OFF | ON | 0 | 1
[:SENSe]:EVM:ULINK:SYNC:CPLength:AUTO?
[:SENSe]:EVM:ULINK:SYNC:HSSHift OFF | ON | 0 | 1
[:SENSe]:EVM:ULINK:SYNC:HSSHift?
[:SENSe]:EVM:ULINK:SYNC:IQOComp
[:SENSe]:EVM:ULINK:SYNC:PDSwap OFF | ON | 0 | 1
[:SENSe]:EVM:ULINK:SYNC:PDSwap?
[:SENSe]:EVM:ULINK:SYNC:TYPE RS | PUCCh | SRS | PRACH
[:SENSe]:EVM:ULINK:SYNC:TYPE?
[:SENSe]:EVM:WINDow:LENGth GPP | CUSTom
[:SENSe]:EVM:WINDow:LENGth?

```

```
[ :SENSe ]:EVM:WINDow:LENGth:CUSTom <int>
[ :SENSe ]:EVM:WINDow:LENGth:CUSTom?
[ :SENSe ]:FCAPture:BLOCK <integer>
[ :SENSe ]:FCAPture:BLOCK?
[ :SENSe ]:FCAPture:LENGth <integer>
[ :SENSe ]:FCAPture:LENGth?
[ :SENSe ]:FCAPture:POINter <integer>
[ :SENSe ]:FCAPture:POINter?
[ :SENSe ]:FCAPture:WLENGth AUTO | BIT32 | BIT64
[ :SENSe ]:FCAPture:WLENGth?
[ :SENSe ]:FEED IQ | IONLy | QONLy
[ :SENSe ]:FEED AREFERENCE
[ :SENSe ]:FEED RF | AIQ | EMIXer
[ :SENSe ]:FEED?
[ :SENSe ]:FEED?
[ :SENSe ]:FEED:AREFERENCE REF50 | REF4800 | OFF
[ :SENSe ]:FEED:AREFERENCE?
[ :SENSe ]:FEED:IQ:TYPE IQ | IONLy | QONLy
[ :SENSe ]:FEED:IQ:TYPE?
[ :SENSe ]:FREQuency:CENTer <freq>
[ :SENSe ]:FREQuency:CENTer <freq>
[ :SENSe ]:FREQuency:CENTer?
[ :SENSe ]:FREQuency:CENTer?
[ :SENSe ]:FREQuency:CENTer:STEP:AUTO OFF | ON | 0 | 1
[ :SENSe ]:FREQuency:CENTer:STEP:AUTO OFF | ON | 0 | 1
[ :SENSe ]:FREQuency:CENTer:STEP:AUTO?
[ :SENSe ]:FREQuency:CENTer:STEP:AUTO?
[ :SENSe ]:FREQuency:CENTer:STEP[:INCRement] <freq>
[ :SENSe ]:FREQuency:CENTer:STEP[:INCRement] <freq>
[ :SENSe ]:FREQuency:CENTer:STEP[:INCRement]?
[ :SENSe ]:FREQuency:CENTer:STEP[:INCRement]?
[ :SENSe ]:FREQuency:EMIXer:CENTer <freq>
[ :SENSe ]:FREQuency:EMIXer:CENTer?
[ :SENSe ]:FREQuency:IQ:CENTer <freq>
[ :SENSe ]:FREQuency:IQ:CENTer?
[ :SENSe ]:FREQuency:RF:CENTer <freq>
[ :SENSe ]:FREQuency:RF:CENTer?
[ :SENSe ]:FREQuency:SPAN <freq>
[ :SENSe ]:FREQuency:SPAN?
[ :SENSe ]:FREQuency:SPAN:FULL
[ :SENSe ]:FREQuency:START <freq>
[ :SENSe ]:FREQuency:START?
[ :SENSe ]:FREQuency:STOP <freq>
[ :SENSe ]:FREQuency:STOP?
[ :SENSe ]:MCPower:AVERAge:COUNT (PSAPowerSuite, PSAW-CDMA, PSACdma2000)
[ :SENSe ]:MCPower:CARRier[1]|2:LIST:BANDwidth[:INTEgration] (PSAPowerSuite)
[ :SENSe ]:MCPower:CARRier[1]|2:LIST:BWIDth[:INTEgration] (PSAPowerSuite)
[ :SENSe ]:MCPower:CARRier[1]|2:LIST:PPREsent (PSAPowerSuite)
[ :SENSe ]:MCPower:CARRier[1]|2:LIST:WIDTh (PSAPowerSuite)
[ :SENSe ]:MCPower:CARRier[1]|2[:POWER]
[ :SENSe ]:MCPower:FILTer[:RRC]:ALPHA
[ :SENSe ]:MCPower:FILTer[:RRC][:STATE]
[ :SENSe ]:MCPower:LIMit[:STATE]
```

```

[:SENSE]:MCPower:METHOD (PSAPowerSuite)
[:SENSE]:MCPower:OFFSET[1]|2:LIST:ABSolute (PSAW-CDMA)
[:SENSE]:MCPower:OFFSET[1]|2:LIST:BANDwidth[:INTEgration] (PSAPowerSuite)
[:SENSE]:MCPower:OFFSET[1]|2:LIST:BWIDth[:INTEgration] (PSAPowerSuite)
[:SENSE]:MCPower:OFFSET[1]|2:LIST[:FREQuency] (PSAPowerSuite)
[:SENSE]:MCPower:OFFSET[1]|2:LIST:RCARrier (PSAWCDMA)
[:SENSE]:MCPower:OFFSET[1]|2:LIST:TEST
[:SENSE]:MCPower:RCARrier[1]|2 (PSAPowerSuite)
[:SENSE]:MIXer:BAND A | Q | U | V | W | NA | ND | NE | NF | NG | NJ | NK |
NQ | NU | NV | NW | NY | NEXT | DD | DF | DG | DJ | DK | DQ | DV | DW | DY
| DEXT | MA | ME | MU | MCOAX | USB
[:SENSE]:MIXer:BAND?
[:SENSE]:MIXer:BIAS <real>
[:SENSE]:MIXer:BIAS?
[:SENSE]:MIXer:BIAS:STATE OFF | ON | 0 | 1
[:SENSE]:MIXer:BIAS:STATE?
[:SENSE]:MIXer:CIFLoss <rel_ampl>
[:SENSE]:MIXer:CIFLoss?
[:SENSE]:MIXer:HARMonic <integer>
[:SENSE]:MIXer:HARMonic?
[:SENSE]:MIXer:LODoubler ON | OFF | 0 | 1
[:SENSE]:MIXer:LODoubler?
[:SENSE]:MIXer:TTYPE SINGLE | HARMonic | DOUBLer
[:SENSE]:MIXer:TTYPE?
[:SENSE]:MONitor:AVERage:COUNT <integer>
[:SENSE]:MONitor:AVERage:COUNT?
[:SENSE]:MONitor:AVERage[:STATE] OFF | ON | 0 | 1
[:SENSE]:MONitor:AVERage[:STATE]?
[:SENSE]:MONitor:AVERage:TCONtrol EXPONential | REPEat
[:SENSE]:MONitor:AVERage:TCONtrol?
[:SENSE]:MONitor:BANDwidth[:RESolution] <freq>
[:SENSE]:MONitor:BANDwidth[:RESolution]?
[:SENSE]:MONitor:BANDwidth[:RESolution]:AUTO OFF | ON | 0 | 1
[:SENSE]:MONitor:BANDwidth[:RESolution]:AUTO?
[:SENSE]:MONitor:BANDwidth:VIDeo <bandwidth>
[:SENSE]:MONitor:BANDwidth:VIDeo?
[:SENSE]:MONitor:BANDwidth:VIDeo:AUTO ON | OFF | 1 | 0
[:SENSE]:MONitor:BANDwidth:VIDeo:AUTO?
[:SENSE]:MONitor:BANDwidth:VIDeo:RATio <real>
[:SENSE]:MONitor:BANDwidth:VIDeo:RATio?
[:SENSE]:MONitor:BANDwidth:VIDeo:RATio:AUTO OFF | ON | 0 | 1
[:SENSE]:MONitor:BANDwidth:VIDeo:RATio:AUTO?
[:SENSE]:MONitor:BWIDth[:RESolution]
[:SENSE]:MONitor:BWIDth:VIDeo
[:SENSE]:MONitor:BWIDth:VIDeo:RATio
[:SENSE]:MONitor:DETEctor:AUTO ON | OFF | 1 | 0
[:SENSE]:MONitor:DETEctor:AUTO?
[:SENSE]:MONitor:DETEctor[:FUNction]
[:SENSE]:MONitor:DETEctor:TRACe AVERage | NEGative | NORMal | POSitive |
SAMPLE
[:SENSE]:MONitor:DETEctor:TRACe?
[:SENSE]:MONitor:FREQuency:SPAN <freq>

```

3 Programming the Analyzer

List of SCPI Commands

```
[ :SENSe ]:MONitor:FREQuency:SPAN?
[ :SENSe ]:MONitor:FREQuency:SPAN:BANDwidth[:RESolution]:RATio <integer>
[ :SENSe ]:MONitor:FREQuency:SPAN:BANDwidth[:RESolution]:RATio?
[ :SENSe ]:MONitor:FREQuency:SPAN:BANDwidth[:RESolution]:RATio:AUTO OFF | ON
| 0 | 1
[ :SENSe ]:MONitor:FREQuency:SPAN:BANDwidth[:RESolution]:RATio:AUTO?
[ :SENSe ]:MONitor:FREQuency:SPAN:BWIDth[:RESolution]:RATio
[ :SENSe ]:MONitor:FREQuency:SPAN:FULL
[ :SENSe ]:MONitor:FREQuency:SPAN:PREVious
[ :SENSe ]:MONitor:SWEep:POINts <integer>
[ :SENSe ]:MONitor:SWEep:POINts?
[ :SENSe ]:MONitor:SWEep:TIME <time>
[ :SENSe ]:MONitor:SWEep:TIME?
[ :SENSe ]:MONitor:SWEep:TIME:AUTO OFF | ON | 0 | 1
[ :SENSe ]:MONitor:SWEep:TIME:AUTO?
[ :SENSe ]:OBWidth:AVERAge:COUNT <integer>
[ :SENSe ]:OBWidth:AVERAge:COUNT?
[ :SENSe ]:OBWidth:AVERAge[:STATe] ON | OFF | 1 | 0
[ :SENSe ]:OBWidth:AVERAge[:STATe]?
[ :SENSe ]:OBWidth:AVERAge:TCONtrol EXPonential | REPeat
[ :SENSe ]:OBWidth:AVERAge:TCONtrol?
[ :SENSe ]:OBWidth:BANDwidth[:RESolution] <bandwidth>
[ :SENSe ]:OBWidth:BANDwidth[:RESolution]?
[ :SENSe ]:OBWidth:BANDwidth[:RESolution]:AUTO ON | OFF | 1 | 0
[ :SENSe ]:OBWidth:BANDwidth[:RESolution]:AUTO?
[ :SENSe ]:OBWidth:BANDwidth:SHAPE GAUSSian | FLATtop
[ :SENSe ]:OBWidth:BANDwidth:SHAPE?
[ :SENSe ]:OBWidth:BANDwidth:VIDeo <bandwidth>
[ :SENSe ]:OBWidth:BANDwidth:VIDeo?
[ :SENSe ]:OBWidth:BANDwidth:VIDeo:AUTO ON | OFF | 1 | 0
[ :SENSe ]:OBWidth:BANDwidth:VIDeo:AUTO?
[ :SENSe ]:OBWidth:BWIDth[:RESolution]
[ :SENSe ]:OBWidth:BWIDth:SHAPE
[ :SENSe ]:OBWidth:BWIDth:VIDeo
[ :SENSe ]:OBWidth:DETEctor:AUTO ON | OFF | 1 | 0
[ :SENSe ]:OBWidth:DETEctor:AUTO?
[ :SENSe ]:OBWidth:DETEctor[:FUNction] NORMal | AVERAge | POSitive | SAMPlE
| NEGative
[ :SENSe ]:OBWidth:DETEctor[:FUNction]?
[ :SENSe ]:OBWidth:FREQuency:SPAN <freq>
[ :SENSe ]:OBWidth:FREQuency:SPAN?
[ :SENSe ]:OBWidth:FREQuency:SPAN:AUTO ON | OFF | 0 | 1
[ :SENSe ]:OBWidth:FREQuency:SPAN:AUTO?
[ :SENSe ]:OBWidth:FREQuency:SPAN:FULL
[ :SENSe ]:OBWidth:FREQuency:SPAN:PREVious
[ :SENSe ]:OBWidth:IF:GAIN:AUTO[:STATe] ON | OFF | 1 | 0
[ :SENSe ]:OBWidth:IF:GAIN:AUTO[:STATe]?
[ :SENSe ]:OBWidth:IF:GAIN[:STATe] ON | OFF | 1 | 0
[ :SENSe ]:OBWidth:IF:GAIN[:STATe]?
[ :SENSe ]:OBWidth:MAXHold ON | OFF | 1 | 0
[ :SENSe ]:OBWidth:MAXHold?
[ :SENSe ]:OBWidth:PERCent <real>
[ :SENSe ]:OBWidth:PERCent?
```



```

[:SENSE]:OBwidth:SWEEP:POINTS <integer>
[:SENSE]:OBwidth:SWEEP:POINTS?
[:SENSE]:OBwidth:SWEEP:TIME <time>
[:SENSE]:OBwidth:SWEEP:TIME?
[:SENSE]:OBwidth:SWEEP:TIME:AUTO OFF | ON | 0 | 1
[:SENSE]:OBwidth:SWEEP:TIME:AUTO?
[:SENSE]:OBwidth:SWEEP:TIME:AUTO:RULES NORMAL | ACCURACY
[:SENSE]:OBwidth:SWEEP:TIME:AUTO:RULES?
[:SENSE]:OBwidth:XDB <rel_ampl>
[:SENSE]:OBwidth:XDB?
[:SENSE]:POWER:IQ[:I]:RANGE[:UPPER] <ampl>
[:SENSE]:POWER:IQ[:I]:RANGE[:UPPER]?
[:SENSE]:POWER:IQ:Q:RANGE[:UPPER] <ampl>
[:SENSE]:POWER:IQ:Q:RANGE[:UPPER]?
[:SENSE]:POWER:IQ:RANGE:AUTO OFF | ON | 0 | 1
[:SENSE]:POWER:IQ:RANGE:AUTO?
[:SENSE]:POWER[:RF]:ATTENUATION <rel_ampl>
[:SENSE]:POWER[:RF]:ATTENUATION?
[:SENSE]:POWER[:RF]:ATTENUATION:AUTO OFF | ON | 0 | 1
[:SENSE]:POWER[:RF]:ATTENUATION:AUTO?
[:SENSE]:POWER[:RF]:ATTENUATION:STEP[:INCREMENT] 10 dB | 2 dB
[:SENSE]:POWER[:RF]:ATTENUATION:STEP[:INCREMENT]?
[:SENSE]:POWER[:RF]:EATTENUATION <rel_ampl>
[:SENSE]:POWER[:RF]:EATTENUATION?
[:SENSE]:POWER[:RF]:EATTENUATION:STATE OFF | ON | 0 | 1
[:SENSE]:POWER[:RF]:EATTENUATION:STATE?
[:SENSE]:POWER[:RF]:GAIN:BAND LOW | FULL
[:SENSE]:POWER[:RF]:GAIN:BAND?
[:SENSE]:POWER[:RF]:GAIN[:STATE] OFF | ON | 0 | 1
[:SENSE]:POWER[:RF]:GAIN[:STATE]?
[:SENSE]:POWER[:RF]:MMW:PADJUST
[:SENSE]:POWER[:RF]:MW:PADJUST
[:SENSE]:POWER[:RF]:MW:PATH STD | LNPath | MPBypass | FULL
[:SENSE]:POWER[:RF]:MW:PATH?
[:SENSE]:POWER[:RF]:MW:PRESELECTOR[:STATE] ON | OFF | 0 | 1
[:SENSE]:POWER[:RF]:MW:PRESELECTOR[:STATE]?
[:SENSE]:POWER[:RF]:PADJUST <freq>
[:SENSE]:POWER[:RF]:PADJUST?
[:SENSE]:POWER[:RF]:PADJUST:PRESELECTOR MWAVE | MMWave | EXTERNAL
[:SENSE]:POWER[:RF]:PADJUST:PRESELECTOR?
[:SENSE]:POWER[:RF]:PCENTER
[:SENSE]:POWER[:RF]:RANGE <real>
[:SENSE]:POWER[:RF]:RANGE?
[:SENSE]:POWER[:RF]:RANGE:AUTO ON | OFF | 1 | 0
[:SENSE]:POWER[:RF]:RANGE:AUTO?
[:SENSE]:POWER[:RF]:RANGE:OPTIMIZE IMMEDIATE
[:SENSE]:POWER[:RF]:RANGE:OPTIMIZE:ATTENUATION OFF | ELECTRICAL | COMBINED
[:SENSE]:POWER[:RF]:RANGE:OPTIMIZE:ATTENUATION?
[:SENSE]:PSTATISTIC:BANDWIDTH <freq>
[:SENSE]:PSTATISTIC:BANDWIDTH?
[:SENSE]:PSTATISTIC:BWIDTh
[:SENSE]:PSTATISTIC:COUNTS <integer>
[:SENSE]:PSTATISTIC:COUNTS?

```

```

[:SENSe]:PStatIstIc:GAUSSian[:STATe]
[:SENSe]:PStatIstIc:IF:GAIN:AUTO[:STATe] ON | OFF | 1 | 0
[:SENSe]:PStatIstIc:IF:GAIN:AUTO[:STATe]?
[:SENSe]:PStatIstIc:IF:GAIN[:STATe] ON | OFF | 1 | 0
[:SENSe]:PStatIstIc:IF:GAIN[:STATe]?
[:SENSe]:PStatIstIc:MEAS:OFFSet <time>
[:SENSe]:PStatIstIc:MEAS:OFFSet?
[:SENSe]:PStatIstIc:RTRace[:STATe]
[:SENSe]:PStatIstIc:SLTView[:STATe] OFF | ON | 0 | 1
[:SENSe]:PStatIstIc:SLTView[:STATe]?
[:SENSe]:PStatIstIc:SRTRace
[:SENSe]:PStatIstIc:SWEep:CYCLes <integer>
[:SENSe]:PStatIstIc:SWEep:CYCLes?
[:SENSe]:PStatIstIc:SWEep:TIME <time>
[:SENSe]:PStatIstIc:SWEep:TIME?
[:SENSe]:PVTime:AVERAge:COUNT <integer>
[:SENSe]:PVTime:AVERAge:COUNT?
[:SENSe]:PVTime:AVERAge[:STATe] OFF | ON | 0 | 1
[:SENSe]:PVTime:AVERAge[:STATe]?
[:SENSe]:PVTime:AVERAge:TCONTRol EXPONentIal | REPEat
[:SENSe]:PVTime:AVERAge:TCONTRol?
[:SENSe]:PVTime:AVERAge:TYPE LOG | LPOWer | RMS | POWer
[:SENSe]:PVTime:AVERAge:TYPE?
[:SENSe]:PVTime:BANDwidth <freq>
[:SENSe]:PVTime:BANDwidth?
[:SENSe]:PVTime:CORRection:NOISe[:AUTO] OFF | ON | 0 | 1
[:SENSe]:PVTime:CORRection:NOISe[:AUTO]?
[:SENSe]:PVTime:IF:GAIN:AUTO[:STATe] ON | OFF | 1 | 0
[:SENSe]:PVTime:IF:GAIN:AUTO[:STATe]?
[:SENSe]:PVTime:IF:GAIN[:STATe] ON | OFF | 1 | 0
[:SENSe]:PVTime:IF:GAIN[:STATe]?
[:SENSe]:PVTime:LIMIt:POFF:DLINK <real>
[:SENSe]:PVTime:LIMIt:POFF:DLINK? [:SENSe]:PVTime:LIMIt:POFF:DLINK?
[:SENSe]:PVTime:LIMIt:POFF:ULINK <real>
[:SENSe]:PVTime:LIMIt:POFF:ULINK?
[:SENSe]:PVTime:LIMIt:RAMP:DRTime <time>
[:SENSe]:PVTime:LIMIt:RAMP:DRTime? [:SENSe]:PVTime:LIMIt:RAMP:DRTime?
[:SENSe]:PVTime:LIMIt:RAMP:URTime <time>
[:SENSe]:PVTime:LIMIt:RAMP:URTime?
[:SENSe]:PVTime:RAMP:SEARCh:LENGth <time>
[:SENSe]:PVTime:RAMP:SEARCh:LENGth?
[:SENSe]:PVTime:THReshold:DOWN:END <rel_ampl>
[:SENSe]:PVTime:THReshold:DOWN:END?
[:SENSe]:PVTime:THReshold:DOWN:START <rel_ampl>
[:SENSe]:PVTime:THReshold:DOWN:START?
[:SENSe]:PVTime:THReshold:UP:END <rel_ampl>
[:SENSe]:PVTime:THReshold:UP:END?
[:SENSe]:PVTime:THReshold:UP:START <rel_ampl>
[:SENSe]:PVTime:THReshold:UP:START?
[:SENSe]:RADIo:CPLength NORMAl | EXTended
[:SENSe]:RADIo:CPLength?
[:SENSe]:RADIo:MEASure OFF | PPF0 | PPF1 | PPF2 | PPF3 | PPF4 | SRS | DSRS
[:SENSe]:RADIo:MEASure?

```

```

[:SENSE]:RADio:MINterval
[:SENSE]:RADio:MINterval <integer>
[:SENSE]:RADio:SLOT TS0 | TS1 | DPTS1 | UPTS1 | TS4 | TS5 | TS6 | TS7 |
TS8 | TS9 | TS10 | TS11 | TS12 | TS13 | TS14 | TS15 | TS16 | TS17 | TS18 |
TS19
[:SENSE]:RADio:SLOT?
[:SENSE]:RADio:STANdard:BANDwidth B1M4 | B3M | B5M | B10M | B15M | B20M
[:SENSE]:RADio:STANdard:BANDwidth?
[:SENSE]:RADio:STANdard:DGPU CONF0 | CONF1 | CONF2 | CONF3 | CONF4 | CONF5
| CONF6 | CONF7 | CONF8
[:SENSE]:RADio:STANdard:DGPU?
[:SENSE]:RADio:STANdard:DIRection DLINK | ULINK
[:SENSE]:RADio:STANdard:DIRection?
[:SENSE]:RADio:STANdard:PRESet B1M4 | B3M | B5M | B10M | B15M | B20M
[:SENSE]:RADio:STANdard:ULDL
[:SENSE]:RADio:STANdard:ULDL CONF0 | CONF1 | CONF2 | CONF3 | CONF4 | CONF5
| CONF6
[:SENSE]:ROSCillator:BANDwidth WIDE | NARROW
[:SENSE]:ROSCillator:BANDwidth?
[:SENSE]:ROSCillator:COUPLing NORMAl | NACQuisition
[:SENSE]:ROSCillator:COUPLing?
[:SENSE]:ROSCillator:EXTErnal:FREQuency <freq>
[:SENSE]:ROSCillator:EXTErnal:FREQuency?
[:SENSE]:ROSCillator:SOURce INTernal | EXTErnal
[:SENSE]:ROSCillator:SOURce?
[:SENSE]:ROSCillator:SOURce:TYPE INTernal | EXTErnal | SENSE | PULSE
[:SENSE]:ROSCillator:SOURce:TYPE?
[:SENSE]:SEMask:AVERage:COUNT <integer>
[:SENSE]:SEMask:AVERage:COUNT?
[:SENSE]:SEMask:AVERage[:STATE] ON | OFF | 1 | 0
[:SENSE]:SEMask:AVERage[:STATE]?
[:SENSE]:SEMask:BANDwidth[1]|2:INTEgration <bandwidth>
[:SENSE]:SEMask:BANDwidth[1]|2:INTEgration?
[:SENSE]:SEMask:BANDwidth[1]|2[:RESolution] <bandwidth>
[:SENSE]:SEMask:BANDwidth[1]|2[:RESolution]?
[:SENSE]:SEMask:BANDwidth[1]|2[:RESolution]:AUTO OFF | ON | 1 | 0
[:SENSE]:SEMask:BANDwidth[1]|2[:RESolution]:AUTO?
[:SENSE]:SEMask:BANDwidth:SHAPE ASENse | GAUSSian | FLATtop
[:SENSE]:SEMask:BANDwidth:SHAPE?
[:SENSE]:SEMask:BANDwidth[1]|2:VIDeo <bandwidth>
[:SENSE]:SEMask:BANDwidth[1]|2:VIDeo?
[:SENSE]:SEMask:BANDwidth[1]|2:VIDeo:AUTO OFF | ON | 1 | 0
[:SENSE]:SEMask:BANDwidth[1]|2:VIDeo:AUTO?
[:SENSE]:SEMask:BANDwidth[1]|2:VIDeo:RATio
[:SENSE]:SEMask:BANDwidth[1]|2:VIDeo:RATio <real>
[:SENSE]:SEMask:BANDwidth[1]|2:VIDeo:RATio:AUTO OFF | ON | 1 | 0
[:SENSE]:SEMask:BANDwidth[1]|2:VIDeo:RATio:AUTO?
[:SENSE]:SEMask:BWIDth[1]|2[:RESolution]
[:SENSE]:SEMask:BWIDth[1]|2:VIDeo
[:SENSE]:SEMask:BWIDth[1]|2:VIDeo:RATio
[:SENSE]:SEMask:CARRier:AUTO[:STATE] OFF | ON | 1 | 0
[:SENSE]:SEMask:CARRier:AUTO[:STATE]?

```

3 Programming the Analyzer

List of SCPI Commands

```

[:SENSe]:SEMask:CARRier:CPSD <real>
[:SENSe]:SEMask:CARRier:CPSD?
[:SENSe]:SEMask:CARRier:PEAK[:POWer] <real>
[:SENSe]:SEMask:CARRier:PEAK[:POWer]?
[:SENSe]:SEMask:CARRier[:POWer] <real>
[:SENSe]:SEMask:CARRier[:POWer]?
[:SENSe]:SEMask:DETEctor:CARRier:AUTO ON | OFF | 1 | 0
[:SENSe]:SEMask:DETEctor:CARRier:AUTO?
[:SENSe]:SEMask:DETEctor:CARRier[:FUNction] AVERAge | NEGAtive | NORMAl |
POSitive | SAMPlE
[:SENSe]:SEMask:DETEctor:CARRier[:FUNction]?
[:SENSe]:SEMask:DETEctor:OFFSet:AUTO ON | OFF | 1 | 0
[:SENSe]:SEMask:DETEctor:OFFSet:AUTO?
[:SENSe]:SEMask:DETEctor:OFFSet[:FUNction] AVERAge | NEGAtive | NORMAl |
POSitive | SAMPlE
[:SENSe]:SEMask:DETEctor:OFFSet[:FUNction]?
[:SENSe]:SEMask:FILTEr[:RRC]:ALPHa <real>
[:SENSe]:SEMask:FILTEr[:RRC]:ALPHa?
[:SENSe]:SEMask:FILTEr[:RRC][:STATe] OFF | ON | 0 | 1
[:SENSe]:SEMask:FILTEr[:RRC][:STATe]?
[:SENSe]:SEMask:FREQuency[1]|2:SPAN <freq>
[:SENSe]:SEMask:FREQuency[1]|2:SPAN?
[:SENSe]:SEMask:OFFSet[1]|2:LIST:BWIDth:IMULti
[:SENSe]:SEMask:OFFSet[1]|2:LIST:BWIDth[:RESolution]
[:SENSe]:SEMask:OFFSet[1]|2:LIST:BWIDth:VIDEo
[:SENSe]:SEMask:OFFSet[1]|2:LIST:SWEep[:TIME]
[:SENSe]:SEMask:OFFSet[1]|2[:OUTer]:LIST:BWIDth:IMULti <integer>, ...
[:SENSe]:SEMask:OFFSet[1]|2[:OUTer]:LIST:BWIDth:IMULti?
[:SENSe]:SEMask:OFFSet[1]|2[:OUTer]:LIST:BWIDth[:RESolution]
<bandwidth>, ...
[:SENSe]:SEMask:OFFSet[1]|2[:OUTer]:LIST:BWIDth[:RESolution]?
[:SENSe]:SEMask:OFFSet[1]|2[:OUTer]:LIST:BWIDth[:RESolution]:AUTO OFF |
ON | 1 | 0, ...
[:SENSe]:SEMask:OFFSet[1]|2[:OUTer]:LIST:BWIDth[:RESolution]:AUTO?
[:SENSe]:SEMask:OFFSet[1]|2[:OUTer]:LIST:BWIDth:VIDEo <freq>, ...
[:SENSe]:SEMask:OFFSet[1]|2[:OUTer]:LIST:BWIDth:VIDEo?
[:SENSe]:SEMask:OFFSet[1]|2[:OUTer]:LIST:BWIDth:VIDEo:AUTO OFF | ON | 0
| 1, ...
[:SENSe]:SEMask:OFFSet[1]|2[:OUTer]:LIST:BWIDth:VIDEo:AUTO?
[:SENSe]:SEMask:OFFSet[1]|2[:OUTer]:LIST:BWIDth:VIDEo:RATio <real>, ...
[:SENSe]:SEMask:OFFSet[1]|2[:OUTer]:LIST:BWIDth:VIDEo:RATio?
[:SENSe]:SEMask:OFFSet[1]|2[:OUTer]:LIST:BWIDth:VIDEo:RATio:AUTO OFF |
ON | 0 | 1, ...
[:SENSe]:SEMask:OFFSet[1]|2[:OUTer]:LIST:BWIDth:VIDEo:RATio:AUTO?
[:SENSe]:SEMask:OFFSet[1]|2[:OUTer]:LIST:FREQuency:START <freq>, ...
[:SENSe]:SEMask:OFFSet[1]|2[:OUTer]:LIST:FREQuency:START?
[:SENSe]:SEMask:OFFSet[1]|2[:OUTer]:LIST:FREQuency:STOP <freq>, ...
[:SENSe]:SEMask:OFFSet[1]|2[:OUTer]:LIST:FREQuency:STOP?
[:SENSe]:SEMask:OFFSet[1]|2[:OUTer]:LIST:SIDE BOTH | NEGAtive | POSitive,
...
[:SENSe]:SEMask:OFFSet[1]|2[:OUTer]:LIST:SIDE?
[:SENSe]:SEMask:OFFSet[1]|2[:OUTer]:LIST:START:ABSolute <real>, ...

```

```

[:SENSE]:SEMask:OFFSet[1]|2[:OUTER]:LIST:START:ABSolute?
[:SENSE]:SEMask:OFFSet[1]|2[:OUTER]:LIST:START:RCARrier <rel_ampl>, ...
[:SENSE]:SEMask:OFFSet[1]|2[:OUTER]:LIST:START:RCARrier?
[:SENSE]:SEMask:OFFSet[1]|2[:OUTER]:LIST:STATE ON | OFF | 1 | 0, ...
[:SENSE]:SEMask:OFFSet[1]|2[:OUTER]:LIST:STATE?
[:SENSE]:SEMask:OFFSet[1]|2[:OUTER]:LIST:STOP:ABSolute <real>, ...
[:SENSE]:SEMask:OFFSet[1]|2[:OUTER]:LIST:STOP:ABSolute?
[:SENSE]:SEMask:OFFSet[1]|2[:OUTER]:LIST:STOP:ABSolute:COUPLE ON | OFF | 1
| 0, ...
[:SENSE]:SEMask:OFFSet[1]|2[:OUTER]:LIST:STOP:ABSolute:COUPLE?
[:SENSE]:SEMask:OFFSet[1]|2[:OUTER]:LIST:STOP:RCARrier <rel_ampl>, ...
[:SENSE]:SEMask:OFFSet[1]|2[:OUTER]:LIST:STOP:RCARrier?
[:SENSE]:SEMask:OFFSet[1]|2[:OUTER]:LIST:STOP:RCARrier:COUPLE ON | OFF | 1
| 0, ...
[:SENSE]:SEMask:OFFSet[1]|2[:OUTER]:LIST:STOP:RCARrier:COUPLE?
[:SENSE]:SEMask:OFFSet[1]|2[:OUTER]:LIST:SWEep:TIME <time>, ...
[:SENSE]:SEMask:OFFSet[1]|2[:OUTER]:LIST:SWEep:TIME?
[:SENSE]:SEMask:OFFSet[1]|2[:OUTER]:LIST:SWEep:TIME:AUTO ON | OFF | 1 | 0,
...
[:SENSE]:SEMask:OFFSet[1]|2[:OUTER]:LIST:SWEep:TIME:AUTO?
[:SENSE]:SEMask:OFFSet[1]|2[:OUTER]:LIST:TEST ABSolute | AND | OR |
RELative, ...
[:SENSE]:SEMask:OFFSet[1]|2[:OUTER]:LIST:TEST?
[:SENSE]:SEMask:OFFSet[1]|2:TYPE CTOCenter | CTOEdge | ETOCenter | ETOEdge
[:SENSE]:SEMask:OFFSet[1]|2:TYPE?
[:SENSE]:SEMask:SWEep[1]|2:TIME <time>
[:SENSE]:SEMask:SWEep[1]|2:TIME?
[:SENSE]:SEMask:SWEep[1]|2:TIME:AUTO OFF | 0 | ON | 1
[:SENSE]:SEMask:SWEep[1]|2:TIME:AUTO?
[:SENSE]:SEMask:TYPE PSDRef | TPreF | SPRef
[:SENSE]:SEMask:TYPE?
[:SENSE]:SPECTrum NORMAl | INVert
[:SENSE]:SPECTrum?
[:SENSE]:SPURious:AVERAge:COUNT <integer>
[:SENSE]:SPURious:AVERAge:COUNT?
[:SENSE]:SPURious:AVERAge[:STATE] ON | OFF | 1 | 0
[:SENSE]:SPURious:AVERAge[:STATE]?
[:SENSE]:SPURious:AVERAge:TCONtrol EXPonential | REPeat
[:SENSE]:SPURious:AVERAge:TCONtrol?
[:SENSE]:SPURious:FSMeas ON | OFF | 1 | 0
[:SENSE]:SPURious:FSMeas?
[:SENSE]:SPURious:IF:GAIN:AUTO[:STATE] OFF|ON|0|1, ...
[:SENSE]:SPURious:IF:GAIN:AUTO[:STATE]?
[:SENSE]:SPURious:IF:GAIN[:STATE] OFF|ON|0|1, ...
[:SENSE]:SPURious:IF:GAIN[:STATE]?
[:SENSE]:SPURious:POWer[:RF]:RANGE:AUTO
[:SENSE]:SPURious[:RANGE]:ALL:SWEep:TYPE:AUTO OFF | ON | 0 | 1
[:SENSE]:SPURious[:RANGE]:ALL:SWEep:TYPE:AUTO?
[:SENSE]:SPURious[:RANGE][:LIST]:ATTenuation <rel_ampl>, ...
[:SENSE]:SPURious[:RANGE][:LIST]:ATTenuation?
[:SENSE]:SPURious[:RANGE][:LIST]:ATTenuation:AUTO OFF|ON|0|1, ...
[:SENSE]:SPURious[:RANGE][:LIST]:ATTenuation:AUTO?

```

```

[:SENSe]:SPURious[:RANGe][:LIST]:BANDwidth[:RESolution] <freq>, ...
[:SENSe]:SPURious[:RANGe][:LIST]:BANDwidth[:RESolution]?
[:SENSe]:SPURious[:RANGe][:LIST]:BANDwidth[:RESolution]:AUTO OFF|ON|0|1,
...
[:SENSe]:SPURious[:RANGe][:LIST]:BANDwidth[:RESolution]:AUTO?
[:SENSe]:SPURious[:RANGe][:LIST]:BANDwidth:SHApe GAUSSian|FLATtop, ...
[:SENSe]:SPURious[:RANGe][:LIST]:BANDwidth:SHApe?
[:SENSe]:SPURious[:RANGe][:LIST]:BANDwidth:VIDeo <freq>, ...
[:SENSe]:SPURious[:RANGe][:LIST]:BANDwidth:VIDeo?
[:SENSe]:SPURious[:RANGe][:LIST]:BANDwidth:VIDeo:AUTO OFF|ON|0|1, ...
[:SENSe]:SPURious[:RANGe][:LIST]:BANDwidth:VIDeo:AUTO?
[:SENSe]:SPURious[:RANGe][:LIST]:BWIDth[:RESolution]
[:SENSe]:SPURious[:RANGe][:LIST]:BWIDth:SHApe
[:SENSe]:SPURious[:RANGe][:LIST]:BWIDth:VIDeo
[:SENSe]:SPURious[:RANGe][:LIST]:DETEctor[1][:FUNction]
AVERage|NEGative|NORMal|POSitive|SAMPle|RMS, ...
[:SENSe]:SPURious[:RANGe][:LIST]:DETEctor2[:FUNction]
OFF|AVERage|NEGative|NORMal|POSitive|SAMPle|RMS, ...
[:SENSe]:SPURious[:RANGe][:LIST]:DETEctor[1][:FUNction]?
[:SENSe]:SPURious[:RANGe][:LIST]:DETEctor2[:FUNction]?
[:SENSe]:SPURious[:RANGe][:LIST]:FREQuency:START <freq>, ...
[:SENSe]:SPURious[:RANGe][:LIST]:FREQuency:START?
[:SENSe]:SPURious[:RANGe][:LIST]:FREQuency:STOP <freq>, ...
[:SENSe]:SPURious[:RANGe][:LIST]:FREQuency:STOP?
[:SENSe]:SPURious[:RANGe][:LIST]:PEAK:EXCursion <rel_ampl>, ...
[:SENSe]:SPURious[:RANGe][:LIST]:PEAK:EXCursion?
[:SENSe]:SPURious[:RANGe][:LIST]:PEAK:THReshold <real>, ...
[:SENSe]:SPURious[:RANGe][:LIST]:PEAK:THReshold?
[:SENSe]:SPURious[:RANGe][:LIST]:STATE ON|OFF|1|0, ...
[:SENSe]:SPURious[:RANGe][:LIST]:STATE?
[:SENSe]:SPURious[:RANGe][:LIST]:SWEep:POINTs <integer>
[:SENSe]:SPURious[:RANGe][:LIST]:SWEep:POINTs?
[:SENSe]:SPURious[:RANGe][:LIST]:SWEep:POINTs:AUTO OFF|ON|0|1, ...
[:SENSe]:SPURious[:RANGe][:LIST]:SWEep:POINTs:AUTO?
[:SENSe]:SPURious[:RANGe][:LIST]:SWEep:TIME <time>, ...
[:SENSe]:SPURious[:RANGe][:LIST]:SWEep:TIME?
[:SENSe]:SPURious[:RANGe][:LIST]:SWEep:TIME:AUTO OFF|ON|0|1, ...
[:SENSe]:SPURious[:RANGe][:LIST]:SWEep:TIME:AUTO?
[:SENSe]:SPURious:REPT:MODE ALL | LIMTest | MMARgin
[:SENSe]:SPURious:REPT:MODE?
[:SENSe]:SPURious:SPUR <integer>
[:SENSe]:SPURious:SPUR?
[:SENSe]:SPURious:SWEep:TIME:AUTO:RULEs NORMal | ACCuracy
[:SENSe]:SPURious:SWEep:TIME:AUTO:RULEs?
[:SENSe]:SPURious:TYPE EXAMine | FULL
[:SENSe]:SPURious:TYPE?
[:SENSe]:SWEep:EGATE:CONTRol EDGE | LEVEL
[:SENSe]:SWEep:EGATE:CONTRol?
[:SENSe]:SWEep:EGATE:DELay <time>
[:SENSe]:SWEep:EGATE:DELay?
[:SENSe]:SWEep:EGATE:DELay:COMPensation:TYPE OFF | SETTled | GDELay
[:SENSe]:SWEep:EGATE:DELay:COMPensation:TYPE?

```

```

[:SENSe]:SWEep:EGATe:EXTeRnal[1]|2:LEVel <voltage>
[:SENSe]:SWEep:EGATe:EXTeRnal[1]|2:LEVel?
[:SENSe]:SWEep:EGATe:HOLDoFF <time>
[:SENSe]:SWEep:EGATe:HOLDoFF?
[:SENSe]:SWEep:EGATe:HOLDoFF:AUTO OFF | ON | 0 | 1
[:SENSe]:SWEep:EGATe:HOLDoFF:AUTO?
[:SENSe]:SWEep:EGATe:LENGth <time>
[:SENSe]:SWEep:EGATe:LENGth?
[:SENSe]:SWEep:EGATe:MINFast?
[:SENSe]:SWEep:EGATe:POLarity NEGative | POSitive
[:SENSe]:SWEep:EGATe:POLarity?
[:SENSe]:SWEep:EGATe:SOURce EXTeRnal1 | EXTeRnal2 | LINE | FRAME | RFBurst
[:SENSe]:SWEep:EGATe:SOURce?
[:SENSe]:SWEep:EGATe[:STATE] OFF | ON | 0 | 1
[:SENSe]:SWEep:EGATe[:STATE]?
[:SENSe]:SWEep:EGATe:TIME <time>
[:SENSe]:SWEep:EGATe:TIME?
[:SENSe]:SWEep:EGATe:VIEW ON | OFF | 1 | 0
[:SENSe]:SWEep:EGATe:VIEW?
[:SENSe]:SWEep:EGATe:VIEW:STARt <time>
[:SENSe]:SWEep:EGATe:VIEW:STARt?
[:SENSe]:SWEep:TIME:GATE:LEVel HIGH | LOW
[:SENSe]:SWEep:TIME:GATE:LEVel?
[:SENSe]:VOLtAge:IQ[:I]:RANGE[:UPPer] <voltage>
[:SENSe]:VOLtAge:IQ[:I]:RANGE[:UPPer]?
[:SENSe]:VOLtAge:IQ:Q:RANGE[:UPPer] <voltage>
[:SENSe]:VOLtAge:IQ:Q:RANGE[:UPPer]?
[:SENSe]:VOLtAge:IQ:RANGE:AUTO OFF | ON | 0 | 1
[:SENSe]:VOLtAge:IQ:RANGE:AUTO?
[:SENSe]:VOLtAge|POWER:IQ:MIRROred OFF | ON | 0 | 1
[:SENSe]:VOLtAge|POWER:IQ:MIRROred?
[:SENSe]:WAVeform:ADC:DITHer:AUTO[:STATE] OFF | ON | 0 | 1
[:SENSe]:WAVeform:ADC:DITHer:AUTO[:STATE]?
[:SENSe]:WAVeform:ADC:DITHer[:STATE] OFF | ON | 0 | 1
[:SENSe]:WAVeform:ADC:DITHer[:STATE]?
[:SENSe]:WAVeform:APERture?
[:SENSe]:WAVeform:AVERAge:COUNT <integer>
[:SENSe]:WAVeform:AVERAge:COUNT?
[:SENSe]:WAVeform:AVERAge[:STATE] OFF | ON | 0 | 1
[:SENSe]:WAVeform:AVERAge[:STATE]?
[:SENSe]:WAVeform:AVERAge:TACount <integer>
[:SENSe]:WAVeform:AVERAge:TACount?
[:SENSe]:WAVeform:AVERAge:TCONtrol EXPOntial | REPeat
[:SENSe]:WAVeform:AVERAge:TCONtrol?
[:SENSe]:WAVeform:AVERAge:TYPE LOG | MAXimum | MINimum | RMS | SCALar
[:SENSe]:WAVeform:AVERAge:TYPE?
[:SENSe]:WAVeform:BANDwidth|BWIDth[:RESolution]:TYPE
[:SENSe]:WAVeform:BANDwidth[:RESolution]
[:SENSe]:WAVeform:BANDwidth:SHApe
[:SENSe]:WAVeform:BWIDth[:RESolution]
[:SENSe]:WAVeform:BWIDth:SHApe
[:SENSe]:WAVeform:DIF:BANDwidth <freq>
[:SENSe]:WAVeform:DIF:BANDwidth?

```

3 Programming the Analyzer

List of SCPI Commands

```
[ :SENSe ]:WAVeform:DIF:FILTer:ALPHa <real>
[ :SENSe ]:WAVeform:DIF:FILTer:ALPHa?
[ :SENSe ]:WAVeform:DIF:FILTer:BANDwidth <freq>
[ :SENSe ]:WAVeform:DIF:FILTer:BANDwidth?
[ :SENSe ]:WAVeform:DIF:FILTer:BANDwidth:AUTO ON | OFF | 1 | 0
[ :SENSe ]:WAVeform:DIF:FILTer:BANDwidth:AUTO?
[ :SENSe ]:WAVeform:DIF:FILTer:TYPE GAUSSian | FLATtop
[ :SENSe ]:WAVeform:DIF:FILTer:TYPE GAUSSian | FLATtop | SNYQuist |
RSNYquist | RCOSine | RRCosine
[ :SENSe ]:WAVeform:DIF:FILTer:TYPE?
[ :SENSe ]:WAVeform:DIF:FILTer:TYPE?
[ :SENSe ]:WAVeform:FREQuency:SYNTHeSis:AUTO[:STATE] OFF | ON | 0 | 1
[ :SENSe ]:WAVeform:FREQuency:SYNTHeSis:AUTO[:STATE]?
[ :SENSe ]:WAVeform:FREQuency:SYNTHeSis[:STATE] 1 | 2 | 3
[ :SENSe ]:WAVeform:FREQuency:SYNTHeSis[:STATE]?
[ :SENSe ]:WAVeform:IF:GAIN:AUTO[:STATE] ON | OFF | 1 | 0
[ :SENSe ]:WAVeform:IF:GAIN:AUTO[:STATE]?
[ :SENSe ]:WAVeform:IF:GAIN:OFFSet <rel_ampl>
[ :SENSe ]:WAVeform:IF:GAIN:OFFSet?
[ :SENSe ]:WAVeform:IF:GAIN[:STATE] AUTOrange | LOW | HIGH
[ :SENSe ]:WAVeform:IF:GAIN[:STATE]?
[ :SENSe ]:WAVeform:PDITHer
[ :SENSe ]:WAVeform:SRATe <freq>
[ :SENSe ]:WAVeform:SRATe?
[ :SENSe ]:WAVeform:SWEep:TIME <time>
[ :SENSe ]:WAVeform:SWEep:TIME?
[ :SENSe ]:WAVeform:WBIF:ADC:DITHer
[ :SENSe ]:WAVeform:WBIF:FILTer:ALPHa
[ :SENSe ]:WAVeform:WBIF:FILTer:BANDwidth <real>
[ :SENSe ]:WAVeform:WBIF:FILTer:BANDwidth?
[ :SENSe ]:WAVeform:WBIF:FILTer[:TYPE] GAUSSian | NONE | NYQuist | RNYQuist
| RCOSine | RRCosine
[ :SENSe ]:WAVeform:WBIF:FILTer[:TYPE]?
STATus:OPERation:CONDition?
STATus:OPERation:ENABle <integer>
STATus:OPERation:ENABle?
STATus:OPERation[:EVENT]?
STATus:OPERation:NTRansition <integer>
STATus:OPERation:NTRansition?
STATus:OPERation:PTRansition <integer>
STATus:OPERation:PTRansition?
STATus:PRESet
STATus:QUESTionable:CALibration:CONDition?
STATus:QUESTionable:CALibration:ENABle <integer>
STATus:QUESTionable:CALibration:ENABle?
STATus:QUESTionable:CALibration[:EVENT]?
STATus:QUESTionable:CALibration:EXTended:FAILure:CONDition?
STATus:QUESTionable:CALibration:EXTended:FAILure:ENABle <integer>
STATus:QUESTionable:CALibration:EXTended:FAILure:ENABle?
STATus:QUESTionable:CALibration:EXTended:FAILure[:EVENT]?
STATus:QUESTionable:CALibration:EXTended:FAILure:NTRansition <integer>
STATus:QUESTionable:CALibration:EXTended:FAILure:NTRansition?
STATus:QUESTionable:CALibration:EXTended:FAILure:PTRansition <integer>
```



```
STATUS:QUESTIONABLE:CALIBRATION:EXTENDED:FAILURE:PTRANSITION?
STATUS:QUESTIONABLE:CALIBRATION:EXTENDED:NEEDED:CONDITION?
STATUS:QUESTIONABLE:CALIBRATION:EXTENDED:NEEDED:ENABLE <integer>
STATUS:QUESTIONABLE:CALIBRATION:EXTENDED:NEEDED:ENABLE?
STATUS:QUESTIONABLE:CALIBRATION:EXTENDED:NEEDED[:EVENT]?
STATUS:QUESTIONABLE:CALIBRATION:EXTENDED:NEEDED:NTRANSITION <integer>
STATUS:QUESTIONABLE:CALIBRATION:EXTENDED:NEEDED:NTRANSITION?
STATUS:QUESTIONABLE:CALIBRATION:EXTENDED:NEEDED:PTRANSITION <integer>
STATUS:QUESTIONABLE:CALIBRATION:EXTENDED:NEEDED:PTRANSITION?
STATUS:QUESTIONABLE:CALIBRATION:NTRANSITION <integer>
STATUS:QUESTIONABLE:CALIBRATION:NTRANSITION?
STATUS:QUESTIONABLE:CALIBRATION:PTRANSITION <integer>
STATUS:QUESTIONABLE:CALIBRATION:PTRANSITION?
STATUS:QUESTIONABLE:CALIBRATION:SKIPPED:CONDITION?
STATUS:QUESTIONABLE:CALIBRATION:SKIPPED:ENABLE <integer>
STATUS:QUESTIONABLE:CALIBRATION:SKIPPED:ENABLE?
STATUS:QUESTIONABLE:CALIBRATION:SKIPPED[:EVENT]?
STATUS:QUESTIONABLE:CALIBRATION:SKIPPED:NTRANSITION <integer>
STATUS:QUESTIONABLE:CALIBRATION:SKIPPED:NTRANSITION?
STATUS:QUESTIONABLE:CALIBRATION:SKIPPED:PTRANSITION <integer>
STATUS:QUESTIONABLE:CALIBRATION:SKIPPED:PTRANSITION?
STATUS:QUESTIONABLE:CONDITION?
STATUS:QUESTIONABLE:ENABLE <integer>
STATUS:QUESTIONABLE:ENABLE?
STATUS:QUESTIONABLE[:EVENT]?
STATUS:QUESTIONABLE:FREQUENCY:CONDITION?
STATUS:QUESTIONABLE:FREQUENCY:ENABLE <integer>
STATUS:QUESTIONABLE:FREQUENCY:ENABLE?
STATUS:QUESTIONABLE:FREQUENCY[:EVENT]?
STATUS:QUESTIONABLE:FREQUENCY:NTRANSITION <integer>
STATUS:QUESTIONABLE:FREQUENCY:NTRANSITION?
STATUS:QUESTIONABLE:FREQUENCY:PTRANSITION <integer>
STATUS:QUESTIONABLE:FREQUENCY:PTRANSITION?
STATUS:QUESTIONABLE:INTEGRITY:CONDITION?
STATUS:QUESTIONABLE:INTEGRITY:ENABLE <integer>
STATUS:QUESTIONABLE:INTEGRITY:ENABLE?
STATUS:QUESTIONABLE:INTEGRITY[:EVENT]?
STATUS:QUESTIONABLE:INTEGRITY:NTRANSITION <integer>
STATUS:QUESTIONABLE:INTEGRITY:NTRANSITION?
STATUS:QUESTIONABLE:INTEGRITY:PTRANSITION <integer>
STATUS:QUESTIONABLE:INTEGRITY:PTRANSITION?
STATUS:QUESTIONABLE:INTEGRITY:SIGNAL:CONDITION?
STATUS:QUESTIONABLE:INTEGRITY:SIGNAL:ENABLE <integer>
STATUS:QUESTIONABLE:INTEGRITY:SIGNAL:ENABLE?
STATUS:QUESTIONABLE:INTEGRITY:SIGNAL[:EVENT]?
STATUS:QUESTIONABLE:INTEGRITY:SIGNAL:NTRANSITION <integer>
STATUS:QUESTIONABLE:INTEGRITY:SIGNAL:NTRANSITION?
STATUS:QUESTIONABLE:INTEGRITY:SIGNAL:PTRANSITION <integer>
STATUS:QUESTIONABLE:INTEGRITY:SIGNAL:PTRANSITION?
STATUS:QUESTIONABLE:INTEGRITY:UNCALIBRATED:CONDITION?
STATUS:QUESTIONABLE:INTEGRITY:UNCALIBRATED:ENABLE
STATUS:QUESTIONABLE:INTEGRITY:UNCALIBRATED:ENABLE?
STATUS:QUESTIONABLE:INTEGRITY:UNCALIBRATED[:EVENT]?
```

3 Programming the Analyzer

List of SCPI Commands

```
STAtus:QUEStionable:INTEgrity:UNCalibrated:NTRansition <integer>
STAtus:QUEStionable:INTEgrity:UNCalibrated:NTRansition?
STAtus:QUEStionable:INTEgrity:UNCalibrated:PTRansition <integer>
STAtus:QUEStionable:INTEgrity:UNCalibrated:PTRansition?
STAtus:QUEStionable:NTRansition <integer>
STAtus:QUEStionable:NTRansition?
STAtus:QUEStionable:POWer:CONDition?
STAtus:QUEStionable:POWer:ENABle <integer>
STAtus:QUEStionable:POWer:ENABle?
STAtus:QUEStionable:POWer[:EVENT]?
STAtus:QUEStionable:POWer:NTRansition <integer>
STAtus:QUEStionable:POWer:NTRansition?
STAtus:QUEStionable:POWer:PTRansition <integer>
STAtus:QUEStionable:POWer:PTRansition?>
STAtus:QUEStionable:PTRansition <integer>
STAtus:QUEStionable:PTRansition?
STAtus:QUEStionable:TEMPerature:CONDition?
STAtus:QUEStionable:TEMPerature:ENABle <integer>
STAtus:QUEStionable:TEMPerature:ENABle?
STAtus:QUEStionable:TEMPerature[:EVENT]?
STAtus:QUEStionable:TEMPerature:NTRansition <integer>
STAtus:QUEStionable:TEMPerature:NTRansition?
STAtus:QUEStionable:TEMPerature:PTRansition <integer>
STAtus:QUEStionable:TEMPerature:PTRansition?
SYSTem:APPLication:CATalog[:NAME]?
SYSTem:APPLication:CATalog[:NAME]:COUNT?
SYSTem:APPLication:CATalog:OPTion? <model>
SYSTem:APPLication:CATalog:REVision? <model>
SYSTem:APPLication[:CURRent][:NAME]?
SYSTem:APPLication[:CURRent]:OPTion?
SYSTem:APPLication[:CURRent]:REVision?
SYSTem:COMMunicate:GPIB[1][:SELF]:ADDRes <integer>
SYSTem:COMMunicate:GPIB[1][:SELF]:ADDRes?
SYSTem:COMMunicate:GPIB[1][:SELF]:CONTroller[:ENABle] ON | OFF | 0 | 1
SYSTem:COMMunicate:GPIB[1][:SELF]:CONTroller[:ENABle]?
SYSTem:COMMunicate:LAN:SCPI:HISLip:ENABle OFF | ON | 0 | 1
SYSTem:COMMunicate:LAN:SCPI:HISLip:ENABle?
SYSTem:COMMunicate:LAN:SCPI:SICL:ENABle OFF | ON | 0 | 1
SYSTem:COMMunicate:LAN:SCPI:SICL:ENABle?
SYSTem:COMMunicate:LAN:SCPI:SOCKet:CONTrol?
SYSTem:COMMunicate:LAN:SCPI:SOCKet:ENABle OFF | ON | 0 | 1
SYSTem:COMMunicate:LAN:SCPI:SOCKet:ENABle?
SYSTem:COMMunicate:LAN:SCPI:TELNet:ENABle OFF | ON | 0 | 1
SYSTem:COMMunicate:LAN:SCPI:TELNet:ENABle?
SYSTem:COMMunicate:USB:CONNecTion?
SYSTem:COMMunicate:USB:PACKets?
SYSTem:COMMunicate:USB:STATus?
SYSTem:CONFigure[:SYSTem]?
SYSTem:CSYSTem?
SYSTem:DATE "<year>, <month>, <day>"
SYSTem:DATE?
SYSTem:DEFault [ALL] | ALIGn | INPut | MISC | MODes | PON
SYSTem:ERRor[:NEXT]?
```

```

SYSTEM:ERROR:OVERload[:STATE] 0 | 1 | OFF | ON
SYSTEM:ERROR:VERBoSe OFF | ON | 0 | 1
SYSTEM:ERROR:VERBoSe?
SYSTEM:HELP:HEADers?
SYSTEM:HID?
SYSTEM:IDN <string>
SYSTEM:IDN?
SYSTEM:KLOCK OFF | ON | 0 | 1
SYSTEM:KLOCK?
SYSTEM:LKEY <"OptionInfo">, <"LicenseInfo">
SYSTEM:LKEY? <"OptionInfo">
SYSTEM:LKEY:DELeTe <"OptionInfo">, <"LicenseInfo">
SYSTEM:LKEY:LIST?
SYSTEM:MRELAY:COUNT?
SYSTEM:OPTions?
SYSTEM:PDOWN [NORMAL | FORCE]
SYSTEM:PON:APPLication:LLIST <stringofINSTRument:SElectnames>
SYSTEM:PON:APPLication:LLIST?
SYSTEM:PON:APPLication:VMEMory[:AVAILable]?
SYSTEM:PON:APPLication:VMEMory:TOTAL?
SYSTEM:PON:APPLication:VMEMory:USED?
SYSTEM:PON:APPLication:VMEMory:USED:NAME? <INSTRument:SElectname>
SYSTEM:PON:ETIME?
SYSTEM:PON:MODE SA | BASIC | ADEMOD | NFIGURE | PNOISE | CDMA2K | TDSCDMA
| VSA | VSA89601 | WCDMA | WIMAXOFDMA
SYSTEM:PON:MODE?
SYSTEM:PON:TIME?
SYSTEM:PON:TYPE MODE | USER | LAST
SYSTEM:PON:TYPE PRESet
SYSTEM:PON:TYPE?
SYSTEM:PRESet
SYSTEM:PRESet:TYPE FACTory | MODE | USER
SYSTEM:PRESet:TYPE?
SYSTEM:PRESet:USER
SYSTEM:PRESet:USER:ALL
SYSTEM:PRESet:USER:SAVE
SYSTEM:PRINT:THEME TDColor | TDMonochrome | FColor | FMONochrome
SYSTEM:PRINT:THEME?
SYSTEM:PUP:PROcEss
SYSTEM:SECurity:USB:WPROtect[:ENABLE] ON | OFF | 0 | 1
SYSTEM:SECurity:USB:WPROtect[:ENABLE]?
SYSTEM:SHOW OFF | ERROR | SYSTEM | HARDware | LXI | HWStatistics |
ALIGNment | SOFTware | CAPPLication
SYSTEM:SHOW?
SYSTEM:TEMPerature:HEXTreme?
SYSTEM:TEMPerature:LEXTreme?
SYSTEM:TIME "<hour>, <minute>, <second>"
SYSTEM:TIME?
SYSTEM:VERSIon?
TRACE[1]|2|3:ACPower:DISPlay[:STATE] ON | OFF | 0 | 1
TRACE[1]|2|3:ACPower:DISPlay[:STATE]?
TRACE[1]|2|3:ACPower:TYPE WRITE | AVERAge | MAXHold | MINHold
TRACE[1]|2|3:ACPower:TYPE?

```

3 Programming the Analyzer

List of SCPI Commands

```
TRACe[1]|2|3:ACPower:UPDate[:STATE] ON | OFF | 0 | 1
TRACe[1]|2|3:ACPower:UPDate[:STATE]?
TRACe:CHPower:TYPE WRITE | AVERAge | MAXHold | MINHold
TRACe:CHPower:TYPE?
TRACe:MONitor:CLear [TRACE1] | TRACE2 | TRACE3
TRACe:MONitor:CLear:ALL
TRACe[1]|2|3:MONitor:DISPlay[:STATE] ON | OFF | 0 | 1
TRACe[1]|2|3:MONitor:DISPlay[:STATE]?
TRACe[1]|2|3:MONitor:TYPE WRITE | AVERAge | MAXHold | MINHold
TRACe[1]|2|3:MONitor:TYPE?
TRACe[1]|2|3:MONitor:UPDate[:STATE] ON | OFF | 0 | 1
TRACe[1]|2|3:MONitor:UPDate[:STATE]?
TRACe:OBWidth:TYPE WRITE | AVERAge | MAXHold | MINHold
TRACe:OBWidth:TYPE?
TRACe:SEMask:TYPE WRITE | AVERAge | MAXHold | MINHold
TRACe:SEMask:TYPE?
TRIGger:<measurement>[:SEQuence]:IQ:SOURce EXTernal1 | EXTernal2 |
IMMEdiate | IQMag | IDEMod | QDEMod | IINPut | QINPut | AIQMag
TRIGger:<measurement>[:SEQuence]:IQ:SOURce?
TRIGger:<measurement>[:SEQuence]:RF:SOURce EXTernal1 | EXTernal2 |
IMMEdiate | LINE | FRAME | RFBurst | VIDEo | IF | ALARm | LAN | TV
TRIGger:<measurement>[:SEQuence]:RF:SOURce?
TRIGger:<measurement>[:SEQuence]:SOURce EXTernal1 | EXTernal2 | IMMEdiate
| LINE | FRAME | RFBurst | VIDEo | IF | ALARm | LAN | IQMag | IDEMod |
QDEMod | IINPut | QINPut | AIQMag | TV
TRIGger:<measurement>[:SEQuence]:SOURce?
TRIGger[:SEQuence]:ATRigger <time>
TRIGger[:SEQuence]:ATRigger?
TRIGger[:SEQuence]:ATRigger:STATE OFF | ON | 0 | 1
TRIGger[:SEQuence]:ATRigger:STATE?
TRIGger[:SEQuence]:DELay <time>
TRIGger[:SEQuence]:DELay?
TRIGger[:SEQuence]:DELay:STATE OFF | ON | 0 | 1
TRIGger[:SEQuence]:DELay:STATE?
TRIGger[:SEQuence]:EXTernal:DELay
TRIGger[:SEQuence]:EXTernal1:DELay <time>
TRIGger[:SEQuence]:EXTernal2:DELay <time>
TRIGger[:SEQuence]:EXTernal2:DELay?
TRIGger[:SEQuence]:EXTernal1:DELay?
TRIGger[:SEQuence]:EXTernal2:DELay:COMPensation OFF | ON | 0 | 1
TRIGger[:SEQuence]:EXTernal1:DELay:COMPensation OFF | ON | 0 | 1
TRIGger[:SEQuence]:EXTernal2:DELay:COMPensation?
TRIGger[:SEQuence]:EXTernal1:DELay:COMPensation?
TRIGger[:SEQuence]:EXTernal2:DELay:STATE OFF | ON | 0 | 1
TRIGger[:SEQuence]:EXTernal1:DELay:STATE OFF | ON | 0 | 1
TRIGger[:SEQuence]:EXTernal2:DELay:STATE?
TRIGger[:SEQuence]:EXTernal1:DELay:STATE?
TRIGger[:SEQuence]:EXTernal:LEVel
TRIGger[:SEQuence]:EXTernal1:LEVel <level>
TRIGger[:SEQuence]:EXTernal2:LEVel
TRIGger[:SEQuence]:EXTernal1:LEVel?
TRIGger[:SEQuence]:EXTernal2:LEVel?
```

```

TRIGger[:SEQuence]:EXTErnal:SLOPe
TRIGger[:SEQuence]:EXTErnal2:SLOPe POSitive | NEGative
TRIGger[:SEQuence]:EXTErnal1:SLOPe POSitive | NEGative
TRIGger[:SEQuence]:EXTErnal1:SLOPe?
TRIGger[:SEQuence]:EXTErnal2:SLOPe?
TRIGger[:SEQuence]:FRAME:ADJust <time>
TRIGger[:SEQuence]:FRAME:DELay <time>
TRIGger[:SEQuence]:FRAME:DELay?
TRIGger[:SEQuence]:FRAME:DELay:STATE OFF | ON | 0 | 1
TRIGger[:SEQuence]:FRAME:DELay:STATE?
TRIGger[:SEQuence]:FRAME:EXTErnal2:LEVel
TRIGger[:SEQuence]:FRAME:EXTErnal1:LEVel
TRIGger[:SEQuence]:FRAME:EXTErnal2:SLOPe
TRIGger[:SEQuence]:FRAME:EXTErnal1:SLOPe
TRIGger[:SEQuence]:FRAME:OFFSet <time>
TRIGger[:SEQuence]:FRAME:OFFSet?
TRIGger[:SEQuence]:FRAME:OFFSet:DISPlay:RESet
TRIGger[:SEQuence]:FRAME:PERiod <time>
TRIGger[:SEQuence]:FRAME:PERiod?
TRIGger[:SEQuence]:FRAME:RFBurst:LEVel:ABSolute
TRIGger[:SEQuence]:FRAME:RFBurst:SLOPe
TRIGger[:SEQuence]:FRAME:SYNC EXTErnal1 | EXTErnal2 | RFBurst | OFF
TRIGger[:SEQuence]:FRAME:SYNC EXTErnal
TRIGger[:SEQuence]:FRAME:SYNC?
TRIGger[:SEQuence]:FRAME:SYNC:HOLDoff <time>
TRIGger[:SEQuence]:FRAME:SYNC:HOLDoff?
TRIGger[:SEQuence]:FRAME:SYNC:HOLDoff:STATE OFF | ON | 0 | 1
TRIGger[:SEQuence]:FRAME:SYNC:HOLDoff:STATE?
TRIGger[:SEQuence]:HOLDoff <time>
TRIGger[:SEQuence]:HOLDoff?
TRIGger[:SEQuence]:HOLDoff:STATE OFF | ON | 0 | 1
TRIGger[:SEQuence]:HOLDoff:STATE?
TRIGger[:SEQuence]:HOLDoff:TYPE NORMAl | ABOVe | BELow
TRIGger[:SEQuence]:HOLDoff:TYPE?
TRIGger[:SEQuence]:IF:LEVel
TRIGger[:SEQuence]:IF:LEVel?
TRIGger[:SEQuence]:IF:SLOPe NEGative | POSitive
TRIGger[:SEQuence]:IF:SLOPe?
TRIGger[:SEQuence]:LINE:DELay <time>
TRIGger[:SEQuence]:LINE:DELay?
TRIGger[:SEQuence]:LINE:DELay:STATE OFF | ON | 0 | 1
TRIGger[:SEQuence]:LINE:DELay:STATE?
TRIGger[:SEQuence]:LINE:SLOPe POSitive | NEGative
TRIGger[:SEQuence]:LINE:SLOPe?
TRIGger[:SEQuence]:OFFSet <time>
TRIGger[:SEQuence]:OFFSet?
TRIGger[:SEQuence]:OFFSet:STATE OFF | ON | 0 | 1
TRIGger[:SEQuence]:OFFSet:STATE?
TRIGger[:SEQuence]:RFBurst:DELay <time>
TRIGger[:SEQuence]:RFBurst:DELay?
TRIGger[:SEQuence]:RFBurst:DELay:STATE OFF | ON | 0 | 1
TRIGger[:SEQuence]:RFBurst:DELay:STATE?
TRIGger[:SEQuence]:RFBurst:LEVel

```

3 Programming the Analyzer

List of SCPI Commands

```
TRIGger[:SEquence]:RFBurst:LEVel:ABSolute <ampl>
TRIGger[:SEquence]:RFBurst:LEVel:ABSolute?
TRIGger[:SEquence]:RFBurst:LEVel:RELative <rel_ampl>
TRIGger[:SEquence]:RFBurst:LEVel:RELative?
TRIGger[:SEquence]:RFBurst:LEVel:TYPE ABSolute | RELative
TRIGger[:SEquence]:RFBurst:LEVel:TYPE?
TRIGger[:SEquence]:RFBurst:SLOPe POSitive | NEGative
TRIGger[:SEquence]:RFBurst:SLOPe?
TRIGger[:SEquence]:SLOPe POSitive | NEGative
TRIGger[:SEquence]:SLOPe?
TRIGger[:SEquence]:SOURCe EXTernal
TRIGger[:SEquence]:VIDeo:DELay <time>
TRIGger[:SEquence]:VIDeo:DELay?
TRIGger[:SEquence]:VIDeo:DELay:STATE OFF | ON | 0 | 1
TRIGger[:SEquence]:VIDeo:DELay:STATE?
TRIGger[:SEquence]:VIDeo:LEVel <ampl>
TRIGger[:SEquence]:VIDeo:LEVel?
TRIGger[:SEquence]:VIDeo:SLOPe POSitive | NEGative
TRIGger[:SEquence]:VIDeo:SLOPe?
TRIGger|TRIGger1|TRIGger2[:SEquence]:OUTPut HSWP | MEASuring | MAIN | GATE
| GTRigger | OEVEN | SPOINT | SSWEEP | SSETTLED | S1MARKER | S2MARKER |
S3MARKER | S4MARKER | OFF
TRIGger|TRIGger1|TRIGger2[:SEquence]:OUTPut?
TRIGger|TRIGger1|TRIGger2[:SEquence]:OUTPut:POLarity POSitive | NEGative
TRIGger|TRIGger1|TRIGger2[:SEquence]:OUTPut:POLarity?
UNIT:ACPower:POWER:PSD DBMHZ | DBMMHZ
UNIT:ACPower:POWER:PSD?
UNIT:CHPower:POWER:PSD DBMHZ | DBMMHZ
UNIT:CHPower:POWER:PSD?
```

STATus Subsystem

The following diagram provides a graphical overview of the entire X-Series Status Register System.

For readability, the diagram is split into two sections:

- ["X-Series Status Register System \(1\) " on page 172](#)
- ["X-Series Status Register System \(2\) " on page 173](#)

X-Series Status Register System (1)

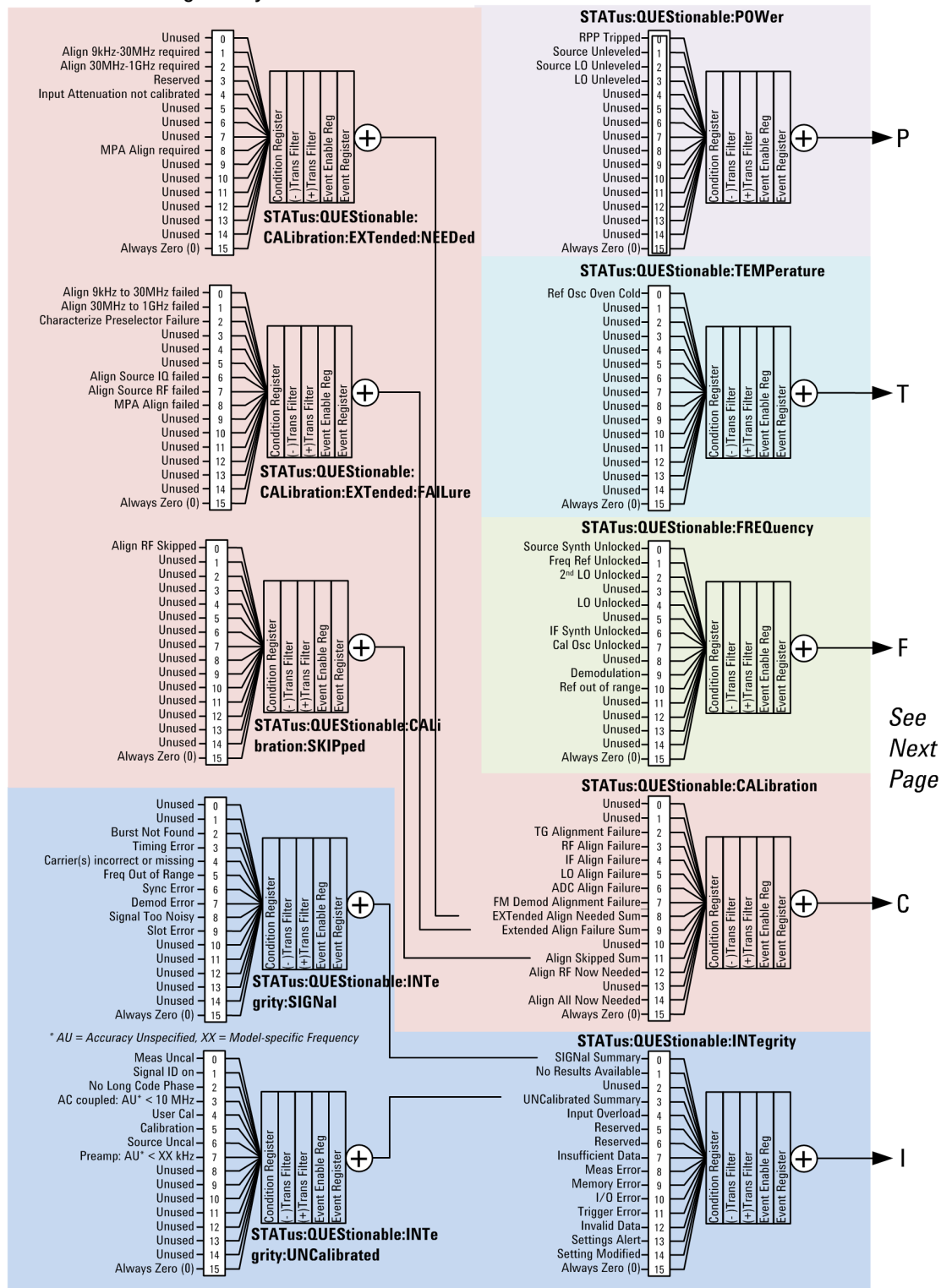

X-Series Status Register System (2)

See
Previous
Page

P
T
F

C
I

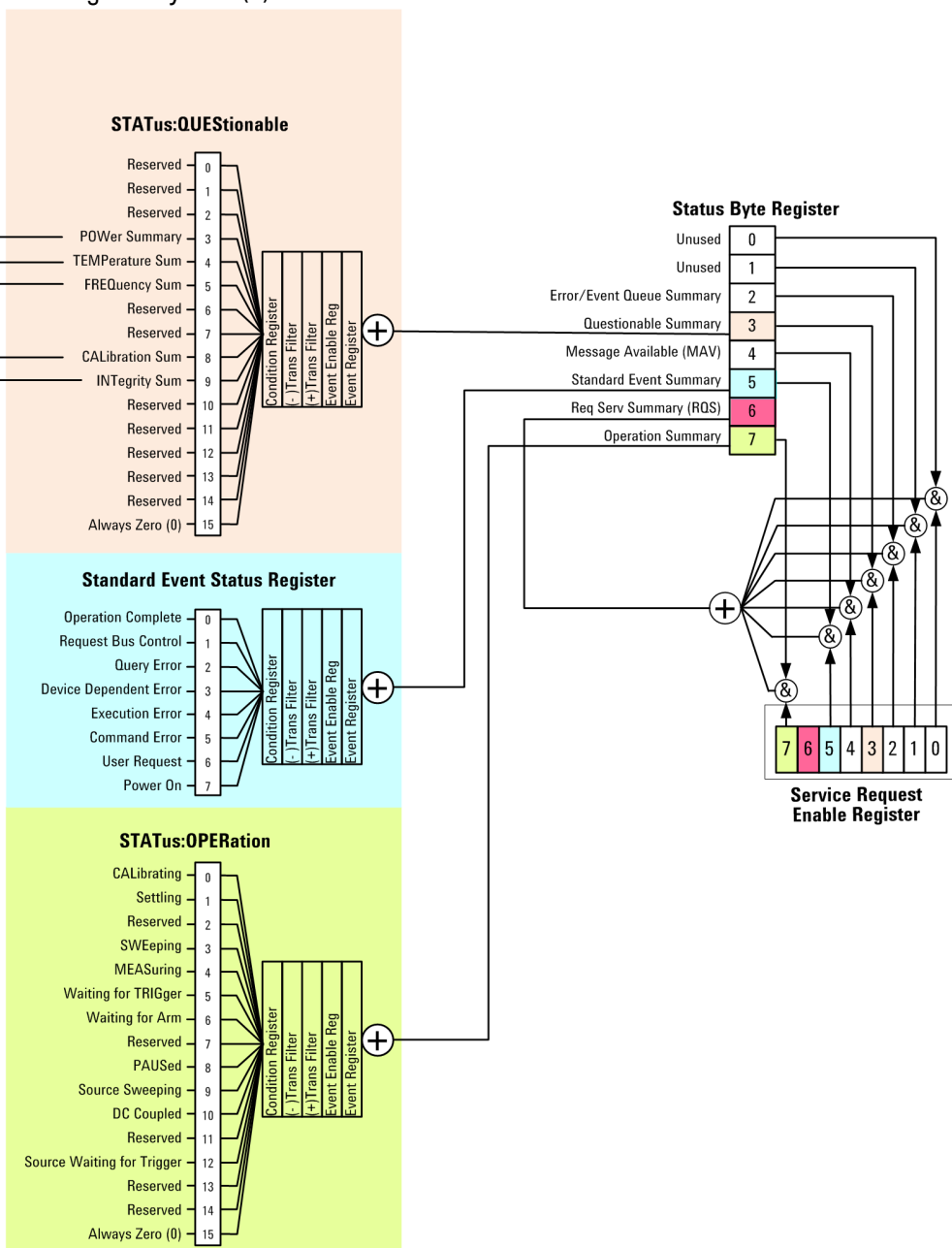

Detailed Description

The STATus subsystem remote commands set and query the status hardware registers. This system of registers monitors various events and conditions in the instrument. Software written to control the instrument may need to monitor some of these events and conditions.

NOTE

All status register commands are sequential. Most commands can be started immediately and will overlap with any existing commands that are already running. This is not true of status commands. All the commands in the spectrum analyzer are assumed to be overlapped unless a command description specifically says that it is sequential.

What Are Status Registers

The status system contains multiple registers that are arranged in a hierarchical order. The lower-level status registers propagate their data to the higher-level registers in the data structures by means of summary bits. The status byte register is at the top of the hierarchy and contains general status information for the instrument's events and conditions. All other individual registers are used to determine the specific events or conditions. For a diagram of the registers and their interconnections, see above.

The operation and questionable status registers are sets of registers that monitor the overall instrument condition. They are accessed with the STATus:OPERation and STATus:QUEStionable commands in the STATus command subsystem. Each register set is made up of five registers:

- Condition Register—It reports the real-time state of the signals monitored by this register set. There is no latching or buffering for a condition register.
- Positive Transition Register—This filter register controls which signals will set a bit in the event register when the signal makes a low to high transition (when the condition bit changes from 0 to 1).
- Negative Transition Register—This filter register controls which signals will set a bit in the event register when the signal makes a high to low transition (when the condition bit changes from 1 to 0).
- Event Register—It latches any signal state changes, in the way specified by the filter registers. Bits in the event register are never cleared by signal state changes. Event registers are cleared when read. They are also cleared by *CLS and by presetting the instrument.
- Event Enable Register—It controls which of the bits, being set in the event register, will be summarized as a single output for the register set. Summary bits are then used by the next higher register.

The STATus:QUEStionable registers report abnormal operating conditions. The status register hierarchy is:

1. The summary outputs from the six STATus:QUEStionable:<keyword> detail registers are inputs to the STATus:QUEStionable register.
2. The summary output from the STATus:QUEStionable register is an input to the Status Byte Register. See the overall system in Figure at the beginning of this section.

The STATus:OPERation register set has no summarized inputs. The inputs to the STATus:OPERation:CONDition register indicate the real time state of the instrument. The STATus:OPERation:EVENT register summary output is an input to the Status Byte Register.

What Are Status Register SCPI Commands

Most monitoring of the instrument conditions is done at the highest level using the IEEE common commands indicated below. Complete command descriptions are available in the IEEE commands section at the beginning of the language reference. Individual status registers can be set and queried using the commands in the STATus subsystem of the language reference.

- *CLS (clear status) clears the status byte by emptying the error queue and clearing all the event registers.
- *ESE, *ESE? (event status enable) sets and queries the bits in the enable register part of the standard event status register.
- *ESR? (event status register) queries and clears the event register part of the standard event status register.

- *OPC, *OPC? (operation complete) sets the standard event status register to monitor the completion of all commands. The query stops any new commands from being processed until the current processing is complete, then returns a '1'.
- *PSC, *PSC? (power-on state clear) sets the power-on state so that it clears the service request enable register and the event status enable register at power on.
- *SRE, *SRE? (service request enable) sets and queries the value of the service request enable register.
- *STB? (status byte) queries the value of the status byte register without erasing its contents.

How to Use the Status Registers

A program often needs to be able to detect and manage error conditions or changes in instrument status. There are two methods you can use to programmatically access the information in status registers:

- The polling method
- The service request (SRQ) method

In the polling method, the instrument has a passive role. It only tells the controller that conditions have changed when the controller asks the right question. In the SRQ method, the instrument takes a more active role. It tells the controller when there has been a condition change without the controller asking. Either method allows you to monitor one or more conditions.

The polling method works well if you do not need to know about changes the moment they occur. The SRQ method should be used if you must know immediately when a condition changes. To detect a change using the polling method, the program must repeatedly read the registers.

Use the SRQ method when:

- you need time-critical notification of changes
- you are monitoring more than one device which supports SRQs
- you need to have the controller do something else while waiting
- you can't afford the performance penalty inherent to polling

Use polling when:

- your programming language/development environment does not support SRQ interrupts
- you want to write a simple, single-purpose program and don't want the added complexity of setting up an SRQ handler
- To monitor a condition:
 - a. Determine which register contains the bit that reports the condition.
 - b. Send the unique SCPI query that reads that register.
 - c. Examine the bit to see if the condition has changed.

You can monitor conditions in different ways.

- Check the current instrument hardware and firmware status.

2. The results of a query are evaluated in a similar way. If the *STB? command returns a decimal value of 140, ($140 = 128 + 8 + 4$) then bit 7 is true, bit 3 is true and bit 2 is true.

Example 2:

1. Suppose you want to know if an Auto-trigger Timeout occurs, but you only cared about that specific condition. So you would want to know what was happening with bit 10 in the Status Questionable Integrity register, and not about any other bits.
2. It's usually a good idea to start by clearing all the status registers with *CLS.
3. Sending the STAT:QUES:INT:ENAB 1024 command lets you monitor only bit 10 events, instead of the default monitoring all the bits in the register. The register default is for positive transition events (0 to 1 transition). That is, when an auto-trigger timeout occurs. If instead, you wanted to know when the Auto-trigger timeout condition is cleared, then you would set the STAT:QUES:INT:PTR 0 and the STAT:QUES:INT:NTR 32767.
4. So now the only output from the Status Questionable Integrity register will come from a bit 10 positive transition. That output goes to the Integrity Sum bit 9 of the Status Questionable register.
5. You can do a similar thing with this register to only look at bit 9 using, STAT:QUES:ENAB 512.
6. The Status Questionable register output goes to the "Status Questionable Summary" bit 3 of the Status Byte Register. The output from this register can be enabled using the *SRE 8 command.
7. Finally, you would use the serial polling functionality available for the particular bus/software that you are using to monitor the Status Byte Register. (You could also use *STB? to poll the Status Byte Register.)

Using the Service Request (SRQ) Method

Your language, bus, and programming environment must be able to support SRQ interrupts. (For example, BASIC used with VXI-11.3 (GPIB over LAN). When you monitor a condition with the SRQ method, you must:

1. Determine which bit monitors the condition.
2. Determine how that bit reports to the request service (RQS) bit of the status byte.
3. Send SCPI commands to enable the bit that monitors the condition and to enable the summary bits that report the condition to the RQS bit.
4. Enable the controller to respond to service requests.

When the condition changes, the instrument sets its RQS bit. The controller is informed of the change as soon as it occurs. As a result, the time the controller would otherwise have used to monitor the condition can be used to perform other tasks. Your program determines how the controller responds to the SRQ.

Generating a Service Request

To use the SRQ method, you must understand how service requests are generated. Bit 6 of the status byte register is the request service (RQS) bit. The *SRE command is used to configure the RQS bit to report changes in instrument status. When such a change occurs, the RQS bit is set. It is cleared when the status byte register is queried using *SRE? (with a serial poll.) It can be queried without erasing the contents with *STB?.

When a register set causes a summary bit in the status byte to change from 0 to 1, the instrument can initiate the service request (SRQ) process. However, the process is only initiated if both of the following conditions are true:

- The corresponding bit of the service request enable register is also set to 1.
- The instrument does not have a service request pending. (A service request is considered to be pending between the time the instrument's SRQ process is initiated and the time the controller reads the status byte register.)

The SRQ process sets the SRQ true. It also sets the status byte's request service (RQS) bit to 1. Both actions are necessary to inform the controller that the instrument requires service. Setting the SRQ line only informs the controller that some device on the bus requires service. Setting the RQS bit allows the controller to determine which instrument requires service.

If your program enables the controller to detect and respond to service requests, it should instruct the controller to perform a serial poll when the SRQ is set true. Each device on the bus returns the contents of its status byte register in response to this poll. The device whose RQS bit is set to 1 is the device that requested service.

When you read the instrument's status byte register with a serial poll, the RQS bit is reset to 0. Other bits in the register are not affected.

If the status register is configured to SRQ on end-of-measurement and the measurement is in continuous mode, then restarting a measurement (INIT command) can cause the measuring bit to pulse low. This causes an SRQ when you have not actually reached the "end-of-measurement" condition. To avoid this:

1. Set INITiate:CONTinuous off.
2. Set/enable the status registers.
3. Restart the measurement (send INIT).

Status Register System

The hardware status registers are combined to form the instrument status system. Specific status bits are assigned to monitor various aspects of the instrument operation and status. See the diagram of the status system above for information about the bit assignments and status register interconnections.

The Status Byte Register

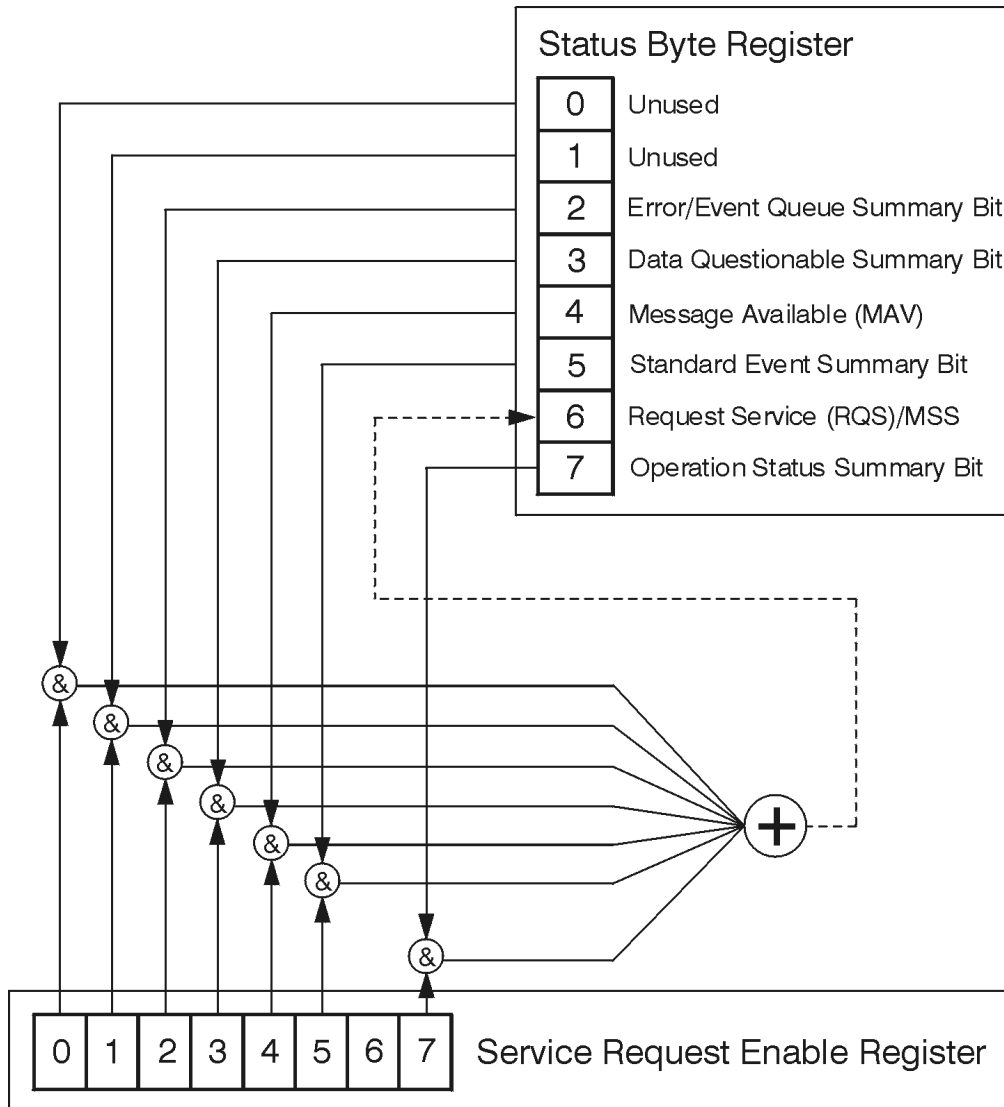

ck776a

The RQS bit is read and reset by a serial poll. The same bit position (MSS) is read, non-destructively by the *STB? command. If you serial poll bit 6 it is read as RQS, but if you send *STB it reads bit 6 as MSS. For more information refer to IEEE 488.2 standards, section 11.

	Description	Standard Operation Status Summary Bit	Request Service (RQS) Summary Bit	Standard Event Status Summary Bit	Message Available (MAV)	Data Questionable Status Summary Bit	Error/Event Queue Summary Bit	Unused	Unused
Bit Number	7	6	5	4	3	2	1	0	

*STB?

Status Byte Register

ck725a

Bit	Description
0, 1	These bits are always set to 0.
2	A 1 in this bit position indicates that the SCPI error queue is not empty which means that it contains at least one error message.
3	A 1 in this bit position indicates that the data questionable summary bit has been set. The data questionable event register can then be read to determine the specific condition that caused this bit to be set.
4	A 1 in this bit position indicates that the instrument has data ready in the output queue. There are no lower status groups that provide input to this bit.
5	A 1 in this bit position indicates that the standard event summary bit has been set. The standard event status register can then be read to determine the specific event that caused this bit to be set.
6	A 1 in this bit position indicates that the instrument has at least one reason to report a status change. This bit is also called the master summary status bit (MSS).
7	A 1 in this bit position indicates that the standard operation summary bit has been set. The standard operation event register can then be read to determine the specific condition that caused this bit to be set.

To query the status byte register, send the command *STB?. The response will be the decimal sum of the bits which are set to 1. For example, if bit number 7 and bit number 3 are set to 1, the decimal sum of the 2 bits is 128 plus 8. So the decimal value 136 is returned. The *STB command does not clear the status register.

In addition to the status byte register, the status byte group also contains the service request enable register. This register lets you choose which bits in the status byte register will trigger a service request.

Send the *SRE <integer> command where <integer> is the sum of the decimal values of the bits you want to enable plus the decimal value of bit 6. For example, assume that you want to enable bit 7 so that whenever the standard operation status register summary bit is set to 1 it will trigger a service request. Send the command *SRE 192 (because 192 = 128 + 64). You must always add 64 (the numeric value of RQS

bit 6) to your numeric sum when you enable any bits for a service request. The command *SRE? returns the decimal value of the sum of the bits previously enabled with the *SRE <integer> command.

The service request enable register presets to zeros (0).

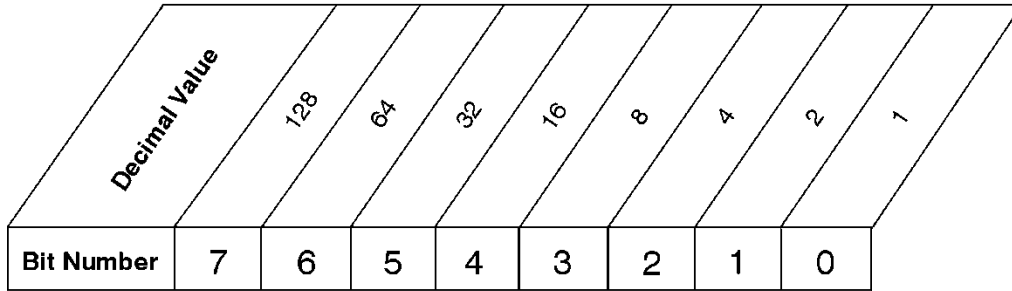

*SRE <num>
 *SRE?

Service Request Enable Register

ck726a

Standard Event Status Register

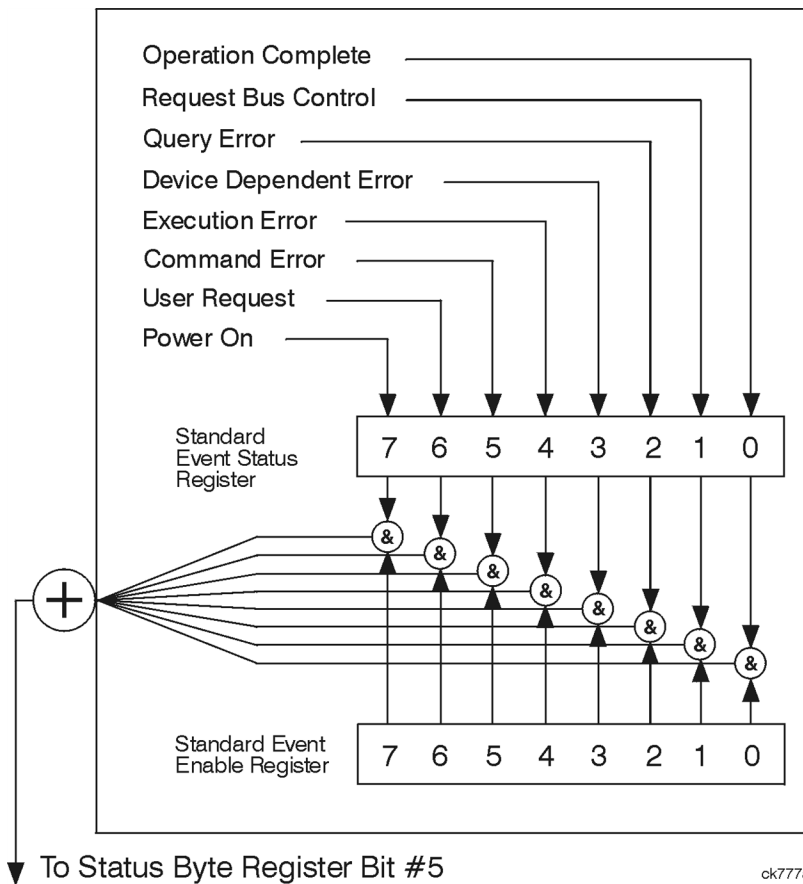

The standard event status register contains the following bits:

byte register will be set to 1, send the command *ESE 192 (128 + 64). The command *ESE? returns the decimal value of the sum of the bits previously enabled with the *ESE <integer> command.

The standard event status enable register presets to zeros (0).

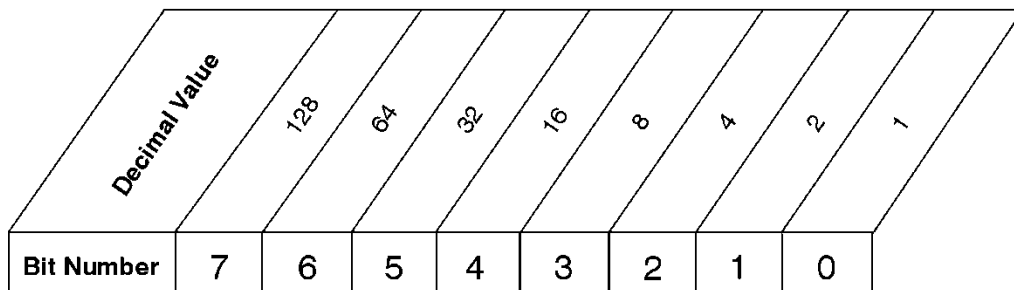

*ESE <num>
 *ESE?

Standard Event Status Enable Register

ck728a

Operation and Questionable Status Registers

The operation and questionable status registers are registers that monitor the overall instrument condition. They are accessed with the STATUS:OPERation and STATUS:QUESTionable commands in the STATUS command subsystem. See the figure at the beginning of this chapter.

Operation Status Register

The operation status register monitors the current instrument measurement state. It checks to see if the instrument is calibrating, sweeping, or waiting for a trigger. For more information see the *OPC? command located in the IEEE Common Commands section.

Bit	Condition	Operation
0	Calibrating	The instrument is busy executing its Align Now process
3	Sweeping	The instrument is busy taking a sweep.
4	Measuring	The instrument is busy making a measurement. Measurements often require multiple sweeps. They are initiated by keys under the MEASURE key or with the MEASure group of commands. The bit is valid for most X-Series Modes.
5	Waiting for trigger	The instrument is waiting for the trigger conditions to be met, then it will trigger a sweep or measurement.

Questionable Status Register

The questionable status register monitors the instrument's condition to see if anything questionable has happened to it. It is looking for anything that might cause an error or a bad measurement like a hardware problem, an out of calibration situation, or a unusual signal. All the bits are summary bits from lower-level event registers.

Bit	Condition	Operation
-----	-----------	-----------

3	Power summary	The instrument hardware has detected a power unlevelled condition.
4	Temperature summary	The instrument is still warming up.
5	Frequency summary	The instrument hardware has detected an unlocked condition or a problem with the external frequency reference.
8	Calibration summary	The instrument has detected a hardware problem while doing the automatic internal alignment process.
9	Integrity summary	The instrument has detected a questionable measurement condition such as: bad timing, bad signal/data, timeout problem, signal overload, or "meas uncal".

STATus Subsystem Command Descriptions

The STATus subsystem controls the SCPI-defined instrument status reporting structures. Each status register has a set of five commands used for querying or masking that particular register.

Numeric values for bit patterns can be entered using decimal or hexadecimal representations. (i.e. 0 to 32767 is equivalent to #H0 to #H7FFF. It is also equal to all ones, 11111111111111) See the SCPI Basics information about using bit patterns for variable parameters.

Operation Register

"Operation Condition Query" on page 184

"Operation Enable" on page 185

"Operation Event Query" on page 185

"Operation Negative Transition" on page 185

"Operation Positive Transition" on page 186

Operation Condition Query

This query returns the decimal value of the sum of the bits in the Status Operation Condition register.

NOTE

The data in this register is continuously updated and reflects the current conditions.

Mode	All
Remote Command	:STATus:OPERation:CONDition?
Example	STAT:OPER:COND?
Preset	0
Status Bits/OPC dependencies	Sequential command
Initial S/W Revision	Prior to A.02.00

Operation Enable

This command determines which bits in the Operation Event register, will set the Operation Status Summary bit (bit 7) in the Status Byte Register. The variable <integer> is the sum of the decimal values of the bits you want to enable.

NOTE

The preset condition is to have all bits in this enable register set to 0. To have any Operation Events reported to the Status Byte Register, one or more bits need to be set to 1.

Mode	All
Remote Command	:STATus:OPERation:ENABle <integer> :STATus:OPERation:ENABle?
Example	STAT:OPER:ENAB 1 Sets the register so that Align Now operation will be reported to the Status Byte Register.
Preset	0
Min	0
Max	32767
Status Bits/OPC dependencies	Sequential command
Initial S/W Revision	Prior to A.02.00

Operation Event Query

This query returns the decimal value of the sum of the bits in the Operation Event register.

NOTE

The register requires that the associated PTR or NTR filters be set before a condition register bit can set a bit in the event register. The data in this register is latched until it is queried. Once queried, the register is cleared.

Mode	All
Remote Command	:STATus:OPERation[:EVENT]?
Example	STAT:OPER?
Preset	0
Status Bits/OPC dependencies	Sequential command
Initial S/W Revision	Prior to A.02.00

Operation Negative Transition

This command determines which bits in the Operation Condition register will set the corresponding bit in the Operation Event register when the condition register bit has a negative transition (1 to 0). The variable <integer> is the sum of the decimal values of the bits that you want to enable.

Mode	All
Remote Command	:STATus:OPERation:NTRansition <integer> :STATus:OPERation:NTRansition?
Example	STAT:OPER:NTR 1 Align Now operation complete will be reported to the Status Byte Register.
Preset	0
Min	0
Max	32767
Status Bits/OPC dependencies	Sequential command
Initial S/W Revision	Prior to A.02.00

Operation Positive Transition

This command determines which bits in the Operation Condition register will set the corresponding bit in the Operation Event register when the condition register bit has a positive transition (0 to 1). The variable <integer> is the sum of the decimal values of the bits that you want to enable.

Mode	All
Remote Command	:STATus:OPERation:PTRansition <integer> :STATus:OPERation:PTRansition?
Example	STAT:OPER:PTR 1 Align Now operation beginning will be reported to the Status Byte Register.
Preset	32767
Min	0
Max	32767
Status Bits/OPC dependencies	Sequential command
Initial S/W Revision	Prior to A.02.00

Preset the Status Byte

Sets bits in most of the enable and transition registers to their default state. It presets all the Transition Filters, Enable Registers, and the Error/Event Queue Enable. It has no effect on Event Registers, Error/Event QUEUE, IEEE 488.2 ESE, and SRE Registers as described in IEEE Standard 488.2–1992, IEEE Standard Codes, Formats, Protocols, and Common Commands for Use with ANSI/IEEE Std 488.1–1987. New York, NY, 1992.

Remote Command	:STATus:PRESet
Example	STAT:PRES
Initial S/W Revision	Prior to A.02.00

Questionable Register

"Questionable Condition " on page 187

"Questionable Enable " on page 187

"Questionable Event Query " on page 188

"Questionable Negative Transition " on page 188

"Questionable Positive Transition" on page 188

Questionable Condition

This query returns the decimal value of the sum of the bits in the Questionable Condition register.

NOTE

The data in this register is continuously updated and reflects the current conditions.

Mode	All
Remote Command	:STATus:QUESTionable:CONDition?
Example	STAT:QUES:COND?
Preset	0
Status Bits/OPC dependencies	Sequential command
Initial S/W Revision	Prior to A.02.00

Questionable Enable

This command determines which bits in the Questionable Event register will set the Questionable Status Summary bit (bit3) in the Status Byte Register. The variable <integer> is the sum of the decimal values of the bits you want to enable.

NOTE

The preset condition is all bits in this enable register set to 0. To have any Questionable Events reported to the Status Byte Register, one or more bits need to be set to 1. The Status Byte Event Register should be queried after each measurement to check the Questionable Status Summary (bit 3). If it is equal to 1, a condition during the test may have made the test results invalid. If it is equal to 0, this indicates that no hardware problem or measurement problem was detected by the analyzer.

Mode	All
Remote Command	:STATus:QUESTionable:ENABle <integer> :STATus:QUESTionable:ENABle?
Example	STAT:OPER:PTR 1 Align Now operation beginning will be reported to the Status Byte Register.
Preset	0
Min	0
Max	32767
Status Bits/OPC dependencies	Sequential command
Initial S/W Revision	Prior to A.02.00

Questionable Event Query

This query returns the decimal value of the sum of the bits in the Questionable Event register.

NOTE The register requires that the associated PTR or NTR filters be set before a condition register bit can set a bit in the event register. The data in this register is latched until it is queried. Once queried, the register is cleared.

Mode	All
Remote Command	:STATus:QUEStionable[:EVENT]?
Example	STAT:QUES?
Preset	0
Status Bits/OPC dependencies	Sequential command
Initial S/W Revision	Prior to A.02.00

Questionable Negative Transition

This command determines which bits in the Questionable Condition register will set the corresponding bit in the Questionable Event register when the condition register bit has a negative transition (1 to 0). The variable <integer> is the sum of the decimal values of the bits that you want to enable.

Mode	All
Remote Command	:STATus:QUEStionable:NTRansition <integer> :STATus:QUEStionable:NTRansition?
Example	STAT:QUES:NTR 16 Temperature summary 'questionable cleared' will be reported to the Status Byte Register.
Preset	0
Min	0
Max	32767
Status Bits/OPC dependencies	Sequential command
Initial S/W Revision	Prior to A.02.00

Questionable Positive Transition

This command determines which bits in the Questionable Condition register will set the corresponding bit in the Questionable Event register when the condition register bit has a positive transition (0 to 1). The variable <integer> is the sum of the decimal values of the bits that you want to enable.

Mode	All
------	-----

Remote Command	:STATus:QUESTionable:PTRansition <integer> :STATus:QUESTionable:PTRansition?
Example	STAT:QUES:PTR 16 Temperature summary 'questionable asserted' will be reported to the Status Byte Register.
Preset	32767
Min	0
Max	32767
Status Bits/OPC dependencies	Sequential command
Initial S/W Revision	Prior to A.02.00

Questionable Calibration Register

"Questionable Calibration Condition " on page 189

"Questionable Calibration Enable " on page 189

"Questionable Calibration Event Query " on page 190

"Questionable Calibration Negative Transition " on page 190

"Questionable Calibration Positive Transition " on page 191

Questionable Calibration Condition

This query returns the decimal value of the sum of the bits in the Questionable Calibration Condition register.

NOTE The data in this register is continuously updated and reflects the current conditions.

Mode	All
Remote Command	:STATus:QUESTionable:CALibration:CONDition?
Example	STAT:QUES:CAL:COND?
Preset	0
Status Bits/OPC dependencies	Sequential command
Initial S/W Revision	Prior to A.02.00

Questionable Calibration Enable

This command determines which bits in the Questionable Calibration Condition Register will set bits in the Questionable Calibration Event register, which also sets the Calibration Summary bit (bit 8) in the Questionable Register. The variable <integer> is the sum of the decimal values of the bits you want to enable.

Mode	All
Remote Command	:STATus:QUESTionable:CALibration:ENABLE <integer> :STATus:QUESTionable:CALibration:ENABLE?
Example	STAT:QUES:CAL:ENAB 16384 Can be used to query if an alignment is needed, if you have turned off the automatic alignment process.
Min	0
Max	32767
Status Bits/OPC dependencies	Sequential command
Initial S/W Revision	Prior to A.02.00

Questionable Calibration Event Query

This query returns the decimal value of the sum of the bits in the Questionable Calibration Event register.

NOTE

The register requires that the associated PTR or NTR filters be set before a condition register bit can set a bit in the event register. The data in this register is latched until it is queried. Once queried, the register is cleared.

Mode	All
Remote Command	:STATus:QUESTionable:CALibration[:EVENT]?
Example	STAT:QUES:CAL?
Preset	0
Status Bits/OPC dependencies	Sequential command
Initial S/W Revision	Prior to A.02.00

Questionable Calibration Negative Transition

This command determines which bits in the Questionable Calibration Condition register will set the corresponding bit in the Questionable Calibration Event register when the condition register bit has a negative transition (1 to 0). The variable <integer> is the sum of the decimal values of the bits that you want to enable.

Mode	All
Remote Command	:STATus:QUESTionable:CALibration:NTRansition <integer> :STATus:QUESTionable:CALibration:NTRansition?
Example	STAT:QUES:CAL:NTR 16384 Alignment is not required.
Preset	0
Min	0

Max	32767
Status Bits/OPC dependencies	Sequential command
Initial S/W Revision	Prior to A.02.00

Questionable Calibration Positive Transition

This command determines which bits in the Questionable Calibration Condition register will set the corresponding bit in the Questionable Calibration Event register when the condition register bit has a positive transition (0 to 1). The variable <integer> is the sum of the decimal values of the bits that you want to enable.

Mode	All
Remote Command	:STATus:QUEStionable:CALibration:PTRansition <integer> :STATus:QUEStionable:CALibration:PTRansition?
Example	STAT:QUES:CAL:PTR 16384 Alignment is required.
Preset	32767
Min	0
Max	32767
Status Bits/OPC dependencies	Sequential command
Initial S/W Revision	Prior to A.02.00

Questionable Calibration Skipped Register

"Questionable Calibration Skipped Condition " on page 191

"Questionable Calibration Skipped Enable " on page 192

"Questionable Calibration Skipped Event Query " on page 192

"Questionable Calibration Skipped Negative Transition " on page 193

"Questionable Calibration Skipped Positive Transition " on page 193

Questionable Calibration Skipped Condition

This query returns the decimal value of the sum of the bits in the Questionable Calibration Skipped Condition register.

NOTE The data in this register is continuously updated and reflects the current conditions.

Mode	All
Remote Command	:STATus:QUEStionable:CALibration:SKIpped:CONDition?

Example	STAT:QUES:CAL:SKIP:COND?
Preset	0
Status Bits/OPC dependencies	Sequential command
Initial S/W Revision	Prior to A.02.00

Questionable Calibration Skipped Enable

This command determines which bits in the Questionable Calibration Skipped Condition Register will set bits in the Questionable Calibration Skipped Event register, which also sets bit 11 of the Questionable Calibration Register. The variable <integer> is the sum of the decimal values of the bits you want to enable.

Mode	All
Remote Command	:STATus:QUESTionable:CALibration:SKIpped:ENABle <integer> :STATus:QUESTionable:CALibration:SKIpped:ENABle?
Example	STAT:QUES:CAL:SKIP:ENAB 1 Can be used to query if an EMI alignment skipped condition is detected
Preset	32767
Min	0
Max	32767
Status Bits/OPC dependencies	Sequential command
Initial S/W Revision	Prior to A.02.00

Questionable Calibration Skipped Event Query

This query returns the decimal value of the sum of the bits in the Questionable Calibration Event register.

NOTE

The register requires that the associated PTR or NTR filters be set before a condition register bit can set a bit in the event register. The data in this register is latched until it is queried. Once queried, the register is cleared.

Mode	All
Remote Command	:STATus:QUESTionable:CALibration:SKIpped[:EVENT]?
Example	STAT:QUES:CAL:SKIP?
Preset	0
Status Bits/OPC dependencies	Sequential command
Initial S/W Revision	Prior to A.02.00

Questionable Calibration Skipped Negative Transition

This command determines which bits in the Questionable Calibration Skipped Condition register will set the corresponding bit in the Questionable Calibration Skipped Event register when the condition register bit has a negative transition (1 to 0). The variable <integer> is the sum of the decimal values of the bits that you want to enable.

Mode	All
Remote Command	:STATus:QUEStionable:CALibration:SKIPped:NTRansition <integer> :STATus:QUEStionable:CALibration:SKIPped:NTRansition?
Example	STAT:QUES:CAL:SKIP:NTR 1 Align RF skipped is not required.
Preset	0
Min	0
Max	32767
Status Bits/OPC dependencies	Sequential command
Initial S/W Revision	Prior to A.02.00

Questionable Calibration Skipped Positive Transition

This command determines which bits in the Questionable Calibration Skipped Condition register will set the corresponding bit in the Questionable Calibration Skipped Event register when the condition register bit has a positive transition (0 to 1). The variable <integer> is the sum of the decimal values of the bits that you want to enable.

Mode	All
Remote Command	:STATus:QUEStionable:CALibration:SKIPped:PTRansition <integer> :STATus:QUEStionable:CALibration:SKIPped:PTRansition?
Example	STAT:QUES:CAL:SKIP:PTR 1 Align RF skipped is required.
Preset	32767
Min	0
Max	32767
Status Bits/OPC dependencies	Sequential command
Initial S/W Revision	Prior to A.02.00

Questionable Calibration Extended Failure Register

"Questionable Calibration Extended Failure Condition " on page 194

"Questionable Calibration Extended Failure Enable " on page 194

"Questionable Calibration Extended Failure Event Query " on page 194

"Questionable Calibration Extended Failure Negative Transition " on page 195

"Questionable Calibration Extended Failure Positive Transition " on page 195

Questionable Calibration Extended Failure Condition

This query returns the decimal value of the sum of the bits in the Questionable Calibration Extended Failure Condition register.

NOTE The data in this register is continuously updated and reflects the current conditions.

Mode	All
Remote Command	:STATus:QUESTionable:CALibration:EXTended:FAILure:CONDition?
Example	STAT:QUES:CAL:EXT:FAIL:COND?
Preset	0
Status Bits/OPC dependencies	Sequential command
Initial S/W Revision	Prior to A.02.00

Questionable Calibration Extended Failure Enable

This command determines which bits in the Questionable Calibration Extended Failure Condition Register will set bits in the Questionable Calibration Extended Failure Event register, which also sets bit 9 of the Questionable Calibration Register. The variable <integer> is the sum of the decimal values of the bits you want to enable.

Mode	All
Remote Command	:STATus:QUESTionable:CALibration:EXTended:FAILure:ENABle <integer> :STATus:QUESTionable:CALibration:EXTended:FAILure:ENABle?
Example	STAT:QUES:CAL:EXT:FAIL:ENAB 1 Can be used to query if an EMI conducted alignment is needed.
Preset	32767
Min	0
Max	32767
Status Bits/OPC dependencies	Sequential command
Initial S/W Revision	Prior to A.02.00

Questionable Calibration Extended Failure Event Query

This query returns the decimal value of the sum of the bits in the Questionable Calibration Extended Failure Event register.

NOTE The register requires that the associated PTR or NTR filters be set before a condition register bit can set a bit in the event register. The data in this register is latched until it is queried. Once queried, the register is cleared.

Mode	All
Remote Command	:STATus:QUESTionable:CALibration:EXTended:FAILure[:EVENT]?
Example	STAT:QUES:CAL:EXT:FAIL?
Preset	0
Status Bits/OPC dependencies	Sequential command
Initial S/W Revision	Prior to A.02.00

Questionable Calibration Extended Failure Negative Transition

This command determines which bits in the Questionable Calibration Extended Failure Condition register will set the corresponding bit in the Questionable Calibration Extended Failure Event register when the condition register bit has a negative transition (1 to 0). The variable <integer> is the sum of the decimal values of the bits that you want to enable.

Mode	All
Remote Command	:STATus:QUESTionable:CALibration:EXTended:FAILure:NTRansition <integer> :STATus:QUESTionable:CALibration:EXTended:FAILure:NTRansition?
Example	STAT:QUES:CAL:EXT:FAIL:NTR 1 EMI conducted align failure is not required.
Preset	0
Min	0
Max	32767
Status Bits/OPC dependencies	Sequential command
Initial S/W Revision	Prior to A.02.00

Questionable Calibration Extended Failure Positive Transition

This command determines which bits in the Questionable Calibration Extended Failure Condition register will set the corresponding bit in the Questionable Calibration Extended Failure Event register when the condition register bit has a positive transition (0 to 1). The variable <integer> is the sum of the decimal values of the bits that you want to enable.

Mode	All
Remote Command	:STATus:QUESTionable:CALibration:EXTended:FAILure:PTRansition <integer> :STATus:QUESTionable:CALibration:EXTended:FAILure:PTRansition?
Example	STAT:QUES:CAL:EXT:FAIL:PTR 1 EMI conducted align failure is required.
Preset	32767
Min	0
Max	32767

Status Bits/OPC dependencies	Sequential command
Initial S/W Revision	Prior to A.02.00

Questionable Calibration Extended Needed Register

"Questionable Calibration Extended Needed Condition " on page 196

"Questionable Calibration Extended Needed Enable " on page 196

"Questionable Calibration Extended Needed Event Query " on page 197

"Questionable Calibration Extended Needed Negative Transition " on page 197

"Questionable Calibration Extended Needed Positive Transition " on page 198

Questionable Calibration Extended Needed Condition

This query returns the decimal value of the sum of the bits in the Questionable Calibration Extended Needed Condition register.

NOTE

The data in this register is continuously updated and reflects the current conditions.

Mode	All
Remote Command	:STATus:QUESTionable:CALibration:EXTended:NEEDed:CONDition?
Example	STAT:QUES:CAL:EXT:NEED:COND?
Preset	0
Status Bits/OPC dependencies	Sequential command
Initial S/W Revision	Prior to A.02.00

Questionable Calibration Extended Needed Enable

This command determines which bits in the Questionable Calibration Extended Needed Condition Register will set bits in the Questionable Calibration Extended Needed Event register, which also sets bit 14 of the Questionable Calibration Register. The variable <integer> is the sum of the decimal values of the bits you want to enable.

Mode	All
Remote Command	:STATus:QUESTionable:CALibration:EXTended:NEEDed:ENABle <integer> :STATus:QUESTionable:CALibration:EXTended:NEEDed:ENABle?
Example	STAT:QUES:CAL:EXT:NEED:ENAB 2 Can be used to query if an EMI conducted alignment is needed.
Preset	32767
Min	0

Max	32767
Status Bits/OPC dependencies	Sequential command
Initial S/W Revision	Prior to A.02.00

Questionable Calibration Extended Needed Event Query

This query returns the decimal value of the sum of the bits in the Questionable Calibration Extended Needed Event register.

NOTE

The register requires that the associated PTR or NTR filters be set before a condition register bit can set a bit in the event register. The data in this register is latched until it is queried. Once queried, the register is cleared.

Mode	All
Remote Command	:STATus:QUESTionable:CALibration:EXTended:NEEDED[:EVENT]?
Example	STAT:QUES:CAL:EXT:NEED?
Preset	0
Status Bits/OPC dependencies	Sequential command
Initial S/W Revision	Prior to A.02.00

Questionable Calibration Extended Needed Negative Transition

This command determines which bits in the Questionable Calibration Extended Needed Condition register will set the corresponding bit in the Questionable Calibration Extended Needed Event register when the condition register bit has a negative transition (1 to 0). The variable <integer> is the sum of the decimal values of the bits that you want to enable.

Mode	All
Remote Command	:STATus:QUESTionable:CALibration:EXTended:NEEDED:NTRansition <integer> :STATus:QUESTionable:CALibration:EXTended:NEEDED:NTRansition?
Example	STAT:QUES:CAL:EXT:NEED:NTR 2 Align EMI conducted is not required.
Preset	0
Min	0
Max	32767
Status Bits/OPC dependencies	Sequential command
Initial S/W Revision	Prior to A.02.00

Questionable Calibration Extended Needed Positive Transition

This command determines which bits in the Questionable Calibration Extended Needed Condition register will set the corresponding bit in the Questionable Calibration Extended Needed Event register when the condition register bit has a positive transition (0 to 1). The variable <integer> is the sum of the decimal values of the bits that you want to enable.

Mode	All
Remote Command	:STATus:QUESTionable:CALibration:EXTended:NEEDed:PTRansition <integer> :STATus:QUESTionable:CALibration:EXTended:NEEDed:PTRansition?
Example	STAT:QUES:CAL:EXT:NEED:PTR 2 Align EMI conducted is required.
Preset	32767
Min	0
Max	32767
Status Bits/OPC dependencies	Sequential command
Initial S/W Revision	Prior to A.02.00

Questionable Frequency Register

"Questionable Frequency Condition " on page 198

"Questionable Frequency Enable " on page 199

"Questionable Frequency Event Query " on page 199

"Questionable Frequency Negative Transition " on page 199

"Questionable Frequency Positive Transition " on page 200

Questionable Frequency Condition

This query returns the decimal value of the sum of the bits in the Questionable Frequency Condition register.

NOTE The data in this register is continuously updated and reflects the current conditions.

Mode	All
Remote Command	:STATus:QUESTionable:FREQuency:CONDition?
Example	STAT:QUES:FREQ:COND?
Preset	0
Status Bits/OPC dependencies	Sequential command
Initial S/W Revision	Prior to A.02.00

Questionable Frequency Enable

This command determines which bits in the Questionable Frequency Condition Register will set bits in the Questionable Frequency Event register, which also sets the Frequency Summary bit (bit 5) in the Questionable Register. The variable <integer> is the sum of the decimal values of the bits you want to enable.

Mode	All
Remote Command	:STATus:QUEStionable:FREQuency:ENABle <integer> :STATus:QUEStionable:FREQuency:ENABle?
Example	STAT:QUES:FREQ:ENAB 2 Frequency Reference Unlocked will be reported to the Frequency Summary of the Status Questionable register.
Preset	32767
Min	0
Max	32767
Status Bits/OPC dependencies	Sequential command
Initial S/W Revision	Prior to A.02.00

Questionable Frequency Event Query

This query returns the decimal value of the sum of the bits in the Questionable Frequency Event register.

NOTE

The register requires that the associated PTR or NTR filters be set before a condition register bit can set a bit in the event register. The data in this register is latched until it is queried. Once queried, the register is cleared.

Mode	All
Remote Command	:STATus:QUEStionable:FREQuency[:EVENT]?
Example	STAT:QUES:FREQ?
Preset	0
Status Bits/OPC dependencies	Sequential command
Initial S/W Revision	Prior to A.02.00

Questionable Frequency Negative Transition

This command determines which bits in the Questionable Frequency Condition register will set the corresponding bit in the Questionable Frequency Event register when the condition register bit has a negative transition (1 to 0). The variable <integer> is the sum of the decimal values of the bits that you want to enable.

Mode	All
------	-----

Remote Command	:STATus:QUESTionable:FREQuency:NTRansition <integer> :STATus:QUESTionable:FREQuency:NTRansition?
Example	STAT:QUES:FREQ:NTR 2 Frequency Reference 'regained lock' will be reported to the Frequency Summary of the Status Questionable register.
Preset	0
Min	0
Max	32767
Status Bits/OPC dependencies	Sequential command
Initial S/W Revision	Prior to A.02.00

Questionable Frequency Positive Transition

This command determines which bits in the Questionable Frequency Condition register will set the corresponding bit in the Questionable Frequency Event register when the condition register bit has a positive transition (0 to 1). The variable <integer> is the sum of the decimal values of the bits that you want to enable.

Mode	All
Remote Command	:STATus:QUESTionable:FREQuency:PTRansition <integer> :STATus:QUESTionable:FREQuency:PTRansition?
Example	STAT:QUES:FREQ:PTR 2 Frequency Reference 'became unlocked' will be reported to the Frequency Summary of the Status Questionable register.
Preset	32767
Min	0
Max	32767
Status Bits/OPC dependencies	Sequential command
Initial S/W Revision	Prior to A.02.00

Questionable Integrity Register

"Questionable Integrity Condition " on page 200

"Questionable Integrity Enable " on page 201

"Questionable Integrity Event Query " on page 201

"Questionable Integrity Negative Transition " on page 202

"Questionable Integrity Positive Transition " on page 202

Questionable Integrity Condition

This query returns the decimal value of the sum of the bits in the Questionable Integrity Condition register.

NOTE

The data in this register is continuously updated and reflects the current conditions.

Mode	All
Remote Command	:STATus:QUESTionable:INTEgrity:CONDition?
Example	STAT:QUES:INT:COND?
Preset	0
Status Bits/OPC dependencies	Sequential command
Initial S/W Revision	Prior to A.02.00

Questionable Integrity Enable

This command determines which bits in the Questionable Integrity Condition Register will set bits in the Questionable Integrity Event register, which also sets the Integrity Summary bit (bit 9) in the Questionable Register. The variable <integer> is the sum of the decimal values of the bits you want to enable.

Mode	All
Remote Command	:STATus:QUESTionable:INTEgrity:ENABle <integer> :STATus:QUESTionable:INTEgrity:ENABle?
Example	STAT:QUES:INT:ENAB 8 Measurement Uncalibrated Summary will be reported to the Integrity Summary of the Status Questionable register.
Preset	32767
Min	0
Max	32767
Status Bits/OPC dependencies	Sequential command
Initial S/W Revision	Prior to A.02.00

Questionable Integrity Event Query

This query returns the decimal value of the sum of the bits in the Questionable Integrity Event register.

NOTE

The register requires that the associated PTR or NTR filters be set before a condition register bit can set a bit in the event register. The data in this register is latched until it is queried. Once queried, the register is cleared.

Mode	All
Remote Command	:STATus:QUESTionable:INTEgrity[:EVENT]?
Example	STAT:QUES:INT?
Preset	0
Status Bits/OPC dependencies	Sequential command
Initial S/W Revision	Prior to A.02.00

Questionable Integrity Negative Transition

This command determines which bits in the Questionable Integrity Condition register will set the corresponding bit in the Questionable Integrity Event register when the condition register bit has a negative transition (1 to 0)

The variable <integer> is the sum of the decimal values of the bits that you want to enable.

Mode	All
Remote Command	:STATus:QUEStionable:INTEgrity:NTRansition <integer> :STATus:QUEStionable:INTEgrity:NTRansition?
Example	STAT:QUES:INT:NTR 8 Measurement 'regained calibration' Summary will be reported to the Integrity Summary of the Status Questionable register.
Preset	0
Min	0
Max	32767
Status Bits/OPC dependencies	Sequential command
Initial S/W Revision	Prior to A.02.00

Questionable Integrity Positive Transition

This command determines which bits in the Questionable Integrity Condition register will set the corresponding bit in the Questionable Integrity Event register when the condition register bit has a positive transition (0 to 1). The variable <integer> is the sum of the decimal values of the bits that you want to enable.

Mode	All
Remote Command	:STATus:QUEStionable:INTEgrity:PTRansition <integer> :STATus:QUEStionable:INTEgrity:PTRansition?
Example	STAT:QUES:INT:PTR 8 Measurement 'became uncalibrated' Summary will be reported to the Integrity Summary of the Status Questionable register.
Preset	32767
Min	0
Max	32767
Status Bits/OPC dependencies	Sequential command
Initial S/W Revision	Prior to A.02.00

Questionable Integrity Signal Register

"Questionable Integrity Signal Condition" on page 203

"Questionable Integrity Signal Enable" on page 203

"Questionable Integrity Signal Event Query" on page 204

"Questionable Integrity Signal Negative Transition" on page 204

"Questionable Integrity Signal Positive Transition" on page 204

Questionable Integrity Signal Condition

This query returns the decimal value of the sum of the bits in the Questionable Integrity Signal Condition register.

NOTE	The data in this register is continuously updated and reflects the current conditions.
Mode	All
Remote Command	:STATus:QUESTionable:INTEgrity:SIGNal:CONDition?
Example	STAT:QUES:INT:SIGN:COND?
Preset	0
Status Bits/OPC dependencies	Sequential command
Initial S/W Revision	Prior to A.02.00

Questionable Integrity Signal Enable

This command determines which bits in the Questionable Integrity Signal Condition Register will set bits in the Questionable Integrity Signal Event register, which also sets the Integrity Summary bit (bit 9) in the Questionable Register. The variable <integer> is the sum of the decimal values of the bits you want to enable.

Mode	All
Remote Command	:STATus:QUESTionable:INTEgrity:SIGNal:ENABle <integer> :STATus:QUESTionable:INTEgrity:SIGNal:ENABle?
Example	STAT:QUES:INT:SIGN:ENAB 4 Burst Not Found will be reported to the Integrity Summary of the Status Questionable register.
Preset	32767
Min	0
Max	32767
Status Bits/OPC dependencies	Sequential command
Initial S/W Revision	Prior to A.02.00

Questionable Integrity Signal Event Query

This query returns the decimal value of the sum of the bits in the Questionable Integrity Signal Event register.

NOTE

The register requires that the associated PTR or NTR filters be set before a condition register bit can set a bit in the event register. The data in this register is latched until it is queried. Once queried, the register is cleared.

Mode	All
Remote Command	:STATus:QUESTionable:INTEgrity:SIGNal[:EVENT]?
Example	STAT:QUES:INT:SIGN?
Preset	0
Status Bits/OPC dependencies	Sequential command
Initial S/W Revision	Prior to A.02.00

Questionable Integrity Signal Negative Transition

This command determines which bits in the Questionable Integrity Signal Condition register will set the corresponding bit in the Questionable Integrity Signal Event register when the condition register bit has a negative transition (1 to 0). The variable <integer> is the sum of the decimal values of the bits that you want to enable.

Mode	All
Remote Command	:STATus:QUESTionable:INTEgrity:SIGNal:NTRansition <integer> :STATus:QUESTionable:INTEgrity:SIGNal:NTRansition?
Example	STAT:QUES:INT:SIGN:NTR 4 Burst found will be reported to the Integrity Summary of the Status Questionable register.
Preset	0
Min	0
Max	32767
Status Bits/OPC dependencies	Sequential command
Initial S/W Revision	Prior to A.02.00

Questionable Integrity Signal Positive Transition

This command determines which bits in the Questionable Integrity Signal Condition register will set the corresponding bit in the Questionable Integrity Signal Event register when the condition register bit has a positive transition (0 to 1). The variable <integer> is the sum of the decimal values of the bits that you want to enable.

Mode	All
Remote Command	:STATus:QUEStionable:INTEgrity:SIGNal:PTRansition <integer> :STATus:QUEStionable:INTEgrity:SIGNal:PTRansition?
Example	STAT:QUES:INT:SIGN:PTR 4 Burst not found will be reported to the Integrity Summary of the Status Questionable register.
Preset	32767
Min	0
Max	32767
Status Bits/OPC dependencies	Sequential command
Initial S/W Revision	Prior to A.02.00

Questionable Integrity Uncalibrated Register

"Questionable Integrity Uncalibrated Condition " on page 205

"Questionable Integrity Uncalibrated Enable " on page 205

"Questionable Integrity Uncalibrated Event Query " on page 206

"Questionable Integrity Uncalibrated Negative Transition " on page 206

"Questionable Integrity Uncalibrated Positive Transition " on page 207

Questionable Integrity Uncalibrated Condition

This query returns the decimal value of the sum of the bits in the Questionable Integrity Uncalibrated Condition register.

NOTE

The data in this register is continuously updated and reflects the current conditions.

Mode	All
Remote Command	:STATus:QUEStionable:INTEgrity:UNCalibrated:CONDition?
Example	STAT:QUES:INT:UNC:COND?
Preset	0
Status Bits/OPC dependencies	Sequential command
Initial S/W Revision	Prior to A.02.00

Questionable Integrity Uncalibrated Enable

This command determines which bits in the Questionable Integrity Uncalibrated Condition Register will set bits in the Questionable Integrity Uncalibrated Event register, which also sets the Data Uncalibrated Summary bit (bit 3) in the Questionable Integrity Register. The variable <integer> is the sum of the decimal values of the bits you want to enable.

Mode	All
Remote Command	:STATus:QUEStionable:INTEgrity:UNCalibrated:ENABle :STATus:QUEStionable:INTEgrity:UNCalibrated:ENABle?
Example	STAT:QUES:INT:UNC:ENAB 1 Oversweep (Meas Uncal) will be reported to the Integrity Summary of the Status Questionable register.
Preset	32767
Min	0
Max	32767
Status Bits/OPC dependencies	Sequential command
Initial S/W Revision	Prior to A.02.00

Questionable Integrity Uncalibrated Event Query

This query returns the decimal value of the sum of the bits in the Questionable Integrity Uncalibrated Event register.

NOTE

The register requires that the associated PTR or NTR filters be set before a condition register bit can set a bit in the event register. The data in this register is latched until it is queried. Once queried, the register is cleared.

Mode	All
Remote Command	:STATus:QUEStionable:INTEgrity:UNCalibrated[:EVENT]?
Example	STAT:QUES:INT:UNC?
Preset	0
Status Bits/OPC dependencies	Sequential command
Initial S/W Revision	Prior to A.02.00

Questionable Integrity Uncalibrated Negative Transition

This command determines which bits in the Questionable Integrity Uncalibrated Condition register will set the corresponding bit in the Questionable Integrity Uncalibrated Event register when the condition register bit has a negative transition (1 to 0). The variable <integer> is the sum of the decimal values of the bits that you want to enable.

Mode	All
Remote Command	:STATus:QUEStionable:INTEgrity:UNCalibrated:NTRansition <integer> :STATus:QUEStionable:INTEgrity:UNCalibrated:NTRansition?
Example	STAT:QUES:INT:UNC:NTR 1 Oversweep cleared will be reported to the Integrity Summary of the Status Questionable register.

Preset	0
Min	0
Max	32767
Status Bits/OPC dependencies	Sequential command
Initial S/W Revision	Prior to A.02.00

Questionable Integrity Uncalibrated Positive Transition

This command determines which bits in the Questionable Integrity Uncalibrated Condition register will set the corresponding bit in the Questionable Integrity Uncalibrated Event register when the condition register bit has a positive transition (0 to 1). The variable <integer> is the sum of the decimal values of the bits that you want to enable.

Mode	All
Remote Command	:STATus:QUEStionable:INTEgrity:UNCalibrated:PTRansition <integer> :STATus:QUEStionable:INTEgrity:UNCalibrated:PTRansition?
Example	STAT:QUES:INT:UNC:PTR 1 Oversweep (Meas Uncal) occurred will be reported to the Integrity Summary of the Status Questionable register.
Preset	32767
Min	0
Max	32767
Status Bits/OPC dependencies	Sequential command
Initial S/W Revision	Prior to A.02.00

Questionable Power Register

["Questionable Power Condition " on page 207](#)

["Questionable Power Enable " on page 208](#)

["Questionable Power Event Query " on page 208](#)

["Questionable Power Negative Transition " on page 209](#)

["Questionable Power Positive Transition " on page 209](#)

Questionable Power Condition

This query returns the decimal value of the sum of the bits in the Questionable Power Condition register.

NOTE

The data in this register is continuously updated and reflects the current conditions.

Mode	All
Remote Command	:STATus:QUESTionable:POWer:CONDition?
Example	STAT:QUES:POW:COND?
Preset	0
Status Bits/OPC dependencies	Sequential command
Initial S/W Revision	Prior to A.02.00

Questionable Power Enable

This command determines which bits in the Questionable Power Condition Register will set bits in the Questionable Power Event register, which also sets the Power Summary bit (bit 3) in the Questionable Register. The variable <integer> is the sum of the decimal values of the bits you want to enable.

Mode	All
Remote Command	:STATus:QUESTionable:POWer:ENABle <integer> :STATus:QUESTionable:POWer:ENABle?
Example	STAT:QUES:POW:ENAB 32 50 MHz Input Pwr too High for Cal will be reported to the Power Summary of the Status Questionable register.
Preset	32767
Min	0
Max	32767
Status Bits/OPC dependencies	Sequential command
Initial S/W Revision	Prior to A.02.00

Questionable Power Event Query

This query returns the decimal value of the sum of the bits in the Questionable Power Event register.

NOTE

The register requires that the associated PTR or NTR filters be set before a condition register bit can set a bit in the event register. The data in this register is latched until it is queried. Once queried, the register is cleared.

Mode	All
Remote Command	:STATus:QUESTionable:POWer[:EVENT]?
Example	STAT:QUES:POW?
Preset	0
Status Bits/OPC dependencies	Sequential command
Initial S/W Revision	Prior to A.02.00

Questionable Power Negative Transition

This command determines which bits in the Questionable Power Condition register will set the corresponding bit in the Questionable Power Event register when the condition register bit has a negative transition (1 to 0). The variable <integer> is the sum of the decimal values of the bits that you want to enable.

Mode	All
Remote Command	:STATus:QUESTionable:POWer:NTRansition <integer> :STATus:QUESTionable:POWer:NTRansition?
Example	STAT:QUES:POW:NTR 32 50 MHz Input Power became OK for Cal will be reported to the Power Summary of the Status Questionable register.
Preset	0
Min	0
Max	32767
Status Bits/OPC dependencies	Sequential command
Initial S/W Revision	Prior to A.02.00

Questionable Power Positive Transition

This command determines which bits in the Questionable Power Condition register will set the corresponding bit in the Questionable Power Event register when the condition register bit has a positive transition (0 to 1). The variable <integer> is the sum of the decimal values of the bits that you want to enable.

Mode	All
Remote Command	:STATus:QUESTionable:POWer:PTRansition <integer> :STATus:QUESTionable:POWer:PTRansition?>
Example	STAT:QUES:POW:PTR 32 50 MHz Input Power became too high for Cal will be reported to the Power Summary of the Status Questionable register.
Preset	32767
Min	0
Max	32767
Status Bits/OPC dependencies	Sequential command
Initial S/W Revision	Prior to A.02.00

Questionable Temperature Register

"Questionable Temperature Condition" on page 210

"Questionable Temperature Enable" on page 210

"Questionable Temperature Event Query" on page 210

"Questionable Temperature Negative Transition" on page 211

"Questionable Temperature Positive Transition" on page 211

Questionable Temperature Condition

This query returns the decimal value of the sum of the bits in the Questionable Temperature Condition register.

NOTE

The data in this register is continuously updated and reflects the current conditions.

Mode	All
Remote Command	:STATus:QUESTionable:TEMPerature:CONDition?
Example	STAT:QUES:TEMP:COND?
Preset	0
Status Bits/OPC dependencies	Sequential command
Initial S/W Revision	Prior to A.02.00

Questionable Temperature Enable

This command determines which bits in the Questionable Temperature Condition Register will set bits in the Questionable Temperature Event register, which also sets the Temperature Summary bit (bit 4) in the Questionable Register. The variable <integer> is the sum of the decimal values of the bits you want to enable.

Mode	All
Remote Command	:STATus:QUESTionable:TEMPerature:ENABle <integer> :STATus:QUESTionable:TEMPerature:ENABle?
Example	STAT:QUES:TEMP:ENAB 1 Reference Oscillator Oven Cold will be reported to the Temperature Summary of the Status Questionable register.
Preset	32767
Min	0
Max	32767
Status Bits/OPC dependencies	Sequential command
Initial S/W Revision	Prior to A.02.00

Questionable Temperature Event Query

This query returns the decimal value of the sum of the bits in the Questionable Temperature Event register.

NOTE

The register requires that the associated PTR or NTR filters be set before a condition register bit can set a bit in the event register. The data in this register is latched until it is queried. Once queried, the register is cleared

Mode	All
Remote Command	:STATus:QUEStionable:TEMPerature[:EVENT]?
Example	STAT:QUES:TEMP?
Preset	0
Status Bits/OPC dependencies	Sequential command
Initial S/W Revision	Prior to A.02.00

Questionable Temperature Negative Transition

This command determines which bits in the Questionable Temperature Condition register will set the corresponding bit in the Questionable Temperature Event register when the condition register bit has a negative transition (1 to 0). The variable <integer> is the sum of the decimal values of the bits that you want to enable.

Mode	All
Remote Command	:STATus:QUEStionable:TEMPerature:NTRansition <integer> :STATus:QUEStionable:TEMPerature:NTRansition?
Example	STAT:QUES:TEMP:NTR 1 Reference Oscillator Oven not cold will be reported to the Temperature Summary of the Status Questionable register.
Preset	0
Min	0
Max	32767
Status Bits/OPC dependencies	Sequential command
Initial S/W Revision	Prior to A.02.00

Questionable Temperature Positive Transition

This command determines which bits in the Questionable Temperature Condition register will set the corresponding bit in the Questionable Temperature Event register when the condition register bit has a positive transition (0 to 1). The variable <integer> is the sum of the decimal values of the bits that you want to enable.

Mode	All
Remote Command	:STATus:QUEStionable:TEMPerature:PTRansition <integer> :STATus:QUEStionable:TEMPerature:PTRansition?
Example	STAT:QUES:TEMP:PTR 1 Reference Oscillator Oven became cold will be reported to the

	Temperature Summary of the Status Questionable register.
Preset	32767
Min	0
Max	32767
Status Bits/OPC dependencies	Sequential command
Initial S/W Revision	Prior to A.02.00

IEEE 488.2 Common Commands

The instrument supports the following subset of IEEE 488.2 Common Commands, as defined in Chapter 10 of [IEEE Standard 488.2–1992](#). As indicated in the detailed descriptions, some of these commands correspond directly to instrument front-panel key functionality, while others are available only as remote commands.

Command	Description
*CAL?	Align Now "All " on page 388
*CLS	"Clear Status " on page 215
*ESE	"Standard Event Status Enable " on page 215
*ESE?	
*ESR?	"Standard Event Status Register Query " on page 216
*IDN?	"Identification Query " on page 216
*OPC	"Operation Complete " on page 217
*OPC?	
*OPT?	"Query Instrument Options " on page 218
*RCL	"Recall Instrument State " on page 218
*RST	"*RST (Remote Command Only)" on page 219
*SAV	"Save Instrument State " on page 219
*SRE	"Service Request Enable " on page 219
*SRE?	
*STB?	"Status Byte Query " on page 220
*TRG	"Trigger " on page 220
*TST?	"Self Test Query " on page 220
*WAI	"Wait-to-Continue " on page 221

All

(In MXE the key label is "All (plus RF Presel 20 Hz – 3.6 GHz)")Immediately executes an alignment of all subsystems In MXE, the Align Now All is followed by additionally aligning the RF Preselector section, so in MXE, the key label contains the parenthetical note "(plus RF Presel 20 Hz – 3.6 GHz)". The instrument stops any measurement currently underway, performs the alignment, then restarts the measurement from the beginning (similar to pressing the Restart key).

If an interfering user signal is present at the RF Input, the alignment is performed on all subsystems except the RF. After completion, the Error Condition message "Align skipped: 50 MHz interference" or "Align skipped: 4.8 GHz interference" is generated. In addition the Error Condition message "Align Now, RF required" is generated, and bits 11 and 12 are set in the Status Questionable Calibration register.

The query form of the remote commands (:CALibration[:ALL]? or *CAL?) invokes the alignment of all subsystems and returns a success or failure value. An interfering user signal is not grounds for failure; if the

alignment was able to succeed on all portions but unable to align the RF because of an interfering signal, the resultant will be the success value.

Successful completion of Align Now, All will clear the “Align Now, All required” Error Condition, and clear bit 14 in the Status Questionable Calibration register. It will also begin the elapsed time counter for Last Align Now, All Time, and capture the Last Align Now, All Temperature.

In the MXE, successful completion will also clear the “Align 20 Hz to 30 MHz required” Error Condition, the “Align 30 MHz to 3.6 GHz required” Error Condition, and the “Align 20 Hz to 3.6 GHz required” Error Condition, and clear bits 1 and bit 2 and clear the bit 1 in the Status Questionable Calibration Extended Needed register.

If the Align RF subsystem succeeded in aligning (no interfering signal present), the elapsed time counter begins for Last Align Now, RF Time, and the temperature is captured for the Last Align Now, RF Temperature. In addition the Error Conditions “Align skipped: 50 MHz interference” and “Align skipped: 4.8 GHz interference” are cleared, the Error Condition “Align Now, RF required” is cleared, and bits 11 and 12 are cleared in the Status Questionable Calibration register

Align Now, All can be interrupted by pressing the Cancel (ESC) front-panel key or remotely with Device Clear followed by the :ABORt SCPI command. When this occurs the Error Condition message “Align Now, All required” is generated, and bit 14 is set in the Status Questionable Condition register. This is because new alignment data may be employed for an individual subsystem, but not a cohesive set of data for all subsystems.

In many cases, you might find it more convenient to change alignments to Normal, instead of executing Align Now, All. When the Auto Align process transitions to Normal, the analyzer will immediately start to update only the alignments that have expired, thus efficiently restoring the alignment process.

Key Path	System, Alignments, Align Now
Mode	All
Remote Command	:CALibration[:ALL] :CALibration[:ALL]?
Example	:CAL
Notes	:CALibration[:ALL]? returns 0 if successful :CALibration[:ALL]? returns 1 if failed :CALibration[:ALL]? is the same as *CAL? While Align Now, All is performing the alignment, bit 0 in the Status Operation register is set. Completion, or termination, will clear bit 0 in the Status Operation register. This command is sequential; it must complete before further SCPI commands are processed. Interrupting the alignment from remote is accomplished by invoking Device Clear followed by the :ABORt command. Successful completion will clear bit 14 in the Status Questionable Calibration register. An interfering user signal is not grounds for failure of Align Now, All. However, bits 11 and 12 are set in the Status Questionable Calibration register to indicate Align Now, RF is required. An interfering user supplied signal will result in the instrument requiring an Align Now, RF with the interfering signal removed.
Couplings	Initializes the time for the Last Align Now, All Time. Records the temperature for the Last Align Now, All Temperature.

	If Align RF component succeeded, initializes the time for the Last Align Now, RF Time. If Align RF component succeeded, records the temperature for the Last Align Now, RF Temperature.
Status Bits/OPC dependencies	Bits 11, 12, or 14 may be set in the Status Questionable Calibration register.
Initial S/W Revision	Prior to A.02.00

Mode	All
Remote Command	*CAL?
Example	*CAL?
Notes	*CAL? returns 0 if successful *CAL? returns 1 if failed :CALibration[:ALL]? is the same as *CAL? See additional remarks described with :CALibration[:ALL]? Everything about :CALibration[:ALL]? is synonymous with *CAL? including all conditions, status register bits, and couplings
Initial S/W Revision	Prior to A.02.00

Clear Status

Clears the status byte register. It does this by emptying the error queue and clearing all bits in all of the event registers. The status byte register summarizes the states of the other registers. It is also responsible for generating service requests.

Key Path	No equivalent key. Related key System, Show Errors, Clear Error Queue
Remote Command	*CLS
Example	*CLS Clears the error queue and the Status Byte Register.
Notes	For related commands, see the SYSTem:ERRor[:NEXT]? command. See also the STATus:PRESet command and all commands in the STATus subsystem.
Status Bits/OPC dependencies	Resets all bits in all event registers to 0, which resets all the status byte register bits to 0 also.
Backwards Compatibility Notes	In general the status bits used in the X-Series status system will be backwards compatible with ESA and PSA. However, note that all conditions will generate events that go into the event log, and some will also generate status bits.
Initial S/W Revision	Prior to A.02.00

Standard Event Status Enable

Selects the desired bits from the standard event status enable register. This register monitors I/O errors and synchronization conditions such as operation complete, request control, query error, device

dependent error, status execution error, command error, and power on. The selected bits are OR'd to become a summary bit (bit 5) in the byte register which can be queried.

The query returns the state of the standard event status enable register.

Key Path	No equivalent key. Related key System, Show Errors, Clear Error Queue
Remote Command	*ESE <integer> *ESE?
Example	*ESE 36 Enables the Standard Event Status Register to monitor query and command errors (bits 2 and 5). *ESE? Returns a 36 indicating that the query and command status bits are enabled.
Notes	For related commands, see the STATus subsystem and SYSTem:ERRor[:NEXT]? commands.
Preset	255
State Saved	Not saved in state.
Min	0
Max	255
Status Bits/OPC dependencies	Event Enable Register of the Standard Event Status Register.
Initial S/W Revision	Prior to A.02.00

Standard Event Status Register Query

Queries and clears the standard event status event register. (This is a destructive read.) The value returned is a hexadecimal number that reflects the current state (0/1) of all the bits in the register.

Remote Command	*ESR?
Example	*ESR? Returns a 1 if there is either a query or command error, otherwise it returns a zero.
Notes	For related commands, see the STATus subsystem commands.
Preset	0
Min	0
Max	255
Status Bits/OPC dependencies	Standard Event Status Register (bits 0 – 7).
Initial S/W Revision	Prior to A.02.00

Identification Query

Returns a string of instrument identification information. The string will contain the model number, serial number, and firmware revision.

The response is organized into four fields separated by commas. The field definitions are as follows:

- Manufacturer

- Model
- Serial number
- Firmware version

Key Path	No equivalent key. See related key System, Show System.
Remote Command	*IDN?
Example	*IDN? Returns instrument identification information, such as: Keysight Technologies, N9020A, US01020004, A.01.02
Initial S/W Revision	Prior to A.02.00

Operation Complete

The *OPC command sets bit 0 in the standard event status register (SER) to “1” when pending operations have finished, that is when all overlapped commands are complete. It does not hold off subsequent operations. You can determine when the overlapped commands have completed either by polling the OPC bit in SER, or by setting up the status system such that a service request (SRQ) is asserted when the OPC bit is set.

The *OPC? query returns a “1” after all the current overlapped commands are complete. So it holds off subsequent commands until the “1” is returned, then the program continues. This query can be used to synchronize events of other instruments on the external bus.

Remote Command	*OPC *OPC?
Example	INIT:CONT 0 Selects single sweeping. INIT:IMM Initiates a sweep. *OPC? Holds off any further commands until the sweep is complete.
Status Bits/OPC dependencies	Not global to all remote ports or front panel. *OPC only considers operation that was initiated on the same port as the *OPC command was issued from. *OPC is an overlapped command, but *OPC? is sequential.
Backwards Compatibility Notes	<ol style="list-style-type: none"> 1. The ESA/PSA/VSA products do not meet all the requirements for the *OPC command specified by IEEE 488.2. This is corrected for X-Series. This will sometimes cause behavior that is not backward compatible, but it will work as customers expect. 2. Commands such as, *OPC/*OPC?/*WAI/*RST used to be global. They considered front panel operation in conjunction with the GPIB functionality. Now they are evaluated on a per channel basis. That is, the various rear panel remote ports and the front panel i/o are all considered separately. Only the functionality initiated on the port where the *OPC was sent, is considered for its operation. 3. *OPC used to hold off until the operation bits were cleared. Now it holds off until all overlapping commands are completed. Also, earlier instruments did not wait for completion of all processes, only the ones identified here (in the STATus:OPERation register): Calibrating: monitored by PSA, ESA, VSA (E4406A) Sweeping: monitored by PSA, ESA, VSA (E4406A) Waiting for Trigger: monitored by PSA, ESA, VSA (E4406A)

	Measuring: monitored by PSA and ESA (but not in all Modes). Paused: monitored by VSA (E4406A). Printing: monitored by VSA (E4406A). Mass memory busy: monitored by VSA (E4406A).
Initial S/W Revision	Prior to A.02.00

Query Instrument Options

Returns a string of all the installed instrument options. It is a comma separated list with quotes, such as: "503,P03,PFR".

To be IEEE compliant, this command should return an arbitrary ascii variable that would not begin and end with quotes. But the quotes are needed to be backward compatible with previous SA products and software. So, the actual implementation will use arbitrary ascii. But quotes will be sent as the first and last ascii characters that are sent with the comma-separated option list.

Remote Command	*OPT?
Initial S/W Revision	Prior to A.02.00

Recall Instrument State

This command recalls the instrument state from the specified instrument memory register.

- If the state being loaded has a newer firmware revision than the revision of the instrument, no state is recalled and an error is reported
- If the state being loaded has an equal firmware revision than the revision of the instrument, the state will be loaded.
- If the state being loaded has an older firmware revision than the revision of the instrument, the instrument will only load the parts of the state that apply to the older revision.

Remote Command	*RCL <register #>
Example	*RCL 7 Recalls the instrument state that is currently stored in register 7.
Notes	Registers 0 through 6 are accessible from the front panel in menu keys for Recall Registers.
Min	0
Max	127
Status Bits/OPC dependencies	The command is sequential.
Initial S/W Revision	Prior to A.02.00

*RST (Remote Command Only)

*RST is equivalent to :SYST:PRES::INIT:CONT OFF, which is a Mode Preset in the Single measurement state. This remote command is preferred over Mode Preset remote command - :SYST:PRES, as optimal remote programming occurs with the instrument in the single measurement state.

Remote Command	*RST
Example	*RST
Notes	Sequential Clears all pending OPC bits and the Status Byte is set to 0.
Couplings	A *RST will cause the currently running measurement to be aborted and cause the default measurement to be active. *RST gets the mode to a consistent state with all of the default couplings set.
Backwards Compatibility Notes	In legacy analyzers *RST did not set the analyzer to Single, but in the X-Series it does, for compliance with the IEEE 488.2 specification. In the X-Series, *RST does not do a *CLS (clear the status bits and the error queue). In legacy analyzers, *RST used to do the equivalent of SYSTem:PRESet, *CLS and INITiate:CONTinuous OFF. But to be 488.2 compliant, *RST in the X-Series does not do a *CLS.
Initial S/W Revision	Prior to A.02.00

Save Instrument State

This command saves the current instrument state and mode to the specified instrument memory register.

Remote Command	*SAV <register #>
Example	*SAV 9 Saves the instrument state in register 9.
Notes	Registers 0 through 6 are accessible from the front panel in menu keys for Save Registers.
Min	0
Max	127
Status Bits/OPC dependencies	The command is sequential.
Initial S/W Revision	Prior to A.02.00

Service Request Enable

This command enables the desired bits of the service request enable register.

The query returns the value of the register, indicating which bits are currently enabled.

Remote Command	*SRE <integer> *SRE?
Example	*SRE 22 Enables bits 1, 2, and 4 in the service request enable register.

Notes	For related commands, see the STATus subsystem and SYSTem:ERRor[:NEXT]? commands.
Preset	0
Min	0
Max	255
Status Bits/OPC dependencies	Service Request Enable Register (all bits, 0 – 7).
Initial S/W Revision	Prior to A.02.00

Status Byte Query

Returns the value of the status byte register without erasing its contents.

Remote Command	*STB?
Example	*STB? Returns a decimal value for the bits in the status byte register. For example, if a 16 is returned, it indicates that bit 5 is set and one of the conditions monitored in the standard event status register is set.
Notes	See related command *CLS.
Status Bits/OPC dependencies	Status Byte Register (all bits, 0 – 7).
Initial S/W Revision	Prior to A.02.00

Trigger

This command triggers the instrument. Use the :TRIGger[:SEQuence]:SOURce command to select the trigger source.

Key Path	No equivalent key. See related keys Single and Restart.
Remote Command	*TRG
Example	*TRG Triggers the instrument to take a sweep or start a measurement, depending on the current instrument settings.
Notes	See related command :INITiate:IMMediate.
Initial S/W Revision	Prior to A.02.00

Self Test Query

This query performs the internal self-test routines and returns a number indicating the success of the testing. A zero is returned if the test is successful, 1 if it fails.

Remote Command	*TST?
Example	*TST? Runs the self-test routines and returns 0=passed, 1=some part failed.
Initial S/W Revision	Prior to A.02.00

Wait-to-Continue

This command causes the instrument to wait until all overlapped commands are completed before executing any additional commands. There is no query form for the command.

Remote Command	*WAI
Example	INIT:CONT OFF; INIT;*WAI Sets the instrument to single sweep. Starts a sweep and waits for its completion.
Status Bits/OPC dependencies	Not global to all remote ports or front panel. *OPC only considers operation that was initiated on the same port as the *OPC command was issued from.
Initial S/W Revision	Prior to A.02.00

4 Input/Output Functions

Input/Output

The Input/Output features are common across multiple Modes and Measurements. These common features are described in this section. See the Measurement description for information on features that are unique.

The Input/Output key accesses the keys that control the Input/Output parameters of the instrument. In general, these are functions associated with external connections to the analyzer, either to the inputs or the outputs. Since these connections tend to be fairly stable within a given setup, in general, the input/output settings do not change when you Preset the analyzer.

Other functions related to the input/output connections, but which tend to change on a measurement by measurement basis, can be found under the Trigger and AMPTD Y Scale keys. In addition, some of the digital I/O bus configurations can be found under the System key.

NOTE

The functions in the Input/Output menu are "global" (common) to all Modes (applications). But individual Input/Output functions only appear in a Mode if they apply to that Mode. Functions that apply to a Mode but not to all measurements in the Mode may be grayed-out in some measurements.

["Input/Output variables - Preset behavior" on page 225](#)

The Input Port selection is the first menu under the Input/Output key:

Key Path	Front-panel key
Remote Command	<code>[:SENSe] :FEED RF AIQ EMIXer</code> <code>[:SENSe] :FEED?</code>
Example	<code>:FEED RF</code> <code>:FEED?</code>
Couplings	The <code>[:SENSe] :FEED RF</code> command turns the calibrator OFF
Preset	This setting is unaffected by a Preset or power cycle. It survives a Mode Preset and mode changes. It is set to RF on a "Restore Input/Output Defaults" or "Restore System Defaults->All"
State Saved	Saved in instrument state
Backwards Compatibility SCPI	<code>[:SENSe] :FEED AREFERENCE</code> In the PSA the calibrator was one of the inputs and selected using the AREF parameter to the same <code>:FEED</code> command that switched the inputs. In the X-Series it is controlled in a separate menu and overrides the input selection. For code compatibility the <code>[:SENSe] :FEED AREFERENCE</code> command is provided, and is aliased to <code>[:SENSe] :FEED :AREF REF50</code> , which causes the input to be switched to the 50 MHz calibrator. The <code>[:SENSe] :FEED RF</code> command switches the input back to the RF port and turns the calibrator OFF, thus providing full compatibility with the PSA calibrator function. Note that after sending this, the query <code>[:SENSe] :FEED?</code> will NOT return "AREF" but instead the currently selected input.
Backwards Compatibility SCPI	<code>[:SENSe] :FEED IQ IONLy QONLy</code> <code>[:SENSe] :FEED?</code> The parameters <code>IQ IONLy QONLy</code> are supported for backwards compatibility with the E44406A. <code>[:SENSe] :FEED IQ</code> aliases to <code>[:SENSe] :FEED :IQ :TYPE IQ</code> <code>[:SENSe] :FEED IONLy</code> aliases to <code>[:SENSe] :FEED :IQ :TYPE IONLy</code>

	<p>[;SENSe]:FEED QONLy aliases to [;SENSe]:FEED:IQ:TYPE QONLy</p> <p>The query [;SENSe]:FEED? will always returns AIQ whatever the type of legacy parameters IQ IONLy QONLy has been used.</p>
Backwards Compatibility Notes	<p>Most of the settings in the X-Series Input/Output system, including External Gain, Amplitude Corrections settings and data, etc., are shared by all modes and are not changed by a mode switch. Furthermore, most variables in the Input/Output system key are not affected by Mode Preset. Both of these behaviors represent a departure from legacy behavior.</p> <p>In the X-Series. Input/Output settings are reset by using the "Restore Input/Output Defaults" function. They can also be reset to their default values through the System->Restore System Defaults-> In/Out Config key or through the System ->Restore System Defaults -> All key (and corresponding SCPI).</p> <p>While this matches most use cases better, it does create some code compatibility issues. For example, Amplitude Corrections are no longer turned off by a Mode Preset, but instead by using the "Restore Input/Output Defaults" key/SCPI.</p> <p>Although Input/Output settings are not part of each Mode's State, they are saved in the Save State files, so that all of the instrument settings can be recalled with Recall State, as in legacy instruments.</p>
Initial S/W Revision	Prior to A.02.00
Remote Command	<p>:INPut:MIXer EXTernal INTernal</p> <p>:INPut:MIXer?</p>
Example	<p>INP:MIX INT</p> <p>INP:MIX?</p>
Notes	<p>In legacy analyzers you choose between the Internal mixer or an External Mixer. In the X-Series, the External Mixer is one of the choices for the Input and is selected using the FEED command (:SENSe:FEED EXTMIxer).</p> <p>For compatibility, the INPut:MIXer EXTernal INTernal legacy command is mapped as follows:</p> <ol style="list-style-type: none"> 1. When INPut:MIXer EXTernal is received, SENSe:FEED EMIXer is executed. 2. When INPut:MIXer INTernal is received, SENSe:FEED RF is executed. 3. When INPut:MIXer? is received, the response will be INT if any input other than the external mixer is selected and EXT if the external mixer is selected
Preset	INT
Backwards Compatibility Notes	<p>PSA supports the following SCPI Command :</p> <p>:INPut:MIXer:TYPE PRESelected UNPREselect</p> <p>:INPut:MIXer:TYPE?</p> <p>PXA does not support the :INPut:MIXer:TYPE command.</p>
Initial S/W Revision	A.08.01

Input/Output variables - Preset behavior

Virtually all the input/output settings are NOT a part of mode preset. They can be set to their default value

by one of the three ways:

- by using the Restore Input/Output Defaults key on the first page of the input/output menu,
- by using the System->Restore System Defaults->Input/Output Settings or,
- by using the System -> Restore System Defaults->All. Also, they survive a Preset and a Power cycle.

A very few of the Input/Output settings do respond to a Mode Preset; for example, if the Calibrator is on it turns off on a Preset, and if DC coupling is in effect it switches to AC on a Preset. These exceptions are made in the interest of reliability and usability, which overrides the need for absolute consistency. Exceptions are noted in the SCPI table for the excepted functions.

RF Input

Selects the front-panel RF input port to be the analyzer signal input. If RF is already selected, pressing this key accesses the RF input setup functions.

Key Path	Input/Output
Example	[:SENSe]:FEED RF
Couplings	The act of connecting the U7227A USB Preamplifier to one of the analyzer's USB ports will cause the Input to automatically switch to the RF Input. If the RF Calibrator is on, it is turned off. Subsequently disconnecting the USB Preamp from USB does not change the Input selection nor restore the previous selection.
Readback	The RF input port, RF coupling, and current input impedance settings appear on this key as: "XX, YY, ZZ" where XX is RF, RF2, RFIO1, RFIO2, depending on what input is selected (only appears on analyzers with multiple RF inputs) YY is AC or DC ZZ is 50Ω or 75Ω
Initial S/W Revision	Prior to A.02.00
Modified at S/W Revision	A.14.00

Input Z Correction

Sets the input impedance for unit conversions. This affects the results when the y-axis unit is voltage or current units (dBmV, dBμV, dBμA, V, A), but not when it is power units (dBm, W). The impedance you select is for computational purposes only, since the actual impedance is set by internal hardware to 50 ohms. Setting the computational input impedance to 75 ohms is useful when using a 75 ohm to 50 ohm adapter to measure a 75 ohm device on an analyzer with a 50 ohm input impedance.

There are a variety ways to make 50 to 75 ohm transitions, such as impedance transformers or minimum loss pads. The choice of the solution that is best for your measurement situation requires balancing the amount of loss that you can tolerate with the amount of measurement frequency range that you need. If you are using one of these pads/adaptors with the Input Z Corr function, you might also want to use the Ext Gain key. This function is used to set a correction value to compensate for the gain (loss) through your pad. This correction factor is applied to the displayed measurement values.

Key Path	Input/Output, RF Input
Remote Command	[:SENSe] :CORRection:IMPedance [:INPut] [:MAGNitude] 50 75 [:SENSe] :CORRection:IMPedance [:INPut] [:MAGNitude] ?
Example	CORR:IMP 75 sets the input impedance correction to 75 ohms. CORR:IMP?
Couplings	In the N9000A option C75, when RF Input 2 is selected, the Input Z Correction will automatically change to 75 ohms. You may then change it to whatever is desired. When the main RF Input is selected, the Input Z Correction will automatically change to 50 ohms. You may then change it to whatever is desired.
Preset	This is unaffected by a Preset but is set to 50 ohms on a "Restore Input/Output Defaults" or "Restore System Defaults->All" Some instruments/options may have 75 ohms available.
State Saved	Saved in instrument state
Readback	50 Ω or 75 Ω . Current setting reads back to the RF key.
Initial S/W Revision	Prior to A.02.00

RF Coupling

Specifies alternating current (AC) or direct current (DC) coupling at the analyzer RF input port. Selecting AC coupling switches in a blocking capacitor that blocks any DC voltage present at the analyzer input. This decreases the input frequency range of the analyzer, but prevents damage to the input circuitry of the analyzer if there is a DC voltage present at the RF input.

In AC coupling mode, you can view signals below the corner frequency of the DC block, but below a certain frequency the amplitude accuracy is not specified. The frequency below which specifications do not apply is:

X-Series Model	Lowest Freq for meeting specs when AC coupled	Lowest Freq for meeting specs when DC coupled
N9000A-503/507	100 kHz	n/a
N9000A-C75 Input 2	1 MHz	n/a
N9000A-513/526	10 MHz	9 kHz
N9010A	10 MHz	9 kHz
N9020A	10 MHz	20 Hz
N9030A	10 MHz	3 Hz

Some amplitude specifications apply only when coupling is set to DC. Refer to the appropriate amplitude specifications and characteristics for your analyzer.

When operating in DC coupled mode, ensure protection of the analyzer input circuitry by limiting the DC part of the input level to within 200 mV of 0 Vdc. In AC or DC coupling, limit the input RF power to +30 dBm (1 Watt).

Key Path	Input/Output, RF Input
Remote Command	:INPut:COUPling AC DC :INPut:COUPling?
Example	INP:COUP DC
Dependencies	This key does not appear in models that are always AC coupled. When the SCPI command to set DC coupling is sent to these models, it results in the error "Illegal parameter value; This model is always AC coupled" In these models, the SCPI query INP:COUP? always returns AC. This key does not appear in models that are always DC coupled. When the SCPI command to set AC coupling is sent to these models, it results in the error "Illegal parameter value; This instrument is always DC coupled" In these models, the SCPI query INP:COUP? always returns DC.
Preset	AC on models that support AC coupling On models that are always DC coupled, such as millimeter wave models (frequency ranges 30 GHz and above), the preset is DC.
State Saved	Saved in instrument state.
Initial S/W Revision	Prior to A.02.00
Modified at S/W Revision	A.03.00

External Mixer

This key allows you to choose an External Mixer through which to apply signal input to the analyzer. When chosen, the LO/IF port becomes the input to the analyzer.

External Mixing requires option EXM. The External Mixer key will not appear unless option EXM is installed. The presence of the LO/IF connector alone does not indicate that you have Option EXM licensed. To verify that option EXM is installed, press System, Show, System.

When External Mixer is selected, the Center Freq key controls the setting of the Center Freq in external mixing, which is separate from the settings of Center Freq for the RF Input or BBIQ. Each input retains its unique settings for Center Freq. A unique SCPI command is provided solely for the external mixing Center Freq (see the Center Freq key description), which only affects the External Mixer CF, although sending the generic Center Freq command while External Mixer is selected also controls the External Mixer CF.

See "[More Information](#)" on page 229

Key Path	Input/Output
Example	:FEED EMIX
Notes	Not all measurements support the use of the External Mixer input. When External Mixer is selected in a measurement that does not support it, the "No result; Meas invalid with Ext Mixing" error condition occurs.
Dependencies	Unless option EXM is present, the External Mixer key is blanked, and all SCPI commands associated with menus accessed by this key return an error

	Manual FFT mode is available with external mixing, but not with Signal ID.
Preset	All settings under this key are returned to their default state when Restore Input/Output Defaults is pressed.
State Saved	All settings under this key, and all Frequency settings, are remembered when you go out of External Mixer, so that when External Mixer is chosen again, all the external mixer functions will retain their previous settings, with the exception of Signal ID which is set to OFF (Signal ID is also set to Off unless External Mixer is the selected Input).
Readback Text	The readback text on this key shows the currently selected mixer, in square brackets.
Backwards Compatibility Notes	Unlike PSA, all external mixer settings including Center Frequency are retained when you go in and out of External Mixing. Also, Preset does not take you out of External Mixing (Restore Input/Output Defaults does).
Initial S/W Revision	A.08.01

More Information

X-series analyzers have a combined LO Out/IF In connection, whereas earlier analyzers used separate ports for the LO Out and the IF in. Internal diplexers in the analyzer and the mixer simplify the connection for the user – only a single SMA cable is required.

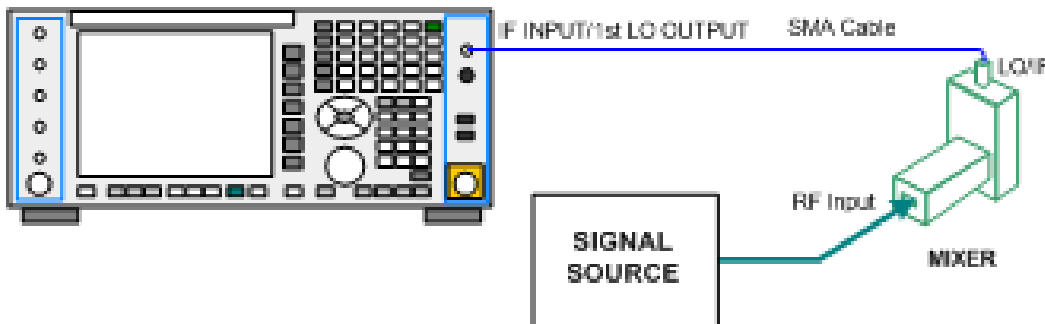

Legacy HP/Agilent and some third party mixers have separate LO In and IF out connections. This requires you to use an external diplexer to connect these mixers. A diplexer can easily be purchased for this purpose (for example, Diplexer Model # DPL.26 or # DPL.313B from OML Inc., Morgan Hill CA)

The connection diagram for such a legacy mixer is:

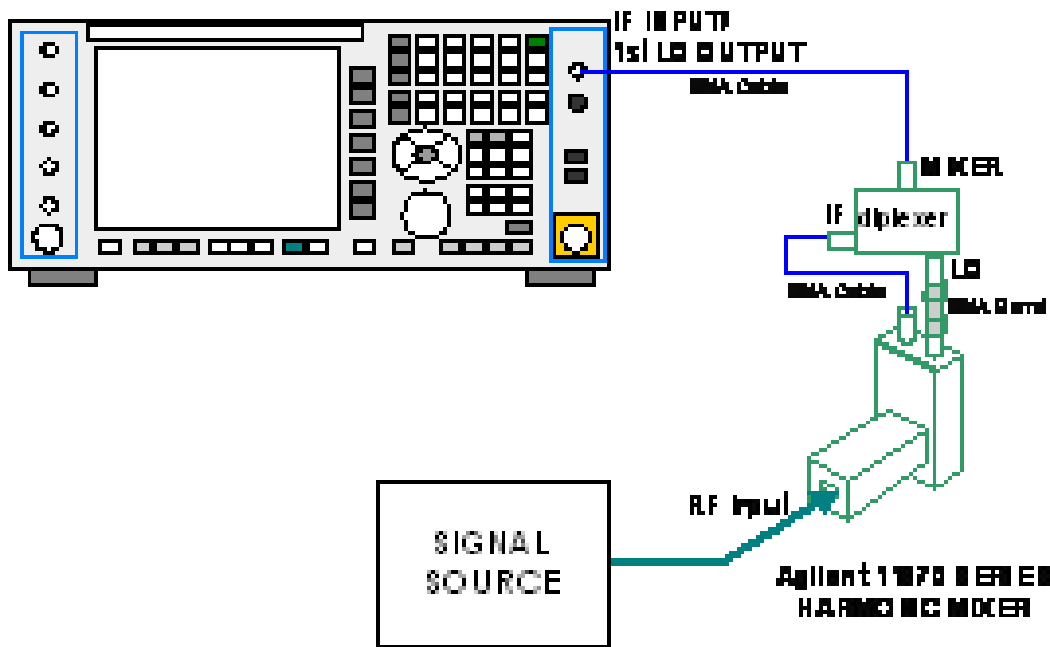

In addition, External Mixing in the X-Series supports the new Agilent M1970 series of Harmonic Mixers, which provide a USB connection for download of calibration data and additional control.

The connection diagram for one of the Agilent USB mixers is:

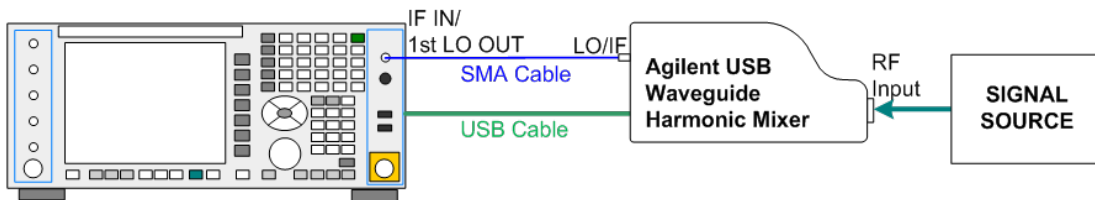

External Mixing is only supported in certain Modes and Measurements in the X-Series, as shown in the table below:

Mode	Measurements	Sig ID (Image Suppress only)
Spectrum Analyzer	Swept SA	Y*
	TOI	Y
	Harmonics	N
	Spurious Emissions	Y
	Channel Power	Y
	Occupied BW	Y
	ACP	Y
	Spectrum Emissions Mask	Y
	CCDF	N

	Burst Power	N
	List Sweep	N
Phase Noise	Monitor Spectrum	Y
	Log Plot	Y
	Spot Frequency	N
	Waveform	N
I/Q Analyzer	Complex Spectrum	N
	Waveform	N
Vector Signal Analyzer	Vector Analysis	N
	Analog Demod	N
	Digital Demod	N

* the Swept SA measurement also supports Image Shift

Ext Mix Setup

This menu lets you select the mixer type, and lets you configure your mixer (if necessary). While in this menu, and any of its submenus, the External Mixer Setup screen appears, showing you the current settings for the selected mixer. These settings may be dependent on which IF path is currently in use, whether a + or – harmonic is currently selected, etc.

To apply any amplitude correction factors needed to correct mixer flatness, you enter values into one of the Correction tables (under Input/Output, Corrections). The correction conversion loss values can be extracted from data supplied with the mixer or from manual measurements you make to determine the conversion loss. Note that the correction applied by the Correction tables is global to the analyzer; therefore you should make sure to turn off the External Mixer corrections when you are not using the External Mixer input.

NOTE

The Agilent USB Mixers automatically give their flatness data to the analyzer, and the correction is applied internally. No correction needs to be entered by the user, and the correction does not appear in the user-accessible Corrections tables. The user is free to enter additional corrections into the Correction tables under Input/Output, Corrections.

Key Path	Input/Output, External Mixer
State Saved	All settings in the Mixer Setup are part of the Input/Output system, and hence are saved whenever State is saved.
Readback Text	The readback line on this key shows the currently selected mixer, in square brackets.
Initial S/W Revision	A.08.01
Modified at S/W Revision	A.08.50

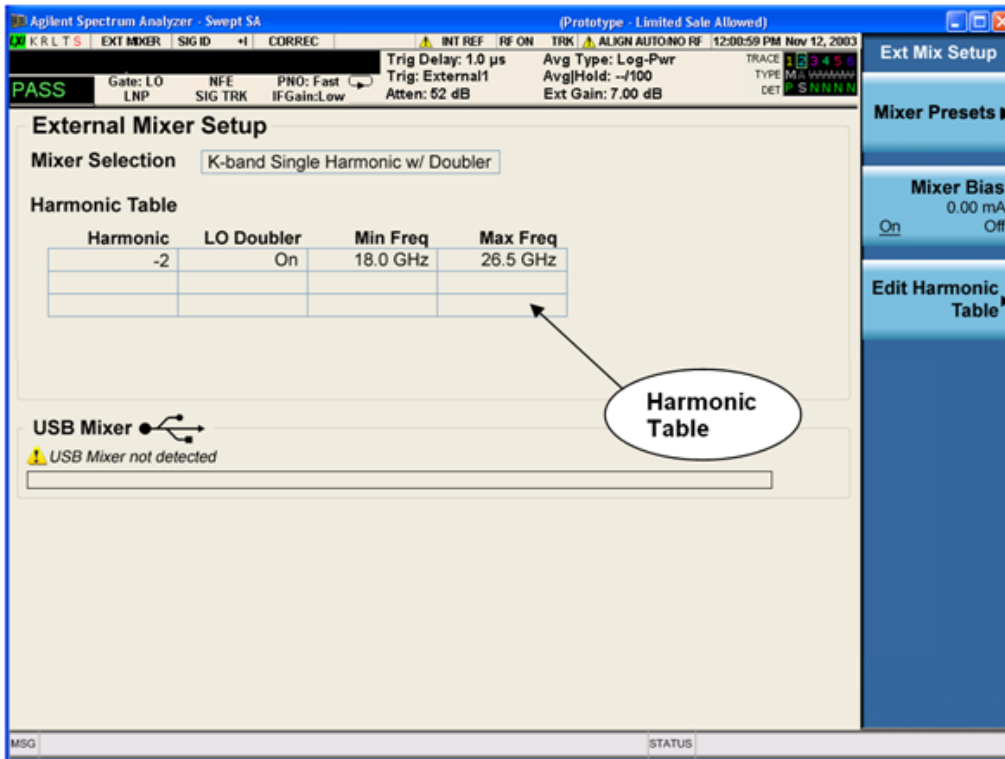

The External Mixer Setup screen looks like this

The current Mixer selection (the current or most recently connected USB Mixer, or the most recent Mixer Preset, or “Custom” if the user has modified the setup) reads out at the top of this screen.

The Harmonic Table currently being used reads out below the Mixer Selection. It shows each range being used for the current mixer. Note that a band may be made up of up to 3 ranges. Each range represents a choice of mixer harmonic and doubler state. When you select a Mixer Preset, it sets the analyzer Start and Stop frequency to the values shown in the Harmonic Table; Start Freq is set to the Min Freq for the bottom range, and Stop Freq is set to the Max Freq for the top range. In many cases you can exceed these nominal values; the absolute maximum and minimum frequency for each preset are shown in the tables that accompany the key descriptions for the Mixer Presets.

NOTE

If the current measurement has a limited Span available to it, and cannot achieve the Span shown in the table ($\text{Span} = \text{Stop Freq} - \text{Start Freq}$), the analyzer uses the maximum Span the measurement allows, and sets the Center Freq to the midpoint of the Start and Stop Freq values in the Harmonic Table.

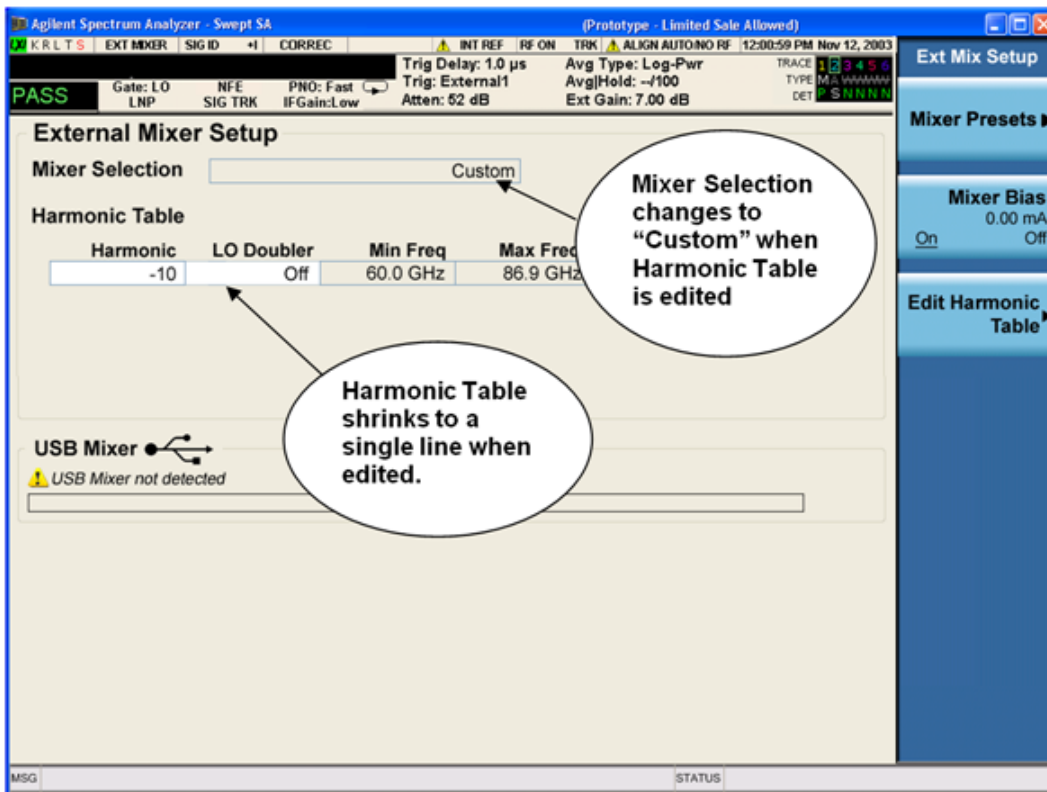

You may customize the Harmonic Table, but when you do this the analyzer goes into “single harmonic” mode. You may enter the harmonic number and whether to use the doubler or not, but now range switching is not supported, so you can only have one harmonic.

When you edit the Harmonic Table, the Mixer Selection changes to “Custom.” To change it back you must go back into the Mixer Presets menu and select a Preset.

When you edit the Harmonic Table, the nominal Min Freq and Max Freq that are available will usually be different than the Preset you were using; and the absolute frequency limits will change as well. This may result in a change to your Start and/or Stop Freq, if the current values fall outside the new range, requiring you to retune your Center Freq to get your signal back in the center.

The analyzer supports the Agilent M1970 Series Harmonic Mixers with USB connection. While in External Mixing, if one of these mixers is plugged in to a USB port, it is automatically detected and displayed in the “USB Mixer” area of the setup screen, including its model number and serial number.

The analyzer assumes that if you plug a mixer into the USB, that is the mixer you want to use. Therefore:

1. If a USB mixer is connected to the USB port, the Mixer Presets menu is grayed out, as none of the presets make sense with a USB Mixer connected. Note that once the analyzer has acquired the USB Mixer, the mixer selection will remain if it is subsequently unplugged from the USB, allowing you to plug it back in with no change to your settings. However, once you unplug it, the Mixer Presets key will stop being grayed out, allowing you to preset to a different mixer.
2. When Restore Input/Output Defaults is performed, if an Agilent USB Mixer is plugged into the analyzer’s USB port, the Mixer Selection remains unchanged.

3. When recalling an instrument state, if an Agilent USB Mixer is plugged into the analyzer's USB port, and the Mixer Selection in the recalled state is for a USB Mixer that does not match the mixer currently plugged in, you will have to unplug your mixer and then plug it back in to get the analyzer to recognize your mixer.

As long as the selection in Ext Mixer Setup shows one of the USB mixers, both the Mixer Bias and Edit Harmonic Table keys will be grayed out.

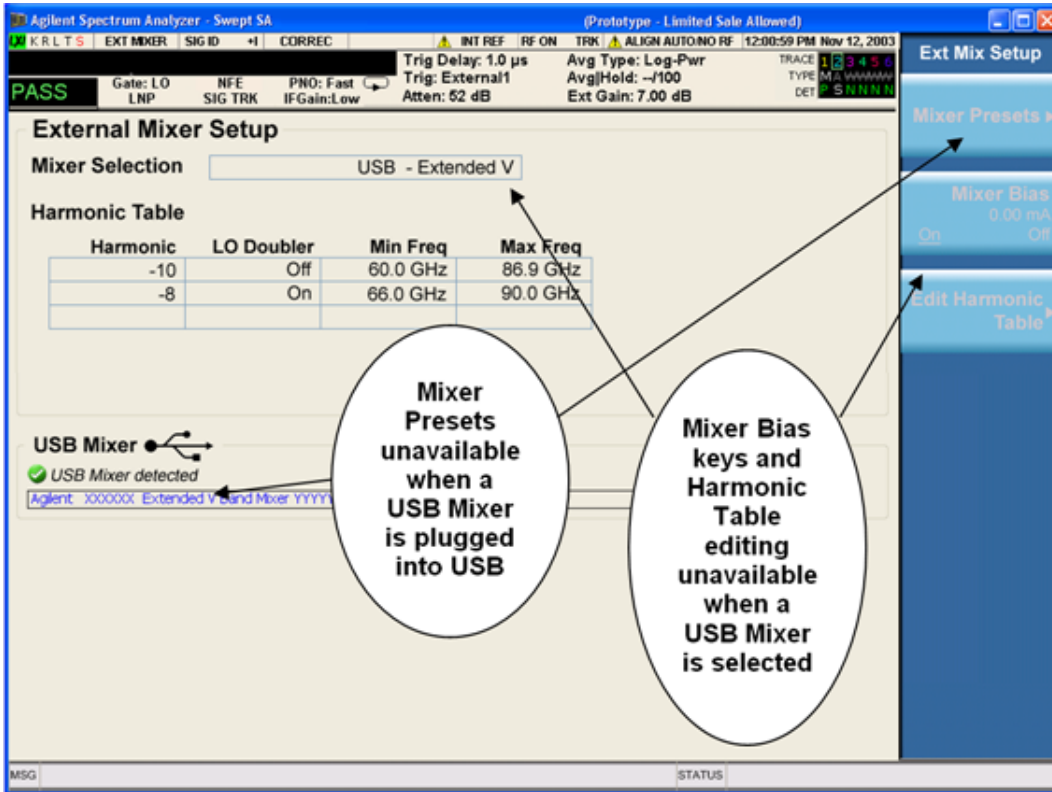

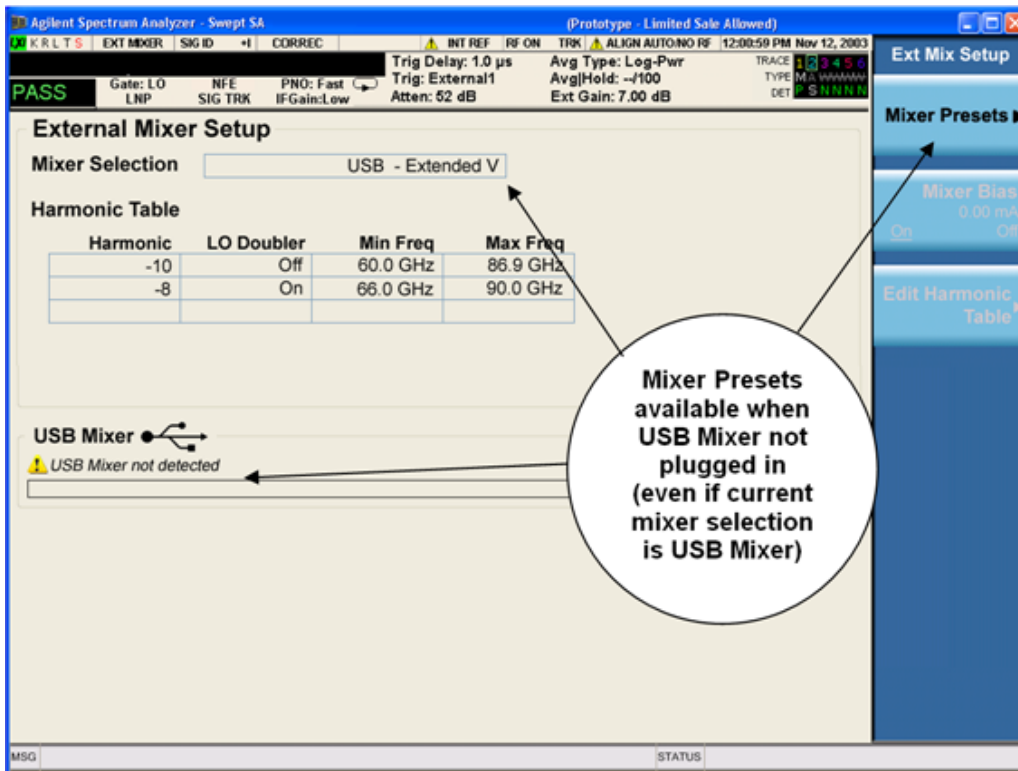

Only one USB Mixer is supported at a time. To switch to a different USB Mixer, disconnect the one that is no longer being used prior to connecting a new one.

The Mixer Selection displayed and softkey readback for the Agilent M1970 series mixers is:

Mixer Model	Mixer Selection display on Setup Screen	Readback on softkeys
Agilent M1970E: Option 001: 60 to 90 GHz Waveguide Harmonic Mixer	USB - M1970E E-Band	USB Mixer E-Band
Agilent M1970V Option 001: 50 to 75 GHz Waveguide Harmonic Mixer	USB - M1970V-001 V-Band	USB Mixer V-Band
Agilent M1970V Option 002: 50 to 80 GHz Waveguide Harmonic Mixer	USB - M1970V-002 Extended V-Band	USB Mixer Extended V
Agilent M1970W: 75 to 110 GHz Waveguide Harmonic Mixer	USB - M1970W W-Band	USB Mixer W-Band

The Agilent USB mixer essentially acts as a “remote front end” and is fully calibrated over the specified frequency range, without requiring any user interaction. This is particularly useful at high mm-wave frequencies, where cable loss is typically quite large, and it is desirable to bring the front end right up to the device under test, rather than bringing the mm-wave signal to the analyzer using a lossy and uncalibrated cable or waveguide connection.

Connecting the mixer to the USB port on the analyzer switches you to External Mixing, aborts the current measurement, and initiates an alignment of the mixer. A popup message, “USB Mixer connected” appears on the display. When a USB mixer and the LO/IF cable are connected the alignment is performed. When the alignment begins, an “Aligning” popup replaces the previous message on the display. When the alignment completes, the current measurement restarts.

Mixer Presets

This menu lets you preset the mixer setup for the particular type of mixer that you are using.

These presets are divided into four groups:

- one for Agilent legacy mixers,
- three for general purpose mixers:
 - o presets that use a single harmonic and no doubling
 - o presets that use a single harmonic but double the LO
 - o presets that use multiple harmonics

Note that the IF/LO port provides a 3.8–14 GHz LO in two bands: 3.8–8.7 (LO fundamental), and 8.6–14 GHz (doubled LO).

In most cases, once you have executed the preset, you will not need to adjust any further settings.

Key Path	Input/Output, External Mixer, Ext Mix Setup
Remote Command	[:SENSe]:MIXer:BAND A Q U V W NA ND NE NF NG NJ NK NQ NU NV NW NY NEXT DD DF DG DJ DK DQ DV DW DY DEXT MA ME MU MCOAX USB [:SENSe]:MIXer:BAND?
Example	:MIX:BAND A :MIX:BAND?
Notes	A Q U V W select Agilent 11970 mixer presets NA ND NE NF NG NJ NK NQ NU NV NW NY NEXT select single harmonic, non-doubled LO presets DD DF DG DJ DK DQ DV DW DY DEXT select single harmonic, doubled LO presets MA ME MU MCOAX select multiple harmonic presets All of these presets are detailed in their respective key descriptions The query form of this command returns the most recent preset, UNLESS the harmonic table has been edited after the preset was executed. If the harmonic table has been edited it returns CUSTOM The command USB will refresh the USB mixer connection and automatically detect the mixer band. The query form of this command returns the following if an Agilent USB Mixer is plugged into the analyzer’s USB port: USB E Agilent E-Band USB Mixer USB V Agilent V-Band USB Mixer USB VEXT Agilent Extended V-Band USB Mixer USB W Agilent W-Band USB Mixer Note that the parameters CUSTOM, USBV, USBVEXT, and USBW are query responses only, and cannot be sent TO the analyzer.

	<p>The following cross-reference matches the mixer band designators used by Agilent to the EIA waveguide designations:</p> <p>EIAAgilentFreq Range</p> <p>WR-28 A26.5 – 40 GHz</p> <p>WR-22 Q33 – 50 GHz</p> <p>WR-19 U40 – 60 GHz</p> <p>WR-15 V50 – 75 GHz</p> <p>WR-12 E60 – 90 GHz</p> <p>WR-10 W75 – 110 GHz</p> <p>WR-8 F90 – 140 GHz</p> <p>WR-6 D110 – 170 GHz</p> <p>WR-5 G140 – 220 GHz</p> <p>WR-3 J220 – 325 GHz</p>
Preset	<p>When Restore Input/Output Defaults is performed, an “A” mixer preset is also issued (11970A band), unless an Agilent USB Mixer is plugged into the analyzer’s USB port, in which case the Mixer Selection remains unchanged.</p> <p>When using Agilent USB Mixers, if a Restore All Defaults (SCPI command SYSTem:DEFault) has been performed, either remove and reinsert the USB cable or press the Refresh USB Mixer Connection softkey.</p>
Backwards Compatibility Notes	<p>The [:SENSe]:MIXer:BAND command was used in PSA and ESA to select the mixer band. In the X-Series, only the legacy parameters A, Q, U, V, and W are honored, and they preset the analyzer to match the corresponding Agilent 11970 legacy mixer. Parameters D, E, F, G, J, K, Y, which were accepted in ESA and PSA, return an error if sent. If you are using a mixer in one of these bands, you should study the tables of presets and choose the appropriate preset to match your application. Also the USER parameter is no longer accepted, as the control model for mixer customization is very different in the X-Series.</p>
Initial S/W Revision	A.08.01
Modified at S/W Revision	A.14.00

Agilent 11970

This menu allows you to preset for one of the models in the HP/Agilent 11970 series.

Because the X-Series has an LO range of 3.8 – 14 GHz, and older analyzers had an LO range of 3.0 – 6.8 GHz, the harmonic numbers used in the X-Series may differ from those used on older analyzers for the same mixers. Additionally, some of the 11970 mixers cannot be operated over their full range with the X-Series without switching harmonics. Consequently, you will find that some of the bands (A-Band, for example) are broken into two ranges for use with the X-Series.

See ["More Information" on page 238](#)

Key Path	Input/Output, External Mixer, Ext Mix Setup, Mixer Presets
Example	MIX:BAND A
Initial S/W Revision	A.08.01

More Information

Below are the 11970A presets. The 11970U and the 11970W use a single harmonic. The other three switch harmonics mid-band. Both harmonic ranges are shown in the table. None of these mixers use LO doubling.

The 11970 K-band mixer and the 11974 preselected mixer series are not supported.

Preset	Readout in setup screen	Readback on softkeys	Range	Harm #	RF start	RF stop	RF center
A-band	Agilent 11970A	Agilent 11970A	1	-6	26.5	30.45	28.475
			2	-8	30.35	40	35.175
Q-band	Agilent 11970Q	Agilent 11970Q	1	-8	33	40.8	36.9
			2	-10	39.8	50	44.9
U-band	Agilent 11970U	Agilent 11970U	..	-10	40	60	50
V-band	Agilent 11970V	Agilent 11970V	1	-12	50	66	58
			2	-14	53	75	64
W-band	Agilent 11970W	Agilent 11970W	..	-18	75	110	92.5

Single Harmonic

These presets choose a setup that uses a single harmonic and no doubling for the LO.

Key Path	Input/Output, External Mixer, Ext Mix Setup, Mixer Presets
Example	MIX:BAND NA
Initial S/W Revision	A.08.01

These are the presets for single harmonic operation with no doubler:

Mixer	Readout in setup screen	Readback on softkeys	Harm #	RF start	RF stop	RF center
K-band	K-band Single Harmonic, no doubler	Sngl harm LOx1 K-band	-4	18	26.5	22.25
A-band	A-band Single Harmonic, no doubler	Sngl harm LOx1 A-band	-6	26.5	40	33.25
D-band	D-band Single Harmonic, no doubler	Sngl harm LOx1 D-band	-20	110	170	140
E-band	E-band Single Harmonic, no doubler	Sngl harm LOx1 E-band	-12	60	90	75
F-band	F-band Single Harmonic, no doubler	Sngl harm LOx1	-18	90	140	115

Mixer	Readout in setup screen	Readback on softkeys	Harm #	RF start	RF stop	RF center
		F-band				
Q-band	Q-band Single Harmonic, no doubler	Sngl harm LOx1 Q-band	-6	33	50	41.5
U-band	U-band Single Harmonic, no doubler	Sngl harm LOx1 U-band	-8	40	60	50
V-band	V-band Single Harmonic, no doubler	Sngl harm LOx1 V-band	-10	50	75	62.5
W-band	W-band Single Harmonic, no doubler	Sngl harm LOx1 W-band	-14	75	110	92.5
G-band	G-band Single Harmonic, no doubler	Sngl harm LOx1 G-band	-26	140	220	180
Y-band	Y-band Single Harmonic, no doubler	Sngl harm LOx1 Y-band	-30	170	260	215
J-band	J-band Single Harmonic, no doubler	Sngl harm LOx1 J-band	-38	220	325	272.5
Extended	Extended Single Harmonic, no doubler	Sngl harm LOx1 Extended	-40	155	345	250

Single Harmonic w/doubler

These presets choose a setup that uses a single harmonic and doubling for the LO.

Key Path	Input/Output, External Mixer, Ext Mix Setup, Mixer Presets
Example	MIX:BAND DW
Initial S/W Revision	A.08.01

These are the presets for single harmonic operation with LO doubling:

Mixer	Readout in setup screen	Readback on softkeys	Harm #	RF start	RF stop	RF center
D-band	D-band Single Harmonic w/doubler	Sngl harm LOx2 K-band	-14	110	170	140
F-band	F-band Single Harmonic w/doubler	Sngl harm LOx2 A-band	-10	90	140	115
G-band	G-band Single Harmonic w/doubler	Sngl harm LOx2 A-band	-16	140	220	180
J-band	J-band Single	Sngl harm LOx2	-24	220	325	272.5

Mixer	Readout in setup screen	Readback on softkeys	Harm #	RF start	RF stop	RF center
	Harmonic w/doubler	A-band				
K-band	K-band Single Harmonic w/doubler	Sngl harm LOx2 A-band	-2	18	26.5	22.25
Q-band	Q-band Single Harmonic w/doubler	Sngl harm LOx2 A-band	-4	33	50	41.5
V-band	V-band Single Harmonic w/doubler	Sngl harm LOx2 A-band	-6	50	75	62.5
W-band	W-band Single Harmonic w/doubler	Sngl harm LOx2 A-band	-8	75	110	92.5
Y-band	Y-band Single Harmonic w/doubler	Sngl harm LOx2 A-band	-20	170	260	215
Extended	Extended Single Harmonic w/doubler	Sngl harm LOx2 A-band	-28	245	390	317.5

Multiple Harmonics

These presets choose a setup that uses multiple harmonics and may or may not use doubling for the LO.

Key Path	Input/Output, External Mixer, Ext Mix Setup, Mixer Presets
Example	MIX:BAND MA
Initial S/W Revision	A.08.01

These are the presets for multiple harmonic operation:

Mixer	Readout in setup screen	Readback on softkeys	Range	Harm #	Dblr?	RF start	RF stop	RF Center
A-band	A-band Multiple Harmonic	Multi harm A-band	1	-4	N	26.5	34.1	30.3
			2	-4	Y	33.1	40	36.55
E-band	E-band Multiple Harmonic	Multi harm E-band	1	-6	Y	60	83	71.5
			2	-8	Y	65	90	77.5
U-band	U-band Multiple Harmonic	Multi harm U-band	1	-6	N	40	51.5	45.75
			2	-6	Y	49.5	60	54.75
Coaxial	Coaxial Multiple Harmonic	Multi harm Coaxial	1	-4	N	26.5	34	30.25
			2	-4	Y	32.5	55	43.75
			3	-6	Y	50	70	60

Mixer Bias

Adjusts an internal bias source for use with external mixers. The bias signal is present on the center conductor of the IF input connector on the front panel. The shunt current range is from -10 mA to 10 mA and it can be set whether Mixer Bias state is On or Off, but it will only be applied if it is On.

The bias remains as set if the user switches to another input (e.g., the RF Input).

Key Path	Input/Output, External Mixer, Ext Mix Setup
Remote Command	[:SENSe]:MIXer:BIAS <real> [:SENSe]:MIXer:BIAS? [:SENSe]:MIXer:BIAS:STATe OFF ON 0 1 [:SENSe]:MIXer:BIAS:STATe?
Example	:MIX:BIAS 0 :MIX:BIAS? MIX:BIAS:STAT 0 MIX:BIAS:STAT?
Preset	This is unaffected by Preset but is set to OFF and 0 on a "Restore Input/Output Defaults"
State Saved	Saved in instrument state
Min	-10 mA
Max	10 mA
Initial S/W Revision	A.08.01

Edit Harmonic Table

This menu lets you directly configure the Harmonic number and LO Doubler state of your mixer by editing the Harmonic Table. The Harmonic Table can be configured:

- as a single row (meaning only one harmonic number is used and the LO Doubler is either on or off),
- as two rows where the harmonic number switches between the first row and the second, or
- as two rows where the LO Doubler state switches between the first row and the second

When you press the Edit Harmonic Table key, a dialog appears on the display informing you that when you edit the Harmonic Table you will go into Custom mixer mode, and that to undo your changes you must go to the Mixer Presets menu and choose the preset appropriate for your mixer. You may cancel out of this dialog and not enter the Edit Harmonic Table menu. If you choose to enter the menu, the Mixer Selection changes to "Custom".

In Custom mode, your maximum start and stop frequencies are strictly set by the LO range and the harmonic number you have chosen. The undoubled LO range is approximately $3.8 - 8.7$ GHz, and (for LO's that support doubling) the doubled range is approximately $8.0 - 14.0$ GHz. That range times the harmonic you have selected will determine your tuning range. If your frequency is currently outside that range when you edit the Harmonic Table, your frequency will be changed to fall at the edge of the range. To change it back you must go into the Mixer Presets menu and select a Preset.

Whenever you are in the Edit Harmonic Table menu, the editable fields in the table have a white background, indicating that they can be edited. These fields vary depending on the Table Type.

Table Type	Fields you can edit
Single Row	Harmonic and LO Doubler cells
Harmonic Switching	Harmonic and LO Doubler cells (only the first row)
Doubler Switching	Harmonics cell (only the first row)

Note that you cannot add or delete rows from the table; you can only modify the rows that are already there.

Key Path	Input/Output, External Mixer, Ext Mix Setup
Initial S/W Revision	A.08.01
Modified at S/W Revision	A.09.491

Table Type

This parameter determines which type of configuration you want the Custom Mixer to be. You can choose Single Row, Harmonic Switching, or Doubler Switching. See detail under each of these keys.

Key Path	Input/Output, External Mixer, Ext Mix Setup, Edit Harmonic Table
Remote Command	<code>[:SENSe] :MIXer :TTYPe SINGle HARMonic DOUBler</code> <code>[:SENSe] :MIXer :TTYPE ?</code>
Example	<code>:MIX:TTYP SING</code>
Couplings	When you change the Table Type, the Mixer Selection changes to "Custom"
Preset	Depends on the current Mixer Preset. This is unaffected by Mode Preset, but on a "Restore Input/Output Defaults" the Mixer is preset to 11970A, for which the Table Type is Harmonic Switching
State Saved	Saved in instrument state
Initial S/W Revision	A.09.491

Single Row

In the Single Row type, the External Mixer always stays in the same Harmonic Number and the LO Doubler is either on or off and does not change state during a sweep. You may change the Harmonic Number and you may change the state of the Doubler.

Key Path	Input/Output, External Mixer, Ext Mix Setup, Edit Harmonic Table, Table Type
Example	<code>:MIX:TTYP SING</code>
State Saved	Saved in instrument state
Initial S/W Revision	A.09.491

Harmonic Switching

In the Harmonic Switching type, the External Mixer switches the Harmonic Number in the middle of the sweep. The Lo Doubler may be on or off but it is the same for both Harmonic Numbers. You can set the initial Harmonic Number, and when it switches it decrements by two when the harmonic is negative and increments by two when the harmonic is positive. For example, if you set the initial number to -6, when it switches it will go to -8. If you set the harmonic number to 8 when it switches it will go to 10.

Key Path	Input/Output, External Mixer, Ext Mix Setup, Edit Harmonic Table, Table Type
Example	:MIX:TTYP HARM
State Saved	Saved in instrument state
Initial S/W Revision	A.09.491

Doubler Switching

In the Doubler Switching type, the External Mixer switches the doubler from Off to On in the middle of the sweep. You can set the Harmonic Number but it stays the same for the Doubler Off state as for the Doubler On state. The LO Doubler key is grayed out in this table type.

Key Path	Input/Output, External Mixer, Ext Mix Setup, Edit Harmonic Table, Table Type
Example	:MIX:TTYP DOUB
State Saved	Saved in instrument state
Initial S/W Revision	A.09.491

Harmonic

This lets you enter the Harmonic value with its associated sign (mixing mode).

The harmonic number is a signed integer, where the sign has the meaning of choosing between positive and negative mixing products. Desired mixing products occur at an IF frequency which equals the difference between the RF frequency (f_{RF}) and the LO frequency (Nf_{LO}). When this difference is positive, we can say $f_{IF} = f_{RF} - Nf_{LO}$. When this difference is negative, we can say $f_{IF} = Nf_{LO} - f_{RF}$. Thus, a negative harmonic means the analyzer will be tuned such that the harmonic of the LO is higher than the indicated frequency by the frequency of the first IF. A positive harmonic means the analyzer will be tuned such that the harmonic of the LO is lower than the indicated frequency by the frequency of the first IF.

Key Path	Input/Output, External Mixer, Ext Mix Setup, Edit Harmonic Table
Remote Command	[:SENSe] :MIXer:HARMonic <integer> [:SENSe] :MIXer:HARMonic?
Example	:MIX:HARM -28 :MIX:HARM?
Notes	The query returns the harmonic value of the first row of the harmonic table.

Couplings	When you set a value for the Harmonic via SCPI, the Mixer Selection changes to "Custom"
Preset	This is unaffected by Mode Preset, but on a "Restore Input/Output Defaults" editing is turned off, the Harmonic Table returns to normal, and the Mixer is preset to 11970A, which has -6 in the first row of its Harmonic Table
State Saved	Saved in instrument state
Min	-400
Max	400
Initial S/W Revision	A.08.01
Modified at S/W Revision	A.09.491

LO Doubler

This lets you enter the LO Doubler setting. The LO Doubler setting controls the choice of the LO doubler state for LO's that support doubled operation.

In LO's that support doubling, the fundamental band is approximately 3.8 – 8.7 GHz, and the doubled band is approximately 8.0 – 14 GHz. The higher LO frequency can result in a lower mixer harmonic and reduced mixer conversion loss.

Key Path	Input/Output, External Mixer, Ext Mix Setup, Edit Harmonic Table
Remote Command	<code>[:SENSe] :MIXer :LODoubler ON OFF 0 1</code> <code>[:SENSe] :MIXer :LODoubler?</code>
Example	<code>:MIX:LOD 0</code> <code>:MIX:LOD?</code>
Notes	The query returns the doubler value of the first row of the harmonic table.
Dependencies	This key is grayed out and set to Off when Table Type is set to Doubler Switching.
Couplings	When you set a value for the doubler setting via SCPI, the Mixer Selection changes to "Custom"
Preset	This is unaffected by Mode Preset, but on a "Restore Input/Output Defaults" editing is turned off, the Harmonic Table returns to normal, and the Mixer is preset to 11970A, which has the doubler Off in the first row of its Harmonic Table
State Saved	Saved in instrument state
Initial S/W Revision	A.08.01
Modified at S/W Revision	A.09.491

Cable IF Loss

The loss at the IF in the IF/LO cable can be compensated for with this function, by entering the loss in dB for your cable.

The cable loss will depend on the IF frequency. The IF frequency varies depending on which IF path your measurement is using. For best accuracy, characterize your cable's loss for the IF frequency or frequencies you will be using.

IF Frequencies:

10 MHz path: 322.5 MHz

25 MHz path: 322.5 MHz

40 MHz path: 250 MHz

140 MHz path: 300 MHz

Key Path	Input/Output, External Mixer
Key Path	Input/Output, External Mixer, Calibrate Mixer
Remote Command	[:SENSe] :MIXer :CIFLoss <rel_ampl> [:SENSe] :MIXer :CIFLoss?
Example	:MIX:CIFL 0.23 DB :MIX:CIFL?
Preset	0.26 dB
State Saved	Saved in instrument state
Min	-100
Max	100
Initial S/W Revision	A.08.01

I/Q

This feature is not available unless the "Baseband I/Q (Option BBA)" on page 245 is installed.

Selects the front-panel I/Q input ports to be the analyzer signal input. If I/Q is already selected, pressing this key accesses the I/Q setup menu.

Key Path	Input/Output
Mode	BASIC, CDMA2K, EDGE GSM, TDSCDMA, VSA89601, WIMAX OFDMA, LTE, LTE TDD, LTE FDD, LTE ATDD, DCATV, DTMB (CTTB), DVB-T/H with T2, CMMB, ISDBT, WCDMA, VXA, CDMA1XEV
Example	FEED AIQ
Notes	Not all measurements support the use of the I/Q signal input. When I/Q is selected in a measurement that does not support it, the "No Result; Meas invalid with I/Q inputs" error condition message appears. This is error 135
Initial S/W Revision	Prior to A.02.00

Baseband I/Q (Option BBA)

The Baseband I/Q functionality is a hardware option. It is option BBA. If the option is not installed, none of the I/Q functionality is enabled.

The Baseband I/Q has four input ports and one output port. The input ports are I, I-bar, Q, and Q-bar. The I and I-bar together compose the I channel and the Q and Q-bar together compose the Q channel. Each channel has two modes of operation, Single-Ended (also called "unbalanced") and Differential Input (also called "balanced"). When in Single-Ended operation, only the main port (I or Q) is used and the complementary port (I-bar or Q-bar) is ignored. When in Differential Input mode, both main and complementary ports are used.

The input settings (range, attenuation, skew, impedance, external gain) apply to the channels, not the individual ports.

The system supports a variety of 1 M Ω input passive probes as well as the Agilent 113x Series active differential probes using the Infinimax probe interface.

The Agilent 113x Series active probes can be used for both single ended and differential measurements. In either case a single connection is made for each channel (on either the I or Q input). The input is automatically configured to 50 Ω single ended and the probe power is supplied through the Infinimax interface. The probe can be configured for a variety of input coupling and low frequency rejection modes. In addition, a wide range of offset voltages and probe attenuation accessories are supported at the probe interface. The active probe has the advantage that it does not significantly load the circuit under test, even with unity gain probing.

With passive 1 M Ω probes, the probe will introduce a capacitive load on the circuit, unless higher attenuation is used at the probe interface. Higher attenuation reduces the signal level and degrades the signal-to-noise-ratio of the measurement. Passive probes are available with a variety of attenuation values for a moderate cost. Most Agilent passive probes can be automatically identified by the system, setting the input impedance setting required as well as the nominal attenuation. For single ended measurements a single probe is used for each channel. Other passive probes can be used, with the attenuation and impedance settings configured manually.

For full differential measurements, the system supports probes on each of the four inputs. The attenuation of the probes should be the same for good common mode rejection and channel match.

Both active and passive probes in single ended and differential configurations can be calibrated. This calibration uses the Cal Out BNC connection and a probe connection accessory. The calibration achieves excellent absolute gain flatness in a probed measurement. It matches both the gain and frequency response of the I and Q channels as well as any delay skew, resulting in high accuracy in derived measurements such as Error Vector Magnitude (EVM).

When a probe is connected a status message will be displayed. The message will indicate if calibration data is available or not. Calibration data is saved for each type of probe (including "none") for each port and will be reapplied whenever that type of probe is re-connected to the same port. For probes with EEPROM identification, the calibration data will be stored based on the unique probe identifier and will reapply data for that particular probe if it is available. The data will not follow a probe from one port to another. For probes without EEPROM identification, the instrument cannot distinguish between different probes of the same type and it will use the data from the last calibration for that probe type on that port.

When in differential mode, both the main and complementary probes are expected to be of the same type.

In some situations, the I and Q channels should be configured identically. In other situations it is convenient to control them independently. Some menus have a "Q Same as I" setting that will cause the Q channel configuration to mirror the I channel configuration, avoiding the overhead of double data entry when the channels should be the same.

The output port is for calibrating the I/Q input ports, although it can also be manually controlled.

There are two types of calibrations available: cable calibration and probe calibration. The cable calibration will guide the user through connecting each input port in turn. All ports must be calibrated together. The probe calibration is done for a specific channel (I or Q). If in Single-Ended mode, only the main port is calibrated. When in Differential Input mode, the user is guided through calibrating both main and complementary ports.

The front panel I/Q port LEDs indicate the current state of that port. On (green) indicates it is active, and off (dark) indicates it is not in use. For example, the Cal Out port LED is on if and only if there is signal coming out of that port.

The input is a context and some parameters have separate values for each context. The SCPI for these parameters has an optional "[:RF|IQ]" node. If the specific context is omitted, the command acts on the current input context's value. Here are the parameters that are input context sensitive:

- Center Frequency
- Trigger Source

It is important to distinguish between the I and Q input ports and the displayed I and Q data values. The I and Q input ports feed into a digital receiver that does digital tuning and filtering. The I and Q data seen by the user (either on the display or through SCPI) corresponds to the real ("I") and the imaginary ("Q") output from the digital receiver. When the input path is I+jQ or I Only and the center frequency is 0 Hz the I input ends up in as the real output from the receiver and appears as "I" data. Likewise, when the input path is I+jQ and the center frequency is 0 Hz, the Q input ends up as the imaginary output from the receiver and appears as "Q" data. However, when the input path is Q Only, the Q input is sent to the receiver as Q+j0, so the receiver output has the Q input coming out on the real output, and so in Q Only, the signal from the Q input port appears as the "I" data. Another situation where the I and Q data do not necessarily correspond directly to the I and Q inputs is when the center frequency is non-zero. The digital processing involved in the tuning is a complex operation. This will result in I Only data appearing as both "I" and "Q" data, the same as that signal would appear if seen through the RF input port.

Baseband I/Q Remote Language Compatibility

For the Agilent E4406A VSA Series Transmitter Tester, Option B7C provided baseband I/Q inputs. Code compatibility has been provided to allow many of the commands for option B7C to function properly with the X-Series. The X-Series has hardware differences and additional capabilities (e.g., E4406A does not have independent settings of I & Q nor does it provide for probe calibrations) which make 100% compatibility impossible.

1. The following commands are supported:

```
:CALibration:IQ:FLATness
```

```
:INPut:IMPedance:IQ U50|B50|U1M|B1M
```

```
:INPut:IMPedance:REFerence <integer>
```

2. The [:SENSe]:FEED RF|IQ|IONLy|QONLy|AREFerence|IFALign command supports all parameters except IFALign. The FEED? query will return only RF|AIQ|AREF.

3. The following commands are not supported:

```
:CALibration:GIQ
```

```
:CALibration:IQ:CMR
```

:INPut:IQ:ALIGn OFF|ON|0|1

The Rohde & Schwarz FSQ-B71 also provides baseband I/Q inputs. A certain amount of code compatibility is provided in the X-Series, however hardware differences make this a somewhat limited set.

Supported:

The "<1|2>" is supported as "[1]".

INPut<1|2>:IQ:BALanced[:STATe] ON | OFF

INPut<1|2>:IQ:TYPE I | Q | IQ

INPut<1|2>:IQ:IMPedance LOW | HIGH

Not Supported:

INPut<1|2>:SELEct AIQ | RF

TRACe<1|2>:IQ:DATA:FORMat COMPatible | IQBLock | IQPair>

TRACe<1|2>:IQ:DATA:MEMory? <offset samples>, <# of samples>

TRACe<1|2>:IQ:DATA?

TRACe<1|2>:IQ:SET <filter type>, <rbw>, <sample rate>, <trigger source>, <trigger slope>, <pretrigger samples>, <# of samples>

TRACe<1|2>:IQ:SRATe 10.0kHz to 81.6MHz

TRACe<1|2>:IQ[:STATe] ON|OFF

The Rohde & Schwarz FMU has the following SCPI, which is not supported (these commands start/abort the probe calibration procedure, which is manually interactive from the front panel):

CALibration:ABORt

CALibration:PROBe[:STARt]

I/Q Path

Selects which I/Q input channels are active. The LED next to each I/Q input port will be on when that port is active.

The analysis bandwidth for each channel is the same as that of the instrument. For example, the base N9020A has a bandwidth of 10 MHz. With I/Q input the I and Q channels would each have an analysis bandwidth of 10 MHz, giving 20 MHz of bandwidth when the I/Q Path is I+jQ. With option B25, the available bandwidth becomes 25 MHz, giving 25 MHz each to I and Q and 50 MHz to I+jQ.

I/Q voltage to power conversion processing is dependent on the I/Q Path selected.

- With I+jQ input we know that the input signal may not be symmetrical about 0 Hz, because it has a complex component. Therefore, above 0 Hz only the positive frequency information is displayed, and below 0 Hz only the negative frequency information is displayed.
- With all other Input Path selections, the input signal has no complex component and therefore is always symmetrical about 0 Hz. In this case, by convention, the power conversion shows the combined voltage for both the positive and negative frequencies. The information displayed below 0 Hz is the mirror of the

information displayed above 0 Hz. This results in a power reading 6.02 dB higher (for both) than would be seen with only the positive frequency voltage. Note also that, in this case the real signal may have complex modulation embedded in it, but that must be recovered by further signal processing.

Key Path	Input/Output, I/Q
Remote Command	[:SENSE] :FEED:IQ:TYPE IQ IONLY QONLY [:SENSE] :FEED:IQ:TYPE?
Example	Set the input to be both the I and Q channels, combined as $I + j * Q$. FEED:IQ:TYPE IQ
Preset	IQ
State Saved	Yes This is unaffected by a Preset but is set to the default value on a "Restore Input/Output Defaults" or "Restore System Defaults->All"
Range	I+jQ I Only Q Only
Readback Text	I+jQ I Only Q Only
Initial S/W Revision	Prior to A.02.00

Remote Command	:INPut [1] :IQ:TYPE IQ I Q :INPut [1] :IQ:TYPE?
Notes	For R&S FSQ-B71 compatibility
Preset	IQ
Initial S/W Revision	Prior to A.02.00

I+jQ

Sets the signal input to be both the I and Q channels. The I and Q channel data will be combined as $I + j * Q$.

Key Path	Input/Output, I/Q, I/Q Path
Example	Set the input to be both the I and Q channels, combined as $I + j * Q$. FEED:IQ:TYPE IQ
Initial S/W Revision	Prior to A.02.00

I Only

Sets the signal input to be only the I channel. The Q channel will be ignored. The data collected is still complex. When the center frequency is 0 the imaginary part will always be zero, but for any other center frequency both the real and imaginary parts will be significant.

Key Path	Input/Output, I/Q, I/Q Path
Example	Set the input to be only the I channel.

	FEED:IQ:TYPE IONL
Initial S/W Revision	Prior to A.02.00

Q Only

Sets the signal input to be only the Q channel. The I channel will be ignored. The Q channel will be sent to the digital receiver block as $Q+j0$. The receiver's output is still complex. When the center frequency is 0 the imaginary part will always be zero, but for any other center frequency both the real and imaginary parts will be significant. Note that since the receiver's real output is displayed as the "I" data, when the center frequency is 0, the Q Only input appears as the "I" data.

Key Path	Input/Output, I/Q, I/Q Path
Example	Set the input to be only the Q channel. FEED:IQ:TYPE QONL
Initial S/W Revision	Prior to A.02.00

I Setup

Access the channel setup parameters for the I channel.

Key Path	Input/Output, I/Q
Initial S/W Revision	Prior to A.02.00

I Differential Input

Selects differential input on or off for the I channel. For differential input (also called balanced input), the analyzer uses both main and complementary ports. When differential input is off (also called single-ended or unbalanced input), the analyzer uses only the main port.

Key Path	Input/Output, I/Q, I Setup
Remote Command	:INPut:IQ[:I]:DIFFerential OFF ON 0 1 :INPut:IQ[:I]:DIFFerential?
Example	Put the I channel in Differential Input mode INP:IQ:DIFF ON
Notes	When I Differential Input = On, the analyzer will check for attenuation mismatches between the I and I-bar ports. If the difference in attenuation values exceeds 0.5 dB a Settings Alert error condition, error 159 will be set. When I Differential Input = On, and IQ Path is I+jQ, the Q Differential input must also be On. Similarly, when I Differential Input = Off, and IQ Path is I+jQ, the Q Differential input must also be Off. If the states of the two inputs do not match, an error condition message is generated, 159;Settings Alert;I/Q mismatch:Differential.

Couplings	Some active probes include built-in differential capability. When one of these probes is sensed, this key is disabled. Since the differential capability is handled in the probe, the Analyzer will use only the main port and the key will show that the Analyzer's Differential Input mode is Off (indicating that the complementary port is not in use). When Q Same as I is On, the value set for I will also be copied to Q.
Preset	Off
State Saved	Yes This is unaffected by a Preset but is set to the default value on a "Restore Input/Output Defaults" or "Restore System Defaults->All"
Range	Off On
Initial S/W Revision	Prior to A.02.00

Remote Command	:INPut [1] :IQ:BAALanced[:STATe] OFF ON 0 1 :INPut [1] :IQ:BAALanced[:STATe] ?
Notes	For R&S FSQ-B71 compatibility, with no independent settings for the I and Q channels. Therefore, it is tied only to the I channel and does not provide an equivalent for the Q channel. For proper operation of the backwards compatibility command Q Same as I should be set to On.
Preset	OFF
Initial S/W Revision	Prior to A.02.00

I Input Z

Selects the input impedance for the I channel. The impedance applies to both the I and I-bar ports.

The input impedance controls the hardware signal path impedance match. It is not used for converting voltage to power. The voltage to power conversion always uses the Reference Z parameter. The Reference Z parameter applies to both I and Q channels.

Key Path	Input/Output, I/Q, I Setup
Remote Command	:INPut [1] :IQ[:I] :IMPedance LOW HIGH :INPut [1] :IQ[:I] :IMPedance ?
Example	Set the I channel input impedance to 1 M Ω INP:IQ:IMP HIGH
Notes	LOW = 50 Ω , HIGH = 1 M Ω When IQ Path is I+jQ, the I Input Z setting must be the same as the Q Input Z setting. If the settings of the two inputs do not match, an error condition message is generated, 159;Settings Alert;I/Q mismatch:Input Z.
Couplings	Input impedance is a built-in characteristic of a probe. Therefore, whenever a probe is sensed, this key is disabled and the value is set to match the probe. When no probe is sensed on Q and Q Same as I is On, the value set for I will also be copied to Q.
Preset	LOW

State Saved	Yes This is unaffected by a Preset but is set to the default value on a "Restore Input/Output Defaults" or "Restore System Defaults->All"
Range	50 Ω 1 M Ω
Initial S/W Revision	Prior to A.02.00

I Skew

Sets the skew factor for the I channel. The skew will shift the channel's data in time. Use this to compensate for differences in the electrical lengths of the input paths due to cabling.

Key Path	Input/Output, I/Q, I Setup
Remote Command	<code>[:SENSe]:CORRection:IQ[:I]:SKEW <seconds></code> <code>[:SENSe]:CORRection:IQ[:I]:SKEW?</code>
Example	Delay the data for the I channel by 10 ns. CORR:IQ:SKEW 10 ns
Preset	0
State Saved	Yes This is unaffected by Preset but is set to the default value on a "Restore Input/Output Defaults" or "Restore System Defaults->All"
Range	0 s to 100 ns
Min	0 s
Max	+100 ns
Initial S/W Revision	Prior to A.02.00

I Probe

Access the probe setup parameters for the I channel. See "[I/Q Probe Setup](#)" on page 261.

Key Path	Input/Output, I/Q, I Setup
State Saved	No
Readback Text	[<I port probe id>] This is reporting the type of probe sensed on the I port. There is no parameter for overriding what is sensed.
Initial S/W Revision	Prior to A.02.00

Attenuation

The attenuation is part of the calibration data stored with the probe type and is initially the value that was returned by the last calibration. You can modify this value and any changes will be stored with the

calibration data and will survive power cycles and presets. When a probe calibration is performed the attenuation value will be overwritten by the calibration.

Key Path	Input/Output, I/Q, I Setup Q Setup, I Probe Q Probe
Remote Command	<code>[:SENSe] :CORRection:IQ:I Q:ATTenuation:RATio <real></code> <code>[:SENSe] :CORRection:IQ:I Q:ATTenuation:RATio?</code>
Example	Set the attenuation for the current I probe to 100.00:1. CORR:IQ:I:ATT:RAT 100
Notes	Each probe type has its own attenuation setting. As probes are changed the attenuation value will reflect the new probe's setting. Changing the attenuation affects only the current probe type's setting and leaves all others unchanged. When the IQ Path is I+jQ, the Q probe attenuation setting must match the I Probe attenuation setting within 1 dB. If this is not the case, an error condition message is generated, 159;Settings Alert;I/Q mismatch:Attenuation.
Preset	Each probe type has its own default. The default for the "Unknown" probe type is 1:1.
State Saved	Saved with probe calibration data. It survives a power cycle and is not affected by a Preset or Restore.
Range	0.001 to 10000
Min	0.001
Max	10000
Initial S/W Revision	Prior to A.02.00

This is an alternate form of the SCPI that allows input as a power instead of a ratio.

Remote Command	<code>[:SENSe] :CORRection:IQ:I Q:ATTenuation <rel_amp></code> <code>[:SENSe] :CORRection:IQ:I Q:ATTenuation?</code>
Example	Set the attenuation for the current I probe type to 100.00:1. CORR:IQ:I:ATT 20 dB
Range	-60 dB to +80 dB
Min	-60 dB
Max	+80 dB
Initial S/W Revision	Prior to A.02.00

Calibrate

Invokes the guided probe calibration. The guided probe calibration is context sensitive and depends on the channel (I or Q) and the Differential Input state. The calibration is only performed on the selected channel. When Differential Input is on, both the probe attached to the main port and the probe attached to the complementary port are calibrated. When Differential Input is off, only the probe attached to the main port is calibrated. See "[I/Q Guided Calibration](#)" on page 302.

Key Path	Input/Output, I/Q, I Setup Q Setup, I Probe Q Probe, Coupling
Readback Text	The last calibration date, or if no calibration exists, "(empty)". Last: <cal date> <cal time> Example: Last: 8/22/2007 1:02:49 PM
Initial S/W Revision	Prior to A.02.00

Clear Calibration

Clears the calibration data for the current port and probe. It does not clear the data for other probe types or other ports. If the sensed probe has EEPROM identification, only the data for that specific probe is cleared. After this command has completed, the probe calibration state will be the same as if no probe calibration had ever been performed for the specified channel and probe. The probe attenuation will be the default value for that probe type and the Cable Calibration frequency response corrections will be used. This command is dependent on the Differential Input state. When Differential Input is on, both the data for the probe attached to the main port and the data for the probe attached to the complementary port are cleared. When Differential Input is off, only data for the probe attached to the main port is cleared.

Key Path	Input/Output, I/Q, I Setup Q Setup, I Probe Q Probe
Remote Command	:CALibration:IQ:PROBe:I Q:CLEar
Example	Clear the calibration data for the I channel and the current probe (with EEPROM identification) or probe type (without EEPROM identification). :CAL:IQ:PROBe:I:CLE
Initial S/W Revision	Prior to A.02.00

Combined Differential/Input Z (Remote Command Only)

This is Remote Command only (no front panel) and is for backwards compatibility only. It combines the Differential Input and Input Z selections into a single SCPI command.

Remote Command	:INPut:IMPedance:IQ U50 B50 U1M B1M :INPut:IMPedance:IQ?
Example	:INPut:IMPedance:IQ U50 This is equivalent to the following two SCPI commands: :INP:IQ:DIFF OFF :INP:IQ:IMP 50
Notes	Provided for E4406A code compatibility. The enum values translate as follows: U50: Differential Input = Off, Input Z = 50Ω

	<p>B50: Differential Input = On, Input Z = 50Ω</p> <p>U1M: Differential Input = Off, Input Z = 1 MΩ</p> <p>B1M: Differential Input = On, Input Z = 1 MΩ</p> <p>This command is for backwards compatibility. It combines the Input Z (50Ω or 1 MΩ) parameter with the Differential Input (Off = "Unbalanced", On = "Balanced") parameter into a single enumeration.</p> <p>This backwards compatibility SCPI command was for an instrument without independent settings for the I and Q channels. Therefore, it is tied only to the I channel and does not provide an equivalent for the Q channel. For proper operation of the backwards compatibility command Q Same as I should be set to On.</p> <p>Also, note the subtle difference between this SCPI command and the backwards compatibility command for Input Z. The Input Z SCPI has "IQ" before "IMP" while this command has that order reversed.</p>
Couplings	This command does not have an independent parameter, but instead is tied to the Differential Input and Input Z parameters. The coupling for those parameters apply to this command too.
Preset	U50
Initial S/W Revision	Prior to A.02.00

Q Setup

Access the channel setup parameters for the Q channel.

Key Path	Input/Output, I/Q
Readback Text	When Q Same as I is On the readback is "Q Same as I".
Initial S/W Revision	Prior to A.02.00

Q Same as I

Many, but not all, usages require the I and Q channels have an identical setup. To simplify channel setup, the Q Same as I will cause the Q channel parameters to be mirrored from the I channel. That way you only need to set up one channel (the I channel). The I channel values are copied to the Q channel, so at the time Q Same as I is turned off the I and Q channel setups will be identical. This does not apply to Probe settings or to parameters that are determined by the probe.

Key Path	Input/Output, I/Q, Q Setup
Remote Command	<pre>:INPut:IQ:MIRROred OFF ON 0 1</pre> <pre>:INPut:IQ:MIRROred?</pre>
Example	<p>Turn off the mirroring of parameters from I to Q.</p> <pre>INP:IQ:MIRR OFF</pre>
Couplings	Only displayed for the Q channel. When Yes, the I channel values for some parameters are mirrored (copied) to the Q channel. However, when a parameter is determined by the type of probe and a probe is sensed, the probe setting is always used and the I channel setting is ignored. The following

	parameters are mirrored: Differential Input (when not determined by probe) Input Z (when not determined by probe)
Preset	This is unaffected by a Preset but is set to the default value (Q Same as I set to "On") on a "Restore Input/Output Defaults" or "Restore System Defaults->All"
State Saved	Saved in instrument state
Range	On Off
Readback Text	"Q Same as I" when On, otherwise none.
Initial S/W Revision	Prior to A.02.00

Q Differential Input

Selects differential input on or off for the Q channel. For differential input (also called balanced input), the analyzer uses both the Q and Q-bar ports. When differential input is off (also called single-ended or unbalanced input), the analyzer uses only the Q port.

Key Path	Input/Output, I/Q, Q Setup
Remote Command	:INPut:IQ:Q:DIFFerential OFF ON 0 1 :INPut:IQ:Q:DIFFerential?
Example	Put the Q channel in Differential Input mode INP:IQ:Q:DIFF ON
Notes	When Differential Input = On, the analyzer will check for attenuation mismatches between the Q and Q-bar ports. If the difference in attenuation values exceeds 0.5 dB a Settings Alert error condition, error 159 will be set. When Q Differential Input = On, and IQ Path is I+jQ, the I Differential input must also be On. Similarly, when Q Differential Input = Off, and IQ Path is I+jQ, the I Differential input must also be Off. If the states of the two inputs do not match, an error condition message is generated, 159;Settings Alert;l/Q mismatch:Differential.
Couplings	Some active probes include built-in differential capability. When one of these probes is sensed, this key is disabled. Since the differential capability is handled in the probe, the Analyzer will use only the main port and the key will show that the Analyzer's Differential Input mode is Off (indicating that the complementary port not in use). When a differential probe is not sensed and Q Same as I is On, the value set for I will be copied to Q. This key is disabled when Q Same as I is On.
Preset	Off
State Saved	Yes This is unaffected by a Preset but is set to the default value on a "Restore Input/Output Defaults" or "Restore System Defaults->All"
Range	Off On
Initial S/W Revision	Prior to A.02.00

Q Input Z

Selects the input impedance for the Q channel. The impedance applies to both the Q and Q-bar ports.

The input impedance controls the hardware signal path impedance match. It is not used for converting voltage to power. The voltage to power conversion always uses the Reference Z parameter. The Reference Z parameter applies to both I and Q channels.

Key Path	Input/Output, I/Q, Q Setup
Remote Command	:INPut [1] :IQ:Q:IMPedance LOW HIGH :INPut [1] :IQ:Q:IMPedance?
Example	Set the Q channel input impedance to 1 M Ω INP:IQ:Q:IMP HIGH
Notes	LOW = 50 Ω , HIGH = 1 M Ω When IQ Path is I+jQ, the I Input Z setting must be the same as the Q Input Z setting. If the settings of the two inputs do not match, an error condition message is generated, 159;Settings Alert;I/Q mismatch:Input Z.
Couplings	Input impedance is a built-in characteristic of a probe. Therefore, whenever a probe is sensed, this key is disabled and the value is set to match the probe. When no probe is sensed and Q Same as I is On, the value set for I will also be copied to Q. This key is disabled when Q Same as I is On.
Preset	LOW
State Saved	Yes This is unaffected by Preset but is set to the default value on a "Restore Input/Output Defaults" or "Restore System Defaults->All"
Range	50 Ω 1 M Ω
Initial S/W Revision	Prior to A.02.00

Q Skew

Sets the skew factor for the Q channel. The skew will shift the channel's data in time. Use this to compensate for differences in the electrical lengths of the input paths due to cabling and probes.

Key Path	Input/Output, I/Q, Q Setup
Remote Command	[:SENSe]:CORRection:IQ:Q:SKEW <seconds> [:SENSe]:CORRection:IQ:Q:SKEW?
Example	Delay the data for the Q channel by 10 ns. CORR:IQ:Q:SKEW 10 ns
Preset	0
State Saved	Yes This is unaffected by a Preset but is set to the default value on a "Restore Input/Output Defaults" or "Restore System Defaults->All"
Range	0 s to 100 ns

Min	0 s
Max	+100 ns
Initial S/W Revision	Prior to A.02.00

Q Probe

Accesses the probe setup parameters for the Q channel. See "[I/Q Probe Setup](#)" on page 261.

Key Path	Input/Output, I/Q, Q Setup
State Saved	No
Readback Text	[<Q port probe id> This is reporting the type of probe sensed on the Q port. There is no parameter for overriding what is sensed.
Initial S/W Revision	Prior to A.02.00

Attenuation

The attenuation is part of the calibration data stored with the probe type and is initially the value that was returned by the last calibration. You can modify this value and any changes will be stored with the calibration data and will survive power cycles and presets. When a probe calibration is performed the attenuation value will be overwritten by the calibration.

Key Path	Input/Output, I/Q, I Setup Q Setup, I Probe Q Probe
Remote Command	[:SENSe] :CORRection:IQ:I Q:ATTenuation:RATio <real> [:SENSe] :CORRection:IQ:I Q:ATTenuation:RATio?
Example	Set the attenuation for the current I probe to 100.00:1. CORR:IQ:I:ATT:RAT 100
Notes	Each probe type has its own attenuation setting. As probes are changed the attenuation value will reflect the new probe's setting. Changing the attenuation affects only the current probe type's setting and leaves all others unchanged. When the IQ Path is I+jQ, the Q probe attenuation setting must match the I Probe attenuation setting within 1 dB. If this is not the case, an error condition message is generated, 159;Settings Alert;I/Q mismatch:Attenuation.
Preset	Each probe type has its own default. The default for the "Unknown" probe type is 1:1.
State Saved	Saved with probe calibration data. It survives a power cycle and is not affected by a Preset or Restore.
Range	0.001 to 10000
Min	0.001
Max	10000
Initial S/W Revision	Prior to A.02.00

This is an alternate form of the SCPI that allows input as a power instead of a ratio.

Remote Command	<code>[:SENSe]:CORRection:IQ:I Q:ATTenuation <rel_amp1></code> <code>[:SENSe]:CORRection:IQ:I Q:ATTenuation?</code>
Example	Set the attenuation for the current I probe type to 100.00:1. CORR:IQ:I:ATT 20 dB
Range	-60 dB to +80 dB
Min	-60 dB
Max	+80 dB
Initial S/W Revision	Prior to A.02.00

Calibrate

Invokes the guided probe calibration. The guided probe calibration is context sensitive and depends on the channel (I or Q) and the Differential Input state. The calibration is only performed on the selected channel. When Differential Input is on, both the probe attached to the main port and the probe attached to the complementary port are calibrated. When Differential Input is off, only the probe attached to the main port is calibrated. See "[I/Q Guided Calibration](#)" on page 302.

Key Path	Input/Output, I/Q, I Setup Q Setup, I Probe Q Probe, Coupling
Readback Text	The last calibration date, or if no calibration exists, "(empty)". Last: <cal date> <cal time> Example: Last: 8/22/2007 1:02:49 PM
Initial S/W Revision	Prior to A.02.00

Clear Calibration

Clears the calibration data for the current port and probe. It does not clear the data for other probe types or other ports. If the sensed probe has EEPROM identification, only the data for that specific probe is cleared. After this command has completed, the probe calibration state will be the same as if no probe calibration had ever been performed for the specified channel and probe. The probe attenuation will be the default value for that probe type and the Cable Calibration frequency response corrections will be used. This command is dependent on the Differential Input state. When Differential Input is on, both the data for the probe attached to the main port and the data for the probe attached to the complementary port are cleared. When Differential Input is off, only data for the probe attached to the main port is cleared.

Key Path	Input/Output, I/Q, I Setup Q Setup, I Probe Q Probe
Remote Command	<code>:CALibration:IQ:PROBe:I Q:CLEar</code>
Example	Clear the calibration data for the I channel and the current probe (with EEPROM identification) or probe type (without EEPROM identification).

	:CAL:IQ:PROBE:I:CLE
Initial S/W Revision	Prior to A.02.00

Reference Z

Sets the value of the impedance to be used in converting voltage to power for the I and Q channels. This does not change the hardware's path impedance (see "[I Input Z](#)" on page 251).

Key Path	Input/Output, I/Q
Remote Command	:INPut:IMPedance:REFerence <integer> :INPut:IMPedance:REFerence?
Example	Set the I/Q reference impedance to 50 Ω INP:IMP:REF 50
Preset	50 Ω
State Saved	Yes This is unaffected by a Preset but is set to the default value on a "Restore Input/Output Defaults" or "Restore System Defaults->All"
Range	1 Ω to 1 MΩ
Min	1 Ω
Max	1 MΩ
Initial S/W Revision	Prior to A.02.00

I/Q Cable Calibrate...

The I/Q cable calibration creates correction data for each of the front panel I/Q ports. This calibration data is used whenever no probe specific calibration data is available. It is important that all ports are calibrated using the same short BNC cable so that the data is comparable from port to port.

The guided calibration (front panel only) will show connection diagrams and guide you through the isolation calibration and calibrating each port. The calibration data for each port is stored separately, so as soon as a port is calibrated that data is saved and will be used. If you press "Exit" to exit the calibration process, the data for the ports already completed will still be used. It is recommended that a calibration be completed once started, or if exited, that it be properly done before the next use of the I/Q ports. The "Next" button will perform the calibration for the current port and then proceed to the next step in the calibration procedure. The "Back" button will return to the prior port in the procedure. Both keys and dialog buttons are supplied for ease of use. The dialog buttons are for mouse use and the softkeys for front panel use.

The calibration can also be done via SCPI, but no connection diagrams will be shown. You will have to make the correct connections before issuing each port calibration command. Again, it is recommended that all ports be calibrated at the same time.

The instrument state remains as it was prior to entering the calibration procedure except while a port is actually being calibrated. Once a port is calibrated it returns to the prior state. A port calibration is in

process only from the time the "Next" button is pressed until the next screen is shown. For SCPI, this corresponds to the time from issuing the CAL:IQ:FLAT:I|B|Q|QB command until the operation is complete.

For example, if the prior instrument state is Cal Out = Off, Input = I+jQ, and Differential = Off, then up until the time the "Next" button is pressed the I Input and Q Input LEDs are on and the Cal Out, I-bar Input and Q-bar Input LEDs are off. Once the "Next" button is pressed for the I port calibration, only the Cal Out and I Input LEDs will be on and the others will be off. When the screen progresses to the next step ("Next" button again enabled), the prior state is restored and only the I Input and Q Input LEDs are on (Cal Out is off again).

The last calibration date and time for each port will be displayed. Any calibrations that are more than a day older than the most recent calibration will be displayed with the color amber.

Key Path	Input/Output, I/Q
Initial S/W Revision	Prior to A.02.00

I/Q Probe Setup

The set of I/Q probe setup parameters will change based on the type of probe that is sensed. All probe types have the Attenuation parameter, and all probe types can be calibrated. The remaining parameters are only available for some probe types and will not be shown when not available. The probe type is determined by and reported for only for the I and Q ports, never the I-bar or Q-bar ports. The menu title will be "<ch>: <probe id>", where "<ch>" is either "I" or "Q" and "<probe id>" is the type of probe. For example, for the I Probe setup with an Agilent 1130A probe connected to the I port, the title will be "I: 1130A".

Probe calibration data is stored for each probe type for each channel. When no probe is sensed, the probe type "Unknown" is used, and this is also treated like a probe type with its own calibration data. When a probe is changed, the calibration data for that probe type for that port is restored. An advisory message will be displayed showing the new probe type and the calibration status. The calibration data is stored permanently (survives a power cycle) and is not affected by a Preset or any of the Restore commands. When the probe has EEPROM identification (most newer Agilent probes have this), the calibration data is stored by probe serial number and port, so if you have two probes of the same type, the correct calibration data will be used for each. For probes that do not have EEPROM identification, the calibration data is stored by probe type and port and the instrument cannot distinguish between different probes of the same type. In all cases (with or without EEPROM identification), the calibration data is port specific, so it will not follow a specific probe from port to port if the probe is moved.

The "Unknown" probe type is used whenever no probe is sensed. When no calibration data exists for "Unknown" the latest cable calibration data is used (see "[I/Q Guided Calibration](#)" on page 302).

Attenuation

The attenuation is part of the calibration data stored with the probe type and is initially the value that was returned by the last calibration. You can modify this value and any changes will be stored with the calibration data and will survive power cycles and presets. When a probe calibration is performed the attenuation value will be overwritten by the calibration.

Key Path	Input/Output, I/Q, I Setup Q Setup, I Probe Q Probe
Remote Command	[:SENSe] :CORRection:IQ:I Q:ATTenuation:RATio <real> [:SENSe] :CORRection:IQ:I Q:ATTenuation:RATio?

Example	Set the attenuation for the current I probe to 100.00:1. CORR:IQ:I:ATT:RAT 100
Notes	Each probe type has its own attenuation setting. As probes are changed the attenuation value will reflect the new probe's setting. Changing the attenuation affects only the current probe type's setting and leaves all others unchanged. When the IQ Path is I+jQ, the Q probe attenuation setting must match the I Probe attenuation setting within 1 dB. If this is not the case, an error condition message is generated, 159;Settings Alert;I/Q mismatch:Attenuation.
Preset	Each probe type has its own default. The default for the "Unknown" probe type is 1:1.
State Saved	Saved with probe calibration data. It survives a power cycle and is not affected by a Preset or Restore.
Range	0.001 to 10000
Min	0.001
Max	10000
Initial S/W Revision	Prior to A.02.00

This is an alternate form of the SCPI that allows input as a power instead of a ratio.

Remote Command	<code>[[:SENSE]:CORRection:IQ:I Q:ATTenuation <rel_ampl></code> <code>[[:SENSE]:CORRection:IQ:I Q:ATTenuation?</code>
Example	Set the attenuation for the current I probe type to 100.00:1. CORR:IQ:I:ATT 20 dB
Range	-60 dB to +80 dB
Min	-60 dB
Max	+80 dB
Initial S/W Revision	Prior to A.02.00

Offset

Some active probes have DC offset capability. When one of these probes is connected this control will be visible. The signal is adjusted for the DC offset before entering the analyzer's port. This allows for removal of a DC offset before reaching the analyzer's input port voltage limits. For example, a signal that varies 1 V peak-to-peak with a DC offset equal to the analyzer's max input voltage would exceed the input limits of the analyzer for half its cycle. Removing the DC offset allows the analyzer to correctly process the entire signal.

Key Path	Input/Output, I/Q, I Setup Q Setup, I Probe Q Probe
Remote Command	<code>:INPut:OFFSet:I Q <voltage></code> <code>:INPut:OFFSet:I Q?</code>
Example	Remove a DC offset of -0.5 V from the I channel input. INP:OFFS:I -0.5

Notes	Only some probe types support Offset. For those that do, each probe type has its own Offset setting. As probes are changed the Offset value will reflect the new probe's setting. Changing the Offset affects only the current probe type's setting and leaves all others unchanged.
Preset	0 V
State Saved	Saved with probe calibration data. It survives power cycle and is not affected by Preset or Restore.
Range	-18 V to +18 V
Min	-18 V
Max	+18 V
Initial S/W Revision	Prior to A.02.00

Coupling

Some probe types allow coupling to reject low frequencies. This will filter out the DC component of a signal that is composed of a DC bias plus some AC signal. This control is visible only for probe types that have this capability.

Key Path	Input/Output, I/Q, I Setup Q Setup, I Probe Q Probe
Remote Command	:INPut:COUPling:I Q DC LFR1 LFR2 :INPut:COUPling:I Q?
Example	Set the probe to low frequency rejection below 1.7 Hz. INP:COUP:I LFR1
Notes	Only some probe types support Coupling. For those that do, each probe type has its own Coupling setting. As probes are changed the Coupling value will reflect the new probe's setting. Changing the Coupling affects only the current probe type's setting and leaves all others unchanged.
Preset	DC
State Saved	Saved with probe calibration data. It survives a power cycle and is not affected by a Preset or Restore.
Range	DC AC 1.7 Hz LFR1 AC 0.14 Hz LFR2
Readback Text	DC LFR1 LFR2
Initial S/W Revision	Prior to A.02.00

DC

Turns off low frequency rejection, allowing signals down to DC.

Key Path	Input/Output, I/Q, I Setup Q Setup, I Probe Q Probe, Coupling
Example	Turn off low frequency rejection on the I channel INP:COUP:I DC
Initial S/W Revision	Prior to A.02.00

LFR1

Turns on low frequency rejection, rejecting signal component lower than 1.7 Hz.

Key Path	Input/Output, I/Q, I Setup Q Setup, I Probe Q Probe, Coupling
Example	Turn on low frequency rejection on the I channel for frequencies lower than 1.7 Hz INP:COUP:I LFR1
Initial S/W Revision	Prior to A.02.00

LFR2

Turns on low frequency rejection, rejecting signal component lower than 0.14 Hz.

Key Path	Input/Output, I/Q, I Setup Q Setup, I Probe Q Probe, Coupling
Example	Turn on low frequency rejection on the I channel for frequencies lower than 0.14 Hz INP:COUP:I LFR2
Initial S/W Revision	Prior to A.02.00

Calibrate

Invokes the guided probe calibration. The guided probe calibration is context sensitive and depends on the channel (I or Q) and the Differential Input state. The calibration is only performed on the selected channel. When Differential Input is on, both the probe attached to the main port and the probe attached to the complementary port are calibrated. When Differential Input is off, only the probe attached to the main port is calibrated. See "[I/Q Guided Calibration](#)" on page 302.

Key Path	Input/Output, I/Q, I Setup Q Setup, I Probe Q Probe, Coupling
Readback Text	The last calibration date, or if no calibration exists, "(empty)". Last: <cal date> <cal time> Example: Last: 8/22/2007 1:02:49 PM
Initial S/W Revision	Prior to A.02.00

Clear Calibration

Clears the calibration data for the current port and probe. It does not clear the data for other probe types or other ports. If the sensed probe has EEPROM identification, only the data for that specific probe is cleared. After this command has completed, the probe calibration state will be the same as if no probe calibration had ever been performed for the specified channel and probe. The probe attenuation will be the default value for that probe type and the Cable Calibration frequency response corrections will be used. This command is dependent on the Differential Input state. When Differential Input is on, both the data for

the probe attached to the main port and the data for the probe attached to the complementary port are cleared. When Differential Input is off, only data for the probe attached to the main port is cleared.

Key Path	Input/Output, I/Q, I Setup Q Setup, I Probe Q Probe
Remote Command	:CALibration:IQ:PROBe:I Q:CLEAr
Example	Clear the calibration data for the I channel and the current probe (with EEPROM identification) or probe type (without EEPROM identification). :CAL:IQ:PROBe:I:CLE
Initial S/W Revision	Prior to A.02.00

RF Calibrator

Lets you choose a calibrator signal to look at or turns the calibrator "off".

Key Path	Input/Output
Remote Command	[[:SENSe]:FEED:AREFERENCE REF50 REF4800 OFF [:SENSe]:FEED:AREFERENCE?
Example	FEED:AREF REF50 selects the 50 MHz amplitude reference as the signal input. FEED:AREF REF4800 selects the 4.8 GHz amplitude reference as the signal input FEED:AREF OFF turns the calibrator "off" (switches back to the selected input – RF or I/Q)
Dependencies	Selecting an input (RF or I/Q) turns the Calibrator OFF. This is true whether the input is selected by the keys or with the [:SENSe]:FEED command. The 4.8 GHz internal reference is only available in some models and frequency range options. If the 4.8 GHz reference is not present, the 4.8 GHz softkey will be blanked, and if the REF4800 parameter is sent, the analyzer will generate an error.
Couplings	When one of the calibrator signals is selected, the analyzer routes that signal (an internal amplitude reference) to the analyzer, and changes the main input selection to RF so the calibrator signal can be seen. When you turn the calibrator off it does not switch back to the previously selected input.
Preset	OFF
State Saved	Saved in instrument state
Readback	Off, 50 MHz, 4.8 GHz
Initial S/W Revision	Prior to A.02.00

Remote Command	:CALibration:SOURce:STATe OFF ON 0 1 :CALibration:SOURce:STATe?
Notes	For ESA backwards compatibility. In the ESA the calibrator was a separate output which you connected to the input and switched on with this command. In the X-Series, the ON parameter is aliased to the [:SENSe]:FEED:AREF REF50 command and the OFF parameter is aliased to [:SENSe]:FEED:AREF OFF.

	When CALibration:SOURce:STATe? is received, 1 will be returned if any of the references is selected and 0 if the Calibrator is "Off"
Preset	OFF
Initial S/W Revision	Prior to A.02.00

50 MHz

Selects the 50 MHz internal reference as the input signal.

Key Path	Input/Output, RF Calibrator
Example	:FEED:AREF REF50
Readback	50 MHz
Initial S/W Revision	Prior to A.02.00

4.8 GHz

Selects the 4.8 GHz internal reference as the input signal.

Key Path	Input/Output, RF Calibrator
Example	:FEED:AREF REF4800
Dependencies	The 4.8 GHz internal reference is only available in some models and frequency range options. If the 4.8 GHz reference is not present, the 4.8 GHz softkey will be blanked, and if the REF4800 parameter is sent, the analyzer will generate an error.
Readback	4.8 GHz
Initial S/W Revision	Prior to A.02.00
Modified at S/W Revision	A.03.00

Off

Switches the input back to the selected input (RF or I/Q)

Key Path	Input/Output, RF Calibrator
Example	:FEED:AREF OFF
Readback	Off
Initial S/W Revision	Prior to A.02.00

External Gain

Compensates for gain or loss in the measurement system outside the spectrum analyzer. The External Gain is subtracted from the amplitude readout (or the loss is added to the amplitude readout). So, the displayed signal level represents the signal level at the output of the device-under-test, which can be the input of an external device that provides gain or loss.

Entering an External Gain value does not affect the Reference Level, therefore the trace position on screen changes, as do all of the values represented by the trace data. Thus, the values of exported trace data, queried trace data, marker amplitudes, trace data used in calculations such as N dB points, trace math, peak threshold, etc., are all affected by External Gain. Changing the External Gain, even on a trace that is not updating, will immediately change all of the above, without new data needing to be taken.

NOTE

Changing the External Gain causes the analyzer to immediately stop the current sweep and prepare to begin a new sweep. The data will not change until the trace data updates because the offset is applied to the data as it is taken. If a trace is exported with a nonzero External Gain, the exported data will contain the trace data with the offset applied.

In the Spectrum Analyzer mode, a Preamp is the common external device providing gain or loss. In a measurement application mode like GSM or W-CDMA, the gain or loss could be from a BTS (Base Transceiver Station) or an MS (Mobile Station). So in the Spectrum Analyzer mode MS and BTS would be grayed out and the only choice would be Ext Preamp. Similarly in some of the digital communications applications, Ext Preamp will be grayed out and you would have a choice of MS or BTS.

Key Path	Input/Output
Couplings	The Ext Preamp, MS, and BS keys may be grayed out depending on which measurement is currently selected. If any of the grayed out keys are pressed, or the equivalent SCPI command is sent, an advisory message is generated.
Readback	1-of-N selection [variable]
Initial S/W Revision	Prior to A.02.00

Ext Preamp

This function is similar to the reference level offset function. Both affect the displayed signal level. Ref Lvl Offset is a mathematical offset only, no analyzer configuration is affected. Ext Preamp gain is used when determining the auto-coupled value of the Attenuator. The External Gain value and the Maximum Mixer Level settings are both part of the automatic setting equation for the RF attenuation setting. (10 dB of Attenuation is added for every 10 dB of External Gain.)

Note that the Ref Lvl Offset and Maximum Mixer Level are described in the Amplitude section. They are reset by the instrument Preset. The External Preamp Gain is reset by the "Restore Input/Output Defaults" or "Restore System Defaults->All functions. . The External Gain is subtracted from the amplitude readout so that the displayed signal level represents the signal level at the output of the device-under-test, which is the input of the external device that is providing gain or loss.

["More Information" on page 268](#)

Key Path	Input/Output, External Gain
----------	-----------------------------

Remote Command	<code>[:SENSe] :CORRection:SA[:RF]:GAIN <rel_ampl></code> <code>[:SENSe] :CORRection:SA[:RF]:GAIN?</code>
Example	CORR:SA:GAIN 10 sets the Ext Gain value to 10 dB CORR:SA:GAIN -10 sets the Ext Gain value to -10 dB (that is, an attenuation of 10 dB)
Notes	Does not auto return.
Dependencies	The reference level limits are determined in part by the External Gain/Atten, Max Mixer Level, and RF Atten. This key is grayed out in Modes that do not support External Gain
Preset	This is unaffected by Preset but is set to 0 dB on a "Restore Input/Output Defaults" or "Restore System Defaults->All"
State Saved	Saved in instrument state
Min	-120 dB
Max	120 dB
Readback	Preamp Gain, <Ext Gain value> dB
Backwards Compatibility SCPI	<code>[:SENSe] :CORRection:OFFSet[:MAGNitude]</code> The legacy "Ext Preamp Gain" key is now called "Ext Gain" and the sub-menu has choices of Ext Preamp MS BTS for backwards compatibility.
Initial S/W Revision	Prior to A.02.00
Modified at S/W Revision	A.14.00

More Information

The U7227A USB Preamplifier is an accessory for the X-Series Signal Analyzer that provides gain externally, and whose gain settings are automatically loaded into the analyzer over USB whenever it is connected to one of the analyzer's USB ports.

While the USB Preamplifier is plugged into one of the analyzer's USB ports, the analyzer will consider it to be in the signal path of the RF Input and will apply the calibration data from the USB Preamp to measurements taken at the RF Input (on 2 input boxes, it will be considered to be in the signal path of RF Input 1; it is not supported for RF Input 2).

The USB Preamplifier contains its own cal data. This includes a noise trace suitable for use with NFE, for those models which support NFE. The act of connecting the Preamp to USB will cause the cal data to be downloaded from the preamp. When this happens an informational message is provided saying "Cal data loaded from USB Preamp". The analyzer will then automatically apply the calibration factors loaded from the Preamp in any measurement that supports the USB Preamp.

The External Preamp Gain setting may still be used, even though it is not required for the USB Preamp (since the USB Preamp supplies its own gain data to the analyzer which is applied automatically). Connecting the USB Preamp does not change the External Preamp Gain setting, however unless you have another gain or attenuation element in the signal path, the appropriate setting for External Preamp Gain is 0 dB.

Overload detection and reporting will apply when the USB preamplifier is connected to USB. The USB Preamplifier has its own overload detector which reports overloads to the instrument over USB. This generates an error condition, "Input Overload;USB Preamp."

If, while the USB Preamp is connected to USB, a measurement is selected that does not support the USB preamplifier, the "No result; Meas invalid with Preamp" error condition is generated.

MS

Sets an external gain/attenuation value for MS (Mobile Station) tests.

Key Path	Input/Output, External Gain
Remote Command	<code>[:SENSe] :CORRection:MS[:RF]:GAIN <rel_ampl></code> <code>[:SENSe] :CORRection:MS[:RF]:GAIN?</code>
Example	CORR:MS:GAIN 10 sets the Ext Gain value to 10 dB CORR:MS:GAIN -10 sets the Ext Gain value to -10 dB (that is, a loss of 10 dB.)
Notes	Does not auto return.
Dependencies	The reference level limits are determined in part by the External Gain, Max Mixer Level, RF Atten This key is grayed out in modes that do not support MS.
Preset	This is unaffected by a Preset but is set to 0 dB on a "Restore Input/Output Defaults" or "Restore System Defaults->All"
State Saved	Saved in instrument state.
Min	-100 dB
Max	100 dB
Readback	MS, <Ext Gain value> dB
Initial S/W Revision	Prior to A.02.00

Remote Command	<code>[:SENSe] :CORRection:MS[:RF]:LOSS <rel_ampl></code> <code>[:SENSe] :CORRection:MS[:RF]:LOSS?</code>
Example	CORR:MS:LOSS 10 sets the Ext Gain value to -10 dB, and subsequently querying :LOSS will give 10 dB CORR:MS:LOSS -10 sets the Ext Gain value to 10 dB, and subsequently querying :LOSS will give -10 dB
Notes	A positive value of <rel_ampl> in the above command means a loss and a negative value indicates a gain. Anytime :LOSS is set it sets :GAIN to the negative value of the parameter sent. Anytime :LOSS is queried it gives the negative of :GAIN
Preset	This is unaffected by a Preset but is set to 0 dB on a "Restore Input/Output Defaults" or "Restore System Defaults->All"
Min	100 dB
Max	-100 dB
Initial S/W Revision	Prior to A.02.00

BTS

Sets an external attenuation value for BTS (Base Transceiver Station) tests.

Key Path	Input/Output, External Gain
Remote Command	<code>[:SENSe]:CORRection:BTS[:RF]:GAIN <rel_ampl></code> <code>[:SENSe]:CORRection:BTS[:RF]:GAIN?</code>
Example	<code>CORR:BTS:GAIN 10</code> sets the Ext Gain value to 10 dB <code>CORR:BTS:GAIN -10</code> sets the Ext Gain value to -10 dB (that is, a loss of 10 dB.)
Notes	Does not auto return.
Dependencies	The reference level limits are determined in part by the External Gain, Max Mixer Level, RF Atten This key is grayed out in modes that do not support BTS.
Preset	This is unaffected by a Preset but is set to 0 dB on a "Restore Input/Output Defaults" or "Restore System Defaults->All"
State Saved	Saved in instrument state.
Min	-100 dB
Max	100 dB
Readback	BTS, <Ext Gain value> dB
Initial S/W Revision	Prior to A.02.00

Remote Command	<code>[:SENSe]:CORRection:BTS[:RF]:LOSS <rel_ampl></code> <code>[:SENSe]:CORRection:BTS[:RF]:LOSS?</code>
Example	<code>CORR:BTS:LOSS 10</code> sets the Ext Gain value to -10 dB, and subsequently querying :LOSS will give 10 dB <code>CORR:BTS:LOSS -10</code> sets the Ext Gain value to 10 dB, and subsequently querying :LOSS will give -10 dB
Notes	A positive value of <rel_ampl> in the above command means a loss and a negative value indicates a gain. Anytime :LOSS is set it sets :GAIN to the negative value of the parameter sent. Anytime :LOSS is queried it gives the negative of :GAIN
Preset	This is unaffected by a Preset but is set to 0 dB on a "Restore Input/Output Defaults" or "Restore System Defaults->All"
Min	100 dB
Max	-100 dB
Initial S/W Revision	Prior to A.02.00

I Ext Gain

This function affects the I channel input. However, when Q Gain in I+jQ is set to Same as I Gain, this value is applied to both I and Q channel inputs.

Key Path	Input/Output, External Gain
Remote Command	<code>[:SENSE] :CORREction:IQ:I:GAIN <rel_amp1></code> <code>[:SENSE] :CORREction:IQ:I:GAIN?</code>
Example	Set the I Ext Gain to 10 dB <code>CORR:IQ:I:GAIN 10</code> Set the I Ext Gain to -10 dB (that is, a loss of 10 dB.) <code>CORR:IQ:I:GAIN -10</code>
Dependencies	Not available unless option BBA is installed
Preset	0 dB This is unaffected by a Preset but is set to 0 dB on a "Restore Input/Output Defaults" or "Restore System Defaults->All"
State Saved	Saved in instrument state.
Min	-100 dB
Max	100 dB
Readback Text	I Gain, <I Ext Gain> dB
Initial S/W Revision	Prior to A.02.00

Q Ext Gain

This function affects the Q channel input.

Key Path	Input/Output, External Gain
Remote Command	<code>[:SENSE] :CORREction:IQ:Q:GAIN <rel_amp1></code> <code>[:SENSE] :CORREction:IQ:Q:GAIN?</code>
Example	Set the Q Ext Gain to 10 dB <code>CORR:IQ:Q:GAIN 10</code> Set the Q Ext Gain to -10 dB (that is, a loss of 10 dB.) <code>CORR:IQ:Q:GAIN -10</code>
Dependencies	Not available unless option BBA is installed.
Preset	0 dB This is unaffected by a Preset but is set to 0 dB on a "Restore Input/Output Defaults" or "Restore System Defaults->All"
State Saved	Saved in instrument state
Min	-100 dB

Max	100 dB
Readback Text	Q Gain, <l Ext Gain> dB
Initial S/W Revision	Prior to A.02.00

Restore Input/Output Defaults

This selection causes the group of settings and data associated with the Input/Output key to be a reset to their default values. In addition, when a Source is installed, licensed and selected, Restore Input/Output defaults will initiate a Source Preset.

This level of Restore System Defaults does not affect any other system settings or mode settings and does not cause a mode switch. All the features described in this section are reset using this key, including Input Corrections and Data (described in the Corrections section).

Key Path	Input/Output
Example	:SYST:DEF INP presets all the Input/Output variables to their factory default values.
Notes	Refer to the Utility Functions for information about Restore System Defaults and the complete description of the :SYSTEM:Default INPut: command.
Initial S/W Revision	Prior to A.02.00

Corrections

This key accesses the Amplitude Corrections menu.

Amplitude Corrections arrays can be entered, sent over SCPI, or loaded from a file. They allow you to correct the response of the analyzer for various use cases. The X-series supports four separate Corrections arrays, each of which can contain up to 2000 points. They can be turned on and off individually and any or all can be on at the same time.

Trace data is in absolute units and corrections data is in relative units, but we want to be able to display trace data at the same time as corrections data. Therefore we establish a reference line to be used while building or editing a Corrections table. The reference line is halfway up the display and represents 0 dB of correction. It is labeled "0 dB CORREC". It is drawn in blue.

Corrections data is always in dB. Whatever dB value appears in the correction table represents the correction applied to that trace at that frequency. So if a table entry shows 30 dB that means we ADD 30 dB to each trace to correct it before displaying it.

In zero span, where the frequency is always the center frequency of the analyzer, we apply the (interpolated) correction for the center frequency to all points in the trace. In the event where there are two correction amplitudes at the center frequency, we apply the first one in the table.

Note that the corrections are applied as the data is taken; therefore, a trace in View (Update Off) will not be affected by changes made to the corrections table after the trace is put in View.

Key Path	Input/Output, Corrections
----------	---------------------------

Mode	SA, I/Q Analyzer, Phase Noise, VXA, RTSA, EMI Receiver, DVB-T/H, DTMB, DVB-T/H, DTMB, W-CDMA, LTE & LTE-Adv FDD, LTE & LTE-Adv TDD, Sequence Analyzer, BTooth
Dependencies	This key will only appear if you have the proper option installed in your instrument. Amplitude correction may not be available in all modes; if a mode does not support amplitude correction, the Corrections key should be blanked while in that mode. If an application supports corrections but the current measurement does not, then the key should be grayed out in that measurement
Preset	Corrections arrays are reset (deleted) by Restore Input/Output Defaults. They survive shutdown and restarting of the analyzer application, which means they will survive a power cycle.
Initial S/W Revision	A.02.00
Modified at S/W Revision	x.14.50

Select Correction

Specifies the selected correction. The term "selected correction" is used throughout this document to specify which correction will be affected by the functions.

Key Path	Input/Output, Corrections
Mode	SA, I/Q Analyzer, Phase Noise, VXA, RTSA, EMI Receiver, DVB-T/H, DTMB, DVB-T/H, DTMB, W-CDMA, LTE & LTE-Adv FDD, LTE & LTE-Adv TDD, Sequence Analyzer, BTooth
Notes	The selected correction is remembered even when not in the correction menu.
Preset	Set to Correction 1 by Restore Input/Output Defaults
Readback	Correction 1 Correction 2 Correction 3 Correction 4 Correction 5 Correction 6 Correction 7 Correction 8
Initial S/W Revision	A.02.00
Modified at S/W Revision	x.14.50

Correction On/Off

Turning the Selected Correction from the OFF state to the ON state allows the values in it to be applied to the data. This state transition also automatically turns on "Apply Corrections" (sets it to ON), otherwise the correction would not take effect.

A new sweep is initiated if an amplitude correction is switched on or off. Note that changing, sending or loading corrections data does NOT directly initiate a sweep, however in general these operations will turn corrections on, which DOES initiate a sweep.

Key Path	Input/Output, Corrections
Remote Command	<code>[:SENSe] :CORRection:CSET[1] 2 ... 8[:STATe] ON OFF 1 0</code> <code>[:SENSe] :CORRection:CSET[1] 2 ... 8[:STATe]?</code>

Example	SENS:CORR:CSET1 ON
Dependencies	<p>Changing this from the OFF state to the ON state automatically turns on "Apply Corrections".</p> <p>Only the first correction array (Correction 1) supports antenna units. When this array is turned on, and it contains an Antenna Unit other than "None", the Y Axis Unit of the analyzer is forced to that Antenna Unit. All other Y Axis Unit choices are grayed out.</p> <p>Note that this means that a correction file with an Antenna Unit can only be loaded into the Corrections 1 register. Consequently only for Correction 1 does the dropdown in the Recall dialog include.ant, and if an attempt is made to load a correction file into any other Correction register which DOES contain an antenna unit, a Mass Storage error is generated.</p> <p>This command will generate an "Option not available" error unless you have the proper option installed in your instrument.</p>
Preset	Not affected by a Preset. Set to OFF by Restore Input/Output Defaults
State Saved	Saved in instrument state.
Backwards Compatibility Notes	Unlike legacy analyzers, Preset does not turn Corrections off (Restore Input/Output Defaults does).
Initial S/W Revision	A.02.00
Modified at S/W Revision	A.14.00

Properties

Accesses a menu that lets you set the properties of the selected correction.

Key Path	Input/Output, Corrections
Initial S/W Revision	A.02.00

Select Correction

Specifies the selected correction. The term "selected correction" is used throughout this document to specify which correction will be affected by the functions.

Key Path	Input/Output, Corrections
Mode	SA, I/Q Analyzer, Phase Noise, VXA, RTSA, EMI Receiver, DVB-T/H, DTMB, DVB-T/H, DTMB, W-CDMA, LTE & LTE-Adv FDD, LTE & LTE-Adv TDD, Sequence Analyzer, BTooth
Notes	The selected correction is remembered even when not in the correction menu.
Preset	Set to Correction 1 by Restore Input/Output Defaults
Readback	Correction 1 Correction 2 Correction 3 Correction 4 Correction 5 Correction 6 Correction 7 Correction 8
Initial S/W Revision	A.02.00
Modified at S/W Revision	x.14.50

Antenna Unit

For devices (like antennas) that make measurements of field strength or flux density, the correction array should contain within its values the appropriate conversion factors such that, when the data on the analyzer is presented in dB μ V, the display is calibrated in the appropriate units. The "Antenna Unit" used for the conversion is contained within the corrections array database. It may be specified or loaded in from an external file or SCPI.

When an array with an Antenna Unit other than "None" is turned on, the Y Axis Unit of the analyzer is forced to that unit. When this array is turned on, and it contains an Antenna Unit other than "None", the Y Axis Unit of the analyzer is forced to that Antenna Unit., and all other Y Axis Unit choices are grayed out.

Antenna Unit does not appear in all Modes that support Corrections. Only the modes listed in the Mode row of the table below support Antenna Units.

Key Path	Input/Output, Corrections, Properties
Mode	SA, I/Q Analyzer, Phase Noise, VXA, RTSA, EMI Receiver, DVB-T/H, DTMB, DVB-T/H, DTMB, W-CDMA, LTE & LTE-Adv FDD, LTE & LTE-Adv TDD, Sequence Analyzer, BTooth
Remote Command	[:SENSe] :CORRection:CSET[1]:ANTenna[:UNIT] GAUSs PTES1a UVM UAM UA NOConversion [:SENSe] :CORRection:CSET[1]:ANTenna[:UNIT] ?
Example	CORR:CSET:ANT GAUS
Dependencies	Only the first correction array (Correction 1) supports antenna units. Note that this means that a correction file with an Antenna Unit can only be loaded into the Corrections 1 register. Consequently only for Correction 1 does the dropdown in the Recall dialog include.ant, and if an attempt is made to load a correction file into any other Correction register which DOES contain an antenna unit, a Mass Storage error is generated.
Preset	Unaffected by Preset. Set to NOC by Restore Input/Output Defaults
State Saved	Saved in instrument state
Initial S/W Revision	A.02.00
Modified at S/W Revision	x.14.50

None

Selects no antenna unit for this Correction set. Thus no Y Axis unit will be forced.

Key Path	Input/Output, Corrections, Properties, Antenna Unit
Example	:CORR:CSET:ANT NOC
Readback	"None"
Initial S/W Revision	A.02.00

dB μ V/m

Sets the antenna unit to dB μ V/m. If this correction is turned on, and Apply Corrections is on, the Y Axis Unit will then be forced to dB μ V/m and all other Y Axis Unit selections will be grayed out.

Key Path	Input/Output, Corrections, Properties, Antenna Unit
Example	:CORR:CSET:ANT UVM
Readback	"dB μ V/m"
Initial S/W Revision	A.02.00

dB μ A/m

Sets the antenna unit to dB μ A/m. If this correction is turned on, and Apply Corrections is on, the Y Axis Unit will then be forced to dB μ A/m and all other Y Axis Unit selections will be grayed out.

Key Path	Input/Output, Corrections, Properties, Antenna Unit
Example	:CORR:CSET:ANT UVA
Readback	" dB μ A/m"
Initial S/W Revision	A.02.00

dBpT

Sets the antenna unit to dBpT. If this correction is turned on, and Apply Corrections is on, the Y Axis Unit will then be forced to dBpT and all other Y Axis Unit selections will be grayed out.

Key Path	Input/Output, Corrections, Properties, Antenna Unit
Example	:CORR:CSET:ANT PTES
Readback	"dBpT"
Initial S/W Revision	A.02.00

dBG

Sets the antenna unit to dBG. If this correction is turned on, and Apply Corrections is on, the Y Axis Unit will then be forced to dBG and all other Y Axis Unit selections will be grayed out.

Key Path	Input/Output, Corrections, Properties, Antenna Unit
Example	:CORR:CSET:ANT GAUS
Readback	" dBG"
Initial S/W Revision	A.02.00

dB μ A

Sets the antenna unit to dB μ A. If this correction is turned on, and Apply Corrections is on, the Y Axis Unit will then be forced to dB μ A and all other Y Axis Unit selections will be grayed out.

Key Path	Input/Output, Corrections, Properties, Antenna Unit
Example	:CORR:CSET:ANT UA
Readback	" dBμA"
Initial S/W Revision	A.11.00

Frequency Interpolation

This setting controls how the correction values per-bucket are calculated. We interpolate between frequencies in either the logarithmic or linear scale.

This setting is handled and stored individually per correction set.

See ["Interpolation" on page 277](#)

Key Path	Input/Output, Corrections, Properties
Remote Command	[[:SENSE]:CORREction:CSET[1] 2 ... 8:X:SPACing LINear LOGarithmic [:SENSE]:CORREction:CSET[1] 2 ... 8:X:SPACing?
Example	CORR:CSET:X:SPAC LIN
Preset	Unaffected by a Preset. Set to Linear by Restore Input/Output Defaults.
State Saved	Saved in instrument state.
Initial S/W Revision	A.02.00
Modified at S/W Revision	A.14.00

Interpolation

For each bucket processed by the application, all of the correction factors at the frequency of interest (center frequency of each bucket) are summed and added to the amplitude. All trace operations and post processing treat this post-summation value as the true signal to use.

To effect this correction, the goal, for any particular start and stop frequency, is to build a correction trace, whose number of points matches the current Sweep Points setting of the instrument, which will be used to apply corrections on a bucket by bucket basis to the data traces.

For amplitudes that lie between two user specified frequency points, we interpolate to determine the amplitude value. You may select either linear or logarithmic interpolation between the frequencies.

If we interpolate on a log scale, we assume that the line between the two points is a straight line on the log scale. For example, let's say the two points are (2,4) and (20,1). A straight line between them on a log scale looks like:

4 Input/Output Functions Input/Output

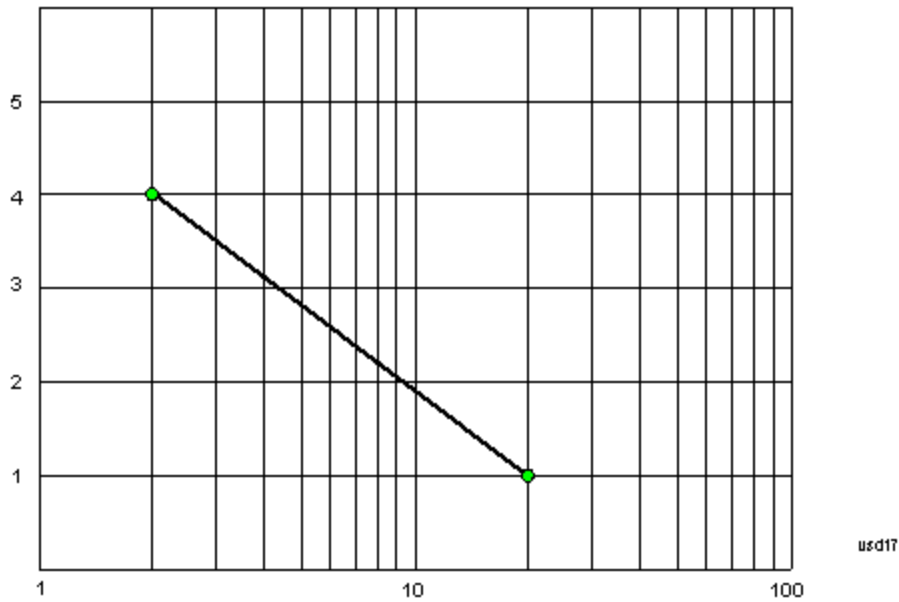

On a linear scale (like that of the spectrum analyzer), this translates to:

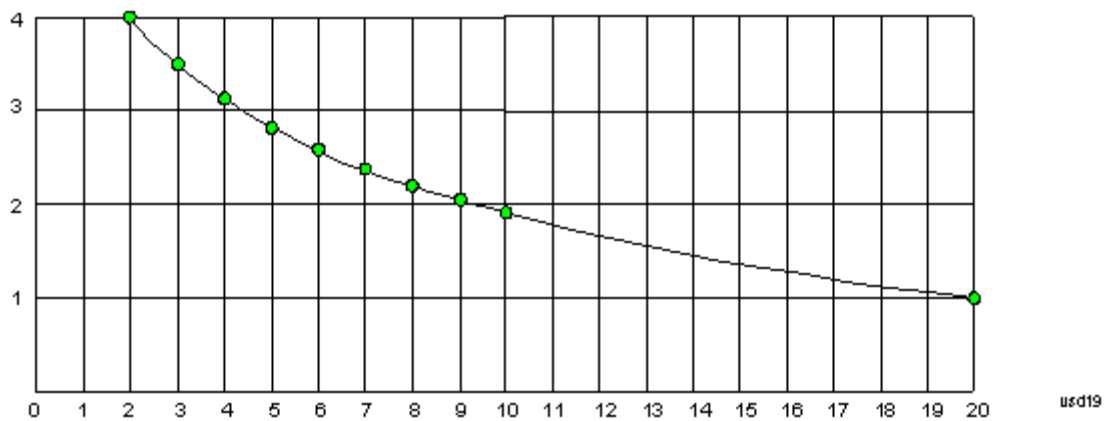

If we interpolate on a linear scale, we assume that the two points are connected by a straight line on the linear scale, as below:

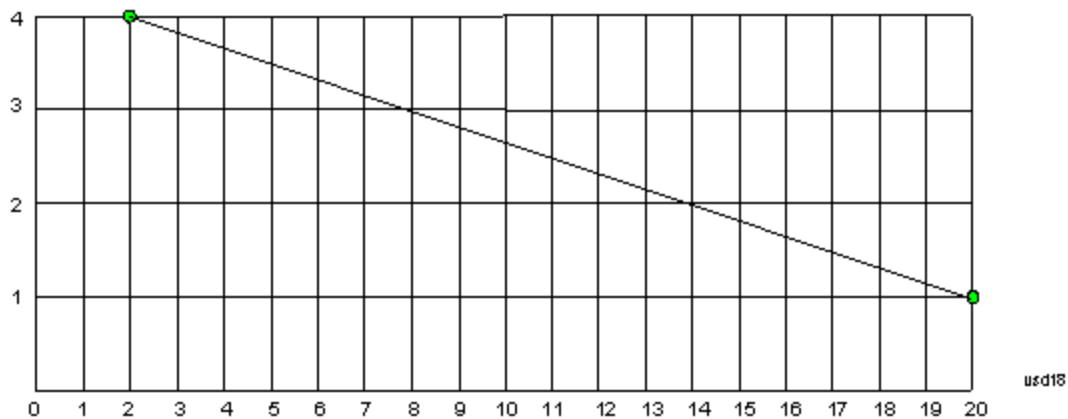

The correction to be used for each bucket is taken from the interpolated correction curve at the center of the bucket.

Description

Sets an ASCII description field which will be stored in an exported file. Can be displayed in the active function area by selecting as the active function, if desired to appear in a screen capture.

Key Path	Input/Output, Corrections, Properties
Remote Command	<code>[:SENSe] :CORRection:CSET[1] 2 ... 8:DESCRiption "text"</code> <code>[:SENSe] :CORRection:CSET[1] 2 ... 8:DESCRiption?</code>
Example	<code>:CORR:CSET1:DESC "11941A Antenna correction"</code>
Notes	45 chars max; may not fit on display if max chars used
Preset	Unaffected by a Preset. Set to empty by Restore Input/Output Defaults
State Saved	Saved in instrument state.
Initial S/W Revision	A.02.00
Modified at S/W Revision	A.14.00

Comment

Sets an ASCII comment field which will be stored in an exported file. Can be displayed in the active function area by selecting as the active function, if desired to appear in a screen capture.

Key Path	Input/Output, Corrections, Properties
Remote Command	<code>[:SENSe] :CORRection:CSET[1] 2 ... 8:COMMeNt "text"</code> <code>[:SENSe] :CORRection:CSET[1] 2 ... 8:COMMeNt?</code>
Example	<code>:CORR:CSET1:COMM "this is a comment"</code>
Notes	60 chars max; may not fit on display if max chars used
Preset	Unaffected by Preset. Set to empty by Restore Input/Output Defaults
State Saved	Saved in instrument state
Initial S/W Revision	A.02.00
Modified at S/W Revision	A.14.00

Edit

Invokes the integrated editing facility for this correction set.

When entering the menu, the editor window turns on, the selected correction is turned On, Apply Corrections is set to On, the amplitude scale is set to Log, and the Amplitude Correction ("Ampcor") trace is displayed. The actual, interpolated correction trace is shown in green for the selected correction. Note that since the actual interpolated correction is shown, the correction trace may have some curvature to it. This trace represents only the correction currently being edited, rather than the total, accumulated amplitude

correction for all amplitude corrections which are currently on, although the total, accumulated correction for all corrections which are turned on is still applied to the data traces.

Because corrections data is always in dB, but the Y-axis of the analyzer is in absolute units, it is necessary to establish a reference line for display of the Corrections data. The reference line is halfway up the display and represents 0 dB of correction. It is labeled "0 dB CORREC". It is drawn in blue.

Corrections data is always in dB. Whatever dB value appears in the correction table represents the correction to be applied to that trace at that frequency. So if a table entry shows 30 dB that means we ADD 30 dB to each trace to correct it before displaying it. By definition all points are connected. If a gap is desired for corrections data, enter 0 dB.

Note that a well-designed Corrections array should start at 0 dB and end at 0 dB. This is because whatever the high end point is will be extended to the top frequency of the instrument, and whatever the low end point is will be extended down to 0 Hz. So for a Corrections array to have no effect outside its range, you should start and end the array at 0 dB.

NOTE

The table editor will only operate properly if the analyzer is sweeping, because its updates are tied to the sweep system. Thus, you should not try to use the editor in single sweep, and it will be sluggish during compute-intensive operations like narrow-span FFT sweeps.

When exiting the edit menu (by using the Return key or by pressing an instrument front-panel key), the editor window turns off and the Ampcor trace is no longer displayed; however, Apply Corrections remains On, any correction that was on while in the editor remains on, and the amplitude scale returns to its previous setting.

Corrections arrays are not affected by a Preset, because they are in the Input/Output system. They also survive shutdown and restarting of the analyzer application, which means they will survive a power cycle.

When editing a correction, the editor remembers which correction and which element in the correction array you were editing, and returns you to that correction and that element when you return to the editor after leaving it.

Key Path	Input/Output, Corrections
Initial S/W Revision	A.02.00

Navigate

Lets you move through the table to edit the desired point.

Key Path	Input/Output, Corrections, Edit
Notes	There is no value readback on the key
Min	1
Max	2000
Initial S/W Revision	A.02.00

Frequency

Lets you edit the frequency of the current row.

Key Path	Input/Output, Corrections, Edit
Notes	There is no value readback on the key.
Min	0
Max	1 THz
Initial S/W Revision	A.02.00

Amplitude

Lets you edit the Amplitude of the current row.

Key Path	Input/Output, Corrections, Edit
Notes	There is no value readback on the key.
Min	-1000 dB
Max	1000 dB
Initial S/W Revision	A.02.00

Insert Point Below

Inserts a point below the current point. The new point is a copy of the current point and becomes the current point. The new point is not yet entered into the underlying table, and the data in the row is displayed in light gray.

Key Path	Input/Output, Corrections, Edit
Initial S/W Revision	A.02.00

Delete Point

Deletes the currently-selected point, whether or not that point is being edited, and selects the Navigate functionality. The point following the currently-selected point (or the point preceding if there is none) will be selected.

Key Path	Input/Output, Corrections, Edit
Initial S/W Revision	A.02.00

Scale X Axis

Matches the X Axis to the selected Correction, as well as possible. Sets the Start and Stop Frequency to contain the minimum and maximum Frequency of the selected Correction. The range between Start

Frequency and Stop Frequency is 12.5% above the range between the minimum and maximum Frequency, so that span exceeds this range by one graticule division on either side. If in zero-span, or there is no data in the Ampcor table, or the frequency range represented by the table is zero, no action is taken. Standard clipping rules apply if the value in the table is outside the allowable range for the X axis.

Key Path	Input/Output, Corrections, Edit
Dependencies	If either the first or last point in the array is outside the frequency range of the current input, an error message is generated: “-221. Settings conflict; Start or Stop Freq out of range for current input settings”
Initial S/W Revision	A.02.00

Delete Correction

Deletes the correction values for this set. When this key is pressed a prompt is placed on the screen that says “Please press Enter or OK key to delete correction. Press ESC or Cancel to close this dialog.” The deletion is only performed if you press OK or Enter.

Key Path	Input/Output, Corrections
Remote Command	[:SENSe] :CORRection:CSET [1 2 ... 6 :DELete
Example	CORR:CSET:DEL CORR:CSET1:DEL CORR:CSET4:DEL
Notes	Pressing this key when no corrections are present is accepted without error.
Initial S/W Revision	A.02.00

Apply Corrections

Applies amplitude corrections, which are marked as ON to the measured data. If this is set to OFF, then no amplitude correction sets will be used, regardless of their individual on/off settings. If set to ON, the corrections that are marked as ON (see "[Correction On/Off](#)" on page 273) are used.

Key Path	Input/Output, Corrections
Remote Command	[:SENSe] :CORRection:CSET:ALL [:STATe] ON OFF 1 0 [:SENSe] :CORRection:CSET:ALL [:STATe] ?
Example	SENS:CORR:CSET:ALL OFF This command makes sure that no amplitude corrections are applied, regardless of their individual on/off settings.
Preset	Not affected by Preset. Set to OFF by Restore Input/Output Defaults
State Saved	Saved in instrument state.
Initial S/W Revision	A.02.00

Delete All Corrections

Erases all correction values for all 4 Amplitude Correction sets.

When this key is pressed a prompt is placed on the screen that says “Please press Enter or OK key to delete all corrections. Press ESC or Cancel to close this dialog.” The deletion is only performed if you press OK or Enter.

Key Path	Input/Output, Corrections
Remote Command	[:SENSe] :CORRection:CSET:ALL:DELeTe
Example	CORR:CSET:ALL:DEL
Initial S/W Revision	A.02.00

Remote Correction Data Set Commands

This section describes the remote (SCPI) commands used to put values into correction sets. See the correction / table editor section of the Input/Output section for the information on front panel entry of correction data.

["Set \(Replace\) Data \(Remote Command Only\)" on page 283](#)

["Merge Correction Data \(Remote Command Only\)" on page 284](#)

Set (Replace) Data (Remote Command Only)

The command takes an ASCII series of alternating frequency and amplitude points, each value separated by commas.

The values sent in the command will totally replace all existing correction points in the specified set.

An Ampcor array can contain 2000 points maximum.

Remote Command	[:SENSe] :CORRection:CSET[1] 2 ... 8:DATA <freq>, <ampl>, . . . [:SENSe] :CORRection:CSET[1] 2 ... 8:DATA?
Example	CORR:CSET1:DATA 10000000, -1.0, 20000000, 1.0 This defines two correction points at (10 MHz, -1.0 dB) and (20 MHz, 1.0 dB) for correction set 1.
Preset	Empty after Restore Input/Output Defaults. Survives a shutdown or restart of analyzer application (including a power cycle).
State Saved	Saved in instrument state.
Min	Freq: 0 Hz Amptd: -1000 dBm
Max	Freq: 1 THz Amptd: +1000 dBm
Initial S/W Revision	A.02.00
Modified at S/W Revision	A.14.00

Merge Correction Data (Remote Command Only)

The command takes an ASCII series of alternating frequency and amplitude points, each value separated by commas. The difference between this command and Set Data is that this merges new correction points into an existing set.

Any new point with the same frequency as an existing correction point will replace the existing point's amplitude with that of the new point.

An Ampcor array can contain 2000 total points, maximum.

Remote Command	<code>[[:SENSe]:CORRection:CSET[1] 2 ... 8:DATA:MERGe <freq>, <ampl>, ...</code>
Example	<code>CORR:CSET1:DATA:MERGE 15000000, -5.0, 25000000, 5.0</code> This adds two correction points at (15 MHz, -5.0 dB) and (25 MHz, 5.0 dB) to whatever values already exist in correction set 1.
Preset	Empty after Restore Input/Output Defaults. Survives shutdown/restart of analyzer application (including power cycle)
Min	Freq: 0 Hz Amptd: -1000 dBm
Max	Freq: 1 THz Amptd: +1000 dBm
Initial S/W Revision	A.02.00
Modified at S/W Revision	A.14.00

Freq Ref In

Specifies the frequency reference as being the internal reference at the rear panel input labeled EXT REF IN, a 1 pulse per second signal at the EXT REF IN input,, external reference or sensing the presence of a signal at the EXT REF IN input.

When the frequency reference is set to internal, the internal 10 MHz reference is used even if an external reference is connected.

When the frequency reference is set to external, the instrument will use the external reference. However, if there is no external signal present, or it is not within the proper amplitude range, a condition error message is generated. When the external signal becomes valid, the error is cleared.

When the frequency reference is set to Pulse, the instrument expects a 1 pulse per second signal at the EXT REF IN input. The instrument uses this signal to adjust the frequency of the internal reference.

If Sense is selected, the instrument checks whether a signal is present at the external reference connector. If it senses a signal within 5 ppm of the External Ref Freq (as set on the External Ref Freq softkey), it will automatically switch to the external reference. If it senses a 1 pulse per second signal, it enters Pulse mode, wherein the signal is used to adjust the internal reference. When no signal is present, it automatically switches to the internal reference. No message is generated as the reference switches between pulse, external and internal. The monitoring of the external reference occurs approximately on 1 millisecond intervals, and never occurs in the middle of a measurement acquisition, only at the end of the measurement (end of the request).

If for any reason the instrument's frequency reference is not able to obtain lock, Status bit 1 in the Questionable Frequency register will be true and a condition error message is generated. When lock is regained, Status bit 1 in the Questionable Frequency register will be cleared and the condition error will be cleared.

If an external frequency reference is being used, you must enter the frequency of the external reference if it is not exactly 10 MHz. The External Ref Freq key is provided for this purpose.

Key Path	Input/Output
Remote Command	<code>[:SENSe] :ROSCillator :SOURce :TYPE INTernal EXTernal SENSe PULSe</code> <code>[:SENSe] :ROSCillator :SOURce :TYPE?</code>
Dependencies	The PULSe parameter, and support of the 1 pps signal at the EXT REF IN input, are not available in firmware prior to A.13.00. They are also not available in some model numbers. If not available, the Pulse key will be blank, and sending the PULSe parameter via SCPI will generate an error:
Preset	This is unaffected by a Preset but is set to SENSe on a "Restore Input/Output Defaults" or "Restore System Defaults->All".
State Saved	Saved in instrument state.
Status Bits/OPC dependencies	STATus:QUESTionable:FREQuency bit 1 set if unlocked.
Backwards Compatibility Notes	Freq Ref In was not saved in state in the legacy instruments. It is a part of state in the X-Series.
Initial S/W Revision	Prior to A.02.00
Modified at S/W Revision	A.14.00

Remote Command	<code>[:SENSe] :ROSCillator :SOURce?</code>
Notes	The query <code>[SENSe]:ROSCillator:SOURce?</code> returns the current switch setting. This means: <ol style="list-style-type: none"> 1. If it was set to SENSe but there is no external reference nor 1 pps signal so the instrument is actually using the internal reference, then this query returns INTernal and not SENSe. 2. If it was set to SENSe and there is an external reference present, the query returns EXTernal and not SENSe. 3. If it was set to SENSe and there is a 1 pps signal present, the query returns PULSe and not SENSe. 4. If it was set to EXTernal, then the query returns "EXTernal" 5. If it was set to INTernal, then the query returns "INTernal". 6. If it was set to PULSe, then the query returns "PULSe"
Preset	SENSe
Backwards Compatibility Notes	The query <code>[:SENSe] :ROSCillator :SOURce?</code> was a query-only command in ESA which always returned whichever reference the instrument was using. The instrument automatically switched to the ext ref if it was present. In PSA (which had no sensing) the command <code>[:SENSe] :ROSCillator :SOURce</code> set the reference (INT or EXT), so again its query returned the actual routing. Thus the query form of this command is 100% backwards compatible with both instruments.
Initial S/W Revision	Prior to A.02.00

Remote Command	<code>[[:SENSe]:ROSCillator:SOURce INTernal EXTernal</code>
Notes	For PSA compatibility the command form is provided and is directly mapped to <code>[[:SENSe]:ROSCillator:SOURce:TYPE</code>
Initial S/W Revision	Prior to A.02.00

Sense

If Sense is selected, the instrument checks whether a signal is present at the external reference connector. If it senses a signal within 5 ppm of the External Ref Freq (as set on the External Ref Freq softkey), it will use this signal as an External Reference. If it senses a 1 pulse per second signal, it will use this signal to adjust the internal reference by adjusting the User setting of the Timebase DAC. When no signal is present, it automatically switches to the internal reference.

Key Path	Input/Output, Freq Ref In
Example	<code>:ROSC:SOUR:TYPE SENS</code>
Couplings	If set to SENSE and the analyzer senses a 1 pulse per second signal, it sets the System, Alignments, Timebase DAC setting to "User". This setting survives Preset and Power Cycle but is set to "Calibrated" on a System, Restore Defaults, Align or a System, Restore Defaults, All
Readback	Sense
Initial S/W Revision	Prior to A.02.00
Modified at S/W Revision	A.14.00

Internal

The internal reference is used. A 1 pps signal at the EXT REF IN port, or a signal there between 1 and 50 MHz, will cause a warning triangle to appear in the settings panel next to the word "INTERNAL", but will otherwise be ignored.

Key Path	Input/Output, Freq Ref In
Example	<code>:ROSC:SOUR:TYPE INT</code>
Readback	Internal
Initial S/W Revision	Prior to A.02.00
Modified at S/W Revision	A.14.00

External

The external reference is used.

Key Path	Input/Output, Freq Ref In
Example	:ROSC:SOUR:TYPE EXT
Readback	External
Initial S/W Revision	Prior to A.02.00

Ext Ref Freq

This key tells the analyzer the frequency of the external reference. When the external reference is in use (either because the reference has been switched to External or because the Reference has been switched to Sense and there is a valid external reference present) this information is used by the analyzer to determine the internal settings needed to lock to that particular external reference signal.

For the instrument to stay locked, the value entered must be within 5 ppm of the actual external reference frequency. So it is important to get it close, or you risk an unlock condition.

Note that this value only affects the instrument's ability to lock. It does not affect any calculations or measurement results. See "Freq Offset" in the Frequency section for information on how to offset frequency values.

Key Path	Input/Output, Freq Ref In
Remote Command	[:SENSe] :ROSCillator:EXTernal:FREQuency <freq> [:SENSe] :ROSCillator:EXTernal:FREQuency?
Example	ROSC:EXT:FREQ 20 MHz sets the external reference frequency to 20 MHz, but does not select the external reference. ROSC:SOUR:TYPE EXT selects the external reference.
Dependencies	Still available with Internal or Pulse selected, to allow setup for when External is in use. However, the setting has no effect if the Internal Reference is in use (Freq Ref In set to Internal, Pulse, or SENSE:INT or SENSE:PULSE).
Preset	This is unaffected by a Preset but is set to 10 MHz on a "Restore Input/Output Defaults" or "Restore System Defaults->All"
Min	CXA: 10 MHz EXA: 10 MHz MXA: 1 MHz PXA: 1 MHz N8973B, N8974B, N8975B, or N8976B: 10 MHz
Max	CXA: 10 MHz EXA: 10 MHz EXA with option R13: 20 MHz MXA: 50 MHz PXA: 50 MHz

N8973B, N8974B, N8975B, or N8976B: 10 MHz

Default Unit	Hz
Initial S/W Revision	Prior to A.02.00
Modified at S/W Revision	A.14.00

External Reference Lock BW

This control lets you adjust the External Reference phase lock bandwidth. This control is available in some models of the X-Series.

The PXA variable reference loop bandwidth allows an external reference to be used and have the analyzer close-in phase noise improved to match that of the reference. This could result in an improvement of tens of decibels. The choice of “Wide” or “Narrow” affects the phase noise at low offset frequencies, especially 4 to 400 Hz offset. When using an external reference with superior phase noise, we recommend setting the external reference phase-locked-loop bandwidth to wide (60 Hz), to take advantage of that superior performance. When using an external reference with inferior phase noise performance, we recommend setting that bandwidth to narrow (15 Hz). In these relationships, inferior and superior phase noise are with respect to -134 dBc/Hz at 30 Hz offset from a 10 MHz reference. Because most reference sources have phase noise behavior that falls off at a rate of 30 dB/decade, this is usually equivalent to -120 dBc/Hz at 10 Hz offset.

Key Path	Input/Output, Freq Ref In
Scope	Mode Global
Remote Command	<code>[:SENSe] :ROSCillator :BANDwidth WIDE NARROW</code> <code>[:SENSe] :ROSCillator :BANDwidth ?</code>
Example	ROSC:BAND WIDE
Dependencies	Still available with Internal or Pulse selected, to allow setup for when External is in use. However, the setting has no effect if the Internal Reference is in use (Freq Ref In set to Internal, Pulse, or SENSE:INT or SENSE:PULSE). This key only appears in analyzers equipped with the required hardware.
Preset	This is unaffected by a Preset but is set to Narrow on a "Restore Input/Output Defaults" or "Restore System Defaults -> All"
State Saved	Saved in Input/Output state.
Initial S/W Revision	A.04.00
Modified at S/W Revision	A.14.00

External Ref Coupling

Only appears with option ERC installed and licensed.

This function lets you couple the sweep system of the analyzer to the state of the External Reference. If Normal is selected, data acquisition proceeds regardless of the state of the External Reference. When you select Ext Ref Out Of Range Stops Acquisition, the data acquisition (sweep or measurement) stops when either the "521, External ref out of range" or the "503, Frequency Reference unlocked" error message is asserted. Note that this will only take place if the Freq Ref In selection is External.

With the acquisition stopped, the data display will stop updating (even if this occurs in the middle of a sweep or measurement) and no data will be returned to a READ? or MEASure? query; that is, these queries will not complete because the analyzer will not respond to them. Furthermore, no response will be generated to a *WAI? or *OPC? query.

Proper SCPI sequences are shown below, which will always fail to return if the acquisition stops during the requested sweep or measurement. Note that, for predictable operation of this function, it is best to operate the analyzer in single measurement mode (INIT:CONT OFF), because if operating in continuous mode, the analyzer may respond to the above queries even after the acquisition stops, with data left over from the previous acquisition.

```
:INIT:CONT OFF
```

```
:INIT:IMM;*OPC?
```

```
--
```

```
:INIT:CONT OFF
```

```
:INIT:IMM;*WAI?
```

```
--
```

```
:INIT:CONT OFF
```

```
:READ?
```

```
--
```

```
:INIT:CONT OFF
```

```
:MEASure?
```

When the acquisition ceases, in addition to the error condition(s) described above, a popup error message will be generated informing you that the acquisition has ceased due to an invalid external reference. This message will stay on the screen while the acquisition is suspended.

External reference problem.

Data acquisition suspended.

**To resume data acquisition, fix the
problem and press the Restart key**

OR

Press the following keys:

**Input/Output, More 1 of 2, Freq Ref In,
External Ref Coupling, Normal**

OR

**Input/Output, More 1 of 2,
Freq Ref In, Internal**

If you press the Restart key this message will be taken off the screen and a new acquisition will be attempted. If the External Reference problem persists the message will re-appear. You can also remove the message by changing back to the Normal setting of Sweep/Ext Ref Coupling, or by pressing Freq Ref In, Internal, or Freq Ref In, Sense, or Restore Input/Output Defaults.

The setting of External Ref Coupling is persistent across power-cycling and is not reset with a Preset. It is reset to the default state (Normal) when Restore Input/Output Defaults is invoked, which will also restart normal data acquisition.

The detection of invalid external reference is under interrupt processing. If the external reference becomes invalid then returns to valid in too short a time, no error condition will be detected or reported and therefore the acquisition will not be stopped.

Key Path	Input/Output, Freq Ref In
Mode	All
Remote Command	<code>[:SENSe] :ROSCillator :COUPling NORMal NACquisition</code> <code>[:SENSe] :ROSCillator :COUPling ?</code>
Preset	This setting is persistent: it survives power-cycling or a Preset and is reset with Restore Input/Output defaults.
State Saved	Not saved in instrument state
Readback	Normal Stop Acq
Initial S/W Revision	A.02.00

Output Config

Accesses keys that configure various output settings, like the frequency reference output, trigger output and analog output.

Key Path	Input/Output
Backwards Compatibility Notes	In ESA there was not a user interface to enable the Video Output (Analog Output), Trigger Output, or Gate Output. In the X-Series each of these physical connectors requires configuration, thus the user interface has been added for X-Series, along with the potential for an output you think is always on to be switched off.
Initial S/W Revision	Prior to A.02.00

Trig Out

Select the type of output signal that will be output from the Trig 1 Out, or Trig 2 Out connectors.

Key Path	Input/Output, Output Config
Remote Command	<code>:TRIGger TRIGger1 TRIGger2 [:SEquence] :OUTPut HSWP MEASuring MAIN GATE GTRigger OEVEN SPOint SSWeep SSETtled S1Marker S2Marker S3Marker S4Marker OFF</code> <code>:TRIGger TRIGger1 TRIGger2 [:SEquence] :OUTPut ?</code>

Example	TRIG:OUTP HSWP TRIG2:OUTP GATE
Dependencies	The second Trigger output (Trig 2 Out) does not appear in all models; in models that do not support it, the Trig 2 Out key is blanked, and sending the SCPI command for this output generates an error, "Hardware missing; Not available for this model number" In models that do not support the Trigger 2 output, this error is returned if trying to set Trig 2 Out and a query of Trig 2 Out returns OFF.
Preset	Trigger 1: Sweeping (HSWP) Trigger 2: Gate This is unaffected by a Preset but is preset to the above values on a "Restore Input/Output Defaults" or "Restore System Defaults->All"
State Saved	Saved in instrument state
Initial S/W Revision	Prior to A.02.00

Polarity

Sets the output to the Trig 1 Out, or Trig 2 Out, connector to trigger on either the positive or negative polarity.

Key Path	Input/Output, Output Config, Trig 1/2 Output
Remote Command	:TRIGger TRIGger1 TRIGger2[:SEquence]:OUTPut:POLarity POSitive NEGative :TRIGger TRIGger1 TRIGger2[:SEquence]:OUTPut:POLarity?
Example	TRIG1:OUTP:POL POS
Preset	This is unaffected by a Preset but is set to POSitive on a "Restore Input/Output Defaults" or "Restore System Defaults->All"
State Saved	Saved in instrument state
Initial S/W Revision	Prior to A.02.00

Off

Selects no signal to be output to the Trig 1 Out, or Trig 2 Out, connector.

Key Path	Input/Output, Output Config, Trig 1/2 Output
Example	TRIG1:OUTP OFF
Readback	Off
Initial S/W Revision	Prior to A.02.00

Sweeping (HSWP)

Selects the Sweeping Trigger signal to be output to the Trig 1 Out, or Trig 2 Out, connector when a measurement is made. This signal has historically been known as "HSWP" (High = Sweeping), and is 5 V TTL level with 50 ohm output impedance.

Key Path	Input/Output, Output Config, Trig 1/2 Output
Example	TRIG1:OUTP HSWP
Readback	Sweeping
Initial S/W Revision	Prior to A.02.00

Measuring

Selects the Measuring trigger signal to be output to the Trig 1 Out, or Trig 2 Out, connector. This signal is true while the Measuring status bit is true.

Key Path	Input/Output, Output Config, Trig 1/2 Output
Example	TRIG1:OUTP MEAS
Readback	Measuring
Initial S/W Revision	Prior to A.02.00

Main Trigger

Selects the current instrument trigger signal to be output to the Trig 1 Out, or Trig 2 Out, connector.

Key Path	Input/Output, Output Config, Trig 1/2 Output
Example	TRIG1:OUTP MAIN
Readback	Main Trigger
Initial S/W Revision	Prior to A.02.00

Gate Trigger

Selects the gate trigger signal to be output to the Trig 1 Out, or Trig 2 Out, connector. This is the source of the gate timing, not the actual gate signal.

Key Path	Input/Output, Output Config, Trig 1/2 Output
Example	TRIG1:OUTP GTR
Readback	Gate Trigger
Initial S/W Revision	Prior to A.02.00

Gate

Selects the gate signal to be output to the Trig 1 Out, or Trig 2 Out, connector. The gate signal has been delayed and its length determined by delay and length settings. When the polarity is positive, a high on the Trig 1 Out, or Trig 2 Out, represents the time the gate is configured to pass the signal.

Key Path	Input/Output, Output Config, Trig 1/2 Output
Example	TRIG1:OUTP GATE
Readback	Gate
Initial S/W Revision	Prior to A.02.00

Source Point Trigger

Selects the gate signal to be output to the Trig 1 Out, or Trig 2 Out, connector for use as the Point Trigger when operating an external source in Tracking mode. When Ext Trigger 1 is selected as the Point Trigger under Source, the Source Point Trigger under Trig1 Out automatically gets selected. Similarly, when Ext Trigger 2 is selected as the Point Trigger under Source, the Source Point Trigger key under Trig 2 Out automatically gets selected

Key Path	Input/Output, Output Config, Trig 1/2 Output
Example	TRIG1:OUTP SPO
Readback	Source Point
Initial S/W Revision	Prior to A.02.00

Odd/Even Trace Point

Selects either the odd or even trace points as the signal to be output to the Trig 1 Out, or Trig 2 Out, connector when performing swept spectrum analysis. When the polarity is positive, this output goes high during the time the analyzer is sweeping past the first point (Point 0) and every other following trace point. The opposite is true if the polarity is negative.

Key Path	Input/Output, Output Config, Trig 1/2 Output
Example	TRIG1:OUTP OEV
Readback	Odd/Even
Initial S/W Revision	Prior to A.02.00

Analog Out

This menu lets you control which signal is fed to the “Analog Out” connector on the analyzer rear panel.

See ["More Information" on page 294](#)

Key Path	Input/Output, Output Config
----------	-----------------------------

Remote Command	:OUTPut:ANALog OFF SVIDeo LOGVIdео LINVIdео DAUDio :OUTPut:ANALog?
Example	OUTP:ANAL SVIDeo ! causes the analog output type to be Screen Video
Preset	This is unaffected by Preset but is set to DAUDio on a "Restore Input/Output Defaults" or "Restore System Defaults->All
Preset	OFF
State Saved	Saved in Input/Output State
Readback line	1-of-N selection [variable]
Backwards Compatibility Notes	Prior to A.04.00, OFF was the default functionality except when in the Analog Demod application or with Tune and Listen, in which case it was DAUDio, and there was no selection menu. So for backwards compatibility with earlier X-Series firmware versions, Auto (:OUTP:ANAL:AUTO ON) will duplicate the prior behavior. The DNWB and SANalyzer parameters, which were legal in PSA but perform no function in the X-Series, are accepted without error.
Initial S/W Revision	A.04.00

More Information

The table below gives the range for each output.

Analog Out	Nominal Range exc. (10% overrange)	Scale Factor	Notes
Off	0 V		
Screen Video	0 – 1 V open circuit	10%/division	8566 compatible
Log Video	0 – 1 V terminated	1/(192.66 dB/V)	dB referenced to mixer level, 1V out for -10 dBm at the mixer.
Linear Video	0 – 1 V terminated	100%/V	Linear referenced to Ref Level, 1 V out for RF envelope at the Ref Level.
Demod Audio	(varies with analyzer setting)		

Auto

Selects the Auto state for the Analog Output menu. In this state, the Analog Output will automatically be set to the most sensible setting for the current mode or measurement.

If you make a selection manually from the Analog Out menu, this selection will remain in force until you change it (or re-select Auto), even if you go to a mode or measurement for which the selected output does not apply.

Key Path	Input/Output, Output Config, Analog Out
Remote Command	OUTPut:ANALog:AUTO OFF ON 0 1 OUTPut:ANALog:AUTO?
Example	OUTP:ANAL:AUTO ON
Preset	ON
State Saved	Saved in Input/Output State
Initial S/W Revision	A.04.00

Off

Turns off the analog output.

Key Path	Input/Output, Output Config, Analog Out
Example	OUTP:ANAL OFF ! causes the analog output to be off
Readback Text	Off
Initial S/W Revision	A.04.00

Screen Video

Selects the analog output to be the screen video signal. In this mode, the pre-detector data is output to the Analog Out connector. The output looks very much like the trace displayed on the analyzer's screen, and depends on the Log/Lin display Scale, Reference Level, and dB per division, but is not influenced by the selected detector or any digital flatness corrections or trace post-processing (like Trace Averaging).

Note that this mode is similar to the Analog Output of the HP 8566 family and the Video Out (opt 124) capability of the Agilent PSA analyzer (E444x), although there are differences in the behavior.

Key Path	Input/Output, Output Config, Analog Out
Example	OUTP:ANAL SVID
Dependencies	<p>Because the Screen Video output uses one of the two IF processing channels, only one detector is available while Screen Video is selected. All active traces will change to use the same detector as the selected trace when Screen Video is activated.</p> <p>Screen Video output is not available while any EMI Detector is selected (Quasi Peak, RMS Average or EMI Average), because these detectors use both IF processing channels. Consequently, if the user chooses an EMI Detector, there will be no Screen Video output.</p> <p>The output holds at its last value during an alignment and during a marker count. After a sweep:</p> <ul style="list-style-type: none"> • If a new sweep is to follow (as in Continuous sweep mode), the output holds at its last value during the retrace before the next sweep starts. If the analyzer is in zero-span, there is no retrace, as the analyzer remains tuned to the Center Frequency and does not sweep. Therefore, in zero-span, the output simply remains live between display updates. • If no new sweep is to follow (as in Single sweep mode), the output remains live, and continues to show the pre-detector data

	This function depends on optional capability; the key will be blanked and the command will generate an "Option not available" error unless you have Option YAV or YAS licensed in your instrument.
Couplings	Screen Video output changes while in FFT Sweeps, so for measurements that use exclusively FFT Sweeps, or if the user manually chooses FFT Sweeps, the Screen Video output will look different than it does in swept mode.
Readback Text	Screen Video
Backwards Compatibility Notes	See " Backwards Compatibility: " on page 296, below.
Initial S/W Revision	A.04.00

Backwards Compatibility:

The Screen Video function is intended to be very similar to the 8566 Video Output and the PSA Option 124. However, unlike the PSA, it is not always on; it must be switched on by the Screen Video key. Also, unlike the PSA, there are certain dependencies (detailed above) – for example, the Quasi Peak Detector is unavailable when Screen Video is on.

Furthermore, the PSA Option 124 hardware was unipolar and its large range was padded to be exactly right for use as a Screen Video output. In the X-Series, the hardware is bipolar and has a wider range to accommodate the other output choices. Therefore, the outputs won't match up exactly and users may have to modify their setup when applying the X-Series in a PSA application.

Log Video (RF Envelope, Ref=Mixer Level)

Selects the analog output to be the log of the video signal. In this mode, the pre-detector data is output to the Analog Out connector with a Log scaling. The output is referenced to the current level at the mixer, does not depend on display settings like Reference Level or dB per division, and it is not influenced by the selected detector or any digital flatness corrections or trace post-processing (like Trace Averaging), but does change with input attenuation.

The output is designed so that full scale (1 V) corresponds to –10 dBm at the mixer. The full range (0–1 V) covers 192.66 dB ; thus, 0 V corresponds to –202.66 dBm at the mixer.

Key Path	Input/Output, Output Config, Analog Out
Example	OUTP:ANAL LOGV
Dependencies	<p>Because the Log Video output uses one of the two IF processing channels, only one detector is available while Screen Video is selected. All active traces will change to use the same detector as the selected trace when Log Video is activated.</p> <p>Log Video output is not available while any EMI Detector is selected (Quasi Peak, RMS Average or EMI Average), because these detectors use both IF processing channels. Consequently, if the user chooses an EMI Detector, there will be no Log Video output.</p> <p>The output holds at its last value during an alignment, during a marker count, and during retrace (after a sweep and before the next sweep starts).</p> <p>This function depends on optional capability. The key will be blanked and the command will generate an "Option not available" error unless you have Option YAV licensed in your instrument.</p>
Couplings	Log Video output changes while in FFT Sweeps, so for measurements that use exclusively FFT

	Sweeps, or if the user manually chooses FFT Sweeps, the Log Video output will look different than it does in swept mode.
Readback Text	Log Video
Initial S/W Revision	A.04.00

Linear Video (RF Envelope, Ref=Ref Level)

Selects the analog output to be the envelope signal on a linear (voltage) scale. In this mode, the pre-detector data is output to the Analog Out connector with a Linear scaling. The output is based on the current Reference Level, and is not influenced by the selected detector or any digital flatness corrections or trace post-processing (like Trace Averaging).

The scaling is set so that 1 V output occurs with an instantaneous video level equal to the reference level, and 0 V occurs at the bottom of the graticule. This scaling gives you the ability to control the gain without having another setup control for the key. But it requires you to control the look of the display (the reference level) in order to control the analog output.

This mode is ideal for looking at Amplitude Modulated signals, as the linear envelope effectively demodulates the signal.

Key Path	Input/Output, Output Config, Analog Out
Example	OUTP:ANAL LINV
Dependencies	<p>Because the Linear Video output uses one of the two IF processing channels, only one detector is available while Linear Video is selected. All active traces will change to use the same detector as the selected trace when Log Video is activated.</p> <p>Linear Video output is not available while any EMI Detector is selected (Quasi Peak, RMS Average or EMI Average), because these detectors use both IF processing channels. Consequently, if the user chooses an EMI Detector, there will be no Linear Video output.</p> <p>The output holds at its last value during an alignment and during a marker count and during retrace (after a sweep and before the next sweep starts).</p> <p>This function depends on optional capability; the key will be blanked and the command will generate an "Option not available" error unless you have Option YAV licensed in your instrument.</p>
Couplings	Linear Video output changes while in FFT Sweeps, so for measurements that use exclusively FFT Sweeps, or if the user manually chooses FFT Sweeps, the Linear Video output will look different than it does in swept mode.
Readback Text	Linear Video
Initial S/W Revision	A.04.00

Demod Audio

Selects the analog output to be the demodulation of the video signal.

When Demod Audio is selected, the demodulated audio signal appears at this output whenever the Analog Demod application is demodulating a signal or when Analog Demod Tune and Listen is operating in the Swept SA measurement.

When Analog Out is in the Auto state, this output is auto-selected when in the Analog Demod mode or when Analog Demod Tune and Listen is operating in the Swept SA measurement.

If any other Analog Output is manually selected when in the Analog Demod mode or when Analog Demod Tune and Listen is operating in the Swept SA measurement, a condition warning message appears.

Key Path	Input/Output, Output Config, Analog Out
Example	OUTP:ANAL DAUD
Dependencies	<p>This key only appears if the Analog Demod application (N9063A), the N6141A or W6141A application, or Option EMC is installed and licensed, otherwise the key will be blanked and the command will generate an "Option not available" error.</p> <p>The output holds at its last value during an alignment and during a marker count. It is not held between sweeps, in order for Tune and Listen to work properly.</p> <p>When Demod Audio is the selected Analog Output:</p> <ul style="list-style-type: none"> • all active traces are forced to use the same detector. • CISPR detectors (QPD, EMI Avg, RMS Avg) are unavailable
Readback Text	Demod Audio
Initial S/W Revision	Prior to A.02.00 (this was the default functionality, and there was no selection)
Modified at S/W Revision	A.04.00

Digital Bus

This menu allows you to configure the LVDS connector located on the rear panel of the instrument. It is a unidirectional link of real time data at a 90 MSa/s rate. The ADC is sampling a 22.5 MHz IF.

The data that appears on this port is raw, uncorrected ADC samples, unless you have option RTL. With option RTL, you get fully corrected I/Q data.

This connector will only be active when the Narrowband IF Path is currently in use.

Key Path	Input/Output, Output Config
Initial S/W Revision	A.04.00

Bus Out On/Off

When Bus Out is on, all acquisitions are streamed to the output port including acquisitions for internal purposes such as Alignment. The internal processing and routing of acquisitions continues as usual and is unaffected by the state of Bus Out.

When Bus Out is off, no signal appears on the LVDS port.

Key Path	Input/Output, Output Config, Digital Bus
Scope	Mode Global
Remote Command	<pre>:OUTPut:DBUS[1][:STATe] ON OFF 1 0 :OUTPut:DBUS[1][:STATe]?</pre>

Example	OUTP:DBUS ON
Preset	This is unaffected by a Preset but is set to Off on a "Restore Input/Output Defaults" or "Restore System Defaults -> All"
State Saved	Saved in Input/Output State
Initial S/W Revision	Prior to A.02.00
Modified at S/W Revision	A.04.00

I/Q Cal Out

The Baseband I/Q "Cal Out" port can be turned on with either a 1 kHz or a 250 kHz square wave. This can be turned on independent of the input selection. A Preset will reset this to Off.

Key Path	Input/Output, Output Config
Remote Command	:OUTPut:IQ:OUTPut IQ1 IQ250 OFF :OUTPut:IQ:OUTPut?
Example	OUTP:IQ:OUTP IQ1
Couplings	An I/Q Cable Calibration or an I/Q Probe Calibration will change the state of the Cal Out port as needed by the calibration routine. When the calibration is finished the I/Q Cal Out is restored to the pre-calibration state.
Preset	Off
State Saved	Saved in instrument state
Range	1 kHz Square Wave 250 kHz Square Wave Off
Readback Text	1 kHz 250 kHz Off
Initial S/W Revision	Prior to A.02.00

1 kHz Square Wave

Turns on the 1 kHz square wave signal at the Cal Out port. This choice is only available with option BBA.

Key Path	Input/Output, Output Config, I/Q Cal Out
Readback	I/Q 1kHz
Initial S/W Revision	Prior to A.02.00

250 kHz Square Wave

Turns on the 250 kHz square wave signal at the Cal Out port. This choice is only available with option BBA.

Key Path	Input/Output, Output Config, I/Q Cal Out
Readback	I/Q 250kHz
Initial S/W Revision	Prior to A.02.00

Off

Turns off the signal at the Cal Out port. This choice is only available with option BBA.

Key Path	Input/Output, Output Config, I/Q Cal Out
Readback	Off
Initial S/W Revision	Prior to A.02.00

Aux IF Out

This menu controls the signals that appear on the SMA output on the rear panel labeled “AUX IF OUT

The Aux IF Out functionality is only valid for RF and External Mixer inputs. When using the External Mixing path, the Aux IF Out levels (for all three Options CR3, CRP, and ALV) will be uncalibrated because the factory default Aux IF level was set to accommodate the expected IF levels for the RF path.

Key Path	Input/Output, Output Config
Remote Command	:OUTPut:AUX SIF AIF LOGVideo OFF :OUTPut:AUX?
Dependencies	The softkey does not appear in models that do not support the Aux IF Out.
Preset	This is unaffected by a Preset but is set to OFF on a "Restore Input/Output Defaults" or "Restore System Defaults->All"
State Saved	Saved in Input/Output state
Readback line	1-of-N selection [variable]
Backwards Compatibility Notes	In the PSA, the IF output has functionality equivalent to the "Second IF" function in the X-Series' Aux IF Out menu. In the X-Series, it is necessary to switch the Aux IF Out to “Second IF” to get this functionality, whereas in PSA it is always on, since there are no other choices. Hence a command to switch this function to “Second IF” will have to be added by customers migrating from PSA who use the IF Output in PSA.
Initial S/W Revision	A.04.00

Off

In this mode nothing comes out of the “AUX IF OUT” connector on the rear panel. The connector appears as an open-circuit (that is, it is not terminated in any way).

Key Path	Input/Output, Output Config, Aux IF Out
Example	OUTP:AUX OFF causes the aux output type to be off
Readback Text	Off
Initial S/W Revision	A.04.00

Second IF

In this mode the 2nd IF output is routed to the rear panel connector. The annotation on the key shows the current 2nd IF frequency in use in the analyzer.

The frequency of the 2nd IF depends on the current IF signal path as shown in the table below:

IF Path Selected	Frequency of "Second IF" Output
10 MHz	322.5 MHz
25 MHz	322.5 MHz
40 MHz	250 MHz
140 MHz	300 MHz

The signal quality, such as signal to noise ratio and phase noise, are excellent in this mode.

Key Path	Input/Output, Output Config, Aux IF Out
Example	OUTP:AUX SIF causes the aux output type to be Second IF
Dependencies	Does not appear unless Option CR3 is installed.
Readback Text	Second IF
Initial S/W Revision	A.04.00

Arbitrary IF

In this mode the 2nd IF output is mixed with a local oscillator and mixer to produce an arbitrary IF output between 10 MHz and 75 MHz with 500 kHz resolution. The phase noise in this mode will not be as good as in Second IF mode.

The IF output frequency is adjustable, through an active function which appears on the Arbitrary IF selection key, from 10 MHz to 75 MHz with 500 kHz resolution.

The bandwidth of this IF output varies with band and center frequency, but is about 40 MHz at the -3 dB width. When the output is centered at lower frequencies in its range, signal frequencies at the bottom of the bandwidth will "fold". For example, with a 40 MHz bandwidth (20 MHz half-bandwidth), and a 15 MHz IF center, a signal -20 MHz relative to the spectrum analyzer center frequency will have a relative response of about -3 dB with a frequency 20 MHz below the 15 MHz IF center. This -5 MHz frequency will fold to become a +5 MHz signal at the IF output. Therefore, lower IF output frequencies are only useful with known band-limited signals.

Key Path	Input/Output, Output Config, Aux IF Out
Example	OUTP:AUX AIF causes the aux output type to be the Arbitrary IF
Dependencies	Does not appear unless Option CRP is installed.
Readback Text	Arbitrary IF
Initial S/W Revision	A.04.00

Key Path	Input/Output, Output Config, Aux IF Out
Scope	Mode Global
Remote Command	:OUTPut:AUX:AIF <value> :OUTPut:AUX:AIF?
Example	:OUTP:AUX:AIF 50 MHZ
Preset	This is unaffected by a Preset but is set to 70 MHz on a "Restore Input/Output Defaults" or "Restore System Defaults->All"
State Saved	Saved in Input/Output State
Min	10 MHz
Max	75 MHz
Default Unit	Hz
Initial S/W Revision	A.04.00

Fast Log Video

In this mode the 2nd IF output is passed through a log amp and the log envelope of the IF signal is sent to the rear panel. The open circuit output level varies by about 25 mV per dB, with a top-of-screen signal producing about 1.6 Volts. The output impedance is nominally 50 ohms.

This mode is intended to meet the same needs as Option E4440A-H7L Fast Rise Time Video Output on the Agilent E4440A PSA Series, allowing you to characterize pulses with fast rise times using standard measurement suites on modern digital scopes.

Key Path	Input/Output, Output Config, Aux IF Out
Example	OUTP:AUX LOGVideo causes the aux output type to be Fast Log Video
Dependencies	Does not appear unless Option ALV is installed. The output is off during an alignment but not during a marker count, and is not blanked during retrace (after a sweep and before the next sweep starts).
Readback Text	Fast Log Video
Initial S/W Revision	A.04.00

I/Q Guided Calibration

Calibrating the Baseband I/Q ports requires several steps and manual connections. The Guided Calibration will interactively step you through the required steps, displaying diagrams to help with the connections. The steps will vary depending on the setup.

In the Guided Calibration windows, the date and time of the last calibration are displayed. If any of the items listed are displayed in yellow, this indicates that the calibration for that item is inconsistent with the latest calibration, and you should complete the entire calibration process before you exit the calibration.

I/Q Isolation Calibration

The I/Q Isolation Calibration must be run before calibrating any port with either the I/Q Cable Calibration or I/Q Probe Calibration. This calibration is performed with nothing connected to any of the front panel I/Q ports. This is the first step in both the I/Q Cable Calibration and the I/Q Probe Calibration.

Next

Perform the I/Q Isolation calibration.

Key Path	Input/Output, I/Q, I/Q Cable Calibration
Remote Command	:CALibration:IQ:ISOLation
Example	CAL:IQ:ISOL
Notes	All front panel I/Q ports must not be connected to anything.
Notes	All cables and probes should be disconnected from the I/Q ports before issuing the SCPI command.
State Saved	No.
Initial S/W Revision	Prior to A.02.00

Exit

Exits the calibration procedure. All ports calibrated before pressing Exit will use the newly acquired calibration data.

Key Path	Input/Output, I/Q, I/Q Cable Calibration
Notes	Using the Exit button will not restore the calibration data to the state prior to entering the guided calibration. Once a port is calibrated the data is stored immediately and the only way to change it is to redo the calibration step. When the calibration may be left in an inconsistent state, a confirmation dialog will be displayed (see "Exit Confirmation" on page 314).
Initial S/W Revision	Prior to A.02.00

I/Q Isolation Calibration Time (Remote Command Only)

Returns the last date and time that the I/Q Isolation Calibration was performed. This is a remote query command only.

Remote Command	:CALibration:IQ:ISOLation:TIME?
Example	:CAL:IQ:ISOL:TIME?
Notes	This returns 6 integer values: year, month, day, hour, minute, second. When no calibration has been performed, all values will be 0.
Initial S/W Revision	A.02.00

I/Q Cable Calibrate...

The I/Q cable calibration creates correction data for each of the front panel I/Q ports. This calibration data is used whenever no probe specific calibration data is available. It is important that all ports are calibrated using the same short BNC cable so that the data is comparable from port to port.

The guided calibration (front panel only) will show connection diagrams and guide you through the isolation calibration and calibrating each port. The calibration data for each port is stored separately, so as soon as a port is calibrated that data is saved and will be used. If you press "Exit" to exit the calibration process, the data for the ports already completed will still be used. It is recommended that a calibration be completed once started, or if exited, that it be properly done before the next use of the I/Q ports. The "Next" button will perform the calibration for the current port and then proceed to the next step in the calibration procedure. The "Back" button will return to the prior port in the procedure. Both keys and dialog buttons are supplied for ease of use. The dialog buttons are for mouse use and the softkeys for front panel use.

The calibration can also be done via SCPI, but no connection diagrams will be shown. You will have to make the correct connections before issuing each port calibration command. Again, it is recommended that all ports be calibrated at the same time.

The instrument state remains as it was prior to entering the calibration procedure except while a port is actually being calibrated. Once a port is calibrated it returns to the prior state. A port calibration is in process only from the time the "Next" button is pressed until the next screen is shown. For SCPI, this corresponds to the time from issuing the CAL:IQ:FLAT:|I|B|Q|QB command until the operation is complete.

For example, if the prior instrument state is Cal Out = Off, Input = I+jQ, and Differential = Off, then up until the time the "Next" button is pressed the I Input and Q Input LEDs are on and the Cal Out, I-bar Input and Q-bar Input LEDs are off. Once the "Next" button is pressed for the I port calibration, only the Cal Out and I Input LEDs will be on and the others will be off. When the screen progresses to the next step ("Next" button again enabled), the prior state is restored and only the I Input and Q Input LEDs are on (Cal Out is off again).

The last calibration date and time for each port will be displayed. Any calibrations that are more than a day older than the most recent calibration will be displayed with the color amber.

Key Path	Input/Output, I/Q
Initial S/W Revision	Prior to A.02.00

I Port

The I port calibration is performed with the front panel's I port connected via a short BNC cable to the Cal Out port. The guided calibration will show a diagram of the required connections.

Back

Return to the prior step in the calibration procedure.

Key Path	Input/Output, I/Q, Q Setup, Q Probe, Calibrate
Initial S/W Revision	Prior to A.02.00

Next

Perform the I port calibration.

Key Path	Input/Output, I/Q, I/Q Cable Calibrate...
Remote Command	:CALibration:IQ:FLATness:I
Example	CAL:IQ:FLAT:I
Notes	The recommended procedure is to use the same BNC cable to calibrate all I/Q ports. All I/Q ports should be calibrated sequentially during the procedure. The calibration data is saved as soon as the port is calibrated and will survive power cycles. It is not reset by any preset or restore data commands.
Notes	The I port must be connected to the Cal Out port before issuing the SCPI command.
State Saved	No.
Initial S/W Revision	Prior to A.02.00

Exit

Exit the calibration procedure. All ports calibrated before pressing Exit will use the newly acquired calibration data.

Key Path	Input/Output, I/Q, I/Q Cable Calibrate...
Notes	Using the Exit button will not restore the calibration data to the state prior to entering the guided calibration. Once a port is calibrated the data is stored immediately and the only way to change it is to redo the calibration step. When the calibration may be left in an inconsistent state, a confirmation dialog will be displayed (see "Exit Confirmation" on page 314).
Initial S/W Revision	Prior to A.02.00

I-bar Port

The I-bar port calibration is performed with the front panel's I-bar port connected via a short BNC cable to the Cal Out port. The guided calibration will show a diagram of the required connections.

Back

Return to the prior step in the calibration procedure.

Key Path	Input/Output, I/Q, I/Q Cable Calibration
Notes	Using the Back button will not restore the calibration data to a prior state. Once a port is calibrated the data is stored immediately and the only way to change it is to redo the calibration step. The Back button allows the user to go back to a prior step to redo that calibration step.
Initial S/W Revision	Prior to A.02.00

Next

Perform the I-bar port calibration.

Key Path	Input/Output, I/Q, I/Q Cable Calibrate...
Remote Command	:CALibration:IQ:FLATness:IBAR
Example	CAL:IQ:FLAT:IBAR
Notes	The recommended procedure is to use the same BNC cable to calibrate all I/Q ports. All I/Q ports should be calibrated sequentially during the procedure. The calibration data is saved as soon as the port is calibrated and will survive power cycles. It is not reset by any preset or restore data commands.
Notes	The I-bar port must be connected to the Cal Out port before issuing the SCPI command.
State Saved	No
Initial S/W Revision	Prior to A.02.00

Exit

Exit the calibration procedure. All ports calibrated before pressing Exit will use the newly acquired calibration data.

Key Path	Input/Output, I/Q, I/Q Cable Calibrate...
Notes	Using the Exit button will not restore the calibration data to the state prior to entering the guided calibration. Once a port is calibrated the data is stored immediately and the only way to change it is to redo the calibration step. When the calibration may be left in an inconsistent state, a confirmation dialog will be displayed (see "Exit Confirmation" on page 314).
Initial S/W Revision	Prior to A.02.00

Q Port

The Q port calibration is performed with the front panel's Q port connected via a short BNC cable to the Cal Out port. The guided calibration will show a diagram of the required connections.

Back

Return to the prior step in the calibration procedure.

Key Path	Input/Output, I/Q, I/Q Cable Calibrate...
Notes	Using the Back button will not restore the calibration data to a prior state. Once a port is calibrated the data is stored immediately and the only way to change it is to redo the calibration step. The Back button allows the user to go back to a prior step to redo that calibration step.
Initial S/W Revision	Prior to A.02.00

Next

Perform the Q port calibration.

Key Path	Input/Output, I/Q, I/Q Cable Calibrate...
Remote Command	:CALibration:IQ:FLATness:Q
Example	CAL:IQ:FLAT:Q
Notes	The recommended procedure is to use the same BNC cable to calibrate all I/Q ports. All I/Q ports should be calibrated sequentially during the procedure. The calibration data is saved as soon as the port is calibrated and will survive power cycles. It is not reset by any preset or restore data commands.
Notes	The Q port must be connected to the Cal Out port before issuing the SCPI command.
State Saved	No
Initial S/W Revision	Prior to A.02.00

Exit

Exit the calibration procedure. All ports calibrated before pressing Exit will use the newly acquired calibration data.

Key Path	Input/Output, I/Q, I/Q Cable Calibrate...
Notes	Using the Exit button will not restore the calibration data to the state prior to entering the guided calibration. Once a port is calibrated the data is stored immediately and the only way to change it is to redo the calibration step. When the calibration may be left in an inconsistent state, a confirmation dialog will be displayed (see "Exit Confirmation" on page 314).
Initial S/W Revision	Prior to A.02.00

Q-bar Port

The Q-bar port calibration is performed with the front panel's Q-bar port connected via a short BNC cable to the Cal Out port. The guided calibration will show a diagram of the required connections.

Back

Return to the prior step in the calibration procedure.

Key Path	Input/Output, I/Q, I/Q Cable Calibrate...
Notes	Using the Back button will not restore the calibration data to a prior state. Once a port is calibrated the data is stored immediately and the only way to change it is to redo the calibration step. The Back button allows the user to go back to a prior step to redo that calibration step.
Initial S/W Revision	Prior to A.02.00

Next

Perform the Q-bar port calibration.

Key Path	Input/Output, I/Q, I/Q Cable Calibrate...
Remote Command	:CALibration:IQ:FLATness:QBAR
Example	CAL:IQ:FLAT:QBAR
Notes	The recommended procedure is to use the same BNC cable to calibrate all I/Q ports. All I/Q ports should be calibrated sequentially during the procedure. The calibration data is saved as soon as the port is calibrated and will survive power cycles. It is not reset by any preset or restore data commands.
Notes	The Q-bar port must be connected to the Cal Out port before issuing the SCPI command.
State Saved	No
Initial S/W Revision	Prior to A.02.00

Exit

Exit the calibration procedure. All ports calibrated before pressing Exit will use the newly acquired calibration data.

Key Path	Input/Output, I/Q, I/Q Cable Calibrate...
Notes	Using the Exit button will not restore the calibration data to the state prior to entering the guided calibration. Once a port is calibrated the data is stored immediately and the only way to change it is to redo the calibration step. When the calibration may be left in an inconsistent state, a confirmation dialog will be displayed (see " Exit Confirmation " on page 314).
Initial S/W Revision	Prior to A.02.00

I/Q Cable Calibration Time (Remote Command Only)

Returns the last date and time that the I/Q Cable Calibration was performed for a specific port. This is a remote query command only.

Remote Command	:CALibration:IQ:FLATness:I IBAR Q QBAR:TIME?
Example	:CAL:IQ:FLAT:I:TIME?
Notes	This returns 6 integer values: year, month, day, hour, minute, second. When no calibration has been performed, all values will be 0.
Initial S/W Revision	A.02.00

I/Q Probe Calibration

The I/Q probe calibration creates correction data for one of the front panel I/Q channels. When the probe has EEPROM identification, the data is unique to that specific probe. When the probe does not have

EEPROM identification, the data will be used for all probes of the same type. The data is also unique to the channel, so calibration data for the I channel will not be used for the Q channel and vice versa.

The guided calibration (front panel only) will show connection diagrams and guide the user through the I/Q Isolation Calibration and through calibrating each port. The calibration data for each port is stored separately, so as soon as a port is calibrated that data is saved and will be used. If a user presses "Exit" to exit the calibration process, the data for the port already completed will still be used. It is recommended that a calibration be completed once started, or if exited, that it be properly done before the next use of the probe. The "Next" button will perform the calibration for the current port and then proceed to the next step in the calibration procedure. The "Back" button will return to the prior port in the procedure. Both softkeys and dialog buttons are supplied for ease of use. The dialog buttons are for mouse use and the softkeys for front panel use.

The calibration can also be done via SCPI, but no connection diagrams will be shown. The user will have to make the correct connections before issuing each port calibration command. Again, it is recommended that all ports be calibrated at the same time.

For Active probes or when Differential is Off, only the main port is calibrated, otherwise both the main and complementary ports are calibrated.

The instrument state remains as it was prior to entering the calibration procedure except while a port is actually being calibrated. Once a port is calibrated it returns to the prior state. A port calibration is in process only from the time the "Next" button is pressed until the next screen is shown. For SCPI, this corresponds to the time from issuing the CAL:IQ:PROB:|I|B|Q|QB command until the operation is complete.

For example, if the prior instrument state is Cal Out = Off, Input = I+jQ, and Differential = Off, then up until the time the "Next" button is pressed the I Input and Q Input LEDs are on and the Cal Out, I-bar Input and Q-bar Input LEDs are off. Once the "Next" button is pressed for the I port calibration, only the Cal Out and I Input LEDs will be on and the others will be off. When the screen progresses to the next step ("Next" button again enabled), the prior state is restored and only the I Input and Q Input LEDs are on (Cal Out is off again).

The last calibration date and time for each relevant port will be displayed. For passive probes with Differential On, any calibration that is more than a day older than the most recent calibration will be displayed with the color amber.

I Port

The I port calibration is performed with the probe body attached to the front panel's I port and the probe tip connected via an adapter to the Cal Out port. The guided calibration will show a diagram of the required connections.

Show Adapter

Show a connection diagram and instructions for the probe and adapter. See ["Show Adapter Screen" on page 314](#).

Key Path	Input/Output, I/Q, I Setup, I Probe, Calibrate
Notes	Either a passive or an active probe adapter diagram will be shown, depending on the type of probe attached.
Initial S/W Revision	Prior to A.02.00

Back

Return to the prior step in the calibration procedure.

Key Path	Input/Output, I/Q, Q Setup, Q Probe, Calibrate
Initial S/W Revision	Prior to A.02.00

Next

Perform the I port calibration.

Key Path	Input/Output, I/Q, I Setup, I Probe, Calibrate
Remote Command	:CALibration:IQ:PROBe:I
Example	CAL:IQ:PROB:I
Notes	The I port must be connected to the Cal Out port before issuing the SCPI command. The calibration data is saved as soon as the port is calibrated and will survive power cycles. It is not reset by any preset or restore data commands.
State Saved	No
Initial S/W Revision	Prior to A.02.00

Exit

Exit the calibration procedure. All ports calibrated before pressing Exit will use the newly acquired calibration data.

Key Path	Input/Output, I/Q, I Setup, I Probe, Calibrate
Notes	Using the Exit button will not restore the calibration data to the state prior to entering the guided calibration. Once a port is calibrated the data is stored immediately and the only way to change it is to redo the calibration step. When the calibration may be left in an inconsistent state, a confirmation dialog will be displayed (see "Exit Confirmation" on page 314).
Initial S/W Revision	Prior to A.02.00

I-bar Port

The I-bar port calibration is performed with the probe body attached to the front panel's I-bar port and the probe tip connected via an adapter to the Cal Out port. The I-bar probe calibration is only available for passive probes with Differential On. The guided calibration will show a diagram of the required connections.

Show Adapter

Show a connection diagram and instructions for the probe and adapter. See ["Show Adapter Screen" on page 314](#).

Key Path	Input/Output, I/Q, I Setup, I Probe, Calibrate
Notes	Either a passive or an active probe adapter diagram will be shown, depending on the type of probe attached.
Initial S/W Revision	Prior to A.02.00

Back

Return to the prior step in the calibration procedure.

Key Path	Input/Output, I/Q, I Setup, I Probe, Calibrate
Notes	Using the Back button will not restore the calibration data to a prior state. Once a port is calibrated the data is stored immediately and the only way to change it is to redo the calibration step. The Back button allows the user to go back to a prior step to redo that calibration step.
Initial S/W Revision	Prior to A.02.00

Next

Perform the I-bar port calibration.

Key Path	Input/Output, I/Q, I Setup, I Probe, Calibrate
Remote Command	:CALibration:IQ:PROBe:IBar
Example	CAL:IQ:PROB:IB
Notes	The I-bar port must be connected to the Cal Out port before issuing the SCPI command. The calibration data is saved as soon as the port is calibrated and will survive power cycles. It is not reset by any preset or restore data commands.
State Saved	No
Initial S/W Revision	Prior to A.02.00

Exit

Exit the calibration procedure. All ports calibrated before pressing Exit will use the newly acquired calibration data.

Key Path	Input/Output, I/Q, I Setup, I Probe, Calibrate
Notes	Using the Exit button will not restore the calibration data to the state prior to entering the guided calibration. Once a port is calibrated the data is stored immediately and the only way to change it is to redo the calibration step. When the calibration may be left in an inconsistent state, a confirmation dialog will be displayed (see " Exit Confirmation " on page 314).
Initial S/W Revision	Prior to A.02.00

Q Port

The Q port calibration is performed with the probe body attached to the front panel's Q port and the probe tip connected via an adapter to the Cal Out port. The guided calibration will show a diagram of the required connections.

Show Adapter

Show a connection diagram and instructions for the probe and adapter. See ["Show Adapter Screen" on page 314](#).

Key Path	Input/Output, I/Q, Q Setup, Q Probe, Calibrate
Notes	Either a passive or an active probe adapter diagram will be shown, depending on the type of probe attached.
Initial S/W Revision	Prior to A.02.00

Back

Return to the prior step in the calibration procedure.

Key Path	Input/Output, I/Q, Q Setup, Q Probe, Calibrate
Initial S/W Revision	Prior to A.02.00

Next

Perform the Q port calibration.

Key Path	Input/Output, I/Q, Q Setup, Q Probe, Calibrate
Remote Command	:CALibration:IQ:PROBe:Q
Example	CAL:IQ:PROB:Q
Notes	The Q port must be connected to the Cal Out port before issuing the SCPI command. The calibration data is saved as soon as the port is calibrated and will survive power cycles. It is not reset by any preset or restore data commands.
State Saved	No
Initial S/W Revision	Prior to A.02.00

Exit

Exit the calibration procedure. All ports calibrated before pressing Exit will use the newly acquired calibration data.

Key Path	Input/Output, I/Q, Q Setup, Q Probe, Calibrate
Notes	Using the Exit button will not restore the calibration data to the state prior to entering the guided calibration. Once a port is calibrated the data is stored immediately and the only way to change it is

to redo the calibration step.

When the calibration may be left in an inconsistent state, a confirmation dialog will be displayed (see ["Exit Confirmation" on page 314](#)).

Initial S/W Revision	Prior to A.02.00
----------------------	------------------

Q-bar Port

The Q-bar port calibration is performed with the probe body attached to the front panel's Q-bar port and the probe tip connected via an adapter to the Cal Out port. The Q-bar probe calibration is only available for passive probes with Differential On. The guided calibration will show a diagram of the required connections.

Show Adapter

Show a connection diagram and instructions for the probe and adapter. See ["Show Adapter Screen" on page 314](#).

Key Path	Input/Output, I/Q, Q Setup, Q Probe, Calibrate
Notes	Either a passive or an active probe adapter diagram will be shown, depending on the type of probe attached.
Initial S/W Revision	Prior to A.02.00

Back

Return to the prior step in the calibration procedure.

Key Path	Input/Output, I/Q, Q Setup, Q Probe, Calibrate
Notes	Using the Back button will not restore the calibration data to a prior state. Once a port is calibrated the data is stored immediately and the only way to change it is to redo the calibration step. The Back button allows the user to go back to a prior step to redo that calibration step.
Initial S/W Revision	Prior to A.02.00

Next

Perform the Q-bar port calibration.

Key Path	Input/Output, I/Q, Q Setup, Q Probe, Calibrate
Remote Command	:CALibration:IQ:PROBe:QBar
Example	CAL:IQ:PROB:QB
Notes	The Q-bar port must be connected to the Cal Out port before issuing the SCPI command. The calibration data is saved as soon as the port is calibrated and will survive power cycles. It is not reset by any preset or restore data commands.
State Saved	No
Initial S/W Revision	Prior to A.02.00

Exit

Exit the calibration procedure. All ports calibrated before pressing Exit will use the newly acquired calibration data.

Key Path	Input/Output, I/Q, Q Setup, Q Probe, Calibrate
Notes	Using the Exit button will not restore the calibration data to the state prior to entering the guided calibration. Once a port is calibrated the data is stored immediately and the only way to change it is to redo the calibration step. When the calibration may be left in an inconsistent state, a confirmation dialog will be displayed (see "Exit Confirmation" on page 314).
Initial S/W Revision	Prior to A.02.00

Show Adapter Screen

When one of the Probe Calibration Show Adapter buttons is pressed, a diagram of the probe with its adapter will be shown. Depending on the type of probe attached, either the Passive Probe Adapter or the Active Probe Adapter diagram will be shown.

I/Q Probe Calibration Time (Remote Command Only)

Return the last date and time that the I/Q Probe Calibration was performed for a specific port. This is a remote query command only.

Remote Command	:CALibration:IQ:PROBE:I IBAR Q QBAR:TIME?
Example	:CAL:IQ:PROB:I:TIME?
Notes	This returns 6 integer values: year, month, day, hour, minute, second. When no calibration has been performed, all values will be 0. The value is specific to both the port and probe, so the value will change as probes are connected or disconnected.
Initial S/W Revision	A.02.00

Exit Confirmation

When Exit is pressed during one of the calibration routines, the calibration may be in an inconsistent state with some of the ports having newly measured calibration data and others with old data. If this is the case, a dialog box will appear to confirm that the user really wants to exit. A "Yes" answer will exit the calibration procedure, leaving potentially inconsistent calibration data in place. A "No" answer will return to the calibration procedure.

5 Mode Functions

Mode

The Mode key allows you to select the available measurement applications or “Modes”. Modes are a collection of measurement capabilities packaged together to provide an instrument personality that is specific to your measurement needs. Each application software product is ordered separately by Model Number and must be licensed to be available. Once an instrument mode is selected, only the commands that are valid for that mode can be executed.

NOTE

Key operation can be different between modes. The information displayed in Help is about the current mode.

To access Help for a different Mode you must first exit Help (by pressing the Cancel (Esc) key). Then select the desired mode and re-access Help.

For more information on Modes, preloading Modes, and memory requirements for Modes,

see ["More Information" on page 317](#)

Key Path	Front-panel key
Remote Command	:INSTrument[:SElect] SA RTSA SEQAN EMI BASIC WCDMA EDGE GSM WIMAXOFDMA VSA PNOISE NFIGure ADEMOD BTooth TDSCDMA CDMA2K CDMA1XEV LTE LTETDD LTEAFDD LTEATDD MSR DVB DTMB DCATV ISDBT CMMB WLAN CWLAN CWIMAXOFDM WIMAXFIXED IDEN RLC SCPI LC VSA89601 :INSTrument[:SElect]?
Example	:INST SA
Notes	The available parameters are dependent upon installed and licensed applications resident in the instrument. Parameters given here are an example, specific parameters are in the individual Application. A list of the valid mode choices is returned with the INST:CAT? Query.
Preset	This is unaffected by a Preset but is set on a “Restore System Defaults->All” to: For N9038A: EMI For N8973B, N8974B, N8975B, or N8976B: NFIG For all other models: SA
State Saved	Saved in instrument state
Backwards Compatibility SCPI	:INSTrument[:SElect] GSM provided for backwards compatibility. Mapped to EDGE GSM.
Backwards Compatibility SCPI	:INSTrument[:SElect] SANalyzer provided for ESU compatibility. When this command is received, the analyzer aliases it to the following: INST:SEL SCPI LC This results in the analyzer being placed in SCPI Language Compatibility Mode, in order to emulate

	the ESU Spectrum Analyzer Mode.
Backwards Compatibility SCPI	:INSTrument[:SElect] RECeiver provided for ESU compatibility. When this command is received, the analyzer aliases it to the following: :INST:SEL EMI :CONF FSC This results in the analyzer being placed in the EMI Receiver Mode, running the Frequency Scan measurement, in order to emulate the ESU Receiver Mode.
Initial S/W Revision	Prior to A.02.00
Modified at S/W Revision	A.13.00

Example	:INST 'SA'
Notes	The query is not a quoted string. It is an enumeration as indicated in the Instrument Select table above. The command must be sequential: i.e. continued parsing of commands cannot proceed until the instrument select is complete and the resultant SCPI trees are available.
Backwards Compatibility SCPI	:INSTrument[:SElect] 'SA' 'PNOISE' 'EDGE' 'GSM' 'BASIC'
Initial S/W Revision	Prior to A.02.00

More Information

The Mode name appears on the banner after the word “Agilent” followed by the Measurement Title. For example, for the Spectrum Analyzer mode with the Swept SA measurement running:



It is possible to specify the order in which the Modes appear in the Mode menu, using the Configure Applications utility (System, Power On, Configure Applications). It is also possible, using the same utility, to specify a subset of the available applications to load into memory at startup time, which can significantly decrease the startup time of the analyzer. During runtime, if an application that is not loaded into memory is selected (by either pressing that applications Mode key or sending that applications :INST:SEL command over SCPI), there will be a pause while the Application is loaded. During this pause a message box that says “Loading application, please wait...” is displayed.

Each application (Mode) that runs in the X-Series signal analyzers consumes virtual memory. The various applications consume varying amounts of virtual memory, and as more applications run, the memory consumption increases. Once an application is run, some of its memory remains allocated even when it is not running, and is not released until the analyzer program (xSA.exe) is shut down.

Agilent characterizes each Mode and assigns a memory usage quantity based on a conservative estimate. There is a limited amount of virtual memory available to applications (note that this is virtual memory and is independent of how much physical RAM is in the instrument). The instrument keeps track of how much

memory is being used by all loaded applications – which includes those that preloaded at startup, and all of those that have been run since startup.

When you request a Mode that is not currently loaded, the instrument looks up the memory estimate for that Mode, and adds it to the residual total for all currently loaded Modes. If there is not enough virtual memory to load the Mode, a dialog box and menu will appear that gives you four options:

1. Close and restart the analyzer program without changing your configured preloads. This may free up enough memory to load the requested Mode, depending on your configured preloads
2. Clear out all preloads and close and restart the analyzer program with only the requested application preloaded, and with that application running. This choice is guaranteed to allow you to run the requested application; but you will lose your previously configured preloads. In addition, there may be little or no room for other applications, depending on the size of the requested application.
3. Bring up the Configure Applications utility in order to reconfigure the preloaded apps to make room for the applications you want to run (this will then require restarting the analyzer program with your new configuration). This is the recommended choice because it gives you full flexibility to select exactly what you want.
4. Exit the dialog box without doing anything, which means you will be unable to load the application you requested.

In each case except 4, this will cause the analyzer software to close, and you will lose all unsaved traces and results.

If you attempt to load a mode via SCPI that will exceed memory capacity, the Mode does not load and an error message is returned:

```
-225,"Out of memory;Insufficient resources to load Mode (mode name)"
```

where “mode name” is the SCPI parameter for the Mode in question, for example, SA for Spectrum Analyzer Mode.

Spectrum Analyzer

Selects the Spectrum Analyzer mode for general purpose measurements. There are several measurements available in this mode. General spectrum analysis measurements, in swept and zero span, can be done using the first key in the Meas menu, labeled Swept SA. Other measurements in the Meas Menu are designed to perform specialized measurement tasks, including power and demod measurements.

If you are using the Help feature, this mode must be currently active to access its detailed information. If it is not active, exit the Help feature (Esc key), select the mode, and re-access Help.

Key Path	Mode
Example	INST:SEL SA INST:NSEL 1
Initial S/W Revision	Prior to A.02.00

Noise Figure

The Noise Figure mode provides pre-configured measurements for making general purpose measurements of device noise figure.

If you are using the Help feature, this mode must be currently active to access its detailed information. If it is not active, exit the Help feature (Esc key), select the mode, and re-access Help.

Key Path	Mode
Example	INST:SEL NFIGURE INST:NSEL 219
Initial S/W Revision	Prior to A.02.00

Vector Signal Analyzer (VXA)

The N9064A (formerly 89601X) VXA Vector signal and WLAN modulation analysis application provides solutions for basic vector signal analysis, analog demodulation, and digital demodulation. The digital demodulation portion of N9064A allows you to perform measurements on standard-based formats such as cellular, wireless networking and digital video as well as general purpose flexible modulation analysis for wide range of digital formats, FSK to 1024QAM, with easy-to-use measurements and display tools such as constellation and eye diagram, EVM traces and up to four simultaneous displays. Analog baseband analysis is available using the MXA and PXA with option BBA. Option 3FP WLAN has been discontinued.

N9064A honors existing 89601X licenses with all features and functionalities found on X-Series software versions prior to A.06.00. Specifically:

N9064A-1 is equivalent to 89601X-205

N9064A-2 is equivalent to 89601X-AYA

If you are using the Help feature, this mode must be currently active to access its detailed information. If it is not active, exit the Help feature (Esc key), select the mode, and re-access Help.

Key Path	Mode
Example	INST:SEL VSA INST:NSEL 100
Initial S/W Revision	Prior to A.02.00

Analog Demod

Selects the Analog Demod mode for making measurements of AM, FM and phase modulated signals.

If you are using the Help feature, this mode must be currently active to access its detailed information. If it is not active, exit the Help feature (Esc key), select the mode, and re-access Help.

Key Path	Mode
Example	INST:SEL ADEMOM

	INST:NSEL 234
Initial S/W Revision	Prior to A.02.00

Phase Noise

The Phase Noise mode provides pre-configured measurements for making general purpose measurements of device phase noise.

If you are using the Help feature, this mode must be currently active to access its detailed information. If it is not active, exit the Help feature (Esc key), select the mode, and re-access Help.

Key Path	Mode
Example	INST:SEL PNOISE or INST:NSEL 14
Initial S/W Revision	Prior to A.02.00

CMMB

Selects the CMMB mode for measurements of digital video signals using this format. There are several power and demod measurements available in this mode.

If you are using the Help feature, this mode must be currently active to access its detailed information. If it is not active, exit the Help feature (Esc key), select the mode, and re-access Help.

Key Path	Mode
Example	INST:SEL CMMB INST:NSEL 240
Initial S/W Revision	A.03.00

Combined WLAN

Selects the CWLAN mode for general purpose measurements of signals following this standard. There are several measurements available in this mode.

If you are using the Help feature, this mode must be currently active to access its detailed information. If it is not active, exit the Help feature (Esc key), select the mode, and re-access Help.

Key Path	Mode
Example	INST:SEL CWLAN INST:NSEL 19
Initial S/W Revision	A.02.00

TD-SCDMA with HSPA/8PSK

Selects the TD-SCDMA mode for general purpose measurements of signals following this standard. There are several measurements available in this mode.

If you are using the Help feature, this mode must be currently active to access its detailed information. If it is not active, exit the Help feature (Esc key), select the mode, and re-access Help.

Key Path	Mode
Example	INST:SEL TDSCDMA INST:NSEL 211
Initial S/W Revision	Prior to A.02.00

IQ Analyzer (Basic)

The IQ Analyzer Mode makes general purpose frequency domain and time domain measurements. These measurements often use alternate hardware signal paths when compared with a similar measurement in the Signal Analysis Mode using the Swept SA measurement. These frequency domain and time domain measurements can be used to output I/Q data results when measuring complex modulated digital signals.

If you are using the Help feature, this mode must be currently active to access its detailed information. If it is not active, exit the Help feature (Esc key), select the mode, and re-access Help.

Key Path	Mode
Example	INST:SEL BASIC INST:NSEL 8
Initial S/W Revision	Prior to A.02.00

GSM/EDGE/EDGE Evo

Selects the GSM with EDGE mode for general purpose measurements of signals following this standard. There are several measurements available in this mode.

If you are using the Help feature, this mode must be currently active to access its detailed information. If it is not active, exit the Help feature (Esc key), select the mode, and re-access Help.

Key Path	Mode
Example	INST:SEL EDGEGSM INST:NSEL 13
Initial S/W Revision	Prior to A.02.00
Modified at S/W Revision	A.02.00

Combined Fixed WiMAX

Selects the Combined Fixed WiMAX mode for general purpose measurements of signals following this standard. There are several measurements available in this mode.

If you are using the Help feature, this mode must be currently active to access its detailed information. If it is not active, exit the Help feature (Esc key), select the mode, and re-access Help.

Key Path	Mode
Example	INST:SEL CWIMAXOFDM INST:NSEL 81
Initial S/W Revision	A.02.00

W-CDMA with HSPA+

Selects the W-CDMA with HSPA+ mode for general purpose measurements of signals following this standard. There are several measurements available in this mode.

If you are using the Help feature, this mode must be currently active to access its detailed information. If it is not active, exit the Help feature (Esc key), select the mode, and re-access Help.

Key Path	Mode
Example	INST:SEL WCDMA INST:NSEL 9
Initial S/W Revision	Prior to A.02.00

DVB-T/H with T2

Selects the DVB-T/H mode for measurements of digital video signals using this format. There are several power and demod measurements available in this mode.

If you are using the Help feature, this mode must be currently active to access its detailed information. If it is not active, exit the Help feature (Esc key), select the mode, and re-access Help.

Key Path	Mode
Example	INST:SEL DVB INST:NSEL 235
Initial S/W Revision	A.02.00
Modified at S/W Revision	A.07.00

EMI Receiver

The EMI Receiver Mode makes EMC measurements. Several measurements are provided to aid the user in characterizing EMC performance of their systems, including looking at signals with CISPR-16 compliant

detectors, performing scans for interfering signals, and determining and charting interfering signals over time.

If you are using the Help feature, this mode must be currently active to access its detailed information. If it is not active, exit the Help feature (Esc key), select the mode, and re-access Help.

Key Path	Mode
Example	INST:SEL EMI INST:NSEL 141
Initial S/W Revision	A.07.01

802.16 OFDM (Fixed WiMAX)

Selects the 802.16 OFDM (Fixed WiMAX) mode. This mode allows modulation quality measurements of signals that comply with IEEE 802.16a–2003 and IEEE 802.16–2004 standards, with flexibility to measure nonstandard OFDM formats. Along with the typical digital demodulation measurement results, several additional 802.16 OFDM unique trace data formats and numeric error data results provide enhanced data analysis.

If you are using the Help feature, this mode must be currently active to access its detailed information. If it is not active, exit the Help feature (Esc key), select the mode, and re-access Help.

Key Path	Mode
Example	INST:SEL WIMAXFIXED INST:NSEL 104
Initial S/W Revision	A.02.00

WLAN

Selects the WLAN mode for general purpose measurements of signals following this standard. There are several measurements available in this mode.

If you are using the Help feature, this mode must be currently active to access its detailed information. If it is not active, exit the Help feature (Esc key), select the mode, and re-access Help.

Key Path	Mode
Example	INST:SEL WLAN INST:NSEL 217
Initial S/W Revision	A.09.491

1xEV-DO

Selects the 1xEV-DO mode for general purpose measurements of signals following this standard. There are several measurements available in this mode.

If you are using the Help feature, this mode must be currently active to access its detailed information. If it is not active, exit the Help feature (Esc key), select the mode, and re-access Help.

Key Path	Mode
Example	INST:SEL CDMA1XEV INST:NSEL 15
Initial S/W Revision	Prior to A.02.00

802.16 OFDMA (WiMAX/WiBro)

Selects the OFDMA mode for general purpose measurements of WiMAX signals. There are several measurements available in this mode.

If you are using the Help feature, this mode must be currently active to access its detailed information. If it is not active, exit the Help feature (Esc key), select the mode, and re-access Help.

Key Path	Mode
Example	INST:SEL WIMAXOFDMA INST:NSEL 75
Initial S/W Revision	Prior to A.02.00

89601 VSA

Selecting the 89601 VSA mode will start the 89600 VSA software. The 89600 VSA software is powerful, PC-based software, offering the industry's most sophisticated general purpose and standards specific signal evaluation and troubleshooting tools for R&D engineers. Even for proprietary and non-standard signals in SATCOM or MILCOM applications, you can make signal quality measurements with customized IQ constellation. Reach deeper into signals, gather more data on signal problems, and gain greater insight.

- Over 35 general-purpose analog and digital demodulators ranging from 2FSK to 4096QAM
- Flexible and custom IQ and OFDM signal analysis for single carrier
- Standards specific modulation analysis including:
 - Cellular: GSM/EDGE, cdma2000, W-CDMA, TD-SCDMA, LTE(FDD/TDD),
 - LTE-Advanced and more
 - Wireless networking: 802.11a/b/g, 802.11n, 802.ac, 802.16 WiMAX (fixed/mobile), WiSUN (MR-FSK PHY)
 - RFID
 - Digital satellite video and other satellite signals, radar, LMDS
 - Up to 400K bin FFT, for the highest resolution spectrum analysis

- A full suite of time domain analysis tools, including signal capture and playback, time gating, and CCDF measurements
- 20 simultaneous trace displays and the industry's most complete set of marker functions
- Easy-to-use Microsoft® Windows® graphical user interface

For more information see the Agilent 89600 Series VSA web site at www.agilent.com/find/89600vsa

To learn more about how to use the 89600 VSA running in the X-Series, after the 89600 VSA software is running, open the 89600 VSA Help and open the "About Agilent X-Series Signal Analyzer with 89600 VSA Software" help topic.

Key Path	Mode
Example	INST:SEL VSA89601 INST:NSEL 101
Initial S/W Revision	Prior to A.02.00

MSR

Selects the MSR mode. The MSR mode makes several measurements for Cellular Communication devices that can be configured with multiple radio formats simultaneously following the 3GPP standard of Multi-Standard Radio, including GSM/EDGE, WCDMA/HSPA+ and LTE.

If you are using the Help feature, this mode must be currently active to access its detailed information. If it is not active, exit the Help feature (Esc key), select the mode, and re-access Help.

Key Path	Mode
Example	INST:SEL MSR INST:NSEL 106
Initial S/W Revision	A.09.491

cdma2000

Selects the cdma2000 mode for general purpose measurements of signals following this standard. There are several measurements available in this mode.

If you are using the Help feature, this mode must be currently active to access its detailed information. If it is not active, exit the Help feature (Esc key), select the mode, and re-access Help.

Key Path	Mode
Example	INST:SEL CDMA2K INST:NSEL 10
Initial S/W Revision	Prior to A.02.00

Bluetooth

Selects the Bluetooth mode for Bluetooth specific measurements. There are several measurements available in this mode.

If you are using the Help feature, this mode must be currently active to access its detailed information. If it is not active, exit the Help feature (Esc key), select the mode, and re-access Help.

Key Path	Mode
Example	INST:SEL BT INST:NSEL 228
Initial S/W Revision	A.06.01

LTE

Selects the LTE mode for general purpose measurements of signals following the LTE FDD standard. There are several measurements available in this mode.

If you are using the Help feature, this mode must be currently active to access its detailed information. If it is not active, exit the Help feature (Esc key), select the mode, and re-access Help.

Key Path	Mode
Example	INST:SEL LTE INST:NSEL 102
Initial S/W Revision	Prior to A.02.00

SCPI Language Compatibility

The SCPI Language Compatibility mode provides remote language compatibility for SCPI-based instruments, such as the Rohde and Schwartz FSP and related series of spectrum analyzers.

NOTE After changing into or out of this mode, allow a 1 second delay before sending any subsequent commands.

If you are using the Help feature, this mode must be currently active to access its detailed information. If it is not active, exit the Help feature (Esc key), select the mode, and re-access Help.

Key Path	Mode
Example	INST:SEL SCPI LC Or INST:NSEL 270
Initial S/W Revision	A.06.00

iDEN/WiDEN/MOTOTalk

Selects the iDEN/WiDEN/MOTOTalk mode for general purpose measurements of iDEN and iDEN-related signals. There are several measurements available in this mode.

If you are using the Help feature, this mode must be currently active to access its detailed information. If it is not active, exit the Help feature (Esc key), select the mode, and re-access Help.

Key Path	Mode
Example	INST:SEL IDEN INST:NSEL 103
Initial S/W Revision	A.02.00

ISDB-T

Selects the ISDB-T mode for measurements of digital video signals using this format. There are several power and demod measurements available in this mode.

If you are using the Help feature, this mode must be currently active to access its detailed information. If it is not active, exit the Help feature (Esc key), select the mode, and re-access Help.

Key Path	Mode
Example	INST:SEL ISDBT INST:NSEL 239
Initial S/W Revision	A.03.00

Digital Cable TV

Selects the Digital Cable TV mode for measurements of digital cable television systems. There are several power and demod measurements available in this mode.

If you are using the Help feature, this mode must be currently active to access its detailed information. If it is not active, exit the Help feature (Esc key), select the mode, and re-access Help.

Key Path	Mode
Example	INST:SEL DCATV INST:NSEL 238
Initial S/W Revision	A.07.00

LTE TDD

Selects the LTE TDD mode for general purpose measurements of signals following the LTE TDD standard. There are several measurements available in this mode.

If you are using the Help feature, this mode must be currently active to access its detailed information. If it is not active, exit the Help feature (Esc key), select the mode, and re-access Help.

Key Path	Mode
Example	INST:SEL LTETDD INST:NSEL 105
Initial S/W Revision	A.03.00

Remote Language Compatibility

The Remote Language Compatibility (RLC) mode provides remote command backwards compatibility for the 8560 series of spectrum analyzers, known as legacy spectrum analyzers.

NOTE After changing into or out of this mode, allow a 1 second delay before sending any subsequent commands.

If you are using the Help feature, this mode must be currently active to access its detailed information. If it is not active, exit the Help feature (Esc key), select the mode, and re-access Help.

Key Path	Mode
Example	INST:SEL RLC Or INST:NSEL 266
Initial S/W Revision	Prior to A.02.00

DTMB (CTTB)

Selects the DTMB (CTTB) mode for measurements of digital video signals using this format. There are several power and demod measurements available in this mode.

If you are using the Help feature, this mode must be currently active to access its detailed information. If it is not active, exit the Help feature (Esc key), select the mode, and re-access Help.

Key Path	Mode
Example	INST:SEL DTMB INST:NSEL 236
Initial S/W Revision	A.02.00

Application Mode Number Selection (Remote Command Only)

Select the measurement mode by its mode number. The actual available choices depend upon which applications are installed in your instrument. The modes appear in this table in the same order they appear in the Mode menu (if the order is not changed by the Configure Applications utility found in the System, Power On menu). See ["Detailed List of Modes" on page 333](#) for Mode details.

The Mode Number is the parameter for use with the :INSTrument:NSElect command. The Mode Parameter is the parameter for use with the :INSTrument[:SElect] command.

Mode	Mode Number	Mode Parameter
Spectrum Analyzer	1	SA
Real Time Spectrum Analyzer	107	RTSA
Sequence Analyzer	400	SEQAN
EMI Receiver	141	EMI
I/Q Analyzer (Basic)	8	BASIC
WCDMA with HSPA+	9	WCDMA
GSM/EDGE/EDGE Evo	13	EDGE GSM
802.16 OFDMA (WiMAX/WiBro)	75	WIMAX OFDMA
Vector Signal Analyzer (VXA)	100	VSA
Phase Noise	14	PNOISE
Noise Figure	219	NFIGure
Analog Demod	234	ADEM0D
Bluetooth	228	BT00th
TD-SCDMA with HSPA/8PSK	211	TDSCDMA
cdma2000	10	CDMA2K
1xEV-DO	15	CDMA1XEV
LTE	102	LTE
LTE TDD	105	LTETDD
LTE-Advanced FDD	107	LTEAFDD
LTE-Advanced TDD	108	LTEATDD
MSR	106	MSR
DVB-T/H with T2	235	DVB
DTMB (CTTB)	236	DTMB
Digital Cable TV	238	DCATV
ISDB-T	239	ISDBT
CMMB	240	CMMB
WLAN	217	WLAN
Combined WLAN	19	CWLAN
Combined Fixed WiMAX	81	CWIMAX OFDM
802.16 OFDM (Fixed WiMAX)	104	WIMAX FIXED
iDEN/WiDEN/MotoTalk	103	IDEN
Remote Language Compatibility	266	RLC
SCPI Language Compatibility	270	SCPILC
89601 VSA	101	VSA89601

Remote Command	:INSTrument:NSElect <integer> :INSTrument:NSElect?
Example	:INST:NSEL 1
Notes	SA mode is 1 The command must be sequential: i.e. continued parsing of commands cannot proceed until the instrument select is complete and the resultant SCPI trees are available.
Preset	Not affected by Preset. Set to default mode (1 for SA mode) following Restore System Defaults.
State Saved	Saved in instrument state
Initial S/W Revision	Prior to A.02.00

Application Mode Catalog Query (Remote Command Only)

Returns a string containing a comma separated list of names of all the installed and licensed measurement modes (applications). These names can only be used with the :INSTrument[:SElect] command.

Remote Command	:INSTrument:CATalog?
Example	:INST:CAT?
Notes	Query returns a quoted string of the installed and licensed modes separated with a comma. Example: "SA,PNOISE,WCDMA"
Backwards Compatibility Notes	VSA (E4406A) :INSTrument:CATalog? returned a list of installed INSTrument:SELECT items as a comma separated list of string values: "BASIC", "GSM", "EDGE GSM", "CDMA", "NADC", "PDC", "WCDMA", "CDMA2K", "CDMA1XEV", "IDEN", "WIDEN", "WLAN", "SERVICE" X-Series uses the ESA/PSA compatible query of a string contain comma separated values: "SA,PNOISE,NFIGURE,BASIC,CDMA,CDMA2K,WCDMA,CDMA1XEV,EDGE GSM,GSM,NADC,PDC,TDSCDMA,DMODULATION,WLAN"
Initial S/W Revision	Prior to A.02.00

Application Identification (Remote Commands Only)

Each entry in the Mode Menu will have a Model Number and associated information: Version, and Options. This information is displayed in the Show System screen. The corresponding SCPI remote commands are defined here.

"Current Application Model " on page 331

"Current Application Revision" on page 331

"Current Application Options" on page 331

Current Application Model

Returns a string that is the Model Number of the currently selected application (mode).

Remote Command	:SYSTem:APPLication[:CURRent] [:NAME]?
Example	:SYST:APPL?
Notes	Query returns a quoted string that is the Model Number of the currently selected application (Mode). Example: "N9060A" String length is 6 characters.
Preset	Not affected by Preset
State Saved	Not saved in state, the value will be the selected application when a Save is done.
Initial S/W Revision	Prior to A.02.00

Current Application Revision

Returns a string that is the Revision of the currently selected application (mode).

Remote Command	:SYSTem:APPLication[:CURRent]:REVision?
Example	:SYST:APPL:REV?
Notes	Query returns a quoted string that is the Revision of the currently selected application (Mode). Example: "1.0.0.0" String length is a maximum of 23 characters. (each numeral can be an integer + 3 decimal points)
Preset	Not affected by a Preset
State Saved	Not saved in state, the value will be the selected application when a Save is done.
Initial S/W Revision	Prior to A.02.00

Current Application Options

Returns a string that is the Options list of the currently selected application (Mode).

Remote Command	:SYSTem:APPLication[:CURRent]:OPTion?
Example	:SYST:APPL:OPT?
Notes	Query returns a quoted string that is the Option list of the currently selected application (Mode). The format is the name as the *OPT? or SYSTem:OPTion command: a comma separated list of option identifiers. Example: "1FP,2FP" String length is a maximum of 255 characters.

Preset	Not affected by a Preset
State Saved	Not saved in state per se, the value will be the selected application when a Save is invoked.
Initial S/W Revision	Prior to A.02.00

Application Identification Catalog (Remote Commands Only)

A catalog of the installed and licensed applications (Modes) can be queried for their identification.

"Application Catalog Number of Entries" on page 332

"Application Catalog Model Numbers" on page 332

"Application Catalog Revision" on page 332

"Application Catalog Options" on page 333

Application Catalog Number of Entries

Returns the number of installed and licensed applications (Modes).

Remote Command	:SYSTem:APPLication:CATalog[:NAME]:COUNT?
Example	:SYST:APPL:CAT:COUN?
Preset	Not affected by Preset
State Saved	Not saved in instrument state.
Initial S/W Revision	Prior to A.02.00

Application Catalog Model Numbers

Returns a list of Model Numbers for the installed and licensed applications (Modes).

Remote Command	:SYSTem:APPLication:CATalog[:NAME]?
Example	:SYST:APPL:CAT?
Notes	Returned value is a quoted string of a comma separated list of Model Numbers. Example, if SAMS and Phase Noise are installed and licensed: "N9060A,N9068A" String length is COUNT * 7 - 1. (7 = Model Number length + 1 for comma. -1 = no comma for the 1st entry.)
Preset	Not affected by a Preset
State Saved	Not saved in instrument state.
Initial S/W Revision	Prior to A.02.00

Application Catalog Revision

Returns the Revision of the provided Model Number.

Remote Command	:SYSTem:APPLication:CATalog:REVision? <model>
Example	:SYST:APPL:CAT:REV? 'N9060A'
Notes	Returned value is a quoted string of revision for the provided Model Number. The revision will be a null-string ("") if the provided Model Number is not installed and licensed. Example, if SAMS is installed and licensed: "1.0.0.0"
Preset	Not affected by a Preset.
State Saved	Not saved in instrument state.
Initial S/W Revision	Prior to A.02.00

Application Catalog Options

Returns a list of Options for the provided Model Number

Remote Command	:SYSTem:APPLication:CATalog:OPTion? <model>
Example	:SYST:APPL:CAT:OPT? 'N9060A'
Notes	Returned value is a quoted string of a comma separated list of Options, in the same format as *OPT? or :SYSTem:OPTion?. If the provided Model Number is not installed and licensed a null-string ("") will be returned. Example, if SAMS is installed and licensed: "2FP" String length is a maximum of 255 characters.
Preset	Not affected by a Preset
State Saved	Not saved in instrument state.
Initial S/W Revision	Prior to A.02.00

Detailed List of Modes

This section contains an alphabetical list of Modes available in the X-Series, along with a brief description of each Mode.

Note that with the exception of the 89601 VSA, only licensed applications appear in the Mode menu. The 89601 will always appear, because it's licensing is handled differently.

1xEV-DO

Selects the 1xEV-DO mode for general purpose measurements of signals following this standard. There are several measurements available in this mode.

If you are using the Help feature, this mode must be currently active to access its detailed information. If it is not active, exit the Help feature (Esc key), select the mode, and re-access Help.

Key Path	Mode
----------	------

Example	INST:SEL CDMA1XEV INST:NSEL 15
Initial S/W Revision	Prior to A.02.00

802.16 OFDMA (WiMAX/WiBro)

Selects the OFDMA mode for general purpose measurements of WiMAX signals. There are several measurements available in this mode.

If you are using the Help feature, this mode must be currently active to access its detailed information. If it is not active, exit the Help feature (Esc key), select the mode, and re-access Help.

Key Path	Mode
Example	INST:SEL WIMAXOFDMA INST:NSEL 75
Initial S/W Revision	Prior to A.02.00

802.16 OFDM (Fixed WiMAX)

Selects the 802.16 OFDM (Fixed WiMAX) mode. This mode allows modulation quality measurements of signals that comply with IEEE 802.16a–2003 and IEEE 802.16–2004 standards, with flexibility to measure nonstandard OFDM formats. Along with the typical digital demodulation measurement results, several additional 802.16 OFDM unique trace data formats and numeric error data results provide enhanced data analysis.

If you are using the Help feature, this mode must be currently active to access its detailed information. If it is not active, exit the Help feature (Esc key), select the mode, and re-access Help.

Key Path	Mode
Example	INST:SEL WIMAXFIXED INST:NSEL 104
Initial S/W Revision	A.02.00

89601 VSA

Selecting the 89601 VSA mode will start the 89600 VSA software. The 89600 VSA software is powerful, PC-based software, offering the industry's most sophisticated general purpose and standards specific signal evaluation and troubleshooting tools for R&D engineers. Even for proprietary and non-standard signals in SATCOM or MILCOM applications, you can make signal quality measurements with customized IQ constellation. Reach deeper into signals, gather more data on signal problems, and gain greater insight.

- Over 35 general-purpose analog and digital demodulators ranging from 2FSK to 4096QAM
- Flexible and custom IQ and OFDM signal analysis for single carrier

- Standards specific modulation analysis including:
 - Cellular: GSM/EDGE, cdma2000, W-CDMA, TD-SCDMA, LTE(FDD/TDD),
 - LTE-Advanced and more
 - Wireless networking: 802.11a/b/g, 802.11n, 802.ac, 802.16 WiMAX (fixed/mobile), WiSUN (MR-FSK PHY)
 - RFID
 - Digital satellite video and other satellite signals, radar, LMDS
 - Up to 400K bin FFT, for the highest resolution spectrum analysis
 - A full suite of time domain analysis tools, including signal capture and playback, time gating, and CCDF measurements
 - 20 simultaneous trace displays and the industry's most complete set of marker functions
 - Easy-to-use Microsoft ® Windows ® graphical user interface

For more information see the Agilent 89600 Series VSA web site at www.agilent.com/find/89600vsa

To learn more about how to use the 89600 VSA running in the X-Series, after the 89600 VSA software is running, open the 89600 VSA Help and open the "About Agilent X-Series Signal Analyzer with 89600 VSA Software" help topic.

Key Path	Mode
Example	INST:SEL VSA89601 INST:NSEL 101
Initial S/W Revision	Prior to A.02.00

Analog Demod

Selects the Analog Demod mode for making measurements of AM, FM and phase modulated signals.

If you are using the Help feature, this mode must be currently active to access its detailed information. If it is not active, exit the Help feature (Esc key), select the mode, and re-access Help.

Key Path	Mode
Example	INST:SEL ADEMODO INST:NSEL 234
Initial S/W Revision	Prior to A.02.00

Bluetooth

Selects the Bluetooth mode for Bluetooth specific measurements. There are several measurements available in this mode.

If you are using the Help feature, this mode must be currently active to access its detailed information. If it is not active, exit the Help feature (Esc key), select the mode, and re-access Help.

Key Path	Mode
Example	INST:SEL BT INST:NSEL 228
Initial S/W Revision	A.06.01

cdma2000

Selects the cdma2000 mode for general purpose measurements of signals following this standard. There are several measurements available in this mode.

If you are using the Help feature, this mode must be currently active to access its detailed information. If it is not active, exit the Help feature (Esc key), select the mode, and re-access Help.

Key Path	Mode
Example	INST:SEL CDMA2K INST:NSEL 10
Initial S/W Revision	Prior to A.02.00

CMMB

Selects the CMMB mode for measurements of digital video signals using this format. There are several power and demod measurements available in this mode.

If you are using the Help feature, this mode must be currently active to access its detailed information. If it is not active, exit the Help feature (Esc key), select the mode, and re-access Help.

Key Path	Mode
Example	INST:SEL CMMB INST:NSEL 240
Initial S/W Revision	A.03.00

Combined WLAN

Selects the CWLAN mode for general purpose measurements of signals following this standard. There are several measurements available in this mode.

If you are using the Help feature, this mode must be currently active to access its detailed information. If it is not active, exit the Help feature (Esc key), select the mode, and re-access Help.

Key Path	Mode
Example	INST:SEL CWLAN

	INST:NSEL 19
Initial S/W Revision	A.02.00

Combined Fixed WiMAX

Selects the Combined Fixed WiMAX mode for general purpose measurements of signals following this standard. There are several measurements available in this mode.

If you are using the Help feature, this mode must be currently active to access its detailed information. If it is not active, exit the Help feature (Esc key), select the mode, and re-access Help.

Key Path	Mode
Example	INST:SEL CWIMAXOFDM INST:NSEL 81
Initial S/W Revision	A.02.00

Digital Cable TV

Selects the Digital Cable TV mode for measurements of digital cable television systems. There are several power and demod measurements available in this mode.

If you are using the Help feature, this mode must be currently active to access its detailed information. If it is not active, exit the Help feature (Esc key), select the mode, and re-access Help.

Key Path	Mode
Example	INST:SEL DCATV INST:NSEL 238
Initial S/W Revision	A.07.00

DTMB (CTTB)

Selects the DTMB (CTTB) mode for measurements of digital video signals using this format. There are several power and demod measurements available in this mode.

If you are using the Help feature, this mode must be currently active to access its detailed information. If it is not active, exit the Help feature (Esc key), select the mode, and re-access Help.

Key Path	Mode
Example	INST:SEL DTMB INST:NSEL 236
Initial S/W Revision	A.02.00

DVB-T/H with T2

Selects the DVB-T/H mode for measurements of digital video signals using this format. There are several power and demod measurements available in this mode.

If you are using the Help feature, this mode must be currently active to access its detailed information. If it is not active, exit the Help feature (Esc key), select the mode, and re-access Help.

Key Path	Mode
Example	INST:SEL DVB INST:NSEL 235
Initial S/W Revision	A.02.00
Modified at S/W Revision	A.07.00

EMI Receiver

The EMI Receiver Mode makes EMC measurements. Several measurements are provided to aid the user in characterizing EMC performance of their systems, including looking at signals with CISPR-16 compliant detectors, performing scans for interfering signals, and determining and charting interfering signals over time.

If you are using the Help feature, this mode must be currently active to access its detailed information. If it is not active, exit the Help feature (Esc key), select the mode, and re-access Help.

Key Path	Mode
Example	INST:SEL EMI INST:NSEL 141
Initial S/W Revision	A.07.01

GSM/EDGE/EDGE Evo

Selects the GSM with EDGE mode for general purpose measurements of signals following this standard. There are several measurements available in this mode.

If you are using the Help feature, this mode must be currently active to access its detailed information. If it is not active, exit the Help feature (Esc key), select the mode, and re-access Help.

Key Path	Mode
Example	INST:SEL EDGE GSM INST:NSEL 13
Initial S/W Revision	Prior to A.02.00
Modified at S/W Revision	A.02.00

iDEN/WiDEN/MOTOTalk

Selects the iDEN/WiDEN/MOTOTalk mode for general purpose measurements of iDEN and iDEN-related signals. There are several measurements available in this mode.

If you are using the Help feature, this mode must be currently active to access its detailed information. If it is not active, exit the Help feature (Esc key), select the mode, and re-access Help.

Key Path	Mode
Example	INST:SEL IDEN INST:NSEL 103
Initial S/W Revision	A.02.00

IQ Analyzer (Basic)

The IQ Analyzer Mode makes general purpose frequency domain and time domain measurements. These measurements often use alternate hardware signal paths when compared with a similar measurement in the Signal Analysis Mode using the Swept SA measurement. These frequency domain and time domain measurements can be used to output I/Q data results when measuring complex modulated digital signals.

If you are using the Help feature, this mode must be currently active to access its detailed information. If it is not active, exit the Help feature (Esc key), select the mode, and re-access Help.

Key Path	Mode
Example	INST:SEL BASIC INST:NSEL 8
Initial S/W Revision	Prior to A.02.00

ISDB-T

Selects the ISDB-T mode for measurements of digital video signals using this format. There are several power and demod measurements available in this mode.

If you are using the Help feature, this mode must be currently active to access its detailed information. If it is not active, exit the Help feature (Esc key), select the mode, and re-access Help.

Key Path	Mode
Example	INST:SEL ISDBT INST:NSEL 239
Initial S/W Revision	A.03.00

LTE

Selects the LTE mode for general purpose measurements of signals following the LTE FDD standard. There are several measurements available in this mode.

If you are using the Help feature, this mode must be currently active to access its detailed information. If it is not active, exit the Help feature (Esc key), select the mode, and re-access Help.

Key Path	Mode
Example	INST:SEL LTE INST:NSEL 102
Initial S/W Revision	Prior to A.02.00

LTE TDD

Selects the LTE TDD mode for general purpose measurements of signals following the LTE TDD standard. There are several measurements available in this mode.

If you are using the Help feature, this mode must be currently active to access its detailed information. If it is not active, exit the Help feature (Esc key), select the mode, and re-access Help.

Key Path	Mode
Example	INST:SEL LTETDD INST:NSEL 105
Initial S/W Revision	A.03.00

LTE-Advanced FDD

As LTE-Advanced FDD and LTE modes are converged into one single application, the single softkey under Mode menu is designed to select the covered mode. The display mode of the LTE and LTE-Advanced FDD are distinguished by the licenses.

If you are using the Help feature, this mode must be currently active to access its detailed information. If it is not active, exit the Help feature (Esc key), select the mode, and re-access Help.

Key Path	Mode
Example	INST:SEL LTEAFDD INST:NSEL 107
Notes	When the N9080A/80B-1FP exists, the display mode name is LTE. When the N9080A/80B-1FP and N9080B-2FP all exist, the display mode name is LTE FDD & LTE-A FDD.
Backwards Compatibility SCPI	INST:SEL LTE INST:NSEL 102
Initial S/W Revision	A.14.00
Modified at S/W Revision	A.14.50

LTE-Advanced TDD

As LTE-Advanced TDD and LTE TDD modes are converged into one single application, the single softkey under Mode menu is designed to select the covered mode. The display mode of the LTE TDD and LTE-Advanced TDD are distinguished by the licenses.

If you are using the Help feature, this mode must be currently active to access its detailed information. If it is not active, exit the Help feature (Esc key), select the mode, and re-access Help.

Key Path	Mode
Example	INST:SEL LTEATDD INST:NSEL 108
Notes	When the N9082A/82B-1FP exists, the display mode name is LTE TDD. When the N9082A/82B-1FP and N9082B-2FP all exist, the display mode name is LTE TDD & LTE-A TDD.
Backwards Compatibility SCPI	INST:SEL LTETDD INST:NSEL 105
Initial S/W Revision	A.14.00
Modified at S/W Revision	A.14.50

MSR

Selects the MSR mode. The MSR mode makes several measurements for Cellular Communication devices that can be configured with multiple radio formats simultaneously following the 3GPP standard of Multi-Standard Radio, including GSM/EDGE, WCDMA/HSPA+ and LTE.

If you are using the Help feature, this mode must be currently active to access its detailed information. If it is not active, exit the Help feature (Esc key), select the mode, and re-access Help.

Key Path	Mode
Example	INST:SEL MSR INST:NSEL 106
Initial S/W Revision	A.09.491

Noise Figure

The Noise Figure mode provides pre-configured measurements for making general purpose measurements of device noise figure.

If you are using the Help feature, this mode must be currently active to access its detailed information. If it is not active, exit the Help feature (Esc key), select the mode, and re-access Help.

Key Path	Mode
Example	INST:SEL NFIGURE INST:NSEL 219
Initial S/W Revision	Prior to A.02.00

Phase Noise

The Phase Noise mode provides pre-configured measurements for making general purpose measurements of device phase noise.

If you are using the Help feature, this mode must be currently active to access its detailed information. If it is not active, exit the Help feature (Esc key), select the mode, and re-access Help.

Key Path	Mode
Example	INST:SEL PNOISE or INST:NSEL 14
Initial S/W Revision	Prior to A.02.00

Real Time Spectrum Analyzer

The Real Time Spectrum Analyzer (RTSA) mode provides real-time signal analysis, very high probability-of-intercept for intermittent signals with appropriate triggers.

If you are using the Help feature, this mode must be currently active to access its detailed information. If it is not active, exit the Help feature (Esc key), select the mode, and re-access Help.

Key Path	Mode
Example	INST:SEL RTSA or INST:NSEL 107
Initial S/W Revision	A.13.00

Remote Language Compatibility

The Remote Language Compatibility (RLC) mode provides remote command backwards compatibility for the 8560 series of spectrum analyzers, known as legacy spectrum analyzers.

NOTE After changing into or out of this mode, allow a 1 second delay before sending any subsequent commands.

If you are using the Help feature, this mode must be currently active to access its detailed information. If it is not active, exit the Help feature (Esc key), select the mode, and re-access Help.

Key Path	Mode
Example	INST:SEL RLC Or INST:NSEL 266
Initial S/W Revision	Prior to A.02.00

SCPI Language Compatibility

The SCPI Language Compatibility mode provides remote language compatibility for SCPI-based instruments, such as the Rohde and Schwartz FSP and related series of spectrum analyzers.

NOTE After changing into or out of this mode, allow a 1 second delay before sending any subsequent commands.

If you are using the Help feature, this mode must be currently active to access its detailed information. If it is not active, exit the Help feature (Esc key), select the mode, and re-access Help.

Key Path	Mode
Example	INST:SEL SCPILC Or INST:NSEL 270
Initial S/W Revision	A.06.00

Spectrum Analyzer

Selects the Spectrum Analyzer mode for general purpose measurements. There are several measurements available in this mode. General spectrum analysis measurements, in swept and zero span, can be done using the first key in the Meas menu, labeled Swept SA. Other measurements in the Meas Menu are designed to perform specialized measurement tasks, including power and demod measurements.

If you are using the Help feature, this mode must be currently active to access its detailed information. If it is not active, exit the Help feature (Esc key), select the mode, and re-access Help.

Key Path	Mode
Example	INST:SEL SA INST:NSEL 1
Initial S/W Revision	Prior to A.02.00

TD-SCDMA with HSPA/8PSK

Selects the TD-SCDMA mode for general purpose measurements of signals following this standard. There are several measurements available in this mode.

If you are using the Help feature, this mode must be currently active to access its detailed information. If it is not active, exit the Help feature (Esc key), select the mode, and re-access Help.

Key Path	Mode
Example	INST:SEL TDSCDMA INST:NSEL 211
Initial S/W Revision	Prior to A.02.00

Vector Signal Analyzer (VXA)

The N9064A (formerly 89601X) VXA Vector signal and WLAN modulation analysis application provides solutions for basic vector signal analysis, analog demodulation, and digital demodulation. The digital demodulation portion of N9064A allows you to perform measurements on standard-based formats such as cellular, wireless networking and digital video as well as general purpose flexible modulation analysis for wide range of digital formats, FSK to 1024QAM, with easy-to-use measurements and display tools such as constellation and eye diagram, EVM traces and up to four simultaneous displays. Analog baseband analysis is available using the MXA and PXA with option BBA. Option 3FP WLAN has been discontinued.

N9064A honors existing 89601X licenses with all features and functionalities found on X-Series software versions prior to A.06.00. Specifically:

N9064A-1 is equivalent to 89601X-205

N9064A-2 is equivalent to 89601X-AYA

If you are using the Help feature, this mode must be currently active to access its detailed information. If it is not active, exit the Help feature (Esc key), select the mode, and re-access Help.

Key Path	Mode
Example	INST:SEL VSA INST:NSEL 100
Initial S/W Revision	Prior to A.02.00

W-CDMA with HSPA+

Selects the W-CDMA with HSPA+ mode for general purpose measurements of signals following this standard. There are several measurements available in this mode.

If you are using the Help feature, this mode must be currently active to access its detailed information. If it is not active, exit the Help feature (Esc key), select the mode, and re-access Help.

Key Path	Mode
Example	INST:SEL WCDMA INST:NSEL 9
Initial S/W Revision	Prior to A.02.00

WLAN

Selects the WLAN mode for general purpose measurements of signals following this standard. There are several measurements available in this mode.

If you are using the Help feature, this mode must be currently active to access its detailed information. If it is not active, exit the Help feature (Esc key), select the mode, and re-access Help.

Key Path	Mode
----------	------

Example	INST:SEL WLAN INST:NSEL 217
Initial S/W Revision	A.09.491

Global Settings

Opens a menu that allows you to switch certain Meas Global parameters to a Mode Global state. These switches apply to all Modes that support global settings. No matter what Mode you are in when you set the “Global Center Frequency” switch to on, it applies to all Modes that support Global Settings.

Key Path	Mode Setup
Initial S/W Revision	Prior to A.02.00

Global Center Freq

The software maintains a Mode Global value called “Global Center Freq”.

When the Global Center Freq key is switched to On in any mode, the current mode’s center frequency is copied into the Global Center Frequency, and from then on all modes that support global settings use the Global Center Frequency. So you can switch between any of these modes and the Center Freq will remain unchanged.

Adjusting the Center Freq of any mode which supports Global Settings, while Global Center Freq is On, will modify the Global Center Frequency.

When Global Center Freq is turned Off, the Center Freq of the current mode is unchanged, but now the Center Freq of each mode is once again independent.

When Mode Preset is pressed while Global Center Freq is On, the Global Center Freq is preset to the preset Center Freq of the current mode.

This function is reset to Off when the Restore Defaults key is pressed in the Global Settings menu, or when System, Restore Defaults, All Modes is pressed.

Key Path	Mode Setup, Global Settings
Scope	Mode Global
Remote Command	:INSTrument:COUPle:FREQuency:CENTer ALL NONE :INSTrument:COUPle:FREQuency:CENTer?
Example	INST:COUP:FREQ:CENT ALL INST:COUP:FREQ:CENT?
Preset	Set to Off on Global Settings, Restore Defaults and System, Restore Defaults, All Modes
Range	On Off
Initial S/W Revision	Prior to A.02.00

Remote Command	:GLOBal:FREQuency:CENTer[:STATe] 1 0 ON OFF :GLOBal:FREQuency:CENTer[:STATe]?
Preset	Off
Initial S/W Revision	Prior to A.02.00

Restore Defaults

This key resets all of the functions in the Global Settings menu to Off. This also occurs when System, Restore Defaults, All Modes is pressed.

Key Path	Mode Setup, Global Settings
Remote Command	:INSTrument:COUPle:DEFault
Example	INST:COUP:DEF
Backwards Compatibility SCPI	:GLOBal:DEFault
Initial S/W Revision	Prior to A.02.00

Mode Setup

This key accesses a menu to allow you to select mode parameters. These settings will be in effect for all measurements in the current mode.

Key Path	Front Panel Key
Initial S/W Revision	A.03.00

Radio

Keys under Radio define the common parameters of LTE TDD measurements.

Key Path	Mode Setup
Mode	LTETDD

Direction

This key allows you to set the Direction of the signal being measured. The choice of link direction will determine the Sync/Format, Chan Profile and Time. Advanced menus will all change based on the link direction selected. Also, since downlink and uplink signals use OFDMA and SC-FDMA respectively, the list of trace results available and the default traces presented will also change based on the link direction parameter.

Key Path	Mode Setup, Radio
Mode	LTETDD
Remote Command	[:SENSe] :RADio:STANdard:DIRectioN DLINK ULINK [:SENSe] :RADio:STANdard:DIRectioN?
Example	RAD:STAN:DIR DLIN
Couplings	Changing in direction will affect the Gate Source. If direction is uplink, the Gate Source is Periodic Timer(Frame Trigger), with RF Burst as its Sync Source. If direction is downlink, the Gate Source is External 1. Changing in direction will also affect the Trigger Source in Transmit On/Off Power Measurement . If direction is uplink, the Trigger Source is Periodic Timer(Frame Trigger), with RF Burst as its Sync Source. If direction is downlink, the Trigger Source is External 1.
Preset	DLIN
State Saved	Saved in instrument state.
Range	Downlink Uplink
Initial S/W Revision	A.03.00

UL/DL Config

This key allows you to set the Uplink and Downlink allocation configuration of the signal being measured. The choice of link direction will determine which slot in the frame is used for uplink transmission, and which slot for downlink transmission.

Key Path	Mode Setup, Radio
Mode	LTETDD
Remote Command	[:SENSe] :RADIo:STANdard:ULDL CONF0 CONF1 CONF2 CONF3 CONF4 CONF5 CONF6 [:SENSe] :RADIo:STANdard:ULDL
Example	RAD:STAN:ULDL CONF0
Notes	CONF0: Configuration 0 (DSUUUDSUUU) CONF1: Configuration 1 (DSUUDDSUUD) CONF2: Configuration 2 (DSUDDDSUDD) CONF3: Configuration 3 (DSUUUDDDDDD) CONF4: Configuration 4 (DSUUDDDDDDD) CONF5: Configuration 5 (DSUDDDDDDDD) CONF6: Configuration 6 (DSUUUDSUUD)
Preset	CONF0
State Saved	Saved in instrument state.
Range	Configuration 0 Configuration 1 Configuration 2 Configuration 3 Configuration 4 Configuration 5 Configuration 6
Initial S/W Revision	A.03.00

Dw/GP/Up Len

This key allows you to set the DwPTS/GP/UpPTS length configuration of the signal being measured. The choice of link direction will determine the length of DwPTS, GP and UpPTS in the Special Subframe.

Key Path	Mode Setup, Radio
Mode	LTETDD
Remote Command	[:SENSe] :RADIo:STANdard:DGPU CONF0 CONF1 CONF2 CONF3 CONF4 CONF5 CONF6 CONF7 CONF8 [:SENSe] :RADIo:STANdard:DGPU?
Example	RAD:STAN:DGPU CONF0
Notes	CONF0: Configuration 0 CONF1: Configuration 1 CONF2: Configuration 2 CONF3: Configuration 3 CONF4: Configuration 4 CONF5: Configuration 5

	CONF6: Configuration 6 CONF7: Configuration 7 CONF8: Configuration 8
Preset	CONF0
State Saved	Saved in instrument state.
Range	Configuration 0 Configuration 1 Configuration 2 Configuration 3 Configuration 4 Configuration 5 Configuration 6 Configuration 7 Configuration 8
Initial S/W Revision	A.03.00

Pre-defined Parameters

The parameters under this key will impact the gate or trigger length and delay of below measurements:

- Monitor Spectrum
- Channel Power
- ACP
- Power Stat CCDF
- Occupied BW
- Spectrum Emission Mask
- Spurious Emission

Key Path	Mode Setup
Mode	LTETDD

Analysis Slot

This parameter specifies the starting analysis slot. The measurement will adjust the gate delay or trigger delay according to this parameter.

Key Path	Mode Setup, Pre-defined Parameters
Mode	LTETDD
Remote Command	[[:SENSe]:RADio:SLOT TS0 TS1 DPTS1 UPTS1 TS4 TS5 TS6 TS7 TS8 TS9 TS10 TS11 TS12 TS13 TS14 TS15 TS16 TS17 TS18 TS19 [:SENSe]:RADio:SLOT?
Example	RAD:SLOT TS0
Couplings	Measurement's gate length or meas interval will couple according to this parameter.
Preset	TS0

State Saved	Saved in instrument state.
Range	TS0 TS1 DwPTS1 UpPTS1 TS4 TS5 TS6 TS7 TS8 TS9 TS10 TS11 TS12(DwPTS2) TS13(UpPTS2) TS14 TS15 TS16 TS17 TS18 TS19
Initial S/W Revision	A.03.00

Meas Interval

This parameter specifies the desired slots count that needs to be analyzed. The measurement will adjust the gate length or meas interval according to this parameter.

Key Path	Mode Setup, Pre-defined Parameters
Mode	LTETDD
Remote Command	[:SENSe] :RADio :MINTerval <integer> [:SENSe] :RADio :MINTerval
Example	:RAD:MINT 1
Couplings	If “Measure PRACH” is active and not off, this key is disabled., and the actual meas interval is the length PRACH or SRS channel.
Preset	1
State Saved	Saved in instrument state.
Min	1
Max	20
Initial S/W Revision	A.03.00

CP Length

This parameter specifies whether the cyclic prefix is configured as Normal or Extended for power measurement. The measurement will adjust the gate length or meas interval according to this parameter.

Key Path	Mode Setup, Pre-defined Parameters
Mode	LTETDD
Remote Command	[:SENSe] :RADio :CPLength NORMal EXTended [:SENSe] :RADio :CPLength?
Example	RAD:CPL NORM
Preset	NORMal
State Saved	Saved in instrument state.
Range	Normal Extended
Initial S/W Revision	A.03.00

Measure PRACH/SRS

This key specifies whether the analysis slot is used for PRACH channel or SRS and the PRACH preamble format of the analysis slot.

The measurement will adjust the gate length or meas interval according to this parameter.

Key Path	Mode Setup, Pre-defined Parameters
Mode	LTETDD
Remote Command	[:SENSe] :RADio:MEASure OFF PPF0 PPF1 PPF2 PPF3 PPF4 SRS DSRS [:SENSe] :RADio:MEASure?
Example	RAD:MEAS OFF
Couplings	If direction is downlink, the key is disabled and the value is set to off. If this key value is not off, Meas Interval is disabled.
Preset	OFF
State Saved	Saved in instrument state.
Range	Off Preamble 0 Preamble 1 Preamble 2 Preamble 3 Preamble 4 SRS DSRS
Initial S/W Revision	A.03.00

Demod

Keys under Demod define the common parameters of LTE TDD modulation analysis measurement.

Key Path	Mode Setup
Mode	LTETDD

Bandwidth

This key allows you to set the Bandwidth of the signal being measured.

Key Path	Mode Setup, Demod
Mode	LTETDD
Remote Command	[:SENSe] :RADio:STANdard:BANDwidth B1M4 B3M B5M B10M B15M B20M [:SENSe] :RADio:STANdard:BANDwidth?
Example	RAD:STAN:BAND B5M
Couplings	Bandwidth changes affect instrument span
Preset	B5M
State Saved	Saved in instrument state.
Range	1.4 MHz (6 RB) 3 MHz (15 RB) 5 MHz (25 RB) 10 MHz (50 RB) 15 MHz (75 RB) 20 MHz (100 RB)
Initial S/W Revision	A.03.00

Spectrum

This function determines if the spectrum of the incoming data is mirrored or not. The actual mirroring is accomplished by conjugating the complex time data.

Note that only the Mod Analysis measurement and Conformance EVM measurement support this feature.

Key Path	Mode Setup, Demod
Mode	LTETDD
Remote Command	<code>[:SENSe] :SPEctrum NORMal INVert</code> <code>[:SENSe] :SPEctrum?</code>
Example	SPEC INV SPEC?
Preset	NORM
State Saved	Saved in instrument state.
Range	Normal Invert
Initial S/W Revision	A.03.00

Fixed Equalization

Enables you to apply a fixed FIR equalization filter to the time data, before it is used in further analysis. You define the filter by its frequency response rather than by its impulse response. The frequency response must be stored in a data register.

Note that only the Mod Analysis measurement supports this feature.

Key Path	Mode Setup, Demod
Mode	LTETDD
Initial S/W Revision	A.03.00

Fixed EQ Mode

Enables you to turn fixed equalization off/on in normal mode, or on in inverted mode. The effect of Normal mode is to divide the spectrum of the unequalized data by the frequency response in the data register. Invert mode multiplies instead of dividing.

Key Path	Mode Setup, Demod, Fixed Equalization
Mode	LTETDD
Remote Command	<code>[:SENSe] :CORRection:FEQualizer OFF NORMal INVert</code> <code>[:SENSe] :CORRection:FEQualizer?</code>
Example	CORR:FEQ NORM

	CORR:FEQ?
Preset	OFF
State Saved	Saved in instrument state.
Range	Off Normal Invert
Initial S/W Revision	A.03.00

Freq Response Register

Enables you to choose a register that contains the frequency response information for fixed equalization.

Key Path	Mode Setup, Demod, Fixed Equalization
Mode	LTETDD
Remote Command	[:SENSe] :CORRection:FEQualizer:REGister D1 D2 D3 D4 D5 D6 [:SENSe] :CORRection:FEQualizer:REGister?
Example	CORR:FEQ:REG D2 CORR:FEQ:REG?
Preset	D1
State Saved	Saved in instrument state.
Range	Data 1 Data 2 Data 3 Data 4 Data 5 Data 6
Initial S/W Revision	A.03.00

Preset to Standard

This parameter presets all demodulation parameters to their default values, and also presets the instrument span to an appropriate value for the selected standard.

Key Path	Mode Setup
Mode	LTETDD
Remote Command	[:SENSe] :RADio:STANdard:PRESet B1M4 B3M B5M B10M B15M B20M
Example	RAD:STAN:PRES B5M
Couplings	Presets the instrument span to an appropriate value for the selected bandwidth setting and sets other parameters to their preset value.
Preset	B5M
State Saved	Saved in instrument state.
Range	1.4 MHz (6 RB) 3 MHz (15 RB) 5 MHz (25 RB) 10 MHz (50 RB) 15 MHz (75 RB) 20 MHz (100 RB)
Initial S/W Revision	A.03.00

Noise Reduction

Noise Reduction accesses a menu for configuring the noise compensation of the instrument. This menu only appears in models that support Noise Reduction.

Key Path	Mode Setup
Initial S/W Revision	A.04.00

Noise Floor Extension

Turns on the Noise Floor Extension function. When this function is On, the expected noise power of the analyzer (derived from a factory calibration) is subtracted from the trace data. This will usually reduce the apparent noise level by about 10 dB in low band, and 8 dB in high band (>~3.6 GHz).

Noise Floor Extension works with any RBW, VBW, detector, any setting of Average Type, any amount of trace averaging, and any signal type. It is ineffective when the trace is not smoothed (smoothing processes include narrow VBWs, trace averaging, and long sweep times with the detector set to Average or Peak). It works best with extreme amounts of smoothing, and with the average detector, with the Average Type set to Power.

NOTE

Noise Floor Extensions has no effect unless the RF Input is selected, therefore it does nothing when External Mixing is selected.

In those cases where the cancellation is ineffective, it nonetheless has no undesirable side-effects. There is no significant speed impact to having Noise Floor Extension on.

The best accuracy is achieved when substantial smoothing occurs in each point before trace averaging. Thus, when using the average detector, results are better with long sweep times and fewer trace averages. When using the sample detector, the VBW filter should be set narrow with less trace averaging, instead of a wide VBW filter with more trace averaging.

See "[More Information](#)" on page 355

Key Path	Mode Setup, Noise Reduction
Scope	Meas Global
Remote Command	[:SENSe] :CORRection:NOISe:FLOor ON OFF 1 0 [:SENSe] :CORRection:NOISe:FLOor?
Example	CORR:NOIS:FLO ON
Dependencies	This key only appears in instruments with the NFE or NF2 license installed. In all others, the key does not appear, however the SCPI command will be accepted without error (but will have no effect).
Couplings	When NFE is enabled in any mode manually, a prompt will be displayed reminding you to perform the Characterize Noise Floor operation if it is needed. If NFE is enabled through SCPI and a Characterize Noise Floor operation is needed, an error will be entered in the system error queue.
Preset	Unaffected by Mode Preset. Turned off by Restore Mode Defaults.
State Saved	No
Initial S/W Revision	A.04.00

More Information

The analyzer is characterized in the factory (or during a field calibration) with a model of the noise, referred to the input mixer, versus frequency in each band and path combination. Bands are 0 (low band) and 1 through 4 (high band) in a 26.5 GHz instrument, for example. Paths include normal paths, preamp paths, the electronic attenuator, etc.

In most band/path combinations, the noise can be well characterized based on just two parameters and the analyzer frequency response before compensation for frequency-dependent losses.

After the noise density at the input mixer is estimated, the effects of the input attenuator, RBW, detector, etc. are computed to get the estimated input-port-referred noise level.

In the simplest case, the measured power (signal plus analyzer noise) in each display point (bucket) is compensated by subtracting the estimated noise power, leaving just the signal power. This is the operation when the detector is Average and the Average Type is set to Power.

In other cases, operation is often not quite as good but still highly effective. With peak detection, the noise floor is estimated based on the RBW and the duration of the bucket using the same equations used in the noise marker function. The voltage of the noise is subtracted from the voltage of the observed signal-plus-noise measurement to compute the estimated signal voltage. The peak detector is one example of processing that varies with detector to give good estimates of the signal level without the analyzer noise.

For best operation, the average detector and the power scale are recommended, as already stated. Peak detection for pulsed-RF can still give excellent effectiveness. FFT analysis does not work well, and does not do NFE well, with pulsed-RF signals, so this combination is not recommended. Negative peak detection is not very useful, either. Sample detection works well, but is never better than the average detector because it doesn't smooth as well. The Normal detector is a combination of peak and negative peak behaviors, and works about as well as these.

For best operation, extreme smoothing is desirable, as already stated. Using narrow VBWs works well, but using very long bucket durations and the average detector works best. Reducing the number of trace points will make the buckets longer.

For best operation, the power scale (Average Type = Power) is optimum. When making CW measurements in the presence of noise without NFE, averaging on the decibel scale has the advantage of reducing the effect of noise. When using NFE, the NFE does an even better job than using the log scale ever could. Using NFE with the log scale is not synergistic, though; NFE with the power scale works a little better than NFE with log averaging type.

The results from NFE with internal preamp can often be lower than the theoretical noise in a signal source at room temperature, a noise density of -174 dBm/Hz. This is expected and useful behavior, because NFE is designed to report the amount of input signal that is in excess of the thermal noise, not the amount that includes the thermal noise. This can be a useful behavior because thermal noise often interferes with what you want to measure, instead of being part of what you want to measure. Note that NFE is not adequately accurate to always be able to read below kTB.

On instruments with the NF2 license installed, the calibrated Noise Floor used by Noise Floor Extensions should be refreshed periodically. Agilent recommends that the Characterize Noise Floor operation be performed after the first 500 hours of operation, and once every calendar year. The key to perform this is located in the System, Alignments, Advanced menu. If you have not done this yourself at the recommended interval, then when you turn on Noise Floor Extensions, the analyzer will prompt you to do so with a dialog that says:

“This action will take several minutes to perform. Please disconnect all cables from the RF input and press Enter to proceed. Press ESC to cancel, or Postpone to postpone for a week.”

If you Cancel, you will be prompted again the next time you turn NFE on. If you postpone, you will be prompted again after a week passes and you then turn NFE on.

Restore Mode Defaults

Resets the state for the currently active mode by resetting the mode persistent settings to their factory default values, clearing mode data and by performing a Mode Preset. This function will never cause a mode switch. This function performs a full preset for the currently active mode; whereas, Mode Preset performs a partial preset. Restore Mode Defaults does not affect any system settings. System settings are reset by the Restore System Defaults function. This function does reset mode data; as well as settings.

Key Path	Mode Setup
Remote Command	:INSTRument:DEFault
Example	:INST:DEF
Notes	Clears all pending OPC bits. The Status Byte is set to 0. A message comes up saying: “If you are sure, press key again”.
Couplings	A Restore Mode Defaults will cause the currently running measurement to be aborted and causes the default measurement to be active. It gets the mode to a consistent state with all of the default couplings set.
Initial S/W Revision	Prior to A.02.00

Global Settings

Opens a menu that allows you to switch certain Meas Global parameters to a Mode Global state. These switches apply to all Modes that support global settings. No matter what Mode you are in when you set the “Global Center Frequency” switch to on, it applies to all Modes that support Global Settings.

Key Path	Mode Setup
Initial S/W Revision	Prior to A.02.00

Global Center Freq

The software maintains a Mode Global value called “Global Center Freq”.

When the Global Center Freq key is switched to On in any mode, the current mode’s center frequency is copied into the Global Center Frequency, and from then on all modes that support global settings use the Global Center Frequency. So you can switch between any of these modes and the Center Freq will remain unchanged.

Adjusting the Center Freq of any mode which supports Global Settings, while Global Center Freq is On, will modify the Global Center Frequency.

When Global Center Freq is turned Off, the Center Freq of the current mode is unchanged, but now the Center Freq of each mode is once again independent.

When Mode Preset is pressed while Global Center Freq is On, the Global Center Freq is preset to the preset Center Freq of the current mode.

This function is reset to Off when the Restore Defaults key is pressed in the Global Settings menu, or when System, Restore Defaults, All Modes is pressed.

Key Path	Mode Setup, Global Settings
Scope	Mode Global
Remote Command	:INSTrument:COUPle:FREQuency:CENTer ALL NONE :INSTrument:COUPle:FREQuency:CENTer?
Example	INST:COUP:FREQ:CENT ALL INST:COUP:FREQ:CENT?
Preset	Set to Off on Global Settings, Restore Defaults and System, Restore Defaults, All Modes
Range	On Off
Initial S/W Revision	Prior to A.02.00

Remote Command	:GLOBal:FREQuency:CENTer[:STATe] 1 0 ON OFF :GLOBal:FREQuency:CENTer[:STATe]?
Preset	Off
Initial S/W Revision	Prior to A.02.00

Restore Defaults

This key resets all of the functions in the Global Settings menu to Off. This also occurs when System, Restore Defaults, All Modes is pressed.

Key Path	Mode Setup, Global Settings
Remote Command	:INSTrument:COUPle:DEFault
Example	INST:COUP:DEF
Backwards Compatibility SCPI	:GLOBal:DEFault
Initial S/W Revision	Prior to A.02.00

6 System Functions

File

Opens a menu that enables you to access various standard and custom Windows functions. Press any other front-panel key to exit

Key Path	Front-panel key
Initial S/W Revision	Prior to A.02.00

File Explorer

Opens the standard Windows File Explorer. The File Explorer opens in the My Documents directory for the current user.

The File Explorer is a separate Windows application, so to return to the analyzer once you are in the File Explorer, you may either:

Exit the File Explorer by clicking on the red X in the upper right corner, with a mouse

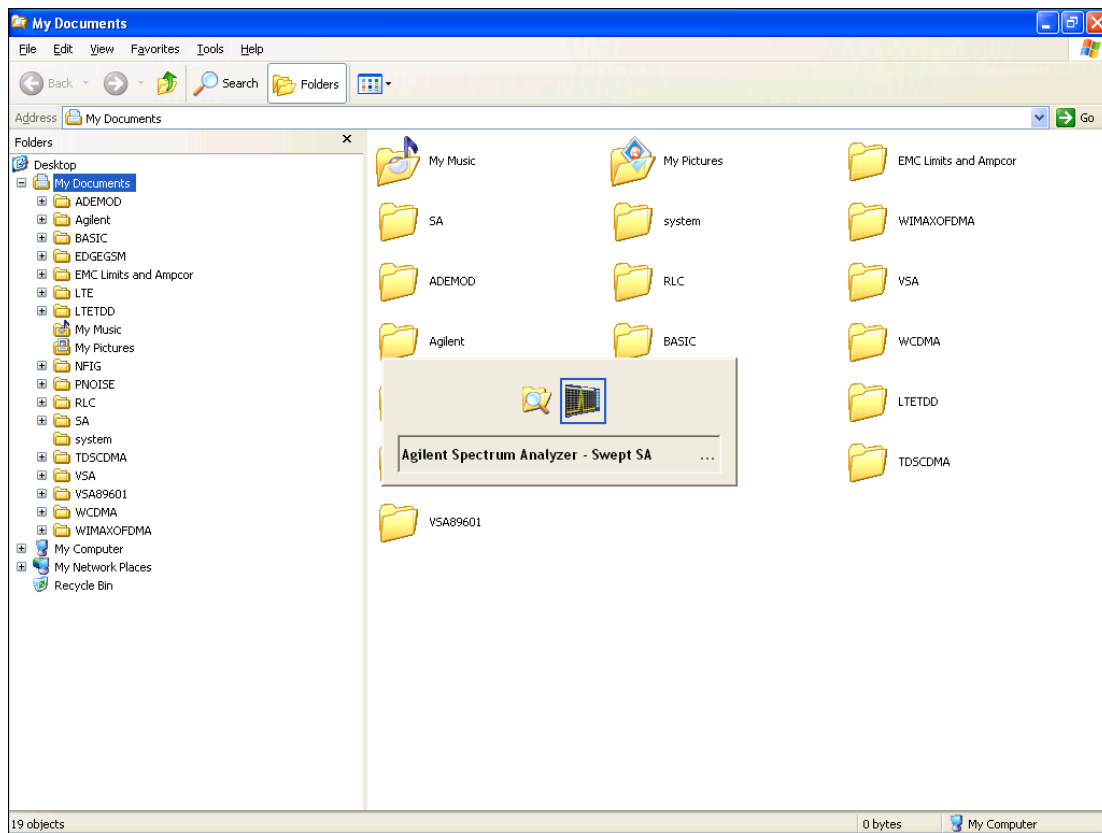

Or use Alt-Tab: press and hold the Alt key and press and release the Tab key until the Analyzer logo is showing in the window in the center of the screen, as shown above, then release the Alt key.

The ability to access File Explorer is not available if Option SF1 is installed.

Key Path	File
Initial S/W Revision	Prior to A.02.00

Page Setup

The Page Setup key brings up a Windows Page Setup dialog that allows you to control aspects of the pages sent to the printer when the PRINT hardkey is pressed.

Key Path	File
Initial S/W Revision	Prior to A.02.00

Paper size, the printer paper source, the page orientation and the margins are all settable. Just like any standard Windows dialog, you may navigate the dialog using the front-panel keys, or a mouse. There are no SCPI commands for controlling these parameters.

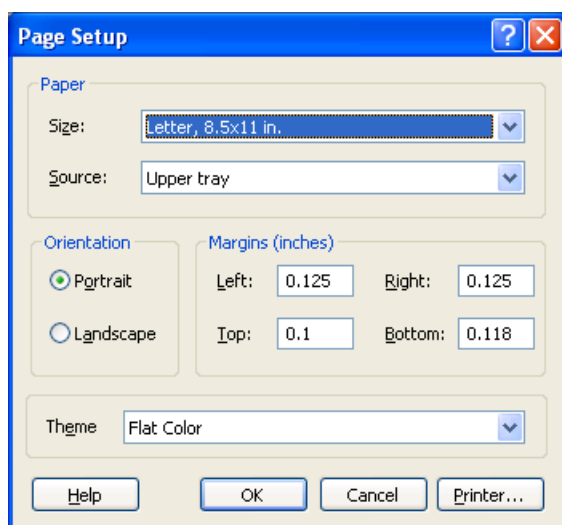

Also contained in this dialog is a drop-down control that lets you select the Theme to use when printing. For more on Themes, see information under View/Display, Display, System Display Settings, Theme. The Theme control has a corresponding SCPI command.

Parameter Name	Print Themes
Parameter Type	Enum
Mode	All
Remote Command	:SYSTem:PRINt:THEME TDCoLor TDMonochrome FCOLor FMONochrome :SYSTem:PRINt:THEME?
Example	:SYST:PRIN:THEM FCOL
Setup	:SYSTem:DEFault MISC
Preset	FCOL; not part of Preset, but is reset by Restore Misc Defaults or Restore System Defaults All and

	survives subsequent running of the modes.
State Saved	No
Initial S/W Revision	Prior to A.02.00

Print

This front-panel key is equivalent to performing a File, Print, OK. It immediately performs the currently configured Print to the Default printer.

The :HCOPY command is equivalent to pressing the PRINT key. The HCOpy:ABORt command can be used to abort a print which is already in progress. Sending HCOpy:ABORt will cause the analyzer to stop sending data to the printer, although the printer may continue or even complete the print, depending on how much data was sent to the printer before the user sent the ABORt command.

Key Path	Front-panel key
Remote Command	:HCOPY[:IMMEDIATE]
Initial S/W Revision	Prior to A.02.00

Key Path	SCPI command only
Remote Command	:HCOPY:ABORt
Initial S/W Revision	Prior to A.02.00

Restore Down

This key allows you to Restore Down the Instrument Application and reverses the action taken by Maximize. This key is only visible when the application has been maximized, and after the Restore Down action has been completed this key is replaced by the Maximize key.

Key Path	File
Mode	All
Notes	No equivalent remote command for this key.
State Saved	No
Initial S/W Revision	A.05.01

Minimize

The Minimize key causes the analyzer display to disappear down into the task bar, allowing you to see the Windows Desktop. You can use Alt-Tab (press and hold the Alt  key and press and release the Tab key) to restore the analyzer display.

Key Path	File
Mode	All
Notes	No equivalent remote command for this key.
State Saved	No
Initial S/W Revision	A.05.01

Exit

This key, when pressed, will exit the Instrument Application. A dialog box is used to confirm that you intended to exit the application:

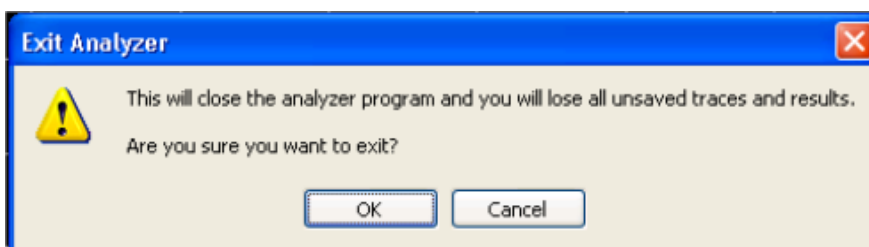

Key Path	File
Mode	All
Notes	The Instrument Application will close. No further SCPI commands can be sent. Use with caution!
Initial S/W Revision	Prior to A.02.00

Print

The Print key opens a Print dialog for configured printing (for example, to the printer of your choice). Refer to your Microsoft Windows Operating System manual for more information.

Maximize/Restore Down

These keys allow the Instrument Application to be maximized and then restored to its prior state. Only one of the two keys is visible at a time. When not already maximized the Maximize Application key is visible, and when maximized, the Restore Down Application key is visible and replaces the Maximize Application key.

Maximize

This key allows you to Maximize the Instrument Application, which causes the analyzer display to fill the screen. Once the application is maximized, this key is replaced by the Restore Down key.

Key Path	File
Mode	All

Notes	No equivalent remote command for this key.
State Saved	No
Initial S/W Revision	A.05.01

Restore Down

This key allows you to Restore Down the Instrument Application and reverses the action taken by Maximize. This key is only visible when the application has been maximized, and after the Restore Down action has been completed this key is replaced by the Maximize key.

Key Path	File
Mode	All
Notes	No equivalent remote command for this key.
State Saved	No
Initial S/W Revision	A.05.01

Print

This front-panel key is equivalent to performing a File, Print, OK. It immediately performs the currently configured Print to the Default printer.

The `:HCOPY` command is equivalent to pressing the PRINT key. The `HCOPY:ABORT` command can be used to abort a print which is already in progress. Sending `HCOPY:ABORT` will cause the analyzer to stop sending data to the printer, although the printer may continue or even complete the print, depending on how much data was sent to the printer before the user sent the `ABORT` command.

Key Path	Front-panel key
Remote Command	<code>:HCOPY[:IMMEDIATE]</code>
Initial S/W Revision	Prior to A.02.00

Key Path	SCPI command only
Remote Command	<code>:HCOPY:ABORT</code>
Initial S/W Revision	Prior to A.02.00

System

Opens a menu of keys that access various configuration menus and dialogs.

Key Path	Front-panel key
Notes	No remote command for this key specifically.
Initial S/W Revision	Prior to A.02.00

Show

Accesses a menu of choices that enable you to select the information window you want to view.

Key Path	System
Mode	All
Remote Command	:SYSTem:SHOW OFF ERRor SYSTem HARDware LXI HWSTatistics ALIGNment SOFTware CAPplication :SYSTem:SHOW?
Example	:SYST:SHOW SYST
Notes	This command displays (or exits) the various System information screens.
Preset	OFF
State Saved	No
Range	OFF ERRor SYSTem HARDware LXI HWSTatistics ALIGNment SOFTware CAPplication
Initial S/W Revision	Prior to A.02.00

Errors

There are two modes for the Errors selection, History and Status.

The list of errors displayed in the Errors screen does not automatically refresh. You must press the Refresh key or leave the screen and return to it to refresh it.

History brings up a screen displaying the event log in chronological order, with the newest event at the top. The history queue can hold up to 100 messages (if a message has a repeat count greater than 1 it only counts once against this number of 100). Note that this count bears no relation to the size of the SCPI queue. If the queue extends onto a second page, a scroll bar appears to allow scrolling with a mouse. Time is displayed to the second.

Status brings up a screen summarizing the status conditions currently in effect. Note that the time is displayed to the second.

The fields on the Errors display are:

Type (unlabeled) - Displays the icon identifying the event or condition as an error or warning.

ID - Displays the error number.

Message - Displays the message text.

Repeat (RPT) - This field shows the number of consecutive instances of the event, uninterrupted by other events. If an event occurs 5 times with no other intervening event, the value of repeat will be 5.

If the value of Repeat is 1 the field does not display. If the value of Repeat is >1, the time and date shown are those of the most recent occurrence. If the value of repeat reaches 999,999 it stops there.

Time - Shows the most recent time (including the date) at which the event occurred.

Key Path	System, Show
Mode	All
Remote Command	:SYSTem:ERRor[:NEXT]?
Example	:SYST:ERR?
Notes	The return string has the format: “<Error Number>,<Error>” Where <Error Number> and <Error> are those shown on the Show Errors screen
Backwards Compatibility Notes	In some legacy analyzers, the Repeat field shows the number of times the message has repeated since the last time the error queue was cleared. In the X-Series, the Repeat field shows the number of times the error has repeated since the last intervening error. So the count may very well be different than in the past even for identical signal conditions Unlike previous analyzers, in the X-Series all errors are reported through the Message or Status lines and are logged to the event queue. They never appear as text in the graticule area (as they sometimes do in previous analyzers) and they are never displayed in the settings panel at the top of the screen (as they sometimes do, by changing color, in previous analyzers). As a consequence of the above, the user can only see one status condition (the most recently generated) without looking at the queue. In the past, at least in the Spectrum Analyzer, multiple status conditions might display on the right side of the graticule. In general, there is no backwards compatibility specified or guaranteed between the error numbers in the X-Series and those of earlier products. Error, event, and status processing code in customers' software will probably need to be rewritten to work with X-Series. In the legacy analyzers, some conditions report as errors and others simply turn on status bits. Conditions that report as errors often report over and over as long as the condition exists. In the X-series, all conditions report as start and stop events. Consequently, software that repeatedly queries for a condition error until it stops reporting will have to be rewritten for the X-series.
Initial S/W Revision	Prior to A.02.00

Previous Page

See ["Next Page" on page 368](#).

Key Path	System, Show, Errors
Initial S/W Revision	Prior to A.02.00

Next Page

Next Page and Previous Page menu keys move you between pages of the log, if it fills more than one page. These keys are grayed out in some cases:

- If on the last page of the log, the Next Page key is grayed-out
- If on the first page of the log, the Previous Page key is grayed-out.
- If there is only one page, both keys are grayed out.

Key Path	System, Show, Errors
Initial S/W Revision	Prior to A.02.00

History

The History and Status keys select the Errors view. The Status key has a second line that shows a number in [square brackets]. This is the number of currently open status items.

Key Path	System, Show, Errors
Initial S/W Revision	Prior to A.02.00

Verbose SCPI On/Off

When you turn Verbose SCPI on, additional information is returned when you send the :SYSTem:ERRor? query. The additional information consists of the characters that stimulated the error. This can aid you in debugging your test programs by indicating where in the parsing of a SCPI command the instrument encountered an invalid command or query.

Specifically, with Verbose SCPI on, the SYSTem:ERRor? query is expanded to show the SCPI data received, with the indicator <Err> at the point in the stream that the error occurred.

Verbose SCPI has no effect on the Show Errors screen or front panel Message Line; it only changes the response to the :SYST:ERR? query.

See the example below, where the invalid command "SENS:BOGUS" is sent:

Normal response to :SYST:ERR (using the Telnet window):

```
SCPI> SENS:BOGUS
```

```
SCPI> SYST:ERR?
```

```
-113,"Undefined header"
```

Now after turning on Verbose SCPI:

```
SCPI> SYST:BOGUS
```

```
SCPI> SYST:ERR?
```

```
-113,"Undefined header;SYST:BOGUS<Err>"
```

Key Path	System, Show, Errors
Mode	All
Remote Command	:SYSTem:ERRor:VERBose OFF ON 0 1 :SYSTem:ERRor:VERBose?
Example	:SYST:ERR:VERB ON
Preset	This is unaffected by Preset but is set to OFF on a "Restore System Defaults->Misc"
State Saved	No
Range	On Off
Initial S/W Revision	Prior to A.02.00

Refresh

When pressed, refreshes the Show Errors display.

Key Path	System, Show, Errors
Initial S/W Revision	Prior to A.02.00

Clear Error Queue

This clears all errors in all error queues.

Note the following:

- Clear Error Queue does not affect the current status conditions.
- Mode Preset does not clear the error queue.
- Restore System Defaults will clear all error queues.
- *CLS only clears the queue if it is sent remotely and *RST does not affect any error queue.
- Switching modes does not affect any error queues.

Key Path	System, Show, Errors
Initial S/W Revision	Prior to A.02.00

Status

See "[History](#)" on page 368.

Input Overload Enable (Remote Command Only)

Input Overload errors are reported using the Input Overload status bit (bit 12 in the Measurement Integrity status register). Input Overloads (for example, ADC Overload errors) can come and go with great frequency, generating many error events (for example, for signals just on the verge of overload), and so are

not put into the SCPI error queue by default. Normally the status bit is the only way for detecting these errors remotely.

It is possible to enable Input Overload reporting to the SCPI queue, by issuing the :SYSTem:ERRor:OVERload ON command. To return to the default state, issue the :SYSTem:ERRor:OVERload OFF command. In either case, Input Overloads always set the status bit.

NOTE

For versions of firmware before A.10.01, the Input Overload was only a Warning and so was never available in the SCPI queue, although it did set the status bit. For A.10.01 and later, the Input Overload is an error and can be enabled to the SCPI queue using this command.

Key Path	SCPI only
Remote Command	:SYSTem:ERRor:OVERload[:STATe] 0 1 OFF ON
Example	:SYST:ERR:OVER 1 Enable overload errors
Preset	Set to OFF by Restore Misc Defaults (no Overload errors go to SCPI)
State Saved	Saved in instrument state.
Initial S/W Revision	A.10.01

System

The System screen is formatted into three groupings: product descriptive information, options tied to the hardware, and software products:

```

<Product Name> <Product Description>
Product Number: N9020A
Serial Number: US46220924
Firmware Revision: A.01.01
Computer Name: <hostname>
Host ID: N9020A,US44220924

N9020A-503      Frequency Range to 3.6 GHz
N9020A-PFR     Precision Frequency Reference
N9020A-P03     Preamp 3.6 GHz

N9060A-2FP     Spectrum Analysis Measurement Suite  1.0.0.0
N9073A-1FP     WCDMA                               1.0.0.0
N9073A-2FP     WCDMA with HSDPA                      1.0.0.0
    
```

The Previous Page is grayed-out if the first page of information is presently displayed. The Next Page menu key is grayed-out if the last page is information is presently displayed.

Key Path	System, Show
----------	--------------

Mode	All
Example	SYST:SHOW SYST
Backwards Compatibility Notes	The hardware statistics that are displayed in the PSA Show System screen have been moved to a dedicated Show Hardware Statistics screen in the Service Menu.
Initial S/W Revision	Prior to A.02.00

Show System contents (Remote Command Only)

A remote command is available to obtain the contents of the Show System screen (the entire contents, not just the currently displayed page).

Remote Command	:SYSTem:CONFigure[:SYSTem]?
Example	:SYST:CONF?
Notes	The output is an IEEE Block format of the Show System contents. Each line is separated with a new-line character.
Initial S/W Revision	Prior to A.02.00

Computer System description (Remote Command Only)

A remote command is available to obtain the Computer System description. The Computer System is the operating system and patch level as reported by operating system.

Remote Command	:SYSTem:CSYSem?
Example	:SYST:CSYS?
Notes	The return value is the Computer System name and service pack level.
Initial S/W Revision	Prior to A.12.00

Hardware

The show hardware screen is used to view details of the installed hardware. This information can be used to determine versions of hardware assemblies and field programmable devices, in the advent of future upgrades or potential repair needs.

The screen is formatted into two groupings: product descriptive information and hardware information. The hardware information is listed in a table format:

Key Path	System
Mode	All
Remote Command	:SYSTem:PON:TYPE MODE USER LAST :SYSTem:PON:TYPE?
Example	:SYST:PON:TYPE MODE
Preset	This is unaffected by a Preset but is set to Mode on a “Restore System Defaults->All”
State Saved	No
Backwards Compatibility SCPI	:SYSTem:PON:TYPE PRESet the “PRESet” parameter is supported for backward compatibility only and behaves the same as MODE.
Backwards Compatibility Notes	The Preset Type key in legacy analyzers has been removed, and the Power On toggle key has been replaced by this 1-of-N key in the System menu.
Initial S/W Revision	Prior to A.02.00

Mode and Input/Output Defaults

When the analyzer is powered on in Mode and Input/Output Defaults, it performs a Restore Mode Defaults to all modes in the instrument and also performs a Restore Input/Output Defaults.

Persistent parameters (such as Amplitude Correction tables or Limit tables) are not affected at power on, even though they are normally cleared by Restore Input/Output Defaults and/or Restore Mode Defaults.

Key Path	System, Power On
Mode	All
Example	SYST:PON:TYPE MODE
Readback Text	Defaults
Initial S/W Revision	Prior to A.02.00

User Preset

Sets Power On to User Preset. When the analyzer is powered on in User Preset, it will User Preset each mode and switch to the power-on mode. Power On User Preset will not affect any settings beyond what a normal User Preset affects.

NOTE

An instrument could never power up for the first time in User Preset.

Key Path	System, Power On
Mode	All
Example	SYST:PON:TYPE USER
Readback Text	User Preset

Backwards Compatibility Notes	Power On User Preset will cause the instrument to power up in the power-on mode, not the last mode the instrument was in prior to shut down. Also, Power On User Preset will User Preset all modes. This does not exactly match legacy behavior.
Initial S/W Revision	Prior to A.02.00

Last State

Sets Power On to **Last**. When the analyzer is powered on, it will put all modes in the last state they were in prior to when the analyzer was put into Power Standby and it will wake up in the mode it was last in prior to powering off the instrument. The saving of the active mode prior to shutdown happens behind the scenes when a controlled shutdown is requested by using the front panel power Standby key or by using the remote command SYSTem:PDOWn. The non-active modes are saved as they are deactivated and recalled by Power On Last State.

NOTE

An instrument can never power up for the first time in Last.

If line power to the analyzer is interrupted, for example by pulling the line cord plug or by switching off power to a test rack, Power On Last State may not work properly. For proper operation, Power On Last State depends on you shutting down the instrument using the Standby key or the SYSTem:PDOWn SCPI command. This will ensure the last state of each mode is saved and can be recalled during a power up.

Key Path	System, Power On
Mode	All
Example	SYST:PON:TYPE LAST
Notes	Power on Last State only works if you have done a controlled shutdown prior to powering on in Last. If a controlled shutdown is not done when in Power On Last State, the instrument will power up in the last active mode, but it may not power up in the active mode's last state. If an invalid mode state is detected, a Mode Preset will occur. To control the shutdown under remote control use the :SYSTem:PDOWn command.
Readback Text	Last State
Backwards Compatibility Notes	It is no longer possible to power-up the analyzer in the last mode the analyzer was running with that mode in the preset state. (ESA/PSA SYST:PRESET:TYPE MODE with SYST:PON:PRESET) You can power-on the analyzer in the last mode the instrument was running in its last state (SYST:PON:TYPE LAST), or you can specify the mode to power-up in its preset state (SYST:PON:MODE <mode>).
Initial S/W Revision	Prior to A.02.00

Power On Application

Accesses a menu that lists the available Modes and lets you select which Mode is to be the power-on application.

This application is used for Power On Type “Mode and Input/Output Defaults” and Restore System Defaults All.

Key Path	System, Power On
Mode	All
Remote Command	:SYSTem:PON:MODE SA BASIC ADEMOD NFIGURE PNOISE CDMA2K TDSCDMA VSA VSA89601 WCDMA WIMAXOFDMA :SYSTem:PON:MODE?
Example	SYST:PON:MODE SA
Notes	The list of possible modes (and remote parameters) to choose from is dependent on which modes are installed in the instrument.
Preset	This is unaffected by a Preset but is set on a "Restore System Defaults->All" to: For N9038A: EMI For N8973B, N8974B, N8975B, or N8976B: NFIG For all other models: SA
State Saved	No
Initial S/W Revision	Prior to A.02.00

Configure Applications

The Configure Applications utility can be used to:

- select applications for preload
- determine how many applications can fit in memory at one time
- specify the order of the Modes in the Mode menu.

This utility consists of a window with instructions, a set of "Select Application" checkboxes, a "fuel bar" style memory gauge, and keys that help you set up your configuration.

For more information, see the following topics:

["Preloading Applications" on page 376](#)

["Access to Configure Applications utility" on page 376](#)

["Virtual memory usage" on page 376](#)

Key Path	System, Power On
Example	:SYST:SHOW CAPP Displays the Config Applications screen
Initial S/W Revision	A.02.00

Preloading Applications

During runtime, if a Mode that is not preloaded is selected using the Mode menu or sending SCPI commands, there will be a pause while the Application is loaded. During this pause a message that says “Loading application, please wait ...” is displayed. Once loaded, the application stays loaded, so the next time you select it during a session, there is no delay.

Preloading enables you to “preload” at startup, to eliminate the runtime delay. Preloading an application will cause it to be loaded into the analyzer’s memory when the analyzer program starts up. If you do this, the delay will increase the time it takes to start up the analyzer program, but this may be preferable to having to wait the first time you select an application. Note that, once an application is loaded into memory, it cannot be unloaded without exiting and restarting the analyzer program.

Note that there are more applications available for the X-Series than can fit into Windows Virtual Memory. By allowing you to choose which licensed applications to load at startup, the Configure Applications utility allows you to make optimal use of your memory.

Access to Configure Applications utility

A version of the utility runs the first time you power up the analyzer after purchasing it from Agilent. The utility automatically configures preloads so that as many licensed applications as possible are preloaded while keeping the total estimated virtual memory usage below the limit. This auto-configuration only takes place at the very first run, and after analyzer software upgrades.

You may, at any time, manually call up the Configure Applications utility by pressing System, Power On, Configure Applications, to find a configuration that works best for you, and then restart the analyzer program.

The utility may also be called if, during operation of the analyzer, you attempt to load more applications than can fit in memory at once.

Virtual memory usage

There are more applications available for the X-Series than can fit into memory at any one time, so the Configure Applications utility includes a memory tracker that serves two purposes:

1. It will not let you preload more applications than will fit into memory at once.
2. You can determine how many of your favorite applications can reside in memory at one time.

The utility provides a graphical representation of the amount of memory (note that the memory in question here is Virtual memory and is a limitation imposed by the operating system, not by the amount of physical memory you have in your analyzer). You select applications to preload by checking the boxes on the left. Checked applications preload at startup. The colored fuel bar indicates the total memory required when all the checked applications are loaded (either preloaded or selected during runtime).

Here is what the fuel bar colors mean:

RED: the applications you have selected cannot all fit into the analyzer’s memory. You must deselect applications until the fuel bar turns yellow.

YELLOW: the applications you have selected can all fit into the analyzer’s memory, but there is less than 10% of the memory left, probably not enough to load any other applications, either via preload or by selecting a Mode while the analyzer is running..

GREEN: The indicator is green when <90% of the memory limit is consumed. This means the applications you have selected can all fit into the analyzer's memory with room to spare. You will likely be able to load one or more other applications without running out of memory.

Select All

Marks all applications in the selection list. This allows you to enable all applications licensed on the instrument for pre-loading, or is a convenience for selecting all applications in one operation and then letting you deselect individual applications.

Key Path	System, Power On, Configure Applications
Initial S/W Revision	A.02.00

Deselect All

Clears the marks from all applications in the selection list, except the Power On application. The Power On application cannot be eliminated from the pre-load list.

Key Path	System, Power On, Configure Applications
Initial S/W Revision	A.02.00

Move Up

The application list is the order that applications appear in the Mode Menu. This key enables you to shift the selected application up in the list, thus moving the selected application earlier in the Mode Menu.

Key Path	System, Power On, Configure Applications
Initial S/W Revision	A.02.00

Move Down

The application list is the order that applications appear in the Mode Menu. This key enables you to shift the selected application down in the list, thus moving the selected application later in the Mode Menu.

Key Path	System, Power On, Configure Applications
Initial S/W Revision	A.02.00

Select/Deselect

Toggles the currently highlighted application in the list.

Key Path	System, Power On, Configure Applications
Initial S/W Revision	A.02.00

Save Changes and Exit

Applies the configuration of the applications list. The marked applications will be pre-loaded in memory the next time the instrument application is started, and the order of the applications in the list will be the order of the applications in the Mode Menu.

After saving your changes, the analyzer asks you if you would like it to restart so that your changes can take effect (see dialog box, below). If you choose not to restart, the changes will not take affect until the next time you shut down and restart the analyzer.

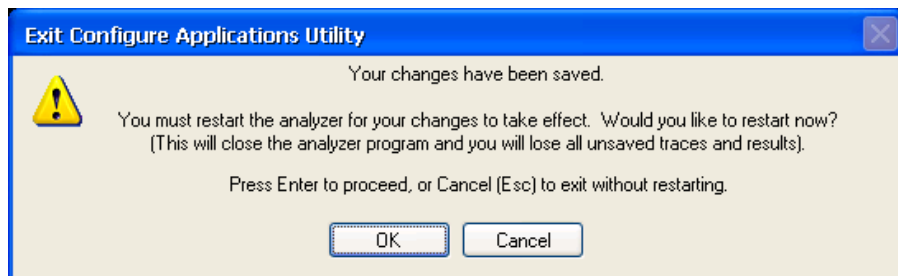

Key Path	System, Power On, Configure Applications
Remote Command	:SYSTem:PUP:PROcess
Example	:SYST:PUP:PROC This is the SCPI command for restarting the analyzer. You must Wait after this command for the instrument application to restart
Notes	The softkey will be grayed-out when the virtual memory of the selected applications exceeds 100% of the limit.
Notes	You cannot use *WAI or *OPC? to synchronize operation after a restart. This command stops and restarts the instrument application, thus the SCPI operation is terminated and restarted. A remote program must use fixed wait time to resume sending commands to the instrument. The wait time will be dependent upon which applications are pre-loaded.
Initial S/W Revision	A.02.00
Modified at S/W Revision	A.04.00

Exit Without Saving

Pressing this key will exit the Configure Applications utility without saving your changes.

Key Path	System, Power On, Configure Applications
Initial S/W Revision	A.02.00
Modified at S/W Revision	A.04.00

Restore Power On Defaults

This selection causes the Power On Type and Power On Application settings to be a reset to their default values. This level of Restore System Defaults does not affect any other system settings, mode settings and

does not cause a mode switch. The Power On key, under the Restore System Defaults menu, causes the same action.

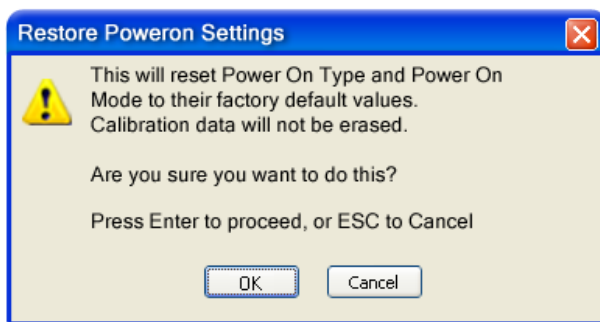

If you press any key other than OK or Enter, it is construed as a Cancel, because the only path that will actually cause the reset to be executed is through OK or Enter.

Key Path	System, Power On
Example	:SYST:DEF PON
Initial S/W Revision	Prior to A.02.00

Configure Applications - Instrument boot-up

At start-up of the analyzer program a dialog box similar to the one under the System, Power On, Configure Applications key will be displayed allowing you to choose which licensed applications are to be loaded. This dialog will only be displayed if the memory required to pre-load all of the licensed applications exceeds the Virtual Memory available.

Configure Applications - Windows desktop

The Configure Applications Utility may be run from the Windows Desktop. The utility is launched by double-

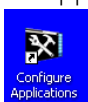

clicking the icon on the desktop, which brings-up a dialog box similar to the one under the System, Power On, Configure Applications key, allowing you to choose which licensed applications are to be loaded when the analyzer program starts up. This dialog box has mouse buttons on it that do the job the softkeys normally do in the System, Power On, Configure Applications menu.

Configure Applications - Remote Commands

The following topics provide details on using remote commands to configure the list of applications you want to load into the instrument memory or query the Virtual Memory utilization for your applications.

- ["Configuration list \(Remote Command Only\)" on page 380](#)
- ["Configuration Memory Available \(Remote Command Only\)" on page 380](#)
- ["Configuration Memory Total \(Remote Command Only\)" on page 380](#)
- ["Configuration Memory Used \(Remote Command Only\)" on page 380](#)

- "Configuration Application Memory (Remote Command Only)" on page 381

Configuration list (Remote Command Only)

This remote command is used to set or query the list of applications to be loaded in-memory.

Remote Command	:SYSTem:PON:APPLication:LLISt <string of INSTRument:SElect names> :SYSTem:PON:APPLication:LLISt?
Example	:SYST:PON:APPL:LLIS "SA,BASIC,WCDMA"
Notes	<string of INSTRument:SElect names> are from the enums of the :INSTRument:SElect command. The order of the <INSTRument:SElect names> is the order that the applications are loaded into memory, and the order that they appear in the Mode Menu. Error message -225 "Out of Memory" is reported when more applications are listed than can reside in Virtual Memory. When this occurs, the existing applications load list is unchanged.
Preset	Not affected by Preset
State Saved	Not saved in instrument state
Initial S/W Revision	A.02.00

Configuration Memory Available (Remote Command Only)

This remote command is used to query the amount of Virtual Memory remaining.

Remote Command	:SYSTem:PON:APPLication:VMEMory[:AVAIlable]?
Example	:SYST:PON:APPL:VMEM?
Preset	Not affected by Preset
Initial S/W Revision	A.02.00

Configuration Memory Total (Remote Command Only)

This remote command is used to query the limit of Virtual Memory allowed for applications.

Remote Command	:SYSTem:PON:APPLication:VMEMory:TOTal?
Example	:SYST:PON:APPL:VMEM:TOT?
Preset	Not affected by Preset
Initial S/W Revision	A.02.00

Configuration Memory Used (Remote Command Only)

This remote command is a query of the amount of Virtual Memory used by all measurement applications.

Remote Command	:SYSTem:PON:APPLication:VMEMory:USED?
Example	:SYST:PON:APPL:VMEM:USED?

Preset	Not affected by Preset
Initial S/W Revision	A.02.00

Configuration Application Memory (Remote Command Only)

This remote command is used to query the amount of Virtual Memory a particular application consumes.

Remote Command	:SYSTem:PON:APPLication:VMEMory:USED:NAME? <INSTRument:SElect name>
Example	:SYST:PON:APPL:VMEM:USED:NAME? CDMA2K
Notes	<INSTRument:SElect name> is from the enums of the :INSTRument:SElect command Value returned will be 0 (zero) if the name provided is invalid.
Preset	Not affected by Preset
Initial S/W Revision	Prior to A.02.00

Alignments

The Alignments Menu controls and displays the automatic alignment of the instrument, and provides the ability to restore the default alignment values.

The current setting of the alignment system is displayed in the system Settings Panel along the top of the display, including a warning icon for conditions that may cause specifications to be impacted.



Key Path	System
Initial S/W Revision	Prior to A.02.00

Auto Align

Configures the method for which the automatic background alignment is run.

Automatic background alignments are run periodically between measurement acquisitions. The instrument's software determines when alignments are to be performed to maintain warranted operation. The recommended setting for Auto Align is Normal.

An Auto Align execution cannot be aborted with the Cancel (ESC) key. To interrupt an Auto Align execution, select Auto Align Off.

Key Path	System, Alignments
Mode	All
Remote Command	:CALibration:AUTO ON PARTial OFF :CALibration:AUTO?
Example	:CAL:AUTO ON

Notes	While Auto Align is executing, bit 0 of Status Operation register is set.
Couplings	Auto Align is set to Off if Restore Align Data is invoked.
Preset	This is unaffected by Preset but is set to ON upon a “Restore System Defaults->Align”.
State Saved	No
Status Bits/OPC dependencies	When Auto Align is executing, bit 0 in the Status Operational register is set.
Backwards Compatibility SCPI	:CALibration:AUTO ALERt
	Parameter ALERt is for backward compatibility only and is mapped to PARTial
Backwards Compatibility Notes	<ol style="list-style-type: none"> 1. ESA SCPI for Auto Align is :CALibration:AUTO <Boolean>. The command for X-Series is an enumeration. Thus the parameters of “0” and “1” are not possible in X-Series. 2. Similarly, the ESA SCPI for :CALibration:AUTO? returned the Boolean value 1 or 0, in X-Series it is an Enumeration (string). Thus, queries by customer applications into numeric variables will result in an error 3. In PSA Auto Align OFF was not completely off, it is equivalent to PARTial in X-Series. In X-Series, OFF will be fully OFF. This means users of PSA SCPI who choose OFF may see degraded performance and should migrate their software to use PARTial.
Initial S/W Revision	Prior to A.02.00

Normal

Auto Align, Normal turns on the automatic alignment of all measurement systems. The Auto Align, Normal selection maintains the instrument in warranted operation across varying temperature and over time.

If the condition “Align Now, All required” is set, transition to Auto Align, Normal will perform the required alignments and clear the “Align Now, All required” condition and then continue with further alignments as required to maintain the instrument adequately aligned for warranted operation.

When Auto Align, Normal is selected the Auto Align Off time is set to zero.

When Auto Align, Normal is selected the Settings Panel indicates ALIGN AUTO.

Key Path	System, Alignments, Auto Align
Mode	All
Example	:CAL:AUTO ON
Notes	<p>Alignment processing as a result of the transition to Normal will be executed sequentially. Thus, *OPC? or *WAI following CAL:AUTO ON will return when the alignment processing is complete.</p> <p>The presence of an external signal may interfere with the RF portion of the alignment. If so, the Error Condition message “Align skipped: 50 MHz interference” or “Align skipped: 4.8 GHz interference” is reported, and bit 11 is set in the Status Questionable Calibration register. After the interfering signal is removed, subsequent alignment of the RF will clear the condition, and clear bit 11 in the Status Questionable Calibration register.</p>
Readback Text	Normal
Status Bits/OPC dependencies	An interfering user signal may prevent automatic alignment of the RF subsystem. If this occurs, the Error Condition message “Align skipped: 50 MHz interference” or “Align skipped: 4.8 GHz

interference” is reported, the Status Questionable Calibration bit 11 is set, and the alignment proceeds. When a subsequent alignment of the RF subsystem succeeds, either by the next cycle of automatic alignment or from an Align Now, RF, the Error Condition and Status Questionable Calibration bit 11 are cleared.

Initial S/W Revision	Prior to A.02.00
----------------------	------------------

Partial

Auto Align, Partial disables the full automatic alignment and the maintenance of warranted operation for the benefit of improved measurement throughput. Accuracy is retained for the Resolution Bandwidth filters and the IF Passband, which is critical to FFT accuracy, demodulation, and many measurement applications. With Auto Align set to Partial, you are now responsible for maintaining warranted operation by updating the alignments when they expire. The Auto Align, Alert mechanism will notify you when alignments have expired. One solution to expired alignments is to perform the Align All, Now operation. Another is to return the Auto Align selection to Normal.

Auto Align, Partial is recommended for measurements where the throughput is so important that a few percent of improvement is more valued than an increase in the accuracy errors of a few tenths of a decibel. One good application of Auto Align, Partial would be an automated environment where the alignments can be called during overhead time when the device-under-test is exchanged.

When Auto Align, Partial is selected the elapsed time counter begins for Auto Align Off time.

When Auto Align, Partial is selected the Settings Panel indicates ALIGN PARTIAL with a warning icon. The warning icon is to inform the operator that they are responsible for maintaining the warranted operation of the instrument

Key Path	System, Alignments, Auto Align
Mode	All
Example	:CAL:AUTO PART
Notes	Auto Align Partial begins the elapsed time counter for Auto Align Off time.
Readback Text	Partial
Initial S/W Revision	Prior to A.02.00

Off

Auto Align, Off disables automatic alignment and the maintenance of warranted operation, for the benefit of maximum measurement throughput. With Auto Align set to Off, you are now responsible for maintaining warranted operation by updating the alignments when they expire. The Auto Align, Alert mechanism will notify you when alignments have expired. One solution to expired alignments is to perform the Align All, Now operation. Another is to return the Auto Align selection to Normal.

The Auto Align, Off setting is rarely the best choice, because Partial gives almost the same improvement in throughput while maintaining the warranted performance for a much longer time. The choice is intended for unusual circumstances such as the measurement of radar pulses where you might like the revisit time to be as consistent as possible.

When Auto Align, Off is selected the Auto Align Off time is initialized and the elapsed time counter begins.

When Auto Align, Off is selected the Settings Panel indicates ALIGN OFF with a warning icon. The warning icon is to inform the operator that they are responsible for maintaining the warranted operation of the instrument:

Key Path	System, Alignments, Auto Align
Mode	All
Example	:CAL:AUTO OFF
Notes	Auto Align Off begins the elapsed time counter for Auto Align Off time.
Couplings	Auto Align is set to Off if Restore Align Data is invoked.
Readback Text	Off
Initial S/W Revision	Prior to A.02.00

All but RF

Auto Align, All but RF, configures automatic alignment to include or exclude the RF subsystem. (Eliminating the automatic alignment of the RF subsystem prevents the input impedance from changing. The normal input impedance of 50 ohms can change to an open circuit when alignments are being used. Some devices under test do not behave acceptably under such circumstances, for example by showing instability.) When Auto Align, All but RF ON is selected, the operator is responsible for performing an Align Now, RF when RF-related alignments expire. The Auto Align, Alert mechanism will notify the operator to perform an Align Now, All when the combination of time and temperature variation is exceeded.

When Auto Align, All but RF ON is selected the Settings Panel indicates ALIGN AUTO/NO RF with a warning icon (warning icon is intended to inform the operator they are responsible for the maintaining the RF alignment of the instrument):

Key Path	System, Alignments, Auto Align
Mode	All
Remote Command	:CALibration:AUTO:MODE ALL NRF :CALibration:AUTO:MODE?
Example	:CAL:AUTO:MODE NRF
Preset	This is unaffected by Preset but is set to ALL on a "Restore System Defaults->Align".
State Saved	No
Readback Text	RF or NRF
Initial S/W Revision	Prior to A.02.00

Alert

The instrument will signal an Alert when conditions exist such that you will need to perform a full alignment (for example, Align Now, All). The Alert can be configured in one of four settings; Time & Temperature, 24 hours, 7 days, or None. A confirmation is required when a selection other than Time & Temperature is chosen. This prevents accidental deactivation of alerts.

With Auto Align set to Normal, the configuration of Alert is not relevant because the instrument's software maintains the instrument in warranted operation.

Key Path	System, Alignments, Auto Align
Mode	All
Remote Command	:CALibration:AUTO:ALERT TTEMperature DAY WEEK NONE :CALibration:AUTO:ALERT?
Example	:CAL:AUTO:ALERTTEM
Notes	The alert that alignment is needed is the setting of bit 14 in the Status Questionable Calibration register.
Preset	This is unaffected by Preset but is set to TTEMperature on a "Restore System Defaults->Align".
State Saved	No
Status Bits/OPC dependencies	The alert is the Error Condition message "Align Now, All required" and bit 14 is set in the Status Questionable Calibration register.
Initial S/W Revision	Prior to A.02.00

Time & Temperature

With Auto Align Alert set to Time & Temperature the instrument will signal an alert when alignments expire due to the combination of the passage of time and changes in temperature. The alert is the Error Condition message "Align Now, All required". If this choice for Alert is selected, the absence of an alert means that the analyzer alignment is sufficiently up-to-date to maintain warranted accuracy.

Key Path	System, Alignments, Auto Align, Alert
Mode	All
Example	:CAL:AUTO:ALERTTEM
Readback Text	Time & Temp
Status Bits/OPC dependencies	Bit 14 is set in the Status Questionable Calibration register.
Initial S/W Revision	Prior to A.02.00

24 hours

With Auto Align Alert set to 24 Hours the instrument will signal an alert after a time span of 24 hours since the last successful full alignment (for example, Align Now, All or completion of a full Auto Align). You may choose this selection in an environment where the temperature is stable on a daily basis at a small risk of accuracy errors in excess of the warranted specifications. The alert is the Error Condition message "Align Now, All required".

For front-panel operation, confirmation is required to transition into this setting of Alert. The confirmation dialog is:

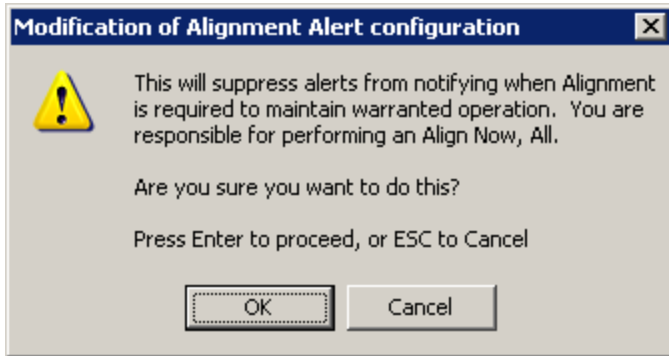

No confirmation is required when Alert is configured through a remote command.

Key Path	System, Alignments, Auto Align, Alert
Mode	All
Example	:CAL:AUTO:ALER DAY
Readback Text	24 hours
Status Bits/OPC dependencies	Bit 14 is set in the Status Questionable Calibration register.
Initial S/W Revision	Prior to A.02.00

7 days

With Auto Align Alert is set to 7 days the instrument will signal an alert after a time span of 168 hours since the last successful full alignment (for example, Align Now, All or completion of a full Auto Align). You may choose this selection in an environment where the temperature is stable on a weekly basis, at a modest risk of accuracy degradations in excess of warranted performance. The alert is the Error Condition message “Align Now, All required”.

For front panel operation, confirmation is required for the customer to transition into this setting of Alert. The confirmation dialog is:

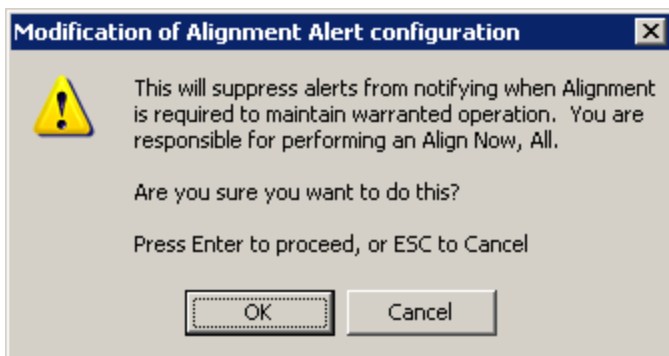

No confirmation is required when Alert is configured through a remote command.

Key Path	System, Alignments, Auto Align, Alert
Mode	All
Example	:CAL:AUTO:ALER WEEK
Readback Text	7 days
Status Bits/OPC dependencies	Bit 14 is set in the Status Questionable Calibration register.
Initial S/W Revision	Prior to A.02.00

None

With Auto Align Alert set to None the instrument will not signal an alert. This is provided for rare occasions where you are making a long measurement which cannot tolerate Auto Align interruptions, and must have the ability to capture a screen image at the end of the measurement without an alert posted to the display. Agilent does not recommends using this selection in any other circumstances, because of the risk of accuracy performance drifting well beyond expected levels without the operator being informed.

For front panel operation, confirmation is required to transition into this setting of Alert. The confirmation dialog is:

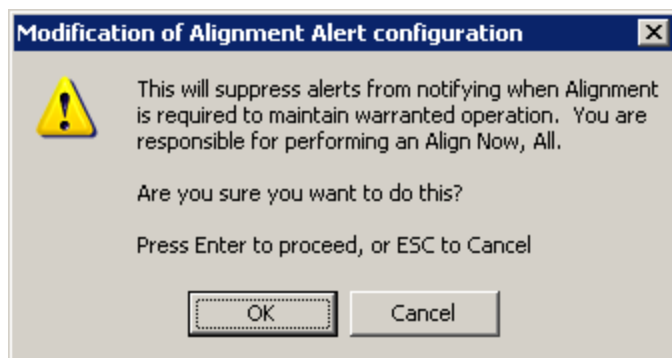

No confirmation is required when Alert is configured through a remote command.

Key Path	System, Alignments, Auto Align, Alert
Mode	All
Example	:CAL:AUTO:ALER NONE
Initial S/W Revision	Prior to A.02.00

Execute Expired Alignments (Remote Command Only)

Alignments can be expired in the situation where Auto Align is in the state of Partial or Off. This feature runs the alignments that have expired. This is different than performing an Align All, Now operation. Align All, Now performs an alignment of all subsystems regardless of whether they are needed or not, with Execute Expired Alignments, only the individual subsystems that have become due are aligned.

Mode	All
Remote Command	:CALibration:EXPIred?
Example	:CAL:EXP?
Notes	:CALibration:EXPIred? returns 0 if successful :CALibration:EXPIred? returns 1 if failed
Initial S/W Revision	Prior to A.02.00

Align Now

Accesses alignment processes that are immediate action operations. They perform complete operations and run until they are complete.

Key Path	System, Alignments
Initial S/W Revision	Prior to A.02.00

All

(In MXE the key label is “All (plus RF Presel 20 Hz – 3.6 GHz)”)Immediately executes an alignment of all subsystems In MXE, the Align Now All is followed by additionally aligning the RF Preselector section, so in MXE, the key label contains the parenthetical note “(plus RF Presel 20 Hz – 3.6 GHz)”. The instrument stops any measurement currently underway, performs the alignment, then restarts the measurement from the beginning (similar to pressing the Restart key).

If an interfering user signal is present at the RF Input, the alignment is performed on all subsystems except the RF. After completion, the Error Condition message “Align skipped: 50 MHz interference” or “Align skipped: 4.8 GHz interference” is generated. In addition the Error Condition message “Align Now, RF required” is generated, and bits 11 and 12 are set in the Status Questionable Calibration register.

The query form of the remote commands (:CALibration[:ALL]? or *CAL?) invokes the alignment of all subsystems and returns a success or failure value. An interfering user signal is not grounds for failure; if the alignment was able to succeed on all portions but unable to align the RF because of an interfering signal, the resultant will be the success value.

Successful completion of Align Now, All will clear the “Align Now, All required” Error Condition, and clear bit 14 in the Status Questionable Calibration register. It will also begin the elapsed time counter for Last Align Now, All Time, and capture the Last Align Now, All Temperature.

In the MXE, successful completion will also clear the “Align 20 Hz to 30 MHz required” Error Condition, the “Align 30 MHz to 3.6 GHz required” Error Condition, and the “Align 20 Hz to 3.6 GHz required” Error Condition, and clear bits 1 and bit 2 and clear the bit 1 in the Status Questionable Calibration Extended Needed register.

If the Align RF subsystem succeeded in aligning (no interfering signal present), the elapsed time counter begins for Last Align Now, RF Time, and the temperature is captured for the Last Align Now, RF Temperature. In addition the Error Conditions “Align skipped: 50 MHz interference” and “Align skipped: 4.8

GHz interference” are cleared, the Error Condition “Align Now, RF required” is cleared, and bits 11 and 12 are cleared in the Status Questionable Calibration register

Align Now, All can be interrupted by pressing the Cancel (ESC) front-panel key or remotely with Device Clear followed by the :ABORt SCPI command. When this occurs the Error Condition message “Align Now, All required” is generated, and bit 14 is set in the Status Questionable Condition register. This is because new alignment data may be employed for an individual subsystem, but not a cohesive set of data for all subsystems.

In many cases, you might find it more convenient to change alignments to Normal, instead of executing Align Now, All. When the Auto Align process transitions to Normal, the analyzer will immediately start to update only the alignments that have expired, thus efficiently restoring the alignment process.

Key Path	System, Alignments, Align Now
Mode	All
Remote Command	:CALibration[:ALL] :CALibration[:ALL]?
Example	:CAL
Notes	:CALibration[:ALL]? returns 0 if successful :CALibration[:ALL]? returns 1 if failed :CALibration[:ALL]? is the same as *CAL? While Align Now, All is performing the alignment, bit 0 in the Status Operation register is set. Completion, or termination, will clear bit 0 in the Status Operation register. This command is sequential; it must complete before further SCPI commands are processed. Interrupting the alignment from remote is accomplished by invoking Device Clear followed by the :ABORt command. Successful completion will clear bit 14 in the Status Questionable Calibration register. An interfering user signal is not grounds for failure of Align Now, All. However, bits 11 and 12 are set in the Status Questionable Calibration register to indicate Align Now, RF is required. An interfering user supplied signal will result in the instrument requiring an Align Now, RF with the interfering signal removed.
Couplings	Initializes the time for the Last Align Now, All Time. Records the temperature for the Last Align Now, All Temperature. If Align RF component succeeded, initializes the time for the Last Align Now, RF Time. If Align RF component succeeded, records the temperature for the Last Align Now, RF Temperature.
Status Bits/OPC dependencies	Bits 11, 12, or 14 may be set in the Status Questionable Calibration register.
Initial S/W Revision	Prior to A.02.00

Mode	All
Remote Command	*CAL?
Example	*CAL?
Notes	*CAL? returns 0 if successful

	<p>*CAL? returns 1 if failed :CALibration[:ALL]? is the same as *CAL? See additional remarks described with :CALibration[:ALL]? Everything about :CALibration[:ALL]? is synonymous with *CAL? including all conditions, status register bits, and couplings</p>
Initial S/W Revision	Prior to A.02.00

All but RF

(In MXE the key label is “All but RF (not including RF Presel)”)

Immediately executes an alignment of all subsystems except the RF subsystem . The instrument will stop any measurement currently underway, perform the alignment, and then restart the measurement from the beginning (similar to pressing the Restart key). This can be used to align portions of the instrument that are not impacted by an interfering user input signal.

This operation might be chosen instead of All if you do not want the device under test to experience a large change in input impedance, such as a temporary open circuit at the analyzer input.

The query form of the remote commands (:CALibration:NRF?) will invoke the alignment and return a success or failure value.

Successful completion of Align Now, All but RF will clear the “Align Now, All required” Error Condition, and clear bit 14 in the Status Questionable Calibration register. If “Align Now, All required” was in effect prior to executing the All but RF, the Error Condition message “Align Now, RF required” is generated and bit 12 in the Status Questionable Calibration register is set. It will also begin the elapsed time counter for Last Align Now, All Time, and capture the Last Align Now, All Temperature.

Align Now, All but RF can be interrupted by pressing the Cancel (ESC) front-panel key or remotely with Device Clear followed by the :ABORt SCPI command. When this occurs the Error Condition message “Align Now, All required” is generated, and bit 14 is set in the Status Questionable Condition register. This is because new alignment data may be used for an individual subsystem, but not a full new set of data for all subsystems.

In models with the RF Preselector, such as the N9038A, the “All but RF” alignment will execute an alignment of all subsystems except the RF subsystem of the Spectrum Analyzer, as well as the system gain of the RF Preselector.

Key Path	System, Alignments, Align Now
Mode	All
Remote Command	:CALibration:NRF :CALibration:NRF?
Example	:CAL:NRF
Notes	:CALibration:NRF? returns 0 if successful :CALibration:NRF? returns 1 if failed While Align Now, All but RF is performing the alignment, bit 0 in the Status Operation register is set. Completion, or termination, will clear bit 0 in the Status Operation register.

	This command is sequential; it must complete before further SCPI commands are processed. Interrupting the alignment from remote is accomplished by invoking Device Clear followed by the :ABORt command. Successful completion will clear bit 14 in the Status Questionable Calibration register and set bit 12 if invoked with “Align Now, All required”.
Couplings	Initializes the time for the Last Align Now, All Time. Records the temperature for the Last Align Now, All Temperature.
Status Bits/OPC dependencies	Bits 12 or 14 may be set in the Status Questionable Calibration register.
Initial S/W Revision	Prior to A.02.00

RF

(In MXE the key label is “RF Only”)

Immediately executes an alignment of the RF subsystem . The instrument stops any measurement currently underway, performs the alignment, then restarts the measurement from the beginning (similar to pressing the Restart key).

This operation might be desirable if the alignments had been set to not include RF alignments, or if previous RF alignments could not complete because of interference which has since been removed.

If an interfering user signal is present at the RF Input, the alignment will terminate and generate the Error Condition message “Align skipped: 50 MHz interference” or “Align skipped: 4.8 GHz interference”, and Error Condition “Align Now, RF required”. In addition, bits 11 and 12 will be set in the Status Questionable Calibration register.

The query form of the remote commands (:CALibration:RF?) will invoke the alignment of the RF subsystem and return a success or failure value. An interfering user signal is grounds for failure.

Successful completion of Align Now, RF will begin the elapsed time counter for Last Align Now, RF Time, and capture the Last Align Now, RF Temperature.

Align Now, RF can be interrupted by pressing the Cancel (ESC) front-panel key or remotely with Device Clear followed by the :ABORt SCPI command. When this occurs, the Error Condition message “Align Now, RF required” is generated, and bit 12 is set in the Status Questionable Condition register. None of the new alignment data is used.

In models with the RF Preselector, such as the N9038A, the RF alignment will execute an alignment of the RF subsystem of the Spectrum Analyzer, as well as the RF subsystem on RF Preselector path.

Key Path	System, Alignments, Align Now
Mode	All
Remote Command	:CALibration:RF :CALibration:RF?
Example	:CAL:RF
Notes	:CALibration:RF? returns 0 if successful

:CALibration:RF?	<p>returns 1 if failed (including interfering user signal)</p> <p>While Align Now, RF is performing the alignment, bit 0 in the Status Operation register is set. Completion, or termination, will clear bit 0 in the Status Operation register.</p> <p>This command is sequential; it must complete before further SCPI commands are processed. Interrupting the alignment from remote is accomplished by invoking Device Clear followed by the :ABORt command.</p> <p>Successful completion clears the Error Conditions “Align skipped: 50 MHz interference” and “Align skipped: 4800 MHz interference” and the Error Conditions “Align RF failed” and “Align Now, RF required”, and clears bits 3, 11, and 12 in the Status Questionable Calibration register.</p> <p>A failure encountered during alignment will generate the Error Condition message “Align RF failed” and set bit 3 in the Status Questionable Calibration register.</p> <p>An interfering user signal will result in bits 11 and 12 to be set in the Status Questionable Calibration register to indicate Align Now, RF is required.</p> <p>An interfering user supplied signal will result in the instrument requiring an Align Now, RF with the interfering signal removed.</p>
Couplings	<p>Initializes the time for the Last Align Now, RF Time.</p> <p>Records the temperature for the Last Align Now, RF Temperature.</p>
Status Bits/OPC dependencies	<p>Bits 11, 12, or 14 may be set in the Status Questionable Calibration register.</p>
Initial S/W Revision	<p>Prior to A.02.00</p>

External Mixer

Immediately executes an alignment of the External Mixer that is plugged into the USB port. The instrument stops any measurement currently underway, performs the alignment, then restarts the measurement from the beginning (similar to pressing the Restart key). As this alignment calibrates the LO power to the mixer, this is considered an LO alignment; and failure is classified as an LO alignment failure.

The query form of the remote commands (:CALibration:EMIXer?) will invoke the alignment of the External Mixer and return a success or failure value.

Key Path	System, Alignments, Align Now
Mode	All
Remote Command	:CALibration:EMIXer :CALibration:EMIXer?
Example	:CAL:EMIX
Notes	<p>:CAL:EMIX? returns 0 if successful</p> <p>:CAL:EMIX? returns 1 if failed</p> <p>While Align Now, Ext Mix is performing the alignment, bit 0 in the Status Operation register is set. Completion, or termination, will clear bit 0 in the Status Operation register.</p> <p>This command is sequential; it must complete before further SCPI commands are processed. Interrupting the alignment from remote is accomplished by invoking Device Clear followed by the :ABORt command.</p>

	A failure encountered during alignment will generate the Error Condition message “Align LO failed” and set bit 5 in the Status Questionable Calibration register. Successful completion will clear the “Align LO failed” message and bit 5 in the Status Questionable Calibration register.
Dependencies	This key does not appear unless option EXM is present and is grayed-out unless a USB mixer is plugged in to the USB.
Status Bits/OPC dependencies	Bit3 may be set in the Status Questionable Calibration Extended Failure register.
Initial S/W Revision	A.08.00

Show Alignment Statistics

Shows alignment information you can use to ensure that the instrument is operating in a specific manner. The Show Alignment Statistics screen is where you can view time and temperature information.

Values which are displayed are only updated when the Show Alignment Statistics screen is invoked, they are not updated while the Show Alignment Statistics screen is being displayed. The remote commands that access this information obtain current values.

An example of the Show Alignment Statistics screen would be similar to:

Std Header	Product Number: N9020A Serial Number: US46340924 Firmware Revision: A.01.01	
Instrument Info	Time since start-up: 300 hrs Current Temperature: +28 degC	
Auto Align Info	Time while Auto Align off: 90 min	
Std Align Now	Time since last Align Now All: 12.5 hrs Temperature since last Align Now All: -1.3 degC Time since last Align Now RF: 5 min Temperature since last Align Now RF: +0.1 degC	Times & Temperature delta. Shown as “...” if none since start-up.
If TG Option (Not Zorro1)	Time since last Align TG: 2.5 hrs Temperature since last Align TG: +0.2 degC	
Opts 508,513 526	Last Characterize Preselector: Jun 1, 2006 15:00:00 Last Characterize Preselector Temperature: +32.1 degC	Time & Temperature 'stamp'

A successful Align Now, RF will set the Last Align RF temperature to the current temperature, and reset the Last Align RF time. A successful Align Now, All or Align Now, All but RF will set the Last Align Now All temperature to the current temperature, and reset the Last Align Now All time. A successful Align Now, All will also reset the Last Align RF items if the RF portion of the Align Now succeeded.

Key Path	System, Alignments
Mode	All

Notes	The values displayed on the screen are only updated upon entry to the screen and not updated while the screen is being displayed.
Initial S/W Revision	Prior to A.02.00

Key Path	Visual annotation in the Show Alignment Statistics screen
Mode	All
Remote Command	:SYSTem:PON:TIME?
Example	:SYST:PON:TIME?
Notes	Value is the time since the most recent start-up in seconds.
State Saved	No
Initial S/W Revision	Prior to A.02.00

Key Path	Visual annotation in the Show Alignment Statistics screen
Mode	All
Remote Command	:CALibration:TEMPerature:CURRent?
Example	:CAL:TEMP:CURR?
Notes	Value is in degrees Centigrade. Value is invalid if using default alignment data (Align Now, All required)
State Saved	No
Initial S/W Revision	Prior to A.02.00

Key Path	Visual annotation in the Show Alignment Statistics screen
Mode	All
Remote Command	:CALibration:TIME:LALL?
Example	:CAL:TIME:LALL?
Notes	Value is the elapsed time, in seconds, since the last successful Align Now, All or Align Now, All but RF was executed.
State Saved	No
Initial S/W Revision	Prior to A.02.00

Key Path	Visual annotation in the Show Alignment Statistics screen
Mode	All
Remote Command	:CALibration:TEMPerature:LALL?
Example	:CAL:TEMP:LALL?

Notes	Value is in degrees Centigrade at which the last successful Align Now, All or Align Now, All but RF was executed.
State Saved	No
Initial S/W Revision	Prior to A.02.00

Key Path	Visual annotation in the Show Alignment Statistics screen
Mode	All
Remote Command	:CALibration:TIME:LRF?
Example	:CAL:TIME:LRF?
Notes	Value is the elapsed time, in seconds, since the last successful Align Now, RF was executed, either individually or as a component of Align Now, All.
State Saved	No
Initial S/W Revision	Prior to A.02.00

Key Path	Visual annotation in the Show Alignment Statistics screen
Mode	All
Remote Command	:CALibration:TEMPerature:LRF?
Example	:CAL:TEMP:LRF?
Notes	Value is in degrees Centigrade at which the last successful Align Now, RF was executed, either individually or as a component of Align Now, All.
State Saved	No
Initial S/W Revision	Prior to A.02.00

Key Path	Visual annotation in the Show Alignment Statistics screen
Mode	All
Remote Command	:CALibration:TIME:LPreselector?
Example	:CAL:TIME:LPR?
Notes	Value is the date and time the last successful Characterize Preselector was executed. The date is separated from the time by a space character. Returns "" if no Characterize Preselector has ever been performed on the instrument.
Dependencies	In models that do not include preselectors, this command is not enabled and any attempt to set or query will yield an error.
State Saved	No
Initial S/W Revision	Prior to A.02.00

Key Path	Visual annotation in the Show Alignment Statistics screen
Mode	All
Remote Command	:CALibration:TEMPerature:LPreselector?
Example	:CAL:TEMP:LPR?
Notes	Value is in degrees Centigrade at which the last successful Characterize Preselector was executed.
Dependencies	In models that do not include preselectors, this command is not enabled and any attempt to set or query will yield an error.
State Saved	No
Initial S/W Revision	Prior to A.02.00

Key Path	Visual annotation in the Show Alignment Statistics screen
Mode	All
Remote Command	:CALibration:AUTO:TIME:OFF?
Example	:CAL:AUTO:TIME:OFF?
Notes	Value is the elapsed time, in seconds, since Auto Align has been set to Off or Off with Alert. The value is 0 if Auto Align is ALL or NORF.
State Saved	No
Initial S/W Revision	Prior to A.02.00

Key Path	Visual annotation in the Show Alignment Statistics screen
Mode	All
Remote Command	:CALibration:TIME:RFPSector:LCONducted?
Example	:CAL:TIME:RFPS:LCON?
Notes	Values are the date and time the last successful Align Now, 20 Hz – 30 MHz was executed. The date is separated from the time by a semi-colon character.
State Saved	No

Key Path	Visual annotation in the Show Alignment Statistics screen
Mode	All
Remote Command	:CALibration:TEMPerature:RFPSector:LCONducted?
Example	:CAL:TEMP:RFPS:LCON?
Notes	Value is in degrees Centigrade at which the last successful Align Now, 20 Hz – 30 MHz was executed.
State Saved	No

Key Path	Visual annotation in the Show Alignment Statistics screen
Mode	All
Remote Command	:CALibration:TIME:RFPSector:LRADiated?
Example	:CAL:TIME:RFPS:LRAD?
Notes	Value is the date and time the last successful Align Now, 30 MHz – 3.6 GHz was executed. The date is separated from the time by a semi-colon character.
State Saved	No

Key Path	Visual annotation in the Show Alignment Statistics screen
Mode	All
Remote Command	:CALibration:TEMPerature:RFPSector:LRADiated?
Example	:CAL:TEMP:RFPS:LRAD?
Notes	Value is in degrees Centigrade at which the last successful Align Now, 30 MHz – 3.6 GHz was executed.
State Saved	No

Key Path	Visual annotation in the Show Alignment Statistics screen
Mode	All
Remote Command	:CALibration:RFPSector:SCHeuler:TIME:NEXT? This query returns data using the following format “YYYY/MM/DD; HH:MM:SS”
Example	:CAL:RFPS:SCH:TIME:NEXT?
Notes	The next run time will be updated based on the start date/time and recurrence set by the users. “date” is representation of the date the task will run in the form of “YYYY/MM/DD” where: –YYYY is the four digit representation of year. (for example, 2009) –MM is the two digit representation of month. (for example, 01 to 12) –DD is the two digit representation of the day. (for example, 01 to 28, 29, 30 or 31 depending on the month and year) “time” is a representation of the time of day the task will run in the form of “HH:MM:SS” where: –HH is the two digit representation of the hour in 24 hour format –MM is the two digit representation of minute –SS is the two digit representation of seconds For model N9038A only.
State Saved	No

Restore Align Defaults

Initializes the alignment user interface settings, not alignment data, to the factory default values. Align Now, All must be executed if the value of the Timebase DAC results in a change.

For front panel operation, you are prompted to confirm action before setting the alignment parameters to factory defaults:

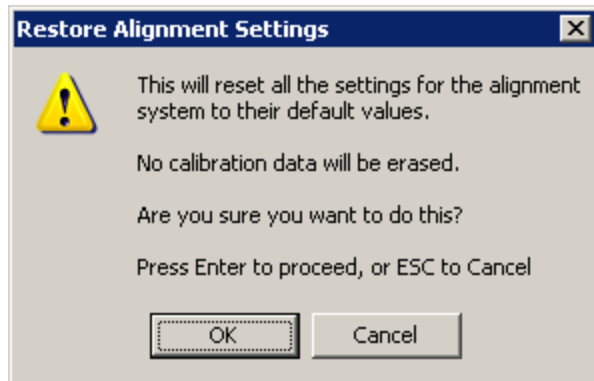

The parameters affected are:

Parameter	Setting
Timebase DAC	Calibrated
Timebase DAC setting	Calibrated value
Auto Align State	Normal (if the instrument is not operating with default alignment data, Off otherwise)
Auto Align All but RF	Off
Auto Align Alert	Time & Temperature

Key Path	System, Alignments
Mode	All
Example	:SYST:DEF ALIG
Notes	Alignment processing that results as the transition to Auto Alignment Normal will be executed sequentially; thus *OPC? or *WAI will wait until the alignment processing is complete.
Initial S/W Revision	Prior to A.02.00

Backup or Restore Align Data...

Opens the utility for backing-up or restoring the alignment data.

Alignment data for the instrument resides on the hard drive in a database. Agilent uses high quality hard drives; however it is highly recommended the alignment data be backed-up to storage outside of the instrument. Additionally, for customers who use multiple CPU Assemblies or multiple disk drives, the

alignment that pertains to the instrument must be transferred to the resident hard drive after a CPU or hard drive is replaced. This utility facilitates backing-up and restoring the alignment data.

NOTE

This utility allows the operator to navigate to any location of the Windows file system. It is intended that the operator use a USB memory device or Mapped Network Drive to back up the alignment data to storage outside of the instrument.

Key Path	System, Alignments
Initial S/W Revision	A.02.00

Key Path	System, Alignments
Mode	All
Remote Command	:CALibration:DATA:DEFault
Example	:CAL:DATA:DEF
Couplings	Sets Auto Align to Off. Sets bit 14 in the Status Questionable Calibration register. The Error Condition message "Align Now, All required" is generated.
Initial S/W Revision	Prior to A.02.00

Alignment Data Wizard

The Backup or Restore Alignment Data wizard guides you through the operation of backing-up or restoring the alignment data.

The following dialogue boxes operates without a mouse or external keyboard when you use the default file names.

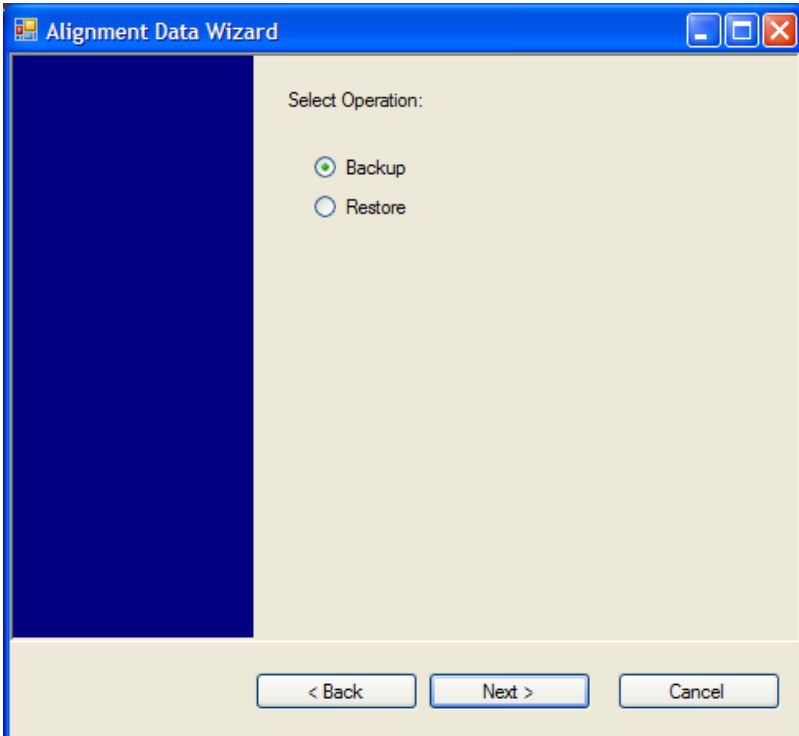
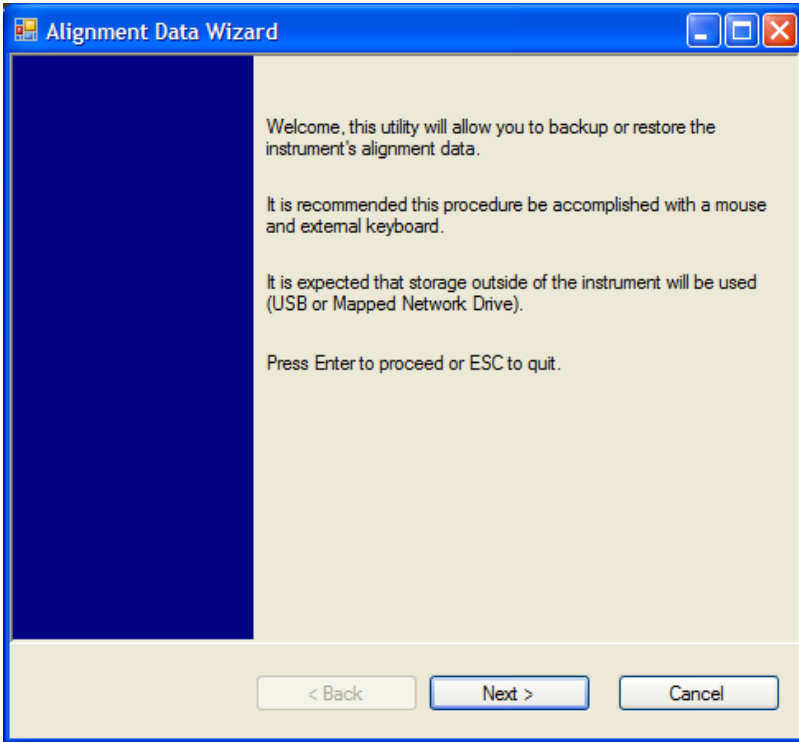

The backup screen indicates the approximate amount of space required to contain the backup file.

The default file name will be AlignDataBackup_<model number>_<serial number>_<date in YYYYMMDDHHMMSS>.bak.

The default backup location will be first drive identified as an external drive (USB or LAN) if such is available; if not, the internal D: partition will be selected.

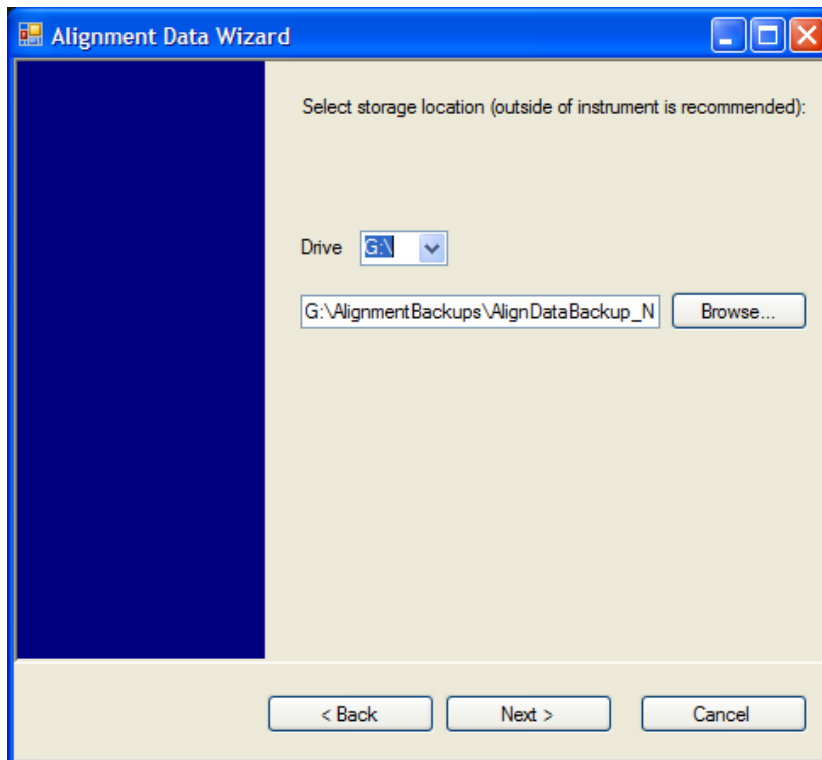

Changing the drive letter will also modify the path displayed in the box below. When this step is first loaded, the drive drop-down menu is populated with connected drives, which provide the user with write access. If there are many unreachable network drives connected to the instrument, this step can take a few seconds. If a USB drive is present, it will be selected by default. The path defaults to the AlignmentBackups folder, and a filename is automatically created in the form of AlignDataBackup_<model>_<serial number>_<date><time>. When the "Next >" button is pressed, you will be prompted to create a new folder if the chosen path does not yet exist.

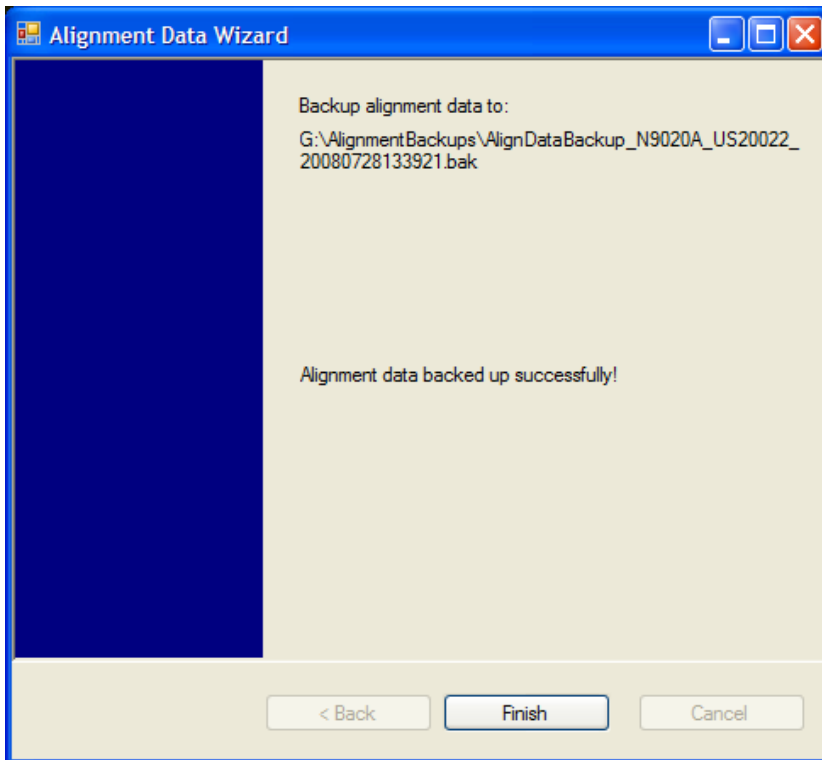
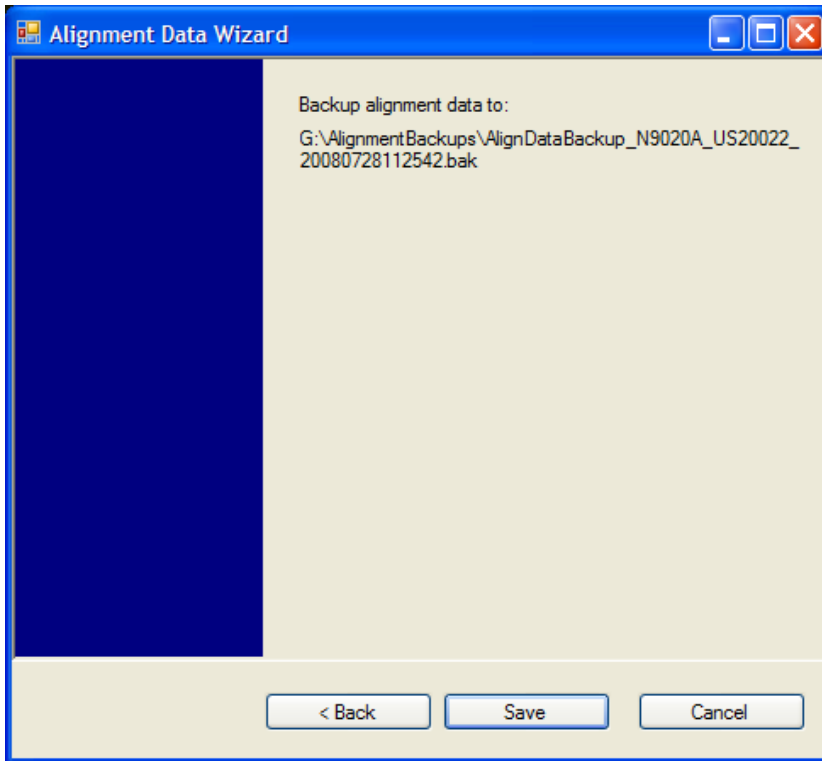

The restore operation checks the validity of the restore file using the database's built-in file validation. If the restore file is corrupt, the existing alignment data will remain in use.

If the serial number information in the backup file being restored is different from that of the instrument, the following message appears (the serial number shown are examples):

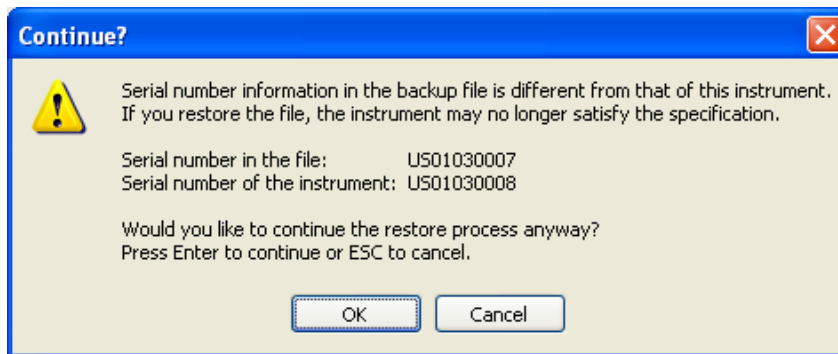

The default restore location will be first drive identified as an external drive (USB or LAN) if such is available; if not, the internal D: partition will be selected. The default restore file will be the most recent file that matches the default backup file name format: AlignDataBackup_<model number>_<serial number>_<date>.bak

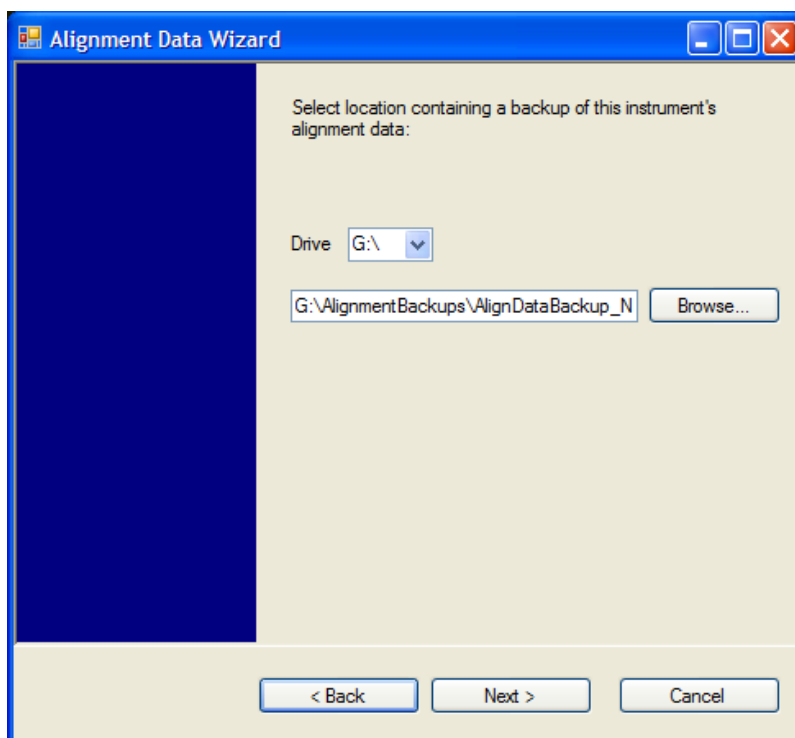

Changing the drive letter also modifies the path displayed in the box below. When this step is first loaded, the drive drop-down menu is populated with connected drives, which provide you with read access. The path defaults to the AlignBackups folder. The most recent *.bak file in the folder will also be selected by default.

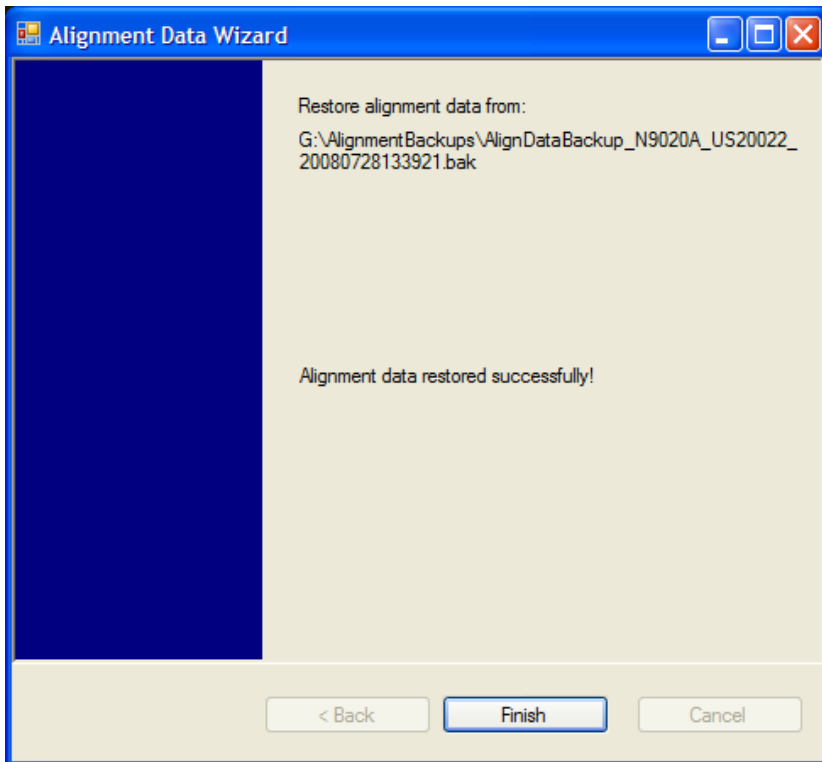
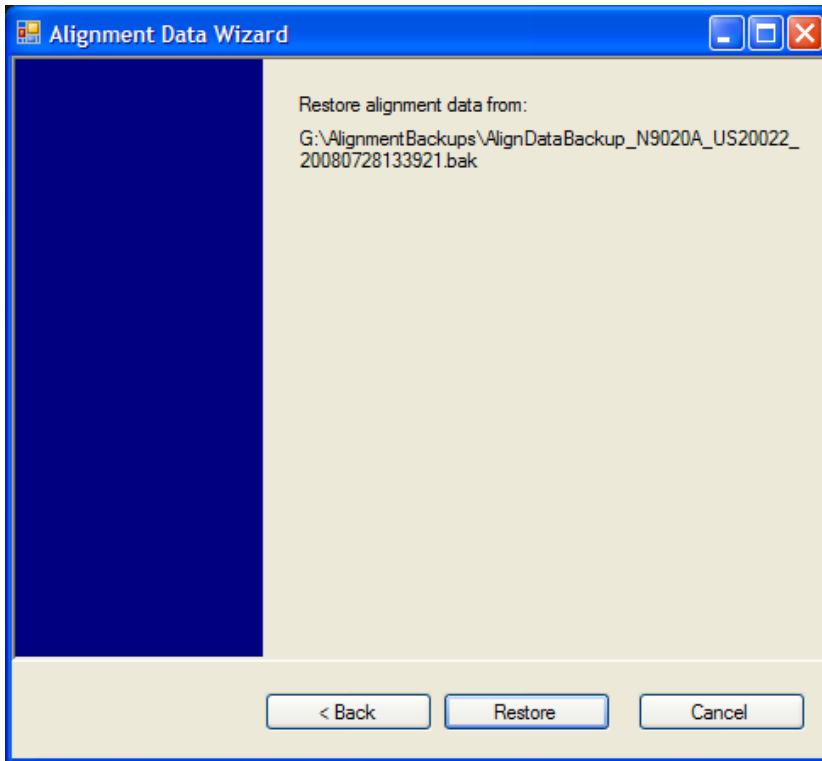

Perform Backup (Remote Command Only)

Invokes an alignment data backup operation to the provided Folder.

NOTE

It is recommended that the Folder provided is outside of the instrument (USB or Mapped Network Drive).

Remote Command	:CALibration:DATA:BACKup <filename>
Example	:CAL:DATA:BACK "F:\AlignDataBackup_N9020A_US00000001_2008140100.bak"
Initial S/W Revision	A.02.00

Perform Restore (Remote Command Only)

Invokes an alignment data restore operation from the provided filename.

Remote Command	:CALibration:DATA:REStore <filename>
Example	:CAL:DATA:RESt "F:\ AlignDataBackup_N9020A_US00000001_2008140100.bak "
Initial S/W Revision	A.02.00

Advanced

Accesses alignment processes that are immediate action operations that perform operations that run until complete. Advanced alignments are performed on an irregular basis, or require additional operator interaction

Key Path	System, Alignments
Initial S/W Revision	Prior to A.02.00

Characterize Preselector

The Preselector tuning curve drifts over temperature and time. Recognize that the Amplitude, Presel Center function adjusts the preselector for accurate amplitude measurements at an individual frequency. Characterize Preselector improves the amplitude accuracy by ensuring the Preselector is approximately centered at all frequencies without the use of the Amplitude, Presel Center function. Characterize Preselector can be useful in situations where absolute amplitude accuracy is not of utmost importance, and the throughput savings or convenience of not performing a Presel Center is desired. Presel Center is required prior to any measurement for best (and warranted) amplitude accuracy.

Agilent recommends that the Characterize Preselector operation be performed yearly as part of any calibration, but performing this operation every three months can be worthwhile.

Characterize Preselector immediately executes a characterization of the Preselector, which is a YIG-tuned filter (YTF). The instrument stops any measurement currently underway, performs the characterization, then restarts the measurement from the beginning (similar to pressing the Restart key).

The query form of the remote commands (:CALibration:YTF?) will invoke the alignment of the YTF subsystem and return a success or failure value.

A failure encountered during alignment will generate the Error Condition message "Characterize Preselector failure" and set bit 3 in the STATus:QUEStionable:CALibration:EXTended:FAILure status register. Successful completion of Characterize Preselector will clear this Condition. It will also begin the

elapsed time counter for Last Characterize Preselector Time, and capture the Last Characterize Preselector Temperature.

The last Characterize Preselector Time and Temperature survives across the power cycle as this operation is performed infrequently.

NOTE

The Characterize Preselector function can be interrupted by pressing the Cancel (ESC) front-panel key or remotely with Device Clear followed by the :ABORt SCPI command. None of the new characterization data is then used. However, since the old characterization data is purged at the beginning of the characterization, you now have an uncharacterized preselector. You should re-execute this function and allow it to finish before making any further preselected measurements.

Key Path	System, Alignments, Advanced
Mode	All
Remote Command	:CALibration:YTF :CALibration:YTF?
Example	:CAL:YTF
Notes	:CALibration:YTF? returns 0 if successful :CALibration:YTF? returns 1 if failed (including interfering user signal) While Advanced, Characterize Preselector is performing the alignment, bit 0 in the Status Operation register is set. Completion, or termination, will clear bit 0 in the Status Operation register. This command is sequential; it must complete before further SCPI commands are processed. Interrupting the alignment from remote is accomplished by invoking Device Clear followed by the :ABORt command. Successful completion will clear bit 9 in the Status Questionable Calibration register. A failure encountered during alignment will generate the Error Condition message "Characterize Preselector failed" and set bit 9 in the Status Questionable Calibration register. For Options that support frequencies > 3.6 GHz only.
Dependencies	This key does not appear in models that do not contain preselectors. In these models the SCPI command is accepted without error but no action is taken.
Couplings	Initializes the time for the Last Characterize Preselector Time. Records the temperature for the Last Characterize Preselector Temperature.
Initial S/W Revision	Prior to A.02.00

Characterize Reference Clock

Characterizing the reference clock is calibrating the Reference Input Phase with the External Reference Output. This feature is only available when either option DP2 or B40 is present. It requires connecting the 10 MHz OUT to the EXT REF IN port with a BNC cable before running the characterization.

See ["Front panel guided calibration sequence" on page 408](#)

Key Path	System, Alignments, Advanced
Mode	All

Remote Command	:CALibration:REFErence:CLOCK?
Example	:CAL:REF:CLOC:INIT? //connect cable :CAL:REF:CLOC? //disconnect cable :CAL:REF:CLOC:END?
Notes	:CALibration:REFErence:CLOCK? returns 0 if successful :CALibration:REFErence:CLOCK? returns 1 if failed
Dependencies	Option DP2 or B40
Couplings	Initializes the time for the Last Characterize Reference Clock Time. Records the temperature for the Last Characterize Reference Clock Temperature. Expected to be run after :CAL:REF:CLOC:INIT, and before :CAL:REF:CLOC:END.
Initial S/W Revision	A.13.00

Parameter Name	Characterize Reference Clock Initialization
Mode	All
Remote Command	:CALibration:REFErence:CLOCK:INITialize?
Example	:CAL:REF:CLOC:INIT?
Notes	:CALibration:REFErence:CLOCK:INIT? returns 0 if successful :CALibration:REFErence:CLOCK:INIT? returns 1 if failed
Dependencies	Option DP2 or B40
Couplings	Expected to be run before sending the :CAL:REF:CLOC? command. This will stop the current measurement when it has completed (does not abort the current data acquisition), and it will prepare the instrument for the expected cabling.
Force Restart	Yes
Initial S/W Revision	A.12.00

Parameter Name	Characterize Reference Clock End
Mode	All
Remote Command	:CALibration:REFErence:CLOCK:END?
Example	:CAL:REF:CLOC:END?
Notes	:CALibration:REFErence:CLOCK:END? returns 0 if successful :CALibration:REFErence:CLOCK:END? returns 1 if failed
Dependencies	Option DP2 or B40
Couplings	Expected to be run after sending the :CAL:REF:CLOC? command, and after removing the cable used in that Characterize Reference Clock step. This will resume any queued measurements, and it concludes the reference clock characterization.
Force Restart	Yes
Initial S/W Revision	A.12.00

Parameter Name	Last Characterize Reference Clock
Key Path	Visual annotation in the Show Alignment Statistics screen
Parameter Type	String
Mode	All
Remote Command	:CALibration:TIME:REFeRence:CLOCK?
Example	:CAL:TIME:REFeRence:CLOCK?
Notes	Value is the date and time the last successful Characterize Reference Clock was executed. The date is separated from the time by a space character. Returns "" if Characterize Reference Clock has never been performed on the instrument.
Dependencies	Option DP2 or B40
State Saved	No
Initial S/W Revision	A.12.00

Front panel guided calibration sequence

When selecting "Characterize Reference Clock" through the front panel, the following form will be shown. Step 1 of the guided calibration sequence:

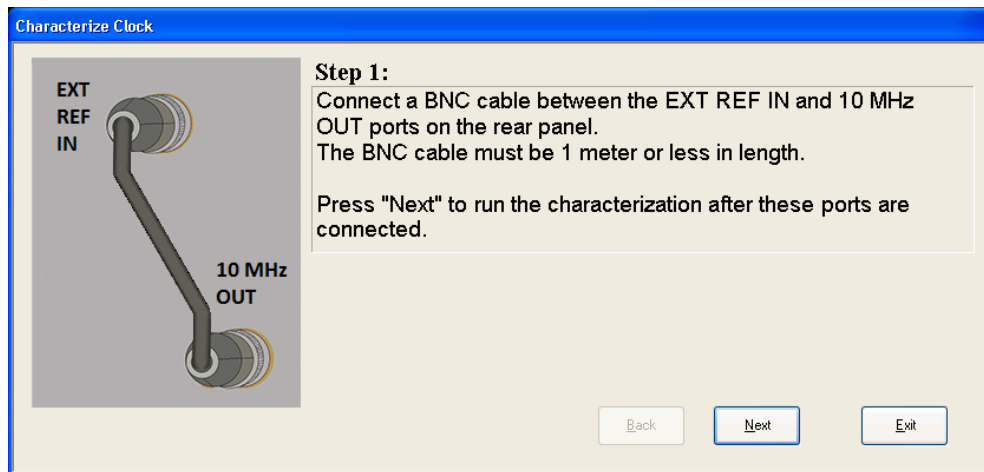

Step 2 of the guided calibration sequence:

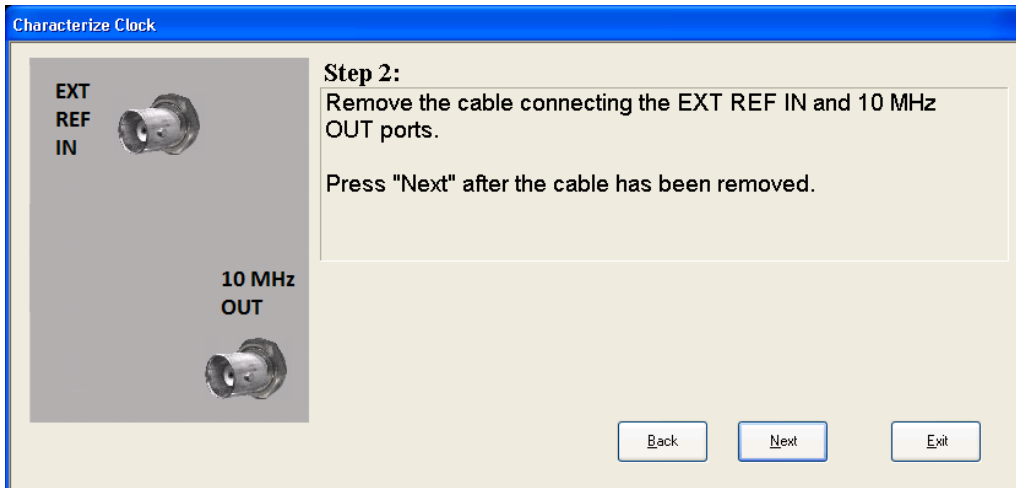

Step 3 of the guided calibration sequence:

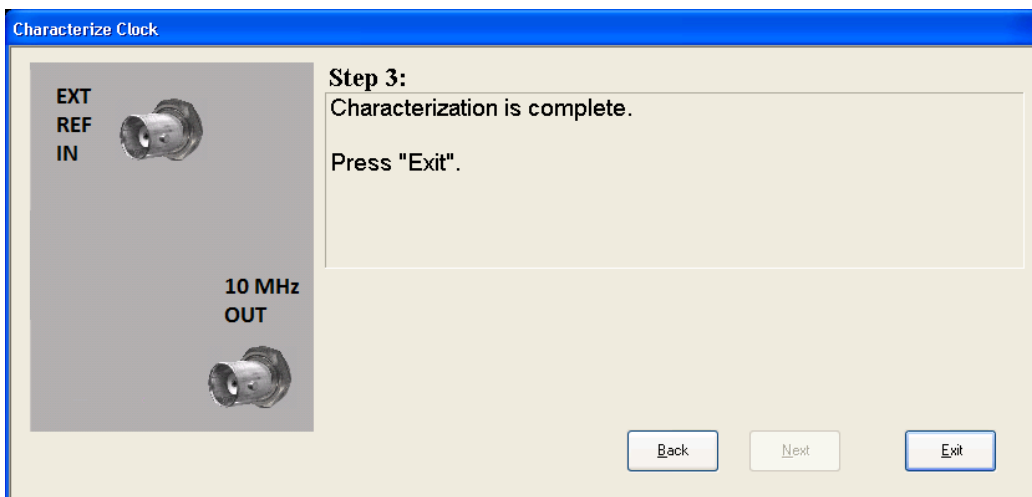

Characterize Noise Floor

On instruments with the NF2 license installed, the calibrated Noise Floor used by Noise Floor Extensions should be refreshed periodically. To do this, press the Characterize Noise Floor key. When you press this key, the instrument stops any measurement currently underway, and a dialog appears with an OK and Cancel button which says:

"This action will take several minutes to perform. Please disconnect all cables from the RF input and press Enter to proceed. Press ESC to cancel."

When you press Enter or OK, the characterization proceeds. After the characterization, the analyzer restarts the measurement from the beginning (similar to pressing the Restart key). The characterization takes many minutes to run.

The noise floor model used by NFE includes an estimation of the temperature behavior of the noise floor, but this is only an estimation. The noise floor changes little with the age of the components. However, even small changes in the estimated level of the noise floor can make large changes in the effective noise floor, because the effective noise floor is the error in the estimation of the noise floor. Agilent recommends that

the Characterize Noise Floor operation be performed when the analyzer is operating at an ambient temperature that is significantly different than the ambient temperature at which this alignment was last run. In addition, Agilent recommends that the Characterize Noise Floor operation be performed after the first 500 hours of operation, and once every calendar year.

The noise floor model from the last operation of Characterize Noise Floor survives across the power cycle.

NOTE

The Characterize Noise Floor function can be interrupted by pressing the Cancel (ESC) front-panel key or remotely with Device Clear followed by the :ABORt SCPI command. None of the new characterization data is then used. However, since the old characterization data is purged at the beginning of the characterization, you now have an uncharacterized noise floor. You should re-execute this function and allow it to finish before making any further measurements with NFE. Until you do, the analyzer will display a “Characterize Noise Floor required” message and set bit 12 in the Status Questionable Calibration register (STATus:QUESTionable:CALibration:EXTended:NEEDED).

Key Path	System, Alignments, Advanced
Mode	All
Remote Command	:CALibration:NFLoor :CALibration:NFLoor?
Example	:CAL:NFL
Notes	:CALibration:NFLoor? returns 0 if successful :CALibration:NFLoor? returns 1 if failed (including interfering user signal) While Characterize Noise Floor is performing the alignment, bit ? in the Status Operation register is set. Completion, or termination, will clear bit ? in the Status Operation register. This command is sequential; it must complete before further SCPI commands are processed. Interrupting the alignment from remote is accomplished by invoking Device Clear followed by the :ABORt command. A failure encountered during characterization will generate the Error Condition message “Characterize Noise Floor failed” message and set bit ? in the Status Questionable Calibration register. Successful completion will clear bit ? in the Status Questionable Calibration register.
Dependencies	This key does not appear in models that do not contain NFE. In these models the SCPI command is accepted without error but no action is taken.
Couplings	Successful completion of Characterize Noise Floor will begin the elapsed time counter or the Last Characterize Noise Floor Time.
Initial S/W Revision	A.14.00

Key Path	Visual annotation in the Show Alignment Statistics screen
Mode	All
Remote Command	:CALibration:TIME:NFLoor?
Example	:CAL:TIME:NFL?
Notes	Value is the date and time the last successful Characterize Noise Floor was executed. The date is separated from the time by a space character. Returns “” if no Characterize Noise Floor has ever been performed on the instrument.

Dependencies	In models that do not include NFE, this command is not enabled and any attempt to set or query will yield an error.
State Saved	No
Initial S/W Revision	A.14.00

Key Path	Visual annotation in the Show Alignment Statistics screen
Mode	All
Remote Command	:CALibration:TEMPerature:NFLoor?
Example	:CAL:TEMP:NFL?
Notes	Value is the temperature of the last successful Characterize Noise Floor was executed. Returns "" if no Characterize Noise Floor has ever been performed on the instrument.
Dependencies	In models that do not include NFE, this command is not enabled and any attempt to set or query will yield an error.
State Saved	No
Initial S/W Revision	A.14.00

Key Path	Visual annotation in the Show Alignment Statistics screen
Mode	All
Remote Command	:CALibration:TIME:ELAPsed:NFLoor?
Example	:CAL:TIME:ELAP:NFL?
Notes	Value is the elapsed time the instrument was powered-on since the last successful Characterize Noise Floor was executed. Returns "" if no Characterize Noise Floor has ever been performed on the instrument.
Dependencies	In models that do not include NFE, this command is not enabled and any attempt to set or query will yield an error.
State Saved	No
Initial S/W Revision	A.14.00

Timebase DAC

Allows control of the internal 10 MHz reference oscillator timebase. This may be used to adjust for minor frequency alignment between the signal and the internal frequency reference. This adjustment has no effect if the instrument is operating with an External Frequency Reference.

If the value of the Timebase DAC changes (by switching to Calibrated from User with User set to a different value, or in User with a new value entered) an alignment may be necessary. The alignment system will take appropriate action; which will either invoke an alignment or cause an Alert.

Key Path	System, Alignments
Mode	All
Remote Command	:CALibration:FREQuency:REFerence:MODE CALibrated USER :CALibration:FREQuency:REFerence:MODE?
Example	:CAL:FREQ:REF:MODE CAL
Notes	If the value of the timebase is changed the alignment system automatically performs an alignment or alerts that an alignment is due. If the value of the timebase is changed the alignment system automatically performs an alignment or alerts that an alignment is due.
Preset	This is unaffected by Preset but is set to CALibrated on a "Restore System Defaults->Align".
State Saved	No
Initial S/W Revision	Prior to A.02.00

Calibrated

Sets the Timebase DAC to the value established during factory or field calibration. The value displayed on the menu key is the calibrated value.

Key Path	System, Alignments, Timebase DAC
Mode	All
Example	:CAL:FREQ:REF:MODE CAL
Readback Text	[xxx] < where xxx is the calibrated value
Initial S/W Revision	Prior to A.02.00

User

Allows setting the Timebase DAC to a value other than the value established during the factory or field calibration. The value displayed on the menu key is the calibrated value.

Key Path	System, Alignments, Timebase DAC
Mode	All
Example	:CAL:FREQ:REF:MODE USER
Readback Text	xxx < where xxx is the Timebase DAC setting
Initial S/W Revision	Prior to A.02.00

Key Path	System, Alignments, Timebase DAC
Mode	All
Remote Command	:CALibration:FREQuency:REFerence:FINE <integer>

	:CALibration:FREQuency:REFeRence:FINE?
Example	:CAL:FREQ:REF:FINE 8191
Notes	If the value of the timebase is changed the alignment system automatically performs an alignment or alerts that an alignment is due.
Couplings	Setting :CAL:FREQ:REF:FINE sets :CAL:FREQ:REF:MODE USER
Preset	This is unaffected by Preset but is set to the factory setting on a “Restore System Defaults->Align”.
State Saved	No
Min	0
Max	16383
Backwards Compatibility SCPI	:CALibration:FREQuency:REFeRence:COARse ESA hardware contained two DAC controls for the Timebase. In X-Series the command :CALibration:FREQuency:REFeRence:FINE is the method for adjusting the timebase. The :COARse command is provided as an alias to :FINE.
Initial S/W Revision	Prior to A.02.00

Remote Command	:CALibration:FREQuency:REFeRence:COARse <integer> :CALibration:FREQuency:REFeRence:COARse?
Example	:CAL:FREQ:REF:COAR 8191
Notes	This is an alias for CAL:FREQ:REF:FINE any change to COARse is reflected in FINE and vice-versa. See CAL:FREQ:REF:FINE for description of functionality.
Couplings	Setting :CAL:FREQ:REF:COAR sets :CAL:FREQ:REF:MODE USER
Initial S/W Revision	Prior to A.02.00

I/O Config

Activates a menu for identifying and changing the I/O configuration for remote control.

Key Path	System
Initial S/W Revision	Prior to A.02.00

GPIB

Activates a menu for configuring the GPIB I/O port.

Key Path	System, I/O Config
Initial S/W Revision	A.02.00

GPIO Address

Select the GPIO remote address.

Key Path	System, I/O Config, GPIO
Mode	All
Remote Command	:SYSTem:COMMunicate:GPIO[1][:SELF]:ADDRESS <integer> :SYSTem:COMMunicate:GPIO[1][:SELF]:ADDRESS?
Example	:SYST:COMM:GPIO:ADDR 17
Notes	Changing the Address on the GPIO port requires all further communication to use the new address.
Preset	This is unaffected by Preset but is set to 18 on a "Restore System Defaults->Misc"
State Saved	No
Range	0 to 30
Min	0
Max	30
Initial S/W Revision	Prior to A.02.00

GPIO Controller

Sets the GPIO port into controller or device mode. In the normal state, GPIO controller is disabled, which allows the analyzer to be controlled by a remote computer. When GPIO Controller is enabled, the instrument can run software applications that use the instrument's computer as a GPIO controller; controlling devices connected to the instrument's GPIO port.

NOTE

When GPIO Controller is enabled, the analyzer application itself cannot be controlled over GPIO. In this case it can easily be controlled via LAN or USB. The GPIO port cannot be a controller and device at the same time. Only one controller can be active on the GPIO bus at any given time. If the analyzer is the controller, an external PC cannot be a controller.

To control the instrument from the software that is performing GPIO controller operation, you can use an internal TCP/IP connection to the analyzer application. Use the address TCPIP0:localhost:inst0:INSTR to send SCPI commands to the analyzer application.

Key Path	System, I/O Config, GPIO
Mode	All
Scope	Mode Global
Remote Command	:SYSTem:COMMunicate:GPIO[1][:SELF]:CONTROLLER[:ENABLE] ON OFF 0 1 :SYSTem:COMMunicate:GPIO[1][:SELF]:CONTROLLER[:ENABLE]?
Example	:SYST:COMM:GPIO:CONT ON Will set GPIO port to Controller
Notes	When the instrument becomes the Controller bit 0 in the Standard Event Status Register is set (and when the instrument relinquishes Controller capability bit 0 is cleared in the Standard Event Status Register).
Preset	This is unaffected by Preset but is set to OFF on a "Restore System Defaults->Misc"

State Saved	No
Range	Disabled Enabled
Initial S/W Revision	A.02.00

Disabled

Disables the GPIB Controller capability, this is the default (or normal) setting.

Key Path	System, I/O Config, GPIB, GPIB Controller	
Example	:SYST:COMM:GPIB:CONT OFF	Will set GPIB port to Device
Initial S/W Revision	A.02.00	

Enabled

Enables the GPIB Controller capability.

Key Path	System, I/O Config, GPIB, GPIB Controller	
Example	:SYST:COMM:GPIB:CONT ON	Will set GPIB port to Controller
Initial S/W Revision	A.02.00	

SCPI LAN

Activates a menu for identifying and changing the SCPI over a LAN configuration. There are a number of different ways to send SCPI remote commands to the instrument over LAN. It can be a problem to have multiple users simultaneously accessing the instrument over the LAN. These keys limit that somewhat by disabling the telnet, socket, and/or SICL capability.

Key Path	System, I/O Config
Initial S/W Revision	Prior to A.02.00

SCPI Telnet

Turns the SCPI LAN telnet capability On or Off allowing you to limit SCPI access over LAN through telnet.

Key Path	System, I/O Config, SCPI LAN	
Mode	All	
Remote Command	:SYSTem:COMMunicate:LAN:SCPI:TELNet:ENABle OFF ON 0 1 :SYSTem:COMMunicate:LAN:SCPI:TELNet:ENABle?	
Example	:SYST:COMM:LAN:SCPI:TELN:ENAB OFF	
Preset	This is unaffected by Preset but is set to ON with a "Restore System Defaults->Misc"	

State Saved	No
Range	On Off
Initial S/W Revision	Prior to A.02.00

SCPI Socket

Turns the capability of establishing Socket LAN sessions On or Off. This allows you to limit SCPI access over LAN through socket sessions.

Key Path	System, I/O Config, SCPI LAN
Mode	All
Remote Command	:SYSTem:COMMunicate:LAN:SCPI:SOCKet:ENABle OFF ON 0 1 :SYSTem:COMMunicate:LAN:SCPI:SOCKet:ENABle?
Example	:SYST:COMM:LAN:SCPI:SOCK:ENAB OFF
Preset	This is unaffected by a Preset but is set to ON with a "Restore System Defaults->Misc"
State Saved	No
Range	On Off
Initial S/W Revision	Prior to A.02.00

SICL Server

Turns the SICL server capability On or Off, enabling you to limit SCPI access over LAN through the SICL server. (SICL IEEE 488.2 protocol.)

Parameter	Description	Setting
Maximum Connections	The maximum number of connections that can be accessed simultaneously	5
Instrument Name	The name (same as the remote SICL address) of your analyzer	inst0
Instrument Logical Unit	The unique integer assigned to your analyzer when using SICL LAN	8
Emulated GPIB Name	The name (same as the remote SICL address) of the device used when communicating with your analyzer	gpib7
Emulated GPIB Logical Unit	The unique integer assigned to your device when it is being controlled using SICL LAN	8
Emulated GPIB Address	The emulated GPIB address assigned to your transmitter tester when it is a SICL server (the same as your GPIB address)	18

Key Path	System, I/O Config, SCPI LAN
Mode	All

Remote Command	:SYSTem:COMMunicate:LAN:SCPI:SIcL:ENABle OFF ON 0 1 :SYSTem:COMMunicate:LAN:SCPI:SIcL:ENABle?
Example	:SYST:COMM:LAN:SCPI:SIcL:ENAB OFF
Preset	This is unaffected by Preset, but is set to ON with a “Restore System Defaults->Misc”
State Saved	No
Range	On Off
Initial S/W Revision	Prior to A.02.00

HiSLIP Server

Turns the HiSLIP server capability On or Off, enabling you to limit SCPI access over LAN through the HiSLIP server.

HiSLIP stands for High Speed LAN Instrument Protocol and is part of the IVI-6.1 specification.

Here is an example of a VISA connection string used to connect to the HiSLIP Server on an X-Series Spectrum Analyzer:

```
TCPIP0::a-n9030a-93016::hislip0::INSTR
```

In the example above, hislip0 is the HiSLIP device name that VISA users must include in their HiSLIP VISA Address strings. Your HiSLIP device name may be different depending on your VISA settings.

Key Path	System, I/O Config, SCPI LAN
Mode	All
Remote Command	:SYSTem:COMMunicate:LAN:SCPI:HISLip:ENABle OFF ON 0 1 :SYSTem:COMMunicate:LAN:SCPI:HISLip:ENABle?
Example	:SYST:COMM:LAN:SCPI:HISL:ENAB OFF
Preset	This is unaffected by Preset, but is set to ON with a “Restore System Defaults->Misc”
State Saved	No
Range	On Off
Initial S/W Revision	A.11.00

SCPI Socket Control Port (Remote Command Only)

Returns the TCP/IP port number of the control socket associated with the SCPI socket session. This query enables you to obtain the unique port number to open when a device clear is to be sent to the instrument. Every time a connection is made to the SCPI socket, the instrument creates a peer control socket. The port number for this socket is random. The user must use this command to obtain the port number of the control socket. To force a device clear on this socket, open the port and send the string “DCL ” to the instrument.

If this SCPI command is sent to a non SCPI Socket interface, then 0 is returned.

Mode	All
Remote Command	:SYSTem:COMMunicate:LAN:SCPI:SOCKet:CONTRol?
Example	:SYST:COMM:LAN:SCPI:SOCK:CONT?
Preset	This is unaffected by Preset or "Restore System Defaults->Misc".
State Saved	No
Range	0 to 65534
Min	0
Max	65534
Initial S/W Revision	Prior to A.02.00

Reset Web Password

The embedded web server contains certain capability which are password protected; modifying the LAN configuration of the instrument, and access to web pages that can change the settings of the instrument. The default password from the factory is 'agilent' (without the quotes). The control provided here is the means to set the web password as the user desires, or to reset the password to the factory default.

Selecting Reset web password brings up a control for resetting the password as the user desires, or to the factory default. A keyboard is required to change the password from the factory default of 'agilent' or to set a new password that contains alphabetic characters. The control is:

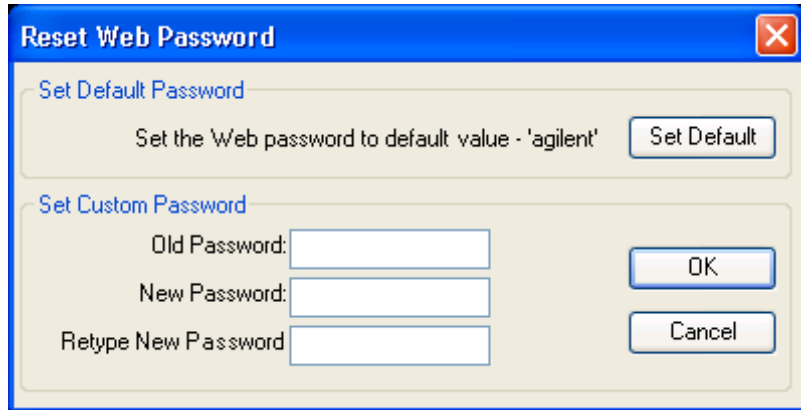

If this control is entered without an external keyboard or mouse connected, you can cancel the control by pressing the Cancel (ESC) front-panel key.

Key Path	System, I/O Config
Mode	All
Initial S/W Revision	Prior to A.02.00

LXI

Opens a menu that allows you to access the various LXI configuration properties.

Key Path	System, I/O Config
Initial S/W Revision	Prior to A.02.00

LAN Reset

Resets the LAN connection.

Key Path	System, I/O Config, LXI
Initial S/W Revision	Prior to A.02.00

Device Identification (Remote Command Only)

Enabling the LXI device identification will place the LXI Status Indicator to the 'Identify' state. Disabling the LXI device identification will place the LXI Status Indicator to the 'No Fault' state. The LXI Status indicator is in the upper left region of the instrument's graphical user interface (.

Mode	All
Remote Command	:LXI:IDENtify[:STATe] OFF ON 0 1 :LXI:IDENtify[:STATe]?
Example	:LXI:IDEN ON
Preset	Not part of Preset, but reset to OFF on Restore System Defaults All
State Saved	No
Range	On Off
Initial S/W Revision	A.12.50

System IDN Response

This key allows you to specify a response to the *IDN? query, or to return the analyzer to the Factory response if you have changed it.

To choose the factory-set response, press the Factory key.

To specify your own response, press the User key, and enter your desired response.

Key Path	System, I/O Config
Mode	All
Remote Command	:SYSTem:IDN <string> :SYSTem:IDN?
Notes	<ul style="list-style-type: none"> This affects the response given in all Modes of the Analyzer, unless the current Mode has also specified a custom response, in which case the current Mode's custom IDN response takes precedence over the System's, but only while that Mode is the current Mode..

	<ul style="list-style-type: none"> • It survives shutdown and restart of the software and therefore survives a power cycle • Null string as parameter restores the Factory setting
Preset	This is unaffected by Preset but is set to the original factory setting on a "Restore System Defaults->Misc"
State Saved	No
Initial S/W Revision	A.06.00

Factory

This key selects the factory setting, for example:

"Agilent Technologies,N9020A,MY00012345,A.05.01"

where the fields are manufacturer, model number, serial number, firmware revision.

Key Path	System, I/O Config, IDN Response
Example	:SYST:IDN "" null string, restores the factory setting
Initial S/W Revision	A.06.0

User

This key allows you to specify your own response to the *IDN? query. You may enter your desired response with the Alpha Editor or a plugin PC keyboard.

When you press this key, the active function becomes the current User string with the cursor at the end. This makes it easy to edit the existing string.

If you enter a null string (for example, by clearing the User String while editing and then pressing Done) the analyzer automatically reverts to the Factory setting.

Key Path	System, I/O Config, IDN Response
Example	:SYST:IDN "XYZ Corp, Model 12, 012345, A.01.01" user specified response
Initial S/W Revision	A.06.00

Query USB Connection (Remote Command Only)

Enables you to determine the speed of the USB connection.

Mode	All
Remote Command	:SYSTem:COMMunicate:USB:CONNectioN?
Example	:SYST:COMM:USB:CONN?
Notes	NONE - Indicates no USB connection has been made.

LSpeed – Indicates a USB low speed connection (1.5 Mbps).

This is reserved for future use, the T+M488 protocol is not supported on low speed connections.

HSPeed – Indicates that a USB high speed connection (480 Mbps) has been negotiated.

FSPeed – Indicates that a USB full speed connection (12 Mbps) has been negotiated.

State Saved	No
Range	NONE LSpeed HSPeed FSPeed
Initial S/W Revision	Prior to A.02.00

USB Connection Status (Remote Command Only)

Enables you to determine the current status of the USB connection.

Mode	All
Remote Command	:SYSTem:COMMunicate:USB:STATus?
Example	:SYST:COMM:USB:STAT?
Notes	<p>SUSPended – Indicates that the USB bus is currently in its suspended state. The bus is in the suspended state when:</p> <ul style="list-style-type: none"> • The bus is not connected to any controller • The controller is currently powered off • The controller has explicitly placed the USB device into the suspended state. <p>When in the suspended state, no USB activity, including start of frame packets are received.</p> <p>ACTive – Indicates that the USB device is in the active state. When the device is in the active state, it is receiving periodic start of frames but it isn't necessarily receiving or transmitting data.</p>
State Saved	No
Range	SUSPended ACTive
Initial S/W Revision	Prior to A.02.00

USB Packet Count (Remote Command Only)

Enables you to determine the number of packets received and transmitted on the USB bus.

Mode	All
Remote Command	:SYSTem:COMMunicate:USB:PACKets?
Example	:SYST:COMM:USB:PACK?
Notes	<p>Two integers are returned. The first is the number of packets received since application invocation, the second is the number of packets transmitted since application invocation. If no packets have been received or transmitted the response is 0,0.</p> <p>The packet count is initialized to 0,0 when the instrument application is started.</p>
State Saved	No
Initial S/W Revision	Prior to A.02.00

Restore Defaults

Provides incremental initialization of the system setting groups along with supporting a comprehensive reset of the entire instrument back to a factory default state. The menu selections are the groups of system settings and when one is selected, that particular group of system settings is reset back to their default values.

Key Path	System
Mode	All
Remote Command	:SYSTem:DEFault [ALL] ALIGn INPut MISC MODes PON
Example	SYST:DEF
State Saved	No
Initial S/W Revision	Prior to A.02.00

Restore Input/Output Defaults

Causes the group of settings and data associated with Input/Output front-panel key to be a reset to their default values. This level of Restore System Defaults does not affect any other system settings, mode settings and does not cause a mode switch. .

Confirmation is required to restore the Input/Output setting. The confirmation dialog is:

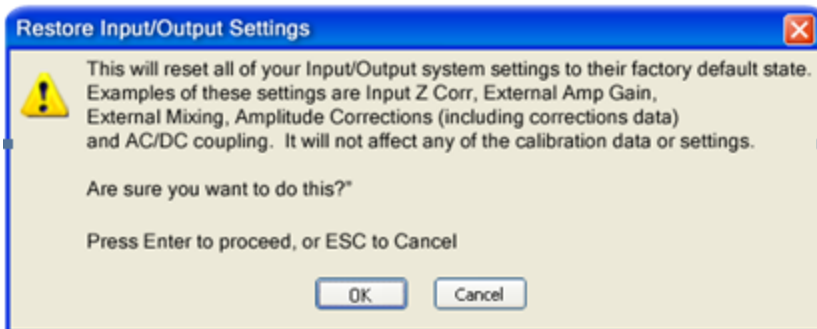

Key Path	System, Restore System Defaults
Example	:SYST:DEF INP
Initial S/W Revision	Prior to A.02.00

Restore Power On Defaults

This selection causes the Power On settings to be a reset to their default value. This level of Restore System Defaults does not affect any other system settings, mode settings and does not cause a mode switch. The Power On settings and their default values are Power On Type reset to Mode and Input/Output Defaults and Power On Application reset to whatever the factory set as its default value.

Confirmation is required to restore the factory default values. The confirmation dialog is:

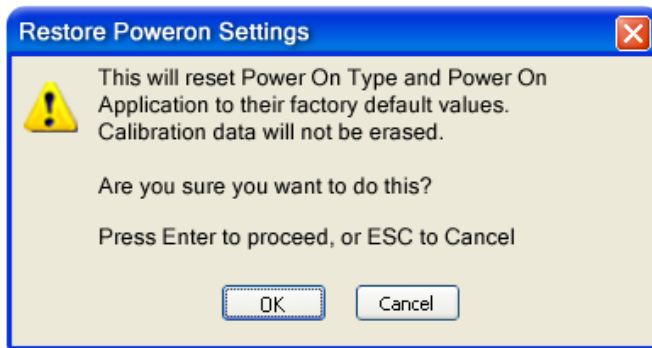

Key Path	System, Restore System Defaults
Example	:SYST:DEF PON
Initial S/W Revision	Prior to A.02.00

Restore Align Defaults

This selection causes the Alignment system settings to be a reset to their default values. This does not affect any Alignment data stored in the system. This level of Restore System Defaults does not affect any other system settings, mode settings and does not cause a mode switch.

After performing this function, it may impact the auto-alignment time of the instrument until a new alignment baseline has been established.

Confirmation is required to restore the factory default values. The confirmation dialog is:

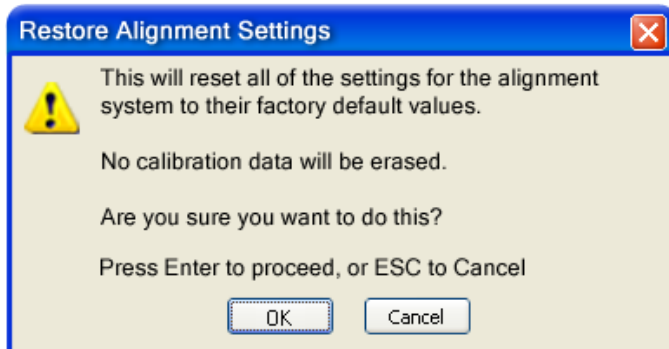

Key Path	System, Restore System Defaults
Example	:SYST:DEF ALIG
Initial S/W Revision	Prior to A.02.00

Restore Misc Defaults

This selection causes miscellaneous system settings to be reset to their default values. With this reset, you lose the GPIB address and it is reset to 18, so this should be used with caution. This level of Restore System Defaults does not affect any other system settings, mode settings and does not cause a mode switch. This miscellaneous group contains the rest of the settings that have not been part of the other Restore System Defaults groups. The following table is a complete list of settings associated with this group:

Miscellaneous Setting	Default Value
Verbose SCPI	Off
The SYST:PRES:TYPE	MODE
Auto File Name Number	000
Save Type	State
State Save To	Register 1
Screen Save To	SCREEN000.png
DISP:ENABLe	ON
Full Screen	Off
SCPI Telnet	ON
SCPI Socket	ON
SICL Server	ON
Softkey Language	English
System Annotation	ON
Display Theme	TDColor
System IDN Response	Factory result of *IDN?
Display Intensity	100
Display Backlight	ON
GPIB Address	18

Confirmation is required to restore the factory default values. The confirmation dialog is:

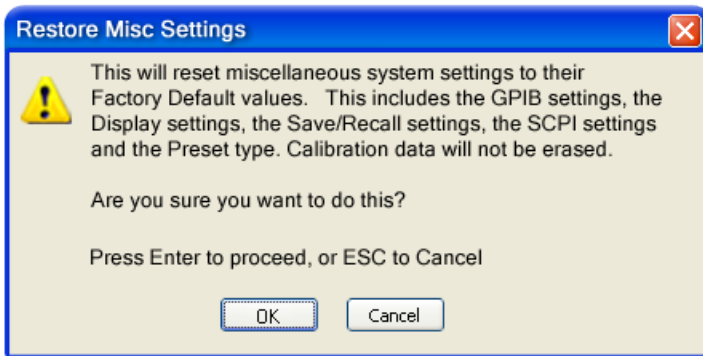

Key Path	System, Restore System Defaults
Example	:SYST:DEF MISC
Initial S/W Revision	Prior to A.02.00

Restore Mode Defaults (All Modes)

This selection resets all of the modes in the instrument back to their default state just as a Restore Mode Defaults does and it switches the instrument to the power-on mode and causes the default measurement for the power-on mode to be active. This level of Restore System Defaults does not affect any system settings, but it does affect the state of all modes and does cause a mode switch unless the instrument was already in the power-on mode.

Confirmation is required to restore the factory default values. The confirmation dialog is:

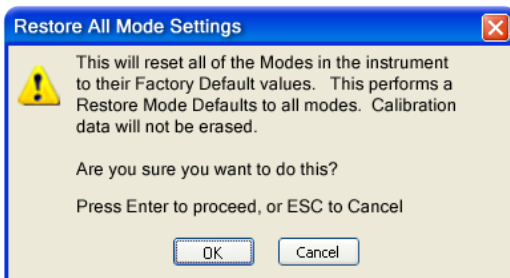

Key Path	System, Restore System Defaults
Example	:SYST:DEF MOD
Couplings	An All Mode will cause the currently running measurement to be aborted, mode switch to the power-on mode and activate the default measurement for the power-on mode.. It gets the mode to a consistent state with all of the default couplings set.
Initial S/W Revision	Prior to A.02.00

All

This performs a comprehensive reset of ALL analyzer settings to their factory default values. It resets all of the system setting groups, causes a Restore Mode Defaults for all modes in the instrument, and switches back to the power-on mode. It does not affect the User Preset file or any user saved files.

Confirmation is required to restore the factory default values. The confirmation dialog is:

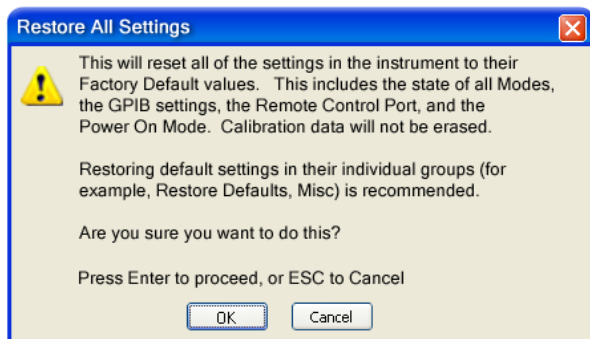

NOTE

If you are using an Agilent USB External Mixer, then you will need to perform a Refresh USB Mixer Connection after Restoring All Defaults.

Key Path	System, Restore System Defaults
Example	:SYST:DEF ALL
Notes	If using Agilent USB External Mixer, perform a Refresh USB Mixer Connection (SCPI command :MIX:BAND USB) following a Restore All Defaults.
Couplings	An All will cause the currently running measurement to be aborted and get all modes to a consistent state, so it is unnecessary to couple any settings.
Initial S/W Revision	Prior to A.02.00
Modified at S/W Revision	A.14.00

Control Panel...

Opens the Windows Control Panel. The Control Panel is used to configure certain elements of Windows that are not configured through the hardkey/softkey System menus.

NOTE

This feature is not available if option SF1 is installed.

The Control Panel is a separate Windows application, so to return to the analyzer once you are in the Control Panel, you may either:

Exit the Control Panel by clicking on the red X in the upper right hand corner, with a mouse

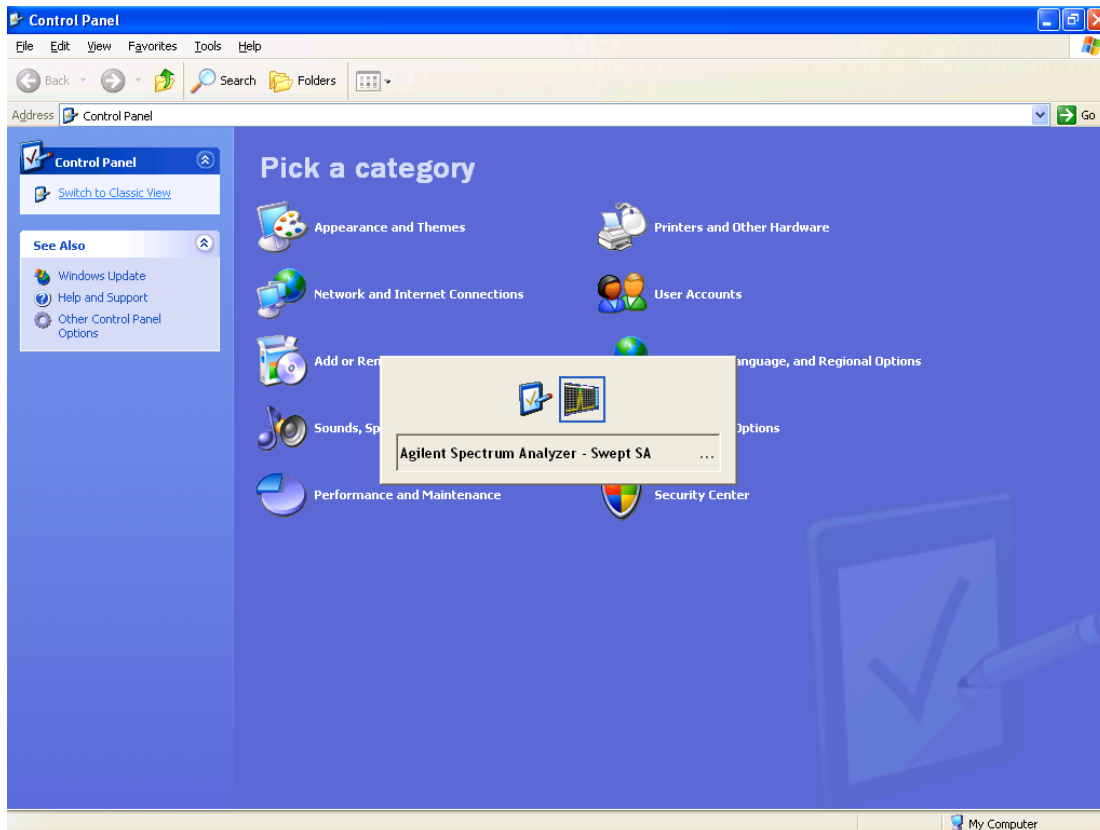

Or use Alt-Tab: press and hold the Alt  key and press and release the Tab key until the Analyzer logo is showing in the window in the center of the screen, as above, then release the Alt key.

Key Path	System
Notes	No remote command for this key.
Initial S/W Revision	Prior to A.02.00

Licensing...

Opens the license explorer.

NOTE This feature is not available if option SF1 is installed.

For Help on this key, select Help in the menu bar at the top of the license explorer window.

Key Path	System
Notes	No equivalent remote command for this key.
Backwards Compatibility Notes	In ESA the SCPI command for displaying the Show Licenses screen is: :SYSTem:CONFigure:LKEY:STATe OFF ON 0 1 :SYSTem:CONFigure:LKEY:STATe? There are no equivalent SCPI commands in the X-Series for displaying the License Explorer.
Initial S/W Revision	Prior to A.02.00

Remote Command	<code>:SYSTem:LKEY <"OptionInfo">, <"LicenseInfo"></code>
Example	<code>SYST:LKEY "N9073A-1FP", "027253AD27F83CDA5673A9BA5F427FDA5E4F25AEB1017638211AC9F60D9C639FE539735909C551DE0A91"</code>
Notes	<p>The <"OptionInfo"> contains the feature and the version. You must specify the feature but can omit the version. If you omit the version, the system regards it as the latest one, since the system knows which version is supported for each feature.</p> <p>The <"LicenseInfo"> contains the signature, the expiration date, and serial number for transport if transportable. You must specify the signature, but you can omit the other information. If you omit the expiration date, the system regards it as permanent. If you omit the serial number, the system regards it as non-transportable. As a result, this supports reverse compatibility.</p>
Initial S/W Revision	Prior to A.02.00

Remote Command	<code>:SYSTem:LKEY:DELeTe <"OptionInfo">,<"LicenseInfo"></code>
Example	<code>SYST:LKEY:DEL 'N9073A-1FP', "027253AD27F83CDA5673A9BA5F427FDA5E4F25AEB1017638211AC9F60D9C639FE539735909C551DE0A91"</code>
Notes	<p>The <"OptionInfo"> contains the feature and the version. You must specify the feature but can omit the version. If you omit the version, the system regards it as the latest one, if more than one version is installed.</p> <p>The <"LicenseInfo"> contains the signature, the expiration date, and whether or not be transportable. You must specify the signature, but you can omit the other information. If you omit the expiration date, the system regards it as permanent. If you omit the transportability, the system regards it as non-transportable. As a result, this supports reverse compatibility.</p>
Initial S/W Revision	Prior to A.02.00

Remote Command	<code>:SYSTem:LKEY:LIST?</code>
Notes	<p>Return Value: An <arbitrary block data> of all the installed instrument licenses. The format of each license is as follows. <Feature>,<Version>,<Signature>,<Expiration Date>,<Serial Number for Transport> Return Value Example: #3136 N9073A-1FP,1.000,B043920A51CA N9060A-2FP,1.000,4D1D1164BE64</p>

N9020A-508,1.000,389BC042F920
 N9073A-1F1,1.000,5D71E9BA814C,13-aug-2005
 <arbitrary block data> is:
 #NMMM<data>
 Where:
 N is the number of digits that describes the number of MMM characters. For example if the data was 55 bytes, N would be 2.
 MMM would be the ASCII representation of the number of bytes. In the previous example, N would be 55.
 <data> ASCII contents of the data

Initial S/W Revision Prior to A.02.00

Remote Command :SYSTem:LKEY? <"OptionInfo">

Example SYST:LKEY? "N9073A-1FP"

Notes The <"OptionInfo"> contains the feature and the version. You must specify the feature but can omit the version. If you omit the version, the system regards it as the latest one.

Return Value:

<"LicenseInfo"> if the license is valid, null otherwise.

<"LicenseInfo"> contains the signature, the expiration date, and serial number if transportable.

Return Value Example:

"B043920A51CA"

Initial S/W Revision Prior to A.02.00

Remote Command :SYSTem:HID?

Notes Return value is the host ID as a string

Initial S/W Revision Prior to A.02.00

Security

Accesses capabilities for operating the instrument in a security controlled environment.

Key Path System

Initial S/W Revision A.04.00

USB

The Windows operating system can be configured to disable write access to the USB ports for users who are in a secure environment where transferring data from the instrument is prohibited. This user interface

is a convenient way for the customer to disable write access to USB.

Key Path	System, Security
Mode	All
Scope	Mode Global
Remote Command	:SYSTem:SECurity:USB:WPRotect[:ENABLE] ON OFF 0 1 :SYSTem:SECurity:USB:WPRotect[:ENABLE]?
Example	:SYST:SEC:USB:WPR ON Will set USB ports to Read-only
Notes	When the USB ports are in Read-only mode then no data can be stored to USB, including the internal USB memory used for a back-up location for the calibration data.
Dependencies	This key is grayed-out unless the current user has administrator privileges.
Preset	This is unaffected by Preset or any Restore System Defaults. An Agilent Recovery will set the USB to write protect OFF
State Saved	No
Range	Read-Write Read only
Initial S/W Revision	A.04.00

Read-Write

Selection for allowing full read-write access to the USB ports.

Key Path	System, Security, USB
Example	:SYST:SEC:USB:WPR OFF Will set USB ports to Read-Write
Initial S/W Revision	A.04.00

Read only

Selection for disabling write access to the USB ports.

Key Path	System, Security, USB
Example	:SYST:SEC:USB:WPR ON Will set USB ports to Read only
Initial S/W Revision	A.04.00

Diagnostics

The Diagnostics key in the System menu gives you access to basic diagnostic capabilities of the instrument.

Key Path	System
Initial S/W Revision	Prior to A.02.00

Show Hardware Statistics

Provides a display of various hardware statistics. The statistics include the following:

- Mechanical relay cycles
- High and Low temperature extremes
- Elapsed time that the instrument has been powered-on (odometer)

The display should appear listing the statistics, product number, serial number, and firmware revision.

Hardware Statistical Information	
Agilent MXA Signal Analyzer	
Product Number: N9020A	
Serial Number: US00061145	
Instrument S/W Revision: A.12.00	
Revision Date: 7/11/2012 12:11:10 PM	
Component Name	Value
MechAtten #1 Count Total	457304
Calibrator Switch Cycles	105953
AC/DC Switch Cycles	114240
2 dB #1 Mechanical Atten Cycles	112655
2 dB #2 Mechanical Atten Cycles	124456
MechAtten #2 Count Total	472265
6 dB Mechanical Atten Cycles	115302
10 dB Mechanical Atten Cycles	93602
20 dB Mechanical Atten Cycles	144781
30 dB Mechanical Atten Cycles	118580
Low Noise Path Switch	45668
Preselector Bypass Cycles	31133
High temperature operating extreme	45.75
Low temperature operating extreme	-23.9375
Elapsed Time (On-Time)(hours)	134164

In some CXA models
this field is called
"Fixed Aten"

Some CXA models
omit these fields

Only shown if LNP installed

Only shown if MPB installed

The CXA models in which the AC/DC Switch field is called Fixed Aten and that omit the mechanical attenuation fields are the N9000A–503/507 models.

Modular HWs only have time and temperature information in Show Hardware Statistics.

The data will be updated only when the Show Hardware Statistics menu key is pressed, it will not be updated while the screen is displayed.

The tabular data should be directly printable.

Key Path	System, Diagnostics
Mode	All
Notes	The values displayed on the screen are only updated upon entry to the screen and not updated while

	the screen is being displayed.
Initial S/W Revision	Prior to A.02.00

SCPI for Show Hardware Statistics (Remote Commands Only)

Each of the hardware statistic items can be queried via SCPI.

- "Query the Mechanical Relay Cycle Count" on page 432
- "Query the Operating Temperature Extremes" on page 432
- "Query the Elapsed Time since 1st power on" on page 433

Query the Mechanical Relay Cycle Count

Return the count of mechanical relay cycles. For N9038A model, there are additional 2 Mechanical Relays which are <N9038A Input2>, <N9038A Bypass>.

Remote Command	:SYSTem:MRELay:COUNT?
Example	:SYST:MREL:COUN?
Notes	<p>Query Only</p> <p>The return value is a comma separated list of the individual counts for each mechanical relay.</p> <p>The position of the relays in the list is:</p> <p>"<Cal Signal>,<AC/DC>,<2dB #1 Atten>,<2dB #2 Atten>,<6dB Atten>,<10dB Atten>,<20dB Atten>,<30dB Atten>,<Fixed Atten>,<Low Noise Path Switch>,<Presel Bypass>,<N9038A Input2>,<N9038A Bypass>"</p> <p>Items in the list not pertaining to your particular hardware configuration will return as -999 for those items.</p>
Initial S/W Revision	Prior to A.02.00
Modified at S/W Revision	A.08.00

Query the Operating Temperature Extremes

Returns the low operating temperature extreme value. The value survives a power-cycle and is the temperature extreme encountered since the value was reset by the factory or service center.

Mode	All
Remote Command	:SYSTem:TEMPerature:LEXTreme?
Example	:SYST:TEMP:LEXT?
Notes	Value is in degrees Celsius at which the lowest operating temperature has been recorded since 1st power-up.
State Saved	No
Initial S/W Revision	Prior to A.02.00

Mode	All
Remote Command	:SYSTem:TEMPerature:HEXTreme?
Example	:SYST:TEMP:HEXT?
Notes	Value is in degrees Celsius at which the highest operating temperature has been recorded since 1st power-up.
State Saved	No
Initial S/W Revision	Prior to A.02.00

Query the Elapsed Time since 1st power on

Returns the elapsed on-time in minutes since 1st power-on.

Remote Command	:SYSTem:PON:ETIME?
Example	:SYST:PON:ETIM?
Notes	Query Only
Initial S/W Revision	Prior to A.02.00

Internet Explorer...

This key launches Microsoft Internet Explorer. A mouse and external keyboard are highly desired for using Internet Explorer. When Internet Explorer is running, close Internet Explorer to return focus to the Instrument Application (or use Alt-Tab).

NOTE This feature is not available if option SF1 is installed.

Key Path	System
Mode	All
Notes	No equivalent remote command for this key.
Initial S/W Revision	A.05.01

System Remote Commands (Remote Commands Only)

The commands in this section have no front-panel key equivalent.

"System Powerdown (Remote Command Only)" on page 434

"List installed Options (Remote Command Only)" on page 434

"Lock the Front-panel keys (Remote Command Only)" on page 434

"List SCPI Commands (Remote Command Only)" on page 435

"SCPI Version Query (Remote Command Only)" on page 435

"Date (Remote Command Only)" on page 435

"Time (Remote Command Only)" on page 436

Initial S/W Revision	Prior to A.02.00
----------------------	------------------

System Powerdown (Remote Command Only)

Remote Command	<code>SYSTem:PDOWn [NORMal FORCe]</code>
Notes	Shuts down the instrument in the normal way (NORMal) or forced way (FORCe). In case there is another application with modified data pending for saving, the application prompt the user. The system waits until the user responds in the normal mode. It will go off after 20 seconds of wait in the force mode and all data will be lost.

List installed Options (Remote Command Only)

Lists the installed options that pertain to the instrument (signal analyzer). .

Mode	All
Remote Command	<code>:SYSTem:OPTions?</code>
Example	<code>:SYST:OPT?</code>
Notes	The return string is a comma separated list of the installed options. For example: "503,P03,PFR" <code>:SYSTem:OPTions?</code> and <code>*OPT?</code> are the same.
State Saved	No
Initial S/W Revision	Prior to A.02.00

Lock the Front-panel keys (Remote Command Only)

Disables the instrument keyboard to prevent local input when the instrument is controlled remotely. Annunciation showing a "K" for 'Klock" (keyboard lock) alerts the local user that the keyboard is locked. Klock is similar to the GPIB Local Lockout function; namely that no front-panel keys are active with the exception of the Power Standby key. (The instrument is allowed to be turned-off if Klock is ON.) The Klock command is used in remote control situations where Local Lockout cannot be used.

Although primary intent of Klock is to lock-out the front panel, it will lock-out externally connected keyboards through USB. Klock has no effect on externally connected pointing devices (mice).

The front panel 'Local' key (Cancel/Esc) has no effect if Klock is ON.

Mode	All
Remote Command	<code>:SYSTem:KLOCK OFF ON 0 1</code> <code>:SYSTem:KLOCK?</code>

Example	:SYST:KLOC ON
Notes	Keyboard lock remains in effect until turned-off or the instrument is power-cycled
Preset	Initialized to OFF at startup, unaffected by Preset
State Saved	No
Initial S/W Revision	Prior to A.02.00

List SCPI Commands (Remote Command Only)

Outputs a list of the valid SCPI commands for the currently selected Mode.

Remote Command	:SYSTem:HELP:HEADers?
Example	:SYST:HELP:HEAD?
Notes	The output is an IEEE Block format with each command separated with the New-Line character (hex 0x0A)
Initial S/W Revision	Prior to A.02.00

SCPI Version Query (Remote Command Only)

Returns the SCPI version number with which the instrument complies. The SCPI industry standard changes regularly. This command indicates the version used when the instrument SCPI commands were defined.

Remote Command	:SYSTem:VERSion?
Example	:SYST:VERS?
Initial S/W Revision	Prior to A.02.00

Date (Remote Command Only)

The recommended access to the Date, Time, and Time zone of the instrument is through the Windows native control (Control Panel or accessing the Task Bar). You may also access this information remotely, as shown in this command and Time (below).

Sets or queries the date in the instrument.

Mode	All
Remote Command	:SYSTem:DATE "<year>, <month>, <day>" :SYSTem:DATE?
Example	:SYST:DATE "2006,05,26"
Notes	<year> is the four digit representation of year. (for example, 2006) <month> is the two digit representation of year. (for example. 01 to 12) <day> is the two digit representation of day. (for example, 01 to 28, 29, 30, or 31) depending on the

	month and year Unless the current account has Power User or Administrator privileges, an error will be generated by this command and no action will be taken.
Initial S/W Revision	Prior to A.02.00

Time (Remote Command Only)

Sets or queries the time in the instrument.

Mode	All
Remote Command	:SYSTem:TIME "<hour>,<minute>,<second>" :SYSTem:TIME?
Example	:SYST:TIME "13,05,26"
Notes	<hour> is the two digit representation of the hour in 24 hour format <minute> is the two digit representation of minute <second> is the two digit representation of second Unless the current account has Power User or Administrator privileges, an error will be generated by this command and no action will be taken.
Initial S/W Revision	Prior to A.02.00

7 Trigger Functions

Trigger

Accesses a menu of keys to control the selection of the trigger source and the setup of each of the trigger sources. The analyzer is designed to allow triggering from a number of different sources, for example, Free Run, Video, External, RF Burst, and so forth.

The TRIG:SOURCe command (below) will specify the trigger source for the currently selected input (RF or I/Q). If you change inputs, the new input remembers the trigger source it was last programmed to for the current measurement, and uses that trigger source. You can directly set the trigger source for each input using the TRIGger:RF:SOURce and TRIGger:IQ:SOURce commands (later in this section). When in External Mixing, the analyzer uses the RF trigger source.

Note the inclusion of the <measurement> parameter in the command below. Because each measurement remembers its own Trigger Source, the command must be qualified with the measurement name. Note that for the Swept SA measurement this is not the case; for backwards compatibility, no <measurement> parameter is used when setting the Trigger Source for the Swept SA measurement.

See ["Trigger Source Presets" on page 439](#)

See ["RF Trigger Source" on page 442](#)

See ["I/Q Trigger Source" on page 443](#)

See ["More Information" on page 444](#)

Key Path	Front-panel key
Remote Command	<pre>:TRIGger:<measurement>[:SEquence]:SOURce EXTernal1 EXTernal2 IMMediate LINE FRAMe RFBurst VIDeo IF ALARm LAN IQMag IDEMod QDEMod IINPut QINPut AIQMag TV :TRIGger:<measurement>[:SEquence]:SOURce?</pre> <p>where <measurement> is the measurement for which you wish to set the Source (blank for the Swept SA measurement)</p>
Example	<pre>TRIG:ACP:SOUR EXT1</pre> <p>Selects the external 1 trigger input for the ACP measurement and the selected input</p> <pre>TRIG:SOUR VID</pre> <p>Selects video triggering for the Swept SA (SANalyzer) measurement in the Spectrum Analyzer mode. For SAN, do not use the <measurement> keyword. Only send this form in the Spectrum Analyzer mode or you will get an Undefined Header error</p>
Notes	<p>Not all measurements have all the trigger sources available to them. Check the trigger source documentation for your specific measurement to see what sources are available.</p> <p>Not all trigger sources are available for each input. See the "RF Trigger Source" on page 442 and "I/Q Trigger Source" on page 443 commands for detailed information on which trigger sources are available for each input.</p> <p>Other trigger-related commands are found in the INITiate and ABORt SCPI command subsystems.</p> <p>*OPC should be used after requesting data. This will hold off any subsequent changes to the selected trigger source, until after the sweep is completed and the data is returned.</p> <p>Available ranges and presets can vary from mode to mode.</p>
Dependencies	<p>In some models, there is no second External input. In these models, the External 2 key is blanked and</p>

	the EXternal2 parameter will generate a "Hardware missing; Not available for this model number" message.
Preset	See table below
Status Bits/OPC dependencies	The Status Operation Register bit 5 "Waiting for Trigger" is set at the same time as the Sweeping or Measuring bit is set. It is cleared when the trigger actually occurs (that is, after the trigger event occurs and all the applicable trigger criteria have been met). A corresponding pop-up message ("Waiting for trigger") is generated if no trigger signal appears after approximately 2 sec. This message goes away when a trigger signal appears.
Backwards Compatibility SCPI	:TRIGger[:SEquence]:SOURCe EXTernal For backward compatibility, the parameter EXTernal is mapped to EXTernal1
Backwards Compatibility SCPI	[:SENSe]:<measurement>:TRIGger:SOURce This backwards compatibility alias command is provided for ESA/PSA compatibility This backwards compatibility command does not apply to the Swept SA measurement, for that just use :TRIGger:SOURCe This backwards compatibility command does not apply to the monitor spectrum, log plot and spot frequency measurements
Backwards Compatibility SCPI	[:SENSe]:<measurement>:TRIGger:SOURce IF In earlier instruments, the parameter IF was used by apps for the video trigger, so using the IF parameter selects VIDeo triggering. Sending IF in the command causes VID to be returned to a query.
Backwards Compatibility SCPI	[:SENSe]:ACPr:TRIGger:SOURce This backwards Compatibility SCPI command is provided to support the same functionality as [:SENSe]:ACPr:TRIGger:SOURce (PSA W-CDMA, PSA cdma2000 and PSA 1xEVDO) due to the fact that the ACPr node conflicts with the ACPower node.
Initial S/W Revision	Prior to A.02.00
Modified at S/W Revision	A.03.00

Trigger Source Presets

Here are the Trigger Source Presets for the various measurements:

Meas	Mode	Preset for RF	Preset for IQ	Notes
Swept SA	SA	IMM	IQ not supported	
CHP	SA, WCDMA, C2K, WIMAX OFDMA, 1xEVDO, DVB-T/H, DTMB, LTE, LTETDD, CMMB, ISDB-T, Digital Cable TV, MSR	IMM	IQ not supported	
OBW	SA, WCDMA, C2K, WIMAX OFDMA,	1xEVDO: EXT1 others: IMM	IQ not supported	For 1xEVDO mode, the trigger source is coupled with the gate state, as well as the gate

	TD-SCDMA, 1xEVDO, LTE, LTETDD, CMMB, ISDB-T, MSR			source. When the trigger source changes to RFBurst, External1 or External2, the gate state is set to on, and the gate source is set identically with the trigger source. When the trigger source changes to IMMEDIATE, VIDEO, LINE, FRAME or IF, the gate state is set to off.
CCDF	SA, WCDMA, C2K, WIMAX OFDMA, TD-SCDMA, 1xEV-DO, DVB-T/H, DTMB, LTE, LTETDD, CMMB, ISDB-T, Digital Cable TV, MSR	WIMAX OFDMA: RFBurst LTETDD: BTS: External 1 MS: Periodic Timer TD-SCDMA and 1xEV-DO: BTS: External 1 MS: RFBurst SA, WCDMA, C2K, LTE, CMMB, ISDB-T, DVB-T/H, DTMB, Digital Cable TV, MSR: IMMEDIATE	TD-SCDMA and 1xEV-DO: BTS: External 1 MS: IQMag LTETDD: BTS: External 1 MS: Periodic Timer Others: IMM	For TD-SCDMA: Trigger source is coupled with radio device. When radio device changes to BTS, trigger source will be changed to EXTERNAL1. When radio device changes to MS, trigger source will be set as RFBurst for RF or IQ Mag for BBIQ. When TriggerSource is RFBurst or IQ Mag, Measure Interval is grayed out.
ACP	SA, WCDMA, C2K, WIMAX OFDMA, TD-SCDMA, 1xEVDO, DVB-T/H, DTMB, LTE, LTETDD, CMMB, ISDB-T, Digital Cable TV, MSR	IMM	IQ not supported	
Tx Power	SA, GSM, TD-SCDMA	SA, GSM: RFBurst TD-SCDMA: EXTERNAL	IMM	TD-SCDMA doesn't support the Line and Periodic Timer parameters. When the mode is TD-SCDMA, if the Radio Device is switched to BTS, the value will be changed to External 1 and if the Radio device is switched to MS, the value will be changed to RFBurst
SPUR	SA, WCDMA, C2K, WIMAX OFDMA, TD-SCDMA, 1xEV-DO, DVB-T/H, LTE, LTETDD, MSR	IMM	IQ not supported	
SEM	SA, WCDMA, C2K, WIMAX OFDMA, TD-SCDMA, 1xEVDO, DVB-	1xEVDO(BTS): EXTERNAL1 All others: IMMEDIATE	IQ not supported	

	T/H, DTMB, LTE, LTETDD, CMMB, ISDB-T, Digital Cable TV, MSR			
CDP	WCDMA	IMM	IMM	
RHO	WCDMA	IMM	IMM	
PCON	WCDMA	IMM	IMM	
QPSK	WCDMA, C2K, 1xEVDO	All except CDMA1xEVDO: IMMediate CDMA1xEVDO: EXT1	IMM	
MON	All except SA and BASIC	IMM	IQ not supported	
WAV		LTETDD: BTS: External 1 MS: Periodic Timer GSM/EDGE: RFBurst All others: IMMediate	LTETDD: BTS: External 1 MS: Periodic Timer GSM/EDGE: IQMag All others: IMMMediate	
PVT	WIMAXOFDMA	RFB	IMM	
EVM	WIMAXOFDMA, DVB-T/H, DTMB, LTE, LTETDD, CMMB, ISDB-T, Digital Cable TV	All but CMMB: IMM CMMB: Periodic Timer	All but CMMB: IMM CMMB: External 1	LTE, LTETDD supports Free Run, Video and External 1 only.
SPEC	BASIC	IMM	IMM	
LOG Plot	PN	IMM	IQ not supported	
Spot Freq	PN	IMM	IQ not supported	
GMSK PVT	EDGE/GSM	RFB	IMM	
GMSK PFER	EDGE/GSM	RFB	IQMag	
GMSK ORFS	EDGE/GSM	RF Burst	IQ not supported	
EDGE PVT	EDGE/GSM	RFB	IMM	

EDGE EVM	EDGE/GSM	RFB	IQMag
EDGE ORFS	EDGE/GSM	Periodic Timer	IQ not supported
Combined WCDMA	WCDMA	IMM	IQ not supported
Combined GSM	EDGE/GSM	RFB	IQ not supported
List Power Step	WCDMA, EDGE/GSM	IMM	IQ not supported
Transmit On/Off Power	LTETDD	LTETDD: BTS: External 1 MS: Periodic Timer	LTETDD: BTS: External 1 MS: Periodic Timer
Transmit Analysis	BLUETOOTH	RFB	IQ not supported
Adjacent Channel Power	BLUETOOTH	IMM	IQ not supported
LE In-band Emissions	BLUETOOTH	IMM	IQ not supported
EDR In-band Spurious Emissions	BLUETOOTH	Periodic Timer	IQ not supported
Conformance EVM	LTE, LTETDD, MSR	IMM	IMM

RF Trigger Source

The RF Trigger Source command selects the trigger to be used for the specified measurement when RF is the selected input. The RF trigger source can be queried and changed even while another input is selected, but it is inactive until RF becomes the selected input.

Note the inclusion of the <measurement> parameter in the command below. Because each measurement remembers its own Trigger Source, the command must be qualified with the measurement name. Note that for the Swept SA measurement this is not the case; for backwards compatibility, no <measurement> parameter is used when setting the Trigger Source for the Swept SA measurement.

Remote Command	<code>:TRIGger:<measurement>[:SEquence]:RF:SOURce EXTernal1 EXTernal2 IMMEDIATE LINE FRAME RFBurst VIDEO IF ALARm LAN TV</code> <code>:TRIGger:<measurement>[:SEquence]:RF:SOURce?</code>
-----------------------	--

Example	<code>TRIG:ACP:RF:SOUR EXT1</code> Selects the external 1 trigger input for the ACP measurement and the RF input
----------------	---

	<p>TRIG:RF:SOUR VID</p> <p>Selects video triggering for the SANalyzer measurement and the RF input. For SAN, do not use the <measurement> keyword.</p>
Notes	<p>Not all measurements have all the trigger sources available to them. Check the trigger source documentation for your specific measurement to see what sources are available.</p> <p>Not all trigger sources are available for each input. For the RF Trigger Source, the following trigger sources are available:</p> <ul style="list-style-type: none"> –IMMediate - free run triggering –VIDeo - triggers on the video signal level –LINE - triggers on the power line signal –EXTernal1 (or EXTernal) - triggers on an externally connected trigger source marked “Trigger 1 In” on the rear panel –EXTernal2 - triggers on an externally connected trigger source marked “Trigger 2 In” on the front panel. In some models, there is no second External input. In these models, the External 2 key is blanked and the EXTernal2 parameter will generate a “Hardware missing; Not available for this model number” message –RFBurst - triggers on the bursted frame –FRAMe - triggers on the periodic timer –IF (video) - same as video, for backwards compatibility only <p>*OPC should be used after requesting data. This will hold off any subsequent changes to the selected trigger source, until after the sweep is completed and the data is returned.</p> <p>Available ranges, and presets can vary from mode to mode.</p>
Status Bits/OPC dependencies	<p>The Status Operation Register bit 5 "Waiting for Trigger" is set at the same time as the Sweeping or Measuring bit is set. It is cleared when the trigger actually occurs (that is, after the trigger event occurs and all the applicable trigger criteria have been met). A corresponding pop-up message ("Waiting for trigger") is generated if no trigger signal appears after approximately 2 sec. This message goes away when a trigger signal appears.</p>
Initial S/W Revision	Prior to A.02.00

I/Q Trigger Source

This command selects the trigger to be used for the specified measurement when I/Q (which requires option BBA) is the selected input. The I/Q trigger source can be queried and changed even while another input is selected, but it is inactive until I/Q becomes the selected input.

Remote Command	<pre>:TRIGger:<measurement>[:SEquence]:IQ:SOURce EXTernal1 EXTernal2 IMMediate IQMag IDEMod QDEMod IINPut QINPut AIQMag :TRIGger:<measurement>[:SEquence]:IQ:SOURce?</pre>
Example	<p>TRIG:WAVeform:SOUR IQM</p> <p>Selects I/Q magnitude triggering for the IQ Waveform measurement and the I/Q input</p>
Notes	<p>Not all measurements have all the trigger sources available to them. Check the trigger source documentation for your specific measurement to see what sources are available.</p> <p>Not all trigger sources are available for each input. For the I/Q Trigger Source, the following trigger sources are available:</p>

	<ul style="list-style-type: none"> –IMMediate - free run triggering –EXternal1 (or EXternal) - triggers on an externally connected trigger source on the rear panel –EXternal2 - triggers on an externally connected trigger source on the front panel –IQMag - triggers on the magnitude of the I/Q signal –IDEMod - triggers on the I/Q signal's demodulated I voltage –QDEMod - triggers on the I/Q signal's demodulated Q voltage –IINPut - triggers on the I channel's ADC voltage –QINPut - triggers on the Q channel's ADC voltage –AIQMag - triggers on the magnitude of the auxiliary receiver channel I/Q signal <p>*OPC should be used after requesting data. This will hold off any subsequent changes to the selected trigger source, until after the sweep is completed and the data is returned.</p> <p>Available ranges, and from mode to mode presets can vary</p>
Status Bits/OPC dependencies	The Status Operation Register bit 5 "Waiting for Trigger" is set at the same time as the Sweeping or Measuring bit is set. It is cleared when the trigger actually occurs (that is, after the trigger event occurs and all the applicable trigger criteria have been met). A corresponding pop-up message ("Waiting for trigger") is generated if no trigger signal appears after approximately 2 sec. This message goes away when a trigger signal appears.
Initial S/W Revision	Prior to A.02.00

More Information

The trigger menus let you select the trigger source and trigger settings for a sweep or measurement. In triggered operation (basically, any trigger source other than Free Run), the analyzer will begin a sweep or measurement only with the selected trigger conditions are met, generally when your trigger source signal meets the specified trigger level and polarity requirements. (In FFT measurements, the trigger controls when the data acquisition begins for FFT conversion.)

For each of the trigger sources, you may define a set of operational parameters or settings which will be applied when that source is selected as the current trigger source. Examples of these settings are Trigger Level, Trigger Delay, and Trigger Slope. You may apply different settings for each source; so, for example, you could have a Trigger Level of 1v for External 1 trigger and –10 dBm for Video trigger.

Once you have established the settings for a given trigger source, they generally will remain unchanged for that trigger source as you go from measurement to measurement within a Mode (although the settings do change as you go from Mode to Mode). Furthermore, the trigger settings within a Mode are the same for the **Trigger** menu, the **Gate Source** menu, and the **Sync Source** menu that is part of the **Periodic Timer Trigger Setup** menu. That is, if **Ext1** trigger level is set to 1v in the **Trigger** menu, it will appear as 1v in both the **Gate Source** and the **Sync Source** menus. For these reasons the trigger settings commands are not qualified with the measurement name, the way the trigger source commands are.

The settings setup menu can be accessed by pressing the key for the current trigger source a second time. For example, one press of Video selects the Video trigger as the source. The Video key becomes highlighted and the hollow arrow on the key turns black. Now a second press of the key takes you into the Video Trigger Setup menu.

Trigger Setup Parameters:

The following examples show trigger setup parameters using an external trigger source.

Example 1 illustrates the trigger conditions with negative slope and no trigger occurs during trigger Holdoff time.

Example 2 illustrates the trigger conditions with positive slope, trigger delay, and auto trigger time.

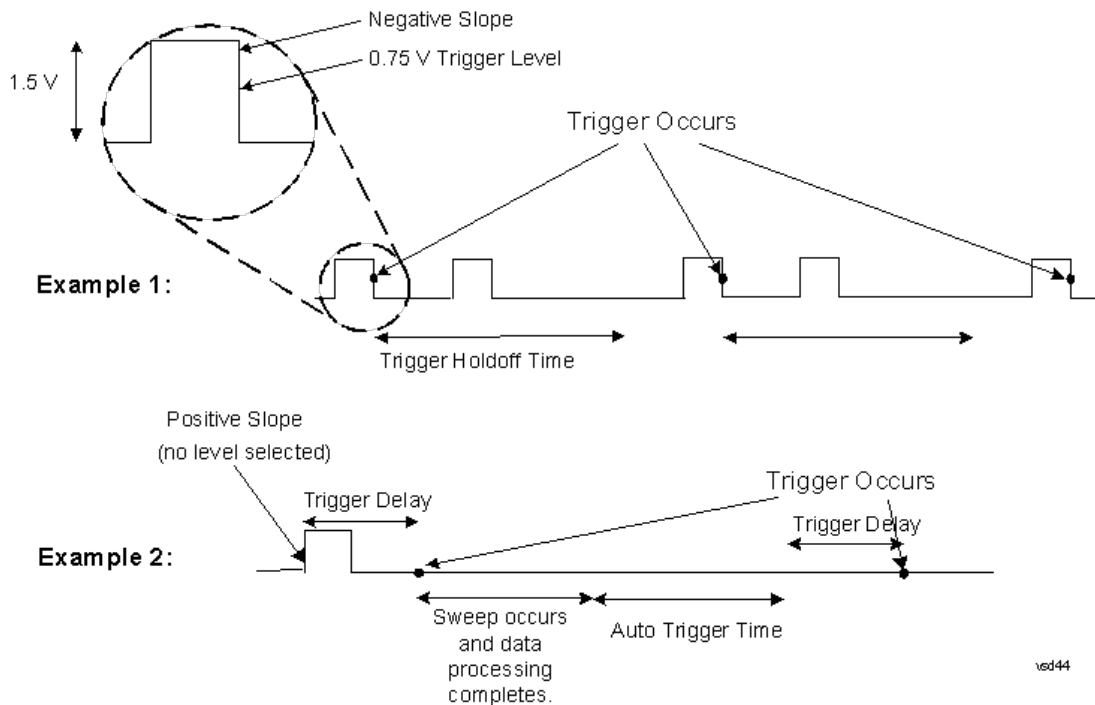

Free Run

Pressing this key, when it is not selected, selects free-run triggering. Free run triggering occurs immediately after the sweep/measurement is initiated.

Key Path	Trigger
Example	TRIG:SOUR IMM Swept SA measurement TRIG:<meas>:SOUR IMM Measurements other than Swept SA
State Saved	Saved in instrument state
Status Bits/OPC dependencies	The Status Operation Register bit 5 "Waiting for Trigger" is set at the same time as the Sweeping or Measuring bit is set. It is cleared when the trigger actually occurs (that is, after the trigger event occurs and all the applicable trigger criteria have been met). A corresponding pop-up message ("Waiting for trigger") is generated if no trigger signal appears after approximately 2 sec. This message goes away when a trigger signal appears.
Initial S/W Revision	Prior to A.02.00

Video (IF Envelope)

Pressing this key, when it is not selected, selects the video signal as the trigger. The Video trigger condition is met when the video signal (the filtered and detected version of the input signal, including both RBW and VBW filtering) crosses the video trigger level.

NOTE When the detector selected for all active traces is the average detector, the video signal for triggering does not include any VBW filtering.

The video trigger level is shown as a labeled line on the display. The line is displayed as long as video is the selected trigger source.

Pressing this key, when it is already selected, accesses the video trigger setup functions.

Key Path	Trigger
Example	TRIG:SOUR VID Swept SA measurement TRIG:<meas>:SOUR VID Measurements other than Swept SA
Notes	Log Plot and Spot Frequency measurements do not support Video Trigger
Dependencies	Video trigger is allowed in average detector mode.
State Saved	Saved in instrument state
Status Bits/OPC dependencies	The Status Operation Register bit 5 "Waiting for Trigger" is set at the same time as the Sweeping or Measuring bit is set. It is cleared when the trigger actually occurs (that is, after the trigger event occurs and all the applicable trigger criteria have been met). A corresponding pop-up message ("Waiting for trigger") is generated if no trigger signal appears after approximately 2 sec. This message goes away when a trigger signal appears.
Backwards Compatibility Notes	In the past, the Average detector was not available when Video triggering was on, and consequently, functions that set the detector to average (such as Marker Noise or Band/Intvl Power) were not available when the video trigger was on. Similarly, Video triggering was not available when the detector was Average. In the X-Series, these restrictions are removed.
Initial S/W Revision	Prior to A.02.00

Trigger Level

Sets a level for the video signal trigger. When the video signal crosses this level, with the chosen slope, the trigger occurs. This level is displayed with a horizontal line only if **Video** is the selected trigger source.

Key Path	Trigger, Video
Remote Command	:TRIGger[:SEquence]:VIDeo:LEVel <ampl> :TRIGger[:SEquence]:VIDeo:LEVel?
Example	TRIG:VID:LEV -40 dBm
Notes	When sweep type = FFT, the video trigger uses the amplitude envelope in a bandwidth wider than the FFT width as a trigger source. This might often be useful, but does not have the same relationship between the displayed trace and the trigger level as in swept triggering. Amplitude Corrections are not taken into account by the Video Trig Level. For example, if you have

given yourself effective gain with an amplitude correction factor, the Video Trigger will not fire until you have dropped the trigger line that far below the displayed signal level, rather than simply dropping it down to the displayed signal level.

Note that other corrections, specifically External Gain and Ref Level Offset, modify the actual trace data as it is taken and therefore ARE taken into account by Trig Level.

Couplings	This same level is used for the Video trigger source in the Trigger menu and for the Video selection in the Gate Source menu.
Preset	Set the Video Trigger Level -25 dBm on Preset. When the Video Trigger Level becomes the active function, if the value is off screen, set it to either the top or bottom of screen, depending on which direction off screen it was.
State Saved	Saved in instrument state
Min	-170 dBm
Max	+30 dBm
Default Unit	Depends on the current selected Y axis unit
Backwards Compatibility SCPI	:TRIGger[:SEquence]:IF:LEVel :TRIGger[:SEquence]:IF:LEVel?
Backwards Compatibility Notes	This alias is provided for backward compatibility with VSA/PSA comms apps.
Initial S/W Revision	Prior to A.02.00

Trig Slope

Controls the trigger polarity. It is set positive to trigger on a rising edge and negative to trigger on a falling edge.

Key Path	Trigger, Video
Remote Command	:TRIGger[:SEquence]:VIDeo:SLOPe POSitive NEGative :TRIGger[:SEquence]:VIDeo:SLOPe?
Example	TRIG:VID:SLOP NEG
Preset	POSitive
State Saved	Saved in instrument state
Backwards Compatibility SCPI	:TRIGger[:SEquence]:IF:SLOPe NEGative POSitive :TRIGger[:SEquence]:IF:SLOPe? For backward compatibility with VSA/PSA comms apps
Backwards Compatibility Notes	The legacy :TRIGger[:SEquence]:SLOPe command affects the slopes for the VID, LINE, EXT1, EXT2, and RFB triggers.
Initial S/W Revision	Prior to A.02.00

Remote Command	:TRIGger[:SEquence]:SLOPe POSitive NEGative :TRIGger[:SEquence]:SLOPe?
Example	TRIG:SLOP NEG
Preset	POSitive
State Saved	Saved in instrument state
Backwards Compatibility Notes	In ESA/PSA, the Trigger Slope was global to all triggers. In the X-Series, the slope can be set individually for each Trigger Source. For backward compatibility, the global SLOPe command updates all instances of trigger slope (VID, LINE, EXT1, EXT2, TV, RFB). The query returns the trigger slope setting of the currently selected trigger source.
Initial S/W Revision	Prior to A.02.00

Trig Delay

Controls a time delay during that the analyzer will wait to begin a sweep after meeting the trigger criteria. You can use negative delay to pre-trigger the instrument in the time domain or FFT, but not in swept spans.

Key Path	Trigger, Video
Remote Command	:TRIGger[:SEquence]:VIDeo:DELaY <time> :TRIGger[:SEquence]:VIDeo:DELaY? :TRIGger[:SEquence]:VIDeo:DELaY:STATe OFF ON 0 1 :TRIGger[:SEquence]:VIDeo:DELaY:STATe?
Example	TRIG:VID:DEL:STAT ON TRIG:VID:DEL 100 ms
Notes	Video trigger delay may be set to negative values, in time domain, FFT and even swept. It makes intuitive sense in time domain and works well in FFT mode where the bandwidth of the filter before the video trigger is about 1.25 span. In swept spans, negative settings of Trig Delay are treated as a zero setting within the internal hardware and the advisory message "Neg. Trig Delay unavailable in Swept Mode, zero delay used." is generated when such a delay is set.
Preset	Off, 1 us
State Saved	Saved in instrument state
Min	-150 ms
Max	+500 ms
Default Unit	s
Backwards Compatibility Notes	! For backward compatibility with VSA/PSA comms apps :TRIGger[:SEquence]:IF:DELaY :TRIGger[:SEquence]:DELaY The legacy :TRIGger[:SEquence]:DELaY command affects the delay for the VID, LINE, EXT1, EXT2, and RFB triggers.
Initial S/W Revision	Prior to A.02.00

Remote Command	:TRIGger[:SEquence]:DELay <time> :TRIGger[:SEquence]:DELay? :TRIGger[:SEquence]:DELay:STATE OFF ON 0 1 :TRIGger[:SEquence]:DELay:STATE?
Example	TRIG:DEL 1 ms
Preset	1 us
State Saved	Saved in instrument state
Backwards Compatibility Notes	In ESA/PSA, the Trigger Delay was global to all triggers. In the X-Series, the delay can be set individually for each Trigger Source. For backward compatibility, the global DELay command updates all instances of trigger slope (VID, LINE, EXT1, EXT2) except TV and RFBurst. The query returns the trigger delay setting of the currently selected trigger source.
Initial S/W Revision	Prior to A.02.00

Remote Command	:TRIGger[:SEquence]:OFFSet <time> :TRIGger[:SEquence]:OFFSet? :TRIGger[:SEquence]:OFFSet:STATE OFF ON 0 1 :TRIGger[:SEquence]:OFFSet:STATE?
Example	TRIG:OFFS ON TRIG:OFFS -100 ms
Notes	These are ESA commands for trigger offset that allowed you to use a positive or negative delay when in zero span and in a Res BW \geq 1 kHz. For ESA compatibility, X-series analyzers keep track of this offset and adds it to the Trigger Delay for VIDEo, LINE, EXTernal1 or EXTernal2 whenever the value is sent to the hardware, if in Zero Span and RBW \geq 1 kHz.
Preset	Off, 0 s
State Saved	Saved in instrument state
Min	-11 s
Max	+11 s
Initial S/W Revision	Prior to A.02.00

Line

Pressing this key, when it is not selected, selects the line signal as the trigger. A new sweep/measurement will start synchronized with the next cycle of the line voltage. Pressing this key, when it is already selected, access the line trigger setup menu.

Key Path	Trigger
Example	TRIG:SOUR LINE Swept SA measurement TRIG:<meas>:SOUR LINE Measurements other than Swept SA
Dependencies	Line trigger is not available when operating from a "dc power source", for example, when the

	instrument is powered from batteries.
State Saved	Saved in instrument state
Status Bits/OPC dependencies	The Status Operation Register bit 5 "Waiting for Trigger" is set at the same time as the Sweeping or Measuring bit is set. It is cleared when the trigger actually occurs (that is, after the trigger event occurs and all the applicable trigger criteria have been met). A corresponding pop-up message ("Waiting for trigger") is generated if no trigger signal appears after approximately 2 sec. This message goes away when a trigger signal appears.
Initial S/W Revision	Prior to A.02.00

Trig Slope

Controls the trigger polarity. It is set positive to trigger on a rising edge and negative to trigger on a falling edge.

Key Path	Trigger, Line
Remote Command	:TRIGger[:SEquence]:LINE:SLOPe POSitive NEGative :TRIGger[:SEquence]:LINE:SLOPe?
Example	TRIG:LINE:SLOP NEG
Preset	POSitive
State Saved	Saved in instrument state
Backwards Compatibility Notes	The legacy :TRIGger[:SEquence]:SLOPe command affects the slopes for the VID, LINE, EXT1, EXT2, and RFB triggers.
Initial S/W Revision	Prior to A.02.00

Trig Delay

Controls a time delay during which the analyzer will wait to begin a sweep after meeting the trigger criteria. You can use negative delay to pre-trigger the instrument in time domain or FFT, but not in swept spans.

Key Path	Trigger, Line
Remote Command	:TRIGger[:SEquence]:LINE:DELay <time> :TRIGger[:SEquence]:LINE:DELay? :TRIGger[:SEquence]:LINE:DELay:STATe OFF ON 0 1 :TRIGger[:SEquence]:LINE:DELay:STATe?
Example	TRIG:LINE:DEL:STAT ON TRIG:LINE:DEL 100 ms
Notes	Video trigger delay may be set to negative values, in time domain, FFT and even swept. It makes intuitive sense in time domain and works well in FFT mode where the bandwidth of the filter before the video trigger is about 1.25 span. In swept spans, negative settings of Trig Delay are treated as a

	zero setting within the internal hardware and the advisory message "Neg. Trig Delay unavailable in Swept Mode, zero delay used." is generated when such a delay is set.
Preset	Off, 1.000 us
State Saved	Saved in instrument state
Min	-150 ms
Max	500 ms
Default Unit	S
Backwards Compatibility Notes	The legacy :TRIGger[:SEQuence]:DELay command affects the delay for the VID, LINE, EXT1, EXT2, and RFB triggers. The legacy :TRIGger[:SEQuence]:OFFSet command is supported for the VIDeo, LINE, EXT1, and EXT2 triggers.
Initial S/W Revision	Prior to A.02.00

External 1

Pressing this key, when it is not selected, selects an external input signal as the trigger. A new sweep/measurement will start when the external trigger condition is met using the external 1 input connector on the rear panel.

Pressing this key, when it is already selected, accesses the external 1 trigger setup menu.

Key Path	Trigger
Example	TRIG:SOUR EXT1 Swept SA measurement TRIG:<meas>:SOUR EXT1 Measurements other than Swept SA
Dependencies	Grayed out if in use by Point Trigger in the Source Setup menu. Forced to Free Run if already selected and Point Trigger is set to External 1.
State Saved	Saved in instrument state
Status Bits/OPC dependencies	The Status Operation Register bit 5 "Waiting for Trigger" is set at the same time as the Sweeping or Measuring bit is set. It is cleared when the trigger actually occurs (that is, after the trigger event occurs and all the applicable trigger criteria have been met). A corresponding pop-up message ("Waiting for trigger") is generated if no trigger signal appears after approximately 2 sec. This message goes away when a trigger signal appears.
Initial S/W Revision	Prior to A.02.00

Trigger Level

Sets the value where the external 1 trigger input will trigger a new sweep/measurement.

Key Path	Trigger, External 1
Remote Command	:TRIGger[:SEQuence]:EXTernal1:LEVel <level>

	:TRIGger[:SEquence]:EXTernal1:LEVel?
Example	TRIG:EXT1:LEV 0.4 V
Couplings	This same level is used for the Ext1 trigger source in the Trigger menu, for the Ext1 selection in the Periodic Timer sync source (in the Trigger menu and in the Gate Source menu), and also for the Ext1 selection in the Gate Source menu.
Preset	1.2 V
State Saved	Saved in instrument state
Min	-5 V
Max	5 V
Default Unit	V
Backwards Compatibility SCPI	:TRIGger[:SEquence]:EXTernal:LEVel
Backwards Compatibility SCPI	For backward compatibility, the parameter EXTernal is mapped to EXTernal1
Backwards Compatibility SCPI	:TRIGger[:SEquence]:FRAMe:EXTernal1:LEVel
Initial S/W Revision	Prior to A.02.00

Trig Slope

Controls the trigger polarity. It is set positive to trigger on a rising edge and negative to trigger on a falling edge.

Key Path	Trigger, External 1
Remote Command	:TRIGger[:SEquence]:EXTernal1:SLOPe POSitive NEGative :TRIGger[:SEquence]:EXTernal1:SLOPe?
Example	TRIG:EXT1:SLOP NEG
Couplings	This same slope is used in the Ext1 selection for the trigger source in the Trigger menu and for the period timer sync source (in the Trigger menu and in the Gate Source menu).
Preset	POSitive
State Saved	Saved in instrument state
Backwards Compatibility SCPI	:TRIGger[:SEquence]:EXTernal:SLOPe
Backwards Compatibility SCPI	For backward compatibility, the parameter EXTernal is mapped to EXTernal1
Backwards Compatibility SCPI	:TRIGger[:SEquence]:FRAMe:EXTernal1:SLOPe
Backwards Compatibility Notes	The legacy :TRIGger[:SEquence]:SLOPe command affects the slopes for the VID, LINE, EXT1, EXT2, and RFB triggers.
Initial S/W Revision	Prior to A.02.00

Trig Delay

Controls a time delay during which the analyzer will wait to begin a sweep after meeting the trigger criteria. You can use negative delay to pre-trigger the instrument in time domain or FFT, but not in swept spans.

Key Path	Trigger, External 1
Remote Command	:TRIGger[:SEquence]:EXTernal1:DElay <time> :TRIGger[:SEquence]:EXTernal1:DElay? :TRIGger[:SEquence]:EXTernal1:DElay:STATe OFF ON 0 1 :TRIGger[:SEquence]:EXTernal1:DElay:STATe?
Example	TRIG:EXT1:DEL:STAT ON TRIG:EXT1:DEL 100 ms
Notes	Video trigger delay may be set to negative values, in time domain, FFT and even swept. It makes intuitive sense in time domain and works well in FFT mode where the bandwidth of the filter before the video trigger is about 1.25 span. In swept spans, negative settings of Trig Delay are treated as a zero setting within the internal hardware and the advisory message "Neg. Trig Delay unavailable in Swept Mode, zero delay used." is generated when such a delay is set.
Preset	Off, 1.000 us
State Saved	Saved in instrument state
Min	-150 ms
Max	+500 ms
Default Unit	s
Backwards Compatibility SCPI	:TRIGger[:SEquence]:EXTernal:DElay
Backwards Compatibility Notes	The legacy :TRIGger[:SEquence]:DElay command affects the delay for the VID, LINE, EXT1, EXT2, and RFB triggers. The legacy :TRIGger[:SEquence]:OFFSet command is supported for the VIDeO, LINE, EXT1, and EXT2 triggers.
Initial S/W Revision	Prior to A.02.00

Zero Span Delay Comp On/Off

In zero span, there is a natural delay in the signal path, which comes from the RBW filter. This is usually desirable, as it allows you to trigger on events and also see those events, because the signal is delayed from the trigger event. However, in some cases it is desirable to eliminate this delay, so that trigger events line up exactly with the zero time point in zero span. You can use the Zero Span Delay Comp On/Off feature to enable or disable zero span delay compensation.

Key Path	Trigger, External 1
Remote Command	:TRIGger[:SEquence]:EXTernal1:DElay:COMPensation OFF ON 0 1 :TRIGger[:SEquence]:EXTernal1:DElay:COMPensation?
Example	TRIG:EXT1:DEL:COMP ON

Dependencies	No effect except in zero-span, but not locked out in nonzero spans. Blanked in modes that do not support zero-span measurements. If the SCPI command is sent when the key is blanked, an error is returned: -221, "Settings conflict; Feature not supported for this measurement" In analyzers shipping N9060A, this feature requires N9060A-7FP.
Preset	OFF
State Saved	Saved in instrument state
Initial S/W Revision	A.11.00

External 2

Pressing this key, when it is not selected, selects an external input signal as the trigger. A new sweep/measurement will start when the external trigger condition is met using the external 2 input connector. The external trigger 2 input connector is on the rear panel.

Pressing this key, when it is already selected, accesses the external 2 trigger setup menu.

Key Path	Trigger
Example	TRIG:SOUR EXT2 Swept SA measurement TRIG:<meas>:SOUR EXT2 Measurements other than Swept SA
Dependencies	In some models, there is no second External input. In these models, the External 2 key is blanked and the EXTernal2 parameter will generate a "Hardware missing; Not available for this model number" message. Grayed out if in use by Point Trigger in the Source Setup menu. Forced to Free Run if already selected and Point Trigger is set to External 2.
State Saved	Saved in instrument state
Status Bits/OPC dependencies	The Status Operation Register bit 5 "Waiting for Trigger" is set at the same time as the Sweeping or Measuring bit is set. It is cleared when the trigger actually occurs (that is, after the trigger event occurs and all the applicable trigger criteria have been met). A corresponding pop-up message ("Waiting for trigger") is generated if no trigger signal appears after approximately 2 sec. This message goes away when a trigger signal appears.
Initial S/W Revision	Prior to A.02.00
Modified at S/W Revision	A.03.00

Trigger Level

Sets the value where the external 2 trigger input will trigger a new sweep/measurement.

Key Path	Trigger, External 2
Remote Command	:TRIGger[:SEquence]:EXTernal2:LEVel :TRIGger[:SEquence]:EXTernal2:LEVel?

Example	TRIG:EXT2:LEV 1.1 V
Couplings	This same level is used for the Ext2 trigger source in the Trigger menu, for the Ext2 selection in the Periodic Timer sync source (in the Trigger menu and in the Gate Source menu), and also for the Ext2 selection in the Gate Source menu.
Preset	1.2 V
State Saved	Saved in instrument state
Min	-5 V
Max	5 V
Default Unit	V
Backwards Compatibility SCPI	:TRIGger[:SEquence]:FRAMe:EXTernal2:LEVel
Initial S/W Revision	Prior to A.02.00

Trig Slope

Controls the trigger polarity. It is set positive to trigger on a rising edge and negative to trigger on a falling edge.

Key Path	Trigger, External 2
Remote Command	:TRIGger[:SEquence]:EXTernal2:SLOPe POSitive NEGative :TRIGger[:SEquence]:EXTernal2:SLOPe?
Example	TRIG:EXT2:SLOP NEG
Couplings	This same slope is used in the Ext2 selection for the trigger source in the Trigger menu and for the period timer sync source (in the Trigger menu and in the Gate Source menu).
Preset	POSitive
State Saved	Saved in instrument state
Backwards Compatibility SCPI	:TRIGger[:SEquence]:FRAMe:EXTernal2:SLOPe
Backwards Compatibility Notes	The legacy :TRIGger[:SEquence]:SLOPe command affects the slopes for the VID, LINE, EXT1, EXT2, and RFB triggers.
Initial S/W Revision	Prior to A.02.00

Trig Delay

Controls a time delay during which the analyzer will wait to begin a sweep after meeting the trigger criteria. You can use negative delay to pre-trigger the instrument in time domain or FFT, but not in swept spans.

Key Path	Trigger, External 2
Remote Command	:TRIGger[:SEquence]:EXTernal2:DELay <time>

	:TRIGger[:SEquence]:EXternal2:DElay?
	:TRIGger[:SEquence]:EXternal2:DElay:STATe OFF ON 0 1
	:TRIGger[:SEquence]:EXternal2:DElay:STATe?
Example	TRIG:EXT2:DEL:STAT ON TRIG:EXT2:DEL 100 ms
Notes	Video trigger delay may be set to negative values, in time domain, FFT and even swept. It makes intuitive sense in time domain and works well in FFT mode where the bandwidth of the filter before the video trigger is about 1.25 span. In swept spans, negative settings of Trig Delay are treated as a zero setting within the internal hardware and the advisory message "Neg. Trig Delay unavailable in Swept Mode, zero delay used." is generated when such a delay is set.
Preset	Off, 1.000 us
State Saved	Saved in instrument state
Min	-150 ms
Max	500 ms
Default Unit	s
Backwards Compatibility Notes	The legacy :TRIGger[:SEquence]:DElay command affects the delay for the VID, LINE, EXT1, EXT2, and RFB triggers. The legacy :TRIGger[:SEquence]:OFFSet command is supported for the VIDEO, LINE, EXT1, and EXT2 triggers.
Initial S/W Revision	Prior to A.02.00

Zero Span Delay Comp On/Off

In zero span, there is a natural delay in the signal path, which comes from the RBW filter. This is usually desirable, as it allows you to trigger on events and also see those events, because the signal is delayed from the trigger event. However, in some cases it is desirable to eliminate this delay, so that trigger events line up exactly with the zero time point in zero span. You can use the Zero Span Delay Comp On/Off feature to enable or disable zero span delay compensation.

Key Path	Trigger, External 2
Remote Command	:TRIGger[:SEquence]:EXternal2:DElay:COMPensation OFF ON 0 1 :TRIGger[:SEquence]:EXternal2:DElay:COMPensation?
Example	TRIG:EXT2:DEL:COMP ON
Dependencies	No effect except in zero-span, but not locked out in nonzero spans. Blanked in modes that do not support zero-span measurements. If the SCPI command is sent when the key is blanked, an error is returned: -221, "Settings conflict; Feature not supported for this measurement" In analyzers shipping N9060A, this feature requires N9060A-7FP.
Preset	OFF
State Saved	Saved in instrument state
Initial S/W Revision	A.11.00

RF Burst

Pressing this key, when it is not selected, selects the RF Burst as the trigger. A new sweep/measurement will start when an RF burst envelope signal is identified from the signal at the RF Input connector. Pressing this key, when it is already selected, accesses the RF Burst trigger setup menu.

In some models, a variety of burst trigger circuitry is available, resulting in various available burst trigger bandwidths. The analyzer automatically chooses the appropriate trigger path based on the hardware configuration and other settings of the analyzer.

Key Path	Trigger
Example	TRIG:SOUR RFB Swept SA measurement TRIG:<meas>:SOUR RFB Measurements other than Swept SA
State Saved	Saved in instrument state
Status Bits/OPC dependencies	The Status Operation Register bit 5 "Waiting for Trigger" is set at the same time as the Sweeping or Measuring bit is set. It is cleared when the trigger actually occurs (that is, after the trigger event occurs and all the applicable trigger criteria have been met). A corresponding pop-up message ("Waiting for trigger") is generated if no trigger signal appears after approximately 2 sec. This message goes away when a trigger signal appears.
Backwards Compatibility Notes	The legacy command: :TRIGger[:SEquence]:RFBurst:FSElectivity[:STATe] OFF ON 0 1 is not supported in the X-Series, as the hardware to do Frequency Selective burst triggers does not exist in X-Series.
Initial S/W Revision	Prior to A.02.00
Modified at S/W Revision	A.04.00

Absolute Trigger Level

Sets the absolute trigger level for the RF burst envelope.

When using the External Mixing path, the Absolute Trigger Level is uncalibrated because the factory default was set to accommodate the expected IF levels for the RF path.

Key Path	Trigger, RF Burst
Scope	Meas Global
Remote Command	:TRIGger[:SEquence]:RFBurst:LEVel:ABSolute <ampl> :TRIGger[:SEquence]:RFBurst:LEVel:ABSolute?
Example	TRIG:RFB:LEV:ABS 10 dBm sets the trigger level of the RF burst envelope signal to the absolute level of 10 dBm
Notes	Sending this command does not switch the setting from relative to absolute; to switch it you need to send the :TRIGger[:SEquence]:RFBurst:LEVel:TYPE command, below. Amplitude Corrections are not taken into account by the Absolute Trigger Level. For example, if you

	<p>have given yourself effective gain with an amplitude correction factor, the Absolute Trigger will not fire until you have set the trigger level that far below the displayed signal level, rather than simply to the displayed signal level. This is only true for Amplitude Corrections, not External Gain or Ref Level Offset functions.</p> <p>If mode is Bluetooth, the default value is -50 dBm.</p>
Couplings	This same level is used for the RF Burst trigger source in the Trigger menu, for the RF Burst selection in the Periodic Timer sync source (in the Trigger menu and in the Gate Source menu), and also for the RF Burst selection in the Gate Source menu
Preset	-20 dBm
State Saved	Saved in instrument state
Min	-200 dBm
Max	100 dBm
Default Unit	depends on the current selected Y-Axis unit
Backwards Compatibility SCPI	:TRIGger[:SEquence]:FRAME:RFBurst:LEVel:ABSolute
Initial S/W Revision	Prior to A.02.00
Modified at S/W Revision	A.04.00

Key Path	Trigger, RF Burst
Remote Command	:TRIGger[:SEquence]:RFBurst:LEVel:TYPE ABSolute RELative :TRIGger[:SEquence]:RFBurst:LEVel:TYPE?
Example	TRIG:RFB:LEV:TYPE REL sets the trigger level type of the RF burst trigger to Relative.
Preset	ABSolute
State Saved	Saved in instrument state
Initial S/W Revision	Prior to A.02.00
Modified at S/W Revision	A.04.00

Relative Trigger Level

Sets the relative trigger level for the RF burst envelope.

In some models, the relative burst trigger function is implemented in hardware. In other models, without the advanced triggering hardware required, the relative burst trigger function is implemented in software in some measurements, and is unavailable in other measurements.

When implemented in software, the relative RF Burst trigger function is implemented as follows:

1. The measurement starts with the absolute RF Burst trigger setting. If it cannot get a trigger with that level, auto trigger fires and the acquisition starts anyway. After the acquisition, the measurement searches for the peak in the acquired waveform and saves it.

2. Now, in the next cycle of the measurement, the measurement determines a new absolute RF Burst level based on the peak value from the first measurement and the Relative RF Burst Trigger Level (always 0 or negative dB) set by the user. The following formula is used:
 3. absolute RF Burst level = peak level of the previous acquisition + relative RF Burst level
 4. If the new absolute RF Burst level differs from the previous by more than 0.5 dB, the new level is sent to the hardware; otherwise it is not updated (to avoid slowing down the acquisition)
- Steps 2 and 3 repeat for subsequent measurements.

Key Path	Trigger, RF Burst
Scope	Meas Global
Remote Command	:TRIGger[:SEquence]:RFBurst:LEVel:RELative <rel_ampl> :TRIGger[:SEquence]:RFBurst:LEVel:RELative?
Example	TRIG:RFB:LEV:REL -10 dB sets the trigger level of the RF burst envelope signal to the relative level of -10 dB
Notes	Sending this command does not switch the setting from absolute to relative; to switch it you need to send the :TRIGger[:SEquence]:RFBurst:LEVel:TYPE command, above. The relative trigger level is not available in some measurements. In those measurements the RELative parameter, and the :TRIGger[:SEquence]:RFBurst:LEVel:TYPE command (above), will generate an error if sent.
Dependencies	This key is grayed out and Absolute Trigger Level selected if the required hardware is not present in your analyzer and the current measurement does not support Relative triggering.
Preset	-6 dB GSM: -25 dB
State Saved	Saved in instrument state
Min	-45 dB
Max	0 dB
Default Unit	dB or dBc
Backwards Compatibility SCPI	:TRIGger[:SEquence]:RFBurst:LEVel This legacy command is aliased to :TRIGger[:SEquence]:RFBurst:LEVel:RELative because the PSA had ONLY relative burst triggering
Initial S/W Revision	Prior to A.02.00
Modified at S/W Revision	A.04.00

Trigger Slope

It is set positive to trigger on a rising edge and negative to trigger on a falling edge.

Key Path	Trigger, RF Burst
Remote Command	:TRIGger[:SEquence]:RFBurst:SLOPe POSitive NEGative :TRIGger[:SEquence]:RFBurst:SLOPe?

Example	TRIG:RFB:SLOP NEG
Couplings	This same slope is used in the RF Burst selection for the trigger source in the Trigger menu and for the period timer sync source (in the Trigger menu and in the Gate Source menu).
Preset	POSitive
State Saved	Saved in instrument state
Backwards Compatibility SCPI	:TRIGger[:SEQuence]:FRAMe:RFBurst:SLOPe
Backwards Compatibility Notes	The legacy :TRIGger[:SEQuence]:SLOPe command affects the slopes for the VID, LINE, EXT1, EXT2, and RFB triggers.
Initial S/W Revision	Prior to A.02.00

Trig Delay

Controls a time delay during which the analyzer will wait to begin a sweep after meeting the trigger criteria. You can use negative delay to pre-trigger the instrument in time domain or FFT, but not in swept spans.

Key Path	Trigger, RF Burst
Remote Command	:TRIGger[:SEQuence]:RFBurst:DELAy <time> :TRIGger[:SEQuence]:RFBurst:DELAy? :TRIGger[:SEQuence]:RFBurst:DELAy:STATe OFF ON 0 1 :TRIGger[:SEQuence]:RFBurst:DELAy:STATe?
Example	TRIG:RFB:DEL:STAT ON TRIG:RFB:DEL 100 ms
Notes	Video trigger delay may be set to negative values, in time domain, FFT and even swept. It makes intuitive sense in time domain and works well in FFT mode where the bandwidth of the filter before the video trigger is about 1.25 span. In swept spans, negative settings of Trig Delay are treated as a zero setting within the internal hardware and the advisory message "Neg. Trig Delay unavailable in Swept Mode, zero delay used." is generated when such a delay is set.
Preset	Off, 1.000 us
State Saved	Saved in instrument state
Min	-150 ms
Max	500 ms
Default Unit	s
Backwards Compatibility Notes	The legacy :TRIGger[:SEQuence]:DELAy command affects the delay for the VID, LINE, EXT1, EXT2, and RFB triggers.
Initial S/W Revision	Prior to A.02.00

Periodic Timer (Frame Trigger)

Pressing this key, when it is not selected, selects the internal periodic timer signal as the trigger. Triggering occurrences are set by the **Period** parameter, which is modified by the **Sync Source** and **Offset**. Pressing this key, when it is already selected, accesses the periodic timer trigger setup functions.

If you do not have a sync source selected (it is Off), then the internal timer will not be synchronized with any external timing events.

Key Path	Trigger
Example	TRIG:SOUR FRAM Swept SA measurement
	TRIG:<meas>:SOUR FRAM Measurements other than Swept SA
State Saved	Saved in instrument state
Readback	[Sync: <value of Sync Source>], for example, [Sync: External 1]
Status Bits/OPC dependencies	The Status Operation Register bit 5 "Waiting for Trigger" is set at the same time as the Sweeping or Measuring bit is set. It is cleared when the trigger actually occurs (that is, after the trigger event occurs and all the applicable trigger criteria have been met). A corresponding pop-up message ("Waiting for trigger") is generated if no trigger signal appears after approximately 2 sec. This message goes away when a trigger signal appears.
Initial S/W Revision	Prior to A.02.00

Periodic Timer Triggering:

This feature selects the internal periodic timer signal as the trigger. Trigger occurrences are set by the **Periodic Timer** parameter, which is modified by the **Sync Source** and **Offset**.

The figure below shows the action of the periodic timer trigger. Before reviewing the figure, we'll explain some uses for the periodic trigger.

A common application is measuring periodic burst RF signals for which a trigger signal is not easily available. For example, we might be measuring a TDMA radio which bursts every 20 ms. Let's assume that the 20 ms period is very consistent. Let's also assume that we do not have an external trigger source available that is synchronized with the period, and that the signal-to-noise ratio of the signal is not high enough to provide a clean RF burst trigger at all of the analysis frequencies. For example, we might want to measure spurious transmissions at an offset from the carrier that is larger than the bandwidth of the RF burst trigger. In this application, we can set the Periodic Timer to a 20.00 ms period and adjust the offset from that timer to position our trigger just where we want it. If we find that the 20.00 ms is not exactly right, we can adjust the period slightly to minimize the drift between the period timer and the signal to be measured.

A second way to use this feature would be to use **Sync Source** temporarily, instead of **Offset**. In this case, we might tune to the signal in a narrow span and use the RF Burst trigger to synchronize the periodic timer. Then we would turn the sync source off so that it would not miss-trigger. Miss-triggering can occur when we are tuned so far away from the RF burst trigger that it is no longer reliable.

A third example would be to synchronize to a signal that has a reference time element of much longer period than the period of interest. In some CDMA applications, it is useful to look at signals with a short periodicity, by synchronizing that periodicity to the "even-second clock" edge that happens every two

seconds. Thus, we could connect the even-second clock trigger to Ext1 and use then Ext1 as the sync source for the periodic timer.

The figure below illustrates this third example. The top trace represents the even-second clock. It causes the periodic timer to synchronize with the leading edge shown. The analyzer trigger occurs at a time delayed by the accumulated offset from the period trigger event. The periodic timer continues to run, and triggers continue to occur, with a periodicity determined by the analyzer time base. The timer output (labeled "late event") will drift away from its ideal time due to imperfect matching between the time base of the signal being measured and the time base of the analyzer, and also because of imperfect setting of the period parameter. But the synchronization is restored on the next even-second clock event. ("Accumulated offset" is described in the in the **Offset** function section.)

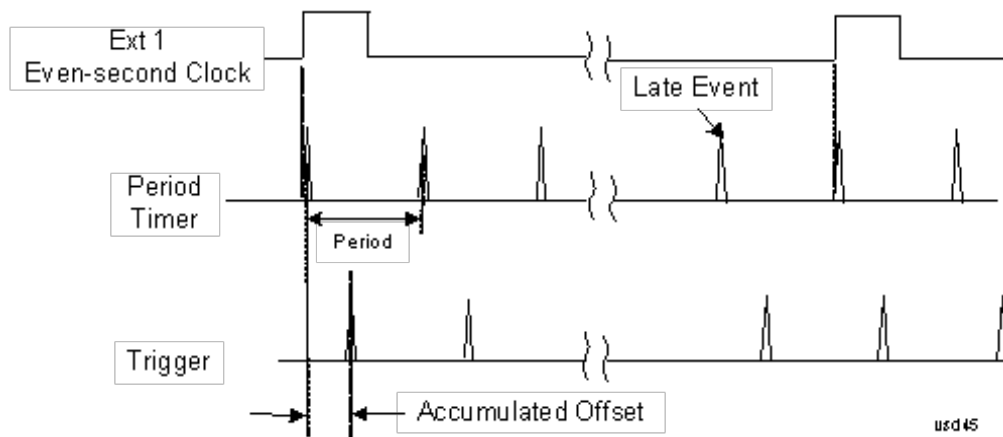

Period

Sets the period of the internal periodic timer clock. For digital communications signals, this is usually set to the frame period of your current input signal. In the case that sync source is not set to OFF, and the external sync source rate is changed for some reason, the periodic timer is synchronized at the every external synchronization pulse by resetting the internal state of the timer circuit.

Key Path	Trigger, Periodic Timer
Remote Command	:TRIGger[:SEquence]:FRAMe:PERiod <time> :TRIGger[:SEquence]:FRAMe:PERiod?
Example	TRIG:FRAM:PER 100 ms
Dependencies	The invalid data indicator turns on when the period is changed, until the next sweep/measurement completes.
Couplings	The same period is used in the Gate Source selection of the period timer.
Preset	20 ms GSM: 4.615383
State Saved	Saved in instrument state
Min	100.000 ns
Max	559.0000 ms
Default Unit	S
Initial S/W Revision	Prior to A.02.00

Offset

Adjusts the accumulated offset between the periodic timer events and the trigger event. Adjusting the accumulated offset is different than setting an offset, and requires explanation.

The periodic timer is usually not synchronized with any external events, so the timing of its output events has no absolute meaning. Since the timing relative to external events (RF signals) is important, you need to be able to adjust (offset) it. However, you have no direct way to see when the periodic timer events occur. All that you can see is the trigger timing. When you want to adjust the trigger timing, you will be changing the internal offset between the periodic timer events and the trigger event. Because the absolute value of that internal offset is unknown, we will just call that the accumulated offset. Whenever the Offset parameter is changed, you are changing that accumulated offset. You can reset the displayed offset using Reset Offset Display. Changing the display does not change the value of the accumulated offset, and you can still make additional changes to accumulated offset.

To avoid ambiguity, we define that an increase in the "offset" parameter, either from the knob or the SCPI adjust command, serves to delay the timing of the trigger event.

Key Path	Trigger, Periodic Timer
Remote Command	:TRIGger[:SEquence]:FRAMe:OFFSet <time> :TRIGger[:SEquence]:FRAMe:OFFSet?
Example	TRIG:FRAM:OFFS 1.2 ms
Notes	<p>The front panel interface (for example, the knob), and this command, adjust the accumulated offset, which is shown on the active function display. However, the actual amount sent to the hardware each time the offset is updated is the delta value, that is, the current accumulated offset value minus the previous accumulated offset value. Note that the accumulated offset value is essentially arbitrary; it represents the accumulated offset from the last time the offset was zeroed (with the Reset Offset Display key).</p> <p>Note that this command does not change the period of the trigger waveform. Note also that Offset is used only when the sync source is set to OFF, otherwise delay is used, see section "Trig Delay" on page 470.</p> <p>An increase in the "offset" parameter, either from the knob or the SCPI adjust command, serves to delay the timing of the trigger event.</p>
Notes	<p>When the SCPI command is sent the value shown on the key (and the Active Function, if this happens to be the active function) is updated with the new value. However, the actual amount sent to the hardware is the delta value, that is, the current accumulated offset value minus the previous accumulated offset value.</p> <p>The SCPI query simply returns the value currently showing on the key.</p>
Dependencies	The invalid data indicator turns on when the offset is changed, until the next sweep/measurement completes.
Couplings	The same offset is used in the Gate Source selection of the period timer.
Preset	0 s
State Saved	Saved in instrument state
Min	-10.000 s
Max	10.000 s

Default Unit	S
Initial S/W Revision	Prior to A.02.00

Reset Offset Display

Resets the value of the periodic trigger offset display setting to 0.0 seconds. The current displayed trigger location may include an offset value defined with the Offset key. Pressing this key redefines the currently displayed trigger location as the new trigger point that is 0.0 s offset. The Offset key can then be used to add offset relative to this new timing.

Key Path	Trigger, Periodic Timer
Remote Command	:TRIGger[:SEquence]:FRAMe:OFFSet:DISPlay:RESet
Example	TRIG:FRAM:OFFS:DISP:RES
Initial S/W Revision	Prior to A.02.00

Sync Source

Selects a signal source for you to synchronize your periodic timer trigger to, otherwise you are triggering at some arbitrary location in the frame. Synchronization reduces the precision requirements on the setting of the period.

For convenience you may adjust the level and slope of the selected sync source in a conditional branch setup menu accessed from the Sync Source menu. Note that these settings match those in the **Trigger** and **Gate Source** menus; that is, each trigger source has only one value of level and slope, regardless of which menu it is accessed from.

Key Path	Trigger, Periodic Timer
Remote Command	:TRIGger[:SEquence]:FRAMe:SYNC EXTernal1 EXTernal2 RFBurst OFF :TRIGger[:SEquence]:FRAMe:SYNC?
Example	TRIG:FRAM:SYNC EXT2
Dependencies	In some models, there is no second External input. In these models, the External 2 key is blanked and the EXTernal2 parameter will generate a "Hardware missing; Not available for this model number" message.
Preset	Off GSM/EDGE, MSR,LTE,LTETDD: RFBurst
State Saved	Saved in instrument state
Readback	The current setting is read back to this key and it is also Readback to the previous Periodic Timer trigger key.
Backwards Compatibility SCPI	:TRIGger[:SEquence]:FRAMe:SYNC EXTernal For backward compatibility, the parameter EXTernal is mapped to EXTernal1
Initial S/W Revision	Prior to A.02.00
Modified at S/W Revision	A.03.00, A.14.00

Off

Turns off the sync source for your periodic trigger. With the sync source off, the timing will drift unless the signal source frequency is locked to the analyzer frequency reference.

Key Path	Trigger, Periodic Timer, Sync Source
Example	TRIG:FRAM:SYNC OFF
Readback	Off
Initial S/W Revision	Prior to A.02.00

External 1

Pressing this key, when it is not selected, selects an external input signal as the trigger. A new sweep/measurement will start when the external trigger condition is met using the external 1 input connector on the rear panel.

Pressing this key, when it is already selected, accesses the external 1 trigger setup menu.

Key Path	Trigger
Example	TRIG:SOUR EXT1 Swept SA measurement TRIG:<meas>:SOUR EXT1 Measurements other than Swept SA
Dependencies	Grayed out if in use by Point Trigger in the Source Setup menu. Forced to Free Run if already selected and Point Trigger is set to External 1.
State Saved	Saved in instrument state
Status Bits/OPC dependencies	The Status Operation Register bit 5 "Waiting for Trigger" is set at the same time as the Sweeping or Measuring bit is set. It is cleared when the trigger actually occurs (that is, after the trigger event occurs and all the applicable trigger criteria have been met). A corresponding pop-up message ("Waiting for trigger") is generated if no trigger signal appears after approximately 2 sec. This message goes away when a trigger signal appears.
Initial S/W Revision	Prior to A.02.00

Trigger Level

Sets the value where the external 1 trigger input will trigger a new sweep/measurement.

Key Path	Trigger, External 1
Remote Command	:TRIGger[:SEquence]:EXTernal1:LEVel <level> :TRIGger[:SEquence]:EXTernal1:LEVel?
Example	TRIG:EXT1:LEV 0.4 V
Couplings	This same level is used for the Ext1 trigger source in the Trigger menu, for the Ext1 selection in the Periodic Timer sync source (in the Trigger menu and in the Gate Source menu), and also for the Ext1

	selection in the Gate Source menu.
Preset	1.2 V
State Saved	Saved in instrument state
Min	-5 V
Max	5 V
Default Unit	V
Backwards Compatibility SCPI	:TRIGger[:SEQuence]:EXTernal:LEVel For backward compatibility, the parameter EXTernal is mapped to EXTernal1
Backwards Compatibility SCPI	:TRIGger[:SEQuence]:FRAMe:EXTernal1:LEVel
Initial S/W Revision	Prior to A.02.00

Trig Slope

Controls the trigger polarity. It is set positive to trigger on a rising edge and negative to trigger on a falling edge.

Key Path	Trigger, External 1
Remote Command	:TRIGger[:SEQuence]:EXTernal1:SLOPe POSitive NEGative :TRIGger[:SEQuence]:EXTernal1:SLOPe?
Example	TRIG:EXT1:SLOP NEG
Couplings	This same slope is used in the Ext1 selection for the trigger source in the Trigger menu and for the period timer sync source (in the Trigger menu and in the Gate Source menu).
Preset	POSitive
State Saved	Saved in instrument state
Backwards Compatibility SCPI	:TRIGger[:SEQuence]:EXTernal:SLOPe For backward compatibility, the parameter EXTernal is mapped to EXTernal1
Backwards Compatibility SCPI	:TRIGger[:SEQuence]:FRAMe:EXTernal1:SLOPe
Backwards Compatibility Notes	The legacy :TRIGger[:SEQuence]:SLOPe command affects the slopes for the VID, LINE, EXT1, EXT2, and RFB triggers.
Initial S/W Revision	Prior to A.02.00

External 2

Pressing this key, when it is not selected, selects an external input signal as the trigger. A new sweep/measurement will start when the external trigger condition is met using the external 2 input connector. The external trigger 2 input connector is on the rear panel.

Pressing this key, when it is already selected, accesses the external 2 trigger setup menu.

Key Path	Trigger
Example	TRIG:SOUR EXT2 Swept SA measurement TRIG:<meas>:SOUR EXT2 Measurements other than Swept SA
Dependencies	In some models, there is no second External input. In these models, the External 2 key is blanked and the EXTernal2 parameter will generate a "Hardware missing; Not available for this model number" message. Grayed out if in use by Point Trigger in the Source Setup menu. Forced to Free Run if already selected and Point Trigger is set to External 2.
State Saved	Saved in instrument state
Status Bits/OPC dependencies	The Status Operation Register bit 5 "Waiting for Trigger" is set at the same time as the Sweeping or Measuring bit is set. It is cleared when the trigger actually occurs (that is, after the trigger event occurs and all the applicable trigger criteria have been met). A corresponding pop-up message ("Waiting for trigger") is generated if no trigger signal appears after approximately 2 sec. This message goes away when a trigger signal appears.
Initial S/W Revision	Prior to A.02.00
Modified at S/W Revision	A.03.00

Trigger Level

Sets the value where the external 2 trigger input will trigger a new sweep/measurement.

Key Path	Trigger, External 2
Remote Command	:TRIGger[:SEquence]:EXTernal2:LEVel :TRIGger[:SEquence]:EXTernal2:LEVel?
Example	TRIG:EXT2:LEV 1.1 V
Couplings	This same level is used for the Ext2 trigger source in the Trigger menu, for the Ext2 selection in the Periodic Timer sync source (in the Trigger menu and in the Gate Source menu), and also for the Ext2 selection in the Gate Source menu.
Preset	1.2 V
State Saved	Saved in instrument state
Min	-5 V
Max	5 V
Default Unit	V
Backwards Compatibility SCPI	:TRIGger[:SEquence]:FRAMe:EXTernal2:LEVel
Initial S/W Revision	Prior to A.02.00

Trig Slope

Controls the trigger polarity. It is set positive to trigger on a rising edge and negative to trigger on a falling edge.

Key Path	Trigger, External 2
Remote Command	:TRIGger[:SEquence]:EXternal2:SLOPe POSitive NEGative :TRIGger[:SEquence]:EXternal2:SLOPe?
Example	TRIG:EXT2:SLOP NEG
Couplings	This same slope is used in the Ext2 selection for the trigger source in the Trigger menu and for the period timer sync source (in the Trigger menu and in the Gate Source menu).
Preset	POSitive
State Saved	Saved in instrument state
Backwards Compatibility SCPI	:TRIGger[:SEquence]:FRAMe:EXternal2:SLOPe
Backwards Compatibility Notes	The legacy :TRIGger[:SEquence]:SLOPe command affects the slopes for the VID, LINE, EXT1, EXT2, and RFB triggers.
Initial S/W Revision	Prior to A.02.00

RF Burst

Pressing this key, when it is not selected, selects the RF Burst as the trigger. A new sweep/measurement will start when an RF burst envelope signal is identified from the signal at the RF Input connector. Pressing this key, when it is already selected, accesses the RF Burst trigger setup menu.

In some models, a variety of burst trigger circuitry is available, resulting in various available burst trigger bandwidths. The analyzer automatically chooses the appropriate trigger path based on the hardware configuration and other settings of the analyzer.

Key Path	Trigger
Example	TRIG:SOUR RFB Swept SA measurement TRIG:< meas>:SOUR RFB Measurements other than Swept SA
State Saved	Saved in instrument state
Status Bits/OPC dependencies	The Status Operation Register bit 5 "Waiting for Trigger" is set at the same time as the Sweeping or Measuring bit is set. It is cleared when the trigger actually occurs (that is, after the trigger event occurs and all the applicable trigger criteria have been met). A corresponding pop-up message ("Waiting for trigger") is generated if no trigger signal appears after approximately 2 sec. This message goes away when a trigger signal appears.
Backwards Compatibility Notes	The legacy command: :TRIGger[:SEquence]:RFBurst:FSElectivity[:STATe] OFF ON 0 1 is not supported in the X-Series, as the hardware to do Frequency Selective burst triggers does not exist in X-Series.
Initial S/W Revision	Prior to A.02.00
Modified at S/W Revision	A.04.00

Absolute Trigger Level

Sets the absolute trigger level for the RF burst envelope.

When using the External Mixing path, the Absolute Trigger Level is uncalibrated because the factory default was set to accommodate the expected IF levels for the RF path.

Key Path	Trigger, RF Burst
Scope	Meas Global
Remote Command	<code>:TRIGger[:SEquence]:RFBurst:LEVel:ABSolute <ampl></code> <code>:TRIGger[:SEquence]:RFBurst:LEVel:ABSolute?</code>
Example	TRIG:RFB:LEV:ABS 10 dBm sets the trigger level of the RF burst envelope signal to the absolute level of 10 dBm
Notes	Sending this command does not switch the setting from relative to absolute; to switch it you need to send the <code>:TRIGger[:SEquence]:RFBurst:LEVel:TYPE</code> command, below. Amplitude Corrections are not taken into account by the Absolute Trigger Level. For example, if you have given yourself effective gain with an amplitude correction factor, the Absolute Trigger will not fire until you have set the trigger level that far below the displayed signal level, rather than simply to the displayed signal level. This is only true for Amplitude Corrections, not External Gain or Ref Level Offset functions. If mode is Bluetooth, the default value is -50 dBm.
Couplings	This same level is used for the RF Burst trigger source in the Trigger menu, for the RF Burst selection in the Periodic Timer sync source (in the Trigger menu and in the Gate Source menu), and also for the RF Burst selection in the Gate Source menu
Preset	-20 dBm
State Saved	Saved in instrument state
Min	-200 dBm
Max	100 dBm
Default Unit	depends on the current selected Y-Axis unit
Backwards Compatibility SCPI	<code>:TRIGger[:SEquence]:FRAMe:RFBurst:LEVel:ABSolute</code>
Initial S/W Revision	Prior to A.02.00
Modified at S/W Revision	A.04.00

Key Path	Trigger, RF Burst
Remote Command	<code>:TRIGger[:SEquence]:RFBurst:LEVel:TYPE ABSolute RELative</code> <code>:TRIGger[:SEquence]:RFBurst:LEVel:TYPE?</code>
Example	TRIG:RFB:LEV:TYPE REL sets the trigger level type of the RF burst trigger to Relative.
Preset	ABSolute

State Saved	Saved in instrument state
Initial S/W Revision	Prior to A.02.00
Modified at S/W Revision	A.04.00

Trigger Slope

It is set positive to trigger on a rising edge and negative to trigger on a falling edge.

Key Path	Trigger, RF Burst
Remote Command	:TRIGger[:SEquence]:RFBurst:SLOPe POSitive NEGative :TRIGger[:SEquence]:RFBurst:SLOPe?
Example	TRIG:RFB:SLOP NEG
Couplings	This same slope is used in the RF Burst selection for the trigger source in the Trigger menu and for the period timer sync source (in the Trigger menu and in the Gate Source menu).
Preset	POSitive
State Saved	Saved in instrument state
Backwards Compatibility SCPI	:TRIGger[:SEquence]:FRAME:RFBurst:SLOPe
Backwards Compatibility Notes	The legacy :TRIGger[:SEquence]:SLOPe command affects the slopes for the VID, LINE, EXT1, EXT2, and RFB triggers.
Initial S/W Revision	Prior to A.02.00

Trig Delay

This setting delays the measurement timing relative to the Periodic Timer.

Key Path	Trigger, Periodic Timer
Remote Command	:TRIGger[:SEquence]:FRAME:DELay <time> :TRIGger[:SEquence]:FRAME:DELay? :TRIGger[:SEquence]:FRAME:DELay:STATE OFF ON 0 1 :TRIGger[:SEquence]:FRAME:DELay:STATE?
Notes	Note that delay is used when the sync source is not set to OFF. If the sync source is set to OFF, offset is used.
Preset	Off, 1.000 us
State Saved	Saved in instrument state
Min	-150 ms
Max	+500 ms
Default Unit	s
Initial S/W Revision	Prior to A.02.00

Auto/Holdoff

Opens up a menu that lets you adjust Auto Trigger and Trigger Holdoff parameters

Key Path	Trigger
Readback line	Displays a summary of the Auto Trig and Holdoff settings, in square brackets First line: Auto Off or Auto On Second Line: "Hld" followed by: <ul style="list-style-type: none"> • If Holdoff is Off, readback Off • If Holdoff On and Type = Normal, readback value • If Holdoff On and Type = Above, readback value followed by AL • If Holdoff On and Type = Below, readback value followed by BL • If Holdoff Type selection is not supported by the current measurement, Holdoff Type is always Normal
Initial S/W Revision	A.02.00

Auto Trig

Sets the time that the analyzer will wait for the trigger conditions to be met. If they are not met after that much time, then the analyzer is triggered anyway.

Key Path	Trigger, Auto/Holdoff
Remote Command	:TRIGger[:SEQuence]:ATRigger <time> :TRIGger[:SEQuence]:ATRigger? :TRIGger[:SEQuence]:ATRigger:STATe OFF ON 0 1 :TRIGger[:SEQuence]:ATRigger:STATe?
Example	TRIG:ATR:STAT ON TRIG:ATR 100 ms
Notes	The "time that the analyzer will wait" starts when the analyzer is ready for a trigger, which may be hundreds of ms after the data acquisition for a sweep is done. The "time" ends when the trigger condition is satisfied, not when the delay ends.
Preset	Off, 100 ms
State Saved	Saved in instrument state
Min	1 ms
Max	100 s
Default Unit	s
Initial S/W Revision	Prior to A.02.00

Trig Holdoff

Sets the holdoff time between triggers. When the trigger condition is satisfied, the trigger occurs, the delay begins, and the holdoff time begins. New trigger conditions will be ignored until the holdoff time expires. For a free-running trigger, the holdoff value is the minimum time between triggers.

Key Path	Trigger, Auto/Holdoff
Remote Command	:TRIGger[:SEquence]:HOLDoff <time> :TRIGger[:SEquence]:HOLDoff? :TRIGger[:SEquence]:HOLDoff:STATe OFF ON 0 1 :TRIGger[:SEquence]:HOLDoff:STATe?
Example	TRIG:HOLD:STAT ON TRIG:HOLD 100 ms
Dependencies	Unavailable if the selected Input is BBIQ. If this is the case, the key is grayed out if it is pressed the informational message "Feature not supported for this Input" is displayed. If the SCPI command is sent, the error "Settings conflict; Feature not supported for this Input" is generated.
Preset	Off, 100 ms
State Saved	Saved in instrument state
Min	0 s
Max	0.5 s
Default Unit	s
Initial S/W Revision	Prior to A.02.00

Holdoff Type

Lets you set the Trigger Holdoff Type.

NOTE Holdoff Type is not supported by all measurements. If the current measurement does not support it, this key will be blank and the Holdoff Type will be Normal. If the Holdoff Type SCPI is sent while in such a measurement, the SCPI will be accepted and the setting remembered, but it will have no effect until a measurement is in force that supports Holdoff Type.

Trigger Holdoff Type functionality:

- NORMAl
- This is the "oscilloscope" type of trigger holdoff, and is the setting when the Holdoff Type key does not appear. In this type of holdoff, no new trigger will be accepted until the holdoff interval has expired after the previous trigger.
- ABOVE
- If the trigger slope is positive, a trigger event is generated only if the signal characteristic of interest crosses the trigger threshold (with positive slope) and then remains above the threshold for at least the holdoff time. For negative slope, the trigger event is generated if the signal characteristic crosses the

threshold (with negative slope) after having been above the threshold for at least the holdoff time. In either case, the trigger event is associated with the time the level was crossed.

- BELow
- If the trigger slope is positive, a trigger event is generated only if the signal characteristic of interest crosses the trigger threshold (with positive slope) after having been below the threshold for at least the holdoff time. For negative slope, the trigger event is generated if the signal characteristic crosses the threshold (with negative slope) and then remains below the threshold for at least the holdoff time. In either case, the trigger event is associated with the time the level was crossed.

Key Path	Trigger, Auto/Holdoff
Remote Command	:TRIGger[:SEquence]:HOLDoff:TYPE NORMal ABOVe BELow :TRIGger[:SEquence]:HOLDoff:TYPE?
Example	TRIG:HOLD:TYPE NORM
Preset	All modes but GSM/EDGE: Normal GSM/EDGE: Below
State Saved	Saved in instrument state
Initial S/W Revision	A.02.00

8 Channel Power Measurement

The Channel Power measurement is used to find the total power present in a specified bandwidth. The power spectral density (the power in the signal normalized to 1 Hz) is also reported (In WLAN mode or WLAN radio standard in SA mode, the peak power spectral density for 1 MHz is reported). For measurement results and views, see ["View/Display" on page 648](#).

This topic contains the following sections:

["Measurement Commands for Channel Power" on page 476](#)

["Remote CommandResults for Channel Power Measurement" on page 477](#)

Measurement Commands for Channel Power

These commands are used to measure the total rms power in a specified integration bandwidth.

Use `:INSTrument:SElect` to set the mode.

```
:CONFigure:CHPower
:CONFigure:CHPower:NDEFault
:INITiate:CHPower
:FETCh:CHPower[n]?
:MEASure:CHPower[n]?
:READ:CHPower[n]?
:FETCh:CHPower:CHPower?
:MEASure:CHPower:CHPower?
:READ:CHPower:CHPower?
:FETCh:CHPower:DENSity?
:MEASure:CHPower:DENSity?
:READ:CHPower:DENSity
```

For more measurement related commands, see the SENSE subsystem, and the section "[Remote Measurement Functions](#)" on page 2770.

Remote CommandResults for Channel Power Measurement

For DVB-T/H and DTMB (CTTB) mode, see ["DVB-T/H and DTMB \(CTTB\) Mode Remote Command Results" on page 478](#).

For ISDB-T and CMMB mode, see ["ISDB-T and CMMB mode Remote Command Results" on page 480](#).

For MSR, see ["Remote Command Results for WLAN Channel Power Measurement" on page 483](#)

For LTE-Advanced FDD/TDD, see ["LTE-Advanced FDD/TDD Mode Remote Command Results " on page 482](#)

For WLAN, see ["MSR Mode Remote Command Results" on page 481](#)

Command	Return Value
FETCh:CHPower[n]?	Refer to the table below.
MEASure:CHPower[n]?	
READ:CHPower[n]?	
FETCh:CHPower:CHPower?	Returns the Channel Power (dBm) (BW compatibility functionality)
MEASure:CHPower:CHPower?	
READ:CHPower:CHPower?	
FETCh:CHPower:DENSity?	Returns the Power Spectral Density (dBm/Hz) (BW compatibility functionality)
MEASure:CHPower:DENSity?	
READ:CHPower:DENSity?	

n	Results Returned
n=1 (or not specified)	Returns scalar results: <ol style="list-style-type: none"> 1. Channel Power is a floating point number representing the total channel power in the specified integration bandwidth. 2. PSD (Power Spectral Density) is the power in the specified unit bandwidth. The unit bandwidth is selected by the PSD Unit parameter in either dBm/Hz or dBm/MHz.
2	Returns floating point numbers that are the captured trace data of the power (in dBm/resolution BW) of the signal. The frequency span of the captured trace data is specified by the Span key.

DVB-T/H and DTMB (CTTB) Mode Remote Command Results

The following commands are available only for DVB-T/H and DTMB (CTTB) mode.

Condition	n	Results Returned
	n=1 (or not specified)	Returns scalar results: 1. Channel Power is a floating point number representing the total channel power in the specified integration bandwidth. 2. PSD (Power Spectral Density) is the power in the specified unit bandwidth. The unit bandwidth is selected by the PSD Unit parameter in either dBm/Hz or dBm/MHz.
	2	Returns floating point numbers that are the captured trace data of the power (in dBm/resolution BW) of the signal. The frequency span of the captured trace data is specified by the Span key.
Mode = DVB-T/H or Mode = DTMB (CTTB)	3	Returns 7 comma-separated scalar results, in the following order. 1. The shoulder attenuation result (dB) 2. Lower shoulder attenuation result (dB) 3. Upper shoulder attenuation result (dB) 4. Lower Offset - MAX shoulder point power (dBm) 5. Lower Offset - MAX shoulder point frequency (MHz) 6. Upper Offset - MAX shoulder point power (dBm) 7. Upper Offset - MAX shoulder point frequency (MHz) If the results are not available, -999.0 is returned. For example, if current view is RF spectrum or spectrum mask, -999.0 is returned.
Mode = DVB-T/H or Mode = DTMB (CTTB)	4	Returns floating point numbers that are the captured trace data of the power (in dBm/resolution BW) of the signal in the left graph of the shoulder attenuation view. If the results are not available, -999.0 is returned. For example, if current view is RF spectrum or spectrum mask, -999.0 is returned.
Mode = DVB-T/H or Mode = DTMB (CTTB)	5	Returns floating point numbers that are the captured trace data of the power (in dBm/resolution BW) of the signal in the right graph of the shoulder attenuation view. If the results are not available, -999.0 is returned. For example, if current view is RF spectrum or spectrum mask, -999.0 is returned.
Mode = DVB-T/H or Mode = DTMB (CTTB)	6	Returns floating point numbers that are the captured trace data of the power (in dBm/resolution BW) of the mask in the spectrum mask view. If the results are not available, -999.0 is returned. For example, if current view is RF spectrum or shoulder attenuation, -999.0 is returned.
Mode = DVB-T/H or Mode = DTMB (CTTB)	7	Returns the failed point information in the following order: 1. the 1st failed point frequency (MHz) 2. the 1st failed point absolute power (dBm) 3. the 1st failed point relative power (dB) 4. the 2nd failed point frequency (MHz) 5. the 2nd failed point absolute power (dBm)

6. the 2nd failed point relative power (dB)

...

$3*N-2$. the ($3*N-2$)th failed point frequency (MHz)

$3*N-1$. the ($3*N-1$)th failed point absolute power (dBm)

$3*N$. the ($3*N$)th failed point relative power (dB)

If the number of failed points is less than 20, it will show all of them (frequency, power and relative power), $N < 20$;

If the number of failed points is great than 20, the first ten failed points and the last ten failed points will be show, $N = 20$.

If the results are not available, -999.0 is returned.

For example, if current view is RF spectrum or shoulder attenuation, -999.0 is returned.

ISDB-T and CMMB mode Remote Command Results

The following commands are available only for ISDB-T and CMMB mode.

Condition	n	Results Returned
	n=1 (or not specified)	Returns scalar results: 1. Channel Power is a floating point number representing the total channel power in the specified integration bandwidth. 2. PSD (Power Spectral Density) is the power in the specified unit bandwidth. The unit bandwidth is selected by the PSD Unit parameter in either dBm/Hz or dBm/MHz.
	2	Returns floating point numbers that are the captured trace data of the power (in dBm/resolution BW) of the signal. The frequency span of the captured trace data is specified by the Span key.
Mode = ISDB-T or Mode = CMMB	3	Returns 7 comma-separated scalar results, in the following order. 1. The shoulder attenuation result (dB) 2. Lower shoulder attenuation result (dB) 3. Upper shoulder attenuation result (dB) 4. Lower Offset - MAX shoulder point power (dBm) 5. Lower Offset - MAX shoulder point frequency (MHz) 6. Upper Offset - MAX shoulder point power (dBm) 7. Upper Offset - MAX shoulder point frequency (MHz) If the results are not available, -999.0 is returned. For example, if current view is RF spectrum or spectrum mask, -999.0 is returned.
Mode = ISDB-T or Mode = CMMB	4	Returns floating point numbers that are the captured trace data of the power (in dBm/resolution BW) of the signal in the left window of the shoulder attenuation view. If the results are not available, -999.0 is returned. For example, if current view is RF spectrum or spectrum mask, -999.0 is returned.
Mode = ISDB-T or Mode = CMMB	5	Returns floating point numbers that are the captured trace data of the power (in dBm/resolution BW) of the signal in the right window of the shoulder attenuation view. If the results are not available, -999.0 is returned. For example, if current view is RF spectrum or spectrum mask, -999.0 is returned.

MSR Mode Remote Command Results

The following commands are available only for MSR mode.

Condition	n	Results Returned
	n=1 (or not specified)	Returns scalar results: 1. Channel Power is a floating point number representing the total channel power in the specified integration bandwidth. 2. PSD (Power Spectral Density) is the power in the specified unit bandwidth. The unit bandwidth is selected by the PSD Unit parameter in either dBm/Hz or dBm/MHz.
	2	Returns floating point numbers that are the captured trace data of the power (in dBm/resolution BW) of the signal. The frequency span of the captured trace data is specified by the Span key.
Mode = MSR	3	Returns [Carriers] comma-separated scalar results, in the following order. 1. Total Power of Carrier 1 (dBm) 2. Total Power of Carrier 2 (dBm) ... [Carriers]. Total Power of Carrier [Carriers] (dBm) If the result is not available, NaN (9.91E+37) is returned. Number of returned values might be changed in future releases.
Mode = MSR	4	Returns comma-separated scalar results, in the following order. 1. Total Power of LTE FDD carriers (dBm) 2. Total Power of W-CDMA carriers (dBm) 3. Total Power of GSM/EDGE carriers (dBm) 4. Total Power of cdma2000 carriers (dBm) 5. Total Power of 1xEV-DO carriers (dBm) ... The number of results is incremented by one when a new format is supported. If the result is not available, NaN (9.91E+37) is returned. Number of returned values will be changed in future releases if the number of supported radio format is increased.

LTE-Advanced FDD/TDD Mode Remote Command Results

The following commands are available only for LTE-Advanced FDD/TDD mode.

Condition	n	Results Returned
	n=1 (or not specified)	Returns scalar results: 1. Channel Power is a floating point number representing the total channel power in the specified integration bandwidth. 2. PSD (Power Spectral Density) is the power in the specified unit bandwidth. The unit bandwidth is selected by the PSD Unit parameter in either dBm/Hz or dBm/MHz.
	2	Returns floating point numbers that are the captured trace data of the power (in dBm/resolution BW) of the signal. The frequency span of the captured trace data is specified by the Span key.
Mode = LTEATDD/ LTEAFDD	3	Returns comma-separated scalar results, in the following order. 1. Total Power of Component Carrier 0 (dBm) 2. Total Power of Component Carrier 1 (dBm) 3. Total Power of Component Carrier 2 (dBm) 4. Total Power of Component Carrier 3 (dBm) 5. Total Power of Component Carrier 4 (dBm) If the result is not available, NaN (9.91E+37) is returned.
Mode = LTEATDD/ LTEAFDD	4	Returns comma-separated scalar results, in the following order. The unit bandwidth is selected by the PSD Unit parameter in either dBm/Hz or dBm/MHz. 1. Total Power Spectral Density of Component Carrier 0 (PSD Unit) 2. Total Power Spectral Density of Component Carrier 1 (PSD Unit) 3. Total Power Spectral Density of Component Carrier 2 (PSD Unit) 4. Total Power Spectral Density of Component Carrier 3 (PSD Unit) 5. Total Power Spectral Density of Component Carrier 4 (PSD Unit) If the result is not available, NaN (9.91E+37) is returned.

Remote Command Results for WLAN Channel Power Measurement

n	Results Returned
n=1 (or not specified)	<p>Returns scalar results:</p> <p>When the radio standard is NOT WLAN 802.11ac 80 + 80 MHz:</p> <ol style="list-style-type: none"> 1. Channel Power is a floating point number representing the total channel power in the specified integration bandwidth. 2. PSD (Power Spectral Density) is the power in the specified unit bandwidth. The unit bandwidth is selected by the PSD Unit parameter in either dBm/Hz or dBm/MHz. <p>When the radio standard is WLAN 802.11ac 80 + 80 MHz:</p> <ol style="list-style-type: none"> 1. Channel Power of the carrier of which the center frequency is indicated by Freq Segment 1 is a floating point number representing the total channel power of the first segment in the specified integration bandwidth. 2. PSD (Power Spectral Density) of the carrier of which the center frequency is indicated by Freq Segment 1 is the power in the specified unit bandwidth of the first segment. The unit bandwidth is selected by the PSD Unit parameter in either dBm/Hz or dBm/MHz. 3. Channel Power of the carrier of which the center frequency is indicated by Freq Segment 2 is a floating point number representing the total channel power of the second segment in the specified integration bandwidth. 4. PSD (Power Spectral Density) of the carrier of which the center frequency is indicated by Freq Segment 2 is the power in the specified unit bandwidth of the second segment. The unit bandwidth is selected by the PSD Unit parameter in either dBm/Hz or dBm/MHz.
2	Returns floating point numbers that are the captured trace data of the power (in dBm/resolution BW) of the signal. The frequency span of the captured trace data is specified by the Span key.
Key Path	Meas
Mode	SA, WCDMA, C2K, WIMAX OFDMA, 1xEVDO, DVB-T/H, DTMB (CTTB), ISDB-T, CMMB, LTE, LTE-TDD, Digital Cable TV, WLAN, MSR, LTEAFDD, LTEATDD
Initial S/W Revision	Prior to A.02.00
Modified at S/W Revision	A.03.00

AMPTD Y Scale

Accesses a menu of functions that enable you to set the vertical scale parameters. The parameter values are measurement independent, except all Attenuation values and the Internal Preamp selection, which are the same across all measurements.

Key Path	Front-panel key
Initial S/W Revision	Prior to A.02.00

Ref Value

Sets the value for the absolute power reference. However, since the Auto Scaling is defaulted to On, this value is automatically determined by the measurement result. When you set a value manually, Auto Scaling automatically changes to Off.

Key Path	AMPTD Y Scale
Mode	SA, WCDMA, C2K, WIMAX OFDMA, 1xEVDO, DVB-T/H, DTMB (CTTB), ISDB-T, CMMB, LTE, LTETDD, Digital Cable TV, WLAN, MSR, LTEAFDD, LTEATDD
Remote Command	:DISPlay:CHPower:VIEW[1]:WINDow[1]:TRACe:Y[:SCALe]:RLEVel <real> :DISPlay:CHPower:VIEW[1]:WINDow[1]:TRACe:Y[:SCALe]:RLEVel?
Example	DISP:CHP:VIEW:WIND:TRAC:Y:RLEV 10 dBm DISP:CHP:VIEW:WIND:TRAC:Y:RLEV?
Notes	You must be in the Spectrum Analysis mode, W-CDMA mode, cdma2000 mode, DVB-T/H mode, DTMB (CTTB) mode, ISDB-T mode, CMMB mode, Digital Cable TV mode, LTD mode, LTE TDD mode, WLAN mode, 1xEVDO mode, MSR, LTE-Advanced FDD/TDD mode or WIMAX OFDMA mode to use this command. Use :INSTrument:SElect to set the mode.
Couplings	When the Auto Scaling is On, this value is automatically determined by the measurement result. When you set a value manually, Auto Scaling automatically changes to Off.
Preset	10.00 dBm
State Saved	Saved in instrument state.
Min	-250.00 dBm
Max	250.00 dBm
Initial S/W Revision	Prior to A.02.00
Modified at S/W Revision	A.02.00, A.03.00

Attenuation

This menu controls the attenuator functions and interactions between the attenuation system components.

There are two attenuator configurations in the X-Series. One is a dual attenuator configuration consisting of a mechanical attenuator and an optional electronic attenuator. The other configuration uses a single

attenuator with combined mechanical and electronic sections that controls all the attenuation functions. Different models in the X-Series come with different configurations.

See ["Dual Attenuator Configurations:" on page 485](#)

See ["Single Attenuator Configuration:" on page 486](#)

Most Attenuation settings are the same for all measurements – they do not change as you change measurements. Settings like these are called “Meas Global” and are unaffected by Meas Preset.

Key Path	AMPTD Y Scale
Scope	Meas Global
Dependencies	In measurements that support the I/Q inputs, this key is unavailable when I/Q is the selected input, and is replaced by the Range key in that case.
Readback Line	Contains a summary in [] brackets of the current total attenuation. See the descriptions of the , " (Mech) Atten " on page 2736, and " Enable Elec Atten " on page 2737 keys for more detail on the contributors to the total attenuation. Note that when "Pre-Adjust for Min Clip" is on, this value can change at the start of every measurement.
Initial S/W Revision	Prior to A.02.00
Modified at S/W Revision	A.03.00

Dual Attenuator Configurations:

Configuration 1: Mechanical attenuator + optional electronic attenuator

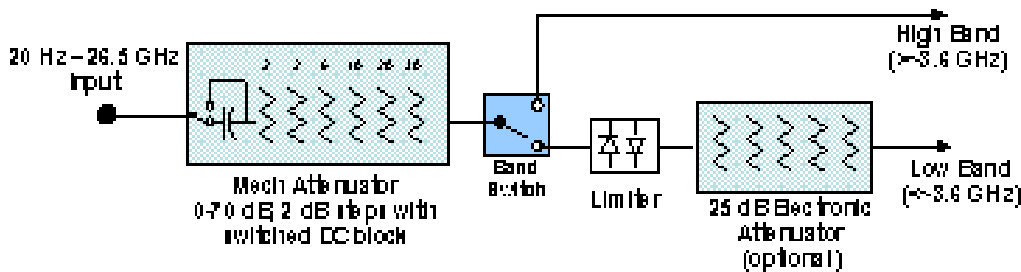

Configuration 2: Mechanical attenuator, no optional electronic attenuator

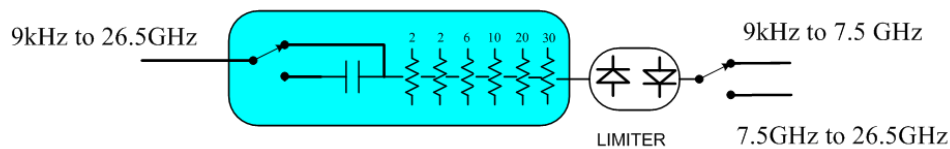

(note that Configuration 2 is not strictly speaking a dual-section attenuator, since there is no electronic section available. However, it behaves exactly like Configuration 1 without the Electronic Attenuator option EA3, therefore for the sake of this document it is grouped into the “Dual Attenuator” configuration)

Single Attenuator Configuration:

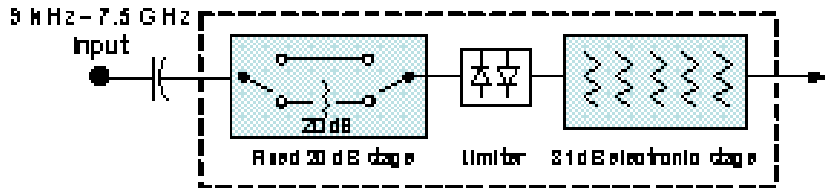

You can tell which attenuator configuration you have by pressing the Attenuation key, which (in most Modes) opens the Attenuation menu. If the first key in the Attenuation menu says Mech Atten you have the dual attenuator configuration. If the first key says Atten you have the single attenuator configuration.

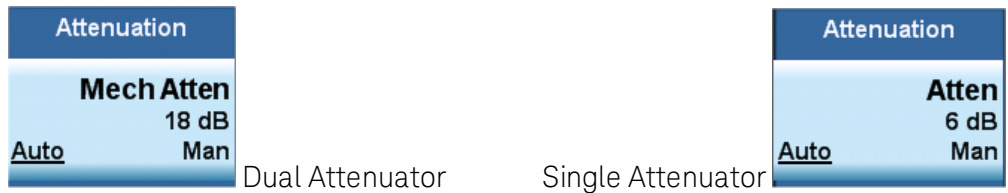

In the single attenuator configuration, you control the attenuation with a single control, as the fixed stage has only two states. In the dual attenuator configuration, both stages have significant range so you are given separate control of the mechanical and electronic attenuator stages.

When you have the dual attenuator configuration, you may still have only a single attenuator, because unless option EA3 (the Electronic Attenuator option) is available, and you purchase it, you will have only the mechanical attenuator.

(Mech) Atten

This key is labeled Mech Atten in dual attenuator models and Atten in single attenuator models. In the dual attenuator configuration, this key only affects the mechanical attenuator.

This key lets you modify the attenuation applied to the RF input signal path. This value is normally auto coupled to the Ref Level, the Internal Preamp Gain, any External Gain that is entered, and the Max Mixer Level, as described in the table below.

See ["Attenuator Configurations and Auto/Man" on page 488](#)

Key Path	AMPTD Y Scale, Attenuation
Remote Command	<pre>[:SENSE] : POWer [:RF] : ATTenuation <rel_ampl> [:SENSE] : POWer [:RF] : ATTenuation? [:SENSE] : POWer [:RF] : ATTenuation : AUTO OFF ON 0 1 [:SENSE] : POWer [:RF] : ATTenuation : AUTO?</pre>
Example	<p>POW:ATT 20</p> <p>Dual attenuator configuration: sets the mechanical attenuator to 20 dB</p> <p>Single attenuator mode: sets the main attenuation to 20 dB (see below for definition of “main” attenuation).</p> <p>If the attenuator was in Auto, it sets it to Manual.</p>
Dependencies	Some measurements do not support the Auto setting of (Mech) Atten. In these measurements, the

Auto/Man selection is not available, and the Auto/Man line on the key disappears.

In dual attenuator configurations, when the electronic attenuator is enabled, the mechanical attenuator has no auto setting and the Auto/Man line on the key disappears. The state of Auto/Man is remembered and restored when the electronic attenuator is once again disabled. This is described in more detail in the "[Enable Elec Atten](#)" on page 2737 key description.

See "[Attenuator Configurations and Auto/Man](#)" on page 488 for more information on the Auto/Man functionality of Attenuation.

Couplings

When (Mech) Atten is in Auto, it uses the following algorithm to determine a value:
 If the USB Preamp is connected to USB, use 0 dB.
 Otherwise, $Atten = ReferenceLevel + PreAmpGain + ExternalGain - RefLevelOffset - MaxMixerLevel + IF\ Gain$.
 Limit this value to be between 6 dB and the Max value. No value below 6 dB can ever be chosen by Auto.
 The resulting value is rounded up to the largest value possible given the attenuation step setting. That is, 50.01 dB would change to 60 dB (for a 10 dB attenuation step).
 The "IF Gain" term in the equation above is either 0 dB or +10 dB, depending on the settings of FFT IF Gain, Swept IF Gain, max Ref Level and the Auto/Man setting of Mech Atten.
 In External Mixing and BBIQ, where the Attenuator is not in the signal path, the Attenuator setting changes as described above when (Mech) Atten is in Auto, but no changes are made to the actual attenuator hardware setting until the input is changed back to the RF Input.

Preset The preset for Mech Attenuation is "Auto."
 The Auto value of attenuation is:
 CXA, EXA, MXA and PXA: 10 dB

State Saved Saved in instrument state

Min 0 dB
 The attenuation set by this key cannot be decreased below 6 dB with the knob or step keys. To get to a value below 6 dB it has to be directly entered from the keypad or via SCPI. This protects from adjusting the attenuation to a dangerously small value which can put the instrument at risk of damage to input circuitry. However, if the current mechanical attenuation is below 6 dB it can be increased with the knob and step keys, but not decreased.

Max CXA N9000A-503/507: 50 dB
 CXA N9000A-513/526: 70dB
 EXA: 60 dB
 MXA and PXA: 70 dB
 In the single attenuator configuration, the total of ATT and EATT cannot exceed 50 dB, so if the EATT is set to 24 dB first, the main attenuation cannot be greater than 26 dB and will be reduced accordingly; if the main attenuator is set to 40 dB first, EATT cannot be greater than 10 dB.

Initial S/W Revision Prior to A.02.00

Modified at S/W Revision A.03.00

Attenuator Configurations and Auto/Man

As described in the Attenuation key description, there are two distinct attenuator configurations available in the X-Series, the single attenuator and dual attenuator configurations. In dual attenuator configurations, we have the mechanical attenuation and the electronic attenuation, and the current total attenuation is the sum of the electronic + mechanical attenuation. In single attenuator configurations, we refer to the attenuation set using the (Mech) Atten key (or POW:ATT SCPI) as the “main” attenuation; and the attenuation that is set by the SCPI command POW:EATT as the “soft” attenuation (the POW:EATT command is honored even in the single attenuator configuration, for compatibility purposes). Then the current total attenuation is the sum of the main + soft attenuation. See the Elec Atten key description for more on “soft” attenuation.

In the dual attenuator configuration, when the electronic attenuator is enabled, there is no Auto/Man functionality for the mechanical attenuator, and the third line of the key label (the Auto/Man line) disappears:



Enable Elec Atten

Enables the Electronic Attenuator.

The electronic attenuator offers finer steps than the mechanical attenuator, has no acoustical noise, is faster, and is less subject to wear. These advantages primarily aid in remote operation and are negligible for front panel use. See ["Using the Electronic Attenuator: Pros and Cons" on page 490](#) for a detailed discussion of the pros and cons of using the electronic attenuator.

For the single attenuator configuration, for SCPI backwards compatibility, the “soft” attenuation feature replaces the dual attenuator configuration’s electronic attenuator. All the same couplings and limitations apply. See ["Attenuator Configurations and Auto/Man" on page 2737](#)

See ["More Information" on page 489](#)

Key Path	AMPTD Y Scale, Attenuation
Remote Command	[:SENSe] : POWer [:RF] : EATTenuation : STATE OFF ON 0 1 [:SENSe] : POWer [:RF] : EATTenuation : STATE ?
Example	POW:EATT:STAT ON
Dependencies	This key only appears in Dual Attenuator models with an Electronic Attenuator installed. It does not appear in models with the Single Attenuator configuration, as in the single attenuator configuration there is no “electronic attenuator” there is only a single integrated attenuator (which has both a mechanical and electronic stage). However, in the single attenuator configuration, EATT SCPI commands are accepted for compatibility with other X-series instruments and set a “soft” attenuation as described in "Attenuator Configurations and Auto/Man" on page 2737 . The electronic attenuator (and the “soft” attenuation function provided in single attenuator configurations) is unavailable above 3.6 GHz. Therefore, if the Stop Frequency of the analyzer is > 3.6 GHz then the Enable Elec Atten key will be OFF and grayed out.

If the Internal Preamp is on, meaning it is set to Low Band or Full, the electronic attenuator (and the “soft” attenuation function provided in single attenuator configurations) is unavailable. In this case the Enable Elec Atten key will be OFF and grayed out.

If either of the above is true, if the SCPI command is sent, an error indicating that the electronic attenuator is unavailable will be sent.

If the electronic/soft Attenuator is enabled, then the Stop Freq of the analyzer is limited to 3.6 GHz and the Internal Preamp is unavailable.

The SCPI-only “soft” electronic attenuation for the single-attenuator configuration is not available in all measurements; in particular, it is not available in the Swept SA measurement.

Couplings	Enabling and disabling the Electronic Attenuator affects the setting of the Mechanical Attenuator (in dual attenuator configurations). This is described in more detail below this table.
Preset	OFF for Swept SA measurement; ON for all other measurements that support the electronic attenuator
State Saved	Saved in instrument state
Initial S/W Revision	Prior to A.02.00
Modified at S/W Revision	A.03.00

More Information

Mechanical Attenuator Transition Rules

When the Electronic Attenuator is enabled, the Mechanical Attenuator transitions to a state that has no Auto function. Below are the rules for transitioning the Mechanical Attenuator. NOTE that the information below ONLY applies to the dual attenuator configurations, and ONLY when the Electronic Attenuator is installed:

When the Electronic Attenuation is enabled from a disabled state:

- The Mechanical Attenuator is initialized to 10 dB (this is its optimal performance setting). You can then set it as desired with SCPI, numeric keypad, step keys, or knob, and it behaves as it normally would in manual mode
- The Auto/Man state of (Mech) Atten is saved
- The Auto/Man line on the (Mech) Atten key disappears and the auto rules are disabled
- The Electronic Attenuator is set to 10 dB less than the previous value of the Mechanical Attenuator, within the limitation that it must stay within the range of 0 to 24 dB of attenuation.

Examples in the dual attenuator configuration:

- Mech Atten at 20 dB. Elec Atten enabled, Mech Atten set to 10 dB, and Elec Atten set to 10 dB. New total attenuation equals the value before Elec Atten enabled.
- Mech Atten at 0 dB. Elec Atten enabled, Mech Atten set to 10 dB, and Elec Atten set to 0 dB. New total attenuation does not equal the value before Elec Atten enabled.
- Mech Atten at 40 dB. Elec Atten enabled, Mech Atten set to 10 dB, and Elec Atten set to 24 dB. New total attenuation does not equal the value before Elec Atten enabled.

When the Electronic Attenuation is disabled from an enabled state:

- The Elec Atten key is grayed out
- The Auto/Man state of (Mech) Atten is restored
- If now in Auto, (Mech) Atten recouples
- If now in Man, (Mech) Atten is set to the value of total attenuation that existed before the Elec Atten was disabled. The resulting value is rounded up to the smallest value possible given the (Mech) Atten Step setting - (That is, 57 dB changes to 58 dB when (Mech) Atten Step is 2 dB.)

Using the Electronic Attenuator: Pros and Cons

The electronic attenuator offers finer steps than the mechanical attenuator, has no acoustical noise, is faster, and is less subject to wear.

The “finer steps” advantage of the electronic attenuator is beneficial in optimizing the alignment of the analyzer dynamic range to the signal power in the front panel as well as remote use. Thus, you can achieve improved relative signal measurement accuracy. Compared to a mechanical attenuator with 2 dB steps, the 1 dB resolution of the electronic attenuator only gives better resolution when the odd-decibel steps are used. Those odd-decibel steps are less accurately calibrated than the even-decibel steps, so one tradeoff for this superior relative accuracy is reduced absolute amplitude accuracy.

Another disadvantage of the electronic attenuator is that the spectrum analyzer loses its “Auto” setting, making operation less convenient.

Also, the relationship between the dynamic range specifications (TOI, SHI, compression and noise) and instrument performance are less well-known with the electrical attenuator. With the mechanical attenuator, TOI, SHI and compression threshold levels increase dB-for-dB with increasing attenuation, and the noise floor does as well. With the electronic attenuator, there is an excess attenuation of about 1 to 3 dB between 0 and 3.6 GHz, making the effective TOI, SHI, and so forth, less well known. Excess attenuation is the actual attenuation relative to stated attenuation. Excess attenuation is accounted for in the analyzer calibration

Elec Atten

Controls the Electronic Attenuator in dual attenuator configurations. This key does not appear in single attenuator configurations, as the control of both the mechanical and electronic stages of the single attenuator is integrated into the single Atten key.

Key Path	AMPTD Y Scale, Attenuation
Remote Command	<code>[:SENSe] :POWer [:RF] :EATTenuation <rel_amp1></code> <code>[:SENSe] :POWer [:RF] :EATTenuation?</code>
Notes	Electronic Attenuation’s specification is defined only when Mechanical Attenuation is 6 dB.
Dependencies	This key only appears in Dual Attenuator models with an Electronic Attenuator installed. It does not appear in models with the Single Attenuator configuration, as in the single attenuator configuration there is no “electronic attenuator” there is only a single integrated attenuator (which has both a mechanical and electronic stage). However, in the single attenuator configuration, EATT SCPI commands are accepted for compatibility with other X-series instruments and set a “soft” attenuation as described in "Attenuator Configurations and Auto/Man" on page 2737 . The “soft” attenuation is treated as an addition to the “main” attenuation value set by the Atten softkey or the

	POW:ATT SCPI command and affects the total attenuation displayed on the Attenuation key and the Meas Bar. When Enable Elec Atten is off or grayed out, the Elec Atten key is grayed out.
Preset	0 dB
State Saved	Saved in instrument state
Min	0 dB
Max	Dual attenuator configuration: 24 dB Single attenuator configuration: the total of ATT and EATT cannot exceed 50 dB, so if the EATT is set to 24 dB first, the main attenuation cannot be greater than 26 dB and will be reduced accordingly; if the main attenuator is set to 40 dB first, EATT cannot be greater than 10 dB
Initial S/W Revision	Prior to A.02.00
Modified at S/W Revision	A.03.00

Adjust Atten for Min Clip

Sets the combination of mechanical and electronic attenuation and gain based on the current measured signal level so that clipping will be at a minimum.

This is an "immediate action" function, that is, it executes once, when the key is pressed.

This key is grayed out in measurements that do not support this functionality. The spectrum analyzer measurement, Swept SA, does not support this functionality.

Key Path	AMPTD Y Scale, Attenuation
Remote Command	<code>[:SENSe] :POWer [:RF] :RANGe:OPTimize IMMEDIATE</code>
Initial S/W Revision	Prior to A.02.00
Modified at S/W Revision	A.03.00

Pre-Adjust for Min Clip

If this function is on, it does the adjustment described under "[Adjust Atten for Min Clip](#)" on page 2740 each time a measurement restarts. Therefore, in Continuous measurement mode, it only executes before the first measurement.

In dual attenuator models, you can set Elec+Mech Atten, in which case both attenuators participate in the autoranging, or Elec Atten Only, in which case the mechanical attenuator does not participate in the autoranging. This latter case results in less wear on the mechanical attenuator and is usually faster.

This key is grayed out in measurements that do not support this functionality. The spectrum analyzer measurement, Swept SA, does not support this functionality.

Key Path	AMPTD Y Scale, Attenuation
Remote Command	<code>[:SENSe] :POWer [:RF] :RANGe:OPTimize:ATTenuation OFF ELECTRical COMBined</code>

	<code>[:SENSe] :POWer [:RF] :RANGe:OPTimize:ATTenuation?</code>
Notes	The SCPI parameter ELECtrical sets this function to On in single attenuator models. The SCPI parameter COMBined is mapped to ELECtrical in single attenuator models; if you send COMBined, it sets the function to On and returns ELEC to a query.
Dependencies	This key only appears in Dual Attenuator models with an Electronic Attenuator installed. In instruments with Dual Attenuator model, when Enable Elec Atten is off or grayed out, the Pre-Adjust for Min Clip key is grayed out.
Preset	OFF for Swept SA measurement; ON for all other measurements that support Pre-Adjust for Min Clip
State Saved	Saved in instrument state
Range	Dual attenuator models: Off Elec Atten Only Mech + Elec Atten Single attenuator models: Off On
Initial S/W Revision	Prior to A.02.00
Modified at S/W Revision	A.03.00

Remote Command	<code>[:SENSe] :POWer [:RF] :RANGe:AUTO ON OFF 1 0</code> <code>[:SENSe] :POWer [:RF] :RANGe:AUTO?</code>
Notes	ON aliases to "Elec Atten Only" (:POW:RANG:OPT:ATT ELEC) OFF aliases to "Off" (:POW:RANG:OPT:ATT OFF) The query :POW:RANG:AUTO? returns true if :POW:RANG:OPT:ATT is not "Off"
Initial S/W Revision	Prior to A.02.00

Off

Turns Pre-Adjust for Min Clip off. This is the default setting.

This key is grayed out in measurements that do not support this functionality. The spectrum analyzer measurement, Swept SA, does not support this functionality.

Key Path	AMPTD Y Scale, Attenuation, Pre-Adjust for Min Clip
Example	:POW:RANGe:OPT:ATT OFF
Initial S/W Revision	Prior to A.02.00

Elec Atten Only

Selects only the electric attenuator to participate in auto ranging. This offers less wear on the mechanical attenuator and is usually faster.

This key is grayed out in measurements that do not support this functionality. The spectrum analyzer measurement, Swept SA, does not support this functionality.

Key Path	AMPTD Y Scale, Attenuation, Pre-Adjust for Min Clip
Example	:POW:RANGe:OPT:ATT ELEC
Initial S/W Revision	Prior to A.02.00

Mech + Elec Atten

In dual attenuator models, this selects both attenuators participate in the autoranging.

This key is grayed out in measurements that do not support this functionality. The spectrum analyzer measurement, Swept SA, does not support this functionality.

Key Path	AMPTD Y Scale, Attenuation, Pre-Adjust for Min Clip
Example	:POW:RANGe:OPT:ATT COMB
Initial S/W Revision	Prior to A.02.00

(Mech) Atten Step

This controls the step size used when making adjustments to the input attenuation.

This key is labeled Mech Atten Step in dual attenuator models and Atten Step in single attenuator models. In the dual attenuator configuration, this key only affects the step size of the mechanical attenuator.

Key Path	AMPTD Y Scale, Attenuation
Remote Command	[[:SENSe]:POWer[:RF]:ATTenuation:STEP[:INCRement] 10 dB 2 dB [:SENSe]:POWer[:RF]:ATTenuation:STEP[:INCRement]?
Example	POW:ATT:STEP 2
Notes	Note this feature works like a 1-N choice from the front panel, but it takes a specific value (in dB) when used remotely. The only valid values are 2 and 10.
Dependencies	Blanked in CXA and EXA if option FSA (2 dB steps) is not present. If blanked, attempts to set it via SCPI will yield an error.
Couplings	When the attenuation step size changes, the current mechanical attenuation value is adjusted (if necessary) to be quantized to the new step size. That is, if step is set to 10 dB, mech atten is increased if necessary so it is a multiple of 10 dB
Preset	PXA and MXA: 2 dB EXA and CXA: 10 dB (2 dB with option FSA)
State Saved	Saved in instrument state
Initial S/W Revision	Prior to A.02.00
Modified at S/W Revision	A.03.00

Scale/Div

Sets the units per division of the vertical scale in the logarithmic display. However, since the Auto Scaling is defaulted to On, this value is automatically determined by the measurement result. When you set a value manually, Auto Scaling automatically changes to Off.

Key Path	AMPTD Y Scale
Mode	SA, WCDMA, C2K, WIMAX OFDMA, 1xEVDO, DVB-T/H, DTMB (CTTB), ISDB-T, CMMB, LTE, LTETDD, Digital Cable TV, WLAN, MSR, LTEAFDD, LTEATDD
Remote Command	:DISPlay:CHPower:VIEW[1]:WINDow[1]:TRACe:Y[:SCALe]:PDIVision <rel_amp1> :DISPlay:CHPower:VIEW[1]:WINDow[1]:TRACe:Y[:SCALe]:PDIVision?
Example	DISP:CHP:VIEW:WIND:TRAC:Y:PDIV 2 DISP:CHP:VIEW:WIND:TRAC:Y:PDIV?
Notes	You must be in the Spectrum Analysis mode, W-CDMA mode, cdma2000 mode, DVB-T/H mode, DTMB (CTTB) mode, ISDB-T mode, CMMB mode, Digital Cable TV mode, LTE mode, LTE TDD mode, WLAN mode, 1xEVDO mode, MSR, LTE-Advanced FDD/TDD mode or WIMAX OFDMA mode to use this command. Use :INSTrument:SElect to set the mode.
Couplings	When the Auto Scaling is On, this value is automatically determined by the measurement result. When you set a value manually, Auto Scaling automatically changes to Off.
Preset	10.00 dB
State Saved	Saved in instrument state.
Min	0.10 dB
Max	20.00 dB
Initial S/W Revision	Prior to A.02.00
Modified at S/W Revision	A.02.00, A.03.00

Presel Center

When this key is pressed, the centering of the preselector filter is adjusted to optimize the amplitude accuracy at the frequency of the selected marker. If the selected marker is not on when Presel Center is pressed, the analyzer will turn on the selected marker, perform a peak search, and then perform centering on the marker's center frequency. If the selected marker is already on and between the start and stop frequencies of the analyzer, the analyzer performs the preselector calibration on that marker's frequency. If the selected marker is already on, but outside the frequency range between Start Freq and Stop Freq, the analyzer will first perform a peak search, and then perform centering on the marker's center frequency.

The value displayed on the Presel Adjust key will change to reflect the new preselector tuning (see Presel Adjust).

A number of considerations should be observed to ensure proper operation. See ["Proper Preselector Operation" on page 495](#).

Key Path	AMPTD Y Scale
Remote Command	[:SENSE]:POWer[:RF]:PCENTER

Example	POW:PCEN
Notes	Note that the rules outlined above under the key description apply for the remote command as well as the key. The result of the command is dependent on marker position, and so forth. Any message shown by the key press is also shown in response to the remote command.
Dependencies	<ul style="list-style-type: none"> • Grayed out if the microwave preselector is off.) • If the selected marker's frequency is below Band 1, advisory message 0.5001 is generated and no action is taken. • Grayed out if entirely in Band 0. • Blank in models that do not include a preselector, such as option 503. If the SCPI is sent in these instruments, it is accepted without error, and the query always returns 0. • Grayed out in the Spectrogram View.
Couplings	<p>The active marker position determines where the centering will be attempted.</p> <p>If the analyzer is in a measurement such as averaging when centering is initiated, the act of centering the preselector will restart averaging but the first average trace will not be taken until the centering is completed.</p>
Status Bits/OPC dependencies	<p>When centering the preselector, *OPC will not return true until the process is complete and a subsequent measurement has completed, nor will results be returned to a READ or MEASURE command.</p> <p>The Measuring bit should remain set while this command is operating and should not go false until the subsequent sweep/measurement has completed.</p>
Initial S/W Revision	Prior to A.02.00
Modified at S/W Revision	A.03.00

Proper Preselector Operation

A number of considerations should be observed to ensure proper operation:

1. If the selected marker is off, the analyzer will turn on a marker, perform a peak search, and adjust the preselector using the selected marker's frequency. It uses the "highest peak" peak search method unqualified by threshold or excursion, so that there is no chance of a 'no peak found' error. It continues with that peak, even if it is the peak of just noise. Therefore, for this operation to work properly, there should be a signal on screen in a preselected range for the peak search to find.
2. If the selected marker is already on, the analyzer will attempt the centering at that marker's frequency. There is no preselector for signals below about 3.6 GHz, therefore if the marker is on a signal below 3.6 GHz, no centering will be attempted and an advisory message generated
3. In some models, the preselector can be bypassed. If it is bypassed, no centering will be attempted in that range and a message will be generated.

Preselector Adjust

Allows you to manually adjust the preselector filter frequency to optimize its response to the signal of interest. This function is only available when **"Presel Center"** on page 2743 is available.

For general purpose signal analysis, using Presel Center is recommended. Centering the filter minimizes the impact of long-term preselector drift. Presel Adjust can be used instead to manually optimize the preselector. One application of manual optimization would be to peak the preselector response, which both optimizes the signal-to-noise ratio and minimizes amplitude variations due to small (short-term) preselector drifting.

Key Path	AMPTD Y Scale
Scope	Meas Global
Remote Command	<code>[:SENSe] :POWer [:RF] :PADJust <freq></code> <code>[:SENSe] :POWer [:RF] :PADJust?</code>
Example	POW:PADJ 100KHz POW:PADJ?
Notes	The value on the key reads out to 0.1 MHz resolution.
Dependencies	<ul style="list-style-type: none"> • Grayed out if microwave preselector is off.) • Grayed out if entirely in Band 0. • Blank in models that do not include a preselector, such as option 503. If the SCPI is sent in these instruments, it is accepted without error, and the query always returns 0. • Grayed out in the Spectrogram View.
Preset	0 MHz
State Saved	The Presel Adjust value set by Presel Center, or by manually adjusting Presel Adjust, is not saved in instrument state, and does not survive a Preset or power cycle.
Min	-500 MHz
Max	500 MHz
Default Unit	Hz
Backwards Compatibility SCPI	<code>[:SENSe] :POWer [:RF] :MW :PADJust</code> <code>[:SENSe] :POWer [:RF] :MMW :PADJust</code> PSA had multiple preselectors, but the X-Series has only one. These commands simply alias to <code>[:SENSe] :POWer [:RF] :PADJust</code>
Initial S/W Revision	Prior to A.02.00
Modified at S/W Revision	A.03.00

Remote Command	<code>[:SENSe] :POWer [:RF] :PADJust :PRESelector MWAVE MMWave EXTERNAL</code> <code>[:SENSe] :POWer [:RF] :PADJust :PRESelector?</code>
Notes	PSA had multiple preselectors, and you could select which preselector to adjust. Since the X-Series has only one mm/uW preselector, the preselector selection softkey is no longer available. However, to provide backward compatibility, we accept the legacy remote commands. The command form has no effect, the query always returns MWAVE
Initial S/W Revision	Prior to A.02.00

μW Path Control

The μW Path Control functions include the μW Preselector Bypass (Option MPB) and Low Noise Path (Option LNP) controls in the High Band path circuits.

When the μW Preselector is bypassed, the user has better flatness, but will be subject to spurs from out of band interfering signals. When the Low Noise Path is enabled, the analyzer automatically switches around certain circuitry in the high frequency bands which can contribute to noise, when it is appropriate based on other analyzer settings.

For most applications, the preset state is Standard Path, which gives the best remote-control throughput, minimizes acoustic noise from switching and minimizes the risk of wear out in the hardware switches. For applications that utilize the wideband IF paths, the preset state is the μW Preselector Bypass path, if option MPB is present. This is because, when using a wideband IF such as the 140 MHz IF, the μW Preselector's bandwidth can be narrower than the available IF bandwidth, causing degraded amplitude flatness and phase linearity, so it is desirable to bypass the preselector in the default case.

Users may choose Low Noise Path Enable. It gives a lower noise floor, especially in the 21–26.5 GHz region, though without improving many measures of dynamic range, and without giving the best possible noise floor. The preamp, if purchased and used, gives better noise floor than does the Low Noise Path, however its compression threshold and third-order intercept are much poorer than that of the non-preamp Low Noise Path. There are some applications, typically for signals around –30 dBm, for which the third-order dynamic range of the standard path is good enough, but the noise floor is not low enough even with 0 dB input attenuation. When the third-order dynamic range of the preamp path is too little and the noise floor of the standard path is too high, the Low Noise Path can provide the best dynamic range.

Key Path	AMPTD Y Scale
Mode	SA, BASIC, PNOISE, VSA , LTE, LTETDD
Scope	Meas Global
Remote Command	[:SENSe] :POWer [:RF] :MW:PATH STD LNPath MPBypass FULL [:SENSe] :POWer [:RF] :MW:PATH?
Example	:POW:MW:PATH LNP Enables the Low Noise path
Notes	If a Presel Center is performed, the analyzer will momentarily switch to the Standard Path, regardless of the setting of μW Path Control The DC Block will always be switched in when the low noise path is switched in, to protect succeeding circuitry from DC. Note that this does not mean “when the low noise path is enabled” but when, based on the Low Noise Path rules, the path is actually switched in. This can happen when the selection is Low Noise Path Enable . In the case where the DC Block is switched in the analyzer is now AC coupled. However, if the user has selected DC coupling, the UI will still behave as though it were DC coupled, including all annunciation, warnings, status bits, and responses to SCPI queries. This is because, based on other settings, the analyzer could switch out the low noise path at any time and hence go back to being DC coupled. Alignment switching ignores the settings in this menu, and restores them when finished.
Dependencies	Unavailable in BBIQ and External Mixing
Preset	All modes other than IQ Analyzer mode and VXA: STD IQ Analyzer, VXA and WLAN mode:

	MPB option present and licensed: MPB MPB option not present and licensed: STD
State Saved	Save in instrument state
Readback	Value selected in the submenu
Initial S/W Revision	A.04.00
Modified at S/W Revision	A.10.00

Standard Path

This path gives the best remote-control throughput, minimizes acoustic noise from switching and minimizes the risk of wear in the hardware switches, particularly in remote test scenarios where both low band and high band setups will follow in rapid succession.

In this path, the bypass of the low band/high band switch and microwave preamp is never activated, which can cause some noise degradation but preserves the life of the bypass switch.

Key Path	AMPTD Y Scale, μ W Path Control
Example	:POW:MW:PATH STD
Readback Text	Standard Path
Initial S/W Revision	A.04.00

Low Noise Path Enable

You may choose Low Noise Path Enable, which gives a lower noise floor under some circumstances, particularly when operating in the 21–26.5 GHz region. With the Low Noise Path enabled, the low band/high band switch and microwave preamp are bypassed whenever all of the following are true:

- The analyzer is not in the Low Band, meaning:
- the start frequency is above 3.5 GHz and
- the stop frequency is above 3.6 GHz.
- the internal preamp is not installed or (if installed) is set to Off or Low Band

Note that this means that, when any part of a sweep is done in Low Band, the Low Noise Path is not used, whether or not the Low Noise Path Enable is selected in the user interface. Also, if the preamp is turned on, the Low Noise Path is not used, whether or not the Low Noise Path Enable is selected in the user interface. The only time the Low Noise Path is used is when Low Noise Path Enable is selected, the sweep is completely in High Band (> 3.6 GHz) and no preamp is in use.

See "[More Information](#)" on page 499

Key Path	AMPTD Y Scale, μ W Path Control
Measurement	Swept SA

Example	:POW:MW:PATH LNP
Notes	<p>For measurements that use IQ acquisition, the low noise path is used when the Center Frequency is in High Band (> 3.6 GHz) and no preamp is in use.</p> <p>In other words, the rules above are modified to use only the center frequency to qualify which path to switch in.</p> <p>This is not the case for FFT's in the Swept SA measurement; they use the same rules as swept measurements.</p>
Dependencies	<p>Key is blanked if current mode does not support it.</p> <p>Key is grayed out if mode supports it but current measurement does not support it.</p> <p>Unless Option LNP is present and licensed, key is blank and if SCPI command sent, error -241, "Hardware missing; Option not installed" is generated.</p>
Readback Text	Low Noise Path Enable
Initial S/W Revision	A.04.00

More Information

The user should understand that the Low Noise Path, while giving improved DANL, has the disadvantage of decreased TOI performance and decreased gain compression performance relative to the standard path.

The user should also understand that the bypass switch is a mechanical switch and has finite life, so if the Low Noise Path is enabled, it is possible to cause frequent cycling of this switch by frequently changing analyzer settings such that the above conditions hold true only some of the time. A user making tests of this nature should consider opting for the Standard Path, which will never throw the bypass switch, at the expense of some degraded noise performance.

The low noise path is useful for situations where the signal level is so low that the analyzer performance is dominated by noise even with 0 dB attenuation, but still high enough that the preamp option would have excessive third-order intermodulation or compression. The preamp, if purchased and used, gives better noise floor than does the "Low Noise Path." However, its compression threshold and third-order intercept are much poorer than that of the non-preamp path. There are some applications, typically for signals around -30 dBm, for which the third-order dynamic range of the standard path is good enough, but the noise floor is not low enough even with 0 dB input attenuation. When the third-order dynamic range of the preamp path is too little and the noise floor of the standard path is too high, the Low Noise Path can provide the best dynamic range

The graph below illustrates the concept. It shows, in red, the performance of an analyzer at different attenuation settings, both with the preamp on and off, in a measurement that is affected by both analyzer noise and analyzer TOI. The green shows the best available dynamic range, offset by 0.5 dB for clarity. The blue shows how the best available dynamic range improves for moderate signal levels with the low noise path switched in. In this illustration, the preamp improves the noise floor by 15 dB while degrading the third-order intercept by 30 dB, and the low noise path reduces loss by 8 dB. The attenuator step size is 2 dB.

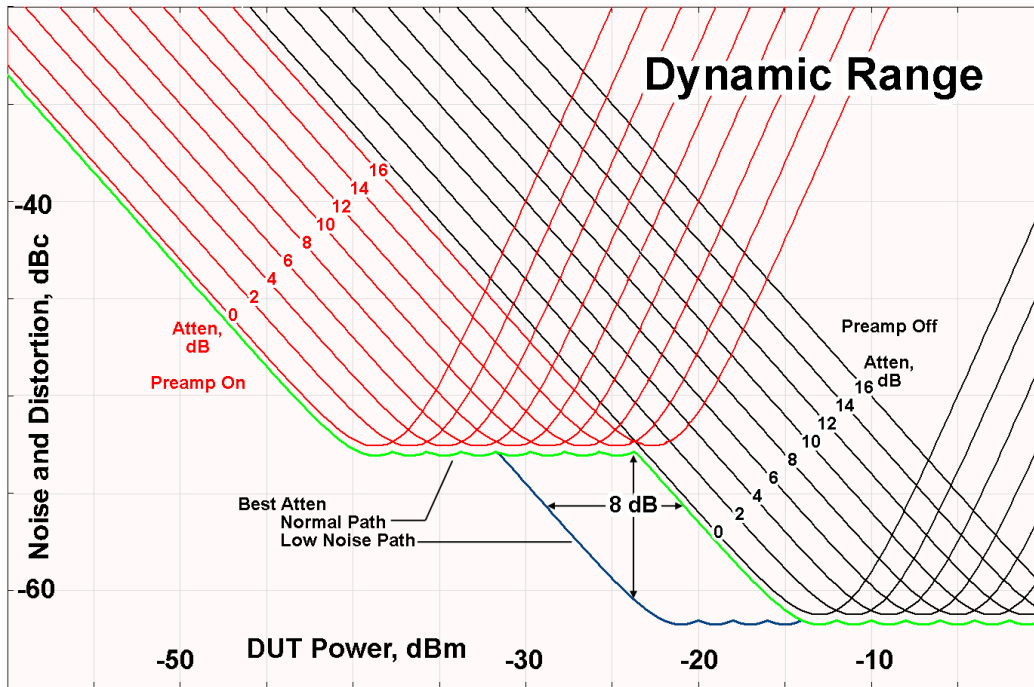

There are other times where selecting the low noise path improves performance, too. Compression-limited measurements such as finding the nulls in a pulsed-RF spectrum can profit from the low noise path in a way similar to the TOI-limited measurement illustrated. Accuracy can be improved when the low noise path allows the optimum attenuation to increase from a small amount like 0, 2 or 4 dB to a larger amount, giving better return loss at the analyzer input. Harmonic measurements, such as second and third harmonic levels, are much improved using the low noise path because of the superiority of that path for harmonic (though not intermodulation) distortion performance.

μW Preselector Bypass

This key toggles the preselector bypass switch for band 1 and higher. When the microwave preselector is on, the signal path is preselected. When the microwave preselector is off, the signal path is not preselected. The preselected path is the normal path for the analyzer.

The preselector is a tunable bandpass filter which prevents signals away from the frequency of interest from combining in the mixer to generate in-band spurious signals (images). The consequences of using a preselector filter are its limited bandwidth, the amplitude and phase ripple in its passband, and any amplitude and phase instability due to center frequency drift.

Option MPB or pre-selector bypass provides an unpreselected input mixer path for certain X-Series signal analyzers with frequency ranges above 3.6 GHz. This signal path allows a wider bandwidth and less amplitude variability, which is an advantage when doing modulation analysis and broadband signal analysis. The disadvantage is that, without the preselector, image signals will be displayed. Another disadvantage of bypassing the preselector is increased LO emission levels at the front panel input port.

Image responses are separated from the real signal by twice the 1st IF. For IF Paths of 10 MHz and 25 MHz, the 1st IF is 322.5 MHz, so the image response and the real signal will be separated by 645 MHz. The 1st IF will be different for other IF Path settings. When viewing a real signal and its corresponding image response in internal mixing, the image response will be to the left of the real signal.

Also, the image response and the real signal typically have the same amplitude and exhibit the same shape factor.

However, if Option FS1, Fast Sweep Capability, is enabled, the image response in the Swept SA measurement will appear lower in amplitude and have a much wider shape factor compared to the real signal.

Key Path	AMPTD Y Scale, μ W Path Control
Example	:POW:MW:PATH MPB
Dependencies	Key is blanked if current mode does not support it. Key is grayed out if mode supports it but current measurement does not support it. Key is blank unless Option MPB is present and licensed. If SCPI command sent when MPB not present, error -241, "Hardware missing; Option not installed" is generated.
Readback Text	μ W Preselector Bypass
Initial S/W Revision	A.04.00

Remote Command	[:SENSe] :POWer [:RF] :MW :PRESelector [:STATe] ON OFF 0 1 [:SENSe] :POWer [:RF] :MW :PRESelector [:STATe] ?
Example	:POW:MW:PRES OFF Bypasses the microwave preselector
Notes	The ON parameter sets the STD path (:POW:MW:PATH STD) The OFF parameter sets path MPB (:POW:MW:PATH MPB)
Preset	ON

Internal Preamp

Accesses a menu of keys that control the internal preamps. Turning on the preamp gives a better noise figure, but a poorer TOI to noise floor dynamic range. You can optimize this setting for your particular measurement.

The instrument takes the preamp gain into account as it sweeps. If you sweep outside of the range of the preamp the instrument will also account for that. The displayed result will always reflect the correct gain.

For some measurements, when the preamp is on and any part of the displayed frequency range is below the lowest frequency for which the preamp has specifications, a warning condition message appears in the status line. For example, for a preamp with a 9 kHz lowest specified frequency: "Preamp: Accy unspec'd below 9 kHz".

Key Path	AMPTD Y Scale
Scope	Meas Global
Remote Command	[:SENSe] :POWer [:RF] :GAIN [:STATe] OFF ON 0 1 [:SENSe] :POWer [:RF] :GAIN [:STATe] ?
Dependencies	Preamp is not available on all hardware platforms. If the preamp is not present or is unlicensed, the

	key is not shown. The preamp is not available when the electronic/soft attenuator is enabled.
--	--

Couplings	<p>The act of connecting the U7227A USB Preamplifier to one of the analyzer's USB ports will cause the Internal Preamp to be switched on. When this happens an informational message will be generated: "Internal Preamp turned on for optimal operation with USB Preamp." Note that if the Internal Preamp was already on, there will be no change to the setting, but if it was Off it will be switched On, to Full Range.</p> <p>Note that this same action occurs when the SA mode is selected while the USB Preamp is connected to one of the analyzer's USB ports, if it is the first time that the SA mode has run since powerup, or if the last time the SA mode was running the USB Preamp was NOT connected.</p> <p>Subsequently disconnecting the USB Preamp from USB does not change the Internal Preamp setting nor restore the previous setting.</p>
Preset	OFF
State Saved	Saved in instrument state
Initial S/W Revision	Prior to A.02.00
Modified at S/W Revision	A.14.00

Key Path	AMPTD Y Scale, Internal Preamp
Scope	Meas Global
Remote Command	<pre>[:SENSe] : POWer [:RF] : GAIN : BAND LOW FULL [:SENSe] : POWer [:RF] : GAIN : BAND ?</pre>
Dependencies	<p>Preamp is not available on all hardware platforms. If the preamp is not present or is unlicensed, the key is not shown.</p> <p>If a POW:GAIN:BAND FULL command is sent when a low band preamp is available, the preamp band parameter is to LOW instead of FULL, and an "Option not installed" message is generated.</p>
Preset	LOW
State Saved	Saved in instrument state
Initial S/W Revision	Prior to A.02.00

Off

Turns the internal preamp off

Key Path	AMPTD Y Scale, Internal Preamp
Example	:POW:GAIN OFF
Readback	Off
Initial S/W Revision	Prior to A.02.00

Low Band

Sets the internal preamp to use only the low band.

The frequency range of the installed (optional) low-band preamp is displayed in square brackets on the Low Band key label.

Key Path	AMPTD Y Scale, Internal Preamp
Example	:POW:GAIN ON :POW:GAIN:BAND LOW
Readback	Low Band
Initial S/W Revision	Prior to A.02.00

Full Range

Sets the internal preamp to use its full range. The low band (0–3.6 GHz or 0–3GHz, depending on the model) is supplied by the low band preamp and the frequencies above low band are supplied by the high band preamp.

The frequency range of the installed (optional) preamp is displayed in square brackets on the Full Range key label. If the high band option is not installed the Full Range key does not appear.

Key Path	AMPTD Y Scale, Internal Preamp
Example	:POW:GAIN ON :POW:GAIN:BAND FULL
Readback	Full Range
Initial S/W Revision	Prior to A.02.00

Ref Position

Positions the reference level at the top, center, or bottom of the Y Scale display. Changing the reference position does not change the reference level value.

Key Path	AMPTD Y Scale
Mode	SA, WCDMA, C2K, WIMAX OFDMA, 1xEVDO, DVB-T/H, DTMB (CTTB), ISDB-T, CMMB, LTE, LTE-TDD, Digital Cable TV, WLAN, MSR, LTEAFDD, LTEATDD
Remote Command	:DISPlay:CHPower:VIEW[1]:WINDow[1]:TRACe:Y[:SCALE]:RPOSition TOP CENTER BOTTom :DISPlay:CHPower:VIEW[1]:WINDow[1]:TRACe:Y[:SCALE]:RPOSition?
Example	DISP:CHP:VIEW:WIND:TRAC:Y:RPOS CENT DISP:CHP:VIEW:WIND:TRAC:Y:RPOS?
Notes	You must be in the Spectrum Analysis mode, W-CDMA mode, cdma2000 mode, DVB-T/H mode, DTMB (CTTB) mode, ISDB-T mode, CMMB mode, Digital Cable TV mode, LTE mode, LTE TDD mode, WLAN mode, 1xEVDO mode, MSR, LTE-Advanced FDD/TDD mode or WIMAX OFDMA mode to use

	this command. Use :INSTrument:SElect to set the mode.
Preset	TOP
State Saved	Saved in instrument state.
Range	Top Ctr Bot
Initial S/W Revision	Prior to A.02.00
Modified at S/W Revision	A.02.00, A.03.00

Auto Scaling

Toggles the Auto Scaling function between On and Off.

Key Path	AMPTD Y Scale
Mode	SA, WCDMA, C2K, WIMAX OFDMA, 1xEVDO, DVB-T/H, DTMB (CTTB), ISDB-T, CMMB, LTE, LTETDD, Digital Cable TV, WLAN, MSR, LTEAFDD, LTEATDD
Remote Command	:DISPlay:CHPower:VIEW[1]:WINDow[1]:TRACe:Y[:SCALE]:COUPle 0 1 OFF ON :DISPlay:CHPower:VIEW[1]:WINDow[1]:TRACe:Y[:SCALE]:COUPle?
Example	DISP:CHP:VIEW:WIND:TRAC:Y:COUP OFF DISP:CHP:VIEW:WIND:TRAC:Y:COUP?
Couplings	When Auto Scaling is On, and the Restart front-panel key is pressed, this function automatically sets the scale per division to 10 dB and determines the reference values based on the measurement results. When you set a value to either Scale/Div or Ref Value manually, Auto Scaling automatically changes to Off.
Preset	1
State Saved	Saved in instrument state.
Range	On Off
Initial S/W Revision	Prior to A.02.00
Modified at S/W Revision	A.02.00, A.03.00

Auto Couple

The Auto Couple feature provides a quick and convenient way to automatically couple multiple instrument settings. This helps ensure accurate measurements and optimum dynamic range. When the Auto Couple feature is activated, either from the front panel or remotely, all parameters of the current measurement that have an Auto/Manual mode are set to Auto mode and all measurement settings dependent on (or coupled to) the Auto/Man parameters are automatically adjusted for optimal performance.

However, the Auto Couple key actions are confined to the current measurement only. It does not affect other measurements in the mode, and it does not affect markers, marker functions, or trace or display attributes.

See "[More Information](#)" on page 505

Key Path	Front-panel key
Remote Command	:COUPle ALL NONE
Example	:COUP ALL
Notes	:COUPle ALL puts all Auto/Man parameters in Auto mode (equivalent to pressing the Auto Couple key). :COUPLE NONE puts all Auto/Man parameters in manual mode. It decouples all the coupled instrument parameters and is not recommended for making measurements.
Initial S/W Revision	Prior to A.02.00

More Information

There are two types of functions that have Auto/Manual modes.

Auto/Man Active Function keys

An Auto/Man toggle key controls the binary state associated with an instrument parameter by toggling between Auto (where the parameter is automatically coupled to the other parameters it is dependent upon) and Man (where the parameter is controlled independent of the other parameters), as well as making the parameter the active function. The current mode is indicated on the softkey with either Auto or Man underlined as illustrated below.



Auto/Man 1-of-N keys

An Auto/Man 1-of-N key allows you to manually pick from a list of parameter values, or place the function in Auto, in which case the value is automatically selected (and indicated) as shown below. If in Auto, Auto is underlined on the calling key. If in manual operation, manual is indicated on the calling key. But the calling key does not actually toggle the function, it simply opens the menu.

8 Channel Power Measurement
Auto Couple

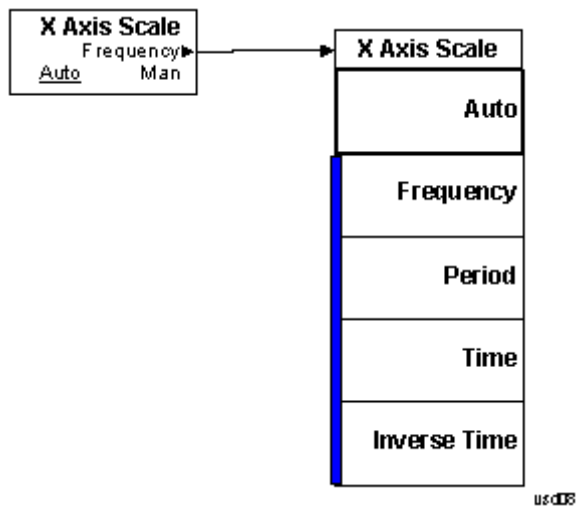

BW

Accesses a menu of functions that enable you to specify and control the video and resolution bandwidths. You can also select the type of filter for the measurement and set the filter bandwidth.

Key Path	Front-panel key
Initial S/W Revision	Prior to A.02.00

Res BW

Sets the value of the resolution bandwidth (RBW). If an unavailable bandwidth is entered with the numeric keypad, the closest available bandwidth is selected.

LTE-Advanced FDD/TDD Auto RBW:

Bandwidth	RBW (KHz)
1.4MHz	20
3MHz	43
5MHz	68
10MHz	150
15MHz	220
20MHz	270

the resolution bandwidth is predefined based on the corresponding bandwidth of the single LTE carrier, which is listed above. When ResBW mode is Auto, the narrowest RBW over the active carriers is selected for Multi-carriers.

Key Path	BW
Mode	SA, WCDMA, C2K, WIMAX OFDMA, 1xEVDO, DVB-T/H, DTMB (CTTB), ISDB-T, CMMB, LTE, LTE-TDD, Digital Cable TV, WLAN, MSR, LTEAFDD, LTEATDD
Remote Command	<pre>[:SENSe]:CHPower:BANDwidth[:RESolution] <bandwidth> [:SENSe]:CHPower:BANDwidth[:RESolution]? [:SENSe]:CHPower:BANDwidth[:RESolution]:AUTO ON OFF 1 0 [:SENSe]:CHPower:BANDwidth[:RESolution]:AUTO?</pre>
Example	<pre>CHP:BAND 5 MHz CHP:BAND? CHP:BAND:AUTO ON CHP:BAND:AUTO?</pre>
Notes	You must be in the Spectrum Analysis mode, W-CDMA mode, cdma2000 mode, DVB-T/H mode, DTMB (CTTB) mode, ISDB-T mode, CMMB mode, Digital Cable TV mode, LTE mode, LTE TDD mode, WLAN mode, 1xEVDO mode, MSR, LTE-Advanced FDD/TDD mode or WIMAX OFDMA mode to use this command. Use :INSTRument:SElect to set the mode.

Couplings	<p>Sweep time is coupled to the RBW. As the RBW changes, the sweep time (if set to Auto) is changed to maintain amplitude calibration.</p> <p>Video bandwidth (VBW) is coupled to the RBW. As the resolution bandwidth changes, the video bandwidth (if set to Auto) changes to maintain the ratio of VBW/RBW (10:1).</p> <p>When the Res BW is set to Auto, the resolution bandwidth is auto-coupled to the span. The ratio of Span/RBW is approximately 106:1 when auto coupled. When Res BW is set to Man, and the bandwidths are entered manually, these bandwidths are used regardless of other analyzer settings.</p>
Preset	<p>SA: Auto</p> <p>WCDMA: 240 kHz</p> <p>C2K: 24 kHz</p> <p>WIMAX OFDMA: 100kHz</p> <p>1xEVDO: 30kHz</p> <p>DVB-T/H: 3.9kHz</p> <p>DTMB (CTTB): 3.9kHz</p> <p>ISDB-T: 30kHz</p> <p>CMMB: 3.9kHz</p> <p>LTE: Auto</p> <p>LTETDD: Auto</p> <p>Digital Cable TV: 3.9kHz</p> <p>WLAN: 100 kHz</p> <p>MSR: 100kHz</p> <p>LTEAFDD/LTEATDD: Auto</p> <p>WCDMA, C2K, 1xEVDO , WIMAX OFDMA, DVB-T/H, DTMB (CTTB), ISDB-T, CMMB, Digital Cable TV, WLAN, MSR, LTEAFDD, LTEATDD: OFF</p> <p>SA, LTE, LTETDD: ON</p>
State Saved	Saved in instrument state.
Min	1 Hz
Max	8 MHz
Backwards Compatibility SCPI	<code>[:SENSe] :CHPower:BWIDth [:RESolution]</code>
Initial S/W Revision	Prior to A.02.00
Modified at S/W Revision	A.02.00, A.03.00

Video BW

Changes the analyzer post-detection filter (VBW).

Key Path	BW
Mode	SA, WCDMA, C2K, WIMAX OFDMA, 1xEVDO, DVB-T/H, DTMB (CTTB), ISDB-T, CMMB, LTE, LTETDD, Digital Cable TV, WLAN, MSR, LTEAFDD, LTEATDD
Remote Command	<code>[:SENSe] :CHPower:BAWdth:VIdEo <bandwidth></code>

	<pre>[:SENSe] :CHPower :BANDwidth :VIDeo?</pre> <pre>[:SENSe] :CHPower :BANDwidth :VIDeo :AUTO ON OFF 1 0</pre> <pre>[:SENSe] :CHPower :BANDwidth :VIDeo :AUTO?</pre>
Example	<pre>CHP:BAND:VID 2.4 MHz</pre> <pre>CHP:BAND:VID?</pre> <pre>CHP:BAND:VID:AUTO OFF</pre> <pre>CHP:BAND:VID:AUTO?</pre>
Notes	You must be in the Spectrum Analysis mode, W-CDMA mode, cdma2000 mode, DVB-T/H mode, DTMB (CTTB) mode, ISDB-T mode, CMMB mode, Digital Cable TV mode, LTE mode, LTE TDD mode, WLAN mode, 1xEVDO mode, MSR,LTE-Advanced FDD/TDD mode or WIMAX OFDMA mode to use this command. Use :INSTrument:SElect to set the mode.
Dependencies	See Couplings
Couplings	<p>Video bandwidth (VBW) is coupled to the RBW. As the resolution bandwidth changes, the video bandwidth (if set to Auto) changes to maintain the ratio set by VBW/RBW.</p> <p>Sweep Time is coupled to the Video Bandwidth (VBW). As the VBW is changed, the sweep time (when set to Auto) is changed to maintain amplitude calibration. This occurs because of common hardware between the two circuits, even though the Video BW filter is not actually “in-circuit” when the detector is set to Average. Because the purpose of the average detector and the VBW filter are the same, either can be used to reduce the variance of the result.</p> <p>Although the VBW filter is not “in-circuit” when using the average detector, the Video BW key can have an effect on (Auto) sweep time, and is not disabled. In this case, reducing the VBW setting increases the sweep time, which increases the averaging time, producing a lower-variance trace.</p> <p>When using the average detector with either Sweep Time set to Man, or in zero span, the VBW setting has no effect and is disabled (grayed out).</p> <p>When the video bandwidth is AUTO coupled, the video bandwidth value is set to: Resolution Bandwidth * Video Bandwidth to Resolution Bandwidth Ratio</p>
Preset	<pre>SA: Auto</pre> <pre>WCDMA: 2.4MHz</pre> <pre>C2K: 240 kHz</pre> <pre>WIMAX OFDMA: Auto</pre> <pre>1xEVDO: 300 kHz</pre> <pre>DVB-T/H: 39kHz</pre> <pre>DTMB (CTTB): 39kHz</pre> <pre>ISDB-T: 300kHz</pre> <pre>CMMB: 39kHz</pre> <pre>LTE, MSR: Auto</pre> <pre>LTETDD: Auto</pre> <pre>LTEAFDD,LTEATDD:Auto</pre> <pre>Digital Cable TV: 39kHz</pre> <pre>WLAN: Auto</pre> <pre>ON</pre>

State Saved	Saved in instrument state.
Min	1 Hz
Max	50 MHz
Initial S/W Revision	Prior to A.02.00
Modified at S/W Revision	A.02.00, A.03.00

Filter Type

Selects the type of bandwidth filter that is used. The choices are Gaussian or Flat top.

Key Path	BW
Mode	SA, WCDMA, C2K, WIMAX OFDMA, 1xEVDO, DVB-T/H, DTMB (CTTB), ISDB-T, CMMB, LTE, LTE-TDD, Digital Cable TV, WLAN, MSR, LTEAFDD, LTEATDD
Remote Command	[:SENSe] :CHPower :BANDwidth :SHAPE GAUSSian FLATtop [:SENSe] :CHPower :BANDwidth :SHAPE?
Example	CHP:BAND:SHAP GAUS CHP:BAND:SHAP?
Preset	GAUSSian
State Saved	Saved in instrument state.
Range	Gaussian Flattop
Backwards Compatibility SCPI	[:SENSe] :CHPower :BWIDth :SHAPE
Initial S/W Revision	Prior to A.02.00
Modified at S/W Revision	A.02.00, A.03.00

Cont (Continuous Measurement/Sweep)

Sets the analyzer for Continuous measurement operation. The single/continuous state is Meas Global so the setting will affect all measurements. If you are Paused, pressing Cont does a Resume.

Key Path	Front-panel key
Remote Command	:INITiate:CONTinuous OFF ON 0 1 :INITiate:CONTinuous?
Example	:INIT:CONT 0 puts analyzer in Single measurement operation. :INIT:CONT 1 puts analyzer in Continuous measurement operation
Preset	ON (Note that SYST:PRESet sets INIT:CONT to ON but *RST sets INIT:CONT to OFF)
State Saved	Saved in instrument state
Backwards Compatibility Notes	For Spectrum Analysis mode in ESA and PSA, there is no Cont hardkey, instead there is a Sweep Single/Cont key. In these analyzers, switching the Sweep Single/Cont key from Single to Cont restarts averages (displayed average count reset to 1), but does not restart Max Hold and Min Hold. The X-Series has Single and Cont keys in place of the SweepSingleCont key. In the X-Series, if in single measurement, the Cont key (and INIT:CONT ON) switches to continuous measurement, but never restarts a measurement and never resets a sweep.
Initial S/W Revision	Prior to A.02.00

In Swept SA Measurement (Spectrum Analysis Mode):

The analyzer takes repetitive sweeps, averages, measurements, etc., when in Continuous mode. When the average count reaches the Average/Hold Number the count stops incrementing, but the analyzer keeps sweeping. See the Trace/Detector section for the averaging formula used both before and after the Average/Hold Number is reached. The trigger condition must be met prior to each sweep. The type of trace processing for multiple sweeps, is set under the Trace/Detector key, with choices of Trace Average, Max Hold, or Min Hold.

In Other Measurements/Modes:

With Avg/Hold Num (in the Meas Setup menu) set to Off or set to On with a value of 1, a sweep is taken after the trigger condition is met; and the analyzer continues to take new sweeps after the current sweep has completed and the trigger condition is again met. However, with Avg/Hold Num set to On with a value >1, multiple sweeps (data acquisitions) are taken for the measurement. The trigger condition must be met prior to each sweep. The sweep is not stopped when the average count k equals the number N set for Avg/Hold Num is reached, but the number k stops incrementing. A measurement average usually applies to all traces, marker results, and numeric results. But sometimes it only applies to the numeric results.

If the analyzer is in Single measurement, pressing the Cont key does not change k and does not cause the sweep to be reset; the only action is to put the analyzer into Continuous measurement operation.

If it is already in continuous sweep:

the INIT:CONT 1 command has no effect

8 Channel Power Measurement Cont (Continuous Measurement/Sweep)

the INIT:CONT 0 command will place the analyzer in Single Sweep but will have no effect on the current sequence until $k = N$, at which point the current sequence will stop and the instrument will go to the idle state.

File

See "File" on page 360

FREQ Channel

Accesses a menu of keys that allow you to control the Frequency and Channel parameters of the instrument.

Some features in the Frequency menu are the same for all measurements – they do not change as you change measurements. Settings like these are called “Meas Global” and are unaffected by Meas Preset. For example, the Center Freq setting is the same for all measurements - it does not change as you change measurements.

Key Path	Front-panel key
Initial S/W Revision	Prior to A.02.00

Center Freq

Sets the frequency that corresponds to the horizontal center of the graticule (when frequency Scale Type is set to linear). While adjusting the Center Frequency the Span is held constant, which means that both Start Frequency and Stop Frequency will change.

Pressing Center Freq also sets the frequency entry mode to Center/Span. In Center/Span mode, the center frequency and span values are displayed below the graticule, and the default active function in the Frequency menu is Center Freq.

The center frequency setting is the same for all measurements within a mode, that is, it is Meas Global. Some modes are also able to share a Mode Global center frequency value. If this is the case, the Mode will have a Global Settings key in its Mode Setup menu.

The Center Freq function sets (and queries) the Center Frequency for the currently selected input. If your analyzer has multiple inputs, and you select another input, the Center Freq changes to the value for that input. SCPI commands are available to directly set the Center Freq for a specific input.

Center Freq is remembered as you go from input to input. Thus you can set a Center Freq of 10 GHz with the RF Input selected, change to BBIQ and set a Center Freq of 20 MHz, then switch to External Mixing and set a Center Freq of 60 GHz, and when you go back to the RF Input the Center Freq will go back to 10 GHz; back to BBIQ and it is 20 MHz; back to External Mixing and it is 60 GHz.

See ["RF Center Freq" on page 517](#)

See [Ext Mix Center Freq](#)

See ["I/Q Center Freq" on page 519](#)

See ["Center Frequency Presets" on page 515](#)

Key Path	FREQ Channel
Scope	Meas Global
Remote Command	<code>[:SENSe] :FREQuency:CENTer <freq></code> <code>[:SENSe] :FREQuency:CENTer?</code>

Example	FREQ:CENT 50 MHz FREQ:CENT UP changes the center frequency to 150 MHz if you use FREQ:CENT:STEP 100 MHz to set the center frequency step size to 100 MHz FREQ:CENT?
Notes	This command sets either the RF or I/Q Center Frequency depending on the selected input. For RF input it is equivalent to FREQ:RF:CENT For I/Q input it is equivalent to FREQ:IQ:CENT Preset and Max values are dependent on Hardware Options (5xx) If no terminator (e.g. MHz) is sent the terminator Hz is used. If a terminator with unit other than Frequency is used, an invalid suffix error message is generated.
Dependencies	The Center Frequency can be limited by Start or Stop Freq limits, if the Span is so large that Start or Stop reach their limit.
Couplings	When operating in “swept span”, any value of the Center Frequency or Span that is within the frequency range of the analyzer is allowed when the value is being set through the front panel numeric key pad or the SCPI command. The other parameter is forced to a different value if needed, to keep the Start and the Stop Frequencies within the analyzer’s frequency range
Preset	Depends on instrument maximum frequency, mode, measurement, and selected input. See "Center Frequency Presets" on page 515 and "RF Center Freq" on page 517 and Ext Mix Center Freq and "I/Q Center Freq" on page 519 .
State Saved	Saved in instrument state
Min	Depends on instrument maximum frequency, mode, measurement, and selected input.. See "Center Frequency Presets" on page 515 and "RF Center Freq" on page 517 and "I/Q Center Freq" on page 519 .
Max	Depends on instrument maximum frequency, mode, measurement, and selected input.. See "Center Frequency Presets" on page 515 and "RF Center Freq" on page 517 and "I/Q Center Freq" on page 519 .
Default Unit	Hz
Status Bits/OPC	Non-overlapped
Dependencies	
Initial S/W Revision	Prior to A.02.00

Center Frequency Presets

The following table provides the Center Frequency Presets for the Spectrum Analyzer mode, and the Max Freq, for the various frequency options:

Freq Option	CF after Mode Preset	Stop Freq after Mode Preset	Max Freq (can't tune)

8 Channel Power Measurement
FREQ Channel

			above)
503 (all but N9000A)	1.805 GHz	3.6 GHz	3.7 GHz
503 (N9000A)	1.505 GHz	3.0 GHz	3.08 GHz
507 (all but N9000A)	3.505 GHz	7.0 GHz	7.1 GHz
507 (N9000A)	3.755 GHz	7.5 GHz	7.58 GHz
508 (all but N9038A)	1.805 GHz	3.6 GHz	8.5 GHz
508 (N9038A)	4.205 GHz	8.4 GHz	8.5 GHz
513	6.805 GHz	13.6 GHz	13.8 GHz
526 (all but N9000A and N9038A)	13.255 GHz	26.5 GHz	27.0 GHz
526 (N9000A)	13.255 GHz	26.5 GHz	26.55 GHz
526 (N9038A)	1.805 GHz	3.6 GHz	27.0 GHz
532	16.005 GHz	32.0 GHz	32.5 GHz
543	21.505 GHz	43.0 GHz	TBD
544	22.005 GHz	44.0 GHz	44.5 GHz
550	25.005 GHz	50.0 GHz	51 GHz

Input 2:

Model	CF after Mode Preset	Stop Freq after Mode Preset	Max Freq (can't tune above)
N9000A opt C75	0.7505GHz	1.5 GHz	1.58 GHz
N9038A	505 MHz	1 GHz	1.000025 GHz

Tracking Generator Frequency Limits (N9000A only):

Tracking Generator Option	Min Freq (clips to this freq when turn TG on and	If above this Freq, Stop Freq clipped to this Freq when	Max Freq (can't tune above) while TG

	can't tune below while TG on)	TG turned on	on
T03	9 kHz	3.0 GHz	3.08 GHz
T06	9 kHz	6.0 GHz	6.05 GHz

The following table shows the Center Frequency Presets for modes other than Spectrum Analyzer:

Mode	CF Preset for RF
WCDMA	1 GHz
WIMAXOFDMA,	1 GHz
BASIC	1 GHz
ADEMOD	1 GHz
VSA	1 GHz
TDSCDMA	1 GHz
PNOISE	1 GHz
LTE	1 GHz
LTETDD	1 GHz
MSR	1 GHz
GSM	935.2 MHz
NFIGURE	1.505 GHz

RF Center Freq

SCPI command for specifying the RF Center Frequency. This command will set the Center Frequency to be used when the RF input is selected, even if the RF input is not the input that is selected at the time the command is sent. Note that the Center Freq function in the Frequency menu on the front panel always applies to the currently selected input.

Scope	Meas Global
Remote Command	<code>[:SENSe] :FREQuency:RF:CENTer <freq></code> <code>[:SENSe] :FREQuency:RF:CENTer?</code>
Example	FREQ:RF:CENT 30 MHz
Notes	This command is the same in all modes, but the parameter is Measurement Global. So the value is independent in each mode and common across all the measurements in the mode.
Dependencies	If the electronic/soft attenuator is enabled, any attempt to set Center Frequency such that the Stop Frequency would be >3.6 GHz fails and results in an advisory message. If the equivalent SCPI command is sent, this same message is generated as part of a “-221, Settings conflict” warning. If Source Mode is set to Tracking, and the Max or Min Center Freq is therefore limited by the limits of the source, a warning message is generated, “Data out of range;clipped to source max/min” if these limits are exceeded. Note that for an external source, these limits can be affected by the settings of

	Source Numerator, Source Denominator and Power Sweep.
Preset	See table above
State Saved	Saved in instrument state.
Min	-79.999995 MHz, unless Source Mode is set to Tracking, in which case it is limited by the minimum frequency of the Source
Max	See table above. Basically instrument maximum frequency - 5 Hz. Note that, if the Source Mode is set to Tracking, the effective instrument maximum frequency may be limited by the source maximum frequency. If the knob or step keys are being used, also depends on the value of the other three interdependent parameters Span, Start Frequency and Stop Frequency
Initial S/W Revision	Prior to A.02.00
Modified at S/W Revision	A.03.00

Ext Mix Center Freq

SCPI command for specifying the External Mixer Center Frequency. This command will set the Center Frequency to be used when the External Mixer is selected, even if the External Mixer input is not the input which is selected at the time the command is sent. Note that the Center Freq function in the Frequency menu on the front panel always applies to the currently selected input.

Scope	Meas Global
Remote Command	<code>[:SENSe] :FREQuency:EMIXer:CENTer <freq></code> <code>[:SENSe] :FREQuency:EMIXer:CENTer?</code>
Example	<code>:FREQ:EMIX:CENT 60 GHz</code> <code>:FREQ:EMIX:CENT?</code>
Notes	This command is the same in all modes, but the parameter is Measurement Global. So the value is independent in each mode and common across all the measurements in the mode.
Couplings	When returning to External Mixing after having been switched to one of the other inputs (e.g., RF), you will come back into the settings that you had when you left External Mixing. So you will come back to the band you were in with the Center Frequency that you had. However, Span is not an input-dependent parameter, therefore you will bring the span over from the other input. Therefore, the analyzer comes back with the span from the previous input, limited as necessary by the current mixer setup.
Preset	When a Mode Preset is performed while in External Mixing, the Start frequency of the current Mode is set to the nominal Min Freq of the lowest harmonic range in the Harmonic Table for the current mixer setup. Similarly, the Stop frequency of the current Mode is set to the nominal Max Freq of the highest harmonic range in the Harmonic Table. The Center Freq thus presets to the point arithmetically equidistant from these two frequencies. If the current measurement has a limited Span available to it, and cannot achieve the Span shown in the table (Span=Stop Freq - Start Freq), the analyzer uses the maximum Span the measurement allows, and still sets the Center Freq to the midpoint of the Start and Stop Freq values in the Harmonic Table.

	When Restore Input/Output Defaults is performed, the mixer presets to the 11970A, whose Start and Stop frequencies are 26.5 and 40 GHz respectively. The center of these two frequencies is 33.25 GHz. Therefore, after a Restore Input/Output Defaults, if you go into External Mixing and do a Mode Preset while in the Spectrum Analyzer Mode, the resulting Center Freq is 33.25 GHz.
State Saved	Saved in instrument state.
Min	The minimum frequency in the currently selected mixer band + 5 Hz
Max	The maximum frequency in the currently selected mixer band – 5 Hz If the knob or step keys are being used, also depends on the value of the other three interdependent parameters Span, Start Frequency and Stop Frequency
Initial S/W Revision	A.08.01

I/Q Center Freq

SCPI command for specifying the I/Q Center Frequency. This command will set the Center Frequency to be used when the I/Q input is selected, even if the I/Q input is not the input which is selected at the time the command is sent. Note that the Center Freq function in the Frequency menu on the front panel always applies to the currently selected input.

Scope	Meas Global
Remote Command	<code>[:SENSe] :FREQuency:IQ:CENTer <freq></code> <code>[:SENSe] :FREQuency:IQ:CENTer?</code>
Example	FREQ:IQ:CENT: 30 MHz
Notes	This command is the same in all modes, but the parameter is Measurement Global. So the value is independent in each mode and common across all the measurements in the mode.
Preset	0 Hz
State Saved	Saved in instrument state.
Min	-40.049995 MHz
Max	40.049995 MHz
Initial S/W Revision	Prior to A.02.00

CF Step

Changes the step size for the center frequency and start and stop frequency functions. Once a step size has been selected and the center frequency function is active, the step keys (and the UP|DOWN parameters for Center Frequency from remote commands) change the center frequency by the step-size value. The step size function is useful for finding harmonics and sidebands beyond the current frequency span of the analyzer.

Note that the start and stop frequencies also step by the CF Step value.

Key Path	FREQ Channel
Remote Command	[:SENSe]:FREQuency:CENTer:STEP[:INCRement] <freq> [:SENSe]:FREQuency:CENTer:STEP[:INCRement]? [:SENSe]:FREQuency:CENTer:STEP:AUTO OFF ON 0 1 [:SENSe]:FREQuency:CENTer:STEP:AUTO?
Example	FREQ:CENt:STEP:AUTO ON FREQ:CENt:STEP 500 MHz FREQ:CENt UP increases the current center frequency value by 500 MHz FREQ:CENt:STEP? FREQ:CENt:STEP:AUTO?
Notes	Preset and Max values are depending on Hardware Options (503, 507, 508, 513, 526)
Notes	Preset and Max values are dependent on Hardware Options (5xx)
Dependencies	Freq Offset is not available in External Mixing. In this case the Freq Offset key is grayed out and shows a value of zero. It will once again be available, and show the previously set value, when you return to the RF Input.
Dependencies	Span, RBW, Center frequency If the electronic/soft attenuator is enabled, any attempt to change the value of the center frequency >3.6 GHz by pressing the Up-arrow key, fails and results in an advisory message. If the equivalent SCPI command is sent, this same message is generated as part of a “-221, Settings conflict” warning.
Couplings	When auto-coupled in a non-zero span, the center frequency step size is set to 10% of the span. When auto-coupled in zero span, the center frequency step size is set to the equivalent -3 dB RBW value.
Preset	Auto ADEMOD: 1 MHz ON
State Saved	Saved in instrument state
Min	– (the maximum frequency of the instrument). That is, 27 GHz max freq instrument has a CF step range of +/- 27 GHz. Note that this is the maximum frequency given the current settings of the instrument, so in External Mixing, for example, it is the maximum frequency of the current mixer band.
Max	The maximum frequency of the instrument. That is, 27 GHz max freq instrument has a CF step range of +/- 27 GHz. Note that this is the maximum frequency given the current settings of the instrument, so in External Mixing, for example, it is the maximum frequency of the current mixer band.
Default Unit	Hz
Status Bits/OPC dependencies	non-overlapped
Initial S/W Revision	Prior to A.02.00
Modified at S/W Revision	A.03.00

Input/Output

See ["Input/Output" on page 224](#)

Marker

Accesses a menu that enables you to select, set up and control the markers for the current measurement.

Key Path	Front-panel key
Initial S/W Revision	Prior to A.02.00

Select Marker

Displays 12 markers available for selection.

Key Path	Marker
Initial S/W Revision	Prior to A.02.00

Marker Type

Sets the marker control mode to Normal, Delta, Fixed or Off. All interactions and dependencies detailed under the key description are enforced when the remote command is sent. If the selected marker is Off, pressing Marker sets it to Normal and places it at the center of the screen on the trace determined by the Marker Trace rules. At the same time, Marker X Axis Value appears on the Active Function area.

The default active function is the active function for the currently selected marker control mode. If the current control mode is Off, there is no active function and the active function is turned off.

Key Path	Marker
Mode	SA, WCDMA, C2K, WIMAX OFDMA, 1xEVDO, DVB-T/H, DTMB (CTTB), ISDB-T, CMMB, LTE, LTE-TDD, Digital Cable TV, WLAN, MSR, LTEAFDD, LTEATDD
Remote Command	:CALCulate:CHPower:MARKer[1] 2 ... 12:MODE POSITION DELTa OFF :CALCulate:CHPower:MARKer[1] 2 ... 12:MODE?
Example	CALC:CHP:MARK3:MODE POS CALC:CHP:MARK3:MODE?
Notes	If the selected marker is Off, pressing Marker sets it to Normal and places it at the center of the screen on the trace determined by the Marker Trace rules. At the same time, Marker X Axis Value appears on the Active Function area. Default Active Function: the active function for the selected marker's current control mode. If the current control mode is Off, there is no active function and the active function is turned off. Active Function Display: the marker X axis value entered in the active function area displays the marker value to its full entered precision.
Preset	OFF
State Saved	Saved in instrument state.
Range	Normal Delta Off
Initial S/W Revision	Prior to A.02.00
Modified at S/W Revision	A.02.00, A.03.00

Properties

Accesses the marker properties menu.

Key Path	Marker
Initial S/W Revision	Prior to A.02.00

Select Marker

Displays 12 markers available for selection.

Key Path	Marker
Initial S/W Revision	Prior to A.02.00

Relative To

Sets the reference marker to which the selected marker is relative.

Key Path	Marker, Properties
Mode	SA, WCDMA, C2K, WIMAX OFDMA, 1xEVDO, DVB-T/H, DTMB (CTTB), ISDB-T, CMMB, LTE, LTETDD, Digital Cable TV, WLAN, MSR, LTEAFDD, LTEATDD
Remote Command	:CALCulate:CHPower:MARKer[1] 2 ... 12:REFerence <integer> :CALCulate:CHPower:MARKer[1] 2 ... 12:REFerence?
Example	CALC:CHP:MARK:REF 5 CALC:CHP:MARK:REF?
Notes	A marker cannot be relative to itself so that choice is grayed out, and if sent from SCPI generates error -221: "Settings conflict; marker cannot be relative to itself." When queried, a single value is returned (the specified marker numbers relative marker). You must be in the Spectrum Analysis or WCDMA mode to use this command. Use :INSTrument:SElect to set the mode.
Preset	2 3 4 5 6 7 8 9 10 11 12 1
State Saved	Saved in instrument state.
Min	1
Max	12
Initial S/W Revision	Prior to A.02.00
Modified at S/W Revision	A.02.00, A.03.00

All Markers Off

Turns off all markers.

Key Path	Marker
Mode	SA, WCDMA, C2K, WIMAX OFDMA, 1xEVDO, DVB-T/H, DTMB (CTTB), ISDB-T, CMMB, LTE, LTETDD, Digital Cable TV, WLAN, MSR, LTEAFDD, LTEATDD
Remote Command	:CALCulate:CHPower:MARKer:AOff
Example	CALC:CHP:MARK:AOff
Initial S/W Revision	Prior to A.02.00
Modified at S/W Revision	A.02.00, A.03.00

Marker X Axis Value (Remote Command Only)

Sets the marker X Axis value in the current marker X Axis Scale unit. It has no effect if the control mode is Off, but is the SCPI equivalent of entering an X value if the control mode is Normal, Delta, or Fixed.

Mode	SA, WCDMA, CDMA2K, WIMAXOFDMA, CDMA1XEV, DVB, DTMB, ISDBT, CMMB, LTE, LTETDD, DCATV, WLAN, MSR, LTEAFDD, LTEATDD
Remote Command	:CALCulate:CHPower:MARKer[1] 2 ... 12:X <real> :CALCulate:CHPower:MARKer[1] 2 ... 12:X?
Example	CALC:CHP:MARK3:X 0 CALC:CHP:MARK3:X?
Notes	The query returns the marker's absolute X Axis value if the control mode is Normal, or the offset from the marker's reference marker if the control mode is Delta. The query is returned in the fundamental units for the current marker X Axis scale: Hz for Frequency.
Preset	After a preset, all markers are turned OFF, so Marker X Axis Value query returns a not a number (NAN).
State Saved	Saved in instrument state.
Min	-9.9E+37
Max	9.9E+37
Initial S/W Revision	Prior to A.02.00
Modified at S/W Revision	A.02.00, A.03.00

Marker X Axis Position (Remote Command Only)

Sets the marker X Axis Scale position in trace points. This setting has no effect if the control mode is Off, but is the SCPI equivalent of entering a value if the control mode is Normal or Delta . The entered value is immediately translated into the current X Axis Scale units for setting the value of the marker.

Mode	SA, WCDMA, CDMA2K, WIMAXOFDMA, CDMA1XEV, DVB, DTMB, ISDBT, CMMB, LTE, LTETDD, DCATV, WLAN, MSR, LTEAFDD, LTEATDD
Remote Command	:CALCulate:CHPower:MARKer[1] 2 ... 12:X:POStion <real> :CALCulate:CHPower:MARKer[1] 2 ... 12:X:POStion?
Example	CALC:CHP:MARK10:X:POS 0

	CALC:CHP:MARK10:X:POS?
Notes	The query returns the marker's absolute X Axis value in trace points if the control mode is Normal, or the offset from the marker's reference marker in trace points if the control mode is Delta.
Preset	After a preset, all markers are turned OFF, so Marker X Axis Value query returns a not a number (NAN).
State Saved	Saved in instrument state.
Min	-9.9E+37
Max	9.9E+37
Initial S/W Revision	Prior to A.02.00
Modified at S/W Revision	A.02.00, A.03.00

Marker Y Axis Value (Remote Command only)

Returns the marker Y Axis value in the current marker Y Axis unit.

Mode	SA, WCDMA, CDMA2K, WIMAXOFDMA, CDMA1XEV, DVB, DTMB, ISDBT, CMMB, LTE, LTETDD, DCATV, WLAN, MSR, LTEAFDD, LTEATDD
Remote Command	:CALCulate:CHPower:MARKer[1] 2 ... 12:Y?
Example	CALC:CHP:MARK11:Y?
Preset	Result dependent on Markers setup and signal source.
State Saved	Saved in instrument state.
Initial S/W Revision	Prior to A.02.00
Modified at S/W Revision	A.02.00, A.03.00

Backward Compatibility SCPI Commands

Sets or queries the state of a marker. Setting a marker which is OFF to state ON or 1 puts it in Normal mode and places it at the center of the screen.

Mode	SA, WCDMA, CDMA2K, WIMAXOFDMA, CDMA1XEV, DVB, DTMB, ISDBT, CMMB, LTE, LTETDD, DCATV, WLAN, MSR, LTEAFDD, LTEATDD
Remote Command	:CALCulate:CHPower:MARKer[1] 2 ... 12:STATe OFF ON 0 1 :CALCulate:CHPower:MARKer[1] 2 ... 12:STATe?
Example	CALC:CHP:MARK3:STAT ON CALC:CHP:MARK3:STAT?
Preset	OFF
State Saved	Saved in instrument state.
Range	On Off
Initial S/W Revision	Prior to A.02.00
Modified at S/W Revision	A.02.00, A.03.00

Marker Function

There are no 'Marker Functions' supported in Channel Power, so this front-panel key displays a blank menu when pressed.

Key Path	Front-panel key
Initial S/W Revision	Prior to A.02.00

Marker To

There is no 'Marker To' functionality supported in Channel Power measurement, so this front-panel key displays a blank key menu when pressed.

Key Path	Front-panel key
Initial S/W Revision	Prior to A.02.00

Meas

The information in this section is common to all measurements. For key and remote command information for a specific measurement, refer to the section that describes the measurement of interest.

Measurements available under the Meas key are specific to the current Mode.

When viewing Help for measurements, note the following:

NOTE

Operation for some keys differs between measurements. The information displayed in Help pertains to the current measurement. To see how a key operates in a different measurement, exit Help (press the Cancel Esc key), select the measurement, then reenter Help (press the Help key) and press that key.

Key Path	Front-panel key
Initial S/W Revision	Prior to A.02.00

Remote Measurement Functions

This section contains the following topics:

["Measurement Group of Commands" on page 2771](#)

["Current Measurement Query \(Remote Command Only\)" on page 2773](#)

["Limit Test Current Results \(Remote Command Only\)" on page 2773](#)

["Data Query \(Remote Command Only\)" on page 2773](#)

["Calculate/Compress Trace Data Query \(Remote Command Only\)" on page 2774](#)

["Calculate Peaks of Trace Data \(Remote Command Only\)" on page 2779](#)

[Hardware-Accelerated Fast Power Measurement \(Remote Command Only\)](#)

["Format Data: Numeric Data \(Remote Command Only\)" on page 2780](#)

["Format Data: Byte Order \(Remote Command Only\)" on page 2781](#)

Initial S/W Revision	Prior to A.02.00
----------------------	------------------

Measurement Group of Commands

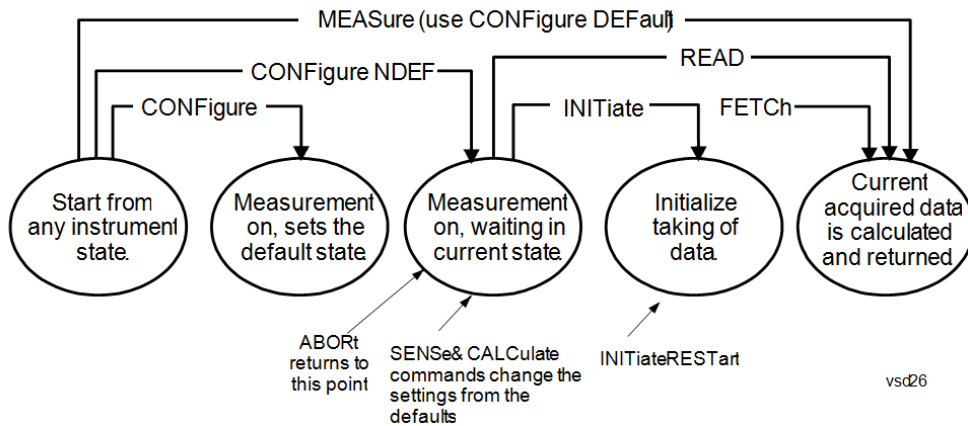

Measure Commands:

:MEASure:<measurement>[n]?

This is a fast single-command way to make a measurement using the factory default instrument settings. These are the settings and units that conform to the Mode Setup settings (e.g. radio standard) that you have currently selected.

- Stops the current measurement (if any) and sets up the instrument for the specified measurement using the factory defaults
- Initiates the data acquisition for the measurement
- Blocks other SCPI communication, waiting until the measurement is complete before returning results.
- If the function does averaging, it is turned on and the number of averages is set to 10.
- After the data is valid it returns the scalar results, or the trace data, for the specified measurement. The type of data returned may be defined by an [n] value that is sent with the command.
- The scalar measurement results will be returned if the optional [n] value is not included, or is set to 1. If the [n] value is set to a value other than 1, the selected trace data results will be returned. See each command for details of what types of scalar results or trace data results are available.
- ASCII is the default format for the data output. (Older versions of Spectrum Analysis and Phase Noise mode measurements only use ASCII.) The binary data formats should be used for handling large blocks of data since they are smaller and faster than the ASCII format. Refer to the FORMat:DATA command for more information.

If you need to change some of the measurement parameters from the factory default settings you can set up the measurement with the CONFigure command. Use the commands in the SENSE:<measurement> and CALCulate:<measurement> subsystems to change the settings. Then you can use the READ? command to initiate the measurement and query the results.

If you need to repeatedly make a given measurement with settings other than the factory defaults, you can use the commands in the SENSE:<measurement> and CALCulate:<measurement> subsystems to set up the measurement. Then use the READ? command to initiate the measurement and query results.

Measurement settings persist if you initiate a different measurement and then return to a previous one. Use READ:<measurement>? if you want to use those persistent settings. If you want to go back to the default settings, use MEASure:<measurement>?.

Configure Commands:

:CONFigure:<measurement>

This command stops the current measurement (if any) and sets up the instrument for the specified measurement using

the factory default instrument settings. It does not initiate the taking of measurement data unless INIT:CONTInuous is ON. If you change any measurement settings after using the CONFigure command, the READ command can be used to initiate a measurement without changing the settings back to their defaults.

In the Swept SA measurement in Spectrum Analyzer mode the CONFigure command also turns the averaging function on and sets the number of averages to 10 for all measurements.

:CONFigure: <measurement>: NDEFault stops the current measurement and changes to the specified measurement. It does not change the settings to the defaults. It does not initiate the taking of measurement data unless INIT:CONTInuous is ON.

The CONFigure? query returns the current measurement name.

The CONFigure:CATalog? query returns a quoted string of all licensed measurement names in the current mode. For example, "SAN, CHP, OBW, ACP, PST, TXP, SPUR, SEM, LIST".

Fetch Commands:

:FETCh:<measurement>[n]?

This command puts selected data from the most recent measurement into the output buffer. Use FETCh if you have already made a good measurement and you want to return several types of data (different [n] values, for example, both scalars and trace data) from a single measurement. FETCh saves you the time of re-making the measurement. You can only FETCh results from the measurement that is currently active, it will not change to a different measurement. An error message is reported if a measurement other than the current one is specified.

If you need to get new measurement data, use the READ command, which is equivalent to an INITiate followed by a FETCh.

The scalar measurement results will be returned if the optional [n] value is not included, or is set to 1. If the [n] value is set to a value other than 1, the selected trace data results will be returned. See each command for details of what types of scalar results or trace data results are available. The binary data formats should be used for handling large blocks of data since they are smaller and transfer faster than the ASCII format. (FORMat:DATA)

FETCh may be used to return results other than those specified with the original READ or MEASure command that you sent.

INITiate Commands:

:INITiate:<measurement>

This command is not available for measurements in all the instrument modes:

- Initiates a trigger cycle for the specified measurement, but does not output any data. You must then use the FETCh<meas> command to return data. If a measurement other than the current one is specified, the instrument will switch to that measurement and then initiate it.
- For example, suppose you have previously initiated the ACP measurement, but now you are running the channel power measurement. If you send INIT:ACP? it will change from channel power to ACP and will initiate an ACP measurement.
- Does not change any of the measurement settings. For example, if you have previously started the ACP measurement and you send INIT:ACP? it will initiate a new ACP measurement using the same instrument settings as the last time ACP was run.
- If your selected measurement is currently active (in the idle state) it triggers the measurement, assuming the trigger conditions are met. Then it completes one trigger cycle. Depending upon the measurement and the number of averages, there may be multiple data acquisitions, with multiple trigger events, for one full trigger cycle. It also holds off additional commands on GPIB until the acquisition is complete.

READ Commands:

:READ:<measurement>[n]?

- Does not preset the measurement to the factory default settings. For example, if you have previously initiated the ACP
-

measurement and you send READ:ACP? it will initiate a new measurement using the same instrument settings.

- Initiates the measurement and puts valid data into the output buffer. If a measurement other than the current one is specified, the instrument will switch to that measurement before it initiates the measurement and returns results.
 - For example, suppose you have previously initiated the ACP measurement, but now you are running the channel power measurement. Then you send READ:ACP? It will change from channel power back to ACP and, using the previous ACP settings, will initiate the measurement and return results.
 - Blocks other SCPI communication, waiting until the measurement is complete before returning the results
 - If the optional [n] value is not included, or is set to 1, the scalar measurement results will be returned. If the [n] value is set to a value other than 1, the selected trace data results will be returned. See each command for details of what types of scalar results or trace data results are available. The binary data formats should be used when handling large blocks of data since they are smaller and faster than the ASCII format. (FORMat:DATA)
-

Initial S/W Revision	Prior to A.02.00
----------------------	------------------

Current Measurement Query (Remote Command Only)

This command returns the name of the measurement that is currently running.

Remote Command	:CONFigure?
-----------------------	-------------

Example	CONF?
----------------	-------

Initial S/W Revision	Prior to A.02.00
----------------------	------------------

Limit Test Current Results (Remote Command Only)

Queries the status of the current measurement limit testing. It returns a 0 if the measured results pass when compared with the current limits. It returns a 1 if the measured results fail any limit tests.

Remote Command	:CALCulate:CLIMits:FAIL?
-----------------------	--------------------------

Example	CALC:CLIM:FAIL? queries the current measurement to see if it fails the defined limits. Returns a 0 or 1: 0 it passes, 1 it fails.
----------------	--

Initial S/W Revision	Prior to A.02.00
----------------------	------------------

Data Query (Remote Command Only)

Returns the designated measurement data for the currently selected measurement and subopcode.

n = any valid subopcode for the current measurement. See the measurement command results table for your current measurement, for information about what data is returned for the subopcodes.

This command uses the data setting specified by the FORMat:BORDER and FORMat:DATA commands and can return real or ASCII data. (See the format command descriptions under Input/Output in the Analyzer Setup section.)

Remote Command	:CALCulate:DATA[n]?
Notes	The return trace depends on the measurement. In CALCulate:<meas>:DATA[n], n is any valid subopcode for the current measurement. It returns the same data as the FETCH:<measurement>? query where <measurement> is the current measurement.
Initial S/W Revision	Prior to A.02.00

Calculate/Compress Trace Data Query (Remote Command Only)

Returns compressed data for the currently selected measurement and sub-opcode [n].

n = any valid sub-opcode for that measurement. See the MEASure:<measurement>? command description of your specific measurement for information on the data that can be returned.

The data is returned in the current Y Axis Unit of the analyzer. The command is used with a sub-opcode <n> (default=1) to specify the trace. With trace queries, it is best if the analyzer is not sweeping during the query. Therefore, it is generally advisable to be in Single Sweep, or Update=Off.

This command is used to compress or decimate a long trace to extract and return only the desired data. A typical example would be to acquire N frames of GSM data and return the mean power of the first burst in each frame. The command can also be used to identify the best curve fit for the data.

Remote Command	:CALCulate:DATA<n>:COMPRESS? BLOCK CFIT MAXimum MINimum MEAN DMEan RMS RMSCubed SAMPLE SDEVIation PPHase [,<soffset> [,<length>[,<roffset>[,<rlimit>]]]]
Example	To query the mean power of a set of GSM bursts: Supply a signal that is a set of GSM bursts. Select the IQ Waveform measurement (in IQ Analyzer Mode). Set the sweep time to acquire at least one burst. Set the triggers such that acquisition happens at a known position relative to a burst. Then query the mean burst levels using, CALC:DATA2:COMP? MEAN, 24e-6, 526e-6 (These parameter values correspond to GSM signals, where 526e-6 is the length of the burst in the slot and you just want 1 burst.)
Notes	The command supports 5 parameters. Note that the last 4 (<soffset>, <length>, <roffset>, <rlimit>) are optional. But these optional parameters must be entered in the specified order. For example, if you want to specify <length>, then you must also specify <soffset>. See details below for a definition of each of these parameters. This command uses the data in the format specified by FORMat:DATA, returning either binary or ASCII data.
Initial S/W Revision	Prior to A.02.00

- BLOCK or block data - returns all the data points from the region of the trace data that you specify. For example, it could be used to return the data points of an input signal over several timeslots, excluding the portions of the trace data that you do not want. (This is x,y pairs for trace data and I,Q pairs for complex data.)

- CFIT or curve fit - applies curve fitting routines to the data. <soffset> and <length> are required to define the data that you want. <roffset> is an optional parameter for the desired order of the curve equation. The query will return the following values: the x-offset (in seconds) and the curve coefficients ((order + 1) values).

MIN, MAX, MEAN, DME, RMS, RMSC, SAMP, SDEV and PPH return one data value for each specified region (or <length>) of trace data, for as many regions as possible until you run out of trace data (using <roffset> to specify regions). Or they return the number of regions you specify (using <rlimit>) ignoring any data beyond that.

- MINimum - returns the minimum data point (y value) for the specified region(s) of trace data. For I/Q trace data, the minimum magnitude of the I/Q pairs is returned.
- MAXimum - returns the maximum data point (y value) for the specified region(s) of trace data. For I/Q trace data, the maximum magnitude of the I/Q pairs is returned.
- MEAN - returns a single value that is the arithmetic mean of the data point values (in dB/ dBm) for the specified region(s) of trace data. For I/Q trace data, the mean of the magnitudes of the I/Q pairs is returned. See the following equations.

NOTE If the original trace data is in dB, this function returns the arithmetic mean of those log values, not log of the mean power which is a more useful value. The mean of the log is the better measurement technique when measuring CW signals in the presence of noise. The mean of the power, expressed in dB, is useful in power measurements such as Channel Power. To achieve the mean of the power, use the RMS option.

Equation 1

Mean Value of Data Points for Specified Region(s)

$$MEAN = \frac{1}{n} \sum_{X_i \in \text{region}(s)} X_i$$

where X_i is a data point value, and n is the number of data points in the specified region(s).

Equation 2

Mean Value of I/Q Data Pairs for Specified Region(s)

$$MEAN = \frac{1}{n} \sum_{X_i \in \text{region}(s)} |X_i|$$

where $|X_i|$ is the magnitude of an I/Q pair, and n is the number of I/Q pairs in the specified region(s).

- DMEan - returns a single value that is the mean power (in dB/ dBm) of the data point values for the specified region(s) of trace data. See the following equation:

Equation 3

DMEan Value of Data Points for Specified Region(s)

$$\text{DME} = 10 \times \log_{10} \left(\frac{1}{n} \sum_{X_i \in \text{region}(s)} 10^{\frac{X_i}{10}} \right)$$

- RMS - returns a single value that is the average power on a root-mean-squared voltage scale (arithmetic rms) of the data point values for the specified region(s) of trace data. See the following equation.

NOTE For I/Q trace data, the rms of the magnitudes of the I/Q pairs is returned. See the following equation. This function is very useful for I/Q trace data. However, if the original trace data is in dB, this function returns the rms of the log values which is not usually needed.

Equation 4

RMS Value of Data Points for Specified Region(s)

$$\text{RMS} = \sqrt{\frac{1}{n} \sum_{X_i \in \text{region}(s)} X_i^2}$$

where X_i is a data point value, and n is the number of data points in the specified region(s).

Equation 5

RMS Value of I/Q Data Pairs for Specified Region(s)

$$\text{RMS} = \sqrt{\frac{1}{n} \sum_{X_i \in \text{region}(s)} X_i X_i^*}$$

where X_i is the complex value representation of an I/Q pair, X_i^* its conjugate complex number, and n is the number of I/Q pairs in the specified region(s).

Once you have the rms value for a region of trace data (linear or I/Q), you may want to calculate the mean power. You must convert this rms value (peak volts) to power in dBm:

$$10 \times \log[10 \times (\text{rms value})^2]$$

- SAMPLe - returns the first data value (x,y pair) for the specified region(s) of trace data. For I/Q trace data, the first I/Q pair is returned.
- SDEViation - returns a single value that is the arithmetic standard deviation for the data point values for the specified region(s) of trace data. See the following equation.
- For I/Q trace data, the standard deviation of the magnitudes of the I/Q pairs is returned. See the following equation.

Equation 6

Standard Deviation of Data Point Values for Specified Region(s)

$$\text{SDEV} = \sqrt{\frac{1}{n} \sum_{X_i \in \text{region}(s)} (X_i - \bar{X})^2}$$

where X_i is a data point value, \bar{X} is the arithmetic mean of the data point values for the specified region (s), and n is the number of data points in the specified region(s).

$$\text{SDEV} = \sqrt{\frac{1}{n} \sum_{X_i \in \text{region}(s)} (|X_i| - \bar{X})^2}$$

where $|X_i|$ is the magnitude of an I/Q pair, \bar{X} is the mean of the magnitudes for the specified region(s), and n is the number of data points in the specified region(s).

- PPHase - returns the x,y pairs of both rms power (dBm) and arithmetic mean phase (radian) for every specified region and frequency offset (Hz). The number of pairs is defined by the specified number of regions. This parameter can be used for I/Q vector ($n=0$) in Waveform (time domain) measurement and all parameters are specified by data point in PPHase.

The rms power of the specified region may be expressed as:

$$\text{Power} = 10 \times \log [10 \times (\text{RMS I/Q value})] + 10.$$

The RMS I/Q value (peak volts) is:

$$\sqrt{\frac{1}{n} \sum_{X_i \in \text{region}} X_i X_i^*}$$

where X_i is the complex value representation of an I/Q pair, X_i^* its conjugate complex number, and n is the number of I/Q pairs in the specified region.

The arithmetic mean phase of the specified region may be expressed as:

$$\frac{1}{n} \sum_{Y_i \in \text{region}} Y_i$$

where Y_i is the unwrapped phase of I/Q pair with applying frequency correction and n is the number of I/Q pairs in the specified region.

The frequency correction is made by the frequency offset calculated by the arithmetic mean of every specified region's frequency offset. Each frequency offset is calculated by the least square method against the unwrapped phase of I/Q pair.

Sample Trace Data - Constant Envelope

(See below for explanation of variables.)

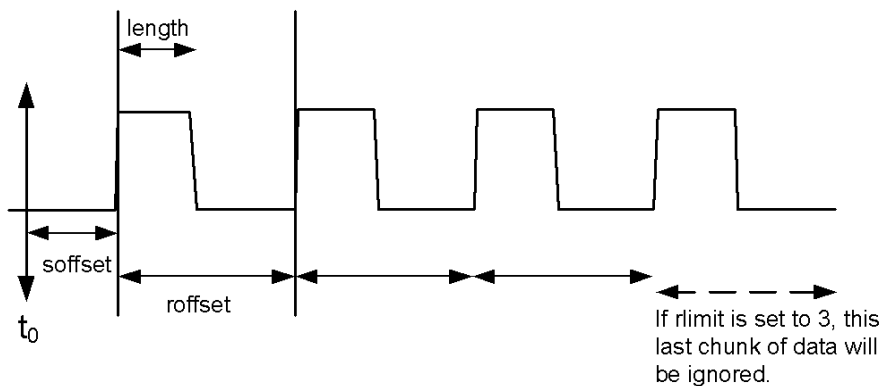

Sample Trace Data - Not Constant Envelope

(See below for explanation of variables.)

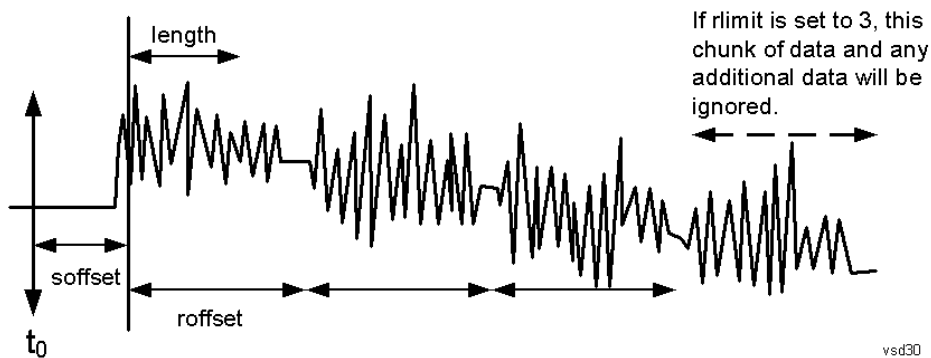

<soffset> - start offset is an optional real number. (It is in seconds for time-domain traces, and is a dimensionless index 0 to Npoints - 1, for frequency-domain traces). It specifies the amount of data at the beginning of the trace that will be ignored before the decimation process starts. It is the time or frequency change from the start of the trace to the point where you want to start using the data. The default value is zero.

<length> - is an optional real number. (It is in seconds for time-domain traces, and is a dimensionless index 0 to Npoints - 1, for frequency-domain traces). It defines how much data will be compressed into one value. This parameter has a default value equal to the current trace length.

<roffset> - repeat offset is an optional real number. (It is in seconds for time-domain traces, and is a dimensionless index 0 to Npoints - 1, for frequency-domain traces). It defines the beginning of the next field of trace elements to be compressed. This is relative to the beginning of the previous field. This parameter has a default value equal to the <length> variable. Note that this parameter is used for a completely different purpose when curve fitting (see CFIT above).

<rlimit> - repeat limit is an optional integer. It specifies the number of data items that you want returned. It will ignore any additional items beyond that number. You can use the Start offset and the Repeat limit to pick out exactly what part of the data you want to use. The default value is all the data.

Calculate Peaks of Trace Data (Remote Command Only)

Returns a list of all the peaks for the currently selected measurement and sub-opcode [n]. The peaks must meet the requirements of the peak threshold and excursion values.

n = any valid sub-opcode for the current measurement. See the MEASure:<measurement> command description of your specific measurement for information on the data that can be returned.

The command can only be used with specific sub-opcodes with measurement results that are trace data. Both real and complex traces can be searched, but complex traces are converted to magnitude in dBm. In many measurements the sub-opcode n=0, is the raw trace data which cannot be searched for peaks. And Sub-opcode n=1, is often calculated results values which also cannot be searched for peaks.

This command uses the data setting specified by the FORMat:BORDER and FORMat:DATA commands and can return real or ASCII data. If the format is set to INT,32, it returns REAL,32 data.

The command has four types of parameters:

- Threshold (in dBm)
- Excursion (in dB)
- Sorting order (amplitude, frequency, time)
- Optional in some measurements: Display line use (all, > display line, < display line)

Remote Command	<p>For Swept SA measurement:</p> <pre>:CALCulate:DATA[1] 2 ... 6:PEAKs? <threshold>,<excursion>[,AMPLitude FREQuency TIME[,ALL GTDLLine LTDLine]]</pre> <p>For most other measurements:</p> <pre>:CALCulate:DATA[1] 2 ... 6:PEAKs? <threshold>,<excursion>[,AMPLitude FREQuency TIME]</pre>
-----------------------	---

Example	<p>Example for Swept SA measurement in Spectrum Analyzer Mode:</p> <p>CALC:DATA4:PEAK? -40, 10, FREQ, GTDL This will identify the peaks of trace 4 that are above -40 dBm, with excursions of at least 10 dB. The peaks are returned in order of increasing frequency, starting with the lowest frequency. Only the peaks that are above the display line are returned.</p> <p>Query Results 1:</p> <p>With FORMat:DATA REAL, 32 selected, it returns a list of floating-point numbers. The first value in the list is the number of peak points that are in the following list. A peak point consists of two values: a peak amplitude followed by its corresponding frequency (or time).</p> <p>If no peaks are found the peak list will consist of only the number of peaks, (0).</p>
----------------	---

Notes	<p><n> - is the trace that will be used</p> <p><threshold> - is the level below which trace data peaks are ignored. Note that the threshold value is required and is always used as a peak criterion. To effectively disable the threshold criterion for this command, provide a substantially low threshold value such as -200 dBm. Also note that the threshold value used in this command is independent of and has no effect on the threshold value stored under the Peak Criteria menu.</p> <p><excursion> - is the minimum amplitude variation (rise and fall) required for a signal to be identified as peak. Note that the excursion value is required and is always used as a peak criterion. To effectively disable the excursion criterion for this command, provide the minimum value of 0.0 dB. Also note that the excursion value used in this command is independent of and has no effect on the</p>
--------------	---

excursion value stored under the Peak Criteria menu.

Values must be provided for threshold and excursion. The sorting and display line parameters are optional (defaults are AMPLitude and ALL).

Note that there is always a Y-axis value for the display line, regardless of whether the display line state is on or off. It is the current Y-axis value of the display line which is used by this command to determine whether a peak should be reported

Sorting order:

AMPLitude - lists the peaks in order of descending amplitude, with the highest peak first (default if optional parameter not sent)

FREQUency - lists the peaks in order of occurrence, left to right across the x-axis.

TIME - lists the peaks in order of occurrence, left to right across the x-axis.

Peaks vs. Display Line:

ALL - lists all of the peaks found (default if optional parameter not sent).

GTDLine (greater than display line) - lists all of the peaks found above the display line.

LTDLine (less than display line) - lists all of the peaks found below the display line.

Initial S/W Revision Prior to A.02.00

Format Data: Numeric Data (Remote Command Only)

This command specifies the format of the trace data input and output. It specifies the formats used for trace data during data transfer across any remote port. It affects only the data format for setting and querying trace data for the :TRACe[:DATA], TRACe[:DATA]?, :CALCulate:DATA[n]? and FETCh:SANalyzer [n]? commands and queries.

Remote Command :FORMat[:TRACe][:DATA] ASCii|INTeger,32|REAL,32 |REAL,64
:FORMat[:TRACe][:DATA]?

Notes The query response is:
ASCii: ASC,8
REAL,32: REAL,32
REAL,64: REAL,64
INTeger,32: INT,32

When the numeric data format is REAL or ASCii, data is output in the current Y Axis unit. When the data format is INTeger, data is output in units of m dBm (.001 dBm).

The INT,32 format returns binary 32-bit integer values in internal units (m dBm), in a definite length block.

Dependencies Sending a data format spec with an invalid number (for example, INT,48) generates no error. The analyzer simply uses the default (8 for ASCii, 32 for INTeger, 32 for REAL).

Sending data to the analyzer which does not conform to the current FORMat specified, results in an error. Sending ASCII data when a definite block is expected generates message -161 "Invalid Block Data" and sending a definite block when ASCII data is expected generates message -121 "Invalid Character in Number".

Preset ASCii

Backwards Compatibility Notes Note that the INT,32 format is only applicable to the command, TRACe:DATA. This preserves backwards compatibility for the Swept SA measurement. For all other commands/queries which honor FORMat:DATA, if INT,32 is sent the analyzer will behave as though it were set to REAL,32.

Initial S/W Revision Prior to A.02.00

The specs for each output type follow:

ASCIi - Amplitude values are in ASCII, in the current Y Axis Unit, one ASCII character per digit, values separated by commas, each value in the form:

SX.YYYYYEsZZ

Where:

S = sign (+ or -)

X = one digit to left of decimal point

Y = 5 digits to right of decimal point

E = E, exponent header

s = sign of exponent (+ or -)

ZZ = two digit exponent

REAL,32 - Binary 32-bit real values in the current Y Axis Unit, in a definite length block.

REAL,64 - Binary 64-bit real values in the current Y Axis Unit, in a definite length block.

Format Data: Byte Order (Remote Command Only)

This command selects the binary data byte order for data transfer and other queries. It controls whether binary data is transferred in normal or swapped mode. This command affects only the byte order for setting and querying trace data for the :TRACe[:DATA], TRACe[:DATA]? , :CALCulate:DATA[n]? and FETCh:SANalyzer[n]? commands and queries.

By definition any command that says it uses FORMat:DATA uses any format supported by FORMat:DATA.

The NORMal order is a byte sequence that begins with the most significant byte (MSB) first, and ends with the least significant byte (LSB) last in the sequence: 1|2|3|4. SWAPped order is when the byte sequence begins with the LSB first, and ends with the MSB last in the sequence: 4|3|2|1.

Remote Command	:FORMat:BORDER NORMal SWAPped :FORMat:BORDER?
Preset	NORMal
Initial S/W Revision	Prior to A.02.00

Meas Setup

Displays the setup menu for the currently selected measurement. The parameters included in this menu are as follows.

- Averaging
- IF Gain
- Channel Power Span
- Integrated Bandwidth
- Filter Bandwidth
- Root Raised Cosine (RRC) Filter

Key Path	Front-panel key
Initial S/W Revision	Prior to A.02.00

Avg/Hold Num

Specifies the number of measurement averages used to calculate the measurement result. The average is displayed at the end of each sweep. After the specified number of average counts, the averaging mode (terminal control) setting determines the averaging action.

Key Path	Meas Setup
Mode	SA, WCDMA, C2K, WIMAX OFDMA, 1xEVDO, DVB-T/H, DTMB (CTTB), ISDB-T, CMMB, LTE, LTETDD, Digital Cable TV, WLAN, MSR, LTEAFDD, LTEATDD
Remote Command	[:SENSe]:CHPower:AVERage:COUNT <integer> [:SENSe]:CHPower:AVERage:COUNT? [:SENSe]:CHPower:AVERage[:STATe] ON OFF 1 0 [:SENSe]:CHPower:AVERage[:STATe]?
Example	CHP:AVER:COUN 15 CHP:AVER:COUN? CHP:AVER ON CHP:AVER?
Notes	You must be in the Spectrum Analysis mode, W-CDMA mode, cdma2000 mode, DVB-T/H mode, DTMB (CTTB) mode, ISDB-T mode, CMMB mode, Digital Cable TV mode, LTE mode, LTE TDD mode 1xEVDO mode or WIMAX OFDMA mode to use this command. Use :INSTRument:SElect to set the mode.
Preset	SA: 10 WCDMA: 200 WIMAX OFDMA, LTE, LTETDD, MSR: 200 CDMA2K: 20 1xEVDO: 20

	DVB-T/H: 20 DTMB (CTTB): 20 ISDB-T: 10 CMMB: 10 Digital Cable TV: 10 WLAN: 10 LTEAFDD, LTEATDD:200 ON
State Saved	Saved in instrument state.
Min	1
Max	10000
Initial S/W Revision	Prior to A.02.00
Modified at S/W Revision	A.02.00, A.03.00

Avg Mode

Allows you to select the type of termination control used for the averaging function. This determines the averaging action after the specified number of data acquisitions (average count) is reached.

When set to Exponential (Exp) the measurement averaging continues using the specified number of averages to compute each exponentially-weighted averaged value. The average is displayed at the end of each sweep.

When set to Repeat, the measurement resets the average counter each time the specified number of averages is reached.

Key Path	Meas Setup
Mode	SA, WCDMA, C2K, WIMAX OFDMA, 1xEVDO, DVB-T/H, DTMB (CTTB), ISDB-T, CMMB, LTE, LTEATDD, Digital Cable TV, WLAN, MSR, LTEAFDD, LTEATDD
Remote Command	[:SENSe] :CHPower:AVERage:TCONtrol EXPonential REPeat [:SENSe] :CHPower:AVERage:TCONtrol?
Example	CHP:AVER:TCON EXP CHP:AVER:TCON?
Notes	You must be in the Spectrum Analysis mode, W-CDMA mode, cdma2000 mode, DVB-T/H mode, DTMB (CTTB) mode, ISDB-T mode, CMMB mode, Digital Cable TV mode, LTE mode, LTE TDD mode, WLAN mode, 1xEVDO mode or WIMAX OFDMA mode to use this command. Use :INSTrument:SElect to set the mode.
Preset	EXP
State Saved	Saved in instrument state.
Range	Exp Repeat
Initial S/W Revision	Prior to A.02.00
Modified at S/W Revision	A.02.00, A.03.00

Integ BW

Specifies the range of integration used in calculating the power in the channel. The integration bandwidth (IBW) is displayed on the trace as two markers connected by an arrow.

Key Path	Meas Setup
Mode	SA, WCDMA, C2K, WIMAX OFDMA, 1xEVDO, DVB-T/H, DTMB (CTTB), ISDB-T, CMMB, LTE, LTETDD, Digital Cable TV, WLAN
Remote Command	<code>[:SENSe] :CHPower :BANDwidth :INTEgration <bandwidth></code> <code>[:SENSe] :CHPower :BANDwidth :INTEgration?</code>
Example	CHP:BAND:INT 10MHz CHP:BAND:INT?
Notes	You must be in the Spectrum Analysis mode, W-CDMA mode, cdma2000 mode, DVB-T/H mode, DTMB (CTTB) mode, ISDB-T mode, CMMB mode, Digital Cable TV mode, LTE mode, LTE TDD mode, WLAN mode, 1xEVDO mode or WIMAX OFDMA mode to use this command. Use :INSTrument:SElect to set the mode.
Dependencies	For MSR/LTE-Advanced FDD/TDD mode, this key is blank.
Couplings	The minimum value of the span is coupled with the integration bandwidth.
Preset	SA: 2 MHz WCDMA: 5 MHz C2K: 1.23 MHz WIMAX OFDMA: 10 MHz 1xEVDO: 1.23 MHz DVB-T/H: 7.61MHz DTMB (CTTB): 8MHz ISDB-T: 5.6MHz CMMB: 8MHz LTE: 5 MHz LTETDD: 5 MHz Digital Cable TV: 8MHz WLAN: if Radio Std is 802.11a/g(OFDM/DSSS-OFDM): 20 MHz if Radio Std is 802.11b: 25 MHz if Radio Std is 802.11n(20MHz): 20 MHz if Radio Std is 802.11n(40MHz): 40 MHz if Radio Std is 802.11ac (20 MHz): 20 MHz if Radio Std is 802.11ac (40 MHz): 40 MHz if Radio Std is 802.11ac (80 MHz): 80 MHz if Radio Std is 802.11ac (160 MHz): 160 MHz if Radio Std is 802.11ac (80 MHz + 80 MHz): 80 MHz

State Saved	Saved in instrument state.
Min	100 Hz
Max	Hardware Maximum Span
Initial S/W Revision	Prior to A.02.00
Modified at S/W Revision	A.02.00, A.03.00

PhNoise Opt

Selects the LO (local oscillator) phase noise behavior for various operating conditions. Refer to PhNoise Opt

in the Swept SA measurement for details.

Key Path	Meas Setup
Initial S/W Revision	A.04.20

PhNoise Opt Auto

Selects the LO (local oscillator) phase noise behavior to optimize dynamic range and speed for various instrument operating conditions. Refer to PhNoise Opt Auto State in the Swept SA measurement for details.

Key Path	Meas Setup
Remote Command	<code>[:SENSe] :CHPower:FREQuency:SYNTHeSis:AUTO [:STATe] OFF ON 0 1</code> <code>[:SENSe] :CHPower:FREQuency:SYNTHeSis:AUTO [:STATe] ?</code>
Example	CHP:FREQ:SYNT:AUTO 1 CHP:FREQ:SYNT:AUTO?
Preset	OFF
State Saved	Saved in instrument state.
Range	Auto Man
Readback Text	“Auto” is underlined when Auto is selected, otherwise Man is underlined.
Initial S/W Revision	A.04.20

PhNoise Opt State

Selects the LO (local oscillator) phase noise behavior for various operating conditions. Refer to PhNoise Opt in the Swept SA measurement for details.

Key Path	Meas Setup
----------	------------

Remote Command	<code>[:SENSe] :CHPower:FREQuency:SYNThesis[:STATe] 1 2 3</code> <code>[:SENSe] :CHPower:FREQuency:SYNThesis[:STATe] ?</code>
Example	CHP:FREQ:SYNT 1 CHP:FREQ:SYNT?
Notes	Parameter key: 1. optimizes phase noise for close-in from the carrier. 2. optimizes phase noise for wide-offset from the carrier. 3. optimizes LO for tuning speed.
Couplings	Best Close-in Φ Noise The frequency below which the phase noise is optimized is model dependent: PXA with option EP1: [offset <140 kHz] Models with option EP2: [offset <70 kHz] CXA with option EP4: [offset <90 kHz] CXA without option EP4: n/a All other models: [offset <20 kHz] Best Wide-offset Φ Noise The frequency below which the phase noise is optimized is model dependent: PXA with option EP1: [offset >160 kHz] Models with option EP2: [offset >100 kHz] CXA with option EP4: [offset >130 kHz] CXA without option EP4: n/a All other models: [offset >30 kHz] Fast Tuning The Fast Tuning details are model dependent: CXA without option EP4: n/a PXA with option EP1: [single loop] Models with option EP2: [medium loop bandwidth] All other models: [same as Close-in]
Preset	3
State Saved	Saved in instrument state.
Range	Best Close-in Φ Noise [offset < 140 kHz] Best Wide-offset Φ Noise [offset > 160 kHz] Fast Tuning [same as Close-in] [] is model dependent. See Couplings for details.
Initial S/W Revision	A.04.20

IF Gain

Sets the IF Gain function to Auto, Low Gain or High Gain. These settings affect sensitivity and IF overloads.

Key Path	Meas Setup
-----------------	------------

Dependencies	The IF Gain keys (FFT IF Gain and Swept IF Gain) have no effect when the U7227A USB Preamplifier is connected. This is not annotated or reflected on any softkey; there are no keys grayed out nor any SCPI locked out. The analyzer simply behaves as though both FFT IF Gain and Swept IF Gain are set to Low regardless of the setting on the keys.
Initial S/W Revision	Prior to A.02.00

IF Gain Auto

Activates the auto rules for IF Gain. When Auto is active, the IF Gain is set to High Gain under any of the following conditions:

- The input attenuator is set to 0 dB
- The preamp is turned On and the frequency range is under 3.6 GHz

For other settings, Auto sets the IF Gain to Low Gain.

Key Path	Meas Setup, IF Gain
Remote Command	[:SENSe] :CHPower:IF:GAIN:AUTO [:STATe] ON OFF 1 0 [:SENSe] :CHPower:IF:GAIN:AUTO [:STATe] ?
Example	CHP:IF:GAIN:AUTO ON CHP:IF:GAIN:AUTO?
Couplings	When the auto attenuation exists (for example, with an electrical attenuator), IF Gain State differs depending on the condition. Auto sets IF Gain to High Gain under any of the following conditions: The input attenuator is set to 0 dB, or the preamp is turned on and the frequency range is under 3.6 GHz. For other conditions, Auto sets IF Gain to Low Gain.
Preset	OFF
State Saved	Saved in instrument state.
Range	Off On
Initial S/W Revision	Prior to A.02.00

IF Gain State

Selects the range of the IF Gain.

Key Path	Meas Setup, IF Gain
Remote Command	[:SENSe] :CHPower:IF:GAIN [:STATe] ON OFF 1 0 [:SENSe] :CHPower:IF:GAIN [:STATe] ?
Example	CHP:IF:GAIN ONCHP:IF:GAIN?
Notes	ON = high gain OFF = low gain

Couplings	When the auto attenuation exists (for example, with an electrical attenuator), IF Gain State differs depending on the condition. Auto sets IF Gain to High Gain under any of the following conditions: The input attenuator is set to 0 dB, or the preamp is turned on and the frequency range is under 3.6 GHz. For other conditions, Auto sets IF Gain to Low Gain.
Preset	OFF
State Saved	Saved in instrument state.
Range	Low Gain High Gain
Initial S/W Revision	Prior to A.02.00

Method

Turns the Root Raised Cosine (RRC) filter On or Off. The α value (roll off) for the filter is set to the value of the Filter Alpha parameter, and the RRC filter bandwidth is set to the Filter BW parameter.

Key Path	Meas Setup
Mode	SA, WCDMA, WIMAX OFDMA, DVB-T/H, DTMB (CTTB), ISDB-T, CMMB, LTE, LTETDD, Digital Cable TV, WLAN
Remote Command	<code>[:SENSe] :CHPower :FILTer [:RRC] [:STATe] OFF ON 0 1</code> <code>[:SENSe] :CHPower :FILTer [:RRC] [:STATe] ?</code>
Example	CHP:FILT OFF CHP:FILT?
Notes	This parameter is normally used when TETRA is selected as the Radio Std. You must be in the Spectrum Analysis mode, DVB-T/H mode, DTMB (CTTB) mode, ISDB-T mode, CMMB mode, LTE mode, LTE TDD mode, WLAN mode, WIMAX OFDMA mode or W-CDMA mode to use this command. Use :INSTrument:SElect to set the mode.
Dependencies	For CDMA2K mode, this key is blank. For 1xEVDO mode, this key is blank. For MSR mode, this key is blank. For LTE-Advanced FDD/TDD mode, this key is blank. For WLAN 802.11 ac (80 + 80 MHz), RRC Weighted is not supported .
Preset	OFF
State Saved	Saved in instrument state.
Range	Integ BW RRC Weighted
Initial S/W Revision	Prior to A.02.00
Modified at S/W Revision	A.02.00, A.03.00, A.10.00

Method

Turns the Root Raised Cosine (RRC) filter On or Off. The α value (roll off) for the filter is set to the value of the Filter Alpha parameter, and the RRC filter bandwidth is set to the Filter BW parameter.

Key Path	Meas Setup
Mode	SA, WCDMA,WIMAX OFDMA, DVB-T/H, DTMB (CTTB), ISDB-T, CMMB, LTE, LTETDD, Digital Cable TV, WLAN
Remote Command	<code>[:SENSe] :CHPower:FILTer [:RRC] [:STATe] OFF ON 0 1</code> <code>[:SENSe] :CHPower:FILTer [:RRC] [:STATe] ?</code>
Example	CHP:FILT OFF CHP:FILT?
Notes	This parameter is normally used when TETRA is selected as the Radio Std. You must be in the Spectrum Analysis mode, DVB-T/H mode, DTMB (CTTB) mode, ISDB-T mode, CMMB mode, LTE mode, LTE TDD mode, WLAN mode,WIMAX OFDMA mode or W-CDMA mode to use this command. Use :INSTRument:SElect to set the mode.
Dependencies	For CDMA2K mode, this key is blank. For 1xEVDO mode, this key is blank. For MSR mode, this key is blank. For LTE-Advanced FDD/TDD mode, this key is blank. For WLAN 802.11 ac (80 + 80 MHz), RRC Weighted is not supported .
Preset	OFF
State Saved	Saved in instrument state.
Range	Integ BW RRC Weighted
Initial S/W Revision	Prior to A.02.00
Modified at S/W Revision	A.02.00, A.03.00, A.10.00

Filter Alpha

Inputs the alpha value for the Root Raised Cosine (RRC) filter.

Key Path	Meas Setup, Method
Mode	SA, WCDMA,WIMAX OFDMA, DVB-T/H, DTMB (CTTB), ISDB-T, CMMB, LTE, LTETDD, Digital Cable TV, WLAN
Remote Command	<code>[:SENSe] :CHPower:FILTer [:RRC] :ALPHa <real></code> <code>[:SENSe] :CHPower:FILTer [:RRC] :ALPHa ?</code>
Example	CHP:FILT:ALPH 0.5 CHP:FILT:ALPH?
Notes	This parameter is normally used when TETRA is selected as the Radio Std. You must be in the Spectrum Analysis mode, DVB-T/H mode, DTMB (CTTB) mode, ISDB-T mode, CMMB mode, LTE mode, LTE TDD mode, WLAN mode,WIMAX OFDMA mode or W-CDMA mode to use this command. Use :INSTRument:SElect to set the mode.

Dependencies	For CDMA2K mode, this key is blank. For 1xEVDO mode, this key is blank. For MSR mode, this key is blank. For LTE-Advanced FDD/TDD mode, this key is blank
Preset	SA, WCDMA, , WIMAX OFDMA, DVB-T/H, ISDB-T, CMMB, LTE, LTETDD, WLAN: 0.22 DTMB (CTTB): 0.05 Digital Cable TV: 0.15
State Saved	Saved in instrument state.
Min	0.01
Max	1.00
Initial S/W Revision	Prior to A.02.00
Modified at S/W Revision	A.02.00, A.03.00, A.10.00

Filter BW

Inputs the Root Raised Cosine (RRC) filter bandwidth. Normally, the filter bandwidth is the same as the symbol rate of the signal.

Key Path	Meas Setup, Method, RRC Weighted
Mode	SA, WCDMA, WIMAX OFDMA, DVB-T/H, DTMB (CTTB), ISDB-T, CMMB, LTE, LTETDD, Digital Cable TV, WLAN
Remote Command	<code>[:SENSe] :CHPower :FILTer [:RRC] :BANDwidth <real></code> <code>[:SENSe] :CHPower :FILTer [:RRC] :BANDwidth?</code>
Example	CHP:FILT:BAND 10MHz CHP:FILT:BAND?
Notes	This parameter is normally used when TETRA is selected as the Radio Std. You must be in the Spectrum Analysis mode, DVB-T/H mode, DTMB (CTTB) mode, ISDB-T mode, CMMB mode, LTE mode, LTE TDD mode, WLAN mode, WIMAX OFDMA mode or W-CDMA mode to use this command. Use :INSTrument:SElect to set the mode.
Dependencies	For CDMA2K mode, this key is blank. For 1xEVDO mode, this key is blank. For MSR mode, this key is blank. For LTE-Advanced FDD/TDD, this key is blank.
Preset	SA, LTE, LTETDD: 3.84MHz WCDMA: 3.84MHz WIMAX OFDMA: 10MHz DVB-T/H: 8MHz DTMB (CTTB): 7.56MHz ISDB-T: 5.6MHz CMMB: 7.512MHz

	Digital Cable TV: 6.9MHz WLAN: if Radio Std is 802.11a/g(OFDM/DSSS-OFDM): 16.6 MHz if Radio Std is 802.11b: 22 MHz if Radio Std is 802.11n(20MHz): 17.8 MHz if Radio Std is 802.11n(40MHz): 36.6 MHz
State Saved	Saved in instrument state.
Min	100 Hz
Max	100 MHz
Backwards Compatibility SCPI	[:SENSe] :CHPower:FILTer [:RRC] :BWIDth
Initial S/W Revision	Prior to A.02.00
Modified at S/W Revision	A.02.00, A.03.00, A.10.00

Limits

Accesses the Limits menu that allows you to set up the test limit for channel power or power spectral density.

When DVB-T/H mode or DTMB (CTTB) mode is selected or DVB-T radio standard is selected in SA mode, this functionality is disabled and input signal will be compared against pre-defined spectrum mask, instead. See 1.3.2 Limit Line Mask for DVB-T for more details.

In DVB-T/H, DTMB (CTTB), ISDB-T, CMMB mode, this key is blank. If DVB-T is selected as current Radio Std in SA Mode, this key is grayed out.

In MSR, LTE-Advanced FDD/TDD mode, this feature is not supported and the key is blank because the power of each carrier may be different.

Key Path	Meas Setup
Initial S/W Revision	A.10.00

Power Limit

If Power Limit is on, Power Limit is used as threshold which can judge whether the real measured channel power can be passed or not. If real measured channel power exceeds Power Limit, channel power test fails, otherwise, it passes. If Power Limit is off, channel power test is always passed.

Key Path	Meas Setup, Limits
Mode	SA, WCDMA, C2K, WIMAX OFDMA, 1xEVDO, LTE, LTETDD, Digital Cable TV, WLAN
Remote Command	:CALCulate:CHPower:LIMit:POWer <ampl> :CALCulate:CHPower:LIMit:POWer? :CALCulate:CHPower:LIMit:POWer:STATe OFF ON 0 1

	:CALCulate:CHPower:LIMit:POWer:STATe?
Example	CALC:CHP:LIM:POW 16.00 CALC:CHP:LIM:POW? CALC:CHP:LIM:POW:STAT ON CALC:CHP:LIM:POW:STAT?
Notes	This parameter and PSD Limit can determine Pass/Fail criteria. If ((power limit = On) and (PSD limit= Off)) Pass if (power test passes) Fail if (power test fails) If ((power limit = On) and (PSD limit= On)) Pass if (both power test and PSD test pass) Fail if (either of power test or PSD test fails) If ((power limit = Off) and (PSD limit= On)) Pass if (PSD test passes) Fail if (PSD test fails) If ((power limit = Off) and (PSD limit= Off)) Always Pass For MSR mode, this key is blank. For LTE-Advanced FDD/TDD mode, this key is blank. For WLAN 802.11ac (80 MHz + 80 MHz), the power test and the PSD test are performed to both carriers. Which means the power (or PSD) readouts of both carriers should be compared with the power (or PSD) limit individually, and the test passes only when both values are lower than the limit.
Preset	16.00 SA, WCDMA, C2K, WIMAX OFDMA, 1xEVDO, DVB-T/H, DTMB (CTTB), LTE, LTETDD, Digital Cable TV: OFF WLAN: ON
State Saved	Saved in instrument state.
Min	-200.0
Max	200.0
Initial S/W Revision	A.10.00

PSD Limit

If PSD (power spectral density) Limit is ON, PSD Limit is used as threshold which can judge whether the real measured PSD can be passed or not. If real measured PSD exceeds PSD Limit, PSD test fails, otherwise, it passes. If PSD is off, PSD test is always passed.

Key Path	Meas Setup, Limits
Mode	SA, WCDMA, C2K, WIMAX OFDMA, 1xEVDO, LTE, LTETDD, Digital Cable TV, WLAN
Remote Command	:CALCulate:CHPower:LIMit:PSDensity <real> :CALCulate:CHPower:LIMit:PSDensity?

	:CALCulate:CHPower:LIMit:PSDensity:STATE OFF ON 0 1 :CALCulate:CHPower:LIMit:PSDensity:STATE?
Example	CALC:CHP:LIM:PSD 4.00 CALC:CHP:LIM:PSD? CALC:CHP:LIM:POW:STAT ON CALC:CHP:LIM:POW:STAT?
Notes	This parameter and Power Limit can determine Pass/Fail criteria. If ((power limit = On) and (PSD limit= Off)) Pass if (power test passes) Fail if (power test fails) If ((power limit = On) and (PSD limit= On)) Pass if (both power test and PSD test pass) Fail if (either of power test or PSD test fails) If ((power limit = Off) and (PSD limit= On)) Pass if (PSD test passes) Fail if (PSD test fails) If ((power limit = Off) and (PSD limit= Off)) Always Pass For MSR mode, this key is blank. For LTE-Advanced FDD/TDD mode, this key is blank. For WLAN 802.11ac (80 MHz + 80 MHz), the power test and the PSD test are performed to both carriers. Which means the PSD (or power) readouts of both carriers should be compared with the PSD (or power) limit individually, and the test passes only when both values are lower than the limit.
Couplings	The value is automatically converted when PSD Unit is changed.
Preset	4.00 SA, WCDMA, C2K, WIMAX OFDMA, 1Xevdo, LTE, LTETDD, Digital Cable TV: OFF WLAN: ON
State Saved	Saved in instrument state.
Min	-200.0
Max	200.0
Initial S/W Revision	A.10.00

Power Limit Fail (remote command only)

The command is query only and used to query if power test passes or fails. When DVB-T/H mode or DTMB (CTTB) mode is selected or DVB-T radio standard is selected in SA mode, this query SCPI command does not make any sense.

Remote Command	:CALCulate:CHPower:LIMit:POWer:FAIL?
-----------------------	--------------------------------------

Example	CALC:CHP:LIM:POW:FAIL?
Notes	This command is query only. When Power Limit is off, the returned value is always 0 (pass). When Power Limit is on, the returned value is 0(pass) while power test passes and 1 (fail) while power test fails. In MSR, LTE-Advanced FDD/TDD mode, this feature is not supported.
Initial S/W Revision	A.10.00

PSD Limit Fail (remote command only)

The command is query only and used to query if PSD test passes or fails. When DVB-T/H mode or DTMB (CTTB) mode is selected or DVB-T radio standard is selected in SA mode, this query SCPI command does not make any sense.

Remote Command	:CALCulate:CHPower:LIMit:PSD:FAIL?
Example	CALC:CHP:LIM:PSD:FAIL?
Notes	This command is query only. When PSD Limit is off, the returned value is always 0 (pass). When PSD Limit is on, the returned value is 0(pass) while PSD test passes and 1 (fail) while PSD test fails.
Initial S/W Revision	A.10.00

PSD Unit

Sets the unit bandwidth for Power Spectral Density. The available units are dBm/Hz and dBm/MHz.

Key Path	Meas Setup
Mode	SA, WCDMA, WIMAX OFDMA, 1xEVDO, DVB-T/H, DTMB (CTTB), LTE, LTE-TDD, Digital Cable TV, WLAN, MSR, LTE-AFDD, LTE-TDD
Remote Command	:UNIT:CHPower:POWer:PSD DBMHZ DBMMHZ :UNIT:CHPower:POWer:PSD?
Example	UNIT:CHP:POW:PSD DBMMHZ UNIT:CHP:POW:PSD?
Couplings	When the PSD unit is changed, the PSD result of the "MEAS READ FETCH:CHP1?" is also changed by the PSD unit basis (in either dBm/Hz or dBm/MHz).
Preset	DBMHZ WLAN: DBMMHZ
State Saved	Saved in instrument state.
Range	dBm/Hz dBm/MHz
Initial S/W Revision	Prior to A.02.00
Modified at S/W Revision	A.02.00, A.03.00

Meas Preset

Restores all the measurement parameters to their default values.

Key Path	Meas Setup
Mode	SA, WCDMA, C2K, WIMAX OFDMA, 1xEVDO, DVB-T/H, DTMB (CTTB), ISDB-T, CMMB, LTE, LTETDD, Digital Cable TV, WLAN, MSR, LTEAFDD, LTEATDD
Remote Command	:CONFigure:CHPower
Example	CONF:CHP
Initial S/W Revision	Prior to A.02.00
Modified at S/W Revision	A.02.00, A.03.00

Mode

See "Mode" on page 316

Mode Preset

Returns the active mode to a known state.

Mode Preset does the following for the currently active mode:

- Aborts the currently running measurement.
- Brings up the default menu for the mode, with no active function.
- Sets measurement Global settings to their preset values for the active mode only.
- Activates the default measurement.
- Brings up the default menu for the mode.
- Clears the input and output buffers.
- Sets Status Byte to 0.

Mode Preset does not:

- Cause a mode switch
- Affect mode persistent settings
- Affect system settings

See "[How-To Preset](#)" on page 557 for more information.

Key Path	Front-panel key
Remote Command	:SYSTem:PRESet
Example	:SYST:PRES
Notes	*RST is preferred over :SYST:PRES for remote operation. *RST does a Mode Preset, as done by the :SYST:PRES command, and it sets the measurement mode to Single measurement rather than Continuous for optimal remote control throughput. Clears all pending OPC bits. The Status Byte is set to 0.
Couplings	A Mode Preset aborts the currently running measurement, activates the default measurement, and gets the mode to a consistent state with all of the default couplings set.
Backwards Compatibility Notes	In the X-Series, the legacy "Factory Preset" has been replaced with Mode Preset, which only presets the currently active mode, not the entire instrument. In the X-Series, the way to preset the entire instrument is by using System, Restore System Defaults All, which behaves essentially the same way as restore System Defaults does on ESA and PSA. There is also no "Preset Type" as there is on the PSA. There is a green Mode Preset front-panel key that does a Mode Preset and a white-with-green-letters User Preset front-panel key that does a User Preset. The old PRESet:TYPE command is ignored (without generating an error), and SYST:PRES without a parameter does a Mode Preset, which should cover most backward code compatibility issues. The settings and correction data under the Input/Output front-panel key (examples: Input Z Corr, Ext Amp Gain, etc.) are no longer part of any Mode, so they will not be preset by a Mode Preset. They are preset using Restore Input/Output Defaults, Restore System Defaults All. Note that because User Preset does a Recall State, and all of these settings are saved in State, they ARE recalled when using

	User Preset.
Initial S/W Revision	Prior to A.02.00

How-To Preset

The table below shows all possible presets, their corresponding SCPI commands and front-panel access (key paths). Instrument settings depend on the current measurement context. Some settings are local to the current measurement, some are global (common) across all the measurements in the current mode, and some are global to all the available modes. In a similar way, restoring the settings to their preset state can be done within the different contexts.

Auto Couple - is a measurement local key. It sets all Auto/Man parameter couplings in the measurement to Auto. Any Auto/Man selection that is local to other measurements in the mode will not be affected.

Meas Preset - is a measurement local key. Meas Preset resets all the variables local to the current measurement except the persistent ones.

Mode Preset - resets all the current mode's measurement local and measurement global variables except the persistent ones.

Restore Mode Defaults - resets ALL the Mode variables (and all the Meas global and Meas local variables), including the persistent ones.

Type Of Preset	SCPI Command	Front Panel Access
Auto Couple	:COUPlE ALL	Auto Couple front-panel key
Meas Preset	:CONFIgure:<Measurement>	Meas Setup Menu
Mode Preset	:SYSTem:PRESet	Mode Preset (green key)
Restore Mode Defaults	:INSTRument:DEFault	Mode Setup Menu
Restore All Mode Defaults	:SYSTem:DEFault MODEs	System Menu; Restore System Default Menu
*RST	*RST	not possible (Mode Preset with Single)
Restore Input/Output Defaults	:SYSTem:DEFault INPut	System Menu; Restore System Default Menu
Restore Power On Defaults	:SYSTem:DEFault PON	System Menu; Restore System Default Menu
Restore Alignment Defaults	:SYSTem:DEFault ALIGn	System Menu; Restore System Default Menu
Restore Miscellaneous Defaults	:SYSTem:DEFault MISC	System Menu; Restore System Default Menu
Restore All System Defaults	:SYSTem:DEFault [ALL] :SYSTem:PRESet:PERSistent	System Menu; Restore System Default Menu
User Preset	:SYSTem:PRESet:USER	User Preset Menu
User Preset All Modes	:SYSTem:PRESet:USER:ALL	User Preset Menu

Power On Mode Preset	:SYSTem:PON:TYPE MODE	System Menu
Power On User Preset	:SYSTem:PON:TYPE USER	System Menu
Power On Last State	:SYSTem:PON:TYPE LAST	System Menu

Preset Type (Remote Command Only)

As stated in the Backward Compatibility section, to be compatible with ESA/PSA the PRESet:TYPE command will be implemented as a no-op.

Mode	All
Remote Command	:SYSTem:PRESet:TYPE FACTory MODE USER :SYSTem:PRESet:TYPE?
Example	:SYST:PRESet:TYPE FACT
Notes	This command is supported for backward compatibility only. It is a no-op which does not change the behavior of any preset operation.
Preset	This is unaffected by Preset but is set to Mode on a "Restore System Defaults->All"
State Saved	No
Initial S/W Revision	Prior to A.02.00

Mode Setup

See ["Mode Setup" on page 347](#)

Peak Search

Places the selected marker on the trace point with the maximum y-axis value. Pressing Peak Search with the selected marker Off causes the selected marker to be set to Normal, then a peak search is immediately performed.

Key Path	Front panel key
Mode	SA, WCDMA, C2K, WIMAX OFDMA, 1xEVDO, DVB-T/H, DTMB (CTTB), ISDB-T, CMMB, LTE, LTETDD, Digital Cable TV, WLAN, MSR, LTEAFDD, LTEATDD
Remote Command	:CALCulate:CHPower:MARKer[1] 2 ... 12:MAXimum
Example	CALC:CHP:MARK2:MAX
Initial S/W Revision	Prior to A.02.00
Modified at S/W Revision	A.02.00, A.03.00

Print

See "Print" on page 365

Quick Save

The Quick Save front-panel key repeats the most recent save that was performed from the Save menu, with the following exceptions:

- Register saves are not remembered as Saves for the purpose of the Quick Save function
- If the current measurement does not support the last non-register save that was performed, an informational message is generated, “File type not supported for this measurement”

Quick Save repeats the last type of qualified save (that is, a save qualified by the above criteria) in the last save directory by creating a unique filename using the Auto File Naming algorithm described below.

If Quick Save is pressed after startup and before any qualified Save has been performed, the Quick Save function performs a Screen Image save using the current settings for Screen Image saves (current theme, current directory), which then becomes the “last save” for the purpose of subsequent Quick Saves.

The Auto File Naming feature automatically generates a file name for use when saving a file. The filename consists of a prefix and suffix separated by a dot, as is standard for the Windows® file system. A default prefix exists for each of the available file types:

Type	Default Prefix	Menu
State	State_	(Save/Recall)
Trace + State	State_	(Save/Recall)
Screen	Screen_	(Save/Recall)
Amplitude Corrections	Ampcor_	(Import/Export)
Traces	Trace_	(Import/Export)
Limit Lines	LLine_	(Import/Export)
Measurement Result	MeasR_	(Import/Export)
Capture Buffer	CapBuf_	(Import/Export)

A four digit number is appended to the prefix to create a unique file name. The numbering sequence starts at 0000 within each Mode for each file type and updates incrementally to 9999, then wraps to 0000 again. It remembers where it was through a Mode Preset and when leaving and returning to the Mode. It is reset by Restore Misc Defaults and Restore System Defaults and subsequent running of the instrument application. So, for example, the first auto file name generated for State files is State_0000.state. The next is State_0001, and so forth.

One of the key features of Auto File Name is that we guarantee that the Auto File Name will never conflict with an existing file. The algorithm looks for the next available number. If it gets to 9999, then it looks for holes. If it find no holes, that is no more numbers are available, it gives an error.

For example, if when we get to State_0010.state there is already a State_0010.state file in the current directory, it advances the counter to State_0011.state to ensure that no conflict will exist (and then it verifies that State_0011.state also does not exist in the current directory and advances again if it does, and so forth).

If you enter a file name for a given file type, then the prefix becomes the filename you entered instead of the default prefix, followed by an underscore. The last four letters (the suffix) are the 4-digit number.

For example, if you save a measurement results file as “fred.csv”, then the next auto file name chosen for a measurement results save will be fred_0000.csv.

NOTE

Although 0000 is used in the example above, the number that is used is actually the current number in the Meas Results sequence, that is, the number that would have been used if you had not entered your own file name.

NOTE

If the filename you entered ends with _dddd, where d=any number, making it look just like an auto file name, then the next auto file name picks up where you left off with the suffix being dddd + 1.

Key Path	Front-panel key
Notes	No remote command for this key specifically.
Initial S/W Revision	Prior to A.02.00

Recall

In the LTE TDD mode, four types of recall functions are available under the Data menu: “Limit Mask”, “E-UTRA Test Model”, “Signal Studio Setup” and “Vector Signal Analyzer”. “Limit Mask” enables setting of a preset limit mask for Power Suite-based measurements, and currently it is available for the SEM/ACP measurements with the LTE TDD mode. Recalling “E-UTRA Test Model” sets complicated RB settings for each Test Model for the Modulation Analysis and Conformance EVM measurements. Recalling “Signal Studio Setup” or “89600 Vector Signal Analyzer” enables you to recall parameters which have been set and saved on the external platform.

Key Path	Front Panel
Mode	LTETDD
Initial S/W Revision	Prior to A.02.00
Modified at S/W Revision	A.06.00

State

The Recall State menu lets you choose a register or file from which to recall the state.

The content of a state file includes all of the settings and data required to return the analyzer as closely as possible to the Mode it was in, with the exact settings that were in place, when the save occurred. The Mode settings in each state file include the settings that are affected by Mode Preset, as well as the additional settings affected by Restore Mode Defaults; all of the Mode’s settings. In addition, all of the settings of the Input/Output system are included, even though they are outside of the Mode’s state, because they are needed to restore the complete setup. Persistent System settings (for example, GPIB address) are not affected by either a Mode Preset or Restore Mode Defaults, nor are they included in a saved State file.

Since each state file is only for one Mode, the settings for other Modes are unaffected when it is loaded. Recall State will cause a mode switch if the state being recalled is not from the current active mode.

After the recall completes, the message "File <filename> recalled" or “Recalled State Register <register number>” is displayed.

For rapid recalls, the State menu lists 16 registers that you can choose from to recall. Pressing a Register key initiates the recall. You can also select a file from which to recall.

The default path for all State Files is:

My Documents\<<mode name>\state

where <mode name> is the parameter used to select the mode with the INST:SEL command (for example, SA for the Spectrum Analyzer).

See "[More Information](#)" on page 565.

Key Path	Recall
Mode	All

Remote Command	:MMEMory:LOAD:STATe <filename>
Example	:MMEM:LOAD:STAT "myState.state" This recalls the file myState.state on the default path
Example	MMEM:LOAD:STAT "MyStateFile.state" This loads the state file data (on the default file directory path) into the instrument state.
Notes	<p>When you pick a file to recall, the analyzer first verifies that the file is recallable in the current instrument by checking the software version and model number of the instrument. If everything matches, a full recall proceeds by aborting the currently running measurement, clearing any pending operations, and then loading the State from the saved state file. You can open state files from any mode, so recalling a State file switches to the mode that was active when the save occurred. After switching to the mode of the saved state file, mode settings and data (if any for the mode) are loaded with values from the saved file. The saved measurement of the mode becomes the newly active measurement and the data relevant to the measurement (if there is any) is recalled.</p> <p>If there is a mismatch between file version or model number or instrument version or model number, the recall function tries to recall as much as possible and returns a warning message. It may limit settings that differ based on model number, licensing or version number.</p> <p>After recalling the state, the Recall State function does the following:</p> <ul style="list-style-type: none"> • Makes the saved measurement for the mode the active measurement. • Clears the input and output buffers. • Status Byte is set to 0. • Executes a *CLS <p>If the file specified is empty an error is generated. If the specified file does not exist, another error is generated. If there is a mismatch between the file and the proper file type, an error is generated. If there is a mismatch between file version or model number or instrument version or model number, a warning is displayed. Then it returns to the State menu and File Open dialog goes away.</p> <p>After the Recall, the analyzer exits the Recall menu and returns to the previous menu.</p>
Backwards Compatibility SCPI	:MMEMory:LOAD:STATe 1,<filename> For backwards compatibility, the above syntax is supported. The "1" is simply ignored.
Initial S/W Revision	Prior to A.02.00

More Information

In measurements that support saving Traces, for example, Swept SA, the Trace data is saved along with the State in the State file. When recalling the State, the Trace data is recalled as well. Traces are recalled exactly as they were stored, including the writing mode and update and display modes. If a Trace was updating and visible when the State was saved, it will come back updating and visible, and its data will be rewritten right away. When you use State to save and recall traces, any trace whose data must be preserved should be placed in View or Blank mode before saving.

The following table describes the Trace Save and Recall possibilities:

You want to recall state and one trace's data, leaving other traces unaffected.	Save Trace+State from 1 trace. Make sure that no other traces are updating (they should all be in View	On Recall, specify the trace you want to load the one trace's data into. This trace will load in View.
---	--	--

	or Blank mode) when the save is performed.	All other traces' data will be unaffected, although their trace mode will be as it was when the state save was performed.
You want to recall all traces	Save Trace+State from ALL traces.	On Recall, all traces will come back in View (or Blank if they were in Blank or Background when saved)
You want all traces to load exactly as they were when saved.	Save State	On recall, all traces' mode and data will be exactly as they were when saved. Any traces that were updating will have their data immediately overwritten.

From File...

When you press “From File”, the analyzer brings up a Windows dialog and a menu entitled “File Open.” This menu allows you to navigate to the various fields in the Windows dialog without using a keyboard or mouse. The Tab and Arrow keys can also be used for dialog navigation.

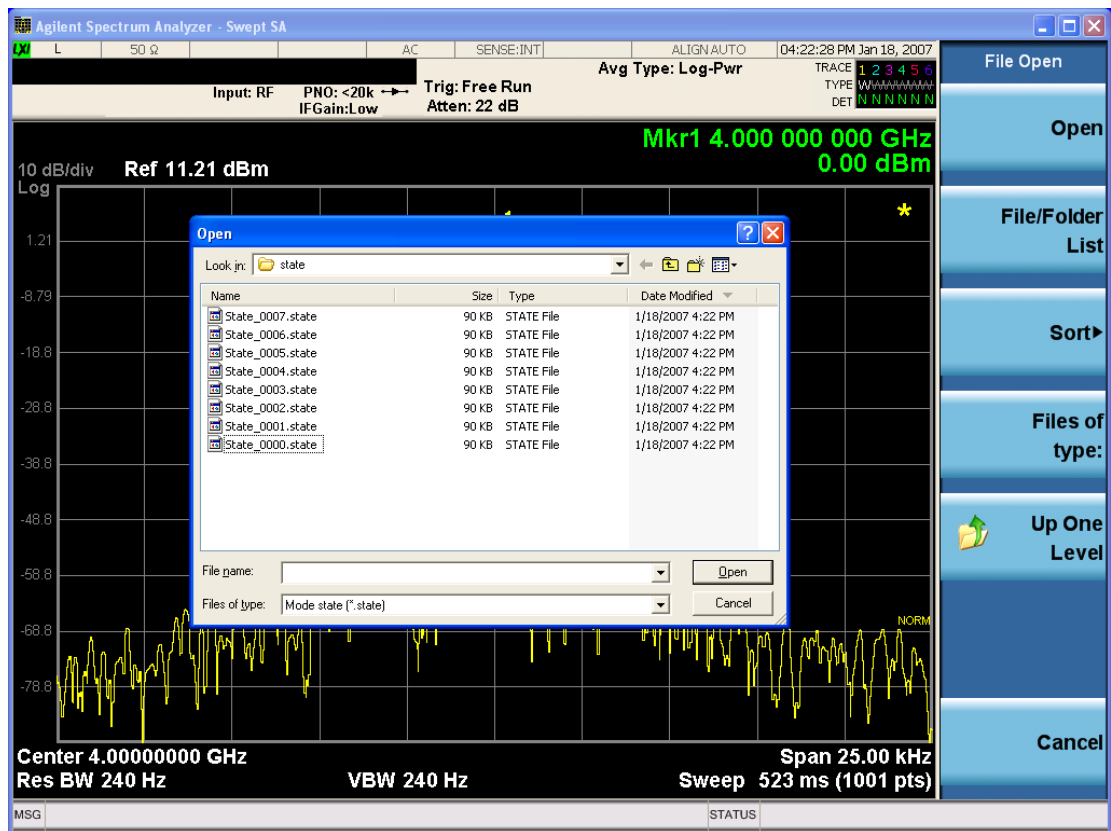

Listed below are the functions of the various fields in the dialog, and the corresponding softkeys:

Open

Performs the recall of the specified file. While the recall is being performed, the floppy icon appears briefly in the Meas bar.

File/Folder List

Enables you to navigate to the center of the dialog that contains the list of files and folders. Once here you can get information about the file and use the tab keys to navigate to the other fields in the dialog, such as Look In.

Look In

The Look In field shows the path from which the file will be recalled and allows you to change the path using the up and down arrow keys to navigate to other paths; the Enter key to open a directory; and the Backspace key to go back one directory. The **Look In field** first uses the last path from the Save As dialog **Save In:** path for that same file type. There is no softkey for directly navigating to the Look In field, but you can use the left tab to get here from the File/Folder List.

User specified paths are remembered when you leave and return to a Mode and are reset back to the default using Restore Mode Defaults.

Sort

Accesses a menu that enables you to sort the files within the File Open dialog. Only one sorting type can be selected at a time and the sorting happens immediately. The sorting types are By Date, By Name, By extension, and By Size.

Files of Type

This field shows the file suffix for the type of file you have selected to recall. For example, if you navigated here while recalling State, "Mode state (*.state)" is in the field. If you navigated here while recalling Trace, ""Mode state (*.trace)" is in the field. If you navigated here while importing a trace data file, "Trace Data (*.csv)" is in the field. For some file types, there is more than one choice in the dropdown menu, which you can select by using the up and down arrow keys and Enter.

Up One Level

This key corresponds to the icon of a folder with the up arrow that is in the tool bar of the dialog. When pressed, it causes the file and folder list to navigate up one level in the directory structure. The Backspace key does the same thing.

Cancel

This key corresponds to the Cancel selection in the dialog. It causes the current **Open** request to be cancelled. The ESC key does the same thing.

Key Path	Recall, State
Notes	Brings up the Open dialog for recalling a State Save Type
Initial S/W Revision	Prior to A.02.00

Edit Register Names

You may enter a custom name on any of the Register keys, to help you remember what you are using that state to save. To do this, press the Edit Register Names key, choose the register whose name you wish to edit, and then enter the desired label using the Alpha Editor or an external PC keyboard.

The maximum number of characters that can be added is 30. In most cases, 30 characters will fit on two lines of the key.

For more information and the SCPI command, see Edit Register Names under the Save, State function.

Key Path	Recall, State
Mode	All
Dependencies	N9060A-7FP or N9060B-2FP license required to edit the register names. When the feature is not licensed, sending the SCPI command generates an error, -221, "Settings conflict;Option not available"
Initial S/W Revision	A.11.00

Register 1 thru Register 16

Selecting any one of these register keys causes the State of the mode from the specified Register to be recalled. Each of the register keys annotates whether it is empty or at what date and time it was last modified. In addition, you can use the Edit Register Names key under Save, State to enter custom names for each register.

Registers are shared by all modes, so recalling from any one of the registers will cause a mode switch to the mode that was active when the save to the Register occurred.

Although these 16 registers are the only registers available from the front panel, there are 128 state registers available in the instrument. Registers 17-128 are only available from the SCPI interface, using the *RCL command.

After the recall completes, the message "Register <register number> recalled" appears in the message bar. If you are in the Spectrum Analyzer Mode, and you are recalling a register that was saved in the Spectrum Analyzer Mode, then after the recall, you will still be in the Recall Register menu. If the Recall causes you to switch modes, then after the Recall, you will be in the Frequency menu.

If a requested register is empty an error is generated.

Key Path	Recall, State
Example	*RCL 1
Range	1-16 from front panel, 1-128 from SCPI
Readback	Date and time with seconds resolution are displayed on the key OR A custom name of up to 30 characters entered using the Save, State,Edit Register Names key OR “(empty)” if no prior save operation has been performed to this register.
Initial S/W Revision	Prior to A.02.00
Modified at S/W Revision	Prior to A.11.00

Register 1 thru Register 16

Selecting any one of these register keys causes the State of the mode from the specified Register to be recalled. Each of the register keys annotates whether it is empty or at what date and time it was last modified. In addition, you can use the Edit Register Names key under Save, State to enter custom names for each register.

Registers are shared by all modes, so recalling from any one of the registers will cause a mode switch to the mode that was active when the save to the Register occurred.

Although these 16 registers are the only registers available from the front panel, there are 128 state registers available in the instrument. Registers 17–128 are only available from the SCPI interface, using the *RCL command.

After the recall completes, the message "Register <register number> recalled" appears in the message bar. If you are in the Spectrum Analyzer Mode, and you are recalling a register that was saved in the Spectrum Analyzer Mode, then after the recall, you will still be in the Recall Register menu. If the Recall causes you to switch modes, then after the Recall, you will be in the Frequency menu.

If a requested register is empty an error is generated.

Key Path	Recall, State
Example	*RCL 1
Range	1–16 from front panel, 1–128 from SCPI
Readback	Date and time with seconds resolution are displayed on the key OR A custom name of up to 30 characters entered using the Save, State, Edit Register Names key OR “(empty)” if no prior save operation has been performed to this register.
Initial S/W Revision	Prior to A.02.00
Modified at S/W Revision	Prior to A.11.00

Recall

In the LTE TDD mode, four types of recall functions are available under the Data menu: “Limit Mask”, “E-UTRA Test Model”, “Signal Studio Setup” and “Vector Signal Analyzer”. “Limit Mask” enables setting of a preset limit mask for Power Suite-based measurements, and currently it is available for the SEM/ACP measurements with the LTE TDD mode. Recalling “E-UTRA Test Model” sets complicated RB settings for each Test Model for the Modulation Analysis and Conformance EVM measurements. Recalling “Signal Studio Setup” or “89600 Vector Signal Analyzer” enables you to recall parameters which have been set and saved on the external platform.

Key Path	Front Panel
Mode	LTETDD
Initial S/W Revision	Prior to A.02.00
Modified at S/W Revision	A.06.00

Import Trace Data

Enables you to import previously saved trace data into a Data Register and optionally display it. Selecting this key displays a menu that enables you to select the destination data register, and also enables you to choose whether or not to display the recalled data in the currently selected trace. After making these selections, select Open... and use the file dialog to select the file you want to recall.

Recalling trace data into an already used Data Register overwrites the previous data. If the data register is displayed on any trace, the display is updated to reflect the new data.

The SCPI command

```
:MMEM:LOAD:TRAC:DATA D1|D2|D3|D4|D5|D6,<filename>
```

recalls data into a specified register, but does not display it in the selected trace. Use the command

```
:DISP:<meas>:TRAC<n>:FEED D1|D2|D3|D4|D5|D6
```

to display the register in the desired trace.

It is possible to recall trace data saved by other VXA measurements, or measurements made using the LTE, LTETDD, iDEN, or 89601 applications.

Key Path	Recall, Data (Import)
Mode	VSA, LTE, LTETDD, IDEN
Remote Command	:MMEMory:LOAD:TRACe:DATA D1 D2 D3 D4 D5 D6,<filename>[,CSV TXT SDF MAT4 MAT HDF5 BIN]
Example	:MMEM:LOAD:TRAC:DATA D1,"Trc1.txt",TXT
Notes	<p>The Open: dialog box has the following filter options when you are recalling trace data::</p> <ul style="list-style-type: none"> • CSV (Comma delimited) (*.csv) • SDF (Fast) (*.sdf;*.dat) • Text (Tab delimited) (*.txt) <p>The file must have the same format as that created by the Export Recorded Data command.</p> <p>The SCPI command has an optional file format parameter. If you do not include this parameter in the SCPI command, the file format is determined by the file name extension. If no file extension is recognized, the file is scanned to determine the format.</p> <p>If you are not licensed to recall a particular file type, then error -203.9010 is returned. If the file format cannot be determined or the file cannot be recalled successfully, then error -250.5290 is returned. If the recall is successful, then advisory 0.1600 is shown.</p>
State Saved	No
Readback	Data 1 Data 2 Data 3 Data 4 Data 5 Data 6

Data 1

Selects the Data 1 register as the destination for the imported data.

Key Path	Recall, Data (Import), Trace (to)
Mode	VSA, LTE, LTETDD, IDEN

Data 2

Selects the Data 2 register as the destination for the imported data.

Key Path	Recall, Data (Import), Trace (to)
Mode	VSA, LTE, LTETDD, IDEN

Data 3

Selects the Data 3 register as the destination for the imported data.

Key Path	Recall, Data (Import), Trace (to)
Mode	VSA, LTE, LTETDD, IDEN

Data 4

Selects the Data 4 register as the destination for the imported data.

Key Path	Recall, Data (Import), Trace (to)
Mode	VSA, LTE, LTETDD, IDEN

Data 5

Selects the Data 5 register as the destination for the imported data..

Key Path	Recall, Data (Import), Trace (to)
Mode	VSA, LTE, LTETDD, IDEN

Data 6

Selects the Data 6 register as the destination for the imported data.

Key Path	Recall, Data (Import), Trace (to)
Mode	VSA, LTE, LTETDD, IDEN

Display in Selected Trace

Enables you to select whether the recalled trace data is displayed in the current Trace.

Key Path	Recall, Data (Import), Trace (to)
----------	-----------------------------------

Mode	VSA, LTE, LTETDD, IDEN
State Saved	No

Signal Studio Setup

This key allows you to recall the Agilent Signal Studio setup file created on the Signal Studio (N7625B). This key is valid only for the Mod Analysis measurement. For E-TM test model signal, please use corresponding EVM setup file under My Documents\LTETDD\data\evmsetup.

For the supported carrier types, see the table below.

Signal Studio	Carrier Type
N7625B Signal Studio for 3GPP LTE TDD	Advanced LTE TDD(2009-03)
	Advanced LTE TDD(2009-12)
	Basic LTE TDD(2009-03)
	Basic LTE TDD(2009-12)

File Location and Extension

File location: "My Documents\LTETDD\data"

File type: xml

File extension: .scp

You need to place the Signal Studio Setup file created on N7625B in the above directory in advance. Pressing OPEN under the Import Data menu will open this directory from which you can select the setup file.

Example:

File Location: My Documents\LTETDD\data

File Name: Uplink PUSCH.scp

Key Path	Recall, Data
Mode	LTETDD
Remote Command	MMEemory:LOAD:SSSetup <string>
Example	MME:LOAD:SSS "Uplink PUSCH.scp"
Notes	Sets of parameters related to Signal Studio Setup are overwritten by the contents of the setup file.
Initial S/W Revision	A.06.00

89601 VSA Setup

Enables you to import the 89600 Vector Signal Analyzer Setup file created using the 89600 Vector Signal Analyzer Option BHE (LTE TDD). This key is valid only for the Mod Analysis measurement.

File Location and Extension

File location: “My Documents\LTETDD\data”

File type: text file

File extension: .set, .setx

Place the 89600 Vector Signal Analyzer Setup file that you saved on 89600 in the above directory. When you select OPEN under the Import Data menu, the directory opens enabling you to select your setup file.

Example:

File Location: My Documents\LTETDD\data

File Name: Uplink PRACH.set

Key Path	Recall, Data
Mode	LTETDD
Remote Command	MME ^M o ^R y:LOAD:VSAS ^S etup <string>
Example	MME:LOAD:VSAS "Uplink PRACH.set"
Notes	Sets of parameters related to Vector Signal Analyzer Setup are overwritten by the contents of the setup file.
Initial S/W Revision	A.06.00
Modified at S/W Revision	A.10.00

Masks

This key allows you to recall a preset mask file from the list. The preset mask file contains configuration for only Carrier, Offset, Limit settings and the preset profile BW. Any set of values not specified by the preset mask file will not be overwritten.

You cannot change or create the preset mask file since it is a binary file. This key is valid for the Spectrum Emission Mask and ACP measurements.

File location: “My Documents\LTETDD\data\masks”

Note that “My Documents” is an alias to a directory and its place differs depending on which user is logged in. At XSA start up, XSA will overwrite all of the limit mask files to the current user’s “My Documents\LTETDD\data\masks” each time.

File type: Binary

Filename: The filename follows the rule below, in which the word is connected with underscores.

<Measurement>_<Direction>_<Bandwidth>_<Condition>.mask

Where

<Measurement> Measurement the limit mask file is applied to: SEM or ACP

<Direction> Direction: BS (Downlink) or MS (Uplink).

<Bandwidth> Bandwidth

<Condition> Condition. It depends on the measurement.

File extension: .mask

Pressing OPEN under the Import Data menu will open the above directory from which you can select a mask file. When you change the Bandwidth or Direction, all Power Suite measurement parameters are reset to the hard coded preset parameters. Thus you must recall the appropriate preset mask file again after the change.

You cannot read the contents of the provided preset mask file since it is a binary file. Detailed contents of the file are provided by a PDF format file located in the same directory as the preset mask file.

Example:

File Location: My Documents/LTETDD/data/masks/SEM_MS

File Name: SEM_MS_15MHz_Add_NS04.mask

The following table shows the sets of variables imported to the ACP measurement.

Offset	Start Freq (MHz)	Stop Freq (MHz)	Res BW (Hz)	Meas BW	Rel Start	Rel Stop	Fail Mask
A	5	7.14	30k	1	-8	-25	Rel
B	7.14	10.57	30k	1	-25	-27	Rel
C	10.57	20	30k	1	-27	-50	Rel
D	20	25	30k	1	-50	-50	Rel
E	25	30	30k	1	-50	-50	Rel

Key Path	Recall, Data
Mode	LTETDD
Remote Command	MMEMOry:LOAD:MASK <string>
Example	MMEM:LOAD:MASK "ACP_BS\ACP_BS_3MHz_pairE-UTRA_CatA.mask"
Notes	Sets of parameters related to Limit, Carrier and Offset are overwritten by the contents of the preset mask file.
Initial S/W Revision	A.03.00

EVM Setup

This key allows you to recall EVM parameter setting to measure E-UTRA Test Model in 3GPP standard (36.141-810 6.1.1).

- E-UTRA Test Model 1.1 (E-TM1.1)
- E-UTRA Test Model 1.2 (E-TM1.2)
- E-UTRA Test Model 2 (E-TM2)
- E-UTRA Test Model 3.1 (E-TM3.1)

- E-UTRA Test Model 3.2 (E-TM3.2)
- E-UTRA Test Model 3.3 (E-TM3.3)

This key is valid for the Modulation Analysis and Conformance EVM measurements only.

File Location and Extension

File location: My Documents\LTETDD\data\evmsetup

Note that “My Documents” is an alias to a directory and its place differs depending on which user is logged in. At XSA start up, XSA will overwrite all of the EVM Setup files to the current user’s “My Documents\LTETDD\data\evmsetup” each time.

File type: binary

File extension: .evms

Pressing OPEN under the Import Data menu will open the above directory from which you can select an EVM Setup file. When you change the Bandwidth, parameters are reset to the hard coded preset parameters. Thus you must recall the appropriate EVM Setup file again after the change.

You cannot read the contents of the provided EVM Setup file since it is a binary file.

Example:

File Location: My Documents\LTETDD\data\evmsetup

Filename: TM3.1-BW1.4MHz.evms

Key Path	Recall, Data
Mode	LTETDD
Remote Command	MMEemory:LOAD:EVMSSetup <string>
Example	MMEM:LOAD:EVMS "TM2-BW15MHz.evms"
Notes	Sets of parameters related to EVM Setup are overwritten by the contents of the EVM Setup file.
Initial S/W Revision	A.03.00, A.08.00

Open...

When you press “Open”, the analyzer brings up a Windows dialog and a menu entitled “File Open.” This menu allows you to navigate to the various fields in the Windows dialog without using a keyboard or mouse. The Tab and Arrow keys can also be used for dialog navigation.

See "[From File...](#)" on page 2797 in Recall, State, for a full description of this dialog and menu.

Key Path	Recall, Data
Notes	The key location is mode-dependent and will vary. Brings up Open dialog for recalling a <mode specific> Save Type
Initial S/W Revision	Prior to A.02.00

Restart

The Restart function restarts the current sweep, or measurement, or set of averaged/held sweeps or measurements. If you are Paused, pressing Restart does a Resume.

The Restart function is accessed in several ways:

- Pressing the Restart key
- Sending the remote command INIT:IMMEDIATE
- Sending the remote command INIT:RESTART

See "[More Information](#)" on page 576

Key Path	Front-panel key
Remote Command	:INITiate[:IMMEDIATE] :INITiate:RESTART
Example	:INIT:IMM :INIT:REST
Notes	:INITiate:RESTART and :INITiate:IMMEDIATE perform exactly the same function.
Couplings	Resets average/hold count k. For the first sweep overwrites all active (update=on) traces with new current data. For application modes, it resets other parameters as required by the measurement.
Status Bits/OPC dependencies	This is an Overlapped command. The STATus:OPERation register bits 0 through 8 are cleared. The STATus:QUESTionable register bit 9 (INTegrity sum) is cleared. The SWEEPING bit is set. The MEASURING bit is set.
Backwards Compatibility Notes	For Spectrum Analysis mode in ESA and PSA, the Restart hardkey and the INITiate:RESTART command restart trace averages (displayed average count reset to 1) for a trace in Clear Write, but did not restart Max Hold and Min Hold. In the X-Series, the Restart hardkey and the INITiate:RESTART command restart not only Trace Average, but MaxHold and MinHold traces as well. For wireless comms modes in ESA and PSA, the Restart hardkey and the INITiate:RESTART command restart every measurement, which includes all traces and numeric results. There is no change to this operation.
Initial S/W Revision	Prior to A.02.00

More Information

The **Restart** function first aborts the current sweep/measurement as quickly as possible. It then resets the sweep and trigger systems, sets up the measurement and initiates a new data measurement sequence with a new data acquisition (sweep) taken once the trigger condition is met.

If the analyzer is in the process of aligning when **Restart** is executed, the alignment finishes before the restart function is performed.

Even when set for Single operation, multiple sweeps may be taken when Restart is pressed (for example, when averaging/holding is on). Thus when we say that **Restart** "restarts a measurement," we may mean:

- It restarts the current sweep
- It restarts the current measurement
- It restarts the current set of sweeps if any trace is in Trace Average, Max Hold or Min Hold
- It restarts the current set of measurements if Averaging, or Max Hold, or Min Hold is on for the measurement
- depending on the current settings.

With **Average/Hold Number** (in **Meas Setup** menu) set to 1, or Averaging off, or no trace in Trace Average or Hold, a single sweep is equivalent to a single measurement. A single sweep is taken after the trigger condition is met; and the analyzer stops sweeping once that sweep has completed. However, with **Average/Hold Number** >1 and at least one trace set to **Trace Average, Max Hold, or Min Hold (SA Measurement)** or **Averaging on (most other measurements)**, multiple sweeps/data acquisitions are taken for a single measurement. The trigger condition must be met prior to each sweep. The sweep is stopped when the average count k equals the number N set for **Average/Hold Number**. A measurement average usually applies to all traces, marker results, and numeric results; but sometimes it only applies to the numeric results.

Once the full set of sweeps has been taken, the analyzer will go to idle state. To take one more sweep without resetting the average count, increment the average count by 1, by pressing the step up key while **Average/Hold Number** is the active function, or sending the remote command `CALC:AVER:TCON UP`.

Save

The Save menu lets you choose what you want to save and where you want to save it. Among the types of files you can save are **States**, **Traces**, and **Screen Images**. In addition, an Export (Data) option lets you save a number of data types as CSV files for easy import into Excel and other spreadsheet programs.

Key Path	Front-panel key
Mode	All
Notes	No remote command for this key specifically, but the :MMEM:STOR:STATe <filename> command is available for specific file types. An example is :MMEM:STOR:STATe <filename>.
Initial S/W Revision	Prior to A.02.00

State

The Save State menu lets you choose a register or file for saving the state.

The content of a state file includes all of the settings and data required to return the analyzer as closely as possible to the Mode it was in, with the exact settings which were in place, when the save occurred. The Mode settings in each state file include the settings that are affected by Mode Preset, as well as the additional settings affected by Restore Mode Defaults; all of the Mode's settings. In addition, all of the settings of the Input/Output system are included, even though they are outside of the Mode's state, because they are needed to restore the complete setup. Persistent System settings (for example, Verbose SCPI) are not affected by either Mode Preset or Restore Mode Defaults, nor are they included in a saved State file.

After the save completes, the message "File <filename> saved" or "State Register <register number> saved" is displayed.

For rapid saving, the State menu lists 16 registers to save to. Pressing a Register key initiates the save. You can also select a file to save to.

The default path for all State Files is:

My Documents\<<mode name>\state

where <mode name> is the parameter used to select the mode with the INST:SEL command (for example, SA for the Spectrum Analyzer).

Key Path	Save
Mode	All
Remote Command	:MMEMory:STORe:STATe <filename>
Example	MMEM:STOR:STATe "MyStateFile.state" This stores the current instrument state data in the file MyStateFile.state in the default directory.
Notes	Both single and double quotes are supported for any filename parameter over remote. After saving to a register, that register's menu key is updated with the date the time, unless a custom label has been entered for that key. After saving to a register, you remain in the Save State menu, so that you can see the Register key

update. After saving to a file, the analyzer automatically returns to the previous menu and any Save As dialog goes away.

Backwards Compatibility SCPI	:MMEMoRY:STORe:STATe 1,<filename>
Initial S/W Revision	Prior to A.02.00

To File . . .

When you press “To File”, the analyzer brings up a Windows dialog and a menu entitled “**Save As.**” This menu allows you to navigate to the various fields in the Windows dialog without using a keyboard or mouse. The Tab and Arrow keys can also be used for dialog navigation.

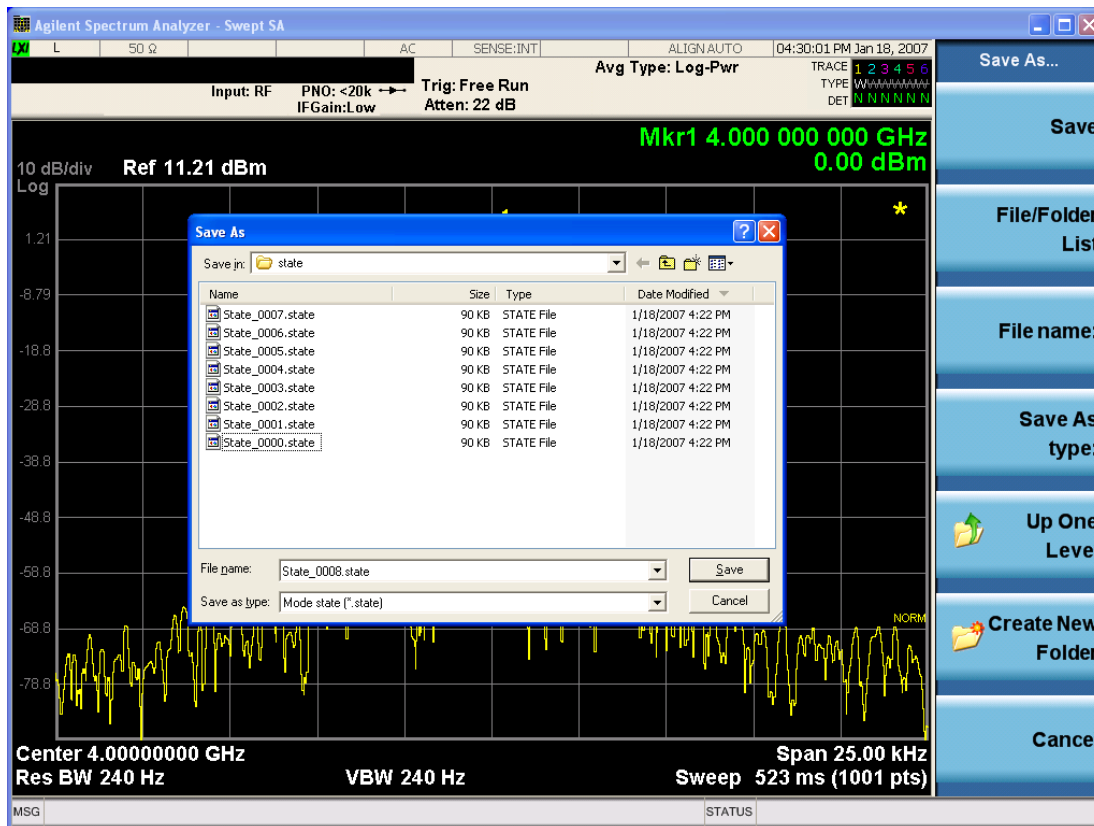

The Listed below

are the functions of the various fields in the dialog, and the corresponding softkeys:

Save

Performs the save to the specified file of the selected type. If the file already exists, a dialog will appear that allows you to replace the existing file by selecting OK, or you can Cancel the request. If you select OK, the file will be overwritten. Using the C: drive is strongly discouraged, since it runs the risk of being overwritten during an instrument software upgrade.

While the save is being performed, the floppy icon appears briefly in the Meas bar.

File/Folder List

Enables you to navigate to the center of the dialog that contains the list of files and folders. Once here you can get information about the file and use the tab keys to navigate to the other fields in the dialog, such as Save In.

Save In

The Save In field shows the path to which the file will be saved and allows you to change the path using the up and down arrow keys to navigate to other paths; the Enter key to open a directory; and the Backspace key to go back one directory. The **Save In field** defaults to the default path for this type of file and remembers the last path you used to save this type of file. There is no softkey for directly navigating to the Save In field but you can use left tab to get here from the File/Folder List.

User specified paths are remembered when you leave and return to a Mode and are reset back to the default using Restore Mode Defaults.

File Name

The File Name field is initially loaded with an automatically generated filename specific to the appropriate Save Type. The automatically generated filename is guaranteed not to conflict with any filename currently in the directory. You may replace or modify this filename using the File Name key. See the ["Quick Save " on page 2793](#) documentation for more on the automatic file naming algorithm.

When you press the File Name key the analyzer displays the Alpha Editor. Use the knob to choose the letter to add and the front-panel Enter key to add the letter to the file name. The BK character moves you back and the FW character moves you forward in the filename. The Select key on the front panel generates a space character. When you are done entering the filename press the Done softkey. This returns back to the **File Open** dialog and menu, but does not cause the save to occur.

Save As Type

This field shows the file suffix for the type of file you have selected to save. For example, if you navigated here while saving State, "Mode state (*.state)" is in the field. If you navigated here from saving Trace, ""Mode state (*.trace)" is in the field. If you navigated here while exporting a trace data file, "Trace Data (*.csv)" is in the field. For some file types, there is more than one choice in the dropdown, which you can select by using the up and down arrow keys and Enter.

Up One Level

This key corresponds to the icon of a folder with the up arrow that is in the tool bar of the dialog. When pressed, it causes the file and folder list to navigate up one level in the directory structure. The Backspace key does the same thing.

Create New Folder

This key corresponds to the icon of a folder with the "*" that is in the tool bar of the dialog. When pressed, a new folder is created in the current directory with the name **New Folder** and you can enter a new folder name using the Alpha Editor.

Cancel

This key corresponds to the Cancel selection in the dialog. It causes the current **Save As** request to be cancelled. The ESC key does the same thing.

Key Path	Save, State
Mode	All
Notes	Brings up Save As dialog for saving a State Save Type
Initial S/W Revision	Prior to A.02.00

Edit Register Names

You may enter a custom name on any of the Register keys, to help you remember what you are using that state to save. To do this, press the Edit Register Names key, choose the register whose name you wish to edit, and then enter the desired label using the Alpha Editor or an external PC keyboard.

The maximum number of characters that can be added is 30. In most cases, 30 characters will fit on two lines of the key.

See ["More Information" on page 581](#)

Key Path	Save, State
Mode	All
Remote Command	:MMEMory:REGister:STATe:LABel <reg number>,"label" :MMEMory:REGister:STATe:LABel? <reg number>
Example	:MMEM:REG:STAT:LAB 1,"my label"
Notes	<reg number> is an integer from 1 to 16. If the SCPI specifies an invalid register number an error message is generated, -222,"Data out of range;Invalid register label number" "label" is a string from 0 to 30 characters in length. If a label exceeds 30 characters, an error message is generated, -150,"String data error;Label clipped to 30 characters" "label" of length 0 erases the custom label and restores the default (time and date) label. E.g.: :MMEM:REG:STAT:LAB 1,""
Dependencies	N9060A-7FP or N9060B-2FP license required to edit the register names. When the feature is not licensed, sending this command generates an error, -221,"Settings conflict;Option not available"
Preset	The names are unaffected by Preset or power cycle but are set to the default label (time and date) on a "Restore System Defaults->Misc"
Initial S/W Revision	A.11.00

More Information

When you edit one of the register names, the time and date field will be replaced by the custom name.

If you delete all the characters in the custom name, it restores the default (time and date).

The register names are stored within the state files, but they are not part of the instrument state; that is, once you have edited a register name, loading a new state will not change that register name. Another consequence of this is that the names will be persistent through a power cycle. Also, if a named state file is transferred to another analyzer, it will bring its custom name along with it.

If you try to edit the name of an empty register, the analyzer will first save the state to have a file to put the name in. If you load a named state file into an analyzer with older firmware it will ignore the metadata.

The *SAV and *RCL commands will not be affected by the custom register names, nor will the MMEM commands.

Register 1 thru Register 16

Selecting any one of these register menu keys causes the State of the currently active mode to be saved to the specified Register. The registers are provided for rapid saving and recalling, since you do not need to specify a filename or navigate to a file. Each of the register menu keys annotates whether it is empty or at what date and time it was last modified. In addition, you can use the Edit Register Names key to enter custom names for each register.

Although these 16 registers are the only registers available from the front panel, there are 128 state registers available in the instrument. Registers 17–128 are only available from the SCPI interface, using the *SAV command.

There is one set of 128 state registers in the instrument, not one set for each Mode. When a state is saved, the Mode it was saved from is saved with it; then when it is recalled, the instrument switches to that Mode.

After the save completes, the corresponding register menu key annotation is updated with the date and time and the message "Register <register number> saved" is displayed.

Key Path	Save, State
Mode	All
Example	*SAV 1
Range	1–16 from front panel, 1–128 from SCPI
Readback	Date and time with seconds resolution are displayed on the key OR A custom name of up to 30 characters entered using the Edit Register Names key OR “(empty)” if no prior save operation has been performed to this register.
Initial S/W Revision	Prior to A.02.00
Modified at S/W Revision	A.11.00

Register 1 thru Register 16

Selecting any one of these register menu keys causes the State of the currently active mode to be saved to the specified Register. The registers are provided for rapid saving and recalling, since you do not need to specify a filename or navigate to a file. Each of the register menu keys annotates whether it is empty or at what date and time it was last modified. In addition, you can use the Edit Register Names key to enter custom names for each register.

Although these 16 registers are the only registers available from the front panel, there are 128 state registers available in the instrument. Registers 17–128 are only available from the SCPI interface, using the *SAV command.

There is one set of 128 state registers in the instrument, not one set for each Mode. When a state is saved, the Mode it was saved from is saved with it; then when it is recalled, the instrument switches to that Mode.

After the save completes, the corresponding register menu key annotation is updated with the date and time and the message "Register <register number> saved" is displayed.

Key Path	Save, State
Mode	All
Example	*SAV 1
Range	1–16 from front panel, 1–128 from SCPI
Readback	Date and time with seconds resolution are displayed on the key OR A custom name of up to 30 characters entered using the Edit Register Names key OR “(empty)” if no prior save operation has been performed to this register.
Initial S/W Revision	Prior to A.02.00
Modified at S/W Revision	A.11.00

Data (Export)

Exporting a data file stores data from the current measurement to mass storage files. The Export Menu only contains data types that are supported by the current measurement.

Since the commonly exported data files are in .csv format, the data can be edited by you prior to importing. This allows you to export a data file, manipulate the data in Excel (the most common PC Application for manipulating .csv files) and then import it.

Selecting an Export Data menu key will not actually cause the exporting to occur, since the analyzer still needs to know where you wish to save the data. Pressing the Save As key in this menu brings up the Save As dialog and Save As menu that allows you to specify the destination file and directory. Once a filename has been selected or entered in the Open menu, the export will occur as soon as the Save key is pressed.

Key Path	Save
Mode	All
Notes	The menu is built from whatever data types are available for the mode. So the key locations in the sub menu will vary. No SCPI command directly controls the Data Type that this key controls. The Data Type is included in the MMEM:STORe commands.
Dependencies	If a file type is not used by a certain measurement, that type is grayed out for that measurement. The key for a file type will not show at all if there are no measurements in the Mode that support it.
Preset	Is not affected by a Preset or shutdown, but is reset during Restore Mode Defaults
Readback	The data type that is currently selected
Initial S/W Revision	Prior to A.02.00

Export Trace Data

Enables you to export trace data with (optional) associated headers. Selecting this key displays a menu that enables you to choose which Trace to save (default is the selected Trace) and whether or not to save headers with the data. The header information is used by the VXA application when saved trace data is recalled, and enables it to be displayed with the same formatting and scaling that it had when saved. If headers are not saved, the scaling and format are set to default values when the trace is recalled. After making these selections, press Save As... and use the file dialog to choose a file name and format for the saved data.

Trace data can be exported in several different formats. Text and comma-separated variable (CSV) formats are useful for viewing the data or importing it to a spreadsheet program. The other formats are binary and thus more compact. Trace data files can be recalled for viewing into other VXA, LTE, LTETDD, iDEN, or 89601 measurements.

Key Path	Save, Data (Export)
Mode	VSA, LTE, LTETDD, IDEN
Remote Command	:MMEMory:StORe:TRACe:DATA TRACE1 TRACE2 TRACE3 TRACE4 TRACE5 TRACE6, "<filename>" [,CSV TXT SDF MAT4 MAT HDF5 BIN [,OFF ON 0 1]]
Example	:MMEM:StOR:TRAC:DATA TRACE1, "TRC1.TXT", TXT, ON
Notes	<p>The Save As... dialog box has the following format options when you are saving trace data:</p> <ul style="list-style-type: none"> • CSV (Comma delimited) (*.csv) • SDF (Fast) (*.sdf;*.dat) • Text (Tab delimited) (*.txt) <p>File format saved depends on selection. The appropriate file extension is appended to the filename if it is not supplied by the user.</p> <p>If the SCPI command includes just a file name, the file format is determined by the filename extension, which must be one of the choices above. *.sdf or an unrecognized extension chooses the SDF fast format. If the optional file format enumerator is included in the command, then this determines the file format and the file extension is ignored. The optional binary parameter determines if file headers are saved. The default is ON. If file headers are not wanted, use the optional "OFF" parameter.</p> <p>The optional Boolean parameter determines whether headers are saved in the file. By default the headers are saved.</p> <p>If you are not licensed to save a particular file type, then error -203.9010 is returned. If an invalid file format is specified or the file cannot be saved successfully, then error -25x is returned. If the save is successful, then advisory 0.1500 is shown.</p>
State Saved	No
Readback	(Trace 1 Trace 2 Trace 3 Trace 4 Trace 5 Trace 6)(with without) headers

Trace 1

Selects the Trace 1 register as the destination for the imported data.

Key Path	Save, Data (Export), Trace
Mode	VSA, LTE, LTETDD, IDEN

Trace 2

Selects the Trace 2 register as the destination for the imported data.

Key Path	Save, Data (Export), Trace
Mode	VSA, LTE, LTETDD, IDEN

Trace 3

Selects the Trace 3 register as the destination for the imported data.

Key Path	Save, Data (Export), Trace
Mode	VSA, LTE, LTETDD, IDEN

Trace 4

Selects the Trace 4 register as the destination for the imported data.

Key Path	Save, Data (Export), Trace
Mode	VSA, LTE, LTETDD, IDEN

Include Header

Enables you to select whether or not the saved trace data includes header information describing scaling, formatting, etc.

Key Path	Save, Data (Export), Trace
Mode	VSA, LTE, LTETDD, IDEN
State Saved	No

Measurement Results

Pressing this key selects Meas Results as the data type to be exported.

The Meas Results file contains information which describes the current state of the analyzer. It is detailed in Meas Result File Contents below.

Key Path	Save, Data
Remote Command	:MMEMory:STORe:RESults <string>
Example	:MMEM:STOR:RES "MeasR_0000.csv"
Notes	If the save is initiated via SCPI and the file already exists, the file will be overwritten.

	<p>The SCPI command exports Channel Power measurement results to the file specified as the parameter in the current path. The default path is My Documents\<current mode>\data\chp\results.<="" p=""> <p>Using the C: drive is strongly discouraged, since it runs the risk of being overwritten during an instrument software upgrade.</p> <p>The SCPI parameter is a quoted string, which specifies the filename. Both single and double quotes are supported for any filename parameter over SCPI.</p> </current></p>
Dependencies	The current active measurement must be the Channel Power measurement to use this command.
Status Bits/OPC dependencies	Sequential – waits for the previous measurement to complete.
Initial S/W Revision	Prior to A.02.00

Meas Results File Contents

A Meas Results File contains measurement results with the following information.

- File ID string, which is “MeasResult”
- Measurement ID following Mode ID, which is “SA:CHP” for example.
- Firmware rev and model number
- Option string
- Auto Sweep Time Rules
- Average Mode
- Average Number
- Average State
- Center Frequency
- Detector
- Electrical Atten
- Electrical Atten State
- IFGain
- IFGainAuto
- Impedance
- Integ BW
- Internal Preamp
- Internal Preamp Band
- Mechanical Atten
- MechanicalAttenStepEnum

- PSD Unit
- Resolution Band Width
- Resolution Bandwidth Shape
- RRC Filter Alpha
- RRC Filter BW
- RRC Filter State
- Span
- Sweep Points
- Sweep Time
- Sweep Time Auto
- TriggerSource
- Video Bandwidth
- Y Axis Unit

The file contains these data followed by MeasResult1 and MeasResult2 that flag the start of the measurement results. Each line of Measurement Results consists of two comma separated values, MeasResult1 value and MeasResult2 value. MeasResult1 contains the same results as MEAS/READ/FETCH:CHPower1; MeasResult2, MEAS/READ/FETCH:CHPower2.

Exported file is .csv file. The Meas Results file, when imported into Excel, will show the following data:

MeasResult	
SA:CHP	
A.10.53	N9030A
526 ALV ATP B1X B1Y B25 B40 BBA CR3 CRP DCF DDA DP2 DRD EA3 EDP EMC EP1 ERC ESC ESP EXM FSA LFE LNP MAT MPB NFE NUL P26 PFR PNC RTL RTS S40 SB1 SEC SM1 TVT YAS YAV	1
Auto Sweep Time Rules	Normal
Average Mode	Exponential
Average Number	10
Average State	TRUE
Center Frequency	13255000000
Detector	Average
IFGain	FALSE
IFGainAuto	FALSE
Impedance	50
Integ BW	2000000

Internal Preamp	FALSE
Internal Preamp Band	Low
PSD Unit	DbmHz
Resolution Band Width	27000
Resolution Bandwidth Shape	Gaussian
RRC Filter Alpha	0.22
RRC Filter BW	3840000
RRC Filter State	FALSE
Span	3000000
Sweep Points	1001
Sweep Time	0.004933333
Sweep Time Auto	TRUE
TriggerSource	Free
Video Bandwidth	270000
Y Axis Unit	DecibelMilliwatt
MeasResult1	MeasResult2
-76.8141133132837	-95.29174
-139.824413269924	-94.99601
	-94.95281
	-95.17146

Save As . . .

When you press “Save As”, the analyzer brings up a Windows dialog and a menu entitled “**Save As.**” This menu allows you to navigate to the various fields in the Windows dialog without using a keyboard or mouse. The Tab and Arrow keys can also be used for dialog navigation.

See "[To File . . .](#)" on page 2810 in Save, State for a full description of this dialog and menu.

The default path for saving files is:

For all of the Trace Data Files:

My Documents\`<mode name>`\data\traces

For all of the Limit Data Files:

My Documents\`<mode name>`\data\limits

For all of the Measurement Results Data Files:

My Documents\`<mode name>`\data\`<measurement name>`\results

For all of the Capture Buffer Data Files:

My Documents\`<mode name>`\data\captureBuffer

Key Path	Save, Data
Mode	All
Notes	The key location is mode-dependent and will vary. Brings up the Save As dialog for saving a <mode specific> Save Type. The save is performed immediately and does not wait until the measurement is complete.
Initial S/W Revision	Prior to A.02.00

Screen Image

Pressing Screen Image accesses a menu of functions that enable you to specify a format and location for the saved screen image. It brings up a menu that allows you to specify the color scheme of the Screen Image (Themes) or navigate to the Save As dialog to perform the actual save.

Screen Image files contain an exact representation of the analyzer display. They cannot be loaded back onto the analyzer, but they can be loaded into your PC for use in many popular applications.

The image to be saved is actually captured when the Save front panel key is pressed, and kept in temporary storage to be used if you ask for a Screen Image save. When the Screen Image key is pressed, a "thumbnail" of the captured image is displayed, as shown below:

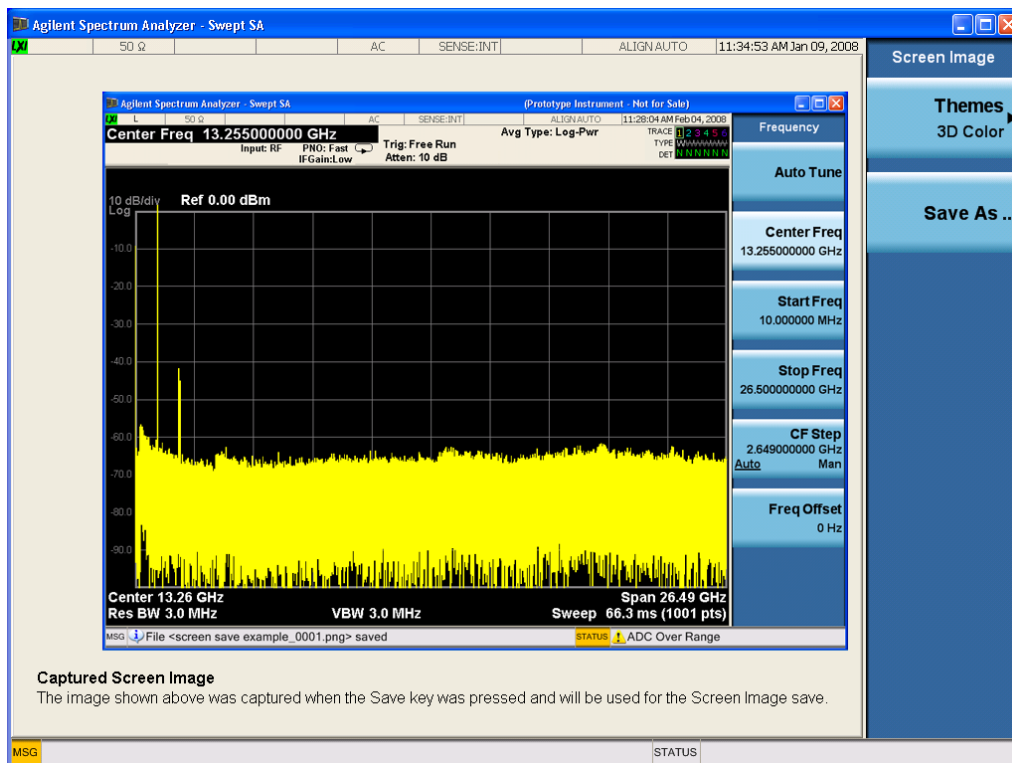

When you continue on into the Save As menu and complete the Screen Image save, the image depicted in the thumbnail is the one that gets saved, showing the menus that were on the screen before going into the Save menus. The save is performed immediately and does not wait until the measurement is complete.

After you have completed the save, the Quick Save front-panel key lets you quickly repeat the last save performed, using an auto-named file, with the current screen data.

NOTE

For versions previous to A.01.55, if you initiate a screen image save by navigating through the Save menus, the image that is saved will contain the Save menu softkeys, not the menus and the active function that were on the screen when you first pressed the Save front panel key.

Key Path	Save
Mode	All
Remote Command	:MMEMory:STORe:SCReen <filename>
Example	:MMEM:STOR:SCR "myScreen.png" This stores the current screen image in the file MyScreenFile.png in the default directory.
Initial S/W Revision	Prior to A.02.00

Themes

Accesses a menu of functions that enable you to choose the theme to be used when saving the screen image.

The **Themes** option is the same as the **Themes** option under the **Display** and **Page Setup** dialogs. It allows you to choose between themes to be used when saving the screen image.

Key Path	Save, Screen Image
Remote Command	:MMEMory:STORe:SCReen:THEMe TDColor TDMonochrome FCOLor FMONochrome :MMEMory:STORe:SCReen:THEMe?
Example	:MMEM:STOR:SCR:THEM TDM
Preset	3D Color; Is not part of Preset, but is reset by Restore Misc Defaults or Restore System Defaults All and survives subsequent running of the modes.
Readback	3D Color 3D Mono Flat Color Flat Mono
Backwards Compatibility Notes	In ESA and PSA we offer the choice of "Reverse Bitmap" or "Reverse Metafile" when saving screen images. This is much like the "Flat Color" theme available in X-Series. Also, if you selected Reverse Bitmap AND a black & white screen image, that would be much like "Flat Monochrome". In other words, each of the X-Series themes has a similar screen image type in ESA/PSA. But they are not identical.
Initial S/W Revision	Prior to A.02.00

3D Color

Selects a standard color theme with each object filled, shaded and colored as designed.

Key Path	Save, Screen Image, Themes
Example	MMEM:STOR:SCR:THEM TDC

Readback	3D Color
Initial S/W Revision	Prior to A.02.00

3D Monochrome

Selects a format that is like 3D color but shades of gray are used instead of colors.

Key Path	Save, Screen Image, Themes
Example	MMEM:STOR:SCR:THEM TDM
Readback	3D Mono
Initial S/W Revision	Prior to A.02.00

Flat Color

Selects a format that is best when the screen is to be printed on an ink printer.

Key Path	Save, Screen Image, Themes
Example	MMEM:STOR:SCR:THEM FCOL
Readback	Flat Color
Initial S/W Revision	Prior to A.02.00

Flat Monochrome

Selects a format that is like Flat Color. But only black is used (no colors, not even gray), and no fill.

Key Path	Save, Screen Image, Themes
Example	MMEM:STOR:SCR:THEM FMON
Readback	Flat Mono
Initial S/W Revision	Prior to A.02.00

Save As...

When you press "Save As", the analyzer brings up a Windows dialog and a menu entitled "**Save As.**" This menu allows you to navigate to the various fields in the Windows dialog without using a keyboard or mouse. The Tab and Arrow keys can also be used for dialog navigation.

See "[To File . . .](#)" on page 2810 in Save, State for a full description of this dialog and menu.

The default path for Screen Images is

My Documents\`<mode name>`\screen.

where <mode name> is the parameter used to select the mode with the INST:SEL command (for example, SA for the Spectrum Analyzer).

Key Path	Save, Screen Image
Notes	Brings up Save As dialog for saving a Screen Image Save Type
Initial S/W Revision	Prior to A.02.00

Mass Storage Catalog (Remote Command Only)

Key path	SCPI Only
Remote Command	:MMEMory:CATalog? [<directory_name>]
Notes	<p>The string must be a valid logical path.</p> <p>Queries disk usage information (drive capacity, free space available) and obtains a list of files and directories in a specified directory in the following format:</p> <p><numeric_value>,<numeric_value>,{<file_entry>}</p> <p>It returns two numeric parameters and as many strings as there are files and directories. The first parameter indicates the total amount of storage currently used in bytes. The second parameter indicates the total amount of storage available, also in bytes. The <file_entry> is a string. Each <file_entry> indicates the name, type, and size of one file in the directory list:</p> <p><file_name>,<file_type>,<file_size></p> <p>As the windows file system has an extension that indicates file type, <file_type> is always empty. <file_size> provides the size of the file in bytes. For directories, <file_entry> is surrounded by square brackets and both <file_type> and <file_size> are empty</p>
Initial S/W Revision	Prior to A.02.00

Mass Storage Change Directory (Remote Command Only)

Key path	SCPI Only
Remote Command	:MMEMory:CDIRectory [<directory_name>] :MMEMory:CDIRectory?
Notes	<p>The string must be a valid logical path.</p> <p>Changes the default directory for a mass memory file system. The <directory_name> parameter is a string. If no parameter is specified, the directory is set to the *RST value.</p> <p>At *RST, this value is set to the default user data storage area, that is defined as System.Environment.SpecialFolder.Personal.</p> <p>Query returns full path of the default directory.</p>
Initial S/W Revision	Prior to A.02.00

Mass Storage Copy (Remote Command Only)

Key path	SCPI Only
Remote Command	:MMEMory:COpy <string>,<string>[,<string>,<string>]
Notes	<p>The string must be a valid logical path.</p> <p>Copies an existing file to a new file or an existing directory to a new directory.</p> <p>Two forms of parameters are allowed. The first form has two parameters. In this form, the first parameter specifies the source, and the second parameter specifies the destination.</p> <p>The second form has four parameters. In this form, the first and third parameters specify the source. The second and fourth parameters specify the directories. The first pair of parameters specifies the source. The second pair specifies the destination. An error is generated if the source doesn't exist or the destination file already exists.</p> <p>This command will generate an "access denied" error if the destination is a restricted folder (e.g., C:\Windows) and the current user does not have Power User or Administrator privileges.</p>

Mass Storage Device Copy (Remote Command Only)

This command transfers data to/from a file and a peripheral device.

Key path	SCPI Only
Remote Command	:MMEMory:COpy:DEvice <source_string>,<dest_string>
Notes	<p>The strings must be a valid logical path or a valid device keyword. If the dest_string is a device keyword, the data is copied from the source file to the device. If the source_string is a device keyword, the data is copied to the source file from the device.</p> <p>Valid device keywords are:</p> <p>SNS (smart noise source)</p> <p>An error is generated if the file or device is not found.</p>

Mass Storage Delete (Remote Command Only)

Key path	SCPI Only
Remote Command	:MMEMory:DElete <file_name>[,<directory_name>]
Notes	<p>The string must be a valid logical path.</p> <p>Removes a file from the specified directory. The <file_name> parameter specifies the file name to be removed. This command will generate an "access denied" error if the file is in a restricted folder (e.g., C:\Windows) and the current user does not have Power User or Administrator privileges.</p>
Initial S/W Revision	Prior to A.02.00

Mass Storage Data (Remote Command Only)

Creates a file containing the specified data OR queries the data from an existing file.

Key path	SCPI Only
Remote Command	:MMEMory:DATA <file_name>, <data> :MMEMory:DATA? <file_name>
Notes	The string must be a valid logical path. The command form is MMEMory:DATA <file_name>,<data>. It loads <data> into the file <file_name>. <data> is in 488.2 block format. <file_name> is string data. The query form is MMEMory:DATA? <file_name> with the response being the associated <data> in block format.
Initial S/W Revision	Prior to A.02.00

Mass Storage Make Directory (Remote Command Only)

Key path	SCPI Only
Remote Command	:MMEMory:MDIRectory <directory_name>
Notes	The string must be a valid logical path. Creates a new directory. The <directory_name> parameter specifies the name to be created. This command will generate an “access denied” error if the new directory would be in a restricted folder (e.g., C:\Windows) and the current user does not have Power User or Administrator privileges.
Initial S/W Revision	Prior to A.02.00

Mass Storage Move (Remote Command Only)

Key path	SCPI Only
Remote Command	:MMEMory:MOVE <string>,<string>[,<string>,<string>]
Notes	The string must be a valid logical path. Moves an existing file to a new file or an existing directory to a new directory. Two forms of parameters are allowed. The first form has two parameters. In this form, the first parameter specifies the source, and the second parameter specifies the destination. The second form has four parameters. In this form, the first and third parameters specify the source. The second and fourth parameters specify the directories. The first pair of parameters specifies the source. The second pair specifies the destination. An error is generated if the source doesn't exist or the destination file already exists. This command will generate an “access denied” error if the destination is a restricted folder (e.g., C:\Windows) and the current user does not have Power User or Administrator privileges.
Initial S/W Revision	Prior to A.02.00

Mass Storage Remove Directory (Remote Command Only)

Key path	SCPI Only
Remote Command	<code>:MMEMory:RDIrectory <directory_name></code>
Notes	<p>The string must be a valid logical path.</p> <p>Removes a directory. The <directory_name> parameter specifies the directory name to be removed. All files and directories under the specified directory shall also be removed.</p> <p>This command will generate an “access denied” error if the folder is a restricted folder (e.g., C:\Windows) or is in a restricted folder and the current user does not have Power User or Administrator privileges.</p>
Initial S/W Revision	Prior to A.02.00

Single (Single Measurement/Sweep)

Sets the analyzer for Single measurement operation. The single/continuous state is Meas Global, so the setting will affect all the measurements. If you are Paused, pressing Single does a Resume.

See ["More Information" on page 596](#)

Key Path	Front-panel key
Example	:INIT:CONT OFF
Notes	See Cont key description.
Backwards Compatibility Notes	<p>For Spectrum Analysis mode in ESA and PSA, the Single hardkey and the INITiate:IMM switched from continuous measurement to single measurement and restarted sweeps and averages (displayed average count reset to 1), but did not restart Max Hold and Min Hold. In the X-Series, the Single hardkey and the INITiate:IMM command initiate a sweep/ measurement/ average sequence/hold sequence including MaxHold and MinHold.</p> <p>For Spectrum Analysis mode in ESA and PSA, the Single hardkey restarted the sweep regardless of whether or not you were in an active sweep or sweep sequence. In the X-Series, Restart does this but Single only restarts the sweep or sweep sequence if you are in the idle state.</p> <p>INIT[:IMM] in ESA & PSA Spectrum Analysis Mode does an implied ABORT. In some other PSA Modes, INIT[:IMM] is ignored if not in the idle state. . The X-Series follows the ESA/PSA SA Mode model, which may cause some Modes to have compatibility problems.</p>
Initial S/W Revision	Prior to A.02.00

More Information

See ["Restart" on page 2807](#) for details on the INIT:IMMEDIATE (Restart) function.

If you are already in single sweep, the INIT:CONT OFF command has no effect.

If you are already in Single Sweep, then pressing the Single key in the middle of a sweep does not restart the sweep or sequence. Similarly, pressing the Single key does not restart the sweep or sequence if the sweep is not in the idle state (for example, if you are taking a very slow sweep, or the analyzer is waiting for a trigger). Instead, it results in a message. "Already in Single, press Restart to initiate a new sweep or sequence". Even though pressing the Single key in the middle of a sweep does not restart the sweep, sending INIT:IMMEDIATE does reset it.

To take one more sweep without resetting the average count, increment the average count by 1, by pressing the step up key while **Average/Hold Number** is the active function, or sending the remote command CALC:AVER:TCON UP.

Source

There is no Source control functionality for this measurement. When this key is pressed, the screen either displays a blank menu, or the previously-selected menu remains unchanged.

Key Path	Front-panel key
----------	-----------------

Span X Scale

Accesses a menu of functions that enable you set the horizontal scale parameters.

Key Path	Front-panel key
Initial S/W Revision	Prior to A.02.00

Span

Changes the frequency range symmetrically about the center frequency.

The default (and minimum) Span is calculated using the number of carriers and the carrier width where;

$$\text{Span} = (\text{Upper Carrier Freq} + (\text{max offset IBW} * (1 + \alpha)) / 2) - (\text{Lower Carrier Freq} - (\text{max offset IBW} * (1 + \alpha)) / 2)$$

The span is increased by a factor of 1 + Filter Alpha if the RRC Filter in on.

Key Path	Span X Scale
Mode	SA, WCDMA, C2K, WIMAX OFDMA, 1xEVDO, DVB-T/H, DTMB (CTTB), ISDB-T, CMMB, LTE, LTETDD, Digital Cable TV, WLAN
Remote Command	[:SENSe] :CHPower:FREQuency:SPAN <freq> [:SENSe] :CHPower:FREQuency:SPAN?
Example	CHP:FREQ:SPAN 10 MHz CHP:FREQ:SPAN?
Notes	You must be in the Spectrum Analysis mode, W-CDMA mode, cdma2000 mode, DVB-T/H mode, DTMB (CTTB) mode, ISDB-T mode, CMMB mode, Digital Cable TV mode, LTE mode, LTE TDD mode, WLAN mode, 1xEVDO mode or WIMAX OFDMA mode to use this command. Use :INSTrument:SElect to set the mode.
Dependencies	For MSR mode, this key is blank. For LTE-Advanced FDD/TDD mode, this key is blank. For WLAN 802.11 ac (80 MHz + 80 MHz), the key is not enabled and its value is coupled with the spacing between the center frequencies of the two carriers. Span = Center Frequency 1 – Center Frequency 2 + Integ BW + 40 MHz Margin. When the calculated span is over 1 GHz, it's still coupled to its maximum value, which is 1 GHz.
Couplings	When Res BW is set to Auto, the resolution bandwidth is auto-coupled to span. The ratio of span /RBW is approximately 106:1. When the Res BW is set to Man, bandwidths are entered by the user, and these bandwidths are used regardless of other analyzer settings. Since Span is coupled to Integ BW in the factory default condition, if you change the integration bandwidth setting, the span setting changes by a proportional amount until a limit value is reached. However, the span can be individually set. The minimum value of the span is coupled with the integration bandwidth.
Preset	SA: 3 MHz WCDMA: 7.5 MHz

	C2K: 1.845 MHz WIMAX OFDMA: 20 MHz 1xEVDO: 2.0MHz DVB-T/H: 10MHz DTMB (CTTB): 10MHz ISDB-T: 10MHz CMMB: 10MHz LTE: 7.5 MHz LTE TDD: 7.5 MHz Digital Cable TV: 10MHz WLAN: if Radio Std is 802.11a/g(OFDM/DSSS-OFDM): 30 MHz if Radio Std is 802.11b: 37.5MHz if Radio Std is 802.11n(20MHz): 30 MHz if Radio Std is 802.11n(40MHz): 60 MHz if Radio Std is 802.11ac (20 MHz): 30 MHz if Radio Std is 802.11ac (40 MHz): 60 MHz if Radio Std is 802.11ac (80 MHz): 120 MHz if Radio Std is 802.11ac (160 MHz): 240 MHz if Radio Std is 802.11ac (80 MHz + 80 MHz): 360 MHz
State Saved	Saved in instrument state.
Min	100 Hz
Max	Hardware Maximum Span
Initial S/W Revision	Prior to A.02.00
Modified at S/W Revision	A.02.00, A.03.00

Full Span

Changes the span to show the full frequency range of the spectrum analyzer.

Key Path	Span X Scale
Mode	SA, WCDMA, C2K, WIMAX OFDMA, 1xEVDO, DVB-T/H, DTMB (CTTB), ISDB-T, CMMB, LTE, LTE TDD, Digital Cable TV, WLAN
Remote Command	[:SENSe] :CHPower :FREQuency :SPAN :FULL
Example	CHP:FREQ:SPAN:FULL
Notes	You must be in the Spectrum Analysis mode, W-CDMA mode, cdma2000 mode, DVB-T/H mode, DTMB (CTTB) mode, ISDB-T mode, CMMB mode, Digital Cable TV mode, LTE mode, LTE TDD mode, WLAN mode, 1xEVDO mode or WIMAX OFDMA mode to use this command. Use :INSTrument:SElect to set the mode.

Dependencies	For MSR mode, this key is blank. For LTE-Advanced FDD/TDD mode, this key is blank.
Couplings	Selecting full span changes the measurement span value.
Initial S/W Revision	Prior to A.02.00
Modified at S/W Revision	A.02.00, A.03.00

Last Span

Changes the span to the previous span setting. If no previous span value exists, then the span remains unchanged.

Key Path	Span X Scale
Mode	SA, WCDMA, C2K, WIMAX OFDMA, 1xEVDO, DVB-T/H, DTMB (CTTB), ISDB-T, CMMB, LTE, LTETDD, Digital Cable TV, WLAN
Remote Command	[:SENSe] :CHPower:FREQuency:SPAN:PREvious
Example	CHP:FREQ:SPAN:PREV
Notes	You must be in the Spectrum Analysis mode, W-CDMA mode, cdma2000 mode, DVB-T/H mode, DTMB (CTTB) mode, ISDB-T mode, CMMB mode, Digital Cable TV mode, LTE mode, LTE TDD mode, WLAN mode, 1xEVDO mode or WIMAX OFDMA mode to use this command. Use :INSTrument:SElect to set the mode.
Dependencies	For MSR mode, this key is blank. For LTE-Advanced FDD/TDD mode, this key is blank.
Couplings	Selecting last span changes the measurement span value.
Initial S/W Revision	Prior to A.02.00
Modified at S/W Revision	A.02.00, A.03.00

Sweep/Control

Accesses a menu of functions that enable you to set up and control the sweep time and source for the current measurement. See "[Sweep/Control](#)" on page 2703 for more information.

Key Path	Front-panel key
Initial S/W Revision	Prior to A.02.00

Sweep Time

Selects the length of time that the spectrum analyzer sweeps the displayed frequency span. Additional overhead time, which impacts the sweep rate, is not calculated as part of the sweep time. In fact:

$$\text{sweep rate} = \text{span} / \text{sweep time}$$

$$\text{update rate} = 1 / (\text{sweep time} + \text{overhead})$$

$$\text{sweep cycle time} = \text{sweep time} + \text{overhead}$$

Sweep time is coupled to RBW and VBW, and is impacted by the number of sweep points, so changing those parameters may change the sweep time.

Key Path	Sweep/Control
Mode	SA, WCDMA, C2K, WIMAX OFDMA, 1xEVDO, DVB-T/H, DTMB (CTTB), ISDB-T, CMMB, LTE, LTETDD, Digital Cable TV, WLAN, MSR, LTEAFDD, LTEATDD
Remote Command	[:SENSe]:CHPower:SWEep:TIME <time> [:SENSe]:CHPower:SWEep:TIME? [:SENSe]:CHPower:SWEep:TIME:AUTO OFF ON 0 1 [:SENSe]:CHPower:SWEep:TIME:AUTO?
Example	CHP:SWE:TIME 25ms CHP:SWE:TIME? CHP:SWE:TIME:AUTO OFF CHP:SWE:TIME:AUTO?
Preset	SA, WIMAX OFDMA: Automatically Calculated WCDMA: 1.0 ms CDMA2K: 9.4ms 1xEVDO: 2.66ms DVB-T/H: Automatically Calculated DTMB (CTTB): Automatically Calculated ISDB-T: Automatically Calculated CMMB: Automatically Calculated LTE, MSR: Automatically Calculated LTETDD: Automatically Calculated Digital Cable TV: Automatically Calculated

	WLAN: Automatically Calculated LTEAFDD,LTEATDD:Automatically Calculated
State Saved	Saved in instrument state.
Min	1 ms
Max	4000 s
Initial S/W Revision	Prior to A.02.00
Modified at S/W Revision	A.02.00, A.03.00

Sweep Setup

Accesses a menu that enables you to set the sweep state for the current measurement.

Key Path	Sweep/Control
Initial S/W Revision	Prior to A.02.00

Auto Sweep Time Rules

Switches the analyzer between normal and accuracy sweep states.

Setting Auto Sweep Time to Accy results in slower sweep times, usually about three times as long, but yields better amplitude accuracy for CW signals. The instrument amplitude accuracy specifications only apply when Auto Sweep Time is set to Accy.

Additional amplitude errors which occur when Auto Sweep Time is set to Norm are usually well under 0.1 dB, though this is not guaranteed. Because of the faster sweep times and still low errors, Norm is the preferred setting of Auto Sweep Time. Auto Sweep Time is set to Norm on a Preset or Auto Couple. This means that in the Preset or Auto Coupled state, instrument amplitude accuracy specifications do not apply.

Key Path	Sweep/Control, Sweep Setup
Mode	SA, WCDMA, C2K, WIMAX OFDMA, 1xEVDO, DVB-T/H, DTMB (CTTB), ISDB-T, CMMB, LTE, LTETDD, Digital Cable TV, WLAN, MSR, LTEAFDD, LTEATDD
Remote Command	[:SENSe] :CHPower:SWEep:TIME:AUTO:RULEs NORMal ACCuracy [:SENSe] :CHPower:SWEep:TIME:AUTO:RULEs?
Example	CHP:SWE:TIME:AUTO:RUL NORM CHP:SWE:TIME:AUTO:RUL?
Notes	In Zero Span, this key is irrelevant and inaccessible (because the whole Sweep Setup menu is grayed out in Zero Span), however its settings can be changed remotely with no error indication. Set to Norm when Auto Couple is pressed or sent remotely

Preset	NORMal
State Saved	Saved in instrument state.
Range	Norm Accy
Initial S/W Revision	Prior to A.02.00
Modified at S/W Revision	A.02.00, A.03.00

Pause

Pauses a measurement after the current data acquisition is complete. When Paused, the label on the key changes to Resume. Pressing the Resume key resumes the measurement at the point it was at when paused. See ["Pause/Resume" on page 2703](#) for more details.

Key Path	Sweep/Control
Initial S/W Revision	Prior to A.02.00

Gate

Accesses a menu that enables you to control the gating function. The Gate functionality is used to view signals best viewed by qualifying them with other events.

Gate setup parameters are the same for all measurements – they do not change as you change measurements. Settings like these are called “Meas Global” and are unaffected by Meas Preset.

Note that Sweep Time autocoupling rules and annotation are changed by Gate being on.

Key Path	Sweep/Control
Scope	Meas Global
Readback	The state and method of Gate, as [Off, LO] or [On, Video]. Note that for measurements that only support gated LO, the method is nonetheless read back, but always as LO.
Initial S/W Revision	Prior to A.02.00

Gate On/Off

Turns the gate function on and off.

When the Gate Function is on, the selected Gate Method is used along with the gate settings and the signal at the gate source to control the sweep and video system with the gate signal. Not all measurements allow every type of Gate Methods.

When Gate is on, the annunciation in the measurement bar reflects that it is on and what method is used, as seen in the following "Gate: LO" annunciator graphic.

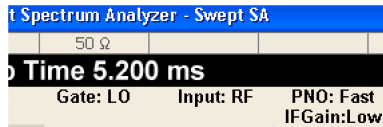

Key Path	Sweep/Control, Gate
Remote Command	[:SENSe] :SWEep:EGATe [:STATe] OFF ON 0 1 [:SENSe] :SWEep:EGATe [:STATe] ?
Example	SWE:EGAT ON SWE:EGAT?
Dependencies	<p>The function is unavailable (grayed out) and Off when:</p> <ul style="list-style-type: none"> • Gate Method is LO or Video and FFT Sweep Type is manually selected. • Gate Method is FFT and Swept Sweep Type is manually selected. • Marker Count is ON. <p>The following are unavailable whenever Gate is on:</p> <ul style="list-style-type: none"> • FFT under Sweep Type when Method=LO or Video or Swept under Sweep Type when Method=FFT • Marker Count <p>While Gate is on, the Auto Rules for Sweep Type are modified so that the choice agrees with the Gate Method: i.e., FFT for Method = FFT and Swept for Method = LO or Video.</p> <p>The Gate softkey and all SCPI under the [:SENSe]:SWEep:EGATe SCPI node are grayed out when Source Mode is Tracking with an external source. This is because the Gate circuitry is used to sync the external source. If the Tracking Source is turned on, the Gate is turned off.</p> <p>When in the ACP measurement:</p> <ul style="list-style-type: none"> • When Meas Method is RBW or FAST, this function is unavailable and the key is grayed out. • Whenever Gate is on, Meas Method, RBW or FAST is unavailable and keys for those are grayed out. • When Gate is on, Offset Res BW and Offset Video BW are ignored (if you set these values) and the measurement works as if all Offset Res BW and all Offset Video BW are coupled with the Res BW and the Video BW under the BW menu. When Gate is on, the Offset BW key in the Offset/Limit menu is grayed out.
Preset	Off LTETDD: On
State Saved	Saved in instrument state
Range	On Off
Backwards Compatibility SCPI	[:SENSe]:SWEep:TIME:GATE[:STATe] ESA compatibility
Backwards Compatibility Notes	In ESA, Trig Delay (On) and Gate (On) could not be active at the same time.. This dependency does not exist in PSA or in the X-Series.
Initial S/W Revision	Prior to A.02.00

Gate View On/Off

Turning on Gate View in the Swept SA measurement provides a single-window gate view display..

Turning on Gate View in other measurements shows the split-screen Gate View. In these measurements, when the Gate View is on, the regular view of the current measurement traces and results are reduced vertically to about 70% of the regular height. The Zero Span window, showing the positions of the Gate, is shown between the Measurement Bar and the reduced measurement window. By reducing the height of the measurement window, some of the annotation on the Data Display may not fit and is not shown.

Key Path	Sweep/Control, Gate
Remote Command	[:SENSe] :SWEep:EGATe:VIEW ON OFF 1 0 [:SENSe] :SWEep:EGATe:VIEW?
Example	SWE:EGAT:VIEW ON turns on the gate view.
Dependencies	In the Swept SA measurement: In Gate View, the regular Sweep Time key is grayed out . When pressed, the grayed out key puts up the informational message "Use Gate View Sweep Time in the Gate menu." In the other measurements: When you turn Gate View on, the lower window takes on the current state of the instrument. Upon leaving Gate View, the instrument takes on the state of the lower window. When you turn Gate View on, the upper window Sweep Time is set to the gate view sweep time.
Couplings	These couplings apply to the Swept SA measurement: <ul style="list-style-type: none"> • When Gate View is turned on, the instrument is set to Zero Span. • Gate View automatically turns off whenever a Span other than Zero is selected. • Gate View automatically turns off if you press the Last Span key while in Gate View, and the instrument returns to the Span it was in before entering Gate View (even if that is Zero Span). • When Gate View is turned on, the sweep time used is the gate view sweep time. This is set according to the rules in section "Gate View Setup" on page 2499 • When Gate View is turned off, Sweep Time is set to the normal Swept SA measurement sweep time. • If Gate View is on and Gate is off, then turning on Gate turns off Gate View.
Preset	OFF
State Saved	Saved in instrument state
Range	On Off
Initial S/W Revision	Prior to A.02.00

A sample of the Gate View screen in the Swept SA measurement is shown in the following graphic :

8 Channel Power Measurement Sweep/Control

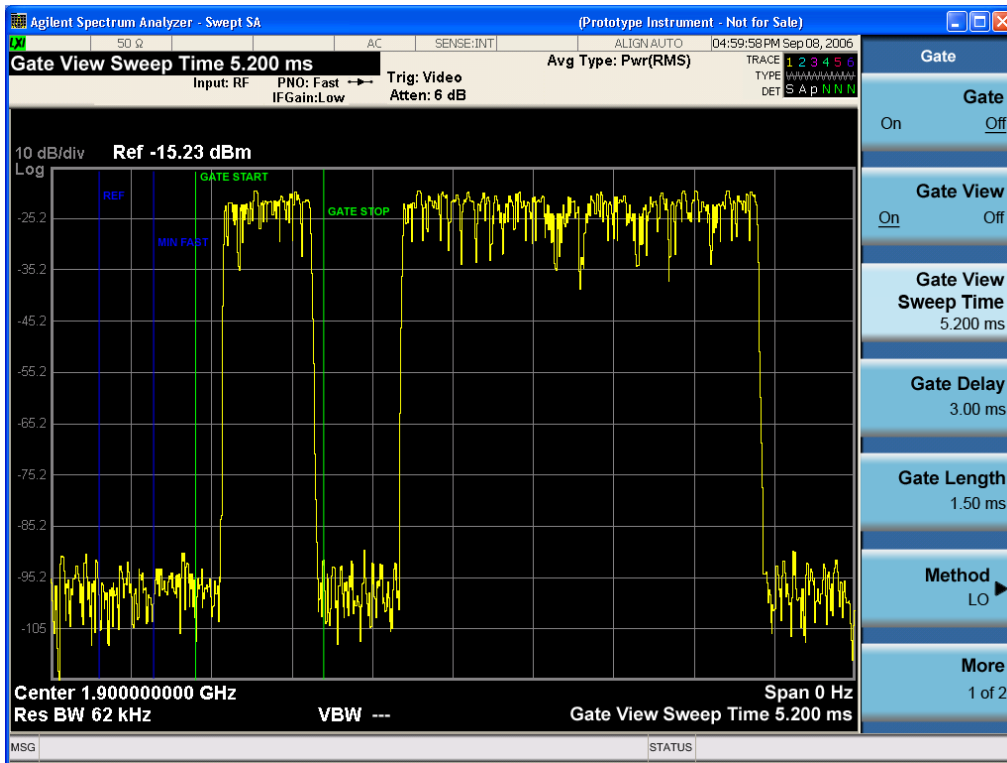

A sample of the Gate View screen in other measurements is shown in the following graphic. This example is for the ACP measurement:

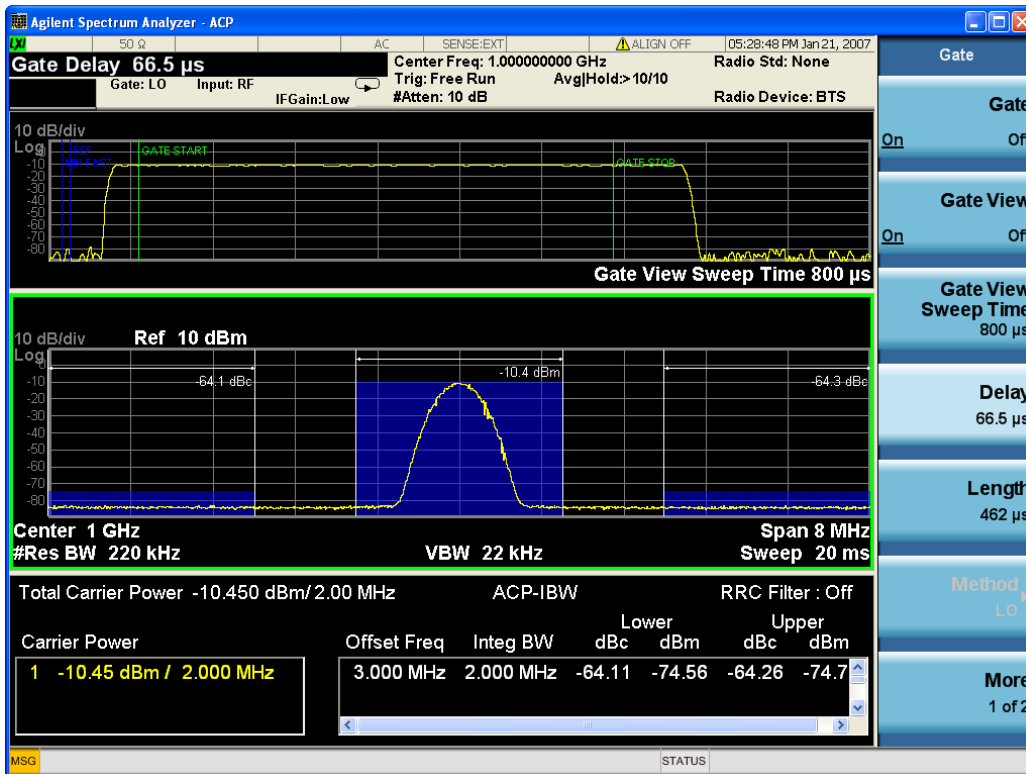

Turning Gate View off returns the analyzer to the Normal measurement view.

In the Swept SA, the normal measurement view is the single-window Swept SA view. When returning to this view, the Swept SA measurement returns to the Span it was in before entering **Gate View** (even if that is Zero Span).

The **Gate View** window is triggered from the Gate Source, with zero trigger delay. Also, when updating the **Gate View** window, the Gate itself must not operate. So it is internally shut off while the gate view window is being updated. For the Swept SA measurement, this means that the Gate is internally shut off whenever the gate view window is displayed. The measurement bar and softkeys continue to show the Trigger source for the main sweep window and give no indication that the Gate is shut off or that the Gate View window is triggered from the Gate Source.

When in **Gate View**, vertical lines are displayed in the Gate View window as follows:

- Green lines are displayed at the gate edges as follows: in Edge Gate, a line is shown for Delay and one for the end of the Gate period, defined by Length. In Level Gate a line is shown only for Delay. You can adjust the position of the green lines by adjusting the gate length and the gate delay. These lines update in the Gate View window as the active function changes, even if the window is not being updated. In Gated LO and Gated Video, these lines are positioned relative to the delay reference line (not relative to 0 time). In Gated FFT, their location is relative to the left edge of the screen.
- A blue line is displayed showing the delay reference, that is, the reference point for the Gate Delay within the Zero Span window. The blue line represents where (in time) the effective location of the gate start would be if the gate were programmed to zero delay.
-
- The second blue line is labeled "MIN FAST" as shown in the figure above because it represents the minimum Gate Delay for fast Gated LO operation. This line is only displayed in Gated LO. You cannot scroll (knob) or decrement (down key) the Gate Delay to less than that represented by the position of this line, it can only be set below this position manually, although once there it can be moved freely with the knob while below the line.
- A yellow line in the Gated Video case only, is displayed at Blength, where Blength is the display point (bucket) length for the swept trace, which is given by the sweep time for that trace divided by number of Points – 1. So it is referenced to 0 time, not to the delay reference. This line is labeled NEXT PT (it is not shown in the figure above because the figure above is for Gated LO).
- The yellow line represents the edge of a display point (bucket). Normally in Gated Video, the bucket length must be selected so that it exceeds the off time of the burst. There is another way to use the analyzer in Gated Video measurements, and that is to set the bucket width much shorter than the off time of the burst. Then use the Max Hold trace function to fill in "missing" buckets more slowly. This allows you to see some of the patterns of the Gated Video results earlier, though seeing a completely filled-in spectrum later.

Gate View Setup

Accesses a menu that enables you to setup parameters relevant to the Gate View

Key Path	Sweep/Control, Gate
Scope	Meas Global
Initial S/W Revision	A.10.00

Gate View Sweep Time

Controls the sweep time in the Gate View window. To provide an optimal view of the gate signal, the analyzer initializes Gate View Sweep Time based on the current settings of Gate Delay and Gate Length.

Key Path	Sweep/Control, Gate, Gate View Setup
Remote Command	[:SENSe] :SWEep:EGATe:TIME <time> [:SENSe] :SWEep:EGATe:TIME?
Example	SWE:EGAT:TIME 500 ms
Dependencies	Gate View Sweep Time is initialized: <ul style="list-style-type: none"> • On Preset (after initializing delay and length). • Every time the Gate Method is set/changed. <p>Additionally, in the Swept SA measurement, whenever you do a Preset, or leave Gate View, the analyzer remembers the Gate Delay and Gate Length settings. Then, when returning to Gate View, if the current Gate Delay and/or Gate Length do not match the remembered values Gate View Sweep Time is re-initialized.</p> <ol style="list-style-type: none"> 1. Compute the location of the "gate stop" line, which you know is at time $t = t_{min} + \text{GateDelay} + \text{GateLength}$.
Preset	519.3 μ s WiMAX OFDMA: 5 ms GSM/EDGE: 1 ms
State Saved	Saved in instrument state
Max	6000 s
Initial S/W Revision	Prior to A.02.00

Gate View Start Time

Controls the time at the left edge of the Gate View.

Key Path	Sweep/Control, Gate, Gate View Setup
Remote Command	[:SENSe] :SWEep:EGATe:VIEW:START <time> [:SENSe] :SWEep:EGATe:VIEW:START?
Example	SWE:EGAT:VIEW:STAR 10ms
Notes	Units of time are required or no units; otherwise an invalid suffix error message will be generated. See error -131.
Preset	0 ms
State Saved	Saved in instrument state
Min	0
Max	500 ms
Initial S/W Revision	A.10.00

Gate Delay

Controls the length of time from the time the gate condition goes True until the gate is turned on.

Key Path	Sweep/Control, Gate
Remote Command	[:SENSe] :SWEep:EGATe:DELay <time> [:SENSe] :SWEep:EGATe:DELay?
Example	SWE:EGAT:DELay 500ms SWE:EGAT:DELay?
Notes	Units of time are required or no units; otherwise an invalid suffix error message will be generated.
Preset	57.7 us WiMAX OFDMA: 71 us GSM/EDGE: 600 us WLAN: 500 us
State Saved	Saved in instrument state
Min	0.0 us
Max	100 s
Backwards Compatibility SCPI	[:SENSe] :SWEep:TIME:GATE:DELay ESA compatibility
Initial S/W Revision	Prior to A.02.00

Gate Length

Controls the length of time that the gate is on after it opens.

Key Path	Sweep/Control, Gate
Remote Command	[:SENSe] :SWEep:EGATe:LENGth <time> [:SENSe] :SWEep:EGATe:LENGth?
Example	SWE:EGAT:LENG 1 SWE:EGAT:LENG?
Notes	Units of time are required or no units; otherwise an invalid suffix error message will be generated.
Dependencies	<p>Grayed out when Gate Method is set to FFT in which case the label changes to that shown below.</p> <div style="border: 1px solid black; padding: 5px; display: inline-block;"> <p>Gate Length (=1.83/RBW) 2.8 ms</p> </div> <p style="margin-left: 20px;">vsd 39-1</p> <p>The key is also grayed out if Gate Control = Level.</p>
Preset	461.6 us

	WiMAX OFDMA: 50 us GSM/EDGE: 200 us WLAN: 1.54 ms
State Saved	Saved in instrument state
Min	100 ns
Max	5 s
Backwards Compatibility SCPI	[:SENSe] :SWEep:TIME:GATE:LENGth ESA compatibility
Initial S/W Revision	Prior to A.02.00

Gate Source

The menus under the Gate Source key are the same as those under the Trigger key, with the exception that neither Free Run nor Video are available as Gate Source selections. However, a different SCPI command is used to select the Gate Source (see table below) because you may independently set the Gate Source and the Trigger Source.

Any changes to the settings in the setup menus under each Gate Source selection key (for example: Trigger Level, Trigger Delay, etc.) also affect the corresponding settings under the Trigger menu keys. The SCPI commands used for these are the same for Trigger and Gate, since there is only one setting which affects both Gate and Trigger. Example: to set the Trigger Level for External 1 you use the command :TRIG:EXT1:LEV regardless of whether you are using External 1 as a Trigger Source or a Gate Source.

Key Path	Sweep/Control, Gate
Remote Command	<pre>[:SENSe] :SWEep:EGATE:SOURce EXTernal1 EXTernal2 LINE FRAME RFBurst [:SENSe] :SWEep:EGATE:SOURce?</pre>
Dependencies	In some models, there is no second External input. In these models, the External 2 key is blanked and the EXTernal2 parameter will generate a "Hardware missing; Not available for this model number" error.
Preset	EXTernal 1 GSM/EDGE, MSR: FRAME LTETDD: EXTernal 1When Direction is Downlink, FRAME when Direction is Uplink.
Backwards Compatibility Notes	In ESA, there is a single Gate input port. In PSA, the Gate Source may be taken from one of two specified input ports. In the X-Series, any Trigger Source can be a Gate Source.
Initial S/W Revision	Prior to A.02.00
Modified at S/W Revision	A.03.00, A.14.00

Line

Pressing this key, when it is not selected, selects the line signal as the trigger. A new sweep/measurement will start synchronized with the next cycle of the line voltage. Pressing this key, when it is already selected, access the line trigger setup menu.

Key Path	Trigger
Example	TRIG:SOUR LINE Swept SA measurement TRIG:<meas>:SOUR LINE Measurements other than Swept SA
Dependencies	Line trigger is not available when operating from a "dc power source", for example, when the instrument is powered from batteries.
State Saved	Saved in instrument state
Status Bits/OPC dependencies	The Status Operation Register bit 5 "Waiting for Trigger" is set at the same time as the Sweeping or Measuring bit is set. It is cleared when the trigger actually occurs (that is, after the trigger event occurs and all the applicable trigger criteria have been met). A corresponding pop-up message ("Waiting for trigger") is generated if no trigger signal appears after approximately 2 sec. This message goes away when a trigger signal appears.
Initial S/W Revision	Prior to A.02.00

Trig Slope

Controls the trigger polarity. It is set positive to trigger on a rising edge and negative to trigger on a falling edge.

Key Path	Trigger, Line
Remote Command	:TRIGger[:SEQuence]:LINE:SLOPe POSitive NEGative :TRIGger[:SEQuence]:LINE:SLOPe?
Example	TRIG:LINE:SLOP NEG
Preset	POSitive
State Saved	Saved in instrument state
Backwards Compatibility Notes	The legacy :TRIGger[:SEQuence]:SLOPe command affects the slopes for the VID, LINE, EXT1, EXT2, and RFB triggers.
Initial S/W Revision	Prior to A.02.00

External 1

Pressing this key, when it is not selected, selects an external input signal as the trigger. A new sweep/measurement will start when the external trigger condition is met using the external 1 input connector on the rear panel.

Pressing this key, when it is already selected, accesses the external 1 trigger setup menu.

Key Path	Trigger
Example	TRIG:SOUR EXT1 Swept SA measurement TRIG:<meas>:SOUR EXT1 Measurements other than Swept SA
Dependencies	Grayed out if in use by Point Trigger in the Source Setup menu. Forced to Free Run if already selected and Point Trigger is set to External 1.
State Saved	Saved in instrument state
Status Bits/OPC dependencies	The Status Operation Register bit 5 "Waiting for Trigger" is set at the same time as the Sweeping or Measuring bit is set. It is cleared when the trigger actually occurs (that is, after the trigger event occurs and all the applicable trigger criteria have been met). A corresponding pop-up message ("Waiting for trigger") is generated if no trigger signal appears after approximately 2 sec. This message goes away when a trigger signal appears.
Initial S/W Revision	Prior to A.02.00

Trigger Level

Sets the value where the external 1 trigger input will trigger a new sweep/measurement.

Key Path	Trigger, External 1
Remote Command	:TRIGger[:SEquence]:EXTernal1:LEVel <level> :TRIGger[:SEquence]:EXTernal1:LEVel?
Example	TRIG:EXT1:LEV 0.4 V
Couplings	This same level is used for the Ext1 trigger source in the Trigger menu, for the Ext1 selection in the Periodic Timer sync source (in the Trigger menu and in the Gate Source menu), and also for the Ext1 selection in the Gate Source menu.
Preset	1.2 V
State Saved	Saved in instrument state
Min	-5 V
Max	5 V
Default Unit	V
Backwards Compatibility SCPI	:TRIGger[:SEquence]:EXTernal:LEVel For backward compatibility, the parameter EXTernal is mapped to EXTernal1
Backwards Compatibility SCPI	:TRIGger[:SEquence]:FRAME:EXTernal1:LEVel
Initial S/W Revision	Prior to A.02.00

Trig Slope

Controls the trigger polarity. It is set positive to trigger on a rising edge and negative to trigger on a falling edge.

Key Path	Trigger, External 1
Remote Command	:TRIGger[:SEquence]:EXTernal1:SLOPe POSitive NEGative :TRIGger[:SEquence]:EXTernal1:SLOPe?
Example	TRIG:EXT1:SLOP NEG
Couplings	This same slope is used in the Ext1 selection for the trigger source in the Trigger menu and for the period timer sync source (in the Trigger menu and in the Gate Source menu).
Preset	POSitive
State Saved	Saved in instrument state
Backwards Compatibility SCPI	:TRIGger[:SEquence]:EXTernal:SLOPe For backward compatibility, the parameter EXTernal is mapped to EXTernal1
Backwards Compatibility SCPI	:TRIGger[:SEquence]:FRAMe:EXTernal1:SLOPe
Backwards Compatibility Notes	The legacy :TRIGger[:SEquence]:SLOPe command affects the slopes for the VID, LINE, EXT1, EXT2, and RFB triggers.
Initial S/W Revision	Prior to A.02.00

Zero Span Delay Comp On/Off

In zero span, there is a natural delay in the signal path, which comes from the RBW filter. This is usually desirable, as it allows you to trigger on events and also see those events, because the signal is delayed from the trigger event. However, in some cases it is desirable to eliminate this delay, so that trigger events line up exactly with the zero time point in zero span. You can use the Zero Span Delay Comp On/Off feature to enable or disable zero span delay compensation.

Key Path	Trigger, External 1
Remote Command	:TRIGger[:SEquence]:EXTernal1:DELAy:COMPensation OFF ON 0 1 :TRIGger[:SEquence]:EXTernal1:DELAy:COMPensation?
Example	TRIG:EXT1:DEL:COMP ON
Dependencies	No effect except in zero-span, but not locked out in nonzero spans. Blanked in modes that do not support zero-span measurements. If the SCPI command is sent when the key is blanked, an error is returned: -221, "Settings conflict; Feature not supported for this measurement" In analyzers shipping N9060A, this feature requires N9060A-7FP.
Preset	OFF
State Saved	Saved in instrument state
Initial S/W Revision	A.11.00

External 2

Pressing this key, when it is not selected, selects an external input signal as the trigger. A new sweep/measurement will start when the external trigger condition is met using the external 2 input

connector. The external trigger 2 input connector is on the rear panel.

Pressing this key, when it is already selected, accesses the external 2 trigger setup menu.

Key Path	Trigger
Example	TRIG:SOUR EXT2 Swept SA measurement TRIG:<meas>:SOUR EXT2 Measurements other than Swept SA
Dependencies	In some models, there is no second External input. In these models, the External 2 key is blanked and the EXTernal2 parameter will generate a "Hardware missing; Not available for this model number" message. Grayed out if in use by Point Trigger in the Source Setup menu. Forced to Free Run if already selected and Point Trigger is set to External 2.
State Saved	Saved in instrument state
Status Bits/OPC dependencies	The Status Operation Register bit 5 "Waiting for Trigger" is set at the same time as the Sweeping or Measuring bit is set. It is cleared when the trigger actually occurs (that is, after the trigger event occurs and all the applicable trigger criteria have been met). A corresponding pop-up message ("Waiting for trigger") is generated if no trigger signal appears after approximately 2 sec. This message goes away when a trigger signal appears.
Initial S/W Revision	Prior to A.02.00
Modified at S/W Revision	A.03.00

Trigger Level

Sets the value where the external 2 trigger input will trigger a new sweep/measurement.

Key Path	Trigger, External 2
Remote Command	:TRIGger[:SEquence]:EXTernal2:LEVel :TRIGger[:SEquence]:EXTernal2:LEVel?
Example	TRIG:EXT2:LEV 1.1 V
Couplings	This same level is used for the Ext2 trigger source in the Trigger menu, for the Ext2 selection in the Periodic Timer sync source (in the Trigger menu and in the Gate Source menu), and also for the Ext2 selection in the Gate Source menu.
Preset	1.2 V
State Saved	Saved in instrument state
Min	-5 V
Max	5 V
Default Unit	V
Backwards Compatibility SCPI	:TRIGger[:SEquence]:FRAMe:EXTernal2:LEVel
Initial S/W Revision	Prior to A.02.00

Trig Slope

Controls the trigger polarity. It is set positive to trigger on a rising edge and negative to trigger on a falling edge.

Key Path	Trigger, External 2
Remote Command	:TRIGger[:SEquence]:EXTernal2:SLOPe POSitive NEGative :TRIGger[:SEquence]:EXTernal2:SLOPe?
Example	TRIG:EXT2:SLOP NEG
Couplings	This same slope is used in the Ext2 selection for the trigger source in the Trigger menu and for the period timer sync source (in the Trigger menu and in the Gate Source menu).
Preset	POSitive
State Saved	Saved in instrument state
Backwards Compatibility SCPI	:TRIGger[:SEquence]:FRAMe:EXTernal2:SLOPe
Backwards Compatibility Notes	The legacy :TRIGger[:SEquence]:SLOPe command affects the slopes for the VID, LINE, EXT1, EXT2, and RFB triggers.
Initial S/W Revision	Prior to A.02.00

Zero Span Delay Comp On/Off

In zero span, there is a natural delay in the signal path, which comes from the RBW filter. This is usually desirable, as it allows you to trigger on events and also see those events, because the signal is delayed from the trigger event. However, in some cases it is desirable to eliminate this delay, so that trigger events line up exactly with the zero time point in zero span. You can use the Zero Span Delay Comp On/Off feature to enable or disable zero span delay compensation.

Key Path	Trigger, External 2
Remote Command	:TRIGger[:SEquence]:EXTernal2:DELAy:COMPensation OFF ON 0 1 :TRIGger[:SEquence]:EXTernal2:DELAy:COMPensation?
Example	TRIG:EXT2:DEL:COMP ON
Dependencies	No effect except in zero-span, but not locked out in nonzero spans. Blanked in modes that do not support zero-span measurements. If the SCPI command is sent when the key is blanked, an error is returned: -221, "Settings conflict; Feature not supported for this measurement" In analyzers shipping N9060A, this feature requires N9060A-7FP.
Preset	OFF
State Saved	Saved in instrument state
Initial S/W Revision	A.11.00

RF Burst

Pressing this key, when it is not selected, selects the RF Burst as the trigger. A new sweep/measurement will start when an RF burst envelope signal is identified from the signal at the RF Input connector. Pressing this key, when it is already selected, accesses the RF Burst trigger setup menu.

In some models, a variety of burst trigger circuitry is available, resulting in various available burst trigger bandwidths. The analyzer automatically chooses the appropriate trigger path based on the hardware configuration and other settings of the analyzer.

Key Path	Trigger
Example	TRIG:SOUR RFB Swept SA measurement TRIG:< meas>:SOUR RFB Measurements other than Swept SA
State Saved	Saved in instrument state
Status Bits/OPC dependencies	The Status Operation Register bit 5 "Waiting for Trigger" is set at the same time as the Sweeping or Measuring bit is set. It is cleared when the trigger actually occurs (that is, after the trigger event occurs and all the applicable trigger criteria have been met). A corresponding pop-up message ("Waiting for trigger") is generated if no trigger signal appears after approximately 2 sec. This message goes away when a trigger signal appears.
Backwards Compatibility Notes	The legacy command: :TRIGger[:SEQuence]:RFBurst:FSElectivity[:STATe] OFF ON 0 1 is not supported in the X-Series, as the hardware to do Frequency Selective burst triggers does not exist in X-Series.
Initial S/W Revision	Prior to A.02.00
Modified at S/W Revision	A.04.00

Absolute Trigger Level

Sets the absolute trigger level for the RF burst envelope.

When using the External Mixing path, the Absolute Trigger Level is uncalibrated because the factory default was set to accommodate the expected IF levels for the RF path.

Key Path	Trigger, RF Burst
Scope	Meas Global
Remote Command	:TRIGger[:SEQuence]:RFBurst:LEVel:ABSolute <ampl> :TRIGger[:SEQuence]:RFBurst:LEVel:ABSolute?
Example	TRIG:RFB:LEV:ABS 10 dBm sets the trigger level of the RF burst envelope signal to the absolute level of 10 dBm
Notes	Sending this command does not switch the setting from relative to absolute; to switch it you need to send the :TRIGger[:SEQuence]:RFBurst:LEVel:TYPE command, below. Amplitude Corrections are not taken into account by the Absolute Trigger Level. For example, if you have given yourself effective gain with an amplitude correction factor, the Absolute Trigger will not fire until you have set the trigger level that far below the displayed signal level, rather than simply to

	the displayed signal level. This is only true for Amplitude Corrections, not External Gain or Ref Level Offset functions. If mode is Bluetooth, the default value is -50 dBm.
Couplings	This same level is used for the RF Burst trigger source in the Trigger menu, for the RF Burst selection in the Periodic Timer sync source (in the Trigger menu and in the Gate Source menu), and also for the RF Burst selection in the Gate Source menu
Preset	-20 dBm
State Saved	Saved in instrument state
Min	-200 dBm
Max	100 dBm
Default Unit	depends on the current selected Y-Axis unit
Backwards Compatibility SCPI	:TRIGger[:SEquence]:FRAMe:RFBurst:LEVel:ABSolute
Initial S/W Revision	Prior to A.02.00
Modified at S/W Revision	A.04.00

Key Path	Trigger, RF Burst
Remote Command	:TRIGger[:SEquence]:RFBurst:LEVel:TYPE ABSolute RELative :TRIGger[:SEquence]:RFBurst:LEVel:TYPE?
Example	TRIG:RFB:LEV:TYPE REL sets the trigger level type of the RF burst trigger to Relative.
Preset	ABSolute
State Saved	Saved in instrument state
Initial S/W Revision	Prior to A.02.00
Modified at S/W Revision	A.04.00

Relative Trigger Level

Sets the relative trigger level for the RF burst envelope.

In some models, the relative burst trigger function is implemented in hardware. In other models, without the advanced triggering hardware required, the relative burst trigger function is implemented in software in some measurements, and is unavailable in other measurements.

When implemented in software, the relative RF Burst trigger function is implemented as follows:

1. The measurement starts with the absolute RF Burst trigger setting. If it cannot get a trigger with that level, auto trigger fires and the acquisition starts anyway. After the acquisition, the measurement searches for the peak in the acquired waveform and saves it.

2. Now, in the next cycle of the measurement, the measurement determines a new absolute RF Burst level based on the peak value from the first measurement and the Relative RF Burst Trigger Level (always 0 or negative dB) set by the user. The following formula is used:
 3. absolute RF Burst level = peak level of the previous acquisition + relative RF Burst level
 4. If the new absolute RF Burst level differs from the previous by more than 0.5 dB, the new level is sent to the hardware; otherwise it is not updated (to avoid slowing down the acquisition)
- Steps 2 and 3 repeat for subsequent measurements.

Key Path	Trigger, RF Burst
Scope	Meas Global
Remote Command	:TRIGger[:SEquence]:RFBurst:LEVel:RELative <rel_ampl> :TRIGger[:SEquence]:RFBurst:LEVel:RELative?
Example	TRIG:RFB:LEV:REL -10 dB sets the trigger level of the RF burst envelope signal to the relative level of -10 dB
Notes	Sending this command does not switch the setting from absolute to relative; to switch it you need to send the :TRIGger[:SEquence]:RFBurst:LEVel:TYPE command, above. The relative trigger level is not available in some measurements. In those measurements the RELative parameter, and the :TRIGger[:SEquence]:RFBurst:LEVel:TYPE command (above), will generate an error if sent.
Dependencies	This key is grayed out and Absolute Trigger Level selected if the required hardware is not present in your analyzer and the current measurement does not support Relative triggering.
Preset	-6 dB GSM: -25 dB
State Saved	Saved in instrument state
Min	-45 dB
Max	0 dB
Default Unit	dB or dBc
Backwards Compatibility SCPI	:TRIGger[:SEquence]:RFBurst:LEVel This legacy command is aliased to :TRIGger[:SEquence]:RFBurst:LEVel:RELative because the PSA had ONLY relative burst triggering
Initial S/W Revision	Prior to A.02.00
Modified at S/W Revision	A.04.00

Trigger Slope

It is set positive to trigger on a rising edge and negative to trigger on a falling edge.

Key Path	Trigger, RF Burst
Remote Command	:TRIGger[:SEquence]:RFBurst:SLOPe POSitive NEGative :TRIGger[:SEquence]:RFBurst:SLOPe?

Example	TRIG:RFB:SLOP NEG
Couplings	This same slope is used in the RF Burst selection for the trigger source in the Trigger menu and for the period timer sync source (in the Trigger menu and in the Gate Source menu).
Preset	POSitive
State Saved	Saved in instrument state
Backwards Compatibility SCPI	:TRIGger[:SEQuence]:FRAMe:RFBurst:SLOPe
Backwards Compatibility Notes	The legacy :TRIGger[:SEQuence]:SLOPe command affects the slopes for the VID, LINE, EXT1, EXT2, and RFB triggers.
Initial S/W Revision	Prior to A.02.00

Periodic Timer (Frame Trigger)

Pressing this key, when it is not selected, selects the internal periodic timer signal as the trigger. Triggering occurrences are set by the **Period** parameter, which is modified by the **Sync Source** and **Offset**. Pressing this key, when it is already selected, accesses the periodic timer trigger setup functions.

If you do not have a sync source selected (it is Off), then the internal timer will not be synchronized with any external timing events.

Key Path	Trigger
Example	TRIG:SOUR FRAM Swept SA measurement TRIG:<meas>:SOUR FRAM Measurements other than Swept SA
State Saved	Saved in instrument state
Readback	[Sync: <value of Sync Source>], for example, [Sync: External 1]
Status Bits/OPC dependencies	The Status Operation Register bit 5 "Waiting for Trigger" is set at the same time as the Sweeping or Measuring bit is set. It is cleared when the trigger actually occurs (that is, after the trigger event occurs and all the applicable trigger criteria have been met). A corresponding pop-up message ("Waiting for trigger") is generated if no trigger signal appears after approximately 2 sec. This message goes away when a trigger signal appears.
Initial S/W Revision	Prior to A.02.00

Periodic Timer Triggering:

This feature selects the internal periodic timer signal as the trigger. Trigger occurrences are set by the **Periodic Timer** parameter, which is modified by the **Sync Source** and **Offset**.

The figure below shows the action of the periodic timer trigger. Before reviewing the figure, we'll explain some uses for the periodic trigger.

A common application is measuring periodic burst RF signals for which a trigger signal is not easily available. For example, we might be measuring a TDMA radio which bursts every 20 ms. Let's assume that the 20 ms period is very consistent. Let's also assume that we do not have an external trigger source

available that is synchronized with the period, and that the signal-to-noise ratio of the signal is not high enough to provide a clean RF burst trigger at all of the analysis frequencies. For example, we might want to measure spurious transmissions at an offset from the carrier that is larger than the bandwidth of the RF burst trigger. In this application, we can set the Periodic Timer to a 20.00 ms period and adjust the offset from that timer to position our trigger just where we want it. If we find that the 20.00 ms is not exactly right, we can adjust the period slightly to minimize the drift between the period timer and the signal to be measured.

A second way to use this feature would be to use **Sync Source** temporarily, instead of **Offset**. In this case, we might tune to the signal in a narrow span and use the RF Burst trigger to synchronize the periodic timer. Then we would turn the sync source off so that it would not miss-trigger. Miss-triggering can occur when we are tuned so far away from the RF burst trigger that it is no longer reliable.

A third example would be to synchronize to a signal that has a reference time element of much longer period than the period of interest. In some CDMA applications, it is useful to look at signals with a short periodicity, by synchronizing that periodicity to the "even-second clock" edge that happens every two seconds. Thus, we could connect the even-second clock trigger to Ext1 and use then Ext1 as the sync source for the periodic timer.

The figure below illustrates this third example. The top trace represents the even-second clock. It causes the periodic timer to synchronize with the leading edge shown. The analyzer trigger occurs at a time delayed by the accumulated offset from the period trigger event. The periodic timer continues to run, and triggers continue to occur, with a periodicity determined by the analyzer time base. The timer output (labeled "late event") will drift away from its ideal time due to imperfect matching between the time base of the signal being measured and the time base of the analyzer, and also because of imperfect setting of the period parameter. But the synchronization is restored on the next even-second clock event. ("Accumulated offset" is described in the in the **Offset** function section.)

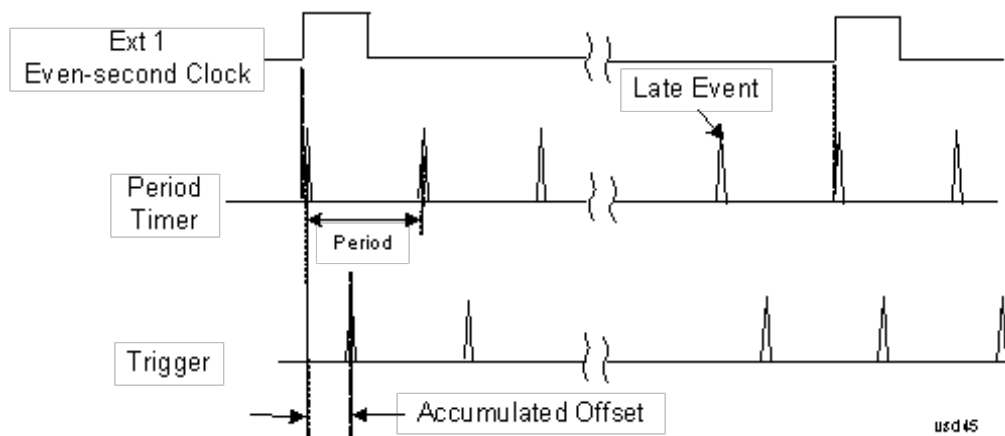

Period

Sets the period of the internal periodic timer clock. For digital communications signals, this is usually set to the frame period of your current input signal. In the case that sync source is not set to OFF, and the external sync source rate is changed for some reason, the periodic timer is synchronized at the every external synchronization pulse by resetting the internal state of the timer circuit.

Key Path	Trigger, Periodic Timer
Remote Command	:TRIGger[:SEquence]:FRAME:PERiod <time>

	:TRIGger[:SEquence]:FRAMe:PERiod?
Example	TRIG:FRAM:PER 100 ms
Dependencies	The invalid data indicator turns on when the period is changed, until the next sweep/measurement completes.
Couplings	The same period is used in the Gate Source selection of the period timer.
Preset	20 ms GSM: 4.615383
State Saved	Saved in instrument state
Min	100.000 ns
Max	559.0000 ms
Default Unit	S
Initial S/W Revision	Prior to A.02.00

Offset

Adjusts the accumulated offset between the periodic timer events and the trigger event. Adjusting the accumulated offset is different than setting an offset, and requires explanation.

The periodic timer is usually not synchronized with any external events, so the timing of its output events has no absolute meaning. Since the timing relative to external events (RF signals) is important, you need to be able to adjust (offset) it. However, you have no direct way to see when the periodic timer events occur. All that you can see is the trigger timing. When you want to adjust the trigger timing, you will be changing the internal offset between the periodic timer events and the trigger event. Because the absolute value of that internal offset is unknown, we will just call that the accumulated offset. Whenever the Offset parameter is changed, you are changing that accumulated offset. You can reset the displayed offset using Reset Offset Display. Changing the display does not change the value of the accumulated offset, and you can still make additional changes to accumulated offset.

To avoid ambiguity, we define that an increase in the "offset" parameter, either from the knob or the SCPI adjust command, serves to delay the timing of the trigger event.

Key Path	Trigger, Periodic Timer
Remote Command	:TRIGger[:SEquence]:FRAMe:OFFSet <time> :TRIGger[:SEquence]:FRAMe:OFFSet?
Example	TRIG:FRAM:OFFS 1.2 ms
Notes	The front panel interface (for example, the knob), and this command, adjust the accumulated offset, which is shown on the active function display. However, the actual amount sent to the hardware each time the offset is updated is the delta value, that is, the current accumulated offset value minus the previous accumulated offset value. Note that the accumulated offset value is essentially arbitrary; it represents the accumulated offset from the last time the offset was zeroed (with the Reset Offset Display key). Note that this command does not change the period of the trigger waveform. Note also that Offset is used only when the sync source is set to OFF, otherwise delay is used, see section " Trig Delay " on page 470 .

	An increase in the "offset" parameter, either from the knob or the SCPI adjust command, serves to delay the timing of the trigger event.
Notes	When the SCPI command is sent the value shown on the key (and the Active Function, if this happens to be the active function) is updated with the new value. However, the actual amount sent to the hardware is the delta value, that is, the current accumulated offset value minus the previous accumulated offset value. The SCPI query simply returns the value currently showing on the key.
Dependencies	The invalid data indicator turns on when the offset is changed, until the next sweep/measurement completes.
Couplings	The same offset is used in the Gate Source selection of the period timer.
Preset	0 s
State Saved	Saved in instrument state
Min	-10.000 s
Max	10.000 s
Default Unit	S
Initial S/W Revision	Prior to A.02.00

Offset Adjust (Remote Command Only)

This remote command does not work at all like the related front panel keys. This command lets you advance the phase of the frame trigger by the amount you specify.

It does not change the period of the trigger waveform. If the command is sent multiple times, it advances the phase of the frame trigger an additional amount each time it is sent. Negative numbers are permitted.

Remote Command	:TRIGger[:SEquence]:FRAMe:ADJust <time>
Example	TRIG:FRAM:ADJ 1.2 ms
Notes	Note also that Offset is used only when the sync source is set to OFF, otherwise delay is used, see section "Trig Delay" on page 470 An increase in the "offset" parameter, either from the knob or the SCPI adjust command, serves to delay the timing of the trigger event.
Notes	The front panel interface (for example, the knob) and the :TRIG:FRAM:OFFS command adjust the accumulated offset, which is shown on the active function display. However, the actual amount sent to the hardware is the delta value, that is, the current offset value minus the previous offset value. When the SCPI command is sent the value shown on the key (and the Active Function, if this happens to be the active function) is updated by increasing it (or decreasing it if the value sent is negative) by the amount specified in the SCPI command. This is a "command only" SCPI command, with no query.
Dependencies	The invalid data indicator turns on when the offset is changed, until the next sweep/measurement completes.
Couplings	The same offset is used in the Gate Source selection of the period timer.
Preset	0 s

State Saved	Saved in instrument state
Min	-10.000 s
Max	10.000 s
Default Unit	S
Initial S/W Revision	Prior to A.02.00

Reset Offset Display

Resets the value of the periodic trigger offset display setting to 0.0 seconds. The current displayed trigger location may include an offset value defined with the Offset key. Pressing this key redefines the currently displayed trigger location as the new trigger point that is 0.0 s offset. The Offset key can then be used to add offset relative to this new timing.

Key Path	Trigger, Periodic Timer
Remote Command	:TRIGger[:SEquence]:FRAMe:OFFSet:DISPlay:RESet
Example	TRIG:FRAM:OFFS:DISP:RES
Initial S/W Revision	Prior to A.02.00

Sync Source

Selects a signal source for you to synchronize your periodic timer trigger to, otherwise you are triggering at some arbitrary location in the frame. Synchronization reduces the precision requirements on the setting of the period.

For convenience you may adjust the level and slope of the selected sync source in a conditional branch setup menu accessed from the Sync Source menu. Note that these settings match those in the **Trigger** and **Gate Source** menus; that is, each trigger source has only one value of level and slope, regardless of which menu it is accessed from.

Key Path	Trigger, Periodic Timer
Remote Command	:TRIGger[:SEquence]:FRAMe:SYNC EXTernal1 EXTernal2 RFBurst OFF :TRIGger[:SEquence]:FRAMe:SYNC?
Example	TRIG:FRAM:SYNC EXT2
Dependencies	In some models, there is no second External input. In these models, the External 2 key is blanked and the EXTernal2 parameter will generate a "Hardware missing; Not available for this model number" message.
Preset	Off GSM/EDGE, MSR,LTE,LTETDD: RFBurst
State Saved	Saved in instrument state
Readback	The current setting is read back to this key and it is also Readback to the previous Periodic Timer trigger key.

Backwards Compatibility SCPI	:TRIGger[:SEquence]:FRAMe:SYNC EXTernal
Initial S/W Revision	Prior to A.02.00
Modified at S/W Revision	A.03.00, A.14.00

Off

Turns off the sync source for your periodic trigger. With the sync source off, the timing will drift unless the signal source frequency is locked to the analyzer frequency reference.

Key Path	Trigger, Periodic Timer, Sync Source
Example	TRIG:FRAM:SYNC OFF
Readback	Off
Initial S/W Revision	Prior to A.02.00

External 1

Pressing this key, when it is not selected, selects an external input signal as the trigger. A new sweep/measurement will start when the external trigger condition is met using the external 1 input connector on the rear panel.

Pressing this key, when it is already selected, accesses the external 1 trigger setup menu.

Key Path	Trigger
Example	TRIG:SOUR EXT1 Swept SA measurement TRIG:<meas>:SOUR EXT1 Measurements other than Swept SA
Dependencies	Grayed out if in use by Point Trigger in the Source Setup menu. Forced to Free Run if already selected and Point Trigger is set to External 1.
State Saved	Saved in instrument state
Status Bits/OPC dependencies	The Status Operation Register bit 5 "Waiting for Trigger" is set at the same time as the Sweeping or Measuring bit is set. It is cleared when the trigger actually occurs (that is, after the trigger event occurs and all the applicable trigger criteria have been met). A corresponding pop-up message ("Waiting for trigger") is generated if no trigger signal appears after approximately 2 sec. This message goes away when a trigger signal appears.
Initial S/W Revision	Prior to A.02.00

Trigger Level

Sets the value where the external 1 trigger input will trigger a new sweep/measurement.

Key Path	Trigger, External 1
Remote Command	:TRIGger[:SEquence]:EXTernal1:LEVel <level> :TRIGger[:SEquence]:EXTernal1:LEVel?
Example	TRIG:EXT1:LEV 0.4 V
Couplings	This same level is used for the Ext1 trigger source in the Trigger menu, for the Ext1 selection in the Periodic Timer sync source (in the Trigger menu and in the Gate Source menu), and also for the Ext1 selection in the Gate Source menu.
Preset	1.2 V
State Saved	Saved in instrument state
Min	-5 V
Max	5 V
Default Unit	V
Backwards Compatibility SCPI	:TRIGger[:SEquence]:EXTernal:LEVel For backward compatibility, the parameter EXTernal is mapped to EXTernal1
Backwards Compatibility SCPI	:TRIGger[:SEquence]:FRAMe:EXTernal1:LEVel
Initial S/W Revision	Prior to A.02.00

Trig Slope

Controls the trigger polarity. It is set positive to trigger on a rising edge and negative to trigger on a falling edge.

Key Path	Trigger, External 1
Remote Command	:TRIGger[:SEquence]:EXTernal1:SLOPe POSitive NEGative :TRIGger[:SEquence]:EXTernal1:SLOPe?
Example	TRIG:EXT1:SLOP NEG
Couplings	This same slope is used in the Ext1 selection for the trigger source in the Trigger menu and for the period timer sync source (in the Trigger menu and in the Gate Source menu).
Preset	POSitive
State Saved	Saved in instrument state
Backwards Compatibility SCPI	:TRIGger[:SEquence]:EXTernal:SLOPe For backward compatibility, the parameter EXTernal is mapped to EXTernal1
Backwards Compatibility SCPI	:TRIGger[:SEquence]:FRAMe:EXTernal1:SLOPe
Backwards Compatibility Notes	The legacy :TRIGger[:SEquence]:SLOPe command affects the slopes for the VID, LINE, EXT1, EXT2, and RFB triggers.
Initial S/W Revision	Prior to A.02.00

External 2

Pressing this key, when it is not selected, selects an external input signal as the trigger. A new sweep/measurement will start when the external trigger condition is met using the external 2 input connector. The external trigger 2 input connector is on the rear panel.

Pressing this key, when it is already selected, accesses the external 2 trigger setup menu.

Key Path	Trigger
Example	TRIG:SOUR EXT2 Swept SA measurement TRIG:<meas>:SOUR EXT2 Measurements other than Swept SA
Dependencies	In some models, there is no second External input. In these models, the External 2 key is blanked and the EXTERNAL2 parameter will generate a "Hardware missing; Not available for this model number" message. Grayed out if in use by Point Trigger in the Source Setup menu. Forced to Free Run if already selected and Point Trigger is set to External 2.
State Saved	Saved in instrument state
Status Bits/OPC dependencies	The Status Operation Register bit 5 "Waiting for Trigger" is set at the same time as the Sweeping or Measuring bit is set. It is cleared when the trigger actually occurs (that is, after the trigger event occurs and all the applicable trigger criteria have been met). A corresponding pop-up message ("Waiting for trigger") is generated if no trigger signal appears after approximately 2 sec. This message goes away when a trigger signal appears.
Initial S/W Revision	Prior to A.02.00
Modified at S/W Revision	A.03.00

Trigger Level

Sets the value where the external 2 trigger input will trigger a new sweep/measurement.

Key Path	Trigger, External 2
Remote Command	:TRIGger[:SEquence]:EXTernal2:LEVel :TRIGger[:SEquence]:EXTernal2:LEVel?
Example	TRIG:EXT2:LEV 1.1 V
Couplings	This same level is used for the Ext2 trigger source in the Trigger menu, for the Ext2 selection in the Periodic Timer sync source (in the Trigger menu and in the Gate Source menu), and also for the Ext2 selection in the Gate Source menu.
Preset	1.2 V
State Saved	Saved in instrument state
Min	-5 V
Max	5 V
Default Unit	V
Backwards Compatibility SCPI	:TRIGger[:SEquence]:FRAMe:EXTernal2:LEVel
Initial S/W Revision	Prior to A.02.00

Trig Slope

Controls the trigger polarity. It is set positive to trigger on a rising edge and negative to trigger on a falling edge.

Key Path	Trigger, External 2
Remote Command	:TRIGger[:SEquence]:EXTernal2:SLOPe POSitive NEGative :TRIGger[:SEquence]:EXTernal2:SLOPe?
Example	TRIG:EXT2:SLOP NEG
Couplings	This same slope is used in the Ext2 selection for the trigger source in the Trigger menu and for the period timer sync source (in the Trigger menu and in the Gate Source menu).
Preset	POSitive
State Saved	Saved in instrument state
Backwards Compatibility SCPI	:TRIGger[:SEquence]:FRAMe:EXTernal2:SLOPe
Backwards Compatibility Notes	The legacy :TRIGger[:SEquence]:SLOPe command affects the slopes for the VID, LINE, EXT1, EXT2, and RFB triggers.
Initial S/W Revision	Prior to A.02.00

RF Burst

Pressing this key, when it is not selected, selects the RF Burst as the trigger. A new sweep/measurement will start when an RF burst envelope signal is identified from the signal at the RF Input connector. Pressing this key, when it is already selected, accesses the RF Burst trigger setup menu.

In some models, a variety of burst trigger circuitry is available, resulting in various available burst trigger bandwidths. The analyzer automatically chooses the appropriate trigger path based on the hardware configuration and other settings of the analyzer.

Key Path	Trigger
Example	TRIG:SOUR RFB Swept SA measurement TRIG:<meas>:SOUR RFB Measurements other than Swept SA
State Saved	Saved in instrument state
Status Bits/OPC dependencies	The Status Operation Register bit 5 "Waiting for Trigger" is set at the same time as the Sweeping or Measuring bit is set. It is cleared when the trigger actually occurs (that is, after the trigger event occurs and all the applicable trigger criteria have been met). A corresponding pop-up message ("Waiting for trigger") is generated if no trigger signal appears after approximately 2 sec. This message goes away when a trigger signal appears.
Backwards Compatibility Notes	The legacy command: :TRIGger[:SEquence]:RFBurst:FSElectivity[:STATe] OFF ON 0 1 is not supported in the X-Series, as the hardware to do Frequency Selective burst triggers does not exist in X-Series.

Initial S/W Revision	Prior to A.02.00
Modified at S/W Revision	A.04.00

Absolute Trigger Level

Sets the absolute trigger level for the RF burst envelope.

When using the External Mixing path, the Absolute Trigger Level is uncalibrated because the factory default was set to accommodate the expected IF levels for the RF path.

Key Path	Trigger, RF Burst
Scope	Meas Global
Remote Command	:TRIGger[:SEquence]:RFBurst:LEVel:ABSolute <ampl> :TRIGger[:SEquence]:RFBurst:LEVel:ABSolute?
Example	TRIG:RFB:LEV:ABS 10 dBm sets the trigger level of the RF burst envelope signal to the absolute level of 10 dBm
Notes	Sending this command does not switch the setting from relative to absolute; to switch it you need to send the :TRIGger[:SEquence]:RFBurst:LEVel:TYPE command, below. Amplitude Corrections are not taken into account by the Absolute Trigger Level. For example, if you have given yourself effective gain with an amplitude correction factor, the Absolute Trigger will not fire until you have set the trigger level that far below the displayed signal level, rather than simply to the displayed signal level. This is only true for Amplitude Corrections, not External Gain or Ref Level Offset functions. If mode is Bluetooth, the default value is -50 dBm.
Couplings	This same level is used for the RF Burst trigger source in the Trigger menu, for the RF Burst selection in the Periodic Timer sync source (in the Trigger menu and in the Gate Source menu), and also for the RF Burst selection in the Gate Source menu
Preset	-20 dBm
State Saved	Saved in instrument state
Min	-200 dBm
Max	100 dBm
Default Unit	depends on the current selected Y-Axis unit
Backwards Compatibility SCPI	:TRIGger[:SEquence]:FRAME:RFBurst:LEVel:ABSolute
Initial S/W Revision	Prior to A.02.00
Modified at S/W Revision	A.04.00

Key Path	Trigger, RF Burst
Remote Command	:TRIGger[:SEquence]:RFBurst:LEVel:TYPE ABSolute RELative :TRIGger[:SEquence]:RFBurst:LEVel:TYPE?

Example	TRIG:RFB:LEV:TYPE REL sets the trigger level type of the RF burst trigger to Relative.
Preset	ABSolute
State Saved	Saved in instrument state
Initial S/W Revision	Prior to A.02.00
Modified at S/W Revision	A.04.00

Trigger Slope

It is set positive to trigger on a rising edge and negative to trigger on a falling edge.

Key Path	Trigger, RF Burst
Remote Command	:TRIGger[:SEQuence]:RFBurst:SLOPe POSitive NEGative :TRIGger[:SEQuence]:RFBurst:SLOPe?
Example	TRIG:RFB:SLOP NEG
Couplings	This same slope is used in the RF Burst selection for the trigger source in the Trigger menu and for the period timer sync source (in the Trigger menu and in the Gate Source menu).
Preset	POSitive
State Saved	Saved in instrument state
Backwards Compatibility SCPI	:TRIGger[:SEQuence]:FRAME:RFBurst:SLOPe
Backwards Compatibility Notes	The legacy :TRIGger[:SEQuence]:SLOPe command affects the slopes for the VID, LINE, EXT1, EXT2, and RFB triggers.
Initial S/W Revision	Prior to A.02.00

Sync Holdoff

Sync Holdoff specifies the duration that the sync source signal must be kept false before the transition to true to be recognized as the sync timing. The periodic timer phase is aligned when the sync source signal becomes true, after the Holdoff time is satisfied.

A holdoff of 2 ms will work with most WiMAX signals, but there may be cases where the burst off duration is less than 1 ms and this value will need to be changed.

Key Path	Trigger, Periodic Timer
Remote Command	:TRIGger[:SEQuence]:FRAME:SYNC:HOLDoff <time> :TRIGger[:SEQuence]:FRAME:SYNC:HOLDoff? :TRIGger[:SEQuence]:FRAME:SYNC:HOLDoff:STATe OFF ON 0 1 :TRIGger[:SEQuence]:FRAME:SYNC:HOLDoff:STATe?
Preset	On, 1.000 ms

State Saved	Saved in instrument state
Min	0 ms
Max	+500 ms
Default Unit	s
Initial S/W Revision	Prior to A.02.00

Control Edge/Level

Sets the method of controlling the gating function from the gating signal.

Edge

In Edge triggering, the gate opens (after the Delay) on the selected edge (for example, positive) of the gate signal and closes on the alternate edge (for example, negative).

Level

In Level triggering, the gate opens (after the Delay) when the gate signal has achieved a certain level and stays open as long as that level is maintained.

Key Path	Sweep/Control, Gate
Remote Command	<code>[:SENSe] :SWEep:EGATe:CONTRol EDGE LEVe1</code> <code>[:SENSe] :SWEep:EGATe:CONTRol?</code>
Example	SWE:EGAT:CONT EDGE
Dependencies	If the Gate Method is FFT the Control key is grayed out and Edge is selected. If the Gate Source is TV, Frame or Line, the Control key is grayed out and Edge is selected.
Preset	EDGE
State Saved	Saved in instrument state
Backwards Compatibility SCPI	<code>[:SENSe] :SWEep:TIME:GATE:TYPE</code> ESA Compatibility
Initial S/W Revision	Prior to A.02.00

Gate Holdoff

Lets you increase or decrease the wait time after a gate event ends before the analyzer will respond to the next gate signal.

After any Gate event finishes, the analyzer must wait for the sweep system to settle before it can respond to another Gate signal. The analyzer calculates a "wait time," taking into account a number of factors, including RBW and Phase Noise Optimization settings. The goal is to achieve the same accuracy when gated as in ungated operation. The figure below illustrates this concept:

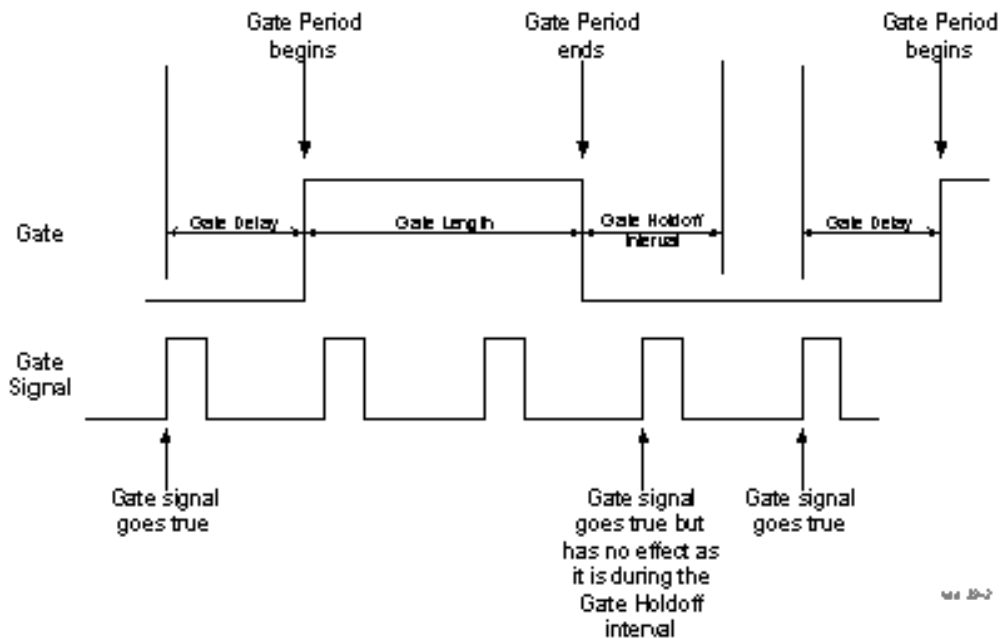

When Gate Holdoff is in Auto, the wait time calculated by the analyzer is used. When Gate Time is in Manual, the user may adjust the wait time, usually decreasing it in order to achieve greater speed, but at the risk of decreasing accuracy.

When the Method key is set to Video or FFT, the Gate Holdoff function has no effect.

In measurements that do not support Auto, the value shown when Auto is selected is “---” and the manually set holdoff is returned to a query.

Key Path	Sweep/Control, Gate
Remote Command	<pre>[:SENSe] :SWEep:EGATe:HOLDoff <time> [:SENSe] :SWEep:EGATe:HOLDoff? [:SENSe] :SWEep:EGATe:HOLDoff:AUTO OFF ON 0 1 [:SENSe] :SWEep:EGATe:HOLDoff:AUTO?</pre>
Example	<pre>SWE:EGAT:HOLD 0.0002 SWE:EGAT:HOLD? SWE:EGAT:HOLD:AUTO ON SWE:EGAT:HOLD:AUTO?</pre>
Couplings	<p>When Gate Holdoff is Auto, the Gate Holdoff key shows the value calculated by the analyzer for the wait time.</p> <p>Pressing the Gate Holdoff key while it is in Auto and not selected, causes the key to become selected and allows the user to adjust the value. If the value is adjusted, the setting changes to Man.</p> <p>Pressing the Gate Holdoff key, while it is in Auto and selected, does not change the value of Gate Holdoff, but causes the setting to change to Man. Now the user can adjust the value.</p> <p>Pressing the key while it is in Man and selected, cause the value to change back to Auto.</p> <p>Pressing the key while it is in Man and not selected, causes the key to become selected and allows the user to adjust the value.</p>

	When Method is set to Video or FFT, the Gate Holdoff function has no effect.
Preset	Auto Auto/On
State Saved	Saved in instrument state
Min	1 µsec
Max	1 sec
Initial S/W Revision	Prior to A.02.00

Gate Delay Compensation

This function allows you to select an RBW-dependent value by which to adjust the gate delay, to compensate for changes in the delay caused by RBW effects.

You can select between uncompensated operation and two types of compensation, Delay Until RBW Settled and Compensate for RBW Group Delay.

See "[More Information](#)" on page 633

Key Path	Sweep/Control, Gate
Scope	Meas Global
Remote Command	[:SENSe] :SWEep:EGATe:DELay:COMPensation:TYPE OFF SETTled GDELay [:SENSe] :SWEep:EGATe:DELay:COMPensation:TYPE?
Example	SWE:EGAT:DEL:COMP:TYPE SETT SWE:EGAT:DEL:COMP:TYPE?
Notes	Although this function is Meas Global, there are some measurements that do not support this function. In those measurements the operation will be Uncompensated. Going into one of those measurements will not change the Meas Global selection; it will simply display the grayed-out menu key with "Uncompensated" showing as the selection. This is a non-forceful grayout, so the SCPI command is still accepted. If Gate Delay Compensation is not supported at all within a particular mode, the key is not displayed, and if the SCPI command is sent while in a measurement within that mode, an "Undefined Header" message is generated. Measurements that do not support this function include: Swept SA
Preset	TD-SCDMA mode: Compensate for RBW Group Delay All other modes: Delay Until RBW Settled
State Saved	Saved in instrument state
Range	Uncompensated Delay Until RBW Settled Compensate for RBW Group Delay
Readback text	Uncompensated Settled Group Delay
Initial S/W Revision	Prior to A.02.00
Modified at S/W Revision	A.11.0

More Information

Selecting Uncompensated means that the actual gate delay is as you sets it.

Selecting Delay Until RBW Settled causes the gate delay to be increased above the user setting by an amount equal to $3.06/\text{RBW}$. This compensated delay causes the GATE START and GATE STOP lines on the display to move by the compensation amount, and the actual hardware gate delay to be increased by the same amount. All the other gate lines (for example, MIN FAST) are unaffected. If the RBW subsequently changes, the compensation is readjusted for the new RBW. The value shown on the Gate Delay key does NOT change.

Delay Until RBW Settled allows excellent measurements of gated signals, by allowing the IF to settle following any transient that affects the burst. Excellent measurements also require that the analysis region not extend into the region affected by the falling edge of the burst. Thus, excellent measurements can only be made over a width that declines with narrowing RBWs, which is achieved by decreasing the gate length below the user setting by an amount equal to $2.53/\text{RBW}$. Therefore, for general purpose compensation, you will still want to change the gate length with changes in RBW even if the gate delay is compensated. The compensated Gate Length is limited by the analyzer so that it will never go below 10% of the value shown on the Gate Length key, as otherwise the sweep times could get very long. Anytime the Gate Length and RBW values combine in such a way that this limiting takes place, a warning is displayed. For measurements which contain multiple sweeps with different RBW like SEM and SPUR, the smallest RBW is used for this limiting.

Selecting Compensate for RBW Group Delay causes the gate delay to be increased above the user setting by an amount equal to $1.81/\text{RBW}$. This compensated delay causes the GATE START, GATE STOP lines on the display to move by the compensation amount, and the actual hardware gate delay to be increased by the same amount. All the other gate lines (for example, MIN FAST) are unaffected. If the RBW subsequently changes, the compensation is readjusted for the new RBW. The value shown on the Gate Delay key does NOT change. Compensate for RBW Group Delay also includes gate length compensation; the gate length itself is adjusted as necessary to attempt to compensate for delay effects imposed by the RBW.

Compensate for RBW Group Delay is similar to Delay Until RBW Settled, but compensates for the group delay of the RBW filter, rather than the filter settling time. As the RBW gets narrow, this can allow the settling tail of the RBW to affect the beginning part of the gated measurement, and allow the beginning of the RBW settling transient to affect the end of the gated measurement. These two effects are symmetric because the RBW response is symmetric. Because the gate length is not automatically compensated, some users might find this compensation to be more intuitive than compensation for RBW settling.

Min Fast Position Query (Remote Command Only)

This command queries the position of the MIN FAST line, relative to the delay reference (REF) line. See section "[Gate View On/Off](#)" on page 2496. If this query is sent while not in gate view, the MinFast calculation is performed based on the current values of the appropriate parameters and the result is returned. Knowing this value lets you set an optimal gate delay value for the current measurement setup.

Remote Command	[:SENSe] :SWEep:EGATe:MINFast?
Example	SWE:EGAT:MIN?
Initial S/W Revision	Prior to A.02.00

Gate Preset (Remote Command Only)

Presets the time-gated spectrum analysis capability.

This command sets gate parameter values to the ESA preset values, as follows:

Gate trigger type = edge

Gate polarity = positive

Gate delay = 1 us

Gate length = 1 us

Remote Command	<code>[:SENSe]:SWEep:TIME:GATE:PRESet</code> ESA Compatibility
Initial S/W Revision	Prior to A.02.00

Gate Level (Remote Command Only)

Sets the gate input transition point level for the external TRIGGER inputs on the front and rear panel. This is a legacy command for PSA compatibility. It is simply an alias to the equivalent trigger level command.

Remote Command	<code>[:SENSe]:SWEep:EGATE:EXTErnal[1] 2:LEVel <voltage></code> <code>[:SENSe]:SWEep:EGATE:EXTErnal[1] 2:LEVel?</code>
Notes	This command is simply an alias to <code>:TRIGger[:SEQuence]:EXTErnal[1] 2:LEVel</code> For details refer
Initial S/W Revision	Prior to A.02.00

Gate Polarity (Remote Command Only)

Sets the polarity for the gate signal. This setup is now done using the gate trigger's slope setting.

When Positive (Pos) is selected, a positive-going edge (Edge) or a high voltage (Level) will satisfy the gate condition, after the delay set with the Gate Delay key. When Negative (Neg) is selected, a negative-going edge (Edge) or a low voltage (Level) will satisfy the gate condition after the delay.

Remote Command	<code>[:SENSe]:SWEep:EGATE:POLarity</code> NEGative POSitive <code>[:SENSe]:SWEep:EGATE:POLarity?</code>
Example	<code>SWE:EGAT:POL</code> NEG <code>SWE:EGAT:POL?</code>
Preset	POSitive
State Saved	Saved in instrument state
Backwards Compatibility SCPI	<code>[:SENSe]:SWEep:TIME:GATE:POLarity</code> ESA compatibility
Initial S/W Revision	Prior to A.02.00

Remote Command	<code>[:SENSe] :SWEep:TIME:GATE:LEVel HIGH LOW</code> <code>[:SENSe] :SWEep:TIME:GATE:LEVel?</code> ESA compatibility
Preset	HIGH
Initial S/W Revision	Prior to A.02.00

Points

Sets the number of points per sweep. The resolution of setting the sweep time depends on the number of points selected. If Preset is selected, the number of points per sweep defaults to 1001. The current value of points is displayed parenthetically, next to the sweep time in the lower-right corner of the display.

Changing the number of points has several effects on the analyzer. Since markers are read at the point location, the marker reading may change. All trace data is cleared.

Key Path	Sweep/Control
Mode	SA, WCDMA, C2K, WIMAX OFDMA, 1xEVDO, DVB-T/H, DTMB (CTTB), ISDB-T, CMMB, LTE, LTE-TDD, Digital Cable TV, WLAN, MSR, LTEAFDD, LTEATDD
Remote Command	<code>[:SENSe] :CHPower:SWEep:POINts <integer></code> <code>[:SENSe] :CHPower:SWEep:POINts?</code>
Example	CHP:SWE:POIN 501 CHP:SWE:POIN?
Notes	Whenever the number of sweep points changes: All trace data is erased Any traces with Update Off also go to Display Off (like going from View to Blank in the older analyzers) Sweep time is re-quantized Any limit lines that are on are updated If averaging/hold is on, averaging/hold starts over
Couplings	Whenever the number of sweep points changes, the sweep time is re-quantized.
Preset	DVB-T/H: 2001 DTMB (CTTB): 2001 Other: 1001 ISDB-T: 2001 CMMB: 2001 1xEVDO: 512 Digital Cable TV: 2001
State Saved	Saved in instrument state.
Min	101

8 Channel Power Measurement
Sweep/Control

Max	20001
Initial S/W Revision	Prior to A.02.00
Modified at S/W Revision	A.02.00, A.03.00

System

See "System" on page 366

Trace/Detector

Accesses a menu of functions that enable you to control the detectors for the current measurement.

Key Path	Front-panel key
Initial S/W Revision	Prior to A.02.00

Trace Type

Allows you to select the type of trace you want to use for the current measurement. The first page of this menu contains a 1-of-N selection of the trace type (Clear Write, Average, Max Hold, Min Hold) for the selected trace.

Key Path	Trace/Detector
Mode	SA, WCDMA, C2K, WIMAX OFDMA, 1xEVDO, DVB-T/H, DTMB (CTTB), ISDB-T, CMMB, LTE, LTETDD, Digital Cable TV, WLAN, MSR, LTEAFDD, LTEATDD
Remote Command	:TRACe:CHPower:TYPE WRITe AVERAge MAXHold MINHold :TRACe:CHPower:TYPE?
Example	TRAC:CHP:TYPE WRIT TRAC:CHP:TYPE?
Notes	WRITe = Clear Write AVERAge = Average MAXHold = Maximum Hold MINHold = Minimum Hold
Couplings	When Detector setting is "Auto" (:SENSe]:CHPower:DETEctor:AUTO?), Detector (:SENSe]:CHPower:DETEctor[:FUNCTION]?) switches aligning with the switch of this parameter: "NORMal" with WRITe (Clear Write), "AVERAge" with AVERAge, "POSitive (peak)" with MAXHold, and "NEGative (peak)" with MINHold.
Preset	AVERAge
State Saved	Saved in instrument state.
Range	ClearWrite Average MaxHold MinHold
Initial S/W Revision	Prior to A.02.00
Modified at S/W Revision	A.02.00, A.03.00

Detector

Accesses a menu of functions that enable you to control the detectors for the current measurement. The following choices are available:

- Auto– the detector selected depends on marker functions, trace functions, average type, and the trace averaging function.

- Normal—the detector determines the peak of the CW-like signals, and it yields alternating maximums and minimums of noise-like signals. This is also referred to as Rosenfell detection.
- Average—the detector determines the average of the signal within the sweep points. The averaging method depends upon the Average Type selection (voltage, power or log scales).
- Peak—the detector determines the maximum of the signal within the sweep points.
- Sample—the detector indicates the instantaneous level of the signal at the center of the sweep points represented by each display point.
- Negative Peak—the detector determines the minimum of the signal within the sweep points.

Key Path	Detector
Initial S/W Revision	Prior to A.02.00

Auto

Sets the detector for the currently selected trace to Auto.

Key Path	Trace/Detector
Mode	SA, WCDMA, C2K, WIMAX OFDMA, 1xEVDO, DVB-T/H, DTMB (CTTB), ISDB-T, CMMB, LTE, LTE-TDD, Digital Cable TV, WLAN, MSR, LTEAFDD, LTEATDD
Remote Command	<code>[[:SENSe]:CHPower:DETEctor:AUTO ON OFF 1 0</code> <code>[[:SENSe]:CHPower:DETEctor:AUTO?</code>
Example	CHP:DET:AUTO ON CHP:DET:AUTO?
Couplings	When Detector setting is “Auto” (<code>[[:SENSe]:CHPower:DETEctor:AUTO?</code>), Detector (<code>[[:SENSe]:CHPower:DETEctor[:FUNCTION]?</code>) switches aligning with the switch of this parameter: “NORMal” with Clear Write, “AVERage” with AVERage, “POSitive (peak)” with MAXHold, and “NEGative (peak)” with MINHold.
Preset	Others: ON DVB-T/H, DTMB (CTTB), ISDB-T, CMMB, Digital Cable TV: OFF
State Saved	Saved in instrument state.
Initial S/W Revision	Prior to A.02.00
Modified at S/W Revision	A.02.00, A.03.00

Detector Selection

Selects a detector to be used by the analyzer for the current measurement.

Key Path	Trace/Detector
Mode	SA, WCDMA, C2K, WIMAX OFDMA, 1xEVDO, DVB-T/H, DTMB (CTTB), ISDB-T, CMMB, LTE, LTE-TDD, Digital Cable TV, WLAN, MSR, LTEAFDD, LTEATDD

Remote Command	[:SENSe]:CHPower:DETEctor[:FUNction] NORMal AVERage POSitive SAMPlE NEGative [:SENSe]:CHPower:DETEctor[:FUNction]?
Example	CHP:DET NORM CHP:DET?
Notes	<p>When you manually select a detector (instead of selecting Auto), that detector is used regardless of other analyzer settings.</p> <p>The Normal detector determines the peak of CW-like signals, and it yields alternating maximums and minimums of noise-like signals. This method of detection is also referred to as Rosenfell detection.</p> <p>The Average detector determines the average of the signal within the sweep points. The averaging method is Power Average (RMS).</p> <p>The Peak detector determines the maximum of the signal within the sweep points.</p> <p>The Sample detector indicates the instantaneous level of the signal at the center of the sweep points represented by each display point.</p> <p>The Negative Peak detector determines the minimum of the signal within the sweep points.</p>
Couplings	When Detector setting is "Auto" ([:SENSe]:CHPower:DETEctor:AUTO?), Detector ([:SENSe]:CHPower:DETEctor[:FUNction]?) switches aligning with the switch of this parameter: "NORMal" with Clear Write, "AVERage" with AVERage, "POSitive (peak)" with MAXHold, and "NEGative (peak)" with MINHold.
Preset	AVERage
State Saved	Saved in instrument state.
Range	Normal Average Peak Sample Negative Peak
Initial S/W Revision	Prior to A.02.00
Modified at S/W Revision	A.02.00, A.03.00

Trigger

See ["Trigger" on page 438](#)

Free Run

See ["Free Run " on page 445](#)

Video

See ["Video \(IF Envelope\) " on page 446](#)

Trigger Level

See ["Trigger Level " on page 446](#)

Trig Slope

See ["Trig Slope " on page 447](#)

Trig Delay

See ["Trig Delay " on page 448](#)

Line

See ["Line " on page 2503](#)

Trig Slope

See ["Trig Slope " on page 2503](#)

Trig Delay

See ["Trig Delay " on page 450](#)

External 1

See ["External 1 " on page 2516](#)

Trigger Level

See ["Trigger Level " on page 2516](#)

Trig Slope

See ["Trig Slope " on page 2517](#)

Trig Delay

See ["Trig Delay " on page 453](#)

Zero Span Delay Comp

See ["Zero Span Delay Comp On/Off" on page 2505](#)

External 2

See "[External 2](#) " on page 2518

Trigger Level

See "[Trigger Level](#) " on page 2518

Trig Slope

See "[Trig Slope](#) " on page 2519

Trig Delay

See "[Trig Delay](#) " on page 455

Zero Span Delay Comp

See "[Zero Span Delay Comp On/Off](#)" on page 2507

RF Burst

See "[RF Burst](#) " on page 2519

Absolute Trigger

See "[Absolute Trigger Level](#)" on page 2520

Relative Trigger

See "[Relative Trigger Level](#)" on page 2509

Trig Slope

See "[Trigger Slope](#) " on page 2521

Trig Delay

See "[Trig Delay](#) " on page 460

Periodic Timer

See "[Periodic Timer \(Frame Trigger\)](#) " on page 2511

Period

See "[Period](#) " on page 2512

Offset

See "[Offset](#) " on page 2513

Reset Offset Display

See "[Reset Offset Display](#) " on page 2515

Sync Source

See ["Sync Source "](#) on page 2515

Off

See ["Off "](#) on page 2516

External 1

See ["External 1 "](#) on page 2516

Trigger Level

See ["Trigger Level "](#) on page 2516

Trig Slope

See ["Trig Slope "](#) on page 2517

External 2

See ["External 2 "](#) on page 2518

Trigger Level

See ["Trigger Level "](#) on page 2518

Trig Slope

See ["Trig Slope "](#) on page 2519

RF Burst

See ["RF Burst "](#) on page 2519

Absolute Trigger

See ["Absolute Trigger Level"](#) on page 2520

Trig Slope

See ["Trigger Slope "](#) on page 2521

Trig Delay

See ["Trig Delay"](#) on page 470

Auto/Holdoff

See ["Auto/Holdoff "](#) on page 471

Auto Trig

See ["Auto Trig "](#) on page 471

Trig Holdoff

See ["Trig Holdoff "](#) on page 472

Holdoff Type

See "[Holdoff Type](#)" on page 472

User Preset

Accesses a menu that gives you the following three choices:

- User Preset – recalls a state previously saved using the Save User Preset function.
- User Preset All Modes – presets all of the modes in the analyzer
- Save User Preset– saves the current state for the current mode

Key Path	Front-panel key
Backwards Compatibility Notes	<p>User Preset is actually loading a state, and in legacy analyzers, it was possible to load a state without affecting the trace data, limit lines or correction data. Similarly it was possible to do a User Preset without affecting the trace data, limit lines or correction data.</p> <p>In the X-Series, “state” always includes all of this data; so whenever state is loaded, or User Preset is executed, all of the traces, limit lines and corrections are affected. Although this differs from previous behavior, it is desirable behavior, and should not cause adverse issues for users.</p> <p>On ESA and PSA, User Preset affected the entire instrument’s state. In the X-Series, User Preset only recalls the state for the active mode. There is a User Preset file for each mode. User Preset can never cause a mode switch as it can in legacy analyzers. If you want to recall all modes to their user preset file state, you will need to do a User Preset after mode switching into each mode.</p> <p>User Preset recalls mode state which can now include data like traces; whereas on ESA and PSA, User Preset did not affect data.</p>
Initial S/W Revision	Prior to A.02.00

User Preset

User Preset sets the state of the currently active mode back to the state that was previously saved for this mode using the Save User Preset menu key or the SCPI command, SYST:PRES:USER:SAV. It not only recalls the Mode Preset settings, but it also recalls all of the mode persistent settings, and the Input/Output system setting that existed at the time Save User Preset was executed.

If a Save User Preset has not been done at any time, User Preset recalls the default user preset file for the currently active mode. The default user preset files are created if, at power-on, a mode detects there is no user preset file. There will never be a scenario when there is no user preset file to restore. For each mode, the default user preset state is the same state that would be saved if a Save User Preset is performed in each mode right after doing a Restore Mode Default and after a Restore Input/Output Defaults.

The User Preset function does the following:

- Aborts the currently running measurement.
- Sets the mode State to the values defined by Save User Preset.
- Makes the saved measurement for the currently running mode the active measurement.
- Brings up the saved menu for the power-on mode.
- Clears the input and output buffers.
- Sets the Status Byte to 0.

Key Path	User Preset
Remote Command	:SYSTem:PRESet:USER
Example	:SYST:PRES:USER:SAVE:SYST:PRES:USER
Notes	:SYST:PRES:USER:SAVE is used to save the current state as the user preset state. Clears all pending OPC bits. The Status Byte is set to 0. Pressing the User Preset front-panel key while already in the User Preset menu will cause the User Preset to get executed
Couplings	A user preset will cause the currently running measurement to be aborted and cause the saved measurement to be active. Recalling a User Preset file has the same issues that recalling a Save State file has. Some settings may need to be limited and therefore re-coupled, since the capabilities of the mode may have changes when the User Preset file was last saved.
Initial S/W Revision	Prior to A.02.00

User Preset All Modes

Recalls all of the User Preset files for each mode, switches to the power-on mode, and activates the saved measurement from the power-on mode User Preset file.

NOTE

When the instrument is secured, all of the user preset files are converted back to their default user preset files.

The User Preset function does the following:

- Aborts the currently running measurement.
- Switches the Mode to the power-on mode.
- Restores the User Preset files for each mode.
- Makes the saved measurement for the power-on mode the active measurement.
- Brings up the saved menu for the power-on mode.
- Clears the input and output buffers.
- Sets the Status Byte to 0.

Key Path	User Preset
Remote Command	:SYSTem:PRESet:USER:ALL
Example	:SYST:PRES:USER:SAVE:SYST:PRES:USER:ALL
Notes	Clears all pending OPC bits. The Status Byte is set to 0. :SYST:PRES:USER:SAVE is used to save the current state as the user preset state.
Couplings	A user preset will cause the currently running measurement to be aborted, cause a mode switch to the power-on mode, and cause the saved measurement to be active in the power-on mode. Recalling a User Preset file has the same issues that recalling a Save State file has. Some settings may need to be limited and therefore re-coupled, since the capabilities of the mode may have changes when the User Preset file was last saved.
Initial S/W Revision	Prior to A.02.00

Save User Preset

Saves the currently active mode and its State. You can recall this User Preset file by pressing the User Preset menu key or sending the SYST:PRES:USER remote command. This same state is also saved by the Save State function.

Key Path	User Preset
Remote Command	:SYSTem:PRESet:USER:SAVE
Example	:SYST:PRES:USER:SAVE
Notes	:SYST:PRES:SAVE creates the same file as if the user requested a *SAV or a MMEM:STOR:STAT, except User Preset Save does not allow the user to specify the filename or the location of the file.
Initial S/W Revision	Prior to A.02.00

View/Display

Accesses a menu of functions that enable you to control the instrument display as well as turn the bar graph On and Off.

If current mode is NOT DVB-T/H, DTMB (CTTB), ISDB-T, MSR, LTE-Advanced FDD/TDD or CMMB mode, the front panel views only contain one view: Spectrum View. The results of the measurement can be displayed as a single spectrum trace view or displayed with a Bar Graph trace on the spectrum trace.

Spectrum View with Bar Graph off

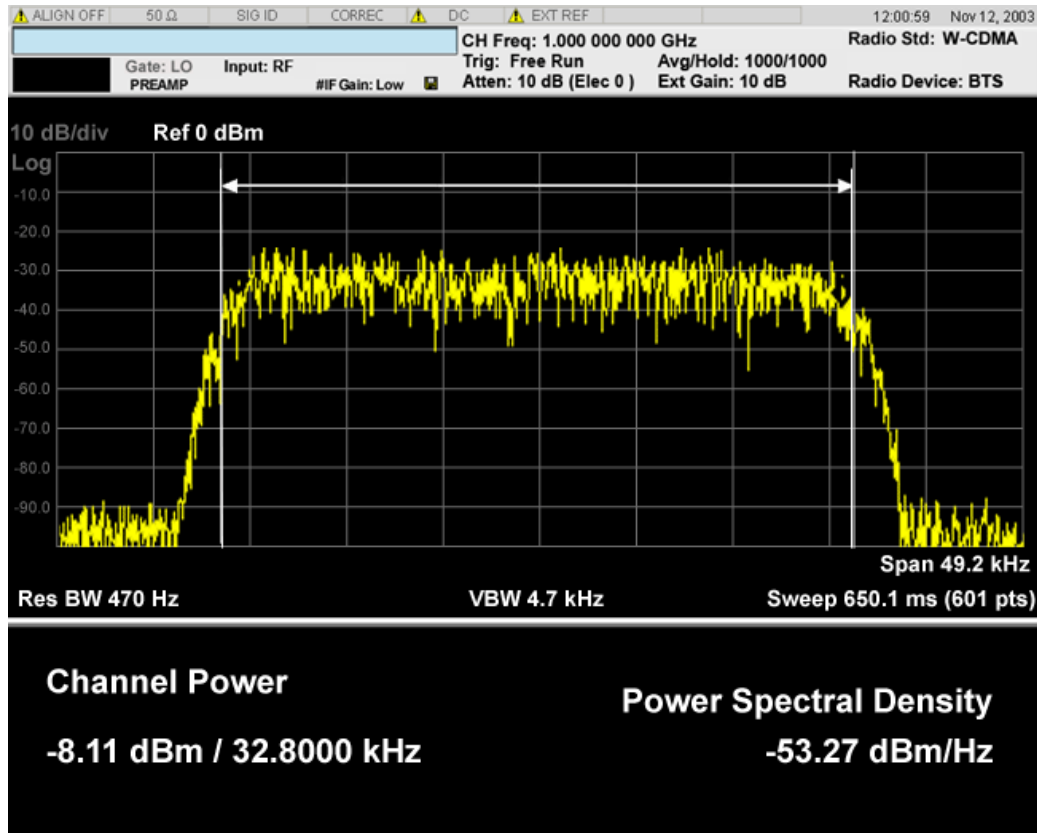

Spectrum View with Bar Graph on

This View is the same as the 'Spectrum' view, but has a blue bar between the markers that indicates the measured output power level. The bar graph is activated when the "Bar Graph" Soft Key is set to ON under the View/Display menu. The actual measured output power level is displayed on the display at the bottom of the bar.

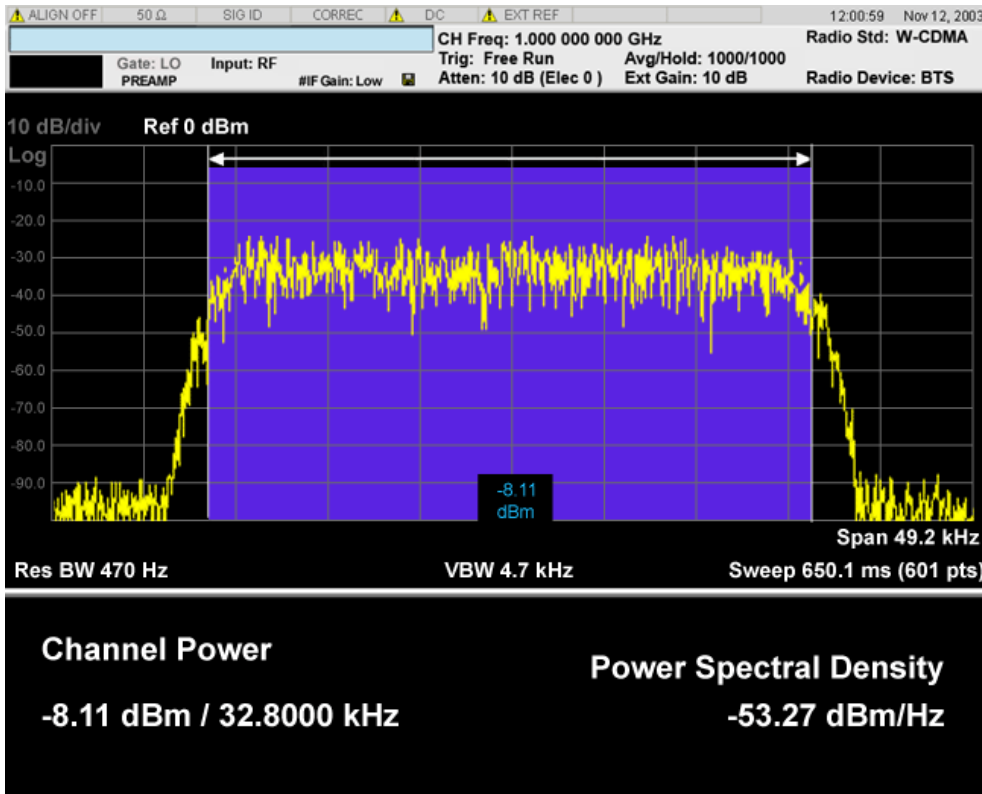

If current mode is MSR and LTE-Advanced FDD/TDD, there are two views, Power Results and Carrier Info. Power Results view is almost the same as the common CHP view.

If the current mode is WLAN and the format is WLAN 802.11ac 80+80 MHz, the spectrum view is changed a little so that the results of both carrier segments can be displayed.

Spectrum View with Bar Graph off for WLAN 802.11ac (80 + 80 MHz):

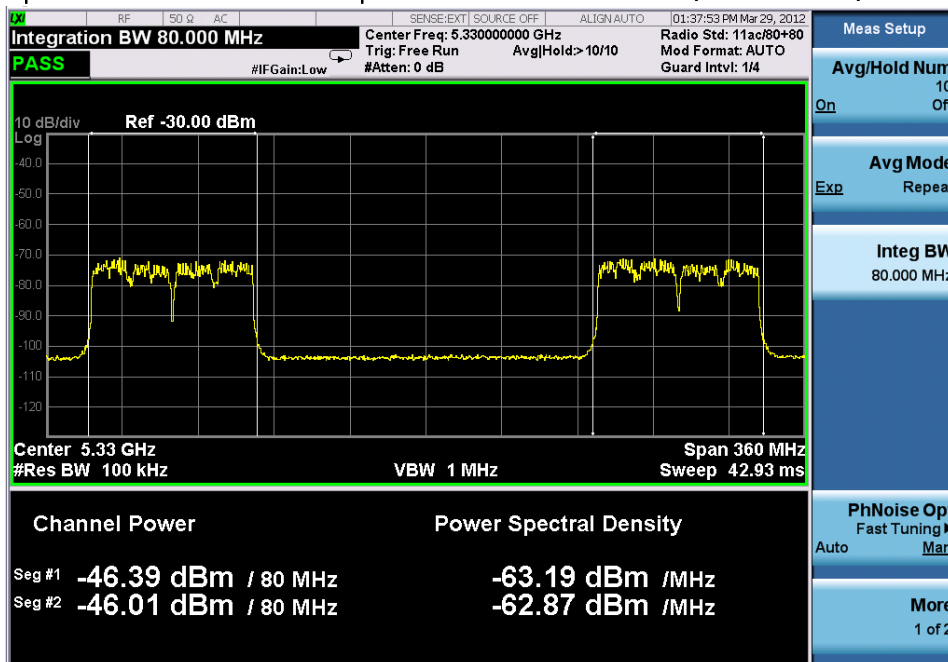

Spectrum View with Bar Graph on for WLAN 802.11ac (80 + 80 MHz):

8 Channel Power Measurement
View/Display

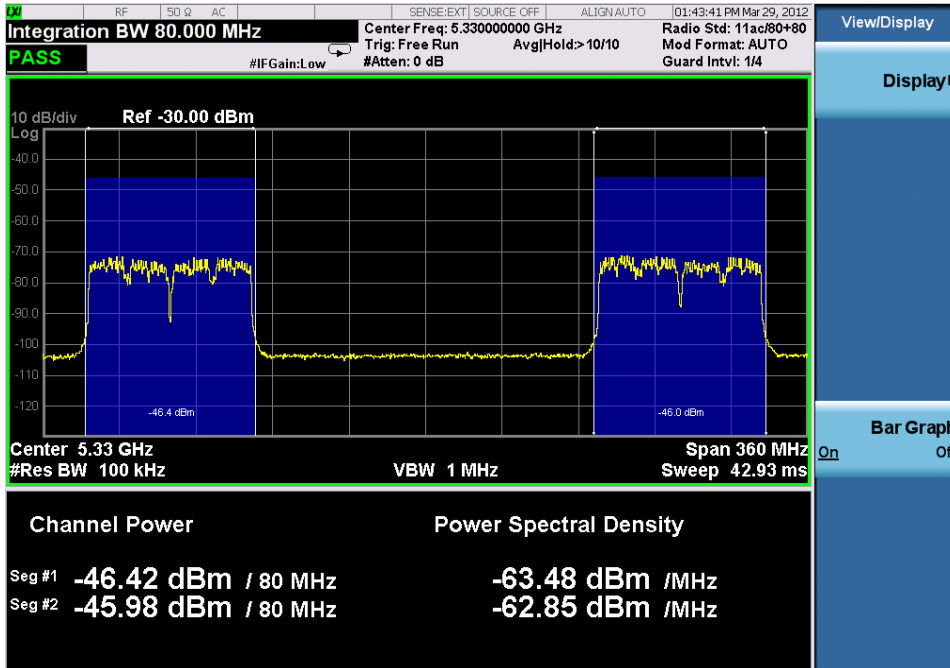

Power Results:

The spectrum trace and power bars are displayed in the upper window. Total carrier power, total PSD and total format carrier power are displayed in the lower window. Total format carrier power is total power of carriers of the same Radio Format. If there is no carrier of the corresponding format, it is not displayed. Thus items in the total format power table changes depending on the carrier configuration. Since the metrics window of MSR and LTE-Advanced FDD/TDD is a bit denser than the common CHP, vertical positions of total power and power spectral density goes up a little bit.

Carrier Info:

The lower window of Power Results view is replaced by the carrier info table in this view. Carrier center frequency can be displayed in either offset or absolute frequency depending on Carrier Freq. The table can be scrolled by Carrier Result on Meas Setup menu or by Select Carrier on Config Carriers menu. The highlighted row changes as either Carrier Result or Select Carrier is changed. The highlighted row and these keys are not coupled.

View selection by name (MSR and LTE-Advanced FDD/TDD only)

Selects the results view. The following SCPI command allows you to select the desired measurement view by enumeration.

Key Path	No equivalent front-panel key
Mode	MSR, LTEAFDD, LTEATDD
Remote Command	:DISPlay:CHPower:VIEW[:SElect] PRESult CINformation :DISPlay:CHPower:VIEW[:SElect]?
Example	:DISP:CHP:VIEW PRES :DISP:CHP:VIEW?

Preset	PRESult
State Saved	Saved in instrument state
Range	Power Results Carrier Info
Initial S/W Revision	A.10.00

Selects the results view. The following SCPI command allows you to select the desired measurement view by enumeration.

Key Path	No equivalent front-panel key
Mode	MSR, LTEAFDD, LTEATDD
Remote Command	:DISPlay:CHPower:VIEW:NSElect <integer> :DISPlay:CHPower:VIEW:NSElect?
Example	DISP:CHP:VIEW:NSEL 1 DISP:CHP:VIEW:NSEL?
Preset	1
State Saved	Saved in instrument state
Min	1
Max	2
Initial S/W Revision	A.10.00

View selection by name (DTMB (CTTB), DVB-T/H only)

Selects the results view. The following SCPI command allows you to select the desired measurement view by enumeration.

Key Path	No equivalent front-panel key
Mode	DVB-T/H, DTMB (CTTB)
Remote Command	:DISPlay:CHPower:VIEW[:SElect] RFSpectrum SHOulder MASK :DISPlay:CHPower:VIEW[:SElect]?
Example	DISP:CHP:VIEW RFSP DISP:CHP:VIEW?
Preset	RFSpectrum
State Saved	Saved in instrument state.
Range	RF Spectrum Shoulder Attenuation Spectrum Mask
Initial S/W Revision	A.02.00

View selection by name (ISDB-T, CMMB only)

Selects the results view. The following SCPI command allows you to select the desired measurement view by enumeration.

Key Path	No equivalent front-panel key
Mode	ISDB-T, CMMB
Remote Command	:DISPlay:CHPower:VIEW[:SElect] RFSPectrum SHOUlder :DISPlay:CHPower:VIEW[:SElect]?
Example	DISP:CHP:VIEW RFSP DISP:CHP:VIEW?
Preset	RFSPectrum
State Saved	Saved in instrument state.
Range	RF Spectrum Shoulder Attenuation
Initial S/W Revision	A.03.00

Key Path	Front-panel key
Initial S/W Revision	Prior to A.02.00

Display

The Display menu is common to most measurements, and is used for configuring items on the display. Some Display menu settings apply to all the measurements in a mode, and some only to the current measurement. Those under the System Display Settings key apply to all measurements in all modes.

Key Path	Display
Key Path	View/Display
Initial S/W Revision	Prior to A.02.00

Annotation

Turns on and off various parts of the display annotation. The annotation is divided up into four categories:

1. Meas Bar: This is the measurement bar at the top of the screen. It does not include the settings panel or the Active Function. Turning off the Meas Bar turns off the settings panel and the Active Function. When the Meas Bar is off, the graticule area expands to fill the area formerly occupied by the Meas Bar.
2. Screen Annotation: this is the annotation and annunciation around the graticule, including any annotation on lines (such as the display line, the threshold line, etc.) This does NOT include the marker number or the N dB result. When off, the graticule expands to fill the entire graticule area.
3. Trace annotation: these are the labels on the traces, showing their detector (or their math mode).

4. Active Function annotation: this is the active function display in the meas bar, and all of the active function values displayed on softkeys.

See the figure below. Each type of annotation can be turned on and off individually.

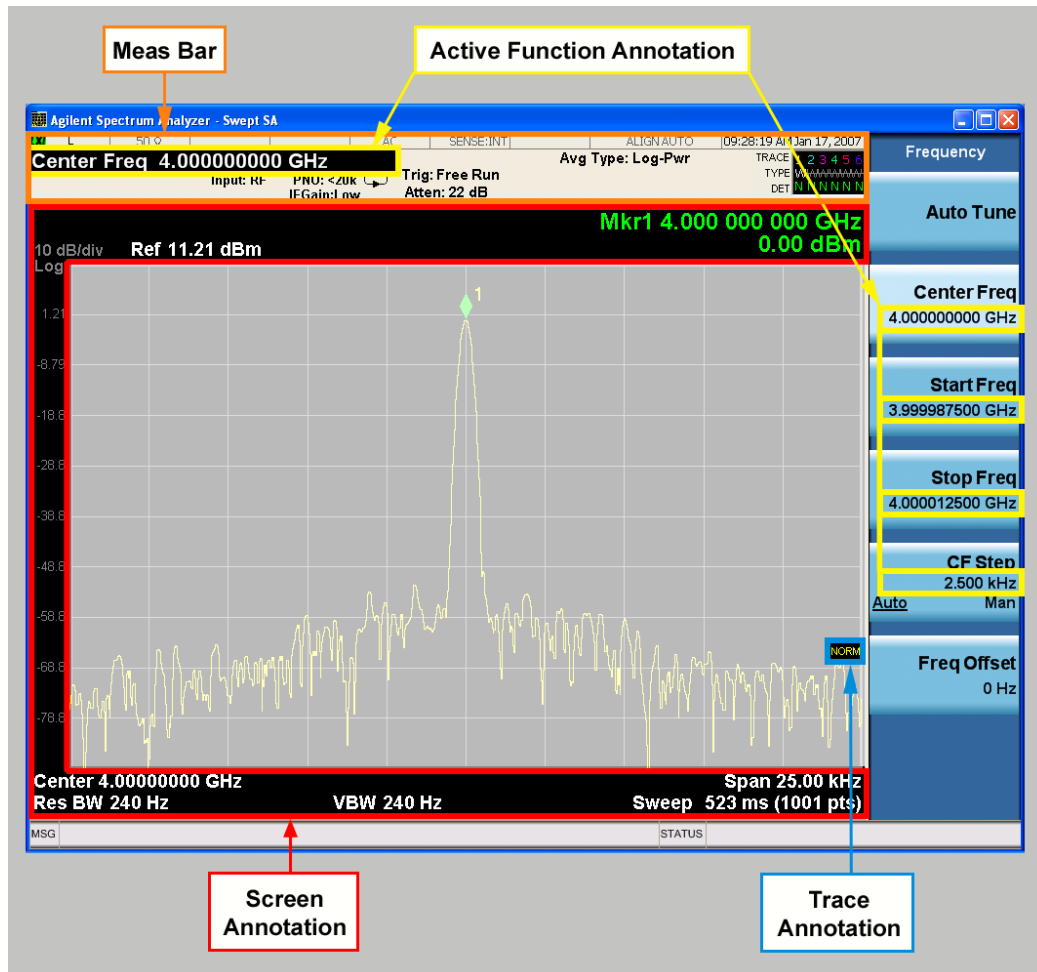

Key Path	View/Display, Display
Initial S/W Revision	Prior to A.02.00

Meas Bar On/Off

This function turns the Measurement Bar on and off, including the settings panel. When off, the graticule area expands to fill the area formerly occupied by the Measurement Bar.

Key Path	View/Display, Display, Annotation
Remote Command	:DISPlay:ANNotation:MBAR[:STATe] OFF ON 0 1 :DISPlay:ANNotation:MBAR[:STATe]?
Example	DISP:ANN:MBAR OFF

Dependencies	Grayed out and forced to OFF when System Display Settings, Annotation is set to Off.
Preset	On This should remain Off through a Preset when System DisplaySettings, Annotation is set to Off.
State Saved	Saved in instrument state.
Initial S/W Revision	Prior to A.02.00

Screen

This controls the display of the annunciation and annotation around the graticule, including any annotation on lines (such as the display line, the threshold line, etc.) and the y-axis annotation. This does NOT include marker annotation (or the N dB result). When off, the graticule expands to fill the entire graticule area, leaving only the 1.5% gap above the graticule as described in the Trace/Detector chapter.

Key Path	View/Display, Display, Annotation
Remote Command	:DISPlay:ANNotation:SCReen[:STATe] OFF ON 0 1 :DISPlay:ANNotation:SCReen[:STATe]?
Example	DISP:ANN:SCR OFF
Dependencies	Grayed-out and forced to OFF when System Display Settings, Annotation is set to Off.
Preset	On This should remain Off through a Preset when System DisplaySettings, Annotation is set to Off
State Saved	Saved in instrument state.
Initial S/W Revision	Prior to A.02.00

Active Function Values On/Off

Turns on and off the active function display in the Meas Bar, and all of the active function values displayed on the softkeys.

Note that all of the softkeys that have active functions have these numeric values blanked when this function is on. This is a security feature..

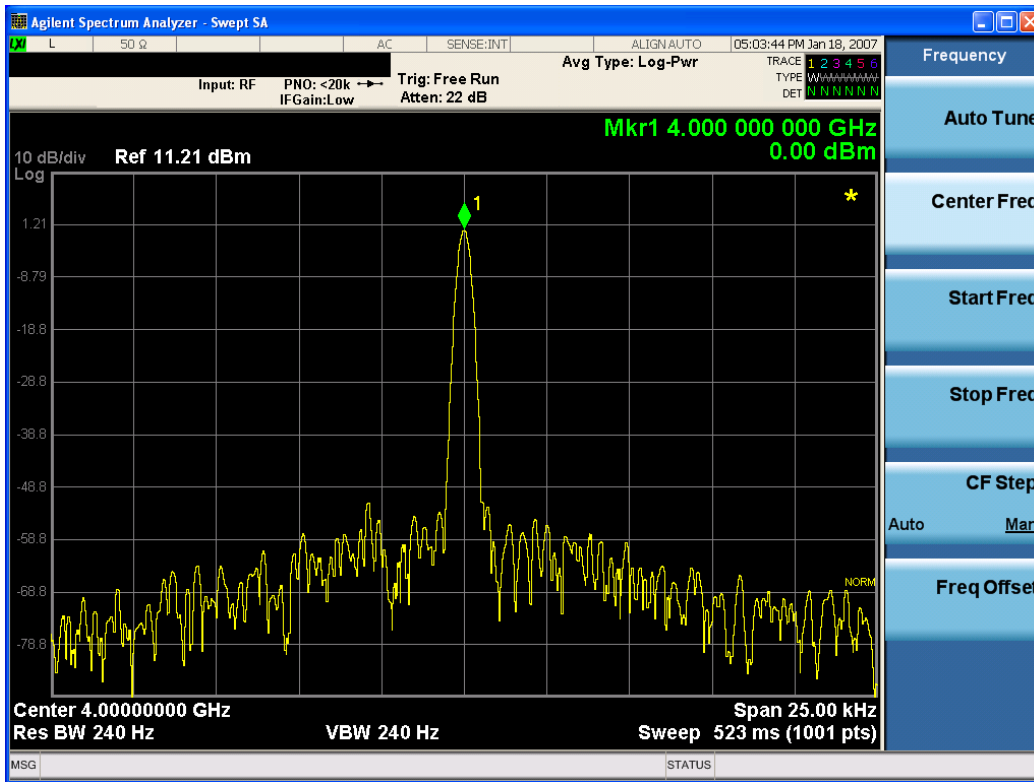

Key Path	View/Display, Display, Annotation
Remote Command	:DISPlay:ACTivefunc[:STATE] ON OFF 1 0 :DISPlay:ACTivefunc[:STATE]?
Example	DISP:ACT OFF
Dependencies	Grayed out and forced to OFF when System Display Settings, Annotation is set to Off.
Preset	On This should remain Off through a Preset when System DisplaySettings, Annotation is set to Off
State Saved	Saved in instrument state.
Initial S/W Revision	Prior to A.02.00

Title

Displays menu keys that enable you to change or clear a title on your display.

Key Path	View/Display, Display
Initial S/W Revision	Prior to A.02.00

Change Title

Writes a title into the "measurement name" field in the banner, for example, "Swept SA".

Press Change Title to enter a new title through the alpha editor. Press Enter or Return to complete the entry. Press ESC to cancel the entry and preserve your existing title.

The display title will replace the measurement name. It remains for this measurement until you press Change Title again, or you recall a state, or a Preset is performed. A title can also be cleared by pressing Title, Clear Title.

NOTE

Notice the inclusion of the <measurement> parameter in the command below. Because each measurement remembers the Display Title, the command must be qualified with the measurement name. For the Swept SA measurement this is not the case; no <measurement> parameter is used when changing the Display Title for the Swept SA measurement.

Key Path	View/Display, Display, Title
Mode	All
Remote Command	:DISPlay:<measurement>:ANNotation:TITLe:DATA <string> :DISPlay:<measurement>:ANNotation:TITLe:DATA?
Example	DISP:ANN:TITL:DATA "This Is My Title" This example is for the Swept SA measurement in the Spectrum Analyzer mode. The SANalyzer <measurement> name is not used. DISP:ACP:ANN:TITL:DATA "This Is My Title" This example is for Measurements other than Swept SA. Both set the title to: This Is My Title
Notes	Pressing this key cancels any active function. When a title is edited the previous title remains intact (it is not cleared) and the cursor goes at the end so that characters can be added or BKSP can be used to go back over previous characters.
Preset	No title (measurement name instead)
State Saved	Saved in instrument state.
Initial S/W Revision	Prior to A.02.00

Clear Title

Clears a title from the front-panel display. Once cleared, the title cannot be retrieved. After the title is cleared, the current Measurement Name replaces it in the title bar.

Key Path	View/Display, Display, Title
Example	The following commands clear the title and restore the measurement's original title: DISP:ANN:TITL:DATA "" This example is for the Swept SA measurement in the Spectrum Analyzer mode. The SANalyzer <measurement> name is not used. DISP:ACP:ANN:TITL:DATA "" This example is for ACP; in measurements other than Swept SA the measurement name is required.
Notes	Uses the :DISPlay:<measurement>:ANNotation:TITLe:DATA <string> command with an empty string (in the Swept SA, the <measurement> is omitted).
Preset	Performed on Preset.
Initial S/W Revision	Prior to A.02.00

Graticule

Pressing Graticule turns the display graticule On or Off. It also turns the graticule y-axis annotation on and off.

Key Path	View/Display, Display
Remote Command	:DISPlay:WINDow[1]:TRACe:GRATicule:GRID[:STATe] OFF ON 0 1 :DISPlay:WINDow[1]:TRACe:GRATicule:GRID[:STATe]?
Example	DISP:WIND:TRAC:GRAT:GRID OFF
Notes	The graticule is the set of horizontal and vertical lines that make up the grid/divisions for the x-axis and y-axis.
Preset	On
State Saved	Saved in instrument state
Initial S/W Revision	Prior to A.02.00

System Display Settings

These settings are "Mode Global" – they affect all modes and measurements and are reset only by Restore Misc Defaults or Restore System Defaults under System.

Key Path	View/Display, Display
Initial S/W Revision	Prior to A.02.00

Annotation Local Settings

This is a Mode Global override of the meas local annotation settings. When it is All Off, it forces ScreenAnnotation, Meas Bar, Trace, and Active Function Values settings to be OFF for all measurements in all modes. This provides the security based "annotation off" function of previous analyzers; hence it uses the legacy SCPI command.

When it is All Off, the Screen, Meas Bar, Trace, and Active Function Values keys under the Display, Annotation menu are grayed out and forced to Off. When Local Settings is selected, you are able to set the local annotation settings on a measurement by measurement basis.

Key Path	View/Display, Display, System Display Settings
Remote Command	:DISPlay:WINDow[1]:ANNotation[:ALL] OFF ON 0 1 :DISPlay:WINDow[1]:ANNotation[:ALL]?
Example	:DISP:WIND:ANN OFF
Preset	On (Set by Restore Misc Defaults)
State Saved	Not saved in instrument state.
Backwards Compatibility Notes	The WINDow parameter and optional subopcode is included for backwards compatibility but ignored – all windows are equally affected.
Initial S/W Revision	Prior to A.02.00

Themes

Accesses a menu of functions that enable you to choose the theme to be used when saving the screen image.

The **Themes** option is the same as the **Themes** option under the **Display** and **Page Setup** dialogs. It allows you to choose between themes to be used when saving the screen image.

Key Path	Save, Screen Image
Remote Command	:MMEMory:STORe:SCReen:THEMe TDColor TDMonochrome FCOLor FMONochrome :MMEMory:STORe:SCReen:THEMe?
Example	:MMEM:STOR:SCR:THEM TDM
Preset	3D Color; Is not part of Preset, but is reset by Restore Misc Defaults or Restore System Defaults All and survives subsequent running of the modes.
Readback	3D Color 3D Mono Flat Color Flat Mono
Backwards Compatibility Notes	In ESA and PSA we offer the choice of "Reverse Bitmap" or "Reverse Metafile" when saving screen images. This is much like the "Flat Color" theme available in X-Series. Also, if you selected Reverse Bitmap AND a black & white screen image, that would be much like "Flat Monochrome". In other words, each of the X-Series themes has a similar screen image type in ESA/PSA. But they are not identical.
Initial S/W Revision	Prior to A.02.00

3D Color

Selects a standard color theme with each object filled, shaded and colored as designed.

Key Path	Save, Screen Image, Themes
Example	MMEM:STOR:SCR:THEM TDC
Readback	3D Color
Initial S/W Revision	Prior to A.02.00

3D Monochrome

Selects a format that is like 3D color but shades of gray are used instead of colors.

Key Path	Save, Screen Image, Themes
Example	MMEM:STOR:SCR:THEM TDM
Readback	3D Mono
Initial S/W Revision	Prior to A.02.00

Flat Color

Selects a format that is best when the screen is to be printed on an ink printer.

Key Path	Save, Screen Image, Themes
Example	MMEM:STOR:SCR:THEM FCOL
Readback	Flat Color
Initial S/W Revision	Prior to A.02.00

Flat Monochrome

Selects a format that is like Flat Color. But only black is used (no colors, not even gray), and no fill.

Key Path	Save, Screen Image, Themes
Example	MMEM:STOR:SCR:THEM FMON
Readback	Flat Mono
Initial S/W Revision	Prior to A.02.00

Backlight

Accesses the display backlight on/off keys. This setting may interact with settings under the Windows "Power" menu.

When the backlight is off, pressing ESC, TAB, SPACE, ENTER, UP, DOWN, LEFT, RIGHT, DEL, BKSP, CTRL, or ALT turns the backlight on without affecting the application. Pressing any other key will turn backlight on and could potentially perform the action as well.

Key Path	View/Display, Display, System Display Settings
Remote Command	:DISPlay:BACKlight ON OFF :DISPlay:BACKlight?
Preset	ON (Set by Restore Misc Defaults)
Initial S/W Revision	Prior to A.02.00

Backlight Intensity

An active function used to set the backlight intensity. It goes from 0 to 100 where 100 is full on and 0 is off. This value is independent of the values set under the Backlight on/off key.

Key Path	View/Display, Display, System Display Settings
Remote Command	:DISPlay:BACKlight:INTensity <integer> :DISPlay:BACKlight:INTensity?
Example	DISP:BACK:INT 50

Preset	100 (Set by Restore Misc Defaults)
Min	0
Max	100
Initial S/W Revision	Prior to A.02.00

Bar Graph

Turns the Bar Graph On and Off.

Key Path	DVB-T/H, DTMB (CTTB), ISDB-T, CMMB: View/Display, RF SpectrumOthers: View/Display
Mode	SA, WCDMA, C2K, WIMAX OFDMA, 1xEVDO, DVB-T/H, DTMB (CTTB), ISDB-T, CMMB, LTE, LTETDD, Digital Cable TV, WLAN, MSR, LTEAFDD, LTEATDD
Remote Command	:DISPlay:CHPower:VIEW[1]:WINDow[1]:BGRaph ON OFF 1 0 :DISPlay:CHPower:VIEW[1]:WINDow[1]:BGRaph?
Example	DISP:CHP:VIEW:WIND:BGR ON DISP:CHP:VIEW:WIND:BGR?
Notes	You must be in the Spectrum Analysis mode, W-CDMA mode, cdma2000 mode, DVB-T/H mode, DTMB (CTTB) mode, ISDB-T mode, CMMB mode, Digital Cable TV mode, LTE mode, LTE TDD mode, WLAN mode, 1xEVDO mode, MSR, LTE-Advanced FDD/TDD mode or WIMAX OFDMA mode to use this command. Use :INSTrument:SElect to set the mode.
Preset	OFF
State Saved	Saved in instrument state.
Range	On Off
Initial S/W Revision	Prior to A.02.00
Modified at S/W Revision	A.02.00, A.03.00

9 Occupied Bandwidth Measurement

The Occupied Bandwidth measurement computes and displays the bandwidth occupied by a given percentage of the total mean power of a signal. For measurement results and views, see ["View/Display" on page 821](#).

This topic contains the following sections:

["Remote Commands for Occupied Bandwidth" on page 662](#)

["Remote Command Results for Occupied Bandwidth Measurement" on page 663](#)

Remote Commands for Occupied Bandwidth

The following commands and queries can be used to retrieve the measurement results:

```
:CONFigure:OBWidth  
:CONFigure:OBWidth:NDEFault  
:INITiate:OBWidth  
:FETCh:OBWidth[n]?  
:MEASure:OBWidth[n]?  
:READ:OBWidth[n]?  
:FETCh:OBWidth:OBWidth?  
:MEASure:OBWidth:OBWidth?  
:READ:OBWidth:OBWidth?  
:FETCh:OBWidth:FERRor?  
:MEASure:OBWidth:FERRor?  
:READ:OBWidth:FERRor?  
:FETCh:OBWidth:XDB?  
:MEASure:OBWidth:XDB?  
:READ:OBWidth:XDB?
```

See also the section, "[Remote Measurement Functions](#)" on page 2770.

Remote Command Results for Occupied Bandwidth Measurement

The following table describes the results returned by the FETCh:OBWidth[n]?, MEASure:OBWidth[n]?, and READ:OBWidth[n]? queries listed above, according to the index value n.

n	Results Returned
n=1 (or not specified)	Returns 7 scalar results, in the following order: 1. Occupied bandwidth - Hz 2. Total Power - dBm (Total Power will be obsolete in TD-SCDMA mode, this place will be replaced by NaN) 3. Span - Hz 4. Spectrum Trace Points - points 5. Res BW - Hz 6. Transmit Frequency Error Hz 7. x DB Bandwidth - Hz
2	Returns the frequency-domain spectrum trace (data array) for the entire frequency range being measured.
n = 3 (Mode = MSR, LTEAFDD, LTEATDD)	1. Number of active carriers Returns number of active carriers within Span in Auto detected mode, otherwise the command is out of scope

Key Path	Meas
Initial S/W Revision	Prior to A.02.00

AMPTD Y Scale (Amplitude/Y Scale)

Activates the Reference Value function and displays the Amplitude menu keys. These functions control how data on the vertical (Y) axis is displayed and control instrument settings that affect the vertical axis

See "[AMPTD Y Scale](#)" on page 2734 for more information.

Key Path	Front-panel key
Initial S/W Revision	Prior to A.02.00

Ref Value

Sets the absolute power reference value. However, since the Auto Scaling is defaulted to On, this value is automatically determined by the measurement result. When you set a value manually, Auto Scaling automatically changes to Off.

Key Path	AMPTD Y Scale
Mode	SA, WCDMA, C2K, WIMAX OFDMA, TD-SCDMA, 1xEVDO, ISDB-T, CMMB, LTE, LTETDD, BLUETOOTH, WLAN, MSR, LTEAFDD, LTEATDD
Remote Command	:DISPlay:OBWidth:VIEW[1]:WINDow[1]:TRACe:Y[:SCALe]:RLEVel <real> :DISPlay:OBWidth:VIEW[1]:WINDow[1]:TRACe:Y[:SCALe]:RLEVel?
Example	DISP:OBW:VIEW:WIND:TRAC:Y:RLEV 125 DISP:OBW:VIEW:WIND:TRAC:Y:RLEV?
Notes	You must be in the Spectrum Analysis mode, W-CDMA mode, cdma2000 mode, TD-SCDMA mode, ISDB-T mode, CMMB mode, BLUETOOTH mode, LTE mode, LTE TDD mode, WLAN mode, 1xEVDO mode, MSR, LTE-Advanced FDD/TDD or WIMAX OFDMA mode to use this command. Use:INSTrument:SElect to set the mode.
Couplings	When the Auto Scaling is On, this value is automatically determined by the measurement result. When you set a value manually, Auto Scaling automatically changes to Off.
Preset	10.00 dBm
State Saved	Saved in instrument state.
Min	-250.00 dBm
Max	250.00 dBm
Initial S/W Revision	Prior to A.02.00
Modified at S/W Revision	A.03.00

Attenuation

This menu controls the attenuator functions and interactions between the attenuation system components.

There are two attenuator configurations in the X-Series. One is a dual attenuator configuration consisting of a mechanical attenuator and an optional electronic attenuator. The other configuration uses a single

attenuator with combined mechanical and electronic sections that controls all the attenuation functions. Different models in the X-Series come with different configurations.

See ["Dual Attenuator Configurations:" on page 665](#)

See ["Single Attenuator Configuration:" on page 666](#)

Most Attenuation settings are the same for all measurements – they do not change as you change measurements. Settings like these are called “Meas Global” and are unaffected by Meas Preset.

Key Path	AMPTD Y Scale
Scope	Meas Global
Dependencies	In measurements that support the I/Q inputs, this key is unavailable when I/Q is the selected input, and is replaced by the Range key in that case.
Readback Line	Contains a summary in [] brackets of the current total attenuation. See the descriptions of the , " (Mech) Atten " on page 2736, and " Enable Elec Atten " on page 2737 keys for more detail on the contributors to the total attenuation. Note that when "Pre-Adjust for Min Clip" is on, this value can change at the start of every measurement.
Initial S/W Revision	Prior to A.02.00
Modified at S/W Revision	A.03.00

Dual Attenuator Configurations:

Configuration 1: Mechanical attenuator + optional electronic attenuator

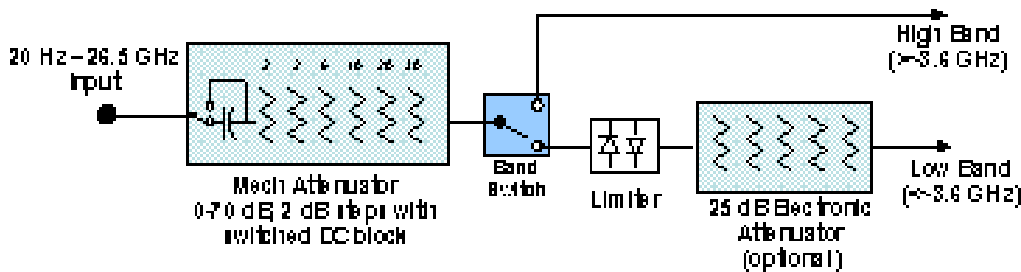

Configuration 2: Mechanical attenuator, no optional electronic attenuator

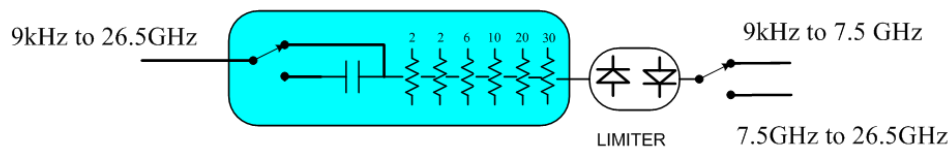

(note that Configuration 2 is not strictly speaking a dual-section attenuator, since there is no electronic section available. However, it behaves exactly like Configuration 1 without the Electronic Attenuator option EA3, therefore for the sake of this document it is grouped into the “Dual Attenuator” configuration)

Single Attenuator Configuration:

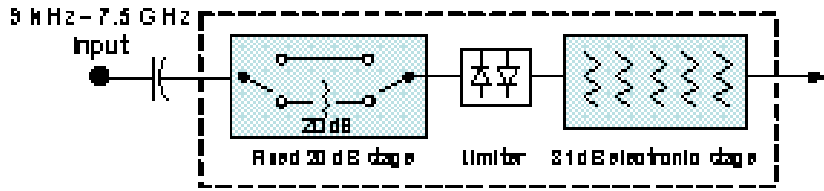

You can tell which attenuator configuration you have by pressing the Attenuation key, which (in most Modes) opens the Attenuation menu. If the first key in the Attenuation menu says Mech Atten you have the dual attenuator configuration. If the first key says Atten you have the single attenuator configuration.

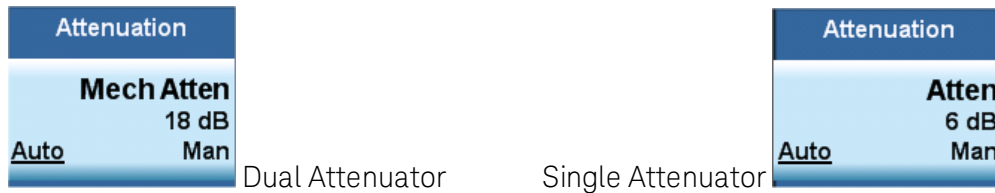

In the single attenuator configuration, you control the attenuation with a single control, as the fixed stage has only two states. In the dual attenuator configuration, both stages have significant range so you are given separate control of the mechanical and electronic attenuator stages.

When you have the dual attenuator configuration, you may still have only a single attenuator, because unless option EA3 (the Electronic Attenuator option) is available, and you purchase it, you will have only the mechanical attenuator.

(Mech) Atten

This key is labeled Mech Atten in dual attenuator models and Atten in single attenuator models. In the dual attenuator configuration, this key only affects the mechanical attenuator.

This key lets you modify the attenuation applied to the RF input signal path. This value is normally auto coupled to the Ref Level, the Internal Preamp Gain, any External Gain that is entered, and the Max Mixer Level, as described in the table below.

See "[Attenuator Configurations and Auto/Man](#)" on page 668

Key Path	AMPTD Y Scale, Attenuation
Remote Command	<pre>[:SENSe] : POWer [:RF] : ATTenuation <rel_ampl> [:SENSe] : POWer [:RF] : ATTenuation? [:SENSe] : POWer [:RF] : ATTenuation : AUTO OFF ON 0 1 [:SENSe] : POWer [:RF] : ATTenuation : AUTO?</pre>
Example	<p>POW:ATT 20</p> <p>Dual attenuator configuration: sets the mechanical attenuator to 20 dB</p> <p>Single attenuator mode: sets the main attenuation to 20 dB (see below for definition of “main” attenuation).</p> <p>If the attenuator was in Auto, it sets it to Manual.</p>
Dependencies	Some measurements do not support the Auto setting of (Mech) Atten. In these measurements, the

Auto/Man selection is not available, and the Auto/Man line on the key disappears.

In dual attenuator configurations, when the electronic attenuator is enabled, the mechanical attenuator has no auto setting and the Auto/Man line on the key disappears. The state of Auto/Man is remembered and restored when the electronic attenuator is once again disabled. This is described in more detail in the ["Enable Elec Atten" on page 2737](#) key description.

See ["Attenuator Configurations and Auto/Man" on page 668](#) for more information on the Auto/Man functionality of Attenuation.

Couplings

When (Mech) Atten is in Auto, it uses the following algorithm to determine a value:
If the USB Preamp is connected to USB, use 0 dB.
Otherwise, $Atten = ReferenceLevel + PreAmpGain + ExternalGain - RefLevelOffset - MaxMixerLevel + IF\ Gain$.

Limit this value to be between 6 dB and the Max value. No value below 6 dB can ever be chosen by Auto.

The resulting value is rounded up to the largest value possible given the attenuation step setting. That is, 50.01 dB would change to 60 dB (for a 10 dB attenuation step).

The "IF Gain" term in the equation above is either 0 dB or +10 dB, depending on the settings of FFT IF Gain, Swept IF Gain, max Ref Level and the Auto/Man setting of Mech Atten.

In External Mixing and BBIQ, where the Attenuator is not in the signal path, the Attenuator setting changes as described above when (Mech) Atten is in Auto, but no changes are made to the actual attenuator hardware setting until the input is changed back to the RF Input.

Preset The preset for Mech Attenuation is "Auto."
The Auto value of attenuation is:
CXA, EXA, MXA and PXA: 10 dB

State Saved Saved in instrument state

Min 0 dB
The attenuation set by this key cannot be decreased below 6 dB with the knob or step keys. To get to a value below 6 dB it has to be directly entered from the keypad or via SCPI. This protects from adjusting the attenuation to a dangerously small value which can put the instrument at risk of damage to input circuitry. However, if the current mechanical attenuation is below 6 dB it can be increased with the knob and step keys, but not decreased.

Max CXA N9000A-503/507: 50 dB
CXA N9000A-513/526: 70dB
EXA: 60 dB
MXA and PXA: 70 dB
In the single attenuator configuration, the total of ATT and EATT cannot exceed 50 dB, so if the EATT is set to 24 dB first, the main attenuation cannot be greater than 26 dB and will be reduced accordingly; if the main attenuator is set to 40 dB first, EATT cannot be greater than 10 dB.

Initial S/W Revision Prior to A.02.00

Modified at S/W Revision A.03.00

Attenuator Configurations and Auto/Man

As described in the Attenuation key description, there are two distinct attenuator configurations available in the X-Series, the single attenuator and dual attenuator configurations. In dual attenuator configurations, we have the mechanical attenuation and the electronic attenuation, and the current total attenuation is the sum of the electronic + mechanical attenuation. In single attenuator configurations, we refer to the attenuation set using the (Mech) Atten key (or POW:ATT SCPI) as the “main” attenuation; and the attenuation that is set by the SCPI command POW:EATT as the “soft” attenuation (the POW:EATT command is honored even in the single attenuator configuration, for compatibility purposes). Then the current total attenuation is the sum of the main + soft attenuation. See the Elec Atten key description for more on “soft” attenuation.

In the dual attenuator configuration, when the electronic attenuator is enabled, there is no Auto/Man functionality for the mechanical attenuator, and the third line of the key label (the Auto/Man line) disappears:

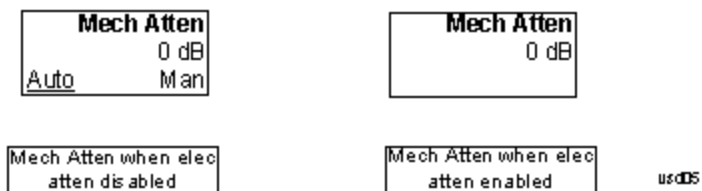

Enable Elec Atten

Enables the Electronic Attenuator.

The electronic attenuator offers finer steps than the mechanical attenuator, has no acoustical noise, is faster, and is less subject to wear. These advantages primarily aid in remote operation and are negligible for front panel use. See ["Using the Electronic Attenuator: Pros and Cons" on page 670](#) for a detailed discussion of the pros and cons of using the electronic attenuator.

For the single attenuator configuration, for SCPI backwards compatibility, the “soft” attenuation feature replaces the dual attenuator configuration’s electronic attenuator. All the same couplings and limitations apply. See ["Attenuator Configurations and Auto/Man" on page 2737](#)

See ["More Information" on page 669](#)

Key Path	AMPTD Y Scale, Attenuation
Remote Command	[:SENSe] : POWer [:RF] : EATTenuation : STATE OFF ON 0 1 [:SENSe] : POWer [:RF] : EATTenuation : STATE?
Example	POW:EATT:STAT ON
Dependencies	This key only appears in Dual Attenuator models with an Electronic Attenuator installed. It does not appear in models with the Single Attenuator configuration, as in the single attenuator configuration there is no “electronic attenuator” there is only a single integrated attenuator (which has both a mechanical and electronic stage). However, in the single attenuator configuration, EATT SCPI commands are accepted for compatibility with other X-series instruments and set a “soft” attenuation as described in "Attenuator Configurations and Auto/Man" on page 2737 . The electronic attenuator (and the “soft” attenuation function provided in single attenuator configurations) is unavailable above 3.6 GHz. Therefore, if the Stop Frequency of the analyzer is > 3.6 GHz then the Enable Elec Atten key will be OFF and grayed out.

	<p>If the Internal Preamp is on, meaning it is set to Low Band or Full, the electronic attenuator (and the “soft” attenuation function provided in single attenuator configurations) is unavailable. In this case the Enable Elec Atten key will be OFF and grayed out.</p> <p>If either of the above is true, if the SCPI command is sent, an error indicating that the electronic attenuator is unavailable will be sent.</p> <p>If the electronic/soft Attenuator is enabled, then the Stop Freq of the analyzer is limited to 3.6 GHz and the Internal Preamp is unavailable.</p> <p>The SCPI-only “soft” electronic attenuation for the single-attenuator configuration is not available in all measurements; in particular, it is not available in the Swept SA measurement.</p>
Couplings	Enabling and disabling the Electronic Attenuator affects the setting of the Mechanical Attenuator (in dual attenuator configurations). This is described in more detail below this table.
Preset	OFF for Swept SA measurement; ON for all other measurements that support the electronic attenuator
State Saved	Saved in instrument state
Initial S/W Revision	Prior to A.02.00
Modified at S/W Revision	A.03.00

More Information

Mechanical Attenuator Transition Rules

When the Electronic Attenuator is enabled, the Mechanical Attenuator transitions to a state that has no Auto function. Below are the rules for transitioning the Mechanical Attenuator. NOTE that the information below ONLY applies to the dual attenuator configurations, and ONLY when the Electronic Attenuator is installed:

When the Electronic Attenuation is enabled from a disabled state:

- The Mechanical Attenuator is initialized to 10 dB (this is its optimal performance setting). You can then set it as desired with SCPI, numeric keypad, step keys, or knob, and it behaves as it normally would in manual mode
- The Auto/Man state of (Mech) Atten is saved
- The Auto/Man line on the (Mech) Atten key disappears and the auto rules are disabled
- The Electronic Attenuator is set to 10 dB less than the previous value of the Mechanical Attenuator, within the limitation that it must stay within the range of 0 to 24 dB of attenuation.

Examples in the dual attenuator configuration:

- Mech Atten at 20 dB. Elec Atten enabled, Mech Atten set to 10 dB, and Elec Atten set to 10 dB. New total attenuation equals the value before Elec Atten enabled.
- Mech Atten at 0 dB. Elec Atten enabled, Mech Atten set to 10 dB, and Elec Atten set to 0 dB. New total attenuation does not equal the value before Elec Atten enabled.
- Mech Atten at 40 dB. Elec Atten enabled, Mech Atten set to 10 dB, and Elec Atten set to 24 dB. New total attenuation does not equal the value before Elec Atten enabled.

When the Electronic Attenuation is disabled from an enabled state:

- The Elec Atten key is grayed out
- The Auto/Man state of (Mech) Atten is restored
- If now in Auto, (Mech) Atten recouples
- If now in Man, (Mech) Atten is set to the value of total attenuation that existed before the Elec Atten was disabled. The resulting value is rounded up to the smallest value possible given the (Mech) Atten Step setting - (That is, 57 dB changes to 58 dB when (Mech) Atten Step is 2 dB.)

Using the Electronic Attenuator: Pros and Cons

The electronic attenuator offers finer steps than the mechanical attenuator, has no acoustical noise, is faster, and is less subject to wear.

The “finer steps” advantage of the electronic attenuator is beneficial in optimizing the alignment of the analyzer dynamic range to the signal power in the front panel as well as remote use. Thus, you can achieve improved relative signal measurement accuracy. Compared to a mechanical attenuator with 2 dB steps, the 1 dB resolution of the electronic attenuator only gives better resolution when the odd-decibel steps are used. Those odd-decibel steps are less accurately calibrated than the even-decibel steps, so one tradeoff for this superior relative accuracy is reduced absolute amplitude accuracy.

Another disadvantage of the electronic attenuator is that the spectrum analyzer loses its “Auto” setting, making operation less convenient.

Also, the relationship between the dynamic range specifications (TOI, SHI, compression and noise) and instrument performance are less well-known with the electrical attenuator. With the mechanical attenuator, TOI, SHI and compression threshold levels increase dB-for-dB with increasing attenuation, and the noise floor does as well. With the electronic attenuator, there is an excess attenuation of about 1 to 3 dB between 0 and 3.6 GHz, making the effective TOI, SHI, and so forth, less well known. Excess attenuation is the actual attenuation relative to stated attenuation. Excess attenuation is accounted for in the analyzer calibration

Elec Atten

Controls the Electronic Attenuator in dual attenuator configurations. This key does not appear in single attenuator configurations, as the control of both the mechanical and electronic stages of the single attenuator is integrated into the single Atten key.

Key Path	AMPTD Y Scale, Attenuation
Remote Command	<code>[:SENSe] :POWer [:RF] :EATTenuation <rel_amp1></code> <code>[:SENSe] :POWer [:RF] :EATTenuation?</code>
Notes	Electronic Attenuation’s specification is defined only when Mechanical Attenuation is 6 dB.
Dependencies	This key only appears in Dual Attenuator models with an Electronic Attenuator installed. It does not appear in models with the Single Attenuator configuration, as in the single attenuator configuration there is no “electronic attenuator” there is only a single integrated attenuator (which has both a mechanical and electronic stage). However, in the single attenuator configuration, EATT SCPI commands are accepted for compatibility with other X-series instruments and set a “soft” attenuation as described in "Attenuator Configurations and Auto/Man" on page 2737 . The “soft” attenuation is treated as an addition to the “main” attenuation value set by the Atten softkey or the

	POW:ATT SCPI command and affects the total attenuation displayed on the Attenuation key and the Meas Bar. When Enable Elec Atten is off or grayed out, the Elec Atten key is grayed out.
Preset	0 dB
State Saved	Saved in instrument state
Min	0 dB
Max	Dual attenuator configuration: 24 dB Single attenuator configuration: the total of ATT and EATT cannot exceed 50 dB, so if the EATT is set to 24 dB first, the main attenuation cannot be greater than 26 dB and will be reduced accordingly; if the main attenuator is set to 40 dB first, EATT cannot be greater than 10 dB
Initial S/W Revision	Prior to A.02.00
Modified at S/W Revision	A.03.00

Adjust Atten for Min Clip

Sets the combination of mechanical and electronic attenuation and gain based on the current measured signal level so that clipping will be at a minimum.

This is an "immediate action" function, that is, it executes once, when the key is pressed.

This key is grayed out in measurements that do not support this functionality. The spectrum analyzer measurement, Swept SA, does not support this functionality.

Key Path	AMPTD Y Scale, Attenuation
Remote Command	<code>[:SENSe] :POWer [:RF] :RANGe:OPTimize IMMEDIATE</code>
Initial S/W Revision	Prior to A.02.00
Modified at S/W Revision	A.03.00

Pre-Adjust for Min Clip

If this function is on, it does the adjustment described under "[Adjust Atten for Min Clip](#)" on page 2740 each time a measurement restarts. Therefore, in Continuous measurement mode, it only executes before the first measurement.

In dual attenuator models, you can set Elec+Mech Atten, in which case both attenuators participate in the autoranging, or Elec Atten Only, in which case the mechanical attenuator does not participate in the autoranging. This latter case results in less wear on the mechanical attenuator and is usually faster.

This key is grayed out in measurements that do not support this functionality. The spectrum analyzer measurement, Swept SA, does not support this functionality.

Key Path	AMPTD Y Scale, Attenuation
Remote Command	<code>[:SENSe] :POWer [:RF] :RANGe:OPTimize:ATTenuation OFF ELECTRical COMBined</code>

	<code>[:SENSe] :POWer [:RF] :RANGe:OPTimize:ATTenuation?</code>
Notes	The SCPI parameter ELECtrical sets this function to On in single attenuator models. The SCPI parameter COMBined is mapped to ELECtrical in single attenuator models; if you send COMBined, it sets the function to On and returns ELEC to a query.
Dependencies	This key only appears in Dual Attenuator models with an Electronic Attenuator installed. In instruments with Dual Attenuator model, when Enable Elec Atten is off or grayed out, the Pre-Adjust for Min Clip key is grayed out.
Preset	OFF for Swept SA measurement; ON for all other measurements that support Pre-Adjust for Min Clip
State Saved	Saved in instrument state
Range	Dual attenuator models: Off Elec Atten Only Mech + Elec Atten Single attenuator models: Off On
Initial S/W Revision	Prior to A.02.00
Modified at S/W Revision	A.03.00

Remote Command	<code>[:SENSe] :POWer [:RF] :RANGe:AUTO ON OFF 1 0</code> <code>[:SENSe] :POWer [:RF] :RANGe:AUTO?</code>
Notes	ON aliases to "Elec Atten Only" (:POW:RANG:OPT:ATT ELEC) OFF aliases to "Off" (:POW:RANG:OPT:ATT OFF) The query :POW:RANG:AUTO? returns true if :POW:RANG:OPT:ATT is not "Off"
Initial S/W Revision	Prior to A.02.00

Off

Turns Pre-Adjust for Min Clip off. This is the default setting.

This key is grayed out in measurements that do not support this functionality. The spectrum analyzer measurement, Swept SA, does not support this functionality.

Key Path	AMPTD Y Scale, Attenuation, Pre-Adjust for Min Clip
Example	:POW:RANGe:OPT:ATT OFF
Initial S/W Revision	Prior to A.02.00

Elec Atten Only

Selects only the electric attenuator to participate in auto ranging. This offers less wear on the mechanical attenuator and is usually faster.

This key is grayed out in measurements that do not support this functionality. The spectrum analyzer measurement, Swept SA, does not support this functionality.

Key Path	AMPTD Y Scale, Attenuation, Pre-Adjust for Min Clip
Example	:POW:RANGe:OPT:ATT ELEC
Initial S/W Revision	Prior to A.02.00

Mech + Elec Atten

In dual attenuator models, this selects both attenuators participate in the autoranging.

This key is grayed out in measurements that do not support this functionality. The spectrum analyzer measurement, Swept SA, does not support this functionality.

Key Path	AMPTD Y Scale, Attenuation, Pre-Adjust for Min Clip
Example	:POW:RANGe:OPT:ATT COMB
Initial S/W Revision	Prior to A.02.00

(Mech) Atten Step

This controls the step size used when making adjustments to the input attenuation.

This key is labeled Mech Atten Step in dual attenuator models and Atten Step in single attenuator models. In the dual attenuator configuration, this key only affects the step size of the mechanical attenuator.

Key Path	AMPTD Y Scale, Attenuation
Remote Command	[[:SENSe]:POWer[:RF]:ATTenuation:STEP[:INCRement] 10 dB 2 dB [:SENSe]:POWer[:RF]:ATTenuation:STEP[:INCRement]?
Example	POW:ATT:STEP 2
Notes	Note this feature works like a 1-N choice from the front panel, but it takes a specific value (in dB) when used remotely. The only valid values are 2 and 10.
Dependencies	Blanked in CXA and EXA if option FSA (2 dB steps) is not present. If blanked, attempts to set it via SCPI will yield an error.
Couplings	When the attenuation step size changes, the current mechanical attenuation value is adjusted (if necessary) to be quantized to the new step size. That is, if step is set to 10 dB, mech atten is increased if necessary so it is a multiple of 10 dB
Preset	PXA and MXA: 2 dB EXA and CXA: 10 dB (2 dB with option FSA)
State Saved	Saved in instrument state
Initial S/W Revision	Prior to A.02.00
Modified at S/W Revision	A.03.00

Scale/Div

Sets the logarithmic units per vertical graticule division on the display. When the Auto Scaling is On, the Scale/Div is automatically determined by the measurement result. When you set a value manually, Auto Scaling is automatically toggled to Off.

Key Path	AMPTD Y Scale
Mode	SA, WCDMA, C2K, WIMAX OFDMA, TD-SCDMA, 1xEVDO, ISDB-T, CMMB, LTE, LTETDD, BLUETOOTH, WLAN, MSR, LTEAFDD, LTEATDD
Remote Command	:DISPlay:OBWidth:VIEW[1]:WINDow[1]:TRACe:Y[:SCALe]:PDIVision <rel_amp1> :DISPlay:OBWidth:VIEW[1]:WINDow[1]:TRACe:Y[:SCALe]:PDIVision?
Example	DISP:OBW:VIEW:WIND:TRAC:Y:PDIV 5 DISP:OBW:VIEW:WIND:TRAC:Y:PDIV?
Notes	You must be in the Spectrum Analysis mode, W-CDMA mode, cdma2000 mode, TD-SCDMA mode, ISDB-T mode, CMMB mode, LTE mode, LTE TDD mode, BLUETOOTH mode, WLAN mode, 1xEVDO mode, MSR, LTE-Advanced FDD/TDD or WIMAX OFDMA mode to use this command. Use :INSTrument:SElect to set the mode.
Couplings	When the Auto Scaling is On, this value is automatically determined by the measurement result. When you set a value manually, Auto Scaling automatically changes to Off.
Preset	10.00 dB
State Saved	Saved in instrument state.
Min	0.10 dB
Max	20.00 dB
Initial S/W Revision	Prior to A.02.00
Modified at S/W Revision	A.03.00

Presel Center

When this key is pressed, the centering of the preselector filter is adjusted to optimize the amplitude accuracy at the frequency of the selected marker. If the selected marker is not on when Presel Center is pressed, the analyzer will turn on the selected marker, perform a peak search, and then perform centering on the marker's center frequency. If the selected marker is already on and between the start and stop frequencies of the analyzer, the analyzer performs the preselector calibration on that marker's frequency. If the selected marker is already on, but outside the frequency range between Start Freq and Stop Freq, the analyzer will first perform a peak search, and then perform centering on the marker's center frequency.

The value displayed on the Presel Adjust key will change to reflect the new preselector tuning (see Presel Adjust).

A number of considerations should be observed to ensure proper operation. See ["Proper Preselector Operation" on page 675](#).

Key Path	AMPTD Y Scale
Remote Command	[:SENSE]:POWer[:RF]:PCENTER

Example	POW:PCEN
Notes	Note that the rules outlined above under the key description apply for the remote command as well as the key. The result of the command is dependent on marker position, and so forth. Any message shown by the key press is also shown in response to the remote command.
Dependencies	<ul style="list-style-type: none"> • Grayed out if the microwave preselector is off.) • If the selected marker's frequency is below Band 1, advisory message 0.5001 is generated and no action is taken. • Grayed out if entirely in Band 0. • Blank in models that do not include a preselector, such as option 503. If the SCPI is sent in these instruments, it is accepted without error, and the query always returns 0. • Grayed out in the Spectrogram View.
Couplings	<p>The active marker position determines where the centering will be attempted.</p> <p>If the analyzer is in a measurement such as averaging when centering is initiated, the act of centering the preselector will restart averaging but the first average trace will not be taken until the centering is completed.</p>
Status Bits/OPC dependencies	<p>When centering the preselector, *OPC will not return true until the process is complete and a subsequent measurement has completed, nor will results be returned to a READ or MEASURE command.</p> <p>The Measuring bit should remain set while this command is operating and should not go false until the subsequent sweep/measurement has completed.</p>
Initial S/W Revision	Prior to A.02.00
Modified at S/W Revision	A.03.00

Proper Preselector Operation

A number of considerations should be observed to ensure proper operation:

1. If the selected marker is off, the analyzer will turn on a marker, perform a peak search, and adjust the preselector using the selected marker's frequency. It uses the "highest peak" peak search method unqualified by threshold or excursion, so that there is no chance of a 'no peak found' error. It continues with that peak, even if it is the peak of just noise. Therefore, for this operation to work properly, there should be a signal on screen in a preselected range for the peak search to find.
2. If the selected marker is already on, the analyzer will attempt the centering at that marker's frequency. There is no preselector for signals below about 3.6 GHz, therefore if the marker is on a signal below 3.6 GHz, no centering will be attempted and an advisory message generated
3. In some models, the preselector can be bypassed. If it is bypassed, no centering will be attempted in that range and a message will be generated.

Preselector Adjust

Allows you to manually adjust the preselector filter frequency to optimize its response to the signal of interest. This function is only available when "[Presel Center](#)" on page 2743 is available.

For general purpose signal analysis, using Presel Center is recommended. Centering the filter minimizes the impact of long-term preselector drift. Presel Adjust can be used instead to manually optimize the preselector. One application of manual optimization would be to peak the preselector response, which both optimizes the signal-to-noise ratio and minimizes amplitude variations due to small (short-term) preselector drifting.

Key Path	AMPTD Y Scale
Scope	Meas Global
Remote Command	<code>[:SENSe] :POWer [:RF] :PADJust <freq></code> <code>[:SENSe] :POWer [:RF] :PADJust?</code>
Example	POW:PADJ 100KHz POW:PADJ?
Notes	The value on the key reads out to 0.1 MHz resolution.
Dependencies	<ul style="list-style-type: none"> • Grayed out if microwave preselector is off.) • Grayed out if entirely in Band 0. • Blank in models that do not include a preselector, such as option 503. If the SCPI is sent in these instruments, it is accepted without error, and the query always returns 0. • Grayed out in the Spectrogram View.
Preset	0 MHz
State Saved	The Presel Adjust value set by Presel Center, or by manually adjusting Presel Adjust, is not saved in instrument state, and does not survive a Preset or power cycle.
Min	-500 MHz
Max	500 MHz
Default Unit	Hz
Backwards Compatibility SCPI	<code>[:SENSe] :POWer [:RF] :MW :PADJust</code> <code>[:SENSe] :POWer [:RF] :MMW :PADJust</code> PSA had multiple preselectors, but the X-Series has only one. These commands simply alias to <code>[:SENSe] :POWer [:RF] :PADJust</code>
Initial S/W Revision	Prior to A.02.00
Modified at S/W Revision	A.03.00

Remote Command	<code>[:SENSe] :POWer [:RF] :PADJust :PRESelector MWAVE MMWave EXTERNAL</code> <code>[:SENSe] :POWer [:RF] :PADJust :PRESelector?</code>
Notes	PSA had multiple preselectors, and you could select which preselector to adjust. Since the X-Series has only one mm/uW preselector, the preselector selection softkey is no longer available. However, to provide backward compatibility, we accept the legacy remote commands. The command form has no effect, the query always returns MWAVE
Initial S/W Revision	Prior to A.02.00

μW Path Control

The μW Path Control functions include the μW Preselector Bypass (Option MPB) and Low Noise Path (Option LNP) controls in the High Band path circuits.

When the μW Preselector is bypassed, the user has better flatness, but will be subject to spurs from out of band interfering signals. When the Low Noise Path is enabled, the analyzer automatically switches around certain circuitry in the high frequency bands which can contribute to noise, when it is appropriate based on other analyzer settings.

For most applications, the preset state is Standard Path, which gives the best remote-control throughput, minimizes acoustic noise from switching and minimizes the risk of wear out in the hardware switches. For applications that utilize the wideband IF paths, the preset state is the μW Preselector Bypass path, if option MPB is present. This is because, when using a wideband IF such as the 140 MHz IF, the μW Preselector's bandwidth can be narrower than the available IF bandwidth, causing degraded amplitude flatness and phase linearity, so it is desirable to bypass the preselector in the default case.

Users may choose Low Noise Path Enable. It gives a lower noise floor, especially in the 21–26.5 GHz region, though without improving many measures of dynamic range, and without giving the best possible noise floor. The preamp, if purchased and used, gives better noise floor than does the Low Noise Path, however its compression threshold and third-order intercept are much poorer than that of the non-preamp Low Noise Path. There are some applications, typically for signals around –30 dBm, for which the third-order dynamic range of the standard path is good enough, but the noise floor is not low enough even with 0 dB input attenuation. When the third-order dynamic range of the preamp path is too little and the noise floor of the standard path is too high, the Low Noise Path can provide the best dynamic range.

Key Path	AMPTD Y Scale
Mode	SA, BASIC, PNOISE, VSA , LTE, LTETDD
Scope	Meas Global
Remote Command	[:SENSe] :POWer [:RF] :MW:PATH STD LNPath MPBypass FULL [:SENSe] :POWer [:RF] :MW:PATH?
Example	:POW:MW:PATH LNP Enables the Low Noise path
Notes	If a Presel Center is performed, the analyzer will momentarily switch to the Standard Path, regardless of the setting of μW Path Control The DC Block will always be switched in when the low noise path is switched in, to protect succeeding circuitry from DC. Note that this does not mean “when the low noise path is enabled” but when, based on the Low Noise Path rules, the path is actually switched in. This can happen when the selection is Low Noise Path Enable . In the case where the DC Block is switched in the analyzer is now AC coupled. However, if the user has selected DC coupling, the UI will still behave as though it were DC coupled, including all annunciation, warnings, status bits, and responses to SCPI queries. This is because, based on other settings, the analyzer could switch out the low noise path at any time and hence go back to being DC coupled. Alignment switching ignores the settings in this menu, and restores them when finished.
Dependencies	Unavailable in BBIQ and External Mixing
Preset	All modes other than IQ Analyzer mode and VXA: STD IQ Analyzer, VXA and WLAN mode:

	MPB option present and licensed: MPB MPB option not present and licensed: STD
State Saved	Save in instrument state
Readback	Value selected in the submenu
Initial S/W Revision	A.04.00
Modified at S/W Revision	A.10.00

Standard Path

This path gives the best remote-control throughput, minimizes acoustic noise from switching and minimizes the risk of wear in the hardware switches, particularly in remote test scenarios where both low band and high band setups will follow in rapid succession.

In this path, the bypass of the low band/high band switch and microwave preamp is never activated, which can cause some noise degradation but preserves the life of the bypass switch.

Key Path	AMPTD Y Scale, μ W Path Control
Example	:POW:MW:PATH STD
Readback Text	Standard Path
Initial S/W Revision	A.04.00

Low Noise Path Enable

You may choose Low Noise Path Enable, which gives a lower noise floor under some circumstances, particularly when operating in the 21–26.5 GHz region. With the Low Noise Path enabled, the low band/high band switch and microwave preamp are bypassed whenever all of the following are true:

- The analyzer is not in the Low Band, meaning:
- the start frequency is above 3.5 GHz and
- the stop frequency is above 3.6 GHz.
- the internal preamp is not installed or (if installed) is set to Off or Low Band

Note that this means that, when any part of a sweep is done in Low Band, the Low Noise Path is not used, whether or not the Low Noise Path Enable is selected in the user interface. Also, if the preamp is turned on, the Low Noise Path is not used, whether or not the Low Noise Path Enable is selected in the user interface. The only time the Low Noise Path is used is when Low Noise Path Enable is selected, the sweep is completely in High Band (> 3.6 GHz) and no preamp is in use.

See "[More Information](#)" on page 679

Key Path	AMPTD Y Scale, μ W Path Control
Measurement	Swept SA

Example	:POW:MW:PATH LNP
Notes	<p>For measurements that use IQ acquisition, the low noise path is used when the Center Frequency is in High Band (> 3.6 GHz) and no preamp is in use.</p> <p>In other words, the rules above are modified to use only the center frequency to qualify which path to switch in.</p> <p>This is not the case for FFT's in the Swept SA measurement; they use the same rules as swept measurements.</p>
Dependencies	<p>Key is blanked if current mode does not support it.</p> <p>Key is grayed out if mode supports it but current measurement does not support it.</p> <p>Unless Option LNP is present and licensed, key is blank and if SCPI command sent, error -241, "Hardware missing; Option not installed" is generated.</p>
Readback Text	Low Noise Path Enable
Initial S/W Revision	A.04.00

More Information

The user should understand that the Low Noise Path, while giving improved DANL, has the disadvantage of decreased TOI performance and decreased gain compression performance relative to the standard path.

The user should also understand that the bypass switch is a mechanical switch and has finite life, so if the Low Noise Path is enabled, it is possible to cause frequent cycling of this switch by frequently changing analyzer settings such that the above conditions hold true only some of the time. A user making tests of this nature should consider opting for the Standard Path, which will never throw the bypass switch, at the expense of some degraded noise performance.

The low noise path is useful for situations where the signal level is so low that the analyzer performance is dominated by noise even with 0 dB attenuation, but still high enough that the preamp option would have excessive third-order intermodulation or compression. The preamp, if purchased and used, gives better noise floor than does the "Low Noise Path." However, its compression threshold and third-order intercept are much poorer than that of the non-preamp path. There are some applications, typically for signals around -30 dBm, for which the third-order dynamic range of the standard path is good enough, but the noise floor is not low enough even with 0 dB input attenuation. When the third-order dynamic range of the preamp path is too little and the noise floor of the standard path is too high, the Low Noise Path can provide the best dynamic range

The graph below illustrates the concept. It shows, in red, the performance of an analyzer at different attenuation settings, both with the preamp on and off, in a measurement that is affected by both analyzer noise and analyzer TOI. The green shows the best available dynamic range, offset by 0.5 dB for clarity. The blue shows how the best available dynamic range improves for moderate signal levels with the low noise path switched in. In this illustration, the preamp improves the noise floor by 15 dB while degrading the third-order intercept by 30 dB, and the low noise path reduces loss by 8 dB. The attenuator step size is 2 dB.

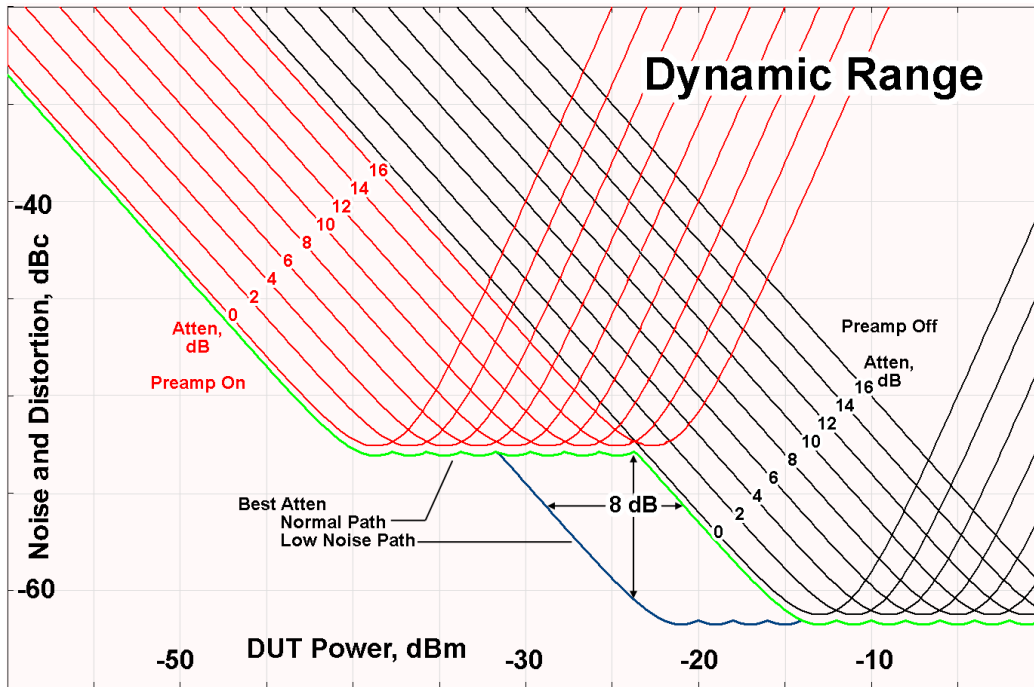

There are other times where selecting the low noise path improves performance, too. Compression-limited measurements such as finding the nulls in a pulsed-RF spectrum can profit from the low noise path in a way similar to the TOI-limited measurement illustrated. Accuracy can be improved when the low noise path allows the optimum attenuation to increase from a small amount like 0, 2 or 4 dB to a larger amount, giving better return loss at the analyzer input. Harmonic measurements, such as second and third harmonic levels, are much improved using the low noise path because of the superiority of that path for harmonic (though not intermodulation) distortion performance.

μW Preselector Bypass

This key toggles the preselector bypass switch for band 1 and higher. When the microwave preselector is on, the signal path is preselected. When the microwave preselector is off, the signal path is not preselected. The preselected path is the normal path for the analyzer.

The preselector is a tunable bandpass filter which prevents signals away from the frequency of interest from combining in the mixer to generate in-band spurious signals (images). The consequences of using a preselector filter are its limited bandwidth, the amplitude and phase ripple in its passband, and any amplitude and phase instability due to center frequency drift.

Option MPB or pre-selector bypass provides an unpreselected input mixer path for certain X-Series signal analyzers with frequency ranges above 3.6 GHz. This signal path allows a wider bandwidth and less amplitude variability, which is an advantage when doing modulation analysis and broadband signal analysis. The disadvantage is that, without the preselector, image signals will be displayed. Another disadvantage of bypassing the preselector is increased LO emission levels at the front panel input port.

Image responses are separated from the real signal by twice the 1st IF. For IF Paths of 10 MHz and 25 MHz, the 1st IF is 322.5 MHz, so the image response and the real signal will be separated by 645 MHz. The 1st IF will be different for other IF Path settings. When viewing a real signal and its corresponding image response in internal mixing, the image response will be to the left of the real signal.

Also, the image response and the real signal typically have the same amplitude and exhibit the same shape factor.

However, if Option FS1, Fast Sweep Capability, is enabled, the image response in the Swept SA measurement will appear lower in amplitude and have a much wider shape factor compared to the real signal.

Key Path	AMPTD Y Scale, μ W Path Control
Example	:POW:MW:PATH MPB
Dependencies	Key is blanked if current mode does not support it. Key is grayed out if mode supports it but current measurement does not support it. Key is blank unless Option MPB is present and licensed. If SCPI command sent when MPB not present, error -241, "Hardware missing; Option not installed" is generated.
Readback Text	μ W Preselector Bypass
Initial S/W Revision	A.04.00

Remote Command	[:SENSe] :POWer [:RF] :MW:PRESelector [:STATe] ON OFF 0 1 [:SENSe] :POWer [:RF] :MW:PRESelector [:STATe] ?
Example	:POW:MW:PRES OFF Bypasses the microwave preselector
Notes	The ON parameter sets the STD path (:POW:MW:PATH STD) The OFF parameter sets path MPB (:POW:MW:PATH MPB)
Preset	ON

Internal Preamp

Accesses a menu of keys that control the internal preamps. Turning on the preamp gives a better noise figure, but a poorer TOI to noise floor dynamic range. You can optimize this setting for your particular measurement.

The instrument takes the preamp gain into account as it sweeps. If you sweep outside of the range of the preamp the instrument will also account for that. The displayed result will always reflect the correct gain.

For some measurements, when the preamp is on and any part of the displayed frequency range is below the lowest frequency for which the preamp has specifications, a warning condition message appears in the status line. For example ,for a preamp with a 9 kHz lowest specified frequency: "Preamp: Accy unspec'd below 9 kHz".

Key Path	AMPTD Y Scale
Scope	Meas Global
Remote Command	[:SENSe] :POWer [:RF] :GAIN [:STATe] OFF ON 0 1 [:SENSe] :POWer [:RF] :GAIN [:STATe] ?
Dependencies	Preamp is not available on all hardware platforms. If the preamp is not present or is unlicensed, the

	key is not shown. The preamp is not available when the electronic/soft attenuator is enabled.
Couplings	The act of connecting the U7227A USB Preamplifier to one of the analyzer's USB ports will cause the Internal Preamp to be switched on. When this happens an informational message will be generated: "Internal Preamp turned on for optimal operation with USB Preamp." Note that if the Internal Preamp was already on, there will be no change to the setting, but if it was Off it will be switched On, to Full Range. Note that this same action occurs when the SA mode is selected while the USB Preamp is connected to one of the analyzer's USB ports, if it is the first time that the SA mode has run since powerup, or if the last time the SA mode was running the USB Preamp was NOT connected. Subsequently disconnecting the USB Preamp from USB does not change the Internal Preamp setting nor restore the previous setting.
Preset	OFF
State Saved	Saved in instrument state
Initial S/W Revision	Prior to A.02.00
Modified at S/W Revision	A.14.00

Key Path	AMPTD Y Scale, Internal Preamp
Scope	Meas Global
Remote Command	[:SENSe] : POWer [:RF] : GAIN : BAND LOW FULL [:SENSe] : POWer [:RF] : GAIN : BAND ?
Dependencies	Preamp is not available on all hardware platforms. If the preamp is not present or is unlicensed, the key is not shown. If a POW:GAIN:BAND FULL command is sent when a low band preamp is available, the preamp band parameter is to LOW instead of FULL, and an "Option not installed" message is generated.
Preset	LOW
State Saved	Saved in instrument state
Initial S/W Revision	Prior to A.02.00

Off

Turns the internal preamp off

Key Path	AMPTD Y Scale, Internal Preamp
Example	:POW:GAIN OFF
Readback	Off
Initial S/W Revision	Prior to A.02.00

Low Band

Sets the internal preamp to use only the low band.

The frequency range of the installed (optional) low-band preamp is displayed in square brackets on the Low Band key label.

Key Path	AMPTD Y Scale, Internal Preamp
Example	:POW:GAIN ON :POW:GAIN:BAND LOW
Readback	Low Band
Initial S/W Revision	Prior to A.02.00

Full Range

Sets the internal preamp to use its full range. The low band (0–3.6 GHz or 0–3GHz, depending on the model) is supplied by the low band preamp and the frequencies above low band are supplied by the high band preamp.

The frequency range of the installed (optional) preamp is displayed in square brackets on the Full Range key label. If the high band option is not installed the Full Range key does not appear.

Key Path	AMPTD Y Scale, Internal Preamp
Example	:POW:GAIN ON :POW:GAIN:BAND FULL
Readback	Full Range
Initial S/W Revision	Prior to A.02.00

Ref Position

Positions the reference level at the top, center or bottom of the Y Scale display. Changing the reference position does not change the reference level value.

Key Path	AMPTD Y Scale
Mode	SA, WCDMA, C2K, WIMAX OFDMA, TD-SCDMA, 1xEVDO, ISDB-T, CMMB, LTE, LTE-TDD, BLUETOOTH, WLAN, MSR, LTEAFDD, LTEATDD
Remote Command	:DISPlay:OBWidth:VIEW[1]:WINDow[1]:TRACe:Y[:SCALE]:RPOSition TOP CENTER BOTTom :DISPlay:OBWidth:VIEW[1]:WINDow[1]:TRACe:Y[:SCALE]:RPOSition?
Example	DISP:OBW:VIEW:WIND:TRAC:Y:RPOS BOTT DISP:OBW:VIEW:WIND:TRAC:Y:RPOS?
Notes	You must be in the Spectrum Analysis mode, W-CDMA mode, cdma2000 mode, TD-SCDMA mode, ISDB-T mode, CMMB mode, LTE mode, LTE TDD mode, BLUETOOTH mode, WLAN mode, 1xEVDO mode, MSR, LTE-Advanced FDD/TDD or WIMAX OFDMA mode to use this command.

	Use:INSTRument:SElect to set the mode.
Preset	TOP
State Saved	Saved in instrument state.
Range	Top Ctr Bot
Initial S/W Revision	Prior to A.02.00
Modified at S/W Revision	A.03.00

Auto Scaling

Allows you to toggle the Auto Scaling function between On and Off.

Key Path	AMPTD Y Scale
Mode	SA, WCDMA, C2K, WIMAX OFDMA, TD-SCDMA, 1xEVDO, ISDB-T, CMMB, LTE, LTETDD, BLUETOOTH, WLAN, MSR, LTEAFDD, LTEATDD
Remote Command	:DISPlay:OBWidth:VIEW[1]:WINDow[1]:TRACe:Y[:SCALe]:COUPle 0 1 OFF ON :DISPlay:OBWidth:VIEW[1]:WINDow[1]:TRACe:Y[:SCALe]:COUPle?
Example	DISP:OBW:VIEW:WIND:TRAC:Y:COUP ON DISP:OBW:VIEW:WIND:TRAC:Y:COUP?
Couplings	When Auto Scaling is On, upon pressing the Restart front-panel key, this function automatically sets the scale per division to 10 dB and determines reference values based on the measurement results. When you set a value to either Scale/Div or Ref Value manually, Auto Scaling automatically changes to Off.
Preset	1
State Saved	Saved in instrument state.
Range	On Off
Initial S/W Revision	Prior to A.02.00
Modified at S/W Revision	A.03.00

Auto Couple

The Auto Couple feature provides a quick and convenient way to automatically couple multiple instrument settings. This helps ensure accurate measurements and optimum dynamic range. When the Auto Couple feature is activated, either from the front panel or remotely, all parameters of the current measurement that have an Auto/Manual mode are set to Auto mode and all measurement settings dependent on (or coupled to) the Auto/Man parameters are automatically adjusted for optimal performance.

However, the Auto Couple key actions are confined to the current measurement only. It does not affect other measurements in the mode, and it does not affect markers, marker functions, or trace or display attributes.

See "[More Information](#)" on page 685

Key Path	Front-panel key
Remote Command	:COUPle ALL NONE
Example	:COUP ALL
Notes	:COUPle ALL puts all Auto/Man parameters in Auto mode (equivalent to pressing the Auto Couple key). :COUPLE NONE puts all Auto/Man parameters in manual mode. It decouples all the coupled instrument parameters and is not recommended for making measurements.
Initial S/W Revision	Prior to A.02.00

More Information

There are two types of functions that have Auto/Manual modes.

Auto/Man Active Function keys

An Auto/Man toggle key controls the binary state associated with an instrument parameter by toggling between Auto (where the parameter is automatically coupled to the other parameters it is dependent upon) and Man (where the parameter is controlled independent of the other parameters), as well as making the parameter the active function. The current mode is indicated on the softkey with either Auto or Man underlined as illustrated below.



Auto/Man 1-of-N keys

An Auto/Man 1-of-N key allows you to manually pick from a list of parameter values, or place the function in Auto, in which case the value is automatically selected (and indicated) as shown below. If in Auto, Auto is underlined on the calling key. If in manual operation, manual is indicated on the calling key. But the calling key does not actually toggle the function, it simply opens the menu.

9 Occupied Bandwidth Measurement
Auto Couple

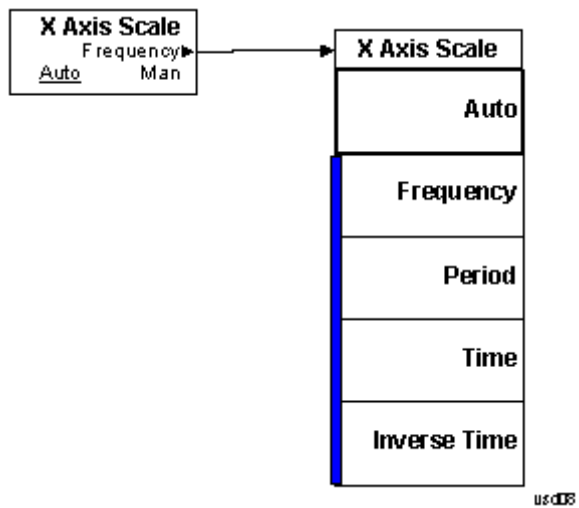

BW

Accesses a menu of functions that enable you to specify and control the video and resolution bandwidths. You can also select the type of filter for the measurement.

Key Path	Front-panel key
Initial S/W Revision	Prior to A.02.00

Res BW

Sets the resolution bandwidth for the current measurement. If an unavailable bandwidth is entered with the numeric keypad, the closest available bandwidth is selected.

Key Path	BW
Mode	SA, WCDMA, C2K, WIMAX OFDMA, TD-SCDMA, 1xEVDO, ISDB-T, CMMB, LTE, LTETDD, BLUETOOTH, WLAN, MSR, LTEAFDD, LTEATDD
Remote Command	<pre>[:SENSe]:OBWidth:BANDwidth[:RESolution] <bandwidth> [:SENSe]:OBWidth:BANDwidth[:RESolution]? [:SENSe]:OBWidth:BANDwidth[:RESolution]:AUTO ON OFF 1 0 [:SENSe]:OBWidth:BANDwidth[:RESolution]:AUTO?</pre>
Example	<pre>OBW:BAND 250000 OBW:BAND? OBW:BAND:AUTO OFF OBW:BAND:AUTO?</pre>
Notes	You must be in the Spectrum Analysis mode, W-CDMA mode, cdma2000 mode, TD-SCDMA mode, ISDB-T mode, CMMB mode, LTE mode, LTE TDD mode, BLUETOOTH mode, WLAN mode, 1xEVDO mode, MSR, LTE-Advanced FDD/TDD or WIMAX OFDMA mode to use this command. Use:INSTRument:SElect to set the mode.
Couplings	<p>Sweep time is coupled to RBW. As the RBW changes, the sweep time (if set to Auto) is changed to maintain amplitude calibration.</p> <p>Video bandwidth (VBW) is coupled to RBW. As the resolution bandwidth changes, the video bandwidth (if set to Auto) changes to maintain the ratio of VBW/RBW (10:1).</p> <p>When Res BW is set to Auto, the resolution bandwidth is auto-coupled to span. The ratio of Span/RBW is approximately 106:1 when auto coupled. When Res BW is set to Man, bandwidths are entered manually, and these bandwidths are used regardless of other analyzer settings.</p>
Preset	<pre>SA: Auto WCDMA: 30 kHz CDMA2K: 12 kHz WIMAX OFDMA: 100 kHz TD-SCDMA: 30 kHz 1xEVDO: 30 kHz ISDB-T: 10 kHz</pre>

	CMMB: 3 kHz LTE: 30 kHz LTETDD: 30 kHz BLUETOOTH:10 kHz WLAN: 100kHz MSR: 30 kHz, LTEAFDD, LTEATDD: 30 kHz SA: ON WCDMA, C2K, TD-SCDMA, WIMAX OFDMA, 1xEVDO , ISDB-T, CMMB, LTE, LTETDD, WLAN, MSR, LTEAFDD, LTEATDD: OFF
State Saved	Saved in instrument state.
Min	1 Hz
Max	8 MHz
Backwards Compatibility SCPI	[:SENSe] :OBWidth:BWIDth[:RESolution]
Initial S/W Revision	Prior to A.02.00
Modified at S/W Revision	A.03.00

Video BW

Changes the analyzer post-detection filter.

Key Path	BW
Mode	SA, WCDMA, C2K, WIMAX OFDMA, TD-SCDMA, 1xEVDO, ISDB-T, CMMB, LTE, LTETDD, BLUETOOTH, WLAN, MSR, LTEAFDD, LTEATDD
Remote Command	<pre>[:SENSe] :OBWidth:BA NDwidth:VIDeo <bandwidth> [:SENSe] :OBWidth:BA NDwidth:VIDeo? [:SENSe] :OBWidth:BA NDwidth:VIDeo:AUTO ON OFF 1 0 [:SENSe] :OBWidth:BA NDwidth:VIDeo:AUTO?</pre>
Example	<pre>OBW:BA ND:VID 5 MHz OBW:BA ND:VID? OBW:BA ND:VID:AUTO ON OBW:BA ND:VID:AUTO?</pre>
Notes	You must be in the Spectrum Analysis mode, W-CDMA mode, cdma2000 mode, TD-SCDMA mode, ISDB-T mode, CMMB mode, LTE mode, LTE TDD mode, BLUETOOTH mode, WLAN mode, 1xEVDO mode, MSR, LTE-Advanced FDD/TDD or WIMAX OFDMA mode to use this command. Use:INSTrument:SElect to set the mode.
Dependencies	When using the average detector with either Sweep Time set to Man, or in zero span, the VBW setting has no effect and is disabled (grayed out).
Couplings	Video bandwidth (VBW) is coupled to RBW. As the resolution bandwidth changes, the video bandwidth (if set to Auto) changes to maintain the ratio set by VBW/RBW.

Sweep Time is coupled to Video Bandwidth (VBW). As the VBW is changed, the sweep time (when set to Auto) is changed to maintain amplitude calibration. This occurs because of common hardware between the two circuits, even though the Video BW filter is not actually “in-circuit” when the detector is set to Average. Because the purpose of the average detector and the VBW filter are the same, either can be used to reduce the variance of the result.

Although the VBW filter is not “in-circuit” when using the average detector, the Video BW key can have an effect on (Auto) sweep time, and is not disabled. In this case, reducing the VBW setting increases the sweep time, which increases the averaging time, producing a lower-variance trace.

When the video bandwidth is AUTO coupled, the video bandwidth value is set to:

Resolution Bandwidth * Video Bandwidth to Resolution Bandwidth Ratio

Preset	SA, LTE, LTETDD, WLAN, MSR, LTEAFDD, LTEATDD: Auto WCDMA: 300 kHz CDMA2K:120 kHz WIMAX OFDMA: 1 MHz TD-SCDMA: 300 kHz 1xEVDO: 300 kHz ISDB-T: 300 Hz CMMB: 3 kHz BLUETOOTH: 30 kHz ON ISDB-T, CMMB: OFF
State Saved	Saved in instrument state.
Min	1 Hz
Max	50 MHz
Backwards Compatibility SCPI	[:SENSe] :OBWidth :BWIDth :VIDeo
Initial S/W Revision	Prior to A.02.00
Modified at S/W Revision	A.03.00

Filter Type

Allows you to select the type of filter to be used for the current measurement. Besides the Gaussian filter shape, there are certain special filter types, such as Flat Top, that are desirable under certain conditions.

Key Path	BW
Mode	SA, WCDMA, C2K, WIMAX OFDMA, TD-SCDMA, 1xEVDO, ISDB-T, CMMB, LTE, LTETDD, BLUETOOTH, WLAN, MSR, LTEAFDD, LTEATDD
Remote Command	[:SENSe] :OBWidth :BANDwidth :SHAPE GAUSSian FLATtop [:SENSe] :OBWidth :BANDwidth :SHAPE?
Example	OBW:BAND:SHAP GAUS

9 Occupied Bandwidth Measurement
BW

	OBW:BAND:SHAP?
Preset	GAUSSian
State Saved	Saved in instrument state.
Range	Gaussian Flattop
Backwards Compatibility SCPI	[:SENSe] :OBWidth:BWIDth:SHAPE
Initial S/W Revision	Prior to A.02.00
Modified at S/W Revision	A.03.00

Cont (Continuous Measurement/Sweep)

Sets the analyzer for Continuous measurement operation. The single/continuous state is Meas Global so the setting will affect all measurements. If you are Paused, pressing Cont does a Resume.

Key Path	Front-panel key
Remote Command	:INITiate:CONTinuous OFF ON 0 1 :INITiate:CONTinuous?
Example	:INIT:CONT 0 puts analyzer in Single measurement operation. :INIT:CONT 1 puts analyzer in Continuous measurement operation
Preset	ON (Note that SYST:PRESet sets INIT:CONT to ON but *RST sets INIT:CONT to OFF)
State Saved	Saved in instrument state
Backwards Compatibility Notes	For Spectrum Analysis mode in ESA and PSA, there is no Cont hardkey, instead there is a Sweep Single/Cont key. In these analyzers, switching the Sweep Single/Cont key from Single to Cont restarts averages (displayed average count reset to 1), but does not restart Max Hold and Min Hold. The X-Series has Single and Cont keys in place of the SweepSingleCont key. In the X-Series, if in single measurement, the Cont key (and INIT:CONT ON) switches to continuous measurement, but never restarts a measurement and never resets a sweep.
Initial S/W Revision	Prior to A.02.00

In Swept SA Measurement (Spectrum Analysis Mode):

The analyzer takes repetitive sweeps, averages, measurements, etc., when in Continuous mode. When the average count reaches the Average/Hold Number the count stops incrementing, but the analyzer keeps sweeping. See the Trace/Detector section for the averaging formula used both before and after the Average/Hold Number is reached. The trigger condition must be met prior to each sweep. The type of trace processing for multiple sweeps, is set under the Trace/Detector key, with choices of Trace Average, Max Hold, or Min Hold.

In Other Measurements/Modes:

With Avg/Hold Num (in the Meas Setup menu) set to Off or set to On with a value of 1, a sweep is taken after the trigger condition is met; and the analyzer continues to take new sweeps after the current sweep has completed and the trigger condition is again met. However, with Avg/Hold Num set to On with a value >1, multiple sweeps (data acquisitions) are taken for the measurement. The trigger condition must be met prior to each sweep. The sweep is not stopped when the average count k equals the number N set for Avg/Hold Num is reached, but the number k stops incrementing. A measurement average usually applies to all traces, marker results, and numeric results. But sometimes it only applies to the numeric results.

If the analyzer is in Single measurement, pressing the Cont key does not change k and does not cause the sweep to be reset; the only action is to put the analyzer into Continuous measurement operation.

If it is already in continuous sweep:

the INIT:CONT 1 command has no effect

9 Occupied Bandwidth Measurement
Cont (Continuous Measurement/Sweep)

the INIT:CONT 0 command will place the analyzer in Single Sweep but will have no effect on the current sequence until $k = N$, at which point the current sequence will stop and the instrument will go to the idle state.

File

See "File" on page 360

FREQ Channel

Accesses a menu of keys that allow you to control the Frequency and Channel parameters of the instrument.

Some features in the Frequency menu are the same for all measurements – they do not change as you change measurements. Settings like these are called “Meas Global” and are unaffected by Meas Preset. For example, the Center Freq setting is the same for all measurements - it does not change as you change measurements.

Key Path	Front-panel key
Initial S/W Revision	Prior to A.02.00

Center Freq

Sets the frequency that corresponds to the horizontal center of the graticule (when frequency Scale Type is set to linear). While adjusting the Center Frequency the Span is held constant, which means that both Start Frequency and Stop Frequency will change.

Pressing Center Freq also sets the frequency entry mode to Center/Span. In Center/Span mode, the center frequency and span values are displayed below the graticule, and the default active function in the Frequency menu is Center Freq.

The center frequency setting is the same for all measurements within a mode, that is, it is Meas Global. Some modes are also able to share a Mode Global center frequency value. If this is the case, the Mode will have a Global Settings key in its Mode Setup menu.

The Center Freq function sets (and queries) the Center Frequency for the currently selected input. If your analyzer has multiple inputs, and you select another input, the Center Freq changes to the value for that input. SCPI commands are available to directly set the Center Freq for a specific input.

Center Freq is remembered as you go from input to input. Thus you can set a Center Freq of 10 GHz with the RF Input selected, change to BBIQ and set a Center Freq of 20 MHz, then switch to External Mixing and set a Center Freq of 60 GHz, and when you go back to the RF Input the Center Freq will go back to 10 GHz; back to BBIQ and it is 20 MHz; back to External Mixing and it is 60 GHz.

See ["RF Center Freq" on page 697](#)

See [Ext Mix Center Freq](#)

See ["I/Q Center Freq" on page 699](#)

See ["Center Frequency Presets" on page 695](#)

Key Path	FREQ Channel
Scope	Meas Global
Remote Command	<code>[:SENSe] :FREQuency:CENTer <freq></code> <code>[:SENSe] :FREQuency:CENTer?</code>

Example	FREQ:CENT 50 MHz FREQ:CENT UP changes the center frequency to 150 MHz if you use FREQ:CENT:STEP 100 MHz to set the center frequency step size to 100 MHz FREQ:CENT?
Notes	This command sets either the RF or I/Q Center Frequency depending on the selected input. For RF input it is equivalent to FREQ:RF:CENT For I/Q input it is equivalent to FREQ:IQ:CENT Preset and Max values are dependent on Hardware Options (5xx) If no terminator (e.g. MHz) is sent the terminator Hz is used. If a terminator with unit other than Frequency is used, an invalid suffix error message is generated.
Dependencies	The Center Frequency can be limited by Start or Stop Freq limits, if the Span is so large that Start or Stop reach their limit.
Couplings	When operating in “swept span”, any value of the Center Frequency or Span that is within the frequency range of the analyzer is allowed when the value is being set through the front panel numeric key pad or the SCPI command. The other parameter is forced to a different value if needed, to keep the Start and the Stop Frequencies within the analyzer’s frequency range
Preset	Depends on instrument maximum frequency, mode, measurement, and selected input. See "Center Frequency Presets" on page 695 and "RF Center Freq" on page 697 and Ext Mix Center Freq and "I/Q Center Freq" on page 699 .
State Saved	Saved in instrument state
Min	Depends on instrument maximum frequency, mode, measurement, and selected input.. See "Center Frequency Presets" on page 695 and "RF Center Freq" on page 697 and "I/Q Center Freq" on page 699 .
Max	Depends on instrument maximum frequency, mode, measurement, and selected input.. See "Center Frequency Presets" on page 695 and "RF Center Freq" on page 697 and "I/Q Center Freq" on page 699 .
Default Unit	Hz
Status Bits/OPC	Non-overlapped
Dependencies	
Initial S/W Revision	Prior to A.02.00

Center Frequency Presets

The following table provides the Center Frequency Presets for the Spectrum Analyzer mode, and the Max Freq, for the various frequency options:

Freq Option	CF after Mode Preset	Stop Freq after Mode Preset	Max Freq (can't tune)

9 Occupied Bandwidth Measurement
FREQ Channel

			above)
503 (all but N9000A)	1.805 GHz	3.6 GHz	3.7 GHz
503 (N9000A)	1.505 GHz	3.0 GHz	3.08 GHz
507 (all but N9000A)	3.505 GHz	7.0 GHz	7.1 GHz
507 (N9000A)	3.755 GHz	7.5 GHz	7.58 GHz
508 (all but N9038A)	1.805 GHz	3.6 GHz	8.5 GHz
508 (N9038A)	4.205 GHz	8.4 GHz	8.5 GHz
513	6.805 GHz	13.6 GHz	13.8 GHz
526 (all but N9000A and N9038A)	13.255 GHz	26.5 GHz	27.0 GHz
526 (N9000A)	13.255 GHz	26.5 GHz	26.55 GHz
526 (N9038A)	1.805 GHz	3.6 GHz	27.0 GHz
532	16.005 GHz	32.0 GHz	32.5 GHz
543	21.505 GHz	43.0 GHz	TBD
544	22.005 GHz	44.0 GHz	44.5 GHz
550	25.005 GHz	50.0 GHz	51 GHz

Input 2:

Model	CF after Mode Preset	Stop Freq after Mode Preset	Max Freq (can't tune above)
N9000A opt C75	0.7505GHz	1.5 GHz	1.58 GHz
N9038A	505 MHz	1 GHz	1.000025 GHz

Tracking Generator Frequency Limits (N9000A only):

Tracking Generator Option	Min Freq (clips to this freq when turn TG on and	If above this Freq, Stop Freq clipped to this Freq when	Max Freq (can't tune above) while TG

	can't tune below while TG on)	TG turned on	on
T03	9 kHz	3.0 GHz	3.08 GHz
T06	9 kHz	6.0 GHz	6.05 GHz

The following table shows the Center Frequency Presets for modes other than Spectrum Analyzer:

Mode	CF Preset for RF
WCDMA	1 GHz
WIMAXOFDMA,	1 GHz
BASIC	1 GHz
ADEMOD	1 GHz
VSA	1 GHz
TDSCDMA	1 GHz
PNOISE	1 GHz
LTE	1 GHz
LTETDD	1 GHz
MSR	1 GHz
GSM	935.2 MHz
NFIGURE	1.505 GHz

RF Center Freq

SCPI command for specifying the RF Center Frequency. This command will set the Center Frequency to be used when the RF input is selected, even if the RF input is not the input that is selected at the time the command is sent. Note that the Center Freq function in the Frequency menu on the front panel always applies to the currently selected input.

Scope	Meas Global
Remote Command	<code>[:SENSe] :FREQuency:RF:CENTer <freq></code> <code>[:SENSe] :FREQuency:RF:CENTer?</code>
Example	FREQ:RF:CENT 30 MHz
Notes	This command is the same in all modes, but the parameter is Measurement Global. So the value is independent in each mode and common across all the measurements in the mode.
Dependencies	If the electronic/soft attenuator is enabled, any attempt to set Center Frequency such that the Stop Frequency would be >3.6 GHz fails and results in an advisory message. If the equivalent SCPI command is sent, this same message is generated as part of a “-221, Settings conflict” warning. If Source Mode is set to Tracking, and the Max or Min Center Freq is therefore limited by the limits of the source, a warning message is generated, “Data out of range;clipped to source max/min” if these limits are exceeded. Note that for an external source, these limits can be affected by the settings of

	Source Numerator, Source Denominator and Power Sweep.
Preset	See table above
State Saved	Saved in instrument state.
Min	-79.999995 MHz, unless Source Mode is set to Tracking, in which case it is limited by the minimum frequency of the Source
Max	See table above. Basically instrument maximum frequency – 5 Hz. Note that, if the Source Mode is set to Tracking, the effective instrument maximum frequency may be limited by the source maximum frequency. If the knob or step keys are being used, also depends on the value of the other three interdependent parameters Span, Start Frequency and Stop Frequency
Initial S/W Revision	Prior to A.02.00
Modified at S/W Revision	A.03.00

Ext Mix Center Freq

SCPI command for specifying the External Mixer Center Frequency. This command will set the Center Frequency to be used when the External Mixer is selected, even if the External Mixer input is not the input which is selected at the time the command is sent. Note that the Center Freq function in the Frequency menu on the front panel always applies to the currently selected input.

Scope	Meas Global
Remote Command	<code>[:SENSe] :FREQuency:EMIXer:CENTer <freq></code> <code>[:SENSe] :FREQuency:EMIXer:CENTer?</code>
Example	<code>:FREQ:EMIX:CENt 60 GHz</code> <code>:FREQ:EMIX:CENt?</code>
Notes	This command is the same in all modes, but the parameter is Measurement Global. So the value is independent in each mode and common across all the measurements in the mode.
Couplings	When returning to External Mixing after having been switched to one of the other inputs (e.g., RF), you will come back into the settings that you had when you left External Mixing. So you will come back to the band you were in with the Center Frequency that you had. However, Span is not an input-dependent parameter, therefore you will bring the span over from the other input. Therefore, the analyzer comes back with the span from the previous input, limited as necessary by the current mixer setup.
Preset	When a Mode Preset is performed while in External Mixing, the Start frequency of the current Mode is set to the nominal Min Freq of the lowest harmonic range in the Harmonic Table for the current mixer setup. Similarly, the Stop frequency of the current Mode is set to the nominal Max Freq of the highest harmonic range in the Harmonic Table. The Center Freq thus presets to the point arithmetically equidistant from these two frequencies. If the current measurement has a limited Span available to it, and cannot achieve the Span shown in the table (Span=Stop Freq – Start Freq), the analyzer uses the maximum Span the measurement allows, and still sets the Center Freq to the midpoint of the Start and Stop Freq values in the Harmonic Table.

	When Restore Input/Output Defaults is performed, the mixer presets to the 11970A, whose Start and Stop frequencies are 26.5 and 40 GHz respectively. The center of these two frequencies is 33.25 GHz. Therefore, after a Restore Input/Output Defaults, if you go into External Mixing and do a Mode Preset while in the Spectrum Analyzer Mode, the resulting Center Freq is 33.25 GHz.
State Saved	Saved in instrument state.
Min	The minimum frequency in the currently selected mixer band + 5 Hz
Max	The maximum frequency in the currently selected mixer band – 5 Hz If the knob or step keys are being used, also depends on the value of the other three interdependent parameters Span, Start Frequency and Stop Frequency
Initial S/W Revision	A.08.01

I/Q Center Freq

SCPI command for specifying the I/Q Center Frequency. This command will set the Center Frequency to be used when the I/Q input is selected, even if the I/Q input is not the input which is selected at the time the command is sent. Note that the Center Freq function in the Frequency menu on the front panel always applies to the currently selected input.

Scope	Meas Global
Remote Command	<code>[:SENSe] :FREQuency:IQ:CENTer <freq></code> <code>[:SENSe] :FREQuency:IQ:CENTer?</code>
Example	FREQ:IQ:CENT: 30 MHz
Notes	This command is the same in all modes, but the parameter is Measurement Global. So the value is independent in each mode and common across all the measurements in the mode.
Preset	0 Hz
State Saved	Saved in instrument state.
Min	-40.049995 MHz
Max	40.049995 MHz
Initial S/W Revision	Prior to A.02.00

CF Step

Changes the step size for the center frequency and start and stop frequency functions. Once a step size has been selected and the center frequency function is active, the step keys (and the UP|DOWN parameters for Center Frequency from remote commands) change the center frequency by the step-size value. The step size function is useful for finding harmonics and sidebands beyond the current frequency span of the analyzer.

Note that the start and stop frequencies also step by the CF Step value.

Key Path	FREQ Channel
Remote Command	<pre>[:SENSe] :FREQuency:CENTer:STEP[:INCRement] <freq> [:SENSe] :FREQuency:CENTer:STEP[:INCRement] ? [:SENSe] :FREQuency:CENTer:STEP:AUTO OFF ON 0 1 [:SENSe] :FREQuency:CENTer:STEP:AUTO?</pre>
Example	<pre>FREQ:CENT:STEP:AUTO ON FREQ:CENT:STEP 500 MHz FREQ:CENT UP increases the current center frequency value by 500 MHz FREQ:CENT:STEP? FREQ:CENT:STEP:AUTO?</pre>
Notes	Preset and Max values are depending on Hardware Options (503, 507, 508, 513, 526)
Notes	Preset and Max values are dependent on Hardware Options (5xx)
Dependencies	Freq Offset is not available in External Mixing. In this case the Freq Offset key is grayed out and shows a value of zero. It will once again be available, and show the previously set value, when you return to the RF Input.
Dependencies	Span, RBW, Center frequency If the electronic/soft attenuator is enabled, any attempt to change the value of the center frequency >3.6 GHz by pressing the Up-arrow key, fails and results in an advisory message. If the equivalent SCPI command is sent, this same message is generated as part of a “-221, Settings conflict” warning.
Couplings	When auto-coupled in a non-zero span, the center frequency step size is set to 10% of the span. When auto-coupled in zero span, the center frequency step size is set to the equivalent -3 dB RBW value.
Preset	Auto ADEM0D: 1 MHz ON
State Saved	Saved in instrument state
Min	– (the maximum frequency of the instrument). That is, 27 GHz max freq instrument has a CF step range of +/- 27 GHz. Note that this is the maximum frequency given the current settings of the instrument, so in External Mixing, for example, it is the maximum frequency of the current mixer band.
Max	The maximum frequency of the instrument. That is, 27 GHz max freq instrument has a CF step range of +/- 27 GHz. Note that this is the maximum frequency given the current settings of the instrument, so in External Mixing, for example, it is the maximum frequency of the current mixer band.
Default Unit	Hz
Status Bits/OPC dependencies	non-overlapped
Initial S/W Revision	Prior to A.02.00
Modified at S/W Revision	A.03.00

Input/Output

See ["Input/Output" on page 224](#)

Marker

Accesses a menu that enables you to select, set up and control the markers for the current measurement.

Key Path	Front-panel key
Initial S/W Revision	Prior to A.02.00

Select Marker

Displays the menu keys that enable you to select, set up and control the markers for the current measurement

Key Path	Marker
Initial S/W Revision	Prior to A.02.00

Select Marker

Displays 12 markers available for selection.

Key Path	Marker, Properties
Initial S/W Revision	Prior to A.02.00

Marker Type

Sets the marker control mode to Normal, Delta or Off, If the selected marker is Off, pressing Marker sets it to Normal and places a single marker at the center of the display. At the same time, Marker X Axis Value appears on the Active Function area.

Key Path	Marker
Mode	SA, WCDMA, C2K, WIMAX OFDMA, TD-SCDMA, 1xEVDO, ISDB-T, CMMB, LTE, LTETDD, BLUETOOTH, WLAN, MSR, LTEAFDD, LTEATDD
Remote Command	:CALCulate:OBWidth:MARKer[1] 2 ... 12:MODE POSition DELTa OFF :CALCulate:OBWidth:MARKer[1] 2 ... 12:MODE?
Example	CALC:OBW:MARK:MODE POS CALC:OBW:MARK:MODE?
Notes	If the selected marker is Off, pressing Marker sets it to Normal and places it at the center of the screen on the trace determined by the Marker Trace rules. At the same time, Marker X Axis Value appears on the Active Function area. Default Active Function: the active function for the selected marker's current control mode. If the current control mode is Off, there is no active function and the active function is turned off. Active Function Display: the marker X axis value entered in the active function area displays the marker value to its full entered precision.

Preset	OFF
State Saved	Saved in instrument state.
Range	Normal Delta Off
Initial S/W Revision	Prior to A.02.00
Modified at S/W Revision	A.03.00

Properties

Accesses the marker properties menu.

Key Path	Marker
Initial S/W Revision	Prior to A.02.00

Select Marker

Displays the menu keys that enable you to select, set up and control the markers for the current measurement

Key Path	Marker
Initial S/W Revision	Prior to A.02.00

Select Marker

Displays 12 markers available for selection.

Key Path	Marker, Properties
Initial S/W Revision	Prior to A.02.00

Relative To

Selects the desired marker. The selected marker will be relative to its reference marker.

Key Path	Marker, Properties
Mode	SA, WCDMA, C2K, WIMAX OFDMA, TD-SCDMA, 1xEVDO, ISDB-T, CMMB, LTE, LTETDD, BLUETOOTH, WLAN, MSR, LTEAFDD, LTEATDD
Remote Command	:CALCulate:OBWidth:MARKer[1] 2 ... 12:REFerence <integer> :CALCulate:OBWidth:MARKer[1] 2 ... 12:REFerence?
Example	CALC:OBW:MARK:REF 2

	CALC:OBW:MARK:REF?
Notes	A marker cannot be relative to itself so that choice is grayed out, and if sent from SCPI generates error -221: "Settings conflict; marker cannot be relative to itself." When queried a single value is returned (the specified marker numbers relative marker). You must be in the Spectrum Analysis mode, WCDMA mode, TD-SCDMA mode, 1xEVDO mode, WIMAX OFDMA mode ISDB-T mode, WLAN mode, CMMB mode, LTE mode, LTETDD mode or BLUETOOTH mode to use this command. Use:INSTrument:SElect to set the mode.
Preset	2 3 4 5 6 7 8 9 10 11 12 1
State Saved	Saved in instrument state.
Min	1
Max	12
Readback	Current selected relative to marker number.
Initial S/W Revision	Prior to A.02.00
Modified at S/W Revision	A.03.00

All Markers Off

Turns off all markers.

Key Path	Marker
Mode	SA, WCDMA, C2K, WIMAX OFDMA, TD-SCDMA, 1xEVDO, ISDB-T, CMMB, LTE, LTETDD, BLUETOOTH, WLAN, MSR, LTEAFDD, LTEATDD
Remote Command	:CALCulate:OBWidth:MARKer:AOff
Example	CALC:OBW:MARK:AOff
Initial S/W Revision	Prior to A.02.00
Modified at S/W Revision	A.03.00

Marker X Axis Value (Remote Command Only)

Sets the marker X Axis value in the current marker X Axis Scale unit. It has no effect if the control mode is Off.

Key Path	SCPI only
Mode	SA, WCDMA, C2K, WIMAX OFDMA, TD-SCDMA, 1xEVDO, ISDB-T, CMMB, LTE, LTETDD, BLUETOOTH, WLAN, MSR, LTEAFDD, LTEATDD
Remote Command	:CALCulate:OBWidth:MARKer[1] 2 ... 12:X <freq> :CALCulate:OBWidth:MARKer[1] 2 ... 12:X?
Example	CALC:OBW:MARK3:X 0 CALC:OBW:MARK3:X?
Notes	The query returns the marker's absolute X Axis value if the control mode is Normal, or the offset from

	the marker's reference marker if the control mode is Delta. The query is returned in the fundamental units for the current marker X Axis scale: Hz for Frequency.
Preset	After a preset, all markers are turned OFF, so Marker X Axis Value query returns a not a number (NAN).
State Saved	No
Min	-9.9E+37
Max	9.9E+37
Initial S/W Revision	Prior to A.02.00
Modified at S/W Revision	A.03.00

Marker X Axis Position (Remote Command Only)

Sets the marker X position in trace points. It has no effect if the control mode is Off.

Key Path	SCPI only
Mode	SA, WCDMA, C2K, WIMAX OFDMA, TD-SCDMA, 1xEVDO, ISDB-T, CMMB, LTE, LTETDD, BLUETOOTH, WLAN, MSR, LTEAFDD, LTEATDD
Remote Command	:CALCulate:OBWidth:MARKer[1] 2 ... 12:X:POSition <real> :CALCulate:OBWidth:MARKer[1] 2 ... 12:X:POSition?
Example	CALC:OBW:MARK10:X:POS 0 CALC:OBW:MARK10:X:POS?
Notes	The query returns the marker's absolute X Axis value in trace points if the control mode is Normal, or the offset from the marker's reference marker in trace points if the control mode is Delta.
Preset	After a preset, all markers are turned OFF, so Marker X Axis Value query returns a not a number (NAN).
State Saved	No
Min	-9.9E+37
Max	9.9E+37
Initial S/W Revision	Prior to A.02.00
Modified at S/W Revision	A.03.00

Marker Y Axis Value (Remote Command Only)

Returns the marker Y Axis value in the current marker Y Axis unit.

Key Path	SCPI only
Mode	SA, WCDMA, C2K, WIMAX OFDMA, TD-SCDMA, 1xEVDO, ISDB-T, CMMB, LTE, LTETDD, BLUETOOTH, WLAN, MSR, LTEAFDD, LTEATDD
Remote Command	:CALCulate:OBWidth:MARKer[1] 2 ... 12:Y?

Example	CALC:OBW:MARK11:Y?
Preset	Result dependent on Markers setup and signal source.
State Saved	No
Min	-9.9E+37
Max	9.9E+37
Initial S/W Revision	Prior to A.02.00
Modified at S/W Revision	A.03.00

Backward Compatibility SCPI Commands

Sets or queries the state of a marker. Setting a marker which is OFF to state ON or 1 puts it in Normal mode and places it at the center of the screen.

Key Path	SCPI only
Mode	SA, WCDMA, C2K, WIMAX OFDMA, TD-SCDMA, 1xEVDO, ISDB-T, CMMB, LTE, LTETDD, BLUETOOTH, WLAN, MSR, LTEAFDD, LTEATDD
Remote Command	:CALCulate:OBWidth:MARKer[1] 2 ... 12:STATe OFF ON 0 1 :CALCulate:OBWidth:MARKer[1] 2 ... 12:STATe?
Example	CALC:OBW:MARK3:STAT ON CALC:OBW:MARK3:STAT?
Preset	OFF
State Saved	Saved in instrument state.
Initial S/W Revision	Prior to A.02.00
Modified at S/W Revision	A.03.00

Marker Function

There are no 'Marker Functions' supported in this measurement. When pressed, this key displays a blank menu.

Key Path	Front panel key
Initial S/W Revision	Prior to A.02.00

Marker To

There is no 'Marker To' functionality supported in this measurement. When pressed, this key displays a blank menu.

Key Path	Front panel key
Initial S/W Revision	Prior to A.02.00

Meas

The information in this section is common to all measurements. For key and remote command information for a specific measurement, refer to the section that describes the measurement of interest.

Measurements available under the Meas key are specific to the current Mode.

When viewing Help for measurements, note the following:

NOTE

Operation for some keys differs between measurements. The information displayed in Help pertains to the current measurement. To see how a key operates in a different measurement, exit Help (press the Cancel Esc key), select the measurement, then reenter Help (press the Help key) and press that key.

Key Path	Front-panel key
Initial S/W Revision	Prior to A.02.00

Remote Measurement Functions

This section contains the following topics:

["Measurement Group of Commands" on page 2771](#)

["Current Measurement Query \(Remote Command Only\)" on page 2773](#)

["Limit Test Current Results \(Remote Command Only\)" on page 2773](#)

["Data Query \(Remote Command Only\)" on page 2773](#)

["Calculate/Compress Trace Data Query \(Remote Command Only\)" on page 2774](#)

["Calculate Peaks of Trace Data \(Remote Command Only\)" on page 2779](#)

[Hardware-Accelerated Fast Power Measurement \(Remote Command Only\)](#)

["Format Data: Numeric Data \(Remote Command Only\)" on page 2780](#)

["Format Data: Byte Order \(Remote Command Only\)" on page 2781](#)

Initial S/W Revision	Prior to A.02.00
----------------------	------------------

Measurement Group of Commands

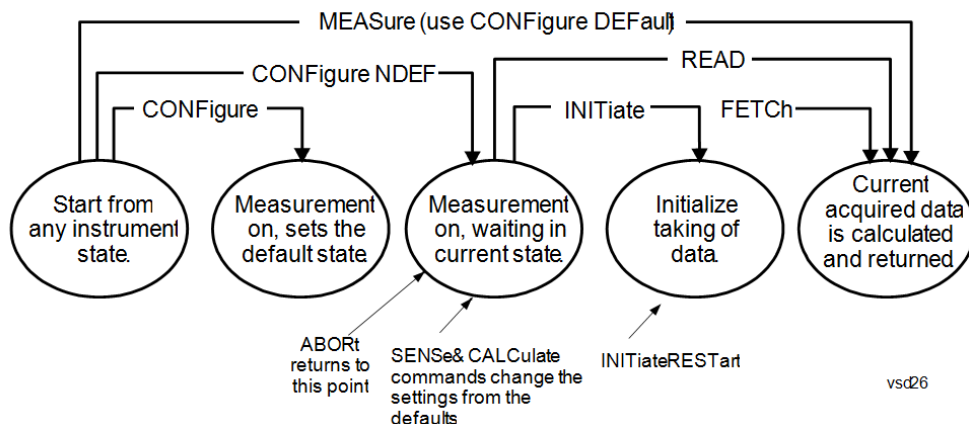

Measure Commands:

:MEASure:<measurement>[n]?

This is a fast single-command way to make a measurement using the factory default instrument settings. These are the settings and units that conform to the Mode Setup settings (e.g. radio standard) that you have currently selected.

- Stops the current measurement (if any) and sets up the instrument for the specified measurement using the factory defaults
- Initiates the data acquisition for the measurement
- Blocks other SCPI communication, waiting until the measurement is complete before returning results.
- If the function does averaging, it is turned on and the number of averages is set to 10.
- After the data is valid it returns the scalar results, or the trace data, for the specified measurement. The type of data returned may be defined by an [n] value that is sent with the command.
- The scalar measurement results will be returned if the optional [n] value is not included, or is set to 1. If the [n] value is set to a value other than 1, the selected trace data results will be returned. See each command for details of what types of scalar results or trace data results are available.
- ASCII is the default format for the data output. (Older versions of Spectrum Analysis and Phase Noise mode measurements only use ASCII.) The binary data formats should be used for handling large blocks of data since they are smaller and faster than the ASCII format. Refer to the FORMat:DATA command for more information.

If you need to change some of the measurement parameters from the factory default settings you can set up the measurement with the CONFigure command. Use the commands in the SENSe:<measurement> and CALCulate:<measurement> subsystems to change the settings. Then you can use the READ? command to initiate the measurement and query the results.

If you need to repeatedly make a given measurement with settings other than the factory defaults, you can use the commands in the SENSe:<measurement> and CALCulate:<measurement> subsystems to set up the measurement. Then use the READ? command to initiate the measurement and query results.

Measurement settings persist if you initiate a different measurement and then return to a previous one. Use READ:<measurement>? if you want to use those persistent settings. If you want to go back to the default settings, use MEASure:<measurement>?.

Configure Commands:

:CONFigure:<measurement>

This command stops the current measurement (if any) and sets up the instrument for the specified measurement using

the factory default instrument settings. It does not initiate the taking of measurement data unless INIT:CONTInuous is ON. If you change any measurement settings after using the CONFIgure command, the READ command can be used to initiate a measurement without changing the settings back to their defaults.

In the Swept SA measurement in Spectrum Analyzer mode the CONFIgure command also turns the averaging function on and sets the number of averages to 10 for all measurements.

:CONFIgure: <measurement>: NDEFault stops the current measurement and changes to the specified measurement. It does not change the settings to the defaults. It does not initiate the taking of measurement data unless INIT:CONTInuous is ON.

The CONFIgure? query returns the current measurement name.

The CONFIgure:CATalog? query returns a quoted string of all licensed measurement names in the current mode. For example, "SAN, CHP, OBW, ACP, PST, TXP, SPUR, SEM, LIST".

Fetch Commands:

:FETCh:<measurement>[n]?

This command puts selected data from the most recent measurement into the output buffer. Use FETCh if you have already made a good measurement and you want to return several types of data (different [n] values, for example, both scalars and trace data) from a single measurement. FETCh saves you the time of re-making the measurement. You can only FETCh results from the measurement that is currently active, it will not change to a different measurement. An error message is reported if a measurement other than the current one is specified.

If you need to get new measurement data, use the READ command, which is equivalent to an INITiate followed by a FETCh.

The scalar measurement results will be returned if the optional [n] value is not included, or is set to 1. If the [n] value is set to a value other than 1, the selected trace data results will be returned. See each command for details of what types of scalar results or trace data results are available. The binary data formats should be used for handling large blocks of data since they are smaller and transfer faster than the ASCII format. (FORMat:DATA)

FETCh may be used to return results other than those specified with the original READ or MEASure command that you sent.

INITiate Commands:

:INITiate:<measurement>

This command is not available for measurements in all the instrument modes:

- Initiates a trigger cycle for the specified measurement, but does not output any data. You must then use the FETCh<meas> command to return data. If a measurement other than the current one is specified, the instrument will switch to that measurement and then initiate it.
- For example, suppose you have previously initiated the ACP measurement, but now you are running the channel power measurement. If you send INIT:ACP? it will change from channel power to ACP and will initiate an ACP measurement.
- Does not change any of the measurement settings. For example, if you have previously started the ACP measurement and you send INIT:ACP? it will initiate a new ACP measurement using the same instrument settings as the last time ACP was run.
- If your selected measurement is currently active (in the idle state) it triggers the measurement, assuming the trigger conditions are met. Then it completes one trigger cycle. Depending upon the measurement and the number of averages, there may be multiple data acquisitions, with multiple trigger events, for one full trigger cycle. It also holds off additional commands on GPIB until the acquisition is complete.

READ Commands:

:READ:<measurement>[n]?

- Does not preset the measurement to the factory default settings. For example, if you have previously initiated the ACP
-

measurement and you send READ:ACP? it will initiate a new measurement using the same instrument settings.

- Initiates the measurement and puts valid data into the output buffer. If a measurement other than the current one is specified, the instrument will switch to that measurement before it initiates the measurement and returns results.
 - For example, suppose you have previously initiated the ACP measurement, but now you are running the channel power measurement. Then you send READ:ACP? It will change from channel power back to ACP and, using the previous ACP settings, will initiate the measurement and return results.
 - Blocks other SCPI communication, waiting until the measurement is complete before returning the results
 - If the optional [n] value is not included, or is set to 1, the scalar measurement results will be returned. If the [n] value is set to a value other than 1, the selected trace data results will be returned. See each command for details of what types of scalar results or trace data results are available. The binary data formats should be used when handling large blocks of data since they are smaller and faster than the ASCII format. (FORMat:DATA)
-

Initial S/W Revision	Prior to A.02.00
----------------------	------------------

Current Measurement Query (Remote Command Only)

This command returns the name of the measurement that is currently running.

Remote Command	:CONFigure?
-----------------------	-------------

Example	CONF?
----------------	-------

Initial S/W Revision	Prior to A.02.00
----------------------	------------------

Limit Test Current Results (Remote Command Only)

Queries the status of the current measurement limit testing. It returns a 0 if the measured results pass when compared with the current limits. It returns a 1 if the measured results fail any limit tests.

Remote Command	:CALCulate:CLIMits:FAIL?
-----------------------	--------------------------

Example	CALC:CLIM:FAIL? queries the current measurement to see if it fails the defined limits. Returns a 0 or 1: 0 it passes, 1 it fails.
----------------	--

Initial S/W Revision	Prior to A.02.00
----------------------	------------------

Data Query (Remote Command Only)

Returns the designated measurement data for the currently selected measurement and subopcode.

n = any valid subopcode for the current measurement. See the measurement command results table for your current measurement, for information about what data is returned for the subopcodes.

This command uses the data setting specified by the FORMat:BORDER and FORMat:DATA commands and can return real or ASCII data. (See the format command descriptions under Input/Output in the Analyzer Setup section.)

Remote Command	:CALCulate:DATA[n]?
Notes	The return trace depends on the measurement. In CALCulate:<meas>:DATA[n], n is any valid subopcode for the current measurement. It returns the same data as the FETCH:<measurement>? query where <measurement> is the current measurement.
Initial S/W Revision	Prior to A.02.00

Calculate/Compress Trace Data Query (Remote Command Only)

Returns compressed data for the currently selected measurement and sub-opcode [n].

n = any valid sub-opcode for that measurement. See the MEASure:<measurement>? command description of your specific measurement for information on the data that can be returned.

The data is returned in the current Y Axis Unit of the analyzer. The command is used with a sub-opcode <n> (default=1) to specify the trace. With trace queries, it is best if the analyzer is not sweeping during the query. Therefore, it is generally advisable to be in Single Sweep, or Update=Off.

This command is used to compress or decimate a long trace to extract and return only the desired data. A typical example would be to acquire N frames of GSM data and return the mean power of the first burst in each frame. The command can also be used to identify the best curve fit for the data.

Remote Command	:CALCulate:DATA<n>:COMPRESS? BLOCK CFIT MAXimum MINimum MEAN DMEan RMS RMSCubed SAMPLE SDEVIation PPHase [,<soffset> [,<length>[,<roffset>[,<rlimit>]]]]
Example	To query the mean power of a set of GSM bursts: Supply a signal that is a set of GSM bursts. Select the IQ Waveform measurement (in IQ Analyzer Mode). Set the sweep time to acquire at least one burst. Set the triggers such that acquisition happens at a known position relative to a burst. Then query the mean burst levels using, CALC:DATA2:COMP? MEAN, 24e-6, 526e-6 (These parameter values correspond to GSM signals, where 526e-6 is the length of the burst in the slot and you just want 1 burst.)
Notes	The command supports 5 parameters. Note that the last 4 (<soffset>, <length>, <roffset>, <rlimit>) are optional. But these optional parameters must be entered in the specified order. For example, if you want to specify <length>, then you must also specify <soffset>. See details below for a definition of each of these parameters. This command uses the data in the format specified by FORMat:DATA, returning either binary or ASCII data.
Initial S/W Revision	Prior to A.02.00

- BLOCK or block data - returns all the data points from the region of the trace data that you specify. For example, it could be used to return the data points of an input signal over several timeslots, excluding the portions of the trace data that you do not want. (This is x,y pairs for trace data and I,Q pairs for complex data.)

- CFIT or curve fit - applies curve fitting routines to the data. <soffset> and <length> are required to define the data that you want. <roffset> is an optional parameter for the desired order of the curve equation. The query will return the following values: the x-offset (in seconds) and the curve coefficients ((order + 1) values).

MIN, MAX, MEAN, DME, RMS, RMSC, SAMP, SDEV and PPH return one data value for each specified region (or <length>) of trace data, for as many regions as possible until you run out of trace data (using <roffset> to specify regions). Or they return the number of regions you specify (using <rlimit>) ignoring any data beyond that.

- MINimum - returns the minimum data point (y value) for the specified region(s) of trace data. For I/Q trace data, the minimum magnitude of the I/Q pairs is returned.
- MAXimum - returns the maximum data point (y value) for the specified region(s) of trace data. For I/Q trace data, the maximum magnitude of the I/Q pairs is returned.
- MEAN - returns a single value that is the arithmetic mean of the data point values (in dB/ dBm) for the specified region(s) of trace data. For I/Q trace data, the mean of the magnitudes of the I/Q pairs is returned. See the following equations.

NOTE If the original trace data is in dB, this function returns the arithmetic mean of those log values, not log of the mean power which is a more useful value. The mean of the log is the better measurement technique when measuring CW signals in the presence of noise. The mean of the power, expressed in dB, is useful in power measurements such as Channel Power. To achieve the mean of the power, use the RMS option.

Equation 1

Mean Value of Data Points for Specified Region(s)

$$\text{MEAN} = \frac{1}{n} \sum_{X_i \in \text{region}(s)} X_i$$

where X_i is a data point value, and n is the number of data points in the specified region(s).

Equation 2

Mean Value of I/Q Data Pairs for Specified Region(s)

$$\text{MEAN} = \frac{1}{n} \sum_{X_i \in \text{region}(s)} |X_i|$$

where $|X_i|$ is the magnitude of an I/Q pair, and n is the number of I/Q pairs in the specified region(s).

- DMEan - returns a single value that is the mean power (in dB/ dBm) of the data point values for the specified region(s) of trace data. See the following equation:

Equation 3

DMEan Value of Data Points for Specified Region(s)

$$\text{DME} = 10 \times \log_{10} \left(\frac{1}{n} \sum_{X_i \in \text{region}(s)} 10^{\frac{X_i}{10}} \right)$$

- RMS - returns a single value that is the average power on a root-mean-squared voltage scale (arithmetic rms) of the data point values for the specified region(s) of trace data. See the following equation.

NOTE For I/Q trace data, the rms of the magnitudes of the I/Q pairs is returned. See the following equation. This function is very useful for I/Q trace data. However, if the original trace data is in dB, this function returns the rms of the log values which is not usually needed.

Equation 4

RMS Value of Data Points for Specified Region(s)

$$\text{RMS} = \sqrt{\frac{1}{n} \sum_{X_i \in \text{region}(s)} X_i^2}$$

where X_i is a data point value, and n is the number of data points in the specified region(s).

Equation 5

RMS Value of I/Q Data Pairs for Specified Region(s)

$$\text{RMS} = \sqrt{\frac{1}{n} \sum_{X_i \in \text{region}(s)} X_i X_i^*}$$

where X_i is the complex value representation of an I/Q pair, X_i^* its conjugate complex number, and n is the number of I/Q pairs in the specified region(s).

Once you have the rms value for a region of trace data (linear or I/Q), you may want to calculate the mean power. You must convert this rms value (peak volts) to power in dBm:

$$10 \times \log[10 \times (\text{rms value})^2]$$

- SAMPLe - returns the first data value (x,y pair) for the specified region(s) of trace data. For I/Q trace data, the first I/Q pair is returned.
- SDEViation - returns a single value that is the arithmetic standard deviation for the data point values for the specified region(s) of trace data. See the following equation.
- For I/Q trace data, the standard deviation of the magnitudes of the I/Q pairs is returned. See the following equation.

Equation 6

Standard Deviation of Data Point Values for Specified Region(s)

$$\text{SDEV} = \sqrt{\frac{1}{n} \sum_{X_i \in \text{region}(s)} (X_i - \bar{X})^2}$$

where X_i is a data point value, \bar{X} is the arithmetic mean of the data point values for the specified region (s), and n is the number of data points in the specified region(s).

$$\text{SDEV} = \sqrt{\frac{1}{n} \sum_{X_i \in \text{region}(s)} (|X_i| - \bar{X})^2}$$

where $|X_i|$ is the magnitude of an I/Q pair, \bar{X} is the mean of the magnitudes for the specified region(s), and n is the number of data points in the specified region(s).

- PPHase - returns the x,y pairs of both rms power (dBm) and arithmetic mean phase (radian) for every specified region and frequency offset (Hz). The number of pairs is defined by the specified number of regions. This parameter can be used for I/Q vector ($n=0$) in Waveform (time domain) measurement and all parameters are specified by data point in PPHase.

The rms power of the specified region may be expressed as:

$$\text{Power} = 10 \times \log [10 \times (\text{RMS I/Q value})] + 10.$$

The RMS I/Q value (peak volts) is:

$$\sqrt{\frac{1}{n} \sum_{X_i \in \text{region}} X_i X_i^*}$$

where X_i is the complex value representation of an I/Q pair, X_i^* its conjugate complex number, and n is the number of I/Q pairs in the specified region.

The arithmetic mean phase of the specified region may be expressed as:

$$\frac{1}{n} \sum_{Y_i \in \text{region}} Y_i$$

where Y_i is the unwrapped phase of I/Q pair with applying frequency correction and n is the number of I/Q pairs in the specified region.

The frequency correction is made by the frequency offset calculated by the arithmetic mean of every specified region's frequency offset. Each frequency offset is calculated by the least square method against the unwrapped phase of I/Q pair.

Sample Trace Data - Constant Envelope

(See below for explanation of variables.)

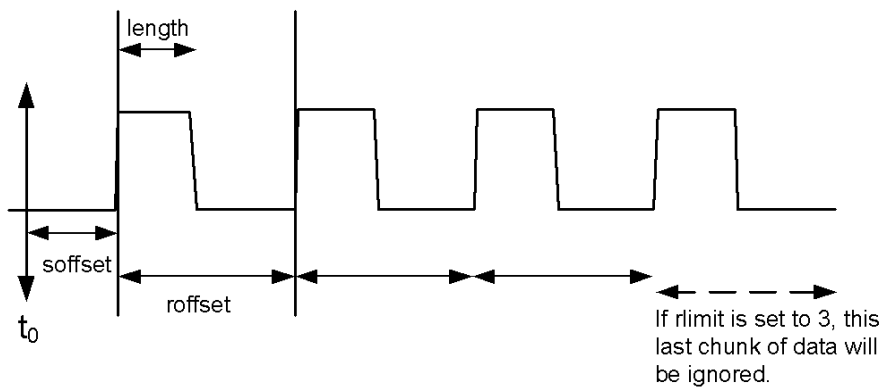

Sample Trace Data - Not Constant Envelope

(See below for explanation of variables.)

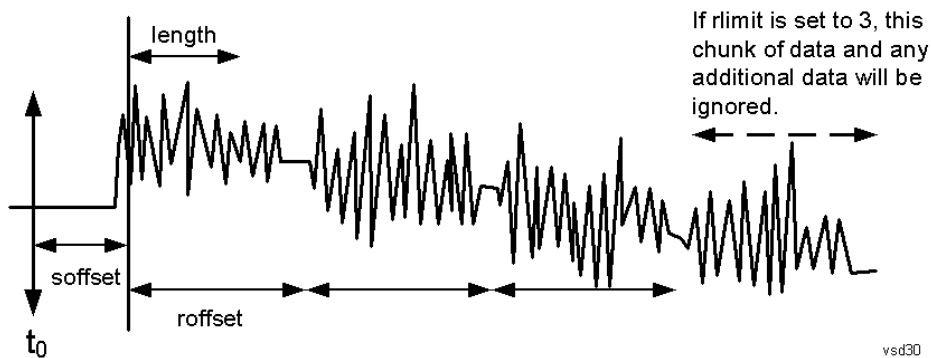

<soffset> - start offset is an optional real number. (It is in seconds for time-domain traces, and is a dimensionless index 0 to Npoints - 1, for frequency-domain traces). It specifies the amount of data at the beginning of the trace that will be ignored before the decimation process starts. It is the time or frequency change from the start of the trace to the point where you want to start using the data. The default value is zero.

<length> - is an optional real number. (It is in seconds for time-domain traces, and is a dimensionless index 0 to Npoints - 1, for frequency-domain traces). It defines how much data will be compressed into one value. This parameter has a default value equal to the current trace length.

<roffset> - repeat offset is an optional real number. (It is in seconds for time-domain traces, and is a dimensionless index 0 to Npoints - 1, for frequency-domain traces). It defines the beginning of the next field of trace elements to be compressed. This is relative to the beginning of the previous field. This parameter has a default value equal to the <length> variable. Note that this parameter is used for a completely different purpose when curve fitting (see CFIT above).

<rlimit> - repeat limit is an optional integer. It specifies the number of data items that you want returned. It will ignore any additional items beyond that number. You can use the Start offset and the Repeat limit to pick out exactly what part of the data you want to use. The default value is all the data.

Calculate Peaks of Trace Data (Remote Command Only)

Returns a list of all the peaks for the currently selected measurement and sub-opcode [n]. The peaks must meet the requirements of the peak threshold and excursion values.

n = any valid sub-opcode for the current measurement. See the MEASure:<measurement> command description of your specific measurement for information on the data that can be returned.

The command can only be used with specific sub-opcodes with measurement results that are trace data. Both real and complex traces can be searched, but complex traces are converted to magnitude in dBm. In many measurements the sub-opcode n=0, is the raw trace data which cannot be searched for peaks. And Sub-opcode n=1, is often calculated results values which also cannot be searched for peaks.

This command uses the data setting specified by the FORMat:BORDER and FORMat:DATA commands and can return real or ASCII data. If the format is set to INT,32, it returns REAL,32 data.

The command has four types of parameters:

- Threshold (in dBm)
- Excursion (in dB)
- Sorting order (amplitude, frequency, time)
- Optional in some measurements: Display line use (all, > display line, < display line)

Remote Command	<p>For Swept SA measurement:</p> <pre>:CALCulate:DATA[1] 2 ... 6:PEAKs? <threshold>,<excursion>[,AMPLitude FREQuency TIME[,ALL GTDLLine LTDLine]]</pre> <p>For most other measurements:</p> <pre>:CALCulate:DATA[1] 2 ... 6:PEAKs? <threshold>,<excursion>[,AMPLitude FREQuency TIME]</pre>
-----------------------	---

Example	<p>Example for Swept SA measurement in Spectrum Analyzer Mode:</p> <p>CALC:DATA4:PEAK? -40, 10, FREQ, GTDL This will identify the peaks of trace 4 that are above -40 dBm, with excursions of at least 10 dB. The peaks are returned in order of increasing frequency, starting with the lowest frequency. Only the peaks that are above the display line are returned.</p> <p>Query Results 1:</p> <p>With FORMat:DATA REAL, 32 selected, it returns a list of floating-point numbers. The first value in the list is the number of peak points that are in the following list. A peak point consists of two values: a peak amplitude followed by its corresponding frequency (or time).</p> <p>If no peaks are found the peak list will consist of only the number of peaks, (0).</p>
----------------	---

Notes	<p><n> - is the trace that will be used</p> <p><threshold> - is the level below which trace data peaks are ignored. Note that the threshold value is required and is always used as a peak criterion. To effectively disable the threshold criterion for this command, provide a substantially low threshold value such as -200 dBm. Also note that the threshold value used in this command is independent of and has no effect on the threshold value stored under the Peak Criteria menu.</p> <p><excursion> - is the minimum amplitude variation (rise and fall) required for a signal to be identified as peak. Note that the excursion value is required and is always used as a peak criterion. To effectively disable the excursion criterion for this command, provide the minimum value of 0.0 dB. Also note that the excursion value used in this command is independent of and has no effect on the</p>
--------------	---

excursion value stored under the Peak Criteria menu.

Values must be provided for threshold and excursion. The sorting and display line parameters are optional (defaults are AMPLitude and ALL).

Note that there is always a Y-axis value for the display line, regardless of whether the display line state is on or off. It is the current Y-axis value of the display line which is used by this command to determine whether a peak should be reported

Sorting order:

AMPLitude - lists the peaks in order of descending amplitude, with the highest peak first (default if optional parameter not sent)

FREQUency - lists the peaks in order of occurrence, left to right across the x-axis.

TIME - lists the peaks in order of occurrence, left to right across the x-axis.

Peaks vs. Display Line:

ALL - lists all of the peaks found (default if optional parameter not sent).

GTDLine (greater than display line) - lists all of the peaks found above the display line.

LTDLine (less than display line) - lists all of the peaks found below the display line.

Initial S/W Revision Prior to A.02.00

Format Data: Numeric Data (Remote Command Only)

This command specifies the format of the trace data input and output. It specifies the formats used for trace data during data transfer across any remote port. It affects only the data format for setting and querying trace data for the :TRACe[:DATA], TRACe[:DATA]?, :CALCulate:DATA[n]? and FETCh:SANalyzer [n]? commands and queries.

Remote Command :FORMat[:TRACe][:DATA] ASCii|INTeger,32|REAL,32 |REAL,64
:FORMat[:TRACe][:DATA]?

Notes The query response is:
ASCii: ASC,8
REAL,32: REAL,32
REAL,64: REAL,64
INTeger,32: INT,32

When the numeric data format is REAL or ASCii, data is output in the current Y Axis unit. When the data format is INTeger, data is output in units of m dBm (.001 dBm).

The INT,32 format returns binary 32-bit integer values in internal units (m dBm), in a definite length block.

Dependencies Sending a data format spec with an invalid number (for example, INT,48) generates no error. The analyzer simply uses the default (8 for ASCii, 32 for INTeger, 32 for REAL).

Sending data to the analyzer which does not conform to the current FORMat specified, results in an error. Sending ASCII data when a definite block is expected generates message -161 "Invalid Block Data" and sending a definite block when ASCII data is expected generates message -121 "Invalid Character in Number".

Preset ASCii

Backwards Compatibility Notes Note that the INT,32 format is only applicable to the command, TRACe:DATA. This preserves backwards compatibility for the Swept SA measurement. For all other commands/queries which honor FORMat:DATA, if INT,32 is sent the analyzer will behave as though it were set to REAL,32.

Initial S/W Revision Prior to A.02.00

The specs for each output type follow:

ASCIi - Amplitude values are in ASCII, in the current Y Axis Unit, one ASCII character per digit, values separated by commas, each value in the form:

SX.YYYYYEsZZ

Where:

S = sign (+ or -)

X = one digit to left of decimal point

Y = 5 digits to right of decimal point

E = E, exponent header

s = sign of exponent (+ or -)

ZZ = two digit exponent

REAL,32 - Binary 32-bit real values in the current Y Axis Unit, in a definite length block.

REAL,64 - Binary 64-bit real values in the current Y Axis Unit, in a definite length block.

Format Data: Byte Order (Remote Command Only)

This command selects the binary data byte order for data transfer and other queries. It controls whether binary data is transferred in normal or swapped mode. This command affects only the byte order for setting and querying trace data for the :TRACe[:DATA], TRACe[:DATA]? , :CALCulate:DATA[n]? and FETCh:SANalyzer[n]? commands and queries.

By definition any command that says it uses FORMat:DATA uses any format supported by FORMat:DATA.

The NORMal order is a byte sequence that begins with the most significant byte (MSB) first, and ends with the least significant byte (LSB) last in the sequence: 1|2|3|4. SWAPped order is when the byte sequence begins with the LSB first, and ends with the MSB last in the sequence: 4|3|2|1.

Remote Command	:FORMat:BORDER NORMal SWAPped :FORMat:BORDER?
Preset	NORMal
Initial S/W Revision	Prior to A.02.00

Meas Setup

Displays the setup menu for the current measurement. The measurement setup parameters include the number of measurement averages used to calculate the measurement result and the averaging mode. The setup menu also includes the option to reset the measurement settings to their factory defaults.

Key Path	Front-panel key
Initial S/W Revision	Prior to A.02.00

Avg/Hold Num

Specifies the number of measurement averages used when calculating the measurement result. The average is displayed at the end of each sweep.

Initiates an averaging routine that averages the sweep points in a number of successive sweeps, resulting in trace smoothing.

After the specified number of average counts, the average mode (termination control) setting determines the average action.

Key Path	Meas Setup
Mode	SA, WCDMA, C2K, WIMAX OFDMA, TD-SCDMA, 1xEVDO, ISDB-T, CMMB, LTE, LTETDD, BLUETOOTH, WLAN, MSR, LTEAFDD, LTEATDD
Remote Command	[:SENSe]:OBWidth:AVERage:COUNT <integer> [:SENSe]:OBWidth:AVERage:COUNT? [:SENSe]:OBWidth:AVERage[:STATe] ON OFF 1 0 [:SENSe]:OBWidth:AVERage[:STATe]?
Example	OBW:AVER:COUN 1500 OBW:AVER:COUN? OBW:AVER ON OBW:AVER?
Notes	You must be in the Spectrum Analysis mode, W-CDMA mode, cdma2000 mode, TD-SCDMA mode, ISDB-T mode, CMMB mode, LTE mode, LTE TDD mode, BLUETOOTH mode, WLAN mode, 1xEVDO mode, MSR, LTE-Advanced FDD/TDD or WIMAX OFDMA mode to use this command. Use:INSTRument:SElect to set the mode.
Couplings	None Averaging state is coupled to Max Hold. If Max Hold is changed from Off to On, Averaging state is automatically set to On.
Preset	10 ON
State Saved	Saved in instrument state.
Min	1
Max	10000

Backwards Compatibility SCPI	<code>[:SENSe] :EBWidth :AVERage :COUnT</code>
Initial S/W Revision	Prior to A.02.00
Modified at S/W Revision	A.03.00

Avg Mode

Enables you to set the averaging mode.

- When set to Exponential (Exp) the measurement averaging continues using the specified number of averages to compute each averaged value. The average is displayed at the end of each sweep.
- When set to Repeat, the measurement resets the average counter each time the specified number of averages is reached.

Key Path	Meas Setup
Mode	SA, WCDMA, C2K, WIMAX OFDMA, TD-SCDMA , 1xEVDO, ISDB-T, CMMB, LTE, LTETDD, BLUETOOTH, WLAN, MSR, LTEAFDD, LTEATDD
Remote Command	<code>[:SENSe] :OBWidth :AVERage :TCONtrol EXPonential REPeat</code> <code>[:SENSe] :OBWidth :AVERage :TCONtrol ?</code>
Example	OBW:AVER:TCON REP OBW:AVER:TCON?
Notes	You must be in the Spectrum Analysis mode, W-CDMA mode, cdma2000 mode, TD-SCDMA mode, ISDB-T mode, CMMB mode, LTE mode, LTE TDD mode, BLUETOOTH mode, WLAN mode, 1xEVDO mode, MSR, LTE-Advanced FDD/TDD or WIMAX OFDMA mode to use this command. Use:INSTrument:SElect to set the mode.
Preset	EXP
State Saved	Saved in instrument state.
Range	Exp Repeat
Initial S/W Revision	Prior to A.02.00
Modified at S/W Revision	A.03.00

Occ BW % Pwr

Assigns the percentage of the total power that is measured within the Occupied Bandwidth for the current measurement. The resulting Occupied Bandwidth limits are displayed by markers placed on the frequencies of the specified percentage.

Key Path	Meas Setup
Mode	SA, WCDMA, C2K, WIMAX OFDMA, TD-SCDMA, 1xEVDO, ISDB-T, CMMB, LTE, LTETDD, BLUETOOTH, WLAN, MSR, LTEAFDD, LTEATDD
Remote Command	<code>[:SENSe] :OBWidth :PERCent <real></code>

	<code>[:SENSe] :OBWidth :PERCent ?</code>
Example	OBW:PERC 75 OBW:PERC?
Notes	You must be in the Spectrum Analysis mode, W-CDMA mode, cdma2000 mode, TD-SCDMA mode, ISDB-T mode, CMMB mode, LTE mode, LTE TDD mode, BLUETOOTH mode, WLAN mode, 1xEVDO mode, MSR, LTE-Advanced FDD/TDD or WIMAX OFDMA mode to use this command. Use:INSTRument:SElect to set the mode. If Mode is BLUETOOTH, the key will be grayed out.
Preset	99.00
State Saved	Saved in instrument state.
Min	10
Max	99.99
Initial S/W Revision	Prior to A.02.00
Modified at S/W Revision	A.03.00

x dB

Sets the x dB value used for the "x dB bandwidth" result that measures the bandwidth between two points on the signal which is x dB down from the highest signal point within the OBW Span.

Key Path	Meas Setup
Mode	SA, WCDMA, C2K, WIMAX OFDMA, TD-SCDMA, 1xEVDO, ISDB-T, CMMB, LTE, LTE TDD, BLUETOOTH, WLAN, MSR, LTEAFDD, LTEATDD
Remote Command	<code>[:SENSe] :OBWidth :XDB <rel_ampl></code> <code>[:SENSe] :OBWidth :XDB ?</code>
Example	OBW:XDB -20 OBW:XDB?
Notes	You must be in the Spectrum Analysis mode, W-CDMA mode, cdma2000 mode, TD-SCDMA mode, ISDB-T mode, CMMB mode, LTE mode, LTE TDD mode, BLUETOOTH mode, WLAN mode, 1xEVDO mode, MSR, LTE-Advanced FDD/TDD or WIMAX OFDMA mode to use this command. Use:INSTRument:SElect to set the mode.
Preset	-26.0 dB BLUETOOTH: -20.0 dB.
State Saved	Saved in instrument state.
Min	-100.0 dB
Max	-0.1 dB
Backwards Compatibility SCPI	<code>[:SENSe] :EBWidth :XDB</code>
Initial S/W Revision	Prior to A.02.00
Modified at S/W Revision	A.03.00

IF Gain

The IF Gain key can be used to set the IF Gain function to Auto, Low Gain or High Gain. These settings affect sensitivity and IF overloads.

This only applies to the RF input. It does not apply to baseband I/Q input.

Key Path	Meas Setup, IF Gain
Dependencies	The IF Gain keys (FFT IF Gain and Swept IF Gain) have no effect when the U7227A USB Preamplifier is connected. This is not annotated or reflected on any softkey; there are no keys grayed out nor any SCPI locked out. The analyzer simply behaves as though both FFT IF Gain and Swept IF Gain are set to Low regardless of the setting on the keys.
Initial S/W Revision	Prior to A.02.00

IF Gain Auto

Activates the Auto Rules for IF Gain. When Auto is active, the IF Gain is set to High Gain under and of the following conditions:

- the input attenuator is set to 0 dB
- the preamp is turned On and the frequency range is under 3.6 GHz

For other settings, Auto sets the IF Gain to Low Gain.

Key Path	Meas Setup, IF Gain
Mode	SA, WCDMA, C2K, WIMAX OFDMA, TD-SCDMA, 1xEVDO, ISDB-T, CMMB, LTE, LTETDD, BLUETOOTH, WLAN, MSR, LTEAFDD, LTEATDD
Remote Command	[:SENSe] :OBWidth :IF :GAIN :AUTO [:STATe] ON OFF 1 0 [:SENSe] :OBWidth :IF :GAIN :AUTO [:STATe] ?
Example	OBW:IF:GAIN:AUTO OFF OBW:IF:GAIN:AUTO?
Couplings	When the auto attenuation exists (for example, with electrical attenuator), the IF Gain setting is changed as following rule. Auto sets IF Gain to High Gain under any of the following conditions: the input attenuator is set to 0 dB, or the preamp is turned on and the frequency range is less than 3.6 GHz. For other settings, Auto sets IF Gain to Low Gain.
Preset	OFF
State Saved	Saved in instrument state.
Range	Off On
Initial S/W Revision	Prior to A.02.00
Modified at S/W Revision	A.03.00

IF Gain State

Selects the range of the IF Gain.

Key Path	Meas Setup, IF Gain
Mode	SA, WCDMA, C2K, WIMAX OFDMA, TD-SCDMA, 1xEVDO, ISDB-T, CMMB, LTE, LTETDD, BLUETOOTH, WLAN, MSR, LTEAFDD, LTEATDD
Remote Command	<code>[:SENSe]:OBWidth:IF:GAIN[:STATe] ON OFF 1 0</code> <code>[:SENSe]:OBWidth:IF:GAIN[:STATe]?</code>
Example	OBW:IF:GAIN ON OBW:IF:GAIN?
Notes	Where ON = high gain OFF = low gain
Couplings	When the auto attenuation exists (for example, with electrical attenuator), the IF Gain setting is changed as following rule. Auto sets IF Gain to High Gain under any of the following conditions: the input attenuator is set to 0 dB, or the preamp is turned on and the frequency range is less than 3.6 GHz. For other settings, Auto sets IF Gain to Low Gain.
Preset	OFF
State Saved	Saved in instrument state.
Range	Low Gain High Gain
Initial S/W Revision	Prior to A.02.00
Modified at S/W Revision	A.03.00

Limit (for all modes except MSR and LTE-Advanced FDD/TDD)

Enables you to turn on or off limit checking at the specified frequency. For results that fail the limit test, a red FAIL appears in the measure bar.

Key Path	Meas Setup
Mode	SA, WCDMA, C2K, WIMAX OFDMA, TD-SCDMA, 1xEVDO, ISDB-T, CMMB, LTE, LTETDD, BLUETOOTH, WLAN
Remote Command	<code>:CALCulate:OBWidth:LIMit:FBLimit <freq></code> <code>:CALCulate:OBWidth:LIMit:FBLimit?</code> <code>:CALCulate:OBWidth:LIMit[:TEST] ON OFF 1 0</code> <code>:CALCulate:OBWidth:LIMit[:TEST]?</code>
Example	CALC:OBW:LIM:FBL 50 kHz CALC:OBW:LIM:FBL? CALC:OBW:LIM OFF CALC:OBW:LIM?
Notes	You must be in the Spectrum Analysis mode, W-CDMA mode, cdma2000 mode, TD-SCDMA mode, ISDB-T mode, CMMB mode, LTE mode, LTE TDD mode, BLUETOOTH mode, WLAN mode, 1xEVDO mode or WIMAX OFDMA mode to use this command. Use:INSTrument:SElect to set the mode.

Preset	SA, WCDMA: 5 MHz C2K: 1.48 MHz WIMAX OFDMA: 10 MHz TD-SCDMA: 1.6 MHz 1xEVDO: 1.48 MHz ISDB-T: 5.7 MHz CMMB: 7.512 MHz LTE, LTETDD: 5 MHz BLUETOOTH: 1 MHz WLAN: If Radio Std is 802.11a/g(OFDM/DSSS-OFDM): 20MHz If Radio Std is 802.11b: 25 MHz If Radio Std is 802.11n(20MHz): 20 MHz If Radio Std is 802.11n(40MHz): 40 MHz If Radio Std is 802.11ac(20MHz): 20 MHz If Radio Std is 802.11ac(40MHz): 40 MHz If Radio Std is 802.11ac(80MHz): 80 MHz If Radio Std is 802.11ac(160MHz): 160 MHz SA: OFF WCDMA, WIMAX OFDMA, TD-SCDMA, 1xEVDO, ISDB-T, CMMB, LTE, LTETDD: ON
State Saved	Saved in instrument state.
Min	1 kHz
Max	Depends on instrument maximum frequency.
Initial S/W Revision	Prior to A.02.00
Modified at S/W Revision	A.03.00

Meas Preset

Restores all measurement parameters to their default values.

Key Path	Meas Setup
Mode	SA, WCDMA, C2K, WIMAX OFDMA, TD-SCDMA, 1xEVDO, ISDB-T, CMMB, LTE, LTETDD, BLUETOOTH, WLAN, MSR, LTEAFDD, LTEATDD
Remote Command	:CONFigure:OBWidth
Example	CONF:OBW
Initial S/W Revision	Prior to A.02.00
Modified at S/W Revision	A.03.00

Max Hold (Remote Command Only)

When On, Max Hold displays and holds the maximum responses of the current measurement. Turn Max Hold to Off to disable the maximum hold feature.

Key Path	SCPI Only
Mode	SA, WCDMA, C2K, WIMAX OFDMA, TD-SCDMA, 1xEVDO, ISDB-T, CMMB, LTE, LTETDD, BLUETOOTH, WLAN, MSR, LTEAFDD, LTEATDD
Remote Command	<code>[:SENSe] :OBwidth:MAXHold ON OFF 1 0</code> <code>[:SENSe] :OBwidth:MAXHold?</code>
Example	OBW:MAXH ON OBW:MAXH?
Notes	You must be in the Spectrum Analysis mode, W-CDMA mode, cdma2000 mode, TD-SCDMA mode, ISDB-T mode, CMMB mode, LTE mode, LTE TDD mode, BLUETOOTH mode, WLAN mode, 1xEVDO mode, MSR, LTE-Advanced FDD/TDD or WIMAX OFDMA mode to use this command. Use:INSTrument:SElect to set the mode.
Couplings	Max Hold is coupled to Average/Hold state. The Max Hold function is activated only if Average state is On. If Max Hold is changed to On when Average state is Off, Average state is automatically set to On.
Preset	OFF
State Saved	Saved in instrument state.
Range	On Off
Backwards Compatibility SCPI	<code>[:SENSe] :EBwidth:MAXHold</code>
Initial S/W Revision	Prior to A.02.00
Modified at S/W Revision	A.03.00

9 Occupied Bandwidth Measurement
Mode

Mode

See "[Mode](#)" on page 316

Mode Preset

Returns the active mode to a known state.

Mode Preset does the following for the currently active mode:

- Aborts the currently running measurement.
- Brings up the default menu for the mode, with no active function.
- Sets measurement Global settings to their preset values for the active mode only.
- Activates the default measurement.
- Brings up the default menu for the mode.
- Clears the input and output buffers.
- Sets Status Byte to 0.

Mode Preset does not:

- Cause a mode switch
- Affect mode persistent settings
- Affect system settings

See "[How-To Preset](#)" on page 730 for more information.

Key Path	Front-panel key
Remote Command	:SYSTem:PRESet
Example	:SYST:PRES
Notes	*RST is preferred over :SYST:PRES for remote operation. *RST does a Mode Preset, as done by the :SYST:PRES command, and it sets the measurement mode to Single measurement rather than Continuous for optimal remote control throughput. Clears all pending OPC bits. The Status Byte is set to 0.
Couplings	A Mode Preset aborts the currently running measurement, activates the default measurement, and gets the mode to a consistent state with all of the default couplings set.
Backwards Compatibility Notes	In the X-Series, the legacy "Factory Preset" has been replaced with Mode Preset, which only presets the currently active mode, not the entire instrument. In the X-Series, the way to preset the entire instrument is by using System, Restore System Defaults All, which behaves essentially the same way as restore System Defaults does on ESA and PSA. There is also no "Preset Type" as there is on the PSA. There is a green Mode Preset front-panel key that does a Mode Preset and a white-with-green-letters User Preset front-panel key that does a User Preset. The old PRESet:TYPE command is ignored (without generating an error), and SYST:PRES without a parameter does a Mode Preset, which should cover most backward code compatibility issues. The settings and correction data under the Input/Output front-panel key (examples: Input Z Corr, Ext Amp Gain, etc.) are no longer part of any Mode, so they will not be preset by a Mode Preset. They are preset using Restore Input/Output Defaults, Restore System Defaults All. Note that because User Preset does a Recall State, and all of these settings are saved in State, they ARE recalled when using

	User Preset.
Initial S/W Revision	Prior to A.02.00

How-To Preset

The table below shows all possible presets, their corresponding SCPI commands and front-panel access (key paths). Instrument settings depend on the current measurement context. Some settings are local to the current measurement, some are global (common) across all the measurements in the current mode, and some are global to all the available modes. In a similar way, restoring the settings to their preset state can be done within the different contexts.

Auto Couple - is a measurement local key. It sets all Auto/Man parameter couplings in the measurement to Auto. Any Auto/Man selection that is local to other measurements in the mode will not be affected.

Meas Preset - is a measurement local key. Meas Preset resets all the variables local to the current measurement except the persistent ones.

Mode Preset - resets all the current mode's measurement local and measurement global variables except the persistent ones.

Restore Mode Defaults - resets ALL the Mode variables (and all the Meas global and Meas local variables), including the persistent ones.

Type Of Preset	SCPI Command	Front Panel Access
Auto Couple	:COUPle ALL	Auto Couple front-panel key
Meas Preset	:CONFigure:<Measurement>	Meas Setup Menu
Mode Preset	:SYSTem:PRESet	Mode Preset (green key)
Restore Mode Defaults	:INSTrument:DEFault	Mode Setup Menu
Restore All Mode Defaults	:SYSTem:DEFault MODes	System Menu; Restore System Default Menu
*RST	*RST	not possible (Mode Preset with Single)
Restore Input/Output Defaults	:SYSTem:DEFault INPUt	System Menu; Restore System Default Menu
Restore Power On Defaults	:SYSTem:DEFault PON	System Menu; Restore System Default Menu
Restore Alignment Defaults	:SYSTem:DEFault ALIGn	System Menu; Restore System Default Menu
Restore Miscellaneous Defaults	:SYSTem:DEFault MISC	System Menu; Restore System Default Menu
Restore All System Defaults	:SYSTem:DEFault [ALL] :SYSTem:PRESet:PERsistent	System Menu; Restore System Default Menu
User Preset	:SYSTem:PRESet:USER	User Preset Menu
User Preset All Modes	:SYSTem:PRESet:USER:ALL	User Preset Menu

Power On Mode Preset	:SYSTem:PON:TYPE MODE	System Menu
Power On User Preset	:SYSTem:PON:TYPE USER	System Menu
Power On Last State	:SYSTem:PON:TYPE LAST	System Menu

Preset Type (Remote Command Only)

As stated in the Backward Compatibility section, to be compatible with ESA/PSA the PRESet:TYPE command will be implemented as a no-op.

Mode	All
Remote Command	:SYSTem:PRESet:TYPE FACTory MODE USER :SYSTem:PRESet:TYPE?
Example	:SYST:PRESet:TYPE FACT
Notes	This command is supported for backward compatibility only. It is a no-op which does not change the behavior of any preset operation.
Preset	This is unaffected by Preset but is set to Mode on a “Restore System Defaults->All”
State Saved	No
Initial S/W Revision	Prior to A.02.00

Mode Setup

See "[Mode Setup](#)" on page 347

Peak Search

Places the selected marker on the trace point with the maximum y-axis value for that marker's trace. Pressing Peak Search with the selected marker off causes the selected marker to be set to Normal, then a peak search is immediately performed.

Key Path	Front panel key
Mode	SA, WCDMA, C2K, WIMAX OFDMA, TD-SCDMA, 1xEVDO, ISDB-T, CMMB, LTE, LTETDD, BLUETOOTH, WLAN, MSR, LTEAFDD, LTEATDD
Remote Command	:CALCulate:OBWidth:MARKer[1] 2 ... 12:MAXimum
Example	CALC:OBW:MARK2:MAX
Initial S/W Revision	Prior to A.02.00
Modified at S/W Revision	A.03.00

9 Occupied Bandwidth Measurement
Print

Print

See ["Print" on page 365](#)

Quick Save

The Quick Save front-panel key repeats the most recent save that was performed from the Save menu, with the following exceptions:

- Register saves are not remembered as Saves for the purpose of the Quick Save function
- If the current measurement does not support the last non-register save that was performed, an informational message is generated, “File type not supported for this measurement”

Quick Save repeats the last type of qualified save (that is, a save qualified by the above criteria) in the last save directory by creating a unique filename using the Auto File Naming algorithm described below.

If Quick Save is pressed after startup and before any qualified Save has been performed, the Quick Save function performs a Screen Image save using the current settings for Screen Image saves (current theme, current directory), which then becomes the “last save” for the purpose of subsequent Quick Saves.

The Auto File Naming feature automatically generates a file name for use when saving a file. The filename consists of a prefix and suffix separated by a dot, as is standard for the Windows® file system. A default prefix exists for each of the available file types:

Type	Default Prefix	Menu
State	State_	(Save/Recall)
Trace + State	State_	(Save/Recall)
Screen	Screen_	(Save/Recall)
Amplitude Corrections	Ampcor_	(Import/Export)
Traces	Trace_	(Import/Export)
Limit Lines	LLine_	(Import/Export)
Measurement Result	MeasR_	(Import/Export)
Capture Buffer	CapBuf_	(Import/Export)

A four digit number is appended to the prefix to create a unique file name. The numbering sequence starts at 0000 within each Mode for each file type and updates incrementally to 9999, then wraps to 0000 again. It remembers where it was through a Mode Preset and when leaving and returning to the Mode. It is reset by Restore Misc Defaults and Restore System Defaults and subsequent running of the instrument application. So, for example, the first auto file name generated for State files is State_0000.state. The next is State_0001, and so forth.

One of the key features of Auto File Name is that we guarantee that the Auto File Name will never conflict with an existing file. The algorithm looks for the next available number. If it gets to 9999, then it looks for holes. If it find no holes, that is no more numbers are available, it gives an error.

For example, if when we get to State_0010.state there is already a State_0010.state file in the current directory, it advances the counter to State_0011.state to ensure that no conflict will exist (and then it verifies that State_0011.state also does not exist in the current directory and advances again if it does, and so forth).

If you enter a file name for a given file type, then the prefix becomes the filename you entered instead of the default prefix, followed by an underscore. The last four letters (the suffix) are the 4-digit number.

For example, if you save a measurement results file as “fred.csv”, then the next auto file name chosen for a measurement results save will be fred_0000.csv.

NOTE

Although 0000 is used in the example above, the number that is used is actually the current number in the Meas Results sequence, that is, the number that would have been used if you had not entered your own file name.

NOTE

If the filename you entered ends with _dddd, where d=any number, making it look just like an auto file name, then the next auto file name picks up where you left off with the suffix being dddd + 1.

Key Path	Front-panel key
Notes	No remote command for this key specifically.
Initial S/W Revision	Prior to A.02.00

Recall

In the LTE TDD mode, four types of recall functions are available under the Data menu: “Limit Mask”, “E-UTRA Test Model”, “Signal Studio Setup” and “Vector Signal Analyzer”. “Limit Mask” enables setting of a preset limit mask for Power Suite-based measurements, and currently it is available for the SEM/ACP measurements with the LTE TDD mode. Recalling “E-UTRA Test Model” sets complicated RB settings for each Test Model for the Modulation Analysis and Conformance EVM measurements. Recalling “Signal Studio Setup” or “89600 Vector Signal Analyzer” enables you to recall parameters which have been set and saved on the external platform.

Key Path	Front Panel
Mode	LTETDD
Initial S/W Revision	Prior to A.02.00
Modified at S/W Revision	A.06.00

State

The Recall State menu lets you choose a register or file from which to recall the state.

The content of a state file includes all of the settings and data required to return the analyzer as closely as possible to the Mode it was in, with the exact settings that were in place, when the save occurred. The Mode settings in each state file include the settings that are affected by Mode Preset, as well as the additional settings affected by Restore Mode Defaults; all of the Mode’s settings. In addition, all of the settings of the Input/Output system are included, even though they are outside of the Mode’s state, because they are needed to restore the complete setup. Persistent System settings (for example, GPIB address) are not affected by either a Mode Preset or Restore Mode Defaults, nor are they included in a saved State file.

Since each state file is only for one Mode, the settings for other Modes are unaffected when it is loaded. Recall State will cause a mode switch if the state being recalled is not from the current active mode.

After the recall completes, the message "File <filename> recalled" or “Recalled State Register <register number>” is displayed.

For rapid recalls, the State menu lists 16 registers that you can choose from to recall. Pressing a Register key initiates the recall. You can also select a file from which to recall.

The default path for all State Files is:

My Documents\<<mode name>\state

where <mode name> is the parameter used to select the mode with the INST:SEL command (for example, SA for the Spectrum Analyzer).

See ["More Information" on page 738](#).

Key Path	Recall
Mode	All

Remote Command	:MMEMory:LOAD:STATe <filename>
Example	:MMEM:LOAD:STAT "myState.state" This recalls the file myState.state on the default path
Example	MMEM:LOAD:STAT "MyStateFile.state" This loads the state file data (on the default file directory path) into the instrument state.
Notes	<p>When you pick a file to recall, the analyzer first verifies that the file is recallable in the current instrument by checking the software version and model number of the instrument. If everything matches, a full recall proceeds by aborting the currently running measurement, clearing any pending operations, and then loading the State from the saved state file. You can open state files from any mode, so recalling a State file switches to the mode that was active when the save occurred. After switching to the mode of the saved state file, mode settings and data (if any for the mode) are loaded with values from the saved file. The saved measurement of the mode becomes the newly active measurement and the data relevant to the measurement (if there is any) is recalled.</p> <p>If there is a mismatch between file version or model number or instrument version or model number, the recall function tries to recall as much as possible and returns a warning message. It may limit settings that differ based on model number, licensing or version number.</p> <p>After recalling the state, the Recall State function does the following:</p> <ul style="list-style-type: none"> • Makes the saved measurement for the mode the active measurement. • Clears the input and output buffers. • Status Byte is set to 0. • Executes a *CLS <p>If the file specified is empty an error is generated. If the specified file does not exist, another error is generated. If there is a mismatch between the file and the proper file type, an error is generated. If there is a mismatch between file version or model number or instrument version or model number, a warning is displayed. Then it returns to the State menu and File Open dialog goes away.</p> <p>After the Recall, the analyzer exits the Recall menu and returns to the previous menu.</p>
Backwards Compatibility SCPI	:MMEMory:LOAD:STATe 1,<filename> For backwards compatibility, the above syntax is supported. The "1" is simply ignored.
Initial S/W Revision	Prior to A.02.00

More Information

In measurements that support saving Traces, for example, Swept SA, the Trace data is saved along with the State in the State file. When recalling the State, the Trace data is recalled as well. Traces are recalled exactly as they were stored, including the writing mode and update and display modes. If a Trace was updating and visible when the State was saved, it will come back updating and visible, and its data will be rewritten right away. When you use State to save and recall traces, any trace whose data must be preserved should be placed in View or Blank mode before saving.

The following table describes the Trace Save and Recall possibilities:

You want to recall state and one trace's data, leaving other traces unaffected.	Save Trace+State from 1 trace. Make sure that no other traces are updating (they should all be in View	On Recall, specify the trace you want to load the one trace's data into. This trace will load in View.
---	---	--

	or Blank mode) when the save is performed.	All other traces' data will be unaffected, although their trace mode will be as it was when the state save was performed.
You want to recall all traces	Save Trace+State from ALL traces.	On Recall, all traces will come back in View (or Blank if they were in Blank or Background when saved)
You want all traces to load exactly as they were when saved.	Save State	On recall, all traces' mode and data will be exactly as they were when saved. Any traces that were updating will have their data immediately overwritten.

From File...

When you press “From File”, the analyzer brings up a Windows dialog and a menu entitled “File Open.” This menu allows you to navigate to the various fields in the Windows dialog without using a keyboard or mouse. The Tab and Arrow keys can also be used for dialog navigation.

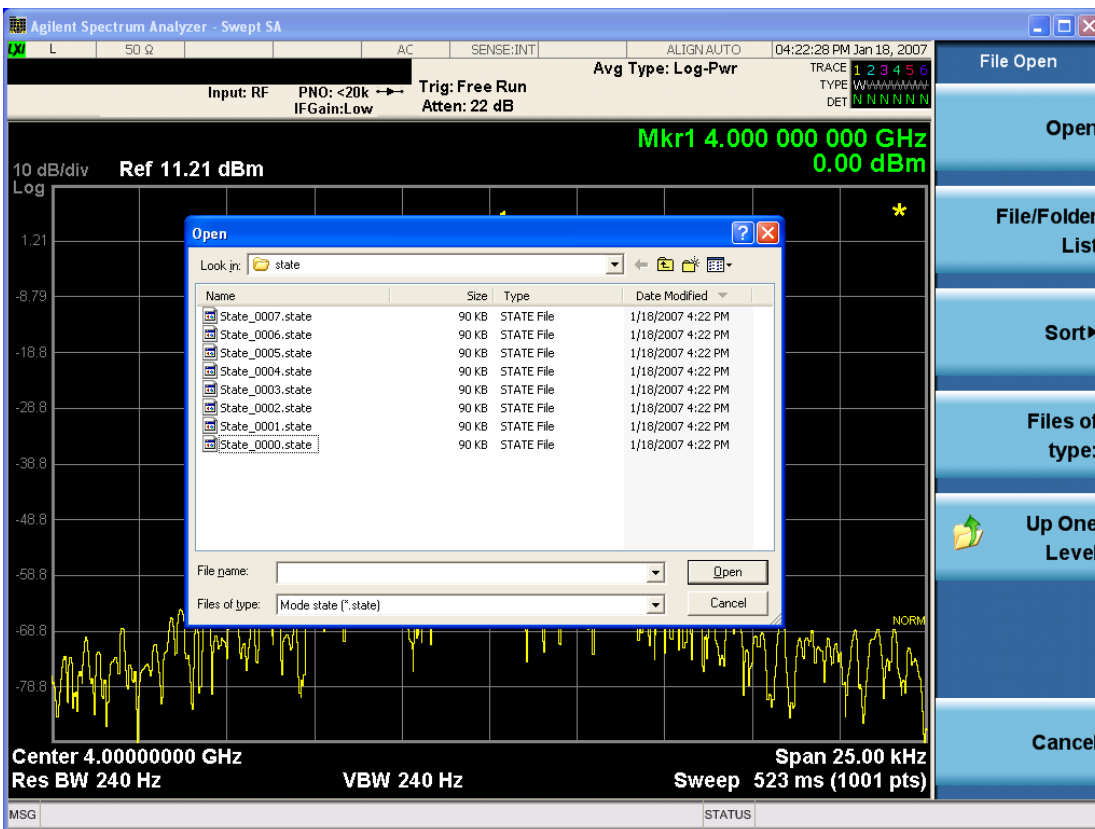

Listed below are the functions of the various fields in the dialog, and the corresponding softkeys:

Open

Performs the recall of the specified file. While the recall is being performed, the floppy icon appears briefly in the Meas bar.

File/Folder List

Enables you to navigate to the center of the dialog that contains the list of files and folders. Once here you can get information about the file and use the tab keys to navigate to the other fields in the dialog, such as Look In.

Look In

The Look In field shows the path from which the file will be recalled and allows you to change the path using the up and down arrow keys to navigate to other paths; the Enter key to open a directory; and the Backspace key to go back one directory. The **Look In field** first uses the last path from the Save As dialog **Save In:** path for that same file type. There is no softkey for directly navigating to the Look In field, but you can use the left tab to get here from the File/Folder List.

User specified paths are remembered when you leave and return to a Mode and are reset back to the default using Restore Mode Defaults.

Sort

Accesses a menu that enables you to sort the files within the File Open dialog. Only one sorting type can be selected at a time and the sorting happens immediately. The sorting types are By Date, By Name, By extension, and By Size.

Files of Type

This field shows the file suffix for the type of file you have selected to recall. For example, if you navigated here while recalling State, "Mode state (*.state)" is in the field. If you navigated here while recalling Trace, ""Mode state (*.trace)" is in the field. If you navigated here while importing a trace data file, "Trace Data (*.csv)" is in the field. For some file types, there is more than one choice in the dropdown menu, which you can select by using the up and down arrow keys and Enter.

Up One Level

This key corresponds to the icon of a folder with the up arrow that is in the tool bar of the dialog. When pressed, it causes the file and folder list to navigate up one level in the directory structure. The Backspace key does the same thing.

Cancel

This key corresponds to the Cancel selection in the dialog. It causes the current **Open** request to be cancelled. The ESC key does the same thing.

Key Path	Recall, State
Notes	Brings up the Open dialog for recalling a State Save Type
Initial S/W Revision	Prior to A.02.00

Edit Register Names

You may enter a custom name on any of the Register keys, to help you remember what you are using that state to save. To do this, press the Edit Register Names key, choose the register whose name you wish to edit, and then enter the desired label using the Alpha Editor or an external PC keyboard.

The maximum number of characters that can be added is 30. In most cases, 30 characters will fit on two lines of the key.

For more information and the SCPI command, see Edit Register Names under the Save, State function.

Key Path	Recall, State
Mode	All
Dependencies	N9060A-7FP or N9060B-2FP license required to edit the register names. When the feature is not licensed, sending the SCPI command generates an error, -221, "Settings conflict;Option not available"
Initial S/W Revision	A.11.00

Register 1 thru Register 16

Selecting any one of these register keys causes the State of the mode from the specified Register to be recalled. Each of the register keys annotates whether it is empty or at what date and time it was last modified. In addition, you can use the Edit Register Names key under Save, State to enter custom names for each register.

Registers are shared by all modes, so recalling from any one of the registers will cause a mode switch to the mode that was active when the save to the Register occurred.

Although these 16 registers are the only registers available from the front panel, there are 128 state registers available in the instrument. Registers 17-128 are only available from the SCPI interface, using the *RCL command.

After the recall completes, the message "Register <register number> recalled" appears in the message bar. If you are in the Spectrum Analyzer Mode, and you are recalling a register that was saved in the Spectrum Analyzer Mode, then after the recall, you will still be in the Recall Register menu. If the Recall causes you to switch modes, then after the Recall, you will be in the Frequency menu.

If a requested register is empty an error is generated.

Key Path	Recall, State
Example	*RCL 1
Range	1-16 from front panel, 1-128 from SCPI
Readback	Date and time with seconds resolution are displayed on the key OR A custom name of up to 30 characters entered using the Save, State,Edit Register Names key OR “(empty)” if no prior save operation has been performed to this register.
Initial S/W Revision	Prior to A.02.00
Modified at S/W Revision	Prior to A.11.00

Register 1 thru Register 16

Selecting any one of these register keys causes the State of the mode from the specified Register to be recalled. Each of the register keys annotates whether it is empty or at what date and time it was last modified. In addition, you can use the Edit Register Names key under Save, State to enter custom names for each register.

Registers are shared by all modes, so recalling from any one of the registers will cause a mode switch to the mode that was active when the save to the Register occurred.

Although these 16 registers are the only registers available from the front panel, there are 128 state registers available in the instrument. Registers 17–128 are only available from the SCPI interface, using the *RCL command.

After the recall completes, the message "Register <register number> recalled" appears in the message bar. If you are in the Spectrum Analyzer Mode, and you are recalling a register that was saved in the Spectrum Analyzer Mode, then after the recall, you will still be in the Recall Register menu. If the Recall causes you to switch modes, then after the Recall, you will be in the Frequency menu.

If a requested register is empty an error is generated.

Key Path	Recall, State
Example	*RCL 1
Range	1–16 from front panel, 1–128 from SCPI
Readback	Date and time with seconds resolution are displayed on the key OR A custom name of up to 30 characters entered using the Save, State, Edit Register Names key OR “(empty)” if no prior save operation has been performed to this register.
Initial S/W Revision	Prior to A.02.00
Modified at S/W Revision	Prior to A.11.00

Recall

In the LTE TDD mode, four types of recall functions are available under the Data menu: “Limit Mask”, “E-UTRA Test Model”, “Signal Studio Setup” and “Vector Signal Analyzer”. “Limit Mask” enables setting of a preset limit mask for Power Suite-based measurements, and currently it is available for the SEM/ACP measurements with the LTE TDD mode. Recalling “E-UTRA Test Model” sets complicated RB settings for each Test Model for the Modulation Analysis and Conformance EVM measurements. Recalling “Signal Studio Setup” or “89600 Vector Signal Analyzer” enables you to recall parameters which have been set and saved on the external platform.

Key Path	Front Panel
Mode	LTETDD
Initial S/W Revision	Prior to A.02.00
Modified at S/W Revision	A.06.00

Import Trace Data

Enables you to import previously saved trace data into a Data Register and optionally display it. Selecting this key displays a menu that enables you to select the destination data register, and also enables you to choose whether or not to display the recalled data in the currently selected trace. After making these selections, select Open... and use the file dialog to select the file you want to recall.

Recalling trace data into an already used Data Register overwrites the previous data. If the data register is displayed on any trace, the display is updated to reflect the new data.

The SCPI command

```
:MMEM:LOAD:TRAC:DATA D1|D2|D3|D4|D5|D6,<filename>
```

recalls data into a specified register, but does not display it in the selected trace. Use the command

```
:DISP:<meas>:TRAC<n>:FEED D1|D2|D3|D4|D5|D6
```

to display the register in the desired trace.

It is possible to recall trace data saved by other VXA measurements, or measurements made using the LTE, LTETDD, iDEN, or 89601 applications.

Key Path	Recall, Data (Import)
Mode	VSA, LTE, LTETDD, IDEN
Remote Command	:MMEMory:LOAD:TRACe:DATA D1 D2 D3 D4 D5 D6,<filename>[,CSV TXT SDF MAT4 MAT HDF5 BIN]
Example	:MMEM:LOAD:TRAC:DATA D1,"Trc1.txt",TXT
Notes	<p>The Open: dialog box has the following filter options when you are recalling trace data::</p> <ul style="list-style-type: none"> • CSV (Comma delimited) (*.csv) • SDF (Fast) (*.sdf;*.dat) • Text (Tab delimited) (*.txt) <p>The file must have the same format as that created by the Export Recorded Data command.</p> <p>The SCPI command has an optional file format parameter. If you do not include this parameter in the SCPI command, the file format is determined by the file name extension. If no file extension is recognized, the file is scanned to determine the format.</p> <p>If you are not licensed to recall a particular file type, then error -203.9010 is returned. If the file format cannot be determined or the file cannot be recalled successfully, then error -250.5290 is returned. If the recall is successful, then advisory 0.1600 is shown.</p>
State Saved	No
Readback	Data 1 Data 2 Data 3 Data 4 Data 5 Data 6

Data 1

Selects the Data 1 register as the destination for the imported data.

Key Path	Recall, Data (Import), Trace (to)
Mode	VSA, LTE, LTETDD, IDEN

Data 2

Selects the Data 2 register as the destination for the imported data.

Key Path	Recall, Data (Import), Trace (to)
Mode	VSA, LTE, LTETDD, IDEN

Data 3

Selects the Data 3 register as the destination for the imported data.

Key Path	Recall, Data (Import), Trace (to)
Mode	VSA, LTE, LTETDD, IDEN

Data 4

Selects the Data 4 register as the destination for the imported data.

Key Path	Recall, Data (Import), Trace (to)
Mode	VSA, LTE, LTETDD, IDEN

Data 5

Selects the Data 5 register as the destination for the imported data..

Key Path	Recall, Data (Import), Trace (to)
Mode	VSA, LTE, LTETDD, IDEN

Data 6

Selects the Data 6 register as the destination for the imported data.

Key Path	Recall, Data (Import), Trace (to)
Mode	VSA, LTE, LTETDD, IDEN

Display in Selected Trace

Enables you to select whether the recalled trace data is displayed in the current Trace.

Key Path	Recall, Data (Import), Trace (to)
----------	-----------------------------------

Mode	VSA, LTE, LTETDD, IDEN
State Saved	No

Signal Studio Setup

This key allows you to recall the Agilent Signal Studio setup file created on the Signal Studio (N7625B). This key is valid only for the Mod Analysis measurement. For E-TM test model signal, please use corresponding EVM setup file under My Documents\LTETDD\data\evmsetup.

For the supported carrier types, see the table below.

Signal Studio	Carrier Type
N7625B Signal Studio for 3GPP LTE TDD	Advanced LTE TDD(2009-03)
	Advanced LTE TDD(2009-12)
	Basic LTE TDD(2009-03)
	Basic LTE TDD(2009-12)

File Location and Extension

File location: "My Documents\LTETDD\data"

File type: xml

File extension: .scp

You need to place the Signal Studio Setup file created on N7625B in the above directory in advance. Pressing OPEN under the Import Data menu will open this directory from which you can select the setup file.

Example:

File Location: My Documents\LTETDD\data

File Name: Uplink PUSCH.scp

Key Path	Recall, Data
Mode	LTETDD
Remote Command	MMEMory:LOAD:SSSetup <string>
Example	MMEM:LOAD:SSS "Uplink PUSCH.scp"
Notes	Sets of parameters related to Signal Studio Setup are overwritten by the contents of the setup file.
Initial S/W Revision	A.06.00

89601 VSA Setup

Enables you to import the 89600 Vector Signal Analyzer Setup file created using the 89600 Vector Signal Analyzer Option BHE (LTE TDD). This key is valid only for the Mod Analysis measurement.

File Location and Extension

File location: "My Documents\LTETDD\data"

File type: text file

File extension: .set, .setx

Place the 89600 Vector Signal Analyzer Setup file that you saved on 89600 in the above directory. When you select OPEN under the Import Data menu, the directory opens enabling you to select your setup file.

Example:

File Location: My Documents\LTETDD\data

File Name: Uplink PRACH.set

Key Path	Recall, Data
Mode	LTETDD
Remote Command	MME ^M o ^R y:LOAD:VSAS ^E tup <string>
Example	MME:LOAD:VSAS "Uplink PRACH.set"
Notes	Sets of parameters related to Vector Signal Analyzer Setup are overwritten by the contents of the setup file.
Initial S/W Revision	A.06.00
Modified at S/W Revision	A.10.00

Masks

This key allows you to recall a preset mask file from the list. The preset mask file contains configuration for only Carrier, Offset, Limit settings and the preset profile BW. Any set of values not specified by the preset mask file will not be overwritten.

You cannot change or create the preset mask file since it is a binary file. This key is valid for the Spectrum Emission Mask and ACP measurements.

File location: "My Documents\LTETDD\data.masks"

Note that "My Documents" is an alias to a directory and its place differs depending on which user is logged in. At XSA start up, XSA will overwrite all of the limit mask files to the current user's "My Documents\LTETDD\data.masks" each time.

File type: Binary

Filename: The filename follows the rule below, in which the word is connected with underscores.

<Measurement>_<Direction>_<Bandwidth>_<Condition>.mask

Where

<Measurement> Measurement the limit mask file is applied to: SEM or ACP

<Direction> Direction: BS (Downlink) or MS (Uplink).

<Bandwidth> Bandwidth

<Condition> Condition. It depends on the measurement.

File extension: .mask

Pressing OPEN under the Import Data menu will open the above directory from which you can select a mask file. When you change the Bandwidth or Direction, all Power Suite measurement parameters are reset to the hard coded preset parameters. Thus you must recall the appropriate preset mask file again after the change.

You cannot read the contents of the provided preset mask file since it is a binary file. Detailed contents of the file are provided by a PDF format file located in the same directory as the preset mask file.

Example:

File Location: My Documents/LTETDD/data/masks/SEM_MS

File Name: SEM_MS_15MHz_Add_NS04.mask

The following table shows the sets of variables imported to the ACP measurement.

Offset	Start Freq (MHz)	Stop Freq (MHz)	Res BW (Hz)	Meas BW	Rel Start	Rel Stop	Fail Mask
A	5	7.14	30k	1	-8	-25	Rel
B	7.14	10.57	30k	1	-25	-27	Rel
C	10.57	20	30k	1	-27	-50	Rel
D	20	25	30k	1	-50	-50	Rel
E	25	30	30k	1	-50	-50	Rel

Key Path	Recall, Data
Mode	LTETDD
Remote Command	MMEemory:LOAD:MASK <string>
Example	MMEemory:LOAD:MASK "ACP_BS\ACP_BS_3MHz_pairE-UTRA_CatA.mask"
Notes	Sets of parameters related to Limit, Carrier and Offset are overwritten by the contents of the preset mask file.
Initial S/W Revision	A.03.00

EVM Setup

This key allows you to recall EVM parameter setting to measure E-UTRA Test Model in 3GPP standard (36.141–810 6.1.1).

- E-UTRA Test Model 1.1 (E-TM1.1)
- E-UTRA Test Model 1.2 (E-TM1.2)
- E-UTRA Test Model 2 (E-TM2)
- E-UTRA Test Model 3.1 (E-TM3.1)

- E-UTRA Test Model 3.2 (E-TM3.2)
- E-UTRA Test Model 3.3 (E-TM3.3)

This key is valid for the Modulation Analysis and Conformance EVM measurements only.

File Location and Extension

File location: My Documents\LTETDD\data\evmsetup

Note that “My Documents” is an alias to a directory and its place differs depending on which user is logged in. At XSA start up, XSA will overwrite all of the EVM Setup files to the current user’s “My Documents\LTETDD\data\evmsetup” each time.

File type: binary

File extension: .evms

Pressing OPEN under the Import Data menu will open the above directory from which you can select an EVM Setup file. When you change the Bandwidth, parameters are reset to the hard coded preset parameters. Thus you must recall the appropriate EVM Setup file again after the change.

You cannot read the contents of the provided EVM Setup file since it is a binary file.

Example:

File Location: My Documents\LTETDD\data\evmsetup

Filename: TM3.1-BW1.4MHz.evms

Key Path	Recall, Data
Mode	LTETDD
Remote Command	MME ^M MoRY:LOAD:EVMS ^E tup <string>
Example	MME:LOAD:EVMS "TM2-BW15MHz.evms"
Notes	Sets of parameters related to EVM Setup are overwritten by the contents of the EVM Setup file.
Initial S/W Revision	A.03.00, A.08.00

Open...

When you press “Open”, the analyzer brings up a Windows dialog and a menu entitled “File Open.” This menu allows you to navigate to the various fields in the Windows dialog without using a keyboard or mouse. The Tab and Arrow keys can also be used for dialog navigation.

See "[From File...](#)" on page 2797 in Recall, State, for a full description of this dialog and menu.

Key Path	Recall, Data
Notes	The key location is mode-dependent and will vary. Brings up Open dialog for recalling a <mode specific> Save Type
Initial S/W Revision	Prior to A.02.00

Restart

The Restart function restarts the current sweep, or measurement, or set of averaged/held sweeps or measurements. If you are Paused, pressing Restart does a Resume.

The Restart function is accessed in several ways:

- Pressing the Restart key
- Sending the remote command INIT:IMMEDIATE
- Sending the remote command INIT:RESTART

See "[More Information](#)" on page 749

Key Path	Front-panel key
Remote Command	:INITiate[:IMMEDIATE] :INITiate:RESTART
Example	:INIT:IMM :INIT:REST
Notes	:INITiate:RESTART and :INITiate:IMMEDIATE perform exactly the same function.
Couplings	Resets average/hold count k. For the first sweep overwrites all active (update=on) traces with new current data. For application modes, it resets other parameters as required by the measurement.
Status Bits/OPC dependencies	This is an Overlapped command. The STATUS:OPERation register bits 0 through 8 are cleared. The STATUS:QUESTIONable register bit 9 (INTEgrity sum) is cleared. The SWEEPING bit is set. The MEASURING bit is set.
Backwards Compatibility Notes	For Spectrum Analysis mode in ESA and PSA, the Restart hardkey and the INITiate:RESTART command restart trace averages (displayed average count reset to 1) for a trace in Clear Write, but did not restart Max Hold and Min Hold. In the X-Series, the Restart hardkey and the INITiate:RESTART command restart not only Trace Average, but MaxHold and MinHold traces as well. For wireless comms modes in ESA and PSA, the Restart hardkey and the INITiate:RESTART command restart every measurement, which includes all traces and numeric results. There is no change to this operation.
Initial S/W Revision	Prior to A.02.00

More Information

The **Restart** function first aborts the current sweep/measurement as quickly as possible. It then resets the sweep and trigger systems, sets up the measurement and initiates a new data measurement sequence with a new data acquisition (sweep) taken once the trigger condition is met.

If the analyzer is in the process of aligning when **Restart** is executed, the alignment finishes before the restart function is performed.

Even when set for Single operation, multiple sweeps may be taken when Restart is pressed (for example, when averaging/holding is on). Thus when we say that **Restart** "restarts a measurement," we may mean:

- It restarts the current sweep
- It restarts the current measurement
- It restarts the current set of sweeps if any trace is in Trace Average, Max Hold or Min Hold
- It restarts the current set of measurements if Averaging, or Max Hold, or Min Hold is on for the measurement
- depending on the current settings.

With **Average/Hold Number** (in **Meas Setup** menu) set to 1, or Averaging off, or no trace in Trace Average or Hold, a single sweep is equivalent to a single measurement. A single sweep is taken after the trigger condition is met; and the analyzer stops sweeping once that sweep has completed. However, with **Average/Hold Number** >1 and at least one trace set to **Trace Average, Max Hold, or Min Hold (SA Measurement)** or **Averaging on (most other measurements)**, multiple sweeps/data acquisitions are taken for a single measurement. The trigger condition must be met prior to each sweep. The sweep is stopped when the average count k equals the number N set for **Average/Hold Number**. A measurement average usually applies to all traces, marker results, and numeric results; but sometimes it only applies to the numeric results.

Once the full set of sweeps has been taken, the analyzer will go to idle state. To take one more sweep without resetting the average count, increment the average count by 1, by pressing the step up key while **Average/Hold Number** is the active function, or sending the remote command `CALC:AVER:TCON UP`.

Save

The Save menu lets you choose what you want to save and where you want to save it. Among the types of files you can save are **States**, **Traces**, and **Screen Images**. In addition, an Export (Data) option lets you save a number of data types as CSV files for easy import into Excel and other spreadsheet programs.

Key Path	Front-panel key
Mode	All
Notes	No remote command for this key specifically, but the :MMEM:STORe command is available for specific file types. An example is :MMEM:STOR:STATe <filename>.
Initial S/W Revision	Prior to A.02.00

State

The Save State menu lets you choose a register or file for saving the state.

The content of a state file includes all of the settings and data required to return the analyzer as closely as possible to the Mode it was in, with the exact settings which were in place, when the save occurred. The Mode settings in each state file include the settings that are affected by Mode Preset, as well as the additional settings affected by Restore Mode Defaults; all of the Mode's settings. In addition, all of the settings of the Input/Output system are included, even though they are outside of the Mode's state, because they are needed to restore the complete setup. Persistent System settings (for example, Verbose SCPI) are not affected by either Mode Preset or Restore Mode Defaults, nor are they included in a saved State file.

After the save completes, the message "File <filename> saved" or "State Register <register number> saved" is displayed.

For rapid saving, the State menu lists 16 registers to save to. Pressing a Register key initiates the save. You can also select a file to save to.

The default path for all State Files is:

My Documents\<<mode name>\state

where <mode name> is the parameter used to select the mode with the INST:SEL command (for example, SA for the Spectrum Analyzer).

Key Path	Save
Mode	All
Remote Command	:MMEMory:STORe:STATe <filename>
Example	MMEM:STOR:STATe "MyStateFile.state" This stores the current instrument state data in the file MyStateFile.state in the default directory.
Notes	Both single and double quotes are supported for any filename parameter over remote. After saving to a register, that register's menu key is updated with the date the time, unless a custom label has been entered for that key. After saving to a register, you remain in the Save State menu, so that you can see the Register key

update. After saving to a file, the analyzer automatically returns to the previous menu and any Save As dialog goes away.

Backwards Compatibility SCPI	:MMEMory:STORe:STATe 1,<filename>
Initial S/W Revision	Prior to A.02.00

To File . . .

When you press “To File”, the analyzer brings up a Windows dialog and a menu entitled “Save As.” This menu allows you to navigate to the various fields in the Windows dialog without using a keyboard or mouse. The Tab and Arrow keys can also be used for dialog navigation.

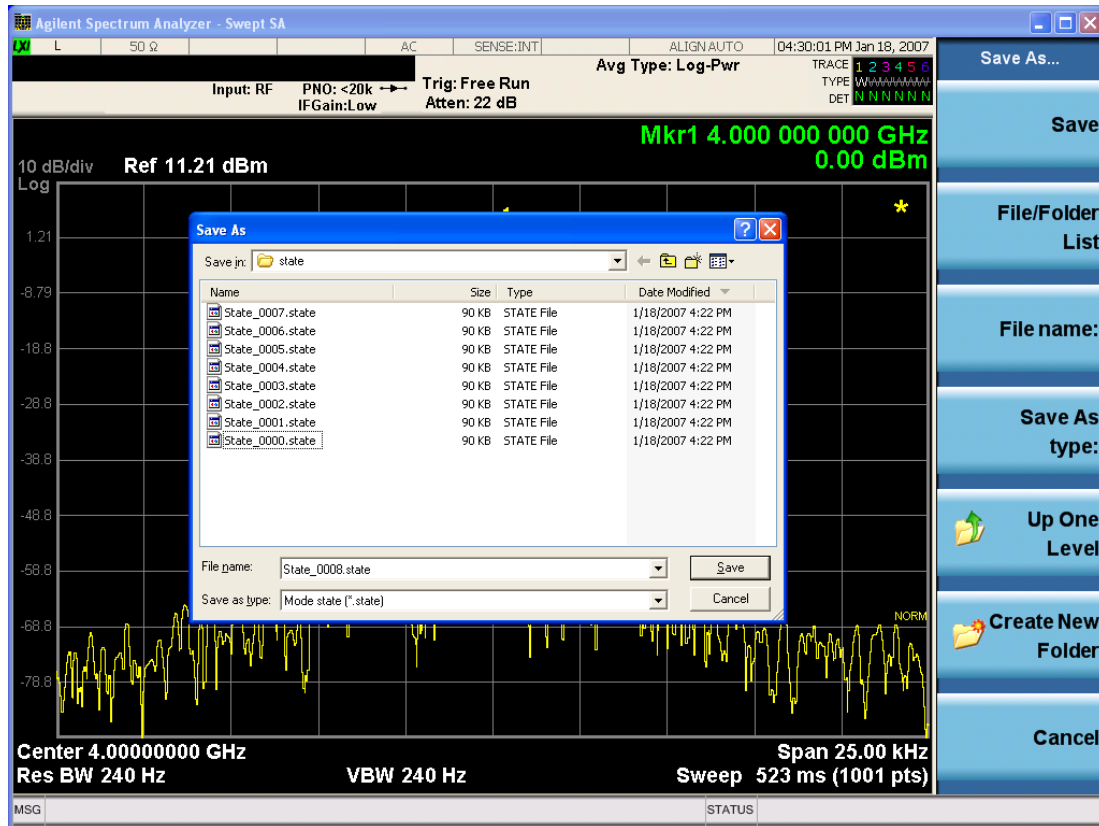

The Listed below

are the functions of the various fields in the dialog, and the corresponding softkeys:

Save

Performs the save to the specified file of the selected type. If the file already exists, a dialog will appear that allows you to replace the existing file by selecting OK, or you can Cancel the request. If you select OK, the file will be overwritten. Using the C: drive is strongly discouraged, since it runs the risk of being overwritten during an instrument software upgrade.

While the save is being performed, the floppy icon appears briefly in the Meas bar.

File/Folder List

Enables you to navigate to the center of the dialog that contains the list of files and folders. Once here you can get information about the file and use the tab keys to navigate to the other fields in the dialog, such as Save In.

Save In

The Save In field shows the path to which the file will be saved and allows you to change the path using the up and down arrow keys to navigate to other paths; the Enter key to open a directory; and the Backspace key to go back one directory. The **Save In field** defaults to the default path for this type of file and remembers the last path you used to save this type of file. There is no softkey for directly navigating to the Save In field but you can use left tab to get here from the File/Folder List.

User specified paths are remembered when you leave and return to a Mode and are reset back to the default using Restore Mode Defaults.

File Name

The File Name field is initially loaded with an automatically generated filename specific to the appropriate Save Type. The automatically generated filename is guaranteed not to conflict with any filename currently in the directory. You may replace or modify this filename using the File Name key. See the ["Quick Save " on page 2793](#) documentation for more on the automatic file naming algorithm.

When you press the File Name key the analyzer displays the Alpha Editor. Use the knob to choose the letter to add and the front-panel Enter key to add the letter to the file name. The BK character moves you back and the FW character moves you forward in the filename. The Select key on the front panel generates a space character. When you are done entering the filename press the Done softkey. This returns back to the **File Open** dialog and menu, but does not cause the save to occur.

Save As Type

This field shows the file suffix for the type of file you have selected to save. For example, if you navigated here while saving State, "Mode state (*.state)" is in the field. If you navigated here from saving Trace, ""Mode state (*.trace)" is in the field. If you navigated here while exporting a trace data file, "Trace Data (*.csv)" is in the field. For some file types, there is more than one choice in the dropdown, which you can select by using the up and down arrow keys and Enter.

Up One Level

This key corresponds to the icon of a folder with the up arrow that is in the tool bar of the dialog. When pressed, it causes the file and folder list to navigate up one level in the directory structure. The Backspace key does the same thing.

Create New Folder

This key corresponds to the icon of a folder with the "*" that is in the tool bar of the dialog. When pressed, a new folder is created in the current directory with the name **New Folder** and you can enter a new folder name using the Alpha Editor.

Cancel

This key corresponds to the Cancel selection in the dialog. It causes the current **Save As** request to be cancelled. The ESC key does the same thing.

Key Path	Save, State
Mode	All
Notes	Brings up Save As dialog for saving a State Save Type
Initial S/W Revision	Prior to A.02.00

Edit Register Names

You may enter a custom name on any of the Register keys, to help you remember what you are using that state to save. To do this, press the Edit Register Names key, choose the register whose name you wish to edit, and then enter the desired label using the Alpha Editor or an external PC keyboard.

The maximum number of characters that can be added is 30. In most cases, 30 characters will fit on two lines of the key.

See ["More Information" on page 754](#)

Key Path	Save, State
Mode	All
Remote Command	:MMEMory:REGister:STATe:LABel <reg number>,"label" :MMEMory:REGister:STATe:LABel? <reg number>
Example	:MMEM:REG:STAT:LAB 1,"my label"
Notes	<reg number> is an integer from 1 to 16. If the SCPI specifies an invalid register number an error message is generated, -222,"Data out of range;Invalid register label number" "label" is a string from 0 to 30 characters in length. If a label exceeds 30 characters, an error message is generated, -150,"String data error;Label clipped to 30 characters" "label" of length 0 erases the custom label and restores the default (time and date) label. E.g.: :MMEM:REG:STAT:LAB 1,""
Dependencies	N9060A-7FP or N9060B-2FP license required to edit the register names. When the feature is not licensed, sending this command generates an error, -221,"Settings conflict;Option not available"
Preset	The names are unaffected by Preset or power cycle but are set to the default label (time and date) on a "Restore System Defaults->Misc"
Initial S/W Revision	A.11.00

More Information

When you edit one of the register names, the time and date field will be replaced by the custom name.

If you delete all the characters in the custom name, it restores the default (time and date).

The register names are stored within the state files, but they are not part of the instrument state; that is, once you have edited a register name, loading a new state will not change that register name. Another consequence of this is that the names will be persistent through a power cycle. Also, if a named state file is transferred to another analyzer, it will bring its custom name along with it.

If you try to edit the name of an empty register, the analyzer will first save the state to have a file to put the name in. If you load a named state file into an analyzer with older firmware it will ignore the metadata.

The *SAV and *RCL commands will not be affected by the custom register names, nor will the MMEM commands.

Register 1 thru Register 16

Selecting any one of these register menu keys causes the State of the currently active mode to be saved to the specified Register. The registers are provided for rapid saving and recalling, since you do not need to specify a filename or navigate to a file. Each of the register menu keys annotates whether it is empty or at what date and time it was last modified. In addition, you can use the Edit Register Names key to enter custom names for each register.

Although these 16 registers are the only registers available from the front panel, there are 128 state registers available in the instrument. Registers 17–128 are only available from the SCPI interface, using the *SAV command.

There is one set of 128 state registers in the instrument, not one set for each Mode. When a state is saved, the Mode it was saved from is saved with it; then when it is recalled, the instrument switches to that Mode.

After the save completes, the corresponding register menu key annotation is updated with the date and time and the message "Register <register number> saved" is displayed.

Key Path	Save, State
Mode	All
Example	*SAV 1
Range	1–16 from front panel, 1–128 from SCPI
Readback	Date and time with seconds resolution are displayed on the key OR A custom name of up to 30 characters entered using the Edit Register Names key OR “(empty)” if no prior save operation has been performed to this register.
Initial S/W Revision	Prior to A.02.00
Modified at S/W Revision	A.11.00

Register 1 thru Register 16

Selecting any one of these register menu keys causes the State of the currently active mode to be saved to the specified Register. The registers are provided for rapid saving and recalling, since you do not need to specify a filename or navigate to a file. Each of the register menu keys annotates whether it is empty or at what date and time it was last modified. In addition, you can use the Edit Register Names key to enter custom names for each register.

Although these 16 registers are the only registers available from the front panel, there are 128 state registers available in the instrument. Registers 17–128 are only available from the SCPI interface, using the *SAV command.

There is one set of 128 state registers in the instrument, not one set for each Mode. When a state is saved, the Mode it was saved from is saved with it; then when it is recalled, the instrument switches to that Mode.

After the save completes, the corresponding register menu key annotation is updated with the date and time and the message "Register <register number> saved" is displayed.

Key Path	Save, State
Mode	All
Example	*SAV 1
Range	1-16 from front panel, 1-128 from SCPI
Readback	Date and time with seconds resolution are displayed on the key OR A custom name of up to 30 characters entered using the Edit Register Names key OR “(empty)” if no prior save operation has been performed to this register.
Initial S/W Revision	Prior to A.02.00
Modified at S/W Revision	A.11.00

Data (Export)

Exporting a data file stores data from the current measurement to mass storage files. The Export Menu only contains data types that are supported by the current measurement.

Since the commonly exported data files are in .csv format, the data can be edited by you prior to importing. This allows you to export a data file, manipulate the data in Excel (the most common PC Application for manipulating .csv files) and then import it.

Selecting an Export Data menu key will not actually cause the exporting to occur, since the analyzer still needs to know where you wish to save the data. Pressing the Save As key in this menu brings up the Save As dialog and Save As menu that allows you to specify the destination file and directory. Once a filename has been selected or entered in the Open menu, the export will occur as soon as the Save key is pressed.

Key Path	Save
Mode	All
Notes	The menu is built from whatever data types are available for the mode. So the key locations in the sub menu will vary. No SCPI command directly controls the Data Type that this key controls. The Data Type is included in the MMEM:STORe commands.
Dependencies	If a file type is not used by a certain measurement, that type is grayed out for that measurement. The key for a file type will not show at all if there are no measurements in the Mode that support it.
Preset	Is not affected by a Preset or shutdown, but is reset during Restore Mode Defaults
Readback	The data type that is currently selected
Initial S/W Revision	Prior to A.02.00

Export Trace Data

Enables you to export trace data with (optional) associated headers. Selecting this key displays a menu that enables you to choose which Trace to save (default is the selected Trace) and whether or not to save headers with the data. The header information is used by the VXA application when saved trace data is recalled, and enables it to be displayed with the same formatting and scaling that it had when saved. If headers are not saved, the scaling and format are set to default values when the trace is recalled. After making these selections, press Save As... and use the file dialog to choose a file name and format for the saved data.

Trace data can be exported in several different formats. Text and comma-separated variable (CSV) formats are useful for viewing the data or importing it to a spreadsheet program. The other formats are binary and thus more compact. Trace data files can be recalled for viewing into other VXA, LTE, LTETDD, iDEN, or 89601 measurements.

Key Path	Save, Data (Export)
Mode	VSA, LTE, LTETDD, IDEN
Remote Command	:MMEMory:STORe:TRACe:DATA TRACE1 TRACE2 TRACE3 TRACE4 TRACE5 TRACE6, "<filename>"[,CSV TXT SDF MAT4 MAT HDF5 BIN[,OFF ON 0 1]]
Example	:MMEM:STOR:TRAC:DATA TRACE1, "TRC1.TXT", TXT, ON
Notes	<p>The Save As... dialog box has the following format options when you are saving trace data:</p> <ul style="list-style-type: none"> • CSV (Comma delimited) (*.csv) • SDF (Fast) (*.sdf;*.dat) • Text (Tab delimited) (*.txt) <p>File format saved depends on selection. The appropriate file extension is appended to the filename if it is not supplied by the user.</p> <p>If the SCPI command includes just a file name, the file format is determined by the filename extension, which must be one of the choices above. *.sdf or an unrecognized extension chooses the SDF fast format. If the optional file format enumerator is included in the command, then this determines the file format and the file extension is ignored. The optional binary parameter determines if file headers are saved. The default is ON. If file headers are not wanted, use the optional "OFF" parameter.</p> <p>The optional Boolean parameter determines whether headers are saved in the file. By default the headers are saved.</p> <p>If you are not licensed to save a particular file type, then error -203.9010 is returned. If an invalid file format is specified or the file cannot be saved successfully, then error -25x is returned. If the save is successful, then advisory 0.1500 is shown.</p>
State Saved	No
Readback	(Trace 1 Trace 2 Trace 3 Trace 4 Trace 5 Trace 6)(with without) headers

Trace 1

Selects the Trace 1 register as the destination for the imported data.

Key Path	Save, Data (Export), Trace
Mode	VSA, LTE, LTETDD, IDEN

Trace 2

Selects the Trace 2 register as the destination for the imported data.

Key Path	Save, Data (Export), Trace
Mode	VSA, LTE, LTETDD, IDEN

Trace 3

Selects the Trace 3 register as the destination for the imported data.

Key Path	Save, Data (Export), Trace
Mode	VSA, LTE, LTETDD, IDEN

Trace 4

Selects the Trace 4 register as the destination for the imported data.

Key Path	Save, Data (Export), Trace
Mode	VSA, LTE, LTETDD, IDEN

Include Header

Enables you to select whether or not the saved trace data includes header information describing scaling, formatting, etc.

Key Path	Save, Data (Export), Trace
Mode	VSA, LTE, LTETDD, IDEN
State Saved	No

Measurement Results

Pressing this key selects Meas Results as the data type to be exported.

The Meas Results file contains measurement result sets, plus information describing the current state of the analyzer, as detailed in ["Meas Results File Definition" on page 759](#) and ["Meas Results File Example" on page 760](#) below.

Key Path	Save, Data
Remote Command	:MMEMory:STORe:RESults <string>
Example	:MMEM:STOR:RES "MeasR_0000.csv"

Notes	<p>If the save is initiated via SCPI and the file already exists, the file will be overwritten.</p> <p>The SCPI command exports Occupied Bandwidth measurement results to the file specified as the parameter in the current path. The default path is My Documents\<current mode>\data\obw\results.<="" p=""> <p>Using the C: drive is strongly discouraged, since it runs the risk of being overwritten during an instrument software upgrade.</p> <p>The SCPI parameter is a quoted string that specifies the filename. Both single and double quotes are supported for any filename parameter over SCPI.</p> </current></p>
Dependencies	The current active measurement must be the Occupied Bandwidth measurement to use this command.
Status Bits/OPC dependencies	Sequential – waits for the previous measurement to complete
Initial S/W Revision	Prior to A.02.00

Meas Results File Definition

The content of a Meas Results File is defined in this section.

The first lines in the file consist of identification and instrument configuration details, as follows.

- File ID string, which is “MeasResult”
- Measurement ID following Mode ID, which is “SA:OBW” for example.
- Firmware rev and model number
- Option string
- Auto Sweep Time Rules
- Average Mode
- Average Number
- Average State
- Center Frequency
- Detector
- Electrical Atten
- Electrical Atten State
- IFGain
- IFGainAuto
- Internal Preamp
- Internal Preamp Band
- Limit

- Limit State
- Max Hold
- Mechanical Atten
- MechanicalAttenStepEnum
- OBW Percent Pwr
- Resolution Band Width
- Resolution Bandwidth Shape
- Span
- Sweep Points
- Sweep Time
- Sweep Time Auto
- TriggerSource
- Video Bandwidth
- x DB

The data above is followed in the file by a line containing “MeasResult1” and “MeasResult2”. This line forms a header for each set of measurement results, which appear in subsequent lines. Each line of Measurement Results consists of two comma-separated values, for MeasResult1 and MeasResult2 respectively.

The MeasResult1 set in the file corresponds to the data returned by MEAS|READ|FETCh:OBWidth1, and the MeasResult2 set corresponds to the data returned by MEAS|READ|FETCh:OBWidth2.

The exported file is in CSV format, with a .csv extension.

Meas Results File Example

When imported into Microsoft Excel, a typical Meas Results CSV file appears as shown in the example below.

MeasResult	
SA:OBW	
A.10.53	N9030A
526 ALV ATP B1X B1Y B25 B40 BBA CR3 CRP DCF DDA DP2 DRD EA3 EDP EMC EP1 ERC ESC ESP EXM FSA LFE LNP MAT MPB NFE NUL P26 PFR PNC RTL RTS S40 SB1 SEC SM1 TVT YAS YAV	1
Auto Sweep Time Rules	Normal
Average Mode	Exponential
Average Number	10

Average State	TRUE
Center Frequency	1.33E+10
Detector	Average
IFGain	FALSE
IFGainAuto	FALSE
Internal Preamp	FALSE
Internal Preamp Band	Low
Limit	5000000
Limit State	FALSE
Max Hold	FALSE
OBW Percent Pwr	99
Resolution Band Width	27000
Resolution Bandwidth Shape	Gaussian
Span	3000000
Sweep Points	1001
Sweep Time	0.004933
Sweep Time Auto	TRUE
TriggerSource	Free
Video Bandwidth	270000
x DB	-26
MeasResult1	MeasResult2
2971020.10835045	-94.3702543927405
-74.9741251886604	-94.1447790390963

Save As . . .

When you press “Save As”, the analyzer brings up a Windows dialog and a menu entitled “**Save As.**” This menu allows you to navigate to the various fields in the Windows dialog without using a keyboard or mouse. The Tab and Arrow keys can also be used for dialog navigation.

See ["To File . . ." on page 2810](#) in Save, State for a full description of this dialog and menu.

The default path for saving files is:

For all of the Trace Data Files:

My Documents\`<mode name>`\data\traces

For all of the Limit Data Files:

My Documents\`<mode name>`\data\limits

For all of the Measurement Results Data Files:

My Documents\<mode name>\data\<measurement name>\results

For all of the Capture Buffer Data Files:

My Documents\<mode name>\data\captureBuffer

Key Path	Save, Data
Mode	All
Notes	The key location is mode-dependent and will vary. Brings up the Save As dialog for saving a <mode specific> Save Type. The save is performed immediately and does not wait until the measurement is complete.
Initial S/W Revision	Prior to A.02.00

Screen Image

Pressing Screen Image accesses a menu of functions that enable you to specify a format and location for the saved screen image. It brings up a menu that allows you to specify the color scheme of the Screen Image (Themes) or navigate to the Save As dialog to perform the actual save.

Screen Image files contain an exact representation of the analyzer display. They cannot be loaded back onto the analyzer, but they can be loaded into your PC for use in many popular applications.

The image to be saved is actually captured when the Save front panel key is pressed, and kept in temporary storage to be used if you ask for a Screen Image save. When the Screen Image key is pressed, a "thumbnail" of the captured image is displayed, as shown below:

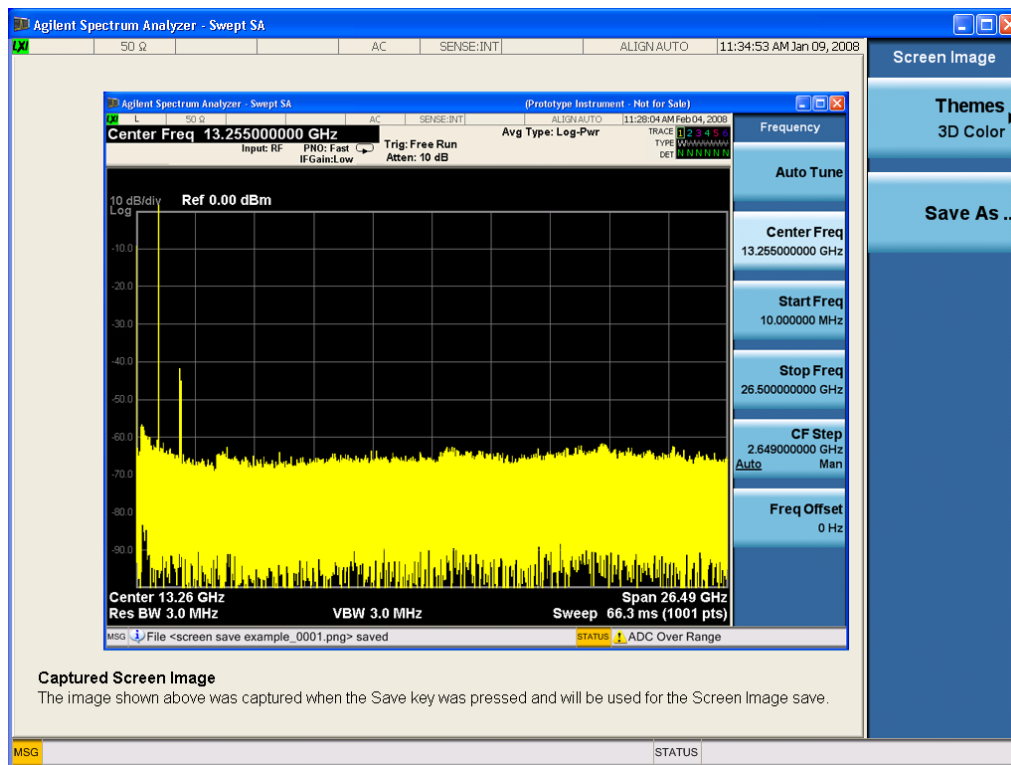

When you continue on into the Save As menu and complete the Screen Image save, the image depicted in the thumbnail is the one that gets saved, showing the menus that were on the screen before going into the Save menus. The save is performed immediately and does not wait until the measurement is complete.

After you have completed the save, the Quick Save front-panel key lets you quickly repeat the last save performed, using an auto-named file, with the current screen data.

NOTE

For versions previous to A.01.55, if you initiate a screen image save by navigating through the Save menus, the image that is saved will contain the Save menu softkeys, not the menu and the active function that were on the screen when you first pressed the Save front panel key.

Key Path	Save
Mode	All
Remote Command	:MMEMory:STORe:SCReen <filename>
Example	:MMEM:STOR:SCR "myScreen.png" This stores the current screen image in the file MyScreenFile.png in the default directory.
Initial S/W Revision	Prior to A.02.00

Themes

Accesses a menu of functions that enable you to choose the theme to be used when saving the screen image.

The **Themes** option is the same as the **Themes** option under the **Display** and **Page Setup** dialogs. It allows you to choose between themes to be used when saving the screen image.

Key Path	Save, Screen Image
Remote Command	:MMEMory:STORe:SCReen:THEME TDColor TDMonochrome FCOlor FMONochrome :MMEMory:STORe:SCReen:THEMe?
Example	:MMEM:STOR:SCR:THEM TDM
Preset	3D Color; Is not part of Preset, but is reset by Restore Misc Defaults or Restore System Defaults All and survives subsequent running of the modes.
Readback	3D Color 3D Mono Flat Color Flat Mono
Backwards Compatibility Notes	In ESA and PSA we offer the choice of "Reverse Bitmap" or "Reverse Metafile" when saving screen images. This is much like the "Flat Color" theme available in X-Series. Also, if you selected Reverse Bitmap AND a black & white screen image, that would be much like "Flat Monochrome". In other words, each of the X-Series themes has a similar screen image type in ESA/PSA. But they are not identical.
Initial S/W Revision	Prior to A.02.00

3D Color

Selects a standard color theme with each object filled, shaded and colored as designed.

Key Path	Save, Screen Image, Themes
Example	MMEM:STOR:SCR:THEM TDC
Readback	3D Color
Initial S/W Revision	Prior to A.02.00

3D Monochrome

Selects a format that is like 3D color but shades of gray are used instead of colors.

Key Path	Save, Screen Image, Themes
Example	MMEM:STOR:SCR:THEM TDM
Readback	3D Mono
Initial S/W Revision	Prior to A.02.00

Flat Color

Selects a format that is best when the screen is to be printed on an ink printer.

Key Path	Save, Screen Image, Themes
Example	MMEM:STOR:SCR:THEM FCOL
Readback	Flat Color
Initial S/W Revision	Prior to A.02.00

Flat Monochrome

Selects a format that is like Flat Color. But only black is used (no colors, not even gray), and no fill.

Key Path	Save, Screen Image, Themes
Example	MMEM:STOR:SCR:THEM FMON
Readback	Flat Mono
Initial S/W Revision	Prior to A.02.00

Save As...

When you press "Save As", the analyzer brings up a Windows dialog and a menu entitled "**Save As.**" This menu allows you to navigate to the various fields in the Windows dialog without using a keyboard or mouse. The Tab and Arrow keys can also be used for dialog navigation.

See "[To File . . .](#)" on page 2810 in Save, State for a full description of this dialog and menu.

The default path for Screen Images is

My Documents\<<mode name>\screen.

where <mode name> is the parameter used to select the mode with the INST:SEL command (for example, SA for the Spectrum Analyzer).

Key Path	Save, Screen Image
Notes	Brings up Save As dialog for saving a Screen Image Save Type
Initial S/W Revision	Prior to A.02.00

Mass Storage Catalog (Remote Command Only)

Key path	SCPI Only
Remote Command	:MMEMory:CATalog? [<directory_name>]
Notes	<p>The string must be a valid logical path.</p> <p>Queries disk usage information (drive capacity, free space available) and obtains a list of files and directories in a specified directory in the following format:</p> <p><numeric_value>,<numeric_value>,{<file_entry>}</p> <p>It returns two numeric parameters and as many strings as there are files and directories. The first parameter indicates the total amount of storage currently used in bytes. The second parameter indicates the total amount of storage available, also in bytes. The <file_entry> is a string. Each <file_entry> indicates the name, type, and size of one file in the directory list:</p> <p><file_name>,<file_type>,<file_size></p> <p>As the windows file system has an extension that indicates file type, <file_type> is always empty. <file_size> provides the size of the file in bytes. For directories, <file_entry> is surrounded by square brackets and both <file_type> and <file_size> are empty</p>
Initial S/W Revision	Prior to A.02.00

Mass Storage Change Directory (Remote Command Only)

Key path	SCPI Only
Remote Command	:MMEMory:CDIRectory [<directory_name>] :MMEMory:CDIRectory?
Notes	<p>The string must be a valid logical path.</p> <p>Changes the default directory for a mass memory file system. The <directory_name> parameter is a string. If no parameter is specified, the directory is set to the *RST value.</p> <p>At *RST, this value is set to the default user data storage area, that is defined as System.Environment.SpecialFolder.Personal.</p> <p>Query returns full path of the default directory.</p>
Initial S/W Revision	Prior to A.02.00

Mass Storage Copy (Remote Command Only)

Key path	SCPI Only
Remote Command	:MMEMory:COpy <string>,<string>[,<string>,<string>]
Notes	<p>The string must be a valid logical path.</p> <p>Copies an existing file to a new file or an existing directory to a new directory.</p> <p>Two forms of parameters are allowed. The first form has two parameters. In this form, the first parameter specifies the source, and the second parameter specifies the destination.</p> <p>The second form has four parameters. In this form, the first and third parameters specify the source. The second and fourth parameters specify the directories. The first pair of parameters specifies the source. The second pair specifies the destination. An error is generated if the source doesn't exist or the destination file already exists.</p> <p>This command will generate an "access denied" error if the destination is a restricted folder (e.g., C:\Windows) and the current user does not have Power User or Administrator privileges.</p>

Mass Storage Device Copy (Remote Command Only)

This command transfers data to/from a file and a peripheral device.

Key path	SCPI Only
Remote Command	:MMEMory:COpy:DEvice <source_string>,<dest_string>
Notes	<p>The strings must be a valid logical path or a valid device keyword. If the dest_string is a device keyword, the data is copied from the source file to the device. If the source_string is a device keyword, the data is copied to the source file from the device.</p> <p>Valid device keywords are:</p> <p>SNS (smart noise source)</p> <p>An error is generated if the file or device is not found.</p>

Mass Storage Delete (Remote Command Only)

Key path	SCPI Only
Remote Command	:MMEMory:DElete <file_name>[,<directory_name>]
Notes	<p>The string must be a valid logical path.</p> <p>Removes a file from the specified directory. The <file_name> parameter specifies the file name to be removed. This command will generate an "access denied" error if the file is in a restricted folder (e.g., C:\Windows) and the current user does not have Power User or Administrator privileges.</p>
Initial S/W Revision	Prior to A.02.00

Mass Storage Data (Remote Command Only)

Creates a file containing the specified data OR queries the data from an existing file.

Key path	SCPI Only
Remote Command	:MMEMory:DATA <file_name>, <data> :MMEMory:DATA? <file_name>
Notes	The string must be a valid logical path. The command form is MMEMory:DATA <file_name>,<data>. It loads <data> into the file <file_name>. <data> is in 488.2 block format. <file_name> is string data. The query form is MMEMory:DATA? <file_name> with the response being the associated <data> in block format.
Initial S/W Revision	Prior to A.02.00

Mass Storage Make Directory (Remote Command Only)

Key path	SCPI Only
Remote Command	:MMEMory:MDIRectory <directory_name>
Notes	The string must be a valid logical path. Creates a new directory. The <directory_name> parameter specifies the name to be created. This command will generate an “access denied” error if the new directory would be in a restricted folder (e.g., C:\Windows) and the current user does not have Power User or Administrator privileges.
Initial S/W Revision	Prior to A.02.00

Mass Storage Move (Remote Command Only)

Key path	SCPI Only
Remote Command	:MMEMory:MOVE <string>,<string>[,<string>,<string>]
Notes	The string must be a valid logical path. Moves an existing file to a new file or an existing directory to a new directory. Two forms of parameters are allowed. The first form has two parameters. In this form, the first parameter specifies the source, and the second parameter specifies the destination. The second form has four parameters. In this form, the first and third parameters specify the source. The second and fourth parameters specify the directories. The first pair of parameters specifies the source. The second pair specifies the destination. An error is generated if the source doesn't exist or the destination file already exists. This command will generate an “access denied” error if the destination is a restricted folder (e.g., C:\Windows) and the current user does not have Power User or Administrator privileges.
Initial S/W Revision	Prior to A.02.00

Mass Storage Remove Directory (Remote Command Only)

Key path	SCPI Only
Remote Command	<code>:MMEMory:RDIRectory <directory_name></code>
Notes	<p>The string must be a valid logical path.</p> <p>Removes a directory. The <directory_name> parameter specifies the directory name to be removed. All files and directories under the specified directory shall also be removed.</p> <p>This command will generate an “access denied” error if the folder is a restricted folder (e.g., C:\Windows) or is in a restricted folder and the current user does not have Power User or Administrator privileges.</p>
Initial S/W Revision	Prior to A.02.00

Single (Single Measurement/Sweep)

Sets the analyzer for Single measurement operation. The single/continuous state is Meas Global, so the setting will affect all the measurements. If you are Paused, pressing Single does a Resume.

See "[More Information](#)" on page 769

Key Path	Front-panel key
Example	:INIT:CONT OFF
Notes	See Cont key description.
Backwards Compatibility Notes	<p>For Spectrum Analysis mode in ESA and PSA, the Single hardkey and the INITiate:IMM switched from continuous measurement to single measurement and restarted sweeps and averages (displayed average count reset to 1), but did not restart Max Hold and Min Hold. In the X-Series, the Single hardkey and the INITiate:IMM command initiate a sweep/ measurement/ average sequence/hold sequence including MaxHold and MinHold.</p> <p>For Spectrum Analysis mode in ESA and PSA, the Single hardkey restarted the sweep regardless of whether or not you were in an active sweep or sweep sequence. In the X-Series, Restart does this but Single only restarts the sweep or sweep sequence if you are in the idle state.</p> <p>INIT[:IMM] in ESA & PSA Spectrum Analysis Mode does an implied ABORT. In some other PSA Modes, INIT[:IMM] is ignored if not in the idle state. . The X-Series follows the ESA/PSA SA Mode model, which may cause some Modes to have compatibility problems.</p>
Initial S/W Revision	Prior to A.02.00

More Information

See "[Restart](#)" on page 2807 for details on the INIT:IMMEDIATE (Restart) function.

If you are already in single sweep, the INIT:CONT OFF command has no effect.

If you are already in Single Sweep, then pressing the Single key in the middle of a sweep does not restart the sweep or sequence. Similarly, pressing the Single key does not restart the sweep or sequence if the sweep is not in the idle state (for example, if you are taking a very slow sweep, or the analyzer is waiting for a trigger). Instead, it results in a message. "Already in Single, press Restart to initiate a new sweep or sequence". Even though pressing the Single key in the middle of a sweep does not restart the sweep, sending INIT:IMMEDIATE does reset it.

To take one more sweep without resetting the average count, increment the average count by 1, by pressing the step up key while **Average/Hold Number** is the active function, or sending the remote command CALC:AVER:TCON UP.

Source

There is no Source control functionality for this measurement. When this key is pressed, the screen either displays a blank menu, or the previously-selected menu remains unchanged.

Key Path	Front-panel key
----------	-----------------

Span X Scale

Activates the Span function and displays the menu of span functions. The parameter values are measurement independent.

Key Path	Front-panel key
Initial S/W Revision	Prior to A.02.00

Span

Set the frequency of the occupied bandwidth span for the current measurement.

Key Path	Span X Scale
Mode	SA, WCDMA, C2K, WIMAX OFDMA, TD-SCDMA, 1xEVDO, ISDB-T, CMMB, LTE, LTETDD, BLUETOOTH, WLAN, MSR, LTEAFDD, LTEATDD
Remote Command	[:SENSe]:OBWidth:FREQuency:SPAN <freq> [:SENSe]:OBWidth:FREQuency:SPAN? [:SENSe]:OBWidth:FREQuency:SPAN:AUTO ON OFF 0 1 [:SENSe]:OBWidth:FREQuency:SPAN:AUTO?
Example	OBW:FREQ:SPAN 2.4 MHz OBW:FREQ:SPAN? OBW:FREQ:SPAN:AUTO 0 OBW:FREQ:SPAN:AUTO?
Notes	Span Auto Detector ([:SENSe]:OBWidth:FREQuency:SPAN:AUTO) is only available in MSR and LTE-Advanced FDD/TDD mode. The BAF SCPI is MSR and LTE-Advanced FDD/TDD only.
Couplings	When changing the Occupied Bandwidth Span, the Resolution Bandwidth and Video Bandwidth are set to AUTO to prevent the span from clipping. This is only available in MSR and LTE-Advanced FDD/TDD mode.
Preset	SA: 3 MHz WCDMA: 10 MHz WIMAX OFDMA: 20 MHz CDMA2K: 2 MHz TD-SCDMA: 4.8 MHz 1xEVDO: 3.75 MHz ISDB-T: 20 MHz CMMB: 8 MHz LTE, LTETDD, LTEAFDD, LTEATDD: 10 MHz BLUETOOTH:2 MHz WLAN: If Radio Std is 802.11a/g 802.11n(20MHz) 802.11ac(20MHz): 25 MHz If Radio Std is 802.11b: 30MHz

	If Radio Std is 802.11n(40MHz), 802.11ac (40MHz): 50 MHz If Radio Std is 802.11ac(80MHz): 100MHz If Radio Std is 802.11ac(160MHz): 200MHz MSR: 20MHz ON
State Saved	Saved in instrument state.
Min	100 Hz
Max	Hardware Maximum Span
Backwards Compatibility SCPI	[:SENSe] :EBWidth:FREQuency:SPAN
Initial S/W Revision	Prior to A.02.00
Modified at S/W Revision	A.03.00, A.10.00, A.14.00

Full Span

Changes the Occupied Bandwidth Span to show the full frequency range of the analyzer. When using external mixing, it changes the displayed frequency span to the frequency range specified for the selected external mixing band.

Key Path	Span X Scale
Mode	SA, WCDMA, C2K, WIMAX OFDMA, ISDB-T, CMMB, LTE, LTETDD, BLUETOOTH, WLAN
Remote Command	[:SENSe] :OBWidth:FREQuency:SPAN:FULL
Example	OBW:FREQ:SPAN:FULL
Notes	You must be in the Spectrum Analysis mode, W-CDMA mode, ISDB-T mode, CMMB mode, LTE mode, LTE TDD mode, BLUETOOTH mode, WLAN mode, cdma2000 mode, MSR or WIMAX OFDMA mode to use this command. Use:INSTrument:SElect to set the mode.
Dependencies	For MSR and LTE-Advanced FDD/TDD mode, this key is blank.
Couplings	Selecting full span changes the measurement span value.
Initial S/W Revision	Prior to A.02.00
Modified at S/W Revision	A.03.00

Last Span

Changes the measurement frequency span to previous measurement span setting. If there is no existing previous span value then the span remains unchanged.

Key Path	Span X Scale
Mode	SA, WCDMA, C2K, WIMAX OFDMA, ISDB-T, CMMB, LTE, LTETDD, BLUETOOTH, WLAN, MSR, LTEAFDD, LTEATDD
Remote Command	[:SENSe] :OBWidth:FREQuency:SPAN:PREVious

Example	OBW:FREQ:SPAN:PREV
Notes	You must be in the Spectrum Analysis mode, W-CDMA mode, ISDB-T mode, CMMB mode, LTE mode, LTE TDD mode, BLUETOOTH mode, WLAN mode, cdma2000 mode, MSR, LTE-Advanced FDD/TDD or WIMAX OFDMA mode to use this command. Use:INSTRument:SElect to set the mode.
Couplings	Selecting last span changes the measurement span value.
Initial S/W Revision	Prior to A.02.00
Modified at S/W Revision	A.03.00

Sweep/Control

Displays a menu of functions that enable you to set up and control the sweep time and source for the current measurement.

For details about this key, see ["Sweep/Control" on page 2703](#).

Key Path	Front-panel key
Initial S/W Revision	Prior to A.02.00

Sweep Time

Selects the length of time in which the spectrum analyzer sweeps the displayed frequency span. Additional overhead time, which impacts the sweep rate, is not calculated as part of the sweep time. In fact:

- sweep rate = span/sweep time
- update rate = 1/(sweep time + overhead)
- sweep cycle time = sweep time + overhead

Sweep time is coupled to RBW and VBW, and is impacted by the number of sweep points, so changing those parameters may change the sweep time.

This function is not available when the selected input is I/Q.

Key Path	Sweep/Control
Mode	SA, WCDMA, C2K, WIMAX OFDMA, TD-SCDMA, 1xEVDO, ISDB-T, CMMB, LTE, LTETDD, BLUETOOTH, WLAN, MSR, LTEAFDD, LTEATDD
Remote Command	[:SENSe] :OBWidth :SWEep :TIME <time> [:SENSe] :OBWidth :SWEep :TIME? [:SENSe] :OBWidth :SWEep :TIME :AUTO OFF ON 0 1 [:SENSe] :OBWidth :SWEep :TIME :AUTO ?
Example	OBW:SWE:TIME 50 ms OBW:SWE:TIME? OBW:SWE:TIME:AUTO ON OBW:SWE:TIME:AUTO?
Couplings	When you manually change the Time, this state automatically goes to 'Man'.
Preset	SA, WIMAX OFDMA, C2K, TD-SCDMA, 1xEVDO, ISDB-T, CMMB, LTE, LTETDD, BLUETOOTH, WLAN, MSR, LTEAFDD, LTEATDD: Automatically Calculated WCDMA: 32.6 ms SA, WIMAX OFDMA, C2K, TD-SCDMA, 1xEVDO, ISDB-T, CMMB, LTE, LTETDD, WLAN, MSR, LTEAFDD, LTEATDD: ON WCDMA: OFF
State Saved	Saved in instrument state.

Min	1 ms
Max	4000 s
Initial S/W Revision	Prior to A.02.00
Modified at S/W Revision	A.03.00

Sweep Setup

Accesses the sweep setup settings for the current measurement.

Key Path	Sweep/Control
Initial S/W Revision	Prior to A.02.00

Auto Sweep Time Rules

Switches the analyzer between normal and accuracy sweep states.

Setting Auto Sweep Time to Accy results in slower sweep times, usually about three times as long, but better amplitude accuracy for CW signals. The instrument amplitude accuracy specifications only apply when Auto Sweep Time is set to Accy.

Additional amplitude errors which occur when Auto Sweep Time is set to Norm are usually well under 0.1 dB, though this is not guaranteed. Because of the faster sweep times and still low errors, Norm is the preferred setting of Auto Sweep Time. Auto Sweep Time is set to Norm on a Preset or Auto Couple. This means that in the Preset or Auto Coupled state, instrument amplitude accuracy specifications do not apply.

Key Path	Sweep/Control, Sweep Setup
Mode	SA, WCDMA, C2K, WIMAX OFDMA, TD-SCDMA, 1xEVDO, ISDB-T, CMMB, LTE, LTETDD, BLUETOOTH, WLAN, MSR, LTEAFDD, LTEATDD
Remote Command	[:SENSe] :OBWidth :SWEep :TIME :AUTO :RULEs NORMal ACCuracy [:SENSe] :OBWidth :SWEep :TIME :AUTO :RULEs ?
Example	OBW:SWE:TIME:AUTO:RUL NORM OBW:SWE:TIME:AUTO:RUL?
Notes	Set to Norm when Auto Couple is pressed or sent remotely.
Preset	NORMal
State Saved	Saved in instrument state.
Range	Norm Accy
Initial S/W Revision	Prior to A.02.00
Modified at S/W Revision	A.03.00

Pause

Pauses the measurement after the current data acquisition is complete.

When Paused, the label on the key changes to Resume. Pressing Resume resumes the measurement at the point where it had been paused.

See "[Pause/Resume](#)" on page 2703 for more information.

Key Path	Sweep/Control
Initial S/W Revision	Prior to A.02.00

Gate

Accesses a menu that enables you to control the gating function. The Gate functionality is used to view signals best viewed by qualifying them with other events.

Gate setup parameters are the same for all measurements – they do not change as you change measurements. Settings like these are called “Meas Global” and are unaffected by Meas Preset.

Note that Sweep Time autocoupling rules and annotation are changed by Gate being on.

Key Path	Sweep/Control
Scope	Meas Global
Readback	The state and method of Gate, as [Off, LO] or [On, Video]. Note that for measurements that only support gated LO, the method is nonetheless read back, but always as LO.
Initial S/W Revision	Prior to A.02.00

Gate On/Off

Turns the gate function on and off.

When the Gate Function is on, the selected Gate Method is used along with the gate settings and the signal at the gate source to control the sweep and video system with the gate signal. Not all measurements allow every type of Gate Methods.

When Gate is on, the annunciation in the measurement bar reflects that it is on and what method is used, as seen in the following "Gate: LO" annunciator graphic.

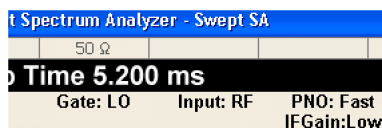

Key Path	Sweep/Control, Gate
Remote Command	[:SENSe] :SWEep:EGATE [:STATe] OFF ON 0 1

	[:SENSe] :SWEep:EGATe [:STATe] ?
Example	SWE:EGAT ON SWE:EGAT?
Dependencies	<p>The function is unavailable (grayed out) and Off when:</p> <ul style="list-style-type: none"> • Gate Method is LO or Video and FFT Sweep Type is manually selected. • Gate Method is FFT and Swept Sweep Type is manually selected. • Marker Count is ON. <p>The following are unavailable whenever Gate is on:</p> <ul style="list-style-type: none"> • FFT under Sweep Type when Method=LO or Video or Swept under Sweep Type when Method=FFT • Marker Count <p>While Gate is on, the Auto Rules for Sweep Type are modified so that the choice agrees with the Gate Method: i.e., FFT for Method = FFT and Swept for Method = LO or Video.</p> <p>The Gate softkey and all SCPI under the [:SENSe]:SWEep:EGATe SCPI node are grayed out when Source Mode is Tracking with an external source. This is because the Gate circuitry is used to sync the external source. If the Tracking Source is turned on, the Gate is turned off.</p> <p>When in the ACP measurement:</p> <ul style="list-style-type: none"> • When Meas Method is RBW or FAST, this function is unavailable and the key is grayed out. • Whenever Gate is on, Meas Method, RBW or FAST is unavailable and keys for those are grayed out. • When Gate is on, Offset Res BW and Offset Video BW are ignored (if you set these values) and the measurement works as if all Offset Res BW and all Offset Video BW are coupled with the Res BW and the Video BW under the BW menu. When Gate is on, the Offset BW key in the Offset/Limit menu is grayed out.
Preset	Off LTETDD: On
State Saved	Saved in instrument state
Range	On Off
Backwards Compatibility SCPI	[:SENSe]:SWEep:TIME:GATE[:STATe] ESA compatibility
Backwards Compatibility Notes	In ESA, Trig Delay (On) and Gate (On) could not be active at the same time.. This dependency does not exist in PSA or in the X-Series.
Initial S/W Revision	Prior to A.02.00

Gate View On/Off

Turning on Gate View in the Swept SA measurement provides a single-window gate view display..

Turning on Gate View in other measurements shows the split-screen Gate View. In these measurements, when the Gate View is on, the regular view of the current measurement traces and results are reduced vertically to about 70% of the regular height. The Zero Span window, showing the positions of the Gate, is shown between the Measurement Bar and the reduced measurement window. By reducing the height of the measurement window, some of the annotation on the Data Display may not fit and is not shown.

Key Path	Sweep/Control, Gate
Remote Command	[:SENSe] :SWEep:EGATe:VIEW ON OFF 1 0 [:SENSe] :SWEep:EGATe:VIEW?
Example	SWE:EGAT:VIEW ON turns on the gate view.
Dependencies	In the Swept SA measurement: In Gate View, the regular Sweep Time key is grayed out . When pressed, the grayed out key puts up the informational message "Use Gate View Sweep Time in the Gate menu." In the other measurements: When you turn Gate View on, the lower window takes on the current state of the instrument. Upon leaving Gate View, the instrument takes on the state of the lower window. When you turn Gate View on, the upper window Sweep Time is set to the gate view sweep time.
Couplings	These couplings apply to the Swept SA measurement: <ul style="list-style-type: none"> • When Gate View is turned on, the instrument is set to Zero Span. • Gate View automatically turns off whenever a Span other than Zero is selected. • Gate View automatically turns off if you press the Last Span key while in Gate View, and the instrument returns to the Span it was in before entering Gate View (even if that is Zero Span). • When Gate View is turned on, the sweep time used is the gate view sweep time. This is set according to the rules in section "Gate View Setup " on page 2499 • When Gate View is turned off, Sweep Time is set to the normal Swept SA measurement sweep time. • If Gate View is on and Gate is off, then turning on Gate turns off Gate View.
Preset	OFF
State Saved	Saved in instrument state
Range	On Off
Initial S/W Revision	Prior to A.02.00

A sample of the Gate View screen in the Swept SA measurement is shown in the following graphic :

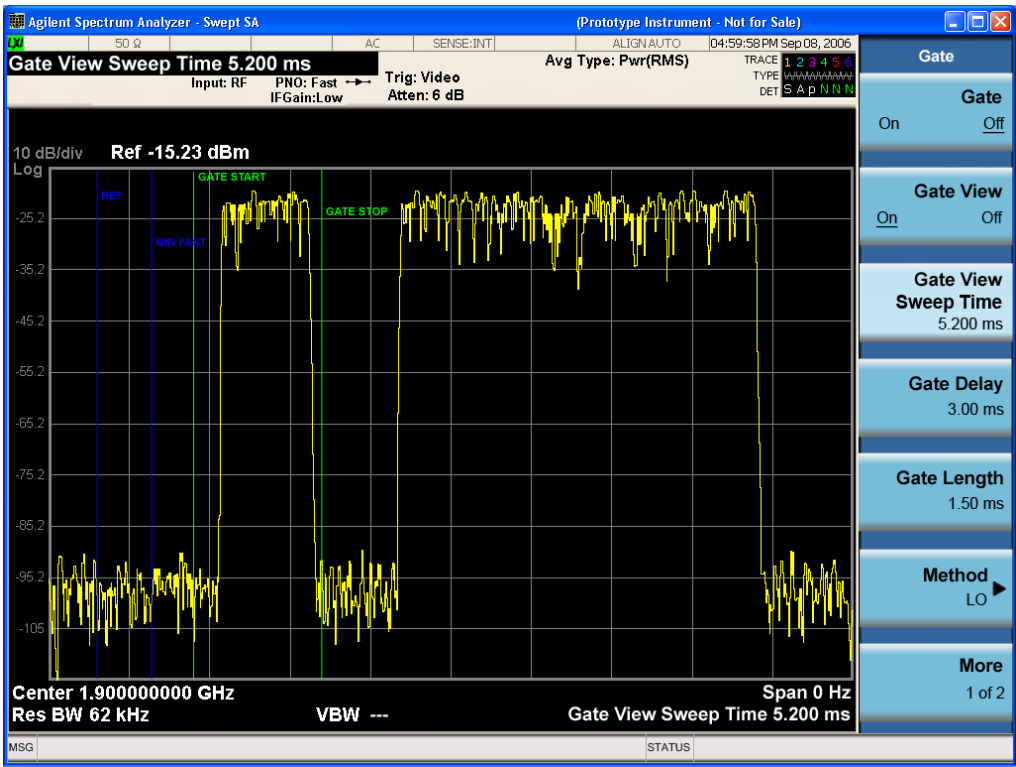

A sample of the Gate View screen in other measurements is shown in the following graphic. This example is for the ACP measurement:

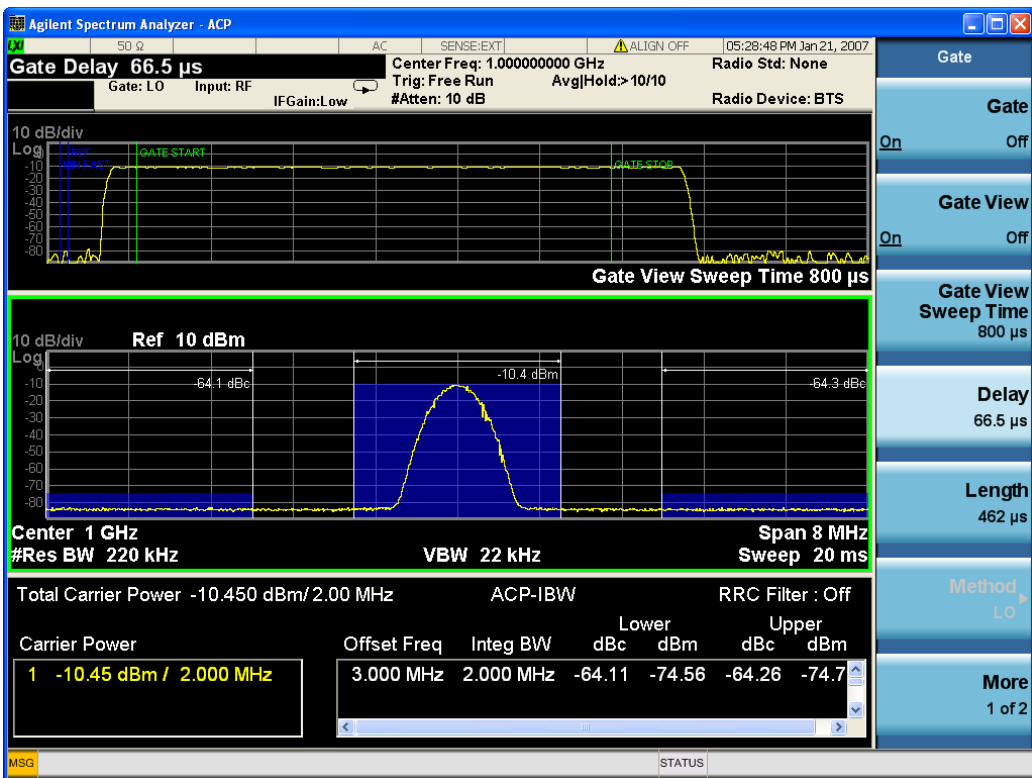

Turning Gate View off returns the analyzer to the Normal measurement view.

In the Swept SA, the normal measurement view is the single-window Swept SA view. When returning to this view, the Swept SA measurement returns to the Span it was in before entering **Gate View** (even if that is Zero Span).

The **Gate View** window is triggered from the Gate Source, with zero trigger delay. Also, when updating the **Gate View** window, the Gate itself must not operate. So it is internally shut off while the gate view window is being updated. For the Swept SA measurement, this means that the Gate is internally shut off whenever the gate view window is displayed. The measurement bar and softkeys continue to show the Trigger source for the main sweep window and give no indication that the Gate is shut off or that the Gate View window is triggered from the Gate Source.

When in **Gate View**, vertical lines are displayed in the Gate View window as follows:

- Green lines are displayed at the gate edges as follows: in Edge Gate, a line is shown for Delay and one for the end of the Gate period, defined by Length. In Level Gate a line is shown only for Delay. You can adjust the position of the green lines by adjusting the gate length and the gate delay. These lines update in the Gate View window as the active function changes, even if the window is not being updated. In Gated LO and Gated Video, these lines are positioned relative to the delay reference line (not relative to 0 time). In Gated FFT, their location is relative to the left edge of the screen.
- A blue line is displayed showing the delay reference, that is, the reference point for the Gate Delay within the Zero Span window. The blue line represents where (in time) the effective location of the gate start would be if the gate were programmed to zero delay.
-
- The second blue line is labeled "MIN FAST" as shown in the figure above because it represents the minimum Gate Delay for fast Gated LO operation. This line is only displayed in Gated LO. You cannot scroll (knob) or decrement (down key) the Gate Delay to less than that represented by the position of this line, it can only be set below this position manually, although once there it can be moved freely with the knob while below the line.
- A yellow line in the Gated Video case only, is displayed at Blength, where Blength is the display point (bucket) length for the swept trace, which is given by the sweep time for that trace divided by number of Points – 1. So it is referenced to 0 time, not to the delay reference. This line is labeled NEXT PT (it is not shown in the figure above because the figure above is for Gated LO).
- The yellow line represents the edge of a display point (bucket). Normally in Gated Video, the bucket length must be selected so that it exceeds the off time of the burst. There is another way to use the analyzer in Gated Video measurements, and that is to set the bucket width much shorter than the off time of the burst. Then use the Max Hold trace function to fill in "missing" buckets more slowly. This allows you to see some of the patterns of the Gated Video results earlier, though seeing a completely filled-in spectrum later.

Gate View Setup

Accesses a menu that enables you to setup parameters relevant to the Gate View

Key Path	Sweep/Control, Gate
Scope	Meas Global
Initial S/W Revision	A.10.00

Gate View Sweep Time

Controls the sweep time in the Gate View window. To provide an optimal view of the gate signal, the analyzer initializes Gate View Sweep Time based on the current settings of Gate Delay and Gate Length.

Key Path	Sweep/Control, Gate, Gate View Setup
Remote Command	[:SENSe] :SWEep:EGATe:TIME <time> [:SENSe] :SWEep:EGATe:TIME?
Example	SWE:EGAT:TIME 500 ms
Dependencies	Gate View Sweep Time is initialized: <ul style="list-style-type: none"> • On Preset (after initializing delay and length). • Every time the Gate Method is set/changed. <p>Additionally, in the Swept SA measurement, whenever you do a Preset, or leave Gate View, the analyzer remembers the Gate Delay and Gate Length settings. Then, when returning to Gate View, if the current Gate Delay and/or Gate Length do not match the remembered values Gate View Sweep Time is re-initialized.</p> <ol style="list-style-type: none"> 1. Compute the location of the "gate stop" line, which you know is at time $t = t_{min} + \text{GateDelay} + \text{GateLength}$.
Preset	519.3 μ s WiMAX OFDMA: 5 ms GSM/EDGE: 1 ms
State Saved	Saved in instrument state
Max	6000 s
Initial S/W Revision	Prior to A.02.00

Gate View Start Time

Controls the time at the left edge of the Gate View.

Key Path	Sweep/Control, Gate, Gate View Setup
Remote Command	[:SENSe] :SWEep:EGATe:VIEW:STARt <time> [:SENSe] :SWEep:EGATe:VIEW:STARt?
Example	SWE:EGAT:VIEW:STAR 10ms
Notes	Units of time are required or no units; otherwise an invalid suffix error message will be generated. See error -131.
Preset	0 ms
State Saved	Saved in instrument state
Min	0
Max	500 ms
Initial S/W Revision	A.10.00

Gate Delay

Controls the length of time from the time the gate condition goes True until the gate is turned on.

Key Path	Sweep/Control, Gate
Remote Command	[:SENSe] :SWEep:EGATe:DELay <time> [:SENSe] :SWEep:EGATe:DELay?
Example	SWE:EGAT:DELay 500ms SWE:EGAT:DELay?
Notes	Units of time are required or no units; otherwise an invalid suffix error message will be generated.
Preset	57.7 us WiMAX OFDMA: 71 us GSM/EDGE: 600 us WLAN: 500 us
State Saved	Saved in instrument state
Min	0.0 us
Max	100 s
Backwards Compatibility SCPI	[:SENSe] :SWEep:TIME:GATE:DELay ESA compatibility
Initial S/W Revision	Prior to A.02.00

Gate Length

Controls the length of time that the gate is on after it opens.

Key Path	Sweep/Control, Gate
Remote Command	[:SENSe] :SWEep:EGATe:LENGth <time> [:SENSe] :SWEep:EGATe:LENGth?
Example	SWE:EGAT:LENG 1 SWE:EGAT:LENG?
Notes	Units of time are required or no units; otherwise an invalid suffix error message will be generated.
Dependencies	<p>Grayed out when Gate Method is set to FFT in which case the label changes to that shown below.</p>  <p>The key is also grayed out if Gate Control = Level.</p>
Preset	461.6 us

	WiMAX OFDMA: 50 us GSM/EDGE: 200 us WLAN: 1.54 ms
State Saved	Saved in instrument state
Min	100 ns
Max	5 s
Backwards Compatibility SCPI	[:SENSe]:SWEep:TIME:GATE:LENGth ESA compatibility
Initial S/W Revision	Prior to A.02.00

Gate Source

The menus under the Gate Source key are the same as those under the Trigger key, with the exception that neither Free Run nor Video are available as Gate Source selections. However, a different SCPI command is used to select the Gate Source (see table below) because you may independently set the Gate Source and the Trigger Source.

Any changes to the settings in the setup menus under each Gate Source selection key (for example: Trigger Level, Trigger Delay, etc.) also affect the corresponding settings under the Trigger menu keys. The SCPI commands used for these are the same for Trigger and Gate, since there is only one setting which affects both Gate and Trigger. Example: to set the Trigger Level for External 1 you use the command :TRIG:EXT1:LEV regardless of whether you are using External 1 as a Trigger Source or a Gate Source.

Key Path	Sweep/Control, Gate
Remote Command	[:SENSe]:SWEep:EGATe:SOURce EXTernal1 EXTernal2 LINE FRAME RFBurst [:SENSe]:SWEep:EGATe:SOURce?
Dependencies	In some models, there is no second External input. In these models, the External 2 key is blanked and the EXTernal2 parameter will generate a "Hardware missing; Not available for this model number" error.
Preset	EXTernal 1 GSM/EDGE, MSR: FRAME LTETDD: EXTernal 1When Direction is Downlink, FRAME when Direction is Uplink.
Backwards Compatibility Notes	In ESA, there is a single Gate input port. In PSA, the Gate Source may be taken from one of two specified input ports. In the X-Series, any Trigger Source can be a Gate Source.
Initial S/W Revision	Prior to A.02.00
Modified at S/W Revision	A.03.00, A.14.00

Line

Pressing this key, when it is not selected, selects the line signal as the trigger. A new sweep/measurement will start synchronized with the next cycle of the line voltage. Pressing this key, when it is already selected, access the line trigger setup menu.

Key Path	Trigger
Example	TRIG:SOUR LINE Swept SA measurement TRIG:< meas>:SOUR LINE Measurements other than Swept SA
Dependencies	Line trigger is not available when operating from a "dc power source", for example, when the instrument is powered from batteries.
State Saved	Saved in instrument state
Status Bits/OPC dependencies	The Status Operation Register bit 5 "Waiting for Trigger" is set at the same time as the Sweeping or Measuring bit is set. It is cleared when the trigger actually occurs (that is, after the trigger event occurs and all the applicable trigger criteria have been met). A corresponding pop-up message ("Waiting for trigger") is generated if no trigger signal appears after approximately 2 sec. This message goes away when a trigger signal appears.
Initial S/W Revision	Prior to A.02.00

Trig Slope

Controls the trigger polarity. It is set positive to trigger on a rising edge and negative to trigger on a falling edge.

Key Path	Trigger, Line
Remote Command	:TRIGger[:SEquence]:LINE:SLOPe POSitive NEGative :TRIGger[:SEquence]:LINE:SLOPe?
Example	TRIG:LINE:SLOP NEG
Preset	POSitive
State Saved	Saved in instrument state
Backwards Compatibility Notes	The legacy :TRIGger[:SEquence]:SLOPe command affects the slopes for the VID, LINE, EXT1, EXT2, and RFB triggers.
Initial S/W Revision	Prior to A.02.00

External 1

Pressing this key, when it is not selected, selects an external input signal as the trigger. A new sweep/measurement will start when the external trigger condition is met using the external 1 input connector on the rear panel.

Pressing this key, when it is already selected, accesses the external 1 trigger setup menu.

Key Path	Trigger
Example	TRIG:SOUR EXT1 Swept SA measurement TRIG:<meas>:SOUR EXT1 Measurements other than Swept SA
Dependencies	Grayed out if in use by Point Trigger in the Source Setup menu. Forced to Free Run if already selected and Point Trigger is set to External 1.
State Saved	Saved in instrument state
Status Bits/OPC dependencies	The Status Operation Register bit 5 "Waiting for Trigger" is set at the same time as the Sweeping or Measuring bit is set. It is cleared when the trigger actually occurs (that is, after the trigger event occurs and all the applicable trigger criteria have been met). A corresponding pop-up message ("Waiting for trigger") is generated if no trigger signal appears after approximately 2 sec. This message goes away when a trigger signal appears.
Initial S/W Revision	Prior to A.02.00

Trigger Level

Sets the value where the external 1 trigger input will trigger a new sweep/measurement.

Key Path	Trigger, External 1
Remote Command	:TRIGger[:SEquence]:EXTernal1:LEVel <level> :TRIGger[:SEquence]:EXTernal1:LEVel?
Example	TRIG:EXT1:LEV 0.4 V
Couplings	This same level is used for the Ext1 trigger source in the Trigger menu, for the Ext1 selection in the Periodic Timer sync source (in the Trigger menu and in the Gate Source menu), and also for the Ext1 selection in the Gate Source menu.
Preset	1.2 V
State Saved	Saved in instrument state
Min	-5 V
Max	5 V
Default Unit	V
Backwards Compatibility SCPI	:TRIGger[:SEquence]:EXTernal:LEVel For backward compatibility, the parameter EXTernal is mapped to EXTernal1
Backwards Compatibility SCPI	:TRIGger[:SEquence]:FRAME:EXTernal1:LEVel
Initial S/W Revision	Prior to A.02.00

Trig Slope

Controls the trigger polarity. It is set positive to trigger on a rising edge and negative to trigger on a falling edge.

Key Path	Trigger, External 1
Remote Command	:TRIGger[:SEquence]:EXTErnal1:SLOPe POSitive NEGative :TRIGger[:SEquence]:EXTErnal1:SLOPe?
Example	TRIG:EXT1:SLOP NEG
Couplings	This same slope is used in the Ext1 selection for the trigger source in the Trigger menu and for the period timer sync source (in the Trigger menu and in the Gate Source menu).
Preset	POSitive
State Saved	Saved in instrument state
Backwards Compatibility SCPI	:TRIGger[:SEquence]:EXTErnal:SLOPe For backward compatibility, the parameter EXTErnal is mapped to EXTErnal1
Backwards Compatibility SCPI	:TRIGger[:SEquence]:FRAMe:EXTErnal1:SLOPe
Backwards Compatibility Notes	The legacy :TRIGger[:SEquence]:SLOPe command affects the slopes for the VID, LINE, EXT1, EXT2, and RFB triggers.
Initial S/W Revision	Prior to A.02.00

Zero Span Delay Comp On/Off

In zero span, there is a natural delay in the signal path, which comes from the RBW filter. This is usually desirable, as it allows you to trigger on events and also see those events, because the signal is delayed from the trigger event. However, in some cases it is desirable to eliminate this delay, so that trigger events line up exactly with the zero time point in zero span. You can use the Zero Span Delay Comp On/Off feature to enable or disable zero span delay compensation.

Key Path	Trigger, External 1
Remote Command	:TRIGger[:SEquence]:EXTErnal1:DELAy:COMPensation OFF ON 0 1 :TRIGger[:SEquence]:EXTErnal1:DELAy:COMPensation?
Example	TRIG:EXT1:DEL:COMP ON
Dependencies	No effect except in zero-span, but not locked out in nonzero spans. Blanked in modes that do not support zero-span measurements. If the SCPI command is sent when the key is blanked, an error is returned: -221, "Settings conflict; Feature not supported for this measurement" In analyzers shipping N9060A, this feature requires N9060A-7FP.
Preset	OFF
State Saved	Saved in instrument state
Initial S/W Revision	A.11.00

External 2

Pressing this key, when it is not selected, selects an external input signal as the trigger. A new sweep/measurement will start when the external trigger condition is met using the external 2 input

connector. The external trigger 2 input connector is on the rear panel.

Pressing this key, when it is already selected, accesses the external 2 trigger setup menu.

Key Path	Trigger
Example	TRIG:SOUR EXT2 Swept SA measurement TRIG:<meas>:SOUR EXT2 Measurements other than Swept SA
Dependencies	In some models, there is no second External input. In these models, the External 2 key is blanked and the EXTernal2 parameter will generate a "Hardware missing; Not available for this model number" message. Grayed out if in use by Point Trigger in the Source Setup menu. Forced to Free Run if already selected and Point Trigger is set to External 2.
State Saved	Saved in instrument state
Status Bits/OPC dependencies	The Status Operation Register bit 5 "Waiting for Trigger" is set at the same time as the Sweeping or Measuring bit is set. It is cleared when the trigger actually occurs (that is, after the trigger event occurs and all the applicable trigger criteria have been met). A corresponding pop-up message ("Waiting for trigger") is generated if no trigger signal appears after approximately 2 sec. This message goes away when a trigger signal appears.
Initial S/W Revision	Prior to A.02.00
Modified at S/W Revision	A.03.00

Trigger Level

Sets the value where the external 2 trigger input will trigger a new sweep/measurement.

Key Path	Trigger, External 2
Remote Command	:TRIGger[:SEquence]:EXTernal2:LEVel :TRIGger[:SEquence]:EXTernal2:LEVel?
Example	TRIG:EXT2:LEV 1.1 V
Couplings	This same level is used for the Ext2 trigger source in the Trigger menu, for the Ext2 selection in the Periodic Timer sync source (in the Trigger menu and in the Gate Source menu), and also for the Ext2 selection in the Gate Source menu.
Preset	1.2 V
State Saved	Saved in instrument state
Min	-5 V
Max	5 V
Default Unit	V
Backwards Compatibility SCPI	:TRIGger[:SEquence]:FRAMe:EXTernal2:LEVel
Initial S/W Revision	Prior to A.02.00

Trig Slope

Controls the trigger polarity. It is set positive to trigger on a rising edge and negative to trigger on a falling edge.

Key Path	Trigger, External 2
Remote Command	:TRIGger[:SEquence]:EXternal2:SLOPe POSitive NEGative :TRIGger[:SEquence]:EXternal2:SLOPe?
Example	TRIG:EXT2:SLOP NEG
Couplings	This same slope is used in the Ext2 selection for the trigger source in the Trigger menu and for the period timer sync source (in the Trigger menu and in the Gate Source menu).
Preset	POSitive
State Saved	Saved in instrument state
Backwards Compatibility SCPI	:TRIGger[:SEquence]:FRAMe:EXternal2:SLOPe
Backwards Compatibility Notes	The legacy :TRIGger[:SEquence]:SLOPe command affects the slopes for the VID, LINE, EXT1, EXT2, and RFB triggers.
Initial S/W Revision	Prior to A.02.00

Zero Span Delay Comp On/Off

In zero span, there is a natural delay in the signal path, which comes from the RBW filter. This is usually desirable, as it allows you to trigger on events and also see those events, because the signal is delayed from the trigger event. However, in some cases it is desirable to eliminate this delay, so that trigger events line up exactly with the zero time point in zero span. You can use the Zero Span Delay Comp On/Off feature to enable or disable zero span delay compensation.

Key Path	Trigger, External 2
Remote Command	:TRIGger[:SEquence]:EXternal2:DELAy:COMPensation OFF ON 0 1 :TRIGger[:SEquence]:EXternal2:DELAy:COMPensation?
Example	TRIG:EXT2:DEL:COMP ON
Dependencies	No effect except in zero-span, but not locked out in nonzero spans. Blanked in modes that do not support zero-span measurements. If the SCPI command is sent when the key is blanked, an error is returned: -221, "Settings conflict; Feature not supported for this measurement" In analyzers shipping N9060A, this feature requires N9060A-7FP.
Preset	OFF
State Saved	Saved in instrument state
Initial S/W Revision	A.11.00

RF Burst

Pressing this key, when it is not selected, selects the RF Burst as the trigger. A new sweep/measurement will start when an RF burst envelope signal is identified from the signal at the RF Input connector. Pressing this key, when it is already selected, accesses the RF Burst trigger setup menu.

In some models, a variety of burst trigger circuitry is available, resulting in various available burst trigger bandwidths. The analyzer automatically chooses the appropriate trigger path based on the hardware configuration and other settings of the analyzer.

Key Path	Trigger
Example	TRIG:SOUR RFB Swept SA measurement TRIG:<meas>:SOUR RFB Measurements other than Swept SA
State Saved	Saved in instrument state
Status Bits/OPC dependencies	The Status Operation Register bit 5 "Waiting for Trigger" is set at the same time as the Sweeping or Measuring bit is set. It is cleared when the trigger actually occurs (that is, after the trigger event occurs and all the applicable trigger criteria have been met). A corresponding pop-up message ("Waiting for trigger") is generated if no trigger signal appears after approximately 2 sec. This message goes away when a trigger signal appears.
Backwards Compatibility Notes	The legacy command: :TRIGger[:SEQuence]:RFBurst:FSElectivity[:STATe] OFF ON 0 1 is not supported in the X-Series, as the hardware to do Frequency Selective burst triggers does not exist in X-Series.
Initial S/W Revision	Prior to A.02.00
Modified at S/W Revision	A.04.00

Absolute Trigger Level

Sets the absolute trigger level for the RF burst envelope.

When using the External Mixing path, the Absolute Trigger Level is uncalibrated because the factory default was set to accommodate the expected IF levels for the RF path.

Key Path	Trigger, RF Burst
Scope	Meas Global
Remote Command	:TRIGger[:SEQuence]:RFBurst:LEVel:ABSolute <amp1> :TRIGger[:SEQuence]:RFBurst:LEVel:ABSolute?
Example	TRIG:RFB:LEV:ABS 10 dBm sets the trigger level of the RF burst envelope signal to the absolute level of 10 dBm
Notes	Sending this command does not switch the setting from relative to absolute; to switch it you need to send the :TRIGger[:SEQuence]:RFBurst:LEVel:TYPE command, below. Amplitude Corrections are not taken into account by the Absolute Trigger Level. For example, if you have given yourself effective gain with an amplitude correction factor, the Absolute Trigger will not fire until you have set the trigger level that far below the displayed signal level, rather than simply to

	the displayed signal level. This is only true for Amplitude Corrections, not External Gain or Ref Level Offset functions. If mode is Bluetooth, the default value is -50 dBm.
Couplings	This same level is used for the RF Burst trigger source in the Trigger menu, for the RF Burst selection in the Periodic Timer sync source (in the Trigger menu and in the Gate Source menu), and also for the RF Burst selection in the Gate Source menu
Preset	-20 dBm
State Saved	Saved in instrument state
Min	-200 dBm
Max	100 dBm
Default Unit	depends on the current selected Y-Axis unit
Backwards Compatibility SCPI	:TRIGger[:SEquence]:FRAME:RFBurst:LEVel:ABSolute
Initial S/W Revision	Prior to A.02.00
Modified at S/W Revision	A.04.00

Key Path	Trigger, RF Burst
Remote Command	:TRIGger[:SEquence]:RFBurst:LEVel:TYPE ABSolute RELative :TRIGger[:SEquence]:RFBurst:LEVel:TYPE?
Example	TRIG:RFB:LEV:TYPE REL sets the trigger level type of the RF burst trigger to Relative.
Preset	ABSolute
State Saved	Saved in instrument state
Initial S/W Revision	Prior to A.02.00
Modified at S/W Revision	A.04.00

Relative Trigger Level

Sets the relative trigger level for the RF burst envelope.

In some models, the relative burst trigger function is implemented in hardware. In other models, without the advanced triggering hardware required, the relative burst trigger function is implemented in software in some measurements, and is unavailable in other measurements.

When implemented in software, the relative RF Burst trigger function is implemented as follows:

1. The measurement starts with the absolute RF Burst trigger setting. If it cannot get a trigger with that level, auto trigger fires and the acquisition starts anyway. After the acquisition, the measurement searches for the peak in the acquired waveform and saves it.

2. Now, in the next cycle of the measurement, the measurement determines a new absolute RF Burst level based on the peak value from the first measurement and the Relative RF Burst Trigger Level (always 0 or negative dB) set by the user. The following formula is used:
 3. absolute RF Burst level = peak level of the previous acquisition + relative RF Burst level
 4. If the new absolute RF Burst level differs from the previous by more than 0.5 dB, the new level is sent to the hardware; otherwise it is not updated (to avoid slowing down the acquisition)
- Steps 2 and 3 repeat for subsequent measurements.

Key Path	Trigger, RF Burst
Scope	Meas Global
Remote Command	:TRIGger[:SEquence]:RFBurst:LEVel:RELative <rel_ampl> :TRIGger[:SEquence]:RFBurst:LEVel:RELative?
Example	TRIG:RFB:LEV:REL -10 dB sets the trigger level of the RF burst envelope signal to the relative level of -10 dB
Notes	Sending this command does not switch the setting from absolute to relative; to switch it you need to send the :TRIGger[:SEquence]:RFBurst:LEVel:TYPE command, above. The relative trigger level is not available in some measurements. In those measurements the RELative parameter, and the :TRIGger[:SEquence]:RFBurst:LEVel:TYPE command (above), will generate an error if sent.
Dependencies	This key is grayed out and Absolute Trigger Level selected if the required hardware is not present in your analyzer and the current measurement does not support Relative triggering.
Preset	-6 dB GSM: -25 dB
State Saved	Saved in instrument state
Min	-45 dB
Max	0 dB
Default Unit	dB or dBc
Backwards Compatibility SCPI	:TRIGger[:SEquence]:RFBurst:LEVel This legacy command is aliased to :TRIGger[:SEquence]:RFBurst:LEVel:RELative because the PSA had ONLY relative burst triggering
Initial S/W Revision	Prior to A.02.00
Modified at S/W Revision	A.04.00

Trigger Slope

It is set positive to trigger on a rising edge and negative to trigger on a falling edge.

Key Path	Trigger, RF Burst
Remote Command	:TRIGger[:SEquence]:RFBurst:SLOPe Positive NEGative :TRIGger[:SEquence]:RFBurst:SLOPe?

Example	TRIG:RFB:SLOP NEG
Couplings	This same slope is used in the RF Burst selection for the trigger source in the Trigger menu and for the period timer sync source (in the Trigger menu and in the Gate Source menu).
Preset	POSitive
State Saved	Saved in instrument state
Backwards Compatibility SCPI	:TRIGger[:SEQuence]:FRAMe:RFBurst:SLOPe
Backwards Compatibility Notes	The legacy :TRIGger[:SEQuence]:SLOPe command affects the slopes for the VID, LINE, EXT1, EXT2, and RFB triggers.
Initial S/W Revision	Prior to A.02.00

Periodic Timer (Frame Trigger)

Pressing this key, when it is not selected, selects the internal periodic timer signal as the trigger. Triggering occurrences are set by the **Period** parameter, which is modified by the **Sync Source** and **Offset**. Pressing this key, when it is already selected, accesses the periodic timer trigger setup functions.

If you do not have a sync source selected (it is Off), then the internal timer will not be synchronized with any external timing events.

Key Path	Trigger
Example	TRIG:SOUR FRAM Swept SA measurement TRIG:<meas>:SOUR FRAM Measurements other than Swept SA
State Saved	Saved in instrument state
Readback	[Sync: <value of Sync Source>], for example, [Sync: External 1]
Status Bits/OPC dependencies	The Status Operation Register bit 5 "Waiting for Trigger" is set at the same time as the Sweeping or Measuring bit is set. It is cleared when the trigger actually occurs (that is, after the trigger event occurs and all the applicable trigger criteria have been met). A corresponding pop-up message ("Waiting for trigger") is generated if no trigger signal appears after approximately 2 sec. This message goes away when a trigger signal appears.
Initial S/W Revision	Prior to A.02.00

Periodic Timer Triggering:

This feature selects the internal periodic timer signal as the trigger. Trigger occurrences are set by the **Periodic Timer** parameter, which is modified by the **Sync Source** and **Offset**.

The figure below shows the action of the periodic timer trigger. Before reviewing the figure, we'll explain some uses for the periodic trigger.

A common application is measuring periodic burst RF signals for which a trigger signal is not easily available. For example, we might be measuring a TDMA radio which bursts every 20 ms. Let's assume that the 20 ms period is very consistent. Let's also assume that we do not have an external trigger source

available that is synchronized with the period, and that the signal-to-noise ratio of the signal is not high enough to provide a clean RF burst trigger at all of the analysis frequencies. For example, we might want to measure spurious transmissions at an offset from the carrier that is larger than the bandwidth of the RF burst trigger. In this application, we can set the Periodic Timer to a 20.00 ms period and adjust the offset from that timer to position our trigger just where we want it. If we find that the 20.00 ms is not exactly right, we can adjust the period slightly to minimize the drift between the period timer and the signal to be measured.

A second way to use this feature would be to use **Sync Source** temporarily, instead of **Offset**. In this case, we might tune to the signal in a narrow span and use the RF Burst trigger to synchronize the periodic timer. Then we would turn the sync source off so that it would not miss-trigger. Miss-triggering can occur when we are tuned so far away from the RF burst trigger that it is no longer reliable.

A third example would be to synchronize to a signal that has a reference time element of much longer period than the period of interest. In some CDMA applications, it is useful to look at signals with a short periodicity, by synchronizing that periodicity to the "even-second clock" edge that happens every two seconds. Thus, we could connect the even-second clock trigger to Ext1 and use then Ext1 as the sync source for the periodic timer.

The figure below illustrates this third example. The top trace represents the even-second clock. It causes the periodic timer to synchronize with the leading edge shown. The analyzer trigger occurs at a time delayed by the accumulated offset from the period trigger event. The periodic timer continues to run, and triggers continue to occur, with a periodicity determined by the analyzer time base. The timer output (labeled "late event") will drift away from its ideal time due to imperfect matching between the time base of the signal being measured and the time base of the analyzer, and also because of imperfect setting of the period parameter. But the synchronization is restored on the next even-second clock event. ("Accumulated offset" is described in the in the **Offset** function section.)

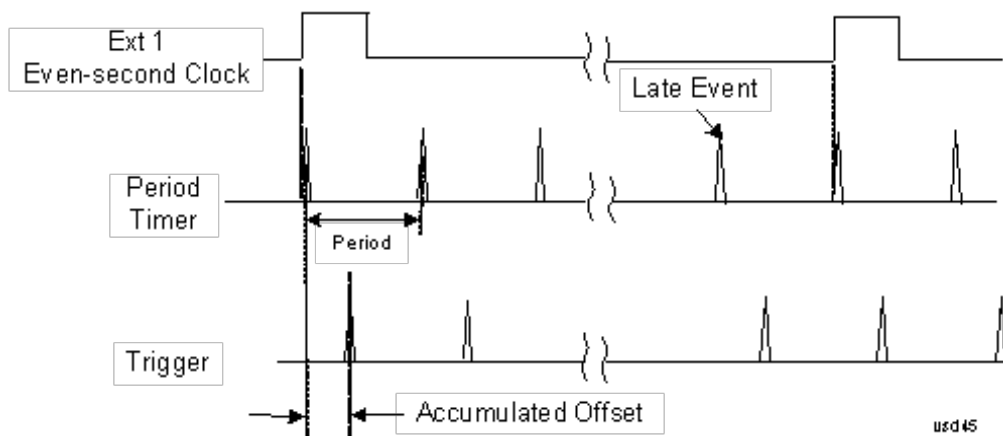

Period

Sets the period of the internal periodic timer clock. For digital communications signals, this is usually set to the frame period of your current input signal. In the case that sync source is not set to OFF, and the external sync source rate is changed for some reason, the periodic timer is synchronized at the every external synchronization pulse by resetting the internal state of the timer circuit.

Key Path	Trigger, Periodic Timer
Remote Command	:TRIGger[:SEquence]:FRAMe:PERIOD <time>

	:TRIGger[:SEquence]:FRAMe:PERiod?
Example	TRIG:FRAM:PER 100 ms
Dependencies	The invalid data indicator turns on when the period is changed, until the next sweep/measurement completes.
Couplings	The same period is used in the Gate Source selection of the period timer.
Preset	20 ms GSM: 4.615383
State Saved	Saved in instrument state
Min	100.000 ns
Max	559.0000 ms
Default Unit	S
Initial S/W Revision	Prior to A.02.00

Offset

Adjusts the accumulated offset between the periodic timer events and the trigger event. Adjusting the accumulated offset is different than setting an offset, and requires explanation.

The periodic timer is usually not synchronized with any external events, so the timing of its output events has no absolute meaning. Since the timing relative to external events (RF signals) is important, you need to be able to adjust (offset) it. However, you have no direct way to see when the periodic timer events occur. All that you can see is the trigger timing. When you want to adjust the trigger timing, you will be changing the internal offset between the periodic timer events and the trigger event. Because the absolute value of that internal offset is unknown, we will just call that the accumulated offset. Whenever the Offset parameter is changed, you are changing that accumulated offset. You can reset the displayed offset using Reset Offset Display. Changing the display does not change the value of the accumulated offset, and you can still make additional changes to accumulated offset.

To avoid ambiguity, we define that an increase in the "offset" parameter, either from the knob or the SCPI adjust command, serves to delay the timing of the trigger event.

Key Path	Trigger, Periodic Timer
Remote Command	:TRIGger[:SEquence]:FRAMe:OFFSet <time> :TRIGger[:SEquence]:FRAMe:OFFSet?
Example	TRIG:FRAM:OFFS 1.2 ms
Notes	The front panel interface (for example, the knob), and this command, adjust the accumulated offset, which is shown on the active function display. However, the actual amount sent to the hardware each time the offset is updated is the delta value, that is, the current accumulated offset value minus the previous accumulated offset value. Note that the accumulated offset value is essentially arbitrary; it represents the accumulated offset from the last time the offset was zeroed (with the Reset Offset Display key). Note that this command does not change the period of the trigger waveform. Note also that Offset is used only when the sync source is set to OFF, otherwise delay is used, see section " Trig Delay " on page 470 .

	An increase in the "offset" parameter, either from the knob or the SCPI adjust command, serves to delay the timing of the trigger event.
Notes	When the SCPI command is sent the value shown on the key (and the Active Function, if this happens to be the active function) is updated with the new value. However, the actual amount sent to the hardware is the delta value, that is, the current accumulated offset value minus the previous accumulated offset value. The SCPI query simply returns the value currently showing on the key.
Dependencies	The invalid data indicator turns on when the offset is changed, until the next sweep/measurement completes.
Couplings	The same offset is used in the Gate Source selection of the period timer.
Preset	0 s
State Saved	Saved in instrument state
Min	-10.000 s
Max	10.000 s
Default Unit	S
Initial S/W Revision	Prior to A.02.00

Offset Adjust (Remote Command Only)

This remote command does not work at all like the related front panel keys. This command lets you advance the phase of the frame trigger by the amount you specify.

It does not change the period of the trigger waveform. If the command is sent multiple times, it advances the phase of the frame trigger an additional amount each time it is sent. Negative numbers are permitted.

Remote Command	:TRIGger[:SEquence]:FRAMe:ADJust <time>
Example	TRIG:FRAM:ADJ 1.2 ms
Notes	Note also that Offset is used only when the sync source is set to OFF, otherwise delay is used, see section " Trig Delay " on page 470 An increase in the "offset" parameter, either from the knob or the SCPI adjust command, serves to delay the timing of the trigger event.
Notes	The front panel interface (for example, the knob) and the :TRIG:FRAM:OFFS command adjust the accumulated offset, which is shown on the active function display. However, the actual amount sent to the hardware is the delta value, that is, the current offset value minus the previous offset value. When the SCPI command is sent the value shown on the key (and the Active Function, if this happens to be the active function) is updated by increasing it (or decreasing it if the value sent is negative) by the amount specified in the SCPI command. This is a "command only" SCPI command, with no query.
Dependencies	The invalid data indicator turns on when the offset is changed, until the next sweep/measurement completes.
Couplings	The same offset is used in the Gate Source selection of the period timer.
Preset	0 s

State Saved	Saved in instrument state
Min	-10.000 s
Max	10.000 s
Default Unit	S
Initial S/W Revision	Prior to A.02.00

Reset Offset Display

Resets the value of the periodic trigger offset display setting to 0.0 seconds. The current displayed trigger location may include an offset value defined with the Offset key. Pressing this key redefines the currently displayed trigger location as the new trigger point that is 0.0 s offset. The Offset key can then be used to add offset relative to this new timing.

Key Path	Trigger, Periodic Timer
Remote Command	:TRIGger[:SEquence]:FRAMe:OFFSet:DISPlay:RESet
Example	TRIG:FRAM:OFFS:DISP:RES
Initial S/W Revision	Prior to A.02.00

Sync Source

Selects a signal source for you to synchronize your periodic timer trigger to, otherwise you are triggering at some arbitrary location in the frame. Synchronization reduces the precision requirements on the setting of the period.

For convenience you may adjust the level and slope of the selected sync source in a conditional branch setup menu accessed from the Sync Source menu. Note that these settings match those in the **Trigger** and **Gate Source** menus; that is, each trigger source has only one value of level and slope, regardless of which menu it is accessed from.

Key Path	Trigger, Periodic Timer
Remote Command	:TRIGger[:SEquence]:FRAMe:SYNC EXTernal1 EXTernal2 RFBurst OFF :TRIGger[:SEquence]:FRAMe:SYNC?
Example	TRIG:FRAM:SYNC EXT2
Dependencies	In some models, there is no second External input. In these models, the External 2 key is blanked and the EXTernal2 parameter will generate a "Hardware missing; Not available for this model number" message.
Preset	Off GSM/EDGE, MSR,LTE,LTETDD: RFBurst
State Saved	Saved in instrument state
Readback	The current setting is read back to this key and it is also Readback to the previous Periodic Timer trigger key.

Backwards Compatibility SCPI	:TRIGger[:SEquence]:FRAMe:SYNC EXTernal
Initial S/W Revision	Prior to A.02.00
Modified at S/W Revision	A.03.00, A.14.00

Off

Turns off the sync source for your periodic trigger. With the sync source off, the timing will drift unless the signal source frequency is locked to the analyzer frequency reference.

Key Path	Trigger, Periodic Timer, Sync Source
Example	TRIG:FRAM:SYNC OFF
Readback	Off
Initial S/W Revision	Prior to A.02.00

External 1

Pressing this key, when it is not selected, selects an external input signal as the trigger. A new sweep/measurement will start when the external trigger condition is met using the external 1 input connector on the rear panel.

Pressing this key, when it is already selected, accesses the external 1 trigger setup menu.

Key Path	Trigger
Example	TRIG:SOUR EXT1 Swept SA measurement TRIG:<meas>:SOUR EXT1 Measurements other than Swept SA
Dependencies	Grayed out if in use by Point Trigger in the Source Setup menu. Forced to Free Run if already selected and Point Trigger is set to External 1.
State Saved	Saved in instrument state
Status Bits/OPC dependencies	The Status Operation Register bit 5 "Waiting for Trigger" is set at the same time as the Sweeping or Measuring bit is set. It is cleared when the trigger actually occurs (that is, after the trigger event occurs and all the applicable trigger criteria have been met). A corresponding pop-up message ("Waiting for trigger") is generated if no trigger signal appears after approximately 2 sec. This message goes away when a trigger signal appears.
Initial S/W Revision	Prior to A.02.00

Trigger Level

Sets the value where the external 1 trigger input will trigger a new sweep/measurement.

Key Path	Trigger, External 1
Remote Command	:TRIGger[:SEquence]:EXTErnal1:LEVel <level> :TRIGger[:SEquence]:EXTErnal1:LEVel?
Example	TRIG:EXT1:LEV 0.4 V
Couplings	This same level is used for the Ext1 trigger source in the Trigger menu, for the Ext1 selection in the Periodic Timer sync source (in the Trigger menu and in the Gate Source menu), and also for the Ext1 selection in the Gate Source menu.
Preset	1.2 V
State Saved	Saved in instrument state
Min	-5 V
Max	5 V
Default Unit	V
Backwards Compatibility SCPI	:TRIGger[:SEquence]:EXTErnal:LEVel For backward compatibility, the parameter EXTErnal is mapped to EXTErnal1
Backwards Compatibility SCPI	:TRIGger[:SEquence]:FRAME:EXTErnal1:LEVel
Initial S/W Revision	Prior to A.02.00

Trig Slope

Controls the trigger polarity. It is set positive to trigger on a rising edge and negative to trigger on a falling edge.

Key Path	Trigger, External 1
Remote Command	:TRIGger[:SEquence]:EXTErnal1:SLOPe POSitive NEGative :TRIGger[:SEquence]:EXTErnal1:SLOPe?
Example	TRIG:EXT1:SLOP NEG
Couplings	This same slope is used in the Ext1 selection for the trigger source in the Trigger menu and for the period timer sync source (in the Trigger menu and in the Gate Source menu).
Preset	POSitive
State Saved	Saved in instrument state
Backwards Compatibility SCPI	:TRIGger[:SEquence]:EXTErnal:SLOPe For backward compatibility, the parameter EXTErnal is mapped to EXTErnal1
Backwards Compatibility SCPI	:TRIGger[:SEquence]:FRAME:EXTErnal1:SLOPe
Backwards Compatibility Notes	The legacy :TRIGger[:SEquence]:SLOPe command affects the slopes for the VID, LINE, EXT1, EXT2, and RFB triggers.
Initial S/W Revision	Prior to A.02.00

External 2

Pressing this key, when it is not selected, selects an external input signal as the trigger. A new sweep/measurement will start when the external trigger condition is met using the external 2 input connector. The external trigger 2 input connector is on the rear panel.

Pressing this key, when it is already selected, accesses the external 2 trigger setup menu.

Key Path	Trigger
Example	TRIG:SOUR EXT2 Swept SA measurement TRIG:<meas>:SOUR EXT2 Measurements other than Swept SA
Dependencies	In some models, there is no second External input. In these models, the External 2 key is blanked and the EXTernal2 parameter will generate a "Hardware missing; Not available for this model number" message. Grayed out if in use by Point Trigger in the Source Setup menu. Forced to Free Run if already selected and Point Trigger is set to External 2.
State Saved	Saved in instrument state
Status Bits/OPC dependencies	The Status Operation Register bit 5 "Waiting for Trigger" is set at the same time as the Sweeping or Measuring bit is set. It is cleared when the trigger actually occurs (that is, after the trigger event occurs and all the applicable trigger criteria have been met). A corresponding pop-up message ("Waiting for trigger") is generated if no trigger signal appears after approximately 2 sec. This message goes away when a trigger signal appears.
Initial S/W Revision	Prior to A.02.00
Modified at S/W Revision	A.03.00

Trigger Level

Sets the value where the external 2 trigger input will trigger a new sweep/measurement.

Key Path	Trigger, External 2
Remote Command	:TRIGger[:SEquence]:EXTernal2:LEVel :TRIGger[:SEquence]:EXTernal2:LEVel?
Example	TRIG:EXT2:LEV 1.1 V
Couplings	This same level is used for the Ext2 trigger source in the Trigger menu, for the Ext2 selection in the Periodic Timer sync source (in the Trigger menu and in the Gate Source menu), and also for the Ext2 selection in the Gate Source menu.
Preset	1.2 V
State Saved	Saved in instrument state
Min	-5 V
Max	5 V
Default Unit	V
Backwards Compatibility SCPI	:TRIGger[:SEquence]:FRAMe:EXTernal2:LEVel
Initial S/W Revision	Prior to A.02.00

Trig Slope

Controls the trigger polarity. It is set positive to trigger on a rising edge and negative to trigger on a falling edge.

Key Path	Trigger, External 2
Remote Command	:TRIGger[:SEQuence]:EXTernal2:SLOPe POSitive NEGative :TRIGger[:SEQuence]:EXTernal2:SLOPe?
Example	TRIG:EXT2:SLOP NEG
Couplings	This same slope is used in the Ext2 selection for the trigger source in the Trigger menu and for the period timer sync source (in the Trigger menu and in the Gate Source menu).
Preset	POSitive
State Saved	Saved in instrument state
Backwards Compatibility SCPI	:TRIGger[:SEQuence]:FRAMe:EXTernal2:SLOPe
Backwards Compatibility Notes	The legacy :TRIGger[:SEQuence]:SLOPe command affects the slopes for the VID, LINE, EXT1, EXT2, and RFB triggers.
Initial S/W Revision	Prior to A.02.00

RF Burst

Pressing this key, when it is not selected, selects the RF Burst as the trigger. A new sweep/measurement will start when an RF burst envelope signal is identified from the signal at the RF Input connector. Pressing this key, when it is already selected, accesses the RF Burst trigger setup menu.

In some models, a variety of burst trigger circuitry is available, resulting in various available burst trigger bandwidths. The analyzer automatically chooses the appropriate trigger path based on the hardware configuration and other settings of the analyzer.

Key Path	Trigger
Example	TRIG:SOUR RFB Swept SA measurement TRIG:< meas>:SOUR RFB Measurements other than Swept SA
State Saved	Saved in instrument state
Status Bits/OPC dependencies	The Status Operation Register bit 5 "Waiting for Trigger" is set at the same time as the Sweeping or Measuring bit is set. It is cleared when the trigger actually occurs (that is, after the trigger event occurs and all the applicable trigger criteria have been met). A corresponding pop-up message ("Waiting for trigger") is generated if no trigger signal appears after approximately 2 sec. This message goes away when a trigger signal appears.
Backwards Compatibility Notes	The legacy command: :TRIGger[:SEQuence]:RFBurst:FSElectivity[:STATe] OFF ON 0 1 is not supported in the X-Series, as the hardware to do Frequency Selective burst triggers does not exist in X-Series.

Initial S/W Revision	Prior to A.02.00
Modified at S/W Revision	A.04.00

Absolute Trigger Level

Sets the absolute trigger level for the RF burst envelope.

When using the External Mixing path, the Absolute Trigger Level is uncalibrated because the factory default was set to accommodate the expected IF levels for the RF path.

Key Path	Trigger, RF Burst
Scope	Meas Global
Remote Command	:TRIGger[:SEquence]:RFBurst:LEVel:ABSolute <ampl> :TRIGger[:SEquence]:RFBurst:LEVel:ABSolute?
Example	TRIG:RFB:LEV:ABS 10 dBm sets the trigger level of the RF burst envelope signal to the absolute level of 10 dBm
Notes	Sending this command does not switch the setting from relative to absolute; to switch it you need to send the :TRIGger[:SEquence]:RFBurst:LEVel:TYPE command, below. Amplitude Corrections are not taken into account by the Absolute Trigger Level. For example, if you have given yourself effective gain with an amplitude correction factor, the Absolute Trigger will not fire until you have set the trigger level that far below the displayed signal level, rather than simply to the displayed signal level. This is only true for Amplitude Corrections, not External Gain or Ref Level Offset functions. If mode is Bluetooth, the default value is -50 dBm.
Couplings	This same level is used for the RF Burst trigger source in the Trigger menu, for the RF Burst selection in the Periodic Timer sync source (in the Trigger menu and in the Gate Source menu), and also for the RF Burst selection in the Gate Source menu
Preset	-20 dBm
State Saved	Saved in instrument state
Min	-200 dBm
Max	100 dBm
Default Unit	depends on the current selected Y-Axis unit
Backwards Compatibility SCPI	:TRIGger[:SEquence]:FRAME:RFBurst:LEVel:ABSolute
Initial S/W Revision	Prior to A.02.00
Modified at S/W Revision	A.04.00

Key Path	Trigger, RF Burst
Remote Command	:TRIGger[:SEquence]:RFBurst:LEVel:TYPE ABSolute RELative :TRIGger[:SEquence]:RFBurst:LEVel:TYPE?

Example	TRIG:RFB:LEV:TYPE REL sets the trigger level type of the RF burst trigger to Relative.
Preset	ABSolute
State Saved	Saved in instrument state
Initial S/W Revision	Prior to A.02.00
Modified at S/W Revision	A.04.00

Trigger Slope

It is set positive to trigger on a rising edge and negative to trigger on a falling edge.

Key Path	Trigger, RF Burst
Remote Command	:TRIGger[:SEquence]:RFBurst:SLOPe POSitive NEGative :TRIGger[:SEquence]:RFBurst:SLOPe?
Example	TRIG:RFB:SLOP NEG
Couplings	This same slope is used in the RF Burst selection for the trigger source in the Trigger menu and for the period timer sync source (in the Trigger menu and in the Gate Source menu).
Preset	POSitive
State Saved	Saved in instrument state
Backwards Compatibility SCPI	:TRIGger[:SEquence]:FRAME:RFBurst:SLOPe
Backwards Compatibility Notes	The legacy :TRIGger[:SEquence]:SLOPe command affects the slopes for the VID, LINE, EXT1, EXT2, and RFB triggers.
Initial S/W Revision	Prior to A.02.00

Sync Holdoff

Sync Holdoff specifies the duration that the sync source signal must be kept false before the transition to true to be recognized as the sync timing. The periodic timer phase is aligned when the sync source signal becomes true, after the Holdoff time is satisfied.

A holdoff of 2 ms will work with most WiMAX signals, but there may be cases where the burst off duration is less than 1 ms and this value will need to be changed.

Key Path	Trigger, Periodic Timer
Remote Command	:TRIGger[:SEquence]:FRAME:SYNC:HOLDoff <time> :TRIGger[:SEquence]:FRAME:SYNC:HOLDoff? :TRIGger[:SEquence]:FRAME:SYNC:HOLDoff:STATE OFF ON 0 1 :TRIGger[:SEquence]:FRAME:SYNC:HOLDoff:STATE?
Preset	On, 1.000 ms

State Saved	Saved in instrument state
Min	0 ms
Max	+500 ms
Default Unit	s
Initial S/W Revision	Prior to A.02.00

Control Edge/Level

Sets the method of controlling the gating function from the gating signal.

Edge

In Edge triggering, the gate opens (after the Delay) on the selected edge (for example, positive) of the gate signal and closes on the alternate edge (for example, negative).

Level

In Level triggering, the gate opens (after the Delay) when the gate signal has achieved a certain level and stays open as long as that level is maintained.

Key Path	Sweep/Control, Gate
Remote Command	[:SENSe] :SWEep:EGATe:CONTRol EDGE LEVel [:SENSe] :SWEep:EGATe:CONTRol?
Example	SWE:EGAT:CONT EDGE
Dependencies	If the Gate Method is FFT the Control key is grayed out and Edge is selected. If the Gate Source is TV, Frame or Line, the Control key is grayed out and Edge is selected.
Preset	EDGE
State Saved	Saved in instrument state
Backwards Compatibility SCPI	[:SENSe] :SWEep:TIME:GATE:TYPE ESA Compatibility
Initial S/W Revision	Prior to A.02.00

Gate Holdoff

Lets you increase or decrease the wait time after a gate event ends before the analyzer will respond to the next gate signal.

After any Gate event finishes, the analyzer must wait for the sweep system to settle before it can respond to another Gate signal. The analyzer calculates a "wait time," taking into account a number of factors, including RBW and Phase Noise Optimization settings. The goal is to achieve the same accuracy when gated as in ungated operation. The figure below illustrates this concept:

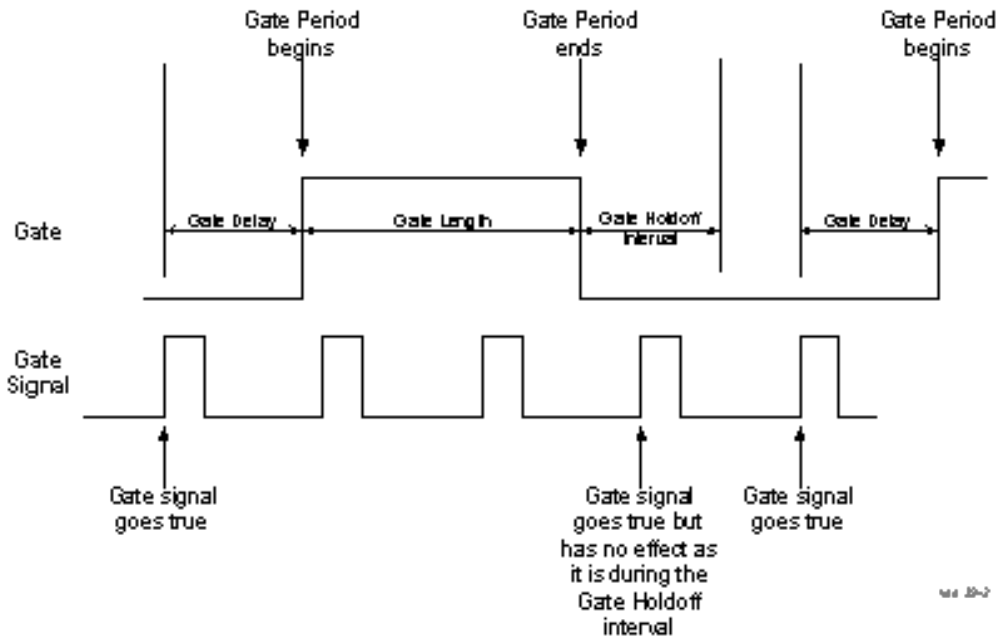

When Gate Holdoff is in Auto, the wait time calculated by the analyzer is used. When Gate Time is in Manual, the user may adjust the wait time, usually decreasing it in order to achieve greater speed, but at the risk of decreasing accuracy.

When the Method key is set to Video or FFT, the Gate Holdoff function has no effect.

In measurements that do not support Auto, the value shown when Auto is selected is “---” and the manually set holdoff is returned to a query.

Key Path	Sweep/Control, Gate
Remote Command	<pre>[:SENSe] :SWEep:EGATe:HOLDoff <time> [:SENSe] :SWEep:EGATe:HOLDoff? [:SENSe] :SWEep:EGATe:HOLDoff:AUTO OFF ON 0 1 [:SENSe] :SWEep:EGATe:HOLDoff:AUTO?</pre>
Example	<pre>SWE:EGAT:HOLD 0.0002 SWE:EGAT:HOLD? SWE:EGAT:HOLD:AUTO ON SWE:EGAT:HOLD:AUTO?</pre>
Couplings	<p>When Gate Holdoff is Auto, the Gate Holdoff key shows the value calculated by the analyzer for the wait time.</p> <p>Pressing the Gate Holdoff key while it is in Auto and not selected, causes the key to become selected and allows the user to adjust the value. If the value is adjusted, the setting changes to Man.</p> <p>Pressing the Gate Holdoff key, while it is in Auto and selected, does not change the value of Gate Holdoff, but causes the setting to change to Man. Now the user can adjust the value.</p> <p>Pressing the key while it is in Man and selected, cause the value to change back to Auto.</p> <p>Pressing the key while it is in Man and not selected, causes the key to become selected and allows the user to adjust the value.</p>

	When Method is set to Video or FFT, the Gate Holdoff function has no effect.
Preset	Auto Auto/On
State Saved	Saved in instrument state
Min	1 μ sec
Max	1 sec
Initial S/W Revision	Prior to A.02.00

Gate Delay Compensation

This function allows you to select an RBW-dependent value by which to adjust the gate delay, to compensate for changes in the delay caused by RBW effects.

You can select between uncompensated operation and two types of compensation, Delay Until RBW Settled and Compensate for RBW Group Delay.

See ["More Information" on page 806](#)

Key Path	Sweep/Control, Gate
Scope	Meas Global
Remote Command	[:SENSe] :SWEep:EGATe:DELaY:COMPensation:TYPE OFF SETTled GDELaY [:SENSe] :SWEep:EGATe:DELaY:COMPensation:TYPE?
Example	SWE:EGAT:DEL:COMP:TYPE SETT SWE:EGAT:DEL:COMP:TYPE?
Notes	Although this function is Meas Global, there are some measurements that do not support this function. In those measurements the operation will be Uncompensated. Going into one of those measurements will not change the Meas Global selection; it will simply display the grayed-out menu key with “Uncompensated” showing as the selection. This is a non-forceful grayout, so the SCPI command is still accepted. If Gate Delay Compensation is not supported at all within a particular mode, the key is not displayed, and if the SCPI command is sent while in a measurement within that mode, an “Undefined Header” message is generated. Measurements that do not support this function include: Swept SA
Preset	TD-SCDMA mode: Compensate for RBW Group Delay All other modes: Delay Until RBW Settled
State Saved	Saved in instrument state
Range	Uncompensated Delay Until RBW Settled Compensate for RBW Group Delay
Readback text	Uncompensated Settled Group Delay
Initial S/W Revision	Prior to A.02.00
Modified at S/W Revision	A.11.0

More Information

Selecting Uncompensated means that the actual gate delay is as you sets it.

Selecting Delay Until RBW Settled causes the gate delay to be increased above the user setting by an amount equal to $3.06/\text{RBW}$. This compensated delay causes the GATE START and GATE STOP lines on the display to move by the compensation amount, and the actual hardware gate delay to be increased by the same amount. All the other gate lines (for example, MIN FAST) are unaffected. If the RBW subsequently changes, the compensation is readjusted for the new RBW. The value shown on the Gate Delay key does NOT change.

Delay Until RBW Settled allows excellent measurements of gated signals, by allowing the IF to settle following any transient that affects the burst. Excellent measurements also require that the analysis region not extend into the region affected by the falling edge of the burst. Thus, excellent measurements can only be made over a width that declines with narrowing RBWs, which is achieved by decreasing the gate length below the user setting by an amount equal to $2.53/\text{RBW}$. Therefore, for general purpose compensation, you will still want to change the gate length with changes in RBW even if the gate delay is compensated. The compensated Gate Length is limited by the analyzer so that it will never go below 10% of the value shown on the Gate Length key, as otherwise the sweep times could get very long. Anytime the Gate Length and RBW values combine in such a way that this limiting takes place, a warning is displayed. For measurements which contain multiple sweeps with different RBW like SEM and SPUR, the smallest RBW is used for this limiting.

Selecting Compensate for RBW Group Delay causes the gate delay to be increased above the user setting by an amount equal to $1.81/\text{RBW}$. This compensated delay causes the GATE START, GATE STOP lines on the display to move by the compensation amount, and the actual hardware gate delay to be increased by the same amount. All the other gate lines (for example, MIN FAST) are unaffected. If the RBW subsequently changes, the compensation is readjusted for the new RBW. The value shown on the Gate Delay key does NOT change. Compensate for RBW Group Delay also includes gate length compensation; the gate length itself is adjusted as necessary to attempt to compensate for delay effects imposed by the RBW.

Compensate for RBW Group Delay is similar to Delay Until RBW Settled, but compensates for the group delay of the RBW filter, rather than the filter settling time. As the RBW gets narrow, this can allow the settling tail of the RBW to affect the beginning part of the gated measurement, and allow the beginning of the RBW settling transient to affect the end of the gated measurement. These two effects are symmetric because the RBW response is symmetric. Because the gate length is not automatically compensated, some users might find this compensation to be more intuitive than compensation for RBW settling.

Min Fast Position Query (Remote Command Only)

This command queries the position of the MIN FAST line, relative to the delay reference (REF) line. See section ["Gate View On/Off" on page 2496](#). If this query is sent while not in gate view, the MinFast calculation is performed based on the current values of the appropriate parameters and the result is returned. Knowing this value lets you set an optimal gate delay value for the current measurement setup.

Remote Command	<code>[:SENSe] :SWEep:EGATe:MINFast?</code>
Example	<code>SWE:EGAT:MIN?</code>
Initial S/W Revision	Prior to A.02.00

Gate Preset (Remote Command Only)

Presets the time-gated spectrum analysis capability.

This command sets gate parameter values to the ESA preset values, as follows:

Gate trigger type = edge

Gate polarity = positive

Gate delay = 1 us

Gate length = 1 us

Remote Command	<code>[[:SENSe]:SWEep:TIME:GATE:PRESet</code> ESA Compatibility
Initial S/W Revision	Prior to A.02.00

Gate Level (Remote Command Only)

Sets the gate input transition point level for the external TRIGGER inputs on the front and rear panel. This is a legacy command for PSA compatibility. It is simply an alias to the equivalent trigger level command.

Remote Command	<code>[[:SENSe]:SWEep:EGATE:EXTernal[1] 2:LEVel <voltage></code> <code>[[:SENSe]:SWEep:EGATE:EXTernal[1] 2:LEVel?</code>
Notes	This command is simply an alias to <code>:TRIGger[:SEQUence]:EXTernal[1] 2:LEVel</code> For details refer
Initial S/W Revision	Prior to A.02.00

Gate Polarity (Remote Command Only)

Sets the polarity for the gate signal. This setup is now done using the gate trigger's slope setting.

When Positive (Pos) is selected, a positive-going edge (Edge) or a high voltage (Level) will satisfy the gate condition, after the delay set with the Gate Delay key. When Negative (Neg) is selected, a negative-going edge (Edge) or a low voltage (Level) will satisfy the gate condition after the delay.

Remote Command	<code>[[:SENSe]:SWEep:EGATE:POLarity NEGative POSitive</code> <code>[[:SENSe]:SWEep:EGATE:POLarity?</code>
Example	<code>SWE:EGAT:POL NEG</code> <code>SWE:EGAT:POL?</code>
Preset	POSitive
State Saved	Saved in instrument state
Backwards Compatibility SCPI	<code>[[:SENSe]:SWEep:TIME:GATE:POLarity</code> ESA compatibility
Initial S/W Revision	Prior to A.02.00

Remote Command	[:SENSe] :SWEep:TIME:GATE:LEVel HIGH LOW [:SENSe] :SWEep:TIME:GATE:LEVel? ESA compatibility
Preset	HIGH
Initial S/W Revision	Prior to A.02.00

Points

Sets the number of points per sweep. The resolution of setting the sweep time depends on the number of points selected. The current value of points is displayed parenthetically, next to the sweep time in the lower-right corner of the display.

Key Path	Sweep/Control
Mode	SA, WCDMA, C2K, WIMAX OFDMA, TD-SCDMA, 1xEVDO, ISDB-T, CMMB, LTE, LTETDD, BLUETOOTH, WLAN, MSR, LTEAFDD, LTEATDD
Remote Command	[:SENSe] :OBWidth:SWEep:POINts <integer> [:SENSe] :OBWidth:SWEep:POINts?
Example	OBW:SWE:POIN 1500 OBW:SWE:POIN?
Notes	This function is not available when signal identification is set to On (external mixing). Affected by: log sweep Grayed out in measurements that don't support swept Blanked in modes that do not support swept. Whenever the number of sweep points change: - All trace data is erased - Any traces with Update Off also go to Display Off (like going from View to Blank in the older analyzers) - Sweep time is re-quantized - Any limit lines that are on are updated - If averaging/hold is on, averaging/hold starts over
Couplings	Whenever the number of sweep points change, the sweep time is re-quantized.
Preset	LTE, LTETDD, MSR, LTEAFDD, LTEATDD: 2001 Other: 1001
State Saved	Saved in instrument state.
Min	101
Max	20001
Initial S/W Revision	Prior to A.02.00
Modified at S/W Revision	A.03.00

System

See "[System](#)" on page 366

Trace/Detector

Accesses a menu of functions that enable you to control the detectors for the current measurement.

Key Path	Front-panel key
Initial S/W Revision	Prior to A.02.00

Trace Type

Allows you to select the type of trace you want to use for the current measurement.

The first page of this menu contains a 1–of–N selection of the trace type (Clear Write, Average, Max Hold, Min Hold) for the selected trace.

Key Path	Trace/Detector
Mode	SA, WCDMA, C2K, WIMAX OFDMA, TD-SCDMA, 1xEVDO, ISDB-T, CMMB, LTE, LTETDD, BLUETOOTH, WLAN, MSR, LTEAFDD, LTEATDD
Remote Command	:TRACe:OBWidth:TYPE WRITe AVERAge MAXHold MINHold :TRACe:OBWidth:TYPE?
Example	TRAC:OBW:TYPE MINH TRAC:OBW:TYPE?
Notes	WRITe = Clear Write AVERAge = Average MAXHold = Maximum Hold MINHold = Minimum Hold
Couplings	When Detector setting is “Auto” ([[:SENSe]:OBWidth:DETEctor:AUTO?]), Detector ([[:SENSe]:OBWidth:DETEctor[:FUNction]?]) switches aligning with the switch of this parameter: “NORMal” with WRITe (Clear Write), “AVERAge” with AVERAge, “POSitive (peak)” with MAXHold, and “NEGative (peak)” with MINHold.
Preset	AVERAge BLUETOOTH: MAX HOLD.
State Saved	Saved in instrument state.
Range	WRITe AVERAge MAXHold MINHold
Initial S/W Revision	Prior to A.02.00
Modified at S/W Revision	A.03.00

Detector

Accesses a menu of functions that enables you to control the detectors for the current measurement. The following choices are available:

- **Auto**– the detector selected depends on marker functions, trace functions, average type, and the trace averaging function.

- **Normal**—the detector determines the peak of the CW-like signals, and it yields alternating maximums and minimums of noise-like signals. This is also referred to as Rosenfell detection.
- **Average**—the detector determines the average of the signal within the sweep points. The averaging method depends upon the Average Type selection (voltage, power or log scales).
- **Peak (Positive)**—the detector determines the maximum of the signal within the sweep points.
- **Sample**—the detector indicates the instantaneous level of the signal at the center of the sweep points represented by each display point.
- **Negative Peak**—the detector determines the minimum of the signal within the sweep points.

Key Path	Detector
Initial S/W Revision	Prior to A.02.00

Auto

When the detector choice is Auto, the analyzer selects the detector. The selected detector depends on marker functions, trace functions, and trace averaging functions for the current measurement.

Key Path	Trace/Detector
Remote Command	[[:SENSe]:OBWidth:DETECTOR:AUTO ON OFF 1 0 [:SENSe]:OBWidth:DETECTOR:AUTO?
Example	OBW:DET:AUTO ON OBW:DET:AUTO?
Couplings	When Detector setting is “Auto” ([[:SENSe]:OBWidth:DETECTOR:AUTO?]), Detector ([[:SENSe]:OBWidth:DETECTOR:FUNCTION?]) switches aligning with the switch of this parameter: “NORMal” with Clear Write, “AVERage” with AVERage, “POSitive (peak)” with MAXHold, and “NEGative (peak)” with MINHold.
Preset	ON ISDB-T: OFF
State Saved	Saved in instrument state.
Initial S/W Revision	Prior to A.02.00
Modified at S/W Revision	A.03.00

Detector Selection

Allows you to select a specific detector for the current measurement. When the detector choice is Auto, the analyzer selects the detector. The selected detector depends on marker functions, trace functions, and trace averaging functions for the current measurement.

Key Path	Trace/Detector
Mode	SA, WCDMA, C2K, WIMAX OFDMA, TD-SCDMA, 1xEVDO, ISDB-T, CMMB, LTE, LTETDD, BLUETOOTH, WLAN, MSR, LTEAFDD, LTEATDD

Remote Command	[:SENSe]:OBWidth:DETEctor[:FUNction] NORMal AVERage POSitive SAMPle NEGative [:SENSe]:OBWidth:DETEctor[:FUNction]?
Example	OBW:DET NORM OBW:DET?
Notes	When you manually select a detector (instead of selecting Auto), that detector is used regardless of other analyzer settings. The detector choices are: The Normal detector determines the peak of CW-like signals, and it yields alternating maximums and minimums of noise-like signals. This is also referred to as Rosenfell detection. The Average detector determines the average of the signal within the sweep points. The averaging method is Power Average (RMS). The Peak detector determines the maximum of the signal within the sweep points. The Sample detector indicates the instantaneous level of the signal at the center of the sweep points represented by each display point. The Negative Peak detector determines the minimum of the signal within the sweep points.
Couplings	When Detector setting is "Auto" ([:SENSe]:OBWidth:DETEctor:AUTO?), Detector ([:SENSe]:OBWidth:DETEctor[:FUNction]?) switches aligning with the switch of this parameter: "NORMal" with Clear Write, "AVERage" with AVERage, "POSitive (peak)" with MAXHold, and "NEGative (peak)" with MINHold.
Preset	AVERage ISDB-T: Peak BLUETOOTH: Peak
State Saved	Saved in instrument state.
Range	Normal Average Peak Sample Negative Peak
Initial S/W Revision	Prior to A.02.00
Modified at S/W Revision	A.03.00

Trigger

See ["Trigger" on page 438](#)

Free Run

See ["Free Run " on page 445](#)

Video

See ["Video \(IF Envelope\) " on page 446](#)

Trigger Level

See ["Trigger Level " on page 446](#)

Trig Slope

See ["Trig Slope " on page 447](#)

Trig Delay

See ["Trig Delay " on page 448](#)

Line

See ["Line " on page 2503](#)

Trig Slope

See ["Trig Slope " on page 2503](#)

Trig Delay

See ["Trig Delay " on page 450](#)

External 1

See ["External 1 " on page 2516](#)

Trigger Level

See ["Trigger Level " on page 2516](#)

Trig Slope

See ["Trig Slope " on page 2517](#)

Trig Delay

See ["Trig Delay " on page 453](#)

Zero Span Delay Comp

See ["Zero Span Delay Comp On/Off" on page 2505](#)

External 2

See ["External 2 "](#) on page 2518

Trigger Level

See ["Trigger Level "](#) on page 2518

Trig Slope

See ["Trig Slope "](#) on page 2519

Trig Delay

See ["Trig Delay "](#) on page 455

Zero Span Delay Comp

See ["Zero Span Delay Comp On/Off"](#) on page 2507

RF Burst

See ["RF Burst "](#) on page 2519

Absolute Trigger

See ["Absolute Trigger Level"](#) on page 2520

Relative Trigger

See ["Relative Trigger Level"](#) on page 2509

Trig Slope

See ["Trigger Slope "](#) on page 2521

Trig Delay

See ["Trig Delay "](#) on page 460

Periodic Timer

See ["Periodic Timer \(Frame Trigger\) "](#) on page 2511

Period

See ["Period "](#) on page 2512

Offset

See ["Offset "](#) on page 2513

Reset Offset Display

See ["Reset Offset Display "](#) on page 2515

Sync Source

See "[Sync Source](#) " on page 2515

Off

See "[Off](#) " on page 2516

External 1

See "[External 1](#) " on page 2516

Trigger Level

See "[Trigger Level](#) " on page 2516

Trig Slope

See "[Trig Slope](#) " on page 2517

External 2

See "[External 2](#) " on page 2518

Trigger Level

See "[Trigger Level](#) " on page 2518

Trig Slope

See "[Trig Slope](#) " on page 2519

RF Burst

See "[RF Burst](#) " on page 2519

Absolute Trigger

See "[Absolute Trigger Level](#)" on page 2520

Trig Slope

See "[Trigger Slope](#) " on page 2521

Trig Delay

See "[Trig Delay](#)" on page 470

Auto/Holdoff

See "[Auto/Holdoff](#) " on page 471

Auto Trig

See "[Auto Trig](#) " on page 471

Trig Holdoff

See "[Trig Holdoff](#) " on page 472

Holdoff Type

See "Holdoff Type" on page 472

User Preset

Accesses a menu that gives you the following three choices:

- User Preset – recalls a state previously saved using the Save User Preset function.
- User Preset All Modes – presets all of the modes in the analyzer
- Save User Preset– saves the current state for the current mode

Key Path	Front-panel key
Backwards Compatibility Notes	<p>User Preset is actually loading a state, and in legacy analyzers, it was possible to load a state without affecting the trace data, limit lines or correction data. Similarly it was possible to do a User Preset without affecting the trace data, limit lines or correction data.</p> <p>In the X-Series, “state” always includes all of this data; so whenever state is loaded, or User Preset is executed, all of the traces, limit lines and corrections are affected. Although this differs from previous behavior, it is desirable behavior, and should not cause adverse issues for users.</p> <p>On ESA and PSA, User Preset affected the entire instrument’s state. In the X-Series, User Preset only recalls the state for the active mode. There is a User Preset file for each mode. User Preset can never cause a mode switch as it can in legacy analyzers. If you want to recall all modes to their user preset file state, you will need to do a User Preset after mode switching into each mode.</p> <p>User Preset recalls mode state which can now include data like traces; whereas on ESA and PSA, User Preset did not affect data.</p>
Initial S/W Revision	Prior to A.02.00

User Preset

User Preset sets the state of the currently active mode back to the state that was previously saved for this mode using the Save User Preset menu key or the SCPI command, SYST:PRES:USER:SAV. It not only recalls the Mode Preset settings, but it also recalls all of the mode persistent settings, and the Input/Output system setting that existed at the time Save User Preset was executed.

If a Save User Preset has not been done at any time, User Preset recalls the default user preset file for the currently active mode. The default user preset files are created if, at power-on, a mode detects there is no user preset file. There will never be a scenario when there is no user preset file to restore. For each mode, the default user preset state is the same state that would be saved if a Save User Preset is performed in each mode right after doing a Restore Mode Default and after a Restore Input/Output Defaults.

The User Preset function does the following:

- Aborts the currently running measurement.
- Sets the mode State to the values defined by Save User Preset.
- Makes the saved measurement for the currently running mode the active measurement.
- Brings up the saved menu for the power-on mode.
- Clears the input and output buffers.
- Sets the Status Byte to 0.

Key Path	User Preset
Remote Command	:SYSTem:PRESet:USER
Example	:SYST:PRES:USER:SAVE:SYST:PRES:USER
Notes	:SYST:PRES:USER:SAVE is used to save the current state as the user preset state. Clears all pending OPC bits. The Status Byte is set to 0. Pressing the User Preset front-panel key while already in the User Preset menu will cause the User Preset to get executed
Couplings	A user preset will cause the currently running measurement to be aborted and cause the saved measurement to be active. Recalling a User Preset file has the same issues that recalling a Save State file has. Some settings may need to be limited and therefore re-coupled, since the capabilities of the mode may have changes when the User Preset file was last saved.
Initial S/W Revision	Prior to A.02.00

User Preset All Modes

Recalls all of the User Preset files for each mode, switches to the power-on mode, and activates the saved measurement from the power-on mode User Preset file.

NOTE

When the instrument is secured, all of the user preset files are converted back to their default user preset files.

The User Preset function does the following:

- Aborts the currently running measurement.
- Switches the Mode to the power-on mode.
- Restores the User Preset files for each mode.
- Makes the saved measurement for the power-on mode the active measurement.
- Brings up the saved menu for the power-on mode.
- Clears the input and output buffers.
- Sets the Status Byte to 0.

Key Path	User Preset
Remote Command	:SYSTem:PRESet:USER:ALL
Example	:SYST:PRES:USER:SAVE:SYST:PRES:USER:ALL
Notes	Clears all pending OPC bits. The Status Byte is set to 0. :SYST:PRES:USER:SAVE is used to save the current state as the user preset state.
Couplings	A user preset will cause the currently running measurement to be aborted, cause a mode switch to the power-on mode, and cause the saved measurement to be active in the power-on mode. Recalling a User Preset file has the same issues that recalling a Save State file has. Some settings may need to be limited and therefore re-coupled, since the capabilities of the mode may have changes when the User Preset file was last saved.
Initial S/W Revision	Prior to A.02.00

Save User Preset

Saves the currently active mode and its State. You can recall this User Preset file by pressing the User Preset menu key or sending the SYST:PRES:USER remote command. This same state is also saved by the Save State function.

Key Path	User Preset
Remote Command	:SYSTem:PRESet:USER:SAVE
Example	:SYST:PRES:USER:SAVE
Notes	:SYST:PRES:SAVE creates the same file as if the user requested a *SAV or a MMEM:STOR:STAT, except User Preset Save does not allow the user to specify the filename or the location of the file.
Initial S/W Revision	Prior to A.02.00

View/Display

Accesses a menu of functions that enable you to set the view and display parameters for the current measurement.

There is a single results view available for this measurement. For more details, and samples of screen content for each supported mode, see "[Spectrum View](#)" on page 821 below.

The following result descriptions are available:

Occupied Bandwidth

The occupied bandwidth result is $f_2 - f_1$, where f_1 and f_2 are calculated.

Total Power

The total power is the power integrated in the specified span setting.

Transmit Freq Error

The transmit freq error (transmit frequency error) result is calculated as the difference between $(f_2+f_1)/2$ and the tuned center frequency of the signal, where f_1 and f_2 are calculated.

x dB Bandwidth

The x dB result is a bandwidth measured between two points on the signal which are a certain number of dBs down from the highest signal point within the OBW Span. For example, If the 'x dB' parameter is set to -26 dB, and the 'Occupied BW Span' is set to 10 MHz, then the maximum signal power level is first determined from the 10 MHz wide trace sweep. Next, the two furthest frequencies below (x_{db_f1}) and above (x_{db_f2}) the frequency of the maximum level occurrence are found where the signal level is 26 dB below the peak level. This calculation also uses linear interpolation to find the lower and upper carrier boundary point within the width of a sweep point (the span divided by the number of sweep points).

The x dB bandwidth is calculated to be $x_{db_f2} - x_{db_f1}$.

Spectrum View

For SA, WCDMA, C2K, 1xEVDO, WIMAX OFDMA, WLAN modes:

9 Occupied Bandwidth Measurement
View/Display

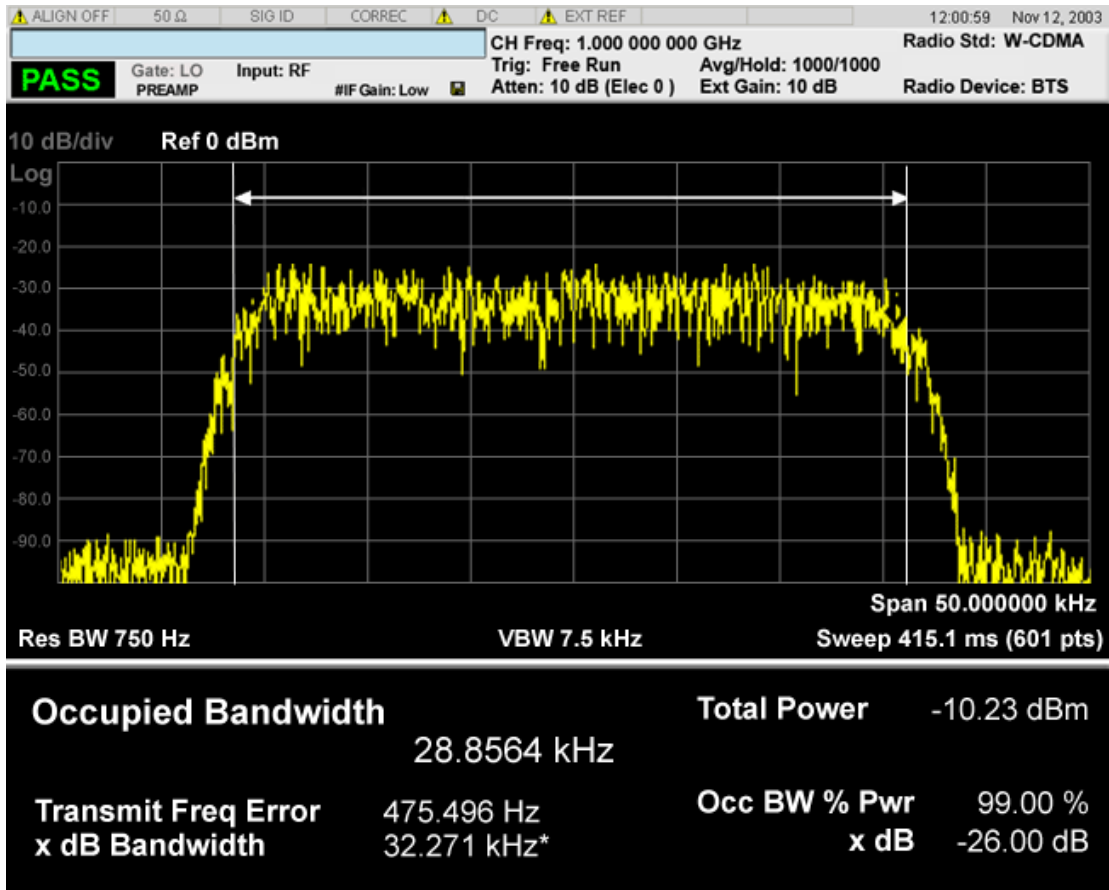

For TD-SCDMA mode only:

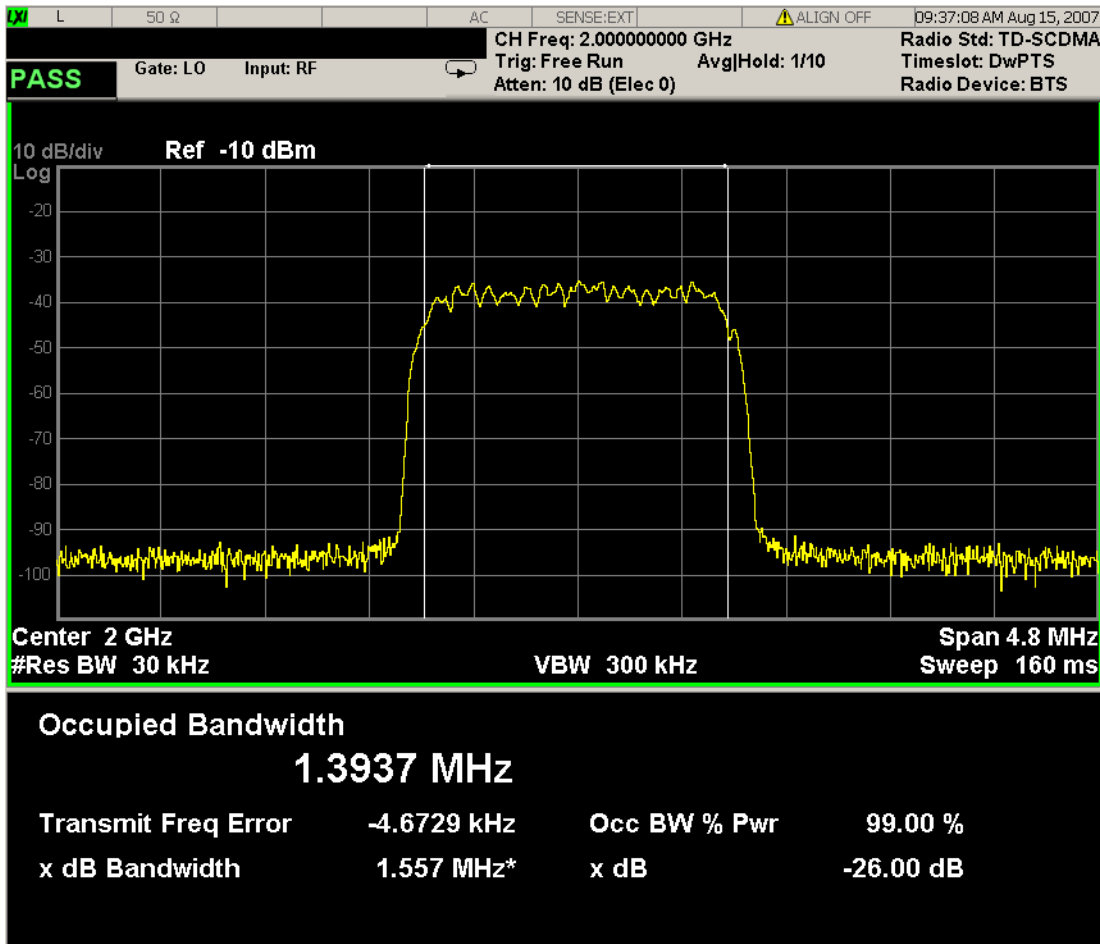

For Bluetooth mode only:

9 Occupied Bandwidth Measurement
View/Display

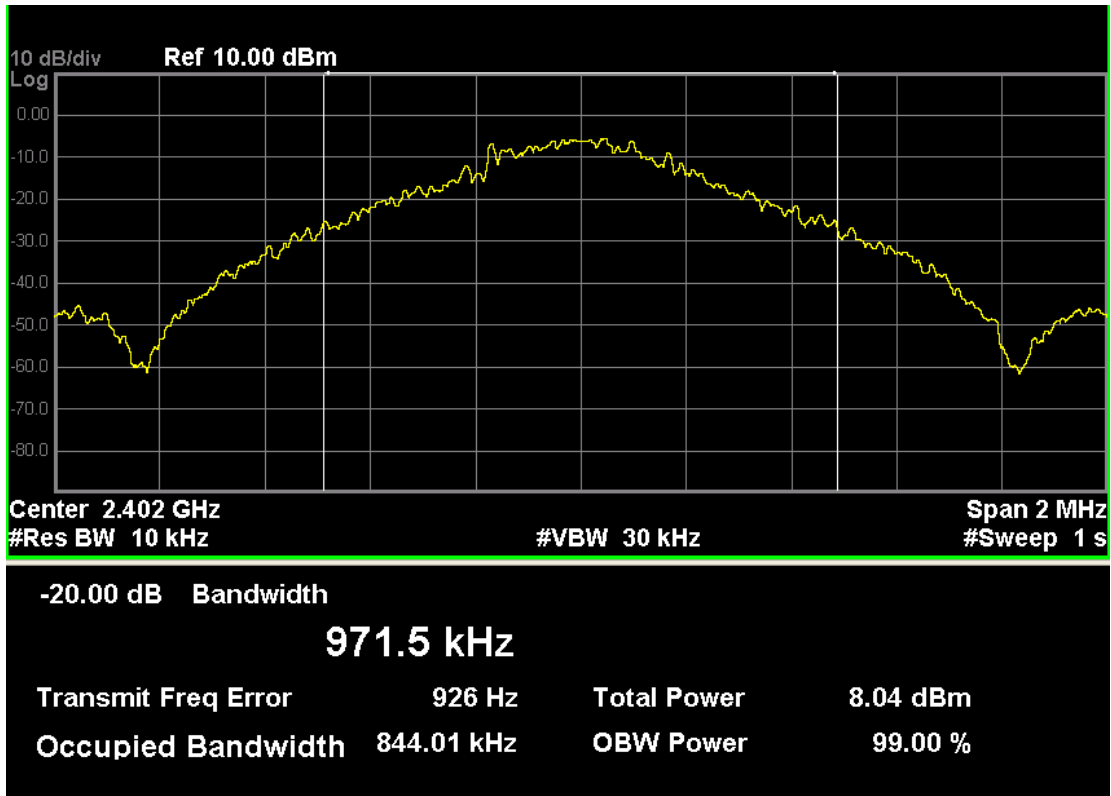

For MSR mode only:

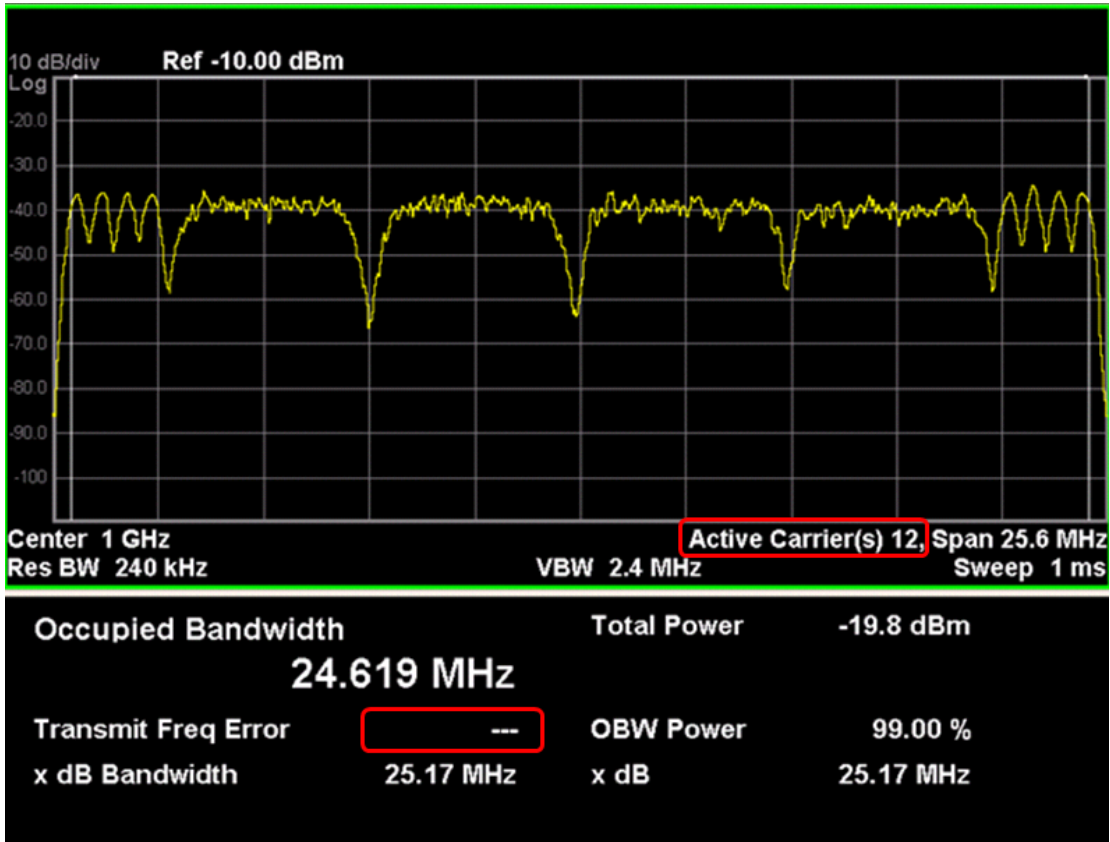

The number of active carriers is displayed. Since span is determined from detected carriers in auto mode, it is necessary to show how many carriers are identified as active., as highlighted above.

When there is one active carrier, Transmit Freq Error is displayed. Otherwise, “---” is displayed, as shown above.

For LTE-Advanced FDD/TDD mode only:

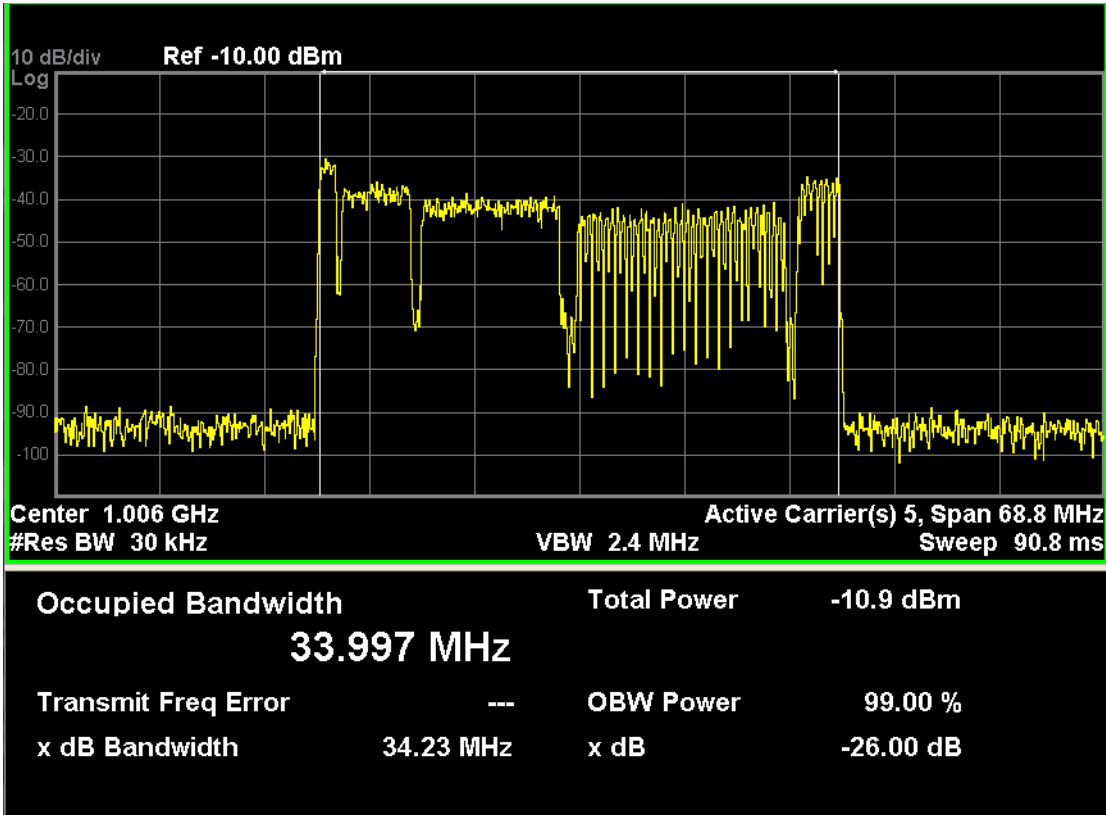

The number of active carriers is displayed to show how many carriers are identified as active in auto detected mode of span, otherwise “-” is displayed to indicate that it is out of scope.

When there is one active carrier, Transmit Freq Error is displayed. Otherwise, “---” is displayed.

Key Path	Front-panel key
Initial S/W Revision	Prior to A.02.00

Display

The Display menu is common to most measurements, and is used for configuring items on the display. Some Display menu settings apply to all the measurements in a mode, and some only to the current measurement. Those under the System Display Settings key apply to all measurements in all modes.

Key Path	Display
Key Path	View/Display
Initial S/W Revision	Prior to A.02.00

Annotation

Turns on and off various parts of the display annotation. The annotation is divided up into four categories:

1. Meas Bar: This is the measurement bar at the top of the screen. It does not include the settings panel or the Active Function. Turning off the Meas Bar turns off the settings panel and the Active Function. When the Meas Bar is off, the graticule area expands to fill the area formerly occupied by the Meas Bar.
2. Screen Annotation: this is the annotation and annunciation around the graticule, including any annotation on lines (such as the display line, the threshold line, etc.) This does NOT include the marker number or the N dB result. When off, the graticule expands to fill the entire graticule area.
3. Trace annotation: these are the labels on the traces, showing their detector (or their math mode).
4. Active Function annotation: this is the active function display in the meas bar, and all of the active function values displayed on softkeys.

See the figure below. Each type of annotation can be turned on and off individually.

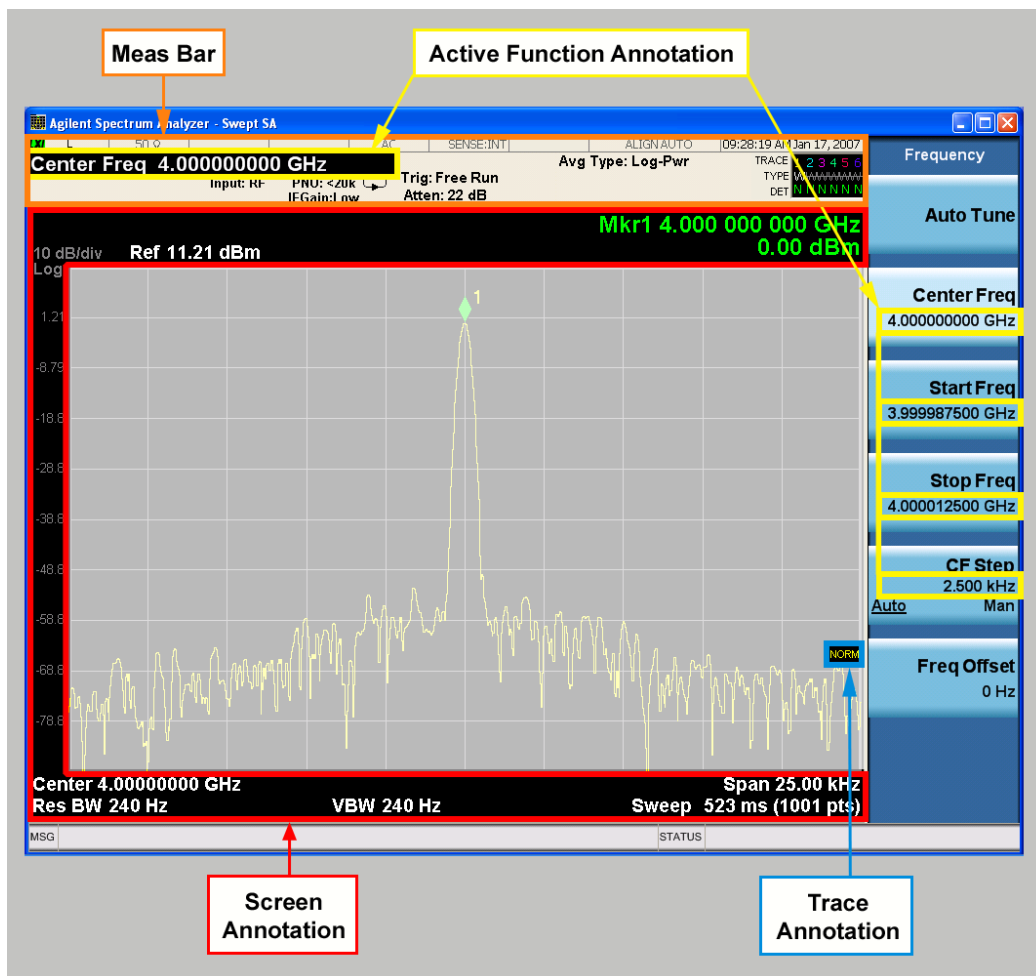

Key Path	View/Display, Display
Initial S/W Revision	Prior to A.02.00

Meas Bar On/Off

This function turns the Measurement Bar on and off, including the settings panel. When off, the graticule area expands to fill the area formerly occupied by the Measurement Bar.

Key Path	View/Display, Display, Annotation
Remote Command	:DISPlay:ANNotation:MBAR[:STATe] OFF ON 0 1 :DISPlay:ANNotation:MBAR[:STATe]?
Example	DISP:ANN:MBAR OFF
Dependencies	Grayed out and forced to OFF when System Display Settings, Annotation is set to Off.
Preset	On This should remain Off through a Preset when System DisplaySettings, Annotation is set to Off.
State Saved	Saved in instrument state.
Initial S/W Revision	Prior to A.02.00

Screen

This controls the display of the annunciation and annotation around the graticule, including any annotation on lines (such as the display line, the threshold line, etc.) and the y-axis annotation. This does NOT include marker annotation (or the N dB result). When off, the graticule expands to fill the entire graticule area, leaving only the 1.5% gap above the graticule as described in the Trace/Detector chapter.

Key Path	View/Display, Display, Annotation
Remote Command	:DISPlay:ANNotation:SCReen[:STATe] OFF ON 0 1 :DISPlay:ANNotation:SCReen[:STATe]?
Example	DISP:ANN:SCR OFF
Dependencies	Grayed-out and forced to OFF when System Display Settings, Annotation is set to Off.
Preset	On This should remain Off through a Preset when System DisplaySettings, Annotation is set to Off
State Saved	Saved in instrument state.
Initial S/W Revision	Prior to A.02.00

Active Function Values On/Off

Turns on and off the active function display in the Meas Bar, and all of the active function values displayed on the softkeys.

Note that all of the softkeys that have active functions have these numeric values blanked when this function is on. This is a security feature..

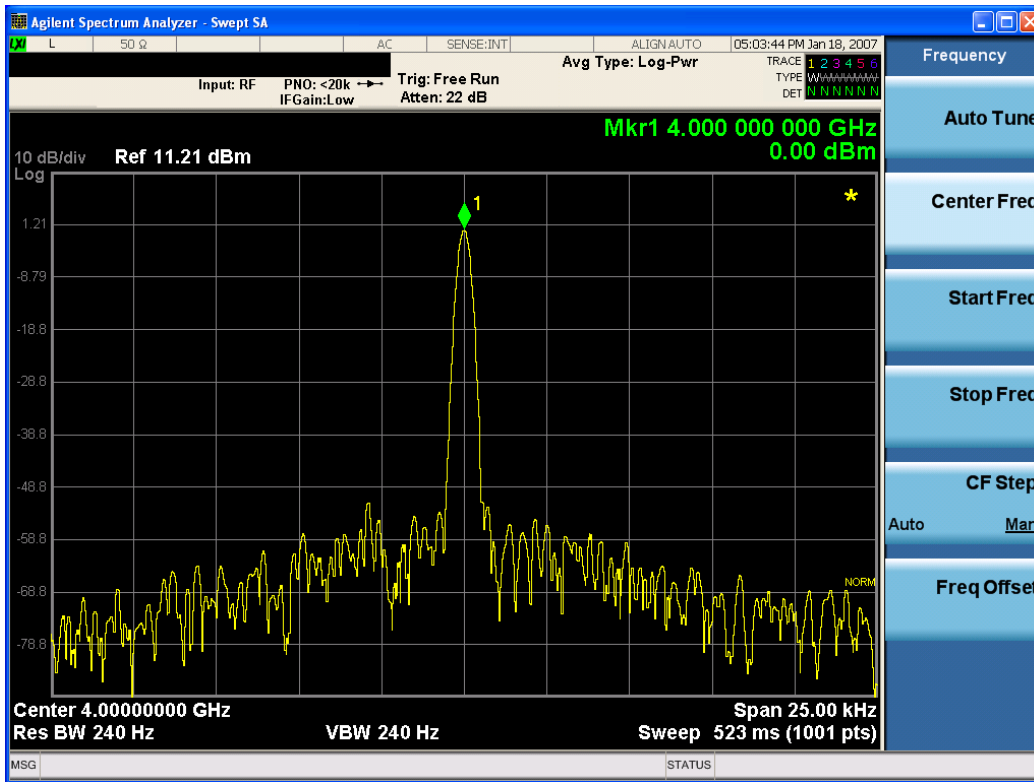

Key Path	View/Display, Display, Annotation
Remote Command	:DISPlay:ACTivefunc[:STATE] ON OFF 1 0 :DISPlay:ACTivefunc[:STATE]?
Example	DISP:ACT OFF
Dependencies	Grayed out and forced to OFF when System Display Settings, Annotation is set to Off.
Preset	On This should remain Off through a Preset when System DisplaySettings, Annotation is set to Off
State Saved	Saved in instrument state.
Initial S/W Revision	Prior to A.02.00

Title

Displays menu keys that enable you to change or clear a title on your display.

Key Path	View/Display, Display
Initial S/W Revision	Prior to A.02.00

Change Title

Writes a title into the "measurement name" field in the banner, for example, "Swept SA".

Press Change Title to enter a new title through the alpha editor. Press Enter or Return to complete the entry. Press ESC to cancel the entry and preserve your existing title.

The display title will replace the measurement name. It remains for this measurement until you press Change Title again, or you recall a state, or a Preset is performed. A title can also be cleared by pressing Title, Clear Title.

NOTE

Notice the inclusion of the <measurement> parameter in the command below. Because each measurement remembers the Display Title, the command must be qualified with the measurement name. For the Swept SA measurement this is not the case; no <measurement> parameter is used when changing the Display Title for the Swept SA measurement.

Key Path	View/Display, Display, Title
Mode	All
Remote Command	:DISPlay:<measurement>:ANNotation:TITLe:DATA <string> :DISPlay:<measurement>:ANNotation:TITLe:DATA?
Example	DISP:ANN:TITL:DATA "This Is My Title" This example is for the Swept SA measurement in the Spectrum Analyzer mode. The SANalyzer <measurement> name is not used. DISP:ACP:ANN:TITL:DATA "This Is My Title" This example is for Measurements other than Swept SA. Both set the title to: This Is My Title
Notes	Pressing this key cancels any active function. When a title is edited the previous title remains intact (it is not cleared) and the cursor goes at the end so that characters can be added or BKSP can be used to go back over previous characters.
Preset	No title (measurement name instead)
State Saved	Saved in instrument state.
Initial S/W Revision	Prior to A.02.00

Clear Title

Clears a title from the front-panel display. Once cleared, the title cannot be retrieved. After the title is cleared, the current Measurement Name replaces it in the title bar.

Key Path	View/Display, Display, Title
Example	The following commands clear the title and restore the measurement's original title: DISP:ANN:TITL:DATA "" This example is for the Swept SA measurement in the Spectrum Analyzer mode. The SANalyzer <measurement> name is not used. DISP:ACP:ANN:TITL:DATA "" This example is for ACP; in measurements other than Swept SA the measurement name is required.
Notes	Uses the :DISPlay:<measurement>:ANNotation:TITLe:DATA <string> command with an empty string (in the Swept SA, the <measurement> is omitted).
Preset	Performed on Preset.
Initial S/W Revision	Prior to A.02.00

Graticule

Pressing Graticule turns the display graticule On or Off. It also turns the graticule y-axis annotation on and off.

Key Path	View/Display, Display
Remote Command	:DISPlay:WINDow[1]:TRACe:GRATicule:GRID[:STATe] OFF ON 0 1 :DISPlay:WINDow[1]:TRACe:GRATicule:GRID[:STATe]?
Example	DISP:WIND:TRAC:GRAT:GRID OFF
Notes	The graticule is the set of horizontal and vertical lines that make up the grid/divisions for the x-axis and y-axis.
Preset	On
State Saved	Saved in instrument state
Initial S/W Revision	Prior to A.02.00

System Display Settings

These settings are "Mode Global" – they affect all modes and measurements and are reset only by Restore Misc Defaults or Restore System Defaults under System.

Key Path	View/Display, Display
Initial S/W Revision	Prior to A.02.00

Annotation Local Settings

This is a Mode Global override of the meas local annotation settings. When it is All Off, it forces ScreenAnnotation, Meas Bar, Trace, and Active Function Values settings to be OFF for all measurements in all modes. This provides the security based "annotation off" function of previous analyzers; hence it uses the legacy SCPI command.

When it is All Off, the Screen, Meas Bar, Trace, and Active Function Values keys under the Display, Annotation menu are grayed out and forced to Off. When Local Settings is selected, you are able to set the local annotation settings on a measurement by measurement basis.

Key Path	View/Display, Display, System Display Settings
Remote Command	:DISPlay:WINDow[1]:ANNOtation[:ALL] OFF ON 0 1 :DISPlay:WINDow[1]:ANNOtation[:ALL]?
Example	:DISP:WIND:ANN OFF
Preset	On (Set by Restore Misc Defaults)
State Saved	Not saved in instrument state.
Backwards Compatibility Notes	The WINDow parameter and optional subopcode is included for backwards compatibility but ignored – all windows are equally affected.
Initial S/W Revision	Prior to A.02.00

Themes

Accesses a menu of functions that enable you to choose the theme to be used when saving the screen image.

The **Themes** option is the same as the **Themes** option under the **Display** and **Page Setup** dialogs. It allows you to choose between themes to be used when saving the screen image.

Key Path	Save, Screen Image
Remote Command	:MMEMory:STORe:SCReem:THEMe TDColor TDMonochrome FCOLor FMONochrome :MMEMory:STORe:SCReem:THEMe?
Example	:MMEM:STOR:SCR:THEM TDM
Preset	3D Color; Is not part of Preset, but is reset by Restore Misc Defaults or Restore System Defaults All and survives subsequent running of the modes.
Readback	3D Color 3D Mono Flat Color Flat Mono
Backwards Compatibility Notes	In ESA and PSA we offer the choice of "Reverse Bitmap" or "Reverse Metafile" when saving screen images. This is much like the "Flat Color" theme available in X-Series. Also, if you selected Reverse Bitmap AND a black & white screen image, that would be much like "Flat Monochrome". In other words, each of the X-Series themes has a similar screen image type in ESA/PSA. But they are not identical.
Initial S/W Revision	Prior to A.02.00

3D Color

Selects a standard color theme with each object filled, shaded and colored as designed.

Key Path	Save, Screen Image, Themes
Example	MMEM:STOR:SCR:THEM TDC
Readback	3D Color
Initial S/W Revision	Prior to A.02.00

3D Monochrome

Selects a format that is like 3D color but shades of gray are used instead of colors.

Key Path	Save, Screen Image, Themes
Example	MMEM:STOR:SCR:THEM TDM
Readback	3D Mono
Initial S/W Revision	Prior to A.02.00

Flat Color

Selects a format that is best when the screen is to be printed on an ink printer.

Key Path	Save, Screen Image, Themes
Example	MMEM:STOR:SCR:THEM FCOL
Readback	Flat Color
Initial S/W Revision	Prior to A.02.00

Flat Monochrome

Selects a format that is like Flat Color. But only black is used (no colors, not even gray), and no fill.

Key Path	Save, Screen Image, Themes
Example	MMEM:STOR:SCR:THEM FMON
Readback	Flat Mono
Initial S/W Revision	Prior to A.02.00

Backlight

Accesses the display backlight on/off keys. This setting may interact with settings under the Windows "Power" menu.

When the backlight is off, pressing ESC, TAB, SPACE, ENTER, UP, DOWN, LEFT, RIGHT, DEL, BKSP, CTRL, or ALT turns the backlight on without affecting the application. Pressing any other key will turn backlight on and could potentially perform the action as well.

Key Path	View/Display, Display, System Display Settings
Remote Command	:DISPlay:BACKlight ON OFF :DISPlay:BACKlight?
Preset	ON (Set by Restore Misc Defaults)
Initial S/W Revision	Prior to A.02.00

Backlight Intensity

An active function used to set the backlight intensity. It goes from 0 to 100 where 100 is full on and 0 is off. This value is independent of the values set under the Backlight on/off key.

Key Path	View/Display, Display, System Display Settings
Remote Command	:DISPlay:BACKlight:INTensity <integer> :DISPlay:BACKlight:INTensity?
Example	DISP:BACK:INT 50

9 Occupied Bandwidth Measurement
View/Display

Preset	100 (Set by Restore Misc Defaults)
Min	0
Max	100
Initial S/W Revision	Prior to A.02.00

10 ACP Measurement

ACP is a measurement of the amount of interference, or power, in an adjacent frequency channel. The results are displayed as a bar graph or as spectrum data, with measurement data at specified offsets. For measurement results and views, see ["View/Display" on page 1051](#).

This topic contains the following sections:

["Measurement Commands for ACP" on page 836](#)

["Remote Command Results for ACP Measurement" on page 837](#)

Measurement Commands for ACP

The following commands are used to retrieve the measurement results:

```
:CONFigure:ACP  
:CONFigure:ACP:NDEFault  
:INITiate:ACP  
:FETCh:ACP[n]?  
:READ:ACP[n]?  
:MEASure:ACP[n]?
```

For more measurement related commands, see the SENSE subsystem, and the section "[Remote Measurement Functions](#)" on page 2770.

Remote Command Results for ACP Measurement

Condition	N	Results Returned
Mode = SA mode, Radio Std = None, Number of carriers = 1 and only offset A is on	Not specified or n = 1	Returns 3 comma-separated values that correspond to: Reference carrier power, lower-adjacent channel power (dBc), and upper-adjacent channel power (dBc).
Mode = DTMB (CTTB) or CMMB, Radio BW = 8 MHz, Number of carriers = 1 and Meas Type = Total power reference	Not specified or n = 1	Returns 32 comma-separated scalar results, in the following order. 1. 0.0 2. Total carrier power (dBm) 3. 0.0 4. Reference carrier power (dBm) 5. Lower offset A - relative power (dB) 6. Lower offset A - absolute power (dBm) 7. Upper offset A - relative power (dB) 8. Upper offset A - absolute power (dBm) 9. Lower offset B - relative power (dB) 10. Lower offset B - absolute power (dBm) 11. Upper offset B - relative power (dB) 12. Upper offset B - absolute power (dBm) ... 25. Lower offset F - relative power (dB) 26. Lower offset F - absolute power (dBm) 27. Upper offset F - relative power (dB) 28. Upper offset F - absolute power (dBm) 29. Inside Adjacent Channel - relative power (dB) 30. Inside Adjacent Channel - absolute power (dBm) 31. Outside Adjacent Channel - relative power (dB) 32. Outside Adjacent Channel - absolute power (dBm) If Radio Device = Exciter, the last four (29, 30, 31 and 32) results returned -999.0. If the results are not available, -999.0 is returned. Note: * Inside Adjacent Channel - absolute power: the maximum of the Lower offset A - absolute power and the Upper offset A - absolute power; ** Inside Adjacent Channel - relative power: the result of Reference carrier power subtracted from Inside Adjacent Channel - absolute power; *** Outside Adjacent Channel - absolute power: the root mean square of the absolute power of the offset B upper/lower, the offset C upper/lower and the offset D upper/lower; **** Outside Adjacent Channel - relative power: the result of Reference carrier power subtracted from Outside Adjacent Channel - absolute power;
Mode = DTMB (CTTB) or	not specified	Returns 32 comma-separated scalar results, in the following order.

Condition	N	Results Returned
CMMB, Radio BW = 8 MHz, Number of carriers = 1 and Meas Type = Power spectral density reference	or n = 1	<ol style="list-style-type: none"> 1. 0.0 2. Total carrier power (dBm/Hz or dBm/MHz) 3. 0.0 4. Reference carrier power (dBm/Hz or dBm/MHz) 5. Lower offset A - relative power (dB) 6. Lower offset A - absolute power (dBm/Hz or dBm/MHz) 7. Upper offset A - relative power (dB) 8. Upper offset A - absolute power (dBm/Hz or dBm/MHz) 9. Lower offset B - relative power (dB) 10. Lower offset B - absolute power (dBm/Hz or dBm/MHz) 11. Upper offset B - relative power (dB) 12. Upper offset B - absolute power (dBm/Hz or dBm/MHz) ... 25. Lower offset F - relative power (dB) 26. Lower offset F - absolute power (dBm/Hz or dBm/MHz) 27. Upper offset F - relative power (dB) 28. Upper offset F - absolute power (dBm/Hz or dBm/MHz) 29. -999.0 30. -999.0 31. -999.0 32. -999.0 <p>The last four (29, 30, 31 and 32) results always returned -999.0. If the results are not available, -999.0 is returned.</p>
Meas Type = Total power reference	Not specified or n = 1	<p>Returns 28 comma-separated scalar results, in the following order.</p> <ol style="list-style-type: none"> 1. 0.0 2. Total carrier power (dBm) 3. 0.0 4. Reference carrier power (dBm) 5. Lower offset A - relative power (dB) 6. Lower offset A - absolute power (dBm) 7. Upper offset A - relative power (dB) 8. Upper offset A - absolute power (dBm) 9. Lower offset B - relative power (dB) 10. Lower offset B - absolute power (dBm) 11. Upper offset B - relative power (dB) 12. Upper offset B - absolute power (dBm) ... 25. Lower offset F - relative power (dB) 26. Lower offset F - absolute power (dBm)

Condition	N	Results Returned
		27. Upper offset F - relative power (dB) 28. Upper offset F - absolute power (dBm) If the results are not available, -999.0 is returned. When in MSR and LTE-Advanced FDD/TDD, this trace includes only outer offset results and their reference value(s).
Meas Type = Power spectral density reference	not specified or n = 1	Returns 28 comma-separated scalar results, in the following order. 1. 0.0 2. Total carrier power (dBm/Hz or dBm/MHz) 3. 0.0 4. Reference carrier power (dBm/Hz or dBm/MHz) 5. Lower offset A - relative power (dB) 6. Lower offset A - absolute power (dBm/Hz or dBm/MHz) 7. Upper offset A - relative power (dB) 8. Upper offset A - absolute power (dBm/Hz or dBm/MHz) 9. Lower offset B - relative power (dB) 10. Lower offset B - absolute power (dBm/Hz or dBm/MHz) 11. Upper offset B - relative power (dB) 12. Upper offset B - absolute power (dBm/Hz or dBm/MHz) ... 25. Lower offset F - relative power (dB) 26. Lower offset F - absolute power (dBm/Hz or dBm/MHz) 27. Upper offset F - relative power (dB) 28. Upper offset F - absolute power (dBm/Hz or dBm/MHz) If the results are not available, -999.0 is returned. When in MSR and LTE-Advanced FDD/TDD, this trace includes only outer offset results and their reference value(s).
Meas Method = FAST	not specified or n = 1	Returns 5 comma-separated results, in the following order: 1. Reference carrier - absolute power (dBm) 2. Lower offset A - absolute power (dBm) 3. Upper offset A - absolute power (dBm) 4. Lower offset B - absolute power (dBm) 5. Upper offset B - absolute power (dBm)
Mode = MSR, LTEAFDD, LTEATDD, Meas Type = Total power reference and Power Ref = Left & Right Carriers	Not specified or n = 1	Returns 28 comma-separated scalar results, in the following order. 1. 0.0 2. Total carrier power (dBm) 3. Left Reference carrier power (dBm) 4. Right Reference carrier power (dBm) 5. Lower offset A - relative power (dB) 6. Lower offset A - absolute power (dBm) 7. Upper offset A - relative power (dB)

Condition	N	Results Returned
		8. Upper offset A - absolute power (dBm) 9. Lower offset B - relative power (dB) 10. Lower offset B - absolute power (dBm) 11. Upper offset B - relative power (dB) 12. Upper offset B - absolute power (dBm) ... 25. Lower offset F - relative power (dB) 26. Lower offset F - absolute power (dBm) 27. Upper offset F - relative power (dB) 28. Upper offset F - absolute power (dBm) If the results are not available, -999.0 is returned.
Mode = MSR , LTEAFDD, LTEATDD, Meas Type = Power spectral density reference and Power Ref = Left & Right Carriers	not specified or n = 1	Returns 28 comma-separated scalar results, in the following order. 1. 0.0 2. Total carrier power (dBm/Hz or dBm/MHz) 3. Left reference carrier power (dBm/Hz or dBm/MHz) 4. Right reference carrier power (dBm/Hz or dBm/MHz) 5. Lower offset A - relative power (dB) 6. Lower offset A - absolute power (dBm/Hz or dBm/MHz) 7. Upper offset A - relative power (dB) 8. Upper offset A - absolute power (dBm/Hz or dBm/MHz) 9. Lower offset B - relative power (dB) 10. Lower offset B - absolute power (dBm/Hz or dBm/MHz) 11. Upper offset B - relative power (dB) 12. Upper offset B - absolute power (dBm/Hz or dBm/MHz) ... 25. Lower offset F - relative power (dB) 26. Lower offset F - absolute power (dBm/Hz or dBm/MHz) 27. Upper offset F - relative power (dB) 28. Upper offset F - absolute power (dBm/Hz or dBm/MHz) If the results are not available, -999.0 is returned. When in MSR and LTE-Advanced FDD/TDD, this trace includes only outer offset results and their reference value(s).
Meas Type = Total power reference	n = 2	Returns 48 scalar results, in the following order: 1. Channel (1) - relative power (dB) 2. Channel (1) - absolute power (dBm) 3. Channel (2) - relative power (dB) 4. Channel (2) - absolute power (dBm) ... 23. Channel (12) - relative power (dB) 24. Channel (12) - absolute power (dBm)

Condition	N	Results Returned
		25. Lower offset A - relative power (dB) 26. Lower offset A - absolute power (dBm) 27. Upper offset A - relative power (dB) 28. Upper offset A - absolute power (dBm) 29. Lower offset B - relative power (dB) 30. Lower offset B - absolute power (dBm) 31. Upper offset B - relative power (dB) 32. Upper offset B - absolute power (dBm) ... 45. Lower offset F - relative power (dB) 46. Lower offset F - absolute power (dBm) 47. Upper offset F - relative power (dB) 48. Upper offset F - absolute power (dBm) If the results are not available, -999.0 is returned. When in MSR and LTE-Advanced FDD/TDD, this trace includes only outer offset results and their reference value(s).
Meas Type = Power spectral density reference	n = 2	Returns 48 scalar results, in the following order: 1. Channel (1) - relative power (dB) 2. Channel (1) - absolute power (dBm/Hz or dBm/MHz) 3. Channel (2) - relative power (dB) 4. Channel (2) - absolute power (dBm/Hz or dBm/MHz) ... 23. Channel (12) - relative power (dB) 24. Channel (12) - absolute power (dBm/Hz or dBm/MHz) 25. Lower offset A - relative power (dB) 26. Lower offset A - absolute power (dBm/Hz or dBm/MHz) 27. Upper offset A - relative power (dB) 28. Upper offset A - absolute power (dBm/Hz or dBm/MHz) 29. Lower offset B - relative power (dB) 30. Lower offset B - absolute power (dBm/Hz or dBm/MHz) 31. Upper offset B - relative power (dB) 32. Upper offset B - absolute power (dBm/Hz or dBm/MHz) ... 45. Lower offset F - relative power (dB) 46. Lower offset F - absolute power (dBm/Hz or dBm/MHz) 47. Upper offset F - relative power (dB) 48. Upper offset F - absolute power (dBm/Hz or dBm/MHz) If the results are not available, -999.0 is returned. When in MSR and LTE-Advanced FDD/TDD, this trace includes only outer offset

Condition	N	Results Returned
Mode = DTMB (CTTB) or CMMB, Radio BW = 8 MHz and Meas Type = Total power reference	n = 3	<p>results.</p> <hr/> <p>Returns 28 scalar values of the pass/fail (0 = passed, or 1 = failed) determined by testing the relative to the reference carrier and by testing the absolute power limit of the offset frequencies (measured as total power in dB):</p> <ol style="list-style-type: none"> 1. Lower offset A - relative limit result 2. Lower offset A - absolute limit result 3. Upper offset A - relative limit result 4. Upper offset A - absolute limit result 5. Lower offset B - relative limit result 6. Lower offset B - absolute limit result 7. Upper offset B - relative limit result 8. Upper offset B - absolute limit result <p>...</p> <ol style="list-style-type: none"> 21. Lower offset F - relative limit result 22. Lower offset F - absolute limit result 23. Upper offset F - relative limit result 24. Upper offset F - absolute limit result 25. Inside Adjacent Channel - relative limit result 26. Inside Adjacent Channel - absolute limit result 27. Outside Adjacent Channel - relative limit result 28. Outside Adjacent Channel - absolute limit result <p>If Radio Device = Exciter, the last four (25, 26, 27 and 28) results returned -999.0.</p>
Mode = DTMB (CTTB) or CMMB, Radio BW = 8 MHz and Meas Type = Power spectral density reference	n = 3	<p>Returns 28 scalar values of the pass/fail (0 = passed, or 1 = failed) determined by testing the relative to the reference carrier and by testing the absolute power limit of the offset frequencies (measured as power spectral density in dB):</p> <ol style="list-style-type: none"> 1. Lower offset A - relative limit result 2. Lower offset A - absolute limit result 3. Upper offset A - relative limit result 4. Upper offset A - absolute limit result 5. Lower offset B - relative limit result 6. Lower offset B - absolute limit result 7. Upper offset B - relative limit result 8. Upper offset B - absolute limit result <p>...</p> <ol style="list-style-type: none"> 21. Lower offset F - relative limit result 22. Lower offset F - absolute limit result 23. Upper offset F - relative limit result 24. Upper offset F - absolute limit result 25. -999.0

Condition	N	Results Returned
		26. -999.0 27. -999.0 28. -999.0 The last four results always returned -999.0.
Meas Type = Total power reference	n = 3	Returns 24 scalar values of the pass/fail (0 = passed, or 1 = failed) determined by testing the relative to the reference carrier and by testing the absolute power limit of the offset frequencies (measured as total power in dB): <ol style="list-style-type: none"> 1. Lower offset A - relative limit result 2. Lower offset A - absolute limit result 3. Upper offset A - relative limit result 4. Upper offset A - absolute limit result 5. Lower offset B - relative limit result 6. Lower offset B - absolute limit result 7. Upper offset B - relative limit result 8. Upper offset B - absolute limit result ... <ol style="list-style-type: none"> 21 Lower offset F - relative limit result 22 Lower offset F - absolute limit result 23 Upper offset F - relative limit result 24 Upper offset F - absolute limit result When in MSR and LTE-Advanced FDD/TDD, this trace includes only outer offset results.
Meas Type = Power spectral density reference	n = 3	Returns 24 scalar values of the pass/fail (0 = passed, or 1 = failed) determined by testing the relative to the reference carrier and by testing the absolute power limit of the offset frequencies (measured as power spectral density in dB): <ol style="list-style-type: none"> 1. Lower offset A - relative limit result 2. Lower offset A - absolute limit result 3. Upper offset A - relative limit result 4. Upper offset A - absolute limit result 5. Lower offset B - relative limit result 6. Lower offset B - absolute limit result 7. Upper offset B - relative limit result 8. Upper offset B - absolute limit result ... <ol style="list-style-type: none"> 21 Lower offset F - relative limit result 22 Lower offset F - absolute limit result 23 Upper offset F - relative limit result 24 Upper offset F - absolute limit result When in MSR and LTE-Advanced FDD/TDD, this trace includes only outer offset results.

Condition	N	Results Returned
	n = 4	Returns <Num Pts> comma-separated scalar values representing the Y values in Trace 1
	n = 5	Returns <Num Pts> comma-separated scalar values representing the Y values in Trace 2
	n = 6	Returns <Num Pts> comma-separated scalar values representing the Y values in Trace 3
Meas Type = Total power reference	n = 7	<p>Returns (2 * Number of Carriers) scalar results, in the following order:</p> <p>The Number of Carriers is the value filled in Carriers under Carrier Setup menu. If license N9060A-5FP is enabled, max value of Number of Carriers is 18, otherwise, max value of Number of Carriers is 12. In MSR mode, max value of Number of Carriers is 100. In LTE-Advanced FDD/TDD mode, max value of number of carriers is 5.</p> <ol style="list-style-type: none"> 1. Channel (1) - relative power (dB) 2. Channel (1) - absolute power (dBm) 3. Channel (2) - relative power (dB) 4. Channel (2) - absolute power (dBm) <p>...</p> <p>2 * Number of Carriers -1. Channel (Number of Carriers) - relative power (dB)</p> <p>2 * Number of Carriers. Channel (Number of Carriers) - absolute power (dBm)</p> <p>If the results are not available, 9.91E+37 is returned.</p>
Meas Type = Power spectral density reference	n = 7	<p>Returns (2 * Number of Carriers) scalar results, in the following order: The Number of Carriers is the value filled in Carriers under Carrier Setup menu.</p> <p>If license N9060A-5FP is enabled, max value of Number of Carriers is 18, otherwise, max value of Number of Carriers is 12. In MSR mode, max value of Number of Carriers is 100. In LTE-Advanced FDD/TDD mode, max value of number of carriers is 5.</p> <ol style="list-style-type: none"> 1. Channel (1) - relative power (dB) 2. Channel (1) - absolute power (dBm/Hz or dBm/MHz) 3. Channel (2) - relative power (dB) 4. Channel (2) - absolute power (dBm/Hz or dBm/MHz) <p>...</p> <p>2 * Number of Carriers -1. Channel (Number of Carriers) - relative power (dB)</p> <p>2 * Number of Carriers. Channel (Number of Carriers) - absolute power (dBm/Hz or dBm/MHz)</p> <p>If the results are not available, 9.91E+37 is returned</p>
Mode = MSR,LTEAFDD,LTEATDD	n = 8	<p>Returns scalar results, in the following order:</p> <ol style="list-style-type: none"> 1. 0.0 2. Total carrier power (dBm) 3. 0.0

Condition	N	Results Returned
		<p>4. Reference carrier power (dBm, dBm/Hz or dBm/MHz)</p> <p>5. Inner Lower offset A - relative power (dB)</p> <p>6. Inner Lower offset A - absolute power (dBm, dBm/Hz or dBm/MHz)</p> <p>7. Inner Upper offset A - relative power (dB)</p> <p>8. Inner Upper offset A - absolute power (dBm, dBm/Hz or dBm/MHz)</p> <p>9. Inner Lower offset B - relative power (dB)</p> <p>10. Inner Lower offset B - absolute power (dBm, dBm/Hz or dBm/MHz)</p> <p>11. Inner Upper offset B - relative power (dB)</p> <p>12. Inner Upper offset B - absolute power (dBm, dBm/Hz or dBm/MHz)</p> <p>...</p> <p>25. Inner Lower offset F - relative power (dB)</p> <p>26. Inner Lower offset F - absolute power (dBm, dBm/Hz or dBm/MHz)</p> <p>27. Inner Upper offset F - relative power (dB)</p> <p>28. Inner Upper offset F - absolute power (dBm, dBm/Hz or dBm/MHz)</p> <p>When Power Ref is either Left & Right Carriers or Max Power Carrier in Sub-block, the first four values are</p> <p>1. 0.0</p> <p>2. Total carrier power (dBm)</p> <p>3. Reference carrier in the lower sub-block (dBm, dBm/Hz or dBm/MHz)</p> <p>4. Reference carrier in the upper sub-block (dBm, dBm/Hz or dBm/MHz)</p> <p>Unit of absolute power results.</p> <p>dBm: Meas Type = Total Pwr Ref</p> <p>dBm/Hz: Meas Type = PSD Ref, PSD Unit = dBm/Hz</p> <p>dBm/MHz: Meas Type = PSD Ref, PSD Unit = dBm/MHz</p> <p>If the results are not available, 9.91E+37 is returned.</p>
Mode = MSR, LTEAFDD,LTEATDD	n = 9	<p>Returns scalar values of the pass/fail (0 = passed, or 1 = failed) determined by testing the relative to the reference carrier and by testing the absolute power limit of the offset frequencies.</p> <p>1. Inner Lower offset A - relative limit result</p> <p>2. Inner Lower offset A - absolute limit result</p> <p>3. Inner Upper offset A - relative limit result</p> <p>4. Inner Upper offset A - absolute limit result</p> <p>5. Inner Lower offset B - relative limit result</p> <p>6. Inner Lower offset B - absolute limit result</p> <p>7. Inner Upper offset B - relative limit result</p> <p>8. Inner Upper offset B - absolute limit result</p> <p>...</p> <p>21. Inner Lower offset F - relative limit result</p> <p>22. Inner Lower offset F - absolute limit result</p> <p>23. Inner Upper offset F - relative limit result</p>

Condition	N	Results Returned
		24. Inner Upper offset F - absolute limit result
Mode = MSR, LTEAFDD,LTEATDD	n = 10	<p>Returns scalar values of offset results. Numbers returned in this trace is 10 x actually measured offsets. Note that upper and lower sides of an offset are returned separately. For example, when only outer offset A is measured with offset side both, $10 \times 2 = 20$ values are returned.</p> <ol style="list-style-type: none"> 1. Inner = 1 or Outer = 2. 2. Offset A~F. (A=1, B=2, ... F=6) 3. Offset Side. Lower=1 or Upper=2 4. Relative power or relative PSD (dBc or dB) 5. Absolute power (dBm) or absolute PSD (dBm/Hz or dBm/MHz) 6. Reference power (dBm) or reference PSD (dBm/Hz or dBm/MHz) 7. Reference Index 1 8. Reference Index 2 9. 0 (Reserved) 10. 0 (Reserved) <p>...</p> <ol style="list-style-type: none"> 10(n-1)+1. Inner = 1 or Outer = 2. 10(n-1)+2. Offset A~F. (A=1, B=2, ... F=6) 10(n-1)+3. Offset Side. Lower=1 or Upper=2 10(n-1)+4. Relative power or relative PSD (dBc or dB) 10(n-1)+5. Absolute power (dBm) or absolute PSD (dBm/Hz or dBm/MHz) 10(n-1)+6. Reference power (dBm) or reference PSD (dBm/Hz or dBm/MHz) 10(n-1)+7. Reference Index 1 10(n-1)+8. Reference Index 2 10(n-1)+9. 0 (Reserved) 10(n-1)+10. 0 (Reserved) <p>Where n is number of offsets.</p> <p>Meas Type determines which type of power result is returned, i.e. power or PSD. Unit for PSD results is determined by PSD Unit.</p> <p>If result is not available, 9.91E+37 is returned.</p>
Key Path	Front-panel key	
Initial S/W Revision	Prior to A.02.00	
Modified at S/W Revision	A.13.00	

AMPTD Y Scale

Accesses a menu of functions that enable you to set the vertical scale parameters. The parameter values are measurement independent, except all Attenuation values and the Internal Preamp selections, which are the same across all measurements.

Key Path	Front-panel key
Initial S/W Revision	Prior to A.02.00

Ref Value

Sets the value for the absolute power reference. However, since the Auto Scaling is defaulted to On, this value is automatically determined by the measurement result. When you set a value manually, Auto Scaling automatically changes to Off.

Key Path	AMPTD Y Scale
Mode	SA, WCDMA, C2K, WIMAX OFDMA, TD-SCDMA, 1xEVDO, DVB-T/H, DTMB (CTTB), ISDB-T, CMMB, LTE, LTE-TDD, Digital Cable TV, MSR, LTEAFDD, LTEATDD
Remote Command	:DISPlay:ACPpower:VIEW[1]:WINDow[1]:TRACe:Y[:SCALe]:RLEVel <real> :DISPlay:ACPpower:VIEW[1]:WINDow[1]:TRACe:Y[:SCALe]:RLEVel?
Example	DISP:ACP:VIEW:WIND:TRAC:Y:RLEV 100 DISP:ACP:VIEW:WIND:TRAC:Y:RLEV?
Notes	You must be in the mode that includes ACP measurements to use this command. Use :INSTrument:SElect to set the mode.
Couplings	When the Auto Scaling is On, this value is automatically determined by the measurement result. When you set a value manually, Auto Scaling automatically changes to Off.
Preset	10dBm
State Saved	Saved in instrument state.
Min	-250.00 dBm
Max	250.00 dBm
Initial S/W Revision	Prior to A.02.00
Modified at S/W Revision	A.02.00, A.03.00

Attenuation

This menu controls the attenuator functions and interactions between the attenuation system components.

There are two attenuator configurations in the X-Series. One is a dual attenuator configuration consisting of a mechanical attenuator and an optional electronic attenuator. The other configuration uses a single attenuator with combined mechanical and electronic sections that controls all the attenuation functions. Different models in the X-Series come with different configurations.

See "Dual Attenuator Configurations:" on page 848

See "Single Attenuator Configuration:" on page 849

Most Attenuation settings are the same for all measurements – they do not change as you change measurements. Settings like these are called “Meas Global” and are unaffected by Meas Preset.

Key Path	AMPTD Y Scale
Scope	Meas Global
Dependencies	In measurements that support the I/Q inputs, this key is unavailable when I/Q is the selected input, and is replaced by the Range key in that case.
Readback Line	Contains a summary in [] brackets of the current total attenuation. See the descriptions of the , " (Mech) Atten " on page 2736, and "Enable Elec Atten" on page 2737 keys for more detail on the contributors to the total attenuation. Note that when "Pre-Adjust for Min Clip" is on, this value can change at the start of every measurement.
Initial S/W Revision	Prior to A.02.00
Modified at S/W Revision	A.03.00

Dual Attenuator Configurations:

Configuration 1: Mechanical attenuator + optional electronic attenuator

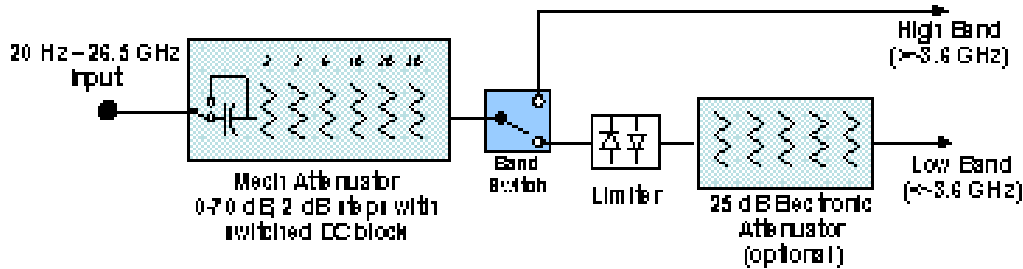

Configuration 2: Mechanical attenuator, no optional electronic attenuator

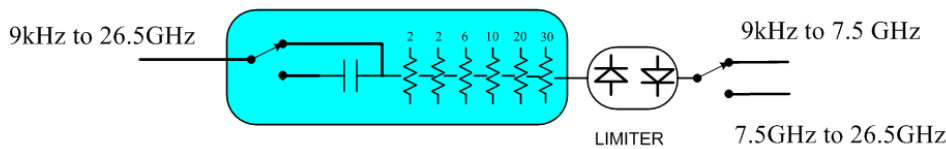

(note that Configuration 2 is not strictly speaking a dual-section attenuator, since there is no electronic section available. However, it behaves exactly like Configuration 1 without the Electronic Attenuator option EA3, therefore for the sake of this document it is grouped into the “Dual Attenuator” configuration)

Single Attenuator Configuration:

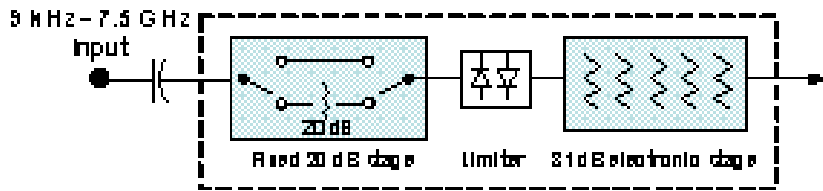

You can tell which attenuator configuration you have by pressing the Attenuation key, which (in most Modes) opens the Attenuation menu. If the first key in the Attenuation menu says Mech Atten you have the dual attenuator configuration. If the first key says Atten you have the single attenuator configuration.

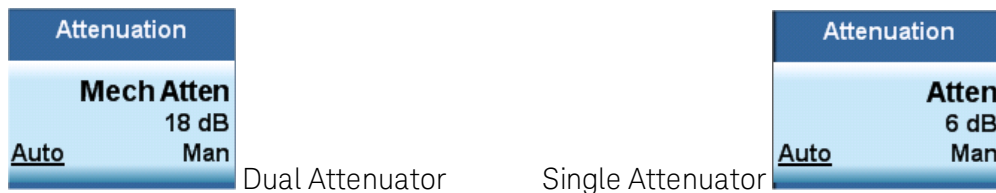

In the single attenuator configuration, you control the attenuation with a single control, as the fixed stage has only two states. In the dual attenuator configuration, both stages have significant range so you are given separate control of the mechanical and electronic attenuator stages.

When you have the dual attenuator configuration, you may still have only a single attenuator, because unless option EA3 (the Electronic Attenuator option) is available, and you purchase it, you will have only the mechanical attenuator.

(Mech) Atten

This key is labeled Mech Atten in dual attenuator models and Atten in single attenuator models. In the dual attenuator configuration, this key only affects the mechanical attenuator.

This key lets you modify the attenuation applied to the RF input signal path. This value is normally auto coupled to the Ref Level, the Internal Preamp Gain, any External Gain that is entered, and the Max Mixer Level, as described in the table below.

See "[Attenuator Configurations and Auto/Man](#)" on page 851

Key Path	AMPTD Y Scale, Attenuation
Remote Command	<pre>[:SENSe]:POWer[:RF]:ATTenuation <rel_amp1></pre> <pre>[:SENSe]:POWer[:RF]:ATTenuation?</pre> <pre>[:SENSe]:POWer[:RF]:ATTenuation:AUTO OFF ON 0 1</pre> <pre>[:SENSe]:POWer[:RF]:ATTenuation:AUTO?</pre>
Example	<p>POW:ATT 20</p> <p>Dual attenuator configuration: sets the mechanical attenuator to 20 dB</p> <p>Single attenuator mode: sets the main attenuation to 20 dB (see below for definition of "main" attenuation).</p> <p>If the attenuator was in Auto, it sets it to Manual.</p>
Dependencies	Some measurements do not support the Auto setting of (Mech) Atten. In these measurements, the

Auto/Man selection is not available, and the Auto/Man line on the key disappears.

In dual attenuator configurations, when the electronic attenuator is enabled, the mechanical attenuator has no auto setting and the Auto/Man line on the key disappears. The state of Auto/Man is remembered and restored when the electronic attenuator is once again disabled. This is described in more detail in the ["Enable Elec Atten" on page 2737](#) key description.

See ["Attenuator Configurations and Auto/Man" on page 851](#) for more information on the Auto/Man functionality of Attenuation.

Couplings

When (Mech) Atten is in Auto, it uses the following algorithm to determine a value:

If the USB Preamp is connected to USB, use 0 dB.

Otherwise, $Atten = ReferenceLevel + PreAmpGain + ExternalGain - RefLevelOffset - MaxMixerLevel + IF\ Gain$.

Limit this value to be between 6 dB and the Max value. No value below 6 dB can ever be chosen by Auto.

The resulting value is rounded up to the largest value possible given the attenuation step setting. That is, 50.01 dB would change to 60 dB (for a 10 dB attenuation step).

The "IF Gain" term in the equation above is either 0 dB or +10 dB, depending on the settings of FFT IF Gain, Swept IF Gain, max Ref Level and the Auto/Man setting of Mech Atten.

In External Mixing and BBIQ, where the Attenuator is not in the signal path, the Attenuator setting changes as described above when (Mech) Atten is in Auto, but no changes are made to the actual attenuator hardware setting until the input is changed back to the RF Input.

Preset

The preset for Mech Attenuation is "Auto."

The Auto value of attenuation is:

CXA, EXA, MXA and PXA: 10 dB

State Saved

Saved in instrument state

Min

0 dB

The attenuation set by this key cannot be decreased below 6 dB with the knob or step keys. To get to a value below 6 dB it has to be directly entered from the keypad or via SCPI. This protects from adjusting the attenuation to a dangerously small value which can put the instrument at risk of damage to input circuitry. However, if the current mechanical attenuation is below 6 dB it can be increased with the knob and step keys, but not decreased.

Max

CXA N9000A-503/507: 50 dB

CXA N9000A-513/526: 70dB

EXA: 60 dB

MXA and PXA: 70 dB

In the single attenuator configuration, the total of ATT and EATT cannot exceed 50 dB, so if the EATT is set to 24 dB first, the main attenuation cannot be greater than 26 dB and will be reduced accordingly; if the main attenuator is set to 40 dB first, EATT cannot be greater than 10 dB.

Initial S/W Revision

Prior to A.02.00

Modified at S/W Revision

A.03.00

Attenuator Configurations and Auto/Man

As described in the Attenuation key description, there are two distinct attenuator configurations available in the X-Series, the single attenuator and dual attenuator configurations. In dual attenuator configurations, we have the mechanical attenuation and the electronic attenuation, and the current total attenuation is the sum of the electronic + mechanical attenuation. In single attenuator configurations, we refer to the attenuation set using the (Mech) Atten key (or POW:ATT SCPI) as the “main” attenuation; and the attenuation that is set by the SCPI command POW:EATT as the “soft” attenuation (the POW:EATT command is honored even in the single attenuator configuration, for compatibility purposes). Then the current total attenuation is the sum of the main + soft attenuation. See the Elec Atten key description for more on “soft” attenuation.

In the dual attenuator configuration, when the electronic attenuator is enabled, there is no Auto/Man functionality for the mechanical attenuator, and the third line of the key label (the Auto/Man line) disappears:

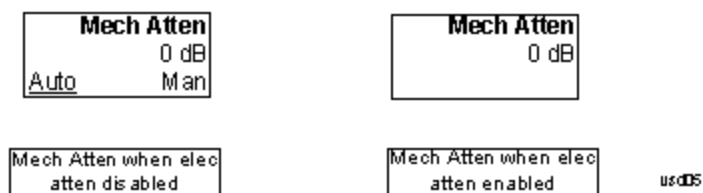

Enable Elec Atten

Enables the Electronic Attenuator.

The electronic attenuator offers finer steps than the mechanical attenuator, has no acoustical noise, is faster, and is less subject to wear. These advantages primarily aid in remote operation and are negligible for front panel use. See ["Using the Electronic Attenuator: Pros and Cons" on page 853](#) for a detailed discussion of the pros and cons of using the electronic attenuator.

For the single attenuator configuration, for SCPI backwards compatibility, the “soft” attenuation feature replaces the dual attenuator configuration’s electronic attenuator. All the same couplings and limitations apply. See ["Attenuator Configurations and Auto/Man" on page 2737](#)

See ["More Information" on page 852](#)

Key Path	AMPTD Y Scale, Attenuation
Remote Command	[:SENSe] :POWer [:RF] :EATTenuation :STATe OFF ON 0 1 [:SENSe] :POWer [:RF] :EATTenuation :STATe ?
Example	POW:EATT:STAT ON
Dependencies	This key only appears in Dual Attenuator models with an Electronic Attenuator installed. It does not appear in models with the Single Attenuator configuration, as in the single attenuator configuration there is no “electronic attenuator” there is only a single integrated attenuator (which has both a mechanical and electronic stage). However, in the single attenuator configuration, EATT SCPI commands are accepted for compatibility with other X-series instruments and set a “soft” attenuation as described in "Attenuator Configurations and Auto/Man" on page 2737 . The electronic attenuator (and the “soft” attenuation function provided in single attenuator configurations) is unavailable above 3.6 GHz. Therefore, if the Stop Frequency of the analyzer is > 3.6 GHz then the Enable Elec Atten key will be OFF and grayed out.

	<p>If the Internal Preamp is on, meaning it is set to Low Band or Full, the electronic attenuator (and the “soft” attenuation function provided in single attenuator configurations) is unavailable. In this case the Enable Elec Atten key will be OFF and grayed out.</p> <p>If either of the above is true, if the SCPI command is sent, an error indicating that the electronic attenuator is unavailable will be sent.</p> <p>If the electronic/soft Attenuator is enabled, then the Stop Freq of the analyzer is limited to 3.6 GHz and the Internal Preamp is unavailable.</p> <p>The SCPI-only “soft” electronic attenuation for the single-attenuator configuration is not available in all measurements; in particular, it is not available in the Swept SA measurement.</p>
Couplings	Enabling and disabling the Electronic Attenuator affects the setting of the Mechanical Attenuator (in dual attenuator configurations). This is described in more detail below this table.
Preset	OFF for Swept SA measurement; ON for all other measurements that support the electronic attenuator
State Saved	Saved in instrument state
Initial S/W Revision	Prior to A.02.00
Modified at S/W Revision	A.03.00

More Information

Mechanical Attenuator Transition Rules

When the Electronic Attenuator is enabled, the Mechanical Attenuator transitions to a state that has no Auto function. Below are the rules for transitioning the Mechanical Attenuator. NOTE that the information below ONLY applies to the dual attenuator configurations, and ONLY when the Electronic Attenuator is installed:

When the Electronic Attenuation is enabled from a disabled state:

- The Mechanical Attenuator is initialized to 10 dB (this is its optimal performance setting). You can then set it as desired with SCPI, numeric keypad, step keys, or knob, and it behaves as it normally would in manual mode
- The Auto/Man state of (Mech) Atten is saved
- The Auto/Man line on the (Mech) Atten key disappears and the auto rules are disabled
- The Electronic Attenuator is set to 10 dB less than the previous value of the Mechanical Attenuator, within the limitation that it must stay within the range of 0 to 24 dB of attenuation.

Examples in the dual attenuator configuration:

- Mech Atten at 20 dB. Elec Atten enabled, Mech Atten set to 10 dB, and Elec Atten set to 10 dB. New total attenuation equals the value before Elec Atten enabled.
- Mech Atten at 0 dB. Elec Atten enabled, Mech Atten set to 10 dB, and Elec Atten set to 0 dB. New total attenuation does not equal the value before Elec Atten enabled.
- Mech Atten at 40 dB. Elec Atten enabled, Mech Atten set to 10 dB, and Elec Atten set to 24 dB. New total attenuation does not equal the value before Elec Atten enabled.

When the Electronic Attenuation is disabled from an enabled state:

- The Elec Atten key is grayed out
- The Auto/Man state of (Mech) Atten is restored
- If now in Auto, (Mech) Atten recouples
- If now in Man, (Mech) Atten is set to the value of total attenuation that existed before the Elec Atten was disabled. The resulting value is rounded up to the smallest value possible given the (Mech) Atten Step setting - (That is, 57 dB changes to 58 dB when (Mech) Atten Step is 2 dB.)

Using the Electronic Attenuator: Pros and Cons

The electronic attenuator offers finer steps than the mechanical attenuator, has no acoustical noise, is faster, and is less subject to wear.

The “finer steps” advantage of the electronic attenuator is beneficial in optimizing the alignment of the analyzer dynamic range to the signal power in the front panel as well as remote use. Thus, you can achieve improved relative signal measurement accuracy. Compared to a mechanical attenuator with 2 dB steps, the 1 dB resolution of the electronic attenuator only gives better resolution when the odd-decibel steps are used. Those odd-decibel steps are less accurately calibrated than the even-decibel steps, so one tradeoff for this superior relative accuracy is reduced absolute amplitude accuracy.

Another disadvantage of the electronic attenuator is that the spectrum analyzer loses its “Auto” setting, making operation less convenient.

Also, the relationship between the dynamic range specifications (TOI, SHI, compression and noise) and instrument performance are less well-known with the electrical attenuator. With the mechanical attenuator, TOI, SHI and compression threshold levels increase dB-for-dB with increasing attenuation, and the noise floor does as well. With the electronic attenuator, there is an excess attenuation of about 1 to 3 dB between 0 and 3.6 GHz, making the effective TOI, SHI, and so forth, less well known. Excess attenuation is the actual attenuation relative to stated attenuation. Excess attenuation is accounted for in the analyzer calibration

Elec Atten

Controls the Electronic Attenuator in dual attenuator configurations. This key does not appear in single attenuator configurations, as the control of both the mechanical and electronic stages of the single attenuator is integrated into the single Atten key.

Key Path	AMPTD Y Scale, Attenuation
Remote Command	<code>[:SENSe]:POWer[:RF]:EATTenuation <rel_ampl></code> <code>[:SENSe]:POWer[:RF]:EATTenuation?</code>
Notes	Electronic Attenuation's specification is defined only when Mechanical Attenuation is 6 dB.
Dependencies	This key only appears in Dual Attenuator models with an Electronic Attenuator installed. It does not appear in models with the Single Attenuator configuration, as in the single attenuator configuration there is no “electronic attenuator” there is only a single integrated attenuator (which has both a mechanical and electronic stage). However, in the single attenuator configuration, EATT SCPI commands are accepted for compatibility with other X-series instruments and set a “soft” attenuation as described in "Attenuator Configurations and Auto/Man" on page 2737 . The “soft” attenuation is treated as an addition to the “main” attenuation value set by the Atten softkey or the

	POW:ATT SCPI command and affects the total attenuation displayed on the Attenuation key and the Meas Bar. When Enable Elec Atten is off or grayed out, the Elec Atten key is grayed out.
Preset	0 dB
State Saved	Saved in instrument state
Min	0 dB
Max	Dual attenuator configuration: 24 dB Single attenuator configuration: the total of ATT and EATT cannot exceed 50 dB, so if the EATT is set to 24 dB first, the main attenuation cannot be greater than 26 dB and will be reduced accordingly; if the main attenuator is set to 40 dB first, EATT cannot be greater than 10 dB
Initial S/W Revision	Prior to A.02.00
Modified at S/W Revision	A.03.00

Adjust Atten for Min Clip

Sets the combination of mechanical and electronic attenuation and gain based on the current measured signal level so that clipping will be at a minimum.

This is an "immediate action" function, that is, it executes once, when the key is pressed.

This key is grayed out in measurements that do not support this functionality. The spectrum analyzer measurement, Swept SA, does not support this functionality.

Key Path	AMPTD Y Scale, Attenuation
Remote Command	<code>[:SENSe] :POWer [:RF] :RANGe :OPTimize IMMEDIATE</code>
Initial S/W Revision	Prior to A.02.00
Modified at S/W Revision	A.03.00

Pre-Adjust for Min Clip

If this function is on, it does the adjustment described under ["Adjust Atten for Min Clip" on page 2740](#) each time a measurement restarts. Therefore, in Continuous measurement mode, it only executes before the first measurement.

In dual attenuator models, you can set Elec+Mech Atten, in which case both attenuators participate in the autoranging, or Elec Atten Only, in which case the mechanical attenuator does not participate in the autoranging. This latter case results in less wear on the mechanical attenuator and is usually faster.

This key is grayed out in measurements that do not support this functionality. The spectrum analyzer measurement, Swept SA, does not support this functionality.

Key Path	AMPTD Y Scale, Attenuation
Remote Command	<code>[:SENSe] :POWer [:RF] :RANGe :OPTimize :ATTenuation OFF ELECTRical COMBined</code>

	<code>[:SENSe] :POWer [:RF] :RANGe:OPTimize:ATTenuation?</code>
Notes	The SCPI parameter <code>ELECTrical</code> sets this function to On in single attenuator models. The SCPI parameter <code>COMBined</code> is mapped to <code>ELECTrical</code> in single attenuator models; if you send <code>COMBined</code> , it sets the function to On and returns <code>ELEC</code> to a query.
Dependencies	This key only appears in Dual Attenuator models with an Electronic Attenuator installed. In instruments with Dual Attenuator model, when Enable Elec Atten is off or grayed out, the Pre-Adjust for Min Clip key is grayed out.
Preset	OFF for Swept SA measurement; ON for all other measurements that support Pre-Adjust for Min Clip
State Saved	Saved in instrument state
Range	Dual attenuator models: Off Elec Atten Only Mech + Elec Atten Single attenuator models: Off On
Initial S/W Revision	Prior to A.02.00
Modified at S/W Revision	A.03.00

Remote Command	<code>[:SENSe] :POWer [:RF] :RANGe:AUTO ON OFF 1 0</code> <code>[:SENSe] :POWer [:RF] :RANGe:AUTO?</code>
Notes	ON aliases to "Elec Atten Only" (<code>:POW:RANG:OPT:ATT ELEC</code>) OFF aliases to "Off" (<code>:POW:RANG:OPT:ATT OFF</code>) The query <code>:POW:RANG:AUTO?</code> returns true if <code>:POW:RANG:OPT:ATT</code> is not "Off"
Initial S/W Revision	Prior to A.02.00

Off

Turns Pre-Adjust for Min Clip off. This is the default setting.

This key is grayed out in measurements that do not support this functionality. The spectrum analyzer measurement, Swept SA, does not support this functionality.

Key Path	AMPTD Y Scale, Attenuation, Pre-Adjust for Min Clip
Example	<code>:POW:RANGe:OPT:ATT OFF</code>
Initial S/W Revision	Prior to A.02.00

Elec Atten Only

Selects only the electric attenuator to participate in auto ranging. This offers less wear on the mechanical attenuator and is usually faster.

This key is grayed out in measurements that do not support this functionality. The spectrum analyzer measurement, Swept SA, does not support this functionality.

Key Path	AMPTD Y Scale, Attenuation, Pre-Adjust for Min Clip
Example	:POW:RANGe:OPT:ATT ELEC
Initial S/W Revision	Prior to A.02.00

Mech + Elec Atten

In dual attenuator models, this selects both attenuators participate in the autoranging.

This key is grayed out in measurements that do not support this functionality. The spectrum analyzer measurement, Swept SA, does not support this functionality.

Key Path	AMPTD Y Scale, Attenuation, Pre-Adjust for Min Clip
Example	:POW:RANGe:OPT:ATT COMB
Initial S/W Revision	Prior to A.02.00

(Mech) Atten Step

This controls the step size used when making adjustments to the input attenuation.

This key is labeled Mech Atten Step in dual attenuator models and Atten Step in single attenuator models. In the dual attenuator configuration, this key only affects the step size of the mechanical attenuator.

Key Path	AMPTD Y Scale, Attenuation
Remote Command	[:SENSe] : POWer [:RF] : ATTenuation : STEP [:INCRement] 10 dB 2 dB [:SENSe] : POWer [:RF] : ATTenuation : STEP [:INCRement] ?
Example	POW:ATT:STEP 2
Notes	Note this feature works like a 1-N choice from the front panel, but it takes a specific value (in dB) when used remotely. The only valid values are 2 and 10.
Dependencies	Blanked in CXA and EXA if option FSA (2 dB steps) is not present. If blanked, attempts to set it via SCPI will yield an error.
Couplings	When the attenuation step size changes, the current mechanical attenuation value is adjusted (if necessary) to be quantized to the new step size. That is, if step is set to 10 dB, mech atten is increased if necessary so it is a multiple of 10 dB
Preset	PXA and MXA: 2 dB EXA and CXA: 10 dB (2 dB with option FSA)
State Saved	Saved in instrument state
Initial S/W Revision	Prior to A.02.00
Modified at S/W Revision	A.03.00

Scale/Div

Sets the units-per-division of the vertical scale in the logarithmic display. However, since the Auto Scaling is defaulted to On, this value is automatically determined by the measurement result. When you set a value manually, Auto Scaling automatically changes to Off.

Key Path	AMPTD Y Scale
Mode	SA, WCDMA, C2K, WIMAX OFDMA, TD-SCDMA, 1xEVDO, DVB-T/H, DTMB (CTTB), ISDB-T, CMMB, LTE, LTE-TDD, Digital Cable TV, MSR, LTEAFDD, LTEATDD
Remote Command	:DISPlay:ACPower:VIEW[1]:WINDow[1]:TRACe:Y[:SCALe]:PDIVision <rel_ampl> :DISPlay:ACPower:VIEW[1]:WINDow[1]:TRACe:Y[:SCALe]:PDIVision?
Example	DISP:ACP:VIEW:WIND:TRAC:Y:PDIV 5 DISP:ACP:VIEW:WIND:TRAC:Y:PDIV?
Notes	You must be in the mode that includes ACP measurements to use this command. Use :INSTrument:SElect to set the mode.
Couplings	When the Auto Scaling is On, this value is automatically determined by the measurement result. When you set a value manually, Auto Scaling automatically changes to Off.
Preset	10.00 dB
State Saved	Saved in instrument state.
Min	0.10 dB
Max	20.00 dB
Initial S/W Revision	Prior to A.02.00
Modified at S/W Revision	A.02.00, A.03.00

Presel Center

When this key is pressed, the centering of the preselector filter is adjusted to optimize the amplitude accuracy at the frequency of the selected marker. If the selected marker is not on when Presel Center is pressed, the analyzer will turn on the selected marker, perform a peak search, and then perform centering on the marker's center frequency. If the selected marker is already on and between the start and stop frequencies of the analyzer, the analyzer performs the preselector calibration on that marker's frequency. If the selected marker is already on, but outside the frequency range between Start Freq and Stop Freq, the analyzer will first perform a peak search, and then perform centering on the marker's center frequency.

The value displayed on the Presel Adjust key will change to reflect the new preselector tuning (see Presel Adjust).

A number of considerations should be observed to ensure proper operation. See ["Proper Preselector Operation" on page 858](#).

Key Path	AMPTD Y Scale
Remote Command	[:SENSe]:POWer[:RF]:PCENter
Example	POW:PCEN
Notes	Note that the rules outlined above under the key description apply for the remote command as well

	as the key. The result of the command is dependent on marker position, and so forth. Any message shown by the key press is also shown in response to the remote command.
Dependencies	<ul style="list-style-type: none"> • Grayed out if the microwave preselector is off.) • If the selected marker's frequency is below Band 1, advisory message 0.5001 is generated and no action is taken. • Grayed out if entirely in Band 0. • Blank in models that do not include a preselector, such as option 503. If the SCPI is sent in these instruments, it is accepted without error, and the query always returns 0. • Grayed out in the Spectrogram View.
Couplings	<p>The active marker position determines where the centering will be attempted.</p> <p>If the analyzer is in a measurement such as averaging when centering is initiated, the act of centering the preselector will restart averaging but the first average trace will not be taken until the centering is completed.</p>
Status Bits/OPC dependencies	<p>When centering the preselector, *OPC will not return true until the process is complete and a subsequent measurement has completed, nor will results be returned to a READ or MEASURE command.</p> <p>The Measuring bit should remain set while this command is operating and should not go false until the subsequent sweep/measurement has completed.</p>
Initial S/W Revision	Prior to A.02.00
Modified at S/W Revision	A.03.00

Proper Preselector Operation

A number of considerations should be observed to ensure proper operation:

1. If the selected marker is off, the analyzer will turn on a marker, perform a peak search, and adjust the preselector using the selected marker's frequency. It uses the "highest peak" peak search method unqualified by threshold or excursion, so that there is no chance of a 'no peak found' error. It continues with that peak, even if it is the peak of just noise. Therefore, for this operation to work properly, there should be a signal on screen in a preselected range for the peak search to find.
2. If the selected marker is already on, the analyzer will attempt the centering at that marker's frequency. There is no preselector for signals below about 3.6 GHz, therefore if the marker is on a signal below 3.6 GHz, no centering will be attempted and an advisory message generated
3. In some models, the preselector can be bypassed. If it is bypassed, no centering will be attempted in that range and a message will be generated.

Preselector Adjust

Allows you to manually adjust the preselector filter frequency to optimize its response to the signal of interest. This function is only available when "Presel Center" on page 2743 is available.

For general purpose signal analysis, using Presel Center is recommended. Centering the filter minimizes the impact of long-term preselector drift. Presel Adjust can be used instead to manually optimize the

preselector. One application of manual optimization would be to peak the preselector response, which both optimizes the signal-to-noise ratio and minimizes amplitude variations due to small (short-term) preselector drifting.

Key Path	AMPTD Y Scale
Scope	Meas Global
Remote Command	<code>[:SENSe] :POWer [:RF] :PADJust <freq></code> <code>[:SENSe] :POWer [:RF] :PADJust?</code>
Example	POW:PADJ 100KHz POW:PADJ?
Notes	The value on the key reads out to 0.1 MHz resolution.
Dependencies	<ul style="list-style-type: none"> • Grayed out if microwave preselector is off.) • Grayed out if entirely in Band 0. • Blank in models that do not include a preselector, such as option 503. If the SCPI is sent in these instruments, it is accepted without error, and the query always returns 0. • Grayed out in the Spectrogram View.
Preset	0 MHz
State Saved	The Presel Adjust value set by Presel Center, or by manually adjusting Presel Adjust, is not saved in instrument state, and does not survive a Preset or power cycle.
Min	-500 MHz
Max	500 MHz
Default Unit	Hz
Backwards Compatibility SCPI	<code>[:SENSe] :POWer [:RF] :MW:PADJust</code> <code>[:SENSe] :POWer [:RF] :MMW:PADJust</code> PSA had multiple preselectors, but the X-Series has only one. These commands simply alias to <code>[:SENSe] :POWer [:RF] :PADJust</code>
Initial S/W Revision	Prior to A.02.00
Modified at S/W Revision	A.03.00

Remote Command	<code>[:SENSe] :POWer [:RF] :PADJust:PRESelector MWAVE MMWave EXternal</code> <code>[:SENSe] :POWer [:RF] :PADJust:PRESelector?</code>
Notes	PSA had multiple preselectors, and you could select which preselector to adjust. Since the X-Series has only one mm/uW preselector, the preselector selection softkey is no longer available. However, to provide backward compatibility, we accept the legacy remote commands. The command form has no effect, the query always returns MWAVE
Initial S/W Revision	Prior to A.02.00

μW Path Control

The μW Path Control functions include the μW Preselector Bypass (Option MPB) and Low Noise Path (Option LNP) controls in the High Band path circuits.

When the μW Preselector is bypassed, the user has better flatness, but will be subject to spurs from out of band interfering signals. When the Low Noise Path is enabled, the analyzer automatically switches around certain circuitry in the high frequency bands which can contribute to noise, when it is appropriate based on other analyzer settings.

For most applications, the preset state is Standard Path, which gives the best remote-control throughput, minimizes acoustic noise from switching and minimizes the risk of wear out in the hardware switches. For applications that utilize the wideband IF paths, the preset state is the μW Preselector Bypass path, if option MPB is present. This is because, when using a wideband IF such as the 140 MHz IF, the μW Preselector's bandwidth can be narrower than the available IF bandwidth, causing degraded amplitude flatness and phase linearity, so it is desirable to bypass the preselector in the default case.

Users may choose Low Noise Path Enable. It gives a lower noise floor, especially in the 21–26.5 GHz region, though without improving many measures of dynamic range, and without giving the best possible noise floor. The preamp, if purchased and used, gives better noise floor than does the Low Noise Path, however its compression threshold and third-order intercept are much poorer than that of the non-preamp Low Noise Path. There are some applications, typically for signals around –30 dBm, for which the third-order dynamic range of the standard path is good enough, but the noise floor is not low enough even with 0 dB input attenuation. When the third-order dynamic range of the preamp path is too little and the noise floor of the standard path is too high, the Low Noise Path can provide the best dynamic range.

Key Path	AMPTD Y Scale
Mode	SA, BASIC, PNOISE, VSA , LTE, LTETDD
Scope	Meas Global
Remote Command	[:SENSe] :POWer [:RF] :MW:PATH STD LNPath MPBypass FULL [:SENSe] :POWer [:RF] :MW:PATH?
Example	:POW:MW:PATH LNP Enables the Low Noise path
Notes	If a Presel Center is performed, the analyzer will momentarily switch to the Standard Path, regardless of the setting of μW Path Control The DC Block will always be switched in when the low noise path is switched in, to protect succeeding circuitry from DC. Note that this does not mean “when the low noise path is enabled” but when, based on the Low Noise Path rules, the path is actually switched in. This can happen when the selection is Low Noise Path Enable . In the case where the DC Block is switched in the analyzer is now AC coupled. However, if the user has selected DC coupling, the UI will still behave as though it were DC coupled, including all annunciation, warnings, status bits, and responses to SCPI queries. This is because, based on other settings, the analyzer could switch out the low noise path at any time and hence go back to being DC coupled. Alignment switching ignores the settings in this menu, and restores them when finished.
Dependencies	Unavailable in BBIQ and External Mixing
Preset	All modes other than IQ Analyzer mode and VXA: STD IQ Analyzer, VXA and WLAN mode: MPB option present and licensed: MPB

	MPB option not present and licensed: STD
State Saved	Save in instrument state
Readback	Value selected in the submenu
Initial S/W Revision	A.04.00
Modified at S/W Revision	A.10.00

Standard Path

This path gives the best remote-control throughput, minimizes acoustic noise from switching and minimizes the risk of wear in the hardware switches, particularly in remote test scenarios where both low band and high band setups will follow in rapid succession.

In this path, the bypass of the low band/high band switch and microwave preamp is never activated, which can cause some noise degradation but preserves the life of the bypass switch.

Key Path	AMPTD Y Scale, μ W Path Control
Example	:POW:MW:PATH STD
Readback Text	Standard Path
Initial S/W Revision	A.04.00

Low Noise Path Enable

You may choose Low Noise Path Enable, which gives a lower noise floor under some circumstances, particularly when operating in the 21–26.5 GHz region. With the Low Noise Path enabled, the low band/high band switch and microwave preamp are bypassed whenever all of the following are true:

- The analyzer is not in the Low Band, meaning:
- the start frequency is above 3.5 GHz and
- the stop frequency is above 3.6 GHz.
- the internal preamp is not installed or (if installed) is set to Off or Low Band

Note that this means that, when any part of a sweep is done in Low Band, the Low Noise Path is not used, whether or not the Low Noise Path Enable is selected in the user interface. Also, if the preamp is turned on, the Low Noise Path is not used, whether or not the Low Noise Path Enable is selected in the user interface. The only time the Low Noise Path is used is when Low Noise Path Enable is selected, the sweep is completely in High Band (> 3.6 GHz) and no preamp is in use.

See "[More Information](#)" on page 862

Key Path	AMPTD Y Scale, μ W Path Control
Measurement	Swept SA
Example	:POW:MW:PATH LNP

Notes	<p>For measurements that use IQ acquisition, the low noise path is used when the Center Frequency is in High Band (> 3.6 GHz) and no preamp is in use.</p> <p>In other words, the rules above are modified to use only the center frequency to qualify which path to switch in.</p> <p>This is not the case for FFT's in the Swept SA measurement; they use the same rules as swept measurements.</p>
Dependencies	<p>Key is blanked if current mode does not support it.</p> <p>Key is grayed out if mode supports it but current measurement does not support it.</p> <p>Unless Option LNP is present and licensed, key is blank and if SCPI command sent, error -241, "Hardware missing; Option not installed" is generated.</p>
Readback Text	Low Noise Path Enable
Initial S/W Revision	A.04.00

More Information

The user should understand that the Low Noise Path, while giving improved DANL, has the disadvantage of decreased TOI performance and decreased gain compression performance relative to the standard path.

The user should also understand that the bypass switch is a mechanical switch and has finite life, so if the Low Noise Path is enabled, it is possible to cause frequent cycling of this switch by frequently changing analyzer settings such that the above conditions hold true only some of the time. A user making tests of this nature should consider opting for the Standard Path, which will never throw the bypass switch, at the expense of some degraded noise performance.

The low noise path is useful for situations where the signal level is so low that the analyzer performance is dominated by noise even with 0 dB attenuation, but still high enough that the preamp option would have excessive third-order intermodulation or compression. The preamp, if purchased and used, gives better noise floor than does the "Low Noise Path." However, its compression threshold and third-order intercept are much poorer than that of the non-preamp path. There are some applications, typically for signals around -30 dBm, for which the third-order dynamic range of the standard path is good enough, but the noise floor is not low enough even with 0 dB input attenuation. When the third-order dynamic range of the preamp path is too little and the noise floor of the standard path is too high, the Low Noise Path can provide the best dynamic range

The graph below illustrates the concept. It shows, in red, the performance of an analyzer at different attenuation settings, both with the preamp on and off, in a measurement that is affected by both analyzer noise and analyzer TOI. The green shows the best available dynamic range, offset by 0.5 dB for clarity. The blue shows how the best available dynamic range improves for moderate signal levels with the low noise path switched in. In this illustration, the preamp improves the noise floor by 15 dB while degrading the third-order intercept by 30 dB, and the low noise path reduces loss by 8 dB. The attenuator step size is 2 dB.

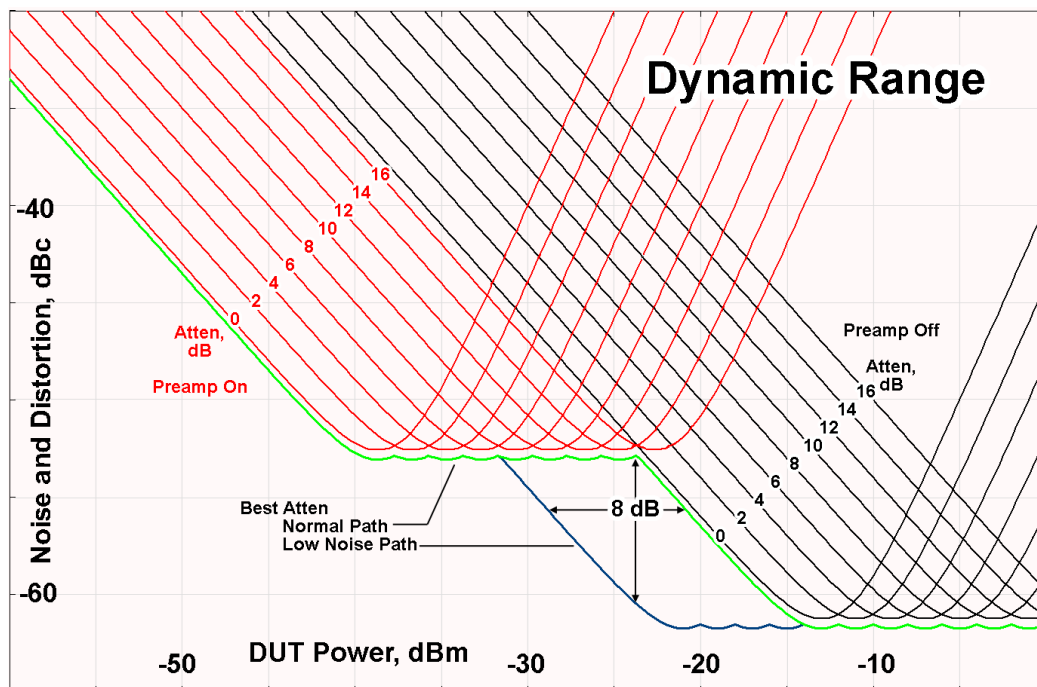

There are other times where selecting the low noise path improves performance, too. Compression-limited measurements such as finding the nulls in a pulsed-RF spectrum can profit from the low noise path in a way similar to the TOI-limited measurement illustrated. Accuracy can be improved when the low noise path allows the optimum attenuation to increase from a small amount like 0, 2 or 4 dB to a larger amount, giving better return loss at the analyzer input. Harmonic measurements, such as second and third harmonic levels, are much improved using the low noise path because of the superiority of that path for harmonic (though not intermodulation) distortion performance.

μ W Preselector Bypass

This key toggles the preselector bypass switch for band 1 and higher. When the microwave preselector is on, the signal path is preselected. When the microwave preselector is off, the signal path is not preselected. The preselected path is the normal path for the analyzer.

The preselector is a tunable bandpass filter which prevents signals away from the frequency of interest from combining in the mixer to generate in-band spurious signals (images). The consequences of using a preselector filter are its limited bandwidth, the amplitude and phase ripple in its passband, and any amplitude and phase instability due to center frequency drift.

Option MPB or pre-selector bypass provides an unpreselected input mixer path for certain X-Series signal analyzers with frequency ranges above 3.6 GHz. This signal path allows a wider bandwidth and less amplitude variability, which is an advantage when doing modulation analysis and broadband signal analysis. The disadvantage is that, without the preselector, image signals will be displayed. Another disadvantage of bypassing the preselector is increased LO emission levels at the front panel input port.

Image responses are separated from the real signal by twice the 1st IF. For IF Paths of 10 MHz and 25 MHz, the 1st IF is 322.5 MHz, so the image response and the real signal will be separated by 645 MHz. The 1st IF will be different for other IF Path settings. When viewing a real signal and its corresponding image response in internal mixing, the image response will be to the left of the real signal.

Also, the image response and the real signal typically have the same amplitude and exhibit the same shape factor.

However, if Option FS1, Fast Sweep Capability, is enabled, the image response in the Swept SA measurement will appear lower in amplitude and have a much wider shape factor compared to the real signal.

Key Path	AMPTD Y Scale, μ W Path Control
Example	:POW:MW:PATH MPB
Dependencies	Key is blanked if current mode does not support it. Key is grayed out if mode supports it but current measurement does not support it. Key is blank unless Option MPB is present and licensed. If SCPI command sent when MPB not present, error -241, "Hardware missing; Option not installed" is generated.
Readback Text	μ W Preselector Bypass
Initial S/W Revision	A.04.00

Remote Command	[:SENSe] :POWeR [:RF] :MW:PRESelector [:STATe] ON OFF 0 1 [:SENSe] :POWeR [:RF] :MW:PRESelector [:STATe] ?
Example	:POW:MW:PRES OFF Bypasses the microwave preselector
Notes	The ON parameter sets the STD path (:POW:MW:PATH STD) The OFF parameter sets path MPB (:POW:MW:PATH MPB)
Preset	ON

Internal Preamp

Accesses a menu of keys that control the internal preamps. Turning on the preamp gives a better noise figure, but a poorer TOI to noise floor dynamic range. You can optimize this setting for your particular measurement.

The instrument takes the preamp gain into account as it sweeps. If you sweep outside of the range of the preamp the instrument will also account for that. The displayed result will always reflect the correct gain.

For some measurements, when the preamp is on and any part of the displayed frequency range is below the lowest frequency for which the preamp has specifications, a warning condition message appears in the status line. For example, for a preamp with a 9 kHz lowest specified frequency: "Preamp: Accy unspec'd below 9 kHz".

Key Path	AMPTD Y Scale
Scope	Meas Global
Remote Command	[:SENSe] :POWeR [:RF] :GAIN [:STATe] OFF ON 0 1 [:SENSe] :POWeR [:RF] :GAIN [:STATe] ?
Dependencies	Preamp is not available on all hardware platforms. If the preamp is not present or is unlicensed, the

key is not shown.
The preamp is not available when the electronic/soft attenuator is enabled.

Couplings	<p>The act of connecting the U7227A USB Preamplifier to one of the analyzer's USB ports will cause the Internal Preamp to be switched on. When this happens an informational message will be generated: "Internal Preamp turned on for optimal operation with USB Preamp." Note that if the Internal Preamp was already on, there will be no change to the setting, but if it was Off it will be switched On, to Full Range.</p> <p>Note that this same action occurs when the SA mode is selected while the USB Preamp is connected to one of the analyzer's USB ports, if it is the first time that the SA mode has run since powerup, or if the last time the SA mode was running the USB Preamp was NOT connected.</p> <p>Subsequently disconnecting the USB Preamp from USB does not change the Internal Preamp setting nor restore the previous setting.</p>
Preset	OFF
State Saved	Saved in instrument state
Initial S/W Revision	Prior to A.02.00
Modified at S/W Revision	A.14.00

Key Path	AMPTD Y Scale, Internal Preamp
Scope	Meas Global
Remote Command	<pre>[:SENSe] :POWer [:RF] :GAIN :BAND LOW FULL [:SENSe] :POWer [:RF] :GAIN :BAND ?</pre>
Dependencies	<p>Preamp is not available on all hardware platforms. If the preamp is not present or is unlicensed, the key is not shown.</p> <p>If a POW:GAIN:BAND FULL command is sent when a low band preamp is available, the preamp band parameter is to LOW instead of FULL, and an "Option not installed" message is generated.</p>
Preset	LOW
State Saved	Saved in instrument state
Initial S/W Revision	Prior to A.02.00

Off

Turns the internal preamp off

Key Path	AMPTD Y Scale, Internal Preamp
Example	:POW:GAIN OFF
Readback	Off
Initial S/W Revision	Prior to A.02.00

Low Band

Sets the internal preamp to use only the low band.

The frequency range of the installed (optional) low-band preamp is displayed in square brackets on the Low Band key label.

Key Path	AMPTD Y Scale, Internal Preamp
Example	:POW:GAIN ON :POW:GAIN:BAND LOW
Readback	Low Band
Initial S/W Revision	Prior to A.02.00

Full Range

Sets the internal preamp to use its full range. The low band (0–3.6 GHz or 0–3GHz, depending on the model) is supplied by the low band preamp and the frequencies above low band are supplied by the high band preamp.

The frequency range of the installed (optional) preamp is displayed in square brackets on the Full Range key label. If the high band option is not installed the Full Range key does not appear.

Key Path	AMPTD Y Scale, Internal Preamp
Example	:POW:GAIN ON :POW:GAIN:BAND FULL
Readback	Full Range
Initial S/W Revision	Prior to A.02.00

Ref Position

Positions the reference level at the top, center, or bottom of the Y- scale display. Changing the reference position does not change the reference level value.

Key Path	AMPTD Y Scale
Mode	SA, WCDMA, C2K, WIMAX OFDMA, TD-SCDMA, 1xEVDO, DVB-T/H, DTMB (CTTB), ISDB-T, CMMB, LTE, LTETDD, Digital Cable TV, MSR, LTEAFDD,LTEATDD
Remote Command	:DISPlay:ACP:Power:VIEW[1]:WINDow[1]:TRACe:Y[:SCALe]:RPOSition TOP CENTer BOTTom :DISPlay:ACP:Power:VIEW[1]:WINDow[1]:TRACe:Y[:SCALe]:RPOSition?
Example	DISP:ACP:VIEW:WIND:TRAC:Y:RPOS CENT DISP:ACP:VIEW:WIND:TRAC:Y:RPOS?
Notes	You must be in the mode that includes ACP measurements to use this command. Use :INSTRument:SElect to set the mode.
Preset	TOP

State Saved	Saved in instrument state.
Range	Top Ctr Bot
Initial S/W Revision	Prior to A.02.00
Modified at S/W Revision	A.02.00, A.03.00

Auto Scaling

Toggles the Auto Scaling function between On and Off.

Key Path	AMPTD Y Scale
Mode	SA, WCDMA, C2K, WIMAX OFDMA, TD-SCDMA, 1xEVDO, DVB-T/H, DTMB (CTTB), ISDB-T, CMMB, LTE, LTE-TDD, Digital Cable TV, MSR, LTEAFDD, LTEATDD
Remote Command	:DISPlay:ACPoweR:VIEW[1]:WINDow[1]:TRACe:Y[:SCALe]:COUPLe 0 1 OFF ON :DISPlay:ACPoweR:VIEW[1]:WINDow[1]:TRACe:Y[:SCALe]:COUPLe?
Example	DISP:ACP:VIEW:WIND:TRAC:Y:COUP ON DISP:ACP:VIEW:WIND:TRAC:Y:COUP?
Notes	You must be in the mode that includes ACP measurements to use this command. Use :INSTrument:SElect to set the mode.
Couplings	When Auto Scaling is On and the Restart front-panel key is pressed, this function automatically determines the scale per division and reference values based on the measurement results. When you set a value to either Scale/Div or Ref Value manually, Auto Scaling automatically changes to Off.
Preset	ON
State Saved	Saved in instrument state.
Range	On Off
Initial S/W Revision	Prior to A.02.00
Modified at S/W Revision	A.02.00, A.03.00

Auto Couple

The Auto Couple feature provides a quick and convenient way to automatically couple multiple instrument settings. This helps ensure accurate measurements and optimum dynamic range. When the Auto Couple feature is activated, either from the front panel or remotely, all parameters of the current measurement that have an Auto/Manual mode are set to Auto mode and all measurement settings dependent on (or coupled to) the Auto/Man parameters are automatically adjusted for optimal performance.

However, the Auto Couple key actions are confined to the current measurement only. It does not affect other measurements in the mode, and it does not affect markers, marker functions, or trace or display attributes.

See "[More Information](#)" on page 868

Key Path	Front-panel key
Remote Command	:COUPle ALL NONE
Example	:COUP ALL
Notes	:COUPle ALL puts all Auto/Man parameters in Auto mode (equivalent to pressing the Auto Couple key). :COUPLE NONE puts all Auto/Man parameters in manual mode. It decouples all the coupled instrument parameters and is not recommended for making measurements.
Initial S/W Revision	Prior to A.02.00

More Information

There are two types of functions that have Auto/Manual modes.

Auto/Man Active Function keys

An Auto/Man toggle key controls the binary state associated with an instrument parameter by toggling between Auto (where the parameter is automatically coupled to the other parameters it is dependent upon) and Man (where the parameter is controlled independent of the other parameters), as well as making the parameter the active function. The current mode is indicated on the softkey with either Auto or Man underlined as illustrated below.



Auto/Man 1-of-N keys

An Auto/Man 1-of-N key allows you to manually pick from a list of parameter values, or place the function in Auto, in which case the value is automatically selected (and indicated) as shown below. If in Auto, Auto is underlined on the calling key. If in manual operation, manual is indicated on the calling key. But the calling key does not actually toggle the function, it simply opens the menu.

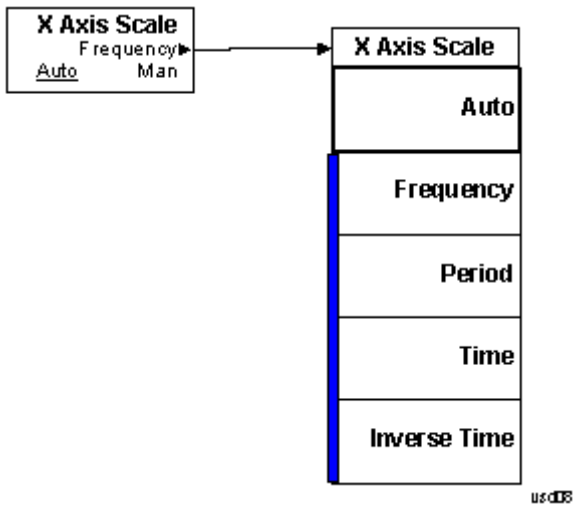

BW

Accesses a menu of functions that enable you to specify and control the video and resolution bandwidths. You can also select the type of filter for the measurement and set the filter bandwidth.

Key Path	Front-panel key
Initial S/W Revision	Prior to A.02.00

Res BW

Sets the value of the resolution bandwidth. If an unavailable bandwidth is entered with the numeric keypad, the closest available bandwidth is selected.

LTE-Advanced FDD/TDD Auto RBW:

Bandwidth	RBW (KHz)
1.4MHz	51KHz
3MHz	
5MHz	100 KHz
10MHz	
15MHz	
20MHz	

the resolution bandwidth is predefined based on the corresponding bandwidth of the single LTE carrier, which is listed above. When ResBW mode is Auto, the narrowest RBW over the active carriers is selected for Multi-carriers.

Key Path	BW
Mode	SA, WCDMA, C2K, WIMAX OFDMA, TD-SCDMA, 1xEVDO, DVB-T/H, DTMB (CTTB), ISDB-T, CMMB, LTE, LTE-TDD, Digital Cable TV, MSR, LTEAFDD, LTEATDD
Remote Command	[:SENSe]:ACPower:BANDwidth[:RESolution] <freq> [:SENSe]:ACPower:BANDwidth[:RESolution]? [:SENSe]:ACPower:BANDwidth[:RESolution]:AUTO ON OFF 1 0 [:SENSe]:ACPower:BANDwidth[:RESolution]:AUTO?
Example	ACP:BAND 25kHz ACP:BAND? ACP:BAND:AUTO ON ACP:BAND:AUTO?
Notes	This key is available only in IBW mode. This parameter is preset by the Meas Method selection. Preset values are as follows: IBW: 100 kHz

	IBWR: 27 kHz FAST (WCDMA): 390 kHz You must be in the mode that includes ACP measurements to use this command. Use :INSTrument:SElect to set the mode.
Dependencies	When Meas Method is RBW or FAST, this key is grayed out and disabled. If the key is pressed, an advisory message is generated. If the equivalent remote command is sent, a "Setting conflict" warning is generated.
Couplings	The resolution bandwidth is coupled to the video bandwidth based on the video to resolution bandwidth ratio setting if AUTO is selected.
Preset	SA: 220 kHz WCDMA: 100 kHz WIMAX OFDMA: 100 kHz C2K: 15 kHz TD-SCDMA: 30 kHz 1xEVDO: 30 kHz DVB-T/H: 39 kHz DTMB (CTTB): 39 kHz ISDB-T: 39 kHz CMMB: 39 kHz LTE: 100 kHz LTETDD: 100 kHz Digital Cable TV: 39 kHz MSR: 100 kHz LTEAFDD, LTEATDD: 100kHz LTEAFDD, LTEATDD: 1 Others:0
State Saved	Saved in instrument state.
Min	1 Hz
Max	8 MHz
Backwards Compatibility SCPI	[:SENSe] :ACP:Power:BWIDth [:RESolution] [:SENSe] :ACP:SWEep:BWIDth BWIDth [:RESolution] (PSA W-CDMA, PSA cdma2000)
Initial S/W Revision	Prior to A.02.00
Modified at S/W Revision	A.02.00, A.03.00

Video BW

Changes the analyzer post-detection filter (VBW).

Key Path	BW
Mode	SA, WCDMA, C2K, WIMAX OFDMA, TD-SCDMA, 1xEVDO, DVB-T/H, DTMB (CTTB), ISDB-T, CMMB,

	LTE, LTETDD, Digital Cable TV, MSR, LTEAFDD, LTEATDD
Remote Command	<pre>[:SENSe] :ACPower :BANDwidth :VIDeo <freq> [:SENSe] :ACPower :BANDwidth :VIDeo? [:SENSe] :ACPower :BANDwidth :VIDeo :AUTO OFF ON 0 1 [:SENSe] :ACPower :BANDwidth :VIDeo :AUTO?</pre>
Example	<pre>ACP:BAND:VID 1kHz ACP:BAND:VID? ACP:BWID:VID:AUTO ON ACP:BWID:VID:AUTO?</pre>
Notes	The values shown in this table reflect the conditions after a Mode Preset.
Dependencies	When Meas Method is RBW or FAST, this key is grayed out and disabled. If the key is pressed, an advisory message is generated. If the equivalent remote command is sent, a "Setting conflict" warning is generated.
Preset	<pre>SA: 22 kHz WCDMA, WIMAX OFDMA: 1 MHz C2K: Method RBW: grayed out (1.2 MHz) Method IBW: 150 kHz TD-SCDMA: 300 kHz 1xEVDO: 300 kHz DVB-T/H: 390 kHz DTMB (CTTB): 390 kHz ISDB-T: 390 kHz CMMB: 390 kHz LTE, LTETDD, MSR: Auto LTETDD: 1 MHz Digital Cable TV: 390 kHz LTEAFDD, LTEATDD: Auto SA: ON WCDMA: OFF WIMAX OFDMA: OFF TD-SCDMA: OFF DVB-T/H: OFF DTMB (CTTB): OFF CDMA1xEVDO: OFF ISDB-T: OFF CMMB: OFF LTE, MSR: ON LTETDD: ON Digital Cable TV: OFF</pre>

	LTEAFDD, LTEATDD: ON
State Saved	Saved in instrument state.
Min	1 Hz
Max	50 MHz
Backwards Compatibility SCPI	[:SENSe] :ACPower :BWIDth :VIDeo
Initial S/W Revision	Prior to A.02.00
Modified at S/W Revision	A.02.00, A.03.00

RBW Control

Accesses a menu that enables you to select the filter bandwidth and type.

Key Path	BW
Initial S/W Revision	Prior to A.02.00

Filter Type

Selects the type of bandwidth filter that is used. The choices are Gaussian or Flat top.

Key Path	BW, RBW Control
Mode	SA, WCDMA, C2K, WIMAX OFDMA, TD-SCDMA, 1xEVDO, DVB-T/H, DTMB (CTTB), ISDB-T, CMMB, LTE, LTE-TDD, Digital Cable TV, MSR, LTEAFDD, LTEATDD
Remote Command	[:SENSe] :ACPower :BANDwidth :SHAPE GAUSSian FLATtop [:SENSe] :ACPower :BANDwidth :SHAPE?
Example	ACP:BAND:SHAP GAUS ACP:BAND:SHAP?
Dependencies	When Meas Method is FAST, this key is grayed out and disabled. If the key is pressed, an advisory message is generated. If the equivalent remote command is sent, a "Setting conflict" warning is generated.
Preset	GAUSSian C2K: FLATtop
State Saved	Saved in instrument state.
Range	Gaussian (Normal) Flattop
Backwards Compatibility SCPI	[:SENSe] :ACPower :BWIDth :SHAPE
Initial S/W Revision	Prior to A.02.00
Modified at S/W Revision	A.02.00, A.03.00

Filter BW

Selects a Gaussian filter based on its -3 dB (Normal) bandwidth or its -6 dB bandwidth.

Key Path	BW, RBW Control
Mode	SA, WCDMA, C2K, WIMAX OFDMA, TD-SCDMA, 1xEVDO, DVB-T/H, DTMB (CTTB), ISDB-T, CMMB, LTE, LTE-TDD, Digital Cable TV, MSR, LTEAFDD, LTEATDD
Remote Command	[:SENSe] :ACPower:BAWdwidth:TYPE DB3 DB6 [:SENSe] :ACPower:BAWdwidth:TYPE?
Example	ACP:BAW:TYPE DB3 ACP:BAW:TYPE?
Dependencies	When Filter Type is Flattop or Meas Method is RBW or FAST, this key is grayed out and disabled. If the key is pressed, an advisory message is generated. If the equivalent remote command is sent, a "Setting conflict" warning is generated.
Preset	DB3
State Saved	Saved in instrument state.
Range	-3 dB (Normal) -6 dB
Backwards Compatibility SCPI	[:SENSe] :ACPower:BWIDth:TYPE
Initial S/W Revision	Prior to A.02.00
Modified at S/W Revision	A.02.00, A.03.00

Cont (Continuous Measurement/Sweep)

Sets the analyzer for Continuous measurement operation. The single/continuous state is Meas Global so the setting will affect all measurements. If you are Paused, pressing Cont does a Resume.

Key Path	Front-panel key
Remote Command	:INITiate:CONTinuous OFF ON 0 1 :INITiate:CONTinuous?
Example	:INIT:CONT 0 puts analyzer in Single measurement operation. :INIT:CONT 1 puts analyzer in Continuous measurement operation
Preset	ON (Note that SYST:PRESet sets INIT:CONT to ON but *RST sets INIT:CONT to OFF)
State Saved	Saved in instrument state
Backwards Compatibility Notes	For Spectrum Analysis mode in ESA and PSA, there is no Cont hardkey, instead there is a Sweep Single/Cont key. In these analyzers, switching the Sweep Single/Cont key from Single to Cont restarts averages (displayed average count reset to 1), but does not restart Max Hold and Min Hold. The X-Series has Single and Cont keys in place of the SweepSingleCont key. In the X-Series, if in single measurement, the Cont key (and INIT:CONT ON) switches to continuous measurement, but never restarts a measurement and never resets a sweep.
Initial S/W Revision	Prior to A.02.00

In Swept SA Measurement (Spectrum Analysis Mode):

The analyzer takes repetitive sweeps, averages, measurements, etc., when in Continuous mode. When the average count reaches the Average/Hold Number the count stops incrementing, but the analyzer keeps sweeping. See the Trace/Detector section for the averaging formula used both before and after the Average/Hold Number is reached. The trigger condition must be met prior to each sweep. The type of trace processing for multiple sweeps, is set under the Trace/Detector key, with choices of Trace Average, Max Hold, or Min Hold.

In Other Measurements/Modes:

With Avg/Hold Num (in the Meas Setup menu) set to Off or set to On with a value of 1, a sweep is taken after the trigger condition is met; and the analyzer continues to take new sweeps after the current sweep has completed and the trigger condition is again met. However, with Avg/Hold Num set to On with a value >1, multiple sweeps (data acquisitions) are taken for the measurement. The trigger condition must be met prior to each sweep. The sweep is not stopped when the average count k equals the number N set for Avg/Hold Num is reached, but the number k stops incrementing. A measurement average usually applies to all traces, marker results, and numeric results. But sometimes it only applies to the numeric results.

If the analyzer is in Single measurement, pressing the Cont key does not change k and does not cause the sweep to be reset; the only action is to put the analyzer into Continuous measurement operation.

If it is already in continuous sweep:

the INIT:CONT 1 command has no effect

10 ACP Measurement
Cont (Continuous Measurement/Sweep)

the INIT:CONT 0 command will place the analyzer in Single Sweep but will have no effect on the current sequence until $k = N$, at which point the current sequence will stop and the instrument will go to the idle state.

File

See "File" on page 360

FREQ Channel

Accesses a menu of keys that allow you to control the Frequency and Channel parameters of the instrument.

Some features in the Frequency menu are the same for all measurements – they do not change as you change measurements. Settings like these are called “Meas Global” and are unaffected by Meas Preset. For example, the Center Freq setting is the same for all measurements - it does not change as you change measurements.

Key Path	Front-panel key
Initial S/W Revision	Prior to A.02.00

Center Freq

Sets the frequency that corresponds to the horizontal center of the graticule (when frequency Scale Type is set to linear). While adjusting the Center Frequency the Span is held constant, which means that both Start Frequency and Stop Frequency will change.

Pressing Center Freq also sets the frequency entry mode to Center/Span. In Center/Span mode, the center frequency and span values are displayed below the graticule, and the default active function in the Frequency menu is Center Freq.

The center frequency setting is the same for all measurements within a mode, that is, it is Meas Global. Some modes are also able to share a Mode Global center frequency value. If this is the case, the Mode will have a Global Settings key in its Mode Setup menu.

The Center Freq function sets (and queries) the Center Frequency for the currently selected input. If your analyzer has multiple inputs, and you select another input, the Center Freq changes to the value for that input. SCPI commands are available to directly set the Center Freq for a specific input.

Center Freq is remembered as you go from input to input. Thus you can set a Center Freq of 10 GHz with the RF Input selected, change to BBIQ and set a Center Freq of 20 MHz, then switch to External Mixing and set a Center Freq of 60 GHz, and when you go back to the RF Input the Center Freq will go back to 10 GHz; back to BBIQ and it is 20 MHz; back to External Mixing and it is 60 GHz.

See ["RF Center Freq" on page 881](#)

See [Ext Mix Center Freq](#)

See ["I/Q Center Freq" on page 883](#)

See ["Center Frequency Presets" on page 879](#)

Key Path	FREQ Channel
Scope	Meas Global
Remote Command	<code>[:SENSe] :FREQuency:CENTer <freq></code> <code>[:SENSe] :FREQuency:CENTer?</code>

Example	FREQ:CENT 50 MHz FREQ:CENT UP changes the center frequency to 150 MHz if you use FREQ:CENT:STEP 100 MHz to set the center frequency step size to 100 MHz FREQ:CENT?
Notes	This command sets either the RF or I/Q Center Frequency depending on the selected input. For RF input it is equivalent to FREQ:RF:CENT For I/Q input it is equivalent to FREQ:IQ:CENT Preset and Max values are dependent on Hardware Options (5xx) If no terminator (e.g. MHz) is sent the terminator Hz is used. If a terminator with unit other than Frequency is used, an invalid suffix error message is generated.
Dependencies	The Center Frequency can be limited by Start or Stop Freq limits, if the Span is so large that Start or Stop reach their limit.
Couplings	When operating in “swept span”, any value of the Center Frequency or Span that is within the frequency range of the analyzer is allowed when the value is being set through the front panel numeric key pad or the SCPI command. The other parameter is forced to a different value if needed, to keep the Start and the Stop Frequencies within the analyzer’s frequency range
Preset	Depends on instrument maximum frequency, mode, measurement, and selected input. See "Center Frequency Presets" on page 879 and "RF Center Freq" on page 881 and Ext Mix Center Freq and "I/Q Center Freq" on page 883 .
State Saved	Saved in instrument state
Min	Depends on instrument maximum frequency, mode, measurement, and selected input.. See "Center Frequency Presets" on page 879 and "RF Center Freq" on page 881 and "I/Q Center Freq" on page 883 .
Max	Depends on instrument maximum frequency, mode, measurement, and selected input.. See "Center Frequency Presets" on page 879 and "RF Center Freq" on page 881 and "I/Q Center Freq" on page 883 .
Default Unit	Hz
Status Bits/OPC	Non-overlapped
Dependencies	
Initial S/W Revision	Prior to A.02.00

Center Frequency Presets

The following table provides the Center Frequency Presets for the Spectrum Analyzer mode, and the Max Freq, for the various frequency options:

Freq Option	CF after Mode Preset	Stop Freq after Mode Preset	Max Freq (can't tune)

10 ACP Measurement
FREQ Channel

			above)
503 (all but N9000A)	1.805 GHz	3.6 GHz	3.7 GHz
503 (N9000A)	1.505 GHz	3.0 GHz	3.08 GHz
507 (all but N9000A)	3.505 GHz	7.0 GHz	7.1 GHz
507 (N9000A)	3.755 GHz	7.5 GHz	7.58 GHz
508 (all but N9038A)	1.805 GHz	3.6 GHz	8.5 GHz
508 (N9038A)	4.205 GHz	8.4 GHz	8.5 GHz
513	6.805 GHz	13.6 GHz	13.8 GHz
526 (all but N9000A and N9038A)	13.255 GHz	26.5 GHz	27.0 GHz
526 (N9000A)	13.255 GHz	26.5 GHz	26.55 GHz
526 (N9038A)	1.805 GHz	3.6 GHz	27.0 GHz
532	16.005 GHz	32.0 GHz	32.5 GHz
543	21.505 GHz	43.0 GHz	TBD
544	22.005 GHz	44.0 GHz	44.5 GHz
550	25.005 GHz	50.0 GHz	51 GHz

Input 2:

Model	CF after Mode Preset	Stop Freq after Mode Preset	Max Freq (can't tune above)
N9000A opt C75	0.7505GHz	1.5 GHz	1.58 GHz
N9038A	505 MHz	1 GHz	1.000025 GHz

Tracking Generator Frequency Limits (N9000A only):

Tracking Generator Option	Min Freq (clips to this freq when turn TG on and	If above this Freq, Stop Freq clipped to this Freq when	Max Freq (can't tune above) while TG

	can't tune below while TG on)	TG turned on	on
T03	9 kHz	3.0 GHz	3.08 GHz
T06	9 kHz	6.0 GHz	6.05 GHz

The following table shows the Center Frequency Presets for modes other than Spectrum Analyzer:

Mode	CF Preset for RF
WCDMA	1 GHz
WIMAXOFDMA,	1 GHz
BASIC	1 GHz
ADEMOD	1 GHz
VSA	1 GHz
TDSCDMA	1 GHz
PNOISE	1 GHz
LTE	1 GHz
LTETDD	1 GHz
MSR	1 GHz
GSM	935.2 MHz
NFIGURE	1.505 GHz

RF Center Freq

SCPI command for specifying the RF Center Frequency. This command will set the Center Frequency to be used when the RF input is selected, even if the RF input is not the input that is selected at the time the command is sent. Note that the Center Freq function in the Frequency menu on the front panel always applies to the currently selected input.

Scope	Meas Global
Remote Command	<code>[:SENSe] :FREQuency:RF:CENTer <freq></code> <code>[:SENSe] :FREQuency:RF:CENTer?</code>
Example	FREQ:RF:CENT 30 MHz
Notes	This command is the same in all modes, but the parameter is Measurement Global. So the value is independent in each mode and common across all the measurements in the mode.
Dependencies	If the electronic/soft attenuator is enabled, any attempt to set Center Frequency such that the Stop Frequency would be >3.6 GHz fails and results in an advisory message. If the equivalent SCPI command is sent, this same message is generated as part of a “-221, Settings conflict” warning. If Source Mode is set to Tracking, and the Max or Min Center Freq is therefore limited by the limits of the source, a warning message is generated, “Data out of range;clipped to source max/min” if these limits are exceeded. Note that for an external source, these limits can be affected by the settings of

	Source Numerator, Source Denominator and Power Sweep.
Preset	See table above
State Saved	Saved in instrument state.
Min	-79.999995 MHz, unless Source Mode is set to Tracking, in which case it is limited by the minimum frequency of the Source
Max	See table above. Basically instrument maximum frequency – 5 Hz. Note that, if the Source Mode is set to Tracking, the effective instrument maximum frequency may be limited by the source maximum frequency. If the knob or step keys are being used, also depends on the value of the other three interdependent parameters Span, Start Frequency and Stop Frequency
Initial S/W Revision	Prior to A.02.00
Modified at S/W Revision	A.03.00

Ext Mix Center Freq

SCPI command for specifying the External Mixer Center Frequency. This command will set the Center Frequency to be used when the External Mixer is selected, even if the External Mixer input is not the input which is selected at the time the command is sent. Note that the Center Freq function in the Frequency menu on the front panel always applies to the currently selected input.

Scope	Meas Global
Remote Command	<code>[:SENSe] :FREQuency:EMIXer:CENTer <freq></code> <code>[:SENSe] :FREQuency:EMIXer:CENTer?</code>
Example	<code>:FREQ:EMIX:CENT 60 GHz</code> <code>:FREQ:EMIX:CENT?</code>
Notes	This command is the same in all modes, but the parameter is Measurement Global. So the value is independent in each mode and common across all the measurements in the mode.
Couplings	When returning to External Mixing after having been switched to one of the other inputs (e.g., RF), you will come back into the settings that you had when you left External Mixing. So you will come back to the band you were in with the Center Frequency that you had. However, Span is not an input-dependent parameter, therefore you will bring the span over from the other input. Therefore, the analyzer comes back with the span from the previous input, limited as necessary by the current mixer setup.
Preset	When a Mode Preset is performed while in External Mixing, the Start frequency of the current Mode is set to the nominal Min Freq of the lowest harmonic range in the Harmonic Table for the current mixer setup. Similarly, the Stop frequency of the current Mode is set to the nominal Max Freq of the highest harmonic range in the Harmonic Table. The Center Freq thus presets to the point arithmetically equidistant from these two frequencies. If the current measurement has a limited Span available to it, and cannot achieve the Span shown in the table (Span=Stop Freq – Start Freq), the analyzer uses the maximum Span the measurement allows, and still sets the Center Freq to the midpoint of the Start and Stop Freq values in the Harmonic Table.

	When Restore Input/Output Defaults is performed, the mixer presets to the 11970A, whose Start and Stop frequencies are 26.5 and 40 GHz respectively. The center of these two frequencies is 33.25 GHz. Therefore, after a Restore Input/Output Defaults, if you go into External Mixing and do a Mode Preset while in the Spectrum Analyzer Mode, the resulting Center Freq is 33.25 GHz.
State Saved	Saved in instrument state.
Min	The minimum frequency in the currently selected mixer band + 5 Hz
Max	The maximum frequency in the currently selected mixer band – 5 Hz If the knob or step keys are being used, also depends on the value of the other three interdependent parameters Span, Start Frequency and Stop Frequency
Initial S/W Revision	A.08.01

I/Q Center Freq

SCPI command for specifying the I/Q Center Frequency. This command will set the Center Frequency to be used when the I/Q input is selected, even if the I/Q input is not the input which is selected at the time the command is sent. Note that the Center Freq function in the Frequency menu on the front panel always applies to the currently selected input.

Scope	Meas Global
Remote Command	[:SENSe] :FREQuency:IQ:CENTer <freq> [:SENSe] :FREQuency:IQ:CENTer?
Example	FREQ:IQ:CENT: 30 MHz
Notes	This command is the same in all modes, but the parameter is Measurement Global. So the value is independent in each mode and common across all the measurements in the mode.
Preset	0 Hz
State Saved	Saved in instrument state.
Min	-40.049995 MHz
Max	40.049995 MHz
Initial S/W Revision	Prior to A.02.00

CF Step

Changes the step size for the center frequency and start and stop frequency functions. Once a step size has been selected and the center frequency function is active, the step keys (and the UP|DOWN parameters for Center Frequency from remote commands) change the center frequency by the step-size value. The step size function is useful for finding harmonics and sidebands beyond the current frequency span of the analyzer.

Note that the start and stop frequencies also step by the CF Step value.

Key Path	FREQ Channel
Remote Command	<pre>[:SENSe] :FREQuency:CENTer:STEP[:INCRement] <freq> [:SENSe] :FREQuency:CENTer:STEP[:INCRement] ? [:SENSe] :FREQuency:CENTer:STEP:AUTO OFF ON 0 1 [:SENSe] :FREQuency:CENTer:STEP:AUTO?</pre>
Example	<pre>FREQ:CENt:STEP:AUTO ON FREQ:CENt:STEP 500 MHz FREQ:CENt UP increases the current center frequency value by 500 MHz FREQ:CENt:STEP? FREQ:CENt:STEP:AUTO?</pre>
Notes	Preset and Max values are depending on Hardware Options (503, 507, 508, 513, 526)
Notes	Preset and Max values are dependent on Hardware Options (5xx)
Dependencies	Freq Offset is not available in External Mixing. In this case the Freq Offset key is grayed out and shows a value of zero. It will once again be available, and show the previously set value, when you return to the RF Input.
Dependencies	Span, RBW, Center frequency If the electronic/soft attenuator is enabled, any attempt to change the value of the center frequency >3.6 GHz by pressing the Up-arrow key, fails and results in an advisory message. If the equivalent SCPI command is sent, this same message is generated as part of a “-221, Settings conflict” warning.
Couplings	When auto-coupled in a non-zero span, the center frequency step size is set to 10% of the span. When auto-coupled in zero span, the center frequency step size is set to the equivalent -3 dB RBW value.
Preset	Auto ADEMOD: 1 MHz ON
State Saved	Saved in instrument state
Min	– (the maximum frequency of the instrument). That is, 27 GHz max freq instrument has a CF step range of +/- 27 GHz. Note that this is the maximum frequency given the current settings of the instrument, so in External Mixing, for example, it is the maximum frequency of the current mixer band.
Max	The maximum frequency of the instrument. That is, 27 GHz max freq instrument has a CF step range of +/- 27 GHz. Note that this is the maximum frequency given the current settings of the instrument, so in External Mixing, for example, it is the maximum frequency of the current mixer band.
Default Unit	Hz
Status Bits/OPC dependencies	non-overlapped
Initial S/W Revision	Prior to A.02.00
Modified at S/W Revision	A.03.00

Input/Output

See "Input/Output" on page 224

Marker

Accesses a menu that enables you to select, set up and control the markers for the current measurement. Note that this hard key and all sub keys are unavailable when "Meas Method" on page 941 is set to RBW.

Key Path	Front-panel key
Initial S/W Revision	Prior to A.02.00

Select Marker

Displays 12 markers available for selection. Note that this key is unavailable when "Meas Method" on page 941 is set to RBW.

Key Path	Marker
Initial S/W Revision	Prior to A.02.00

Marker Type

Sets the marker control mode to Normal, Delta, Fixed or Off. All interactions and dependencies detailed under the key description are enforced when the remote command is sent. If the selected marker is Off, pressing Marker sets it to Normal and places it at the center of the screen on the trace determined by the Marker Trace rules. At the same time, Marker X Axis Value appears on the Active Function area.

The default active function is the active function for the currently selected marker control mode. If the current control mode is Off, there is no active function and the active function is turned off.

Key Path	Marker
Mode	SA, WCDMA, C2K, WIMAX OFDMA, TD-SCDMA, 1xEVDO, DVB-T/H, DTMB (CTTB), ISDB-T, CMMB, LTE, LTE-TDD, Digital Cable TV, MSR, LTEAFDD, LTEATDD
Remote Command	:CALCulate:ACPower:MARKer[1] 2 ... 12:MODE POSition DELTa OFF :CALCulate:ACPower:MARKer[1] 2 ... 12:MODE?
Example	CALC:ACP:MARK2:MODE DELT CALC:ACP:MARK2:MODE?
Notes	If the selected marker is Off, pressing Marker sets it to Normal and places it at the center of the screen on the trace determined by the Marker Trace rules. At the same time, Marker X Axis Value appears on the Active Function area. Default Active Function: the active function for the selected marker's current control mode. If the current control mode is Off, there is no active function and the active function is turned off. Active Function Display: the marker X axis value entered in the active function area will display the marker value to its full entered precision. You must be in the mode that includes ACP measurements to use this command. Use :INSTrument:SElect to set the mode.
Dependencies	This key is unavailable when "Meas Method" on page 941 is set to RBW.

Preset	OFF OFF OFF OFF OFF OFF OFF OFF OFF OFF OFF OFF
State Saved	Saved in instrument state.
Range	Normal Delta Off
Initial S/W Revision	Prior to A.02.00
Modified at S/W Revision	A.02.00, A.03.00

Properties

Accesses the marker properties menu. Note that this key is unavailable when "Meas Method" on page 941 is set to RBW.

Key Path	Marker
Initial S/W Revision	Prior to A.02.00

Select Marker

Displays 12 markers available for selection. Note that this key is unavailable when "Meas Method" on page 941 is set to RBW.

Key Path	Marker
Initial S/W Revision	Prior to A.02.00

Relative To

Selects the desired marker. The selected marker will be relative to its reference marker.

Key Path	Marker, Properties
Mode	SA, WCDMA, C2K, WIMAX OFDMA, TD-SCDMA, 1xEVDO, DVB-T/H, DTMB (CTTB), ISDB-T, CMMB, LTE, LTE-TDD, Digital Cable TV, MSR, LTEAFDD, LTEATDD
Remote Command	:CALCulate:ACPpower:MARKer[1] 2 ... 12:REFerence <integer> :CALCulate:ACPpower:MARKer[1] 2 ... 12:REFerence?
Example	CALC:ACP:MARK2:REF 6 CALC:ACP:MARK2:REF?
Notes	A marker cannot be relative to itself so that choice is grayed out, and if sent from a remote command, generates error -221: "Settings conflict; marker cannot be relative to itself." When queried a single value will be returned (the specified marker numbers relative marker). You must be in the mode that includes ACP measurements to use this command. Use :INSTrument:SELect to set the mode.
Dependencies	This key is unavailable when "Meas Method" on page 941 is set to RBW.

Preset	2 3 4 5 6 7 8 9 10 11 12 1
State Saved	Saved in instrument state.
Min	1
Max	12
Initial S/W Revision	Prior to A.02.00
Modified at S/W Revision	A.02.00, A.03.00

Marker Trace

Selects the trace that you want your marker to be placed on. A marker is associated with one and only one trace. This trace is used to determine the placement, result, and X Axis Scale of the marker. All markers have an associated trace, even Fixed markers; it is from that trace that they determine their attributes and behaviors, and it is to that trace that they go when they become Normal or Delta markers.

Key Path	Marker, Properties
Mode	SA, WCDMA, C2K, WIMAX OFDMA, TD-SCDMA, 1xEVDO, DVB-T/H, DTMB (CTTB), ISDB-T, CMMB, LTE, LTE-TDD, Digital Cable TV, MSR, LTEAFDD, LTEATDD
Remote Command	:CALCulate:ACPpower:MARKer[1] 2 ... 12:TRACe 1 2 3 :CALCulate:ACPpower:MARKer[1] 2 ... 12:TRACe?
Example	CALC:ACP:MARK2:TRAC 2 CALC:ACP:MARK2:TRAC?
Notes	If the selected marker is Off, pressing Marker sets it to Normal and places it at the center of the screen on the trace determined by the Marker Trace rules. At the same time, Marker X Axis Value appears on the Active Function area. Default Active Function: the active function for the selected marker's current control mode. If the current control mode is Off, there is no active function and the active function is turned off. Active Function Display: the marker X axis value entered in the active function area will display the marker value to its full entered precision.
Dependencies	This key is unavailable when " Meas Method " on page 941 is set to RBW.
Couplings	This is not affected by Auto Coupling. Sending the remote command causes the addressed marker to become selected.
Preset	All Markers Off
State Saved	Saved in instrument state.
Range	1 2 3
Initial S/W Revision	Prior to A.02.00
Modified at S/W Revision	A.02.00, A.03.00

Couple Markers

When this function is On, moving any marker causes an equal X axis movement of every other marker which is not Off. By “equal X axis movement” we mean that we preserve the difference between each marker’s X axis value (in the fundamental x-axis units of the trace that marker is on) and the X axis value of the marker being moved (in the same fundamental x-axis units).

Key Path	Marker
Mode	SA, WCDMA, C2K, WIMAX OFDMA, TD-SCDMA, 1xEVDO, DVB-T/H, DTMB (CTTB), ISDB-T, CMMB, LTE, LTE-TDD, Digital Cable TV, MSR, LTEAFDD, LTEATDD
Remote Command	:CALCulate:ACPower:MARKer:COUple[:STATE] ON OFF 1 0 :CALCulate:ACPower:MARKer:COUple[:STATE]?
Example	CALC:ACP:MARK:COUP ON
Dependencies	This key is unavailable when "Meas Method" on page 941 is set to RBW.
Preset	OFF
State Saved	Saved in instrument state.
Range	On Off
Initial S/W Revision	Prior to A.02.00
Modified at S/W Revision	A.02.00, A.03.00

Marker All Off

Turns all active markers off.

Key Path	Marker
Mode	SA, WCDMA, C2K, WIMAX OFDMA, TD-SCDMA, 1xEVDO, DVB-T/H, DTMB (CTTB), ISDB-T, CMMB, LTE, LTE-TDD, Digital Cable TV, MSR, LTEAFDD, LTEATDD
Remote Command	:CALCulate:ACPower:MARKer:AOff
Example	CALC:ACP:MARK:AOff
Dependencies	This key is unavailable when "Meas Method" on page 941 is set to RBW.
Initial S/W Revision	Prior to A.02.00
Modified at S/W Revision	A.02.00, A.03.00

Marker X Axis Value (Remote Command only)

Sets the marker X axis value in the current marker X Axis Scale unit. This value has no effect if the control mode is Off, but is the SCPI equivalent of entering an X value if the control mode is Normal, Delta or Fixed.

Mode	SA, WCDMA, C2K, WIMAX OFDMA, TD-SCDMA, 1xEVDO, DVB-T/H, DTMB (CTTB), ISDB-T, CMMB, LTE, LTE-TDD, Digital Cable TV, MSR, LTEAFDD, LTEATDD
Remote Command	:CALCulate:ACPower:MARKer[1] 2 ... 12:X <freq> :CALCulate:ACPower:MARKer[1] 2 ... 12:X?

Example	CALC:ACP:MARK3:X 0 CALC:ACP:MARK3:X?
Notes	The query returns the marker's absolute X Axis value if the control mode is Normal, or the offset from the marker's reference marker if the control mode is Delta. If the marker is Off the response is not a number.
Dependencies	Unavailable when " Meas Method " on page 941 is set to RBW.
Preset	After a preset, all Markers are turned OFF, so Marker X Axis Value query will return a not a number (NAN).
State Saved	No
Min	-9.9E+37
Max	9.9E+37
Initial S/W Revision	Prior to A.02.00
Modified at S/W Revision	A.02.00, A.03.00

Marker X Axis Position (Remote Command only)

Sets the marker X position in trace points. It has no effect if the control mode is Off, but is the SCPI equivalent of entering a value if the control mode is Normal, Delta or Fixed. The entered value is immediately translated into the current X Axis Scale units for setting the value of the marker.

Mode	SA, WCDMA, C2K, WIMAX OFDMA, TD-SCDMA, 1xEVDO, DVB-T/H, DTMB (CTTB), ISDB-T, CMMB, LTE, LTE-TDD, Digital Cable TV, MSR, LTEAFDD, LTEATDD
Remote Command	:CALCulate:ACPower:MARKer[1] 2 ... 12:X:POsition <real> :CALCulate:ACPower:MARKer[1] 2 ... 12:X:POsition?
Example	CALC:ACP:MARK10:X:POS 0 CALC:ACP:MARK10:X:POS?
Notes	The query returns the marker's absolute X Axis value in trace points if the control mode is Normal, or the offset from the marker's reference marker in trace points if the control mode is Delta. The value is returned as a real number, not an integer, corresponding to the translation from X Axis Scale units to trace points (see "Fractional Trace Points"). If the marker is Off the response is not a number. When a Marker is turned on, it is placed center of the screen on the trace. Therefore the default value depends on instrument condition, although the Preset/Default is defined as 500 (this value might be expected value when all offset is on).
Dependencies	Unavailable when " Meas Method " on page 941 is set to RBW.
Preset	After a preset, all Markers are turned OFF, so Marker X Axis Value query will return a not a number (NAN).
State Saved	No
Min	-9.9E+37
Max	9.9E+37
Initial S/W Revision	Prior to A.02.00
Modified at S/W Revision	A.02.00, A.03.00

Marker Y Axis Value (Remote Command only)

Returns the marker Y axis value in the current marker Y axis unit.

Mode	SA, WCDMA, C2K, WIMAX OFDMA, TD-SCDMA, 1xEVDO, DVB-T/H, DTMB (CTTB), ISDB-T, CMMB, LTE, LTE-TDD, Digital Cable TV, MSR, LTEAFDD, LTEATDD
Remote Command	:CALCulate:ACPower:MARKer [1] 2 ... 12 : Y ?
Example	CALC:ACP:MARK11:Y?
Notes	Since the result value is always calculated from acquisition data, the default value is arbitrary. Although the Preset/Default values are defined.
Dependencies	Unavailable when " Meas Method " on page 941 is set to RBW.
Preset	Result dependent on markers setup and signal source.
State Saved	No
Backwards Compatibility SCPI	:CALCulate:ACPower:MARKer [1] 2 ... 12 : FUNCTION:RESULT?
Initial S/W Revision	Prior to A.02.00
Modified at S/W Revision	A.02.00, A.03.00

Backward Compatibility Remote Commands

Sets or queries the state of a marker. Setting a marker which is off to the on state or 1 puts it in Normal mode and places it at the center of the screen.

Mode	SA, WCDMA, WIMAX OFDMA, CDMA2K, TDSCDMA, CDMA1XEV, DVB, DTMB, ISDBT, CMMB, LTE, LTE-TDD, DCATV, MSR, LTEAFDD, LTEATDD
Remote Command	:CALCulate:ACPower:MARKer [1] 2 ... 12 : STATE OFF ON 0 1 :CALCulate:ACPower:MARKer [1] 2 ... 12 : STATE ?
Example	CALC:ACP:MARK2:STAT ON CALC:ACP:MARK2:STAT?
Notes	This parameter is also accessed from Marker, Properties, 1 You must be in the mode that includes ACP measurements to use this command. Use :INSTRument:SElect to set the mode.
Preset	OFF OFF OFF OFF OFF OFF OFF OFF OFF OFF OFF OFF
State Saved	Saved in instrument state.
Range	On Off
Initial S/W Revision	Prior to A.02.00
Modified at S/W Revision	A.02.00, A.03.00

Marker Function

There are no Marker Functions supported in the ACP measurement. The front-panel key will display a blank key menu when pressed.

Key Path	Front-panel key
Initial S/W Revision	Prior to A.02.00

Marker To

There is no Marker To functionality supported in ACP. The front-panel key will display a blank key menu when pressed.

Key Path	Front-panel key
Initial S/W Revision	Prior to A.02.00

Meas

The information in this section is common to all measurements. For key and remote command information for a specific measurement, refer to the section that describes the measurement of interest.

Measurements available under the Meas key are specific to the current Mode.

When viewing Help for measurements, note the following:

NOTE

Operation for some keys differs between measurements. The information displayed in Help pertains to the current measurement. To see how a key operates in a different measurement, exit Help (press the Cancel Esc key), select the measurement, then reenter Help (press the Help key) and press that key.

Key Path	Front-panel key
Initial S/W Revision	Prior to A.02.00

Remote Measurement Functions

This section contains the following topics:

["Measurement Group of Commands" on page 2771](#)

["Current Measurement Query \(Remote Command Only\)" on page 2773](#)

["Limit Test Current Results \(Remote Command Only\)" on page 2773](#)

["Data Query \(Remote Command Only\)" on page 2773](#)

["Calculate/Compress Trace Data Query \(Remote Command Only\)" on page 2774](#)

["Calculate Peaks of Trace Data \(Remote Command Only\)" on page 2779](#)

[Hardware-Accelerated Fast Power Measurement \(Remote Command Only\)](#)

["Format Data: Numeric Data \(Remote Command Only\)" on page 2780](#)

["Format Data: Byte Order \(Remote Command Only\)" on page 2781](#)

Initial S/W Revision	Prior to A.02.00
----------------------	------------------

Measurement Group of Commands

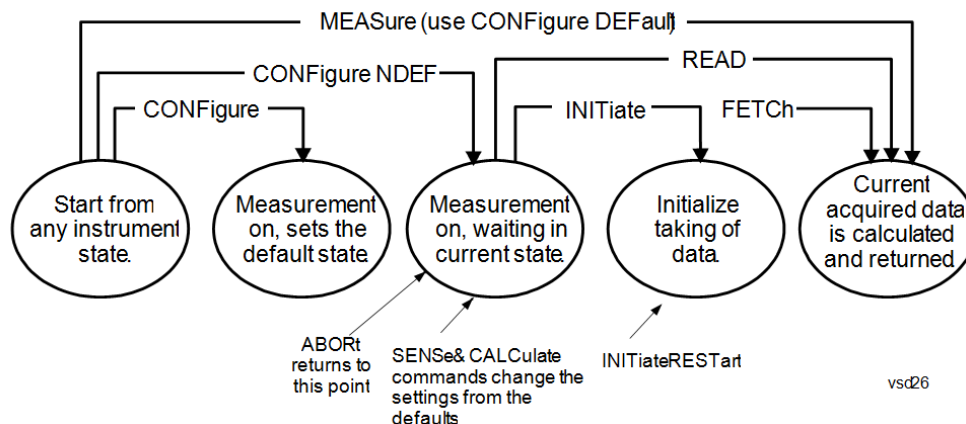

Measure Commands:

:MEASure:<measurement>[n]?

This is a fast single-command way to make a measurement using the factory default instrument settings. These are the settings and units that conform to the Mode Setup settings (e.g. radio standard) that you have currently selected.

- Stops the current measurement (if any) and sets up the instrument for the specified measurement using the factory defaults
- Initiates the data acquisition for the measurement
- Blocks other SCPI communication, waiting until the measurement is complete before returning results.
- If the function does averaging, it is turned on and the number of averages is set to 10.
- After the data is valid it returns the scalar results, or the trace data, for the specified measurement. The type of data returned may be defined by an [n] value that is sent with the command.
- The scalar measurement results will be returned if the optional [n] value is not included, or is set to 1. If the [n] value is set to a value other than 1, the selected trace data results will be returned. See each command for details of what types of scalar results or trace data results are available.
- ASCII is the default format for the data output. (Older versions of Spectrum Analysis and Phase Noise mode measurements only use ASCII.) The binary data formats should be used for handling large blocks of data since they are smaller and faster than the ASCII format. Refer to the FORMat:DATA command for more information.

If you need to change some of the measurement parameters from the factory default settings you can set up the measurement with the CONFIgure command. Use the commands in the SENSe:<measurement> and CALCulate:<measurement> subsystems to change the settings. Then you can use the READ? command to initiate the measurement and query the results.

If you need to repeatedly make a given measurement with settings other than the factory defaults, you can use the commands in the SENSe:<measurement> and CALCulate:<measurement> subsystems to set up the measurement. Then use the READ? command to initiate the measurement and query results.

Measurement settings persist if you initiate a different measurement and then return to a previous one. Use READ:<measurement>? if you want to use those persistent settings. If you want to go back to the default settings, use MEASure:<measurement>?.

Configure Commands:

:CONFIgure:<measurement>

This command stops the current measurement (if any) and sets up the instrument for the specified measurement using

the factory default instrument settings. It does not initiate the taking of measurement data unless INIT:CONTinuous is ON. If you change any measurement settings after using the CONFigure command, the READ command can be used to initiate a measurement without changing the settings back to their defaults.

In the Swept SA measurement in Spectrum Analyzer mode the CONFigure command also turns the averaging function on and sets the number of averages to 10 for all measurements.

:CONFigure: <measurement>: NDEFault stops the current measurement and changes to the specified measurement. It does not change the settings to the defaults. It does not initiate the taking of measurement data unless INIT:CONTinuous is ON.

The CONFigure? query returns the current measurement name.

The CONFigure:CATalog? query returns a quoted string of all licensed measurement names in the current mode. For example, "SAN, CHP, OBW, ACP, PST, TXP, SPUR, SEM, LIST".

Fetch Commands:

:FETCh:<measurement>[n]?

This command puts selected data from the most recent measurement into the output buffer. Use FETCh if you have already made a good measurement and you want to return several types of data (different [n] values, for example, both scalars and trace data) from a single measurement. FETCh saves you the time of re-making the measurement. You can only FETCh results from the measurement that is currently active, it will not change to a different measurement. An error message is reported if a measurement other than the current one is specified.

If you need to get new measurement data, use the READ command, which is equivalent to an INITiate followed by a FETCh.

The scalar measurement results will be returned if the optional [n] value is not included, or is set to 1. If the [n] value is set to a value other than 1, the selected trace data results will be returned. See each command for details of what types of scalar results or trace data results are available. The binary data formats should be used for handling large blocks of data since they are smaller and transfer faster than the ASCII format. (FORMat:DATA)

FETCh may be used to return results other than those specified with the original READ or MEASure command that you sent.

INITiate Commands:

:INITiate:<measurement>

This command is not available for measurements in all the instrument modes:

- Initiates a trigger cycle for the specified measurement, but does not output any data. You must then use the FETCh<meas> command to return data. If a measurement other than the current one is specified, the instrument will switch to that measurement and then initiate it.
 - For example, suppose you have previously initiated the ACP measurement, but now you are running the channel power measurement. If you send INIT:ACP? it will change from channel power to ACP and will initiate an ACP measurement.
 - Does not change any of the measurement settings. For example, if you have previously started the ACP measurement and you send INIT:ACP? it will initiate a new ACP measurement using the same instrument settings as the last time ACP was run.
 - If your selected measurement is currently active (in the idle state) it triggers the measurement, assuming the trigger conditions are met. Then it completes one trigger cycle. Depending upon the measurement and the number of averages, there may be multiple data acquisitions, with multiple trigger events, for one full trigger cycle. It also holds off additional commands on GPIB until the acquisition is complete.
-

READ Commands:

:READ:<measurement>[n]?

- Does not preset the measurement to the factory default settings. For example, if you have previously initiated the ACP
-

measurement and you send READ:ACP? it will initiate a new measurement using the same instrument settings.

- Initiates the measurement and puts valid data into the output buffer. If a measurement other than the current one is specified, the instrument will switch to that measurement before it initiates the measurement and returns results.
 - For example, suppose you have previously initiated the ACP measurement, but now you are running the channel power measurement. Then you send READ:ACP? It will change from channel power back to ACP and, using the previous ACP settings, will initiate the measurement and return results.
 - Blocks other SCPI communication, waiting until the measurement is complete before returning the results
 - If the optional [n] value is not included, or is set to 1, the scalar measurement results will be returned. If the [n] value is set to a value other than 1, the selected trace data results will be returned. See each command for details of what types of scalar results or trace data results are available. The binary data formats should be used when handling large blocks of data since they are smaller and faster than the ASCII format. (FORMat:DATA)
-

Initial S/W Revision	Prior to A.02.00
----------------------	------------------

Current Measurement Query (Remote Command Only)

This command returns the name of the measurement that is currently running.

Remote Command	:CONFigure?
-----------------------	-------------

Example	CONF?
----------------	-------

Initial S/W Revision	Prior to A.02.00
----------------------	------------------

Limit Test Current Results (Remote Command Only)

Queries the status of the current measurement limit testing. It returns a 0 if the measured results pass when compared with the current limits. It returns a 1 if the measured results fail any limit tests.

Remote Command	:CALCulate:CLIMits:FAIL?
-----------------------	--------------------------

Example	CALC:CLIM:FAIL? queries the current measurement to see if it fails the defined limits. Returns a 0 or 1: 0 it passes, 1 it fails.
----------------	--

Initial S/W Revision	Prior to A.02.00
----------------------	------------------

Data Query (Remote Command Only)

Returns the designated measurement data for the currently selected measurement and subopcode.

n = any valid subopcode for the current measurement. See the measurement command results table for your current measurement, for information about what data is returned for the subopcodes.

This command uses the data setting specified by the FORMat:BORDER and FORMat:DATA commands and can return real or ASCII data. (See the format command descriptions under Input/Output in the Analyzer Setup section.)

Remote Command	:CALCulate:DATA[n]?
Notes	The return trace depends on the measurement. In CALCulate:<meas>:DATA[n], n is any valid subopcode for the current measurement. It returns the same data as the FETCH:<measurement>? query where <measurement> is the current measurement.
Initial S/W Revision	Prior to A.02.00

Calculate/Compress Trace Data Query (Remote Command Only)

Returns compressed data for the currently selected measurement and sub-opcode [n].

n = any valid sub-opcode for that measurement. See the MEASure:<measurement>? command description of your specific measurement for information on the data that can be returned.

The data is returned in the current Y Axis Unit of the analyzer. The command is used with a sub-opcode <n> (default=1) to specify the trace. With trace queries, it is best if the analyzer is not sweeping during the query. Therefore, it is generally advisable to be in Single Sweep, or Update=Off.

This command is used to compress or decimate a long trace to extract and return only the desired data. A typical example would be to acquire N frames of GSM data and return the mean power of the first burst in each frame. The command can also be used to identify the best curve fit for the data.

Remote Command	:CALCulate:DATA<n>:COMPRESS? BLOCK CFIT MAXimum MINimum MEAN DMEan RMS RMSCubed SAMPLE SDEVIation PPHase [,<soffset> [,<length>[,<roffset>[,<rlimit>]]]]
Example	To query the mean power of a set of GSM bursts: Supply a signal that is a set of GSM bursts. Select the IQ Waveform measurement (in IQ Analyzer Mode). Set the sweep time to acquire at least one burst. Set the triggers such that acquisition happens at a known position relative to a burst. Then query the mean burst levels using, CALC:DATA2:COMP? MEAN, 24e-6, 526e-6 (These parameter values correspond to GSM signals, where 526e-6 is the length of the burst in the slot and you just want 1 burst.)
Notes	The command supports 5 parameters. Note that the last 4 (<soffset>, <length>, <roffset>, <rlimit>) are optional. But these optional parameters must be entered in the specified order. For example, if you want to specify <length>, then you must also specify <soffset>. See details below for a definition of each of these parameters. This command uses the data in the format specified by FORMat:DATA, returning either binary or ASCII data.
Initial S/W Revision	Prior to A.02.00

- BLOCK or block data - returns all the data points from the region of the trace data that you specify. For example, it could be used to return the data points of an input signal over several timeslots, excluding the portions of the trace data that you do not want. (This is x,y pairs for trace data and I,Q pairs for complex data.)

- CFIT or curve fit - applies curve fitting routines to the data. <soffset> and <length> are required to define the data that you want. <roffset> is an optional parameter for the desired order of the curve equation. The query will return the following values: the x-offset (in seconds) and the curve coefficients ((order + 1) values).

MIN, MAX, MEAN, DME, RMS, RMSC, SAMP, SDEV and PPH return one data value for each specified region (or <length>) of trace data, for as many regions as possible until you run out of trace data (using <roffset> to specify regions). Or they return the number of regions you specify (using <rlimit>) ignoring any data beyond that.

- MINimum - returns the minimum data point (y value) for the specified region(s) of trace data. For I/Q trace data, the minimum magnitude of the I/Q pairs is returned.
- MAXimum - returns the maximum data point (y value) for the specified region(s) of trace data. For I/Q trace data, the maximum magnitude of the I/Q pairs is returned.
- MEAN - returns a single value that is the arithmetic mean of the data point values (in dB/ dBm) for the specified region(s) of trace data. For I/Q trace data, the mean of the magnitudes of the I/Q pairs is returned. See the following equations.

-

NOTE

If the original trace data is in dB, this function returns the arithmetic mean of those log values, not log of the mean power which is a more useful value. The mean of the log is the better measurement technique when measuring CW signals in the presence of noise. The mean of the power, expressed in dB, is useful in power measurements such as Channel Power. To achieve the mean of the power, use the RMS option.

Equation 1

Mean Value of Data Points for Specified Region(s)

$$\text{MEAN} = \frac{1}{n} \sum_{X_i \in \text{region}(s)} X_i$$

where X_i is a data point value, and n is the number of data points in the specified region(s).

Equation 2

Mean Value of I/Q Data Pairs for Specified Region(s)

$$\text{MEAN} = \frac{1}{n} \sum_{X_i \in \text{region}(s)} |X_i|$$

where $|X_i|$ is the magnitude of an I/Q pair, and n is the number of I/Q pairs in the specified region(s).

- DMEan - returns a single value that is the mean power (in dB/ dBm) of the data point values for the specified region(s) of trace data. See the following equation:

Equation 3

DMEan Value of Data Points for Specified Region(s)

$$\text{DME} = 10 \times \log_{10} \left(\frac{1}{n} \sum_{X_i \in \text{region}(s)} 10^{\frac{X_i}{10}} \right)$$

- RMS - returns a single value that is the average power on a root-mean-squared voltage scale (arithmetic rms) of the data point values for the specified region(s) of trace data. See the following equation.

NOTE

For I/Q trace data, the rms of the magnitudes of the I/Q pairs is returned. See the following equation. This function is very useful for I/Q trace data. However, if the original trace data is in dB, this function returns the rms of the log values which is not usually needed.

Equation 4

RMS Value of Data Points for Specified Region(s)

$$\text{RMS} = \sqrt{\frac{1}{n} \sum_{X_i \in \text{region}(s)} X_i^2}$$

where X_i is a data point value, and n is the number of data points in the specified region(s).

Equation 5

RMS Value of I/Q Data Pairs for Specified Region(s)

$$\text{RMS} = \sqrt{\frac{1}{n} \sum_{X_i \in \text{region}(s)} X_i X_i^*}$$

where X_i is the complex value representation of an I/Q pair, X_i^* its conjugate complex number, and n is the number of I/Q pairs in the specified region(s).

Once you have the rms value for a region of trace data (linear or I/Q), you may want to calculate the mean power. You must convert this rms value (peak volts) to power in dBm:

$$10 \times \log[10 \times (\text{rms value})^2]$$

- SAMPLe - returns the first data value (x,y pair) for the specified region(s) of trace data. For I/Q trace data, the first I/Q pair is returned.
- SDEViation - returns a single value that is the arithmetic standard deviation for the data point values for the specified region(s) of trace data. See the following equation.
- For I/Q trace data, the standard deviation of the magnitudes of the I/Q pairs is returned. See the following equation.

Equation 6

Standard Deviation of Data Point Values for Specified Region(s)

$$\text{SDEV} = \sqrt{\frac{1}{n} \sum_{X_i \in \text{region}(s)} (X_i - \bar{X})^2}$$

where X_i is a data point value, \bar{X} is the arithmetic mean of the data point values for the specified region (s), and n is the number of data points in the specified region(s).

$$\text{SDEV} = \sqrt{\frac{1}{n} \sum_{X_i \in \text{region}(s)} (|X_i| - \bar{X})^2}$$

where $|X_i|$ is the magnitude of an I/Q pair, \bar{X} is the mean of the magnitudes for the specified region(s), and n is the number of data points in the specified region(s).

- PPHase - returns the x,y pairs of both rms power (dBm) and arithmetic mean phase (radian) for every specified region and frequency offset (Hz). The number of pairs is defined by the specified number of regions. This parameter can be used for I/Q vector (n=0) in Waveform (time domain) measurement and all parameters are specified by data point in PPHase.

The rms power of the specified region may be expressed as:

$$\text{Power} = 10 \times \log [10 \times (\text{RMS I/Q value})] + 10.$$

The RMS I/Q value (peak volts) is:

$$\sqrt{\frac{1}{n} \sum_{X_i \in \text{region}} X_i X_i^*}$$

where X_i is the complex value representation of an I/Q pair, X_i^* its conjugate complex number, and n is the number of I/Q pairs in the specified region.

The arithmetic mean phase of the specified region may be expressed as:

$$\frac{1}{n} \sum_{Y_i \in \text{region}} Y_i$$

where Y_i is the unwrapped phase of I/Q pair with applying frequency correction and n is the number of I/Q pairs in the specified region.

The frequency correction is made by the frequency offset calculated by the arithmetic mean of every specified region's frequency offset. Each frequency offset is calculated by the least square method against the unwrapped phase of I/Q pair.

Sample Trace Data - Constant Envelope

(See below for explanation of variables.)

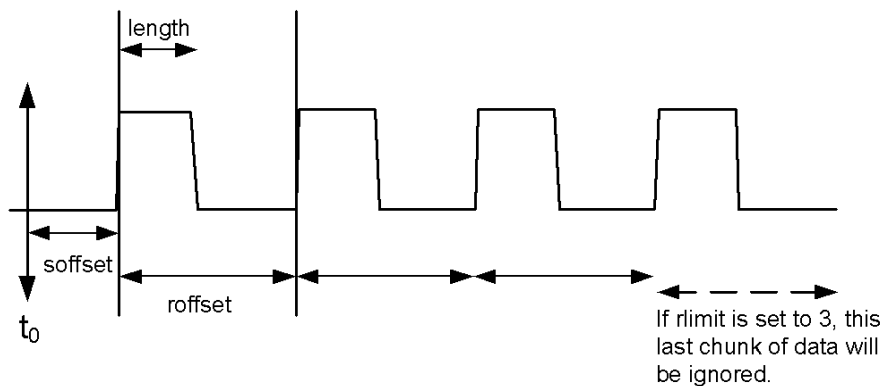

Sample Trace Data - Not Constant Envelope

(See below for explanation of variables.)

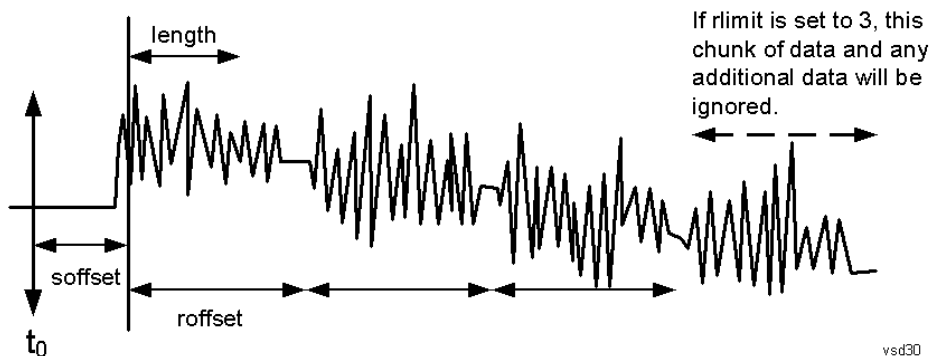

<soffset> - start offset is an optional real number. (It is in seconds for time-domain traces, and is a dimensionless index 0 to Npoints - 1, for frequency-domain traces). It specifies the amount of data at the beginning of the trace that will be ignored before the decimation process starts. It is the time or frequency change from the start of the trace to the point where you want to start using the data. The default value is zero.

<length> - is an optional real number. (It is in seconds for time-domain traces, and is a dimensionless index 0 to Npoints - 1, for frequency-domain traces). It defines how much data will be compressed into one value. This parameter has a default value equal to the current trace length.

<roffset> - repeat offset is an optional real number. (It is in seconds for time-domain traces, and is a dimensionless index 0 to Npoints - 1, for frequency-domain traces). It defines the beginning of the next field of trace elements to be compressed. This is relative to the beginning of the previous field. This parameter has a default value equal to the <length> variable. Note that this parameter is used for a completely different purpose when curve fitting (see CFIT above).

<rlimit> - repeat limit is an optional integer. It specifies the number of data items that you want returned. It will ignore any additional items beyond that number. You can use the Start offset and the Repeat limit to pick out exactly what part of the data you want to use. The default value is all the data.

Calculate Peaks of Trace Data (Remote Command Only)

Returns a list of all the peaks for the currently selected measurement and sub-opcode [n]. The peaks must meet the requirements of the peak threshold and excursion values.

n = any valid sub-opcode for the current measurement. See the MEASure:<measurement> command description of your specific measurement for information on the data that can be returned.

The command can only be used with specific sub-opcodes with measurement results that are trace data. Both real and complex traces can be searched, but complex traces are converted to magnitude in dBm. In many measurements the sub-opcode n=0, is the raw trace data which cannot be searched for peaks. And Sub-opcode n=1, is often calculated results values which also cannot be searched for peaks.

This command uses the data setting specified by the FORMat:BORDER and FORMat:DATA commands and can return real or ASCII data. If the format is set to INT,32, it returns REAL,32 data.

The command has four types of parameters:

- Threshold (in dBm)
- Excursion (in dB)
- Sorting order (amplitude, frequency, time)
- Optional in some measurements: Display line use (all, > display line, < display line)

Remote Command	<p>For Swept SA measurement:</p> <pre>:CALCulate:DATA[1] 2 ... 6:PEAKs? <threshold>,<excursion>[,AMPLitude FREQuency TIME[,ALL GTDLline LTDLine]]</pre> <p>For most other measurements:</p> <pre>:CALCulate:DATA[1] 2 ... 6:PEAKs? <threshold>,<excursion>[,AMPLitude FREQuency TIME]</pre>
-----------------------	---

Example	<p>Example for Swept SA measurement in Spectrum Analyzer Mode:</p> <p>CALC:DATA4:PEAK? -40, 10, FREQ, GTDL This will identify the peaks of trace 4 that are above -40 dBm, with excursions of at least 10 dB. The peaks are returned in order of increasing frequency, starting with the lowest frequency. Only the peaks that are above the display line are returned.</p> <p>Query Results 1:</p> <p>With FORMat:DATA REAL, 32 selected, it returns a list of floating-point numbers. The first value in the list is the number of peak points that are in the following list. A peak point consists of two values: a peak amplitude followed by its corresponding frequency (or time).</p> <p>If no peaks are found the peak list will consist of only the number of peaks, (0).</p>
----------------	---

Notes	<p><n> - is the trace that will be used</p> <p><threshold> - is the level below which trace data peaks are ignored. Note that the threshold value is required and is always used as a peak criterion. To effectively disable the threshold criterion for this command, provide a substantially low threshold value such as -200 dBm. Also note that the threshold value used in this command is independent of and has no effect on the threshold value stored under the Peak Criteria menu.</p> <p><excursion> - is the minimum amplitude variation (rise and fall) required for a signal to be identified as peak. Note that the excursion value is required and is always used as a peak criterion. To effectively disable the excursion criterion for this command, provide the minimum value of 0.0 dB. Also note that the excursion value used in this command is independent of and has no effect on the</p>
--------------	---

excursion value stored under the Peak Criteria menu.

Values must be provided for threshold and excursion. The sorting and display line parameters are optional (defaults are AMPLitude and ALL).

Note that there is always a Y-axis value for the display line, regardless of whether the display line state is on or off. It is the current Y-axis value of the display line which is used by this command to determine whether a peak should be reported

Sorting order:

AMPLitude - lists the peaks in order of descending amplitude, with the highest peak first (default if optional parameter not sent)

FREQuency - lists the peaks in order of occurrence, left to right across the x-axis.

TIME - lists the peaks in order of occurrence, left to right across the x-axis.

Peaks vs. Display Line:

ALL - lists all of the peaks found (default if optional parameter not sent).

GTDLine (greater than display line) - lists all of the peaks found above the display line.

LTDLine (less than display line) - lists all of the peaks found below the display line.

Initial S/W Revision Prior to A.02.00

Format Data: Numeric Data (Remote Command Only)

This command specifies the format of the trace data input and output. It specifies the formats used for trace data during data transfer across any remote port. It affects only the data format for setting and querying trace data for the :TRACe[:DATA], TRACe[:DATA]?, :CALCulate:DATA[n]? and FETCh:SANalyzer [n]? commands and queries.

Remote Command :FORMat [:TRACe] [:DATA] ASCii|INTeger, 32|REAL, 32 |REAL, 64
:FORMat [:TRACe] [:DATA] ?

Notes The query response is:
ASCii: ASC,8
REAL,32: REAL,32
REAL,64: REAL,64
INTeger,32: INT,32

When the numeric data format is REAL or ASCii, data is output in the current Y Axis unit. When the data format is INTeger, data is output in units of m dBm (.001 dBm).

The INT,32 format returns binary 32-bit integer values in internal units (m dBm), in a definite length block.

Dependencies Sending a data format spec with an invalid number (for example, INT,48) generates no error. The analyzer simply uses the default (8 for ASCii, 32 for INTeger, 32 for REAL).

Sending data to the analyzer which does not conform to the current FORMat specified, results in an error. Sending ASCII data when a definite block is expected generates message -161 "Invalid Block Data" and sending a definite block when ASCII data is expected generates message -121 "Invalid Character in Number".

Preset ASCii

Backwards Compatibility Notes Note that the INT,32 format is only applicable to the command, TRACe:DATA. This preserves backwards compatibility for the Swept SA measurement. For all other commands/queries which honor FORMat:DATA, if INT,32 is sent the analyzer will behave as though it were set to REAL,32.

Initial S/W Revision Prior to A.02.00

The specs for each output type follow:

ASCIi - Amplitude values are in ASCII, in the current Y Axis Unit, one ASCII character per digit, values separated by commas, each value in the form:

SX.YYYYYEsZZ

Where:

S = sign (+ or -)

X = one digit to left of decimal point

Y = 5 digits to right of decimal point

E = E, exponent header

s = sign of exponent (+ or -)

ZZ = two digit exponent

REAL,32 - Binary 32-bit real values in the current Y Axis Unit, in a definite length block.

REAL,64 - Binary 64-bit real values in the current Y Axis Unit, in a definite length block.

Format Data: Byte Order (Remote Command Only)

This command selects the binary data byte order for data transfer and other queries. It controls whether binary data is transferred in normal or swapped mode. This command affects only the byte order for setting and querying trace data for the :TRACe[:DATA], TRACe[:DATA]? , :CALCulate:DATA[n]? and FETCh:SANalyzer[n]? commands and queries.

By definition any command that says it uses FORMat:DATA uses any format supported by FORMat:DATA.

The NORMal order is a byte sequence that begins with the most significant byte (MSB) first, and ends with the least significant byte (LSB) last in the sequence: 1|2|3|4. SWAPPed order is when the byte sequence begins with the LSB first, and ends with the MSB last in the sequence: 4|3|2|1.

Remote Command	:FORMat:BORDER NORMal SWAPPed :FORMat:BORDER?
Preset	NORMal
Initial S/W Revision	Prior to A.02.00

Meas Setup

Displays the setup menu for the currently selected measurement. The functions included in the measurement setup menu include setting the parameters for the carriers, offsets, bandwidths, measurement methods and types. This menu also allows you to turn noise correction on and off.

Key Path	Front-panel key
Initial S/W Revision	Prior to A.02.00

Average/Hold Number

Specifies the number of measurement averages used to calculate the measurement result. The average will be displayed at the end of each sweep. After the specified number of average counts, the average mode (termination control) setting determines the average action.

Key Path	Meas Setup
Mode	SA, WCDMA, C2K, WIMAX OFDMA, TD-SCDMA, 1xEVDO, DVB-T/H, DTMB (CTTB), ISDB-T, CMMB, LTE, LTETDD, Digital Cable TV, MSR, LTEAFDD, LTEATDD
Remote Command	[:SENSe]:ACPower:AVERage:COUNT <integer> [:SENSe]:ACPower:AVERage:COUNT? [:SENSe]:ACPower:AVERage[:STATe] OFF ON 0 1 [:SENSe]:ACPower:AVERage[:STATe]?
Example	ACP:AVER:COUN 250 ACP:AVER:COUN? ACP:AVER OFF ACP:AVER?
Notes	You must be in the mode that includes ACP measurements to use this command. Use :INSTrument:SElect to set the mode.
Preset	10 ON
State Saved	Saved in instrument state.
Min	1
Max	1000
Backwards Compatibility SCPI	[:SENSe]:ACPR:AVERage:COUNT [:SENSe]:MCPower:AVERage:COUNT (PSA Power Suite, PSA W-CDMA, PSA cdma2000)
Initial S/W Revision	Prior to A.02.00
Modified at S/W Revision	A.02.00, A.03.00

Avg Mode

Enables you to set the averaging mode. This determines the averaging action after the specified number of data acquisitions (average count) is reached.

When set to Exponential (Exp) the measurement averaging continues using the specified number of averages to compute each averaged value. The average will be displayed at the end of each sweep.

When set to Repeat, the measurement resets the average counter each time the specified number of averages is reached.

Key Path	Meas Setup
Mode	SA, WCDMA, C2K, WIMAX OFDMA, TD-SCDMA, 1xEVDO, DVB-T/H, DTMB (CTTB), ISDB-T, CMMB, LTE, LTETDD, Digital Cable TV, MSR, LTEAFDD, LTEATDD
Remote Command	[:SENSe] :ACPower:AVERage:TCONtrol EXPonential REPeat [:SENSe] :ACPower:AVERage:TCONtrol?
Example	ACP:AVER:TCON EXP ACP:AVER:TCON?
Notes	You must be in the mode that includes ACP measurements to use this command. Use :INSTrument:SElect to set the mode.
Preset	EXponential
State Saved	Saved in instrument state.
Range	Exp Repeat
Backwards Compatibility SCPI	[:SENSe] :ACPR:AVERage:TCONtrol
Initial S/W Revision	Prior to A.02.00
Modified at S/W Revision	A.02.00, A.03.00

Carrier Setup (This menu is unavailable in MSR and LTE-Advanced FDD/TDD)

Accesses a menu that contains Carriers, Ref Carrier, Ref Car Freq, Ref Car Pwr and Configure Carriers.

Key Path	Meas Setup
Initial S/W Revision	Prior to A.02.00

Carriers

Specifies the number of carriers to be measured.

Key Path	Meas Setup, Carrier Setup, Configure Carriers
Mode	SA, WCDMA, C2K, WIMAX OFDMA, 1xEVDO, TD-SCDMA, DVB-T/H, DTMB (CTTB), ISDB-T, CMMB, LTE, LTETDD, Digital Cable TV

Remote Command	<code>[:SENSe] :ACPower :CARRier [1] 2 :COUNT <integer></code> <code>[:SENSe] :ACPower :CARRier [1] 2 :COUNT?</code>
Example	ACP:CARR:COUN 1 ACP:CARR:COUN?
Notes	Carrier sub op code. 1 for BTS, 2 for MS. Default is BTS. Note that Carrier sub op code 2 is supported only in Non-SA modes. In the SA mode, Carrier sub op code 1 is used for both BTS and MS. You must be in the mode that includes ACP measurements to use this command. Use :INSTrument:SElect to set the mode.
Dependencies	When Number of Carriers is 1, Ref Carrier is grayed out. If N9060A-5FP license is enabled, Max of Carrier is 18, otherwise, Max of Carrier is 12.
Couplings	Changing this parameter might affect the Span.
Preset	1
State Saved	Saved in instrument state.
Min	1
Max	Refer to Dependencies item.
Initial S/W Revision	Prior to A.02.00
Modified at S/W Revision	A.02.00, A.03.00

Ref Carrier

Sets the reference carrier. Relative power measurements are made from the reference carrier.

If set to Auto, the measurement selects the carrier with the highest power as the reference carrier and the Ref Carrier parameter is updated. If a value is entered when Ref Carrier Mode is set to Auto, the mode changes to Man.

If set to Man, the value that you enter for the Ref Carrier is used as the reference carrier.

Key Path	Meas Setup, Carrier Setup
Mode	SA, WCDMA, C2K, WIMAX OFDMA, 1xEVDO, TD-SCDMA, DVB-T/H, DTMB (CTTB), ISDB-T, CMMB, LTE, LTE-TDD, Digital Cable TV
Remote Command	<code>[:SENSe] :ACPower :CARRier [1] 2 :RCARrier <integer></code> <code>[:SENSe] :ACPower :CARRier [1] 2 :RCARrier?</code> <code>[:SENSe] :ACPower :CARRier [1] 2 :RCARrier :AUTO OFF ON 0 1</code> <code>[:SENSe] :ACPower :CARRier [1] 2 :RCARrier :AUTO?</code>
Example	ACP:CARR:RCAR 1 ACP:CARR:RCAR? ACP:CARR:RCAR:AUTO OFF ACP:CARR:RCAR:AUTO?

Notes	Carrier sub op code. 1 for BTS, 2 for MS. Default is BTS. Note that Carrier sub op code 2 is supported only in Non-SA modes. In the SA mode, Carrier sub op code 1 is used for both BTS and MS. You must be in the mode that includes ACP measurements to use this command. Use :INSTrument:SElect to set the mode.
Dependencies	If there is only one carrier, this key will be grayed out.
Couplings	If you enter a carrier value that is currently configured as having no power present, that carrier will be changed to having power present. If you enter a ref carrier this parameter will be set to manual.
Preset	Auto determined
State Saved	Saved in instrument state.
Min	1
Max	Number of available carriers
Backwards Compatibility SCPI	[:SENSe] :MCPower:RCARrier [1] 2 (PSA Power Suite)
Initial S/W Revision	Prior to A.02.00
Modified at S/W Revision	A.02.00, A.03.00

Ref Car Freq

Sets the reference carrier frequency.

Key Path	Meas Setup, Carrier Setup
Mode	SA, WCDMA, C2K, WIMAX OFDMA, 1xEVDO, TD-SCDMA, DVB-T/H, DTMB (CTTB), ISDB-T, CMMB, LTE, LTE-TDD, Digital Cable TV
Remote Command	[:SENSe] :ACPpower:CARRier [1] 2 :RCFRrequency <freq> [:SENSe] :ACPpower:CARRier [1] 2 :RCFRrequency? [:SENSe] :ACPpower:CARRier [1] 2 :RCFRrequency:AUTO OFF ON 0 1 [:SENSe] :ACPpower:CARRier [1] 2 :RCFRrequency:AUTO?
Example	ACP:CARR:RCFR 250 MHz ACP:CARR:RCFR? ACP:CARR:RCFR:AUTO OFF ACP:CARR:RCFR:AUTO?
Notes	Carrier sub op code. 1 for BTS, 2 for MS. Default is BTS. Note that Carrier sub op code 2 is supported only in Non-SA modes. In the SA mode, Carrier sub op code 1 is used for both BTS and MS. You must be in the mode that includes ACP measurements to use this command. Use :INSTrument:SElect to set the mode.

Couplings	<p>Coupled to the Center Frequency.</p> <p>If the center frequency changes, the Ref Carrier Frequency is calculated using the following three steps;</p> $\text{Ref Freq1} = \text{Ctr Freq} - (\text{Total of all Carrier Widths} / 2)$ $\text{Ref Freq2} = \text{Ref Freq1} + (\text{Total of all Carrier Widths up to Ref Carrier})$ $\text{Ref Freq} = \text{Ref Freq2} + (0.5 * \text{Carrier Width of Ref Carrier})$ <p>If reference carrier frequency changes the Center Frequency is calculated using the following three steps;</p> $\text{Ctr Freq1} = \text{Ref Freq} - (0.5 * \text{Carrier Width of Ref Carrier})$ $\text{Ctr Freq2} = \text{Ctr Freq1} - (\text{Total of all Carrier Widths up to Ref Carrier})$ $\text{Ctr Freq} = \text{Ctr Freq2} + (\text{Total of all Carrier Widths} / 2)$ <p>This ensures that the carriers are always centered on the screen.</p> <p>If there is only one carrier present the Reference Carrier Frequency will be the same as the Center Frequency.</p>
Preset	Calculated based on the current Center Frequency
State Saved	Saved in instrument state.
Min	-79.999995 MHz
Max	<p>Hardware Dependent:</p> <p>Option 503 = 3.699999995 GHz</p> <p>Option 508 = 8.499999995 GHz</p> <p>Option 513 = 13.799999995 GHz</p> <p>Option 526 = 26.999999995 GHz</p>
Initial S/W Revision	Prior to A.02.00
Modified at S/W Revision	A.02.00, A.03.00

Power Ref

Sets the power reference in the carrier that will be used to compute the relative values for the offsets.

Key Path	Meas Setup, Carrier Setup
Initial S/W Revision	Prior to A.02.00
Modified at S/W Revision	A.03.00, A.04.00

Total Power

Sets the multi-carrier power reference.

When set to Auto, the carrier power result reflects the measured power value in the selected reference carrier.

When set to Man, the result is referenced to the last measured value, or you may specify the reference for the multi-carrier power measurement. Relative values are displayed, referenced to the “Power Reference” value.

Key Path	Meas Setup, Carrier Setup, Power Ref
Mode	SA, WCDMA, C2K, WIMAX OFDMA, TD-SCDMA, DVB-T/H, DTMB (CTTB), ISDB-T, CMMB, LTE, LTETDD, Digital Cable TV, MSR
Remote Command	[:SENSe]:ACPower:CARRier[1] 2[:POWer] <real> [:SENSe]:ACPower:CARRier[1] 2[:POWer]? [:SENSe]:ACPower:CARRier[1] 2:AUTO[:STATe] OFF ON 0 1 [:SENSe]:ACPower:CARRier[1] 2:AUTO[:STATe]?
Example	ACP:CARR 10 ACP:CARR? ACP:CARR:AUTO OFF ACP:CARR:AUTO?
Notes	Although the default value is defined, the value is recalculated by the measurement result just after measurement. Carrier sub op code: 1 for BTS, 2 for MS. Default is BTS. Carrier sub op code 2 is supported only in Non-SA modes. MS is not supported in MSR. In the SA mode, Carrier sub op code 1 is used for both BTS and MS. The Unit Terminator keys differ depending on whether or not the mode supports Y Axis Unit and also which Y Axis Unit is selected. You must be in the mode that includes ACP measurements to use this command. Use :INSTrument:SElect to set the mode. Power Ref State ([:SENSe]:ACPower:CARRier[1] 2:AUTO[:STATe]) is not available in MSR mode.
Dependencies	This key is available only when the Meas Type is TPref. If the Meas Type is not TPref, this key is grayed out.
Preset	0.0 ON
State Saved	Saved in instrument state.
Min	-200 dBm
Max	200 dBm
Backwards Compatibility SCPI	[:SENSe]:MCPower:CARRier[1] 2[:POWer]
Initial S/W Revision	Prior to A.02.00
Modified at S/W Revision	A.02.00, A.03.00, A.04.00, A.10.00

PSD

Sets the power spectral density in the carrier (main channel) that is used to compute the relative power spectral density values for the offsets when Meas Type is set to PSD Ref. When the PSD Ref state is set to Auto, this will be set to the measured carrier power spectral density.

Key Path	Meas Setup, Carrier Setup, Power Ref
Mode	SA, WCDMA, C2K, WIMAX OFDMA, TD-SCDMA, DVB-T/H, DTMB (CTTB), ISDB-T, CMMB, LTE, LTETDD, Digital Cable TV, MSR
Remote Command	<code>[:SENSe] :ACPower :CARRier [1] 2 :CPSD <real></code> <code>[:SENSe] :ACPower :CARRier [1] 2 :CPSD?</code>
Example	ACP:CARR:CPSD 25 ACP:CARR:CPSD?
Notes	Although the default value is defined, the value is recalculated by the measurement result just after measurement. Carrier sub op code. 1 for BTS, 2 for MS. Default is BTS. MS is not supported in MSR. Note that Carrier sub op code 2 is supported only in Non-SA modes. In the SA mode, Carrier sub op code 1 is used for both BTS and MS. You must be in the mode that includes ACP measurements to use this command. Use <code>:INSTrument:SElect</code> to set the mode.
Dependencies	This key is available only when the Meas Type is PSDRef. If the Meas Type is not PSDRef, this key is grayed out.
Couplings	The value of PSD is automatically converted when PSD Unit is changed.
Preset	0.0
State Saved	Saved in instrument state.
Min	-999
Max	999
Initial S/W Revision	Prior to A.02.00
Modified at S/W Revision	A.02.00, A.03.00, A.04.00, A.10.00

Configure Carriers

Accesses a menu that contains Carrier, Carrier Pwr Present, Carrier Width and Carrier Integ BW parameters.

Key Path	Meas Setup, Carrier Setup
Initial S/W Revision	Prior to A.02.00

Carrier

Selects the carrier to configure for the current measurement.

Key Path	Meas Setup, Carrier Setup, Configure Carriers
Mode	SA, WCDMA, C2K, WIMAX OFDMA, 1xEVDO, TD-SCDMA, DVB-T/H, DTMB (CTTB), ISDB-T, CMMB, LTE, LTETDD, Digital Cable TV

Couplings	Max value is the number of available carriers, so this value might change when the number of carriers is changed.
Preset	1
State Saved	No
Min	1
Max	Number of available carriers
Initial S/W Revision	Prior to A.02.00
Modified at S/W Revision	A.02.00, A.03.00

Carrier Pwr Present

Configures the carriers for this measurement. It allows spaces to be inserted between carriers. Carriers with the power present parameter set to Yes are carriers, and those with the power present parameter set to No are spaces. Each carrier power present is set to Yes or No. The individual carriers can be set by selecting the desired carrier on the carrier menu key using the up down arrows, the knob, or numeric keypad, then toggling the carrier power present using the carrier power present menu key.

The query for this parameter returns the current values for all of the carriers. If a carrier is defined as having no power present, the power displayed will be relative to the reference carrier, otherwise the absolute power will be displayed.

If you change the carrier power present to no and that carrier is currently configured as the reference carrier, the next carrier to the left (or the right if there are no carriers to the left) will be assigned as the reference carrier. This also applies to the scenario where there are only two carriers configured as having power present and you configure only one carrier to have no power present.

Key Path	Meas Setup, Carrier Setup, Configure Carriers
Mode	SA, WCDMA, C2K, WIMAX OFDMA, 1xEVDO, TD-SCDMA, DVB-T/H, DTMB (CTTB), ISDB-T, CMMB, LTE, LTE-TDD, Digital Cable TV
Remote Command	[:SENSe]:ACPower:CARRier[1] 2:LIST:PPresent YES NO, YES NO, YES NO, YES NO [:SENSe]:ACPower:CARRier[1] 2:LIST:PPresent?
Example	ACP:CARR2:LIST:PPR YES ACP:CARR2:LIST:PPR?
Notes	Carrier sub op code. 1 for BTS, 2 for MS. Default is BTS. Note that Carrier sub op code 2 is supported only in Non-SA modes. In the SA mode, Carrier sub op code 1 is used for both BTS and MS. When setting these values remotely, the position in the list sent corresponds to the carrier. Missing values are not permitted, therefore if you want to change values 2 and 6 you must send all values up to 6. Subsequent values will remain unchanged, unless the number of values sent is greater than the number of carriers, then subsequent values will be ignored.
Dependencies	If there is only one carrier, this key will be grayed out.
Couplings	Coupled to the number of carriers. When the SCPI command is sent, the number of carriers will be set to the number of entries in the parameter list.

Preset	YES
State Saved	Saved in instrument state.
Range	Yes No
Backwards Compatibility SCPI	[:SENSe] :MCPower :CARRier [1] 2 :LIST :PPResent (PSA Power Suite)
Initial S/W Revision	Prior to A.02.00
Modified at S/W Revision	A.02.00, A.03.00

Carrier Spacing

Sets the width of the carrier spacing. This will be the value applied to all the current slots, whether they are carriers or spaces.

Enter each carrier spacing value individually by selecting the desired carrier on the carrier menu key using the up down arrows, the knob, or the numeric keypad, then enter the carrier width using the carrier spacing menu key.

Key Path	Meas Setup, Carrier Setup, Configure Carriers
Mode	SA, WCDMA, C2K, WIMAX OFDMA, 1xEVDO, TD-SCDMA, DVB-T/H, DTMB (CTTB), ISDB-T, CMMB, LTE, LTETDD, Digital Cable TV
Remote Command	[:SENSe] :ACPpower :CARRier [1] 2 :LIST :WIDTh <freq>, <freq>, <freq>, <freq>, <freq>, <freq> [:SENSe] :ACPpower :CARRier [1] 2 :LIST :WIDTh?
Example	ACP:CARR2:LIST:WIDT 25kHz ACP:CARR2:LIST:WIDT?

Notes

Carrier sub op code. 1 for BTS, 2 for MS. Default is BTS.
 Note that Carrier sub op code 2 is supported only in Non-SA modes.
 In the SA mode, Carrier sub op code 1 is used for both BTS and MS.
 When setting these values remotely, the position in the list sent corresponds to the carrier. Missing values are not permitted, therefore if you want to change values 2 and 6 you must send all values up to 6. Subsequent values will remain unchanged, unless the number of values sent is greater than the number of carriers, then subsequent values will be ignored.
 You must be in the mode that includes ACP measurements to use this command. Use :INSTrument:SElect to set the mode.

Couplings	Coupled to the number of carriers. When the SCPI command is sent, the number of carriers will be set to the number of entries in the parameter list. Changing Carrier Spacing might affect the Span.
Preset	SA, WCDMA: 5 MHz WIMAX OFDMA: 10 MHz C2K: 1.25 MHz 1xEVDO: 1.25 MHz

	TD-SCDMA: 1.6 MHz DVB-T/H: 8 MHz DTMB (CTTB): 8 MHz ISDB-T: 6 MHz CMMB: 8 MHz LTE: 5 MHz LTE-TDD: 5 MHz Digital Cable TV: 8 MHz
State Saved	Saved in instrument state.
Min	0 Hz
Max	1 GHz
Backwards Compatibility SCPI	<code>[:SENSe] :MCPower :CARRier [1] 2 :LIST :WIDTh (PSA Power Suite)</code>
Initial S/W Revision	Prior to A.02.00
Modified at S/W Revision	A.02.00, A.03.00

Measurement Noise Bandwidth

Specifies the Measurement Noise Bandwidth used to calculate the power in the carriers.

Each Measurement Noise Bandwidth value is entered individually by selecting the desired carrier on the carrier menu key using the up down arrows, the knob, or the numeric keypad. Then enter the measurement noise bandwidth using the measurement noise bandwidth key.

Key Path	Meas Setup, Carrier Setup, Configure Carriers
Mode	SA, WCDMA, C2K, WIMAX OFDMA, TD-SCDMA, 1xEVDO, DVB-T/H, DTMB (CTTB), ISDB-T, CMMB, LTE, LTE-TDD, Digital Cable TV
Remote Command	<code>[:SENSe] :ACPpower :CARRier [1] 2 :LIST :BANDwidth [:INTEgration] <freq>, <freq>, <freq>, <freq>, <freq></code> <code>[:SENSe] :ACPpower :CARRier [1] 2 :LIST :BANDwidth [:INTEgration] ?</code>
Example	ACP:CARR2:LIST:BAND 25kHz ACP:CARR2:LIST:BAND?
Notes	In the WCDMA mode, the preset/default value is defined as 3.84 MHz. But internally, 4.6848 MHz is used as the default value. Carrier sub op code. 1 for BTS, 2 for MS. Default is BTS. Note that Carrier sub op code 2 is supported only in Non-SA modes. In the SA mode, Carrier sub op code 1 is used for both BTS and MS. When setting these values remotely, the position in the list sent corresponds to the carrier. Missing values are not permitted, therefore if you want to change values 2 and 6 you must send all values up to 6. Subsequent values will remain unchanged, unless the number of values sent is greater than the number of carriers, then subsequent values will be ignored. You must be in the mode that includes ACP measurements to use this command. Use

	:INSTRument:SElect to set the mode.
Couplings	Coupled to the number of carriers. When the SCPI command is sent, the number of carriers is set to the number of entries in the parameter list.
Preset	SA: 2 MHz WCDMA: 3.84 MHz WIMAX OFDMA: 10 MHz C2K: 1.23MHz TD-SCDMA: 1.28 MHz 1xEVDO: 1.23 MHz DVB-T/H: 7.61 MHz DTMB (CTTB): 7.56 MHz ISDB-T: 5.6 MHz CMMB: 7.512 MHz LTE, LTETDD: 4.515 MHz 4.5 MHz Digital Cable TV: 8.0 MHz
State Saved	Saved in instrument state.
Min	10 Hz
Max	1 GHz
Backwards Compatibility SCPI	[:SENSe] :ACPower :BANDwidth :INTEgration [:SENSe] :ACPower :BWIDth :INTEgration [:SENSe] :ACPower :CARRier [1] 2 :LIST :BWIDth [:INTEgration] [:SENSe] :MCPower :CARRier [1] 2 :LIST :BANDwidth [:INTEgration] (PSA Power Suite) [:SENSe] :MCPower :CARRier [1] 2 :LIST :BWIDth [:INTEgration] (PSA Power Suite)
Initial S/W Revision	Prior to A.02.00
Modified at S/W Revision	A.02.00, A.03.00

Method for Carrier

Accesses the carrier configuration method settings.

Key Path	Meas Setup, Carrier Setup, Configure Carriers
Mode	SA, WCDMA, WIMAX OFDMA, TD-SCDMA, DVB-T/H, DTMB (CTTB), ISDB-T, CMMB, LTE, LTETDD, Digital Cable TV
Remote Command	[:SENSe] :ACPower :CARRier [1] 2 :LIST :FILTer [:RRC] [:STATE] ON OFF 1 0, ON OFF 1 0, ON OFF 1 0, ON OFF 1 0, ON OFF 1 0, ON OFF 1 0 [:SENSe] :ACPower :CARRier [1] 2 :LIST :FILTer [:RRC] [:STATE] ?
Example	ACP:CARR:LIST:FILT 0,0,0,0 ACP:CARR:LIST:FILT?

Notes	The binary values translate as follows: 1 ON = RRC Weighted 0 OFF = Integ BW Maximum of Array length depends on the number of carriers. You must be in the mode that includes ACP measurements to use this command. Use :INSTrument:SElect to set the mode.
Preset	SA, LTE, LTETDD: OFF WCDMA: ON WIMAX OFDMA: OFF TD-SCDMA: ON DVB-T/H: OFF DTMB (CTTB): ON ISDB-T, CMMB: OFF Digital Cable TV: OFF
State Saved	Saved in instrument state.
Range	IntegBW RRC Weight
Initial S/W Revision	Prior to A.02.00
Modified at S/W Revision	A.02.00, A.03.00

Filter Alpha for Carrier

Inputs the alpha value for the filter used in the current carrier configuration.

Key Path	Meas Setup, Carrier Setup, Configure Carriers, Method, RRC Weighted
Mode	SA, WCDMA, WIMAX OFDMA, TD-SCDMA, DVB-T/H, DTMB (CTTB), ISDB-T, CMMB, LTE, LTETDD, Digital Cable TV
Remote Command	<code>[:SENSe] :ACPoweR:CARRier [1] 2 :LIST:FILTer:ALPHa <real>, <real>, <real>, <real>, <real>, <real></code> <code>[:SENSe] :ACPoweR:CARRier [1] 2 :LIST:FILTer:ALPHa?</code>
Example	ACP:CARR2:LIST:FILT:ALPH 0.5 ACP:CARR2:LIST:FILT:ALPH?
Notes	You must be in the mode that includes ACP measurements to use this command. Use :INSTrument:SElect to set the mode.
Preset	0.22 C2K: No DTMB (CTTB): 0.05 Digital Cable TV: 0.15
State Saved	Saved in instrument state.
Min	0.01
Max	1.0

Initial S/W Revision	Prior to A.02.00
Modified at S/W Revision	A.02.00, A.03.00

Carrier Coupling

Couples carrier settings to carrier #1. The coupled parameters are Carrier Power Present, Carrier Spacing, Measurement Noise Bandwidth, Method, and Filter Alpha.

Parameter Name	Carrier Coupling
Key Path	Meas Setup, Carrier Setup, Configure Carriers
Key Type	Binary
Mode	SA, WCDMA, C2K, WIMAX OFDMA, 1xEVDO, TD-SCDMA, DVB-T/H, DTMB (CTTB), ISDB-T, CMMB, LTE, LTETDD, Digital Cable TV
Remote Command	[:SENSe]:ACPoweR:CARRier[1] 2:LIST:COUPle OFF ON 0 1, OFF ON 0 1, OFF ON 0 1, OFF ON 0 1, OFF ON 0 1, OFF ON 0 1 [:SENSe]:ACPoweR:CARRier[1] 2:LIST:COUPle?
Example	ACP:CARR:LIST:COUP OFF ACP:CARR:LIST:COUP?
Notes	Carrier sub op code. 1 for BTS, 2 for MS. Default is BTS. Note that Carrier sub op code 2 is supported only in Non-SA modes. In the SA mode, Carrier sub op code 1 is used for both BTS and MS. You must be in the mode that includes ACP measurements to use this command. Use :INSTRument:SElect to set the mode.
Couplings	When Couple is selected, the carrier settings are coupled to carrier #1. Coupled parameters are Carrier Power Present, Carrier Spacing, Measurement Noise Bandwidth, Method and Filter Alpha. When a setting is changed, the couple is set to Man automatically. Carrier #1 is always set to couple and cannot be changed. Couple/Man selection on the Carrier key is not displayed when selected carrier number is #1.
Preset	ON
Force Restart	No
State Saved	Saved in instrument state.
Range	Couple Man
Initial S/W Revision	Prior to A.02.00
Modified at S/W Revision	A.02.00, A.03.00
Softkey Label	Carrier

Offset/Limits

Accesses a menu of functions that contains Offset, Offset Freq/Offset To Edge, Offset Integ BW, Upper Offset Limit and Lower Offset parameters. When in the MSR and LTE-Advanced FDD/TDD mode, the softkey label changes to Outer Offset/Limits.

Key Path	Meas Setup
Initial S/W Revision	Prior to A.02.00
Modified at S/W Revision	A.13.00

Select Offset

Selects the offset to configure.

Key Path	Meas Setup, Offset/Limits, Limits
Mode	SA, WCDMA, C2K, WIMAX OFDMA, TD-SCDMA, 1xEVDO, DVB-T/H, DTMB (CTTB), ISDB-T, CMMB, LTE, LTE-TDD, Digital Cable TV, MSR, LTEAFDD, LTEATDD
Preset	A
State Saved	Saved in instrument state.
Range	Offset A Offset B Offset C Offset D Offset E Offset F
Initial S/W Revision	Prior to A.02.00
Modified at S/W Revision	A.02.00, A.03.00, A.13.00

Offset Freq

This parameter determines the frequency difference between the center of the main channel and the center of the carrier.

Each Offset Freq state value is entered individually by selecting the desired carrier on the carrier menu key using the up down arrows, RPG or numeric keypad. Then enter the Offset Freq State using the Offset Frequency key.

The list contains up to six (6) entries, depending on the mode selected, for offset frequencies. Each offset frequency in the list corresponds to a reference bandwidth in the bandwidth list.

An offset frequency of zero turns the display of the measurement for that offset off, but the measurement is still made and reported. You can turn off (not use) specific offsets with the [:SENSe]:ACP:OFFSet:LIST:STATe command.

Turning the offset off has the same effect as setting the frequency of the offset to 0 Hz and will cause it to be removed from the results screen.

Key Path	Meas Setup, Offset/Limits
Mode	SA, WCDMA, C2K, WIMAX OFDMA, TD-SCDMA, 1xEVDO, DVB-T/H, DTMB (CTTB), ISDB-T, CMMB, LTE, LTE-TDD, Digital Cable TV, MSR, LTEAFDD, LTEATDD

Remote Command	<pre>[:SENSe]:ACPower:OFFSet [1] 2[:OUTer]:LIST[:FREQuency] <freq>, <freq>, <freq>, <freq>, <freq>, <freq> [:SENSe]:ACPower:OFFSet [1] 2[:OUTer]:LIST[:FREQuency]? [:SENSe]:ACPower:OFFSet [1] 2[:OUTer]:LIST:STATe OFF ON 0 1, OFF ON 0 1, OFF ON 0 1, OFF ON 0 1, OFF ON 0 1, OFF ON 0 1 [:SENSe]:ACPower:OFFSet [1] 2[:OUTer]:LIST:STATe?</pre>
Example	<pre>ACP:OFFS1:LIST 0,0,0,0,0,0 ACP:OFFS1:LIST? ACP:OFFS2:LIST:STAT 1,1,0,0,0,0 ACP:OFFS2:LIST:STAT?</pre>
Notes	<p>The label for this menu key will change depending on the currently selected radio standard or mode. For cdma2000 the label for the menu key will be Offset to Edge. For all other supported standards the label will be Offset Freq.</p> <p>When setting these values remotely, the position in the list sent corresponds to the offset. Missing values are not permitted, unless the number of values sent is greater than the number of carriers, then subsequent values will be ignored.</p> <p>Offset sub op code. 1 for BTS, 2 for MS. Default is BTS.</p> <p>Note that Offset sub op code 2 is supported only in Non-SA modes.</p> <p>In the SA mode, Offset sub op code 1 is used for both BTS and MS.</p> <p>You must be in the mode that includes ACP measurements to use this command. Use :INSTrument:SElect to set the mode.</p>
Couplings	<p>Changing Offset Frequency might affect the Span. See the Span key section for details.</p>
Preset	<pre>SA: 3 MHz, 0 Hz, 0 Hz, 0 Hz, 0 Hz, 0 Hz 3 MHz, 0 Hz, 0 Hz, 0 Hz, 0 Hz, 0 Hz WCDMA: 5.0 MHz, 10.0 MHz, 0 Hz, 0 Hz, 0 Hz, 0 Hz 5.0 MHz, 10.0 MHz, 0 Hz, 0 Hz, 0 Hz, 0 Hz WIMAX OFDMA: 10 MHz, 20 MHz, 0 Hz, 0 Hz, 0 Hz, 0 Hz 10 MHz, 20 MHz, 0 Hz, 0 Hz, 0 Hz, 0 Hz C2K:750KHz, 1.980 MHz, 0 Hz, 0 Hz, 0 Hz, 0 Hz 885 kHz, 1.980 MHz, 0 Hz, 0 Hz, 0 Hz, 0 Hz TD-SCDMA: 1.6 MHz, 3.2 MHz, 0 Hz, 0 Hz, 0 Hz, 0 Hz 1.6 MHz, 3.2 MHz, 0 Hz, 0 Hz, 0 Hz, 0 Hz 1xEVDO: 750KHz, 1.98MHz, 3.125MHz, 4.000MHz, 7.500MHz, 7.500MHz 885KHz, 1.98MHz, 3.125MHz, 4.000MHz, 7.500MHz, 7.500MHz DVB-T/H: 8 MHz, 16 MHz, 0 Hz, 0 Hz, 0 Hz, 0 Hz 8 MHz, 16 MHz, 0 Hz, 0 Hz, 0 Hz, 0 Hz DTMB (CTTB): 8 MHz, 16 MHz, 24 MHz, 32 MHz, 0 Hz, 0 Hz 8 MHz, 16 MHz, 24 MHz, 32 MHz, 0 Hz, 0 Hz ISDB-T: 6 MHz, 12 MHz, 0 Hz, 0 Hz, 0 Hz, 0 Hz 6 MHz, 12 MHz, 0 Hz, 0 Hz, 0 Hz, 0 Hz CMMB: 8 MHz, 16 MHz, 24 MHz, 32 MHz, 0 Hz, 0 Hz 8 MHz, 16 MHz, 24 MHz, 32 MHz, 0 Hz, 0 Hz LTE, LTETDD, MSR, LTEAFDD, LTEATDD: 5 MHz, 10 MHz, 0, 0, 0, 0 5 MHz, 10 MHz, 0, 0, 0, 0 Digital Cable TV: 8 MHz, 16 MHz, 0 Hz, 0 Hz, 0 Hz, 0 Hz 8 MHz, 16 MHz, 0 Hz, 0 Hz, 0 Hz, 0 Hz SA: ON, OFF, OFF, OFF, OFF, OFF ON, OFF, OFF, OFF, OFF, OFF WCDMA: ON, ON, OFF, OFF, OFF, OFF ON, ON, OFF, OFF, OFF, OFF WIMAX OFDMA: ON, ON, OFF, OFF, OFF, OFF ON, ON, OFF, OFF, OFF, OFF TD-SCDMA: ON, ON, OFF, OFF, OFF, OFF ON, ON, OFF, OFF, OFF, OFF DVB-T/H: ON, ON, OFF, OFF, OFF, OFF ON, ON, OFF, OFF, OFF, OFF</pre>

	DTMB (CTTB): ON, ON, OFF, OFF, OFF, OFF ON, ON, OFF, OFF, OFF, OFF CDMA1xEVDO: ON, ON, OFF, OFF, OFF, OFF ON, ON, OFF, OFF, OFF, OFF ISDB-T: ON, ON, OFF, OFF, OFF, OFF ON, ON, OFF, OFF, OFF, OFF CMMB: ON, ON, ON, ON, OFF, OFF ON, ON, ON, ON, OFF, OFF LTE, LTE-TDD, MSR, LTEAFDD, LTEATDD: ON, ON, OFF, OFF, OFF, OFF ON, OFF, OFF, OFF, OFF, OFF Digital Cable TV: ON, ON, OFF, OFF, OFF, OFF ON, ON, OFF, OFF, OFF, OFF
State Saved	Saved in instrument state.
Min	0 Hz
Max	500 MHz
Backwards Compatibility SCPI	<code>[[:SENSe]:MCPower:OFFSet[1] 2:LIST[:FREQuency]</code> (PSA Power Suite)
Initial S/W Revision	Prior to A.02.00
Modified at S/W Revision	A.02.00, A.03.00, A.13.00

Integ BW

Sets the Integration Bandwidth for the offsets. Each resolution bandwidth in the list corresponds to an offset frequency in the list defined by `[[:SENSe]:ACP:OFFSet[n]:OUTer]:LIST[:FREQuency]`.

Enter each value individually by selecting the desired offset on the offset menu key using the up down arrows, the knob, or the numeric keypad, then enter the Offset Integration Bandwidth using the Offset Integration Bandwidth menu key.

You can turn off (not use) specific offsets with the `[[:SENSe]:ACP:OFFSet[n]:OUTer]:LIST:STATe` command.

Key Path	Meas Setup, Offset/Limits
Mode	SA, WCDMA, C2K, WIMAX OFDMA, TD-SCDMA, 1xEVDO, DVB-T/H, DTMB (CTTB), ISDB-T, CMMB, LTE, LTE-TDD, Digital Cable TV, MSR, LTEAFDD, LTEATDD
Remote Command	<code>[[:SENSe]:ACP:OFFSet[1] 2[:OUTer]:LIST:BANDwidth[:INTEgration]</code> <code><freq>, <freq>, <freq>, <freq>, <freq>, <freq></code> <code>[[:SENSe]:ACP:OFFSet[1] 2[:OUTer]:LIST:BANDwidth[:INTEgration]?</code>
Example	ACP:OFFS2:LIST:BAND 2MHz, 2MHz, 2MHz, 2MHz, 2MHz, 2MHz ACP:OFFS2:LIST:BAND?
Notes	<p>When setting these values remotely, the position in the list sent corresponds to the offset. Missing values are not permitted i.e. if you want to change the second value, you must send all values up to it. Subsequent values will remain unchanged, unless the number of values sent is greater than the number of carriers, then subsequent values will be ignored.</p> <p>Offset sub op code. 1 for BTS, 2 for MS. Default is BTS.</p> <p>Note that Offset sub op code 2 is supported only in Non-SA modes.</p> <p>In the SA mode, Offset sub op code 1 is used for both BTS and MS.</p> <p>You must be in the mode that includes ACP measurements to use this command. Use <code>:INSTrument:SElect</code> to set the mode.</p>

Couplings	Changing Integ BW might affect the Span. See Span section for details.
Preset	SA: 2 MHz, 2 MHz, 2 MHz, 2 MHz, 2 MHz, 2 MHz 2 MHz, 2 MHz, 2 MHz, 2 MHz, 2 MHz, 2 MHz WCDMA: 3.84 MHz, 3.84 MHz, 3.84 MHz, 3.84 MHz, 3.84 MHz, 3.84 MHz 3.84 MHz, 3.84 MHz, 3.84 MHz, 3.84 MHz, 3.84 MHz WIMAX OFDMA: 10 MHz, 10 MHz, 10 MHz, 10 MHz, 10 MHz, 10 MHz 10 MHz, 10 MHz, 10 MHz, 10 MHz, 10 MHz, 10 MHz C2K: 30 kHz, 30 kHz, 30 kHz, 30 kHz, 30 kHz, 30 kHz 30 kHz, 30 kHz, 30 kHz, 30 kHz, 30 kHz, 30 kHz TD-SCDMA: 1.28 MHz, 1.28 MHz, 1.28 MHz, 1.28 MHz, 1.28 MHz, 1.28 MHz 1xEVDO: C2K: 30 kHz, 30 kHz, 30 kHz, 30 kHz, 30 kHz, 30 kHz 30 kHz, 30 kHz, 30 kHz, 30 kHz, 30 kHz, 30 kHz DVB-T/H: 7.61 MHz, 7.61 MHz, 7.61 MHz, 7.61 MHz, 7.61 MHz, 7.61 MHz 7.61 MHz, 7.61 MHz, 7.61 MHz, 7.61 MHz, 7.61 MHz, 7.61 MHz DTMB (CTTB): 7.56 MHz, 7.56 MHz, 7.56 MHz, 7.56 MHz, 7.56 MHz, 7.56 MHz 7.56 MHz, 7.56 MHz, 7.56 MHz, 7.56 MHz, 7.56 MHz, 7.56 MHz ISDB-T: 5.6 MHz, 5.6 MHz, 5.6 MHz, 5.6 MHz, 5.6 MHz, 5.6 MHz 5.6 MHz, 5.6 MHz, 5.6 MHz, 5.6 MHz, 5.6 MHz, 5.6 MHz CMMB: 7.512 MHz, 7.512 MHz, 7.512 MHz, 7.512 MHz, 7.512 MHz, 7.512 MHz 7.512 MHz, 7.512 MHz, 7.512 MHz, 7.512 MHz, 7.512 MHz, 7.512 MHz LTE, LTEFDD, MSR, LTEAFDD, LTEATDD: 4.515 MHz, 4.515 MHz, 4.515 MHz, 4.515 MHz, 4.515 MHz, 4.515 MHz 4.5 MHz, 4.5 MHz, 4.5 MHz, 4.5 MHz, 4.5 MHz, 4.5 MHz Digital Cable TV: 8.0 MHz, 8.0 MHz, 8.0 MHz, 8.0 MHz, 8.0 MHz, 8.0 MHz 8.0 MHz, 8.0 MHz, 8.0 MHz, 8.0 MHz, 8.0 MHz, 8.0 MHz
State Saved	Saved in instrument state.
Min	10 Hz
Max	1 GHz
Backwards Compatibility SCPI	[:SENSe] :ACPower:OFFSet [1] 2 :LIST:BWIDth [:INTegration] [:SENSe] :ACPR:OFFSet [1] 2 :LIST:BANDwidth [:SENSe] :ACPR:OFFSet [1] 2 :LIST:BWIDth [:SENSe] :MCPower:OFFSet [1] 2 :LIST:BANDwidth [:INTegration] (PSA Power Suite) [:SENSe] :MCPower:OFFSet [1] 2 :LIST:BWIDth [:INTegration] (PSA Power Suite)
Initial S/W Revision	Prior to A.02.00
Modified at S/W Revision	A.02.00, A.03.00, A.13.00

Offset BW

Accesses the offset bandwidth menu.

Key Path	Meas Setup, Offset/Limits
Initial S/W Revision	Prior to A.02.00

Res BW

Sets the resolution bandwidth. If an unavailable bandwidth is entered with the numeric keypad, the closest available bandwidth is selected.

Key Path	Meas Setup, Offset/Limits
Mode	SA, WCDMA, C2K, WIMAX OFDMA, TD-SCDMA, 1xEVDO, DVB-T/H, DTMB (CTTB), ISDB-T, CMMB, LTE, LTE-TDD, Digital Cable TV, MSR, LTEAFDD, LTEATDD
Remote Command	<pre>[:SENSe]:ACPower:OFFSet[1] 2[:OUTer]:LIST:BANDwidth:RESolution <freq>, <freq>, <freq>, <freq>, <freq> [:SENSe]:ACPower:OFFSet[1] 2[:OUTer]:LIST:BANDwidth:RESolution? [:SENSe]:ACPower:OFFSet[1] 2[:OUTer]:LIST:BANDwidth:RESolution:AUTO ON OFF 1 0, ON OFF 1 0, ON OFF 1 0, ON OFF 1 0, ON OFF 1 0, ON OFF 1 0 [:SENSe]:ACPower:OFFSet[1] 2[:OUTer]:LIST:BANDwidth:RESolution:AUTO?</pre>
Example	<pre>ACP:OFFS2:LIST:BAND:RES 220kHz, 220kHz, 220kHz, 220kHz, 220kHz, 220kHz ACP:OFFS2:LIST:BAND:RES? ACP:OFFS2:LIST:BAND:RES:AUTO 1,1,1,1,1,1 ACP:OFFS2:LIST:BAND:RES:AUTO?</pre>
Notes	<p>Offset sub op code. 1 for BTS, 2 for MS. Default is BTS.</p> <p>Note that Offset sub op code 2 is supported only in Non-SA modes.</p> <p>In the SA mode, Offset sub op code 1 is used for both BTS and MS.</p> <p>You must be in the mode that includes ACP measurements to use this command. Use :INSTrument:SElect to set the mode.</p>
Dependencies	When Meas Method is RBW or FAST, this key is grayed out and disabled. If the key is pressed, an advisory message is generated. If the equivalent remote command is sent, a "Setting conflict" warning is generated.
Couplings	When Res BW Mode is AUTO, this value is exactly same as Res BW under BW key. And when this value is changed by user, Res BW Mode is also changed to Man.
Preset	<pre>SA: 220 kHz, 220 kHz, 220 kHz, 220 kHz, 220 kHz, 220 kHz WCDMA: 100 kHz, 100 kHz, 100 kHz, 100 kHz, 100 kHz, 100 kHz WIMAX OFDMA: 100 kHz, 100 kHz, 100 kHz, 100 kHz, 100 kHz, 100 kHz C2K: Method:RBW 30 kHz Method: IBW C2K: 15 kHz, 15 kHz, 15 kHz, 15 kHz, 15 kHz, 15 kHz 15 kHz, 15 kHz, 15 kHz, 15 kHz, 15 kHz, 15 kHz TD-SCDMA: 30 kHz, 30 kHz, 30 kHz, 30 kHz, 30 kHz, 30 kHz 1xEVDO: 30kHz, 30kHz, 30kHz, 30kHz, 30kHz, 30kHz 30kHz, 30kHz, 30kHz, 30kHz, 30kHz, 30kHz</pre>

	DVB-T/H: 39 kHz, 39 kHz, 39 kHz, 39 kHz, 39 kHz, 39 kHz 39 kHz, 39 kHz, 39 kHz, 39 kHz, 39 kHz, 39 kHz DTMB (CTTB): 39 kHz, 39 kHz, 39 kHz, 39 kHz, 39 kHz, 39 kHz 39 kHz, 39 kHz, 39 kHz, 39 kHz, 39 kHz, 39 kHz ISDB-T: 39 kHz, 39 kHz, 39 kHz, 39 kHz, 39 kHz, 39 kHz 39 kHz, 39 kHz, 39 kHz, 39 kHz, 39 kHz, 39 kHz CMMB: 39 kHz, 39 kHz, 39 kHz, 39 kHz, 39 kHz, 39 kHz 39 kHz, 39 kHz, 39 kHz, 39 kHz, 39 kHz, 39 kHz LTE, LTE-TDD, MSR, LTEAFDD, LTEATDD: 100 kHz, 100 kHz, 100 kHz, 100 kHz, 100kHz, 100 kHz 100 kHz, 100 kHz, 100 kHz, 100 kHz, 100 kHz, 100 kHz Digital Cable TV: 39 kHz, 39 kHz, 39 kHz, 39 kHz, 39 kHz, 39 kHz 39 kHz, 39 kHz, 39 kHz, 39 kHz, 39 kHz, 39 kHz 1, 1, 1, 1, 1, 1
State Saved	Saved in instrument state.
Min	1 Hz
Max	8 MHz
Backwards Compatibility SCPI	[:SENSe] :ACPower:OFFSet [1] 2 :LIST:BWIDth:RESolution
Initial S/W Revision	Prior to A.02.00
Modified at S/W Revision	A.02.00, A.03.00, A.13.00

Video BW

Enables you to change the analyzer post-detection filter (VBW).

Key Path	Meas Setup, Offset/Limits, Offset BW
Mode	SA, WCDMA, C2K, WIMAX OFDMA, TD-SCDMA, 1xEVDO, DVB-T/H, DTMB (CTTB), ISDB-T, CMMB, LTE, LTE-TDD, Digital Cable TV, MSR, LTEAFDD, LTEATDD
Remote Command	[:SENSe] :ACPower:OFFSet [1] 2 [:OUTer] :LIST:BWIDth:VIDeo <freq>, <freq>, <freq>, <freq>, <freq> [:SENSe] :ACPower:OFFSet [1] 2 [:OUTer] :LIST:BWIDth:VIDeo? [:SENSe] :ACPower:OFFSet [1] 2 [:OUTer] :LIST:BWIDth:VIDeo:AUTO OFF ON 0 1, OFF ON 0 1, OFF ON 0 1, OFF ON 0 1, OFF ON 0 1, OFF ON 0 1 [:SENSe] :ACPower:OFFSet [1] 2 [:OUTer] :LIST:BWIDth:VIDeo:AUTO?
Example	ACP:OFFS2:LIST:BWIDth:VIDeo 5MHz, 5MHz, 5MHz, 5MHz, 5MHz, 5MHz ACP:OFFS2:LIST:BWIDth:VIDeo? ACP:OFFS2:LIST:BWIDth:VIDeo:AUTO 0,0,0,0,1,1 ACP:OFFS2:LIST:BWIDth:VIDeo:AUTO?
Notes	The values shown in this table reflect the conditions after a Mode Preset. Offset sub op code. 1 for BTS, 2 for MS. Default is BTS. Note that Offset sub op code 2 is supported only in Non-SA modes.

	In the SA mode, Offset sub op code 1 is used for both BTS and MS. You must be in the mode that includes ACP measurements to use this command. Use :INSTrument:SElect to set the mode. .
Dependencies	When Meas Method is RBW or FAST, this key is grayed out and disabled. If the key is pressed, an advisory message is generated. If the equivalent remote command is sent, a "Setting conflict" warning is generated.
Preset	SA: 22 kHz, 22 kHz, 22 kHz, 22 kHz, 22 kHz, 22 kHz WCDMA, WIMAX OFDMA: 1 MHz, 1 MHz, 1 MHz, 1 MHz, 1 MHz, 1 MHz C2K: 150 kHz, 150 kHz, 150 kHz, 150 kHz, 150 kHz, 150 kHz 150 kHz, 150 kHz, 150 kHz, 1150 kHz, 1150 kHz, 150 kHz TD-SCDMA: 300 kHz, 300 kHz, 300 kHz, 300 kHz, 300 kHz, 300 kHz 1xEVDO: 300KHz, 300KHz, 300KHz, 300KHz, 300KHz, 300KHz 300KHz, 300KHz, 300KHz, 300KHz, 300KHz, 300KHz DVB-T/H: 390 kHz, 390 kHz, 390 kHz, 390 kHz, 390 kHz, 390 kHz 390 kHz, 390 kHz, 390 kHz, 390 kHz, 390 kHz, 390 kHz DTMB (CTTB): 390 kHz, 390 kHz, 390 kHz, 390 kHz, 390 kHz, 390 kHz 390 kHz, 390 kHz, 390 kHz, 390 kHz, 390 kHz, 390 kHz ISDB-T: 390 kHz, 390 kHz, 390 kHz, 390 kHz, 390 kHz, 390 kHz 390 kHz, 390 kHz, 390 kHz, 390 kHz, 390 kHz, 390 kHz CMMB: 390 kHz, 390 kHz, 390 kHz, 390 kHz, 390 kHz, 390 kHz 390 kHz, 390 kHz, 390 kHz, 390 kHz, 390 kHz, 390 kHz LTE, LTEFDD, MSR, LTEAFDD, LTEATDD: 1 MHz, 1 MHz, 1 MHz, 1 MHz, 1 MHz, 1 MHz Digital Cable TV: 390 kHz, 390 kHz, 390 kHz, 390 kHz, 390 kHz, 390 kHz 390 kHz, 390 kHz, 390 kHz, 390 kHz, 390 kHz, 390 kHz ON, ON, ON, ON, ON, ON
State Saved	Saved in instrument state.
Min	1 Hz
Max	50 MHz
Backwards Compatibility SCPI	[:SENSe] :ACPower :OFFSet [1] 2 :LIST :BWIDth :VIDeo
Initial S/W Revision	Prior to A.02.00
Modified at S/W Revision	A.02.00, A.03.00, A.13.00

RBW Control

Accesses the resolution bandwidth control menu.

Key Path	Meas Setup, Offset/Limits, Offset BW
Initial S/W Revision	Prior to A.02.00

Filter Type

Selects the type of bandwidth filter that is used.

Key Path	Meas Setup, Offset/Limits, Offset BW, RBW Control
Mode	SA, WCDMA, C2K, WIMAX OFDMA, TD-SCDMA, 1xEVDO, DVB-T/H, DTMB (CTTB), ISDB-T, CMMB, LTE, LTEFDD, Digital Cable TV, MSR, LTEAFDD, LTEATDD
Remote Command	<code>[[:SENSE]:ACPower:OFFSet[1] 2[:OUTer]:LIST:BANDwidth:SHAPE GAUSSian FLATtop, GAUSSian FLATtop, GAUSSian FLATtop, GAUSSian FLATtop, GAUSSian FLATtop, GAUSSian FLATtop]</code> <code>[[:SENSE]:ACPower:OFFSet[1] 2[:OUTer]:LIST:BANDwidth:SHAPE?</code>
Example	ACP:OFFS2:LIST:BAND:SHAP FLAT, GAUS, GAUS, GAUS, GAUS, GAUS ACP:OFFS2:LIST:BAND:SHAP?
Notes	Offset sub op code. 1 for BTS, 2 for MS. Default is BTS. Note that Offset sub op code 2 is supported only in Non-SA modes. In the SA mode, Offset sub op code 1 is used for both BTS and MS. You must be in the mode that includes ACP measurements to use this command. Use :INSTrument:SElect to set the mode.
Dependencies	When Res BW Mode for the offset is Auto, this key is grayed out and disabled. Since Res BW Mode for the offset is preset to Auto on changing Meas Method to RBW or FAST, this key is grayed out and disabled too. If the key is pressed, an advisory message is generated. If the equivalent remote command is sent, a "Setting conflict" warning is generated.
Couplings	See the description above
Preset	GAUSSian, GAUSSian, GAUSSian, GAUSSian, GAUSSian, GAUSSian
State Saved	Saved in instrument state.
Range	GAUSSian FLATtop
Backwards Compatibility SCPI	<code>[[:SENSE]:ACPower:OFFSet[1] 2:LIST:BWIDth:SHAPE</code>
Initial S/W Revision	Prior to A.02.00
Modified at S/W Revision	A.02.00, A.03.00, A.13.00

Filter BW

Selects a Gaussian filter based on its –3 dB (Normal) bandwidth or its –6 dB bandwidth.

Key Path	Meas Setup, Offset/Limits, Offset BW, RBW Control
Mode	SA, WCDMA, C2K, WIMAX OFDMA, TD-SCDMA, 1xEVDO, DVB-T/H, DTMB (CTTB), ISDB-T, CMMB, LTE, LTEFDD, Digital Cable TV, MSR, LTEAFDD, LTEATDD
Remote Command	<code>[[:SENSE]:ACPower:OFFSet[1] 2[:OUTer]:LIST:BANDwidth:TYPE DB3 DB6, DB3 DB6, DB3 DB6, DB3 DB6, DB3 DB6, DB3 DB6]</code> <code>[[:SENSE]:ACPower:OFFSet[1] 2[:OUTer]:LIST:BANDwidth:TYPE?</code>
Example	ACP:OFFS2:LIST:BAND:TYPE DB3, DB3, DB3, DB3, DB3, DB3 ACP:OFFS2:LIST:BAND:TYPE?

Notes	Offset sub op code. 1 for BTS, 2 for MS. Default is BTS. Note that Offset sub op code 2 is supported only in Non-SA modes. In the SA mode, Offset sub op code 1 is used for both BTS and MS. You must be in the mode that includes ACP measurements to use this command. Use :INSTrument:SElect to set the mode.
Dependencies	When Filter Type is Flattop or Res BW Mode for the offset is Auto, this key is grayed out and disabled. Since Res BW Mode for the offset is preset to Auto on changing Meas Method to RBW or FAST, this key is grayed out and disabled too. If the key is pressed, an advisory message is generated. If the equivalent remote command is sent, a "Setting conflict" warning is generated.
Preset	DB3, DB3, DB3, DB3, DB3, DB3
State Saved	Saved in instrument state.
Range	-3 dB (Normal) -6 dB
Backwards Compatibility SCPI	[:SENSE] :ACPower:OFFSet [1] 2 :LIST:BWIDth:TYPE
Initial S/W Revision	Prior to A.02.00
Modified at S/W Revision	A.02.00, A.03.00, A.13.00

Limits

Limits key accesses a menu of functions that contains Select Offset, Abs Limit, Rel Limit and Fail Mask parameters.

Key Path	Meas Setup, Offset/Limits
Initial S/W Revision	A.03.00

Select Offset

Selects the offset to configure.

Key Path	Meas Setup, Offset/Limits, Limits
Mode	SA, WCDMA, C2K, WIMAX OFDMA, TD-SCDMA, 1xEVDO, DVB-T/H, DTMB (CTTB), ISDB-T, CMMB, LTE, LTE-TDD, Digital Cable TV, MSR, LTEAFDD, LTEATDD
Preset	A
State Saved	Saved in instrument state.
Range	Offset A Offset B Offset C Offset D Offset E Offset F
Initial S/W Revision	Prior to A.02.00
Modified at S/W Revision	A.02.00, A.03.00, A.13.00

Abs Limit

Enters an absolute limit value, which sets the absolute amplitude levels to test against for each of the custom offsets. The list must contain six (6) entries. If there is more than one offset, the offset closest to the carrier channel is the first one in the list. [:SENSE]:ACP:OFFSet[n][:OUTer]:LIST:TEST selects the type of testing to be done at each offset.

You can turn off (not use) specific offsets with the [:SENSE]:ACP:OFFSet[n][:OUTer]:LIST:STATe command.

The query returns the six (6) sets of real numbers that are the current absolute amplitude test limits.

Key Path	Meas Setup, Offset/Limits, Limits
Mode	SA, WCDMA, C2K, WIMAX OFDMA, TD-SCDMA, 1xEVDO, DVB-T/H, DTMB (CTTB), ISDB-T, CMMB, LTE, LTE-TDD, Digital Cable TV, MSR, LTEAFDD, LTEATDD
Remote Command	[:SENSE]:ACP:Power:OFFSet[1] 2[:OUTer]:LIST:ABSolute <real>, <real>, <real>, <real>, <real>, <real> [:SENSE]:ACP:Power:OFFSet[1] 2[:OUTer]:LIST:ABSolute?
Example	ACP:OFFS2:LIST:ABS -10, -10, -10, -10, -10, -10 ACP:OFFS2:LIST:ABS?
Notes	Offset sub op code. 1 for BTS, 2 for MS. Default is BTS. Note that Offset sub op code 2 is supported only in Non-SA modes. In the SA mode, Offset sub op code 1 is used for both BTS and MS. You must be in the mode that includes ACP measurements to use this command. Use :INSTrument:SElect to set the mode.
Couplings	None If current mode is DTMB (CTTB) or CMMB and current device type is Transmitter, the value from position 2 to position 4 are coupled, changing any one will change the others.
Preset	SA: 0dBm, 0 dBm, 0 dBm, 0 dBm, 0 dBm, 0 dBm 0dBm, 0 dBm, 0 dBm, 0 dBm, 0 dBm, 0 dBm WCDMA: 50 dBm, 50 dBm, 50 dBm, 50 dBm, 50 dBm, 50 dBm 50 dBm, 50 dBm, 50 dBm, 50 dBm, 50 dBm, 50 dBm C2K: 50 dBm, 50 dBm, 50 dBm, 50 dBm, 50 dBm, 50 dBm 50 dBm, 50 dBm, 50 dBm, 50 dBm, 50 dBm, 50 dBm WIMAX OFDMA: 50,50,50,50,50,50 TD-SCDMA: 50 dBm, 50 dBm, 50 dBm, 50 dBm, 50 dBm, 50 dBm 50 dBm, 50 dBm, 50 dBm, 50 dBm, 50 dBm, 50 dBm 1xEVDO: -27dBm, -27dBm, -13dBm, -13dBm, -13dBm, -13dBm -27dBm, -27dBm, -13dBm, -13dBm, -13dBm, -13dBm DVB-T/H: 50 dBm, 50 dBm, 50 dBm, 50 dBm, 50 dBm, 50 dBm 50 dBm, 50 dBm, 50 dBm, 50 dBm, 50 dBm, 50 dBm DTMB (CTTB): 11.14 dBm, 11.14dBm, 11.14 dBm, 11.14 dBm, 50 dBm, 50 dBm 11.14 dBm, 11.14 dBm, 11.14 dBm, 11.14 dBm, 50 dBm, 50 dBm ISDB-T: 50 dBm, 50 dBm, 50 dBm, 50 dBm, 50 dBm, 50 dBm 50 dBm, 50 dBm, 50 dBm, 50 dBm, 50 dBm, 50 dBm CMMB: 11.14 dBm, 11.14dBm, 11.14 dBm, 11.14 dBm, 50 dBm, 50 dBm 11.14 dBm, 11.14 dBm, 11.14 dBm, 11.14 dBm, 50 dBm, 50 dBm LTE, LTE-TDD, MSR, LTEAFDD, LTEATDD: -8.45, -8.45, -8.45, -8.45, -8.45, -8.45 -50.0, -50.0, -

	50.0, -50.0, -50.0, -50.0 Digital Cable TV: 50 dBm, 50 dBm, 50 dBm, 50 dBm, 50 dBm, 50 dBm 50 dBm, 50 dBm, 50 dBm, 50 dBm, 50 dBm, 50 dBm
State Saved	Saved in instrument state.
Min	-200.0 dBm
Max	50.0 dBm
Backwards Compatibility SCPI	<code>[[:SENSE]:ACPR:OFFSet[1] 2:LIST:ABSolute (PSA W-CDMA, PSA cdma2000)</code> <code>[[:SENSE]:MCPower:OFFSet[1] 2:LIST:ABSolute (PSA W-CDMA)</code>
Initial S/W Revision	Prior to A.02.00
Modified at S/W Revision	A.02.00, A.03.00, A.13.00

Rel Lim (Car)

Enters a relative limit value for the carrier level. This sets the amplitude levels to test against for the specified offsets.

The amplitude level is relative to the carrier amplitude. If multiple offsets are available, the list contains six (6) entries. The offset closest to the carrier channel is the first one in the list.

`[[:SENSE]:ACP:OFFSet[n][[:OUTer]:LIST:TEST` selects the type of testing to be done at each offset.

You can turn off (not use) specific offsets with the `[[:SENSE]:ACP:OFFSet[n][[:OUTer]:LIST:STATe` command.

The query returns the six (6) sets of real numbers that are the current amplitude test limits, relative to the carrier, for each offset.

Offset[n] n = 1 is base station and n = 2 is mobiles. The default is base station (1).

Key Path	Meas Setup, Offset/Limits, Limits,
Mode	SA, WCDMA, C2K, WIMAX OFDMA, TD-SCDMA, 1xEVDO, DVB-T/H, DTMB (CTTB), ISDB-T, CMMB, LTE, LTE-TDD, Digital Cable TV, MSR, LTEAFDD, LTEATDD
Remote Command	<code>[[:SENSE]:ACP:OFFSet[1] 2[:OUTer]:LIST:RCARrier <real>, <real>, <real>, <real>, <real>, <real></code> <code>[[:SENSE]:ACP:OFFSet[1] 2[:OUTer]:LIST:RCARrier?</code>
Example	<code>ACP:OFFS2:LIST:RCAR 0,0,0,0,0,0</code> <code>ACP:OFFS2:LIST:RCAR?</code>
Notes	Offset sub op code. 1 for BTS, 2 for MS. Default is BTS. Note that Offset sub op code 2 is supported only in Non-SA modes. In the SA mode, Offset sub op code 1 is used for both BTS and MS. You must be in the mode that includes ACP measurements to use this command. Use <code>:INSTrument:SElect</code> to set the mode.
Couplings	None If current mode is DTMB (CTTB) or CMMB and current device type is Transmitter, the value from

	position 2 to position 4 are coupled, changing any one will change the others.
Preset	SA: -45, -60, 0, 0, 0, 0 -45, -60, 0, 0, 0, 0 WCDMA: -44.2, -49.2, -49.2, -49.2, -49.2, -49.2 -32.2, -42.2, -42.2, -42.2, -42.2, -42.2 C2K: 0, 0, 0, 0, 0, 0 0, 0, 0, 0, 0, 0 WIMAX OFDMA: -50,-60,0,0,0,0 TD-SCDMA: -40, -45, -45, -45, -45, -45 -33, -43, -43, -43, -43, -43 1xEVDO: -45, -55, -55, -55, -55, -55 -45, -55, -55, -55, -55, -55 DVB-T/H: -60, -60, 0, 0, 0, 0 -60, -60, 0, 0, 0, 0 DTMB (CTTB): -45, -60, -60, -60, 50, 50 -45, -60, -60, -60, 50, 50 ISDB-T: -60, -60, 0, 0, 0, 0 -60, -60, 0, 0, 0, 0 CMMB: -45, -60, -60, -60, 50, 50 -45, -60, -60, -60, 50, 50 LTE, LTETDD, MSR, LTEAFDD, LTEATDD: -44.2, -44.2, -44.2, -44.2, -44.2, -44.2 -29.2, -29.2, -29.2, -29.2, -29.2, -29.2 Digital Cable TV: -58, -62, -65, -73, -73, -73 -58, -62, -65, -73, -73, -73
State Saved	Saved in instrument state.
Min	-150
Max	50.0
Backwards Compatibility SCPI	<code>[:SENSe] :MCPower :OFFSet [1] 2 :LIST :RCARrier (PSA WCDMA)</code>
Initial S/W Revision	Prior to A.02.00
Modified at S/W Revision	A.02.00, A.03.00, A.04.00, A.13.00

Positive Offset Limit (SCPI only)

Enables you to set the upper limit for the upper segment of the specified offset pair.

Mode	SA, WCDMA, CDMA2K, WIMAXOFDMA, TDSCDMA, CDMA1XEV, DVB, DTMB, LTE, LTETDD, DCATV, MSR, LTEAFDD, LTEATDD
Remote Command	<code>:CALCulate:ACP:OFFSet[:OUTer]:LIST:LIMit:POSitive[:UPPer]:DATA <real>, <real>, <real>, <real>, <real>, <real></code> <code>:CALCulate:ACP:OFFSet[:OUTer]:LIST:LIMit:POSitive[:UPPer]:DATA?</code>
Example	<code>CALC:ACP:OFFS:LIST:LIM:POS:DATA 0, 0, 0, 0, 0, 0</code> <code>CALC:ACP:OFFS:LIST:LIM:POS:DATA?</code>
Notes	SCPI only command
Preset	SA: -45, -60, 0, 0, 0, 0 -45, -60, 0, 0, 0, 0 WCDMA: -44.2, -49.2, -49.2, -49.2, -49.2, -49.2 -32.2, -42.2, -42.2, -42.2, -42.2, -42.2 C2K: 0, 0, 0, 0, 0, 0 0, 0, 0, 0, 0, 0 WIMAX OFDMA: -50, -60, 0, 0, 0, 0 TD-SCDMA: -40, -45, -45, -45, -45, -45 -33, -43, -43, -43, -43, -43 1xEVDO: -45, -55, -55, -55, -55, -55 -45, -55, -55, -55, -55, -55 DVB-T/H: -60, -60, 0, 0, 0, 0 -60, -60, 0, 0, 0, 0

	DTMB (CTTB): -45, -60, -60, -60, 0, 0 -45, -60, -60, -60, 0, 0 Digital Cable TV: -58, -62, -65, -73, -73, -73 -58, -62, -65, -73, -73, -73 LTE, LTE-TDD, MSR, LTE-FDD, LTE-TDD: -44.2, -44.2, -44.2, -44.2, -44.2, -44.2 -29.2, -29.2, -29.2, -29.2, -29.2, -29.2
State Saved	Saved in instrument state.
Min	-150.0
Max	50.0
Backwards Compatibility SCPI	:CALCulate:ACPower:OFFSet:LIST:LIMit:POSitive[:UPPer]:DATA (PSA Power Suite)
Initial S/W Revision	A.04.00
Modified at S/W Revision	A.13.00

Negative Offset Limit

Enables you to set the upper limit for the lower segment of the specified offset pair.

Mode	SA, WCDMA, CDMA2K, WIMAX OFDMA, TDSCDMA, CDMA1XEV, DVB, DTMB, LTE, LTE-TDD, DCATV, MSR, LTE-FDD, LTE-TDD
Remote Command	:CALCulate:ACPower:OFFSet[:OUTer]:LIST:LIMit:NEGative[:UPPer]:DATA <real>, <real>, <real>, <real>, <real>, <real> :CALCulate:ACPower:OFFSet[:OUTer]:LIST:LIMit:NEGative[:UPPer]:DATA?
Example	CALC:ACP:OFFS:LIST:LIM:NEG:DATA 0, 0, 0, 0, 0, 0 CALC:ACP:OFFS:LIST:LIM:NEG:DATA?
Notes	SCPI only command
Preset	SA: -45, -60, 0, 0, 0, 0 -45, -60, 0, 0, 0, 0 WCDMA: -44.2, -49.2, -49.2, -49.2, -49.2, -49.2 -32.2, -42.2, -42.2, -42.2, -42.2, -42.2 C2K: 0, 0, 0, 0, 0, 0 0, 0, 0, 0, 0, 0 WIMAX OFDMA: -50, -60, 0, 0, 0, 0 TD-SCDMA: -40, -45, -45, -45, -45, -45 -33, -43, -43, -43, -43, -43 1xEVDO: -45, -55, -55, -55, -55, -55 -45, -55, -55, -55, -55, -55 DVB-T/H: -60, -60, 0, 0, 0, 0 -60, -60, 0, 0, 0, 0 DTMB (CTTB): -45, -60, -60, -60, 0, 0 -45, -60, -60, -60, 0, 0 Digital Cable TV: -58, -62, -65, -73, -73, -73 -58, -62, -65, -73, -73, -73 LTE, LTE-TDD, MSR, LTE-FDD, LTE-TDD: -44.2, -44.2, -44.2, -44.2, -44.2, -44.2 -29.2, -29.2, -29.2, -29.2, -29.2, -29.2
State Saved	Saved in instrument state.
Min	-150.0
Max	50.0
Backwards Compatibility SCPI	:CALCulate:ACPower:OFFSet:LIST:LIMit:NEGative[:UPPer]:DATA (PSA Power Suite)
Initial S/W Revision	A.04.00
Modified at S/W Revision	A.13.00

Rel Limit (PSD)

Enters a relative limit value for the level of the power spectral density. This sets the amplitude levels to test against for any custom offsets. The amplitude level is relative to the power spectral density. If multiple offsets are available, the list contains six (6) entries. The offset closest to the carrier channel is the first one in the list.

`[[:SENSE]:ACP:OFFSet[n]:OUTer]:LIST:TEST` selects the type of testing to be done at each offset.

You can turn off (not use) specific offsets with the `[[:SENSE]:ACP:OFFSet[n]:OUTer]:LIST:STATe` command.

The query returns the six (6) sets of real numbers that are the current amplitude test limits, relative to the power spectral density, for each offset.

Offset[n] n = 1 is base station and n = 2 is mobiles. The default is base station (1).

Key Path	Meas Setup, Offset/Limits, Limits
Mode	SA, WCDMA, C2K, WIMAX OFDMA, TD-SCDMA, 1xEVDO, DVB-T/H, DTMB (CTTB), ISDB-T, CMMB, LTE, LTETDD, Digital Cable TV, MSR, LTEAFDD, LTEATDD
Remote Command	<code>[[:SENSE]:ACP:OFFSet[1] 2[:OUTer]:LIST:RPSDensity <rel_ampl>, <rel_ampl>, <rel_ampl>, <rel_ampl>, <rel_ampl></code> <code>[[:SENSE]:ACP:OFFSet[1] 2[:OUTer]:LIST:RPSDensity?</code>
Example	<code>ACP:OFFS2:LIST:RPSD 10,10,10,10,10,10</code> <code>ACP:OFFS2:LIST:RPSD?</code>
Notes	Offset sub op code. 1 for BTS, 2 for MS. Default is BTS. Note that Offset sub op code 2 is supported only in Non-SA modes. In the SA mode, Offset sub op code 1 is used for both BTS and MS. You must be in the mode that includes ACP measurements to use this command. Use <code>:INSTrument:SElect</code> to set the mode.
Preset	SA: -28.87 dB, -43.87 dB, 0 dB, 0 dB, 0 dB, 0 dB -28.87 dB, -43.87 dB, 0 dB, 0 dB, 0 dB, 0 dB WCDMA: -44.2 dB, -49.2 dB, -49.2 dB, -49.2 dB, -49.2 dB, -49.2 dB -32.2 dB, -42.2 dB, -42.2 dB C2K: 0 dB, 0 dB, 0 dB, 0 dB, 0 dB, 0 dB 0 dB, 0 dB, 0 dB, 0 dB, 0 dB, 0 dB WIMAX OFDMA: -25,-35,0,0,0,0 TD-SCDMA: -40 dB, -45 dB, -45 dB, -45 dB, -45 dB, -45 dB -33 dB, -43 dB, -43 dB, -43 dB, -43 dB, -43 dB 1xEVDO: -45, -55, -55, -55, -55 -45, -55, -55, -55, -55, -55 DVB-T/H: -60 dB, -60 dB, 0 dB, 0 dB, 0 dB, 0 dB -60 dB, -60 dB, 0 dB, 0 dB, 0 dB, 0 dB DTMB (CTTB): 50 dB, 50 dB, 50 dB, 50 dB, 50 dB, 50 dB 50 dB, 50 dB, 50 dB, 50 dB, 50 dB, 50 dB ISDB-T: -60 dB, -60 dB, 0 dB, 0 dB, 0 dB, 0 dB -60 dB, -60 dB, 0 dB, 0 dB, 0 dB, 0 dB CMMB: 50 dB, 50 dB, 50 dB, 50 dB, 50 dB, 50 dB 50 dB, 50 dB, 50 dB, 50 dB, 50 dB, 50 dB LTE, LTETDD, MSR, LTEAFDD, LTEATDD: 0, 0, 0, 0, 0, 0 0, 0, 0, 0, 0, 0 Digital Cable TV: 50 dB, 50 dB, 50 dB, 50 dB, 50 dB, 50 dB 50 dB, 50dB, 50 dB, 50 dB, 50 dB, 50 dB

State Saved	Saved in instrument state.
Min	-150.0 dB
Max	50.0 dB
Initial S/W Revision	Prior to A.02.00
Modified at S/W Revision	A.02.00, A.03.00, A.13.00

Fail Mask

Accesses a menu that enables you to select one of the logic keys for the fail conditions between the measurement results and the test limits. The setting defines the type of testing to be done at any custom offset frequencies. The measured powers are tested against the absolute values defined with `[:SENSe]:ACP:OFFSet[n][:OUTer]:LIST:ABSolute`, or the relative values defined with `[:SENSe]:ACP:OFFSet[n][:OUTer]:LIST:RPSDensity` and `[:SENSe]:ACP:OFFSet[n][:OUTer]:LIST:RCARrier`.

You can turn off (not use) specific offsets with the `[:SENSe]:ACP:OFFSet[n][:OUTer]:LIST:STATe` command.

- Absolute – Fail is shown if one of the absolute ACP measurement results is larger than the limit for Abs Limit.
- Relative – Fail is shown if one of the relative ACP measurement results is larger than the limit for Rel Lim (Car) or Rel Lim (PSD).
- Abs AND Rel – Fail is shown if one of the absolute ACP measurement results is larger than the limit for Abs Limit AND one of the relative ACP measurement results is larger than the limit for Rel Lim (Car) or Rel Lim (PSD).
- Abs OR Rel – Fail is shown if one of the absolute ACP measurement results is larger than the limit for Abs Limit OR one of the relative ACP measurement results is larger than the limit for Rel Lim (Car) or Rel Lim (PSD).

Key Path	Meas Setup, Offset/Limits, Limits
Mode	SA, WCDMA, C2K, WIMAX OFDMA, TD-SCDMA, 1xEVDO, DVB-T/H, DTMB (CTTB), ISDB-T, CMMB, LTE, LTE-TDD, Digital Cable TV, MSR, LTEAFDD, LTEATDD
Remote Command	<code>[:SENSe]:ACPower:OFFSet[1] 2[:OUTer]:LIST:TEST ABSolute AND OR RELative, ABSolute AND OR RELative, ABSolute AND OR RELative, ABSolute AND OR RELative, ABSolute AND OR RELative</code> <code>[:SENSe]:ACPower:OFFSet[1] 2[:OUTer]:LIST:TEST?</code>
Example	<code>ACP:OFFS2:LIST:TEST ABS, ABS, ABS, ABS, ABS, ABS</code> <code>ACP:OFFS2:LIST:TEST?</code>
Notes	Offset sub op code. 1 for BTS, 2 for MS. Default is BTS. Note that Offset sub op code 2 is supported only in Non-SA modes. In the SA mode, Offset sub op code 1 is used for both BTS and MS. You must be in the mode that includes ACP measurements to use this command. Use <code>:INSTrument:SElect</code> to set the mode.
Couplings	None

	If current mode is DTMB (CTTB) or CMMB and current device type is Transmitter, the value from position 2 to position 4 are coupled, changing any one will change the others.
Preset	SA, WCDMA, C2K, TD-SCDMA: REL, REL, REL, REL, REL, REL REL, REL, REL, REL, REL, REL WIMAX OFDMA: REL, REL, REL, REL, REL, REL DVB-T/H: REL, REL, REL, REL, REL, REL DTMB (CTTB): OR,AND, AND,AND, REL, REL CDMA1xEVDO: REL, REL, ABS, REL, REL, REL REL, REL, ABS, REL, REL, REL ISDB-T : REL, REL, REL, REL, REL, REL CMMB : OR,AND, AND,AND, REL, REL LTE, LTETDD, MSR, LTEAFDD, LTEATDD: AND, AND, AND, AND, AND, AND AND, AND, AND, AND, AND, AND Digital Cable TV: REL, REL, REL, REL, REL, REL
State Saved	Saved in instrument state.
Range	Absolute Relative Abs AND Rel (fail if both fail) Abs OR Rel (fail if either fails)
Backwards Compatibility SCPI	[:SENSe] :MCPower:OFFSet [1] 2 :LIST:TEST
Initial S/W Revision	Prior to A.02.00
Modified at S/W Revision	A.02.00, A.03.00, A.04.00, A13.00

Offset Side

Enables you to turn off (not use) specific offsets with [:SENSe]:ACPPower:OFFSet[1]|2[:Outer]:LIST:SIDE.

- NEGative - Negative (lower) sideband only
- BOTH - Both of the negative (lower) and positive (upper) sidebands
- POSitive - Positive (upper) sideband only

The figure below shows the relation between the negative/positive offset side setups and the upper/lower results in the MSR and LTE-Advanced FDD/TDD.

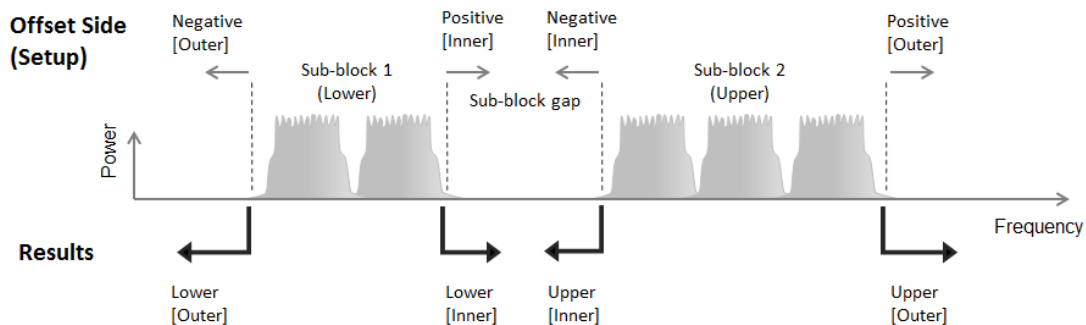

Key Path	Meas Setup, Offset/Limits
Mode	SA, WCDMA, C2K, WIMAX OFDMA, TD-SCDMA, 1xEVDO, DTMB (CTTB), DVB-T/H, LTE, LTETDD,

	Digital Cable TV, MSR,LTEAFDD,LTEATDD
Remote Command	[[:SENSe]:ACPower:OFFSet[1] 2[:OUTer]:LIST:SIDE NEGative BOTH POSitive,NEGative BOTH POSitive,NEGative BOTH POSitive,NEGative BOTH POSitive,NEGative BOTH POSitive,NEGative BOTH POSitive [:SENSe]:ACPower:OFFSet[1] 2[:OUTer]:LIST:SIDE?
Example	ACP:OFFS:LIST:SIDE BOTH ACP:OFFS:LIST:SIDE?
Notes	OFFSet1 is for BTS, 2 for MS. Default is BTS. You must be in the Spectrum Analysis mode, W-CDMA mode, cdma2000 mode, TD-SCDMA mode, DTMB (CTTB) mode, DVB-T/H mode, ISDB-T mode, CMMB mode, Digital Cable TV mode, 1xEVDO mode, WIMAX OFDMA mode, LTE mode, LTETDD ,LTEAFDD,LTEATDD or MSR mode to use this command. Use :INSTrument:SElect to set the mode. If you set POS or NEG in an offset, result of the inactive side will return -999.
Preset	BOTH, BOTH, BOTH, BOTH, BOTH, BOTH BOTH, BOTH, BOTH, BOTH, BOTH, BOTH
State Saved	Saved in instrument state.
Range	Neg Both Pos
Initial S/W Revision	A.03.00
Modified at S/W Revision	A.13.00

Method for Offset

This key allows you to turn RRC filtering of each offset on or off. The value (roll off) for the filter will be set to the value of the Filter Alpha parameter.

Key Path	Meas Setup, Offset/Limits
Mode	SA, WCDMA, WIMAX OFDMA,TD-SCDMA, DVB-T/H, DTMB (CTTB), ISDB-T, CMMB, LTE, LTETDD, Digital Cable TV, MSR, LTEAFDD,LTEATDD
Remote Command	[[:SENSe]:ACPower:OFFSet[1] 2[:OUTer]:LIST:FILTer[:RRC][:STATe] ON OFF 1 0, ON OFF 1 0, ON OFF 1 0, ON OFF 1 0, ON OFF 1 0, ON OFF 1 0 [:SENSe]:ACPower:OFFSet[1] 2[:OUTer]:LIST:FILTer[:RRC][:STATe]?
Example	ACP:OFFS:LIST:FILT 1,0,0 ACP:OFFS:LIST:FILT?
Notes	1 ON = RRC Weighted, 0 OFF = Integ BW This parameter is not available for cdma2000 and 1xEVDO. You must be in the mode that includes ACP measurements to use this command. Use :INSTrument:SElect to set the mode.
Preset	SA: 0, 0, 0, 0, 0, 0 0, 0, 0, 0, 0, 0 WCDMA:1, 1, 1, 1, 1, 1 1, 1, 1, 1, 1, 1 C2K: NO WIMAX OFDMA: 0, 0, 0, 0, 0, 0 0, 0, 0, 0, 0, 0 TD-SCDMA: 1, 1, 1, 1, 1, 1 1, 1, 1, 1, 1, 1

	DVB-T/H: 0, 0, 0, 0, 0, 0 0, 0, 0, 0, 0, 0 DTMB (CTTB): 1, 1, 1, 1, 1, 1 1, 1, 1, 1, 1, 1 ISDB-T: 0, 0, 0, 0, 0, 0 0, 0, 0, 0, 0, 0 CMMB: 1, 1, 1, 1, 1, 1 1, 1, 1, 1, 1, 1 LTE: 0, 0, 0, 0, 0, 0 0, 0, 0, 0, 0, 0 LTETDD: 0, 0, 0, 0, 0, 0 0, 0, 0, 0, 0, 0 Digital Cable TV: 0, 0, 0, 0, 0, 0 0, 0, 0, 0, 0, 0 MSR, LTEAFDD, LTEATDD: 0, 0, 0, 0, 0, 0 0, 0, 0, 0, 0, 0
State Saved	Saved in instrument state.
Range	Integ BW RRC Weighted
Initial S/W Revision	A.03.00
Modified at S/W Revision	A.13.00

Method for Offset

This key allows you to turn RRC filtering of each offset on or off. The value (roll off) for the filter will be set to the value of the Filter Alpha parameter.

Key Path	Meas Setup, Offset/Limits
Mode	SA, WCDMA, WIMAX OFDMA, TD-SCDMA, DVB-T/H, DTMB (CTTB), ISDB-T, CMMB, LTE, LTETDD, Digital Cable TV, MSR, LTEAFDD, LTEATDD
Remote Command	[[:SENSe]:ACPower:OFFSet [1] 2[:OUTer]:LIST:FILTer[:RRC] [:STATe] ON OFF 1 0, ON OFF 1 0, ON OFF 1 0, ON OFF 1 0, ON OFF 1 0, ON OFF 1 0 [:SENSe]:ACPower:OFFSet [1] 2[:OUTer]:LIST:FILTer[:RRC] [:STATe] ?
Example	ACP:OFFS:LIST:FILT 1,0,0 ACP:OFFS:LIST:FILT?
Notes	1 ON = RRC Weighted, 0 OFF = Integ BW This parameter is not available for cdma2000 and 1xEVDO. You must be in the mode that includes ACP measurements to use this command. Use :INSTrument:SElect to set the mode.
Preset	SA: 0, 0, 0, 0, 0, 0 0, 0, 0, 0, 0, 0 WCDMA: 1, 1, 1, 1, 1, 1 1, 1, 1, 1, 1, 1 C2K: NO WIMAX OFDMA: 0, 0, 0, 0, 0, 0 0, 0, 0, 0, 0, 0 TD-SCDMA: 1, 1, 1, 1, 1, 1 1, 1, 1, 1, 1, 1 DVB-T/H: 0, 0, 0, 0, 0, 0 0, 0, 0, 0, 0, 0 DTMB (CTTB): 1, 1, 1, 1, 1, 1 1, 1, 1, 1, 1, 1 ISDB-T: 0, 0, 0, 0, 0, 0 0, 0, 0, 0, 0, 0 CMMB: 1, 1, 1, 1, 1, 1 1, 1, 1, 1, 1, 1 LTE: 0, 0, 0, 0, 0, 0 0, 0, 0, 0, 0, 0

	LTETDD: 0, 0, 0, 0, 0, 0 0, 0, 0, 0, 0, 0 Digital Cable TV: 0, 0, 0, 0, 0, 0 0, 0, 0, 0, 0, 0 MSR, LTEAFDD, LTEATDD: 0, 0, 0, 0, 0, 0 0, 0, 0, 0, 0, 0
State Saved	Saved in instrument state.
Range	Integ BW RRC Weighted
Initial S/W Revision	A.03.00
Modified at S/W Revision	A.13.00

Filter Alpha for Offset

Sets the alpha value for the RRC Filter for each offset.

Key Path	Meas Setup, Offset/Limits, Method, RRC Weighted
Mode	SA, WCDMA, WIMAX OFDMA, TD-SCDMA, DVB-T/H, DTMB (CTTB), ISDB-T, CMMB, LTE, LTETDD, Digital Cable TV, MSR, LTEAFDD, LTEATDD
Remote Command	<code>[:SENSe] :ACPower:OFFSet [1] 2 [:OUTer] :LIST:FILTer:ALPHa <real>, <real>, <real>, <real>, <real>, <real></code> <code>[:SENSe] :ACPower:OFFSet [1] 2 [:OUTer] :LIST:FILTer:ALPHa?</code>
Example	ACP:OFFS:LIST:FILT:ALPH 0.5, 0.5, 0.5, 0.5, 0.5, 0.5 ACP:OFFS:LIST:FILT:ALPH?
Notes	This parameter is not available for cdma2000 and 1xEVDO. You must be in the mode that includes ACP measurements to use this command. Use :INSTrument:SElect to set the mode.
Preset	SA: 0.22, 0.22, 0.22, 0.22, 0.22, 0.22 0.22, 0.22, 0.22, 0.22, 0.22, 0.22 WCDMA: 0.22, 0.22, 0.22, 0.22, 0.22, 0.22 0.22, 0.22, 0.22, 0.22, 0.22, 0.22 WIMAX OFDMA: 0.22, 0.22, 0.22, 0.22, 0.22, 0.22 0.22, 0.22, 0.22, 0.22, 0.22, 0.22 C2K: NO TD-SCDMA: 0.22, 0.22, 0.22, 0.22, 0.22, 0.22 0.22, 0.22, 0.22, 0.22, 0.22, 0.22 DVB-T/H: 0.22, 0.22, 0.22, 0.22, 0.22, 0.22 0.22, 0.22, 0.22, 0.22, 0.22, 0.22 DTMB (CTTB): 0.05, 0.05, 0.05, 0.05, 0.05, 0.05 0.05, 0.05, 0.05, 0.05, 0.05, 0.05 ISDB-T: 0.22, 0.22, 0.22, 0.22, 0.22, 0.22 0.22, 0.22, 0.22, 0.22, 0.22, 0.22 CMMB: 0.22, 0.22, 0.22, 0.22, 0.22, 0.22 0.22, 0.22, 0.22, 0.22, 0.22, 0.22 LTE: 0.22, 0.22, 0.22, 0.22, 0.22, 0.22 0.22, 0.22, 0.22, 0.22, 0.22, 0.22 LTETDD: 0.22, 0.22, 0.22, 0.22, 0.22, 0.22 0.22, 0.22, 0.22, 0.22, 0.22, 0.22 Digital Cable TV: 0.15, 0.15, 0.15, 0.15, 0.15, 0.15 0.15, 0.15, 0.15, 0.15, 0.15, 0.15 MSR, LTEAFDD, LTEATDD: 0.22, 0.22, 0.22, 0.22, 0.22, 0.22 0.22, 0.22, 0.22, 0.22, 0.22, 0.22
State Saved	Saved in instrument state.
Min	0.01
Max	1.00
Initial S/W Revision	A.03.00
Modified at S/W Revision	A.13.00

Offset Frequency Define

This key allows you to select “Offset” definition. Each standard defines each “Offset” from Carrier.

3GPP2 requires the “From Carrier Center to MeasBW Closer Edge” definition. LTE conformance test requires “From Carrier Edge to MeasBW Center” and/or “From Carrier Edge to MeasBW Closer Edge” definition.

- CTOCenter – From the center of the carrier closest to the adjacent channel to the center of the adjacent channel Offset Integ BW
- CTOEdge – From the center of the carrier closest to the adjacent channel to the edge of the closest adjacent channel Offset Integ BW
- ETOCenter – From Center Frequency - Carrier Spacing / 2 (for lower offset), Center Frequency + Carrier Spacing / 2 (for upper offset) of the carrier closest to the adjacent channel's to the center of the adjacent channel Offset Integ BW
- ETOEdge – From Center Frequency - Carrier Spacing / 2 (for lower offset), Center Frequency + Carrier Spacing / 2 (for upper offset) of the carrier closest to the adjacent channel's to the edge of the closest adjacent channel Offset Integ BW

Key Path	Meas Setup, Offset/Limits
Mode	SA, WCDMA, C2K, WIMAX OFDMA, TD-SCDMA, 1xEVDO, DVB-T/H, DTMB (CTTB), ISDB-T, CMMB, LTE, LTE-TDD, Digital Cable TV, MSR, LTEAFDD, LTEATDD
Remote Command	[:SENSe] :ACPpower:OFFSet [1] 2 [:OUTer] :TYPE CTOCenter CTOEdge ETOCenter ETOEdge [:SENSe] :ACPpower:OFFSet [1] 2 [:OUTer] :TYPE?
Example	ACP:OFFS:TYPE ETOC ACP:OFFS:TYPE?
Notes	You must be in the mode that includes ACP measurements to use this command. Use :INSTrument:SElect to set the mode.
Preset	All Except C2K and 1xEVDO: CTOCenter C2K and 1xEVDO: CTOEdge
State Saved	Saved in instrument state.
Range	Carrier Center To Meas BW Center Carrier Center To Meas BW Edge Carrier Edge To Meas BW Center Carrier Edge To Meas BW Edge
Initial S/W Revision	A.03.00
Modified at S/W Revision	A.13.00

Carrier Result

Allows you to view and scroll through the carrier power results.

Key Path	Meas Setup
----------	------------

Mode	SA, WCDMA, C2K, WIMAX OFDMA, TD-SCDMA, 1xEVDO, DVB-T/H, DTMB (CTTB), ISDB-T, CMMB, LTE, LTE-TDD, Digital Cable TV, MSR, LTEAFDD, LTEATDD
Couplings	This key will be grayed out if there is only one carrier.
Preset	1
State Saved	No
Min	1
Max	Number of carriers.
Initial S/W Revision	Prior to A.02.00
Modified at S/W Revision	A.02.00, A.03.00

PhNoise Opt

Selects the LO (local oscillator) phase noise behavior for various operating conditions.

Key Path	Meas Setup
Initial S/W Revision	Prior to A.02.00

PhNoise Opt Auto

Selects the best LO (local oscillator) phase noise behavior for the ACP measurement.

Key Path	Meas Setup
Mode	SA, WCDMA, C2K, WIMAX OFDMA, TD-SCDMA, 1xEVDO, DVB-T/H, DTMB (CTTB), ISDB-T, CMMB, LTE, LTE-TDD, Digital Cable TV, MSR, LTEAFDD, LTEATDD
Remote Command	[:SENSe] :ACPpower:FREQuency:SYNThesis:AUTO [:STATe] OFF ON 0 1 [:SENSe] :ACPpower:FREQuency:SYNThesis:AUTO [:STATe] ?
Example	ACP:FREQ:SYNT:AUTO 1 ACP:FREQ:SYNT:AUTO?
Preset	ON
State Saved	Saved in instrument state.
Range	Auto Man
Initial S/W Revision	Prior to A.02.00
Modified at S/W Revision	A.02.00, A.03.00, A.04.00

PhNoise Opt State

Selects the LO (local oscillator) phase noise behavior for various operating conditions.

Key Path	Meas Setup
----------	------------

Mode	SA, WCDMA, C2K, WIMAX OFDMA, TD-SCDMA, 1xEVDO, DVB-T/H, DTMB (CTTB), ISDB-T, CMMB, LTE, LTE-TDD, Digital Cable TV, MSR, LTEAFDD, LTEATDD
Remote Command	<code>[:SENSe] :ACPower:FREQuency:SYNTHeSis [:STATe] 1 2 3</code> <code>[:SENSe] :ACPower:FREQuency:SYNTHeSis [:STATe] ?</code>
Example	ACP:FREQ:SYNT 1 ACP:FREQ:SYNT?
Notes	Parameter key: 1 - optimizes phase noise for close-in from the carrier. 2 - optimizes phase noise for wide-offset from the carrier. 3 - optimizes LO for tuning speed.
Couplings	Best Close-in Φ Noise The frequency below which the phase noise is optimized is model dependent: PXA with option EP1: [offset <140 kHz] Models with option EP2: [offset <70 kHz] CXA with option EP4: [offset <90 kHz] CXA without option EP4: n/a All other models: [offset <20 kHz] Best Wide-offset Φ Noise The frequency below which the phase noise is optimized is model dependent: PXA with option EP1: [offset >160 kHz] Models with option EP2: [offset >100 kHz] CXA with option EP4: [offset >130 kHz] CXA without option EP4: n/a All other models: [offset >30 kHz] Fast Tuning The Fast Tuning details are model dependent: CXA without option EP4: n/a PXA with option EP1: [single loop] Models with option EP2: [medium loop bandwidth] All other models: [same as Close-in]
Preset	Because this function is in Auto after preset, the state of this function after Preset will be automatically calculated.
State Saved	Saved in instrument state.
Range	Best Close-in Φ Noise [offset < 140 kHz] Best Wide-offset Φ Noise [offset > 160 kHz] Fast Tuning [same as Close-in] [] is model dependent. See Couplings for details.
Initial S/W Revision	Prior to A.02.00
Modified at S/W Revision	A.02.00, A.03.00, A.04.00

Meas Method

Sets the desired method to measure ACP.

Integration BW – one sweep of the trace is taken, and the band power for each offset is computed. Depending on the status of the Meas Type parameter (Total Power Reference or PSD Reference), results are displayed relative to the total power or the power spectral density. The display reflects either the current trace or a bar graph view.

Filtered IBW (max dynamic range) – the ACP Path is used to compute ACP when an ACP path is available. This method increases dynamic range, but increases measurement time as it limits the resolution bandwidth. This method is useful for improving dynamic range on a W-CDMA signal because a sharp cutoff bandpass filter is used. The accuracy of the adjacent channel power ratio is not degraded by this method, but the absolute accuracy of both adjacent channel power and carrier power are degraded by up to about 0.5 dB.

RBW – the algorithm uses zero-span and an appropriate RBW setting to capture all of the power in the carrier channel and the offsets. The zero-span algorithm (RBW method) is slower than the IBW method, but greatly improves repeatability.

Fast (in WCDMA mode or SA mode with 3GPP WCDMA radio standard selected) – this provides the same method as the Integration BW method, but is optimized for speed to measure a W-CDMA signal.

Fast (in CDMA2K mode or SA mode with CDMA2K radio standard selected) – this provides faster measurement using the FFT method with a limited parameter flexibility. When this is selected, CDMA2K preset offsets are given and control of the following are grayed out:

BW menu, Sweep/Control menu except Pause/Resume, Trace/Detector menu, Carrier Setup, Offset Limit, RRC Weighting, Filter Alpha, and Noise Correction softkeys in Meas Setup menu.

Key Path	Meas Setup
Mode	SA, WCDMA, C2K, WIMAX OFDMA, 1xEVDO, DVB-T/H, DTMB (CTTB), ISDB-T, CMMB, LTE, LTE-TDD, Digital Cable TV, MSR,, LTEAFDD, LTEATDD
Remote Command	[:SENSe] :ACPower:METhod IBW IBWRange FAST RBW [:SENSe] :ACPower:METhod?
Example	ACP:METh IBW ACP:METh?

Notes

FAST mode is only supported for WCDMA and C2K signal. You must be in the WCDMA or C2K mode or SA mode with 3GPP WCDMA or CDMA2K radio standard. Otherwise a setting conflict error message will be reported.

In the TDSCDMA mode, only the IBW method is available to use. Therefore, the measure method key is not displayed in the TD-SCDMA mode.

CDMA1xEVDO mode only supports RBW and Integration BW method.

C2K mode only supports RBW, Integration BW and FAST method.

LTE-TDD mode only supports Integration BW and Filtered IBW method.

MSR mode only supports Integration BW and Filtered IBW method.

LTE-Advanced FDD/TDD mode only support IBW and Filtered IBW method.

You must be in the mode that includes ACP measurements to use this command. Use

	:INSTrument:SElect to set the mode.
Dependencies	When RBW or FAST is selected, Gate function is not available. If you try to turn Gate On while Meas Method is RBW or FAST, an error is generated. When Gate function is ON, RBW and FAST method is not available. If you try to change Meas Method to RBW or FAST, an error is generated.
Couplings	IBW (Range) restricts the Res BW available for making this measurement to 30 kHz. When selected, the Res BW is clipped to this value if required and an error number displayed.
Preset	SA, LTE, LTETDD, MSR, LTEAFDD, LTEATDD: IBW WCDMA: IBW C2K: RBW WIMAX OFDMA: IBW 1xEVDO: IBW DVB-T/H: IBW DTMB (CTTB): IBW ISDB-T: IBW CMMB: IBW Digital Cable TV: IBW
State Saved	Saved in instrument state.
Range	Integration BW Filtered IBW (max dynamic range) RBW Fast
Readback Text	IBW Filtered IBW RBW Fast
Backwards Compatibility SCPI	[:SENSe] :ACPR :SWEep :TYPE [:SENSe] :MCPower :METHod (PSA Power Suite)
Initial S/W Revision	Prior to A.02.00
Modified at S/W Revision	A.02.00, A.03.00

Meas Type

Changes the reference used for the measurement. This allows you to make absolute and relative power measurements of either total power or the power normalized to the measurement bandwidth.

Total Pwr Ref (TPR) sets the reference to the total carrier power. PSD Ref (PSDR) sets the reference to the power spectral density of the carrier.

Key Path	Meas Setup
Mode	SA, WCDMA, C2K, WIMAX OFDMA, TD-SCDMA, 1xEVDO, DVB-T/H, DTMB (CTTB), ISDB-T, CMMB, LTE, LTETDD, Digital Cable TV, MSR, LTEAFDD, LTEATDD
Remote Command	[:SENSe] :ACPpower :TYPE TPRef PSDRef [:SENSe] :ACPpower :TYPE?
Example	ACP:TYPE PSDR ACP:TYPE?
Notes	You must be in the mode that includes ACP measurements to use this command. Use

	:INSTrument:SElect to set the mode.
Preset	TPRef
State Saved	Saved in instrument state.
Range	Total Power Ref PSD Ref
Initial S/W Revision	Prior to A.02.00
Modified at S/W Revision	A.02.00, A.03.00

PSD Ref

Sets the unit bandwidth for Power Spectral Density. The available units are dBm/Hz and dBm/MHz.

Key Path	Meas Setup
Mode	A, WCDMA, C2K, WIMAX OFDMA, TD-SCDMA, 1xEVDO, DVB-T/H, DTMB (CTTB), ISDB-T, CMMB, LTE, LTE-TDD, Digital Cable TV, MSR, LTEAFDD, LTEATDD
Remote Command	:UNIT:ACPower:POWer:PSD DBMHZ DBMMHZ :UNIT:ACPower:POWer:PSD?
Example	UNIT:ACP:POW:PSD DBMMHZ UNIT:ACP:POW:PSD?
Couplings	When the PSD unit is changed, the PSD reference result of the "MEAS READ FETCH:ACP[n]?" is also changed by the PSD unit basis (in either dBm/Hz or dBm/MHz).
Preset	DBMHZ
State Saved	Saved in instrument state.
Range	dBm/Hz dBm/MHz
Initial S/W Revision	Prior to A.02.00
Modified at S/W Revision	A.02.00, A.03.00

Limit Test

Turns limit checking for each offset On or Off. The limits may be specified within the Offset menu, for each offset, both sides of the carrier. For results that fail the limit, a red F is appended. In the Combined view, the bar turns red.

Key Path	Meas Setup
Mode	SA, WCDMA, C2K, WIMAX OFDMA, TD-SCDMA, 1xEVDO, DVB-T/H, DTMB (CTTB), ISDB-T, CMMB, LTE, LTE-TDD, Digital Cable TV, MSR, LTEAFDD, LTEATDD
Remote Command	:CALCulate:ACPower:LIMit:STATe OFF ON 0 1 :CALCulate:ACPower:LIMit:STATe?
Example	CALC:ACP:LIM:STAT OFF CALC:ACP:LIM:STAT?

Notes	You must be in the mode that includes ACP measurements to use this command. Use :INSTrument:SElect to set the mode.
Preset	SA: OFF WCDMA: ON C2K: ON WIMAX OFDMA: OFF TD-SCDMA: ON 1xEVDO: ON DVB-T/H: OFF DTMB (CTTB): ON ISDB-T: OFF CMMB: ON LTE, LTETDD, MSR, LTEAFDD, LTEATDD: ON Digital Cable TV: OFF
State Saved	Saved in instrument state.
Range	On Off
Backwards Compatibility SCPI	[:SENSe] :MCPower:LIMit [:STATe] [:SENSe] :ACPpower:LIMit [:STATe]
Initial S/W Revision	Prior to A.02.00
Modified at S/W Revision	A.02.00, A.03.00

Noise Correction

Sets the measurement noise floor correction function to On or Off. On enables measurement noise correction when the measured power in the reference channel or any offset is close to the noise floor of the analyzer. Off turns these corrections off.

In analyzers with the noise floor extensions option (option NFE) enabled, there are two ways to compensate for the analyzer noise floor: through the NFE and through this noise corrections key. The techniques are results are similar but not identical. NFE uses a model of the analyzer noise floor, adapted to the current conditions such as center frequency, RBW and ambient temperature. The parameters of this model are measured in the factory or field calibration in a highly averaged measurement. So they are consistent. However, because the model is imperfect, the corrections are imperfect. Using NFE is very convenient; the user need not wait for the ACP noise corrections calibration to occur. The ACP NC calibration, though, has advantages of being measured very recently, at the current ambient, and the exact center frequency, with no requirement that the model be perfect. So it will often (but not always) have slightly better dynamic range. If both ACP NC is turned on and NFE is turned on, the analyzer uses only the ACP NC. When ACP NC is turned off but NFE is on, NFE is used and performance should still be excellent.

Key Path	Meas Setup
Mode	SA, WCDMA, C2K, WIMAX OFDMA, TD-SCDMA, 1xEVDO, DVB-T/H, DTMB (CTTB), ISDB-T, CMMB, LTE, LTETDD, Digital Cable TV, MSR, LTEAFDD, LTEATDD
Remote Command	[:SENSe] :ACPpower:CORRection:NOISe [:AUTO] OFF ON 0 1

	<code>[:SENSe] :ACPower :CORRection :NOISe [:AUTO] ?</code>
Example	ACP:CORR:NOIS OFF ACP:CORR:NOIS?
Notes	You must be in the mode that includes ACP measurements to use this command. Use <code>:INSTrument:SElect</code> to set the mode.
Dependencies	This parameter is unavailable when Meas Method is set to RBW or Fast.
Preset	0
State Saved	Saved in instrument state.
Range	On Off
Initial S/W Revision	Prior to A.02.00
Modified at S/W Revision	A.02.00, A.03.00, A.04.00

Meas Preset

Restores all the measurement parameters to their default values.

Key Path	Meas Setup
Mode	SA, WCDMA, C2K, WIMAX OFDMA, TD-SCDMA, 1xEVDO, DVB-T/H, DTMB (CTTB), ISDB-T, CMMB, LTE, LTETDD, Digital Cable TV, MSR, LTEAFDD,LTEATDD
Remote Command	<code>:CONFigure:ACPower</code>
Example	CONF:ACP
Notes	You must be in the mode that includes ACP measurements to use this command. Use <code>:INSTrument:SElect</code> to set the mode.
Couplings	Selecting Meas Preset will restore all measurement parameters to their default values.
Initial S/W Revision	Prior to A.02.00
Modified at S/W Revision	A.02.00, A.03.00

Offset RRC Weighting (Backward Compatibility SCPI)

Mode	SA, WCDMA, TD-SCDMA, WIMAX OFDMA, DVB-T/H, DTMB (CTTB), ISDB-T, CMMB, LTE, LTETDD, Digital Cable TV, MSR, LTEAFDD,LTEATDD
Remote Command	<code>[:SENSe] :ACPower :FILTer [:RRC] [:STATe] OFF ON 0 1</code> <code>[:SENSe] :ACPower :FILTer [:RRC] [:STATe] ?</code>
Example	ACP:FILT OFF ACP:FILT?
Notes	This parameter is not available for cdma2000 and 1xEVDO The backwards Compatibility SCPI command, <code>[:SENSe] :ACPR :FILTer [:RRC] [:STATe]</code> , is provided to support same functionality as <code>[:SENSe] :ACPr :FILTer [:RRC] [:STATe]</code> (PSA W-CDMA, PSA cdma2000 and PSA 1xEVDO) due to ACPr node conflicts with ACPower node.

	You must be in the mode that includes ACP measurements to use this command. Use :INSTrument:SElect to set the mode.
Couplings	This command is an alias to [:SENSe]:ACPower:OFFSet[1]2:LIST:FILTer[:RRC][:STATe] Sending the commands to set values of all offsets for BS and MS, however, sending the query always return a value of BS Offset A.
Preset	SA, WIMAX OFDMA, LTE, LTETDD, MSR: OFF WCDMA: ON C2K: NO TD-SCDMA: ON DVB-T/H: OFF DTMB (CTTB):ON ISDB-T: OFF CMMB: OFF Digital Cable TV: ON LTEAFDD,LTEATDD: OFF
State Saved	Saved in instrument state.
Backwards Compatibility SCPI	[:SENSe]:ACPR:FILTer[:RRC][:STATe] [:SENSe]:MCPower:FILTer[:RRC][:STATe]
Initial S/W Revision	Prior to A.02.00
Modified at S/W Revision	A.03.00

Offset Filter Alpha (Backward Compatibility SCPI)

Mode	SA, WCDMA, WIMAX OFDMA, TD-SCDMA, DVB-T/H, DTMB (CTTB), ISDB-T, CMMB, LTE, LTETDD, Digital Cable TV, MSR, LTEAFDD,LTEATDD
Remote Command	[:SENSe]:ACPower:FILTer[:RRC]:ALPHa <real> [:SENSe]:ACPower:FILTer[:RRC]:ALPHa?
Example	ACP:FILT:ALPH 0.5 ACP:FILT:ALPH?
Notes	This parameter is not available for cdma2000 and 1xEVDO The backwards Compatibility SCPI command, [:SENSe]:ACPR:FILTer[:RRC]:ALPHa, is provided to support same functionality as [:SENSe]:ACPr:FILTer[:RRC]:ALPHa (PSA W-CDMA, PSA cdma2000 and PSA 1xEVDO) due to ACPr node conflicts with ACPower node. You must be in the mode that includes ACP measurements to use this command. Use :INSTrument:SElect to set the mode.
Couplings	This command is an alias to [:SENSe]:ACPower:OFFSet[1]2:LIST:FILTer:ALPHa Sending the commands to set values of all offsets for BS and MS, however, sending the query always

	return a value of BS Offset A.
Preset	SA, WCDMA, WIMAX OFDMA, TD-SCDMA, DVB-T/H, ISDB-T, CMMB, LTE, LTETDD, MSR: 0.22 C2K: NO DTMB (CTTB): 0.05 Digital Cable TV: 0.15 LTEAFDD,LTEATDD: 0.22
State Saved	Saved in instrument state.
Min	0.01
Max	1.00
Backwards Compatibility SCPI	<code>[:SENSe] :ACPR:FILTer [:RRC] :ALPHa</code> <code>[:SENSe] :MCPower:FILTer [:RRC] :ALPHa</code>
Initial S/W Revision	Prior to A.02.00
Modified at S/W Revision	A.03.00

Method for Carrier (Backward Compatibility SCPI)

Mode	SA, WCDMA, WIMAX OFDMA, TD-SCDMA, DVB-T/H, DTMB (CTTB), ISDB-T, CMMB, LTE, LTETDD, Digital Cable TV, MSR
Remote Command	<code>[:SENSe] :ACPower:CARRier [1] 2 :LIST:METHod IBW RRC, ...</code> <code>[:SENSe] :ACPower:CARRier [1] 2 :LIST:METHod?</code>
Example	ACP:CARR2:LIST:METH RRC ACP:CARR2:LIST:METH?
Notes	You must be in the mode that includes ACP measurements to use this command. Use :INSTrument:SElect to set the mode. Maximum of Array length depends on the number of carriers.
Couplings	This command is an alias to <code>[:SENSe] :ACPower:CARRier [1] 2 :LIST:FILTer [:RRC] [:STATe]</code> The enum value translates as follows: RRC Weighted = 1 ON Integ BW = 0 OFF Maximum of Array length depends on the number of carriers.
Preset	SA: IBW WCDMA: RRC WIMAX OFDMA: IBW TD-SCDMA: RRC DVB-T/H: IBW DTMB (CTTB): RRC ISDB-T: IBW CMMB: IBW

	LTE, MSR: IBW LTETDD: IBW Digital Cable TV: RRC
State Saved	Saved in instrument state.
Initial S/W Revision	Prior to A.02.00
Modified at S/W Revision	A.03.00

Mode

See "Mode" on page 316

Mode Preset

Returns the active mode to a known state.

Mode Preset does the following for the currently active mode:

- Aborts the currently running measurement.
- Brings up the default menu for the mode, with no active function.
- Sets measurement Global settings to their preset values for the active mode only.
- Activates the default measurement.
- Brings up the default menu for the mode.
- Clears the input and output buffers.
- Sets Status Byte to 0.

Mode Preset does not:

- Cause a mode switch
- Affect mode persistent settings
- Affect system settings

See "[How-To Preset](#)" on page 951 for more information.

Key Path	Front-panel key
Remote Command	:SYSTem:PRESet
Example	:SYST:PRES
Notes	*RST is preferred over :SYST:PRES for remote operation. *RST does a Mode Preset, as done by the :SYST:PRES command, and it sets the measurement mode to Single measurement rather than Continuous for optimal remote control throughput. Clears all pending OPC bits. The Status Byte is set to 0.
Couplings	A Mode Preset aborts the currently running measurement, activates the default measurement, and gets the mode to a consistent state with all of the default couplings set.
Backwards Compatibility Notes	In the X-Series, the legacy "Factory Preset" has been replaced with Mode Preset, which only presets the currently active mode, not the entire instrument. In the X-Series, the way to preset the entire instrument is by using System, Restore System Defaults All, which behaves essentially the same way as restore System Defaults does on ESA and PSA. There is also no "Preset Type" as there is on the PSA. There is a green Mode Preset front-panel key that does a Mode Preset and a white-with-green-letters User Preset front-panel key that does a User Preset. The old PRESet:TYPE command is ignored (without generating an error), and SYST:PRES without a parameter does a Mode Preset, which should cover most backward code compatibility issues. The settings and correction data under the Input/Output front-panel key (examples: Input Z Corr, Ext Amp Gain, etc.) are no longer part of any Mode, so they will not be preset by a Mode Preset. They are preset using Restore Input/Output Defaults, Restore System Defaults All. Note that because User Preset does a Recall State, and all of these settings are saved in State, they ARE recalled when using

	User Preset.
Initial S/W Revision	Prior to A.02.00

How-To Preset

The table below shows all possible presets, their corresponding SCPI commands and front-panel access (key paths). Instrument settings depend on the current measurement context. Some settings are local to the current measurement, some are global (common) across all the measurements in the current mode, and some are global to all the available modes. In a similar way, restoring the settings to their preset state can be done within the different contexts.

Auto Couple - is a measurement local key. It sets all Auto/Man parameter couplings in the measurement to Auto. Any Auto/Man selection that is local to other measurements in the mode will not be affected.

Meas Preset - is a measurement local key. Meas Preset resets all the variables local to the current measurement except the persistent ones.

Mode Preset - resets all the current mode's measurement local and measurement global variables except the persistent ones.

Restore Mode Defaults - resets ALL the Mode variables (and all the Meas global and Meas local variables), including the persistent ones.

Type Of Preset	SCPI Command	Front Panel Access
Auto Couple	:COUPlE ALL	Auto Couple front-panel key
Meas Preset	:CONFIgure:<Measurement>	Meas Setup Menu
Mode Preset	:SYSTem:PRESet	Mode Preset (green key)
Restore Mode Defaults	:INSTrument:DEFault	Mode Setup Menu
Restore All Mode Defaults	:SYSTem:DEFault MODEs	System Menu; Restore System Default Menu
*RST	*RST	not possible (Mode Preset with Single)
Restore Input/Output Defaults	:SYSTem:DEFault INPut	System Menu; Restore System Default Menu
Restore Power On Defaults	:SYSTem:DEFault PON	System Menu; Restore System Default Menu
Restore Alignment Defaults	:SYSTem:DEFault ALIGn	System Menu; Restore System Default Menu
Restore Miscellaneous Defaults	:SYSTem:DEFault MISC	System Menu; Restore System Default Menu
Restore All System Defaults	:SYSTem:DEFault [ALL] :SYSTem:PRESet:PERSistent	System Menu; Restore System Default Menu
User Preset	:SYSTem:PRESet:USER	User Preset Menu
User Preset All Modes	:SYSTem:PRESet:USER:ALL	User Preset Menu

Power On Mode Preset	:SYSTem:PON:TYPE MODE	System Menu
Power On User Preset	:SYSTem:PON:TYPE USER	System Menu
Power On Last State	:SYSTem:PON:TYPE LAST	System Menu

Preset Type (Remote Command Only)

As stated in the Backward Compatibility section, to be compatible with ESA/PSA the PRESet:TYPE command will be implemented as a no-op.

Mode	All
Remote Command	:SYSTem:PRESet:TYPE FACTory MODE USER :SYSTem:PRESet:TYPE?
Example	:SYST:PRESet:TYPE FACT
Notes	This command is supported for backward compatibility only. It is a no-op which does not change the behavior of any preset operation.
Preset	This is unaffected by Preset but is set to Mode on a "Restore System Defaults->All"
State Saved	No
Initial S/W Revision	Prior to A.02.00

Mode Setup

See "Mode Setup" on page 347

Peak Search

Places the selected marker on the trace point with the maximum y-axis value.

Key Path	Peak Search
Mode	SA, WCDMA, C2K, WIMAX OFDMA, TD-SCDMA, 1xEVDO, DVB-T/H, DTMB (CTTB), ISDB-T, CMMB, LTE, LTETDD, Digital Cable TV, MSR, LTEAFDD, LTEATDD
Remote Command	:CALCulate:ACPower:MARKer[1] 2 ... 12:MAXimum
Example	CALC:ACP:MARK2:MAX
Initial S/W Revision	Prior to A.02.00
Modified at S/W Revision	A.02.00, A.03.00

Next Peak

Moves the selected marker to the peak that has the next highest amplitude.

Key Path	Peak Search
Mode	SA, WCDMA, C2K, WIMAX OFDMA, TD-SCDMA, 1xEVDO, DVB-T/H, DTMB (CTTB), ISDB-T, CMMB, LTE, LTETDD, Digital Cable TV, MSR, LTEAFDD, LTEATDD
Remote Command	:CALCulate:ACPower:MARKer[1] 2 ... 12:MAXimum:NEXT
Example	CALC:ACP:MARK2:MAX:NEXT
Initial S/W Revision	Prior to A.02.00
Modified at S/W Revision	A.02.00, A.03.00

Next Pk Right

Moves the selected marker to the nearest peak to the right of the current marker that meets all enabled peak criteria.

Key Path	Peak Search
Mode	SA, WCDMA, C2K, WIMAX OFDMA, TD-SCDMA, 1xEVDO, DVB-T/H, DTMB (CTTB), ISDB-T, CMMB, LTE, LTETDD, Digital Cable TV, MSR, LTEAFDD, LTEATDD
Remote Command	:CALCulate:ACPower:MARKer[1] 2 ... 12:MAXimum:RIGHT
Example	CALC:ACP:MARK2:MAX:RIGH
Initial S/W Revision	Prior to A.02.00
Modified at S/W Revision	A.02.00, A.03.00

Next Pk Left

Moves the selected marker to the nearest peak to the left of the current marker that meets all enabled peak criteria.

Key Path	Peak Search
Mode	SA, WCDMA, C2K, WIMAX OFDMA, TD-SCDMA, 1xEVDO, DVB-T/H, DTMB (CTTB), ISDB-T, CMMB, LTE, LTE-TDD, Digital Cable TV, MSR, LTEAFDD, LTEATDD
Remote Command	:CALCulate:ACPower:MARKer [1] 2 . . . 12:MAXimum:LEFT
Example	CALC:ACP:MARK2:MAX:LEFT
Initial S/W Revision	Prior to A.02.00
Modified at S/W Revision	A.02.00, A.03.00

Marker Delta

Sets the control mode for the selected marker to Delta mode.

See Marker Delta in the "Marker Functions" section for more information.

Key Path	Peak Search
Initial S/W Revision	Prior to A.02.00

Pk-Pk Search

Finds and displays the amplitude and frequency (or time, if in zero span) differences between the highest and lowest y-axis value.

Key Path	Peak Search
Mode	SA, WCDMA, C2K, WIMAX OFDMA, TD-SCDMA, 1xEVDO, DVB-T/H, DTMB (CTTB), ISDB-T, CMMB, LTE, LTE-TDD, Digital Cable TV, MSR, LTEAFDD, LTEATDD
Remote Command	:CALCulate:ACPower:MARKer [1] 2 . . . 12:PTPeak
Example	CALC:ACP:MARK:PTP
Notes	Turns on the Marker Δ active function.
Couplings	This key is not available (key is grayed out) when Coupled Markers is on.
Initial S/W Revision	Prior to A.02.00
Modified at S/W Revision	A.02.00, A.03.00

Min Search

Moves the selected marker to the minimum y-axis value on the current trace.

10 ACP Measurement
Peak Search

Key Path	Peak Search
Mode	SA, WCDMA, C2K, WIMAX OFDMA, TD-SCDMA, 1xEVDO, DVB-T/H, DTMB (CTTB), ISDB-T, CMMB, LTE, LTEFDD, Digital Cable TV, MSR, LTEAFDD, LTEATDD
Remote Command	:CALCulate:ACPower:MARKer[1] 2 ... 12:MINimum
Example	CALC:ACP:MARK:MIN
Initial S/W Revision	Prior to A.02.00
Modified at S/W Revision	A.02.00, A.03.00

Print

See "Print" on page 365

Quick Save

The Quick Save front-panel key repeats the most recent save that was performed from the Save menu, with the following exceptions:

- Register saves are not remembered as Saves for the purpose of the Quick Save function
- If the current measurement does not support the last non-register save that was performed, an informational message is generated, “File type not supported for this measurement”

Quick Save repeats the last type of qualified save (that is, a save qualified by the above criteria) in the last save directory by creating a unique filename using the Auto File Naming algorithm described below.

If Quick Save is pressed after startup and before any qualified Save has been performed, the Quick Save function performs a Screen Image save using the current settings for Screen Image saves (current theme, current directory), which then becomes the “last save” for the purpose of subsequent Quick Saves.

The Auto File Naming feature automatically generates a file name for use when saving a file. The filename consists of a prefix and suffix separated by a dot, as is standard for the Windows® file system. A default prefix exists for each of the available file types:

Type	Default Prefix	Menu
State	State_	(Save/Recall)
Trace + State	State_	(Save/Recall)
Screen	Screen_	(Save/Recall)
Amplitude Corrections	Ampcor_	(Import/Export)
Traces	Trace_	(Import/Export)
Limit Lines	LLine_	(Import/Export)
Measurement Result	MeasR_	(Import/Export)
Capture Buffer	CapBuf_	(Import/Export)

A four digit number is appended to the prefix to create a unique file name. The numbering sequence starts at 0000 within each Mode for each file type and updates incrementally to 9999, then wraps to 0000 again. It remembers where it was through a Mode Preset and when leaving and returning to the Mode. It is reset by Restore Misc Defaults and Restore System Defaults and subsequent running of the instrument application. So, for example, the first auto file name generated for State files is State_0000.state. The next is State_0001, and so forth.

One of the key features of Auto File Name is that we guarantee that the Auto File Name will never conflict with an existing file. The algorithm looks for the next available number. If it gets to 9999, then it looks for holes. If it find no holes, that is no more numbers are available, it gives an error.

For example, if when we get to State_0010.state there is already a State_0010.state file in the current directory, it advances the counter to State_0011.state to ensure that no conflict will exist (and then it verifies that State_0011.state also does not exist in the current directory and advances again if it does, and so forth).

If you enter a file name for a given file type, then the prefix becomes the filename you entered instead of the default prefix, followed by an underscore. The last four letters (the suffix) are the 4-digit number.

For example, if you save a measurement results file as “fred.csv”, then the next auto file name chosen for a measurement results save will be fred_0000.csv.

NOTE

Although 0000 is used in the example above, the number that is used is actually the current number in the Meas Results sequence, that is, the number that would have been used if you had not entered your own file name.

NOTE

If the filename you entered ends with _dddd, where d=any number, making it look just like an auto file name, then the next auto file name picks up where you left off with the suffix being dddd + 1.

Key Path	Front-panel key
Notes	No remote command for this key specifically.
Initial S/W Revision	Prior to A.02.00

Recall

In the LTE TDD mode, four types of recall functions are available under the Data menu: “Limit Mask”, “E-UTRA Test Model”, “Signal Studio Setup” and “Vector Signal Analyzer”. “Limit Mask” enables setting of a preset limit mask for Power Suite-based measurements, and currently it is available for the SEM/ACP measurements with the LTE TDD mode. Recalling “E-UTRA Test Model” sets complicated RB settings for each Test Model for the Modulation Analysis and Conformance EVM measurements. Recalling “Signal Studio Setup” or “89600 Vector Signal Analyzer” enables you to recall parameters which have been set and saved on the external platform.

Key Path	Front Panel
Mode	LTETDD
Initial S/W Revision	Prior to A.02.00
Modified at S/W Revision	A.06.00

State

The Recall State menu lets you choose a register or file from which to recall the state.

The content of a state file includes all of the settings and data required to return the analyzer as closely as possible to the Mode it was in, with the exact settings that were in place, when the save occurred. The Mode settings in each state file include the settings that are affected by Mode Preset, as well as the additional settings affected by Restore Mode Defaults; all of the Mode’s settings. In addition, all of the settings of the Input/Output system are included, even though they are outside of the Mode’s state, because they are needed to restore the complete setup. Persistent System settings (for example, GPIB address) are not affected by either a Mode Preset or Restore Mode Defaults, nor are they included in a saved State file.

Since each state file is only for one Mode, the settings for other Modes are unaffected when it is loaded. Recall State will cause a mode switch if the state being recalled is not from the current active mode.

After the recall completes, the message "File <filename> recalled" or “Recalled State Register <register number>” is displayed.

For rapid recalls, the State menu lists 16 registers that you can choose from to recall. Pressing a Register key initiates the recall. You can also select a file from which to recall.

The default path for all State Files is:

My Documents\<<mode name>\state

where <mode name> is the parameter used to select the mode with the INST:SEL command (for example, SA for the Spectrum Analyzer).

See "[More Information](#)" on page 961.

Key Path	Recall
Mode	All

Remote Command	:MMEMory:LOAD:STATe <filename>
Example	:MMEM:LOAD:STAT "myState.state" This recalls the file myState.state on the default path
Example	MMEM:LOAD:STAT "MyStateFile.state" This loads the state file data (on the default file directory path) into the instrument state.
Notes	<p>When you pick a file to recall, the analyzer first verifies that the file is recallable in the current instrument by checking the software version and model number of the instrument. If everything matches, a full recall proceeds by aborting the currently running measurement, clearing any pending operations, and then loading the State from the saved state file. You can open state files from any mode, so recalling a State file switches to the mode that was active when the save occurred. After switching to the mode of the saved state file, mode settings and data (if any for the mode) are loaded with values from the saved file. The saved measurement of the mode becomes the newly active measurement and the data relevant to the measurement (if there is any) is recalled.</p> <p>If there is a mismatch between file version or model number or instrument version or model number, the recall function tries to recall as much as possible and returns a warning message. It may limit settings that differ based on model number, licensing or version number.</p> <p>After recalling the state, the Recall State function does the following:</p> <ul style="list-style-type: none"> • Makes the saved measurement for the mode the active measurement. • Clears the input and output buffers. • Status Byte is set to 0. • Executes a *CLS <p>If the file specified is empty an error is generated. If the specified file does not exist, another error is generated. If there is a mismatch between the file and the proper file type, an error is generated. If there is a mismatch between file version or model number or instrument version or model number, a warning is displayed. Then it returns to the State menu and File Open dialog goes away.</p> <p>After the Recall, the analyzer exits the Recall menu and returns to the previous menu.</p>
Backwards Compatibility SCPI	:MMEMory:LOAD:STATe 1,<filename> For backwards compatibility, the above syntax is supported. The "1" is simply ignored.
Initial S/W Revision	Prior to A.02.00

More Information

In measurements that support saving Traces, for example, Swept SA, the Trace data is saved along with the State in the State file. When recalling the State, the Trace data is recalled as well. Traces are recalled exactly as they were stored, including the writing mode and update and display modes. If a Trace was updating and visible when the State was saved, it will come back updating and visible, and its data will be rewritten right away. When you use State to save and recall traces, any trace whose data must be preserved should be placed in View or Blank mode before saving.

The following table describes the Trace Save and Recall possibilities:

You want to recall state and one trace's data, leaving other traces unaffected.	Save Trace+State from 1 trace. Make sure that no other traces are updating (they should all be in View	On Recall, specify the trace you want to load the one trace's data into. This trace will load in View.
---	---	--

	or Blank mode) when the save is performed.	All other traces' data will be unaffected, although their trace mode will be as it was when the state save was performed.
You want to recall all traces	Save Trace+State from ALL traces.	On Recall, all traces will come back in View (or Blank if they were in Blank or Background when saved)
You want all traces to load exactly as they were when saved.	Save State	On recall, all traces' mode and data will be exactly as they were when saved. Any traces that were updating will have their data immediately overwritten.

From File...

When you press “From File”, the analyzer brings up a Windows dialog and a menu entitled “File Open.” This menu allows you to navigate to the various fields in the Windows dialog without using a keyboard or mouse. The Tab and Arrow keys can also be used for dialog navigation.

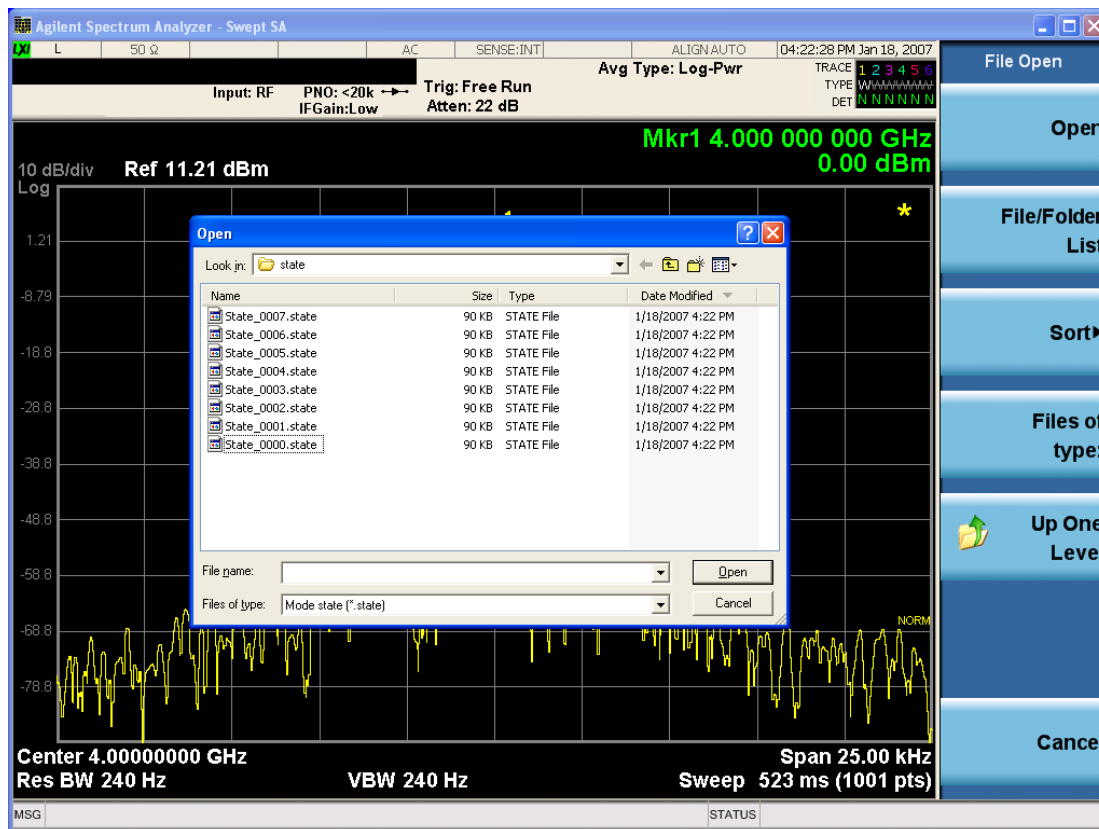

Listed below are the functions of the various fields in the dialog, and the corresponding softkeys:

Open

Performs the recall of the specified file. While the recall is being performed, the floppy icon appears briefly in the Meas bar.

File/Folder List

Enables you to navigate to the center of the dialog that contains the list of files and folders. Once here you can get information about the file and use the tab keys to navigate to the other fields in the dialog, such as Look In.

Look In

The Look In field shows the path from which the file will be recalled and allows you to change the path using the up and down arrow keys to navigate to other paths; the Enter key to open a directory; and the Backspace key to go back one directory. The **Look In field** first uses the last path from the Save As dialog **Save In:** path for that same file type. There is no softkey for directly navigating to the Look In field, but you can use the left tab to get here from the File/Folder List.

User specified paths are remembered when you leave and return to a Mode and are reset back to the default using Restore Mode Defaults.

Sort

Accesses a menu that enables you to sort the files within the File Open dialog. Only one sorting type can be selected at a time and the sorting happens immediately. The sorting types are By Date, By Name, By extension, and By Size.

Files of Type

This field shows the file suffix for the type of file you have selected to recall. For example, if you navigated here while recalling State, "Mode state (*.state)" is in the field. If you navigated here while recalling Trace, ""Mode state (*.trace)" is in the field. If you navigated here while importing a trace data file, "Trace Data (*.csv)" is in the field. For some file types, there is more than one choice in the dropdown menu, which you can select by using the up and down arrow keys and Enter.

Up One Level

This key corresponds to the icon of a folder with the up arrow that is in the tool bar of the dialog. When pressed, it causes the file and folder list to navigate up one level in the directory structure. The Backspace key does the same thing.

Cancel

This key corresponds to the Cancel selection in the dialog. It causes the current **Open** request to be cancelled. The ESC key does the same thing.

Key Path	Recall, State
Notes	Brings up the Open dialog for recalling a State Save Type
Initial S/W Revision	Prior to A.02.00

Edit Register Names

You may enter a custom name on any of the Register keys, to help you remember what you are using that state to save. To do this, press the Edit Register Names key, choose the register whose name you wish to edit, and then enter the desired label using the Alpha Editor or an external PC keyboard.

The maximum number of characters that can be added is 30. In most cases, 30 characters will fit on two lines of the key.

For more information and the SCPI command, see Edit Register Names under the Save, State function.

Key Path	Recall, State
Mode	All
Dependencies	N9060A-7FP or N9060B-2FP license required to edit the register names. When the feature is not licensed, sending the SCPI command generates an error, -221, "Settings conflict;Option not available"
Initial S/W Revision	A.11.00

Register 1 thru Register 16

Selecting any one of these register keys causes the State of the mode from the specified Register to be recalled. Each of the register keys annotates whether it is empty or at what date and time it was last modified. In addition, you can use the Edit Register Names key under Save, State to enter custom names for each register.

Registers are shared by all modes, so recalling from any one of the registers will cause a mode switch to the mode that was active when the save to the Register occurred.

Although these 16 registers are the only registers available from the front panel, there are 128 state registers available in the instrument. Registers 17-128 are only available from the SCPI interface, using the *RCL command.

After the recall completes, the message "Register <register number> recalled" appears in the message bar. If you are in the Spectrum Analyzer Mode, and you are recalling a register that was saved in the Spectrum Analyzer Mode, then after the recall, you will still be in the Recall Register menu. If the Recall causes you to switch modes, then after the Recall, you will be in the Frequency menu.

If a requested register is empty an error is generated.

Key Path	Recall, State
Example	*RCL 1
Range	1-16 from front panel, 1-128 from SCPI
Readback	Date and time with seconds resolution are displayed on the key OR A custom name of up to 30 characters entered using the Save, State,Edit Register Names key OR “(empty)” if no prior save operation has been performed to this register.
Initial S/W Revision	Prior to A.02.00
Modified at S/W Revision	Prior to A.11.00

Register 1 thru Register 16

Selecting any one of these register keys causes the State of the mode from the specified Register to be recalled. Each of the register keys annotates whether it is empty or at what date and time it was last modified. In addition, you can use the Edit Register Names key under Save, State to enter custom names for each register.

Registers are shared by all modes, so recalling from any one of the registers will cause a mode switch to the mode that was active when the save to the Register occurred.

Although these 16 registers are the only registers available from the front panel, there are 128 state registers available in the instrument. Registers 17–128 are only available from the SCPI interface, using the *RCL command.

After the recall completes, the message "Register <register number> recalled" appears in the message bar. If you are in the Spectrum Analyzer Mode, and you are recalling a register that was saved in the Spectrum Analyzer Mode, then after the recall, you will still be in the Recall Register menu. If the Recall causes you to switch modes, then after the Recall, you will be in the Frequency menu.

If a requested register is empty an error is generated.

Key Path	Recall, State
Example	*RCL 1
Range	1–16 from front panel, 1–128 from SCPI
Readback	Date and time with seconds resolution are displayed on the key OR A custom name of up to 30 characters entered using the Save, State, Edit Register Names key OR “(empty)” if no prior save operation has been performed to this register.
Initial S/W Revision	Prior to A.02.00
Modified at S/W Revision	Prior to A.11.00

Recall

In the LTE TDD mode, four types of recall functions are available under the Data menu: “Limit Mask”, “E-UTRA Test Model”, “Signal Studio Setup” and “Vector Signal Analyzer”. “Limit Mask” enables setting of a preset limit mask for Power Suite-based measurements, and currently it is available for the SEM/ACP measurements with the LTE TDD mode. Recalling “E-UTRA Test Model” sets complicated RB settings for each Test Model for the Modulation Analysis and Conformance EVM measurements. Recalling “Signal Studio Setup” or “89600 Vector Signal Analyzer” enables you to recall parameters which have been set and saved on the external platform.

Key Path	Front Panel
Mode	LTETDD
Initial S/W Revision	Prior to A.02.00
Modified at S/W Revision	A.06.00

Import Trace Data

Enables you to import previously saved trace data into a Data Register and optionally display it. Selecting this key displays a menu that enables you to select the destination data register, and also enables you to choose whether or not to display the recalled data in the currently selected trace. After making these selections, select Open... and use the file dialog to select the file you want to recall.

Recalling trace data into an already used Data Register overwrites the previous data. If the data register is displayed on any trace, the display is updated to reflect the new data.

The SCPI command

```
:MMEM:LOAD:TRAC:DATA D1|D2|D3|D4|D5|D6,<filename>
```

recalls data into a specified register, but does not display it in the selected trace. Use the command

```
:DISP:<meas>:TRAC<n>:FEED D1|D2|D3|D4|D5|D6
```

to display the register in the desired trace.

It is possible to recall trace data saved by other VXA measurements, or measurements made using the LTE, LTETDD, iDEN, or 89601 applications.

Key Path	Recall, Data (Import)
Mode	VSA, LTE, LTETDD, IDEN
Remote Command	:MMEMory:LOAD:TRACe:DATA D1 D2 D3 D4 D5 D6,<filename>[,CSV TXT SDF MAT4 MAT HDF5 BIN]
Example	:MMEM:LOAD:TRAC:DATA D1,"Trc1.txt",TXT
Notes	<p>The Open: dialog box has the following filter options when you are recalling trace data::</p> <ul style="list-style-type: none"> • CSV (Comma delimited) (*.csv) • SDF (Fast) (*.sdf;*.dat) • Text (Tab delimited) (*.txt) <p>The file must have the same format as that created by the Export Recorded Data command.</p> <p>The SCPI command has an optional file format parameter. If you do not include this parameter in the SCPI command, the file format is determined by the file name extension. If no file extension is recognized, the file is scanned to determine the format.</p> <p>If you are not licensed to recall a particular file type, then error -203.9010 is returned. If the file format cannot be determined or the file cannot be recalled successfully, then error -250.5290 is returned. If the recall is successful, then advisory 0.1600 is shown.</p>
State Saved	No
Readback	Data 1 Data 2 Data 3 Data 4 Data 5 Data 6

Data 1

Selects the Data 1 register as the destination for the imported data.

Key Path	Recall, Data (Import), Trace (to)
Mode	VSA, LTE, LTETDD, IDEN

Data 2

Selects the Data 2 register as the destination for the imported data.

Key Path	Recall, Data (Import), Trace (to)
Mode	VSA, LTE, LTETDD, IDEN

Data 3

Selects the Data 3 register as the destination for the imported data.

Key Path	Recall, Data (Import), Trace (to)
Mode	VSA, LTE, LTETDD, IDEN

Data 4

Selects the Data 4 register as the destination for the imported data.

Key Path	Recall, Data (Import), Trace (to)
Mode	VSA, LTE, LTETDD, IDEN

Data 5

Selects the Data 5 register as the destination for the imported data..

Key Path	Recall, Data (Import), Trace (to)
Mode	VSA, LTE, LTETDD, IDEN

Data 6

Selects the Data 6 register as the destination for the imported data.

Key Path	Recall, Data (Import), Trace (to)
Mode	VSA, LTE, LTETDD, IDEN

Display in Selected Trace

Enables you to select whether the recalled trace data is displayed in the current Trace.

Key Path	Recall, Data (Import), Trace (to)
----------	-----------------------------------

Mode	VSA, LTE, LTETDD, IDEN
State Saved	No

Signal Studio Setup

This key allows you to recall the Agilent Signal Studio setup file created on the Signal Studio (N7625B). This key is valid only for the Mod Analysis measurement. For E-TM test model signal, please use corresponding EVM setup file under My Documents\LTETDD\data\evmsetup.

For the supported carrier types, see the table below.

Signal Studio	Carrier Type
N7625B Signal Studio for 3GPP LTE TDD	Advanced LTE TDD(2009-03)
	Advanced LTE TDD(2009-12)
	Basic LTE TDD(2009-03)
	Basic LTE TDD(2009-12)

File Location and Extension

File location: "My Documents\LTETDD\data"

File type: xml

File extension: .scp

You need to place the Signal Studio Setup file created on N7625B in the above directory in advance. Pressing OPEN under the Import Data menu will open this directory from which you can select the setup file.

Example:

File Location: My Documents\LTETDD\data

File Name: Uplink PUSCH.scp

Key Path	Recall, Data
Mode	LTETDD
Remote Command	MMEemory:LOAD:SSSetup <string>
Example	MME:LOAD:SSS "Uplink PUSCH.scp"
Notes	Sets of parameters related to Signal Studio Setup are overwritten by the contents of the setup file.
Initial S/W Revision	A.06.00

89601 VSA Setup

Enables you to import the 89600 Vector Signal Analyzer Setup file created using the 89600 Vector Signal Analyzer Option BHE (LTE TDD). This key is valid only for the Mod Analysis measurement.

File Location and Extension

File location: “My Documents\LTETDD\data”

File type: text file

File extension: .set, .setx

Place the 89600 Vector Signal Analyzer Setup file that you saved on 89600 in the above directory. When you select OPEN under the Import Data menu, the directory opens enabling you to select your setup file.

Example:

File Location: My Documents\LTETDD\data

File Name: Uplink PRACH.set

Key Path	Recall, Data
Mode	LTETDD
Remote Command	MMEMory:LOAD:VSASetup <string>
Example	MMEM:LOAD:VSAS "Uplink PRACH.set"
Notes	Sets of parameters related to Vector Signal Analyzer Setup are overwritten by the contents of the setup file.
Initial S/W Revision	A.06.00
Modified at S/W Revision	A.10.00

Masks

This key allows you to recall a preset mask file from the list. The preset mask file contains configuration for only Carrier, Offset, Limit settings and the preset profile BW. Any set of values not specified by the preset mask file will not be overwritten.

You cannot change or create the preset mask file since it is a binary file. This key is valid for the Spectrum Emission Mask and ACP measurements.

File location: “My Documents\LTETDD\data.masks”

Note that “My Documents” is an alias to a directory and its place differs depending on which user is logged in. At XSA start up, XSA will overwrite all of the limit mask files to the current user’s “My Documents\LTETDD\data.masks” each time.

File type: Binary

Filename: The filename follows the rule below, in which the word is connected with underscores.

<Measurement>_<Direction>_<Bandwidth>_<Condition>.mask

Where

<Measurement> Measurement the limit mask file is applied to: SEM or ACP

<Direction> Direction: BS (Downlink) or MS (Uplink).

<Bandwidth> Bandwidth

<Condition> Condition. It depends on the measurement.

File extension: .mask

Pressing OPEN under the Import Data menu will open the above directory from which you can select a mask file. When you change the Bandwidth or Direction, all Power Suite measurement parameters are reset to the hard coded preset parameters. Thus you must recall the appropriate preset mask file again after the change.

You cannot read the contents of the provided preset mask file since it is a binary file. Detailed contents of the file are provided by a PDF format file located in the same directory as the preset mask file.

Example:

File Location: My Documents/LTETDD/data/masks/SEM_MS

File Name: SEM_MS_15MHz_Add_NS04.mask

The following table shows the sets of variables imported to the ACP measurement.

Offset	Start Freq (MHz)	Stop Freq (MHz)	Res BW (Hz)	Meas BW	Rel Start	Rel Stop	Fail Mask
A	5	7.14	30k	1	-8	-25	Rel
B	7.14	10.57	30k	1	-25	-27	Rel
C	10.57	20	30k	1	-27	-50	Rel
D	20	25	30k	1	-50	-50	Rel
E	25	30	30k	1	-50	-50	Rel

Key Path	Recall, Data
Mode	LTETDD
Remote Command	MMEemory:LOAD:MASK <string>
Example	MMEM:LOAD:MASK "ACP_BS\ACP_BS_3MHz_pairE-UTRA_CatA.mask"
Notes	Sets of parameters related to Limit, Carrier and Offset are overwritten by the contents of the preset mask file.
Initial S/W Revision	A.03.00

EVM Setup

This key allows you to recall EVM parameter setting to measure E-UTRA Test Model in 3GPP standard (36.141-810 6.1.1).

- E-UTRA Test Model 1.1 (E-TM1.1)
- E-UTRA Test Model 1.2 (E-TM1.2)
- E-UTRA Test Model 2 (E-TM2)
- E-UTRA Test Model 3.1 (E-TM3.1)

- E-UTRA Test Model 3.2 (E-TM3.2)
- E-UTRA Test Model 3.3 (E-TM3.3)

This key is valid for the Modulation Analysis and Conformance EVM measurements only.

File Location and Extension

File location: My Documents\LTETDD\data\evmsetup

Note that “My Documents” is an alias to a directory and its place differs depending on which user is logged in. At XSA start up, XSA will overwrite all of the EVM Setup files to the current user’s “My Documents\LTETDD\data\evmsetup” each time.

File type: binary

File extension: .evms

Pressing OPEN under the Import Data menu will open the above directory from which you can select an EVM Setup file. When you change the Bandwidth, parameters are reset to the hard coded preset parameters. Thus you must recall the appropriate EVM Setup file again after the change.

You cannot read the contents of the provided EVM Setup file since it is a binary file.

Example:

File Location: My Documents\LTETDD\data\evmsetup

Filename: TM3.1-BW1.4MHz.evms

Key Path	Recall, Data
Mode	LTETDD
Remote Command	MMEemory:LOAD:EVMSSetup <string>
Example	MMEM:LOAD:EVMS "TM2-BW15MHz.evms"
Notes	Sets of parameters related to EVM Setup are overwritten by the contents of the EVM Setup file.
Initial S/W Revision	A.03.00, A.08.00

Open...

When you press “Open”, the analyzer brings up a Windows dialog and a menu entitled “**File Open.**” This menu allows you to navigate to the various fields in the Windows dialog without using a keyboard or mouse. The Tab and Arrow keys can also be used for dialog navigation.

See "[From File...](#)" on page 2797 in Recall, State, for a full description of this dialog and menu.

Key Path	Recall, Data
Notes	The key location is mode-dependent and will vary. Brings up Open dialog for recalling a <mode specific> Save Type
Initial S/W Revision	Prior to A.02.00

Restart

The Restart function restarts the current sweep, or measurement, or set of averaged/held sweeps or measurements. If you are Paused, pressing Restart does a Resume.

The Restart function is accessed in several ways:

- Pressing the Restart key
- Sending the remote command INIT:IMMEDIATE
- Sending the remote command INIT:RESTART

See "[More Information](#)" on page 972

Key Path	Front-panel key
Remote Command	:INITiate[:IMMEDIATE] :INITiate:RESTART
Example	:INIT:IMM :INIT:REST
Notes	:INITiate:RESTART and :INITiate:IMMEDIATE perform exactly the same function.
Couplings	Resets average/hold count k. For the first sweep overwrites all active (update=on) traces with new current data. For application modes, it resets other parameters as required by the measurement.
Status Bits/OPC dependencies	This is an Overlapped command. The STATus:OPERation register bits 0 through 8 are cleared. The STATus:QUESTionable register bit 9 (INTegrity sum) is cleared. The SWEEPING bit is set. The MEASURING bit is set.
Backwards Compatibility Notes	For Spectrum Analysis mode in ESA and PSA, the Restart hardkey and the INITiate:RESTART command restart trace averages (displayed average count reset to 1) for a trace in Clear Write, but did not restart Max Hold and Min Hold. In the X-Series, the Restart hardkey and the INITiate:RESTART command restart not only Trace Average, but MaxHold and MinHold traces as well. For wireless comms modes in ESA and PSA, the Restart hardkey and the INITiate:RESTART command restart every measurement, which includes all traces and numeric results. There is no change to this operation.
Initial S/W Revision	Prior to A.02.00

More Information

The **Restart** function first aborts the current sweep/measurement as quickly as possible. It then resets the sweep and trigger systems, sets up the measurement and initiates a new data measurement sequence with a new data acquisition (sweep) taken once the trigger condition is met.

If the analyzer is in the process of aligning when **Restart** is executed, the alignment finishes before the restart function is performed.

Even when set for Single operation, multiple sweeps may be taken when Restart is pressed (for example, when averaging/holding is on). Thus when we say that **Restart** "restarts a measurement," we may mean:

- It restarts the current sweep
- It restarts the current measurement
- It restarts the current set of sweeps if any trace is in Trace Average, Max Hold or Min Hold
- It restarts the current set of measurements if Averaging, or Max Hold, or Min Hold is on for the measurement
- depending on the current settings.

With **Average/Hold Number** (in **Meas Setup** menu) set to 1, or Averaging off, or no trace in Trace Average or Hold, a single sweep is equivalent to a single measurement. A single sweep is taken after the trigger condition is met; and the analyzer stops sweeping once that sweep has completed. However, with **Average/Hold Number** >1 and at least one trace set to **Trace Average, Max Hold, or Min Hold (SA Measurement)** or **Averaging on (most other measurements)**, multiple sweeps/data acquisitions are taken for a single measurement. The trigger condition must be met prior to each sweep. The sweep is stopped when the average count k equals the number N set for **Average/Hold Number**. A measurement average usually applies to all traces, marker results, and numeric results; but sometimes it only applies to the numeric results.

Once the full set of sweeps has been taken, the analyzer will go to idle state. To take one more sweep without resetting the average count, increment the average count by 1, by pressing the step up key while **Average/Hold Number** is the active function, or sending the remote command `CALC:AVER:TCON UP`.

Save

The Save menu lets you choose what you want to save and where you want to save it. Among the types of files you can save are **States**, **Traces**, and **Screen Images**. In addition, an Export (Data) option lets you save a number of data types as CSV files for easy import into Excel and other spreadsheet programs.

Key Path	Front-panel key
Mode	All
Notes	No remote command for this key specifically, but the :MMEM:STOR:STATe <filename> command is available for specific file types. An example is :MMEM:STOR:STATe <filename>.
Initial S/W Revision	Prior to A.02.00

State

The Save State menu lets you choose a register or file for saving the state.

The content of a state file includes all of the settings and data required to return the analyzer as closely as possible to the Mode it was in, with the exact settings which were in place, when the save occurred. The Mode settings in each state file include the settings that are affected by Mode Preset, as well as the additional settings affected by Restore Mode Defaults; all of the Mode's settings. In addition, all of the settings of the Input/Output system are included, even though they are outside of the Mode's state, because they are needed to restore the complete setup. Persistent System settings (for example, Verbose SCPI) are not affected by either Mode Preset or Restore Mode Defaults, nor are they included in a saved State file.

After the save completes, the message "File <filename> saved" or "State Register <register number> saved" is displayed.

For rapid saving, the State menu lists 16 registers to save to. Pressing a Register key initiates the save. You can also select a file to save to.

The default path for all State Files is:

My Documents\<<mode name>\state

where <mode name> is the parameter used to select the mode with the INST:SEL command (for example, SA for the Spectrum Analyzer).

Key Path	Save
Mode	All
Remote Command	:MMEMory:STORe:STATe <filename>
Example	MMEM:STOR:STATe "MyStateFile.state" This stores the current instrument state data in the file MyStateFile.state in the default directory.
Notes	Both single and double quotes are supported for any filename parameter over remote. After saving to a register, that register's menu key is updated with the date the time, unless a custom label has been entered for that key. After saving to a register, you remain in the Save State menu, so that you can see the Register key

update. After saving to a file, the analyzer automatically returns to the previous menu and any Save As dialog goes away.

Backwards Compatibility SCPI	:MMEMoRY:STORe:STATe 1,<filename>
Initial S/W Revision	Prior to A.02.00

To File . . .

When you press “To File”, the analyzer brings up a Windows dialog and a menu entitled “**Save As.**” This menu allows you to navigate to the various fields in the Windows dialog without using a keyboard or mouse. The Tab and Arrow keys can also be used for dialog navigation.

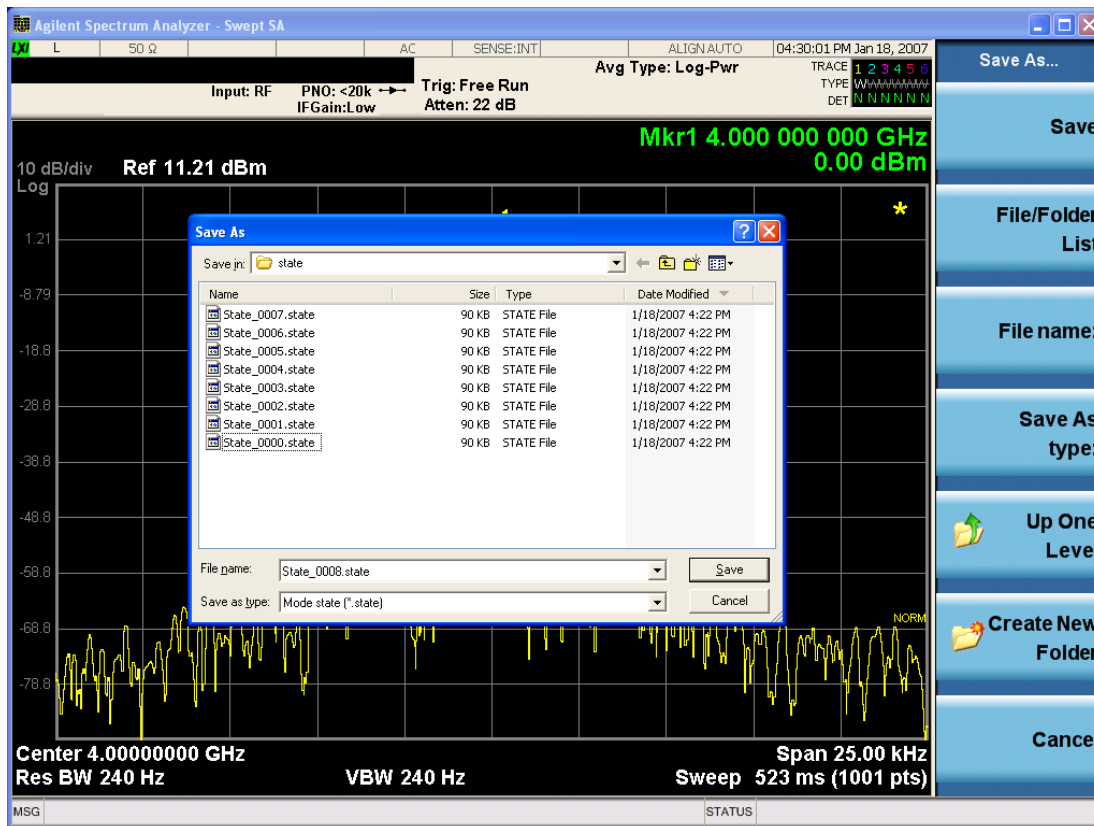

The Listed below

are the functions of the various fields in the dialog, and the corresponding softkeys:

Save

Performs the save to the specified file of the selected type. If the file already exists, a dialog will appear that allows you to replace the existing file by selecting OK, or you can Cancel the request. If you select OK, the file will be overwritten. Using the C: drive is strongly discouraged, since it runs the risk of being overwritten during an instrument software upgrade.

While the save is being performed, the floppy icon appears briefly in the Meas bar.

File/Folder List

Enables you to navigate to the center of the dialog that contains the list of files and folders. Once here you can get information about the file and use the tab keys to navigate to the other fields in the dialog, such as Save In.

Save In

The Save In field shows the path to which the file will be saved and allows you to change the path using the up and down arrow keys to navigate to other paths; the Enter key to open a directory; and the Backspace key to go back one directory. The **Save In field** defaults to the default path for this type of file and remembers the last path you used to save this type of file. There is no softkey for directly navigating to the Save In field but you can use left tab to get here from the File/Folder List.

User specified paths are remembered when you leave and return to a Mode and are reset back to the default using Restore Mode Defaults.

File Name

The File Name field is initially loaded with an automatically generated filename specific to the appropriate Save Type. The automatically generated filename is guaranteed not to conflict with any filename currently in the directory. You may replace or modify this filename using the File Name key. See the ["Quick Save " on page 2793](#) documentation for more on the automatic file naming algorithm.

When you press the File Name key the analyzer displays the Alpha Editor. Use the knob to choose the letter to add and the front-panel Enter key to add the letter to the file name. The BK character moves you back and the FW character moves you forward in the filename. The Select key on the front panel generates a space character. When you are done entering the filename press the Done softkey. This returns back to the **File Open** dialog and menu, but does not cause the save to occur.

Save As Type

This field shows the file suffix for the type of file you have selected to save. For example, if you navigated here while saving State, "Mode state (*.state)" is in the field. If you navigated here from saving Trace, ""Mode state (*.trace)" is in the field. If you navigated here while exporting a trace data file, "Trace Data (*.csv)" is in the field. For some file types, there is more than one choice in the dropdown, which you can select by using the up and down arrow keys and Enter.

Up One Level

This key corresponds to the icon of a folder with the up arrow that is in the tool bar of the dialog. When pressed, it causes the file and folder list to navigate up one level in the directory structure. The Backspace key does the same thing.

Create New Folder

This key corresponds to the icon of a folder with the "*" that is in the tool bar of the dialog. When pressed, a new folder is created in the current directory with the name **New Folder** and you can enter a new folder name using the Alpha Editor.

Cancel

This key corresponds to the Cancel selection in the dialog. It causes the current **Save As** request to be cancelled. The ESC key does the same thing.

Key Path	Save, State
Mode	All
Notes	Brings up Save As dialog for saving a State Save Type
Initial S/W Revision	Prior to A.02.00

Edit Register Names

You may enter a custom name on any of the Register keys, to help you remember what you are using that state to save. To do this, press the Edit Register Names key, choose the register whose name you wish to edit, and then enter the desired label using the Alpha Editor or an external PC keyboard.

The maximum number of characters that can be added is 30. In most cases, 30 characters will fit on two lines of the key.

See ["More Information" on page 977](#)

Key Path	Save, State
Mode	All
Remote Command	:MMEMory:REGister:STATe:LABel <reg number>,"label" :MMEMory:REGister:STATe:LABel? <reg number>
Example	:MMEM:REG:STAT:LAB 1,"my label"
Notes	<reg number> is an integer from 1 to 16. If the SCPI specifies an invalid register number an error message is generated, -222,"Data out of range;Invalid register label number" "label" is a string from 0 to 30 characters in length. If a label exceeds 30 characters, an error message is generated, -150,"String data error;Label clipped to 30 characters" "label" of length 0 erases the custom label and restores the default (time and date) label. E.g.: :MMEM:REG:STAT:LAB 1,""
Dependencies	N9060A-7FP or N9060B-2FP license required to edit the register names. When the feature is not licensed, sending this command generates an error, -221,"Settings conflict;Option not available"
Preset	The names are unaffected by Preset or power cycle but are set to the default label (time and date) on a "Restore System Defaults->Misc"
Initial S/W Revision	A.11.00

More Information

When you edit one of the register names, the time and date field will be replaced by the custom name.

If you delete all the characters in the custom name, it restores the default (time and date).

The register names are stored within the state files, but they are not part of the instrument state; that is, once you have edited a register name, loading a new state will not change that register name. Another consequence of this is that the names will be persistent through a power cycle. Also, if a named state file is transferred to another analyzer, it will bring its custom name along with it.

If you try to edit the name of an empty register, the analyzer will first save the state to have a file to put the name in. If you load a named state file into an analyzer with older firmware it will ignore the metadata.

The *SAV and *RCL commands will not be affected by the custom register names, nor will the MMEM commands.

Register 1 thru Register 16

Selecting any one of these register menu keys causes the State of the currently active mode to be saved to the specified Register. The registers are provided for rapid saving and recalling, since you do not need to specify a filename or navigate to a file. Each of the register menu keys annotates whether it is empty or at what date and time it was last modified. In addition, you can use the Edit Register Names key to enter custom names for each register.

Although these 16 registers are the only registers available from the front panel, there are 128 state registers available in the instrument. Registers 17–128 are only available from the SCPI interface, using the *SAV command.

There is one set of 128 state registers in the instrument, not one set for each Mode. When a state is saved, the Mode it was saved from is saved with it; then when it is recalled, the instrument switches to that Mode.

After the save completes, the corresponding register menu key annotation is updated with the date and time and the message "Register <register number> saved" is displayed.

Key Path	Save, State
Mode	All
Example	*SAV 1
Range	1–16 from front panel, 1–128 from SCPI
Readback	Date and time with seconds resolution are displayed on the key OR A custom name of up to 30 characters entered using the Edit Register Names key OR “(empty)” if no prior save operation has been performed to this register.
Initial S/W Revision	Prior to A.02.00
Modified at S/W Revision	A.11.00

Register 1 thru Register 16

Selecting any one of these register menu keys causes the State of the currently active mode to be saved to the specified Register. The registers are provided for rapid saving and recalling, since you do not need to specify a filename or navigate to a file. Each of the register menu keys annotates whether it is empty or at what date and time it was last modified. In addition, you can use the Edit Register Names key to enter custom names for each register.

Although these 16 registers are the only registers available from the front panel, there are 128 state registers available in the instrument. Registers 17–128 are only available from the SCPI interface, using the *SAV command.

There is one set of 128 state registers in the instrument, not one set for each Mode. When a state is saved, the Mode it was saved from is saved with it; then when it is recalled, the instrument switches to that Mode.

After the save completes, the corresponding register menu key annotation is updated with the date and time and the message "Register <register number> saved" is displayed.

Key Path	Save, State
Mode	All
Example	*SAV 1
Range	1–16 from front panel, 1–128 from SCPI
Readback	Date and time with seconds resolution are displayed on the key OR A custom name of up to 30 characters entered using the Edit Register Names key OR “(empty)” if no prior save operation has been performed to this register.
Initial S/W Revision	Prior to A.02.00
Modified at S/W Revision	A.11.00

Data (Export)

Exporting a data file stores data from the current measurement to mass storage files. The Export Menu only contains data types that are supported by the current measurement.

Since the commonly exported data files are in .csv format, the data can be edited by you prior to importing. This allows you to export a data file, manipulate the data in Excel (the most common PC Application for manipulating .csv files) and then import it.

Selecting an Export Data menu key will not actually cause the exporting to occur, since the analyzer still needs to know where you wish to save the data. Pressing the Save As key in this menu brings up the Save As dialog and Save As menu that allows you to specify the destination file and directory. Once a filename has been selected or entered in the Open menu, the export will occur as soon as the Save key is pressed.

Key Path	Save
Mode	All
Notes	The menu is built from whatever data types are available for the mode. So the key locations in the sub menu will vary. No SCPI command directly controls the Data Type that this key controls. The Data Type is included in the MMEM:STORe commands.
Dependencies	If a file type is not used by a certain measurement, that type is grayed out for that measurement. The key for a file type will not show at all if there are no measurements in the Mode that support it.
Preset	Is not affected by a Preset or shutdown, but is reset during Restore Mode Defaults
Readback	The data type that is currently selected
Initial S/W Revision	Prior to A.02.00

Export Trace Data

Enables you to export trace data with (optional) associated headers. Selecting this key displays a menu that enables you to choose which Trace to save (default is the selected Trace) and whether or not to save headers with the data. The header information is used by the VXA application when saved trace data is recalled, and enables it to be displayed with the same formatting and scaling that it had when saved. If headers are not saved, the scaling and format are set to default values when the trace is recalled. After making these selections, press Save As... and use the file dialog to choose a file name and format for the saved data.

Trace data can be exported in several different formats. Text and comma-separated variable (CSV) formats are useful for viewing the data or importing it to a spreadsheet program. The other formats are binary and thus more compact. Trace data files can be recalled for viewing into other VXA, LTE, LTETDD, iDEN, or 89601 measurements.

Key Path	Save, Data (Export)
Mode	VSA, LTE, LTETDD, IDEN
Remote Command	:MMEMory:STORe:TRACe:DATA TRACE1 TRACE2 TRACE3 TRACE4 TRACE5 TRACE6, "<filename>" [,CSV TXT SDF MAT4 MAT HDF5 BIN[,OFF ON 0 1]]
Example	:MMEM:STOR:TRAC:DATA TRACE1, "TRC1.TXT", TXT, ON
Notes	<p>The Save As... dialog box has the following format options when you are saving trace data:</p> <ul style="list-style-type: none"> • CSV (Comma delimited) (*.csv) • SDF (Fast) (*.sdf;*.dat) • Text (Tab delimited) (*.txt) <p>File format saved depends on selection. The appropriate file extension is appended to the filename if it is not supplied by the user.</p> <p>If the SCPI command includes just a file name, the file format is determined by the filename extension, which must be one of the choices above. *.sdf or an unrecognized extension chooses the SDF fast format. If the optional file format enumerator is included in the command, then this determines the file format and the file extension is ignored. The optional binary parameter determines if file headers are saved. The default is ON. If file headers are not wanted, use the optional "OFF" parameter.</p> <p>The optional Boolean parameter determines whether headers are saved in the file. By default the headers are saved.</p> <p>If you are not licensed to save a particular file type, then error -203.9010 is returned. If an invalid file format is specified or the file cannot be saved successfully, then error -25x is returned. If the save is successful, then advisory 0.1500 is shown.</p>
State Saved	No
Readback	(Trace 1 Trace 2 Trace 3 Trace 4 Trace 5 Trace 6)(with without) headers

Trace 1

Selects the Trace 1 register as the destination for the imported data.

Key Path	Save, Data (Export), Trace
Mode	VSA, LTE, LTETDD, IDEN

Trace 2

Selects the Trace 2 register as the destination for the imported data.

Key Path	Save, Data (Export), Trace
Mode	VSA, LTE, LTETDD, IDEN

Trace 3

Selects the Trace 3 register as the destination for the imported data.

Key Path	Save, Data (Export), Trace
Mode	VSA, LTE, LTETDD, IDEN

Trace 4

Selects the Trace 4 register as the destination for the imported data.

Key Path	Save, Data (Export), Trace
Mode	VSA, LTE, LTETDD, IDEN

Include Header

Enables you to select whether or not the saved trace data includes header information describing scaling, formatting, etc.

Key Path	Save, Data (Export), Trace
Mode	VSA, LTE, LTETDD, IDEN
State Saved	No

Measurement Results

Pressing this key selects Meas Results as the data type to be exported.

The Meas Results file contains information which describes the current state of the analyzer. It is detailed in Meas Result File Contents below.

Key Path	Save, Data
Remote Command	:MMEMory:STORe:RESults <string>
Example	:MMEM:STOR:RES "MeasR_0000.csv"
Notes	If the save is initiated via SCPI and the file already exists, the file will be overwritten.

	<p>The SCPI command exports ACP measurement results to the file specified as the parameter in the current path. The default path is My Documents\<current mode="">\data\ACP\results.</current></p> <p>Using the C: drive is strongly discouraged, since it runs the risk of being overwritten during an instrument software upgrade.</p> <p>The SCPI parameter is a quoted string that specifies the filename. Both single and double quotes are supported for any filename parameter over SCPI.</p>
Dependencies	The current active measurement must be the ACP measurement to use this command.
Status Bits/OPC dependencies	Sequential – waits for the previous measurement to complete
Initial S/W Revision	Prior to A.02.00

Meas Results File Contents

A Meas Results File contains measurement results with the following information.

- File ID string, which is “MeasResult”
- Measurement ID following Mode ID, which is “SA:ACP” for example.
- Firmware rev and model number
- Option string
- Auto Scaling
- Auto Sweep Time Rules
- Automatic Trigger Time
- Automatic Trigger Time State
- Average Mode
- Average Number
- Average State
- Bar Graph
- Carrier Coupling
- Carrier Pwr Present
- Carrier Spacing
- Carriers
- Center Frequency
- Center Frequency Step
- Center Frequency Step State
- Detector Auto

- Detector Selection
- Electrical Atten
- Electrical Atten State
- External Array Trigger Delay
- External Array Trigger Delay State
- External Array Trigger Level
- External Array Trigger Slope
- Filter Alpha
- Filter BW
- Filter Type
- Internal Preamp
- Internal Preamp Band
- Limit Test
- Line Trigger Delay
- Line Trigger Delay State
- Line Trigger Slope
- Meas Method
- Meas Type
- Measurement Noise Bandwidth
- Mechanical Atten
- MechanicalAttenStepEnum
- Method
- Noise Correction
- Offset Abs Limit
- Offset Fail
- Offset Filter Alpha
- Offset Filter BW
- Offset Filter Type
- Offset Freq
- Offset Freq State
- Offset Integ BW

- Offset Method
- Offset Rel Lim (Car)
- Offset Rel Lim (PSD)
- Offset Res BW
- Offset Res BW Mode
- Offset Video BW
- Offset Video BW Mode
- Periodic Timer Period
- Periodic Timer Sync Source
- Periodic Timer Trigger Delay
- Periodic Timer Trigger Delay State
- Points
- Power Ref
- Power Ref State
- Preselector Adjust
- PSD Ref
- PSD Unit
- Ref Car Freq
- Ref Car Freq State
- Ref Carrier
- Ref Carrier Mode
- Ref Position
- Ref Value
- Res BW
- Res BW Mode
- RFBurst Trigger Delay
- RFBurst Trigger Delay State
- RFBurst Trigger Level Abs
- RFBurst Trigger Level Rel
- RFBurst Trigger Level Type
- RFBurst Trigger Slope

- Scale/Div
- Span
- Sweep Time
- Sweep Time Auto
- Trigger Holdoff
- Trigger Holdoff State
- Trigger Source
- Video BW
- Video BW Auto

The file contains these data followed by MeasResult1, MeasResult2, and MeasResult3 that flag the start of the measurement results. Each line of Measurement Results consists of three comma separated values, MeasResult1 value, MeasResult2 value, and MeasResult3 value. MeasResult1 contains the same result as MEAS/READ/FETCH:ACPower1; MeasResult2, MEAS/READ/FETCH:ACPower2; MeasResult3, MEAS/READ/FETCH:ACPower3.

Exported file is .csv file. The Meas Results file, when imported into Excel, will show the following data:

MeasResult	
SA:ACP	
A.10.53	N9030A
526 ALV ATP	1
B1X B1Y B25	
B40 BBA CR3	
CRP DCF DDA	
DP2 DRD EA3	
EDP EMC EP1	
ERC ESC ESP	
EXM FSA LFE	
LNP MAT MPB	
NFE NUL P26	
PFR PNC RTL	
RTS S40 SB1	
SEC SM1 TVT	
YAS YAV	
Auto Scaling	TRUE
Auto Sweep Time Rules	Accy
Automatic Trigger Time	0.1
Automatic Trigger Time State	FALSE

Average Mode	Exponential											
Average Number	10											
Average State	TRUE											
Bar Graph	TRUE											
Carrier Coupling	TRUE	TRUE	TRUE	TRUE	TRUE	TRUE	TRUE	TRUE	TRUE	TRUE	TRUE	TRUE
Carrier Pwr Present	Yes	Yes	Yes	Yes	Yes	Yes	Yes	Yes	Yes	Yes	Yes	Yes
Carrier Spacing	5000000	5000000	500000	500000	500000	500000	500000	500000	500000	500000	500000	500000
Carriers	1											
Center Frequency	1.33E+10											
Center Frequency Step	800000											
Center Frequency Step State	TRUE											
Detector Auto	TRUE											
Detector Selection	Average											
Electrical Atten	0											
Electrical Atten State	FALSE											
External Array Trigger Delay	1.00E-06	1.00E-06										
External Array Trigger Delay State	FALSE	FALSE										
External Array Trigger Level	1.2	1.2										
External Array Trigger Slope	Positive	Positive										
Filter Alpha	0.22	0.22	0.22	0.22	0.22	0.22	0.22	0.22	0.22	0.22	0.22	0.22
Filter BW	Minus3dB											
Filter Type	Gaussian											
Internal	FALSE											

Preamp												
Internal Preamp Band	Low											
Limit Test	FALSE											
Line Trigger Delay	1.00E-06											
Line Trigger Delay State	FALSE											
Line Trigger Slope	Positive											
Meas Method	IbwSpeed											
Meas Type	TPRef											
Measurement Noise Bandwidth	2000000	200000	200000	200000	200000	200000	200000	200000	200000	200000	200000	200000
Mechanical Atten	10											
MechanicalAttenStepEnum	S2dB											
Method	IBW	IBW	IBW	IBW	IBW	IBW	IBW	IBW	IBW	IBW	IBW	IBW
Noise Correction	FALSE											
Offset Abs Limit	0	0	0	0	0	0	0	0	0	0	0	0
Offset Fail	Relative	Relative	Relative	Relative	Relative	Relative	Relative	Relative	Relative	Relative	Relative	Relative
Offset Filter Alpha	0.22											
Offset Filter BW	Minus3dB	Minus3dB	Minus3dB	Minus3dB	Minus3dB	Minus3dB	Minus3dB	Minus3dB	Minus3dB	Minus3dB	Minus3dB	Minus3dB
Offset Filter Type	Gaussian	Gaussian	Gaussian	Gaussian	Gaussian	Gaussian	Gaussian	Gaussian	Gaussian	Gaussian	Gaussian	Gaussian
Offset Freq	3000000	0	0	0	0	0	0	0	0	0	0	0
Offset Freq State	TRUE	FALSE	FALSE	FALSE	FALSE	FALSE	FALSE	FALSE	FALSE	FALSE	FALSE	FALSE
Offset Integ BW	2000000	200000	200000	200000	200000	200000	200000	200000	200000	200000	200000	200000
Offset Method	FALSE											
Offset Rel Lim	-45	-60	0	0	0	0	0	0	0	0	0	0

(Car)						
Offset Rel Lim (PSD)	-28.87	-43.87	0	0	0	0
Offset Res BW	220000	220000	220000	220000	220000	220000
Offset Res BW Mode	TRUE	TRUE	TRUE	TRUE	TRUE	TRUE
Offset Video BW	22000	22000	22000	22000	22000	22000
Offset Video BW Mode	TRUE	TRUE	TRUE	TRUE	TRUE	TRUE
Periodic Timer Period	0.02					
Periodic Timer Sync Source	None					
Periodic Timer Trigger Delay	1.00E-06					
Periodic Timer Trigger Delay State	FALSE					
Points	1001					
Power Ref	-76.81 dBm					
Power Ref State	On					
Preselector Adjust	0					
PSD Ref	-139.82 dBm/Hz					
PSD Unit	DbmHz					
Ref Car Freq	13.25500000 GHz					
Ref Car Freq State	On					
Ref Carrier	1					
Ref Carrier Mode	On					
Ref Position	Top					
Ref Value	-30					
Res BW	220000					
Res BW Mode	FALSE					
RFBurst	1.00E-06					

Trigger Delay		
RFBurst	FALSE	
Trigger Delay State		
RFBurst	-20	
Trigger Level Abs		
RFBurst	-6	
Trigger Level Rel		
RFBurst	Absolute	
Trigger Level Type		
RFBurst	Positive	
Trigger Slope		
Scale/Div	10	
Span	8000000	
Sweep Time	0.02	
Sweep Time Auto	TRUE	
Trigger Holdoff	0.1	
Trigger Holdoff State	FALSE	
Trigger Source	Free	
Video BW	22000	
Video BW Auto	TRUE	
MeasResult1	MeasResult 2	Meas Result 3
- 76.80585177 44559	0	1
0.084790019 950006	- 76.80585 17744559	0
0.028392912 8313787	-999	1
	-999	0
	-999	1

Save As . . .

When you press “Save As”, the analyzer brings up a Windows dialog and a menu entitled “**Save As.**” This menu allows you to navigate to the various fields in the Windows dialog without using a keyboard or mouse. The Tab and Arrow keys can also be used for dialog navigation.

See "[To File . . .](#)" on page 2810 in Save, State for a full description of this dialog and menu.

The default path for saving files is:

For all of the Trace Data Files:

My Documents\<<mode name>\data\traces

For all of the Limit Data Files:

My Documents\<<mode name>\data\limits

For all of the Measurement Results Data Files:

My Documents\<<mode name>\data\<<measurement name>\results

For all of the Capture Buffer Data Files:

My Documents\<<mode name>\data\captureBuffer

Key Path	Save, Data
Mode	All
Notes	The key location is mode-dependent and will vary. Brings up the Save As dialog for saving a <mode specific> Save Type. The save is performed immediately and does not wait until the measurement is complete.
Initial S/W Revision	Prior to A.02.00

Screen Image

Pressing Screen Image accesses a menu of functions that enable you to specify a format and location for the saved screen image. It brings up a menu that allows you to specify the color scheme of the Screen Image (Themes) or navigate to the Save As dialog to perform the actual save.

Screen Image files contain an exact representation of the analyzer display. They cannot be loaded back onto the analyzer, but they can be loaded into your PC for use in many popular applications.

The image to be saved is actually captured when the Save front panel key is pressed, and kept in temporary storage to be used if you ask for a Screen Image save. When the Screen Image key is pressed, a "thumbnail" of the captured image is displayed, as shown below:

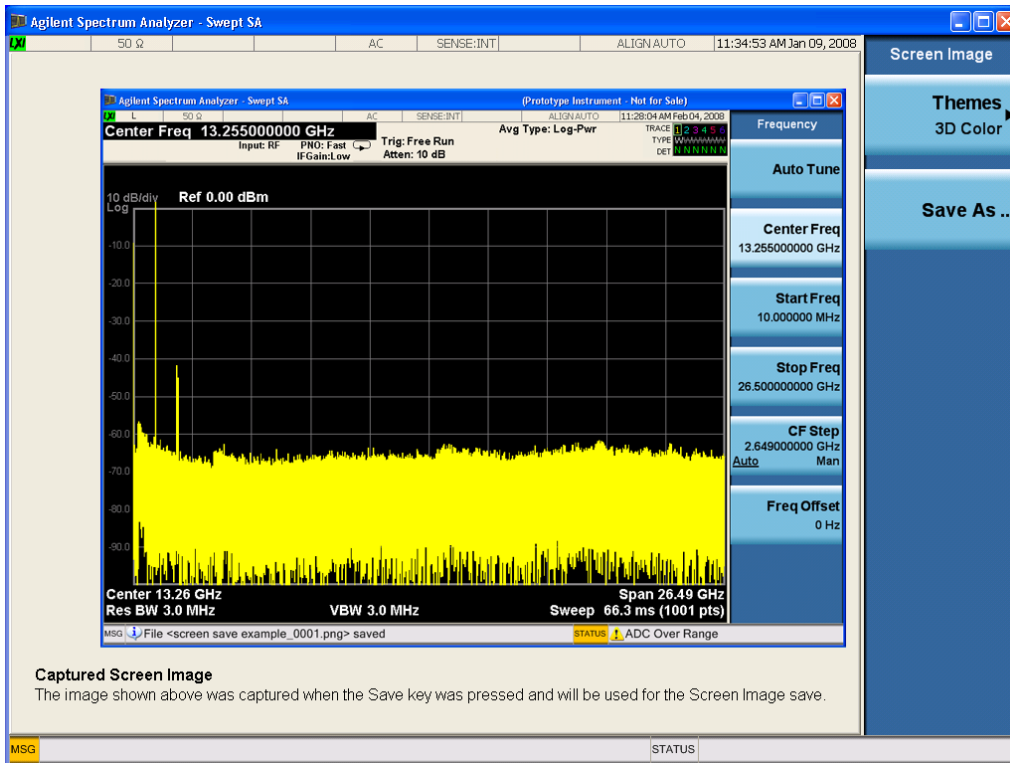

When you continue on into the Save As menu and complete the Screen Image save, the image depicted in the thumbnail is the one that gets saved, showing the menus that were on the screen before going into the Save menus. The save is performed immediately and does not wait until the measurement is complete.

After you have completed the save, the Quick Save front-panel key lets you quickly repeat the last save performed, using an auto-named file, with the current screen data.

NOTE

For versions previous to A.01.55, if you initiate a screen image save by navigating through the Save menus, the image that is saved will contain the Save menu softkeys, not the menus and the active function that were on the screen when you first pressed the Save front panel key.

Key Path	Save
Mode	All
Remote Command	:MMEMory:STORe:SCREen <filename>
Example	:MMEM:STOR:SCR "myScreen.png" This stores the current screen image in the file MyScreenFile.png in the default directory.
Initial S/W Revision	Prior to A.02.00

Themes

Accesses a menu of functions that enable you to choose the theme to be used when saving the screen image.

The **Themes** option is the same as the **Themes** option under the **Display** and **Page Setup** dialogs. It allows you to choose between themes to be used when saving the screen image.

Key Path	Save, Screen Image
Remote Command	:MMEMory:STORe:SCReen:THEMe TDColor TDMonochrome FCOLor FMONochrome :MMEMory:STORe:SCReen:THEMe?
Example	:MMEM:STOR:SCR:THEM TDM
Preset	3D Color; Is not part of Preset, but is reset by Restore Misc Defaults or Restore System Defaults All and survives subsequent running of the modes.
Readback	3D Color 3D Mono Flat Color Flat Mono
Backwards Compatibility Notes	In ESA and PSA we offer the choice of "Reverse Bitmap" or "Reverse Metafile" when saving screen images. This is much like the "Flat Color" theme available in X-Series. Also, if you selected Reverse Bitmap AND a black & white screen image, that would be much like "Flat Monochrome". In other words, each of the X-Series themes has a similar screen image type in ESA/PSA. But they are not identical.
Initial S/W Revision	Prior to A.02.00

3D Color

Selects a standard color theme with each object filled, shaded and colored as designed.

Key Path	Save, Screen Image, Themes
Example	MMEM:STOR:SCR:THEM TDC
Readback	3D Color
Initial S/W Revision	Prior to A.02.00

3D Monochrome

Selects a format that is like 3D color but shades of gray are used instead of colors.

Key Path	Save, Screen Image, Themes
Example	MMEM:STOR:SCR:THEM TDM
Readback	3D Mono
Initial S/W Revision	Prior to A.02.00

Flat Color

Selects a format that is best when the screen is to be printed on an ink printer.

Key Path	Save, Screen Image, Themes
-----------------	----------------------------

Example	MMEM:STOR:SCR:THEM FCOL
Readback	Flat Color
Initial S/W Revision	Prior to A.02.00

Flat Monochrome

Selects a format that is like Flat Color. But only black is used (no colors, not even gray), and no fill.

Key Path	Save, Screen Image, Themes
Example	MMEM:STOR:SCR:THEM FMON
Readback	Flat Mono
Initial S/W Revision	Prior to A.02.00

Save As...

When you press "Save As", the analyzer brings up a Windows dialog and a menu entitled "**Save As.**" This menu allows you to navigate to the various fields in the Windows dialog without using a keyboard or mouse. The Tab and Arrow keys can also be used for dialog navigation.

See "[To File ...](#)" on page 2810 in Save, State for a full description of this dialog and menu.

The default path for Screen Images is

My Documents\`<mode name>`\screen.

where `<mode name>` is the parameter used to select the mode with the INST:SEL command (for example, SA for the Spectrum Analyzer).

Key Path	Save, Screen Image
Notes	Brings up Save As dialog for saving a Screen Image Save Type
Initial S/W Revision	Prior to A.02.00

Mass Storage Catalog (Remote Command Only)

Key path	SCPI Only
Remote Command	:MMEMory:CATalog? [<code><directory_name></code>]
Notes	<p>The string must be a valid logical path.</p> <p>Queries disk usage information (drive capacity, free space available) and obtains a list of files and directories in a specified directory in the following format:</p> <p><code><numeric_value>,<numeric_value>,{<file_entry>}</code></p> <p>It returns two numeric parameters and as many strings as there are files and directories. The first parameter indicates the total amount of storage currently used in bytes. The second parameter</p>

	<p>indicates the total amount of storage available, also in bytes. The <file_entry> is a string. Each <file_entry> indicates the name, type, and size of one file in the directory list: <file_name>,<file_type>,<file_size></p> <p>As the windows file system has an extension that indicates file type, <file_type> is always empty. <file_size> provides the size of the file in bytes. For directories, <file_entry> is surrounded by square brackets and both <file_type> and <file_size> are empty</p>
Initial S/W Revision	Prior to A.02.00

Mass Storage Change Directory (Remote Command Only)

Key path	SCPI Only
Remote Command	:MMEMory:CDIRectory [<directory_name>] :MMEMory:CDIRectory?
Notes	<p>The string must be a valid logical path.</p> <p>Changes the default directory for a mass memory file system. The <directory_name> parameter is a string. If no parameter is specified, the directory is set to the *RST value.</p> <p>At *RST, this value is set to the default user data storage area, that is defined as System.Environment.SpecialFolder.Personal.</p> <p>Query returns full path of the default directory.</p>
Initial S/W Revision	Prior to A.02.00

Mass Storage Copy (Remote Command Only)

Key path	SCPI Only
Remote Command	:MMEMory:COPY <string>,<string>[,<string>,<string>]
Notes	<p>The string must be a valid logical path.</p> <p>Copies an existing file to a new file or an existing directory to a new directory.</p> <p>Two forms of parameters are allowed. The first form has two parameters. In this form, the first parameter specifies the source, and the second parameter specifies the destination.</p> <p>The second form has four parameters. In this form, the first and third parameters specify the source. The second and fourth parameters specify the directories. The first pair of parameters specifies the source. The second pair specifies the destination. An error is generated if the source doesn't exist or the destination file already exists.</p> <p>This command will generate an "access denied" error if the destination is a restricted folder (e.g., C:\Windows) and the current user does not have Power User or Administrator privileges.</p>

Mass Storage Device Copy (Remote Command Only)

This command transfers data to/from a file and a peripheral device.

Key path	SCPI Only
Remote Command	:MMEMory:COpy:DEvice <source_string>,<dest_string>
Notes	<p>The strings must be a valid logical path or a valid device keyword. If the dest_string is a device keyword, the data is copied from the source file to the device. If the source_string is a device keyword, the data is copied to the source file from the device.</p> <p>Valid device keywords are: SNS (smart noise source)</p> <p>An error is generated if the file or device is not found.</p>

Mass Storage Delete (Remote Command Only)

Key path	SCPI Only
Remote Command	:MMEMory:DElete <file_name>[,<directory_name>]
Notes	<p>The string must be a valid logical path.</p> <p>Removes a file from the specified directory. The <file_name> parameter specifies the file name to be removed. This command will generate an “access denied” error if the file is in a restricted folder (e.g., C:\Windows) and the current user does not have Power User or Administrator privileges.</p>
Initial S/W Revision	Prior to A.02.00

Mass Storage Data (Remote Command Only)

Creates a file containing the specified data OR queries the data from an existing file.

Key path	SCPI Only
Remote Command	:MMEMory:DATA <file_name>, <data> :MMEMory:DATA? <file_name>
Notes	<p>The string must be a valid logical path.</p> <p>The command form is MMEMory:DATA <file_name>,<data>. It loads <data> into the file <file_name>. <data> is in 488.2 block format. <file_name> is string data.</p> <p>The query form is MMEMory:DATA? <file_name> with the response being the associated <data> in block format.</p>
Initial S/W Revision	Prior to A.02.00

Mass Storage Make Directory (Remote Command Only)

Key path	SCPI Only
Remote Command	:MMEMory:MDIRectory <directory_name>
Notes	<p>The string must be a valid logical path.</p> <p>Creates a new directory. The <directory_name> parameter specifies the name to be created.</p>

	This command will generate an “access denied” error if the new directory would be in a restricted folder (e.g., C:\Windows) and the current user does not have Power User or Administrator privileges.
Initial S/W Revision	Prior to A.02.00

Mass Storage Move (Remote Command Only)

Key path	SCPI Only
Remote Command	:MMEMory:MOVE <string>,<string>[,<string>,<string>]
Notes	<p>The string must be a valid logical path.</p> <p>Moves an existing file to a new file or an existing directory to a new directory.</p> <p>Two forms of parameters are allowed. The first form has two parameters. In this form, the first parameter specifies the source, and the second parameter specifies the destination.</p> <p>The second form has four parameters. In this form, the first and third parameters specify the source. The second and fourth parameters specify the directories. The first pair of parameters specifies the source. The second pair specifies the destination. An error is generated if the source doesn't exist or the destination file already exists.</p> <p>This command will generate an “access denied” error if the destination is a restricted folder (e.g., C:\Windows) and the current user does not have Power User or Administrator privileges.</p>
Initial S/W Revision	Prior to A.02.00

Mass Storage Remove Directory (Remote Command Only)

Key path	SCPI Only
Remote Command	:MMEMory:RDIRECTory <directory_name>
Notes	<p>The string must be a valid logical path.</p> <p>Removes a directory. The <directory_name> parameter specifies the directory name to be removed. All files and directories under the specified directory shall also be removed.</p> <p>This command will generate an “access denied” error if the folder is a restricted folder (e.g., C:\Windows) or is in a restricted folder and the current user does not have Power User or Administrator privileges.</p>
Initial S/W Revision	Prior to A.02.00

Single (Single Measurement/Sweep)

Sets the analyzer for Single measurement operation. The single/continuous state is Meas Global, so the setting will affect all the measurements. If you are Paused, pressing Single does a Resume.

See "[More Information](#)" on page 997

Key Path	Front-panel key
Example	:INIT:CONT OFF
Notes	See Cont key description.
Backwards Compatibility Notes	<p>For Spectrum Analysis mode in ESA and PSA, the Single hardkey and the INITiate:IMM switched from continuous measurement to single measurement and restarted sweeps and averages (displayed average count reset to 1), but did not restart Max Hold and Min Hold. In the X-Series, the Single hardkey and the INITiate:IMM command initiate a sweep/ measurement/ average sequence/hold sequence including MaxHold and MinHold.</p> <p>For Spectrum Analysis mode in ESA and PSA, the Single hardkey restarted the sweep regardless of whether or not you were in an active sweep or sweep sequence. In the X-Series, Restart does this but Single only restarts the sweep or sweep sequence if you are in the idle state.</p> <p>INIT[:IMM] in ESA & PSA Spectrum Analysis Mode does an implied ABORT. In some other PSA Modes, INIT[:IMM] is ignored if not in the idle state. . The X-Series follows the ESA/PSA SA Mode model, which may cause some Modes to have compatibility problems.</p>
Initial S/W Revision	Prior to A.02.00

More Information

See "[Restart](#)" on page 2807 for details on the INIT:IMMEDIATE (Restart) function.

If you are already in single sweep, the INIT:CONT OFF command has no effect.

If you are already in Single Sweep, then pressing the Single key in the middle of a sweep does not restart the sweep or sequence. Similarly, pressing the Single key does not restart the sweep or sequence if the sweep is not in the idle state (for example, if you are taking a very slow sweep, or the analyzer is waiting for a trigger). Instead, it results in a message. "Already in Single, press Restart to initiate a new sweep or sequence". Even though pressing the Single key in the middle of a sweep does not restart the sweep, sending INIT:IMMEDIATE does reset it.

To take one more sweep without resetting the average count, increment the average count by 1, by pressing the step up key while **Average/Hold Number** is the active function, or sending the remote command CALC:AVER:TCON UP.

Source

There is no Source control functionality for this measurement. When this key is pressed, the screen either displays a blank menu, or the previously-selected menu remains unchanged.

Key Path	Front-panel key
----------	-----------------

SPAN X Scale

Accesses a menu of functions that enable you set the horizontal scale parameters.

Key Path	Front-panel key
Initial S/W Revision	Prior to A.02.00

Span

Changes the frequency range symmetrically about the center frequency.

The default (and minimum) span is calculated using the number of carriers and the carrier width where;

$$\text{Span} = (\text{Upper Carrier Freq} + (\text{max offset IBW} * (1 + \alpha)) / 2) - (\text{Lower Carrier Freq} - (\text{max offset IBW} * (1 + \alpha)) / 2)$$

The span is increased by a factor of 1 + Filter Alpha if the RRC Filter is on.

Key Path	SPAN X Scale
Mode	SA, WCDMA, C2K, WIMAX OFDMA, TD-SCDMA, 1xEVDO, DVB-T/H, DTMB (CTTB), ISDB-T, CMMB, LTE, LTE-TDD, Digital Cable TV, MSR, LTEAFDD, LTEATDD
Remote Command	[:SENSe] :ACPoweR:FREQuency:SPAN <freq> [:SENSe] :ACPoweR:FREQuency:SPAN?
Example	ACP:FREQ:SPAN 25MHz ACP:FREQ:SPAN?
Notes	You must be in the mode that includes ACP measurements to use this command. Use :INSTrument:SElect to set the mode.
Couplings	The span value is clipped when the carrier settings and/or the offset settings are changed. The value is changed to satisfy following formula: $\text{Span} = (\text{Upper Carrier Freq} + (\text{max offset IBW} * (1 + \alpha)) / 2) - (\text{Lower Carrier Freq} - (\text{max offset IBW} * (1 + \alpha)) / 2)$
Preset	SA: 8 MHz WCDMA: 24.6848 MHz WIMAX OFDMA: 50 MHz C2K: 4.5 MHz TD-SCDMA: 8 MHz 1xEVDO: 4.05 MHz DVB-T/H: 40 MHz DTMB (CTTB): 72 MHz ISDB-T: 30 MHz CMMB: 72 MHz LTE, LTE-TDD, MSR: 25 MHz Digital Cable TV: 40 MHz LTEAFDD, LTEATDD: 25MHz

State Saved	Saved in instrument state.
Min	10 Hz
Max	Hardware Dependent: Option 503 = 3.7 GHz Option 507 = 7.1 GHz Option 508 = 8.5 GHz Option 513 = 13.8 GHz Option 526 = 27.0 GHz
Initial S/W Revision	Prior to A.02.00
Modified at S/W Revision	A.02.00, A.03.00

Full Span

Changes the span to show the full frequency range of the spectrum analyzer.

Key Path	SPAN X Scale
Mode	SA, WCDMA, C2K, WiMAX OFDMA, TD-SCDMA, 1xEVDO, DVB-T/H, DTMB (CTTB), ISDB-T, CMMB, LTE, LTETDD, Digital Cable TV
Remote Command	<code>[:SENSe] :ACPower:FREQuency:SPAN:FULL</code>
Example	ACP:FREQ:SPAN:FULL
Notes	You must be in the mode that includes ACP measurements to use this command. Use :INSTrument:SElect to set the mode.
Dependencies	For MSR and LTE-Advanced FDD/TDD mode, this key is blank.
Initial S/W Revision	Prior to A.02.00
Modified at S/W Revision	A.02.00, A.03.00

Last Span

Changes the span to the previous span setting. If no previous span value exists, then the span will remain unchanged.

Key Path	SPAN X Scale
Mode	SA, WCDMA, C2K, WIMAX OFDMA, TD-SCDMA, 1xEVDO, DVB-T/H, DTMB (CTTB), ISDB-T, CMMB, LTE, LTETDD, Digital Cable TV, MSR, LTEAFDD, LTEATDD
Remote Command	<code>[:SENSe] :ACPower:FREQuency:SPAN:PREVious</code>
Example	ACP:FREQ:SPAN:PREV
Notes	You must be in the mode that includes ACP measurements to use this command. Use :INSTrument:SElect to set the mode.
Initial S/W Revision	Prior to A.02.00
Modified at S/W Revision	A.02.00, A.03.00

Sweep/Control

Accesses a menu of functions that enable you to set up and control the sweep time, and source.

See "[Sweep/Control](#)" on page 2703 for more information.

Key Path	Front-panel key
Initial S/W Revision	Prior to A.02.00

Sweep Time

Selects the length of time in which the spectrum analyzer sweeps the displayed frequency span. In swept spans, the sweep time varies from 1 millisecond to 2000 seconds. Additional overhead time, which impacts the sweep rate, is not calculated as part of the sweep time. In fact:

sweep rate = span/sweep time

update rate = 1/(sweep time + overhead)

sweep cycle time = sweep time + overhead

Sweep time is coupled to RBW and VBW, and is impacted by the number of sweep points, so changing those parameters may change the sweep time.

If you increase the sweep time, you increase the length of the time data captured and the number of points measured. You might need to specify a specific sweep speed to accommodate a specific condition in your transmitter. For example, you may have a burst signal and need to measure an exact portion of the burst.

Selecting a specific sweep time may result in a long measurement time since the resulting number of data points may not be the optimum 2n. Use [:SENSe]:ACP:OFFSet:LIST:SWEEp:TIME to set the number of points used for measuring the offset channels for Basic and cdmaOne.

For cdma2000 and W-CDMA, this command sets the sweep time when using the sweep mode. See [:SENSe]:ACP:SWEEp:TYPE

Key Path	Sweep/Control
Mode	SA, WCDMA, C2K, WIMAX OFDMA, TD-SCDMA, 1xEVDO, DVB-T/H, DTMB (CTTB), ISDB-T, CMMB, LTE, LTETDD, Digital Cable TV, MSR, LTEAFDD, LTEATDD
Remote Command	[:SENSe]:ACP:SWEEp:TIME <time> [:SENSe]:ACP:SWEEp:TIME? [:SENSe]:ACP:SWEEp:TIME:AUTO OFF ON 0 1 [:SENSe]:ACP:SWEEp:TIME:AUTO?
Example	ACP:SWEEp:TIME 50ms ACP:SWEEp:TIME? ACP:SWEEp:TIME:AUTO OFF ACP:SWEEp:TIME:AUTO?
Notes	This parameter is preset by Meas Method selection. Preset values are as follows:

	IBW: 29 ms IBWR: 108 ms FAST (WCDMA): 7.5 ms
Preset	SA, LTE, LTETDD, MSR: Automatically calculated WCDMA: 29 ms WIMAX OFDMA: Automatically calculated C2K: Automatically calculated TD-SCDMA: Automatically calculated 1xEVDO: Automatically calculated DVB-T/H: Automatically calculated DTMB (CTTB): Automatically calculated ISDB-T: Automatically calculated CMMB: Automatically calculated Digital Cable TV: Automatically calculated LTEAFDD, LTEATDD: Automatically calculated SA, LTE, LTETDD, MSR, LTEAFDD, LTEATDD: ON WCDMA: OFF C2K: OFF (method IBW) WIMAX OFDMA: ON TD-SCDMA: ON DVB-T/H: ON DTMB (CTTB): ON ISDB-T: ON CMMB: ON Digital Cable TV: ON
State Saved	Saved in instrument state.
Min	1 ms
Max	4000 s
Initial S/W Revision	Prior to A.02.00
Modified at S/W Revision	A.02.00, A.03.00

Sweep Setup

Accesses the sweep setup menu.

Key Path	Sweep/Control
Initial S/W Revision	Prior to A.02.00

Auto Sweep Time Rules

Switches the analyzer between normal and accuracy sweep states.

Key Path	Sweep/Control, Sweep Setup
Mode	SA, WCDMA, C2K, WIMAX OFDMA, TD-SCDMA, 1xEVDO, DVB-T/H, DTMB (CTTB), ISDB-T, CMMB, LTE, LTETDD, Digital Cable TV, MSR, LTEAFDD, LTEATDD
Remote Command	[:SENSe] :ACPoweR :SWEep :TIME :AUTO :RULes NORMal ACCuracy [:SENSe] :ACPoweR :SWEep :TIME :AUTO :RULes ?
Example	ACP:SWE:TIME:AUTO:RUL NORM ACP:SWE:TIME:AUTO:RUL ?
Notes	Set to Norm when Auto Couple is pressed or sent remotely.
Preset	SA, WCDMA, C2K, TD-SCDMA, 1xEVDO, DTMB (CTTB), LTE, LTETDD, MSR, LTEAFDD, LTEATDD: ACCuracy WIMAX OFDMA, DVB-T/H: NORMal ISDB-T, CMMB: NORMal Digital Cable TV: NORMal
State Saved	Saved in instrument state.
Range	Norm Accy
Initial S/W Revision	Prior to A.02.00
Modified at S/W Revision	A.02.00, A.03.00

Pause

Pauses a measurement after the current data acquisition is complete. When Paused, the label on the key changes to Resume. Pressing the Resume key resumes the measurement at the point where it was paused. When Paused, pressing Restart, Single, or Cont does a Resume

See "[Pause/Resume](#)" on page 2703 for more details.

Key Path	Sweep/Control
Initial S/W Revision	Prior to A.02.00

Gate

Accesses a menu that enables you to control the gating function. The Gate functionality is used to view signals best viewed by qualifying them with other events.

Gate setup parameters are the same for all measurements – they do not change as you change measurements. Settings like these are called “Meas Global” and are unaffected by Meas Preset.

Note that Sweep Time autocoupling rules and annotation are changed by Gate being on.

Key Path	Sweep/Control
Scope	Meas Global
Readback	The state and method of Gate, as [Off, LO] or [On, Video]. Note that for measurements that only support gated LO, the method is nonetheless read back, but always as LO.
Initial S/W Revision	Prior to A.02.00

Gate On/Off

Turns the gate function on and off.

When the Gate Function is on, the selected Gate Method is used along with the gate settings and the signal at the gate source to control the sweep and video system with the gate signal. Not all measurements allow every type of Gate Methods.

When Gate is on, the annunciation in the measurement bar reflects that it is on and what method is used, as seen in the following "Gate: LO" annunciator graphic.

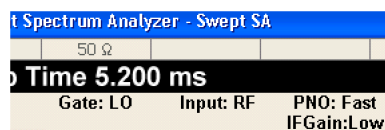

Key Path	Sweep/Control, Gate
Remote Command	[:SENSE] :SWEep:EGATE [:STATE] OFF ON 0 1 [:SENSE] :SWEep:EGATE [:STATE] ?
Example	SWE:EGAT ON SWE:EGAT?

Dependencies

The function is unavailable (grayed out) and Off when:

- Gate Method is LO or Video and FFT Sweep Type is manually selected.
- Gate Method is FFT and Swept Sweep Type is manually selected.
- Marker Count is ON.

The following are unavailable whenever Gate is on:

- FFT under Sweep Type when Method=LO or Video or Swept under Sweep Type when Method=FFT
- Marker Count

While Gate is on, the Auto Rules for Sweep Type are modified so that the choice agrees with the Gate Method: i.e., FFT for Method = FFT and Swept for Method = LO or Video.

The Gate softkey and all SCPI under the [:SENSE]:SWEep:EGATE SCPI node are grayed out when Source Mode is Tracking with an external source. This is because the Gate circuitry is used to sync the external source. If the Tracking Source is turned on, the Gate is turned off.

When in the ACP measurement:

- When Meas Method is RBW or FAST, this function is unavailable and the key is grayed out.

	<ul style="list-style-type: none"> Whenever Gate is on, Meas Method, RBW or FAST is unavailable and keys for those are grayed out. When Gate is on, Offset Res BW and Offset Video BW are ignored (if you set these values) and the measurement works as if all Offset Res BW and all Offset Video BW are coupled with the Res BW and the Video BW under the BW menu. When Gate is on, the Offset BW key in the Offset/Limit menu is grayed out.
Preset	Off LTETDD: On
State Saved	Saved in instrument state
Range	On Off
Backwards Compatibility SCPI	[:SENSe]:SWEep:TIME:GATE[:STATe] ESA compatibility
Backwards Compatibility Notes	In ESA, Trig Delay (On) and Gate (On) could not be active at the same time.. This dependency does not exist in PSA or in the X-Series.
Initial S/W Revision	Prior to A.02.00

Gate View On/Off

Turning on Gate View in the Swept SA measurement provides a single-window gate view display..

Turning on Gate View in other measurements shows the split-screen Gate View. In these measurements, when the Gate View is on, the regular view of the current measurement traces and results are reduced vertically to about 70% of the regular height. The Zero Span window, showing the positions of the Gate, is shown between the Measurement Bar and the reduced measurement window. By reducing the height of the measurement window, some of the annotation on the Data Display may not fit and is not shown.

Key Path	Sweep/Control, Gate
Remote Command	[:SENSe]:SWEep:EGATe:VIEW ON OFF 1 0 [:SENSe]:SWEep:EGATe:VIEW?
Example	SWE:EGAT:VIEW ON turns on the gate view.
Dependencies	<p>In the Swept SA measurement:</p> <p>In Gate View, the regular Sweep Time key is grayed out . When pressed, the grayed out key puts up the informational message "Use Gate View Sweep Time in the Gate menu."</p> <p>In the other measurements:</p> <p>When you turn Gate View on, the lower window takes on the current state of the instrument. Upon leaving Gate View, the instrument takes on the state of the lower window.</p> <p>When you turn Gate View on, the upper window Sweep Time is set to the gate view sweep time.</p>
Couplings	<p>These couplings apply to the Swept SA measurement:</p> <ul style="list-style-type: none"> When Gate View is turned on, the instrument is set to Zero Span. Gate View automatically turns off whenever a Span other than Zero is selected. Gate View automatically turns off if you press the Last Span key while in Gate View, and the instrument returns to the Span it was in before entering Gate View (even if that is Zero Span). When Gate View is turned on, the sweep time used is the gate view sweep time. This is set

according to the rules in section "Gate View Setup " on page 2499

- When Gate View is turned off, Sweep Time is set to the normal Swept SA measurement sweep time.
- If Gate View is on and Gate is off, then turning on Gate turns off Gate View.

Preset	OFF
State Saved	Saved in instrument state
Range	On Off
Initial S/W Revision	Prior to A.02.00

A sample of the Gate View screen in the Swept SA measurement is shown in the following graphic :

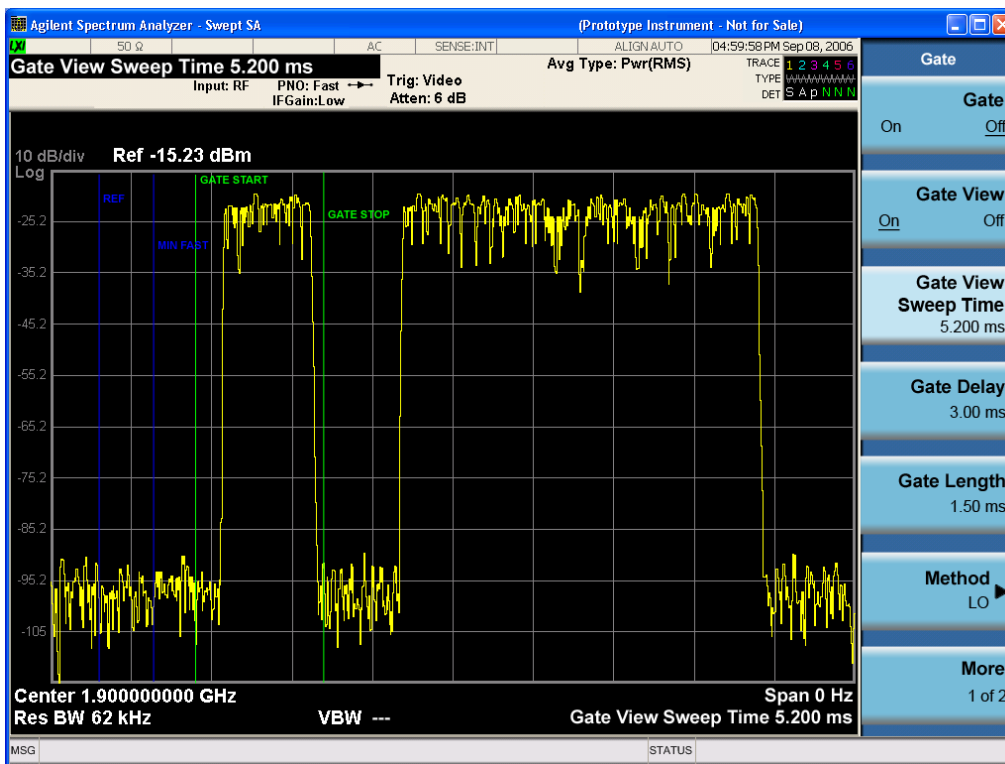

A sample of the Gate View screen in other measurements is shown in the following graphic . This example is for the ACP measurement:

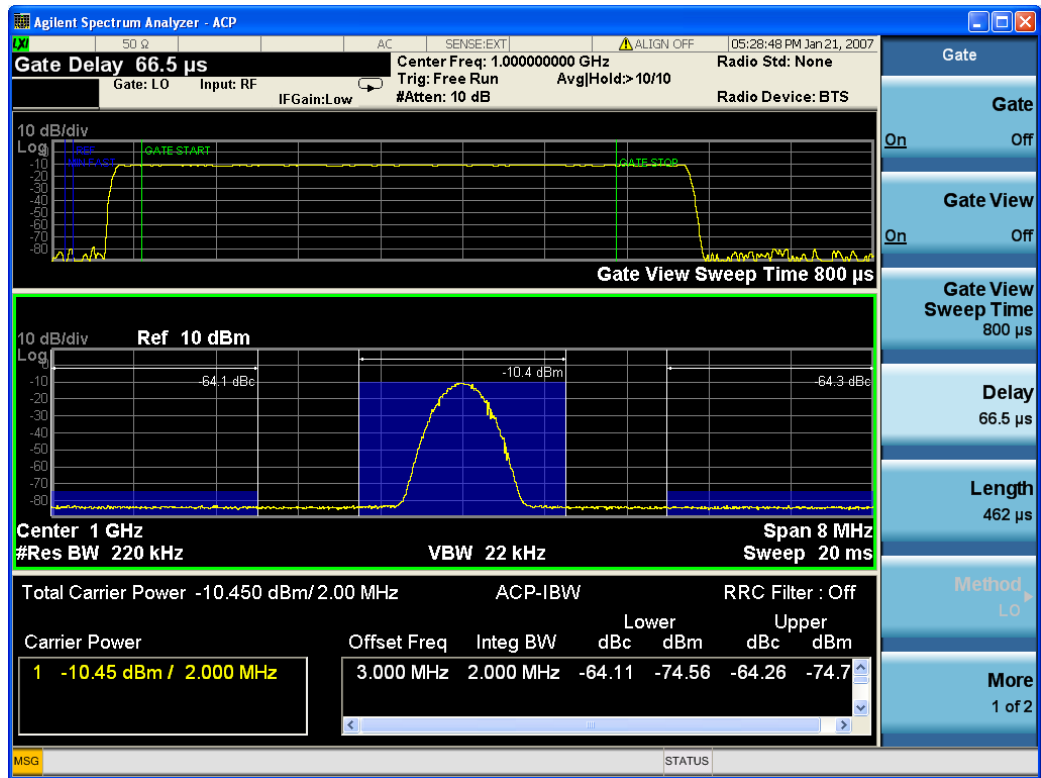

Turning Gate View off returns the analyzer to the Normal measurement view.

In the Swept SA, the normal measurement view is the single-window Swept SA view. When returning to this view, the Swept SA measurement returns to the Span it was in before entering **Gate View** (even if that is Zero Span).

The **Gate View** window is triggered from the Gate Source, with zero trigger delay. Also, when updating the **Gate View** window, the Gate itself must not operate. So it is internally shut off while the gate view window is being updated. For the Swept SA measurement, this means that the Gate is internally shut off whenever the gate view window is displayed. The measurement bar and softkeys continue to show the Trigger source for the main sweep window and give no indication that the Gate is shut off or that the Gate View window is triggered from the Gate Source.

When in **Gate View**, vertical lines are displayed in the Gate View window as follows:

- Green lines are displayed at the gate edges as follows: in Edge Gate, a line is shown for Delay and one for the end of the Gate period, defined by Length. In Level Gate a line is shown only for Delay. You can adjust the position of the green lines by adjusting the gate length and the gate delay. These lines update in the Gate View window as the active function changes, even if the window is not being updated. In Gated LO and Gated Video, these lines are positioned relative to the delay reference line (not relative to 0 time). In Gated FFT, their location is relative to the left edge of the screen.
- A blue line is displayed showing the delay reference, that is, the reference point for the Gate Delay within the Zero Span window. The blue line represents where (in time) the effective location of the gate start would be if the gate were programmed to zero delay.

- The second blue line is labeled "MIN FAST" as shown in the figure above because it represents the minimum Gate Delay for fast Gated LO operation. This line is only displayed in Gated LO. You cannot scroll (knob) or decrement (down key) the Gate Delay to less than that represented by the position of this line, it can only be set below this position manually, although once there it can be moved freely with the knob while below the line.
- A yellow line in the Gated Video case only, is displayed at $Blength$, where $Blength$ is the display point (bucket) length for the swept trace, which is given by the sweep time for that trace divided by number of Points – 1. So it is referenced to 0 time, not to the delay reference. This line is labeled NEXT PT (it is not shown in the figure above because the figure above is for Gated LO).
- The yellow line represents the edge of a display point (bucket). Normally in Gated Video, the bucket length must be selected so that it exceeds the off time of the burst. There is another way to use the analyzer in Gated Video measurements, and that is to set the bucket width much shorter than the off time of the burst. Then use the Max Hold trace function to fill in "missing" buckets more slowly. This allows you to see some of the patterns of the Gated Video results earlier, though seeing a completely filled-in spectrum later.

Gate View Setup

Accesses a menu that enables you to setup parameters relevant to the Gate View

Key Path	Sweep/Control, Gate
Scope	Meas Global
Initial S/W Revision	A.10.00

Gate View Sweep Time

Controls the sweep time in the Gate View window. To provide an optimal view of the gate signal, the analyzer initializes Gate View Sweep Time based on the current settings of Gate Delay and Gate Length.

Key Path	Sweep/Control, Gate, Gate View Setup
Remote Command	[:SENSe] :SWEep:EGATe:TIME <time> [:SENSe] :SWEep:EGATe:TIME?
Example	SWE:EGAT:TIME 500 ms
Dependencies	Gate View Sweep Time is initialized: <ul style="list-style-type: none"> • On Preset (after initializing delay and length). • Every time the Gate Method is set/changed. <p>Additionally, in the Swept SA measurement, whenever you do a Preset, or leave Gate View, the analyzer remembers the Gate Delay and Gate Length settings. Then, when returning to Gate View, if the current Gate Delay and/or Gate Length do not match the remembered values Gate View Sweep Time is re-initialized.</p> <ol style="list-style-type: none"> 1. Compute the location of the "gate stop" line, which you know is at time $t = t_{min} + GateDelay + GateLength$.
Preset	519.3 μ s

	WiMAX OFDMA: 5 ms GSM/EDGE: 1 ms
State Saved	Saved in instrument state
Max	6000 s
Initial S/W Revision	Prior to A.02.00

Gate View Start Time

Controls the time at the left edge of the Gate View.

Key Path	Sweep/Control, Gate, Gate View Setup
Remote Command	[:SENSe] :SWEep:EGATe:VIEW:STARt <time> [:SENSe] :SWEep:EGATe:VIEW:STARt?
Example	SWE:EGAT:VIEW:STAR 10ms
Notes	Units of time are required or no units; otherwise an invalid suffix error message will be generated. See error -131.
Preset	0 ms
State Saved	Saved in instrument state
Min	0
Max	500 ms
Initial S/W Revision	A.10.00

Gate Delay

Controls the length of time from the time the gate condition goes True until the gate is turned on.

Key Path	Sweep/Control, Gate
Remote Command	[:SENSe] :SWEep:EGATe:DELay <time> [:SENSe] :SWEep:EGATe:DELay?
Example	SWE:EGAT:DELay 500ms SWE:EGAT:DELay?
Notes	Units of time are required or no units; otherwise an invalid suffix error message will be generated.
Preset	57.7 us WiMAX OFDMA: 71 us GSM/EDGE: 600 us WLAN: 500 us
State Saved	Saved in instrument state

Min	0.0 us
Max	100 s
Backwards Compatibility SCPI	[:SENSe] :SWEep:TIME:GATE:DELay ESA compatibility
Initial S/W Revision	Prior to A.02.00

Gate Length

Controls the length of time that the gate is on after it opens.

Key Path	Sweep/Control, Gate
Remote Command	[:SENSe] :SWEep:EGATe:LENGth <time> [:SENSe] :SWEep:EGATe:LENGth?
Example	SWE:EGAT:LENG 1 SWE:EGAT:LENG?
Notes	Units of time are required or no units; otherwise an invalid suffix error message will be generated.
Dependencies	

Grayed out when Gate Method is set to FFT in which case the label changes to that shown below.



vsd 39-1

The key is also grayed out if Gate Control = Level.

Preset	461.6 us WiMAX OFDMA: 50 us GSM/EDGE: 200 us WLAN: 1.54 ms
State Saved	Saved in instrument state
Min	100 ns
Max	5 s
Backwards Compatibility SCPI	[:SENSe] :SWEep:TIME:GATE:LENGth ESA compatibility
Initial S/W Revision	Prior to A.02.00

Gate Source

The menus under the Gate Source key are the same as those under the Trigger key, with the exception that neither Free Run nor Video are available as Gate Source selections. However, a different SCPI command

is used to select the Gate Source (see table below) because you may independently set the Gate Source and the Trigger Source.

Any changes to the settings in the setup menus under each Gate Source selection key (for example: Trigger Level, Trigger Delay, etc.) also affect the corresponding settings under the Trigger menu keys. The SCPI commands used for these are the same for Trigger and Gate, since there is only one setting which affects both Gate and Trigger. Example: to set the Trigger Level for External 1 you use the command :TRIG:EXT1:LEV regardless of whether you are using External 1 as a Trigger Source or a Gate Source.

Key Path	Sweep/Control, Gate
Remote Command	[:SENSe] :SWEep:EGATe:SOURce EXTernal1 EXTernal2 LINE FRAME RFBurst [:SENSe] :SWEep:EGATe:SOURce?
Dependencies	In some models, there is no second External input. In these models, the External 2 key is blanked and the EXTernal2 parameter will generate a "Hardware missing; Not available for this model number" error.
Preset	EXTernal 1 GSM/EDGE, MSR: FRAME LTETDD: EXTernal 1 When Direction is Downlink, FRAME when Direction is Uplink.
Backwards Compatibility Notes	In ESA, there is a single Gate input port. In PSA, the Gate Source may be taken from one of two specified input ports. In the X-Series, any Trigger Source can be a Gate Source.
Initial S/W Revision	Prior to A.02.00
Modified at S/W Revision	A.03.00, A.14.00

Line

Pressing this key, when it is not selected, selects the line signal as the trigger. A new sweep/measurement will start synchronized with the next cycle of the line voltage. Pressing this key, when it is already selected, access the line trigger setup menu.

Key Path	Trigger
Example	TRIG:SOUR LINE Swept SA measurement TRIG:<meas>:SOUR LINE Measurements other than Swept SA
Dependencies	Line trigger is not available when operating from a "dc power source", for example, when the instrument is powered from batteries.
State Saved	Saved in instrument state
Status Bits/OPC dependencies	The Status Operation Register bit 5 "Waiting for Trigger" is set at the same time as the Sweeping or Measuring bit is set. It is cleared when the trigger actually occurs (that is, after the trigger event occurs and all the applicable trigger criteria have been met). A corresponding pop-up message ("Waiting for trigger") is generated if no trigger signal appears after approximately 2 sec. This message goes away when a trigger signal appears.
Initial S/W Revision	Prior to A.02.00

Trig Slope

Controls the trigger polarity. It is set positive to trigger on a rising edge and negative to trigger on a falling edge.

Key Path	Trigger, Line
Remote Command	:TRIGger[:SEquence]:LINE:SLOPe POSitive NEGative :TRIGger[:SEquence]:LINE:SLOPe?
Example	TRIG:LINE:SLOP NEG
Preset	POSitive
State Saved	Saved in instrument state
Backwards Compatibility Notes	The legacy :TRIGger[:SEquence]:SLOPe command affects the slopes for the VID, LINE, EXT1, EXT2, and RFB triggers.
Initial S/W Revision	Prior to A.02.00

External 1

Pressing this key, when it is not selected, selects an external input signal as the trigger. A new sweep/measurement will start when the external trigger condition is met using the external 1 input connector on the rear panel.

Pressing this key, when it is already selected, accesses the external 1 trigger setup menu.

Key Path	Trigger
Example	TRIG:SOUR EXT1 Swept SA measurement TRIG:<meas>:SOUR EXT1 Measurements other than Swept SA
Dependencies	Grayed out if in use by Point Trigger in the Source Setup menu. Forced to Free Run if already selected and Point Trigger is set to External 1.
State Saved	Saved in instrument state
Status Bits/OPC dependencies	The Status Operation Register bit 5 "Waiting for Trigger" is set at the same time as the Sweeping or Measuring bit is set. It is cleared when the trigger actually occurs (that is, after the trigger event occurs and all the applicable trigger criteria have been met). A corresponding pop-up message ("Waiting for trigger") is generated if no trigger signal appears after approximately 2 sec. This message goes away when a trigger signal appears.
Initial S/W Revision	Prior to A.02.00

Trigger Level

Sets the value where the external 1 trigger input will trigger a new sweep/measurement.

Key Path	Trigger, External 1
Remote Command	:TRIGger[:SEquence]:EXTernal1:LEVel <level>

	:TRIGger[:SEquence]:EXTernal:LEVel?
Example	TRIG:EXT1:LEV 0.4 V
Couplings	This same level is used for the Ext1 trigger source in the Trigger menu, for the Ext1 selection in the Periodic Timer sync source (in the Trigger menu and in the Gate Source menu), and also for the Ext1 selection in the Gate Source menu.
Preset	1.2 V
State Saved	Saved in instrument state
Min	-5 V
Max	5 V
Default Unit	V
Backwards Compatibility SCPI	:TRIGger[:SEquence]:EXTernal:LEVel
Backwards Compatibility SCPI	For backward compatibility, the parameter EXTernal is mapped to EXTernal1
Backwards Compatibility SCPI	:TRIGger[:SEquence]:FRAMe:EXTernal1:LEVel
Initial S/W Revision	Prior to A.02.00

Trig Slope

Controls the trigger polarity. It is set positive to trigger on a rising edge and negative to trigger on a falling edge.

Key Path	Trigger, External 1
Remote Command	:TRIGger[:SEquence]:EXTernal:SLOPe POSitive NEGative :TRIGger[:SEquence]:EXTernal:SLOPe?
Example	TRIG:EXT1:SLOP NEG
Couplings	This same slope is used in the Ext1 selection for the trigger source in the Trigger menu and for the period timer sync source (in the Trigger menu and in the Gate Source menu).
Preset	POSitive
State Saved	Saved in instrument state
Backwards Compatibility SCPI	:TRIGger[:SEquence]:EXTernal:SLOPe
Backwards Compatibility SCPI	For backward compatibility, the parameter EXTernal is mapped to EXTernal1
Backwards Compatibility SCPI	:TRIGger[:SEquence]:FRAMe:EXTernal1:SLOPe
Backwards Compatibility Notes	The legacy :TRIGger[:SEquence]:SLOPe command affects the slopes for the VID, LINE, EXT1, EXT2, and RFB triggers.
Initial S/W Revision	Prior to A.02.00

Zero Span Delay Comp On/Off

In zero span, there is a natural delay in the signal path, which comes from the RBW filter. This is usually desirable, as it allows you to trigger on events and also see those events, because the signal is delayed from the trigger event. However, in some cases it is desirable to eliminate this delay, so that trigger events line up exactly with the zero time point in zero span. You can use the Zero Span Delay Comp On/Off feature to enable or disable zero span delay compensation.

Key Path	Trigger, External 1
Remote Command	:TRIGger[:SEquence]:EXTernal1:DElay:COMPensation OFF ON 0 1 :TRIGger[:SEquence]:EXTernal1:DElay:COMPensation?
Example	TRIG:EXT1:DEL:COMP ON
Dependencies	No effect except in zero-span, but not locked out in nonzero spans. Blanked in modes that do not support zero-span measurements. If the SCPI command is sent when the key is blanked, an error is returned: -221, "Settings conflict; Feature not supported for this measurement" In analyzers shipping N9060A, this feature requires N9060A-7FP.
Preset	OFF
State Saved	Saved in instrument state
Initial S/W Revision	A.11.00

External 2

Pressing this key, when it is not selected, selects an external input signal as the trigger. A new sweep/measurement will start when the external trigger condition is met using the external 2 input connector. The external trigger 2 input connector is on the rear panel.

Pressing this key, when it is already selected, accesses the external 2 trigger setup menu.

Key Path	Trigger
Example	TRIG:SOUR EXT2 Swept SA measurement TRIG:<meas>:SOUR EXT2 Measurements other than Swept SA
Dependencies	In some models, there is no second External input. In these models, the External 2 key is blanked and the EXTernal2 parameter will generate a "Hardware missing; Not available for this model number" message. Grayed out if in use by Point Trigger in the Source Setup menu. Forced to Free Run if already selected and Point Trigger is set to External 2.
State Saved	Saved in instrument state
Status Bits/OPC dependencies	The Status Operation Register bit 5 "Waiting for Trigger" is set at the same time as the Sweeping or Measuring bit is set. It is cleared when the trigger actually occurs (that is, after the trigger event occurs and all the applicable trigger criteria have been met). A corresponding pop-up message ("Waiting for trigger") is generated if no trigger signal appears after approximately 2 sec. This message goes away when a trigger signal appears.

Initial S/W Revision	Prior to A.02.00
Modified at S/W Revision	A.03.00

Trigger Level

Sets the value where the external 2 trigger input will trigger a new sweep/measurement.

Key Path	Trigger, External 2
Remote Command	:TRIGger[:SEquence]:EXTernal2:LEVel :TRIGger[:SEquence]:EXTernal2:LEVel?
Example	TRIG:EXT2:LEV 1.1 V
Couplings	This same level is used for the Ext2 trigger source in the Trigger menu, for the Ext2 selection in the Periodic Timer sync source (in the Trigger menu and in the Gate Source menu), and also for the Ext2 selection in the Gate Source menu.
Preset	1.2 V
State Saved	Saved in instrument state
Min	-5 V
Max	5 V
Default Unit	V
Backwards Compatibility SCPI	:TRIGger[:SEquence]:FRAMe:EXTernal2:LEVel
Initial S/W Revision	Prior to A.02.00

Trig Slope

Controls the trigger polarity. It is set positive to trigger on a rising edge and negative to trigger on a falling edge.

Key Path	Trigger, External 2
Remote Command	:TRIGger[:SEquence]:EXTernal2:SLOPe POSitive NEGative :TRIGger[:SEquence]:EXTernal2:SLOPe?
Example	TRIG:EXT2:SLOP NEG
Couplings	This same slope is used in the Ext2 selection for the trigger source in the Trigger menu and for the period timer sync source (in the Trigger menu and in the Gate Source menu).
Preset	POSitive
State Saved	Saved in instrument state
Backwards Compatibility SCPI	:TRIGger[:SEquence]:FRAMe:EXTernal2:SLOPe
Backwards Compatibility Notes	The legacy :TRIGger[:SEquence]:SLOPe command affects the slopes for the VID, LINE, EXT1, EXT2, and RFB triggers.
Initial S/W Revision	Prior to A.02.00

Zero Span Delay Comp On/Off

In zero span, there is a natural delay in the signal path, which comes from the RBW filter. This is usually desirable, as it allows you to trigger on events and also see those events, because the signal is delayed from the trigger event. However, in some cases it is desirable to eliminate this delay, so that trigger events line up exactly with the zero time point in zero span. You can use the Zero Span Delay Comp On/Off feature to enable or disable zero span delay compensation.

Key Path	Trigger, External 2
Remote Command	:TRIGger[:SEquence]:EXTernal2:DElay:COMPensation OFF ON 0 1 :TRIGger[:SEquence]:EXTernal2:DElay:COMPensation?
Example	TRIG:EXT2:DEL:COMP ON
Dependencies	No effect except in zero-span, but not locked out in nonzero spans. Blanked in modes that do not support zero-span measurements. If the SCPI command is sent when the key is blanked, an error is returned: -221, "Settings conflict; Feature not supported for this measurement" In analyzers shipping N9060A, this feature requires N9060A-7FP.
Preset	OFF
State Saved	Saved in instrument state
Initial S/W Revision	A.11.00

RF Burst

Pressing this key, when it is not selected, selects the RF Burst as the trigger. A new sweep/measurement will start when an RF burst envelope signal is identified from the signal at the RF Input connector. Pressing this key, when it is already selected, accesses the RF Burst trigger setup menu.

In some models, a variety of burst trigger circuitry is available, resulting in various available burst trigger bandwidths. The analyzer automatically chooses the appropriate trigger path based on the hardware configuration and other settings of the analyzer.

Key Path	Trigger
Example	TRIG:SOUR RFB Swept SA measurement TRIG:<meas>:SOUR RFB Measurements other than Swept SA
State Saved	Saved in instrument state
Status Bits/OPC dependencies	The Status Operation Register bit 5 "Waiting for Trigger" is set at the same time as the Sweeping or Measuring bit is set. It is cleared when the trigger actually occurs (that is, after the trigger event occurs and all the applicable trigger criteria have been met). A corresponding pop-up message ("Waiting for trigger") is generated if no trigger signal appears after approximately 2 sec. This message goes away when a trigger signal appears.
Backwards Compatibility Notes	The legacy command: :TRIGger[:SEquence]:RFBurst:FSElectivity[:STATe] OFF ON 0 1

	is not supported in the X-Series, as the hardware to do Frequency Selective burst triggers does not exist in X-Series.
Initial S/W Revision	Prior to A.02.00
Modified at S/W Revision	A.04.00

Absolute Trigger Level

Sets the absolute trigger level for the RF burst envelope.

When using the External Mixing path, the Absolute Trigger Level is uncalibrated because the factory default was set to accommodate the expected IF levels for the RF path.

Key Path	Trigger, RF Burst
Scope	Meas Global
Remote Command	:TRIGger[:SEquence]:RFBurst:LEVel:ABSolute <ampl> :TRIGger[:SEquence]:RFBurst:LEVel:ABSolute?
Example	TRIG:RFB:LEV:ABS 10 dBm sets the trigger level of the RF burst envelope signal to the absolute level of 10 dBm
Notes	Sending this command does not switch the setting from relative to absolute; to switch it you need to send the :TRIGger[:SEquence]:RFBurst:LEVel:TYPE command, below. Amplitude Corrections are not taken into account by the Absolute Trigger Level. For example, if you have given yourself effective gain with an amplitude correction factor, the Absolute Trigger will not fire until you have set the trigger level that far below the displayed signal level, rather than simply to the displayed signal level. This is only true for Amplitude Corrections, not External Gain or Ref Level Offset functions. If mode is Bluetooth, the default value is -50 dBm.
Couplings	This same level is used for the RF Burst trigger source in the Trigger menu, for the RF Burst selection in the Periodic Timer sync source (in the Trigger menu and in the Gate Source menu), and also for the RF Burst selection in the Gate Source menu
Preset	-20 dBm
State Saved	Saved in instrument state
Min	-200 dBm
Max	100 dBm
Default Unit	depends on the current selected Y-Axis unit
Backwards Compatibility SCPI	:TRIGger[:SEquence]:FRAMe:RFBurst:LEVel:ABSolute
Initial S/W Revision	Prior to A.02.00
Modified at S/W Revision	A.04.00

Key Path	Trigger, RF Burst
Remote Command	:TRIGger[:SEquence]:RFBurst:LEVel:TYPE ABSolute RELative

	:TRIGger[:SEquence]:RFBurst:LEVel:TYPE?
Example	TRIG:RFB:LEV:TYPE REL sets the trigger level type of the RF burst trigger to Relative.
Preset	ABSolute
State Saved	Saved in instrument state
Initial S/W Revision	Prior to A.02.00
Modified at S/W Revision	A.04.00

Relative Trigger Level

Sets the relative trigger level for the RF burst envelope.

In some models, the relative burst trigger function is implemented in hardware. In other models, without the advanced triggering hardware required, the relative burst trigger function is implemented in software in some measurements, and is unavailable in other measurements.

When implemented in software, the relative RF Burst trigger function is implemented as follows:

1. The measurement starts with the absolute RF Burst trigger setting. If it cannot get a trigger with that level, auto trigger fires and the acquisition starts anyway. After the acquisition, the measurement searches for the peak in the acquired waveform and saves it.
2. Now, in the next cycle of the measurement, the measurement determines a new absolute RF Burst level based on the peak value from the first measurement and the Relative RF Burst Trigger Level (always 0 or negative dB) set by the user. The following formula is used:
3. absolute RF Burst level = peak level of the previous acquisition + relative RF Burst level
4. If the new absolute RF Burst level differs from the previous by more than 0.5 dB, the new level is sent to the hardware; otherwise it is not updated (to avoid slowing down the acquisition)

Steps 2 and 3 repeat for subsequent measurements.

Key Path	Trigger, RF Burst
Scope	Meas Global
Remote Command	:TRIGger[:SEquence]:RFBurst:LEVel:RELative <rel_amp> :TRIGger[:SEquence]:RFBurst:LEVel:RELative?
Example	TRIG:RFB:LEV:REL -10 dB sets the trigger level of the RF burst envelope signal to the relative level of -10 dB
Notes	Sending this command does not switch the setting from absolute to relative; to switch it you need to send the :TRIGger[:SEquence]:RFBurst:LEVel:TYPE command, above. The relative trigger level is not available in some measurements. In those measurements the RELative parameter, and the :TRIGger[:SEquence]:RFBurst:LEVel:TYPE command (above), will generate an error if sent.
Dependencies	This key is grayed out and Absolute Trigger Level selected if the required hardware is not present in your analyzer and the current measurement does not support Relative triggering.

Preset	-6 dB GSM: -25 dB
State Saved	Saved in instrument state
Min	-45 dB
Max	0 dB
Default Unit	dB or dBc
Backwards Compatibility SCPI	:TRIGger[:SEquence]:RFBurst:LEVel This legacy command is aliased to :TRIGger[:SEquence]:RFBurst:LEVel:RELative because the PSA had ONLY relative burst triggering
Initial S/W Revision	Prior to A.02.00
Modified at S/W Revision	A.04.00

Trigger Slope

It is set positive to trigger on a rising edge and negative to trigger on a falling edge.

Key Path	Trigger, RF Burst
Remote Command	:TRIGger[:SEquence]:RFBurst:SLOPe POSitive NEGative :TRIGger[:SEquence]:RFBurst:SLOPe?
Example	TRIG:RFB:SLOP NEG
Couplings	This same slope is used in the RF Burst selection for the trigger source in the Trigger menu and for the period timer sync source (in the Trigger menu and in the Gate Source menu).
Preset	POSitive
State Saved	Saved in instrument state
Backwards Compatibility SCPI	:TRIGger[:SEquence]:FRAMe:RFBurst:SLOPe
Backwards Compatibility Notes	The legacy :TRIGger[:SEquence]:SLOPe command affects the slopes for the VID, LINE, EXT1, EXT2, and RFB triggers.
Initial S/W Revision	Prior to A.02.00

Periodic Timer (Frame Trigger)

Pressing this key, when it is not selected, selects the internal periodic timer signal as the trigger. Triggering occurrences are set by the **Period** parameter, which is modified by the **Sync Source** and **Offset**. Pressing this key, when it is already selected, accesses the periodic timer trigger setup functions.

If you do not have a sync source selected (it is Off), then the internal timer will not be synchronized with any external timing events.

Key Path	Trigger
Example	TRIG:SOUR FRAM Swept SA measurement

	TRIG:<meas>:SOUR FRAM Measurements other than Swept SA
State Saved	Saved in instrument state
Readback	[Sync: <value of Sync Source>], for example, [Sync: External 1]
Status Bits/OPC dependencies	The Status Operation Register bit 5 "Waiting for Trigger" is set at the same time as the Sweeping or Measuring bit is set. It is cleared when the trigger actually occurs (that is, after the trigger event occurs and all the applicable trigger criteria have been met). A corresponding pop-up message ("Waiting for trigger") is generated if no trigger signal appears after approximately 2 sec. This message goes away when a trigger signal appears.
Initial S/W Revision	Prior to A.02.00

Periodic Timer Triggering:

This feature selects the internal periodic timer signal as the trigger. Trigger occurrences are set by the **Periodic Timer** parameter, which is modified by the **Sync Source** and **Offset**.

The figure below shows the action of the periodic timer trigger. Before reviewing the figure, we'll explain some uses for the periodic trigger.

A common application is measuring periodic burst RF signals for which a trigger signal is not easily available. For example, we might be measuring a TDMA radio which bursts every 20 ms. Let's assume that the 20 ms period is very consistent. Let's also assume that we do not have an external trigger source available that is synchronized with the period, and that the signal-to-noise ratio of the signal is not high enough to provide a clean RF burst trigger at all of the analysis frequencies. For example, we might want to measure spurious transmissions at an offset from the carrier that is larger than the bandwidth of the RF burst trigger. In this application, we can set the Periodic Timer to a 20.00 ms period and adjust the offset from that timer to position our trigger just where we want it. If we find that the 20.00 ms is not exactly right, we can adjust the period slightly to minimize the drift between the period timer and the signal to be measured.

A second way to use this feature would be to use **Sync Source** temporarily, instead of **Offset**. In this case, we might tune to the signal in a narrow span and use the RF Burst trigger to synchronize the periodic timer. Then we would turn the sync source off so that it would not miss-trigger. Miss-triggering can occur when we are tuned so far away from the RF burst trigger that it is no longer reliable.

A third example would be to synchronize to a signal that has a reference time element of much longer period than the period of interest. In some CDMA applications, it is useful to look at signals with a short periodicity, by synchronizing that periodicity to the "even-second clock" edge that happens every two seconds. Thus, we could connect the even-second clock trigger to Ext1 and use then Ext1 as the sync source for the periodic timer.

The figure below illustrates this third example. The top trace represents the even-second clock. It causes the periodic timer to synchronize with the leading edge shown. The analyzer trigger occurs at a time delayed by the accumulated offset from the period trigger event. The periodic timer continues to run, and triggers continue to occur, with a periodicity determined by the analyzer time base. The timer output (labeled "late event") will drift away from its ideal time due to imperfect matching between the time base of the signal being measured and the time base of the analyzer, and also because of imperfect setting of the

period parameter. But the synchronization is restored on the next even-second clock event. ("Accumulated offset" is described in the in the **Offset** function section.)

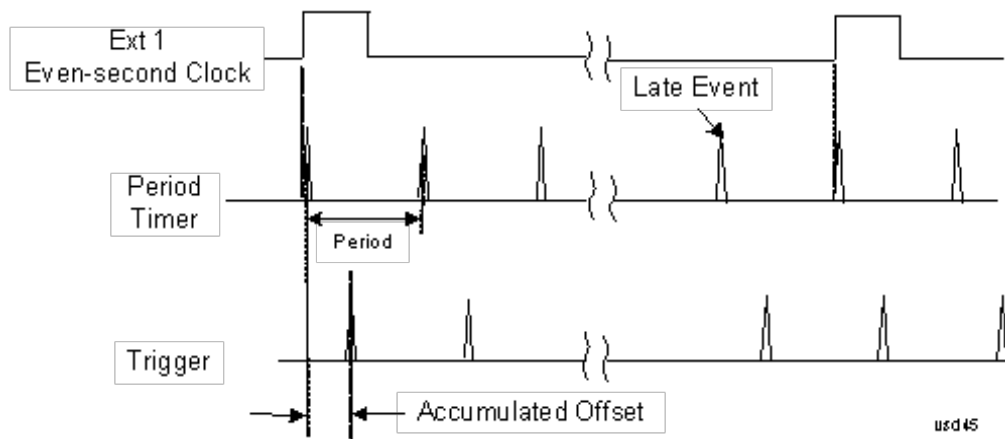

Period

Sets the period of the internal periodic timer clock. For digital communications signals, this is usually set to the frame period of your current input signal. In the case that sync source is not set to OFF, and the external sync source rate is changed for some reason, the periodic timer is synchronized at the every external synchronization pulse by resetting the internal state of the timer circuit.

Key Path	Trigger, Periodic Timer
Remote Command	:TRIGger[:SEquence]:FRAMe:PERiod <time> :TRIGger[:SEquence]:FRAMe:PERiod?
Example	TRIG:FRAM:PER 100 ms
Dependencies	The invalid data indicator turns on when the period is changed, until the next sweep/measurement completes.
Couplings	The same period is used in the Gate Source selection of the period timer.
Preset	20 ms GSM: 4.615383
State Saved	Saved in instrument state
Min	100.000 ns
Max	559.0000 ms
Default Unit	S
Initial S/W Revision	Prior to A.02.00

Offset

Adjusts the accumulated offset between the periodic timer events and the trigger event. Adjusting the accumulated offset is different than setting an offset, and requires explanation.

The periodic timer is usually not synchronized with any external events, so the timing of its output events has no absolute meaning. Since the timing relative to external events (RF signals) is important, you need to

be able to adjust (offset) it. However, you have no direct way to see when the periodic timer events occur. All that you can see is the trigger timing. When you want to adjust the trigger timing, you will be changing the internal offset between the periodic timer events and the trigger event. Because the absolute value of that internal offset is unknown, we will just call that the accumulated offset. Whenever the Offset parameter is changed, you are changing that accumulated offset. You can reset the displayed offset using Reset Offset Display. Changing the display does not change the value of the accumulated offset, and you can still make additional changes to accumulated offset.

To avoid ambiguity, we define that an increase in the "offset" parameter, either from the knob or the SCPI adjust command, serves to delay the timing of the trigger event.

Key Path	Trigger, Periodic Timer
Remote Command	:TRIGger[:SEquence]:FRAMe:OFFSet <time> :TRIGger[:SEquence]:FRAMe:OFFSet?
Example	TRIG:FRAM:OFFS 1.2 ms
Notes	<p>The front panel interface (for example, the knob), and this command, adjust the accumulated offset, which is shown on the active function display. However, the actual amount sent to the hardware each time the offset is updated is the delta value, that is, the current accumulated offset value minus the previous accumulated offset value. Note that the accumulated offset value is essentially arbitrary; it represents the accumulated offset from the last time the offset was zeroed (with the Reset Offset Display key).</p> <p>Note that this command does not change the period of the trigger waveform. Note also that Offset is used only when the sync source is set to OFF, otherwise delay is used, see section "Trig Delay" on page 470.</p> <p>An increase in the "offset" parameter, either from the knob or the SCPI adjust command, serves to delay the timing of the trigger event.</p>
Notes	<p>When the SCPI command is sent the value shown on the key (and the Active Function, if this happens to be the active function) is updated with the new value. However, the actual amount sent to the hardware is the delta value, that is, the current accumulated offset value minus the previous accumulated offset value.</p> <p>The SCPI query simply returns the value currently showing on the key.</p>
Dependencies	The invalid data indicator turns on when the offset is changed, until the next sweep/measurement completes.
Couplings	The same offset is used in the Gate Source selection of the period timer.
Preset	0 s
State Saved	Saved in instrument state
Min	-10.000 s
Max	10.000 s
Default Unit	S
Initial S/W Revision	Prior to A.02.00

Offset Adjust (Remote Command Only)

This remote command does not work at all like the related front panel keys. This command lets you advance the phase of the frame trigger by the amount you specify.

It does not change the period of the trigger waveform. If the command is sent multiple times, it advances the phase of the frame trigger an additional amount each time it is sent. Negative numbers are permitted.

Remote Command	:TRIGger[:SEquence]:FRAMe:ADJust <time>
Example	TRIG:FRAM:ADJ 1.2 ms
Notes	Note also that Offset is used only when the sync source is set to OFF, otherwise delay is used, see section "Trig Delay" on page 470 An increase in the "offset" parameter, either from the knob or the SCPI adjust command, serves to delay the timing of the trigger event.
Notes	The front panel interface (for example, the knob) and the :TRIG:FRAM:OFFS command adjust the accumulated offset, which is shown on the active function display. However, the actual amount sent to the hardware is the delta value, that is, the current offset value minus the previous offset value. When the SCPI command is sent the value shown on the key (and the Active Function, if this happens to be the active function) is updated by increasing it (or decreasing it if the value sent is negative) by the amount specified in the SCPI command. This is a "command only" SCPI command, with no query.
Dependencies	The invalid data indicator turns on when the offset is changed, until the next sweep/measurement completes.
Couplings	The same offset is used in the Gate Source selection of the period timer.
Preset	0 s
State Saved	Saved in instrument state
Min	-10.000 s
Max	10.000 s
Default Unit	S
Initial S/W Revision	Prior to A.02.00

Reset Offset Display

Resets the value of the periodic trigger offset display setting to 0.0 seconds. The current displayed trigger location may include an offset value defined with the Offset key. Pressing this key redefines the currently displayed trigger location as the new trigger point that is 0.0 s offset. The Offset key can then be used to add offset relative to this new timing.

Key Path	Trigger, Periodic Timer
Remote Command	:TRIGger[:SEquence]:FRAMe:OFFSet:DISPlay:RESet
Example	TRIG:FRAM:OFFS:DISP:RES
Initial S/W Revision	Prior to A.02.00

Sync Source

Selects a signal source for you to synchronize your periodic timer trigger to, otherwise you are triggering at some arbitrary location in the frame. Synchronization reduces the precision requirements on the setting of the period.

For convenience you may adjust the level and slope of the selected sync source in a conditional branch setup menu accessed from the Sync Source menu. Note that these settings match those in the **Trigger** and **Gate Source** menus; that is, each trigger source has only one value of level and slope, regardless of which menu it is accessed from.

Key Path	Trigger, Periodic Timer
Remote Command	:TRIGger[:SEquence]:FRAMe:SYNC EXTernal1 EXTernal2 RFBurst OFF :TRIGger[:SEquence]:FRAMe:SYNC?
Example	TRIG:FRAM:SYNC EXT2
Dependencies	In some models, there is no second External input. In these models, the External 2 key is blanked and the EXTernal2 parameter will generate a "Hardware missing; Not available for this model number" message.
Preset	Off GSM/EDGE, MSR,LTE,LTETDD: RFBurst
State Saved	Saved in instrument state
Readback	The current setting is read back to this key and it is also Readback to the previous Periodic Timer trigger key.
Backwards Compatibility SCPI	:TRIGger[:SEquence]:FRAMe:SYNC EXTernal For backward compatibility, the parameter EXTernal is mapped to EXTernal1
Initial S/W Revision	Prior to A.02.00
Modified at S/W Revision	A.03.00, A.14.00

Off

Turns off the sync source for your periodic trigger. With the sync source off, the timing will drift unless the signal source frequency is locked to the analyzer frequency reference.

Key Path	Trigger, Periodic Timer, Sync Source
Example	TRIG:FRAM:SYNC OFF
Readback	Off
Initial S/W Revision	Prior to A.02.00

External 1

Pressing this key, when it is not selected, selects an external input signal as the trigger. A new sweep/measurement will start when the external trigger condition is met using the external 1 input connector on the rear panel.

Pressing this key, when it is already selected, accesses the external 1 trigger setup menu.

Key Path	Trigger
Example	TRIG:SOUR EXT1 Swept SA measurement

	TRIG:<meas>:SOUR EXT1 Measurements other than Swept SA
Dependencies	Grayed out if in use by Point Trigger in the Source Setup menu. Forced to Free Run if already selected and Point Trigger is set to External 1.
State Saved	Saved in instrument state
Status Bits/OPC dependencies	The Status Operation Register bit 5 "Waiting for Trigger" is set at the same time as the Sweeping or Measuring bit is set. It is cleared when the trigger actually occurs (that is, after the trigger event occurs and all the applicable trigger criteria have been met). A corresponding pop-up message ("Waiting for trigger") is generated if no trigger signal appears after approximately 2 sec. This message goes away when a trigger signal appears.
Initial S/W Revision	Prior to A.02.00

Trigger Level

Sets the value where the external 1 trigger input will trigger a new sweep/measurement.

Key Path	Trigger, External 1
Remote Command	:TRIGger[:SEquence]:EXTernal1:LEVel <level> :TRIGger[:SEquence]:EXTernal1:LEVel?
Example	TRIG:EXT1:LEV 0.4 V
Couplings	This same level is used for the Ext1 trigger source in the Trigger menu, for the Ext1 selection in the Periodic Timer sync source (in the Trigger menu and in the Gate Source menu), and also for the Ext1 selection in the Gate Source menu.
Preset	1.2 V
State Saved	Saved in instrument state
Min	-5 V
Max	5 V
Default Unit	V
Backwards Compatibility SCPI	:TRIGger[:SEquence]:EXTernal:LEVel For backward compatibility, the parameter EXTernal is mapped to EXTernal1
Backwards Compatibility SCPI	:TRIGger[:SEquence]:FRAMe:EXTernal1:LEVel
Initial S/W Revision	Prior to A.02.00

Trig Slope

Controls the trigger polarity. It is set positive to trigger on a rising edge and negative to trigger on a falling edge.

Key Path	Trigger, External 1
Remote Command	:TRIGger[:SEquence]:EXTernal1:SLOPe POSitive NEGative

	:TRIGger[:SEQuence]:EXTernal1:SLOPe?
Example	TRIG:EXT1:SLOP NEG
Couplings	This same slope is used in the Ext1 selection for the trigger source in the Trigger menu and for the period timer sync source (in the Trigger menu and in the Gate Source menu).
Preset	POSitive
State Saved	Saved in instrument state
Backwards Compatibility SCPI	:TRIGger[:SEQuence]:EXTernal:SLOPe For backward compatibility, the parameter EXTernal is mapped to EXTernal1
Backwards Compatibility SCPI	:TRIGger[:SEQuence]:FRAMe:EXTernal1:SLOPe
Backwards Compatibility Notes	The legacy :TRIGger[:SEQuence]:SLOPe command affects the slopes for the VID, LINE, EXT1, EXT2, and RFB triggers.
Initial S/W Revision	Prior to A.02.00

External 2

Pressing this key, when it is not selected, selects an external input signal as the trigger. A new sweep/measurement will start when the external trigger condition is met using the external 2 input connector. The external trigger 2 input connector is on the rear panel.

Pressing this key, when it is already selected, accesses the external 2 trigger setup menu.

Key Path	Trigger
Example	TRIG:SOUR EXT2 Swept SA measurement TRIG:<meas>:SOUR EXT2 Measurements other than Swept SA
Dependencies	In some models, there is no second External input. In these models, the External 2 key is blanked and the EXTernal2 parameter will generate a "Hardware missing; Not available for this model number" message. Grayed out if in use by Point Trigger in the Source Setup menu. Forced to Free Run if already selected and Point Trigger is set to External 2.
State Saved	Saved in instrument state
Status Bits/OPC dependencies	The Status Operation Register bit 5 "Waiting for Trigger" is set at the same time as the Sweeping or Measuring bit is set. It is cleared when the trigger actually occurs (that is, after the trigger event occurs and all the applicable trigger criteria have been met). A corresponding pop-up message ("Waiting for trigger") is generated if no trigger signal appears after approximately 2 sec. This message goes away when a trigger signal appears.
Initial S/W Revision	Prior to A.02.00
Modified at S/W Revision	A.03.00

Trigger Level

Sets the value where the external 2 trigger input will trigger a new sweep/measurement.

Key Path	Trigger, External 2
Remote Command	:TRIGger[:SEquence]:EXTernal2:LEVel :TRIGger[:SEquence]:EXTernal2:LEVel?
Example	TRIG:EXT2:LEV 1.1 V
Couplings	This same level is used for the Ext2 trigger source in the Trigger menu, for the Ext2 selection in the Periodic Timer sync source (in the Trigger menu and in the Gate Source menu), and also for the Ext2 selection in the Gate Source menu.
Preset	1.2 V
State Saved	Saved in instrument state
Min	-5 V
Max	5 V
Default Unit	V
Backwards Compatibility SCPI	:TRIGger[:SEquence]:FRAMe:EXTernal2:LEVel
Initial S/W Revision	Prior to A.02.00

Trig Slope

Controls the trigger polarity. It is set positive to trigger on a rising edge and negative to trigger on a falling edge.

Key Path	Trigger, External 2
Remote Command	:TRIGger[:SEquence]:EXTernal2:SLOPe POSitive NEGative :TRIGger[:SEquence]:EXTernal2:SLOPe?
Example	TRIG:EXT2:SLOP NEG
Couplings	This same slope is used in the Ext2 selection for the trigger source in the Trigger menu and for the period timer sync source (in the Trigger menu and in the Gate Source menu).
Preset	POSitive
State Saved	Saved in instrument state
Backwards Compatibility SCPI	:TRIGger[:SEquence]:FRAMe:EXTernal2:SLOPe
Backwards Compatibility Notes	The legacy :TRIGger[:SEquence]:SLOPe command affects the slopes for the VID, LINE, EXT1, EXT2, and RFB triggers.
Initial S/W Revision	Prior to A.02.00

RF Burst

Pressing this key, when it is not selected, selects the RF Burst as the trigger. A new sweep/measurement will start when an RF burst envelope signal is identified from the signal at the RF Input connector. Pressing this key, when it is already selected, accesses the RF Burst trigger setup menu.

In some models, a variety of burst trigger circuitry is available, resulting in various available burst trigger bandwidths. The analyzer automatically chooses the appropriate trigger path based on the hardware configuration and other settings of the analyzer.

Key Path	Trigger
Example	TRIG:SOUR RFB Swept SA measurement TRIG:<meas>:SOUR RFB Measurements other than Swept SA
State Saved	Saved in instrument state
Status Bits/OPC dependencies	The Status Operation Register bit 5 "Waiting for Trigger" is set at the same time as the Sweeping or Measuring bit is set. It is cleared when the trigger actually occurs (that is, after the trigger event occurs and all the applicable trigger criteria have been met). A corresponding pop-up message ("Waiting for trigger") is generated if no trigger signal appears after approximately 2 sec. This message goes away when a trigger signal appears.
Backwards Compatibility Notes	The legacy command: :TRIGger[:SEquence]:RFBurst:FSElectivity[:STATe] OFF ON 0 1 is not supported in the X-Series, as the hardware to do Frequency Selective burst triggers does not exist in X-Series.
Initial S/W Revision	Prior to A.02.00
Modified at S/W Revision	A.04.00

Absolute Trigger Level

Sets the absolute trigger level for the RF burst envelope.

When using the External Mixing path, the Absolute Trigger Level is uncalibrated because the factory default was set to accommodate the expected IF levels for the RF path.

Key Path	Trigger, RF Burst
Scope	Meas Global
Remote Command	:TRIGger[:SEquence]:RFBurst:LEVel:ABSolute <ampl> :TRIGger[:SEquence]:RFBurst:LEVel:ABSolute?
Example	TRIG:RFB:LEV:ABS 10 dBm sets the trigger level of the RF burst envelope signal to the absolute level of 10 dBm
Notes	Sending this command does not switch the setting from relative to absolute; to switch it you need to send the :TRIGger[:SEquence]:RFBurst:LEVel:TYPE command, below. Amplitude Corrections are not taken into account by the Absolute Trigger Level. For example, if you have given yourself effective gain with an amplitude correction factor, the Absolute Trigger will not fire until you have set the trigger level that far below the displayed signal level, rather than simply to the displayed signal level. This is only true for Amplitude Corrections, not External Gain or Ref Level Offset functions. If mode is Bluetooth, the default value is -50 dBm.
Couplings	This same level is used for the RF Burst trigger source in the Trigger menu, for the RF Burst selection in the Periodic Timer sync source (in the Trigger menu and in the Gate Source menu), and also for the

	RF Burst selection in the Gate Source menu
Preset	-20 dBm
State Saved	Saved in instrument state
Min	-200 dBm
Max	100 dBm
Default Unit	depends on the current selected Y-Axis unit
Backwards Compatibility SCPI	:TRIGger[:SEquence]:FRAMe:RFBurst:LEVel:ABSolute
Initial S/W Revision	Prior to A.02.00
Modified at S/W Revision	A.04.00

Key Path	Trigger, RF Burst
Remote Command	:TRIGger[:SEquence]:RFBurst:LEVel:TYPE ABSolute RELative :TRIGger[:SEquence]:RFBurst:LEVel:TYPE?
Example	TRIG:RFB:LEV:TYPE REL sets the trigger level type of the RF burst trigger to Relative.
Preset	ABSolute
State Saved	Saved in instrument state
Initial S/W Revision	Prior to A.02.00
Modified at S/W Revision	A.04.00

Trigger Slope

It is set positive to trigger on a rising edge and negative to trigger on a falling edge.

Key Path	Trigger, RF Burst
Remote Command	:TRIGger[:SEquence]:RFBurst:SLOPe POSitive NEGative :TRIGger[:SEquence]:RFBurst:SLOPe?
Example	TRIG:RFB:SLOP NEG
Couplings	This same slope is used in the RF Burst selection for the trigger source in the Trigger menu and for the period timer sync source (in the Trigger menu and in the Gate Source menu).
Preset	POSitive
State Saved	Saved in instrument state
Backwards Compatibility SCPI	:TRIGger[:SEquence]:FRAMe:RFBurst:SLOPe
Backwards Compatibility Notes	The legacy :TRIGger[:SEquence]:SLOPe command affects the slopes for the VID, LINE, EXT1, EXT2, and RFB triggers.
Initial S/W Revision	Prior to A.02.00

Sync Holdoff

Sync Holdoff specifies the duration that the sync source signal must be kept false before the transition to true to be recognized as the sync timing. The periodic timer phase is aligned when the sync source signal becomes true, after the Holdoff time is satisfied.

A holdoff of 2 ms will work with most WiMAX signals, but there may be cases where the burst off duration is less than 1 ms and this value will need to be changed.

Key Path	Trigger, Periodic Timer
Remote Command	:TRIGger[:SEQuence]:FRAMe:SYNC:HOLDoff <time> :TRIGger[:SEQuence]:FRAMe:SYNC:HOLDoff? :TRIGger[:SEQuence]:FRAMe:SYNC:HOLDoff:STATe OFF ON 0 1 :TRIGger[:SEQuence]:FRAMe:SYNC:HOLDoff:STATe?
Preset	On, 1.000 ms
State Saved	Saved in instrument state
Min	0 ms
Max	+500 ms
Default Unit	s
Initial S/W Revision	Prior to A.02.00

Control Edge/Level

Sets the method of controlling the gating function from the gating signal.

Edge

In Edge triggering, the gate opens (after the Delay) on the selected edge (for example, positive) of the gate signal and closes on the alternate edge (for example, negative).

Level

In Level triggering, the gate opens (after the Delay) when the gate signal has achieved a certain level and stays open as long as that level is maintained.

Key Path	Sweep/Control, Gate
Remote Command	[:SENSe]:SWEep:EGATe:CONTRol EDGE LEVEl [:SENSe]:SWEep:EGATe:CONTRol?
Example	SWE:EGAT:CONT EDGE
Dependencies	If the Gate Method is FFT the Control key is grayed out and Edge is selected. If the Gate Source is TV, Frame or Line, the Control key is grayed out and Edge is selected.
Preset	EDGE
State Saved	Saved in instrument state
Backwards Compatibility SCPI	[:SENSe]:SWEep:TIME:GATE:TYPE ESA Compatibility
Initial S/W Revision	Prior to A.02.00

Gate Holdoff

Lets you increase or decrease the wait time after a gate event ends before the analyzer will respond to the next gate signal.

After any Gate event finishes, the analyzer must wait for the sweep system to settle before it can respond to another Gate signal. The analyzer calculates a "wait time," taking into account a number of factors, including RBW and Phase Noise Optimization settings. The goal is to achieve the same accuracy when gated as in ungated operation. The figure below illustrates this concept:

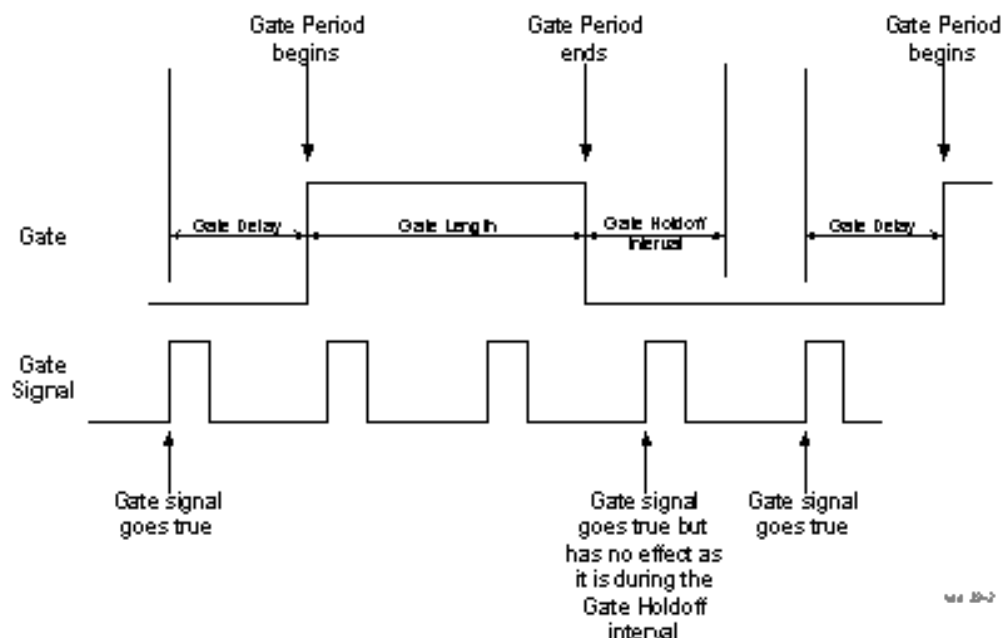

When Gate Holdoff is in Auto, the wait time calculated by the analyzer is used. When Gate Time is in Manual, the user may adjust the wait time, usually decreasing it in order to achieve greater speed, but at the risk of decreasing accuracy.

When the Method key is set to Video or FFT, the Gate Holdoff function has no effect.

In measurements that do not support Auto, the value shown when Auto is selected is “---” and the manually set holdoff is returned to a query.

Key Path	Sweep/Control, Gate
Remote Command	<pre>[:SENSe]:SWEep:EGATe:HOLDoff <time> [:SENSe]:SWEep:EGATe:HOLDoff? [:SENSe]:SWEep:EGATe:HOLDoff:AUTO OFF ON 0 1 [:SENSe]:SWEep:EGATe:HOLDoff:AUTO?</pre>
Example	<pre>SWE:EGAT:HOLD 0.0002 SWE:EGAT:HOLD? SWE:EGAT:HOLD:AUTO ON</pre>

SWE:EGAT:HOLD:AUTO?	
Couplings	<p>When Gate Holdoff is Auto, the Gate Holdoff key shows the value calculated by the analyzer for the wait time.</p> <p>Pressing the Gate Holdoff key while it is in Auto and not selected, causes the key to become selected and allows the user to adjust the value. If the value is adjusted, the setting changes to Man.</p> <p>Pressing the Gate Holdoff key, while it is in Auto and selected, does not change the value of Gate Holdoff, but causes the setting to change to Man. Now the user can adjust the value.</p> <p>Pressing the key while it is in Man and selected, cause the value to change back to Auto.</p> <p>Pressing the key while it is in Man and not selected, causes the key to become selected and allows the user to adjust the value.</p> <p>When Method is set to Video or FFT, the Gate Holdoff function has no effect.</p>
Preset	<p>Auto</p> <p>Auto/On</p>
State Saved	Saved in instrument state
Min	1 μ sec
Max	1 sec
Initial S/W Revision	Prior to A.02.00

Gate Delay Compensation

This function allows you to select an RBW-dependent value by which to adjust the gate delay, to compensate for changes in the delay caused by RBW effects.

You can select between uncompensated operation and two types of compensation, Delay Until RBW Settled and Compensate for RBW Group Delay.

See ["More Information" on page 1034](#)

Key Path	Sweep/Control, Gate
Scope	Meas Global
Remote Command	<pre>[:SENSe] :SWEp:EGATe:DELaY:COMPensation:TYPE OFF SETTled GDELaY [:SENSe] :SWEp:EGATe:DELaY:COMPensation:TYPE?</pre>
Example	<pre>SWE:EGAT:DEL:COMP:TYPE SETT SWE:EGAT:DEL:COMP:TYPE?</pre>
Notes	<p>Although this function is Meas Global, there are some measurements that do not support this function. In those measurements the operation will be Uncompensated. Going into one of those measurements will not change the Meas Global selection; it will simply display the grayed-out menu key with "Uncompensated" showing as the selection. This is a non-forceful grayout, so the SCPI command is still accepted.</p> <p>If Gate Delay Compensation is not supported at all within a particular mode, the key is not displayed, and if the SCPI command is sent while in a measurement within that mode, an "Undefined Header" message is generated.</p> <p>Measurements that do not support this function include:</p>

Swept SA	
Preset	TD-SCDMA mode: Compensate for RBW Group Delay All other modes: Delay Until RBW Settled
State Saved	Saved in instrument state
Range	Uncompensated Delay Until RBW Settled Compensate for RBW Group Delay
Readback text	Uncompensated Settled Group Delay
Initial S/W Revision	Prior to A.02.00
Modified at S/W Revision	A.11.0

More Information

Selecting Uncompensated means that the actual gate delay is as you sets it.

Selecting Delay Until RBW Settled causes the gate delay to be increased above the user setting by an amount equal to $3.06/\text{RBW}$. This compensated delay causes the GATE START and GATE STOP lines on the display to move by the compensation amount, and the actual hardware gate delay to be increased by the same amount. All the other gate lines (for example, MIN FAST) are unaffected. If the RBW subsequently changes, the compensation is readjusted for the new RBW. The value shown on the Gate Delay key does NOT change.

Delay Until RBW Settled allows excellent measurements of gated signals, by allowing the IF to settle following any transient that affects the burst. Excellent measurements also require that the analysis region not extend into the region affected by the falling edge of the burst. Thus, excellent measurements can only be made over a width that declines with narrowing RBWs, which is achieved by decreasing the gate length below the user setting by an amount equal to $2.53/\text{RBW}$. Therefore, for general purpose compensation, you will still want to change the gate length with changes in RBW even if the gate delay is compensated. The compensated Gate Length is limited by the analyzer so that it will never go below 10% of the value shown on the Gate Length key, as otherwise the sweep times could get very long. Anytime the Gate Length and RBW values combine in such a way that this limiting takes place, a warning is displayed. For measurements which contain multiple sweeps with different RBW like SEM and SPUR, the smallest RBW is used for this limiting.

Selecting Compensate for RBW Group Delay causes the gate delay to be increased above the user setting by an amount equal to $1.81/\text{RBW}$. This compensated delay causes the GATE START, GATE STOP lines on the display to move by the compensation amount, and the actual hardware gate delay to be increased by the same amount. All the other gate lines (for example, MIN FAST) are unaffected. If the RBW subsequently changes, the compensation is readjusted for the new RBW. The value shown on the Gate Delay key does NOT change. Compensate for RBW Group Delay also includes gate length compensation; the gate length itself is adjusted as necessary to attempt to compensate for delay effects imposed by the RBW.

Compensate for RBW Group Delay is similar to Delay Until RBW Settled, but compensates for the group delay of the RBW filter, rather than the filter settling time. As the RBW gets narrow, this can allow the settling tail of the RBW to affect the beginning part of the gated measurement, and allow the beginning of the RBW settling transient to affect the end of the gated measurement. These two effects are symmetric

because the RBW response is symmetric. Because the gate length is not automatically compensated, some users might find this compensation to be more intuitive than compensation for RBW settling.

Min Fast Position Query (Remote Command Only)

This command queries the position of the MIN FAST line, relative to the delay reference (REF) line. See section "[Gate View On/Off](#)" on page 2496. If this query is sent while not in gate view, the MinFast calculation is performed based on the current values of the appropriate parameters and the result is returned. Knowing this value lets you set an optimal gate delay value for the current measurement setup.

Remote Command	<code>[:SENSe] :SWEep:EGATe:MINFast?</code>
Example	<code>SWE:EGAT:MIN?</code>
Initial S/W Revision	Prior to A.02.00

Gate Preset (Remote Command Only)

Presets the time-gated spectrum analysis capability.

This command sets gate parameter values to the ESA preset values, as follows:

Gate trigger type = edge

Gate polarity = positive

Gate delay = 1 us

Gate length = 1 us

Remote Command	<code>[:SENSe] :SWEep:TIME:GATE:PRESet</code> ESA Compatibility
Initial S/W Revision	Prior to A.02.00

Gate Level (Remote Command Only)

Sets the gate input transition point level for the external TRIGGER inputs on the front and rear panel. This is a legacy command for PSA compatibility. It is simply an alias to the equivalent trigger level command.

Remote Command	<code>[:SENSe] :SWEep:EGATe:EXTernal [1] 2 :LEVel <voltage></code> <code>[:SENSe] :SWEep:EGATe:EXTernal [1] 2 :LEVel?</code>
Notes	This command is simply an alias to <code>:TRIGger[:SEQUence]:EXTernal[1] 2:LEVel</code> For details refer
Initial S/W Revision	Prior to A.02.00

Gate Polarity (Remote Command Only)

Sets the polarity for the gate signal. This setup is now done using the gate trigger's slope setting.

When Positive (Pos) is selected, a positive-going edge (Edge) or a high voltage (Level) will satisfy the gate condition, after the delay set with the Gate Delay key. When Negative (Neg) is selected, a negative-going edge (Edge) or a low voltage (Level) will satisfy the gate condition after the delay.

Remote Command	<code>[:SENSe] :SWEep:EGATe:POLarity NEGative POSitive</code> <code>[:SENSe] :SWEep:EGATe:POLarity?</code>
Example	<code>SWE:EGAT:POL NEG</code> <code>SWE:EGAT:POL?</code>
Preset	POSitive
State Saved	Saved in instrument state
Backwards Compatibility SCPI	<code>[:SENSe] :SWEep:TIME:GATE:POLarity</code> ESA compatibility
Initial S/W Revision	Prior to A.02.00

Remote Command	<code>[:SENSe] :SWEep:TIME:GATE:LEVel HIGH LOW</code> <code>[:SENSe] :SWEep:TIME:GATE:LEVel?</code> ESA compatibility
Preset	HIGH
Initial S/W Revision	Prior to A.02.00

Points

Sets the number of points per sweep, from 1 to 20001. The sweep time resolution setting will depend on the number of points selected.

Key Path	Sweep/Control
Mode	SA, WCDMA, C2K, WIMAX OFDMA, TD-SCDMA, 1xEVDO, DVB-T/H, DTMB (CTTB), ISDB-T, CMMB, LTE, LTE-TDD, Digital Cable TV, MSR, LTEAFDD, LTEATDD
Remote Command	<code>[:SENSe] :ACPowe:r:SWEep:POINts <integer></code> <code>[:SENSe] :ACPowe:r:SWEep:POINts?</code>
Example	<code>ACP:SWE:POIN 500</code> <code>ACP:SWE:POIN?</code>
Notes	Whenever the number of sweep points changes: <ul style="list-style-type: none"> • All trace data is erased • Any traces with Update Off will also go to Display Off (like going from View to Blank in the older analyzers) • Sweep time is re-quantized • Any limit lines that are on will be updated • If averaging/hold is on, averaging/hold starts over
Couplings	Whenever the number of sweep points changes, the sweep time is re-quantized.

Preset	Others: 1001 DVB-T/H:2001 DTMB (CTTB): 2001 ISDB-T: 2001 CMMB: 2001 Digital Cable TV: 2001
State Saved	Saved in instrument state.
Min	1
Max	20001
Initial S/W Revision	Prior to A.02.00
Modified at S/W Revision	A.02.00, A.03.00

10 ACP Measurement
System

System

See ["System" on page 366](#)

Trace/Detector

Accesses a menu of functions that enable you to control the detectors for the current measurement.

Key Path	Front-panel key
Initial S/W Revision	Prior to A.02.00

Select Trace (Front-panel Only)

This key selects which trace the other parameters under the Trace/Detector menu will apply to.

Key Path	Trace/Detector
Notes	Front-panel only.
Couplings	When Meas Method is RBW or FAST, Select Trace is disabled.
Preset	1
State Saved	Saved in instrument state.
Range	1 2 3
Initial S/W Revision	Prior to A.02.00

Trace Type

Allows you to select the type of trace for the current measurement. The first page of this menu contains a selection of the trace type (Clear Write, Trace Average, Max Hold, Min Hold) for the selected trace.

Key Path	Trace/Detector
Mode	SA, WCDMA, C2K, WIMAX OFDMA, TD-SCDMA, 1xEVDO, DVB-T/H, DTMB (CTTB), ISDB-T, CMMB, LTE, LTE-TDD, Digital Cable TV, MSR, LTEAFDD, LTEATDD
Remote Command	:TRACe [1] 2 3 :ACPoweR :TYPE WRITe AVERAge MAXHold MINHold :TRACe [1] 2 3 :ACPoweR :TYPE?
Example	TRAC:ACP:TYPE MINH TRAC:ACP:TYPE?
Notes	WRITe = Clear Write AVERAge = Average MAXHold = Maximum Hold MINHold = Minimum Hold
Couplings	When Detector setting is "Auto" ([:SENSe]:ACPoweR:DETEctor:AUTO?), Detector is set to what the Radio Standard defaults states (see detector section below) for all conditions of Trace Type and for all traces. When set to Manual, all Traces use the same detector type. When Average State = Off then Trace Types AVERAge, MaxHold and MinHold will not function, since Averaging is required to be 'on' for them to operate.

	When Meas Method is RBW or FAST, Trace Type is disabled.
Preset	AVERage
State Saved	Saved in instrument state.
Initial S/W Revision	Prior to A.02.00
Modified at S/W Revision	A.02.00, A.03.00

View/Blank

Enables you to select how to view the displayed trace.

Key Path	Trace/Detector
Mode	SA,WCDMA, C2K, WIMAX OFDMA, TD-SCDMA, 1xEVDO, DVB-T/H, DTMB (CTTB), ISDB-T, CMMB, LTE, LTE-TDD, Digital Cable TV, MSR, LTEAFDD,LTEATDD
Notes	No remote control. Front panel only.
Couplings	The four states of this 1-of-N actually set two variables, Update and Display, to their four possible combinations. Trace On: Update and Display both On View: Update Off and Display On (Not implemented) Blank: Update Off and Display Off Background: Update On, Display Off (Not implemented) See tables below for detail on remote commands to control these two variables. Selecting a trace type (Clear Write, Trace Average, Max Hold, Min Hold) for a trace (pressing the key or sending the equivalent remote command) puts the trace in 'Trace On' state (Update On and Display On), even if that trace type was already selected. When Meas Method is RBW or FAST, this key is grayed out.
Preset	Trace On
State Saved	Saved in instrument state.
Range	Trace On Blank
Initial S/W Revision	Prior to A.02.00
Modified at S/W Revision	A.03.00

Key Path	Trace/Detector
Mode	WCDMA, C2K, WIMAX OFDMA, TD-SCDMA, 1xEVDO, DVB-T/H, DTMB (CTTB), ISDB-T, CMMB, LTE, LTE-TDD, Digital Cable TV, MSR, LTEAFDD,LTEATDD
Remote Command	:TRACe [1] 2 3 :ACPpower:UPDate [:STATe] ON OFF 0 1 :TRACe [1] 2 3 :ACPpower:UPDate [:STATe] ?
Example	TRAC:ACP:UPD ON TRAC:ACP:UPD?
Couplings	Whenever you set Update to On for any trace, the Display is set to On for that trace. When Meas Method is RBW or FAST, Trace Update is disabled.
Preset	1 0 0 (On for Trace 1; Off for 2 &3)

State Saved	Saved in instrument state.
Range	0 1
Initial S/W Revision	Prior to A.02.00
Modified at S/W Revision	A.03.00
<hr/>	
Key Path	Trace/Detector
Mode	WCDMA, C2K, WIMAX OFDMA, TD-SCDMA, 1xEVDO, DVB-T/H, DTMB (CTTB), ISDB-T, CMMB, LTE, LTETDD, Digital Cable TV, MSR, LTEAFDD,LTEATDD
Remote Command	:TRACe[1] 2 3:ACPpower:DISPlay[:STATe] ON OFF 0 1 :TRACe[1] 2 3:ACPpower:DISPlay[:STATe]?
Example	TRAC:ACP:DISP ON TRAC:ACP:DISP?
Couplings	Whenever you set Update to On for any trace, the Display is set to On for that trace. When Meas Method is RBW or FAST, Trace Display is disabled.
Preset	1 0 0 (On for Trace 1; Off for 2 &3)
State Saved	Saved in instrument state.
Range	0 1
Initial S/W Revision	Prior to A.02.00
Modified at S/W Revision	A.03.00

Detector

Accesses a menu of functions that enables you to control the detectors for the current measurement. Allows up to three (3) traces, but each use the same detector type choice. The following choices are available:

- Auto– the detector selected is set to AVERage, unless the Radio Standard defaults state otherwise e.g. it is set to Peak for Radio Standard = PDC when Device = both MS and BTS, and when Radio Standard = NADC and Device = MS.
- Normal–the detector determines the peak of the CW-like signals, and it yields alternating maximums and minimums of noise-like signals. This is also referred to as Rosenfell detection.
- Average–the detector determines the average of the signal within the sweep points. The averaging method is Power (RMS).
- Peak–the detector determines the maximum of the signal within the sweep points.
- Sample–the detector indicates the instantaneous level of the signal at the center of the sweep points represented by each display point.
- Negative Peak–the detector determines the minimum of the signal within the sweep points.

In swept analysis, the time interval of the data collection for the display sweep points also represents a frequency interval. In FFT analysis, the sweep points represents just a frequency interval. The detector

determines the relationship between the spectrum computed by the FFT and the single data point displayed for the sweep points.

Key Path	Trace/Detector
Initial S/W Revision	Prior to A.02.00

Auto

Sets the detector for the currently selected trace to auto.

Key Path	Trace/Detector
Mode	SA, WCDMA, C2K, WIMAX OFDMA, TD-SCDMA, 1xEVDO, DVB-T/H, DTMB (CTTB), ISDB-T, CMMB, LTE, LTE-TDD, Digital Cable TV, MSR, LTEAFDD, LTEATDD
Remote Command	<code>[:SENSe] :ACPower:DETECTOR:AUTO ON OFF 1 0</code> <code>[:SENSe] :ACPower:DETECTOR:AUTO?</code>
Example	ACP:DET:AUTO 1 ACP:DET?
Couplings	When Detector setting is “Auto” (<code>[:SENSe] :ACPower:DETECTOR:AUTO?</code>), Detector is set to what the Radio Standard defaults states (see detector section) for all conditions of Trace Type and for all traces. When set to Manual, all Traces use the same detector type. When Average State = Off then Trace Types AVERage, MaxHold and MinHold will not function, since Averaging is required to be ‘on’ for them to operate.
Preset	ON
State Saved	Saved in instrument state.
Range	ON OFF
Initial S/W Revision	Prior to A.02.00
Modified at S/W Revision	A.02.00, A.03.00

Detector Selection

Selects a detector to be used by the analyzer for the current measurement. All traces will use the same detector type, similar to Monitor Spectrum measurement

Key Path	Trace/Detector
Mode	SA, WCDMA, C2K, WIMAX OFDMA, TD-SCDMA, 1xEVDO, DVB-T/H, DTMB (CTTB), ISDB-T, CMMB, LTE, LTE-TDD, Digital Cable TV, MSR, LTEAFDD, LTEATDD
Remote Command	<code>[:SENSe] :ACPower:DETECTOR[:FUNCTION] AVERage NEGative NORMal POSitive SAMPlE</code> <code>[:SENSe] :ACPower:DETECTOR[:FUNCTION]?</code>
Example	ACP:DET NORM ACP:DET?
Notes	When you manually select a detector (instead of selecting Auto), that detector is used regardless of

other analyzer settings.

The detector choices are:

- The Normal detector determines the peak of CW-like signals, and it yields alternating maximums and minimums of noise-like signals. This is also referred to as Rosenfell detection.
- The Average detector determines the average of the signal within the data range. The averaging method is Power (RMS).
- The Peak detector determines the maximum of the signal within the data range.
- The Sample detector indicates the instantaneous level of the signal at the center of the data represented by each display point.
- The Negative Peak detector determines the minimum of the signal within the data range.

Because they may not find a spectral component's true peak, neither average nor sample detectors measure amplitudes of CW signals as accurately as peak or normal, but they do measure noise without the biases of peak detection.

When a detector selection is made, the menu returns to the previous menu.

Couplings	When Detector setting is "Auto" (:SENSe]:ACPower:DETECTOR:AUTO?), Detector is set to what the Radio Standard defaults states (see detector section) for all conditions of Trace Type and for all traces. When set to Manual, all Traces use the same detector type. When Average State = Off then Trace Types AVERage, MaxHold and MinHold will not function, since Averaging is required to be 'on' for them to operate. Only one detector type for all 3 traces is allowed. When Meas Method is RBW or FAST, Detector is disabled.
Preset	AVERage
State Saved	Saved in instrument state.
Range	Normal Average Peak Sample Negative Peak
Backwards Compatibility SCPI	[:SENSe] :ACPR :SWEep :DETECTOR [:FUNCTION]
Initial S/W Revision	Prior to A.02.00
Modified at S/W Revision	A.02.00, A.03.00

Trigger

See ["Trigger" on page 438](#)

Free Run

See ["Free Run " on page 445](#)

Video

See ["Video \(IF Envelope\) " on page 446](#)

Trigger Level

See ["Trigger Level " on page 446](#)

Trig Slope

See ["Trig Slope " on page 447](#)

Trig Delay

See ["Trig Delay " on page 448](#)

Line

See ["Line " on page 2503](#)

Trig Slope

See ["Trig Slope " on page 2503](#)

Trig Delay

See ["Trig Delay " on page 450](#)

External 1

See ["External 1 " on page 2516](#)

Trigger Level

See ["Trigger Level " on page 2516](#)

Trig Slope

See ["Trig Slope " on page 2517](#)

Trig Delay

See ["Trig Delay " on page 453](#)

Zero Span Delay Comp

See ["Zero Span Delay Comp On/Off" on page 2505](#)

External 2

See ["External 2 "](#) on page 2518

Trigger Level

See ["Trigger Level "](#) on page 2518

Trig Slope

See ["Trig Slope "](#) on page 2519

Trig Delay

See ["Trig Delay "](#) on page 455

Zero Span Delay Comp

See ["Zero Span Delay Comp On/Off"](#) on page 2507

RF Burst

See ["RF Burst "](#) on page 2519

Absolute Trigger

See ["Absolute Trigger Level"](#) on page 2520

Relative Trigger

See ["Relative Trigger Level"](#) on page 2509

Trig Slope

See ["Trigger Slope "](#) on page 2521

Trig Delay

See ["Trig Delay "](#) on page 460

Periodic Timer

See ["Periodic Timer \(Frame Trigger\) "](#) on page 2511

Period

See ["Period "](#) on page 2512

Offset

See ["Offset "](#) on page 2513

Reset Offset Display

See ["Reset Offset Display "](#) on page 2515

Sync Source

See "[Sync Source](#) " on page 2515

Off

See "[Off](#) " on page 2516

External 1

See "[External 1](#) " on page 2516

Trigger Level

See "[Trigger Level](#) " on page 2516

Trig Slope

See "[Trig Slope](#) " on page 2517

External 2

See "[External 2](#) " on page 2518

Trigger Level

See "[Trigger Level](#) " on page 2518

Trig Slope

See "[Trig Slope](#) " on page 2519

RF Burst

See "[RF Burst](#) " on page 2519

Absolute Trigger

See "[Absolute Trigger Level](#)" on page 2520

Trig Slope

See "[Trigger Slope](#) " on page 2521

Trig Delay

See "[Trig Delay](#)" on page 470

Auto/Holdoff

See "[Auto/Holdoff](#) " on page 471

Auto Trig

See "[Auto Trig](#) " on page 471

Trig Holdoff

See "[Trig Holdoff](#) " on page 472

Holdoff Type

See "Holdoff Type" on page 472

User Preset

Accesses a menu that gives you the following three choices:

- User Preset – recalls a state previously saved using the Save User Preset function.
- User Preset All Modes – presets all of the modes in the analyzer
- Save User Preset– saves the current state for the current mode

Key Path	Front-panel key
Backwards Compatibility Notes	<p>User Preset is actually loading a state, and in legacy analyzers, it was possible to load a state without affecting the trace data, limit lines or correction data. Similarly it was possible to do a User Preset without affecting the trace data, limit lines or correction data.</p> <p>In the X-Series, “state” always includes all of this data; so whenever state is loaded, or User Preset is executed, all of the traces, limit lines and corrections are affected. Although this differs from previous behavior, it is desirable behavior, and should not cause adverse issues for users.</p> <p>On ESA and PSA, User Preset affected the entire instrument’s state. In the X-Series, User Preset only recalls the state for the active mode. There is a User Preset file for each mode. User Preset can never cause a mode switch as it can in legacy analyzers. If you want to recall all modes to their user preset file state, you will need to do a User Preset after mode switching into each mode.</p> <p>User Preset recalls mode state which can now include data like traces; whereas on ESA and PSA, User Preset did not affect data.</p>
Initial S/W Revision	Prior to A.02.00

User Preset

User Preset sets the state of the currently active mode back to the state that was previously saved for this mode using the Save User Preset menu key or the SCPI command, SYST:PRES:USER:SAV. It not only recalls the Mode Preset settings, but it also recalls all of the mode persistent settings, and the Input/Output system setting that existed at the time Save User Preset was executed.

If a Save User Preset has not been done at any time, User Preset recalls the default user preset file for the currently active mode. The default user preset files are created if, at power-on, a mode detects there is no user preset file. There will never be a scenario when there is no user preset file to restore. For each mode, the default user preset state is the same state that would be saved if a Save User Preset is performed in each mode right after doing a Restore Mode Default and after a Restore Input/Output Defaults.

The User Preset function does the following:

- Aborts the currently running measurement.
- Sets the mode State to the values defined by Save User Preset.
- Makes the saved measurement for the currently running mode the active measurement.
- Brings up the saved menu for the power-on mode.
- Clears the input and output buffers.
- Sets the Status Byte to 0.

Key Path	User Preset
Remote Command	:SYSTem:PRESet:USER
Example	:SYST:PRES:USER:SAVE:SYST:PRES:USER
Notes	:SYST:PRES:USER:SAVE is used to save the current state as the user preset state. Clears all pending OPC bits. The Status Byte is set to 0. Pressing the User Preset front-panel key while already in the User Preset menu will cause the User Preset to get executed
Couplings	A user preset will cause the currently running measurement to be aborted and cause the saved measurement to be active. Recalling a User Preset file has the same issues that recalling a Save State file has. Some settings may need to be limited and therefore re-coupled, since the capabilities of the mode may have changes when the User Preset file was last saved.
Initial S/W Revision	Prior to A.02.00

User Preset All Modes

Recalls all of the User Preset files for each mode, switches to the power-on mode, and activates the saved measurement from the power-on mode User Preset file.

NOTE

When the instrument is secured, all of the user preset files are converted back to their default user preset files.

The User Preset function does the following:

- Aborts the currently running measurement.
- Switches the Mode to the power-on mode.
- Restores the User Preset files for each mode.
- Makes the saved measurement for the power-on mode the active measurement.
- Brings up the saved menu for the power-on mode.
- Clears the input and output buffers.
- Sets the Status Byte to 0.

Key Path	User Preset
Remote Command	:SYSTem:PRESet:USER:ALL
Example	:SYST:PRES:USER:SAVE:SYST:PRES:USER:ALL
Notes	Clears all pending OPC bits. The Status Byte is set to 0. :SYST:PRES:USER:SAVE is used to save the current state as the user preset state.
Couplings	A user preset will cause the currently running measurement to be aborted, cause a mode switch to the power-on mode, and cause the saved measurement to be active in the power-on mode. Recalling a User Preset file has the same issues that recalling a Save State file has. Some settings may need to be limited and therefore re-coupled, since the capabilities of the mode may have changes when the User Preset file was last saved.
Initial S/W Revision	Prior to A.02.00

Save User Preset

Saves the currently active mode and its State. You can recall this User Preset file by pressing the User Preset menu key or sending the SYST:PRES:USER remote command. This same state is also saved by the Save State function.

Key Path	User Preset
Remote Command	:SYSTem:PRESet:USER:SAVE
Example	:SYST:PRES:USER:SAVE
Notes	:SYST:PRES:SAVE creates the same file as if the user requested a *SAV or a MMEM:STOR:STAT, except User Preset Save does not allow the user to specify the filename or the location of the file.
Initial S/W Revision	Prior to A.02.00

View/Display

Accesses a menu of functions that enable you to control the instrument display as well as turn the bar graph On and Off.

If current mode is NOT MSR and LTE-Advanced FDD/TDD mode, the front panel views only contain one view: Spectrum View.

The results of the measurement can be displayed as a single spectrum trace view or displayed with a Bar Graph trace on the spectrum trace.

The display consists of the following two windows:

"Spectrum Window" on page 1053

"Results Window" on page 1053

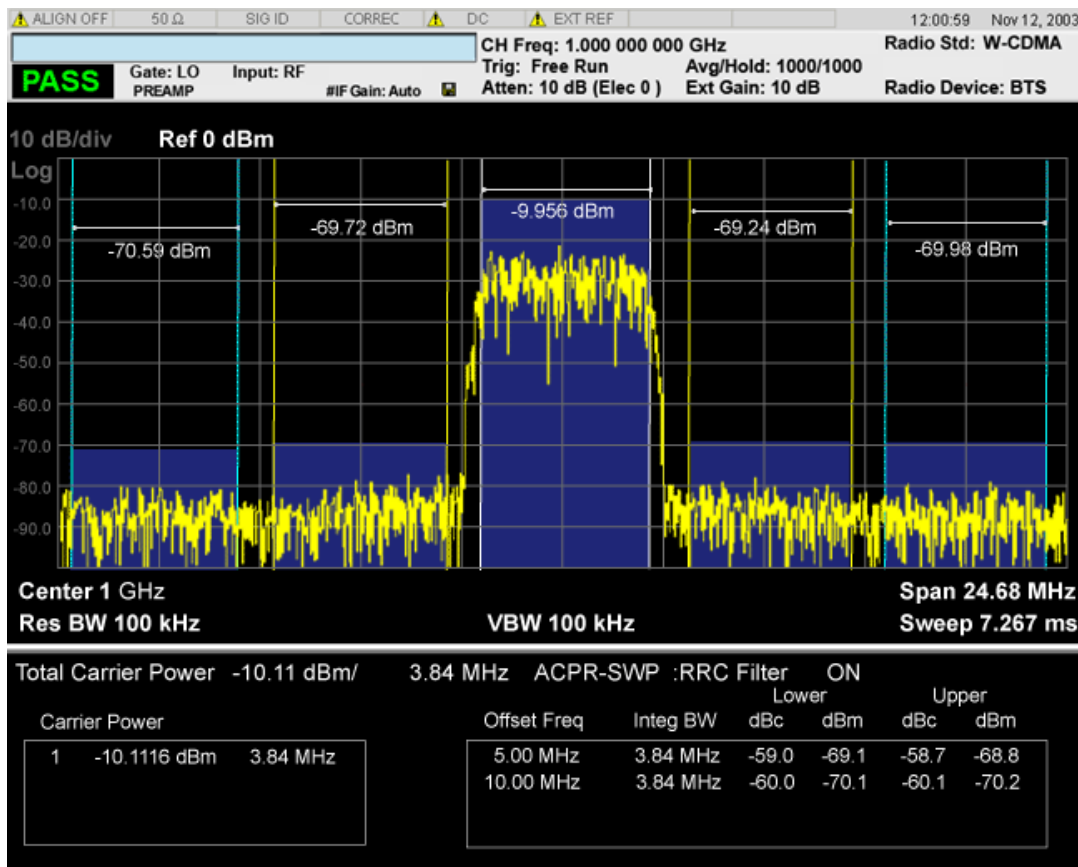

The following two views are only for DTMB (CTTB) and CMMB:

DTMB and CMMB Transmitter:

10 ACP Measurement
View/Display

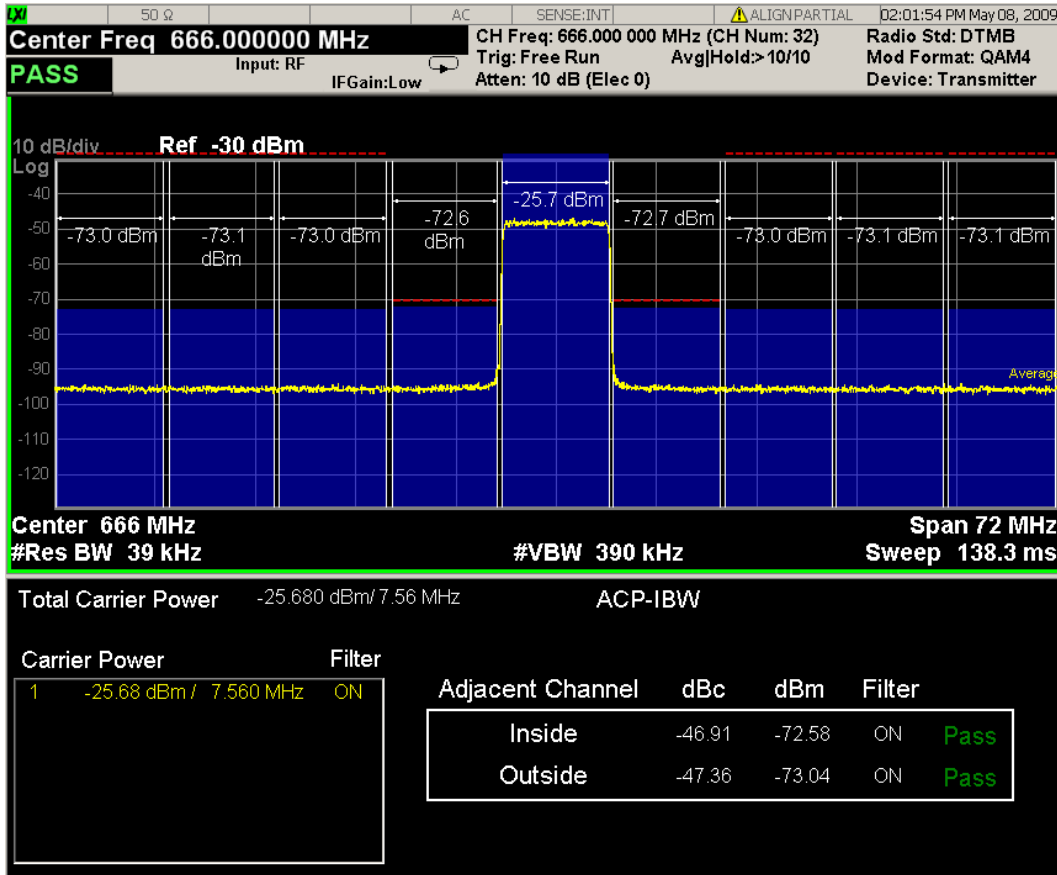

DTMB and CMMB Exciter:

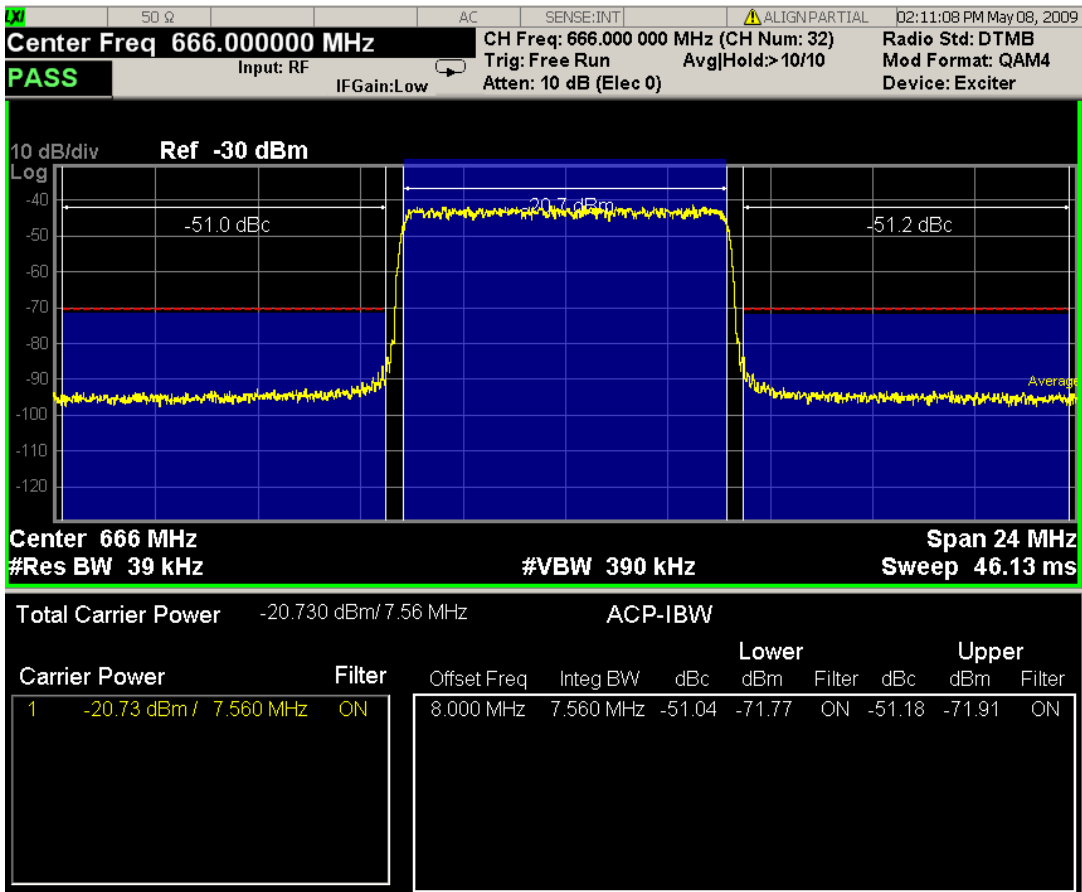

Spectrum Window

When the Bar Graph is On and Limit Test is On, the color of each bar graph reflects the limit test result. When the limit test fails, the bar color is red, and when limit test passes, the bar color is blue.

When RBW is selected as the measurement method, the spectrum trace is not displayed, only the bar graph is displayed. In addition, the Bar Graph key (under the View/Display front-panel key) is set to ON and is grayed out.

The RRC Filter display item is only displayed when RRC filter is on.

Results Window

The text window displays the following results:

Total Carrier Power

This is the total power of all the carriers with carrier power present set to yes. The power is calculated by integrating across the bandwidth declared by the Carrier Integ Bw parameter for each carrier and then totaling the sums. The total integration bandwidth is shown as part of the result. This will be the total of the Carrier Integ Bw of the carriers used in calculating the total carrier power. If the RRC Filter is on, then the integration bandwidth used is $(1 + \alpha)/T$ where $T = 1/(\text{Carrier Integ Bw})$ multiplied by the number of carriers with carrier power present set to yes.

Ref Carrier Power

This is the power in the reference carrier. The power is calculated by integrating across the bandwidth declared by the Carrier Integ Bw parameter for that carrier. The integration bandwidth is shown as part of the result. This is the value of the Carrier Integ Bw for that carrier unless the RRC Filter is on, then the integration bandwidth used is the displayed value, which is $(1 + \alpha)/T$ where $T = 1/(\text{Carrier Integ Bw})$.

Carrier Power

This is the power in all the currently defined carriers. If the carrier has carrier power present, the power will be absolute. If the carrier is defined as not having power present, the power will be relative to the reference carrier. The power is calculated by integrating across the bandwidth declared by the Carrier Integ Bw parameter. The integration bandwidth is shown as part of the result. This is the value of the Carrier Integ Bw for the carrier unless the RRC Filter is on, then the integration bandwidth used is the displayed value, which is $(1 + \alpha)/T$ where $T = 1/(\text{Carrier Integ Bw})$.

As there are potentially more results than can be easily viewed on the display, a scrollable list is used to display all results. The Carrier Results menu key is used to index the carrier amplitude results. This key is grayed out unless the measurement is in single mode (as in continual measurement mode). The display is continuously updating and will not need to be accessed. The currently selected Carrier Result is displayed on the last line of the carrier power result list unless:

- The selected Carrier Result is 4 or less in normal multi carrier power results view. In this case the first 4 carrier power results will be displayed.
- The selected Carrier Result is 9 or greater in normal multi carrier power results view. In this case the last 4 carrier power results will be displayed.
- The zoom mode is selected. In this case all carrier power ranges can be displayed.

Offset Relative Power

This is the power in the offsets relative to the reference carrier. The power is calculated by integrating across the bandwidth declared by the Offset Integ Bw parameter. The offset integration bandwidth is shown as part of the result. This is the value on the Offset Integ Bw menu key unless the RRC Filter is on, then the integration bandwidth used is the displayed value, which is $(1 + \alpha)/T$ where $T = 1/(\text{Offset Integ Bw})$.

Offset Absolute Power

This is the absolute power in the offsets. The power is calculated by integrating across the bandwidth declared by the Offset Integ Bw parameter. The offset integration bandwidth is shown as part of the result. This is the value on the Offset Integ Bw menu key unless the RRC Filter is on, then the integration bandwidth used is the displayed value, which is $(1 + \alpha)/T$ where $T = 1/(\text{Offset Integ Bw})$.

Inside Adjacent Channel Power (DTMB (CTTB) and CMMB only)

This result is only valid for DTMB (CTTB) transmitter and CMMB transmitter. It contains two parts: Relative Power and Absolute Power. The power is calculated by integrating across the bandwidth (Integ Bw) at the frequency Offset A.

Inside Absolute Power = MAX (P_{Lower Offset A}, P_{Upper Offset A});

Inside Relative Power = Inside Absolute Power – Carrier Power;

Outside Adjacent Channel Absolute Power (DTMB (CTTB) and CMMB only)

This result is only valid for DTMB (CTTB) transmitter and CMMB transmitter. It contains two parts: Relative Power and Absolute Power. The power is the Root-Mean-Square of the power calculated by integrating across the bandwidth (Integ Bw) at frequency Offset B, C and D.

$$\text{Outside Absolute Power} = \sqrt{\frac{P_{\text{Lower OffsetB}}^2 + P_{\text{Upper OffsetB}}^2 + P_{\text{Lower OffsetC}}^2 + P_{\text{Upper OffsetC}}^2 + P_{\text{Lower OffsetD}}^2 + P_{\text{Upper OffsetD}}^2}{6}}$$

Outside Relative Power = Outside Absolute Power – Carrier Power;

If current mode is MSR, there are two views, Result Trace and Carrier Info.

NOTE

Y Scale/Div, Y Ref Position, Y Auto Scale, Y Ref Value and Bar Graph affect both views. For example, power bars on the traces in both views appear or disappear when Bar Graph is toggled.

View Selection by Name (MSR and LTE-Advanced FDD/TDD Only)

Selects the results view. The following SCPI command allows you to select the desired measurement view by enumeration.

Key Path	No equivalent front-panel key
Mode	MSR, LTEAFDD,LTEATDD
Remote Command	:DISPlay:ACPower:VIEW[:SElect] PRESult CINformation :DISPlay:ACPower:VIEW[:SElect] ?
Example	DISP:ACP:VIEW PRES DISP:ACP:VIEW?
Notes	This SCPI is only available in MSR and LTE-Advanced FDD/TDD.
Preset	PRESult
State Saved	Saved in instrument state
Range	Power Results Carrier Info
Initial S/W Revision	A.10.00

Key Path	No equivalent front-panel key
Mode	MSR, LTEAFDD,LTEATDD
Remote Command	:DISPlay:ACPower:VIEW:NSElect <integer> :DISPlay:ACPower:VIEW:NSElect ?
Example	DISP:ACP:VIEW:NSEL 1 DISP:ACP:VIEW:NSEL?
Notes	This SCPI is only available in MSR and LTE-Advanced FDD/TDD.
Preset	1
State Saved	Saved in instrument state
Min	1
Max	2
Initial S/W Revision	A.10.00

Key Path	Front-panel key
Initial S/W Revision	Prior to A.02.00

Display

The Display menu is common to most measurements, and is used for configuring items on the display. Some Display menu settings apply to all the measurements in a mode, and some only to the current measurement. Those under the System Display Settings key apply to all measurements in all modes.

Key Path	Display
Key Path	View/Display
Initial S/W Revision	Prior to A.02.00

Annotation

Turns on and off various parts of the display annotation. The annotation is divided up into four categories:

1. Meas Bar: This is the measurement bar at the top of the screen. It does not include the settings panel or the Active Function. Turning off the Meas Bar turns off the settings panel and the Active Function. When the Meas Bar is off, the graticule area expands to fill the area formerly occupied by the Meas Bar.
2. Screen Annotation: this is the annotation and annunciation around the graticule, including any annotation on lines (such as the display line, the threshold line, etc.) This does NOT include the marker number or the N dB result. When off, the graticule expands to fill the entire graticule area.
3. Trace annotation: these are the labels on the traces, showing their detector (or their math mode).
4. Active Function annotation: this is the active function display in the meas bar, and all of the active function values displayed on softkeys.

See the figure below. Each type of annotation can be turned on and off individually.

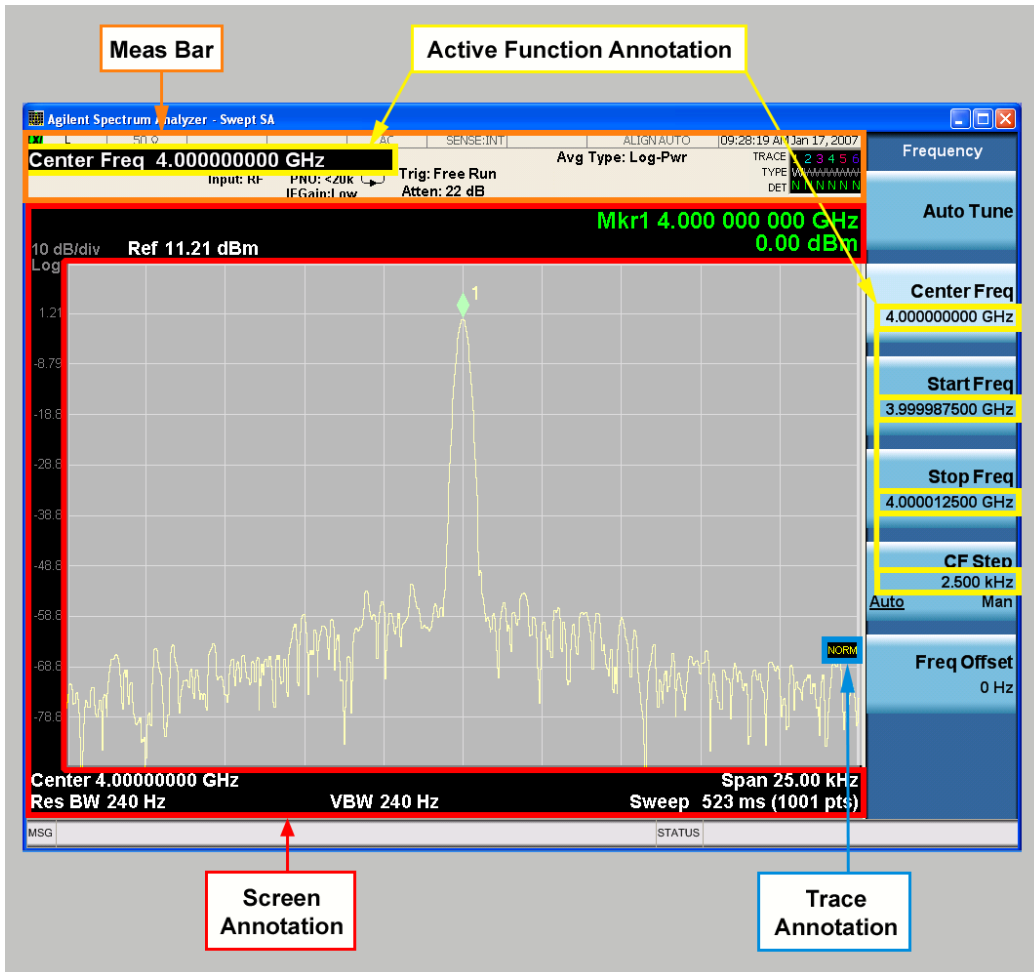

Key Path	View/Display, Display
Initial S/W Revision	Prior to A.02.00

Meas Bar On/Off

This function turns the Measurement Bar on and off, including the settings panel. When off, the graticule area expands to fill the area formerly occupied by the Measurement Bar.

Key Path	View/Display, Display, Annotation
Remote Command	:DISPlay:ANNotation:MBAR[:STATE] OFF ON 0 1 :DISPlay:ANNotation:MBAR[:STATE]?
Example	DISP:ANN:MBAR OFF
Dependencies	Grayed out and forced to OFF when System Display Settings, Annotation is set to Off.
Preset	On This should remain Off through a Preset when System DisplaySettings, Annotation is set to Off.
State Saved	Saved in instrument state.
Initial S/W Revision	Prior to A.02.00

Screen

This controls the display of the annunciation and annotation around the graticule, including any annotation on lines (such as the display line, the threshold line, etc.) and the y-axis annotation. This does NOT include marker annotation (or the N dB result). When off, the graticule expands to fill the entire graticule area, leaving only the 1.5% gap above the graticule as described in the Trace/Detector chapter.

Key Path	View/Display, Display, Annotation
Remote Command	:DISPlay:ANNotation:SCReen[:STATe] OFF ON 0 1 :DISPlay:ANNotation:SCReen[:STATe]?
Example	DISP:ANN:SCR OFF
Dependencies	Grayed-out and forced to OFF when System Display Settings, Annotation is set to Off.
Preset	On This should remain Off through a Preset when System DisplaySettings, Annotation is set to Off
State Saved	Saved in instrument state.
Initial S/W Revision	Prior to A.02.00

Active Function Values On/Off

Turns on and off the active function display in the Meas Bar, and all of the active function values displayed on the softkeys.

Note that all of the softkeys that have active functions have these numeric values blanked when this function is on. This is a security feature..

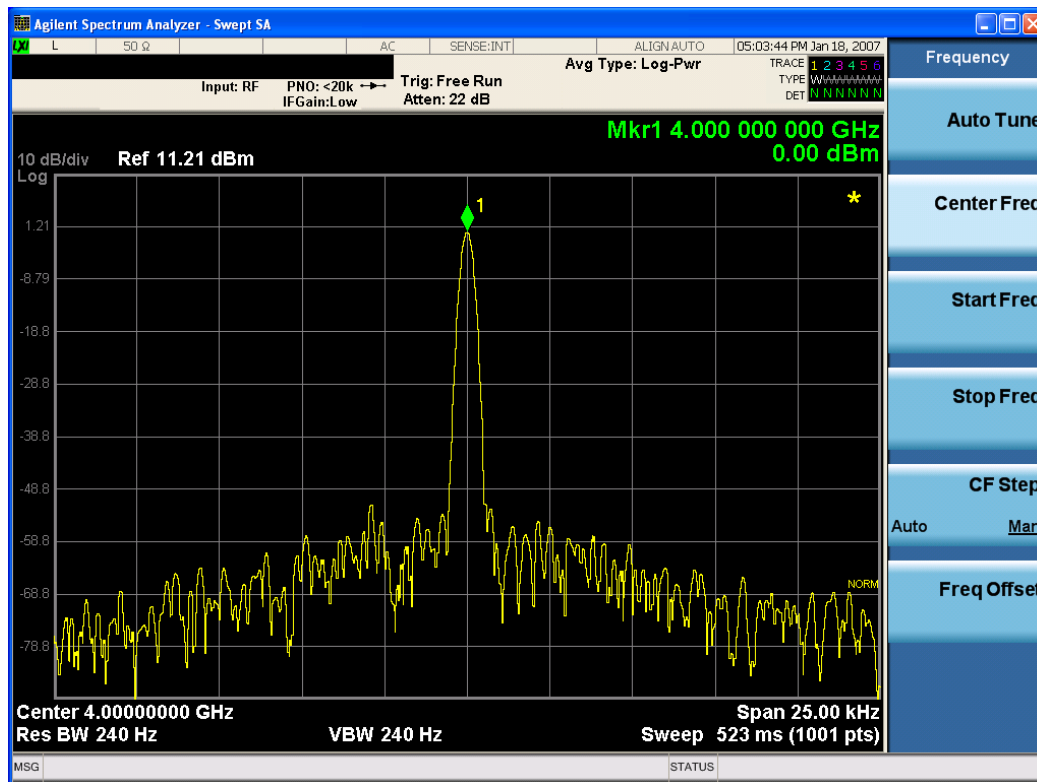

Key Path	View/Display, Display, Annotation
Remote Command	:DISPlay:ACTivefunc[:STATE] ON OFF 1 0 :DISPlay:ACTivefunc[:STATE]?
Example	DISP:ACT OFF
Dependencies	Grayed out and forced to OFF when System Display Settings, Annotation is set to Off.
Preset	On This should remain Off through a Preset when System DisplaySettings, Annotation is set to Off
State Saved	Saved in instrument state.
Initial S/W Revision	Prior to A.02.00

Title

Displays menu keys that enable you to change or clear a title on your display.

Key Path	View/Display, Display
Initial S/W Revision	Prior to A.02.00

Change Title

Writes a title into the "measurement name" field in the banner, for example, "Swept SA".

Press Change Title to enter a new title through the alpha editor. Press Enter or Return to complete the entry. Press ESC to cancel the entry and preserve your existing title.

The display title will replace the measurement name. It remains for this measurement until you press Change Title again, or you recall a state, or a Preset is performed. A title can also be cleared by pressing Title, Clear Title.

NOTE

Notice the inclusion of the <measurement> parameter in the command below. Because each measurement remembers the Display Title, the command must be qualified with the measurement name. For the Swept SA measurement this is not the case; no <measurement> parameter is used when changing the Display Title for the Swept SA measurement.

Key Path	View/Display, Display, Title
Mode	All
Remote Command	:DISPlay:<measurement>:ANNotation:TITLe:DATA <string> :DISPlay:<measurement>:ANNotation:TITLe:DATA?
Example	DISP:ANN:TITL:DATA "This Is My Title" This example is for the Swept SA measurement in the Spectrum Analyzer mode. The SANalyzer <measurement> name is not used. DISP:ACP:ANN:TITL:DATA "This Is My Title" This example is for Measurements other than Swept SA. Both set the title to: This Is My Title
Notes	Pressing this key cancels any active function. When a title is edited the previous title remains intact (it is not cleared) and the cursor goes at the end so that characters can be added or BKSP can be used to go back over previous characters.
Preset	No title (measurement name instead)
State Saved	Saved in instrument state.
Initial S/W Revision	Prior to A.02.00

Clear Title

Clears a title from the front-panel display. Once cleared, the title cannot be retrieved. After the title is cleared, the current Measurement Name replaces it in the title bar.

Key Path	View/Display, Display, Title
Example	The following commands clear the title and restore the measurement's original title: DISP:ANN:TITL:DATA "" This example is for the Swept SA measurement in the Spectrum Analyzer mode. The SANalyzer <measurement> name is not used. DISP:ACP:ANN:TITL:DATA "" This example is for ACP; in measurements other than Swept SA the measurement name is required.
Notes	Uses the :DISPlay:<measurement>:ANNotation:TITLe:DATA <string> command with an empty string (in the Swept SA, the <measurement> is omitted).
Preset	Performed on Preset.
Initial S/W Revision	Prior to A.02.00

Graticule

Pressing Graticule turns the display graticule On or Off. It also turns the graticule y-axis annotation on and off.

Key Path	View/Display, Display
Remote Command	:DISPlay:WINDow[1]:TRACe:GRATicule:GRID[:STATe] OFF ON 0 1 :DISPlay:WINDow[1]:TRACe:GRATicule:GRID[:STATe]?
Example	DISP:WIND:TRAC:GRAT:GRID OFF
Notes	The graticule is the set of horizontal and vertical lines that make up the grid/divisions for the x-axis and y-axis.
Preset	On
State Saved	Saved in instrument state
Initial S/W Revision	Prior to A.02.00

System Display Settings

These settings are "Mode Global" – they affect all modes and measurements and are reset only by Restore Misc Defaults or Restore System Defaults under System.

Key Path	View/Display, Display
Initial S/W Revision	Prior to A.02.00

Annotation Local Settings

This is a Mode Global override of the meas local annotation settings. When it is All Off, it forces ScreenAnnotation, Meas Bar, Trace, and Active Function Values settings to be OFF for all measurements in all modes. This provides the security based "annotation off" function of previous analyzers; hence it uses the legacy SCPI command.

When it is All Off, the Screen, Meas Bar, Trace, and Active Function Values keys under the Display, Annotation menu are grayed out and forced to Off. When Local Settings is selected, you are able to set the local annotation settings on a measurement by measurement basis.

Key Path	View/Display, Display, System Display Settings
Remote Command	:DISPlay:WINDow[1]:ANNOtation[:ALL] OFF ON 0 1 :DISPlay:WINDow[1]:ANNOtation[:ALL]?
Example	:DISP:WIND:ANN OFF
Preset	On (Set by Restore Misc Defaults)
State Saved	Not saved in instrument state.
Backwards Compatibility Notes	The WINDow parameter and optional subopcode is included for backwards compatibility but ignored – all windows are equally affected.
Initial S/W Revision	Prior to A.02.00

Themes

Accesses a menu of functions that enable you to choose the theme to be used when saving the screen image.

The **Themes** option is the same as the **Themes** option under the **Display** and **Page Setup** dialogs. It allows you to choose between themes to be used when saving the screen image.

Key Path	Save, Screen Image
Remote Command	:MMEMory:STORe:SCReen:THEMe TDColor TDMonochrome FCOLor FMONochrome :MMEMory:STORe:SCReen:THEMe?
Example	:MMEM:STOR:SCR:THEM TDM
Preset	3D Color; Is not part of Preset, but is reset by Restore Misc Defaults or Restore System Defaults All and survives subsequent running of the modes.
Readback	3D Color 3D Mono Flat Color Flat Mono
Backwards Compatibility Notes	In ESA and PSA we offer the choice of "Reverse Bitmap" or "Reverse Metafile" when saving screen images. This is much like the "Flat Color" theme available in X-Series. Also, if you selected Reverse Bitmap AND a black & white screen image, that would be much like "Flat Monochrome". In other words, each of the X-Series themes has a similar screen image type in ESA/PSA. But they are not identical.
Initial S/W Revision	Prior to A.02.00

3D Color

Selects a standard color theme with each object filled, shaded and colored as designed.

Key Path	Save, Screen Image, Themes
Example	MMEM:STOR:SCR:THEM TDC
Readback	3D Color
Initial S/W Revision	Prior to A.02.00

3D Monochrome

Selects a format that is like 3D color but shades of gray are used instead of colors.

Key Path	Save, Screen Image, Themes
Example	MMEM:STOR:SCR:THEM TDM
Readback	3D Mono
Initial S/W Revision	Prior to A.02.00

Flat Color

Selects a format that is best when the screen is to be printed on an ink printer.

Key Path	Save, Screen Image, Themes
Example	MMEM:STOR:SCR:THEM FCOL
Readback	Flat Color
Initial S/W Revision	Prior to A.02.00

Flat Monochrome

Selects a format that is like Flat Color. But only black is used (no colors, not even gray), and no fill.

Key Path	Save, Screen Image, Themes
Example	MMEM:STOR:SCR:THEM FMON
Readback	Flat Mono
Initial S/W Revision	Prior to A.02.00

Backlight

Accesses the display backlight on/off keys. This setting may interact with settings under the Windows "Power" menu.

When the backlight is off, pressing ESC, TAB, SPACE, ENTER, UP, DOWN, LEFT, RIGHT, DEL, BKSP, CTRL, or ALT turns the backlight on without affecting the application. Pressing any other key will turn backlight on and could potentially perform the action as well.

Key Path	View/Display, Display, System Display Settings
Remote Command	:DISPlay:BACKlight ON OFF :DISPlay:BACKlight?
Preset	ON (Set by Restore Misc Defaults)
Initial S/W Revision	Prior to A.02.00

Backlight Intensity

An active function used to set the backlight intensity. It goes from 0 to 100 where 100 is full on and 0 is off. This value is independent of the values set under the Backlight on/off key.

Key Path	View/Display, Display, System Display Settings
Remote Command	:DISPlay:BACKlight:INTensity <integer> :DISPlay:BACKlight:INTensity?
Example	DISP:BACK:INT 50

Preset	100 (Set by Restore Misc Defaults)
Min	0
Max	100
Initial S/W Revision	Prior to A.02.00

Bar Graph

Turns the Bar Graph On and Off.

Key Path	View/Display
Mode	SA, WCDMA, C2K, WIMAX OFDMA, TD-SCDMA, 1xEVDO, DVB-T/H, DTMB (CTTB), ISDB-T, CMMB, LTE, LTETDD, Digital Cable TV, MSR, LTEAFDD, LTEATDD
Remote Command	:DISPlay:ACPower:VIEW[1]:WINDow[1]:BGRaph OFF ON 0 1 :DISPlay:ACPower:VIEW[1]:WINDow[1]:BGRaph?
Example	DISP:ACP:VIEW:WIND:BGR OFF DISP:ACP:VIEW:WIND:BGR?
Notes	You must be in the mode that includes ACP measurements to use this command. Use :INSTrument:SElect to set the mode.
Dependencies	When the method is RBW, this key is always set to On and grayed out.
Preset	ON
State Saved	Saved in instrument state.
Range	On Off
Initial S/W Revision	Prior to A.02.00
Modified at S/W Revision	A.02.00, A.03.00

11 Power Stat CCDF Measurement

Many of the digitally modulated signals now look noise-like in the time and frequency domain. This means that statistical measurements of the signals can be a useful characterization. The Power Complementary Cumulative Distribution Function (CCDF) curves characterize the higher level power statistics of a digitally modulated signal. The curves can be useful in determining design parameters for digital communications systems.

For more details, see ["Power Stat CCDF Measurement Description" on page 1069](#).

For measurement results and views, see View/Display

This topic contains the following sections:

["Measurement Commands for Power Stat CCDF" on page 1066](#)

["Remote Command Results for Power Stat CCDF" on page 1067](#)

["Power Stat CCDF Measurement Description" on page 1069](#)

Measurement Commands for Power Stat CCDF

The following commands and queries can be used to retrieve the measurement results:

```
:CONFigure:PStatistic  
:CONFigure:PStatistic:NDEFault  
:INITiate:PStatistic  
:FETCh:PStatistic[n]?  
:READ:PStatistic[n]?  
:MEASure:PStatistic[n]?
```

For more measurement related commands, see the SENSE subsystem, and the section "[Remote Measurement Functions](#)" on page 2770.

Remote Command Results for Power Stat CCDF

The following table describes the results returned by the FETCh, MEASure, and READ queries listed above, according to the index value n.

n	Results Returned
0	Returns unprocessed I/Q trace data, as a series of trace point values, in volts. The I values are listed first in each pair, using the 0 through even-indexed values. The Q values are the odd-indexed values,
not specified or 1	Returns 10 scalar results: <ol style="list-style-type: none"> 1. Average input power (in dBm) 2. Probability at the average input power level (in %) 3. Power level that has 10% of the power 4. Power level that has 1% of the power 5. Power level that has 0.1% of the power 6. Power level that has 0.01% of the power 7. Power level that has 0.001% of the power 8. Power level that has 0.0001% of the power 9. Peak power (in dB) 10.Count
2	Returns a series of 5001 floating point numbers (in percent) that represent the current measured power stat trace. This is the probability at particular power levels (average power), in the following order: <ol style="list-style-type: none"> 1. Probability at 0.0 dB power 2. Probability at 0.01 dB power 3. Probability at 0.02 dB power ... 5000. Probability at 49.9 dB power 5001. Probability at 50.0 dB power
3	Returns a series of 5001 floating point numbers (in percent) that represent the Gaussian trace. This is the probability at particular power levels (average power), in the following order: <ol style="list-style-type: none"> 1. Probability at 0.0 dB power 2. Probability at 0.01 dB power 3. Probability at 0.02 dB power ... 5000. Probability at 49.9 dB power 5001. Probability at 50.0 dB power
4	Returns a series of 5001 floating point numbers (in percent) that represent the user-definable reference trace. This is the probability at particular power levels (average power), in the following order: <ol style="list-style-type: none"> 1. Probability at 0.0 dB power 2. Probability at 0.01 dB power 3. Probability at 0.02 dB power ... 5000. Probability at 49.9 dB power 5001. Probability at 50.0 dB power

Power Stat CCDF Measurement Description

The power statistics CCDF measurement can be affected by many factors. For example, modulation filtering, modulation format, combining the multiple signals at different frequencies, number of active codes, and correlation between symbols on different codes with spread spectrum systems will all affect measurement results. These factors are all related to modulation and signal parameters. External factors such as signal compression and expansion by nonlinear components, group delay distortion from filtering, and power control within the observation interval also affect the measurement.

The power measured in power statistics CCDF curves is actually instantaneous envelope power defined by the equation:

$$P = (I^2 + Q^2) / Z_0$$

where I & Q are the quadrature voltage components of the waveform, and Z_0 is the characteristic impedance.

A CCDF curve is defined by how much time the waveform spends at or above a given power level. The percent of time the signal spends at or above the level defines the probability for that particular power level. For capturing a lower probability down to 0.0001%, this measurement is made in the single mode by pressing Single. To make the power statistics CCDF measurement, the instrument uses digital signal processing (DSP) to sample the input signal in the channel bandwidth. The Gaussian distribution line as the band-limited Gaussian noise CCDF reference line, the user-definable reference trace, and the currently measured trace can be displayed on a semi-log graph. If the currently measured trace is above the user reference trace, it means that the higher peak power levels against the average power are included in the input signal.

Key Path	Meas
Initial S/W Revision	Prior to A.02.00

AMPTD Y Scale

Accesses a menu of functions that enable you to set the vertical scale parameters. The parameter values are measurement independent except all Attenuation values, and the Internal Preamp selection, which are the same across all measurements.

Key Path	Front-panel key
Initial S/W Revision	Prior to A.02.00

Attenuation

This menu controls the attenuator functions and interactions between the attenuation system components.

There are two attenuator configurations in the X-Series. One is a dual attenuator configuration consisting of a mechanical attenuator and an optional electronic attenuator. The other configuration uses a single attenuator with combined mechanical and electronic sections that controls all the attenuation functions. Different models in the X-Series come with different configurations.

See "[Dual Attenuator Configurations:](#)" on page 1070

See "[Single Attenuator Configuration:](#)" on page 1071

Most Attenuation settings are the same for all measurements – they do not change as you change measurements. Settings like these are called “Meas Global” and are unaffected by Meas Preset.

Key Path	AMPTD Y Scale
Scope	Meas Global
Dependencies	In measurements that support the I/Q inputs, this key is unavailable when I/Q is the selected input, and is replaced by the Range key in that case.
Readback Line	Contains a summary in [] brackets of the current total attenuation. See the descriptions of the , " (Mech) Atten " on page 2736, and " Enable Elec Atten " on page 2737 keys for more detail on the contributors to the total attenuation. Note that when "Pre-Adjust for Min Clip" is on, this value can change at the start of every measurement.
Initial S/W Revision	Prior to A.02.00
Modified at S/W Revision	A.03.00

Dual Attenuator Configurations:

Configuration 1: Mechanical attenuator + optional electronic attenuator

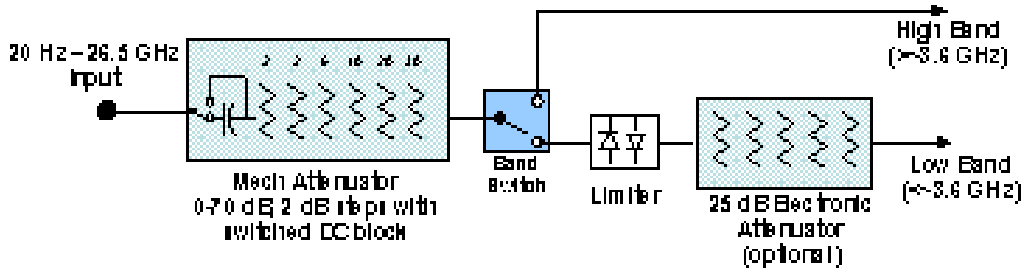

Configuration 2: Mechanical attenuator, no optional electronic attenuator

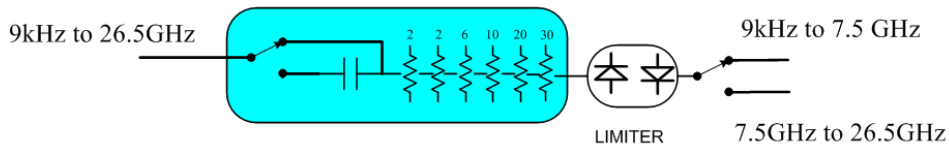

(note that Configuration 2 is not strictly speaking a dual-section attenuator, since there is no electronic section available. However, it behaves exactly like Configuration 1 without the Electronic Attenuator option EA3, therefore for the sake of this document it is grouped into the “Dual Attenuator” configuration)

Single Attenuator Configuration:

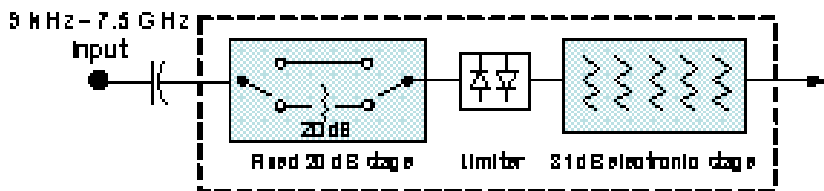

You can tell which attenuator configuration you have by pressing the Attenuation key, which (in most Modes) opens the Attenuation menu. If the first key in the Attenuation menu says Mech Atten you have the dual attenuator configuration. If the first key says Atten you have the single attenuator configuration.

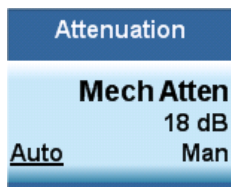

Dual Attenuator

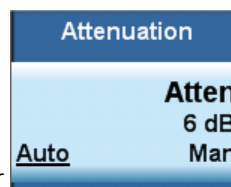

Single Attenuator

In the single attenuator configuration, you control the attenuation with a single control, as the fixed stage has only two states. In the dual attenuator configuration, both stages have significant range so you are given separate control of the mechanical and electronic attenuator stages.

When you have the dual attenuator configuration, you may still have only a single attenuator, because unless option EA3 (the Electronic Attenuator option) is available, and you purchase it, you will have only the mechanical attenuator.

(Mech) Atten

This key is labeled Mech Atten in dual attenuator models and Atten in single attenuator models. In the dual attenuator configuration, this key only affects the mechanical attenuator.

This key lets you modify the attenuation applied to the RF input signal path. This value is normally auto coupled to the Ref Level, the Internal Preamp Gain, any External Gain that is entered, and the Max Mixer Level, as described in the table below.

See "[Attenuator Configurations and Auto/Man](#)" on page 1073

Key Path	AMPTD Y Scale, Attenuation
Remote Command	<pre>[:SENSe] :POWer [:RF] :ATTenuation <rel_ampl> [:SENSe] :POWer [:RF] :ATTenuation? [:SENSe] :POWer [:RF] :ATTenuation:AUTO OFF ON 0 1 [:SENSe] :POWer [:RF] :ATTenuation:AUTO?</pre>
Example	<p>POW:ATT 20</p> <p>Dual attenuator configuration: sets the mechanical attenuator to 20 dB</p> <p>Single attenuator mode: sets the main attenuation to 20 dB (see below for definition of “main” attenuation).</p> <p>If the attenuator was in Auto, it sets it to Manual.</p>
Dependencies	<p>Some measurements do not support the Auto setting of (Mech) Atten. In these measurements, the Auto/Man selection is not available, and the Auto/Man line on the key disappears.</p> <p>In dual attenuator configurations, when the electronic attenuator is enabled, the mechanical attenuator has no auto setting and the Auto/Man line on the key disappears. The state of Auto/Man is remembered and restored when the electronic attenuator is once again disabled. This is described in more detail in the "Enable Elec Atten" on page 2737 key description.</p> <p>See "Attenuator Configurations and Auto/Man" on page 1073 for more information on the Auto/Man functionality of Attenuation.</p>
Couplings	<p>When (Mech) Atten is in Auto, it uses the following algorithm to determine a value:</p> <p>If the USB Preamp is connected to USB, use 0 dB.</p> <p>Otherwise, $Atten = ReferenceLevel + PreAmpGain + ExternalGain - RefLevelOffset - MaxMixerLevel + IF\ Gain$.</p> <p>Limit this value to be between 6 dB and the Max value. No value below 6 dB can ever be chosen by Auto.</p> <p>The resulting value is rounded up to the largest value possible given the attenuation step setting. That is, 50.01 dB would change to 60 dB (for a 10 dB attenuation step).</p> <p>The “IF Gain” term in the equation above is either 0 dB or +10 dB, depending on the settings of FFT IF Gain, Swept IF Gain, max Ref Level and the Auto/Man setting of Mech Atten.</p> <p>In External Mixing and BBIQ, where the Attenuator is not in the signal path, the Attenuator setting changes as described above when (Mech) Atten is in Auto, but no changes are made to the actual attenuator hardware setting until the input is changed back to the RF Input.</p>
Preset	<p>The preset for Mech Attenuation is “Auto.”</p> <p>The Auto value of attenuation is:</p> <p>CXA, EXA, MXA and PXA: 10 dB</p>

State Saved	Saved in instrument state
Min	0 dB The attenuation set by this key cannot be decreased below 6 dB with the knob or step keys. To get to a value below 6 dB it has to be directly entered from the keypad or via SCPI. This protects from adjusting the attenuation to a dangerously small value which can put the instrument at risk of damage to input circuitry. However, if the current mechanical attenuation is below 6 dB it can be increased with the knob and step keys, but not decreased.
Max	CXA N9000A-503/507: 50 dB CXA N9000A-513/526: 70dB EXA: 60 dB MXA and PXA: 70 dB In the single attenuator configuration, the total of ATT and EATT cannot exceed 50 dB, so if the EATT is set to 24 dB first, the main attenuation cannot be greater than 26 dB and will be reduced accordingly; if the main attenuator is set to 40 dB first, EATT cannot be greater than 10 dB.
Initial S/W Revision	Prior to A.02.00
Modified at S/W Revision	A.03.00

Attenuator Configurations and Auto/Man

As described in the Attenuation key description, there are two distinct attenuator configurations available in the X-Series, the single attenuator and dual attenuator configurations. In dual attenuator configurations, we have the mechanical attenuation and the electronic attenuation, and the current total attenuation is the sum of the electronic + mechanical attenuation. In single attenuator configurations, we refer to the attenuation set using the (Mech) Atten key (or POW:ATT SCPI) as the “main” attenuation; and the attenuation that is set by the SCPI command POW:EATT as the “soft” attenuation (the POW:EATT command is honored even in the single attenuator configuration, for compatibility purposes). Then the current total attenuation is the sum of the main + soft attenuation. See the Elec Atten key description for more on “soft” attenuation.

In the dual attenuator configuration, when the electronic attenuator is enabled, there is no Auto/Man functionality for the mechanical attenuator, and the third line of the key label (the Auto/Man line) disappears:

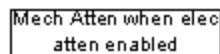
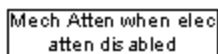
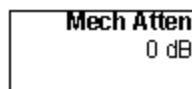
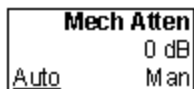

usdB

Enable Elec Atten

Enables the Electronic Attenuator.

The electronic attenuator offers finer steps than the mechanical attenuator, has no acoustical noise, is faster, and is less subject to wear. These advantages primarily aid in remote operation and are negligible

for front panel use. See ["Using the Electronic Attenuator: Pros and Cons" on page 1075](#) for a detailed discussion of the pros and cons of using the electronic attenuator.

For the single attenuator configuration, for SCPI backwards compatibility, the “soft” attenuation feature replaces the dual attenuator configuration’s electronic attenuator. All the same couplings and limitations apply. See ["Attenuator Configurations and Auto/Man" on page 2737](#)

See ["More Information" on page 1074](#)

Key Path	AMPTD Y Scale, Attenuation
Remote Command	[:SENSe] :POWer [:RF] :EATTenuation:STATe OFF ON 0 1 [:SENSe] :POWer [:RF] :EATTenuation:STATe?
Example	POW:EATT:STAT ON
Dependencies	<p>This key only appears in Dual Attenuator models with an Electronic Attenuator installed. It does not appear in models with the Single Attenuator configuration, as in the single attenuator configuration there is no “electronic attenuator” there is only a single integrated attenuator (which has both a mechanical and electronic stage). However, in the single attenuator configuration, EATT SCPI commands are accepted for compatibility with other X-series instruments and set a “soft” attenuation as described in "Attenuator Configurations and Auto/Man" on page 2737.</p> <p>The electronic attenuator (and the “soft” attenuation function provided in single attenuator configurations) is unavailable above 3.6 GHz. Therefore, if the Stop Frequency of the analyzer is > 3.6 GHz then the Enable Elec Atten key will be OFF and grayed out.</p> <p>If the Internal Preamp is on, meaning it is set to Low Band or Full, the electronic attenuator (and the “soft” attenuation function provided in single attenuator configurations) is unavailable. In this case the Enable Elec Atten key will be OFF and grayed out.</p> <p>If either of the above is true, if the SCPI command is sent, an error indicating that the electronic attenuator is unavailable will be sent.</p> <p>If the electronic/soft Attenuator is enabled, then the Stop Freq of the analyzer is limited to 3.6 GHz and the Internal Preamp is unavailable.</p> <p>The SCPI-only “soft” electronic attenuation for the single-attenuator configuration is not available in all measurements; in particular, it is not available in the Swept SA measurement.</p>
Couplings	Enabling and disabling the Electronic Attenuator affects the setting of the Mechanical Attenuator (in dual attenuator configurations). This is described in more detail below this table.
Preset	OFF for Swept SA measurement; ON for all other measurements that support the electronic attenuator
State Saved	Saved in instrument state
Initial S/W Revision	Prior to A.02.00
Modified at S/W Revision	A.03.00

More Information

Mechanical Attenuator Transition Rules

When the Electronic Attenuator is enabled, the Mechanical Attenuator transitions to a state that has no Auto function. Below are the rules for transitioning the Mechanical Attenuator. NOTE that the information

below ONLY applies to the dual attenuator configurations, and ONLY when the Electronic Attenuator is installed:

When the Electronic Attenuation is enabled from a disabled state:

- The Mechanical Attenuator is initialized to 10 dB (this is its optimal performance setting). You can then set it as desired with SCPI, numeric keypad, step keys, or knob, and it behaves as it normally would in manual mode
- The Auto/Man state of (Mech) Atten is saved
- The Auto/Man line on the (Mech) Atten key disappears and the auto rules are disabled
- The Electronic Attenuator is set to 10 dB less than the previous value of the Mechanical Attenuator, within the limitation that it must stay within the range of 0 to 24 dB of attenuation.

Examples in the dual attenuator configuration:

- Mech Atten at 20 dB. Elec Atten enabled, Mech Atten set to 10 dB, and Elec Atten set to 10 dB. New total attenuation equals the value before Elec Atten enabled.
- Mech Atten at 0 dB. Elec Atten enabled, Mech Atten set to 10 dB, and Elec Atten set to 0 dB. New total attenuation does not equal the value before Elec Atten enabled.
- Mech Atten at 40 dB. Elec Atten enabled, Mech Atten set to 10 dB, and Elec Atten set to 24 dB. New total attenuation does not equal the value before Elec Atten enabled.

When the Electronic Attenuation is disabled from an enabled state:

- The Elec Atten key is grayed out
- The Auto/Man state of (Mech) Atten is restored
- If now in Auto, (Mech) Atten recouples
- If now in Man, (Mech) Atten is set to the value of total attenuation that existed before the Elec Atten was disabled. The resulting value is rounded up to the smallest value possible given the (Mech) Atten Step setting - (That is, 57 dB changes to 58 dB when (Mech) Atten Step is 2 dB.)

Using the Electronic Attenuator: Pros and Cons

The electronic attenuator offers finer steps than the mechanical attenuator, has no acoustical noise, is faster, and is less subject to wear.

The “finer steps” advantage of the electronic attenuator is beneficial in optimizing the alignment of the analyzer dynamic range to the signal power in the front panel as well as remote use. Thus, you can achieve improved relative signal measurement accuracy. Compared to a mechanical attenuator with 2 dB steps, the 1 dB resolution of the electronic attenuator only gives better resolution when the odd-decibel steps are used. Those odd-decibel steps are less accurately calibrated than the even-decibel steps, so one tradeoff for this superior relative accuracy is reduced absolute amplitude accuracy.

Another disadvantage of the electronic attenuator is that the spectrum analyzer loses its “Auto” setting, making operation less convenient.

Also, the relationship between the dynamic range specifications (TOI, SHI, compression and noise) and instrument performance are less well-known with the electrical attenuator. With the mechanical

attenuator, TOI, SHI and compression threshold levels increase dB-for-dB with increasing attenuation, and the noise floor does as well. With the electronic attenuator, there is an excess attenuation of about 1 to 3 dB between 0 and 3.6 GHz, making the effective TOI, SHI, and so forth, less well known. Excess attenuation is the actual attenuation relative to stated attenuation. Excess attenuation is accounted for in the analyzer calibration

Elec Atten

Controls the Electronic Attenuator in dual attenuator configurations. This key does not appear in single attenuator configurations, as the control of both the mechanical and electronic stages of the single attenuator is integrated into the single Atten key.

Key Path	AMPTD Y Scale, Attenuation
Remote Command	[:SENSe] :POWer [:RF] :EATTenuation <rel_ampl> [:SENSe] :POWer [:RF] :EATTenuation?
Notes	Electronic Attenuation's specification is defined only when Mechanical Attenuation is 6 dB.
Dependencies	This key only appears in Dual Attenuator models with an Electronic Attenuator installed. It does not appear in models with the Single Attenuator configuration, as in the single attenuator configuration there is no "electronic attenuator" there is only a single integrated attenuator (which has both a mechanical and electronic stage). However, in the single attenuator configuration, EATT SCPI commands are accepted for compatibility with other X-series instruments and set a "soft" attenuation as described in "Attenuator Configurations and Auto/Man" on page 2737 . The "soft" attenuation is treated as an addition to the "main" attenuation value set by the Atten softkey or the POW:ATT SCPI command and affects the total attenuation displayed on the Attenuation key and the Meas Bar. When Enable Elec Atten is off or grayed out, the Elec Atten key is grayed out.
Preset	0 dB
State Saved	Saved in instrument state
Min	0 dB
Max	Dual attenuator configuration: 24 dB Single attenuator configuration: the total of ATT and EATT cannot exceed 50 dB, so if the EATT is set to 24 dB first, the main attenuation cannot be greater than 26 dB and will be reduced accordingly; if the main attenuator is set to 40 dB first, EATT cannot be greater than 10 dB
Initial S/W Revision	Prior to A.02.00
Modified at S/W Revision	A.03.00

Adjust Atten for Min Clip

Sets the combination of mechanical and electronic attenuation and gain based on the current measured signal level so that clipping will be at a minimum.

This is an "immediate action" function, that is, it executes once, when the key is pressed.

This key is grayed out in measurements that do not support this functionality. The spectrum analyzer measurement, Swept SA, does not support this functionality.

Key Path	AMPTD Y Scale, Attenuation
Remote Command	[:SENSe] :POWer [:RF] :RANGe:OPTimize IMMEDIATE
Initial S/W Revision	Prior to A.02.00
Modified at S/W Revision	A.03.00

Pre-Adjust for Min Clip

If this function is on, it does the adjustment described under "[Adjust Atten for Min Clip](#)" on page 2740 each time a measurement restarts. Therefore, in Continuous measurement mode, it only executes before the first measurement.

In dual attenuator models, you can set Elec+Mech Atten, in which case both attenuators participate in the autoranging, or Elec Atten Only, in which case the mechanical attenuator does not participate in the autoranging. This latter case results in less wear on the mechanical attenuator and is usually faster.

This key is grayed out in measurements that do not support this functionality. The spectrum analyzer measurement, Swept SA, does not support this functionality.

Key Path	AMPTD Y Scale, Attenuation
Remote Command	[:SENSe] :POWer [:RF] :RANGe:OPTimize:ATTenuation OFF ELECTrical COMBined [:SENSe] :POWer [:RF] :RANGe:OPTimize:ATTenuation?
Notes	The SCPI parameter ELECTrical sets this function to On in single attenuator models. The SCPI parameter COMBined is mapped to ELECTrical in single attenuator models; if you send COMBined, it sets the function to On and returns ELEC to a query.
Dependencies	This key only appears in Dual Attenuator models with an Electronic Attenuator installed. In instruments with Dual Attenuator model, when Enable Elec Atten is off or grayed out, the Pre-Adjust for Min Clip key is grayed out.
Preset	OFF for Swept SA measurement; ON for all other measurements that support Pre-Adjust for Min Clip
State Saved	Saved in instrument state
Range	Dual attenuator models: Off Elec Atten Only Mech + Elec Atten Single attenuator models: Off On
Initial S/W Revision	Prior to A.02.00
Modified at S/W Revision	A.03.00

Remote Command	[:SENSe] :POWer [:RF] :RANGe:AUTO ON OFF 1 0 [:SENSe] :POWer [:RF] :RANGe:AUTO?
Notes	ON aliases to "Elec Atten Only" (:POW:RANG:OPT:ATT ELEC)

	OFF aliases to "Off" (:POW:RANG:OPT:ATT OFF) The query :POW:RANG:AUTO? returns true if :POW:RANG:OPT:ATT is not "Off"
Initial S/W Revision	Prior to A.02.00

Off

Turns Pre-Adjust for Min Clip off. This is the default setting.

This key is grayed out in measurements that do not support this functionality. The spectrum analyzer measurement, Swept SA, does not support this functionality.

Key Path	AMPTD Y Scale, Attenuation, Pre-Adjust for Min Clip
Example	:POW:RANGe:OPT:ATT OFF
Initial S/W Revision	Prior to A.02.00

Elec Atten Only

Selects only the electric attenuator to participate in auto ranging. This offers less wear on the mechanical attenuator and is usually faster.

This key is grayed out in measurements that do not support this functionality. The spectrum analyzer measurement, Swept SA, does not support this functionality.

Key Path	AMPTD Y Scale, Attenuation, Pre-Adjust for Min Clip
Example	:POW:RANGe:OPT:ATT ELEC
Initial S/W Revision	Prior to A.02.00

Mech + Elec Atten

In dual attenuator models, this selects both attenuators participate in the autoranging.

This key is grayed out in measurements that do not support this functionality. The spectrum analyzer measurement, Swept SA, does not support this functionality.

Key Path	AMPTD Y Scale, Attenuation, Pre-Adjust for Min Clip
Example	:POW:RANGe:OPT:ATT COMB
Initial S/W Revision	Prior to A.02.00

(Mech) Atten Step

This controls the step size used when making adjustments to the input attenuation.

This key is labeled Mech Atten Step in dual attenuator models and Atten Step in single attenuator models. In the dual attenuator configuration, this key only affects the step size of the mechanical attenuator.

Key Path	AMPTD Y Scale, Attenuation
Remote Command	[:SENSe] :POWer [:RF] :ATTenuation:STEP [:INCRement] 10 dB 2 dB [:SENSe] :POWer [:RF] :ATTenuation:STEP [:INCRement] ?
Example	POW:ATT:STEP 2
Notes	Note this feature works like a 1-N choice from the front panel, but it takes a specific value (in dB) when used remotely. The only valid values are 2 and 10.
Dependencies	Blanked in CXA and EXA if option FSA (2 dB steps) is not present. If blanked, attempts to set it via SCPI will yield an error.
Couplings	When the attenuation step size changes, the current mechanical attenuation value is adjusted (if necessary) to be quantized to the new step size. That is, if step is set to 10 dB, mech atten is increased if necessary so it is a multiple of 10 dB
Preset	PXA and MXA: 2 dB EXA and CXA: 10 dB (2 dB with option FSA)
State Saved	Saved in instrument state
Initial S/W Revision	Prior to A.02.00
Modified at S/W Revision	A.03.00

Presel Center

When this key is pressed, the centering of the preselector filter is adjusted to optimize the amplitude accuracy at the frequency of the selected marker. If the selected marker is not on when Presel Center is pressed, the analyzer will turn on the selected marker, perform a peak search, and then perform centering on the marker's center frequency. If the selected marker is already on and between the start and stop frequencies of the analyzer, the analyzer performs the preselector calibration on that marker's frequency. If the selected marker is already on, but outside the frequency range between Start Freq and Stop Freq, the analyzer will first perform a peak search, and then perform centering on the marker's center frequency.

The value displayed on the Presel Adjust key will change to reflect the new preselector tuning (see Presel Adjust).

A number of considerations should be observed to ensure proper operation. See ["Proper Preselector Operation" on page 1080](#).

Key Path	AMPTD Y Scale
Remote Command	[:SENSe] :POWer [:RF] :PCENter
Example	POW:PCEN
Notes	Note that the rules outlined above under the key description apply for the remote command as well as the key. The result of the command is dependent on marker position, and so forth. Any message shown by the key press is also shown in response to the remote command.
Dependencies	• Grayed out if the microwave preselector is off.)

-
- If the selected marker's frequency is below Band 1, advisory message 0.5001 is generated and no action is taken.
 - Grayed out if entirely in Band 0.
 - Blank in models that do not include a preselector, such as option 503. If the SCPI is sent in these instruments, it is accepted without error, and the query always returns 0.
 - Grayed out in the Spectrogram View.

Couplings	The active marker position determines where the centering will be attempted. If the analyzer is in a measurement such as averaging when centering is initiated, the act of centering the preselector will restart averaging but the first average trace will not be taken until the centering is completed.
-----------	--

Status Bits/OPC dependencies	When centering the preselector, *OPC will not return true until the process is complete and a subsequent measurement has completed, nor will results be returned to a READ or MEASure command. The Measuring bit should remain set while this command is operating and should not go false until the subsequent sweep/measurement has completed.
------------------------------	---

Initial S/W Revision	Prior to A.02.00
----------------------	------------------

Modified at S/W Revision	A.03.00
--------------------------	---------

Proper Preselector Operation

A number of considerations should be observed to ensure proper operation:

1. If the selected marker is off, the analyzer will turn on a marker, perform a peak search, and adjust the preselector using the selected marker's frequency. It uses the "highest peak" peak search method unqualified by threshold or excursion, so that there is no chance of a 'no peak found' error. It continues with that peak, even if it is the peak of just noise. Therefore, for this operation to work properly, there should be a signal on screen in a preselected range for the peak search to find.
2. If the selected marker is already on, the analyzer will attempt the centering at that marker's frequency. There is no preselector for signals below about 3.6 GHz, therefore if the marker is on a signal below 3.6 GHz, no centering will be attempted and an advisory message generated
3. In some models, the preselector can be bypassed. If it is bypassed, no centering will be attempted in that range and a message will be generated.

Preselector Adjust

Allows you to manually adjust the preselector filter frequency to optimize its response to the signal of interest. This function is only available when "Presel Center" on page 2743 is available.

For general purpose signal analysis, using Presel Center is recommended. Centering the filter minimizes the impact of long-term preselector drift. Presel Adjust can be used instead to manually optimize the preselector. One application of manual optimization would be to peak the preselector response, which both optimizes the signal-to-noise ratio and minimizes amplitude variations due to small (short-term) preselector drifting.

Key Path	AMPTD Y Scale
Scope	Meas Global
Remote Command	<code>[:SENSe] :POWer [:RF] :PADJust <freq></code> <code>[:SENSe] :POWer [:RF] :PADJust?</code>
Example	POW:PADJ 100KHz POW:PADJ?
Notes	The value on the key reads out to 0.1 MHz resolution.
Dependencies	<ul style="list-style-type: none"> • Grayed out if microwave preselector is off.) • Grayed out if entirely in Band 0. • Blank in models that do not include a preselector, such as option 503. If the SCPI is sent in these instruments, it is accepted without error, and the query always returns 0. • Grayed out in the Spectrogram View.
Preset	0 MHz
State Saved	The Presel Adjust value set by Presel Center, or by manually adjusting Presel Adjust, is not saved in instrument state, and does not survive a Preset or power cycle.
Min	-500 MHz
Max	500 MHz
Default Unit	Hz
Backwards Compatibility SCPI	<code>[:SENSe] :POWer [:RF] :MW :PADJust</code> <code>[:SENSe] :POWer [:RF] :MMW :PADJust</code> PSA had multiple preselectors, but the X-Series has only one. These commands simply alias to <code>[:SENSe] :POWer [:RF] :PADJust</code>
Initial S/W Revision	Prior to A.02.00
Modified at S/W Revision	A.03.00
Remote Command	<code>[:SENSe] :POWer [:RF] :PADJust :PRESelector MWAVE MMWave EXTernal</code> <code>[:SENSe] :POWer [:RF] :PADJust :PRESelector?</code>
Notes	PSA had multiple preselectors, and you could select which preselector to adjust. Since the X-Series has only one mm/uW preselector, the preselector selection softkey is no longer available. However, to provide backward compatibility, we accept the legacy remote commands. The command form has no effect, the query always returns MWAVE
Initial S/W Revision	Prior to A.02.00

μW Path Control

The μW Path Control functions include the μW Preselector Bypass (Option MPB) and Low Noise Path (Option LNP) controls in the High Band path circuits.

When the μW Preselector is bypassed, the user has better flatness, but will be subject to spurs from out of band interfering signals. When the Low Noise Path is enabled, the analyzer automatically switches around certain circuitry in the high frequency bands which can contribute to noise, when it is appropriate based on other analyzer settings.

For most applications, the preset state is Standard Path, which gives the best remote-control throughput, minimizes acoustic noise from switching and minimizes the risk of wear out in the hardware switches. For applications that utilize the wideband IF paths, the preset state is the μW Preselector Bypass path, if option MPB is present. This is because, when using a wideband IF such as the 140 MHz IF, the μW Preselector's bandwidth can be narrower than the available IF bandwidth, causing degraded amplitude flatness and phase linearity, so it is desirable to bypass the preselector in the default case.

Users may choose Low Noise Path Enable. It gives a lower noise floor, especially in the 21–26.5 GHz region, though without improving many measures of dynamic range, and without giving the best possible noise floor. The preamp, if purchased and used, gives better noise floor than does the Low Noise Path, however its compression threshold and third-order intercept are much poorer than that of the non-preamp Low Noise Path. There are some applications, typically for signals around –30 dBm, for which the third-order dynamic range of the standard path is good enough, but the noise floor is not low enough even with 0 dB input attenuation. When the third-order dynamic range of the preamp path is too little and the noise floor of the standard path is too high, the Low Noise Path can provide the best dynamic range.

Key Path	AMPTD Y Scale
Mode	SA, BASIC, PNOISE, VSA , LTE, LTETDD
Scope	Meas Global
Remote Command	[:SENSe] :POWer [:RF] :MW:PATH STD LNPath MPBypass FULL [:SENSe] :POWer [:RF] :MW:PATH?
Example	:POW:MW:PATH LNP Enables the Low Noise path
Notes	If a Presel Center is performed, the analyzer will momentarily switch to the Standard Path, regardless of the setting of μW Path Control The DC Block will always be switched in when the low noise path is switched in, to protect succeeding circuitry from DC. Note that this does not mean “when the low noise path is enabled” but when, based on the Low Noise Path rules, the path is actually switched in. This can happen when the selection is Low Noise Path Enable . In the case where the DC Block is switched in the analyzer is now AC coupled. However, if the user has selected DC coupling, the UI will still behave as though it were DC coupled, including all annunciation, warnings, status bits, and responses to SCPI queries. This is because, based on other settings, the analyzer could switch out the low noise path at any time and hence go back to being DC coupled. Alignment switching ignores the settings in this menu, and restores them when finished.
Dependencies	Unavailable in BBIQ and External Mixing
Preset	All modes other than IQ Analyzer mode and VXA: STD IQ Analyzer, VXA and WLAN mode: MPB option present and licensed: MPB

	MPB option not present and licensed: STD
State Saved	Save in instrument state
Readback	Value selected in the submenu
Initial S/W Revision	A.04.00
Modified at S/W Revision	A.10.00

Standard Path

This path gives the best remote-control throughput, minimizes acoustic noise from switching and minimizes the risk of wear in the hardware switches, particularly in remote test scenarios where both low band and high band setups will follow in rapid succession.

In this path, the bypass of the low band/high band switch and microwave preamp is never activated, which can cause some noise degradation but preserves the life of the bypass switch.

Key Path	AMPTD Y Scale, μ W Path Control
Example	:POW:MW:PATH STD
Readback Text	Standard Path
Initial S/W Revision	A.04.00

Low Noise Path Enable

You may choose Low Noise Path Enable, which gives a lower noise floor under some circumstances, particularly when operating in the 21–26.5 GHz region. With the Low Noise Path enabled, the low band/high band switch and microwave preamp are bypassed whenever all of the following are true:

- The analyzer is not in the Low Band, meaning:
- the start frequency is above 3.5 GHz and
- the stop frequency is above 3.6 GHz.
- the internal preamp is not installed or (if installed) is set to Off or Low Band

Note that this means that, when any part of a sweep is done in Low Band, the Low Noise Path is not used, whether or not the Low Noise Path Enable is selected in the user interface. Also, if the preamp is turned on, the Low Noise Path is not used, whether or not the Low Noise Path Enable is selected in the user interface. The only time the Low Noise Path is used is when Low Noise Path Enable is selected, the sweep is completely in High Band (> 3.6 GHz) and no preamp is in use.

See "[More Information](#)" on page 1084

Key Path	AMPTD Y Scale, μ W Path Control
Measurement	Swept SA
Example	:POW:MW:PATH LNP

Notes	<p>For measurements that use IQ acquisition, the low noise path is used when the Center Frequency is in High Band (> 3.6 GHz) and no preamp is in use.</p> <p>In other words, the rules above are modified to use only the center frequency to qualify which path to switch in.</p> <p>This is not the case for FFT's in the Swept SA measurement; they use the same rules as swept measurements.</p>
Dependencies	<p>Key is blanked if current mode does not support it.</p> <p>Key is grayed out if mode supports it but current measurement does not support it.</p> <p>Unless Option LNP is present and licensed, key is blank and if SCPI command sent, error -241, "Hardware missing; Option not installed" is generated.</p>
Readback Text	Low Noise Path Enable
Initial S/W Revision	A.04.00

More Information

The user should understand that the Low Noise Path, while giving improved DANL, has the disadvantage of decreased TOI performance and decreased gain compression performance relative to the standard path.

The user should also understand that the bypass switch is a mechanical switch and has finite life, so if the Low Noise Path is enabled, it is possible to cause frequent cycling of this switch by frequently changing analyzer settings such that the above conditions hold true only some of the time. A user making tests of this nature should consider opting for the Standard Path, which will never throw the bypass switch, at the expense of some degraded noise performance.

The low noise path is useful for situations where the signal level is so low that the analyzer performance is dominated by noise even with 0 dB attenuation, but still high enough that the preamp option would have excessive third-order intermodulation or compression. The preamp, if purchased and used, gives better noise floor than does the "Low Noise Path." However, its compression threshold and third-order intercept are much poorer than that of the non-preamp path. There are some applications, typically for signals around -30 dBm, for which the third-order dynamic range of the standard path is good enough, but the noise floor is not low enough even with 0 dB input attenuation. When the third-order dynamic range of the preamp path is too little and the noise floor of the standard path is too high, the Low Noise Path can provide the best dynamic range

The graph below illustrates the concept. It shows, in red, the performance of an analyzer at different attenuation settings, both with the preamp on and off, in a measurement that is affected by both analyzer noise and analyzer TOI. The green shows the best available dynamic range, offset by 0.5 dB for clarity. The blue shows how the best available dynamic range improves for moderate signal levels with the low noise path switched in. In this illustration, the preamp improves the noise floor by 15 dB while degrading the third-order intercept by 30 dB, and the low noise path reduces loss by 8 dB. The attenuator step size is 2 dB.

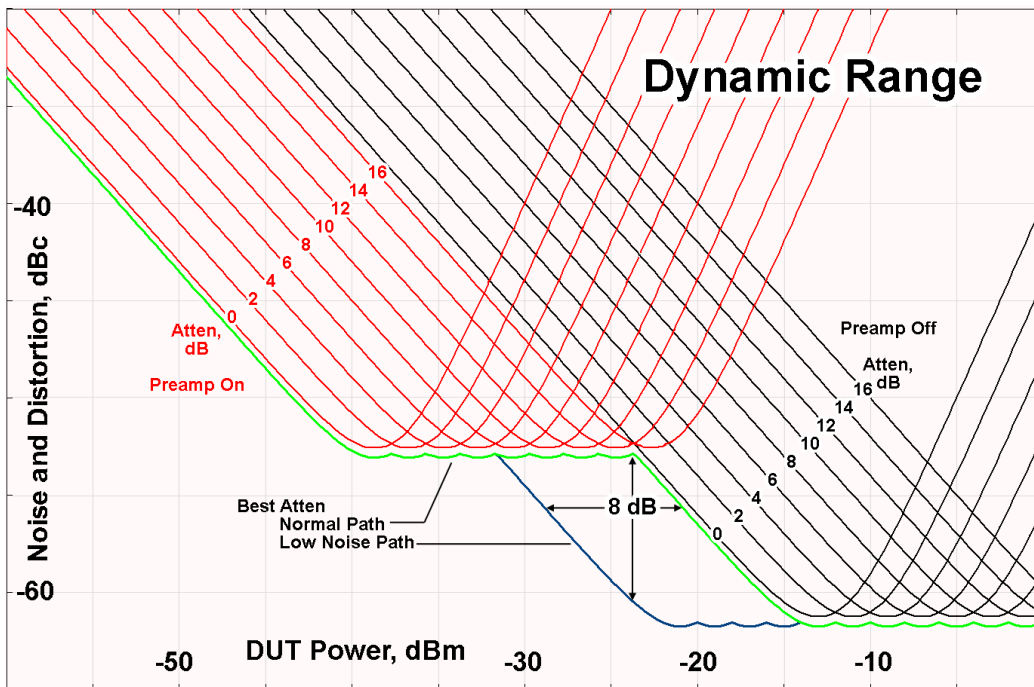

There are other times where selecting the low noise path improves performance, too. Compression-limited measurements such as finding the nulls in a pulsed-RF spectrum can profit from the low noise path in a way similar to the TOI-limited measurement illustrated. Accuracy can be improved when the low noise path allows the optimum attenuation to increase from a small amount like 0, 2 or 4 dB to a larger amount, giving better return loss at the analyzer input. Harmonic measurements, such as second and third harmonic levels, are much improved using the low noise path because of the superiority of that path for harmonic (though not intermodulation) distortion performance.

μW Preselector Bypass

This key toggles the preselector bypass switch for band 1 and higher. When the microwave preselector is on, the signal path is preselected. When the microwave preselector is off, the signal path is not preselected. The preselected path is the normal path for the analyzer.

The preselector is a tunable bandpass filter which prevents signals away from the frequency of interest from combining in the mixer to generate in-band spurious signals (images). The consequences of using a preselector filter are its limited bandwidth, the amplitude and phase ripple in its passband, and any amplitude and phase instability due to center frequency drift.

Option MPB or pre-selector bypass provides an unpreselected input mixer path for certain X-Series signal analyzers with frequency ranges above 3.6 GHz. This signal path allows a wider bandwidth and less amplitude variability, which is an advantage when doing modulation analysis and broadband signal analysis. The disadvantage is that, without the preselector, image signals will be displayed. Another disadvantage of bypassing the preselector is increased LO emission levels at the front panel input port.

Image responses are separated from the real signal by twice the 1st IF. For IF Paths of 10 MHz and 25 MHz, the 1st IF is 322.5 MHz, so the image response and the real signal will be separated by 645 MHz. The 1st IF will be different for other IF Path settings. When viewing a real signal and its corresponding image response in internal mixing, the image response will be to the left of the real signal.

Also, the image response and the real signal typically have the same amplitude and exhibit the same shape factor.

However, if Option FS1, Fast Sweep Capability, is enabled, the image response in the Swept SA measurement will appear lower in amplitude and have a much wider shape factor compared to the real signal.

Key Path	AMPTD Y Scale, μ W Path Control
Example	:POW:MW:PATH MPB
Dependencies	Key is blanked if current mode does not support it. Key is grayed out if mode supports it but current measurement does not support it. Key is blank unless Option MPB is present and licensed. If SCPI command sent when MPB not present, error -241, "Hardware missing; Option not installed" is generated.
Readback Text	μ W Preselector Bypass
Initial S/W Revision	A.04.00

Remote Command	[:SENSe] :POWeR [:RF] :MW :PRESelector [:STATe] ON OFF 0 1 [:SENSe] :POWeR [:RF] :MW :PRESelector [:STATe] ?
Example	:POW:MW:PRES OFF Bypasses the microwave preselector
Notes	The ON parameter sets the STD path (:POW:MW:PATH STD) The OFF parameter sets path MPB (:POW:MW:PATH MPB)
Preset	ON

Internal Preamp

Accesses a menu of keys that control the internal preamps. Turning on the preamp gives a better noise figure, but a poorer TOI to noise floor dynamic range. You can optimize this setting for your particular measurement.

The instrument takes the preamp gain into account as it sweeps. If you sweep outside of the range of the preamp the instrument will also account for that. The displayed result will always reflect the correct gain.

For some measurements, when the preamp is on and any part of the displayed frequency range is below the lowest frequency for which the preamp has specifications, a warning condition message appears in the status line. For example, for a preamp with a 9 kHz lowest specified frequency: "Preamp: Accy unspec'd below 9 kHz".

Key Path	AMPTD Y Scale
Scope	Meas Global
Remote Command	[:SENSe] :POWeR [:RF] :GAIN [:STATe] OFF ON 0 1 [:SENSe] :POWeR [:RF] :GAIN [:STATe] ?
Dependencies	Preamp is not available on all hardware platforms. If the preamp is not present or is unlicensed, the

	key is not shown. The preamp is not available when the electronic/soft attenuator is enabled.
--	--

Couplings	<p>The act of connecting the U7227A USB Preamplifier to one of the analyzer's USB ports will cause the Internal Preamp to be switched on. When this happens an informational message will be generated: "Internal Preamp turned on for optimal operation with USB Preamp." Note that if the Internal Preamp was already on, there will be no change to the setting, but if it was Off it will be switched On, to Full Range.</p> <p>Note that this same action occurs when the SA mode is selected while the USB Preamp is connected to one of the analyzer's USB ports, if it is the first time that the SA mode has run since powerup, or if the last time the SA mode was running the USB Preamp was NOT connected.</p> <p>Subsequently disconnecting the USB Preamp from USB does not change the Internal Preamp setting nor restore the previous setting.</p>
-----------	--

Preset	OFF
State Saved	Saved in instrument state
Initial S/W Revision	Prior to A.02.00
Modified at S/W Revision	A.14.00

Key Path	AMPTD Y Scale, Internal Preamp
Scope	Meas Global
Remote Command	[:SENSe]:POWer[:RF]:GAIN:BAND LOW FULL [:SENSe]:POWer[:RF]:GAIN:BAND?
Dependencies	<p>Preamp is not available on all hardware platforms. If the preamp is not present or is unlicensed, the key is not shown.</p> <p>If a POW:GAIN:BAND FULL command is sent when a low band preamp is available, the preamp band parameter is to LOW instead of FULL, and an "Option not installed" message is generated.</p>
Preset	LOW
State Saved	Saved in instrument state
Initial S/W Revision	Prior to A.02.00

Off

Turns the internal preamp off

Key Path	AMPTD Y Scale, Internal Preamp
Example	:POW:GAIN OFF
Readback	Off
Initial S/W Revision	Prior to A.02.00

Low Band

Sets the internal preamp to use only the low band.

The frequency range of the installed (optional) low-band preamp is displayed in square brackets on the Low Band key label.

Key Path	AMPTD Y Scale, Internal Preamp
Example	:POW:GAIN ON :POW:GAIN:BAND LOW
Readback	Low Band
Initial S/W Revision	Prior to A.02.00

Full Range

Sets the internal preamp to use its full range. The low band (0–3.6 GHz or 0–3GHz, depending on the model) is supplied by the low band preamp and the frequencies above low band are supplied by the high band preamp.

The frequency range of the installed (optional) preamp is displayed in square brackets on the Full Range key label. If the high band option is not installed the Full Range key does not appear.

Key Path	AMPTD Y Scale, Internal Preamp
Example	:POW:GAIN ON :POW:GAIN:BAND FULL
Readback	Full Range
Initial S/W Revision	Prior to A.02.00

Range

This key is only available when I/Q is the selected input. It replaces the Attenuation key in that case.

Each input channel (I and Q) has four internal gain ranges. The maximum allowed voltage in each gain range is slightly more than the nominal value, so the break point between ranges is a couple of millivolts higher than the nominal (setting a peak voltage of 0.502 mV will still map to the 0.5 V Peak range).

Gain Setting	Volts RMS	Volts Peak	Volts Peak - Peak	dBm (50Ω)	Break Point
0 dB	0.7071	1.0	2.0	10	n/a
6 dB	0.3536	0.5	1.0	4	0.502 V Peak
12 dB	0.1768	0.25	0.5	-2	0.252 V Peak
18 dB	0.0884	0.125	0.25	-8	0.127 V Peak

Key Path	AMPTD Y Scale
Notes	Visible only when the selected input is I/Q.
State Saved	No
Readback Text	When Range is Auto, "[Auto]" When Range is Man and I & Q are the same, "[<range value>]" When Range is Man and I & Q are different: "[: <I range value> Q: <Q range value>]" See I Range and Q Range for the <range value> enumeration definition.
Initial S/W Revision	Prior to A.02.00

Range Auto/Man

The Auto setting for Range causes the range to be set based on the Y Scale settings. When Range is "Auto", the I & Q Range are set based on the top of the Y Scale when the Y scale is in dB units (for example, power), or to the max(abs(top), abs(bottom)) when the Y scale reference is not at the top of the screen.

Not all measurements support Range Auto/Man. If Auto is not supported in the current measurement, this key is grayed out and shows "Man" and MAN is returned to a SCPI query, but this does NOT change the Auto/Man setting for Range. When you go to a measurement that supports Auto, it goes back to Auto if it was previously in Auto mode.

Key Path	AMPTD Y Scale, Range
Scope	Meas Global
Remote Command	<code>[:SENSe]:VOLTage:IQ:RANGe:AUTO OFF ON 0 1</code> <code>[:SENSe]:VOLTage:IQ:RANGe:AUTO?</code>
Example	Put the I Range and Q Range in manual. <code>VOLT:IQ:RANG:AUTO OFF</code>
Dependencies	If Auto is not supported, sending the SCPI command will generate an error.
Couplings	When in Auto, both I Range and Q Range are set to the same value, computed as follows: Maximum absolute value is computed for the Y Scale. The top and bottom of the graph are computed based on Ref Value, Scale/Div, and Ref Position. Formula: $Y_{Max} = \max(\text{abs}(\text{top}), \text{abs}(\text{bottom}))$. The I Range and Q Range are then set to YMax.
Preset	ON
State Saved	Saved in instrument state
Range	Auto Man
Initial S/W Revision	Prior to A.02.00

Remote Command	<code>[:SENSe]:POWer:IQ:RANGe:AUTO OFF ON 0 1</code> <code>[:SENSe]:POWer:IQ:RANGe:AUTO?</code>
-----------------------	--

Example	Put the I Range and Q Range in manual. POW:IQ:RANG:AUTO OFF
Notes	The POW:IQ:RANG:AUTO is an alternate form of the VOLT:IQ:RANG:AUTO command. This is to maintain consistency with I Range and Q Range, which support both the POWer and VOLTage forms of the command.
Preset	ON
Range	Auto Man
Initial S/W Revision	Prior to A.02.00

I Range

This is the internal gain range for the I channel when Input Path is I Only or I and I/Q, and it is used for both the I and Q channels when the Input Path is I+jQ. See "[I/Q Gain Ranges](#)" on page 2583.

Key Path	AMPTD Y Scale, Range
Remote Command	[:SENSe] :VOLTage :IQ [:I] :RANGe [:UPPer] <voltage> [:SENSe] :VOLTage :IQ [:I] :RANGe [:UPPer] ?
Example	Set the I Range to 0.5 V Peak VOLT:IQ:RANG 0.5 V
Notes	The numeric entries are mapped to the smallest gain range whose break point is greater than or equal to the value, or 1 V Peak if the value is greater than 1 V.
Couplings	When Q Same as I is On, the I Range value will be copied to the Q Range. Changing the value will also set Range = Man.
Preset	1 V Peak
State Saved	Saved in instrument state
Range	1 V Peak 0.5 V Peak 0.25 V Peak 0.125 V Peak
Min	0.125 V
Max	1 V
Initial S/W Revision	Prior to A.02.00

Remote Command	[:SENSe] :POWer :IQ [:I] :RANGe [:UPPer] <ampl> [:SENSe] :POWer :IQ [:I] :RANGe [:UPPer] ?
Example	Set the I Range to 0.5 V Peak when Reference Z is 50Ω, and to 1.0 V Peak when Reference Z is 75Ω. POW:IQ:RANG 4 dBm
Notes	The POWer form of the command is provided for convenience. It maps to the same underlying gain range parameter as the VOLTage form of the command. The Reference Z (not the I channel Input Z) is used to convert the power to peak voltage, which is then used to set the I Range as with the VOLTage form of the command. The power values of the 4

range states (1V Peak, 0.5V Peak, 0.25V Peak, and 0.125V Peak) will vary with Reference Z. Here are some examples:

50Ω: 10, 4, -2, -8
75Ω: 8.2, 2.2, -3.8, -9.8
600Ω: -0.8, -6.8, -12.8, -18.9

Preset	10.0 dBm
Range	-20 dBm to 10 dBm
Min	-20 dBm
Max	10 dBm
Initial S/W Revision	Prior to A.02.00

1 V Peak

Set the channel gain state to 1 Volt Peak.

Key Path	AMPTD Y Scale, I Range Q Range
Initial S/W Revision	Prior to A.02.00

0.5 V Peak

Set the channel gain state to 0.5 Volt Peak.

Key Path	AMPTD Y Scale, I Range Q Range
Initial S/W Revision	Prior to A.02.00

0.25 V Peak

Set the channel gain state to 0.25 Volt Peak.

Key Path	AMPTD Y Scale, I Range Q Range
Initial S/W Revision	Prior to A.02.00

0.125 V Peak

Set the channel gain state to 0.125 Volt Peak.

Key Path	AMPTD Y Scale, I Range Q Range
Initial S/W Revision	Prior to A.02.00

Q Range Value

This is the internal gain range for the Q channel. See "[I/Q Gain Ranges](#)" on page 2583. The Q Range only applies to Input Path Q Only and Ind I/Q. For input I+jQ the I Range determines both I and Q channel range settings.

Key Path	AMPTD Y Scale, Range
Remote Command	<code>[:SENSe] :VOLTage:IQ:Q:RANGe[:UPPer] <voltage></code> <code>[:SENSe] :VOLTage:IQ:Q:RANGe[:UPPer] ?</code>
Example	Set the Q Range to 0.5 V Peak <code>VOLT:IQ:Q:RANG 0.5 V</code>
Notes	The numeric entries are mapped to the smallest gain range whose break point is greater than or equal to the value, or 1 V Peak if the value is greater than 1 V. The Q Range is only used for Input Path Q Only and Ind I/Q. For input I+jQ the I Range determines both I and Q channel range settings.
Couplings	When Q Same as I is On, the I Range value will be copied to the Q Range and the range value keys are disabled. Changing the value will also set Range = Man.
Preset	1 V Peak
State Saved	Saved in instrument state
Range	1 V Peak 0.5 V Peak 0.25 V Peak 0.125 V Peak
Min	0.125 V
Max	1 V
Initial S/W Revision	Prior to A.02.00

Remote Command	<code>[:SENSe] :POWer:IQ:Q:RANGe[:UPPer] <ampl></code> <code>[:SENSe] :POWer:IQ:Q:RANGe[:UPPer] ?</code>
Example	Will set the Q Range to 0.5 V Peak when Reference Z is 50Ω, and to 1.0 V Peak when Reference Z is 75Ω. <code>POW:IQ:Q:RANG 4 dBm</code>
Notes	The POWER form of the command is provided for convenience. It maps to the same underlying gain range parameter as the VOLTage form of the command. The Reference Z (not the Q channel Input Z) is used to convert the power to peak voltage, which is then used to set the Q Range as with the VOLTage form of the command. The power values of the 4 range states (1V Peak, 0.5V Peak, 0.25V Peak, and 0.125V Peak) will vary with Reference Z. Here are some examples: 50Ω: 10, 4, -2, -8 75Ω: 8.2, 2.2, -3.8, -9.8 600Ω: -0.8, -6.8, -12.8, -18.9
Preset	10.0 dBm
Range	-20 dBm to 10 dBm

Min	-20 dBm
Max	10 dBm
Initial S/W Revision	Prior to A.02.00

Q Same as I

Many, but not all, usages require the I and Q channels to have an identical setup. To simplify channel setup, the Q Same as I will cause the Q channel range to be mirrored from the I channel. That way you only need to set up one channel (the I channel). The I channel values are copied to the Q channel, so at the time Q Same as I is Off, the I and Q channel setups will be identical.

Key Path	AMPTD Y Scale, Range, Q Range
Remote Command	[:SENSe] :VOLTage P OWer : IQ :MIRRed OFF ON 0 1 [:SENSe] :VOLTage P OWer : IQ :MIRRed ?
Example	Turn off the mirroring of I Range to Q Range. VOLT:IQ:MIRR OFF POW:IQ:MIRR OFF
Couplings	When On, the I Range value is mirrored (copied) to the Q Range.
Preset	On
State Saved	Saved in instrument state.
Range	On Off
Readback Text	"Q Same as I" when On, otherwise none.
Initial S/W Revision	Prior to A.02.00

1 V Peak

Set the channel gain state to 1 Volt Peak.

Key Path	AMPTD Y Scale, I Range Q Range
Initial S/W Revision	Prior to A.02.00

0.5 V Peak

Set the channel gain state to 0.5 Volt Peak.

Key Path	AMPTD Y Scale, I Range Q Range
Initial S/W Revision	Prior to A.02.00

0.25 V Peak

Set the channel gain state to 0.25 Volt Peak.

Key Path	AMPTD Y Scale, I Range Q Range
Initial S/W Revision	Prior to A.02.00

0.125 V Peak

Set the channel gain state to 0.125 Volt Peak.

Key Path	AMPTD Y Scale, I Range Q Range
Initial S/W Revision	Prior to A.02.00

I/Q Gain Ranges

See the following sections:

["1 V Peak" on page 2583](#)

["0.5 V Peak" on page 2583](#)

["0.25 V Peak" on page 2583](#)

["0.125 V Peak" on page 2584](#)

1 V Peak

Set the channel gain state to 1 Volt Peak.

Key Path	AMPTD Y Scale, I Range Q Range
Initial S/W Revision	Prior to A.02.00

0.5 V Peak

Set the channel gain state to 0.5 Volt Peak.

Key Path	AMPTD Y Scale, I Range Q Range
Initial S/W Revision	Prior to A.02.00

0.25 V Peak

Set the channel gain state to 0.25 Volt Peak.

Key Path	AMPTD Y Scale, I Range Q Range
Initial S/W Revision	Prior to A.02.00

0.125 V Peak

Set the channel gain state to 0.125 Volt Peak.

Key Path	AMPTD Y Scale, I Range Q Range
Initial S/W Revision	Prior to A.02.00

Presel Center

When this key is pressed, the centering of the preselector filter is adjusted to optimize the amplitude accuracy at the frequency of the selected marker.

See AMPTD Y Scale, "[Presel Center](#)" on page 2743 for more information.

This is only available when the selected input is RF.

Key Path	AMPTD Y Scale
Initial S/W Revision	Prior to A.02.00

Presel Adjust

Allows you to manually adjust the preselector filter frequency to optimize its response to the signal of interest. This function is only available when Presel Center is available.

See AMPTD Y Scale, "[Preselector Adjust](#)" on page 2744 for more information.

This is only available when the selected input is RF.

Key Path	AMPTD Y Scale
Initial S/W Revision	Prior to A.02.00

Auto Couple

The Auto Couple feature provides a quick and convenient way to automatically couple multiple instrument settings. This helps ensure accurate measurements and optimum dynamic range. When the Auto Couple feature is activated, either from the front panel or remotely, all parameters of the current measurement that have an Auto/Manual mode are set to Auto mode and all measurement settings dependent on (or coupled to) the Auto/Man parameters are automatically adjusted for optimal performance.

However, the Auto Couple key actions are confined to the current measurement only. It does not affect other measurements in the mode, and it does not affect markers, marker functions, or trace or display attributes.

See ["More Information" on page 1096](#)

Key Path	Front-panel key
Remote Command	:COUPLe ALL NONE
Example	:COUP ALL
Notes	:COUPLe ALL puts all Auto/Man parameters in Auto mode (equivalent to pressing the Auto Couple key). :COUPLE NONE puts all Auto/Man parameters in manual mode. It decouples all the coupled instrument parameters and is not recommended for making measurements.
Initial S/W Revision	Prior to A.02.00

More Information

There are two types of functions that have Auto/Manual modes.

Auto/Man Active Function keys

An Auto/Man toggle key controls the binary state associated with an instrument parameter by toggling between Auto (where the parameter is automatically coupled to the other parameters it is dependent upon) and Man (where the parameter is controlled independent of the other parameters), as well as making the parameter the active function. The current mode is indicated on the softkey with either Auto or Man underlined as illustrated below.

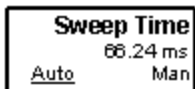

usd07

Auto/Man 1-of-N keys

An Auto/Man 1-of-N key allows you to manually pick from a list of parameter values, or place the function in Auto, in which case the value is automatically selected (and indicated) as shown below. If in Auto, Auto is underlined on the calling key. If in manual operation, manual is indicated on the calling key. But the calling key does not actually toggle the function, it simply opens the menu.

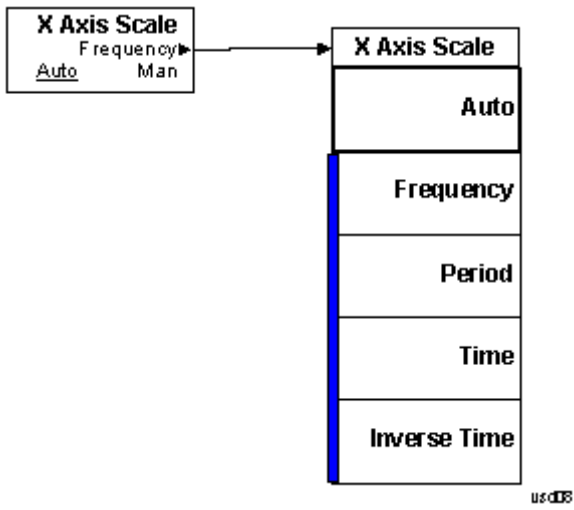

BW

Opens the BW menu, which contains keys to control the information bandwidth functions of the instrument.

Key Path	Front-panel key
Initial S/W Revision	Prior to A.02.00

Info BW

Allows you to enter a frequency value to set the channel bandwidth that will be used for data acquisition.

Key Path	BW
Mode	SA, WCDMA, C2K, WIMAXOFDMA, TD-SCDMA, 1xEV-DO, DVB-T/H, DTMB (CTTB), ISDB-T, CMMB, LTE, LTETDD, Digital Cable TV, WLAN, MSR, LTEATDD, LTEAFDD
Remote Command	[:SENSe] :PStatistic :BANDwidth <freq> [:SENSe] :PStatistic :BANDwidth?
Example	PST:BAND 8 MHz PST:BAND?
Couplings	WiMAX OFDMA: The default value depends on the Radio Standard selection..
Preset	SA, WCDM: 5 MHz C2K:1.5 MHz 1xEV-DO:1.3 MHz WiMAX OFDMA: Hardware Dependent No Option = 10 MHz WB (25 MHz or wider) = 25 MHz TD-SCDMA: 1.3 MHz DVB-T/H, DTMB (CTTB): 8 MHz ISDB-T: 6 MHz CMMB: 8 MHz LTE, LTETDD, LTEATDD, LTEAFDD: 6 MHz Digital Cable TV: 8MHz WLAN: Hardware Dependent No option = 10 MHz Option B25 = 25 MHz Option B40: if Radio Std is 802.11a/b/g/n(20MHz) = 25 MHz if Radio Std is 802.11n(40MHz) = 40 MHz if Radio Std is 802.11ac(20MHz) = 25 MHz if Radio Std is 802.11ac(40MHz) = 40 MHz Option B1X: if Radio Std is 802.11ac(80MHz) = 80 MHz

	<p>Option B1Y: if Radio Std is 802.11ac(160MHz) = 160 MHz MSR: same as max value</p>
State Saved	Saved in instrument state.
Min	10.0 kHz
Max	<p>Hardware Dependent: RF Input: No Option = 10 MHz WB (25MHz or wider) = Hardware Option Limit I/Q Input (for I+jQ): No Option = 20 MHz Option B25 = 50 MHz</p>
Backwards Compatibility SCPI	<code>[:SENSe] :PStatistic:BWIDth</code>
Initial S/W Revision	Prior to A.02.00
Modified at S/W Revision	A.02.00, A.03.00, A.06.00

Cont (Continuous Measurement/Sweep)

Sets the analyzer for Continuous measurement operation. The single/continuous state is Meas Global so the setting will affect all measurements. If you are Paused, pressing Cont does a Resume.

Key Path	Front-panel key
Remote Command	:INITiate:CONTinuous OFF ON 0 1 :INITiate:CONTinuous?
Example	:INIT:CONT 0 puts analyzer in Single measurement operation. :INIT:CONT 1 puts analyzer in Continuous measurement operation
Preset	ON (Note that SYST:PRESet sets INIT:CONT to ON but *RST sets INIT:CONT to OFF)
State Saved	Saved in instrument state
Backwards Compatibility Notes	For Spectrum Analysis mode in ESA and PSA, there is no Cont hardkey, instead there is a Sweep Single/Cont key. In these analyzers, switching the Sweep Single/Cont key from Single to Cont restarts averages (displayed average count reset to 1), but does not restart Max Hold and Min Hold. The X-Series has Single and Cont keys in place of the SweepSingleCont key. In the X-Series, if in single measurement, the Cont key (and INIT:CONT ON) switches to continuous measurement, but never restarts a measurement and never resets a sweep.
Initial S/W Revision	Prior to A.02.00

In Swept SA Measurement (Spectrum Analysis Mode):

The analyzer takes repetitive sweeps, averages, measurements, etc., when in Continuous mode. When the average count reaches the Average/Hold Number the count stops incrementing, but the analyzer keeps sweeping. See the Trace/Detector section for the averaging formula used both before and after the Average/Hold Number is reached. The trigger condition must be met prior to each sweep. The type of trace processing for multiple sweeps, is set under the Trace/Detector key, with choices of Trace Average, Max Hold, or Min Hold.

In Other Measurements/Modes:

With Avg/Hold Num (in the Meas Setup menu) set to Off or set to On with a value of 1, a sweep is taken after the trigger condition is met; and the analyzer continues to take new sweeps after the current sweep has completed and the trigger condition is again met. However, with Avg/Hold Num set to On with a value >1, multiple sweeps (data acquisitions) are taken for the measurement. The trigger condition must be met prior to each sweep. The sweep is not stopped when the average count k equals the number N set for Avg/Hold Num is reached, but the number k stops incrementing. A measurement average usually applies to all traces, marker results, and numeric results. But sometimes it only applies to the numeric results.

If the analyzer is in Single measurement, pressing the Cont key does not change k and does not cause the sweep to be reset; the only action is to put the analyzer into Continuous measurement operation.

If it is already in continuous sweep:

the INIT:CONT 1 command has no effect

the INIT:CONT 0 command will place the analyzer in Single Sweep but will have no effect on the current sequence until $k = N$, at which point the current sequence will stop and the instrument will go to the idle state.

11 Power Stat CCDF Measurement
File

File

See "File" on page 360

FREQ Channel

Accesses a menu of keys that allow you to control the Frequency and Channel parameters of the instrument.

Some features in the Frequency menu are the same for all measurements – they do not change as you change measurements. Settings like these are called “Meas Global” and are unaffected by Meas Preset. For example, the Center Freq setting is the same for all measurements – it does not change as you change measurements.

Key Path	Front-panel key
Initial S/W Revision	Prior to A.02.00

Center Freq

Sets the frequency that corresponds to the horizontal center of the graticule (when frequency Scale Type is set to linear). While adjusting the Center Frequency the Span is held constant, which means that both Start Frequency and Stop Frequency will change.

Pressing Center Freq also sets the frequency entry mode to Center/Span. In Center/Span mode, the center frequency and span values are displayed below the graticule, and the default active function in the Frequency menu is Center Freq.

The center frequency setting is the same for all measurements within a mode, that is, it is Meas Global. Some modes are also able to share a Mode Global center frequency value. If this is the case, the Mode will have a Global Settings key in its Mode Setup menu.

The Center Freq function sets (and queries) the Center Frequency for the currently selected input. If your analyzer has multiple inputs, and you select another input, the Center Freq changes to the value for that input. SCPI commands are available to directly set the Center Freq for a specific input.

Center Freq is remembered as you go from input to input. Thus you can set a Center Freq of 10 GHz with the RF Input selected, change to BBIQ and set a Center Freq of 20 MHz, then switch to External Mixing and set a Center Freq of 60 GHz, and when you go back to the RF Input the Center Freq will go back to 10 GHz; back to BBIQ and it is 20 MHz; back to External Mixing and it is 60 GHz.

See ["RF Center Freq" on page 1106](#)

See [Ext Mix Center Freq](#)

See ["I/Q Center Freq" on page 1108](#)

See ["Center Frequency Presets" on page 1104](#)

Key Path	FREQ Channel
Scope	Meas Global
Remote Command	[:SENSe] :FREQuency:CENTer <freq> [:SENSe] :FREQuency:CENTer?

Example	FREQ:CENT 50 MHz FREQ:CENT UP changes the center frequency to 150 MHz if you use FREQ:CENT:STEP 100 MHz to set the center frequency step size to 100 MHz FREQ:CENT?
Notes	This command sets either the RF or I/Q Center Frequency depending on the selected input. For RF input it is equivalent to FREQ:RF:CENT For I/Q input it is equivalent to FREQ:IQ:CENT Preset and Max values are dependent on Hardware Options (5xx) If no terminator (e.g. MHz) is sent the terminator Hz is used. If a terminator with unit other than Frequency is used, an invalid suffix error message is generated.
Dependencies	The Center Frequency can be limited by Start or Stop Freq limits, if the Span is so large that Start or Stop reach their limit.
Couplings	When operating in "swept span", any value of the Center Frequency or Span that is within the frequency range of the analyzer is allowed when the value is being set through the front panel numeric key pad or the SCPI command. The other parameter is forced to a different value if needed, to keep the Start and the Stop Frequencies within the analyzer's frequency range
Preset	Depends on instrument maximum frequency, mode, measurement, and selected input. See "Center Frequency Presets" on page 1104 and "RF Center Freq" on page 1106 and Ext Mix Center Freq and "I/Q Center Freq" on page 1108.
State Saved	Saved in instrument state
Min	Depends on instrument maximum frequency, mode, measurement, and selected input.. See "Center Frequency Presets" on page 1104 and "RF Center Freq" on page 1106 and "I/Q Center Freq" on page 1108.
Max	Depends on instrument maximum frequency, mode, measurement, and selected input.. See "Center Frequency Presets" on page 1104 and "RF Center Freq" on page 1106 and "I/Q Center Freq" on page 1108.
Default Unit	Hz
Status Bits/OPC	Non-overlapped
Dependencies	
Initial S/W Revision	Prior to A.02.00

Center Frequency Presets

The following table provides the Center Frequency Presets for the Spectrum Analyzer mode, and the Max Freq, for the various frequency options:

Freq Option	CF after Mode Preset	Stop Freq after Mode Preset	Max Freq (can't tune)

			above)
503 (all but N9000A)	1.805 GHz	3.6 GHz	3.7 GHz
503 (N9000A)	1.505 GHz	3.0 GHz	3.08 GHz
507 (all but N9000A)	3.505 GHz	7.0 GHz	7.1 GHz
507 (N9000A)	3.755 GHz	7.5 GHz	7.58 GHz
508 (all but N9038A)	1.805 GHz	3.6 GHz	8.5 GHz
508 (N9038A)	4.205 GHz	8.4 GHz	8.5 GHz
513	6.805 GHz	13.6 GHz	13.8 GHz
526 (all but N9000A and N9038A)	13.255 GHz	26.5 GHz	27.0 GHz
526 (N9000A)	13.255 GHz	26.5 GHz	26.55 GHz
526 (N9038A)	1.805 GHz	3.6 GHz	27.0 GHz
532	16.005 GHz	32.0 GHz	32.5 GHz
543	21.505 GHz	43.0 GHz	TBD
544	22.005 GHz	44.0 GHz	44.5 GHz
550	25.005 GHz	50.0 GHz	51 GHz

Input 2:

Model	CF after Mode Preset	Stop Freq after Mode Preset	Max Freq (can't tune above)
N9000A opt C75	0.7505GHz	1.5 GHz	1.58 GHz
N9038A	505 MHz	1 GHz	1.000025 GHz

Tracking Generator Frequency Limits (N9000A only):

Tracking Generator Option	Min Freq (clips to this freq when turn TG on and	If above this Freq, Stop Freq clipped to this Freq when	Max Freq (can't tune above) while TG

	can't tune below while TG on)	TG turned on	on
T03	9 kHz	3.0 GHz	3.08 GHz
T06	9 kHz	6.0 GHz	6.05 GHz

The following table shows the Center Frequency Presets for modes other than Spectrum Analyzer:

Mode	CF Preset for RF
WCDMA	1 GHz
WIMAXOFDMA,	1 GHz
BASIC	1 GHz
ADEMOD	1 GHz
VSA	1 GHz
TDSCDMA	1 GHz
PNOISE	1 GHz
LTE	1 GHz
LTETDD	1 GHz
MSR	1 GHz
GSM	935.2 MHz
NFIGURE	1.505 GHz

RF Center Freq

SCPI command for specifying the RF Center Frequency. This command will set the Center Frequency to be used when the RF input is selected, even if the RF input is not the input that is selected at the time the command is sent. Note that the Center Freq function in the Frequency menu on the front panel always applies to the currently selected input.

Scope	Meas Global
Remote Command	<code>[:SENSe] :FREQuency:RF:CENTer <freq></code> <code>[:SENSe] :FREQuency:RF:CENTer?</code>
Example	FREQ:RF:CENT 30 MHz
Notes	This command is the same in all modes, but the parameter is Measurement Global. So the value is independent in each mode and common across all the measurements in the mode.
Dependencies	If the electronic/soft attenuator is enabled, any attempt to set Center Frequency such that the Stop Frequency would be >3.6 GHz fails and results in an advisory message. If the equivalent SCPI command is sent, this same message is generated as part of a “-221, Settings conflict” warning. If Source Mode is set to Tracking, and the Max or Min Center Freq is therefore limited by the limits of the source, a warning message is generated, “Data out of range;clipped to source max/min” if these limits are exceeded. Note that for an external source, these limits can be affected by the settings of

	Source Numerator, Source Denominator and Power Sweep.
Preset	See table above
State Saved	Saved in instrument state.
Min	-79.999995 MHz, unless Source Mode is set to Tracking, in which case it is limited by the minimum frequency of the Source
Max	See table above. Basically instrument maximum frequency - 5 Hz. Note that, if the Source Mode is set to Tracking, the effective instrument maximum frequency may be limited by the source maximum frequency. If the knob or step keys are being used, also depends on the value of the other three interdependent parameters Span, Start Frequency and Stop Frequency
Initial S/W Revision	Prior to A.02.00
Modified at S/W Revision	A.03.00

Ext Mix Center Freq

SCPI command for specifying the External Mixer Center Frequency. This command will set the Center Frequency to be used when the External Mixer is selected, even if the External Mixer input is not the input which is selected at the time the command is sent. Note that the Center Freq function in the Frequency menu on the front panel always applies to the currently selected input.

Scope	Meas Global
Remote Command	<code>[:SENSe] :FREQuency:EMIXer:CENTer <freq></code> <code>[:SENSe] :FREQuency:EMIXer:CENTer?</code>
Example	<code>:FREQ:EMIX:CENT 60 GHz</code> <code>:FREQ:EMIX:CENT?</code>
Notes	This command is the same in all modes, but the parameter is Measurement Global. So the value is independent in each mode and common across all the measurements in the mode.
Couplings	When returning to External Mixing after having been switched to one of the other inputs (e.g., RF), you will come back into the settings that you had when you left External Mixing. So you will come back to the band you were in with the Center Frequency that you had. However, Span is not an input-dependent parameter, therefore you will bring the span over from the other input. Therefore, the analyzer comes back with the span from the previous input, limited as necessary by the current mixer setup.
Preset	When a Mode Preset is performed while in External Mixing, the Start frequency of the current Mode is set to the nominal Min Freq of the lowest harmonic range in the Harmonic Table for the current mixer setup. Similarly, the Stop frequency of the current Mode is set to the nominal Max Freq of the highest harmonic range in the Harmonic Table. The Center Freq thus presets to the point arithmetically equidistant from these two frequencies. If the current measurement has a limited Span available to it, and cannot achieve the Span shown in the table ($\text{Span} = \text{Stop Freq} - \text{Start Freq}$), the analyzer uses the maximum Span the measurement allows, and still sets the Center Freq to the midpoint of the Start and Stop Freq values in the Harmonic Table.

	<p>When Restore Input/Output Defaults is performed, the mixer presets to the 11970A, whose Start and Stop frequencies are 26.5 and 40 GHz respectively. The center of these two frequencies is 33.25 GHz.</p> <p>Therefore, after a Restore Input/Output Defaults, if you go into External Mixing and do a Mode Preset while in the Spectrum Analyzer Mode, the resulting Center Freq is 33.25 GHz.</p>
State Saved	Saved in instrument state.
Min	The minimum frequency in the currently selected mixer band + 5 Hz
Max	<p>The maximum frequency in the currently selected mixer band – 5 Hz</p> <p>If the knob or step keys are being used, also depends on the value of the other three interdependent parameters Span, Start Frequency and Stop Frequency</p>
Initial S/W Revision	A.08.01

I/Q Center Freq

SCPI command for specifying the I/Q Center Frequency. This command will set the Center Frequency to be used when the I/Q input is selected, even if the I/Q input is not the input which is selected at the time the command is sent. Note that the Center Freq function in the Frequency menu on the front panel always applies to the currently selected input.

Scope	Meas Global
Remote Command	<pre>[:SENSe] :FREQuency:IQ:CENTer <freq></pre> <pre>[:SENSe] :FREQuency:IQ:CENTer?</pre>
Example	FREQ:IQ:CEN: 30 MHz
Notes	This command is the same in all modes, but the parameter is Measurement Global. So the value is independent in each mode and common across all the measurements in the mode.
Preset	0 Hz
State Saved	Saved in instrument state.
Min	-40.049995 MHz
Max	40.049995 MHz
Initial S/W Revision	Prior to A.02.00

CF Step

Changes the step size for the center frequency and start and stop frequency functions. Once a step size has been selected and the center frequency function is active, the step keys (and the UP|DOWN parameters for Center Frequency from remote commands) change the center frequency by the step-size value. The step size function is useful for finding harmonics and sidebands beyond the current frequency span of the analyzer.

Note that the start and stop frequencies also step by the CF Step value.

Key Path	FREQ Channel
Remote Command	[:SENSe]:FREQuency:CENTer:STEP[:INCRement] <freq> [:SENSe]:FREQuency:CENTer:STEP[:INCRement]? [:SENSe]:FREQuency:CENTer:STEP:AUTO OFF ON 0 1 [:SENSe]:FREQuency:CENTer:STEP:AUTO?
Example	FREQ:CENT:STEP:AUTO ON FREQ:CENT:STEP 500 MHz FREQ:CENT UP increases the current center frequency value by 500 MHz FREQ:CENT:STEP? FREQ:CENT:STEP:AUTO?
Notes	Preset and Max values are depending on Hardware Options (503, 507, 508, 513, 526)
Notes	Preset and Max values are dependent on Hardware Options (5xx)
Dependencies	Freq Offset is not available in External Mixing. In this case the Freq Offset key is grayed out and shows a value of zero. It will once again be available, and show the previously set value, when you return to the RF Input.
Dependencies	Span, RBW, Center frequency If the electronic/soft attenuator is enabled, any attempt to change the value of the center frequency >3.6 GHz by pressing the Up-arrow key, fails and results in an advisory message. If the equivalent SCPI command is sent, this same message is generated as part of a “-221, Settings conflict” warning.
Couplings	When auto-coupled in a non-zero span, the center frequency step size is set to 10% of the span. When auto-coupled in zero span, the center frequency step size is set to the equivalent -3 dB RBW value.
Preset	Auto ADEMOD: 1 MHz ON
State Saved	Saved in instrument state
Min	– (the maximum frequency of the instrument). That is, 27 GHz max freq instrument has a CF step range of +/- 27 GHz. Note that this is the maximum frequency given the current settings of the instrument, so in External Mixing, for example, it is the maximum frequency of the current mixer band.
Max	The maximum frequency of the instrument. That is, 27 GHz max freq instrument has a CF step range of +/- 27 GHz. Note that this is the maximum frequency given the current settings of the instrument, so in External Mixing, for example, it is the maximum frequency of the current mixer band.
Default Unit	Hz
Status Bits/OPC dependencies	non-overlapped
Initial S/W Revision	Prior to A.02.00
Modified at S/W Revision	A.03.00

11 Power Stat CCDF Measurement
Input/Output

Input/Output

See ["Input/Output" on page 224](#)

Marker

Accesses a menu that enables you to select, set up and control the markers for the current measurement.

Key Path	Front-panel key
Initial S/W Revision	Prior to A.02.00

Select Marker

Accesses a menu that allows you to select one of 12 markers for control and function

Key Path	Marker
Initial S/W Revision	Prior to A.02.00

Marker Type

Sets the marker control mode to Normal, Delta, Fixed or Off.

If the selected marker is Off, pressing Marker sets it to Normal and places it at the center of the screen on the trace determined by the Marker Trace rules. At the same time, Marker X Axis Value appears on the Active Function area.

The Active function for the selected marker's current control mode is the default active function. If the current control mode is Off, there is no active function and the active function is turned off. The active function display is the marker X axis value entered in the active function area, which displays the marker value to its full entered precision.

All interactions and dependencies detailed under the key description are enforced when the remote command is sent.

Key Path	Marker
Mode	SA, WCDMA, C2K, WiMAX OFDMA, TD-SCDMA, 1xEV-DO, DVB-T/H, DTMB (CTTB), ISDB-T, CMMB, LTE, LTE-TDD, Digital Cable TV, WLAN, MSR, LTE-TDD, LTE-FDD
Remote Command	:CALCulate:PStatistic:MARKer[1] 2 ... 12:MODE POSition DELTA OFF :CALCulate:PStatistic:MARKer[1] 2 ... 12:MODE?
Example	CALC:PST:MARK:MODE POS CALC:PST:MARK:MODE?
Notes	If the selected marker is Off, pressing Marker sets it to Normal and places it at the center of the screen on the trace determined by the Marker Trace rules. At the same time, Marker X Axis Value appears on the Active Function area. Default Active Function: the active function for the selected marker's current control mode. If the current control mode is Off, there is no active function and the active function is turned off. Active Function Display: the marker X axis value entered in the active function area displays the marker value to its full entered precision.

Preset	OFF
State Saved	Saved in instrument state.
Range	Normal Delta Off
Initial S/W Revision	Prior to A.02.00
Modified at S/W Revision	A.02.00, A.03.00

Properties

Accesses the marker properties menu.

Key Path	Marker
Initial S/W Revision	Prior to A.02.00

Select Marker

Accesses a menu that allows you to select one of 12 markers for control and function

Key Path	Marker
Initial S/W Revision	Prior to A.02.00

Relative To

Sets the reference marker that the selected marker will be relative to.

Key Path	Marker, Properties
Mode	SA, WCDMA, C2K, WIMAXOFDMA, TD-SCDMA, 1xEV-DO, DVB-T/H, DTMB (CTTB), ISDB-T, CMMB, LTE, LTETDD, Digital Cable TV, WLAN, MSR, LTEATDD, LTEAFDD
Remote Command	:CALCulate:PStatistic:MARKer[1] 2 ... 12:REFerence <integer> :CALCulate:PStatistic:MARKer[1] 2 ... 12:REFerence?
Example	CALC:PST:MARK:REF 3 CALC:PST:MARK:REF?
Notes	A marker cannot be relative to itself so that choice is grayed out, and if sent from SCPI generates error -221: "Settings conflict; marker cannot be relative to itself." When queried a single value will be returned (the specified marker numbers relative marker).
Preset	2 3 4 5 6 7 8 9 10 11 12 1
State Saved	Saved in instrument state.
Min	1
Max	12
Initial S/W Revision	Prior to A.02.00
Modified at S/W Revision	A.02.00, A.03.00

Marker Trace

Assigns the specified marker to the designated trace. The trace choices are:

- Measured
- Gaussian
- Reference

Key Path	Marker
Mode	SA, WCDMA, C2K, WIMAXOFDMA, TD-SCDMA, 1xEV-DO, DVB-T/H, DTMB (CTTB), ISDB-T, CMMB, LTE, LTE-TDD, Digital Cable TV, WLAN, MSR, LTE-TDD, LTE-FDD
Remote Command	:CALCulate:PStatistic:MARKer[1] 2 ... 12:TRACe MEASured GAUSSian REFerence :CALCulate:PStatistic:MARKer[1] 2 ... 12:TRACe?
Example	CALC:PST:MARK3:TRAC MEAS CALC:PST:MARK:TRACE?
Preset	MEASured
State Saved	Saved in instrument state.
Range	Measured Gaussian Reference
Initial S/W Revision	Prior to A.02.00
Modified at S/W Revision	A.02.00, A.03.00

Couple Markers

When this function is on, moving any marker causes an equal X axis movement of every other marker that is not off. By “equal X axis movement” we mean that we preserve the difference between each marker’s X axis value (in the fundamental x-axis units of the trace that marker is on) and the X axis value of the marker being moved (in the same fundamental x-axis units).

Key Path	Marker
Initial S/W Revision	Prior to A.02.00

All Markers Off

Turns off all markers.

Key Path	Marker, More
Mode	SA, WCDMA, C2K, WIMAXOFDMA, TD-SCDMA, 1xEV-DO, DVB-T/H, DTMB (CTTB), ISDB-T, CMMB, LTE, LTE-TDD, Digital Cable TV, WLAN, MSR, LTE-TDD, LTE-FDD
Remote Command	:CALCulate:PStatistic:MARKer:AOff

Example	CALC:PST:MARK:AOFF
Initial S/W Revision	Prior to A.02.00
Modified at S/W Revision	A.02.00, A.03.00

Marker X Axis Value (Remote Command Only)

Sets the marker X Axis value in the current marker X Axis Scale unit. This function has no effect if the control mode is Off, but is the remote command equivalent of entering an X value if the control mode is Normal or Delta.

Mode	SA, WCDMA, C2K, WIMAXOFDMA, TD-SCDMA, 1xEV-DO, DVB-T/H, DTMB (CTTB), ISDB-T, CMMB, LTE, LTE-TDD, Digital Cable TV, WLAN, MSR, LTE-TDD, LTEAFDD
Remote Command	:CALCulate:PStatistic:MARKer[1] 2 ... 12:X <rel_ampl> :CALCulate:PStatistic:MARKer[1] 2 ... 12:X?
Example	CALC:PST:MARK3:X 0 CALC:PST:MARK3:X?
Notes	If no suffix is sent, it will use the fundamental units for the current marker X Axis Scale. If a suffix is sent that does not match the current marker X Axis Scale unit, an error "Invalid suffix" will be generated. If the specified marker is Fixed and a Marker Function is on, error -221 "Settings conflict; cannot adjust Fixed marker while Marker Function is on" is generated. The query returns the marker's absolute X Axis value if the control mode is Normal, or the offset from the marker's reference marker if the control mode is Delta. The query is returned in the fundamental units for the current marker X Axis scale: Hz for Frequency and Inverse Time, seconds for Period and Time. If the marker is Off the response is not a number.
Preset	After a preset, all Markers are turned OFF, so Marker X Axis Value query will return a not a number (NAN).
State Saved	No
Min	-9.9E+37
Max	9.9E+37
Initial S/W Revision	Prior to A.02.00
Modified at S/W Revision	A.02.00, A.03.00

Marker Y Axis Value (Remote Command Only)

Queries the marker Y Axis value in the current marker Y Axis unit.

Mode	SA, WCDMA, C2K, WIMAXOFDMA, TD-SCDMA, 1xEV-DO, DVB-T/H, DTMB (CTTB), ISDB-T, CMMB, LTE, LTE-TDD, Digital Cable TV, WLAN, MSR, LTE-TDD, LTEAFDD
Remote Command	:CALCulate:PStatistic:MARKer[1] 2 ... 12:Y?
Example	CALC:PST:MARK11:Y?
Notes	The query returns the marker Y-axis result, if the control mode is Normal, or Delta. If the marker is

	Off the response is not a number.
Preset	0
State Saved	No
Backwards Compatibility SCPI	:CALCulate:PSStatistic:MARKer[1] 2 ... 12:FUNCTION:RESult?
Initial S/W Revision	Prior to A.02.00
Modified at S/W Revision	A.02.00, A.03.00

Marker Function

There are no 'Marker Functions' supported in Power Stat CCDF measurement. The front-panel key displays a blank menu when pressed.

Key Path	Front-panel key
Initial S/W Revision	Prior to A.02.00

Marker To

There is no 'Marker To' functionality supported in Power Stat CCDF measurement. The front-panel key displays a blank menu when pressed.

Key Path	Front-panel key
Initial S/W Revision	Prior to A.02.00

Meas

The information in this section is common to all measurements. For key and remote command information for a specific measurement, refer to the section that describes the measurement of interest.

Measurements available under the Meas key are specific to the current Mode.

When viewing Help for measurements, note the following:

NOTE

Operation for some keys differs between measurements. The information displayed in Help pertains to the current measurement. To see how a key operates in a different measurement, exit Help (press the Cancel Esc key), select the measurement, then reenter Help (press the Help key) and press that key.

Key Path	Front-panel key
Initial S/W Revision	Prior to A.02.00

Remote Measurement Functions

This section contains the following topics:

["Measurement Group of Commands" on page 2771](#)

["Current Measurement Query \(Remote Command Only\)" on page 2773](#)

["Limit Test Current Results \(Remote Command Only\)" on page 2773](#)

["Data Query \(Remote Command Only\)" on page 2773](#)

["Calculate/Compress Trace Data Query \(Remote Command Only\)" on page 2774](#)

["Calculate Peaks of Trace Data \(Remote Command Only\)" on page 2779](#)

[Hardware-Accelerated Fast Power Measurement \(Remote Command Only\)](#)

["Format Data: Numeric Data \(Remote Command Only\)" on page 2780](#)

["Format Data: Byte Order \(Remote Command Only\)" on page 2781](#)

Initial S/W Revision	Prior to A.02.00
----------------------	------------------

Measurement Group of Commands

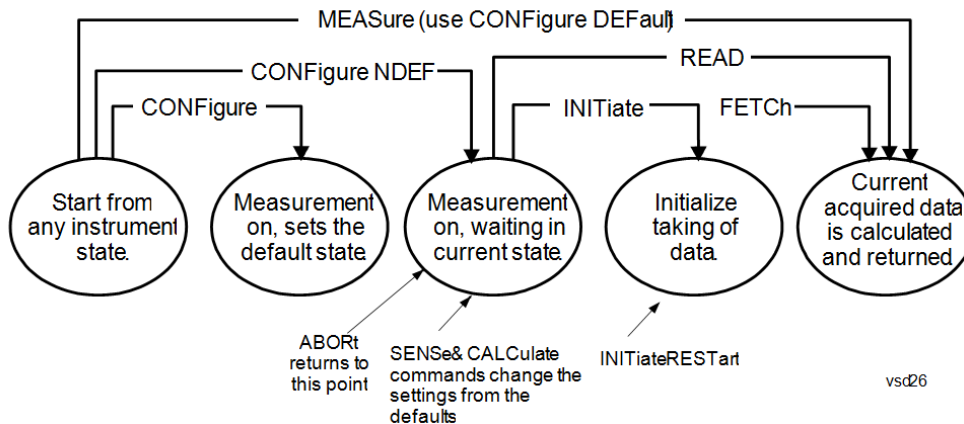

Measure Commands:

:MEASure:<measurement>[n]?

This is a fast single-command way to make a measurement using the factory default instrument settings. These are the settings and units that conform to the Mode Setup settings (e.g. radio standard) that you have currently selected.

- Stops the current measurement (if any) and sets up the instrument for the specified measurement using the factory defaults
- Initiates the data acquisition for the measurement
- Blocks other SCPI communication, waiting until the measurement is complete before returning results.
- If the function does averaging, it is turned on and the number of averages is set to 10.
- After the data is valid it returns the scalar results, or the trace data, for the specified measurement. The type of data returned may be defined by an [n] value that is sent with the command.
- The scalar measurement results will be returned if the optional [n] value is not included, or is set to 1. If the [n] value is set to a value other than 1, the selected trace data results will be returned. See each command for details of what types of scalar results or trace data results are available.
- ASCII is the default format for the data output. (Older versions of Spectrum Analysis and Phase Noise mode measurements only use ASCII.) The binary data formats should be used for handling large blocks of data since they are smaller and faster than the ASCII format. Refer to the FORMat:DATA command for more information.

If you need to change some of the measurement parameters from the factory default settings you can set up the measurement with the CONFIGure command. Use the commands in the SENSE:<measurement> and CALCulate:<measurement> subsystems to change the settings. Then you can use the READ? command to initiate the measurement and query the results.

If you need to repeatedly make a given measurement with settings other than the factory defaults, you can use the commands in the SENSE:<measurement> and CALCulate:<measurement> subsystems to set up the measurement. Then use the READ? command to initiate the measurement and query results.

Measurement settings persist if you initiate a different measurement and then return to a previous one. Use READ:<measurement>? if you want to use those persistent settings. If you want to go back to the default settings, use MEASure:<measurement>?.

Configure Commands:

:CONFigure:<measurement>

This command stops the current measurement (if any) and sets up the instrument for the specified measurement using

the factory default instrument settings. It does not initiate the taking of measurement data unless INIT:CONTinuous is ON. If you change any measurement settings after using the CONFigure command, the READ command can be used to initiate a measurement without changing the settings back to their defaults.

In the Swept SA measurement in Spectrum Analyzer mode the CONFigure command also turns the averaging function on and sets the number of averages to 10 for all measurements.

:CONFigure: <measurement>: NDEFault stops the current measurement and changes to the specified measurement. It does not change the settings to the defaults. It does not initiate the taking of measurement data unless INIT:CONTinuous is ON.

The CONFigure? query returns the current measurement name.

The CONFigure:CATalog? query returns a quoted string of all licensed measurement names in the current mode. For example, "SAN, CHP, OBW, ACP, PST, TXP, SPUR, SEM, LIST".

Fetch Commands:

:FETCh:<measurement>[n]?

This command puts selected data from the most recent measurement into the output buffer. Use FETCh if you have already made a good measurement and you want to return several types of data (different [n] values, for example, both scalars and trace data) from a single measurement. FETCh saves you the time of re-making the measurement. You can only FETCh results from the measurement that is currently active, it will not change to a different measurement. An error message is reported if a measurement other than the current one is specified.

If you need to get new measurement data, use the READ command, which is equivalent to an INITiate followed by a FETCh.

The scalar measurement results will be returned if the optional [n] value is not included, or is set to 1. If the [n] value is set to a value other than 1, the selected trace data results will be returned. See each command for details of what types of scalar results or trace data results are available. The binary data formats should be used for handling large blocks of data since they are smaller and transfer faster than the ASCII format. (FORMat:DATA)

FETCh may be used to return results other than those specified with the original READ or MEASure command that you sent.

INITiate Commands:

:INITiate:<measurement>

This command is not available for measurements in all the instrument modes:

- Initiates a trigger cycle for the specified measurement, but does not output any data. You must then use the FETCh<meas> command to return data. If a measurement other than the current one is specified, the instrument will switch to that measurement and then initiate it.
 - For example, suppose you have previously initiated the ACP measurement, but now you are running the channel power measurement. If you send INIT:ACP? it will change from channel power to ACP and will initiate an ACP measurement.
 - Does not change any of the measurement settings. For example, if you have previously started the ACP measurement and you send INIT:ACP? it will initiate a new ACP measurement using the same instrument settings as the last time ACP was run.
 - If your selected measurement is currently active (in the idle state) it triggers the measurement, assuming the trigger conditions are met. Then it completes one trigger cycle. Depending upon the measurement and the number of averages, there may be multiple data acquisitions, with multiple trigger events, for one full trigger cycle. It also holds off additional commands on GPIB until the acquisition is complete.
-

READ Commands:

:READ:<measurement>[n]?

- Does not preset the measurement to the factory default settings. For example, if you have previously initiated the ACP
-

measurement and you send READ:ACP? it will initiate a new measurement using the same instrument settings.

- Initiates the measurement and puts valid data into the output buffer. If a measurement other than the current one is specified, the instrument will switch to that measurement before it initiates the measurement and returns results.
 - For example, suppose you have previously initiated the ACP measurement, but now you are running the channel power measurement. Then you send READ:ACP? It will change from channel power back to ACP and, using the previous ACP settings, will initiate the measurement and return results.
 - Blocks other SCPI communication, waiting until the measurement is complete before returning the results
 - If the optional [n] value is not included, or is set to 1, the scalar measurement results will be returned. If the [n] value is set to a value other than 1, the selected trace data results will be returned. See each command for details of what types of scalar results or trace data results are available. The binary data formats should be used when handling large blocks of data since they are smaller and faster than the ASCII format. (FORMat:DATA)
-

Initial S/W Revision	Prior to A.02.00
----------------------	------------------

Current Measurement Query (Remote Command Only)

This command returns the name of the measurement that is currently running.

Remote Command	:CONFigure?
-----------------------	-------------

Example	CONF?
----------------	-------

Initial S/W Revision	Prior to A.02.00
----------------------	------------------

Limit Test Current Results (Remote Command Only)

Queries the status of the current measurement limit testing. It returns a 0 if the measured results pass when compared with the current limits. It returns a 1 if the measured results fail any limit tests.

Remote Command	:CALCulate:CLIMits:FAIL?
-----------------------	--------------------------

Example	CALC:CLIM:FAIL? queries the current measurement to see if it fails the defined limits. Returns a 0 or 1: 0 it passes, 1 it fails.
----------------	--

Initial S/W Revision	Prior to A.02.00
----------------------	------------------

Data Query (Remote Command Only)

Returns the designated measurement data for the currently selected measurement and subopcode.

n = any valid subopcode for the current measurement. See the measurement command results table for your current measurement, for information about what data is returned for the subopcodes.

This command uses the data setting specified by the FORMat:BORDER and FORMat:DATA commands and can return real or ASCII data. (See the format command descriptions under Input/Output in the Analyzer Setup section.)

Remote Command	:CALCulate:DATA[n]?
Notes	The return trace depends on the measurement. In CALCulate:<meas>:DATA[n], n is any valid subopcode for the current measurement. It returns the same data as the FETCH:<measurement>? query where <measurement> is the current measurement.
Initial S/W Revision	Prior to A.02.00

Calculate/Compress Trace Data Query (Remote Command Only)

Returns compressed data for the currently selected measurement and sub-opcode [n].

n = any valid sub-opcode for that measurement. See the MEASure:<measurement>? command description of your specific measurement for information on the data that can be returned.

The data is returned in the current Y Axis Unit of the analyzer. The command is used with a sub-opcode <n> (default=1) to specify the trace. With trace queries, it is best if the analyzer is not sweeping during the query. Therefore, it is generally advisable to be in Single Sweep, or Update=Off.

This command is used to compress or decimate a long trace to extract and return only the desired data. A typical example would be to acquire N frames of GSM data and return the mean power of the first burst in each frame. The command can also be used to identify the best curve fit for the data.

Remote Command	:CALCulate:DATA<n>:COMPRESS? BLOCK CFIT MAXimum MINimum MEAN DMEan RMS RMSCubed SAMPLE SDEVIation PPHase [,<soffset> [,<length>[,<roffset>[,<rlimit>]]]]
Example	To query the mean power of a set of GSM bursts: Supply a signal that is a set of GSM bursts. Select the IQ Waveform measurement (in IQ Analyzer Mode). Set the sweep time to acquire at least one burst. Set the triggers such that acquisition happens at a known position relative to a burst. Then query the mean burst levels using, CALC:DATA2:COMP? MEAN, 24e-6, 526e-6 (These parameter values correspond to GSM signals, where 526e-6 is the length of the burst in the slot and you just want 1 burst.)
Notes	The command supports 5 parameters. Note that the last 4 (<soffset>, <length>, <roffset>, <rlimit>) are optional. But these optional parameters must be entered in the specified order. For example, if you want to specify <length>, then you must also specify <soffset>. See details below for a definition of each of these parameters. This command uses the data in the format specified by FORMat:DATA, returning either binary or ASCII data.
Initial S/W Revision	Prior to A.02.00

- BLOCK or block data - returns all the data points from the region of the trace data that you specify. For example, it could be used to return the data points of an input signal over several timeslots, excluding the portions of the trace data that you do not want. (This is x,y pairs for trace data and I,Q pairs for complex data.)

- CFIT or curve fit - applies curve fitting routines to the data. <soffset> and <length> are required to define the data that you want. <roffset> is an optional parameter for the desired order of the curve equation. The query will return the following values: the x-offset (in seconds) and the curve coefficients ((order + 1) values).

MIN, MAX, MEAN, DME, RMS, RMSC, SAMP, SDEV and PPH return one data value for each specified region (or <length>) of trace data, for as many regions as possible until you run out of trace data (using <roffset> to specify regions). Or they return the number of regions you specify (using <rlimit>) ignoring any data beyond that.

- MINimum - returns the minimum data point (y value) for the specified region(s) of trace data. For I/Q trace data, the minimum magnitude of the I/Q pairs is returned.
- MAXimum - returns the maximum data point (y value) for the specified region(s) of trace data. For I/Q trace data, the maximum magnitude of the I/Q pairs is returned.
- MEAN - returns a single value that is the arithmetic mean of the data point values (in dB/ dBm) for the specified region(s) of trace data. For I/Q trace data, the mean of the magnitudes of the I/Q pairs is returned. See the following equations.

-

NOTE

If the original trace data is in dB, this function returns the arithmetic mean of those log values, not log of the mean power which is a more useful value. The mean of the log is the better measurement technique when measuring CW signals in the presence of noise. The mean of the power, expressed in dB, is useful in power measurements such as Channel Power. To achieve the mean of the power, use the RMS option.

Equation 1

Mean Value of Data Points for Specified Region(s)

$$\text{MEAN} = \frac{1}{n} \sum_{X_i \in \text{region}(s)} X_i$$

where X_i is a data point value, and n is the number of data points in the specified region(s).

Equation 2

Mean Value of I/Q Data Pairs for Specified Region(s)

$$\text{MEAN} = \frac{1}{n} \sum_{X_i \in \text{region}(s)} |X_i|$$

where $|X_i|$ is the magnitude of an I/Q pair, and n is the number of I/Q pairs in the specified region(s).

- DMEan - returns a single value that is the mean power (in dB/ dBm) of the data point values for the specified region(s) of trace data. See the following equation:

Equation 3

DMEan Value of Data Points for Specified Region(s)

$$\text{DME} = 10 \times \log_{10} \left(\frac{1}{n} \sum_{X_i \in \text{region}(s)} 10^{\frac{X_i}{10}} \right)$$

- RMS - returns a single value that is the average power on a root-mean-squared voltage scale (arithmetic rms) of the data point values for the specified region(s) of trace data. See the following equation.

NOTE For I/Q trace data, the rms of the magnitudes of the I/Q pairs is returned. See the following equation. This function is very useful for I/Q trace data. However, if the original trace data is in dB, this function returns the rms of the log values which is not usually needed.

Equation 4

RMS Value of Data Points for Specified Region(s)

$$\text{RMS} = \sqrt{\frac{1}{n} \sum_{X_i \in \text{region}(s)} X_i^2}$$

where X_i is a data point value, and n is the number of data points in the specified region(s).

Equation 5

RMS Value of I/Q Data Pairs for Specified Region(s)

$$\text{RMS} = \sqrt{\frac{1}{n} \sum_{X_i \in \text{region}(s)} X_i X_i^*}$$

where X_i is the complex value representation of an I/Q pair, X_i^* its conjugate complex number, and n is the number of I/Q pairs in the specified region(s).

Once you have the rms value for a region of trace data (linear or I/Q), you may want to calculate the mean power. You must convert this rms value (peak volts) to power in dBm:

$$10 \times \log[10 \times (\text{rms value})^2]$$

- SAMPLe - returns the first data value (x,y pair) for the specified region(s) of trace data. For I/Q trace data, the first I/Q pair is returned.
- SDEViation - returns a single value that is the arithmetic standard deviation for the data point values for the specified region(s) of trace data. See the following equation.
- For I/Q trace data, the standard deviation of the magnitudes of the I/Q pairs is returned. See the following equation.

Equation 6

Standard Deviation of Data Point Values for Specified Region(s)

$$\text{SDEV} = \sqrt{\frac{1}{n} \sum_{X_i \in \text{region}(s)} (X_i - \bar{X})^2}$$

where X_i is a data point value, \bar{X} is the arithmetic mean of the data point values for the specified region (s), and n is the number of data points in the specified region(s).

$$\text{SDEV} = \sqrt{\frac{1}{n} \sum_{X_i \in \text{region}(s)} (|X_i| - \bar{X})^2}$$

where $|X_i|$ is the magnitude of an I/Q pair, \bar{X} is the mean of the magnitudes for the specified region(s), and n is the number of data points in the specified region(s).

- PPHase - returns the x,y pairs of both rms power (dBm) and arithmetic mean phase (radian) for every specified region and frequency offset (Hz). The number of pairs is defined by the specified number of regions. This parameter can be used for I/Q vector ($n=0$) in Waveform (time domain) measurement and all parameters are specified by data point in PPHase.

The rms power of the specified region may be expressed as:

$$\text{Power} = 10 \times \log [10 \times (\text{RMS I/Q value})] + 10.$$

The RMS I/Q value (peak volts) is:

$$\sqrt{\frac{1}{n} \sum_{X_i \in \text{region}} X_i X_i^*}$$

where X_i is the complex value representation of an I/Q pair, X_i^* its conjugate complex number, and n is the number of I/Q pairs in the specified region.

The arithmetic mean phase of the specified region may be expressed as:

$$\frac{1}{n} \sum_{Y_i \in \text{region}} Y_i$$

where Y_i is the unwrapped phase of I/Q pair with applying frequency correction and n is the number of I/Q pairs in the specified region.

The frequency correction is made by the frequency offset calculated by the arithmetic mean of every specified region's frequency offset. Each frequency offset is calculated by the least square method against the unwrapped phase of I/Q pair.

Sample Trace Data - Constant Envelope

(See below for explanation of variables.)

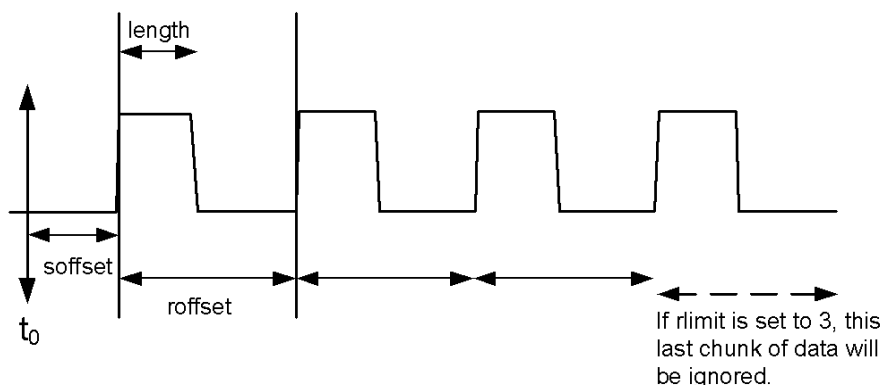

Sample Trace Data - Not Constant Envelope

(See below for explanation of variables.)

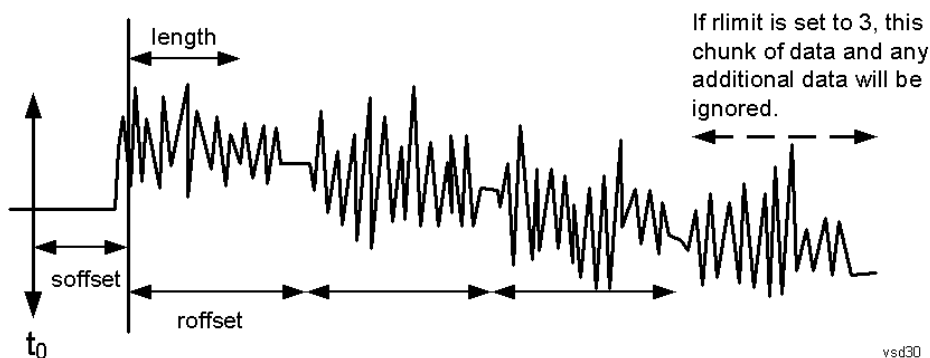

<soffset> - start offset is an optional real number. (It is in seconds for time-domain traces, and is a dimensionless index 0 to Npoints - 1, for frequency-domain traces). It specifies the amount of data at the beginning of the trace that will be ignored before the decimation process starts. It is the time or frequency change from the start of the trace to the point where you want to start using the data. The default value is zero.

<length> - is an optional real number. (It is in seconds for time-domain traces, and is a dimensionless index 0 to Npoints - 1, for frequency-domain traces). It defines how much data will be compressed into one value. This parameter has a default value equal to the current trace length.

<roffset> - repeat offset is an optional real number. (It is in seconds for time-domain traces, and is a dimensionless index 0 to Npoints - 1, for frequency-domain traces). It defines the beginning of the next field of trace elements to be compressed. This is relative to the beginning of the previous field. This parameter has a default value equal to the <length> variable. Note that this parameter is used for a completely different purpose when curve fitting (see CFIT above).

<rlimit> - repeat limit is an optional integer. It specifies the number of data items that you want returned. It will ignore any additional items beyond that number. You can use the Start offset and the Repeat limit to pick out exactly what part of the data you want to use. The default value is all the data.

Calculate Peaks of Trace Data (Remote Command Only)

Returns a list of all the peaks for the currently selected measurement and sub-opcode [n]. The peaks must meet the requirements of the peak threshold and excursion values.

n = any valid sub-opcode for the current measurement. See the MEASure:<measurement> command description of your specific measurement for information on the data that can be returned.

The command can only be used with specific sub-opcodes with measurement results that are trace data. Both real and complex traces can be searched, but complex traces are converted to magnitude in dBm. In many measurements the sub-opcode n=0, is the raw trace data which cannot be searched for peaks. And Sub-opcode n=1, is often calculated results values which also cannot be searched for peaks.

This command uses the data setting specified by the FORMat:BORDER and FORMat:DATA commands and can return real or ASCII data. If the format is set to INT,32, it returns REAL,32 data.

The command has four types of parameters:

- Threshold (in dBm)
- Excursion (in dB)
- Sorting order (amplitude, frequency, time)
- Optional in some measurements: Display line use (all, > display line, < display line)

Remote Command	<p>For Swept SA measurement:</p> <pre>:CALCulate:DATA[1] 2 ... 6:PEAKs? <threshold>,<excursion>[,AMPLitude FREQuency TIME[,ALL GTDLline LTDLine]]</pre> <p>For most other measurements:</p> <pre>:CALCulate:DATA[1] 2 ... 6:PEAKs? <threshold>,<excursion>[,AMPLitude FREQuency TIME]</pre>
Example	<p>Example for Swept SA measurement in Spectrum Analyzer Mode:</p> <p>CALC:DATA4:PEAK? -40, 10, FREQ, GTDL This will identify the peaks of trace 4 that are above -40 dBm, with excursions of at least 10 dB. The peaks are returned in order of increasing frequency, starting with the lowest frequency. Only the peaks that are above the display line are returned.</p> <p>Query Results 1:</p> <p>With FORMat:DATA REAL, 32 selected, it returns a list of floating-point numbers. The first value in the list is the number of peak points that are in the following list. A peak point consists of two values: a peak amplitude followed by its corresponding frequency (or time).</p> <p>If no peaks are found the peak list will consist of only the number of peaks, (0).</p>
Notes	<p><n> - is the trace that will be used</p> <p><threshold> - is the level below which trace data peaks are ignored. Note that the threshold value is required and is always used as a peak criterion. To effectively disable the threshold criterion for this command, provide a substantially low threshold value such as -200 dBm. Also note that the threshold value used in this command is independent of and has no effect on the threshold value stored under the Peak Criteria menu.</p> <p><excursion> - is the minimum amplitude variation (rise and fall) required for a signal to be identified as peak. Note that the excursion value is required and is always used as a peak criterion. To effectively disable the excursion criterion for this command, provide the minimum value of 0.0 dB. Also note that the excursion value used in this command is independent of and has no effect on the</p>

excursion value stored under the Peak Criteria menu.

Values must be provided for threshold and excursion. The sorting and display line parameters are optional (defaults are AMPLitude and ALL).

Note that there is always a Y-axis value for the display line, regardless of whether the display line state is on or off. It is the current Y-axis value of the display line which is used by this command to determine whether a peak should be reported

Sorting order:

AMPLitude - lists the peaks in order of descending amplitude, with the highest peak first (default if optional parameter not sent)

FREQuency - lists the peaks in order of occurrence, left to right across the x-axis.

TIME - lists the peaks in order of occurrence, left to right across the x-axis.

Peaks vs. Display Line:

ALL - lists all of the peaks found (default if optional parameter not sent).

GTDLine (greater than display line) - lists all of the peaks found above the display line.

LTDLine (less than display line) - lists all of the peaks found below the display line.

Initial S/W Revision Prior to A.02.00

Format Data: Numeric Data (Remote Command Only)

This command specifies the format of the trace data input and output. It specifies the formats used for trace data during data transfer across any remote port. It affects only the data format for setting and querying trace data for the :TRACe[:DATA], TRACe[:DATA]?, :CALCulate:DATA[n]? and FETCh:SANalyzer [n]? commands and queries.

Remote Command :FORMat [:TRACe] [:DATA] ASCii|INTeger, 32|REAL, 32 |REAL, 64
:FORMat [:TRACe] [:DATA] ?

Notes The query response is:
ASCii: ASC,8
REAL,32: REAL,32
REAL,64: REAL,64
INTeger,32: INT,32

When the numeric data format is REAL or ASCii, data is output in the current Y Axis unit. When the data format is INTeger, data is output in units of m dBm (.001 dBm).

The INT,32 format returns binary 32-bit integer values in internal units (m dBm), in a definite length block.

Dependencies Sending a data format spec with an invalid number (for example, INT,48) generates no error. The analyzer simply uses the default (8 for ASCii, 32 for INTeger, 32 for REAL).

Sending data to the analyzer which does not conform to the current FORMat specified, results in an error. Sending ASCII data when a definite block is expected generates message -161 "Invalid Block Data" and sending a definite block when ASCII data is expected generates message -121 "Invalid Character in Number".

Preset ASCii

Backwards Compatibility Notes Note that the INT,32 format is only applicable to the command, TRACe:DATA. This preserves backwards compatibility for the Swept SA measurement. For all other commands/queries which honor FORMat:DATA, if INT,32 is sent the analyzer will behave as though it were set to REAL,32.

Initial S/W Revision Prior to A.02.00

The specs for each output type follow:

ASCIi - Amplitude values are in ASCII, in the current Y Axis Unit, one ASCII character per digit, values separated by commas, each value in the form:

SX.YYYYYEsZZ

Where:

S = sign (+ or -)

X = one digit to left of decimal point

Y = 5 digits to right of decimal point

E = E, exponent header

s = sign of exponent (+ or -)

ZZ = two digit exponent

REAL,32 - Binary 32-bit real values in the current Y Axis Unit, in a definite length block.

REAL,64 - Binary 64-bit real values in the current Y Axis Unit, in a definite length block.

Format Data: Byte Order (Remote Command Only)

This command selects the binary data byte order for data transfer and other queries. It controls whether binary data is transferred in normal or swapped mode. This command affects only the byte order for setting and querying trace data for the :TRACe[:DATA], TRACe[:DATA]? , :CALCulate:DATA[n]? and FETCh:SANalyzer[n]? commands and queries.

By definition any command that says it uses FORMat:DATA uses any format supported by FORMat:DATA.

The NORMal order is a byte sequence that begins with the most significant byte (MSB) first, and ends with the least significant byte (LSB) last in the sequence: 1|2|3|4. SWAPPed order is when the byte sequence begins with the LSB first, and ends with the MSB last in the sequence: 4|3|2|1.

Remote Command	:FORMat:BORDER NORMal SWAPPed :FORMat:BORDER?
Preset	NORMal
Initial S/W Revision	Prior to A.02.00

Meas Setup

Accesses the functions that allow you to change the settings for your measurement requirements.

Key Path	Front-panel key
Initial S/W Revision	Prior to A.02.00

Counts

Sets the accumulated number of sampling points for data acquisition. The range is 1.000 kpt (k point) to 2.00000 Gpt (G point) with 1 kpt resolution. Counts couples to Meas Cycles. When the value for counts is changed, the Meas Cycles value will be $(\text{Counts} / \text{SamplingFrequency} * \text{MeasInterval})$.

Key Path	Meas Setup
Mode	SA, WCDMA, C2K, WIMAXOFDMA, TD-SCDMA, 1xEV-DO, DVB-T/H, DTMB (CTTB), ISDB-T, CMMB, LTE, LTE-TDD, Digital Cable TV, WLAN, MSR, LTE-TDD, LTEAFDD
Remote Command	<code>[[:SENSE]:PStatistic:COUNTs <integer></code> <code>[[:SENSE]:PStatistic:COUNTs?</code>
Example	PST:COUN 5001 PST:COUN?
Couplings	This value is coupled to Meas Cycles. When Counts is changed, the MeasCycles value will be $(\text{Counts} / \text{SamplingFrequency} * \text{MeasInterval})$. TD-SCDMA: When Counts is changed, the MeasCycles value will be $(\text{Counts} / (\text{Sampling Frequency} * \text{Time duration of measured time slots} / 5 \text{ msec}))$, Time duration of measured time slots is determined by Analysis Time Slot and Measure Interval.
Preset	10000000
State Saved	Saved in instrument state.
Min	1000
Max	2000000000
Default Unit	Kpt
Initial S/W Revision	Prior to A.02.00
Modified at S/W Revision	A.02.00, A.03.00

Meas Cycles

Set the number of measurement cycles to calculate power statistic data. This number couples to Counts. The Counts value is $(\text{MeasCycles} * \text{Sampling Frequency} * \text{MeasInterval})$.

When the counts value cannot be divided by $(\text{Sampling Frequency} * \text{MeasInterval})$, this value is displayed as a decimal fraction.

Key Path	Meas Setup
----------	------------

Mode	SA, WCDMA, C2K, WiMAX OFDMA, TD-SCDMA, 1xEV-DO, DVB-T/H, DTMB (CTTB), ISDB-T, CMMB, LTE, LTE-TDD, Digital Cable TV, WLAN, MSR, LTE-TDD, LTE-FDD
Remote Command	[:SENSe] :PStatistic:SWEep:CYCLes <integer> [:SENSe] :PStatistic:SWEep:CYCLes?
Example	PST:SWE:CYCL 1001 PST:SWE:CYCL?
Notes	.
Couplings	The Counts value will be (MeasCycles * Sampling Frequency * MeasInterval). TD-SCDMA: The Counts value will be (MeasCycles * Sampling Frequency * Time duration of measured time slots / 5 msec), Time duration of measured time slots is determined by Analysis Time Slot and Measure Interval.
Preset	Depends on the sampling frequency.
Min	1
Max	Depends on the sampling frequency.
Initial S/W Revision	Prior to A.02.00
Modified at S/W Revision	A.02.00, A.03.00

Meas Interval (Not 1xEVDO)

Sets the number of data points to be used as the measurement interval. This value couples to Counts. The Counts value is (MeasCycles * Sampling Frequency * MeasInterval).

Key Path	Meas Setup
Mode	SA, WCDMA, C2K, WiMAX OFDMA, TD-SCDMA, DVB-T/H, DTMB (CTTB), ISDB-T, CMMB, LTE, LTE-TDD, Digital Cable TV, WLAN, MSR, LTE-TDD, LTE-FDD
Remote Command	[:SENSe] :PStatistic:SWEep:TIME <time> [:SENSe] :PStatistic:SWEep:TIME?
Example	PST:SWE:TIME 2 ms PST:SWE:TIME?
Couplings	The Counts value will be (MeasCycles * Sampling Frequency * MeasInterval). WiMAX OFDMA: The default value depends on Radio Device status. TD-SCDMA: The Counts value will be (MeasCycles * Sampling Frequency * Time duration of measured time slots / 5 msec), Time duration of measured time slots is determined by Analysis Time Slot and Measure Interval. When TriggerSource is RFBurst, this button is grayed.
Preset	Others: 1.0 ms TD-SCDMA: 1 slot LTE-TDD, LTE-FDD: 500 us
Min	Others: 50.0 us TD-SCDMA: 1 slot

Max	Others: 10.0 ms TD-SCDMA: 9 slot
Initial S/W Revision	Prior to A.02.00
Modified at S/W Revision	A.02.00, A.03.00

Meas Offset

Sets the value of time to be used as the measurement interval start.

Key Path	Meas Setup
Mode	1xEVDO, LTETDD, LTEATDD
Remote Command	[[:SENSE]:PStatistic:MEAS:OFFSet <time> [:SENSE]:PStatistic:MEAS:OFFSet?
Example	PST:MEAS:OFFS 2 ms PST:MEAS:OFFS?
Preset	325.52 us for CDMA, 1xEVDO; 0.0s for LTETDD, LTEATDD
State Saved	Saved in instrument state.
Min	1.0 us for CDMA, 1xEVDO; 0.0s for LTETDD, LTEATDD
Max	10.0 ms
Initial S/W Revision	Prior to A.02.00

IF Gain

Sets the IF Gain function to Auto, Low Gain or High Gain. These settings affect sensitivity and IF overloads. This only applies to the RF input. It does not apply to baseband I/Q input.

Key Path	Meas Setup
Dependencies	The IF Gain keys (FFT IF Gain and Swept IF Gain) have no effect when the U7227A USB Preamplifier is connected. This is not annotated or reflected on any softkey; there are no keys grayed out nor any SCPI locked out. The analyzer simply behaves as though both FFT IF Gain and Swept IF Gain are set to Low regardless of the setting on the keys.
Initial S/W Revision	Prior to A.02.00

IF Gain Auto

Activates the Auto Rules for IF Gain When Auto is active, the IF Gain is set to High Gain under any of the following conditions:

- the input attenuator is set to 0 dB
- the preamp is turned On

- the Max Mixer Level is –20 dBm or lower

For other settings, Auto sets IF Gain to Off.

Key Path	Meas Setup, IF Gain
Mode	SA, WCDMA, C2K, WiMAX OFDMA, TD-SCDMA, 1xEV-DO, DVB-T/H, DTMB (CTTB), ISDB-T, CMMB, LTE, LTE-TDD, Digital Cable TV, WLAN, MSR, LTE-TDD, LTE-FDD
Remote Command	[[:SENSe]:PStatistic:IF:GAIN:AUTO[:STATe] ON OFF 1 0 [:SENSe]:PStatistic:IF:GAIN:AUTO[:STATe]?
Example	PST:IF:GAIN:AUTO ON PST:IF:GAIN:AUTO?
Notes	IF Gain only applies to the RF input. It does not apply to baseband I/Q input.
Couplings	When either the auto attenuation is active (for example, with electrical attenuator), or the optimize mechanical attenuator range is requested, the IF Gain setting is changed using the following rule. The Auto selection sets IF Gain On under any of the following conditions: <ul style="list-style-type: none"> • the input attenuator is set to 0 dB • the preamp is turned on, • the Max Mixer Level is –20 dBm or lower. For other settings, Auto sets IF Gain to Off.
Preset	OFF
State Saved	Saved in instrument state.
Range	Auto Man
Initial S/W Revision	Prior to A.02.00
Modified at S/W Revision	A.02.00, A.03.00

IF Gain State

Selects the range of IF gain. On sets the high gain option, which allows for better noise level measurements and Off sets low gain when measuring large signals.

Key Path	Meas Setup, IF Gain
Mode	SA, WCDMA, C2K, WIMAX OFDMA, TD-SCDMA, 1xEV-DO, DVB-T/H, DTMB (CTTB), ISDB-T, CMMB, LTE, LTE-TDD, Digital Cable TV, WLAN, MSR, LTE-TDD, LTE-FDD
Remote Command	[[:SENSe]:PStatistic:IF:GAIN[:STATe] ON OFF 1 0 [:SENSe]:PStatistic:IF:GAIN[:STATe]?
Example	PST:IF:GAIN ON PST:IF:GAIN?
Notes	IF Gain only applies to the RF input. It does not apply to baseband I/Q input. where ON = high gain OFF = low gain
Preset	OFF

State Saved	Saved in instrument state.
Range	Low Gain (Best for Large Signals) High Gain (Best Noise Level)
Readback Text	Low Gain High Gain
Initial S/W Revision	Prior to A.02.00
Modified at S/W Revision	A.02.00, A.03.00

Meas Preset

Restores all measurement settings to their default values.

Key Path	Meas Setup
Mode	SA, WCDMA, C2K, WIMAXOFDMA, TD-SCDMA, 1xEV-DO, DVB-T/H, DTMB (CTTB), ISDB-T, CMMB, LTE, LTE-TDD, Digital Cable TV, WLAN, MSR, LTE-TDD, LTE-FDD
Remote Command	:CONFigure:PSTatistic
Example	CONF:PST
Notes	You must be in the Spectrum Analysis mode, W-CDMA mode, cdma2000 mode, TD-SCDMA mode, DVB-T/H mode, DTMB (CTTB) mode, ISDB-T mode, CMMB mode, Digital Cable TV mode or WIMAXOFDMA mode to use this command. Use :INSTrument:SElect to set the mode.
Couplings	Selecting Meas Preset will restore all measurement parameters to their default values.
Initial S/W Revision	Prior to A.02.00
Modified at S/W Revision	A.02.00, A.03.00

Mode

See "Mode" on page 316

Mode Preset

Returns the active mode to a known state.

Mode Preset does the following for the currently active mode:

- Aborts the currently running measurement.
- Brings up the default menu for the mode, with no active function.
- Sets measurement Global settings to their preset values for the active mode only.
- Activates the default measurement.
- Brings up the default menu for the mode.
- Clears the input and output buffers.
- Sets Status Byte to 0.

Mode Preset does not:

- Cause a mode switch
- Affect mode persistent settings
- Affect system settings

See "[How-To Preset](#)" on page 1137 for more information.

Key Path	Front-panel key
Remote Command	:SYSTem:PRESet
Example	:SYST:PRES
Notes	*RST is preferred over :SYST:PRES for remote operation. *RST does a Mode Preset, as done by the :SYST:PRES command, and it sets the measurement mode to Single measurement rather than Continuous for optimal remote control throughput. Clears all pending OPC bits. The Status Byte is set to 0.
Couplings	A Mode Preset aborts the currently running measurement, activates the default measurement, and gets the mode to a consistent state with all of the default couplings set.
Backwards Compatibility Notes	In the X-Series, the legacy "Factory Preset" has been replaced with Mode Preset, which only presets the currently active mode, not the entire instrument. In the X-Series, the way to preset the entire instrument is by using System, Restore System Defaults All, which behaves essentially the same way as restore System Defaults does on ESA and PSA. There is also no "Preset Type" as there is on the PSA. There is a green Mode Preset front-panel key that does a Mode Preset and a white-with-green-letters User Preset front-panel key that does a User Preset. The old PRESet:TYPE command is ignored (without generating an error), and SYST:PRES without a parameter does a Mode Preset, which should cover most backward code compatibility issues. The settings and correction data under the Input/Output front-panel key (examples: Input Z Corr, Ext Amp Gain, etc.) are no longer part of any Mode, so they will not be preset by a Mode Preset. They are preset using Restore Input/Output Defaults, Restore System Defaults All. Note that because User Preset does a Recall State, and all of these settings are saved in State, they ARE recalled when using

	User Preset.
Initial S/W Revision	Prior to A.02.00

How-To Preset

The table below shows all possible presets, their corresponding SCPI commands and front-panel access (key paths). Instrument settings depend on the current measurement context. Some settings are local to the current measurement, some are global (common) across all the measurements in the current mode, and some are global to all the available modes. In a similar way, restoring the settings to their preset state can be done within the different contexts.

Auto Couple - is a measurement local key. It sets all Auto/Man parameter couplings in the measurement to Auto. Any Auto/Man selection that is local to other measurements in the mode will not be affected.

Meas Preset - is a measurement local key. Meas Preset resets all the variables local to the current measurement except the persistent ones.

Mode Preset - resets all the current mode's measurement local and measurement global variables except the persistent ones.

Restore Mode Defaults - resets ALL the Mode variables (and all the Meas global and Meas local variables), including the persistent ones.

Type Of Preset	SCPI Command	Front Panel Access
Auto Couple	:COUPlE ALL	Auto Couple front-panel key
Meas Preset	:CONFIgure:<Measurement>	Meas Setup Menu
Mode Preset	:SYSTem:PRESet	Mode Preset (green key)
Restore Mode Defaults	:INSTrument:DEFault	Mode Setup Menu
Restore All Mode Defaults	:SYSTem:DEFault MODEs	System Menu; Restore System Default Menu
*RST	*RST	not possible (Mode Preset with Single)
Restore Input/Output Defaults	:SYSTem:DEFault INPut	System Menu; Restore System Default Menu
Restore Power On Defaults	:SYSTem:DEFault PON	System Menu; Restore System Default Menu
Restore Alignment Defaults	:SYSTem:DEFault ALIGn	System Menu; Restore System Default Menu
Restore Miscellaneous Defaults	:SYSTem:DEFault MISC	System Menu; Restore System Default Menu
Restore All System Defaults	:SYSTem:DEFault [ALL] :SYSTem:PRESet:PERSistent	System Menu; Restore System Default Menu
User Preset	:SYSTem:PRESet:USER	User Preset Menu
User Preset All Modes	:SYSTem:PRESet:USER:ALL	User Preset Menu

Power On Mode Preset	:SYSTem:PON:TYPE MODE	System Menu
Power On User Preset	:SYSTem:PON:TYPE USER	System Menu
Power On Last State	:SYSTem:PON:TYPE LAST	System Menu

Preset Type (Remote Command Only)

As stated in the Backward Compatibility section, to be compatible with ESA/PSA the PRESet:TYPE command will be implemented as a no-op.

Mode	All
Remote Command	:SYSTem:PRESet:TYPE FACTory MODE USER :SYSTem:PRESet:TYPE?
Example	:SYST:PRESet:TYPE FACT
Notes	This command is supported for backward compatibility only. It is a no-op which does not change the behavior of any preset operation.
Preset	This is unaffected by Preset but is set to Mode on a "Restore System Defaults->All"
State Saved	No
Initial S/W Revision	Prior to A.02.00

Mode Setup

See "Mode Setup" on page 347

Peak Search

There is no 'Peak Search' functionality supported in Power Stat CCDF measurement. The front-panel key displays a blank menu when pressed.

Key Path	Front-panel key
Initial S/W Revision	Prior to A.02.00

Print

See "Print" on page 365

Quick Save

The Quick Save front-panel key repeats the most recent save that was performed from the Save menu, with the following exceptions:

- Register saves are not remembered as Saves for the purpose of the Quick Save function
- If the current measurement does not support the last non-register save that was performed, an informational message is generated, “File type not supported for this measurement”

Quick Save repeats the last type of qualified save (that is, a save qualified by the above criteria) in the last save directory by creating a unique filename using the Auto File Naming algorithm described below.

If Quick Save is pressed after startup and before any qualified Save has been performed, the Quick Save function performs a Screen Image save using the current settings for Screen Image saves (current theme, current directory), which then becomes the “last save” for the purpose of subsequent Quick Saves.

The Auto File Naming feature automatically generates a file name for use when saving a file. The filename consists of a prefix and suffix separated by a dot, as is standard for the Windows® file system. A default prefix exists for each of the available file types:

Type	Default Prefix	Menu
State	State_	(Save/Recall)
Trace + State	State_	(Save/Recall)
Screen	Screen_	(Save/Recall)
Amplitude Corrections	Ampcor_	(Import/Export)
Traces	Trace_	(Import/Export)
Limit Lines	LLine_	(Import/Export)
Measurement Result	MeasR_	(Import/Export)
Capture Buffer	CapBuf_	(Import/Export)

A four digit number is appended to the prefix to create a unique file name. The numbering sequence starts at 0000 within each Mode for each file type and updates incrementally to 9999, then wraps to 0000 again. It remembers where it was through a Mode Preset and when leaving and returning to the Mode. It is reset by Restore Misc Defaults and Restore System Defaults and subsequent running of the instrument application. So, for example, the first auto file name generated for State files is State_0000.state. The next is State_0001, and so forth.

One of the key features of Auto File Name is that we guarantee that the Auto File Name will never conflict with an existing file. The algorithm looks for the next available number. If it gets to 9999, then it looks for holes. If it find no holes, that is no more numbers are available, it gives an error.

For example, if when we get to State_0010.state there is already a State_0010.state file in the current directory, it advances the counter to State_0011.state to ensure that no conflict will exist (and then it verifies that State_0011.state also does not exist in the current directory and advances again if it does, and so forth).

If you enter a file name for a given file type, then the prefix becomes the filename you entered instead of the default prefix, followed by an underscore. The last four letters (the suffix) are the 4-digit number.

For example, if you save a measurement results file as “fred.csv”, then the next auto file name chosen for a measurement results save will be fred_0000.csv.

NOTE Although 0000 is used in the example above, the number that is used is actually the current number in the Meas Results sequence, that is, the number that would have been used if you had not entered your own file name.

NOTE If the filename you entered ends with _dddd, where d=any number, making it look just like an auto file name, then the next auto file name picks up where you left off with the suffix being dddd + 1.

Key Path	Front-panel key
Notes	No remote command for this key specifically.
Initial S/W Revision	Prior to A.02.00

Recall

In the LTE TDD mode, four types of recall functions are available under the Data menu: “Limit Mask”, “E-UTRA Test Model”, “Signal Studio Setup” and “Vector Signal Analyzer”. “Limit Mask” enables setting of a preset limit mask for Power Suite-based measurements, and currently it is available for the SEM/ACP measurements with the LTE TDD mode. Recalling “E-UTRA Test Model” sets complicated RB settings for each Test Model for the Modulation Analysis and Conformance EVM measurements. Recalling “Signal Studio Setup” or “89600 Vector Signal Analyzer” enables you to recall parameters which have been set and saved on the external platform.

Key Path	Front Panel
Mode	LTETDD
Initial S/W Revision	Prior to A.02.00
Modified at S/W Revision	A.06.00

State

The Recall State menu lets you choose a register or file from which to recall the state.

The content of a state file includes all of the settings and data required to return the analyzer as closely as possible to the Mode it was in, with the exact settings that were in place, when the save occurred. The Mode settings in each state file include the settings that are affected by Mode Preset, as well as the additional settings affected by Restore Mode Defaults; all of the Mode’s settings. In addition, all of the settings of the Input/Output system are included, even though they are outside of the Mode’s state, because they are needed to restore the complete setup. Persistent System settings (for example, GPIB address) are not affected by either a Mode Preset or Restore Mode Defaults, nor are they included in a saved State file.

Since each state file is only for one Mode, the settings for other Modes are unaffected when it is loaded. Recall State will cause a mode switch if the state being recalled is not from the current active mode.

After the recall completes, the message "File <filename> recalled" or “Recalled State Register <register number>” is displayed.

For rapid recalls, the State menu lists 16 registers that you can choose from to recall. Pressing a Register key initiates the recall. You can also select a file from which to recall.

The default path for all State Files is:

My Documents\<<mode name>\state

where <mode name> is the parameter used to select the mode with the INST:SEL command (for example, SA for the Spectrum Analyzer).

See "[More Information](#)" on page 1145.

Key Path	Recall
Mode	All

Remote Command	:MMEMory:LOAD:STATe <filename>
Example	:MMEM:LOAD:STAT "myState.state" This recalls the file myState.state on the default path
Example	MMEM:LOAD:STAT "MyStateFile.state" This loads the state file data (on the default file directory path) into the instrument state.
Notes	<p>When you pick a file to recall, the analyzer first verifies that the file is recallable in the current instrument by checking the software version and model number of the instrument. If everything matches, a full recall proceeds by aborting the currently running measurement, clearing any pending operations, and then loading the State from the saved state file. You can open state files from any mode, so recalling a State file switches to the mode that was active when the save occurred. After switching to the mode of the saved state file, mode settings and data (if any for the mode) are loaded with values from the saved file. The saved measurement of the mode becomes the newly active measurement and the data relevant to the measurement (if there is any) is recalled.</p> <p>If there is a mismatch between file version or model number or instrument version or model number, the recall function tries to recall as much as possible and returns a warning message. It may limit settings that differ based on model number, licensing or version number.</p> <p>After recalling the state, the Recall State function does the following:</p> <ul style="list-style-type: none"> • Makes the saved measurement for the mode the active measurement. • Clears the input and output buffers. • Status Byte is set to 0. • Executes a *CLS <p>If the file specified is empty an error is generated. If the specified file does not exist, another error is generated. If there is a mismatch between the file and the proper file type, an error is generated. If there is a mismatch between file version or model number or instrument version or model number, a warning is displayed. Then it returns to the State menu and File Open dialog goes away.</p> <p>After the Recall, the analyzer exits the Recall menu and returns to the previous menu.</p>
Backwards Compatibility SCPI	:MMEMory:LOAD:STATe 1,<filename> For backwards compatibility, the above syntax is supported. The "1" is simply ignored.
Initial S/W Revision	Prior to A.02.00

More Information

In measurements that support saving Traces, for example, Swept SA, the Trace data is saved along with the State in the State file. When recalling the State, the Trace data is recalled as well. Traces are recalled exactly as they were stored, including the writing mode and update and display modes. If a Trace was updating and visible when the State was saved, it will come back updating and visible, and its data will be rewritten right away. When you use State to save and recall traces, any trace whose data must be preserved should be placed in View or Blank mode before saving.

The following table describes the Trace Save and Recall possibilities:

You want to recall state and one trace's data, leaving other traces unaffected.	Save Trace+State from 1 trace. Make sure that no other traces are updating (they should all be in View	On Recall, specify the trace you want to load the one trace's data into. This trace will load in View.
---	---	--

	or Blank mode) when the save is performed.	All other traces' data will be unaffected, although their trace mode will be as it was when the state save was performed.
You want to recall all traces	Save Trace+State from ALL traces.	On Recall, all traces will come back in View (or Blank if they were in Blank or Background when saved)
You want all traces to load exactly as they were when saved.	Save State	On recall, all traces' mode and data will be exactly as they were when saved. Any traces that were updating will have their data immediately overwritten.

From File...

When you press “From File”, the analyzer brings up a Windows dialog and a menu entitled “File Open.” This menu allows you to navigate to the various fields in the Windows dialog without using a keyboard or mouse. The Tab and Arrow keys can also be used for dialog navigation.

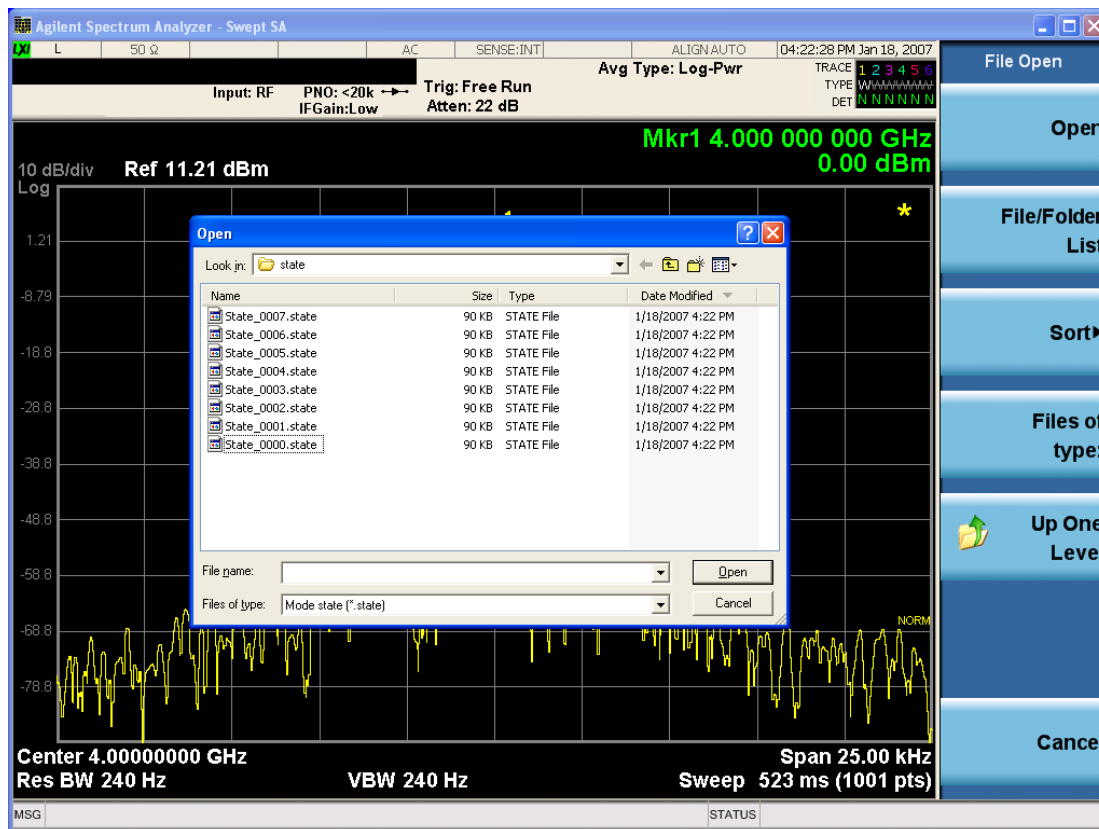

Listed below are the functions of the various fields in the dialog, and the corresponding softkeys:

Open

Performs the recall of the specified file. While the recall is being performed, the floppy icon appears briefly in the Meas bar.

File/Folder List

Enables you to navigate to the center of the dialog that contains the list of files and folders. Once here you can get information about the file and use the tab keys to navigate to the other fields in the dialog, such as Look In.

Look In

The Look In field shows the path from which the file will be recalled and allows you to change the path using the up and down arrow keys to navigate to other paths; the Enter key to open a directory; and the Backspace key to go back one directory. The **Look In field** first uses the last path from the Save As dialog **Save In:** path for that same file type. There is no softkey for directly navigating to the Look In field, but you can use the left tab to get here from the File/Folder List.

User specified paths are remembered when you leave and return to a Mode and are reset back to the default using Restore Mode Defaults.

Sort

Accesses a menu that enables you to sort the files within the File Open dialog. Only one sorting type can be selected at a time and the sorting happens immediately. The sorting types are By Date, By Name, By extension, and By Size.

Files of Type

This field shows the file suffix for the type of file you have selected to recall. For example, if you navigated here while recalling State, "Mode state (*.state)" is in the field. If you navigated here while recalling Trace, ""Mode state (*.trace)" is in the field. If you navigated here while importing a trace data file, "Trace Data (*.csv)" is in the field. For some file types, there is more than one choice in the dropdown menu, which you can select by using the up and down arrow keys and Enter.

Up One Level

This key corresponds to the icon of a folder with the up arrow that is in the tool bar of the dialog. When pressed, it causes the file and folder list to navigate up one level in the directory structure. The Backspace key does the same thing.

Cancel

This key corresponds to the Cancel selection in the dialog. It causes the current **Open** request to be cancelled. The ESC key does the same thing.

Key Path	Recall, State
Notes	Brings up the Open dialog for recalling a State Save Type
Initial S/W Revision	Prior to A.02.00

Edit Register Names

You may enter a custom name on any of the Register keys, to help you remember what you are using that state to save. To do this, press the Edit Register Names key, choose the register whose name you wish to edit, and then enter the desired label using the Alpha Editor or an external PC keyboard.

The maximum number of characters that can be added is 30. In most cases, 30 characters will fit on two lines of the key.

For more information and the SCPI command, see Edit Register Names under the Save, State function.

Key Path	Recall, State
Mode	All
Dependencies	N9060A-7FP or N9060B-2FP license required to edit the register names. When the feature is not licensed, sending the SCPI command generates an error, -221, "Settings conflict;Option not available"
Initial S/W Revision	A.11.00

Register 1 thru Register 16

Selecting any one of these register keys causes the State of the mode from the specified Register to be recalled. Each of the register keys annotates whether it is empty or at what date and time it was last modified. In addition, you can use the Edit Register Names key under Save, State to enter custom names for each register.

Registers are shared by all modes, so recalling from any one of the registers will cause a mode switch to the mode that was active when the save to the Register occurred.

Although these 16 registers are the only registers available from the front panel, there are 128 state registers available in the instrument. Registers 17-128 are only available from the SCPI interface, using the *RCL command.

After the recall completes, the message "Register <register number> recalled" appears in the message bar. If you are in the Spectrum Analyzer Mode, and you are recalling a register that was saved in the Spectrum Analyzer Mode, then after the recall, you will still be in the Recall Register menu. If the Recall causes you to switch modes, then after the Recall, you will be in the Frequency menu.

If a requested register is empty an error is generated.

Key Path	Recall, State
Example	*RCL 1
Range	1-16 from front panel, 1-128 from SCPI
Readback	Date and time with seconds resolution are displayed on the key OR A custom name of up to 30 characters entered using the Save, State,Edit Register Names key OR “(empty)” if no prior save operation has been performed to this register.
Initial S/W Revision	Prior to A.02.00
Modified at S/W Revision	Prior to A.11.00

Register 1 thru Register 16

Selecting any one of these register keys causes the State of the mode from the specified Register to be recalled. Each of the register keys annotates whether it is empty or at what date and time it was last modified. In addition, you can use the Edit Register Names key under Save, State to enter custom names for each register.

Registers are shared by all modes, so recalling from any one of the registers will cause a mode switch to the mode that was active when the save to the Register occurred.

Although these 16 registers are the only registers available from the front panel, there are 128 state registers available in the instrument. Registers 17–128 are only available from the SCPI interface, using the *RCL command.

After the recall completes, the message "Register <register number> recalled" appears in the message bar. If you are in the Spectrum Analyzer Mode, and you are recalling a register that was saved in the Spectrum Analyzer Mode, then after the recall, you will still be in the Recall Register menu. If the Recall causes you to switch modes, then after the Recall, you will be in the Frequency menu.

If a requested register is empty an error is generated.

Key Path	Recall, State
Example	*RCL 1
Range	1–16 from front panel, 1–128 from SCPI
Readback	Date and time with seconds resolution are displayed on the key OR A custom name of up to 30 characters entered using the Save, State, Edit Register Names key OR “(empty)” if no prior save operation has been performed to this register.
Initial S/W Revision	Prior to A.02.00
Modified at S/W Revision	Prior to A.11.00

Recall

In the LTE TDD mode, four types of recall functions are available under the Data menu: “Limit Mask”, “E-UTRA Test Model”, “Signal Studio Setup” and “Vector Signal Analyzer”. “Limit Mask” enables setting of a preset limit mask for Power Suite-based measurements, and currently it is available for the SEM/ACP measurements with the LTE TDD mode. Recalling “E-UTRA Test Model” sets complicated RB settings for each Test Model for the Modulation Analysis and Conformance EVM measurements. Recalling “Signal Studio Setup” or “89600 Vector Signal Analyzer” enables you to recall parameters which have been set and saved on the external platform.

Key Path	Front Panel
Mode	LTETDD
Initial S/W Revision	Prior to A.02.00
Modified at S/W Revision	A.06.00

Import Trace Data

Enables you to import previously saved trace data into a Data Register and optionally display it. Selecting this key displays a menu that enables you to select the destination data register, and also enables you to choose whether or not to display the recalled data in the currently selected trace. After making these selections, select Open... and use the file dialog to select the file you want to recall.

Recalling trace data into an already used Data Register overwrites the previous data. If the data register is displayed on any trace, the display is updated to reflect the new data.

The SCPI command

```
:MMEM:LOAD:TRAC:DATA D1|D2|D3|D4|D5|D6,<filename>
```

recalls data into a specified register, but does not display it in the selected trace. Use the command

```
:DISP:<meas>:TRAC<n>:FEED D1|D2|D3|D4|D5|D6
```

to display the register in the desired trace.

It is possible to recall trace data saved by other VXA measurements, or measurements made using the LTE, LTETDD, IDEN, or 89601 applications.

Key Path	Recall, Data (Import)
Mode	VSA, LTE, LTETDD, IDEN
Remote Command	:MMEMory:LOAD:TRACe:DATA D1 D2 D3 D4 D5 D6,<filename>[,CSV TXT SDF MAT4 MAT HDF5 BIN]
Example	:MMEM:LOAD:TRAC:DATA D1,"Trc1.txt",TXT
Notes	<p>The Open: dialog box has the following filter options when you are recalling trace data::</p> <ul style="list-style-type: none"> • CSV (Comma delimited) (*.csv) • SDF (Fast) (*.sdf;*.dat) • Text (Tab delimited) (*.txt) <p>The file must have the same format as that created by the Export Recorded Data command.</p> <p>The SCPI command has an optional file format parameter. If you do not include this parameter in the SCPI command, the file format is determined by the file name extension. If no file extension is recognized, the file is scanned to determine the format.</p> <p>If you are not licensed to recall a particular file type, then error -203.9010 is returned. If the file format cannot be determined or the file cannot be recalled successfully, then error -250.5290 is returned. If the recall is successful, then advisory 0.1600 is shown.</p>
State Saved	No
Readback	Data 1 Data 2 Data 3 Data 4 Data 5 Data 6

Data 1

Selects the Data 1 register as the destination for the imported data.

Key Path	Recall, Data (Import), Trace (to)
Mode	VSA, LTE, LTETDD, IDEN

Data 2

Selects the Data 2 register as the destination for the imported data.

Key Path	Recall, Data (Import), Trace (to)
Mode	VSA, LTE, LTETDD, IDEN

Data 3

Selects the Data 3 register as the destination for the imported data.

Key Path	Recall, Data (Import), Trace (to)
Mode	VSA, LTE, LTETDD, IDEN

Data 4

Selects the Data 4 register as the destination for the imported data.

Key Path	Recall, Data (Import), Trace (to)
Mode	VSA, LTE, LTETDD, IDEN

Data 5

Selects the Data 5 register as the destination for the imported data..

Key Path	Recall, Data (Import), Trace (to)
Mode	VSA, LTE, LTETDD, IDEN

Data 6

Selects the Data 6 register as the destination for the imported data.

Key Path	Recall, Data (Import), Trace (to)
Mode	VSA, LTE, LTETDD, IDEN

Display in Selected Trace

Enables you to select whether the recalled trace data is displayed in the current Trace.

Key Path	Recall, Data (Import), Trace (to)
----------	-----------------------------------

Mode	VSA, LTE, LTETDD, IDEN
State Saved	No

Signal Studio Setup

This key allows you to recall the Agilent Signal Studio setup file created on the Signal Studio (N7625B). This key is valid only for the Mod Analysis measurement. For E-TM test model signal, please use corresponding EVM setup file under My Documents\LTETDD\data\evmsetup.

For the supported carrier types, see the table below.

Signal Studio	Carrier Type
N7625B Signal Studio for 3GPP LTE TDD	Advanced LTE TDD(2009-03)
	Advanced LTE TDD(2009-12)
	Basic LTE TDD(2009-03)
	Basic LTE TDD(2009-12)

File Location and Extension

File location: "My Documents\LTETDD\data"

File type: xml

File extension: .scp

You need to place the Signal Studio Setup file created on N7625B in the above directory in advance. Pressing OPEN under the Import Data menu will open this directory from which you can select the setup file.

Example:

File Location: My Documents\LTETDD\data

File Name: Uplink PUSCH.scp

Key Path	Recall, Data
Mode	LTETDD
Remote Command	MMEemory:LOAD:SSSetup <string>
Example	MME:LOAD:SSS "Uplink PUSCH.scp"
Notes	Sets of parameters related to Signal Studio Setup are overwritten by the contents of the setup file.
Initial S/W Revision	A.06.00

89601 VSA Setup

Enables you to import the 89600 Vector Signal Analyzer Setup file created using the 89600 Vector Signal Analyzer Option BHE (LTE TDD). This key is valid only for the Mod Analysis measurement.

File Location and Extension

File location: “My Documents\LTETDD\data”

File type: text file

File extension: .set, .setx

Place the 89600 Vector Signal Analyzer Setup file that you saved on 89600 in the above directory. When you select OPEN under the Import Data menu, the directory opens enabling you to select your setup file.

Example:

File Location: My Documents\LTETDD\data

File Name: Uplink PRACH.set

Key Path	Recall, Data
Mode	LTETDD
Remote Command	MMEMory:LOAD:VSASetup <string>
Example	MMEM:LOAD:VSAS "Uplink PRACH.set"
Notes	Sets of parameters related to Vector Signal Analyzer Setup are overwritten by the contents of the setup file.
Initial S/W Revision	A.06.00
Modified at S/W Revision	A.10.00

Masks

This key allows you to recall a preset mask file from the list. The preset mask file contains configuration for only Carrier, Offset, Limit settings and the preset profile BW. Any set of values not specified by the preset mask file will not be overwritten.

You cannot change or create the preset mask file since it is a binary file. This key is valid for the Spectrum Emission Mask and ACP measurements.

File location: “My Documents\LTETDD\data\masks”

Note that “My Documents” is an alias to a directory and its place differs depending on which user is logged in. At XSA start up, XSA will overwrite all of the limit mask files to the current user’s “My Documents\LTETDD\data\masks” each time.

File type: Binary

Filename: The filename follows the rule below, in which the word is connected with underscores.

<Measurement>_<Direction>_<Bandwidth>_<Condition>.mask

Where

<Measurement> Measurement the limit mask file is applied to: SEM or ACP

<Direction> Direction: BS (Downlink) or MS (Uplink).

<Bandwidth> Bandwidth

<Condition> Condition. It depends on the measurement.

File extension: .mask

Pressing OPEN under the Import Data menu will open the above directory from which you can select a mask file. When you change the Bandwidth or Direction, all Power Suite measurement parameters are reset to the hard coded preset parameters. Thus you must recall the appropriate preset mask file again after the change.

You cannot read the contents of the provided preset mask file since it is a binary file. Detailed contents of the file are provided by a PDF format file located in the same directory as the preset mask file.

Example:

File Location: My Documents/LTETDD/data/masks/SEM_MS

File Name: SEM_MS_15MHz_Add_NS04.mask

The following table shows the sets of variables imported to the ACP measurement.

Offset	Start Freq (MHz)	Stop Freq (MHz)	Res BW (Hz)	Meas BW	Rel Start	Rel Stop	Fail Mask
A	5	7.14	30k	1	-8	-25	Rel
B	7.14	10.57	30k	1	-25	-27	Rel
C	10.57	20	30k	1	-27	-50	Rel
D	20	25	30k	1	-50	-50	Rel
E	25	30	30k	1	-50	-50	Rel

Key Path	Recall, Data
Mode	LTETDD
Remote Command	MMEemory:LOAD:MASK <string>
Example	MMEM:LOAD:MASK "ACP_BS\ACP_BS_3MHz_pairE-UTRA_CatA.mask"
Notes	Sets of parameters related to Limit, Carrier and Offset are overwritten by the contents of the preset mask file.
Initial S/W Revision	A.03.00

EVM Setup

This key allows you to recall EVM parameter setting to measure E-UTRA Test Model in 3GPP standard (36.141-810 6.1.1).

- E-UTRA Test Model 1.1 (E-TM1.1)
- E-UTRA Test Model 1.2 (E-TM1.2)
- E-UTRA Test Model 2 (E-TM2)
- E-UTRA Test Model 3.1 (E-TM3.1)

- E-UTRA Test Model 3.2 (E-TM3.2)
- E-UTRA Test Model 3.3 (E-TM3.3)

This key is valid for the Modulation Analysis and Conformance EVM measurements only.

File Location and Extension

File location: My Documents\LTETDD\data\evmsetup

Note that “My Documents” is an alias to a directory and its place differs depending on which user is logged in. At XSA start up, XSA will overwrite all of the EVM Setup files to the current user’s “My Documents\LTETDD\data\evmsetup” each time.

File type: binary

File extension: .evms

Pressing OPEN under the Import Data menu will open the above directory from which you can select an EVM Setup file. When you change the Bandwidth, parameters are reset to the hard coded preset parameters. Thus you must recall the appropriate EVM Setup file again after the change.

You cannot read the contents of the provided EVM Setup file since it is a binary file.

Example:

File Location: My Documents\LTETDD\data\evmsetup

Filename: TM3.1-BW1.4MHz.evms

Key Path	Recall, Data
Mode	LTETDD
Remote Command	MMEemory:LOAD:EVMSSetup <string>
Example	MMEM:LOAD:EVMS "TM2-BW15MHz.evms"
Notes	Sets of parameters related to EVM Setup are overwritten by the contents of the EVM Setup file.
Initial S/W Revision	A.03.00, A.08.00

Open...

When you press “Open”, the analyzer brings up a Windows dialog and a menu entitled “File Open.” This menu allows you to navigate to the various fields in the Windows dialog without using a keyboard or mouse. The Tab and Arrow keys can also be used for dialog navigation.

See "[From File...](#)" on page 2797 in Recall, State, for a full description of this dialog and menu.

Key Path	Recall, Data
Notes	The key location is mode-dependent and will vary. Brings up Open dialog for recalling a <mode specific> Save Type
Initial S/W Revision	Prior to A.02.00

Restart

The Restart function restarts the current sweep, or measurement, or set of averaged/held sweeps or measurements. If you are Paused, pressing Restart does a Resume.

The Restart function is accessed in several ways:

- Pressing the Restart key
- Sending the remote command INIT:IMMEDIATE
- Sending the remote command INIT:RESTART

See "[More Information](#)" on page 1156

Key Path	Front-panel key
Remote Command	:INITiate[:IMMEDIATE] :INITiate:RESTART
Example	:INIT:IMM :INIT:REST
Notes	:INITiate:RESTART and :INITiate:IMMEDIATE perform exactly the same function.
Couplings	Resets average/hold count k. For the first sweep overwrites all active (update=on) traces with new current data. For application modes, it resets other parameters as required by the measurement.
Status Bits/OPC dependencies	This is an Overlapped command. The STATUS:OPERation register bits 0 through 8 are cleared. The STATUS:QUESTionable register bit 9 (INTEGRITY sum) is cleared. The SWEEPING bit is set. The MEASURING bit is set.
Backwards Compatibility Notes	For Spectrum Analysis mode in ESA and PSA, the Restart hardkey and the INITiate:RESTART command restart trace averages (displayed average count reset to 1) for a trace in Clear Write, but did not restart Max Hold and Min Hold. In the X-Series, the Restart hardkey and the INITiate:RESTART command restart not only Trace Average, but MaxHold and MinHold traces as well. For wireless comms modes in ESA and PSA, the Restart hardkey and the INITiate:RESTART command restart every measurement, which includes all traces and numeric results. There is no change to this operation.
Initial S/W Revision	Prior to A.02.00

More Information

The **Restart** function first aborts the current sweep/measurement as quickly as possible. It then resets the sweep and trigger systems, sets up the measurement and initiates a new data measurement sequence with a new data acquisition (sweep) taken once the trigger condition is met.

If the analyzer is in the process of aligning when **Restart** is executed, the alignment finishes before the restart function is performed.

Even when set for Single operation, multiple sweeps may be taken when Restart is pressed (for example, when averaging/holding is on). Thus when we say that **Restart** "restarts a measurement," we may mean:

- It restarts the current sweep
- It restarts the current measurement
- It restarts the current set of sweeps if any trace is in Trace Average, Max Hold or Min Hold
- It restarts the current set of measurements if Averaging, or Max Hold, or Min Hold is on for the measurement
- depending on the current settings.

With **Average/Hold Number** (in **Meas Setup** menu) set to 1, or Averaging off, or no trace in Trace Average or Hold, a single sweep is equivalent to a single measurement. A single sweep is taken after the trigger condition is met; and the analyzer stops sweeping once that sweep has completed. However, with **Average/Hold Number** >1 and at least one trace set to **Trace Average, Max Hold, or Min Hold (SA Measurement)** or **Averaging on (most other measurements)**, multiple sweeps/data acquisitions are taken for a single measurement. The trigger condition must be met prior to each sweep. The sweep is stopped when the average count k equals the number N set for **Average/Hold Number**. A measurement average usually applies to all traces, marker results, and numeric results; but sometimes it only applies to the numeric results.

Once the full set of sweeps has been taken, the analyzer will go to idle state. To take one more sweep without resetting the average count, increment the average count by 1, by pressing the step up key while **Average/Hold Number** is the active function, or sending the remote command `CALC:AVER:TCON UP`.

Save

The Save menu lets you choose what you want to save and where you want to save it. Among the types of files you can save are **States**, **Traces**, and **Screen Images**. In addition, an Export (Data) option lets you save a number of data types as CSV files for easy import into Excel and other spreadsheet programs.

Key Path	Front-panel key
Mode	All
Notes	No remote command for this key specifically, but the :MMEM:STORe command is available for specific file types. An example is :MMEM:STOR:STATe <filename>.
Initial S/W Revision	Prior to A.02.00

State

The Save State menu lets you choose a register or file for saving the state.

The content of a state file includes all of the settings and data required to return the analyzer as closely as possible to the Mode it was in, with the exact settings which were in place, when the save occurred. The Mode settings in each state file include the settings that are affected by Mode Preset, as well as the additional settings affected by Restore Mode Defaults; all of the Mode's settings. In addition, all of the settings of the Input/Output system are included, even though they are outside of the Mode's state, because they are needed to restore the complete setup. Persistent System settings (for example, Verbose SCPI) are not affected by either Mode Preset or Restore Mode Defaults, nor are they included in a saved State file.

After the save completes, the message "File <filename> saved" or "State Register <register number> saved" is displayed.

For rapid saving, the State menu lists 16 registers to save to. Pressing a Register key initiates the save. You can also select a file to save to.

The default path for all State Files is:

My Documents\<<mode name>\state

where <mode name> is the parameter used to select the mode with the INST:SEL command (for example, SA for the Spectrum Analyzer).

Key Path	Save
Mode	All
Remote Command	:MMEMory:STORe:STATe <filename>
Example	MMEM:STOR:STATe "MyStateFile.state" This stores the current instrument state data in the file MyStateFile.state in the default directory.
Notes	Both single and double quotes are supported for any filename parameter over remote. After saving to a register, that register's menu key is updated with the date the time, unless a custom label has been entered for that key. After saving to a register, you remain in the Save State menu, so that you can see the Register key

update. After saving to a file, the analyzer automatically returns to the previous menu and any Save As dialog goes away.

Backwards Compatibility SCPI	:MMEMory:STORe:STATe 1,<filename>
Initial S/W Revision	Prior to A.02.00

To File . . .

When you press “To File”, the analyzer brings up a Windows dialog and a menu entitled “**Save As.**” This menu allows you to navigate to the various fields in the Windows dialog without using a keyboard or mouse. The Tab and Arrow keys can also be used for dialog navigation.

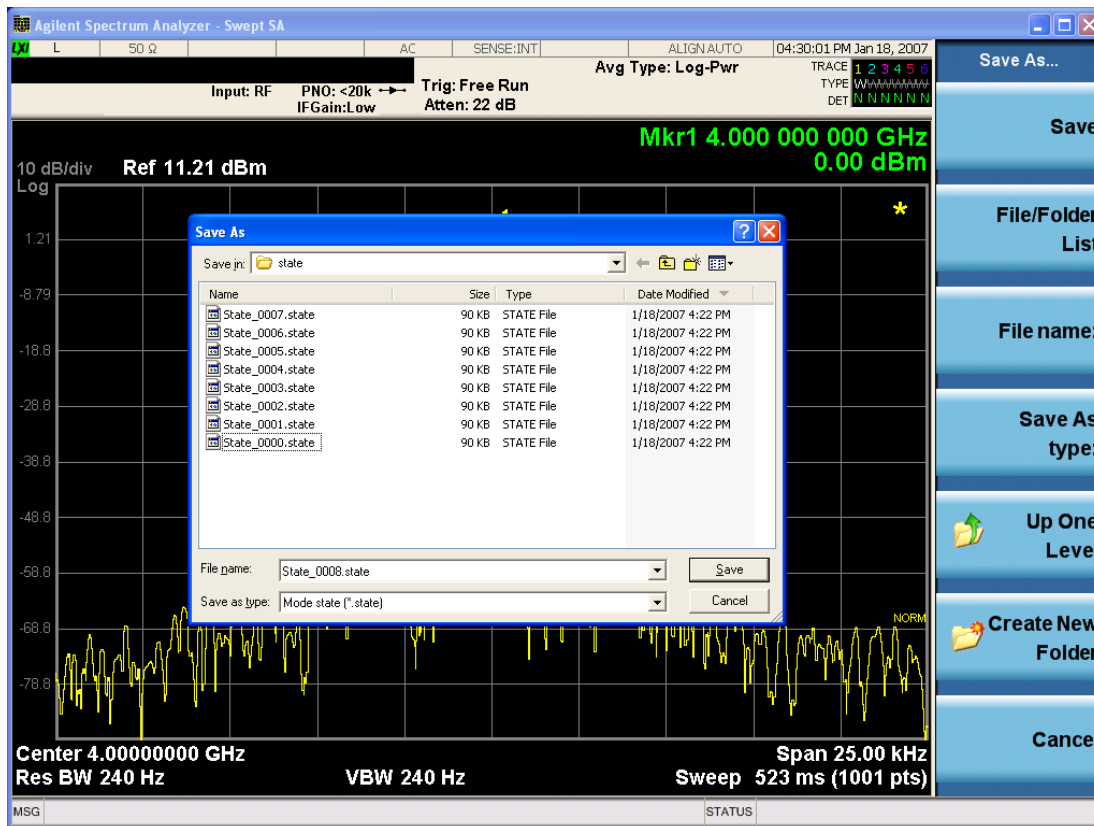

The Listed below

are the functions of the various fields in the dialog, and the corresponding softkeys:

Save

Performs the save to the specified file of the selected type. If the file already exists, a dialog will appear that allows you to replace the existing file by selecting OK, or you can Cancel the request. If you select OK, the file will be overwritten. Using the C: drive is strongly discouraged, since it runs the risk of being overwritten during an instrument software upgrade.

While the save is being performed, the floppy icon appears briefly in the Meas bar.

File/Folder List

Enables you to navigate to the center of the dialog that contains the list of files and folders. Once here you can get information about the file and use the tab keys to navigate to the other fields in the dialog, such as Save In.

Save In

The Save In field shows the path to which the file will be saved and allows you to change the path using the up and down arrow keys to navigate to other paths; the Enter key to open a directory; and the Backspace key to go back one directory. The **Save In field** defaults to the default path for this type of file and remembers the last path you used to save this type of file. There is no softkey for directly navigating to the Save In field but you can use left tab to get here from the File/Folder List.

User specified paths are remembered when you leave and return to a Mode and are reset back to the default using Restore Mode Defaults.

File Name

The File Name field is initially loaded with an automatically generated filename specific to the appropriate Save Type. The automatically generated filename is guaranteed not to conflict with any filename currently in the directory. You may replace or modify this filename using the File Name key. See the ["Quick Save " on page 2793](#) documentation for more on the automatic file naming algorithm.

When you press the File Name key the analyzer displays the Alpha Editor. Use the knob to choose the letter to add and the front-panel Enter key to add the letter to the file name. The BK character moves you back and the FW character moves you forward in the filename. The Select key on the front panel generates a space character. When you are done entering the filename press the Done softkey. This returns back to the **File Open** dialog and menu, but does not cause the save to occur.

Save As Type

This field shows the file suffix for the type of file you have selected to save. For example, if you navigated here while saving State, "Mode state (*.state)" is in the field. If you navigated here from saving Trace, ""Mode state (*.trace)" is in the field. If you navigated here while exporting a trace data file, "Trace Data (*.csv)" is in the field. For some file types, there is more than one choice in the dropdown, which you can select by using the up and down arrow keys and Enter.

Up One Level

This key corresponds to the icon of a folder with the up arrow that is in the tool bar of the dialog. When pressed, it causes the file and folder list to navigate up one level in the directory structure. The Backspace key does the same thing.

Create New Folder

This key corresponds to the icon of a folder with the "*" that is in the tool bar of the dialog. When pressed, a new folder is created in the current directory with the name **New Folder** and you can enter a new folder name using the Alpha Editor.

Cancel

This key corresponds to the Cancel selection in the dialog. It causes the current **Save As** request to be cancelled. The ESC key does the same thing.

Key Path	Save, State
Mode	All
Notes	Brings up Save As dialog for saving a State Save Type
Initial S/W Revision	Prior to A.02.00

Edit Register Names

You may enter a custom name on any of the Register keys, to help you remember what you are using that state to save. To do this, press the Edit Register Names key, choose the register whose name you wish to edit, and then enter the desired label using the Alpha Editor or an external PC keyboard.

The maximum number of characters that can be added is 30. In most cases, 30 characters will fit on two lines of the key.

See ["More Information" on page 1161](#)

Key Path	Save, State
Mode	All
Remote Command	:MMEMory:REGister:STATe:LABel <reg number>,"label" :MMEMory:REGister:STATe:LABel? <reg number>
Example	:MMEM:REG:STAT:LAB 1,"my label"
Notes	<reg number> is an integer from 1 to 16. If the SCPI specifies an invalid register number an error message is generated, -222,"Data out of range;Invalid register label number" "label" is a string from 0 to 30 characters in length. If a label exceeds 30 characters, an error message is generated, -150,"String data error;Label clipped to 30 characters" "label" of length 0 erases the custom label and restores the default (time and date) label. E.g.: :MMEM:REG:STAT:LAB 1,""
Dependencies	N9060A-7FP or N9060B-2FP license required to edit the register names. When the feature is not licensed, sending this command generates an error, -221,"Settings conflict;Option not available"
Preset	The names are unaffected by Preset or power cycle but are set to the default label (time and date) on a "Restore System Defaults->Misc"
Initial S/W Revision	A.11.00

More Information

When you edit one of the register names, the time and date field will be replaced by the custom name.

If you delete all the characters in the custom name, it restores the default (time and date).

The register names are stored within the state files, but they are not part of the instrument state; that is, once you have edited a register name, loading a new state will not change that register name. Another consequence of this is that the names will be persistent through a power cycle. Also, if a named state file is transferred to another analyzer, it will bring its custom name along with it.

If you try to edit the name of an empty register, the analyzer will first save the state to have a file to put the name in. If you load a named state file into an analyzer with older firmware it will ignore the metadata.

The *SAV and *RCL commands will not be affected by the custom register names, nor will the MMEM commands.

Register 1 thru Register 16

Selecting any one of these register menu keys causes the State of the currently active mode to be saved to the specified Register. The registers are provided for rapid saving and recalling, since you do not need to specify a filename or navigate to a file. Each of the register menu keys annotates whether it is empty or at what date and time it was last modified. In addition, you can use the Edit Register Names key to enter custom names for each register.

Although these 16 registers are the only registers available from the front panel, there are 128 state registers available in the instrument. Registers 17–128 are only available from the SCPI interface, using the *SAV command.

There is one set of 128 state registers in the instrument, not one set for each Mode. When a state is saved, the Mode it was saved from is saved with it; then when it is recalled, the instrument switches to that Mode.

After the save completes, the corresponding register menu key annotation is updated with the date and time and the message "Register <register number> saved" is displayed.

Key Path	Save, State
Mode	All
Example	*SAV 1
Range	1–16 from front panel, 1–128 from SCPI
Readback	Date and time with seconds resolution are displayed on the key OR A custom name of up to 30 characters entered using the Edit Register Names key OR “(empty)” if no prior save operation has been performed to this register.
Initial S/W Revision	Prior to A.02.00
Modified at S/W Revision	A.11.00

Register 1 thru Register 16

Selecting any one of these register menu keys causes the State of the currently active mode to be saved to the specified Register. The registers are provided for rapid saving and recalling, since you do not need to specify a filename or navigate to a file. Each of the register menu keys annotates whether it is empty or at what date and time it was last modified. In addition, you can use the Edit Register Names key to enter custom names for each register.

Although these 16 registers are the only registers available from the front panel, there are 128 state registers available in the instrument. Registers 17–128 are only available from the SCPI interface, using the *SAV command.

There is one set of 128 state registers in the instrument, not one set for each Mode. When a state is saved, the Mode it was saved from is saved with it; then when it is recalled, the instrument switches to that Mode.

After the save completes, the corresponding register menu key annotation is updated with the date and time and the message "Register <register number> saved" is displayed.

Key Path	Save, State
Mode	All
Example	*SAV 1
Range	1–16 from front panel, 1–128 from SCPI
Readback	Date and time with seconds resolution are displayed on the key OR A custom name of up to 30 characters entered using the Edit Register Names key OR “(empty)” if no prior save operation has been performed to this register.
Initial S/W Revision	Prior to A.02.00
Modified at S/W Revision	A.11.00

Data (Export)

Exporting a data file stores data from the current measurement to mass storage files. The Export Menu only contains data types that are supported by the current measurement.

Since the commonly exported data files are in .csv format, the data can be edited by you prior to importing. This allows you to export a data file, manipulate the data in Excel (the most common PC Application for manipulating .csv files) and then import it.

Selecting an Export Data menu key will not actually cause the exporting to occur, since the analyzer still needs to know where you wish to save the data. Pressing the Save As key in this menu brings up the Save As dialog and Save As menu that allows you to specify the destination file and directory. Once a filename has been selected or entered in the Open menu, the export will occur as soon as the Save key is pressed.

Key Path	Save
Mode	All
Notes	The menu is built from whatever data types are available for the mode. So the key locations in the sub menu will vary. No SCPI command directly controls the Data Type that this key controls. The Data Type is included in the MMEM:STORe commands.
Dependencies	If a file type is not used by a certain measurement, that type is grayed out for that measurement. The key for a file type will not show at all if there are no measurements in the Mode that support it.
Preset	Is not affected by a Preset or shutdown, but is reset during Restore Mode Defaults
Readback	The data type that is currently selected
Initial S/W Revision	Prior to A.02.00

Export Trace Data

Enables you to export trace data with (optional) associated headers. Selecting this key displays a menu that enables you to choose which Trace to save (default is the selected Trace) and whether or not to save headers with the data. The header information is used by the VXA application when saved trace data is recalled, and enables it to be displayed with the same formatting and scaling that it had when saved. If headers are not saved, the scaling and format are set to default values when the trace is recalled. After making these selections, press Save As... and use the file dialog to choose a file name and format for the saved data.

Trace data can be exported in several different formats. Text and comma-separated variable (CSV) formats are useful for viewing the data or importing it to a spreadsheet program. The other formats are binary and thus more compact. Trace data files can be recalled for viewing into other VXA, LTE, LTETDD, iDEN, or 89601 measurements.

Key Path	Save, Data (Export)
Mode	VSA, LTE, LTETDD, IDEN
Remote Command	:MMEMory:STORe:TRACe:DATA TRACE1 TRACE2 TRACE3 TRACE4 TRACE5 TRACE6, "<filename>" [,CSV TXT SDF MAT4 MAT HDF5 BIN[,OFF ON 0 1]]
Example	:MMEM:STOR:TRAC:DATA TRACE1, "TRC1.TXT", TXT, ON
Notes	<p>The Save As... dialog box has the following format options when you are saving trace data:</p> <ul style="list-style-type: none"> • CSV (Comma delimited) (*.csv) • SDF (Fast) (*.sdf;*.dat) • Text (Tab delimited) (*.txt) <p>File format saved depends on selection. The appropriate file extension is appended to the filename if it is not supplied by the user.</p> <p>If the SCPI command includes just a file name, the file format is determined by the filename extension, which must be one of the choices above. *.sdf or an unrecognized extension chooses the SDF fast format. If the optional file format enumerator is included in the command, then this determines the file format and the file extension is ignored. The optional binary parameter determines if file headers are saved. The default is ON. If file headers are not wanted, use the optional "OFF" parameter.</p> <p>The optional Boolean parameter determines whether headers are saved in the file. By default the headers are saved.</p> <p>If you are not licensed to save a particular file type, then error -203.9010 is returned. If an invalid file format is specified or the file cannot be saved successfully, then error -25x is returned. If the save is successful, then advisory 0.1500 is shown.</p>
State Saved	No
Readback	(Trace 1 Trace 2 Trace 3 Trace 4 Trace 5 Trace 6)(with without) headers

Trace 1

Selects the Trace 1 register as the destination for the imported data.

Key Path	Save, Data (Export), Trace
Mode	VSA, LTE, LTETDD, IDEN

Trace 2

Selects the Trace 2 register as the destination for the imported data.

Key Path	Save, Data (Export), Trace
Mode	VSA, LTE, LTETDD, IDEN

Trace 3

Selects the Trace 3 register as the destination for the imported data.

Key Path	Save, Data (Export), Trace
Mode	VSA, LTE, LTETDD, IDEN

Trace 4

Selects the Trace 4 register as the destination for the imported data.

Key Path	Save, Data (Export), Trace
Mode	VSA, LTE, LTETDD, IDEN

Include Header

Enables you to select whether or not the saved trace data includes header information describing scaling, formatting, etc.

Key Path	Save, Data (Export), Trace
Mode	VSA, LTE, LTETDD, IDEN
State Saved	No

Measurement Results

Pressing this key selects Meas Results as the data type to be exported.

The Meas Results file contains measurement result sets, plus information describing the current state of the analyzer, as detailed in ["Meas Results File Definition" on page 1166](#) and ["Meas Results File Example" on page 1168](#) below.

Key Path	Save, Data
Remote Command	:MMEMory:STORe:RESults <string>
Example	:MMEM:STOR:RES "MeasR_0000.csv"

Notes	<p>If the save is initiated via SCPI and the file already exists, the file will be overwritten.</p> <p>The SCPI command exports Power Stat CCDF measurement results to the file specified as the parameter in the current path. The default path is My Documents\<current mode="">\data\PST\results. Using the C: drive is strongly discouraged, since it runs the risk of being overwritten during an instrument software upgrade.</current></p> <p>The SCPI parameter is a quoted string that specifies the filename. Both single and double quotes are supported for any filename parameter over SCPI.</p>
Dependencies	The current active measurement must be the Power Stat CCDF measurement to use this command.
Status Bits/OPC dependencies	Sequential – waits for the previous measurement to complete
Initial S/W Revision	Prior to A.02.00

Meas Results File Definition

The content of a Meas Results File is defined in this section.

The first lines in the file consist of identification and instrument configuration details, as follows.

- File ID string, which is “MeasResult”
- Measurement ID following Mode ID, which is “SA:PST” for example.
- Firmware rev and model number
- Option string
- Automatic Trigger Time
- Automatic Trigger Time State
- CcdfCurrentCounts
- Center Frequency
- Center Frequency Step
- Center Frequency Step State
- Counts
- Electrical Atten
- Electrical Atten State
- External Array Trigger Delay
- External Array Trigger Delay State
- External Array Trigger Level
- External Array Trigger Slope
- Gaussian Line
- IF Gain Auto

- IF Gain State
- Info BW
- Internal Preamp
- Internal Preamp Band
- Line Trigger Delay
- Line Trigger Delay State
- Line Trigger Slope
- Meas Cycles
- MeasInterval
- Mechanical Atten
- MechanicalAttenStepEnum
- Periodic Timer Period
- Periodic Timer Sync Source
- Periodic Timer Trigger Delay
- Periodic Timer Trigger Delay State
- Preselector Adjust
- Ref Trace
- RFBurst Trigger Delay
- RFBurst Trigger Delay State
- RFBurst Trigger Level Abs
- RFBurst Trigger Level Rel
- RFBurst Trigger Level Type
- RFBurst Trigger Slope
- Scale/Div
- Trigger Holdoff
- Trigger Holdoff State
- TriggerSource

The data above is followed in the file by a line containing “MeasResult1” to “MeasResult4”. This line forms a header for each set of measurement results, which appear in subsequent lines. Each line of Measurement Results consists of 4 comma-separated values, from the MeasResult1 value to the MeasResult4 value.

The MeasResult1 set in the file corresponds to the data returned by MEAS|READ|FETCh:PStatistic1; the MeasResult2 set corresponds to the data returned by MEAS|READ|FETCh:PStatistic2, and so on.

The exported file is in CSV format, with a .csv extension.

Meas Results File Example

When imported into Microsoft Excel, a typical Meas Results CSV file appears as shown in the example below.

MeasResult		
SA:PST		
A.10.53	N9030A	
526 ALV ATP B1X B1Y B25 B40 BBA CR3 CRP DCF DDA DP2 DRD EA3 EDP EMC EP1 ERC ESC ESP EXM FSA LFE LNP MAT MPB NFE NUL P26 PFR PNC RTL RTS S40 SB1 SEC SM1 TVT YAS YAV	1	
Automatic Trigger Time	0.1	
Automatic Trigger Time State	FALSE	
CcdfCurrentCounts	6087500	
Center Frequency	1.33E+10	
Center Frequency Step	5000000	
Center Frequency Step State	TRUE	
Counts	10000000	
Electrical Atten	0	
Electrical Atten State	FALSE	
External Array Trigger Delay	1.00E-06	1.00E-06
External Array Trigger Delay State	FALSE	FALSE
External Array Trigger Level	1.2	1.2
External Array Trigger Slope	Positive	Positive
Gaussian Line	TRUE	
IF Gain AUto	FALSE	
IF Gain State	FALSE	
Info BW	5000000	
Internal Preamp	FALSE	
Internal Preamp Band	Low	
Line Trigger Delay	1.00E-06	
Line Trigger Delay State	FALSE	

Line Trigger Slope	Positive		
Meas Cycles	1600		
MeasInterval	0.001		
Mechanical Atten	10		
MechanicalAttenStepEnum	S2dB		
Periodic Timer Period	0.02		
Periodic Timer Sync Source	None		
Periodic Timer Trigger Delay	1.00E-06		
Periodic Timer Trigger Delay State	FALSE		
Preselector Adjust	0		
Ref Trace	FALSE		
RFBurst Trigger Delay	1.00E-06		
RFBurst Trigger Delay State	FALSE		
RFBurst Trigger Level Abs	-20		
RFBurst Trigger Level Rel	-6		
RFBurst Trigger Level Type	Absolute		
RFBurst Trigger Slope	Positive		
Scale/Div	2		
Trigger Holdoff	0.1		
Trigger Holdoff State	FALSE		
TriggerSource	Free		
MeasResult1	MeasResult2	MeasResult3	MeasResult4
-73.0651058869747	36.9712197125257	36.7879441171442	
36.9712197125257	36.8850431211499	36.7032368203129	

Save As . . .

When you press “Save As”, the analyzer brings up a Windows dialog and a menu entitled “**Save As.**” This menu allows you to navigate to the various fields in the Windows dialog without using a keyboard or mouse. The Tab and Arrow keys can also be used for dialog navigation.

See ["To File . . ." on page 2810](#) in Save, State for a full description of this dialog and menu.

The default path for saving files is:

For all of the Trace Data Files:

My Documents\`<mode name>`\data\traces

For all of the Limit Data Files:

My Documents\`<mode name>`\data\limits

For all of the Measurement Results Data Files:

My Documents\<<mode name>\data\<<measurement name>\results

For all of the Capture Buffer Data Files:

My Documents\<<mode name>\data\captureBuffer

Key Path	Save, Data
Mode	All
Notes	The key location is mode-dependent and will vary. Brings up the Save As dialog for saving a <mode specific> Save Type. The save is performed immediately and does not wait until the measurement is complete.
Initial S/W Revision	Prior to A.02.00

Screen Image

Pressing Screen Image accesses a menu of functions that enable you to specify a format and location for the saved screen image. It brings up a menu that allows you to specify the color scheme of the Screen Image (Themes) or navigate to the Save As dialog to perform the actual save.

Screen Image files contain an exact representation of the analyzer display. They cannot be loaded back onto the analyzer, but they can be loaded into your PC for use in many popular applications.

The image to be saved is actually captured when the Save front panel key is pressed, and kept in temporary storage to be used if you ask for a Screen Image save. When the Screen Image key is pressed, a "thumbnail" of the captured image is displayed, as shown below:

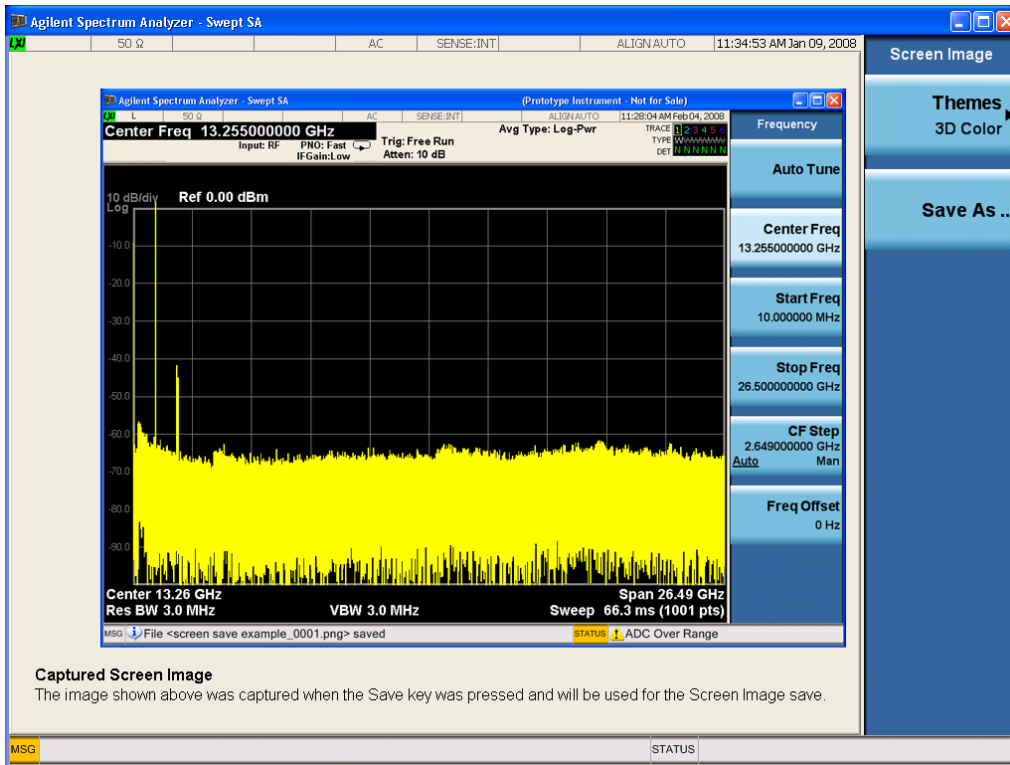

When you continue on into the Save As menu and complete the Screen Image save, the image depicted in the thumbnail is the one that gets saved, showing the menus that were on the screen before going into the Save menus. The save is performed immediately and does not wait until the measurement is complete.

After you have completed the save, the Quick Save front-panel key lets you quickly repeat the last save performed, using an auto-named file, with the current screen data.

NOTE

For versions previous to A.01.55, if you initiate a screen image save by navigating through the Save menus, the image that is saved will contain the Save menu softkeys, not the menus and the active function that were on the screen when you first pressed the Save front panel key.

Key Path	Save
Mode	All
Remote Command	:MMEMory:STORe:SCReem <filename>
Example	:MMEM:STOR:SCR "myScreen.png" This stores the current screen image in the file MyScreenFile.png in the default directory.
Initial S/W Revision	Prior to A.02.00

Themes

Accesses a menu of functions that enable you to choose the theme to be used when saving the screen image.

The **Themes** option is the same as the **Themes** option under the **Display** and **Page Setup** dialogs. It allows you to choose between themes to be used when saving the screen image.

Key Path	Save, Screen Image
Remote Command	:MMEMory:STORe:SCReem:THEMe TDColor TDMonochrome FCOLor FMONochrome :MMEMory:STORe:SCReem:THEMe?
Example	:MMEM:STOR:SCR:THEM TDM
Preset	3D Color; Is not part of Preset, but is reset by Restore Misc Defaults or Restore System Defaults All and survives subsequent running of the modes.
Readback	3D Color 3D Mono Flat Color Flat Mono
Backwards Compatibility Notes	In ESA and PSA we offer the choice of "Reverse Bitmap" or "Reverse Metafile" when saving screen images. This is much like the "Flat Color" theme available in X-Series. Also, if you selected Reverse Bitmap AND a black & white screen image, that would be much like "Flat Monochrome". In other words, each of the X-Series themes has a similar screen image type in ESA/PSA. But they are not identical.
Initial S/W Revision	Prior to A.02.00

3D Color

Selects a standard color theme with each object filled, shaded and colored as designed.

Key Path	Save, Screen Image, Themes
Example	MMEM:STOR:SCR:THEM TDC
Readback	3D Color
Initial S/W Revision	Prior to A.02.00

3D Monochrome

Selects a format that is like 3D color but shades of gray are used instead of colors.

Key Path	Save, Screen Image, Themes
Example	MMEM:STOR:SCR:THEM TDM
Readback	3D Mono
Initial S/W Revision	Prior to A.02.00

Flat Color

Selects a format that is best when the screen is to be printed on an ink printer.

Key Path	Save, Screen Image, Themes
-----------------	----------------------------

Example	MMEM:STOR:SCR:THEM FCOL
Readback	Flat Color
Initial S/W Revision	Prior to A.02.00

Flat Monochrome

Selects a format that is like Flat Color. But only black is used (no colors, not even gray), and no fill.

Key Path	Save, Screen Image, Themes
Example	MMEM:STOR:SCR:THEM FMON
Readback	Flat Mono
Initial S/W Revision	Prior to A.02.00

Save As...

When you press "Save As", the analyzer brings up a Windows dialog and a menu entitled "**Save As.**" This menu allows you to navigate to the various fields in the Windows dialog without using a keyboard or mouse. The Tab and Arrow keys can also be used for dialog navigation.

See "[To File ...](#)" on page 2810 in Save, State for a full description of this dialog and menu.

The default path for Screen Images is

My Documents\`<mode name>`\screen.

where `<mode name>` is the parameter used to select the mode with the INST:SEL command (for example, SA for the Spectrum Analyzer).

Key Path	Save, Screen Image
Notes	Brings up Save As dialog for saving a Screen Image Save Type
Initial S/W Revision	Prior to A.02.00

Mass Storage Catalog (Remote Command Only)

Key path	SCPI Only
Remote Command	:MMEMory:CATalog? [<code><directory_name></code>]
Notes	<p>The string must be a valid logical path.</p> <p>Queries disk usage information (drive capacity, free space available) and obtains a list of files and directories in a specified directory in the following format:</p> <p><code><numeric_value>,<numeric_value>,{<file_entry>}</code></p> <p>It returns two numeric parameters and as many strings as there are files and directories. The first parameter indicates the total amount of storage currently used in bytes. The second parameter</p>

indicates the total amount of storage available, also in bytes. The <file_entry> is a string. Each <file_entry> indicates the name, type, and size of one file in the directory list:

<file_name>,<file_type>,<file_size>

As the windows file system has an extension that indicates file type, <file_type> is always empty. <file_size> provides the size of the file in bytes. For directories, <file_entry> is surrounded by square brackets and both <file_type> and <file_size> are empty

Initial S/W Revision Prior to A.02.00

Mass Storage Change Directory (Remote Command Only)

Key path SCPI Only

Remote Command :MMEMory:CDIRectory [<directory_name>]
 :MMEMory:CDIRectory?

Notes The string must be a valid logical path.

Changes the default directory for a mass memory file system. The <directory_name> parameter is a string. If no parameter is specified, the directory is set to the *RST value.

At *RST, this value is set to the default user data storage area, that is defined as System.Environment.SpecialFolder.Personal.

Query returns full path of the default directory.

Initial S/W Revision Prior to A.02.00

Mass Storage Copy (Remote Command Only)

Key path SCPI Only

Remote Command :MMEMory:COPY <string>,<string>[,<string>,<string>]

Notes The string must be a valid logical path.

Copies an existing file to a new file or an existing directory to a new directory.

Two forms of parameters are allowed. The first form has two parameters. In this form, the first parameter specifies the source, and the second parameter specifies the destination.

The second form has four parameters. In this form, the first and third parameters specify the source. The second and fourth parameters specify the directories. The first pair of parameters specifies the source. The second pair specifies the destination. An error is generated if the source doesn't exist or the destination file already exists.

This command will generate an "access denied" error if the destination is a restricted folder (e.g., C:\Windows) and the current user does not have Power User or Administrator privileges.

Mass Storage Device Copy (Remote Command Only)

This command transfers data to/from a file and a peripheral device.

Key path	SCPI Only
Remote Command	:MMEMory:COpy:DEvice <source_string>,<dest_string>
Notes	The strings must be a valid logical path or a valid device keyword. If the dest_string is a device keyword, the data is copied from the source file to the device. If the source_string is a device keyword, the data is copied to the source file from the device. Valid device keywords are: SNS (smart noise source) An error is generated if the file or device is not found.

Mass Storage Delete (Remote Command Only)

Key path	SCPI Only
Remote Command	:MMEMory:DElete <file_name>[,<directory_name>]
Notes	The string must be a valid logical path. Removes a file from the specified directory. The <file_name> parameter specifies the file name to be removed. This command will generate an “access denied” error if the file is in a restricted folder (e.g., C:\Windows) and the current user does not have Power User or Administrator privileges.
Initial S/W Revision	Prior to A.02.00

Mass Storage Data (Remote Command Only)

Creates a file containing the specified data OR queries the data from an existing file.

Key path	SCPI Only
Remote Command	:MMEMory:DATA <file_name>, <data> :MMEMory:DATA? <file_name>
Notes	The string must be a valid logical path. The command form is MMEMory:DATA <file_name>,<data>. It loads <data> into the file <file_name>. <data> is in 488.2 block format. <file_name> is string data. The query form is MMEMory:DATA? <file_name> with the response being the associated <data> in block format.
Initial S/W Revision	Prior to A.02.00

Mass Storage Make Directory (Remote Command Only)

Key path	SCPI Only
Remote Command	:MMEMory:MDIRectory <directory_name>
Notes	The string must be a valid logical path. Creates a new directory. The <directory_name> parameter specifies the name to be created.

	This command will generate an “access denied” error if the new directory would be in a restricted folder (e.g., C:\Windows) and the current user does not have Power User or Administrator privileges.
Initial S/W Revision	Prior to A.02.00

Mass Storage Move (Remote Command Only)

Key path	SCPI Only
Remote Command	:MMEMory:MOVE <string>,<string>[,<string>,<string>]
Notes	<p>The string must be a valid logical path.</p> <p>Moves an existing file to a new file or an existing directory to a new directory.</p> <p>Two forms of parameters are allowed. The first form has two parameters. In this form, the first parameter specifies the source, and the second parameter specifies the destination.</p> <p>The second form has four parameters. In this form, the first and third parameters specify the source. The second and fourth parameters specify the directories. The first pair of parameters specifies the source. The second pair specifies the destination. An error is generated if the source doesn't exist or the destination file already exists.</p> <p>This command will generate an “access denied” error if the destination is a restricted folder (e.g., C:\Windows) and the current user does not have Power User or Administrator privileges.</p>
Initial S/W Revision	Prior to A.02.00

Mass Storage Remove Directory (Remote Command Only)

Key path	SCPI Only
Remote Command	:MMEMory:RDIRECTory <directory_name>
Notes	<p>The string must be a valid logical path.</p> <p>Removes a directory. The <directory_name> parameter specifies the directory name to be removed. All files and directories under the specified directory shall also be removed.</p> <p>This command will generate an “access denied” error if the folder is a restricted folder (e.g., C:\Windows) or is in a restricted folder and the current user does not have Power User or Administrator privileges.</p>
Initial S/W Revision	Prior to A.02.00

Single (Single Measurement/Sweep)

Sets the analyzer for Single measurement operation. The single/continuous state is Meas Global, so the setting will affect all the measurements. If you are Paused, pressing Single does a Resume.

See ["More Information" on page 1177](#)

Key Path	Front-panel key
Example	:INIT:CONT OFF
Notes	See Cont key description.
Backwards Compatibility Notes	<p>For Spectrum Analysis mode in ESA and PSA, the Single hardkey and the INITiate:IMM switched from continuous measurement to single measurement and restarted sweeps and averages (displayed average count reset to 1), but did not restart Max Hold and Min Hold. In the X-Series, the Single hardkey and the INITiate:IMM command initiate a sweep/ measurement/ average sequence/hold sequence including MaxHold and MinHold.</p> <p>For Spectrum Analysis mode in ESA and PSA, the Single hardkey restarted the sweep regardless of whether or not you were in an active sweep or sweep sequence. In the X-Series, Restart does this but Single only restarts the sweep or sweep sequence if you are in the idle state.</p> <p>INIT[:IMM] in ESA & PSA Spectrum Analysis Mode does an implied ABORT. In some other PSA Modes, INIT[:IMM] is ignored if not in the idle state. . The X-Series follows the ESA/PSA SA Mode model, which may cause some Modes to have compatibility problems.</p>
Initial S/W Revision	Prior to A.02.00

More Information

See ["Restart" on page 2807](#) for details on the INIT:IMMEDIATE (Restart) function.

If you are already in single sweep, the INIT:CONT OFF command has no effect.

If you are already in Single Sweep, then pressing the Single key in the middle of a sweep does not restart the sweep or sequence. Similarly, pressing the Single key does not restart the sweep or sequence if the sweep is not in the idle state (for example, if you are taking a very slow sweep, or the analyzer is waiting for a trigger). Instead, it results in a message. "Already in Single, press Restart to initiate a new sweep or sequence". Even though pressing the Single key in the middle of a sweep does not restart the sweep, sending INIT:IMMEDIATE does reset it.

To take one more sweep without resetting the average count, increment the average count by 1, by pressing the step up key while **Average/Hold Number** is the active function, or sending the remote command CALC:AVER:TCON UP.

Source

There is no Source control functionality for this measurement. When this key is pressed, the screen either displays a blank menu, or the previously-selected menu remains unchanged.

Key Path	Front-panel key
----------	-----------------

Span X Scale

The SPAN X Scale key accesses the menu to set the desired horizontal scale.

Key Path	Front-panel key
Initial S/W Revision	Prior to A.02.00

Scale/Div

Enables you to enter a time value to change the horizontal scale.

Key Path	Span X Scale
Mode	SA, WCDMA, C2K, WIMAXOFDMA, TD-SCDMA, 1xEV-DO, DVB-T/H, DTMB (CTTB), ISDB-T, CMMB, LTE, LTE-TDD, Digital Cable TV, WLAN, MSR,, LTE-TDD, LTE-FDD
Remote Command	:DISPlay:PStatistic:VIEW[1]:WINDow2:TRACe:X[:SCALE]:PDIVision <rel_ ampl> :DISPlay:PStatistic:VIEW[1]:WINDow2:TRACe:X[:SCALE]:PDIVision?
Example	DISP:PST:VIEW:WIND2:TRAC:X:PDIV 10 DISP:PST:VIEW:WIND2:TRAC:X:PDIV?
Notes	CCDF measurement has the trace display only at Window 2.
Couplings	See Notes
Preset	2.00
State Saved	Saved in instrument state.
Min	0.1
Max	20
Backwards Compatibility SCPI	:DISPlay:PStatistic:XScale
Initial S/W Revision	Prior to A.02.00
Modified at S/W Revision	A.02.00, A.03.00

Sweep/Control

Enables you to pause the power statistics CCDF measurement after the current data acquisition is complete. When Paused, the label on the menu key changes to Resume. Press Resume to resume the measurement where it was when it was paused.

Key Path	Front-panel key
Initial S/W Revision	Prior to A.02.00

Pause/Resume

Pauses a measurement after the current data acquisition is complete. When Paused, the label on the key changes to Resume. Press Resume to resume the measurement where it was when it was paused. See ["Pause/Resume" on page 2703](#) for details.

Key Path	Sweep/Control
Initial S/W Revision	Prior to A.02.00

System

See "System" on page 366

Trace/Detector

Accesses a menu of functions that enable you to control the storage and manipulation of the reference trace, as well as controls the display of the trace data.

Key Path	Front-panel key
Initial S/W Revision	Prior to A.02.00

Store Ref Trace

Copies the currently measured curve as the user-definable reference trace. The captured data remains until the other mode is chosen. Pressing this key also refreshes the reference trace.

No query command is available.

Key Path	Trace/Detector
Mode	SA, WCDMA, C2K, WIMAXOFDMA, TD-SCDMA, 1xEV-DO, DVB-T/H, DTMB (CTTB), ISDB-T, CMMB, LTE, LTE-TDD, Digital Cable TV, WLAN, MSR, LTE-TDD, LTE-FDD
Remote Command	:CALCulate:PSTatistic:STORe:REFerence
Example	CALC:PST:STOR:REF
Backwards Compatibility SCPI	[:SENSe]:PSTatistic:SRTRace
Initial S/W Revision	Prior to A.02.00
Modified at S/W Revision	A.02.00, A.03.00

Ref Trace

Toggles the reference trace display between On and Off.

Key Path	Trace/Detector
Mode	SA, WCDMA, C2K, WIMAXOFDMA, TD-SCDMA, 1xEV-DO, DVB-T/H, DTMB (CTTB), ISDB-T, CMMB, LTE, LTE-TDD, Digital Cable TV, WLAN, MSR, LTE-TDD, LTE-FDD
Remote Command	:DISPlay:PSTatistic:RTRace[:STATe] OFF ON 0 1 :DISPlay:PSTatistic:RTRace[:STATe]?
Example	DISP:PST:RTR OFF DISP:PST:RTR?
Preset	OFF
State Saved	Saved in instrument state.
Range	On Off
Backwards Compatibility SCPI	[:SENSe]:PSTatistic:RTRace[:STATe]
Initial S/W Revision	Prior to A.02.00
Modified at S/W Revision	A.02.00, A.03.00, A.04.00

Gaussian Line

Toggles the Gaussian trace display between On and Off.

Key Path	Trace/Detector
Mode	SA, WCDMA, C2K, WIMAXOFDMA, TD-SCDMA, 1xEV-DO, DVB-T/H, DTMB (CTTB), ISDB-T, CMMB, LTE, LTE-TDD, Digital Cable TV, WLAN, MSR, LTE-TDD, LTE-FDD
Remote Command	:DISPlay:PStatistic:GAUSSian[:STATe] OFF ON 0 1 :DISPlay:PStatistic:GAUSSian[:STATe]?
Example	DISP:PST:GAUS OFF DISP:PST:GAUS?
Preset	ON
State Saved	Saved in instrument state.
Range	On Off
Backwards Compatibility SCPI	[:SENSe]:PStatistic:GAUSSian[:STATe]
Initial S/W Revision	Prior to A.02.00
Modified at S/W Revision	A.02.00, A.03.00, A.04.00

Trigger

See ["Trigger" on page 438](#)

Free Run

See ["Free Run " on page 445](#)

Video

See ["Video \(IF Envelope\) " on page 446](#)

Trigger Level

See ["Trigger Level " on page 446](#)

Trig Slope

See ["Trig Slope " on page 447](#)

Trig Delay

See ["Trig Delay " on page 448](#)

Line

See ["Line " on page 2503](#)

Trig Slope

See ["Trig Slope " on page 2503](#)

Trig Delay

See ["Trig Delay " on page 450](#)

External 1

See ["External 1 " on page 2516](#)

Trigger Level

See ["Trigger Level " on page 2516](#)

Trig Slope

See ["Trig Slope " on page 2517](#)

Trig Delay

See ["Trig Delay " on page 453](#)

Zero Span Delay Comp

See ["Zero Span Delay Comp On/Off" on page 2505](#)

External 2

See ["External 2 "](#) on page 2518

Trigger Level

See ["Trigger Level "](#) on page 2518

Trig Slope

See ["Trig Slope "](#) on page 2519

Trig Delay

See ["Trig Delay "](#) on page 455

Zero Span Delay Comp

See ["Zero Span Delay Comp On/Off"](#) on page 2507

RF Burst

See ["RF Burst "](#) on page 2519

Absolute Trigger

See ["Absolute Trigger Level"](#) on page 2520

Relative Trigger

See ["Relative Trigger Level"](#) on page 2509

Trig Slope

See ["Trigger Slope "](#) on page 2521

Trig Delay

See ["Trig Delay "](#) on page 460

Periodic Timer

See ["Periodic Timer \(Frame Trigger\) "](#) on page 2511

Period

See ["Period "](#) on page 2512

Offset

See ["Offset "](#) on page 2513

Offset Adjust (Remote Command Only)

See ["Offset Adjust \(Remote Command Only\)"](#) on page 2514

Reset Offset Display

See ["Reset Offset Display "](#) on page 2515

Sync Source

See ["Sync Source "](#) on page 2515

Off

See ["Off "](#) on page 2516

External 1

See ["External 1 "](#) on page 2516

Trigger Level

See ["Trigger Level "](#) on page 2516

Trig Slope

See ["Trig Slope "](#) on page 2517

External 2

See ["External 2 "](#) on page 2518

Trigger Level

See ["Trigger Level "](#) on page 2518

Trig Slope

See ["Trig Slope "](#) on page 2519

RF Burst

See ["RF Burst "](#) on page 2519

Absolute Trigger

See ["Absolute Trigger Level"](#) on page 2520

Trig Slope

See ["Trigger Slope "](#) on page 2521

Trig Delay

See ["Trig Delay"](#) on page 470

Auto/Holdoff

See ["Auto/Holdoff "](#) on page 471

Auto Trig

See ["Auto Trig "](#) on page 471

Trig Holdoff

See ["Trig Holdoff" on page 472](#)

Holdoff Type

See ["Holdoff Type" on page 472](#)

Baseband I/Q

See [___ on page X](#)

I/Q Mag

See [___ on page X](#)

Trigger Level

See [___ on page X](#)

Trig Slope

See [___ on page X](#)

Trig Delay

See [___ on page X](#)

I

See [___ on page X](#)

Trigger Level

See [___ on page X](#)

Trig Slope

See [___ on page X](#)

Trig Delay

See [___ on page X](#)

Q

See [___ on page X](#)

Trigger Level

See [___ on page X](#)

Trig Slope

See [___ on page X](#)

Trig Delay

See ___ on page X

Input I

See ___ on page X

Trigger Level

See ___ on page X

Trig Slope

See ___ on page X

Trig Delay

See ___ on page X

Input Q

See ___ on page X

Trigger Level

See ___ on page X

Trig Slope

See ___ on page X

Trig Delay

See ___ on page X

Aux Channel Center Freq

See ___ on page X

Trigger Level

See ___ on page X

Trig Slope

See ___ on page X

Trig Delay

See ___ on page X

Trigger Center Freq

See ___ on page X

Trigger BW

See ___ on page X

User Preset

Accesses a menu that gives you the following three choices:

- User Preset – recalls a state previously saved using the Save User Preset function.
- User Preset All Modes – presets all of the modes in the analyzer
- Save User Preset– saves the current state for the current mode

Key Path	Front-panel key
Backwards Compatibility Notes	<p>User Preset is actually loading a state, and in legacy analyzers, it was possible to load a state without affecting the trace data, limit lines or correction data. Similarly it was possible to do a User Preset without affecting the trace data, limit lines or correction data.</p> <p>In the X-Series, “state” always includes all of this data; so whenever state is loaded, or User Preset is executed, all of the traces, limit lines and corrections are affected. Although this differs from previous behavior, it is desirable behavior, and should not cause adverse issues for users.</p> <p>On ESA and PSA, User Preset affected the entire instrument’s state. In the X-Series, User Preset only recalls the state for the active mode. There is a User Preset file for each mode. User Preset can never cause a mode switch as it can in legacy analyzers. If you want to recall all modes to their user preset file state, you will need to do a User Preset after mode switching into each mode.</p> <p>User Preset recalls mode state which can now include data like traces; whereas on ESA and PSA, User Preset did not affect data.</p>
Initial S/W Revision	Prior to A.02.00

User Preset

User Preset sets the state of the currently active mode back to the state that was previously saved for this mode using the Save User Preset menu key or the SCPI command, SYST:PRES:USER:SAV. It not only recalls the Mode Preset settings, but it also recalls all of the mode persistent settings, and the Input/Output system setting that existed at the time Save User Preset was executed.

If a Save User Preset has not been done at any time, User Preset recalls the default user preset file for the currently active mode. The default user preset files are created if, at power-on, a mode detects there is no user preset file. There will never be a scenario when there is no user preset file to restore. For each mode, the default user preset state is the same state that would be saved if a Save User Preset is performed in each mode right after doing a Restore Mode Default and after a Restore Input/Output Defaults.

The User Preset function does the following:

- Aborts the currently running measurement.
- Sets the mode State to the values defined by Save User Preset.
- Makes the saved measurement for the currently running mode the active measurement.
- Brings up the saved menu for the power-on mode.
- Clears the input and output buffers.
- Sets the Status Byte to 0.

Key Path	User Preset
Remote Command	:SYSTem:PRESet:USER
Example	:SYST:PRES:USER:SAVE:SYST:PRES:USER
Notes	:SYST:PRES:USER:SAVE is used to save the current state as the user preset state. Clears all pending OPC bits. The Status Byte is set to 0. Pressing the User Preset front-panel key while already in the User Preset menu will cause the User Preset to get executed
Couplings	A user preset will cause the currently running measurement to be aborted and cause the saved measurement to be active. Recalling a User Preset file has the same issues that recalling a Save State file has. Some settings may need to be limited and therefore re-coupled, since the capabilities of the mode may have changes when the User Preset file was last saved.
Initial S/W Revision	Prior to A.02.00

User Preset All Modes

Recalls all of the User Preset files for each mode, switches to the power-on mode, and activates the saved measurement from the power-on mode User Preset file.

NOTE

When the instrument is secured, all of the user preset files are converted back to their default user preset files.

The User Preset function does the following:

- Aborts the currently running measurement.
- Switches the Mode to the power-on mode.
- Restores the User Preset files for each mode.
- Makes the saved measurement for the power-on mode the active measurement.
- Brings up the saved menu for the power-on mode.
- Clears the input and output buffers.
- Sets the Status Byte to 0.

Key Path	User Preset
Remote Command	:SYSTem:PRESet:USER:ALL
Example	:SYST:PRES:USER:SAVE:SYST:PRES:USER:ALL
Notes	Clears all pending OPC bits. The Status Byte is set to 0. :SYST:PRES:USER:SAVE is used to save the current state as the user preset state.
Couplings	A user preset will cause the currently running measurement to be aborted, cause a mode switch to the power-on mode, and cause the saved measurement to be active in the power-on mode. Recalling a User Preset file has the same issues that recalling a Save State file has. Some settings may need to be limited and therefore re-coupled, since the capabilities of the mode may have changes when the User Preset file was last saved.
Initial S/W Revision	Prior to A.02.00

Save User Preset

Saves the currently active mode and its State. You can recall this User Preset file by pressing the User Preset menu key or sending the SYST:PRES:USER remote command. This same state is also saved by the Save State function.

Key Path	User Preset
Remote Command	:SYSTem:PRESet:USER:SAVE
Example	:SYST:PRES:USER:SAVE
Notes	:SYST:PRES:SAVE creates the same file as if the user requested a *SAV or a MMEM:STOR:STAT, except User Preset Save does not allow the user to specify the filename or the location of the file.
Initial S/W Revision	Prior to A.02.00

View/Display

The View/Display key opens the Display Menu (common to most measurements) and the View menu for the current measurement.

Some measurements have simple View menus, or even no View menu, others provide many different Views.

Views are different ways of looking at data, usually different ways of looking at the same data, often when the data represents a time record that is being digitally processed with an FFT and/or other digital signal processing algorithms.

Key Path	Front-panel key
Initial S/W Revision	Prior to A.02.00

Display

The Display menu is common to most measurements, and is used for configuring items on the display. Some Display menu settings apply to all the measurements in a mode, and some only to the current measurement. Those under the System Display Settings key apply to all measurements in all modes.

Key Path	Display
Key Path	View/Display
Initial S/W Revision	Prior to A.02.00

Annotation

Turns on and off various parts of the display annotation. The annotation is divided up into four categories:

1. Meas Bar: This is the measurement bar at the top of the screen. It does not include the settings panel or the Active Function. Turning off the Meas Bar turns off the settings panel and the Active Function. When the Meas Bar is off, the graticule area expands to fill the area formerly occupied by the Meas Bar.
2. Screen Annotation: this is the annotation and annunciation around the graticule, including any annotation on lines (such as the display line, the threshold line, etc.) This does NOT include the marker number or the N dB result. When off, the graticule expands to fill the entire graticule area.
3. Trace annotation: these are the labels on the traces, showing their detector (or their math mode).
4. Active Function annotation: this is the active function display in the meas bar, and all of the active function values displayed on softkeys.

See the figure below. Each type of annotation can be turned on and off individually.

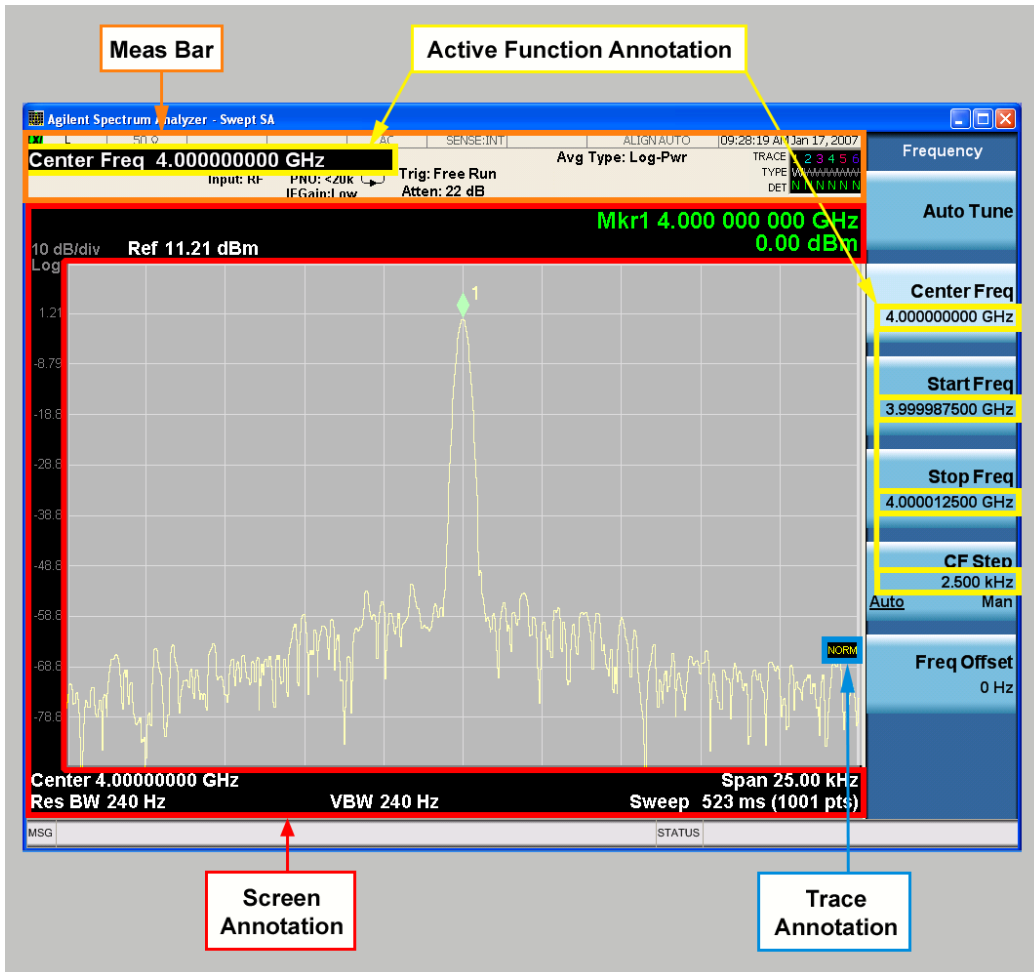

Key Path	View/Display, Display
Initial S/W Revision	Prior to A.02.00

Meas Bar On/Off

This function turns the Measurement Bar on and off, including the settings panel. When off, the graticule area expands to fill the area formerly occupied by the Measurement Bar.

Key Path	View/Display, Display, Annotation
Remote Command	:DISPlay:ANNotation:MBAR[:STATE] OFF ON 0 1 :DISPlay:ANNotation:MBAR[:STATE]?
Example	DISP:ANN:MBAR OFF
Dependencies	Grayed out and forced to OFF when System Display Settings, Annotation is set to Off.
Preset	On This should remain Off through a Preset when System DisplaySettings, Annotation is set to Off.
State Saved	Saved in instrument state.
Initial S/W Revision	Prior to A.02.00

Screen

This controls the display of the annunciation and annotation around the graticule, including any annotation on lines (such as the display line, the threshold line, etc.) and the y-axis annotation. This does NOT include marker annotation (or the N dB result). When off, the graticule expands to fill the entire graticule area, leaving only the 1.5% gap above the graticule as described in the Trace/Detector chapter.

Key Path	View/Display, Display, Annotation
Remote Command	:DISPlay:ANNotation:SCReen[:STATe] OFF ON 0 1 :DISPlay:ANNotation:SCReen[:STATe]?
Example	DISP:ANN:SCR OFF
Dependencies	Grayed-out and forced to OFF when System Display Settings, Annotation is set to Off.
Preset	On This should remain Off through a Preset when System DisplaySettings, Annotation is set to Off
State Saved	Saved in instrument state.
Initial S/W Revision	Prior to A.02.00

Active Function Values On/Off

Turns on and off the active function display in the Meas Bar, and all of the active function values displayed on the softkeys.

Note that all of the softkeys that have active functions have these numeric values blanked when this function is on. This is a security feature..

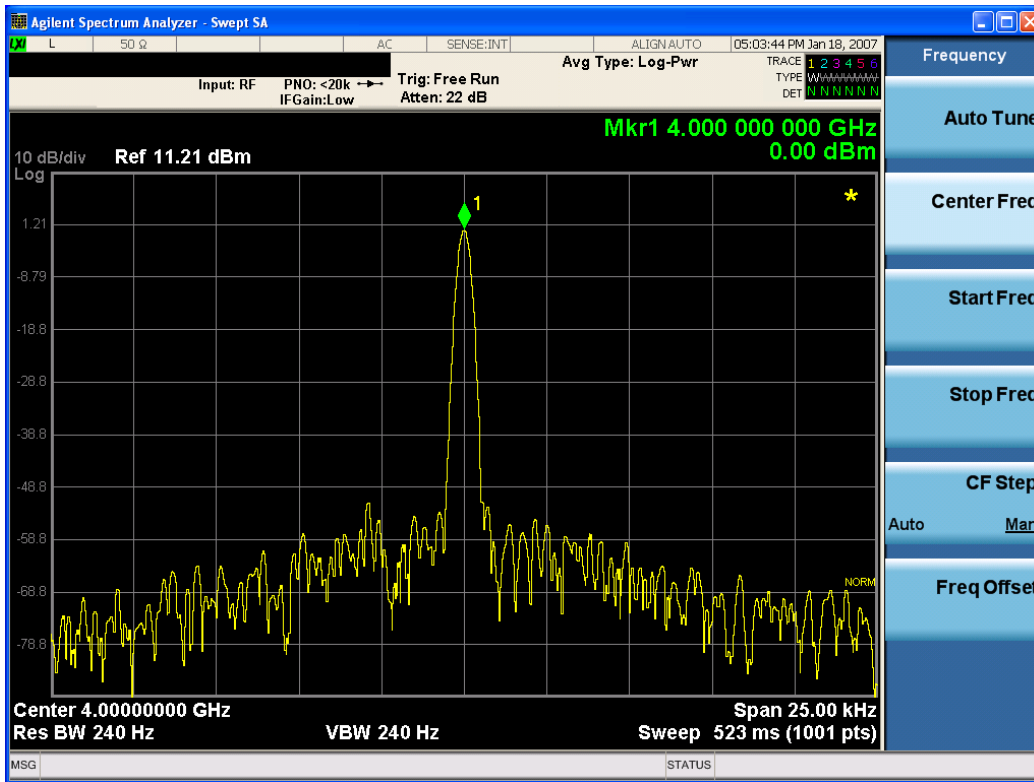

Key Path	View/Display, Display, Annotation
Remote Command	:DISPlay:ACTivefunc[:STATE] ON OFF 1 0 :DISPlay:ACTivefunc[:STATE]?
Example	DISP:ACT OFF
Dependencies	Grayed out and forced to OFF when System Display Settings, Annotation is set to Off.
Preset	On This should remain Off through a Preset when System DisplaySettings, Annotation is set to Off
State Saved	Saved in instrument state.
Initial S/W Revision	Prior to A.02.00

Title

Displays menu keys that enable you to change or clear a title on your display.

Key Path	View/Display, Display
Initial S/W Revision	Prior to A.02.00

Change Title

Writes a title into the "measurement name" field in the banner, for example, "Swept SA".

Press Change Title to enter a new title through the alpha editor. Press Enter or Return to complete the entry. Press ESC to cancel the entry and preserve your existing title.

The display title will replace the measurement name. It remains for this measurement until you press Change Title again, or you recall a state, or a Preset is performed. A title can also be cleared by pressing Title, Clear Title.

NOTE

Notice the inclusion of the <measurement> parameter in the command below. Because each measurement remembers the Display Title, the command must be qualified with the measurement name. For the Swept SA measurement this is not the case; no <measurement> parameter is used when changing the Display Title for the Swept SA measurement.

Key Path	View/Display, Display, Title
Mode	All
Remote Command	:DISPlay:<measurement>:ANNotation:TITLe:DATA <string> :DISPlay:<measurement>:ANNotation:TITLe:DATA?
Example	DISP:ANN:TITL:DATA "This Is My Title" This example is for the Swept SA measurement in the Spectrum Analyzer mode. The SANalyzer <measurement> name is not used. DISP:ACP:ANN:TITL:DATA "This Is My Title" This example is for Measurements other than Swept SA. Both set the title to: This Is My Title
Notes	Pressing this key cancels any active function. When a title is edited the previous title remains intact (it is not cleared) and the cursor goes at the end so that characters can be added or BKSP can be used to go back over previous characters.
Preset	No title (measurement name instead)
State Saved	Saved in instrument state.
Initial S/W Revision	Prior to A.02.00

Clear Title

Clears a title from the front-panel display. Once cleared, the title cannot be retrieved. After the title is cleared, the current Measurement Name replaces it in the title bar.

Key Path	View/Display, Display, Title
Example	The following commands clear the title and restore the measurement's original title: DISP:ANN:TITL:DATA "" This example is for the Swept SA measurement in the Spectrum Analyzer mode. The SANalyzer <measurement> name is not used. DISP:ACP:ANN:TITL:DATA "" This example is for ACP; in measurements other than Swept SA the measurement name is required.
Notes	Uses the :DISPlay:<measurement>:ANNotation:TITLe:DATA <string> command with an empty string (in the Swept SA, the <measurement> is omitted).
Preset	Performed on Preset.
Initial S/W Revision	Prior to A.02.00

Graticule

Pressing Graticule turns the display graticule On or Off. It also turns the graticule y-axis annotation on and off.

Key Path	View/Display, Display
Remote Command	:DISPlay:WINDow[1]:TRACe:GRATicule:GRID[:STATe] OFF ON 0 1 :DISPlay:WINDow[1]:TRACe:GRATicule:GRID[:STATe]?
Example	DISP:WIND:TRAC:GRAT:GRID OFF
Notes	The graticule is the set of horizontal and vertical lines that make up the grid/divisions for the x-axis and y-axis.
Preset	On
State Saved	Saved in instrument state
Initial S/W Revision	Prior to A.02.00

System Display Settings

These settings are "Mode Global" – they affect all modes and measurements and are reset only by Restore Misc Defaults or Restore System Defaults under System.

Key Path	View/Display, Display
Initial S/W Revision	Prior to A.02.00

Annotation Local Settings

This is a Mode Global override of the meas local annotation settings. When it is All Off, it forces ScreenAnnotation, Meas Bar, Trace, and Active Function Values settings to be OFF for all measurements in all modes. This provides the security based "annotation off" function of previous analyzers; hence it uses the legacy SCPI command.

When it is All Off, the Screen, Meas Bar, Trace, and Active Function Values keys under the Display, Annotation menu are grayed out and forced to Off. When Local Settings is selected, you are able to set the local annotation settings on a measurement by measurement basis.

Key Path	View/Display, Display, System Display Settings
Remote Command	:DISPlay:WINDow[1]:ANNOtation[:ALL] OFF ON 0 1 :DISPlay:WINDow[1]:ANNOtation[:ALL]?
Example	:DISP:WIND:ANN OFF
Preset	On (Set by Restore Misc Defaults)
State Saved	Not saved in instrument state.
Backwards Compatibility Notes	The WINDow parameter and optional subopcode is included for backwards compatibility but ignored – all windows are equally affected.
Initial S/W Revision	Prior to A.02.00

Themes

Accesses a menu of functions that enable you to choose the theme to be used when saving the screen image.

The **Themes** option is the same as the **Themes** option under the **Display** and **Page Setup** dialogs. It allows you to choose between themes to be used when saving the screen image.

Key Path	Save, Screen Image
Remote Command	:MMEMory:STORe:SCReen:THEMe TDColor TDMonochrome FCOLor FMONochrome :MMEMory:STORe:SCReen:THEMe?
Example	:MMEM:STOR:SCR:THEM TDM
Preset	3D Color; Is not part of Preset, but is reset by Restore Misc Defaults or Restore System Defaults All and survives subsequent running of the modes.
Readback	3D Color 3D Mono Flat Color Flat Mono
Backwards Compatibility Notes	In ESA and PSA we offer the choice of "Reverse Bitmap" or "Reverse Metafile" when saving screen images. This is much like the "Flat Color" theme available in X-Series. Also, if you selected Reverse Bitmap AND a black & white screen image, that would be much like "Flat Monochrome". In other words, each of the X-Series themes has a similar screen image type in ESA/PSA. But they are not identical.
Initial S/W Revision	Prior to A.02.00

3D Color

Selects a standard color theme with each object filled, shaded and colored as designed.

Key Path	Save, Screen Image, Themes
Example	MMEM:STOR:SCR:THEM TDC
Readback	3D Color
Initial S/W Revision	Prior to A.02.00

3D Monochrome

Selects a format that is like 3D color but shades of gray are used instead of colors.

Key Path	Save, Screen Image, Themes
Example	MMEM:STOR:SCR:THEM TDM
Readback	3D Mono
Initial S/W Revision	Prior to A.02.00

Flat Color

Selects a format that is best when the screen is to be printed on an ink printer.

Key Path	Save, Screen Image, Themes
Example	MMEM:STOR:SCR:THEM FCOL
Readback	Flat Color
Initial S/W Revision	Prior to A.02.00

Flat Monochrome

Selects a format that is like Flat Color. But only black is used (no colors, not even gray), and no fill.

Key Path	Save, Screen Image, Themes
Example	MMEM:STOR:SCR:THEM FMON
Readback	Flat Mono
Initial S/W Revision	Prior to A.02.00

Backlight

Accesses the display backlight on/off keys. This setting may interact with settings under the Windows "Power" menu.

When the backlight is off, pressing ESC, TAB, SPACE, ENTER, UP, DOWN, LEFT, RIGHT, DEL, BKSP, CTRL, or ALT turns the backlight on without affecting the application. Pressing any other key will turn backlight on and could potentially perform the action as well.

Key Path	View/Display, Display, System Display Settings
Remote Command	:DISPlay:BACKlight ON OFF :DISPlay:BACKlight?
Preset	ON (Set by Restore Misc Defaults)
Initial S/W Revision	Prior to A.02.00

Backlight Intensity

An active function used to set the backlight intensity. It goes from 0 to 100 where 100 is full on and 0 is off. This value is independent of the values set under the Backlight on/off key.

Key Path	View/Display, Display, System Display Settings
Remote Command	:DISPlay:BACKlight:INTensity <integer> :DISPlay:BACKlight:INTensity?
Example	DISP:BACK:INT 50

Preset	100 (Set by Restore Misc Defaults)
Min	0
Max	100
Initial S/W Revision	Prior to A.02.00

Slot View

Switch between normal CCDF view and Slot view with additional wave window, this is available only under TD-SCDMA, LTE TDD or LTE-Advanced TDD mode.

Key Path	View/Display
Mode	TD-SCDMA,LTETDD, LTEATDD
Remote Command	<code>[[:SENSe]:PStatistic:SLTView[:STATe] OFF ON 0 1</code> <code>[[:SENSe]:PStatistic: SLTView[:STATe]?</code>
Example	PST:SLTV OFF PST:SLTV?
Preset	OFF
State Saved	Saved in instrument state.
Range	On Off
Initial S/W Revision	Prior to A.02.00

12 Spurious Emissions Measurement

The Spurious Emissions measurement identifies and determines the power level of spurious emissions in certain frequency bands. For measurement results and views, see ["View/Display" on page 1373](#).

This topic contains the following sections:

["Measurement Commands for Spurious Emissions" on page 1202](#)

["Remote Command Results for Spurious Emissions Measurement" on page 1203](#)

Measurement Commands for Spurious Emissions

The following commands can be used to retrieve the measurement results:

`:CONFigure:SPURious`

`:CONFigure:SPURious:NDEFault`

`:INITiate:SPURious`

`:FETCh:SPURious [n]?`

`:READ:SPURious [n]?`

`:MEASure:SPURious [n]?`

For more measurement related commands, see the SENSE subsystem, and the section "[Remote Measurement Functions](#)" on page 2770.

Remote Command Results for Spurious Emissions Measurement

The following table describes the results returned by the FETCh, MEASure, and READ queries listed above, according to the index value n. Note that the queries are not available when viewing the Range Table.

n	Return Value
1 (or not supplied)	Returns a variable-length (1+6*Spurs – up to 1201 entries) comma separated list containing detailed information in the following format: 1. Number of spurs in following list (Integer) 2.[Repeat the following for each spur] a.Spur # b.Range # Spur was located (Integer) c.Frequency of Spur (Hz, Float64) d.Amplitude of Spur (dBm, Float32) e.Absolute Limit (dBm, Float32) f.Pass or Fail (1 0, Boolean)
2 – 21	Returns a comma separated list of the trace data for the selected range (where range number = n – 1) using Detector 1. If selected range is not active SCPI_NAN is returned for each trace data element where SCPI_NAN = 9.91E37.
22	Returns the number of spurs found.
23 – 42	Returns a comma separated list of the trace data for the selected range (where range number = n – 22) using Detector 2. If selected range is not active or Detector 2 selection is off, SCPI_NAN is returned for each trace data element where SCPI_NAN = 9.91E37.
Key Path	Meas
Initial S/W Revision	Prior to A.02.00

AMPTD Y Scale

AMPTD Y Scale opens a menu of functions that enable you to modify the Amplitude parameters.

Key Path	Front-panel key
Initial S/W Revision	Prior to A.02.00

Ref Value

Sets the value for the absolute power reference. When Auto Scaling for the Y-axis is off, the measurement uses the current reference level settings. When Auto Scaling for the Y-axis is on, the analyzer will set the reference level such that the absolute limit will be positioned two divisions down from the top of the display.

Key Path	AMPTD Y Scale
Mode	SA, WCDMA, WIMAX OFDMA, TD-SCDMA,C2k, 1xEV-DO, DVB-T/H, LTE, LTETDD, WLAN, MSR, LTEAFDD, LTEATDD
Remote Command	:DISPlay:SPURious:VIEW[1]:WINDow[1]:TRACe:Y[:SCALE]:RLEVel < real> :DISPlay:SPURious:VIEW[1]:WINDow[1]:TRACe:Y[:SCALE]:RLEVel?
Example	DISP:SPUR:VIEW:WIND:TRAC:Y:RLEV -50 dBm DISP:SPUR:VIEW:WIND:TRAC:Y:RLEV?
Notes	You must be in the Spectrum Analysis mode, W-CDMA mode, cdma2000 mode, DVB-T/H mode, TD-SCDMA mode, LTE mode, LTETDD mode, WLAN mode, MSR, LTE-Advanced FDD/TDD mode or WiMAX mode to use this command. Use INSTRument:SElect to set the mode.
Couplings	When the Y Auto Scaling is off, the measurement uses the current reference level settings. When the Y Auto Scaling is on, the analyzer automatically sets the reference level such that the absolute limit is positioned two divisions down from the top of the display. This is the most useful setting when searching for spurs. The algorithm used for determining the ref level is Ref Level = Absolute Limit + (2 * Scale/Div). All other reference level settings are left as the current base instrument settings.
Preset	0.00 dBm
State Saved	Saved in instrument state.
Min	-250.0 dBm
Max	250.0 dBm
Initial S/W Revision	Prior to A.02.00
Modified at S/W Revision	A.03.00

Attenuation

This menu controls the attenuator functions and interactions between the attenuation system components.

There are two attenuator configurations in the X-Series. One is a dual attenuator configuration consisting of a mechanical attenuator and an optional electronic attenuator. The other configuration uses a single

attenuator with combined mechanical and electronic sections that controls all the attenuation functions. Different models in the X-Series come with different configurations.

See ["Dual Attenuator Configurations:" on page 1205](#)

See ["Single Attenuator Configuration:" on page 1206](#)

Most Attenuation settings are the same for all measurements – they do not change as you change measurements. Settings like these are called “Meas Global” and are unaffected by Meas Preset.

Key Path	AMPTD Y Scale
Scope	Meas Global
Dependencies	In measurements that support the I/Q inputs, this key is unavailable when I/Q is the selected input, and is replaced by the Range key in that case.
Readback Line	Contains a summary in [] brackets of the current total attenuation. See the descriptions of the , " (Mech) Atten " on page 2736, and " Enable Elec Atten " on page 2737 keys for more detail on the contributors to the total attenuation. Note that when "Pre-Adjust for Min Clip" is on, this value can change at the start of every measurement.
Initial S/W Revision	Prior to A.02.00
Modified at S/W Revision	A.03.00

Dual Attenuator Configurations:

Configuration 1: Mechanical attenuator + optional electronic attenuator

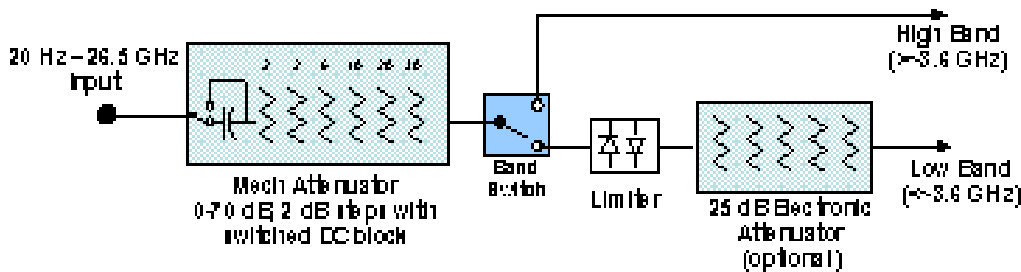

Configuration 2: Mechanical attenuator, no optional electronic attenuator

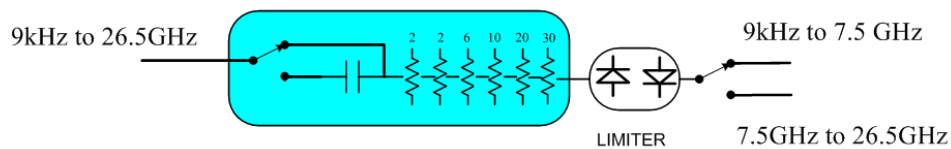

(note that Configuration 2 is not strictly speaking a dual-section attenuator, since there is no electronic section available. However, it behaves exactly like Configuration 1 without the Electronic Attenuator option EA3, therefore for the sake of this document it is grouped into the “Dual Attenuator” configuration)

Single Attenuator Configuration:

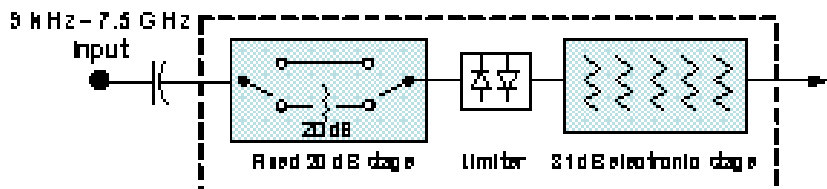

You can tell which attenuator configuration you have by pressing the Attenuation key, which (in most Modes) opens the Attenuation menu. If the first key in the Attenuation menu says Mech Atten you have the dual attenuator configuration. If the first key says Atten you have the single attenuator configuration.

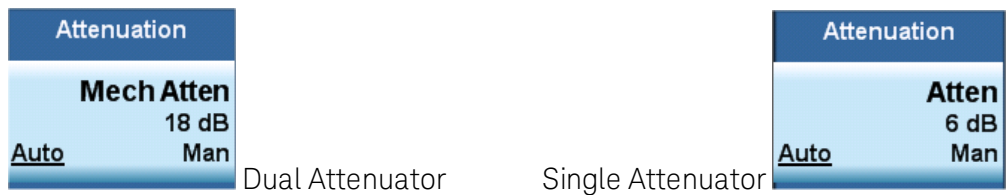

In the single attenuator configuration, you control the attenuation with a single control, as the fixed stage has only two states. In the dual attenuator configuration, both stages have significant range so you are given separate control of the mechanical and electronic attenuator stages.

When you have the dual attenuator configuration, you may still have only a single attenuator, because unless option EA3 (the Electronic Attenuator option) is available, and you purchase it, you will have only the mechanical attenuator.

(Mech) Atten

This key is labeled Mech Atten in dual attenuator models and Atten in single attenuator models. In the dual attenuator configuration, this key only affects the mechanical attenuator.

This key lets you modify the attenuation applied to the RF input signal path. This value is normally auto coupled to the Ref Level, the Internal Preamp Gain, any External Gain that is entered, and the Max Mixer Level, as described in the table below.

See ["Attenuator Configurations and Auto/Man" on page 1208](#)

Key Path	AMPTD Y Scale, Attenuation
Remote Command	<pre>[:SENSe]:POWer[:RF]:ATTenuation <rel_ampl> [:SENSe]:POWer[:RF]:ATTenuation? [:SENSe]:POWer[:RF]:ATTenuation:AUTO OFF ON 0 1 [:SENSe]:POWer[:RF]:ATTenuation:AUTO?</pre>
Example	<p>POW:ATT 20</p> <p>Dual attenuator configuration: sets the mechanical attenuator to 20 dB</p> <p>Single attenuator mode: sets the main attenuation to 20 dB (see below for definition of “main” attenuation).</p> <p>If the attenuator was in Auto, it sets it to Manual.</p>
Dependencies	Some measurements do not support the Auto setting of (Mech) Atten. In these measurements, the

Auto/Man selection is not available, and the Auto/Man line on the key disappears.

In dual attenuator configurations, when the electronic attenuator is enabled, the mechanical attenuator has no auto setting and the Auto/Man line on the key disappears. The state of Auto/Man is remembered and restored when the electronic attenuator is once again disabled. This is described in more detail in the ["Enable Elec Atten" on page 2737](#) key description.

See ["Attenuator Configurations and Auto/Man" on page 1208](#) for more information on the Auto/Man functionality of Attenuation.

Couplings

When (Mech) Atten is in Auto, it uses the following algorithm to determine a value:
 If the USB Preamp is connected to USB, use 0 dB.
 Otherwise, $Atten = ReferenceLevel + PreAmpGain + ExternalGain - RefLevelOffset - MaxMixerLevel + IF\ Gain$.
 Limit this value to be between 6 dB and the Max value. No value below 6 dB can ever be chosen by Auto.
 The resulting value is rounded up to the largest value possible given the attenuation step setting. That is, 50.01 dB would change to 60 dB (for a 10 dB attenuation step).
 The "IF Gain" term in the equation above is either 0 dB or +10 dB, depending on the settings of FFT IF Gain, Swept IF Gain, max Ref Level and the Auto/Man setting of Mech Atten.
 In External Mixing and BBIQ, where the Attenuator is not in the signal path, the Attenuator setting changes as described above when (Mech) Atten is in Auto, but no changes are made to the actual attenuator hardware setting until the input is changed back to the RF Input.

Preset The preset for Mech Attenuation is "Auto."
 The Auto value of attenuation is:
 CXA, EXA, MXA and PXA: 10 dB

State Saved Saved in instrument state

Min 0 dB
 The attenuation set by this key cannot be decreased below 6 dB with the knob or step keys. To get to a value below 6 dB it has to be directly entered from the keypad or via SCPI. This protects from adjusting the attenuation to a dangerously small value which can put the instrument at risk of damage to input circuitry. However, if the current mechanical attenuation is below 6 dB it can be increased with the knob and step keys, but not decreased.

Max CXA N9000A-503/507: 50 dB
 CXA N9000A-513/526: 70dB
 EXA: 60 dB
 MXA and PXA: 70 dB
 In the single attenuator configuration, the total of ATT and EATT cannot exceed 50 dB, so if the EATT is set to 24 dB first, the main attenuation cannot be greater than 26 dB and will be reduced accordingly; if the main attenuator is set to 40 dB first, EATT cannot be greater than 10 dB.

Initial S/W Revision Prior to A.02.00

Modified at S/W Revision A.03.00

Attenuator Configurations and Auto/Man

As described in the Attenuation key description, there are two distinct attenuator configurations available in the X-Series, the single attenuator and dual attenuator configurations. In dual attenuator configurations, we have the mechanical attenuation and the electronic attenuation, and the current total attenuation is the sum of the electronic + mechanical attenuation. In single attenuator configurations, we refer to the attenuation set using the (Mech) Atten key (or POW:ATT SCPI) as the “main” attenuation; and the attenuation that is set by the SCPI command POW:EATT as the “soft” attenuation (the POW:EATT command is honored even in the single attenuator configuration, for compatibility purposes). Then the current total attenuation is the sum of the main + soft attenuation. See the Elec Atten key description for more on “soft” attenuation.

In the dual attenuator configuration, when the electronic attenuator is enabled, there is no Auto/Man functionality for the mechanical attenuator, and the third line of the key label (the Auto/Man line) disappears:

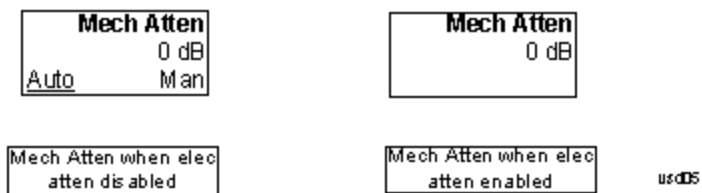

Enable Elec Atten

Enables the Electronic Attenuator.

The electronic attenuator offers finer steps than the mechanical attenuator, has no acoustical noise, is faster, and is less subject to wear. These advantages primarily aid in remote operation and are negligible for front panel use. See ["Using the Electronic Attenuator: Pros and Cons" on page 1210](#) for a detailed discussion of the pros and cons of using the electronic attenuator.

For the single attenuator configuration, for SCPI backwards compatibility, the “soft” attenuation feature replaces the dual attenuator configuration’s electronic attenuator. All the same couplings and limitations apply. See ["Attenuator Configurations and Auto/Man" on page 2737](#)

See ["More Information" on page 1209](#)

Key Path	AMPTD Y Scale, Attenuation
Remote Command	[:SENSe] : POWer [:RF] : EATTenuation : STATE OFF ON 0 1 [:SENSe] : POWer [:RF] : EATTenuation : STATE ?
Example	POW:EATT:STAT ON
Dependencies	This key only appears in Dual Attenuator models with an Electronic Attenuator installed. It does not appear in models with the Single Attenuator configuration, as in the single attenuator configuration there is no “electronic attenuator” there is only a single integrated attenuator (which has both a mechanical and electronic stage). However, in the single attenuator configuration, EATT SCPI commands are accepted for compatibility with other X-series instruments and set a “soft” attenuation as described in "Attenuator Configurations and Auto/Man" on page 2737 . The electronic attenuator (and the “soft” attenuation function provided in single attenuator configurations) is unavailable above 3.6 GHz. Therefore, if the Stop Frequency of the analyzer is > 3.6 GHz then the Enable Elec Atten key will be OFF and grayed out.

	<p>If the Internal Preamp is on, meaning it is set to Low Band or Full, the electronic attenuator (and the “soft” attenuation function provided in single attenuator configurations) is unavailable. In this case the Enable Elec Atten key will be OFF and grayed out.</p> <p>If either of the above is true, if the SCPI command is sent, an error indicating that the electronic attenuator is unavailable will be sent.</p> <p>If the electronic/soft Attenuator is enabled, then the Stop Freq of the analyzer is limited to 3.6 GHz and the Internal Preamp is unavailable.</p> <p>The SCPI-only “soft” electronic attenuation for the single-attenuator configuration is not available in all measurements; in particular, it is not available in the Swept SA measurement.</p>
Couplings	Enabling and disabling the Electronic Attenuator affects the setting of the Mechanical Attenuator (in dual attenuator configurations). This is described in more detail below this table.
Preset	OFF for Swept SA measurement; ON for all other measurements that support the electronic attenuator
State Saved	Saved in instrument state
Initial S/W Revision	Prior to A.02.00
Modified at S/W Revision	A.03.00

More Information

Mechanical Attenuator Transition Rules

When the Electronic Attenuator is enabled, the Mechanical Attenuator transitions to a state that has no Auto function. Below are the rules for transitioning the Mechanical Attenuator. NOTE that the information below ONLY applies to the dual attenuator configurations, and ONLY when the Electronic Attenuator is installed:

When the Electronic Attenuation is enabled from a disabled state:

- The Mechanical Attenuator is initialized to 10 dB (this is its optimal performance setting). You can then set it as desired with SCPI, numeric keypad, step keys, or knob, and it behaves as it normally would in manual mode
- The Auto/Man state of (Mech) Atten is saved
- The Auto/Man line on the (Mech) Atten key disappears and the auto rules are disabled
- The Electronic Attenuator is set to 10 dB less than the previous value of the Mechanical Attenuator, within the limitation that it must stay within the range of 0 to 24 dB of attenuation.

Examples in the dual attenuator configuration:

- Mech Atten at 20 dB. Elec Atten enabled, Mech Atten set to 10 dB, and Elec Atten set to 10 dB. New total attenuation equals the value before Elec Atten enabled.
- Mech Atten at 0 dB. Elec Atten enabled, Mech Atten set to 10 dB, and Elec Atten set to 0 dB. New total attenuation does not equal the value before Elec Atten enabled.
- Mech Atten at 40 dB. Elec Atten enabled, Mech Atten set to 10 dB, and Elec Atten set to 24 dB. New total attenuation does not equal the value before Elec Atten enabled.

When the Electronic Attenuation is disabled from an enabled state:

- The Elec Atten key is grayed out
- The Auto/Man state of (Mech) Atten is restored
- If now in Auto, (Mech) Atten recouples
- If now in Man, (Mech) Atten is set to the value of total attenuation that existed before the Elec Atten was disabled. The resulting value is rounded up to the smallest value possible given the (Mech) Atten Step setting - (That is, 57 dB changes to 58 dB when (Mech) Atten Step is 2 dB.)

Using the Electronic Attenuator: Pros and Cons

The electronic attenuator offers finer steps than the mechanical attenuator, has no acoustical noise, is faster, and is less subject to wear.

The “finer steps” advantage of the electronic attenuator is beneficial in optimizing the alignment of the analyzer dynamic range to the signal power in the front panel as well as remote use. Thus, you can achieve improved relative signal measurement accuracy. Compared to a mechanical attenuator with 2 dB steps, the 1 dB resolution of the electronic attenuator only gives better resolution when the odd-decibel steps are used. Those odd-decibel steps are less accurately calibrated than the even-decibel steps, so one tradeoff for this superior relative accuracy is reduced absolute amplitude accuracy.

Another disadvantage of the electronic attenuator is that the spectrum analyzer loses its “Auto” setting, making operation less convenient.

Also, the relationship between the dynamic range specifications (TOI, SHI, compression and noise) and instrument performance are less well-known with the electrical attenuator. With the mechanical attenuator, TOI, SHI and compression threshold levels increase dB-for-dB with increasing attenuation, and the noise floor does as well. With the electronic attenuator, there is an excess attenuation of about 1 to 3 dB between 0 and 3.6 GHz, making the effective TOI, SHI, and so forth, less well known. Excess attenuation is the actual attenuation relative to stated attenuation. Excess attenuation is accounted for in the analyzer calibration

Elec Atten

Controls the Electronic Attenuator in dual attenuator configurations. This key does not appear in single attenuator configurations, as the control of both the mechanical and electronic stages of the single attenuator is integrated into the single Atten key.

Key Path	AMPTD Y Scale, Attenuation
Remote Command	<code>[:SENSe] :POWer [:RF] :EATTenuation <rel_amp1></code> <code>[:SENSe] :POWer [:RF] :EATTenuation?</code>
Notes	Electronic Attenuation’s specification is defined only when Mechanical Attenuation is 6 dB.
Dependencies	This key only appears in Dual Attenuator models with an Electronic Attenuator installed. It does not appear in models with the Single Attenuator configuration, as in the single attenuator configuration there is no “electronic attenuator” there is only a single integrated attenuator (which has both a mechanical and electronic stage). However, in the single attenuator configuration, EATT SCPI commands are accepted for compatibility with other X-series instruments and set a “soft” attenuation as described in "Attenuator Configurations and Auto/Man" on page 2737 . The “soft” attenuation is treated as an addition to the “main” attenuation value set by the Atten softkey or the

	POW:ATT SCPI command and affects the total attenuation displayed on the Attenuation key and the Meas Bar. When Enable Elec Atten is off or grayed out, the Elec Atten key is grayed out.
Preset	0 dB
State Saved	Saved in instrument state
Min	0 dB
Max	Dual attenuator configuration: 24 dB Single attenuator configuration: the total of ATT and EATT cannot exceed 50 dB, so if the EATT is set to 24 dB first, the main attenuation cannot be greater than 26 dB and will be reduced accordingly; if the main attenuator is set to 40 dB first, EATT cannot be greater than 10 dB
Initial S/W Revision	Prior to A.02.00
Modified at S/W Revision	A.03.00

Adjust Atten for Min Clip

Sets the combination of mechanical and electronic attenuation and gain based on the current measured signal level so that clipping will be at a minimum.

This is an "immediate action" function, that is, it executes once, when the key is pressed.

This key is grayed out in measurements that do not support this functionality. The spectrum analyzer measurement, Swept SA, does not support this functionality.

Key Path	AMPTD Y Scale, Attenuation
Remote Command	<code>[:SENSe] :POWer [:RF] :RANGe:OPTimize IMMEDIATE</code>
Initial S/W Revision	Prior to A.02.00
Modified at S/W Revision	A.03.00

Pre-Adjust for Min Clip

If this function is on, it does the adjustment described under "[Adjust Atten for Min Clip](#)" on page 2740 each time a measurement restarts. Therefore, in Continuous measurement mode, it only executes before the first measurement.

In dual attenuator models, you can set Elec+Mech Atten, in which case both attenuators participate in the autoranging, or Elec Atten Only, in which case the mechanical attenuator does not participate in the autoranging. This latter case results in less wear on the mechanical attenuator and is usually faster.

This key is grayed out in measurements that do not support this functionality. The spectrum analyzer measurement, Swept SA, does not support this functionality.

Key Path	AMPTD Y Scale, Attenuation
Remote Command	<code>[:SENSe] :POWer [:RF] :RANGe:OPTimize:ATTenuation OFF ELECTRical COMBined</code>

	<code>[:SENSe] :POWer [:RF] :RANGe:OPTimize:ATTenuation?</code>
Notes	The SCPI parameter ELECtrical sets this function to On in single attenuator models. The SCPI parameter COMBined is mapped to ELECtrical in single attenuator models; if you send COMBined, it sets the function to On and returns ELEC to a query.
Dependencies	This key only appears in Dual Attenuator models with an Electronic Attenuator installed. In instruments with Dual Attenuator model, when Enable Elec Atten is off or grayed out, the Pre-Adjust for Min Clip key is grayed out.
Preset	OFF for Swept SA measurement; ON for all other measurements that support Pre-Adjust for Min Clip
State Saved	Saved in instrument state
Range	Dual attenuator models: Off Elec Atten Only Mech + Elec Atten Single attenuator models: Off On
Initial S/W Revision	Prior to A.02.00
Modified at S/W Revision	A.03.00

Remote Command	<code>[:SENSe] :POWer [:RF] :RANGe:AUTO ON OFF 1 0</code> <code>[:SENSe] :POWer [:RF] :RANGe:AUTO?</code>
Notes	ON aliases to "Elec Atten Only" (:POW:RANG:OPT:ATT ELEC) OFF aliases to "Off" (:POW:RANG:OPT:ATT OFF) The query :POW:RANG:AUTO? returns true if :POW:RANG:OPT:ATT is not "Off"
Initial S/W Revision	Prior to A.02.00

Off

Turns Pre-Adjust for Min Clip off. This is the default setting.

This key is grayed out in measurements that do not support this functionality. The spectrum analyzer measurement, Swept SA, does not support this functionality.

Key Path	AMPTD Y Scale, Attenuation, Pre-Adjust for Min Clip
Example	:POW:RANGe:OPT:ATT OFF
Initial S/W Revision	Prior to A.02.00

Elec Atten Only

Selects only the electric attenuator to participate in auto ranging. This offers less wear on the mechanical attenuator and is usually faster.

This key is grayed out in measurements that do not support this functionality. The spectrum analyzer measurement, Swept SA, does not support this functionality.

Key Path	AMPTD Y Scale, Attenuation, Pre-Adjust for Min Clip
Example	:POW:RANGe:OPT:ATT ELEC
Initial S/W Revision	Prior to A.02.00

Mech + Elec Atten

In dual attenuator models, this selects both attenuators participate in the autoranging.

This key is grayed out in measurements that do not support this functionality. The spectrum analyzer measurement, Swept SA, does not support this functionality.

Key Path	AMPTD Y Scale, Attenuation, Pre-Adjust for Min Clip
Example	:POW:RANGe:OPT:ATT COMB
Initial S/W Revision	Prior to A.02.00

(Mech) Atten Step

This controls the step size used when making adjustments to the input attenuation.

This key is labeled Mech Atten Step in dual attenuator models and Atten Step in single attenuator models. In the dual attenuator configuration, this key only affects the step size of the mechanical attenuator.

Key Path	AMPTD Y Scale, Attenuation
Remote Command	[[:SENSe]:POWer[:RF]:ATTenuation:STEP[:INCRement] 10 dB 2 dB [:SENSe]:POWer[:RF]:ATTenuation:STEP[:INCRement]?
Example	POW:ATT:STEP 2
Notes	Note this feature works like a 1-N choice from the front panel, but it takes a specific value (in dB) when used remotely. The only valid values are 2 and 10.
Dependencies	Blanked in CXA and EXA if option FSA (2 dB steps) is not present. If blanked, attempts to set it via SCPI will yield an error.
Couplings	When the attenuation step size changes, the current mechanical attenuation value is adjusted (if necessary) to be quantized to the new step size. That is, if step is set to 10 dB, mech atten is increased if necessary so it is a multiple of 10 dB
Preset	PXA and MXA: 2 dB EXA and CXA: 10 dB (2 dB with option FSA)
State Saved	Saved in instrument state
Initial S/W Revision	Prior to A.02.00
Modified at S/W Revision	A.03.00

Scale/Div

Sets the units per division of the vertical scale in the logarithmic display. However, since the Auto Scaling is defaulted to On, this value is automatically determined by the measurement result. When you set a value manually, Auto Scaling automatically changes to Off.

Key Path	AMPTD Y Scale
Mode	SA, WCDMA, C2K, WIMAX OFDMA, TD-SCDMA, DVB-T/H, LTE, LTE-TDD, WLAN, MSR, LTEAFDD, LTEATDD
Remote Command	:DISPlay:SPURious:VIEW[1]:WINDow[1]:TRACe:Y[:SCALe]:PDIVision <rel_ ampl> :DISPlay:SPURious:VIEW[1]:WINDow[1]:TRACe:Y[:SCALe]:PDIVision?
Example	DISP:SPUR:VIEW:WIND:TRAC:Y:PDIV 10 dB DISP:SPUR:VIEW:WIND:TRAC:Y:PDIV?
Notes	You must be in the Spectrum Analysis mode, W-CDMA mode, cdma2000 mode, DVB-T/H mode, TD-SCDMA, LTE mode, LTE TDD mode, WLAN mode, MSR, LTE-Advanced FDD/TDD mode or WiMAX mode to use this command. Use INSTRument:SElect to set the mode.
Couplings	When Auto Scaling is On, this value is automatically determined by the measurement result. When you set a value manually, Auto Scaling automatically changes to Off.
Preset	10.00 dB
State Saved	Saved in instrument state.
Range	0.10 dB to 20.00 dB
Min	0.10 dB
Max	20.00 dB
Initial S/W Revision	Prior to A.02.00
Modified at S/W Revision	A.03.00

Presel Center

When this key is pressed, the centering of the preselector filter is adjusted to optimize the amplitude accuracy at the frequency of the selected marker. If the selected marker is not on when Presel Center is pressed, the analyzer will turn on the selected marker, perform a peak search, and then perform centering on the marker's center frequency. If the selected marker is already on and between the start and stop frequencies of the analyzer, the analyzer performs the preselector calibration on that marker's frequency. If the selected marker is already on, but outside the frequency range between Start Freq and Stop Freq, the analyzer will first perform a peak search, and then perform centering on the marker's center frequency.

The value displayed on the Presel Adjust key will change to reflect the new preselector tuning (see Presel Adjust).

A number of considerations should be observed to ensure proper operation. See ["Proper Preselector Operation" on page 1215](#).

Key Path	AMPTD Y Scale
-----------------	---------------

Remote Command	<code>[:SENSe] :POWer [:RF] :PCENter</code>
Example	POW:PCEN
Notes	Note that the rules outlined above under the key description apply for the remote command as well as the key. The result of the command is dependent on marker position, and so forth. Any message shown by the key press is also shown in response to the remote command.
Dependencies	<ul style="list-style-type: none"> • Grayed out if the microwave preselector is off.) • If the selected marker's frequency is below Band 1, advisory message 0.5001 is generated and no action is taken. • Grayed out if entirely in Band 0. • Blank in models that do not include a preselector, such as option 503. If the SCPI is sent in these instruments, it is accepted without error, and the query always returns 0. • Grayed out in the Spectrogram View.
Couplings	<p>The active marker position determines where the centering will be attempted.</p> <p>If the analyzer is in a measurement such as averaging when centering is initiated, the act of centering the preselector will restart averaging but the first average trace will not be taken until the centering is completed.</p>
Status Bits/OPC dependencies	<p>When centering the preselector, *OPC will not return true until the process is complete and a subsequent measurement has completed, nor will results be returned to a READ or MEASure command.</p> <p>The Measuring bit should remain set while this command is operating and should not go false until the subsequent sweep/measurement has completed.</p>
Initial S/W Revision	Prior to A.02.00
Modified at S/W Revision	A.03.00

Proper Preselector Operation

A number of considerations should be observed to ensure proper operation:

1. If the selected marker is off, the analyzer will turn on a marker, perform a peak search, and adjust the preselector using the selected marker's frequency. It uses the "highest peak" peak search method unqualified by threshold or excursion, so that there is no chance of a 'no peak found' error. It continues with that peak, even if it is the peak of just noise. Therefore, for this operation to work properly, there should be a signal on screen in a preselected range for the peak search to find.
2. If the selected marker is already on, the analyzer will attempt the centering at that marker's frequency. There is no preselector for signals below about 3.6 GHz, therefore if the marker is on a signal below 3.6 GHz, no centering will be attempted and an advisory message generated
3. In some models, the preselector can be bypassed. If it is bypassed, no centering will be attempted in that range and a message will be generated.

Preselector Adjust

Allows you to manually adjust the preselector filter frequency to optimize its response to the signal of interest. This function is only available when "Presel Center" on page 2743 is available.

For general purpose signal analysis, using Presel Center is recommended. Centering the filter minimizes the impact of long-term preselector drift. Presel Adjust can be used instead to manually optimize the preselector. One application of manual optimization would be to peak the preselector response, which both optimizes the signal-to-noise ratio and minimizes amplitude variations due to small (short-term) preselector drifting.

Key Path	AMPTD Y Scale
Scope	Meas Global
Remote Command	<code>[:SENSe] :POWer [:RF] :PADJust <freq></code> <code>[:SENSe] :POWer [:RF] :PADJust?</code>
Example	POW:PADJ 100KHz POW:PADJ?
Notes	The value on the key reads out to 0.1 MHz resolution.
Dependencies	<ul style="list-style-type: none"> • Grayed out if microwave preselector is off.) • Grayed out if entirely in Band 0. • Blank in models that do not include a preselector, such as option 503. If the SCPI is sent in these instruments, it is accepted without error, and the query always returns 0. • Grayed out in the Spectrogram View.
Preset	0 MHz
State Saved	The Presel Adjust value set by Presel Center, or by manually adjusting Presel Adjust, is not saved in instrument state, and does not survive a Preset or power cycle.
Min	-500 MHz
Max	500 MHz
Default Unit	Hz
Backwards Compatibility SCPI	<code>[:SENSe] :POWer [:RF] :MW :PADJust</code> <code>[:SENSe] :POWer [:RF] :MMW :PADJust</code> PSA had multiple preselectors, but the X-Series has only one. These commands simply alias to <code>[:SENSe] :POWer [:RF] :PADJust</code>
Initial S/W Revision	Prior to A.02.00
Modified at S/W Revision	A.03.00
Remote Command	<code>[:SENSe] :POWer [:RF] :PADJust :PRESelector MWAVE MMWave EXTERNAL</code> <code>[:SENSe] :POWer [:RF] :PADJust :PRESelector?</code>
Notes	PSA had multiple preselectors, and you could select which preselector to adjust. Since the X-Series has only one mm/uW preselector, the preselector selection softkey is no longer available. However,

to provide backward compatibility, we accept the legacy remote commands.
The command form has no effect, the query always returns MWAVE

Initial S/W Revision Prior to A.02.00

μW Path Control

The μW Path Control functions include the μW Preselector Bypass (Option MPB) and Low Noise Path (Option LNP) controls in the High Band path circuits.

When the μW Preselector is bypassed, the user has better flatness, but will be subject to spurs from out of band interfering signals. When the Low Noise Path is enabled, the analyzer automatically switches around certain circuitry in the high frequency bands which can contribute to noise, when it is appropriate based on other analyzer settings.

For most applications, the preset state is Standard Path, which gives the best remote-control throughput, minimizes acoustic noise from switching and minimizes the risk of wear out in the hardware switches. For applications that utilize the wideband IF paths, the preset state is the μW Preselector Bypass path, if option MPB is present. This is because, when using a wideband IF such as the 140 MHz IF, the μW Preselector's bandwidth can be narrower than the available IF bandwidth, causing degraded amplitude flatness and phase linearity, so it is desirable to bypass the preselector in the default case.

Users may choose Low Noise Path Enable. It gives a lower noise floor, especially in the 21–26.5 GHz region, though without improving many measures of dynamic range, and without giving the best possible noise floor. The preamp, if purchased and used, gives better noise floor than does the Low Noise Path, however its compression threshold and third-order intercept are much poorer than that of the non-preamp Low Noise Path. There are some applications, typically for signals around –30 dBm, for which the third-order dynamic range of the standard path is good enough, but the noise floor is not low enough even with 0 dB input attenuation. When the third-order dynamic range of the preamp path is too little and the noise floor of the standard path is too high, the Low Noise Path can provide the best dynamic range.

Key Path	AMPTD Y Scale
Mode	SA, BASIC, PNOISE, VSA , LTE, LTETDD
Scope	Meas Global
Remote Command	[:SENSe] :POWer [:RF] :MW:PATH STD LNPath MPBypass FULL [:SENSe] :POWer [:RF] :MW:PATH?
Example	:POW:MW:PATH LNP Enables the Low Noise path
Notes	If a Presel Center is performed, the analyzer will momentarily switch to the Standard Path, regardless of the setting of μW Path Control The DC Block will always be switched in when the low noise path is switched in, to protect succeeding circuitry from DC. Note that this does not mean “when the low noise path is enabled” but when, based on the Low Noise Path rules, the path is actually switched in. This can happen when the selection is Low Noise Path Enable . In the case where the DC Block is switched in the analyzer is now AC coupled. However, if the user has selected DC coupling, the UI will still behave as though it were DC coupled, including all annunciation, warnings, status bits, and responses to SCPI queries. This is because, based on other settings, the analyzer could switch out the low noise path at any time

	and hence go back to being DC coupled. Alignment switching ignores the settings in this menu, and restores them when finished.
Dependencies	Unavailable in BBIQ and External Mixing
Preset	All modes other than IQ Analyzer mode and VXA: STD IQ Analyzer, VXA and WLAN mode: MPB option present and licensed: MPB MPB option not present and licensed: STD
State Saved	Save in instrument state
Readback	Value selected in the submenu
Initial S/W Revision	A.04.00
Modified at S/W Revision	A.10.00

Standard Path

This path gives the best remote-control throughput, minimizes acoustic noise from switching and minimizes the risk of wear in the hardware switches, particularly in remote test scenarios where both low band and high band setups will follow in rapid succession.

In this path, the bypass of the low band/high band switch and microwave preamp is never activated, which can cause some noise degradation but preserves the life of the bypass switch.

Key Path	AMPTD Y Scale, μ W Path Control
Example	:POW:MW:PATH STD
Readback Text	Standard Path
Initial S/W Revision	A.04.00

Low Noise Path Enable

You may choose Low Noise Path Enable, which gives a lower noise floor under some circumstances, particularly when operating in the 21–26.5 GHz region. With the Low Noise Path enabled, the low band/high band switch and microwave preamp are bypassed whenever all of the following are true:

- The analyzer is not in the Low Band, meaning:
 - the start frequency is above 3.5 GHz and
 - the stop frequency is above 3.6 GHz.
- the internal preamp is not installed or (if installed) is set to Off or Low Band

Note that this means that, when any part of a sweep is done in Low Band, the Low Noise Path is not used, whether or not the Low Noise Path Enable is selected in the user interface. Also, if the preamp is turned on, the Low Noise Path is not used, whether or not the Low Noise Path Enable is selected in the user interface. The only time the Low Noise Path is used is when Low Noise Path Enable is selected, the sweep is completely in High Band (> 3.6 GHz) and no preamp is in use.

See "[More Information](#)" on page 1219

Key Path	AMPTD Y Scale, μ W Path Control
Measurement	Swept SA
Example	:POW:MW:PATH LNP
Notes	<p>For measurements that use IQ acquisition, the low noise path is used when the Center Frequency is in High Band (> 3.6 GHz) and no preamp is in use.</p> <p>In other words, the rules above are modified to use only the center frequency to qualify which path to switch in.</p> <p>This is not the case for FFT's in the Swept SA measurement; they use the same rules as swept measurements.</p>
Dependencies	<p>Key is blanked if current mode does not support it.</p> <p>Key is grayed out if mode supports it but current measurement does not support it.</p> <p>Unless Option LNP is present and licensed, key is blank and if SCPI command sent, error -241, "Hardware missing; Option not installed" is generated.</p>
Readback Text	Low Noise Path Enable
Initial S/W Revision	A.04.00

More Information

The user should understand that the Low Noise Path, while giving improved DANL, has the disadvantage of decreased TOI performance and decreased gain compression performance relative to the standard path.

The user should also understand that the bypass switch is a mechanical switch and has finite life, so if the Low Noise Path is enabled, it is possible to cause frequent cycling of this switch by frequently changing analyzer settings such that the above conditions hold true only some of the time. A user making tests of this nature should consider opting for the Standard Path, which will never throw the bypass switch, at the expense of some degraded noise performance.

The low noise path is useful for situations where the signal level is so low that the analyzer performance is dominated by noise even with 0 dB attenuation, but still high enough that the preamp option would have excessive third-order intermodulation or compression. The preamp, if purchased and used, gives better noise floor than does the "Low Noise Path." However, its compression threshold and third-order intercept are much poorer than that of the non-preamp path. There are some applications, typically for signals around -30 dBm, for which the third-order dynamic range of the standard path is good enough, but the noise floor is not low enough even with 0 dB input attenuation. When the third-order dynamic range of the preamp path is too little and the noise floor of the standard path is too high, the Low Noise Path can provide the best dynamic range

The graph below illustrates the concept. It shows, in red, the performance of an analyzer at different attenuation settings, both with the preamp on and off, in a measurement that is affected by both analyzer noise and analyzer TOI. The green shows the best available dynamic range, offset by 0.5 dB for clarity. The blue shows how the best available dynamic range improves for moderate signal levels with the low noise path switched in. In this illustration, the preamp improves the noise floor by 15 dB while degrading the third-order intercept by 30 dB, and the low noise path reduces loss by 8 dB. The attenuator step size is 2 dB.

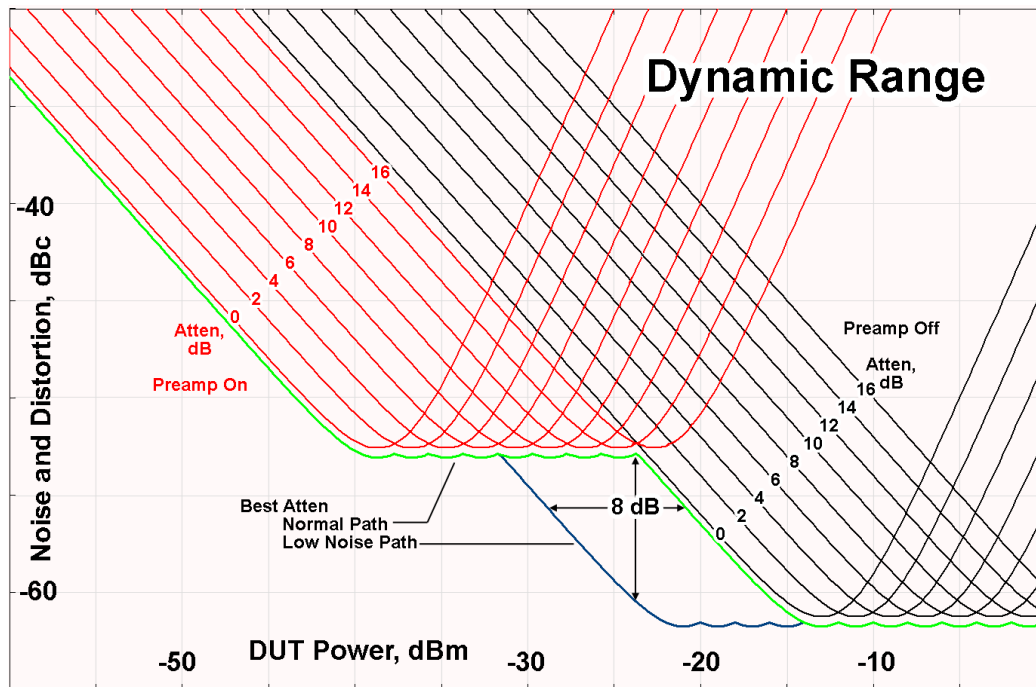

There are other times where selecting the low noise path improves performance, too. Compression-limited measurements such as finding the nulls in a pulsed-RF spectrum can profit from the low noise path in a way similar to the TOI-limited measurement illustrated. Accuracy can be improved when the low noise path allows the optimum attenuation to increase from a small amount like 0, 2 or 4 dB to a larger amount, giving better return loss at the analyzer input. Harmonic measurements, such as second and third harmonic levels, are much improved using the low noise path because of the superiority of that path for harmonic (though not intermodulation) distortion performance.

μW Preselector Bypass

This key toggles the preselector bypass switch for band 1 and higher. When the microwave preselector is on, the signal path is preselected. When the microwave preselector is off, the signal path is not preselected. The preselected path is the normal path for the analyzer.

The preselector is a tunable bandpass filter which prevents signals away from the frequency of interest from combining in the mixer to generate in-band spurious signals (images). The consequences of using a preselector filter are its limited bandwidth, the amplitude and phase ripple in its passband, and any amplitude and phase instability due to center frequency drift.

Option MPB or pre-selector bypass provides an unpreselected input mixer path for certain X-Series signal analyzers with frequency ranges above 3.6 GHz. This signal path allows a wider bandwidth and less amplitude variability, which is an advantage when doing modulation analysis and broadband signal analysis. The disadvantage is that, without the preselector, image signals will be displayed. Another disadvantage of bypassing the preselector is increased LO emission levels at the front panel input port.

Image responses are separated from the real signal by twice the 1st IF. For IF Paths of 10 MHz and 25 MHz, the 1st IF is 322.5 MHz, so the image response and the real signal will be separated by 645 MHz. The 1st IF will be different for other IF Path settings. When viewing a real signal and its corresponding image response in internal mixing, the image response will be to the left of the real signal.

Also, the image response and the real signal typically have the same amplitude and exhibit the same shape factor.

However, if Option FS1, Fast Sweep Capability, is enabled, the image response in the Swept SA measurement will appear lower in amplitude and have a much wider shape factor compared to the real signal.

Key Path	AMPTD Y Scale, μ W Path Control
Example	:POW:MW:PATH MPB
Dependencies	Key is blanked if current mode does not support it. Key is grayed out if mode supports it but current measurement does not support it. Key is blank unless Option MPB is present and licensed. If SCPI command sent when MPB not present, error -241, "Hardware missing; Option not installed" is generated.
Readback Text	μ W Preselector Bypass
Initial S/W Revision	A.04.00

Remote Command	[:SENSe] :POWer [:RF] :MW :PRESelector [:STATe] ON OFF 0 1 [:SENSe] :POWer [:RF] :MW :PRESelector [:STATe] ?
Example	:POW:MW:PRES OFF Bypasses the microwave preselector
Notes	The ON parameter sets the STD path (:POW:MW:PATH STD) The OFF parameter sets path MPB (:POW:MW:PATH MPB)
Preset	ON

Internal Preamp

Accesses a menu of keys that control the internal preamps. Turning on the preamp gives a better noise figure, but a poorer TOI to noise floor dynamic range. You can optimize this setting for your particular measurement.

The instrument takes the preamp gain into account as it sweeps. If you sweep outside of the range of the preamp the instrument will also account for that. The displayed result will always reflect the correct gain.

For some measurements, when the preamp is on and any part of the displayed frequency range is below the lowest frequency for which the preamp has specifications, a warning condition message appears in the status line. For example ,for a preamp with a 9 kHz lowest specified frequency: "Preamp: Accy unspec'd below 9 kHz".

Key Path	AMPTD Y Scale
Scope	Meas Global
Remote Command	[:SENSe] :POWer [:RF] :GAIN [:STATe] OFF ON 0 1 [:SENSe] :POWer [:RF] :GAIN [:STATe] ?
Dependencies	Preamp is not available on all hardware platforms. If the preamp is not present or is unlicensed, the

	key is not shown. The preamp is not available when the electronic/soft attenuator is enabled.
--	--

Couplings	<p>The act of connecting the U7227A USB Preamplifier to one of the analyzer's USB ports will cause the Internal Preamp to be switched on. When this happens an informational message will be generated: "Internal Preamp turned on for optimal operation with USB Preamp." Note that if the Internal Preamp was already on, there will be no change to the setting, but if it was Off it will be switched On, to Full Range.</p> <p>Note that this same action occurs when the SA mode is selected while the USB Preamp is connected to one of the analyzer's USB ports, if it is the first time that the SA mode has run since powerup, or if the last time the SA mode was running the USB Preamp was NOT connected.</p> <p>Subsequently disconnecting the USB Preamp from USB does not change the Internal Preamp setting nor restore the previous setting.</p>
Preset	OFF
State Saved	Saved in instrument state
Initial S/W Revision	Prior to A.02.00
Modified at S/W Revision	A.14.00

Key Path	AMPTD Y Scale, Internal Preamp
Scope	Meas Global
Remote Command	<pre>[:SENSe] : POWer [:RF] : GAIN : BAND LOW FULL [:SENSe] : POWer [:RF] : GAIN : BAND ?</pre>
Dependencies	<p>Preamp is not available on all hardware platforms. If the preamp is not present or is unlicensed, the key is not shown.</p> <p>If a POW:GAIN:BAND FULL command is sent when a low band preamp is available, the preamp band parameter is to LOW instead of FULL, and an "Option not installed" message is generated.</p>
Preset	LOW
State Saved	Saved in instrument state
Initial S/W Revision	Prior to A.02.00

Off

Turns the internal preamp off

Key Path	AMPTD Y Scale, Internal Preamp
Example	:POW:GAIN OFF
Readback	Off
Initial S/W Revision	Prior to A.02.00

Low Band

Sets the internal preamp to use only the low band.

The frequency range of the installed (optional) low-band preamp is displayed in square brackets on the Low Band key label.

Key Path	AMPTD Y Scale, Internal Preamp
Example	:POW:GAIN ON :POW:GAIN:BAND LOW
Readback	Low Band
Initial S/W Revision	Prior to A.02.00

Full Range

Sets the internal preamp to use its full range. The low band (0–3.6 GHz or 0–3GHz, depending on the model) is supplied by the low band preamp and the frequencies above low band are supplied by the high band preamp.

The frequency range of the installed (optional) preamp is displayed in square brackets on the Full Range key label. If the high band option is not installed the Full Range key does not appear.

Key Path	AMPTD Y Scale, Internal Preamp
Example	:POW:GAIN ON :POW:GAIN:BAND FULL
Readback	Full Range
Initial S/W Revision	Prior to A.02.00

Auto Scaling

Toggles the Auto Scaling function between On and Off.

Key Path	AMPTD Y Scale
Mode	SA, WCDMA, C2K, WIMAX OFDMA, TD-SCDMA, DVB-T/H, LTE, LTETDD, WLAN, MSR, LTEAFDD, LTEATDD
Remote Command	:DISPlay:SPURious:VIEW[1]:WINDow[1]:TRACe:Y[:SCALe]:COUPle 0 1 OFF ON :DISPlay:SPURious:VIEW[1]:WINDow[1]:TRACe:Y[:SCALe]:COUPle?
Example	DISP:SPUR:VIEW:WIND:TRAC:Y:COUP OFF DISP:SPUR:VIEW:WIND:TRAC:Y:COUP?
Couplings	When Auto Scaling is On and the Restart front-panel key is pressed, this function automatically determines the scale per division and reference values based on the measurement results. When you set a value to either Scale/Div or Ref Value manually, Auto Scaling automatically changes to Off.

	When the Y Auto Scaling is off, the measurement uses the current reference level settings. When the Y Auto Scaling is on, the analyzer automatically sets the reference level such that the absolute limit is positioned two divisions down from the top of the display. This is the most useful setting when searching for spurs. The algorithm used for determining the ref level is $\text{Ref Level} = \text{Absolute Limit} + (2 * \text{Scale/Div})$. All other reference level settings are left as the current base instrument settings.
Preset	1
State Saved	Saved in instrument state.
Range	On Off
Backwards Compatibility SCPI	[:SENSe] : SPURious : POWer [:RF] : RANGe : AUTO
Initial S/W Revision	Prior to A.02.00
Modified at S/W Revision	A.03.00

Auto Couple

The Auto Couple feature provides a quick and convenient way to automatically couple multiple instrument settings. This helps ensure accurate measurements and optimum dynamic range. When the Auto Couple feature is activated, either from the front panel or remotely, all parameters of the current measurement that have an Auto/Manual mode are set to Auto mode and all measurement settings dependent on (or coupled to) the Auto/Man parameters are automatically adjusted for optimal performance.

However, the Auto Couple key actions are confined to the current measurement only. It does not affect other measurements in the mode, and it does not affect markers, marker functions, or trace or display attributes.

See "[More Information](#)" on page 1225

Key Path	Front-panel key
Remote Command	:COUPle ALL NONE
Example	:COUP ALL
Notes	:COUPle ALL puts all Auto/Man parameters in Auto mode (equivalent to pressing the Auto Couple key). :COUPLE NONE puts all Auto/Man parameters in manual mode. It decouples all the coupled instrument parameters and is not recommended for making measurements.
Initial S/W Revision	Prior to A.02.00

More Information

There are two types of functions that have Auto/Manual modes.

Auto/Man Active Function keys

An Auto/Man toggle key controls the binary state associated with an instrument parameter by toggling between Auto (where the parameter is automatically coupled to the other parameters it is dependent upon) and Man (where the parameter is controlled independent of the other parameters), as well as making the parameter the active function. The current mode is indicated on the softkey with either Auto or Man underlined as illustrated below.



Auto/Man 1-of-N keys

An Auto/Man 1-of-N key allows you to manually pick from a list of parameter values, or place the function in Auto, in which case the value is automatically selected (and indicated) as shown below. If in Auto, Auto is underlined on the calling key. If in manual operation, manual is indicated on the calling key. But the calling key does not actually toggle the function, it simply opens the menu.

12 Spurious Emissions Measurement
Auto Couple

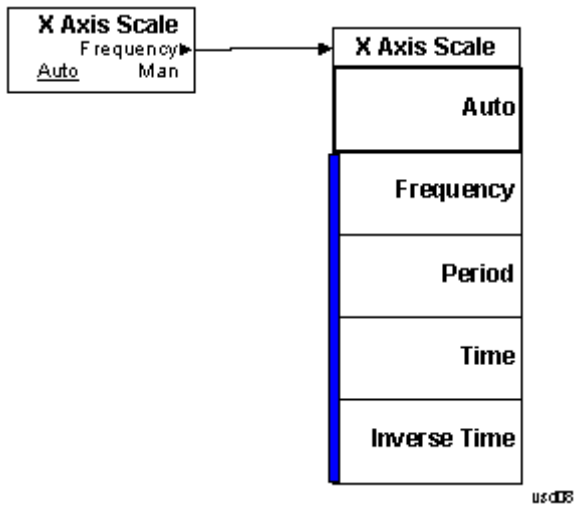

BW

BW is unavailable in the Spurious Emissions measurement. When pressed, this key displays a blank menu.

Key Path	Front-panel key
Initial S/W Revision	Prior to A.02.00

Cont (Continuous Measurement/Sweep)

Sets the analyzer for Continuous measurement operation. The single/continuous state is Meas Global so the setting will affect all measurements. If you are Paused, pressing Cont does a Resume.

Key Path	Front-panel key
Remote Command	:INITiate:CONTinuous OFF ON 0 1 :INITiate:CONTinuous?
Example	:INIT:CONT 0 puts analyzer in Single measurement operation. :INIT:CONT 1 puts analyzer in Continuous measurement operation
Preset	ON (Note that SYST:PRESet sets INIT:CONT to ON but *RST sets INIT:CONT to OFF)
State Saved	Saved in instrument state
Backwards Compatibility Notes	For Spectrum Analysis mode in ESA and PSA, there is no Cont hardkey, instead there is a Sweep Single/Cont key. In these analyzers, switching the Sweep Single/Cont key from Single to Cont restarts averages (displayed average count reset to 1), but does not restart Max Hold and Min Hold. The X-Series has Single and Cont keys in place of the SweepSingleCont key. In the X-Series, if in single measurement, the Cont key (and INIT:CONT ON) switches to continuous measurement, but never restarts a measurement and never resets a sweep.
Initial S/W Revision	Prior to A.02.00

In Swept SA Measurement (Spectrum Analysis Mode):

The analyzer takes repetitive sweeps, averages, measurements, etc., when in Continuous mode. When the average count reaches the Average/Hold Number the count stops incrementing, but the analyzer keeps sweeping. See the Trace/Detector section for the averaging formula used both before and after the Average/Hold Number is reached. The trigger condition must be met prior to each sweep. The type of trace processing for multiple sweeps, is set under the Trace/Detector key, with choices of Trace Average, Max Hold, or Min Hold.

In Other Measurements/Modes:

With Avg/Hold Num (in the Meas Setup menu) set to Off or set to On with a value of 1, a sweep is taken after the trigger condition is met; and the analyzer continues to take new sweeps after the current sweep has completed and the trigger condition is again met. However, with Avg/Hold Num set to On with a value >1, multiple sweeps (data acquisitions) are taken for the measurement. The trigger condition must be met prior to each sweep. The sweep is not stopped when the average count k equals the number N set for Avg/Hold Num is reached, but the number k stops incrementing. A measurement average usually applies to all traces, marker results, and numeric results. But sometimes it only applies to the numeric results.

If the analyzer is in Single measurement, pressing the Cont key does not change k and does not cause the sweep to be reset; the only action is to put the analyzer into Continuous measurement operation.

If it is already in continuous sweep:

the INIT:CONT 1 command has no effect

the INIT:CONT 0 command will place the analyzer in Single Sweep but will have no effect on the current sequence until $k = N$, at which point the current sequence will stop and the instrument will go to the idle state.

12 Spurious Emissions Measurement
File

File

See "File" on page 360

FREQ Channel

Accesses a menu of keys that allow you to control the Frequency and Channel parameters of the instrument.

Some features in the Frequency menu are the same for all measurements – they do not change as you change measurements. Settings like these are called “Meas Global” and are unaffected by Meas Preset. For example, the Center Freq setting is the same for all measurements – it does not change as you change measurements.

Key Path	Front-panel key
Initial S/W Revision	Prior to A.02.00

Center Freq

Sets the frequency that corresponds to the horizontal center of the graticule (when frequency Scale Type is set to linear). While adjusting the Center Frequency the Span is held constant, which means that both Start Frequency and Stop Frequency will change.

Pressing Center Freq also sets the frequency entry mode to Center/Span. In Center/Span mode, the center frequency and span values are displayed below the graticule, and the default active function in the Frequency menu is Center Freq.

The center frequency setting is the same for all measurements within a mode, that is, it is Meas Global. Some modes are also able to share a Mode Global center frequency value. If this is the case, the Mode will have a Global Settings key in its Mode Setup menu.

The Center Freq function sets (and queries) the Center Frequency for the currently selected input. If your analyzer has multiple inputs, and you select another input, the Center Freq changes to the value for that input. SCPI commands are available to directly set the Center Freq for a specific input.

Center Freq is remembered as you go from input to input. Thus you can set a Center Freq of 10 GHz with the RF Input selected, change to BBIQ and set a Center Freq of 20 MHz, then switch to External Mixing and set a Center Freq of 60 GHz, and when you go back to the RF Input the Center Freq will go back to 10 GHz; back to BBIQ and it is 20 MHz; back to External Mixing and it is 60 GHz.

See ["RF Center Freq" on page 1234](#)

See [Ext Mix Center Freq](#)

See ["I/Q Center Freq" on page 1236](#)

See ["Center Frequency Presets" on page 1232](#)

Key Path	FREQ Channel
Scope	Meas Global
Remote Command	[:SENSe] :FREQuency :CENTer <freq> [:SENSe] :FREQuency :CENTer?

Example	FREQ:CENT 50 MHz FREQ:CENT UP changes the center frequency to 150 MHz if you use FREQ:CENT:STEP 100 MHz to set the center frequency step size to 100 MHz FREQ:CENT?
Notes	This command sets either the RF or I/Q Center Frequency depending on the selected input. For RF input it is equivalent to FREQ:RF:CENT For I/Q input it is equivalent to FREQ:IQ:CENT Preset and Max values are dependent on Hardware Options (5xx) If no terminator (e.g. MHz) is sent the terminator Hz is used. If a terminator with unit other than Frequency is used, an invalid suffix error message is generated.
Dependencies	The Center Frequency can be limited by Start or Stop Freq limits, if the Span is so large that Start or Stop reach their limit.
Couplings	When operating in “swept span”, any value of the Center Frequency or Span that is within the frequency range of the analyzer is allowed when the value is being set through the front panel numeric key pad or the SCPI command. The other parameter is forced to a different value if needed, to keep the Start and the Stop Frequencies within the analyzer’s frequency range
Preset	Depends on instrument maximum frequency, mode, measurement, and selected input. See "Center Frequency Presets" on page 1232 and "RF Center Freq" on page 1234 and Ext Mix Center Freq and "I/Q Center Freq" on page 1236 .
State Saved	Saved in instrument state
Min	Depends on instrument maximum frequency, mode, measurement, and selected input.. See "Center Frequency Presets" on page 1232 and "RF Center Freq" on page 1234 and "I/Q Center Freq" on page 1236 .
Max	Depends on instrument maximum frequency, mode, measurement, and selected input.. See "Center Frequency Presets" on page 1232 and "RF Center Freq" on page 1234 and "I/Q Center Freq" on page 1236 .
Default Unit	Hz
Status Bits/OPC	Non-overlapped
Dependencies	
Initial S/W Revision	Prior to A.02.00

Center Frequency Presets

The following table provides the Center Frequency Presets for the Spectrum Analyzer mode, and the Max Freq, for the various frequency options:

Freq Option	CF after Mode Preset	Stop Freq after Mode Preset	Max Freq (can't tune)
-------------	-------------------------	--------------------------------	-----------------------------

			above)
503 (all but N9000A)	1.805 GHz	3.6 GHz	3.7 GHz
503 (N9000A)	1.505 GHz	3.0 GHz	3.08 GHz
507 (all but N9000A)	3.505 GHz	7.0 GHz	7.1 GHz
507 (N9000A)	3.755 GHz	7.5 GHz	7.58 GHz
508 (all but N9038A)	1.805 GHz	3.6 GHz	8.5 GHz
508 (N9038A)	4.205 GHz	8.4 GHz	8.5 GHz
513	6.805 GHz	13.6 GHz	13.8 GHz
526 (all but N9000A and N9038A)	13.255 GHz	26.5 GHz	27.0 GHz
526 (N9000A)	13.255 GHz	26.5 GHz	26.55 GHz
526 (N9038A)	1.805 GHz	3.6 GHz	27.0 GHz
532	16.005 GHz	32.0 GHz	32.5 GHz
543	21.505 GHz	43.0 GHz	TBD
544	22.005 GHz	44.0 GHz	44.5 GHz
550	25.005 GHz	50.0 GHz	51 GHz

Input 2:

Model	CF after Mode Preset	Stop Freq after Mode Preset	Max Freq (can't tune above)
N9000A opt C75	0.7505GHz	1.5 GHz	1.58 GHz
N9038A	505 MHz	1 GHz	1.000025 GHz

Tracking Generator Frequency Limits (N9000A only):

Tracking Generator Option	Min Freq (clips to this freq when turn TG on and	If above this Freq, Stop Freq clipped to this Freq when	Max Freq (can't tune above) while TG

	can't tune below while TG on)	TG turned on	on
T03	9 kHz	3.0 GHz	3.08 GHz
T06	9 kHz	6.0 GHz	6.05 GHz

The following table shows the Center Frequency Presets for modes other than Spectrum Analyzer:

Mode	CF Preset for RF
WCDMA	1 GHz
WIMAXOFDMA,	1 GHz
BASIC	1 GHz
ADEMOD	1 GHz
VSA	1 GHz
TDSCDMA	1 GHz
PNOISE	1 GHz
LTE	1 GHz
LTETDD	1 GHz
MSR	1 GHz
GSM	935.2 MHz
NFIGURE	1.505 GHz

RF Center Freq

SCPI command for specifying the RF Center Frequency. This command will set the Center Frequency to be used when the RF input is selected, even if the RF input is not the input that is selected at the time the command is sent. Note that the Center Freq function in the Frequency menu on the front panel always applies to the currently selected input.

Scope	Meas Global
Remote Command	<code>[:SENSe] :FREQuency:RF:CENTer <freq></code> <code>[:SENSe] :FREQuency:RF:CENTer?</code>
Example	FREQ:RF:CENT 30 MHz
Notes	This command is the same in all modes, but the parameter is Measurement Global. So the value is independent in each mode and common across all the measurements in the mode.
Dependencies	If the electronic/soft attenuator is enabled, any attempt to set Center Frequency such that the Stop Frequency would be >3.6 GHz fails and results in an advisory message. If the equivalent SCPI command is sent, this same message is generated as part of a “-221, Settings conflict” warning. If Source Mode is set to Tracking, and the Max or Min Center Freq is therefore limited by the limits of the source, a warning message is generated, “Data out of range;clipped to source max/min” if these limits are exceeded. Note that for an external source, these limits can be affected by the settings of

	Source Numerator, Source Denominator and Power Sweep.
Preset	See table above
State Saved	Saved in instrument state.
Min	-79.999995 MHz, unless Source Mode is set to Tracking, in which case it is limited by the minimum frequency of the Source
Max	See table above. Basically instrument maximum frequency - 5 Hz. Note that, if the Source Mode is set to Tracking, the effective instrument maximum frequency may be limited by the source maximum frequency. If the knob or step keys are being used, also depends on the value of the other three interdependent parameters Span, Start Frequency and Stop Frequency
Initial S/W Revision	Prior to A.02.00
Modified at S/W Revision	A.03.00

Ext Mix Center Freq

SCPI command for specifying the External Mixer Center Frequency. This command will set the Center Frequency to be used when the External Mixer is selected, even if the External Mixer input is not the input which is selected at the time the command is sent. Note that the Center Freq function in the Frequency menu on the front panel always applies to the currently selected input.

Scope	Meas Global
Remote Command	<code>[:SENSe] :FREQuency:EMIXer:CENTer <freq></code> <code>[:SENSe] :FREQuency:EMIXer:CENTer?</code>
Example	<code>:FREQ:EMIX:CENT 60 GHz</code> <code>:FREQ:EMIX:CENT?</code>
Notes	This command is the same in all modes, but the parameter is Measurement Global. So the value is independent in each mode and common across all the measurements in the mode.
Couplings	When returning to External Mixing after having been switched to one of the other inputs (e.g., RF), you will come back into the settings that you had when you left External Mixing. So you will come back to the band you were in with the Center Frequency that you had. However, Span is not an input-dependent parameter, therefore you will bring the span over from the other input. Therefore, the analyzer comes back with the span from the previous input, limited as necessary by the current mixer setup.
Preset	When a Mode Preset is performed while in External Mixing, the Start frequency of the current Mode is set to the nominal Min Freq of the lowest harmonic range in the Harmonic Table for the current mixer setup. Similarly, the Stop frequency of the current Mode is set to the nominal Max Freq of the highest harmonic range in the Harmonic Table. The Center Freq thus presets to the point arithmetically equidistant from these two frequencies. If the current measurement has a limited Span available to it, and cannot achieve the Span shown in the table ($\text{Span} = \text{Stop Freq} - \text{Start Freq}$), the analyzer uses the maximum Span the measurement allows, and still sets the Center Freq to the midpoint of the Start and Stop Freq values in the Harmonic Table.

	<p>When Restore Input/Output Defaults is performed, the mixer presets to the 11970A, whose Start and Stop frequencies are 26.5 and 40 GHz respectively. The center of these two frequencies is 33.25 GHz.</p> <p>Therefore, after a Restore Input/Output Defaults, if you go into External Mixing and do a Mode Preset while in the Spectrum Analyzer Mode, the resulting Center Freq is 33.25 GHz.</p>
State Saved	Saved in instrument state.
Min	The minimum frequency in the currently selected mixer band + 5 Hz
Max	The maximum frequency in the currently selected mixer band – 5 Hz If the knob or step keys are being used, also depends on the value of the other three interdependent parameters Span, Start Frequency and Stop Frequency
Initial S/W Revision	A.08.01

I/Q Center Freq

SCPI command for specifying the I/Q Center Frequency. This command will set the Center Frequency to be used when the I/Q input is selected, even if the I/Q input is not the input which is selected at the time the command is sent. Note that the Center Freq function in the Frequency menu on the front panel always applies to the currently selected input.

Scope	Meas Global
Remote Command	<pre>[:SENSe] :FREQuency:IQ:CENTer <freq></pre> <pre>[:SENSe] :FREQuency:IQ:CENTer?</pre>
Example	FREQ:IQ:CENT: 30 MHz
Notes	This command is the same in all modes, but the parameter is Measurement Global. So the value is independent in each mode and common across all the measurements in the mode.
Preset	0 Hz
State Saved	Saved in instrument state.
Min	-40.049995 MHz
Max	40.049995 MHz
Initial S/W Revision	Prior to A.02.00

CF Step

Changes the step size for the center frequency and start and stop frequency functions. Once a step size has been selected and the center frequency function is active, the step keys (and the UP|DOWN parameters for Center Frequency from remote commands) change the center frequency by the step-size value. The step size function is useful for finding harmonics and sidebands beyond the current frequency span of the analyzer.

Note that the start and stop frequencies also step by the CF Step value.

Key Path	FREQ Channel
Remote Command	[:SENSe]:FREQuency:CENTer:STEP[:INCRement] <freq> [:SENSe]:FREQuency:CENTer:STEP[:INCRement]? [:SENSe]:FREQuency:CENTer:STEP:AUTO OFF ON 0 1 [:SENSe]:FREQuency:CENTer:STEP:AUTO?
Example	FREQ:CENT:STEP:AUTO ON FREQ:CENT:STEP 500 MHz FREQ:CENT UP increases the current center frequency value by 500 MHz FREQ:CENT:STEP? FREQ:CENT:STEP:AUTO?
Notes	Preset and Max values are depending on Hardware Options (503, 507, 508, 513, 526)
Notes	Preset and Max values are dependent on Hardware Options (5xx)
Dependencies	Freq Offset is not available in External Mixing. In this case the Freq Offset key is grayed out and shows a value of zero. It will once again be available, and show the previously set value, when you return to the RF Input.
Dependencies	Span, RBW, Center frequency If the electronic/soft attenuator is enabled, any attempt to change the value of the center frequency >3.6 GHz by pressing the Up-arrow key, fails and results in an advisory message. If the equivalent SCPI command is sent, this same message is generated as part of a “-221, Settings conflict” warning.
Couplings	When auto-coupled in a non-zero span, the center frequency step size is set to 10% of the span. When auto-coupled in zero span, the center frequency step size is set to the equivalent -3 dB RBW value.
Preset	Auto ADEMOD: 1 MHz ON
State Saved	Saved in instrument state
Min	– (the maximum frequency of the instrument). That is, 27 GHz max freq instrument has a CF step range of +/- 27 GHz. Note that this is the maximum frequency given the current settings of the instrument, so in External Mixing, for example, it is the maximum frequency of the current mixer band.
Max	The maximum frequency of the instrument. That is, 27 GHz max freq instrument has a CF step range of +/- 27 GHz. Note that this is the maximum frequency given the current settings of the instrument, so in External Mixing, for example, it is the maximum frequency of the current mixer band.
Default Unit	Hz
Status Bits/OPC dependencies	non-overlapped
Initial S/W Revision	Prior to A.02.00
Modified at S/W Revision	A.03.00

12 Spurious Emissions Measurement
Input/Output

Input/Output

See "[Input/Output](#)" on page 224

Marker

Displays the menu keys that enable you to select, set up and control the markers for the current measurement.

Key Path	Front-panel key
Initial S/W Revision	Prior to A.02.00

Select Marker

Displays 12 markers available for selection.

Key Path	Marker
Initial S/W Revision	Prior to A.02.00

Marker Type

Sets the marker control mode to Normal, Delta and Off. Normal enables you to activate the selected marker to read the power level and time. Delta enables you to read the differences in the power levels and time scales between the selected marker and the next marker. Off enables you to turn off the selected marker.

All interactions and dependencies detailed under the key description are enforced when the remote command is sent.

Key Path	Marker
Mode	SA, WCDMA, C2K, WIMAX OFDMA, TD-SCDMA, 1xEV-DO, DVB-T/H, LTE, LTETDD, WLAN, MSR, LTEAFDD, LTEATDD
Remote Command	:CALCulate:SPURious:MARKer[1] 2 ... 12:MODE POSition DELTa OFF :CALCulate:SPURious:MARKer[1] 2 ... 12:MODE?
Example	CALC:SPUR:MARK:MODE POS CALC:SPUR:MARK:MODE?
Notes	<p>If the selected marker is Off, pressing Marker sets it to Normal and places it at the center of the screen on the trace determined by the Marker Trace rules. At the same time, Marker X Axis Value appears on the Active Function area.</p> <p>Default Active Function: the active function for the selected marker's current control mode. If the current control mode is Off, there is no active function and the active function is turned off.</p> <p>Active Function Display: the marker X axis value entered in the active function area will display the marker value to its full entered precision.</p> <p>You must be in the cdma2000 mode, 1xEV-DO mode, TD-SCDMA mode, W-CDMA mode, DVB-T/H mode, GSM/EDGE mode, LTE mode, LTE TDD mode, WLAN mode, MSR, LTE-Advanced FDD/TDD mode or WiMAX mode to use this command. Use INSTRument:SElect to set the mode.</p>

Preset	=OFF
State Saved	Saved in instrument state.
Range	Normal Delta Off
Initial S/W Revision	Prior to A.02.00
Modified at S/W Revision	A.03.00

Properties

Accesses the Properties menu to set certain properties of the selected marker.

Key Path	Marker
Initial S/W Revision	Prior to A.02.00

Select Marker

Displays 12 markers available for selection.

Key Path	Marker
Initial S/W Revision	Prior to A.02.00

Relative To

Selects the marker the selected marker will be relative to (its reference marker).

Every marker has another marker to which it is relative. This marker is referred to as the "reference marker" for that marker. This attribute is set by the Marker, Properties, Relative To key. The marker must be a Delta marker to make this attribute relevant. If it is a Delta marker, the reference marker determines how the marker is controlled and how its value is displayed. A marker cannot be relative to itself.

Key Path	Marker, Properties
Mode	SA, WCDMA, C2K, WIMAX OFDMA, TD-SCDMA, 1xEV-DO, DVB-T/H, LTE, LTE TDD, WLAN, MSR, LTE FDD, LTE TDD
Remote Command	:CALCulate:SPURious:MARKer[1] 2 ... 12:REFerence <integer> :CALCulate:SPURious:MARKer[1] 2 ... 12:REFerence?
Example	CALC:SPUR:MARK3:REF 5 CALC:SPUR:MARK:REF?
Notes	A marker cannot be relative to itself so that choice is grayed out, and if sent from SCPI generates error -221: "Settings conflict; marker cannot be relative to itself." When queried a single value will be returned (the specified marker numbers relative marker). You must be in the Spectrum Analysis mode, GSM mode, LTE mode, LTE TDD mode, WLAN mode, MSR, LTE-Advanced FDD/TDD mode or WiMAX mode or TD-SCDMA mode to use this command.

	Use INSTRument:SElect to set the mode.
Preset	2 3 4 5 6 7 8 9 10 11 12 1
State Saved	Saved in instrument state.
Min	1
Max	12
Initial S/W Revision	Prior to A.02.00
Modified at S/W Revision	A.03.00

Couple Markers

When this function is true, moving any marker causes an equal X Axis movement of every other marker which is not Off. By “equal X Axis movement” we mean that we preserve the difference between each marker’s X Axis value (in the fundamental x-axis units of the trace that marker is on) and the X Axis value of the marker being moved (in the same fundamental x-axis units).

Key Path	Marker
Mode	SA, WCDMA, C2K, WIMAX OFDMA, TD-SCDMA, 1xEV-DO, DVB-T/H, LTE, LTETDD, WLAN, MSR, LTEAFDD, LTEATDD
Remote Command	:CALCulate:SPURious:MARKer:COUPle[:STATe] ON OFF 1 0 :CALCulate:SPURious:MARKer:COUPle[:STATe]?
Example	CALC:SPUR:MARK:COUP ON CALC:SPUR:MARK:COUP?
Preset	OFF
State Saved	Saved in instrument state.
Range	On Off
Initial S/W Revision	Prior to A.02.00
Modified at S/W Revision	A.03.00

All Markers Off

Turns off all markers.

Key Path	Marker
Mode	SA, WCDMA, C2K, WIMAX OFDMA, TD-SCDMA, 1xEV-DO, DVB-T/H, LTE, LTETDD, WLAN, MSR, LTEAFDD, LTEATDD
Remote Command	:CALCulate:SPURious:MARKer:AOff
Example	CALC:SPUR:MARK:AOff
Initial S/W Revision	Prior to A.02.00
Modified at S/W Revision	A.03.00

Marker X Axis Value (Remote Command only)

Sets the Marker X Axis value in the current marker X Axis Scale unit. It has no effect if the control mode is Off, but is the SCPI equivalent of entering an X value if the control mode is Normal or Delta.

Mode	SA, WCDMA, C2K, WIMAX OFDMA, TD-SCDMA, DVB-T/H, LTE, LTE-TDD, WLAN, MSR, LTE-FDD, LTE-TDD
Remote Command	:CALCulate:SPURious:MARKer[1] 2 ... 12:X <freq> :CALCulate:SPURious:MARKer[1] 2 ... 12:X?
Example	CALC:SPUR:MARK2:X 25 kHz CALC:SPUR:MARK3:X?
Notes	If no suffix is sent it will use the fundamental units for the current marker X Axis Scale. If a suffix is sent that does not match the current marker X Axis Scale unit, an error "Invalid suffix" will be generated. The query returns the absolute X Axis marker value if the control mode is Normal, or the offset from the reference marker if the control mode is Delta. The query is returned in the fundamental units for the current marker X Axis scale: Hz for Frequency and Inverse Time, seconds for Period and Time. If the marker is Off, the response is not a number.
Preset	1 GHz
State Saved	No
Min	-9.9E+37
Max	9.9E+37
Initial S/W Revision	Prior to A.02.00
Modified at S/W Revision	A.03.00

Marker X Axis Position (Remote Command only)

Sets the Marker X position in trace points. It has no effect if the control mode is Off, but is the SCPI equivalent of entering a value if the control mode is Normal or Delta - except in trace points rather than X Axis Scale units. The entered value is immediately translated into the current X Axis Scale units for setting the value of the marker.

Mode	SA, WCDMA, C2K, WIMAX OFDMA, TD-SCDMA, 1xEV-DO, DVB-T/H, LTE, LTE-TDD, WLAN, MSR, LTE-FDD, LTE-TDD
Remote Command	:CALCulate:SPURious:MARKer[1] 2 ... 12:X:POSition <integer> :CALCulate:SPURious:MARKer[1] 2 ... 12:X:POSition?
Example	CALC:SPUR:MARK10:X:POS 300 CALC:SPUR:MARK10:X:POS?
Notes	The query returns the absolute X Axis marker value in trace points if the control mode is Normal, or the offset from the reference marker in trace points if the control mode is Delta. The value is returned as a real number, not an integer, corresponding to the translation from X Axis Scale units to trace points. If the marker is Off the response is not a number.
Preset	300

State Saved	No
Min	-9.9E+37
Max	9.9E+37
Initial S/W Revision	Prior to A.02.00
Modified at S/W Revision	A.03.00

Marker Y Axis Value (Remote Command only)

Returns the marker Y Axis value in the current marker Y Axis unit.

Mode	SA, WCDMA, C2K, WIMAX OFDMA, TD-SCDMA, 1xEV-DO, DVB-T/H, LTE, LTE-TDD, WLAN, MSR, LTEAFDD, LTEATDD
Remote Command	:CALCulate:SPURious:MARKer[1] 2 ... 12:Y?
Example	CALC:SPUR:MARK11:Y?
Notes	If no suffix is sent, it will use the current Y Axis unit. If a suffix is sent that does not have units of absolute amplitude, an error "Invalid suffix" will be generated.
Preset	Depends on Y axis range of selected Trace.
State Saved	No
Initial S/W Revision	Prior to A.02.00
Modified at S/W Revision	A.03.00

Marker Function

There are no 'Marker Functions' supported in Spurious Emissions so this front-panel key displays a blank menu when pressed.

Key Path	Front-panel key
Initial S/W Revision	Prior to A.02.00

Marker To

There is no 'Marker To' functionality supported in Spurious Emissions, so this front-panel key displays a blank menu when pressed.

Key Path	Front-panel key
Initial S/W Revision	Prior to A.02.00

Meas

The information in this section is common to all measurements. For key and remote command information for a specific measurement, refer to the section that describes the measurement of interest.

Measurements available under the Meas key are specific to the current Mode.

When viewing Help for measurements, note the following:

NOTE

Operation for some keys differs between measurements. The information displayed in Help pertains to the current measurement. To see how a key operates in a different measurement, exit Help (press the Cancel Esc key), select the measurement, then reenter Help (press the Help key) and press that key.

Key Path	Front-panel key
Initial S/W Revision	Prior to A.02.00

Remote Measurement Functions

This section contains the following topics:

["Measurement Group of Commands" on page 2771](#)

["Current Measurement Query \(Remote Command Only\)" on page 2773](#)

["Limit Test Current Results \(Remote Command Only\)" on page 2773](#)

["Data Query \(Remote Command Only\)" on page 2773](#)

["Calculate/Compress Trace Data Query \(Remote Command Only\)" on page 2774](#)

["Calculate Peaks of Trace Data \(Remote Command Only\)" on page 2779](#)

[Hardware-Accelerated Fast Power Measurement \(Remote Command Only\)](#)

["Format Data: Numeric Data \(Remote Command Only\)" on page 2780](#)

["Format Data: Byte Order \(Remote Command Only\)" on page 2781](#)

Initial S/W Revision	Prior to A.02.00
----------------------	------------------

Measurement Group of Commands

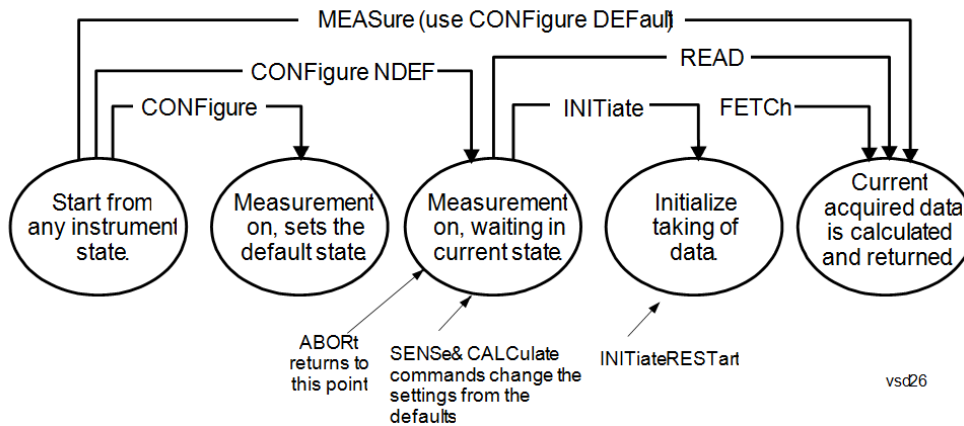

Measure Commands:

:MEASure:<measurement>[n]?

This is a fast single-command way to make a measurement using the factory default instrument settings. These are the settings and units that conform to the Mode Setup settings (e.g. radio standard) that you have currently selected.

- Stops the current measurement (if any) and sets up the instrument for the specified measurement using the factory defaults
- Initiates the data acquisition for the measurement
- Blocks other SCPI communication, waiting until the measurement is complete before returning results.
- If the function does averaging, it is turned on and the number of averages is set to 10.
- After the data is valid it returns the scalar results, or the trace data, for the specified measurement. The type of data returned may be defined by an [n] value that is sent with the command.
- The scalar measurement results will be returned if the optional [n] value is not included, or is set to 1. If the [n] value is set to a value other than 1, the selected trace data results will be returned. See each command for details of what types of scalar results or trace data results are available.
- ASCII is the default format for the data output. (Older versions of Spectrum Analysis and Phase Noise mode measurements only use ASCII.) The binary data formats should be used for handling large blocks of data since they are smaller and faster than the ASCII format. Refer to the FORMat:DATA command for more information.

If you need to change some of the measurement parameters from the factory default settings you can set up the measurement with the CONFIGure command. Use the commands in the SENSe:<measurement> and CALCulate:<measurement> subsystems to change the settings. Then you can use the READ? command to initiate the measurement and query the results.

If you need to repeatedly make a given measurement with settings other than the factory defaults, you can use the commands in the SENSe:<measurement> and CALCulate:<measurement> subsystems to set up the measurement. Then use the READ? command to initiate the measurement and query results.

Measurement settings persist if you initiate a different measurement and then return to a previous one. Use READ:<measurement>? if you want to use those persistent settings. If you want to go back to the default settings, use MEASure:<measurement>?.

Configure Commands:

:CONFigure:<measurement>

This command stops the current measurement (if any) and sets up the instrument for the specified measurement using

the factory default instrument settings. It does not initiate the taking of measurement data unless INIT:CONTinuous is ON. If you change any measurement settings after using the CONFigure command, the READ command can be used to initiate a measurement without changing the settings back to their defaults.

In the Swept SA measurement in Spectrum Analyzer mode the CONFigure command also turns the averaging function on and sets the number of averages to 10 for all measurements.

:CONFigure: <measurement>: NDEFault stops the current measurement and changes to the specified measurement. It does not change the settings to the defaults. It does not initiate the taking of measurement data unless INIT:CONTinuous is ON.

The CONFigure? query returns the current measurement name.

The CONFigure:CATalog? query returns a quoted string of all licensed measurement names in the current mode. For example, "SAN, CHP, OBW, ACP, PST, TXP, SPUR, SEM, LIST".

Fetch Commands:

:FETCh:<measurement>[n]?

This command puts selected data from the most recent measurement into the output buffer. Use FETCh if you have already made a good measurement and you want to return several types of data (different [n] values, for example, both scalars and trace data) from a single measurement. FETCh saves you the time of re-making the measurement. You can only FETCh results from the measurement that is currently active, it will not change to a different measurement. An error message is reported if a measurement other than the current one is specified.

If you need to get new measurement data, use the READ command, which is equivalent to an INITiate followed by a FETCh.

The scalar measurement results will be returned if the optional [n] value is not included, or is set to 1. If the [n] value is set to a value other than 1, the selected trace data results will be returned. See each command for details of what types of scalar results or trace data results are available. The binary data formats should be used for handling large blocks of data since they are smaller and transfer faster than the ASCII format. (FORMat:DATA)

FETCh may be used to return results other than those specified with the original READ or MEASure command that you sent.

INITiate Commands:

:INITiate:<measurement>

This command is not available for measurements in all the instrument modes:

- Initiates a trigger cycle for the specified measurement, but does not output any data. You must then use the FETCh<meas> command to return data. If a measurement other than the current one is specified, the instrument will switch to that measurement and then initiate it.
 - For example, suppose you have previously initiated the ACP measurement, but now you are running the channel power measurement. If you send INIT:ACP? it will change from channel power to ACP and will initiate an ACP measurement.
 - Does not change any of the measurement settings. For example, if you have previously started the ACP measurement and you send INIT:ACP? it will initiate a new ACP measurement using the same instrument settings as the last time ACP was run.
 - If your selected measurement is currently active (in the idle state) it triggers the measurement, assuming the trigger conditions are met. Then it completes one trigger cycle. Depending upon the measurement and the number of averages, there may be multiple data acquisitions, with multiple trigger events, for one full trigger cycle. It also holds off additional commands on GPIB until the acquisition is complete.
-

READ Commands:

:READ:<measurement>[n]?

- Does not preset the measurement to the factory default settings. For example, if you have previously initiated the ACP
-

measurement and you send READ:ACP? it will initiate a new measurement using the same instrument settings.

- Initiates the measurement and puts valid data into the output buffer. If a measurement other than the current one is specified, the instrument will switch to that measurement before it initiates the measurement and returns results.
 - For example, suppose you have previously initiated the ACP measurement, but now you are running the channel power measurement. Then you send READ:ACP? It will change from channel power back to ACP and, using the previous ACP settings, will initiate the measurement and return results.
 - Blocks other SCPI communication, waiting until the measurement is complete before returning the results
 - If the optional [n] value is not included, or is set to 1, the scalar measurement results will be returned. If the [n] value is set to a value other than 1, the selected trace data results will be returned. See each command for details of what types of scalar results or trace data results are available. The binary data formats should be used when handling large blocks of data since they are smaller and faster than the ASCII format. (FORMat:DATA)
-

Initial S/W Revision	Prior to A.02.00
----------------------	------------------

Current Measurement Query (Remote Command Only)

This command returns the name of the measurement that is currently running.

Remote Command	:CONFigure?
-----------------------	-------------

Example	CONF?
----------------	-------

Initial S/W Revision	Prior to A.02.00
----------------------	------------------

Limit Test Current Results (Remote Command Only)

Queries the status of the current measurement limit testing. It returns a 0 if the measured results pass when compared with the current limits. It returns a 1 if the measured results fail any limit tests.

Remote Command	:CALCulate:CLIMits:FAIL?
-----------------------	--------------------------

Example	CALC:CLIM:FAIL? queries the current measurement to see if it fails the defined limits. Returns a 0 or 1: 0 it passes, 1 it fails.
----------------	--

Initial S/W Revision	Prior to A.02.00
----------------------	------------------

Data Query (Remote Command Only)

Returns the designated measurement data for the currently selected measurement and subopcode.

n = any valid subopcode for the current measurement. See the measurement command results table for your current measurement, for information about what data is returned for the subopcodes.

This command uses the data setting specified by the FORMat:BORDER and FORMat:DATA commands and can return real or ASCII data. (See the format command descriptions under Input/Output in the Analyzer Setup section.)

Remote Command	:CALCulate:DATA[n]?
Notes	The return trace depends on the measurement. In CALCulate:<meas>:DATA[n], n is any valid subopcode for the current measurement. It returns the same data as the FETCH:<measurement>? query where <measurement> is the current measurement.
Initial S/W Revision	Prior to A.02.00

Calculate/Compress Trace Data Query (Remote Command Only)

Returns compressed data for the currently selected measurement and sub-opcode [n].

n = any valid sub-opcode for that measurement. See the MEASure:<measurement>? command description of your specific measurement for information on the data that can be returned.

The data is returned in the current Y Axis Unit of the analyzer. The command is used with a sub-opcode <n> (default=1) to specify the trace. With trace queries, it is best if the analyzer is not sweeping during the query. Therefore, it is generally advisable to be in Single Sweep, or Update=Off.

This command is used to compress or decimate a long trace to extract and return only the desired data. A typical example would be to acquire N frames of GSM data and return the mean power of the first burst in each frame. The command can also be used to identify the best curve fit for the data.

Remote Command	:CALCulate:DATA<n>:COMPRESS? BLOCK CFIT MAXimum MINimum MEAN DMEan RMS RMSCubed SAMPLE SDEVIation PPHase [,<soffset> [,<length>[,<roffset>[,<rlimit>]]]]
Example	To query the mean power of a set of GSM bursts: Supply a signal that is a set of GSM bursts. Select the IQ Waveform measurement (in IQ Analyzer Mode). Set the sweep time to acquire at least one burst. Set the triggers such that acquisition happens at a known position relative to a burst. Then query the mean burst levels using, CALC:DATA2:COMP? MEAN, 24e-6, 526e-6 (These parameter values correspond to GSM signals, where 526e-6 is the length of the burst in the slot and you just want 1 burst.)
Notes	The command supports 5 parameters. Note that the last 4 (<soffset>, <length>, <roffset>, <rlimit>) are optional. But these optional parameters must be entered in the specified order. For example, if you want to specify <length>, then you must also specify <soffset>. See details below for a definition of each of these parameters. This command uses the data in the format specified by FORMat:DATA, returning either binary or ASCII data.
Initial S/W Revision	Prior to A.02.00

- BLOCK or block data - returns all the data points from the region of the trace data that you specify. For example, it could be used to return the data points of an input signal over several timeslots, excluding the portions of the trace data that you do not want. (This is x,y pairs for trace data and I,Q pairs for complex data.)

- CFIT or curve fit - applies curve fitting routines to the data. <soffset> and <length> are required to define the data that you want. <roffset> is an optional parameter for the desired order of the curve equation. The query will return the following values: the x-offset (in seconds) and the curve coefficients ((order + 1) values).

MIN, MAX, MEAN, DME, RMS, RMSC, SAMP, SDEV and PPH return one data value for each specified region (or <length>) of trace data, for as many regions as possible until you run out of trace data (using <roffset> to specify regions). Or they return the number of regions you specify (using <rlimit>) ignoring any data beyond that.

- MINimum - returns the minimum data point (y value) for the specified region(s) of trace data. For I/Q trace data, the minimum magnitude of the I/Q pairs is returned.
- MAXimum - returns the maximum data point (y value) for the specified region(s) of trace data. For I/Q trace data, the maximum magnitude of the I/Q pairs is returned.
- MEAN - returns a single value that is the arithmetic mean of the data point values (in dB/ dBm) for the specified region(s) of trace data. For I/Q trace data, the mean of the magnitudes of the I/Q pairs is returned. See the following equations.

-

NOTE

If the original trace data is in dB, this function returns the arithmetic mean of those log values, not log of the mean power which is a more useful value. The mean of the log is the better measurement technique when measuring CW signals in the presence of noise. The mean of the power, expressed in dB, is useful in power measurements such as Channel Power. To achieve the mean of the power, use the RMS option.

Equation 1

Mean Value of Data Points for Specified Region(s)

$$\text{MEAN} = \frac{1}{n} \sum_{X_i \in \text{region}(s)} X_i$$

where X_i is a data point value, and n is the number of data points in the specified region(s).

Equation 2

Mean Value of I/Q Data Pairs for Specified Region(s)

$$\text{MEAN} = \frac{1}{n} \sum_{X_i \in \text{region}(s)} |X_i|$$

where $|X_i|$ is the magnitude of an I/Q pair, and n is the number of I/Q pairs in the specified region(s).

- DMEan - returns a single value that is the mean power (in dB/ dBm) of the data point values for the specified region(s) of trace data. See the following equation:

Equation 3

DMEan Value of Data Points for Specified Region(s)

$$DME = 10 \times \log_{10} \left(\frac{1}{n} \sum_{X_i \in \text{region}(s)} 10^{\frac{X_i}{10}} \right)$$

- RMS - returns a single value that is the average power on a root-mean-squared voltage scale (arithmetic rms) of the data point values for the specified region(s) of trace data. See the following equation.

NOTE

For I/Q trace data, the rms of the magnitudes of the I/Q pairs is returned. See the following equation. This function is very useful for I/Q trace data. However, if the original trace data is in dB, this function returns the rms of the log values which is not usually needed.

Equation 4

RMS Value of Data Points for Specified Region(s)

$$RMS = \sqrt{\frac{1}{n} \sum_{X_i \in \text{region}(s)} X_i^2}$$

where X_i is a data point value, and n is the number of data points in the specified region(s).

Equation 5

RMS Value of I/Q Data Pairs for Specified Region(s)

$$RMS = \sqrt{\frac{1}{n} \sum_{X_i \in \text{region}(s)} X_i X_i^*}$$

where X_i is the complex value representation of an I/Q pair, X_i^* its conjugate complex number, and n is the number of I/Q pairs in the specified region(s).

Once you have the rms value for a region of trace data (linear or I/Q), you may want to calculate the mean power. You must convert this rms value (peak volts) to power in dBm:

$$10 \times \log[10 \times (\text{rms value})^2]$$

- SAMPlE - returns the first data value (x,y pair) for the specified region(s) of trace data. For I/Q trace data, the first I/Q pair is returned.
- SDEVIation - returns a single value that is the arithmetic standard deviation for the data point values for the specified region(s) of trace data. See the following equation.
- For I/Q trace data, the standard deviation of the magnitudes of the I/Q pairs is returned. See the following equation.

Equation 6

Standard Deviation of Data Point Values for Specified Region(s)

$$\text{SDEV} = \sqrt{\frac{1}{n} \sum_{X_i \in \text{region}(s)} (X_i - \bar{X})^2}$$

where X_i is a data point value, \bar{X} is the arithmetic mean of the data point values for the specified region (s), and n is the number of data points in the specified region(s).

$$\text{SDEV} = \sqrt{\frac{1}{n} \sum_{X_i \in \text{region}(s)} (|X_i| - \bar{X})^2}$$

where $|X_i|$ is the magnitude of an I/Q pair, \bar{X} is the mean of the magnitudes for the specified region(s), and n is the number of data points in the specified region(s).

- PPHase - returns the x,y pairs of both rms power (dBm) and arithmetic mean phase (radian) for every specified region and frequency offset (Hz). The number of pairs is defined by the specified number of regions. This parameter can be used for I/Q vector (n=0) in Waveform (time domain) measurement and all parameters are specified by data point in PPHase.

The rms power of the specified region may be expressed as:

$$\text{Power} = 10 \times \log [10 \times (\text{RMS I/Q value})] + 10.$$

The RMS I/Q value (peak volts) is:

$$\sqrt{\frac{1}{n} \sum_{X_i \in \text{region}} X_i X_i^*}$$

where X_i is the complex value representation of an I/Q pair, X_i^* its conjugate complex number, and n is the number of I/Q pairs in the specified region.

The arithmetic mean phase of the specified region may be expressed as:

$$\frac{1}{n} \sum_{Y_i \in \text{region}} Y_i$$

where Y_i is the unwrapped phase of I/Q pair with applying frequency correction and n is the number of I/Q pairs in the specified region.

The frequency correction is made by the frequency offset calculated by the arithmetic mean of every specified region's frequency offset. Each frequency offset is calculated by the least square method against the unwrapped phase of I/Q pair.

Sample Trace Data - Constant Envelope

(See below for explanation of variables.)

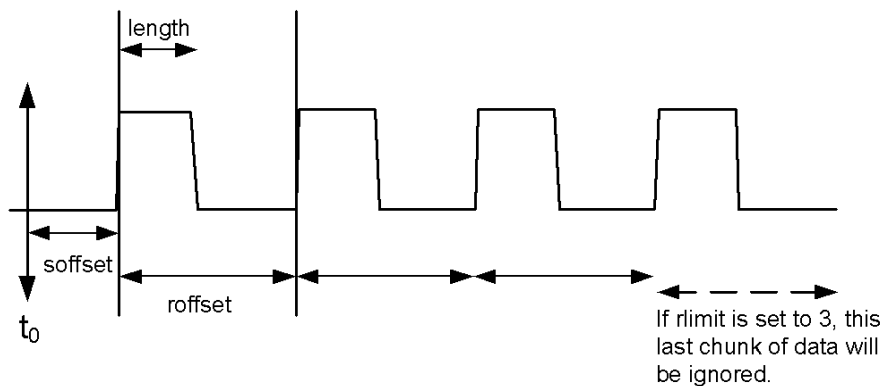

Sample Trace Data - Not Constant Envelope

(See below for explanation of variables.)

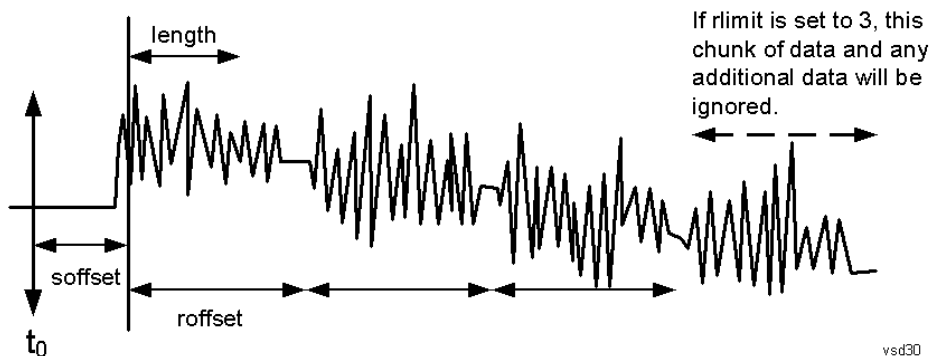

<soffset> - start offset is an optional real number. (It is in seconds for time-domain traces, and is a dimensionless index 0 to Npoints - 1, for frequency-domain traces). It specifies the amount of data at the beginning of the trace that will be ignored before the decimation process starts. It is the time or frequency change from the start of the trace to the point where you want to start using the data. The default value is zero.

<length> - is an optional real number. (It is in seconds for time-domain traces, and is a dimensionless index 0 to Npoints - 1, for frequency-domain traces). It defines how much data will be compressed into one value. This parameter has a default value equal to the current trace length.

<roffset> - repeat offset is an optional real number. (It is in seconds for time-domain traces, and is a dimensionless index 0 to Npoints - 1, for frequency-domain traces). It defines the beginning of the next field of trace elements to be compressed. This is relative to the beginning of the previous field. This parameter has a default value equal to the <length> variable. Note that this parameter is used for a completely different purpose when curve fitting (see CFIT above).

<rlimit> - repeat limit is an optional integer. It specifies the number of data items that you want returned. It will ignore any additional items beyond that number. You can use the Start offset and the Repeat limit to pick out exactly what part of the data you want to use. The default value is all the data.

Calculate Peaks of Trace Data (Remote Command Only)

Returns a list of all the peaks for the currently selected measurement and sub-opcode [n]. The peaks must meet the requirements of the peak threshold and excursion values.

n = any valid sub-opcode for the current measurement. See the MEASure:<measurement> command description of your specific measurement for information on the data that can be returned.

The command can only be used with specific sub-opcodes with measurement results that are trace data. Both real and complex traces can be searched, but complex traces are converted to magnitude in dBm. In many measurements the sub-opcode n=0, is the raw trace data which cannot be searched for peaks. And Sub-opcode n=1, is often calculated results values which also cannot be searched for peaks.

This command uses the data setting specified by the FORMat:BORDER and FORMat:DATA commands and can return real or ASCII data. If the format is set to INT,32, it returns REAL,32 data.

The command has four types of parameters:

- Threshold (in dBm)
- Excursion (in dB)
- Sorting order (amplitude, frequency, time)
- Optional in some measurements: Display line use (all, > display line, < display line)

Remote Command	<p>For Swept SA measurement:</p> <pre>:CALCulate:DATA[1] 2 ... 6:PEAKs? <threshold>,<excursion>[,AMPLitude FREQuency TIME[,ALL GTDLine LTDLine]]</pre> <p>For most other measurements:</p> <pre>:CALCulate:DATA[1] 2 ... 6:PEAKs? <threshold>,<excursion>[,AMPLitude FREQuency TIME]</pre>
Example	<p>Example for Swept SA measurement in Spectrum Analyzer Mode:</p> <p>CALC:DATA4:PEAK? -40, 10, FREQ, GTDL This will identify the peaks of trace 4 that are above -40 dBm, with excursions of at least 10 dB. The peaks are returned in order of increasing frequency, starting with the lowest frequency. Only the peaks that are above the display line are returned.</p> <p>Query Results 1:</p> <p>With FORMat:DATA REAL, 32 selected, it returns a list of floating-point numbers. The first value in the list is the number of peak points that are in the following list. A peak point consists of two values: a peak amplitude followed by its corresponding frequency (or time).</p> <p>If no peaks are found the peak list will consist of only the number of peaks, (0).</p>
Notes	<p><n> - is the trace that will be used</p> <p><threshold> - is the level below which trace data peaks are ignored. Note that the threshold value is required and is always used as a peak criterion. To effectively disable the threshold criterion for this command, provide a substantially low threshold value such as -200 dBm. Also note that the threshold value used in this command is independent of and has no effect on the threshold value stored under the Peak Criteria menu.</p> <p><excursion> - is the minimum amplitude variation (rise and fall) required for a signal to be identified as peak. Note that the excursion value is required and is always used as a peak criterion. To effectively disable the excursion criterion for this command, provide the minimum value of 0.0 dB. Also note that the excursion value used in this command is independent of and has no effect on the</p>

excursion value stored under the Peak Criteria menu.

Values must be provided for threshold and excursion. The sorting and display line parameters are optional (defaults are AMPLitude and ALL).

Note that there is always a Y-axis value for the display line, regardless of whether the display line state is on or off. It is the current Y-axis value of the display line which is used by this command to determine whether a peak should be reported

Sorting order:

AMPLitude - lists the peaks in order of descending amplitude, with the highest peak first (default if optional parameter not sent)

FREQuency - lists the peaks in order of occurrence, left to right across the x-axis.

TIME - lists the peaks in order of occurrence, left to right across the x-axis.

Peaks vs. Display Line:

ALL - lists all of the peaks found (default if optional parameter not sent).

GTDLine (greater than display line) - lists all of the peaks found above the display line.

LTDLine (less than display line) - lists all of the peaks found below the display line.

Initial S/W Revision Prior to A.02.00

Format Data: Numeric Data (Remote Command Only)

This command specifies the format of the trace data input and output. It specifies the formats used for trace data during data transfer across any remote port. It affects only the data format for setting and querying trace data for the :TRACe[:DATA], TRACe[:DATA]?, :CALCulate:DATA[n]? and FETCh:SANalyzer [n]? commands and queries.

Remote Command :FORMat [:TRACe] [:DATA] ASCii|INTeger,32|REAL,32 |REAL,64
:FORMat [:TRACe] [:DATA] ?

Notes The query response is:
ASCii: ASC,8
REAL,32: REAL,32
REAL,64: REAL,64
INTeger,32: INT,32

When the numeric data format is REAL or ASCii, data is output in the current Y Axis unit. When the data format is INTeger, data is output in units of m dBm (.001 dBm).

The INT,32 format returns binary 32-bit integer values in internal units (m dBm), in a definite length block.

Dependencies Sending a data format spec with an invalid number (for example, INT,48) generates no error. The analyzer simply uses the default (8 for ASCii, 32 for INTeger, 32 for REAL).

Sending data to the analyzer which does not conform to the current FORMat specified, results in an error. Sending ASCII data when a definite block is expected generates message -161 "Invalid Block Data" and sending a definite block when ASCII data is expected generates message -121 "Invalid Character in Number".

Preset ASCii

Backwards Compatibility Notes Note that the INT,32 format is only applicable to the command, TRACe:DATA. This preserves backwards compatibility for the Swept SA measurement. For all other commands/queries which honor FORMat:DATA, if INT,32 is sent the analyzer will behave as though it were set to REAL,32.

Initial S/W Revision Prior to A.02.00

The specs for each output type follow:

ASCIi - Amplitude values are in ASCII, in the current Y Axis Unit, one ASCII character per digit, values separated by commas, each value in the form:

SX.YYYYYEsZZ

Where:

S = sign (+ or -)

X = one digit to left of decimal point

Y = 5 digits to right of decimal point

E = E, exponent header

s = sign of exponent (+ or -)

ZZ = two digit exponent

REAL,32 - Binary 32-bit real values in the current Y Axis Unit, in a definite length block.

REAL,64 - Binary 64-bit real values in the current Y Axis Unit, in a definite length block.

Format Data: Byte Order (Remote Command Only)

This command selects the binary data byte order for data transfer and other queries. It controls whether binary data is transferred in normal or swapped mode. This command affects only the byte order for setting and querying trace data for the :TRACe[:DATA], TRACe[:DATA]? , :CALCulate:DATA[n]? and FETCh:SANalyzer[n]? commands and queries.

By definition any command that says it uses FORMat:DATA uses any format supported by FORMat:DATA.

The NORMal order is a byte sequence that begins with the most significant byte (MSB) first, and ends with the least significant byte (LSB) last in the sequence: 1|2|3|4. SWAPPed order is when the byte sequence begins with the LSB first, and ends with the MSB last in the sequence: 4|3|2|1.

Remote Command	:FORMat:BORDER NORMal SWAPPed :FORMat:BORDER?
Preset	NORMal
Initial S/W Revision	Prior to A.02.00

Meas Setup

Displays the measurement setup menu for the currently selected measurement.

Key Path	Front-panel key
Initial S/W Revision	Prior to A.02.00

Avg/Hold Num

Specifies the number of measurement averages used to calculate the measurement result. The average is displayed at the end of each sweep.

Average State allows you to turn averaging on or off.

Key Path	Meas Setup
Mode	SA, WCDMA, C2K, WIMAX OFDMA, CDMA1xEVDO, TD-SCDMA, DVB-T/H, LTE, LTE-TDD, WLAN, MSR, LTE-AFDD, LTE-TDD
Remote Command	[:SENSe]:SPURious:AVERage:COUNT <integer> [:SENSe]:SPURious:AVERage:COUNT? [:SENSe]:SPURious:AVERage[:STATe] ON OFF 1 0 [:SENSe]:SPURious:AVERage[:STATe]?
Example	SPUR:AVER:COUN 2500 SPUR:AVER:COUN? SPUR:AVER ON SPUR:AVER?
Notes	You must be in the Spectrum Analysis mode, W-CDMA mode, cdma2000 mode, DVB-T/H mode, TD-SCDMA mode, LTE mode, LTE TDD mode, WLAN mode, MSR, LTE-Advanced FDD/TDD mode or WiMAX mode to use this command. Use INSTRUMENT:SElect to set the mode.
Preset	10 OFF
State Saved	Saved in instrument state.
Min	1
Max	10000
Initial S/W Revision	Prior to A.02.00
Modified at S/W Revision	A.03.00

Avg Mode

Enables you to set the averaging mode.

- When set to Exponential (Exp) the measurement averaging continues using the specified number of averages to compute each averaged value. The average will be displayed at the end of each sweep.

- When set to Repeat, the measurement resets the average counter each time the specified number of averages is reached.

Key Path	Meas Setup
Mode	SA, WCDMA, WIMAX OFDMA, TD-SCDMA, DVB-T/H, LTE, LTE-TDD, WLAN, MSR, LTEAFDD, LTEATDD
Remote Command	[:SENSe] :SPURious :AVERage :TCONtrol EXPonential REPeat [:SENSe] :SPURious :AVERage :TCONtrol ?
Example	SPUR: AVER: TCON REP SPUR: AVER: TCON ?
Notes	You must be in the cdma2000 mode, TD-SCDMA mode, W-CDMA mode, DVB-T/H mode, GSM/EDGE mode, LTE mode, LTE TDD mode, WLAN mode, MSR, LTE-Advanced FDD/TDD mode or WiMAX mode to use this command. Use INSTRUMENT: SElect to set the mode.
Preset	EXPonential
State Saved	Saved in instrument state.
Range	Exp Repeat
Initial S/W Revision	Prior to A.02.00
Modified at S/W Revision	A.03.00

Range Table

Enables you to set range parameters.

To change a parameter, select the appropriate menu softkey and enter the value using the numeric keypad or the knob. The analyzer settings will be updated with the new parameter values.

When the current view is the Range Table view, the selected range is highlighted and displayed in the Range Table automatically. With the normal window arrangement, up to five ranges are displayed. In the zoom mode, all 20 ranges can be displayed.

In the Range Table window, there are three tables corresponding to each page of the Range Table menu. When the Range Table key is pressed, the table of the first menu page is displayed.

The Displayed table is changed by changing the Range Table menu page. It can also be changed by a remote command. When the Range Table is changed by the command, the menu page changes accordingly if the Range Table menu is displayed.

Key Path	Meas Setup
Initial S/W Revision	Prior to A.02.00

Range

Changing the range updates the values on the other menu keys so that they reflect the settings for the selected range. If Range is turned on, it will be used as part of the measurement. If it is off, it will be excluded. A range is made up of the next fifteen parameters. This parameter can send up to 20 values. The

location in the list sent corresponds to the range the value is associated with. Missing values are not permitted; that is, if you want to change values 2 and 6 you must send all values up to 6. Subsequent values will remain as they were. The query for this parameter always returns 20 values.

Key Path	Meas Setup, Range Table
Mode	SA, WCDMA, C2K, 1xEV-DO, WIMAX OFDMA, TD-SCDMA, DVB-T/H, LTE, LTE-TDD, MSR, LTEAFDD, LTEATDD
Remote Command	<pre> :DISPlay:SPURious:VIEW:RANGe[:SElect] <integer> :DISPlay:SPURious:VIEW:RANGe[:SElect]? [:SENSe]:SPURious[:RANGe][:LIST]:STATe ON OFF 1 0, ON OFF 1 0 0, ON OFF 1 0 [:SENSe]:SPURious[:RANGe][:LIST]:STATe? </pre>
Example	<pre> DISP:SPUR:VIEW:RANG 2 DISP:SPUR:VIEW:RANG? SPUR:STAT ON SPUR:STAT? </pre>
Notes	You must be in cdma2000 mode, TD-SCDMA mode, W-CDMA mode, DVB-T/H mode, GSM/EDGE mode, LTE mode, LTE TDD mode, MSR, LTE-Advanced FDD/TDD mode or WiMAX mode to use this command. Use INSTRUMENT:SElect to set the mode.
Preset	<pre> 1 SA, WIMAX OFDMA:ON, ON, ON, ON, ON, OFF, OFF, OFF, OFF, OFF, OFF, OFF, OFF, OFF, OFF, OFF, OFF, OFF, OFF, OFF WCDMA:ON, ON, ON, ON, ON, ON, ON, ON, OFF, OFF, OFF, OFF, OFF, OFF, OFF, OFF, OFF, OFF, OFF, OFF C2k, 1xEV-DO: ON, ON, ON, ON, OFF, OFF, OFF, OFF, OFF, OFF, OFF, OFF, OFF, OFF, OFF, OFF, OFF, OFF, OFF, OFF TD-SCDMA: ON, ON, ON, ON, OFF, OFF, OFF, OFF, OFF, OFF, OFF, OFF, OFF, OFF, OFF, OFF, OFF, OFF, OFF, OFF DVB-T/H: ON, ON, ON, ON, ON, ON, OFF, OFF, OFF, OFF, OFF, OFF, OFF, OFF, OFF, OFF, OFF, OFF, OFF, OFF LTE, MSR, LTEAFDD: ON, ON, ON, ON, ON, ON, ON, ON, OFF, OFF, OFF, OFF, OFF, OFF, OFF, OFF, OFF, OFF, OFF, OFF LTE-TDD, LT LTEATDD: OFF, OFF, ON, ON, ON, ON, ON, OFF, OFF, OFF, OFF, OFF, OFF, OFF, OFF, OFF, OFF, OFF, OFF, OFF </pre>
State Saved	Not saved in State
Min	1
Max	20
Initial S/W Revision	Prior to A.02.00
Modified at S/W Revision	A.03.00, A.10.00

Start Freq

Sets the start frequency of the analyzer. This parameter can send up to 20 values. The location where the start frequency occurs in the list sent to the measurement corresponds to the range the value is associated with.

Missing values are not permitted. If you want to change values 2 and 6 you must send all values up to 6. Subsequent values will remain as they were. The query for this parameter always returns 20 values.

Key Path	Meas Setup, Range Table
Mode	SA, WCDMA, C2K, WIMAX OFDMA, TD-SCDMA, 1xEV-DO, DVB-T/H, LTE, LTETDD, WLAN
Remote Command	[:SENSe]:SPURious[:RANGe][:LIST]:FREQuency:STARt <freq>, <freq>, <freq>, <freq>, <freq>, <freq>, <freq>, <freq>, <freq>, <freq>, <freq>, <freq>, <freq>, <freq>, <freq>, <freq>, <freq>, <freq>, <freq>, <freq> [:SENSe]:SPURious[:RANGe][:LIST]:FREQuency:STARt?
Example	SPUR:FREQ:STAR 9 kHz, 150 kHz, 30 MHz, 1GHz, 1.5 GHz, 1.5 GHz, 1.5 GHz, 1.5 GHz, 1.5 GHz, 1.5 GHz, 1.5 GHz, 1.5 GHz, 1.5 GHz, 1.5 GHz, 1.5 GHz, 1.5 GHz, 1.5 GHz, 1.5 GHz, 1.5 GHz, 1.5 GHz SPUR:FREQ:STAR?
Notes	You must be in cdma2000 mode, TD-SCDMA mode, W-CDMA mode, DVB-T/H, GSM/EDGE mode, LTE mode, LTE TDD mode, WLAN mode, MSR or WiMAX mode to use this command. Use INSTRument:SElect to set the mode.
Preset	SA, WIMAX OFDMA:+1.92000000E+009, +1.89350000E+009, +2.10000000E+009, +2.17500000E+009, +8.00000000E+008, +1.50000000E+009, +1.50000000E+009, +1.50000000E+009, +1.50000000E+009, +1.50000000E+009, +1.50000000E+009, +1.50000000E+009, +1.50000000E+009, +1.50000000E+009, +1.50000000E+009, +1.50000000E+009, +1.50000000E+009, +1.50000000E+009, +1.50000000E+009, +1.50000000E+009 WCDMA:9kHz, 150kHz, 30MHz, 1GHz, 2.1GHz, 2.1GHz, 2.1774GHz, 2.18GHz, 1.5GHz, 1.5GHz, 1.5GHz, 1.5GHz, 1.5GHz, 1.5GHz, 1.5GHz, 1.5GHz, 1.5GHz, 1.5GHz, 1.5GHz C2K, 1xEV-DO: 9kHz, 150kHz, 30 MHz, 1GHz, 2.5GHz, 2.5GHz, 2.5GHz, 2.5 GHz, 2.5 GHz, 2.5 GHz, 2.5 GHz, 2.5 GHz, 2.5 GHz, 2.5 GHz, 2.5 GHz, 2.5 GHz, 2.5 GHz, 2.5 GHz TD-SCDMA: 9 kHz, 150 kHz, 30 MHz, 1GHz, 1.5 GHz, 1.5 GHz, 1.5 GHz, 1.5 GHz, 1.5 GHz, 1.5 GHz, 1.5 GHz, 1.5 GHz, 1.5 GHz, 1.5 GHz, 1.5 GHz, 1.5 GHz, 1.5 GHz, 1.5 GHz, 1.5 GHz, 1.5 GHz DVB-T/H: 9kHz, 174MHz, 400MHz, 790MHz, 862MHz, 1GHz, 1.5GHz, 1.5GHz, 1.5GHz, 1.5GHz, 1.5GHz, 1.5GHz, 1.5GHz, 1.5GHz, 1.5GHz, 1.5GHz, 1.5GHz, 1.5GHz LTE, MSR: 9 kHz, 150 kHz, 30 MHz, 1 GHz, 1.92GHz, 1.98 GHz, 2.18 GHz, 1.5 GHz, 1.5 GHz, 1.5 GHz, 1.5 GHz, 1.5 GHz, 1.5 GHz, 1.5 GHz, 1.5 GHz, 1.5 GHz, 1.5 GHz LTETDD: 9 kHz, 150 kHz, 30 MHz, 1 GHz, 1.90GHz, 2.01 GHz, 2.025 GHz, 1.5 GHz, 1.5 GHz, 1.5 GHz, 1.5 GHz, 1.5 GHz, 1.5 GHz, 1.5 GHz, 1.5 GHz, 1.5 GHz, 1.5 GHz WLAN: 9 kHz, 150 kHz, 30 MHz, 1 GHz, 1.5 GHz, 1.5 GHz, 1.5 GHz, 1.5 GHz, 1.5 GHz, 1.5 GHz, 1.5 GHz, 1.5 GHz, 1.5 GHz, 1.5 GHz, 1.5 GHz, 1.5 GHz, 1.5 GHz, 1.5 GHz, 1.5 GHz, 1.5 GHz
State Saved	Saved in instrument state.
Min	-80 MHz

Max	Hardware Dependent: Option 503: 3699999990 Option 508: 8499999990 Option 513: 1379999990 Option 526: 2699999990
Initial S/W Revision	Prior to A.02.00
Modified at S/W Revision	A.03.00

Stop Freq

Sets the stop frequency of the analyzer. This parameter can send up to 20 values.

The location of where the stop frequency occurs in the list sent to the measurement corresponds to the range the value is associated with.

Missing values are not permitted. If you want to change values 2 and 6 you must send all values up to 6. Subsequent values will remain as they were. The query for this parameter always returns 20 values.

Key Path	Meas Setup, Range Table
Mode	SA, WCDMA, C2K, WIMAX OFDMA, TD-SCDMA, 1xEV-DO, DVB-T/H, WLAN
Remote Command	<code>[:SENSE] :SPURious [:RANGE] [:LIST] :FREQuency:STOP <freq>, <freq>, <freq>, <freq>, <freq>, <freq>, <freq>, <freq>, <freq>, <freq>, <freq>, <freq>, <freq>, <freq>, <freq>, <freq>, <freq>, <freq></code> <code>[:SENSE] :SPURious [:RANGE] [:LIST] :FREQuency:STOP?</code>
Example	SPUR:FREQ:STOP 150kHz, 30MHz, 1GHz, 2.1GHz, 2.1GHz, 2.1774GHz, 2.18GHz, 12.75GHz, 2.5GHz, 2.5GHz, 2.5GHz, 2.5GHz, 2.5GHz, 2.5GHz, 2.5GHz, 2.5GHz, 2.5GHz, 2.5GHz, 2.5GHz, 2.5GHz SPUR:FREQ:STOP?
Notes	You must be in cdma2000 mode, TD-SCDMA mode, W-CDMA mode, DVB-T/H, GSM/EDGE mode, LTE mode, LTE TDD mode, WLAN mode, MSR or WiMAX mode to use this command. Use INSTRument:SElect to set the mode.
Preset	SA, WIMAX OFDMA: +1.98000000E+009, +1.91960000E+009, +2.10150000E+009, +2.18000000E+009, +1.00000000E+009, +2.50000000E+009, +2.50000000E+009, +2.50000000E+009, +2.50000000E+009, +2.50000000E+009, +2.50000000E+009, +2.50000000E+009, +2.50000000E+009, +2.50000000E+009, +2.50000000E+009, +2.50000000E+009, +2.50000000E+009, +2.50000000E+009, +2.50000000E+009 WCDMA: 150kHz, 30MHz, 1GHz, 2.1GHz, 2.1GHz, 2.1774GHz, 2.18GHz, 12.75GHz, 2.5GHz, 2.5GHz, 2.5GHz, 2.5GHz, 2.5GHz, 2.5GHz, 2.5GHz, 2.5GHz, 2.5GHz, 2.5GHz, 2.5GHz, 2.5GHz C2K, 1xEV-DO: 150kHz, 30 MHz, 1GHz, 5GHz, 2.5GHz, 2.5GHz, 2.5GHz, 2.5 GHz, 2.5 GHz, 2.5 GHz, 2.5 GHz, 2.5 GHz, 2.5 GHz, 2.5 GHz, 2.5 GHz, 2.5 GHz, 2.5 GHz, 2.5 GHz, 2.5 GHz TD-SCDMA: 150kHz, 30 MHz, 1GHz, 12.75GHz, 2.5 GHz, 2.5 GHz, 2.5 GHz, 2.5 GHz, 2.5 GHz, 2.5 GHz, 2.5 GHz, 2.5 GHz, 2.5 GHz, 2.5 GHz, 2.5 GHz, 2.5 GHz, 2.5 GHz DVB-T/H: 174MHz, 400MHz, 790MHz, 862MHz, 1GHz, 4.5GHz, 2.5GHz, 2.5GHz, 2.5GHz,

	2.5GHz, 2.5GHz, 2.5GHz, 2.5GHz, 2.5GHz, 2.5GHz, 2.5GHz, 2.5GHz, 2.5GHz, 2.5GHz, 2.5GHz, 2.5GHz LTE, MSR: 150kHz, 30MHz, 1GHz, 1.92GHz, 1.98GHz, 2.1GHz, 12.75GHz, 2.5GHz, 2.5GHz, 2.5GHz, 2.5GHz, 2.5GHz, 2.5GHz, 2.5GHz, 2.5GHz, 2.5GHz, 2.5GHz, 2.5GHz, 2.5GHz, 2.5GHz, 2.5GHz LTETDD: 150kHz, 30MHz, 1GHz, 1.90GHz, 2.01GHz, 2.025GHz, 12.75GHz, 2.5GHz, 2.5GHz, 2.5GHz, 2.5GHz, 2.5GHz, 2.5GHz, 2.5GHz, 2.5GHz, 2.5GHz, 2.5GHz, 2.5GHz, 2.5GHz, 2.5GHz WLAN: 150 kHz, 30 MHz, 1 GHz, 12.75 GHz, 2.5 GHz, 2.5 GHz, 2.5 GHz, 2.5 GHz, 2.5 GHz, 2.5 GHz, 2.5 GHz, 2.5 GHz, 2.5 GHz, 2.5 GHz, 2.5 GHz, 2.5 GHz, 2.5 GHz, 2.5 GHz, 2.5 GHz, 2.5 GHz, 2.5 GHz
State Saved	Saved in instrument state.
Min	-79999990
Max	Hardware Dependent: Option 503: 3.7 GHz Option 508: 8.5 GHz Option 513: 13.8 GHz Option 526: 27.0 GHz
Initial S/W Revision	Prior to A.02.00
Modified at S/W Revision	A.03.00

Res BW

Sets the resolution bandwidth of the analyzer. This parameter can send up to 20 values.

The location of where the resolution bandwidth occurs in the list sent to the measurement corresponds to the range the value is associated with.

Missing values are not permitted. In other words, if you want to change values 2 and 6 you must send all values up to 6. Subsequent values will remain as they were. The query for this parameter always returns 20 values.

Key Path	Meas Setup, Range Table
Mode	SA, WCDMA, C2K, WIMAX OFDMA, TD-SCDMA, 1xEV-DO, DVB-T/H, LTE, LTETDD, WLAN, MSR, LTEAFDD, LTEATDD
Remote Command	[:SENSe]:SPURious[:RANGe][:LIST]:BANdwidth[:RESolution] <freq>, <freq>, <freq>, <freq>, <freq>, <freq>, <freq>, <freq>, <freq>, <freq>, <freq>, <freq>, <freq>, <freq>, <freq>, <freq>, <freq>, <freq>, <freq>, <freq> [:SENSe]:SPURious[:RANGe][:LIST]:BANdwidth[:RESolution]? [:SENSe]:SPURious[:RANGe][:LIST]:BANdwidth[:RESolution]:AUTO OFF ON 0 1, OFF ON 0 1 [:SENSe]:SPURious[:RANGe][:LIST]:BANdwidth[:RESolution]:AUTO?
Example	SPUR:BAND 1kHz, 10kHz, 100kHz, 1MHz, 1MHz, 1MHz, 1MHz, 3MHz, 3MHz, 3MHz, 3MHz,

	3MHz, 3MHz, 3MHz, 3MHz, 3MHz, 3MHz, 3MHz, 3MHz, 3MHz SPUR:BAND? SPUR:BWID:AUTO ON, ON, ON, OFF, OFF, OFF, OFF, OFF, ON, ON, ON, ON, OFF, OFF, OFF, OFF, OFF, OFF, ON, ON SPUR:BWID:AUTO?
Notes	You must be in cdma2000 mode, TD-SCDMA mode, W-CDMA mode, DVB-T/H, GSM/EDGE mode, LTE mode, LTE TDD mode, WLAN mode, MSR, LTE-Advanced FDD/TDD mode or WiMAX mode to use this command. Use INSTRument:SElect to set the mode.
Preset	SA, WIMAX OFDMA:1.2MHz, 0.51MHz, 0.1MHz, 0.1MHz, 4MHz, 3MHz, 3MHz, 3MHz, 3MHz, 3MHz, 3MHz, 3MHz, 3MHz, 3MHz, 3MHz, 3MHz, 3MHz, 3MHz, 3MHz WCDMA:1kHz, 10kHz, 100kHz, 1MHz, 1MHz, 1MHz, 1MHz, 1MHz, 3MHz, 3MHz, 3MHz, 3MHz, 3MHz, 3MHz, 3MHz, 3MHz, 3MHz, 3MHz, 3MHz, 3MHz C2k, 1xEV-DO: 1kHz, 10kHz, 100kHz, 1MHz, 1MHz, 1MHz, 1MHz, 3MHz, 3MHz, 3MHz, 3MHz, 3MHz, 3MHz, 3MHz, 3MHz, 3MHz, 3MHz, 3MHz, 3MHz TD-SCDMA: 1kHz, 10kHz, 100kHz, 1MHz, 3MHz, 3MHz, 3MHz, 3MHz, 3MHz, 3MHz, 3MHz, 3MHz, 3MHz, 3MHz, 3MHz, 3MHz, 3MHz, 3MHz, 3MHz DVB-T/H: 100kHz, 3.9kHz, 100kHz, 3.9kHz, 100kHz, 100kHz, 3MHz, 3MHz, 3MHz, 3MHz, 3MHz, 3MHz, 3MHz, 3MHz, 3MHz, 3MHz, 3MHz, 3MHz, 3MHz LTE, MSR, LTEAFDD: 1kHz, 10kHz, 100kHz, 1MHz, 100kHz, 1MHz, 1MHz, 3MHz, 3MHz, 3MHz, 3MHz, 3MHz, 3MHz, 3MHz, 3MHz, 3MHz, 3MHz, 3MHz LTETDD, LTEATDD: 1kHz, 10kHz, 100kHz, 1MHz, 1MHz, 1MHz, 1MHz, 3MHz, 3MHz, 3MHz, 3MHz, 3MHz, 3MHz, 3MHz, 3MHz, 3MHz, 3MHz, 3MHz, 3MHz WLAN: 1kHz, 10kHz, 100kHz, 1MHz, 3MHz, 3MHz, 3MHz, 3MHz, 3MHz, 3MHz, 3MHz, 3MHz, 3MHz, 3MHz, 3MHz, 3MHz, 3MHz, 3MHz, 3MHz SA, WIMAX OFDMA:OFF, OFF, OFF, OFF, OFF, ON, ON, ON, ON, ON, ON, ON, ON, ON, ON, ON, ON, ON, ON, ON WCDMA:OFF, OFF, OFF, OFF, OFF, OFF, OFF, OFF, ON, ON, ON, ON, ON, ON, ON, ON, ON, ON, ON C2k, 1xEV-DO:OFF, OFF, OFF, OFF, OFF, OFF, OFF, ON, ON, ON, ON, ON,ON,ON,ON,ON,ON,ON,ON,ON TD-SCDMA: OFF, OFF, OFF, OFF, ON, ON, ON, ON, ON, ON, ON, ON, ON, ON, ON, ON, ON, ON, ON DVB-T/H: OFF, OFF, OFF, OFF, OFF, OFF, ON, ON, ON, ON, ON, ON, ON, ON, ON, ON, ON, ON, ON LTE, MSR, LTEAFDD: OFF, OFF, OFF, OFF, OFF, OFF, OFF, ON, ON, ON, ON, ON, ON, ON, ON, ON, ON, ON, ON, ON LTETDD, LTEATDD: OFF, OFF, OFF, OFF, OFF, OFF, OFF, ON, ON, ON, ON, ON, ON, ON, ON, ON, ON, ON, ON WLAN: OFF, OFF, OFF, OFF, ON, ON, ON, ON, ON, ON, ON, ON, ON, ON, ON, ON, ON, ON, ON, ON
State Saved	Saved in instrument state.
Min	1 Hz

Max	8 MHz
Backwards Compatibility SCPI	<code>[:SENSe] :SPURious [:RANGe] [:LIST] :BWIDth [:RESolution]</code>
Initial S/W Revision	Prior to A.02.00
Modified at S/W Revision	A.03.00

Video BW

Sets the Video BW mode of the analyzer. This can be Auto, where the analyzer determines the optimum setting, or Manual, where you determine the setting. This parameter can send up to 20 values. The location in the list sent corresponds to the range the value is associated with. Missing values are not permitted; that is, if you want to change values 2 and 6 you must send all values up to 6. Subsequent values will remain as they were. The query for this parameter always returns 20 values.

Key Path	Meas Setup, Range Table
Mode	SA, WCDMA, C2K, WIMAX OFDMA, TD-SCDMA, 1xEV-DO, DVB-T/H, LTE, LTE-TDD, WLAN, MSR, LTE-FDD, LTE-TDD
Remote Command	<pre>[:SENSe] :SPURious [:RANGe] [:LIST] :BANDwidth:VIDeo <freq>, <freq>, <freq>, <freq>, <freq>, <freq>, <freq>, <freq>, <freq>, <freq>, <freq>, <freq>, <freq>, <freq>, <freq>, <freq>, <freq>, <freq>, <freq> [:SENSe] :SPURious [:RANGe] [:LIST] :BANDwidth:VIDeo? [:SENSe] :SPURious [:RANGe] [:LIST] :BANDwidth:VIDeo:AUTO OFF ON 0 1, OFF ON 0 1 [:SENSe] :SPURious [:RANGe] [:LIST] :BANDwidth:VIDeo:AUTO?</pre>
Example	<pre>SPUR:BAND:VID 1kHz, 10kHz, 100kHz, 1MHz, 1MHz, 1MHz, 1MHz, 3MHz, 3MHz, 3MHz, 3MHz, 3MHz, 3MHz, 3MHz, 3MHz, 3MHz, 3MHz, 3MHz, 3MHz, 3MHz, 3MHz SPUR:BAND:VID? SPUR:BAND:VID:AUTO ON, ON, OFF, OFF, OFF, ON, ON, ON, OFF, OFF, OFF, OFF, OFF, OFF, OFF, ON, ON, ON, ON, ON SPUR:BAND:VID:AUTO?</pre>
Notes	You must be in the cdma2000 mode, 1xEV-DO mode, TD-SCDMA mode, W-CDMA mode, DVB-T/H mode, GSM/EDGE mode, LTE mode, LTE TDD mode, WLAN mode, MSR, LTE-Advanced FDD/TDD mode or WiMAX mode to use this command. Use INSTRUMENT:SElect to set the mode.
Preset	<p>SA, WCDMA, C2K, WIMAX OFDMA, TD-SCDMA, 1xEV-DO, DVB-T/H WLAN: Automatically calculated</p> <p>LTE, MSR, LTE-TDD: 4.7kHz, 47kHz, 470kHz, 5MHz, 470kHz, 5MHz, 5MHz, 300kHz, 300kHz, 300kHz, 300kHz, 300kHz, 300kHz, 300kHz, 300kHz, 300kHz, 300kHz, 300kHz, 300kHz, 300kHz, 300kHz</p> <p>LTE-TDD, LTE-TDD: 4.7kHz, 47kHz, 470kHz, 5MHz, 470kHz, 5MHz, 5MHz, 300kHz, 300kHz, 300kHz, 300kHz, 300kHz, 300kHz, 300kHz, 300kHz, 300kHz, 300kHz, 300kHz, 300kHz, 300kHz, 300kHz, 300kHz</p> <p>ON, ON, ON, ON, ON, ON, ON, ON, ON, ON, ON, ON, ON, ON, ON, ON, ON, ON, ON, ON</p>

Abs Start Limit

Determines the limit above which spurs will report a failing. If Abs Stop Limit Mode is set to Auto, this is coupled to Abs Stop Limit to make a flat limit line. If set to Man, Abs Start Limit and Abs Stop Limit can take different values to make a sloped limit line.

If the Limit Line Test parameter is off then any spurs which are found to be above the current 'Peak Excursion' will be added to the results table. From these spurs, the amplitude will be checked using the abs limit start and abs limit stop parameters and then calculate the limit. An 'F' will be appended to the amplitude value of the spur if the measured amplitude is above the limit. If the Limit Line Test is on, only the spurs whose amplitudes exceed the limit will be reported.

This parameter can send up to 20 values. The location in the list sent corresponds to the range of the associated value. Missing values are not permitted. If you want to change values 2 and 6 you must send all values up to 6. Subsequent values will remain as they were. The query for this parameter always returns 20 values.

Key Path	Meas Setup, Range Table
Mode	SA, WCDMA, C2K, WIMAX OFDMA, TD-SCDMA, 1xEV-DO, DVB-T/H, LTE, LTETDD, WLAN, MSR, LTEAFDD, LTEATDD
Remote Command	:CALCulate:SPURious[:RANGE][:LIST]:LIMit:ABSolute[:UPPer]:DATA[:START] <ampl>, <ampl>, <ampl>, <ampl>, <ampl>, <ampl>, <ampl>, <ampl>, <ampl>, <ampl>, <ampl>, <ampl>, <ampl>, <ampl>, <ampl>, <ampl>, <ampl>, <ampl>, <ampl>, <ampl> :CALCulate:SPURious[:RANGE][:LIST]:LIMit:ABSolute[:UPPer]:DATA[:START]?
Example	CALC:SPUR:LIM:ABS:DATA 0, 0, 0, 0, 0, 0, 0, 0, 0, 0, 0, 0, 0, 0, 0, 0, 0, 0, 0, 0 CALC:SPUR:LIM:ABS:DATA?
Preset	SA, WIMAX OFDMA: -5.00000000E+001, -5.00000000E+001, -5.00000000E+001, -5.00000000E+001, -5.00000000E+001, -5.00000000E+001, -5.00000000E+001, -5.00000000E+001, -5.00000000E+001, -5.00000000E+001, -5.00000000E+001, -5.00000000E+001, -5.00000000E+001, -5.00000000E+001, -5.00000000E+001, -5.00000000E+001, -5.00000000E+001, -5.00000000E+001, -5.00000000E+001, -5.00000000E+001 WCDMA: -36dBm, -36dBm, -36dBm, -30dBm, -25dBm, -15dBm, -25dBm, -30dBm, -50dBm, -50dBm, -50dBm, -50dBm, -50dBm, -50dBm, -50dBm, -50dBm, -50dBm, -50dBm, -50dBm, -50dBm, -50dBm C2K, 1xEV-DO: -13 dBm, -13dBm, -13 dBm, -13 dBm, -50 dBm, -50 dBm, -50 dBm, -50 dBm, -50 dBm, -50 dBm, -50 dBm, -50 dBm, -50 dBm, -50 dBm, -50 dBm, -50 dBm, -50 dBm, -50 dBm, -50 dBm, -50 dBm TD-SCDMA: -13 dBm, -13dBm, -13 dBm, -13 dBm, -50 dBm, -50 dBm, -50 dBm, -50 dBm, -50 dBm, -50 dBm, -50 dBm, -50 dBm, -50 dBm, -50 dBm, -50 dBm, -50 dBm, -50 dBm, -50 dBm, -50 dBm DVB-T/H: -36dBm, -82dBm, -36dBm, -76dBm, -36dBm, -30dBm, -50dBm, -50dBm, -50dBm, -50dBm, -50dBm, -50dBm, -50dBm, -50dBm, -50dBm, -50dBm, -50dBm, -50dBm, -50dBm, -50dBm LTE, MSR, LTEAFDD: -36dBm, -36dBm, -36dBm, -30dBm, -96dBm, -30dBm, -30dBm, -50dBm,

Peak Excursion

Sets the minimum amplitude variation of signals that can be identified as peaks. If a value of 6 dB is selected, peaks that rise and fall more than 6 dB above the peak threshold value are identified.

This parameter can send up to 20 values. The location in the list sent corresponds to the range of the associated value. Missing values are not permitted. If you want to change values 2 and 6 you must send all values up to 6. Subsequent values will remain as they were. The query for this parameter always returns 20 values.

Key Path	Meas Setup, Range Table
Mode	SA, WCDMA, C2K, WIMAX OFDMA, TD-SCDMA, 1xEV-DO, DVB-T/H, LTE, LTETDD, WLAN, MSR, LTEAFDD, LTEATDD
Remote Command	[:SENSe] : SPURious [:RANGe] [:LIST] : PEAK : EXCursion <rel_ampl>, <rel_ampl>, <rel_ampl>, <rel_ampl>, <rel_ampl>, <rel_ampl>, <rel_ampl>, <rel_ampl>, <rel_ampl>, <rel_ampl>, <rel_ampl>, <rel_ampl>, <rel_ampl>, <rel_ampl>, <rel_ampl>, <rel_ampl>, <rel_ampl>, <rel_ampl>, <rel_ampl>, <rel_ampl> [:SENSe] : SPURious [:RANGe] [:LIST] : PEAK : EXCursion?
Example	SPUR:PEAK:EXC 20, 20 SPUR:PEAK:EXC?
Preset	+6.00000000E+000, +6.00000000E+000, +6.00000000E+000, +6.00000000E+000, +6.00000000E+000, +6.00000000E+000, +6.00000000E+000, +6.00000000E+000, +6.00000000E+000, +6.00000000E+000, +6.00000000E+000, +6.00000000E+000, +6.00000000E+000, +6.00000000E+000, +6.00000000E+000, +6.00000000E+000, +6.00000000E+000, +6.00000000E+000, +6.00000000E+000, +6.00000000E+000
State Saved	Saved in instrument state.
Min	0.0 dB
Max	100.0 dB
Initial S/W Revision	Prior to A.02.00
Modified at S/W Revision	A.03.00

Pk Threshold

Sets the minimum amplitude of signals that can be identified as peaks. For example, if a value of -90 dBm is selected, only peaks that rise and fall more than the peak excursion value which are above -90 dBm are identified.

This parameter can send up to 20 values. The location in the list sent corresponds to the range of the associated value. Missing values are not permitted. If you want to change values 2 and 6 you must send all values up to 6. Subsequent values will remain as they were. The query for this parameter always returns 20 values.

Key Path	Meas Setup, Range Table
Mode	SA, WCDMA, C2K, WIMAX OFDMA, TD-SCDMA, 1xEV-DO, DVB-T/H, LTE, LTETDD, WLAN, MSR, LTEAFDD, LTEATDD
Remote Command	[:SENSe] : SPURious [:RANGe] [:LIST] : PEAK : THReshold <real>, <real>, <real>,

	<pre><real>, <real>, <real>, <real>, <real>, <real>, <real>, <real>, <real>, <real>, <real>, <real>, <real>, <real>, <real>, <real>, <real>, <real> [:SENSe]:SPURious[:RANGe][:LIST]:PEAK:THReshold?</pre>
Example	<pre>SPUR:PEAK:THR 0,0,0 SPUR:PEAK:THR?</pre>
Preset	<pre>-9.00000000E+001, -9.00000000E+001, -9.00000000E+001, -9.00000000E+001, - 9.00000000E+001, -9.00000000E+001, -9.00000000E+001, -9.00000000E+001, - 9.00000000E+001, -9.00000000E+001, -9.00000000E+001, -9.00000000E+001, - 9.00000000E+001, -9.00000000E+001, -9.00000000E+001, -9.00000000E+001, - 9.00000000E+001, -9.00000000E+001, -9.00000000E+001, -9.00000000E+001</pre>
State Saved	Saved in instrument state.
Min	-200
Max	0
Initial S/W Revision	Prior to A.02.00
Modified at S/W Revision	A.03.00, A.07.00

Attenuation

Defines attenuation value for each range.

- When Auto state is ON, attenuation value under AMPTD Y Scale is used.
- When Auto state is OFF, this value is used as mechanical attenuation value without electric attenuation.

Key Path	Meas Setup, Range Table
Mode	SA, WCDMA, C2K, WIMAX OFDMA, TD-SCDMA, 1xEV-DO, DVB-T/H, LTE, LTETDD, WLAN, MSR, LTEAFDD, LTEATDD
Remote Command	<pre>[:SENSe]:SPURious[:RANGe][:LIST]:ATTenuation <rel_ampl>, <rel_ampl>, <rel_ampl>, <rel_ampl>, <rel_ampl>, <rel_ampl>, <rel_ampl>, <rel_ampl>, <rel_ampl>, <rel_ampl>, <rel_ampl>, <rel_ampl>, <rel_ampl>, <rel_ampl>, <rel_ampl>, <rel_ampl>, <rel_ampl>, <rel_ampl>, <rel_ampl>, <rel_ampl> [:SENSe]:SPURious[:RANGe][:LIST]:ATTenuation? [:SENSe]:SPURious[:RANGe][:LIST]:ATTenuation:AUTO OFF ON 0 1, OFF ON 0 1, OFF ON 0 1, OFF ON 0 1, OFF ON 0 1, OFF ON 0 1, OFF ON 0 1, OFF ON 0 1, OFF ON 0 1, OFF ON 0 1, OFF ON 0 1, OFF ON 0 1, OFF ON 0 1, OFF ON 0 1, OFF ON 0 1, OFF ON 0 1, OFF ON 0 1, OFF ON 0 1, OFF ON 0 1, OFF ON 0 1 [:SENSe]:SPURious[:RANGe][:LIST]:ATTenuation:AUTO?</pre>
Example	<pre>SPUR:ATT 10dB, 10dB, 10dB, 10dB, 10dB, 10dB, 10dB, 10dB, 10dB, 10dB, 10dB, 10dB, 10dB, 10dB, 10dB, 10dB, 10dB, 10dB, 10dB, 10dB SPUR:ATT? SPUR:ATT:AUTO 0, 0, 0, 0, 0, 0, 0, 0, 0, 0, 0, 0, 0, 0, 0, 0, 0, 0, 0, 0 SPUR:ATT:AUTO?</pre>

Sweep Time

Sets the sweep time mode of the analyzer. This can be Auto, where the analyzer determines the optimum setting, or Manual, where you determine the setting.

This parameter can send up to 20 values. The location in the list sent corresponds to the range of the associated value. Missing values are not permitted. If you want to change values 2 and 6 you must send all values up to 6. Subsequent values will remain as they were. The query for this parameter always returns 20 values.

Key Path	Meas Setup, Range Table
Mode	SA, WCDMA, C2K, WIMAX OFDMA, TD-SCDMA, 1xEV-DO, DVB-T/H, LTE, LTETDD, WLAN, MSR, LTEAFDD, LTEATDD
Remote Command	<pre>[:SENSE] : SPURious [:RANGE] [:LIST] : SWEep : TIME <time>, <time>, <time>, <time>, <time>, <time>, <time>, <time>, <time>, <time>, <time>, <time>, <time>, <time>, <time>, <time>, <time>, <time>, <time>, <time>, <time> [:SENSE] : SPURious [:RANGE] [:LIST] : SWEep : TIME? [:SENSE] : SPURious [:RANGE] [:LIST] : SWEep : TIME : AUTO OFF ON 0 1, OFF ON 0 1 [:SENSE] : SPURious [:RANGE] [:LIST] : SWEep : TIME : AUTO?</pre>
Example	<pre>SPUR:SWE:TIME 10, 10, 10, 10, 10, 10, 10, 10, 10, 10, 10, 10, 10, 10, 10, 10, 10, 10, 10, 10 SPUR:SWE:TIME? SPUR:SWE:TIME:AUTO ON, ON, ON, ON, ON, ON, ON, ON, ON, ON, ON, ON, ON, ON, ON, ON, ON, ON, ON SPUR:SWE:TIME:AUTO?</pre>
Notes	You must be in cdma2000 mode, TD-SCDMA mode, W-CDMA mode, DVB-T/H, SA mode, LTE mode, LTE TDD mode, WLAN mode, MSR, LTE-Advanced FDD/TDD mode or WiMAX mode to use this command. Use INSTRUMENT:SElect to set the mode.
Preset	Automatically calculated
State Saved	Saved in instrument state.
Min	1.0E-3
Max	2.0E+3
Initial S/W Revision	Prior to A.02.00
Modified at S/W Revision	A.03.00

Points

Sets the number of points per sweep for the measurement. This parameter can send up to 20 values. The location in the list sent corresponds to the range of the associated value. Missing values are not permitted. If you want to change values 2 and 6 you must send all values up to 6. Subsequent values will remain as they were. The query for this parameter always returns 20 values.

The Points mode can be manual, where you determine the setting or auto, where the analyzer determines the number of trace points to ensure the sweep points resolution equals RBW/2. This is calculated using the following algorithm:

Points = (Stop Freq – Start Freq) / (ResBW / 2), with the computed values being clipped to a minimum of 601 and a maximum of 20001.

This parameter can send up to 20 values. The location in the list sent corresponds to the range the value is associated with. Missing values are not permitted; that is, if you want to change values 2 and 6 you must send all values up to 6. Subsequent values will remain as they were. The query for this parameter always returns 20 values.

Key Path	Meas Setup, Range Table
Mode	SA, WCDMA, C2K, WIMAX OFDMA, TD-SCDMA, 1xEV-DO, DVB-T/H, LTE, LTE-TDD, WLAN, MSR, LTEAFDD, LTEATDD
Remote Command	<pre>[:SENSe]:SPURious[:RANGe][:LIST]:SWEp:POINts <integer> [:SENSe]:SPURious[:RANGe][:LIST]:SWEp:POINts? [:SENSe]:SPURious[:RANGe][:LIST]:SWEp:POINts:AUTO OFF ON 0 1, OFF ON 0 1</pre> <pre>[:SENSe]:SPURious[:RANGe][:LIST]:SWEp:POINts:AUTO?</pre>
Example	<pre>SPUR:SWE:POIN 1001,1001,1001 SPUR:SWE:POIN? SPUR:SWE:POIN:AUTO ON,ON,ON SPUR:SWE:POIN:AUTO?</pre>
Preset	<pre>SA, WIMAX OFDMA, DVB-T/H, WLAN: +601, +601 WCDMA: 601, 2985, 9700, 1100, 601, 601, 601, 10570, 601, 601, 601, 601, 601, 601, 601, 601, 601, 601, 601, 601 C2K: 601, 601, 9970, 11750, , 601, 601, 601, 601, 601, 601, 601, 601, 601, 601, 601, 601, 601, 601, 601, 601 CDMA1xEVDO: 601, 601, 9970, 11750, 601, 601, 601, 10570, 601, 601, 601, 601, 601, 601, 601, 601, 601, 601, 601, 601 TD-SCDMA: 601, 5970, 19400, 20001, 601, 601, 601, 601, 601, 601, 601, 601, 601, 601, 601, 601, 601, 601, 601, 601 LTE, LTE-TDD, MSR, LTEAFDD, LTEATDD : Automatically calculated. WLAN: Automatically calculated. OFF, OFF, OFF, OFF, OFF, OFF, OFF, OFF, OFF, OFF, OFF, OFF, OFF, OFF, OFF, OFF, OFF, OFF, OFF LTE, LTE-TDD, WLAN, MSR, LTEAFDD, LTEATDD: ON, ON, ON, ON, ON, ON, ON, ON, ON, ON, ON, ON, ON, ON, ON, ON, ON, ON, ON, ON</pre>
State Saved	Saved in instrument state.
Min	101

Type	Single	Continuous		
No Spurs Found	Spurs Found	No Spurs Found	Spurs Found	
				the worst spur.
Full	All active ranges are measured. On completion measurement is set to idle state and the 'No Spurs' happening is displayed.	All active ranges are measured and spurs found reported. On completion the measurement is set to the idle state, displaying the trace of the last active range.	Measurement continually cycles through all active ranges.	All active ranges are measured and spurs found reported. On each cycle of the active ranges the spurs found are reset. This ensures any remote queries retrieve the trace data that matches the currently displayed results.

Key Path	Meas Setup
Mode	SA, WCDMA, C2K, WIMAX OFDMA, TD-SCDMA, 1xEV-DO, DVB-T/H, LTE, LTE-TDD, WLAN, MSR, LTEAFDD, LTEATDD
Remote Command	[:SENSe] :SPURious:TYPE EXAMine FULL [:SENSe] :SPURious:TYPE?
Example	SPUR:TYPE FULL SPUR:TYPE?
Preset	EXAMine
State Saved	Saved in instrument state.
Range	Examine Full
Initial S/W Revision	Prior to A.02.00
Modified at S/W Revision	A.03.00

Spur

Displays any spurs found. It is only enabled when the measurement type is set to examine and will turn on upon completion of a measurement. Once the Spur menu key has been enabled, you can view any spur. The measurement sets the analyzer to the range in which the currently selected spur was found. The range settings only changes if the spur selected is in a range which is different from the current range settings. A marker is used to identify the currently selected spur on the trace.

Key Path	Meas Setup
Mode	SA, WCDMA, C2K, WIMAX OFDMA, CDMA1xEVDO, TD-SCDMA, DVB-T/H, LTE, LTE-TDD, WLAN, MSR, LTEAFDD, LTEATDD
Remote Command	[:SENSe] :SPURious:SPUR <integer> [:SENSe] :SPURious:SPUR?
Example	SPUR:SPUR 55

SPUR:SPUR?	
Preset	1
State Saved	No
Min	1
Max	200
Initial S/W Revision	Prior to A.02.00
Modified at S/W Revision	A.03.00

Spurious Report Mode

Selects the spurious report mode.

- Select Limit Line Test (LIMTest) to report only spurs above the limit line. Any spurs reported will cause the measurement to fail. See Abs Start Limit for more information.
- Select All Spurs (ALL) to report all spurs detected by Peak Threshold and Peak Excursion.
- Select Minimum Margin (MMARgin) to report only the spur with the minimum margin from the limit line. For the spur above the limit, its margin is defined as the negative margin. If there are more than one spurs above the limit, only one spur with the largest negative margin is reported.

Key Path	Meas Setup
Mode	SA, WCDMA, C2K, WIMAX OFDMA, TD-SCDMA, 1xEV-DO, DVB-T/H, LTE, LTETDD, WLAN, MSR, LTEAFDD, LTEATDD
Remote Command	[:SENSe] :SPURious:REPT:MODE ALL LIMTest MMARgin [:SENSe] :SPURious:REPT:MODE?
Example	SPUR:REPT:MODE LIMIT SPUR:REPT:MODE?
Dependencies	MMARgin is available only when option N9060A-7FP is installed.
Preset	ALL
State Saved	Saved in instrument state.
Range	All Spurs Limit Test Minimum Margin
Initial S/W Revision	Prior to A.02.00
Modified at S/W Revision	A.03.00, A.11.00

Meas Preset

Restores all measurement parameters to their default values.

Key Path	Meas Setup
Mode	SA, WCDMA, C2K, WIMAX OFDMA, TD-SCDMA, 1xEV-DO, DVB-T/H, LTE, LTETDD, WLAN, MSR, LTEAFDD, LTEATDD

Remote Command	:CONFigure:SPURious
Example	CONF:SPUR
Initial S/W Revision	Prior to A.02.00
Modified at S/W Revision	A.03.00

Fast Spurious Meas (Remote Command only)

This command is provided as the backward compatibility SCPI command of the Fast Spurious Measurement. Since this command is another representation of Spurious Report Mode, this command is coupled with the command.

When set to ON, only spurs above the limit line are reported. This is the same as Spurious Report Mode "LIMTest".

When set to OFF, all detected spurs are reported. This is the same as Spurious Report Mode "ALL."

Mode	SA, WCDMA, C2K, WIMAX OFDMA, TD-SCDMA, 1xEV-DO, DVB-T/H, WLAN, MSR, LTEAFDD, LTEATDD
Remote Command	[:SENSe] :SPURious:FSMeas ON OFF 1 0 [:SENSe] :SPURious:FSMeas?
Example	SPUR:FSM ON SPUR:FSM?
Couplings	If SPUR:REPT:MODE is ALL, this parameter is OFF. If SPUR:REPT:MODE is LIMTest, this parameter is ON.
Preset	OFF
State Saved	Saved in instrument state.
Initial S/W Revision	A.04.00

Mode

See "Mode" on page 316

Mode Preset

Returns the active mode to a known state.

Mode Preset does the following for the currently active mode:

- Aborts the currently running measurement.
- Brings up the default menu for the mode, with no active function.
- Sets measurement Global settings to their preset values for the active mode only.
- Activates the default measurement.
- Brings up the default menu for the mode.
- Clears the input and output buffers.
- Sets Status Byte to 0.

Mode Preset does not:

- Cause a mode switch
- Affect mode persistent settings
- Affect system settings

See "[How-To Preset](#)" on page 1283 for more information.

Key Path	Front-panel key
Remote Command	:SYSTem:PRESet
Example	:SYST:PRES
Notes	*RST is preferred over :SYST:PRES for remote operation. *RST does a Mode Preset, as done by the :SYST:PRES command, and it sets the measurement mode to Single measurement rather than Continuous for optimal remote control throughput. Clears all pending OPC bits. The Status Byte is set to 0.
Couplings	A Mode Preset aborts the currently running measurement, activates the default measurement, and gets the mode to a consistent state with all of the default couplings set.
Backwards Compatibility Notes	In the X-Series, the legacy "Factory Preset" has been replaced with Mode Preset, which only presets the currently active mode, not the entire instrument. In the X-Series, the way to preset the entire instrument is by using System, Restore System Defaults All, which behaves essentially the same way as restore System Defaults does on ESA and PSA. There is also no "Preset Type" as there is on the PSA. There is a green Mode Preset front-panel key that does a Mode Preset and a white-with-green-letters User Preset front-panel key that does a User Preset. The old PRESet:TYPE command is ignored (without generating an error), and SYST:PRES without a parameter does a Mode Preset, which should cover most backward code compatibility issues. The settings and correction data under the Input/Output front-panel key (examples: Input Z Corr, Ext Amp Gain, etc.) are no longer part of any Mode, so they will not be preset by a Mode Preset. They are preset using Restore Input/Output Defaults, Restore System Defaults All. Note that because User Preset does a Recall State, and all of these settings are saved in State, they ARE recalled when using

	User Preset.
Initial S/W Revision	Prior to A.02.00

How-To Preset

The table below shows all possible presets, their corresponding SCPI commands and front-panel access (key paths). Instrument settings depend on the current measurement context. Some settings are local to the current measurement, some are global (common) across all the measurements in the current mode, and some are global to all the available modes. In a similar way, restoring the settings to their preset state can be done within the different contexts.

Auto Couple - is a measurement local key. It sets all Auto/Man parameter couplings in the measurement to Auto. Any Auto/Man selection that is local to other measurements in the mode will not be affected.

Meas Preset - is a measurement local key. Meas Preset resets all the variables local to the current measurement except the persistent ones.

Mode Preset - resets all the current mode's measurement local and measurement global variables except the persistent ones.

Restore Mode Defaults - resets ALL the Mode variables (and all the Meas global and Meas local variables), including the persistent ones.

Type Of Preset	SCPI Command	Front Panel Access
Auto Couple	:COUPlE ALL	Auto Couple front-panel key
Meas Preset	:CONFIgure:<Measurement>	Meas Setup Menu
Mode Preset	:SYSTem:PRESet	Mode Preset (green key)
Restore Mode Defaults	:INSTRument:DEFault	Mode Setup Menu
Restore All Mode Defaults	:SYSTem:DEFault MODEs	System Menu; Restore System Default Menu
*RST	*RST	not possible (Mode Preset with Single)
Restore Input/Output Defaults	:SYSTem:DEFault INPut	System Menu; Restore System Default Menu
Restore Power On Defaults	:SYSTem:DEFault PON	System Menu; Restore System Default Menu
Restore Alignment Defaults	:SYSTem:DEFault ALIGn	System Menu; Restore System Default Menu
Restore Miscellaneous Defaults	:SYSTem:DEFault MISC	System Menu; Restore System Default Menu
Restore All System Defaults	:SYSTem:DEFault [ALL] :SYSTem:PRESet:PERSistent	System Menu; Restore System Default Menu
User Preset	:SYSTem:PRESet:USER	User Preset Menu
User Preset All Modes	:SYSTem:PRESet:USER:ALL	User Preset Menu

Power On Mode Preset	:SYSTem:PON:TYPE MODE	System Menu
Power On User Preset	:SYSTem:PON:TYPE USER	System Menu
Power On Last State	:SYSTem:PON:TYPE LAST	System Menu

Preset Type (Remote Command Only)

As stated in the Backward Compatibility section, to be compatible with ESA/PSA the PRESet:TYPE command will be implemented as a no-op.

Mode	All
Remote Command	:SYSTem:PRESet:TYPE FACTory MODE USER :SYSTem:PRESet:TYPE?
Example	:SYST:PRESet:TYPE FACT
Notes	This command is supported for backward compatibility only. It is a no-op which does not change the behavior of any preset operation.
Preset	This is unaffected by Preset but is set to Mode on a "Restore System Defaults->All"
State Saved	No
Initial S/W Revision	Prior to A.02.00

Mode Setup

See ["Mode Setup" on page 347](#)

Peak Search

Performs a peak search and opens the Peak Search menu. The Peak Search functions allow you to define specific search criteria to determine which signals can be considered peaks, excluding unwanted signals from the search.

Places the selected marker on the trace point with the maximum y-axis value for that marker's trace.

Key Path	Front-panel key
Mode	SA, WCDMA, C2K, WIMAX OFDMA, 1xEV-DO, DVB-T/H, LTE, LTE-TDD, WLAN, MSR, LTE-AFDD, LTE-TDD
Remote Command	:CALCulate:SPURious:MARKer[1] 2 ... 12:MAXimum
Example	CALC:SPUR:MARK2:MAX
Initial S/W Revision	Prior to A.02.00
Modified at S/W Revision	A.03.00

Next Peak

Moves the selected marker to the peak that has the next highest amplitude less than the current marker value.

Key Path	Peak Search
Mode	SA, WCDMA, C2K, WIMAX OFDMA, TD-SCDMA, 1xEV-DO, DVB-T/H, LTE, LTE-TDD, WLAN, MSR, LTE-AFDD, LTE-TDD
Remote Command	:CALCulate:SPURious:MARKer[1] 2 ... 12:MAXimum:NEXT
Example	CALC:SPUR:MARK2:MAX:NEXT
Initial S/W Revision	Prior to A.02.00
Modified at S/W Revision	A.03.00

Next Pk Right

Moves the selected marker to the nearest peak to the right of the current marker which meets all enabled peak criteria.

Key Path	Peak Search
Mode	SA, WCDMA, C2K, WIMAX OFDMA, TD-SCDMA, 1xEV-DO, DVB-T/H, LTE, LTE-TDD, WLAN
Remote Command	:CALCulate:SPURious:MARKer[1] 2 ... 12:MAXimum:RIGHT
Example	CALC:SPUR:MARK2:MAX:RIGH
Initial S/W Revision	Prior to A.02.00
Modified at S/W Revision	A.03.00

Next Pk Left

Moves the selected marker to the nearest peak to the left of the current marker which meets all enabled peak criteria.

Key Path	Peak Search
Mode	SA, WCDMA, C2K, WIMAX OFDMA, TD-SCDMA, 1xEV-DO, DVB-T/H, LTE, LTETDD, WLAN, MSR, LTEAFDD, LPEATDD
Remote Command	:CALCulate:SPURious:MARKer[1] 2 ... 12:MAXimum:LEFT
Example	CALC:SPUR:MARK2:MAX:LEFT
Initial S/W Revision	Prior to A.02.00
Modified at S/W Revision	A.03.00

Marker Delta

Performs the same function as the Delta 1-of-N selection key in the Marker menu. This sets the control mode for the selected marker to Delta mode. See the Marker section for the complete description of this function. The key is duplicated here in the Peak Search Menu to allow you to conveniently perform a peak search and change the control of the Marker mode to Delta without having to access two separate menus.

Key Path	Peak Search
Initial S/W Revision	Prior to A.02.00

Pk-Pk Search

Finds and displays the amplitude and frequency (or time, if in zero span) differences between the highest and lowest y-axis value.

Key Path	Peak Search
Mode	SA, WCDMA, C2K, WIMAX OFDMA, TD-SCDMA, 1xEV-DO, DVB-T/H, LTE, LTETDD, WLAN, MSR, LTEAFDD, LPEATDD
Remote Command	:CALCulate:SPURious:MARKer[1] 2 ... 12:PTPeak
Example	CALC:SPUR:MARK:PTP
Notes	Turns on the Marker Δ
Dependencies	This key is not available (key is grayed-out) when Coupled Markers is on.
Initial S/W Revision	Prior to A.02.00
Modified at S/W Revision	A.03.00

Min Search

Moves the selected marker to the minimum y-axis value on the current trace.

12 Spurious Emissions Measurement
Peak Search

Key Path	Peak Search
Mode	SA, WCDMA, C2K, WIMAX OFDMA, TD-SCDMA, 1xEV-DO, DVB-T/H, LTE, LTE-TDD, WLAN, MSR, LTE-FDD, LTE-TDD
Remote Command	:CALCulate:SPURious:MARKer[1] 2 ... 12:MINimum
Example	CALC:SPUR:MARK:MIN
Initial S/W Revision	Prior to A.02.00
Modified at S/W Revision	A.03.00

Print

See "Print" on page 365

Quick Save

The Quick Save front-panel key repeats the most recent save that was performed from the Save menu, with the following exceptions:

- Register saves are not remembered as Saves for the purpose of the Quick Save function
- If the current measurement does not support the last non-register save that was performed, an informational message is generated, “File type not supported for this measurement”

Quick Save repeats the last type of qualified save (that is, a save qualified by the above criteria) in the last save directory by creating a unique filename using the Auto File Naming algorithm described below.

If Quick Save is pressed after startup and before any qualified Save has been performed, the Quick Save function performs a Screen Image save using the current settings for Screen Image saves (current theme, current directory), which then becomes the “last save” for the purpose of subsequent Quick Saves.

The Auto File Naming feature automatically generates a file name for use when saving a file. The filename consists of a prefix and suffix separated by a dot, as is standard for the Windows® file system. A default prefix exists for each of the available file types:

Type	Default Prefix	Menu
State	State_	(Save/Recall)
Trace + State	State_	(Save/Recall)
Screen	Screen_	(Save/Recall)
Amplitude Corrections	Ampcor_	(Import/Export)
Traces	Trace_	(Import/Export)
Limit Lines	LLine_	(Import/Export)
Measurement Result	MeasR_	(Import/Export)
Capture Buffer	CapBuf_	(Import/Export)

A four digit number is appended to the prefix to create a unique file name. The numbering sequence starts at 0000 within each Mode for each file type and updates incrementally to 9999, then wraps to 0000 again. It remembers where it was through a Mode Preset and when leaving and returning to the Mode. It is reset by Restore Misc Defaults and Restore System Defaults and subsequent running of the instrument application. So, for example, the first auto file name generated for State files is State_0000.state. The next is State_0001, and so forth.

One of the key features of Auto File Name is that we guarantee that the Auto File Name will never conflict with an existing file. The algorithm looks for the next available number. If it gets to 9999, then it looks for holes. If it find no holes, that is no more numbers are available, it gives an error.

For example, if when we get to State_0010.state there is already a State_0010.state file in the current directory, it advances the counter to State_0011.state to ensure that no conflict will exist (and then it verifies that State_0011.state also does not exist in the current directory and advances again if it does, and so forth).

If you enter a file name for a given file type, then the prefix becomes the filename you entered instead of the default prefix, followed by an underscore. The last four letters (the suffix) are the 4-digit number.

For example, if you save a measurement results file as “fred.csv”, then the next auto file name chosen for a measurement results save will be fred_0000.csv.

NOTE Although 0000 is used in the example above, the number that is used is actually the current number in the Meas Results sequence, that is, the number that would have been used if you had not entered your own file name.

NOTE If the filename you entered ends with _dddd, where d=any number, making it look just like an auto file name, then the next auto file name picks up where you left off with the suffix being dddd + 1.

Key Path	Front-panel key
Notes	No remote command for this key specifically.
Initial S/W Revision	Prior to A.02.00

Recall

In the LTE TDD mode, four types of recall functions are available under the Data menu: “Limit Mask”, “E-UTRA Test Model”, “Signal Studio Setup” and “Vector Signal Analyzer”. “Limit Mask” enables setting of a preset limit mask for Power Suite-based measurements, and currently it is available for the SEM/ACP measurements with the LTE TDD mode. Recalling “E-UTRA Test Model” sets complicated RB settings for each Test Model for the Modulation Analysis and Conformance EVM measurements. Recalling “Signal Studio Setup” or “89600 Vector Signal Analyzer” enables you to recall parameters which have been set and saved on the external platform.

Key Path	Front Panel
Mode	LTETDD
Initial S/W Revision	Prior to A.02.00
Modified at S/W Revision	A.06.00

State

The Recall State menu lets you choose a register or file from which to recall the state.

The content of a state file includes all of the settings and data required to return the analyzer as closely as possible to the Mode it was in, with the exact settings that were in place, when the save occurred. The Mode settings in each state file include the settings that are affected by Mode Preset, as well as the additional settings affected by Restore Mode Defaults; all of the Mode’s settings. In addition, all of the settings of the Input/Output system are included, even though they are outside of the Mode’s state, because they are needed to restore the complete setup. Persistent System settings (for example, GPIB address) are not affected by either a Mode Preset or Restore Mode Defaults, nor are they included in a saved State file.

Since each state file is only for one Mode, the settings for other Modes are unaffected when it is loaded. Recall State will cause a mode switch if the state being recalled is not from the current active mode.

After the recall completes, the message "File <filename> recalled" or “Recalled State Register <register number>” is displayed.

For rapid recalls, the State menu lists 16 registers that you can choose from to recall. Pressing a Register key initiates the recall. You can also select a file from which to recall.

The default path for all State Files is:

My Documents\<<mode name>\state

where <mode name> is the parameter used to select the mode with the INST:SEL command (for example, SA for the Spectrum Analyzer).

See "[More Information](#)" on page 1293.

Key Path	Recall
Mode	All

Remote Command	:MMEMory:LOAD:STATe <filename>
Example	:MMEM:LOAD:STAT "myState.state" This recalls the file myState.state on the default path
Example	MMEM:LOAD:STAT "MyStateFile.state" This loads the state file data (on the default file directory path) into the instrument state.
Notes	<p>When you pick a file to recall, the analyzer first verifies that the file is recallable in the current instrument by checking the software version and model number of the instrument. If everything matches, a full recall proceeds by aborting the currently running measurement, clearing any pending operations, and then loading the State from the saved state file. You can open state files from any mode, so recalling a State file switches to the mode that was active when the save occurred. After switching to the mode of the saved state file, mode settings and data (if any for the mode) are loaded with values from the saved file. The saved measurement of the mode becomes the newly active measurement and the data relevant to the measurement (if there is any) is recalled.</p> <p>If there is a mismatch between file version or model number or instrument version or model number, the recall function tries to recall as much as possible and returns a warning message. It may limit settings that differ based on model number, licensing or version number.</p> <p>After recalling the state, the Recall State function does the following:</p> <ul style="list-style-type: none"> • Makes the saved measurement for the mode the active measurement. • Clears the input and output buffers. • Status Byte is set to 0. • Executes a *CLS <p>If the file specified is empty an error is generated. If the specified file does not exist, another error is generated. If there is a mismatch between the file and the proper file type, an error is generated. If there is a mismatch between file version or model number or instrument version or model number, a warning is displayed. Then it returns to the State menu and File Open dialog goes away.</p> <p>After the Recall, the analyzer exits the Recall menu and returns to the previous menu.</p>
Backwards Compatibility SCPI	:MMEMory:LOAD:STATe 1,<filename> For backwards compatibility, the above syntax is supported. The "1" is simply ignored.
Initial S/W Revision	Prior to A.02.00

More Information

In measurements that support saving Traces, for example, Swept SA, the Trace data is saved along with the State in the State file. When recalling the State, the Trace data is recalled as well. Traces are recalled exactly as they were stored, including the writing mode and update and display modes. If a Trace was updating and visible when the State was saved, it will come back updating and visible, and its data will be rewritten right away. When you use State to save and recall traces, any trace whose data must be preserved should be placed in View or Blank mode before saving.

The following table describes the Trace Save and Recall possibilities:

You want to recall state and one trace's data, leaving other traces unaffected.	Save Trace+State from 1 trace. Make sure that no other traces are updating (they should all be in View	On Recall, specify the trace you want to load the one trace's data into. This trace will load in View.
---	---	--

	or Blank mode) when the save is performed.	All other traces' data will be unaffected, although their trace mode will be as it was when the state save was performed.
You want to recall all traces	Save Trace+State from ALL traces.	On Recall, all traces will come back in View (or Blank if they were in Blank or Background when saved)
You want all traces to load exactly as they were when saved.	Save State	On recall, all traces' mode and data will be exactly as they were when saved. Any traces that were updating will have their data immediately overwritten.

From File...

When you press “From File”, the analyzer brings up a Windows dialog and a menu entitled “File Open.” This menu allows you to navigate to the various fields in the Windows dialog without using a keyboard or mouse. The Tab and Arrow keys can also be used for dialog navigation.

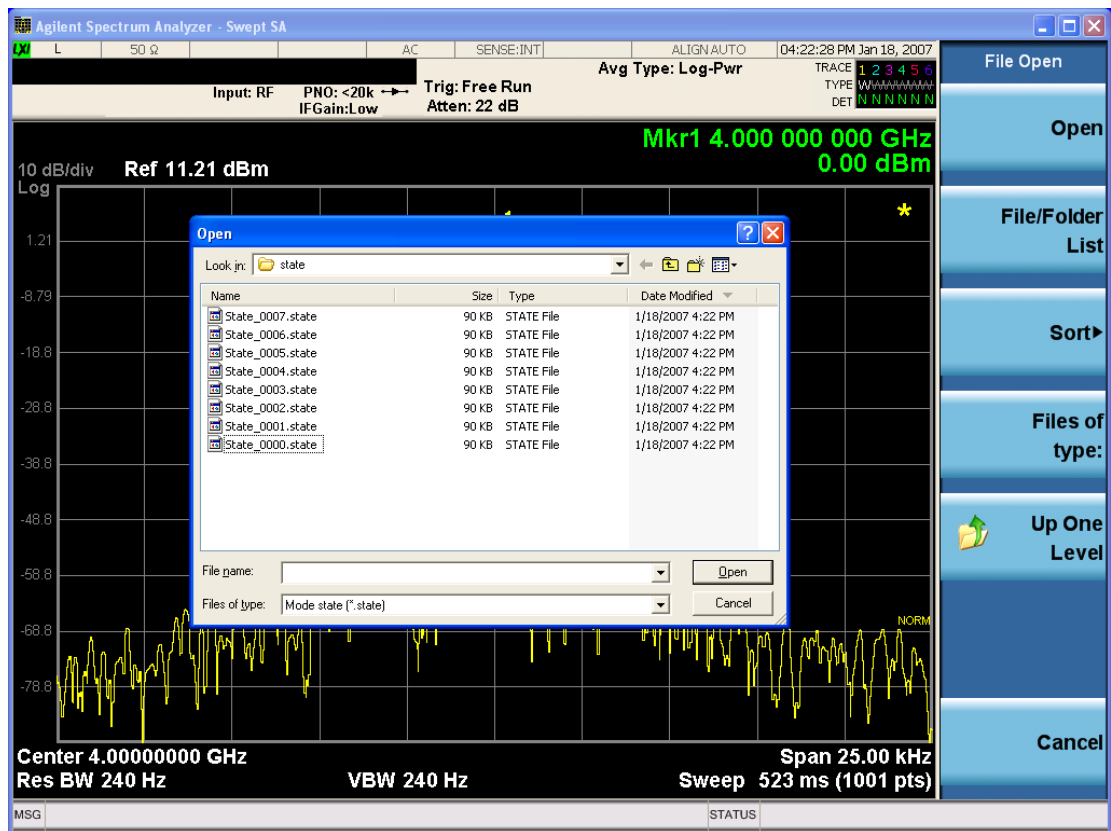

Listed below are the functions of the various fields in the dialog, and the corresponding softkeys:

Open

Performs the recall of the specified file. While the recall is being performed, the floppy icon appears briefly in the Meas bar.

File/Folder List

Enables you to navigate to the center of the dialog that contains the list of files and folders. Once here you can get information about the file and use the tab keys to navigate to the other fields in the dialog, such as Look In.

Look In

The Look In field shows the path from which the file will be recalled and allows you to change the path using the up and down arrow keys to navigate to other paths; the Enter key to open a directory; and the Backspace key to go back one directory. The **Look In field** first uses the last path from the Save As dialog **Save In:** path for that same file type. There is no softkey for directly navigating to the Look In field, but you can use the left tab to get here from the File/Folder List.

User specified paths are remembered when you leave and return to a Mode and are reset back to the default using Restore Mode Defaults.

Sort

Accesses a menu that enables you to sort the files within the File Open dialog. Only one sorting type can be selected at a time and the sorting happens immediately. The sorting types are By Date, By Name, By extension, and By Size.

Files of Type

This field shows the file suffix for the type of file you have selected to recall. For example, if you navigated here while recalling State, "Mode state (*.state)" is in the field. If you navigated here while recalling Trace, ""Mode state (*.trace)" is in the field. If you navigated here while importing a trace data file, "Trace Data (*.csv)" is in the field. For some file types, there is more than one choice in the dropdown menu, which you can select by using the up and down arrow keys and Enter.

Up One Level

This key corresponds to the icon of a folder with the up arrow that is in the tool bar of the dialog. When pressed, it causes the file and folder list to navigate up one level in the directory structure. The Backspace key does the same thing.

Cancel

This key corresponds to the Cancel selection in the dialog. It causes the current **Open** request to be cancelled. The ESC key does the same thing.

Key Path	Recall, State
Notes	Brings up the Open dialog for recalling a State Save Type
Initial S/W Revision	Prior to A.02.00

Edit Register Names

You may enter a custom name on any of the Register keys, to help you remember what you are using that state to save. To do this, press the Edit Register Names key, choose the register whose name you wish to edit, and then enter the desired label using the Alpha Editor or an external PC keyboard.

The maximum number of characters that can be added is 30. In most cases, 30 characters will fit on two lines of the key.

For more information and the SCPI command, see Edit Register Names under the Save, State function.

Key Path	Recall, State
Mode	All
Dependencies	N9060A-7FP or N9060B-2FP license required to edit the register names. When the feature is not licensed, sending the SCPI command generates an error, -221, "Settings conflict;Option not available"
Initial S/W Revision	A.11.00

Register 1 thru Register 16

Selecting any one of these register keys causes the State of the mode from the specified Register to be recalled. Each of the register keys annotates whether it is empty or at what date and time it was last modified. In addition, you can use the Edit Register Names key under Save, State to enter custom names for each register.

Registers are shared by all modes, so recalling from any one of the registers will cause a mode switch to the mode that was active when the save to the Register occurred.

Although these 16 registers are the only registers available from the front panel, there are 128 state registers available in the instrument. Registers 17-128 are only available from the SCPI interface, using the *RCL command.

After the recall completes, the message "Register <register number> recalled" appears in the message bar. If you are in the Spectrum Analyzer Mode, and you are recalling a register that was saved in the Spectrum Analyzer Mode, then after the recall, you will still be in the Recall Register menu. If the Recall causes you to switch modes, then after the Recall, you will be in the Frequency menu.

If a requested register is empty an error is generated.

Key Path	Recall, State
Example	*RCL 1
Range	1-16 from front panel, 1-128 from SCPI
Readback	Date and time with seconds resolution are displayed on the key OR A custom name of up to 30 characters entered using the Save, State,Edit Register Names key OR “(empty)” if no prior save operation has been performed to this register.
Initial S/W Revision	Prior to A.02.00
Modified at S/W Revision	Prior to A.11.00

Register 1 thru Register 16

Selecting any one of these register keys causes the State of the mode from the specified Register to be recalled. Each of the register keys annotates whether it is empty or at what date and time it was last modified. In addition, you can use the Edit Register Names key under Save, State to enter custom names for each register.

Registers are shared by all modes, so recalling from any one of the registers will cause a mode switch to the mode that was active when the save to the Register occurred.

Although these 16 registers are the only registers available from the front panel, there are 128 state registers available in the instrument. Registers 17–128 are only available from the SCPI interface, using the *RCL command.

After the recall completes, the message "Register <register number> recalled" appears in the message bar. If you are in the Spectrum Analyzer Mode, and you are recalling a register that was saved in the Spectrum Analyzer Mode, then after the recall, you will still be in the Recall Register menu. If the Recall causes you to switch modes, then after the Recall, you will be in the Frequency menu.

If a requested register is empty an error is generated.

Key Path	Recall, State
Example	*RCL 1
Range	1–16 from front panel, 1–128 from SCPI
Readback	Date and time with seconds resolution are displayed on the key OR A custom name of up to 30 characters entered using the Save, State, Edit Register Names key OR “(empty)” if no prior save operation has been performed to this register.
Initial S/W Revision	Prior to A.02.00
Modified at S/W Revision	Prior to A.11.00

Recall

In the LTE TDD mode, four types of recall functions are available under the Data menu: “Limit Mask”, “E-UTRA Test Model”, “Signal Studio Setup” and “Vector Signal Analyzer”. “Limit Mask” enables setting of a preset limit mask for Power Suite-based measurements, and currently it is available for the SEM/ACP measurements with the LTE TDD mode. Recalling “E-UTRA Test Model” sets complicated RB settings for each Test Model for the Modulation Analysis and Conformance EVM measurements. Recalling “Signal Studio Setup” or “89600 Vector Signal Analyzer” enables you to recall parameters which have been set and saved on the external platform.

Key Path	Front Panel
Mode	LTETDD
Initial S/W Revision	Prior to A.02.00
Modified at S/W Revision	A.06.00

Import Trace Data

Enables you to import previously saved trace data into a Data Register and optionally display it. Selecting this key displays a menu that enables you to select the destination data register, and also enables you to choose whether or not to display the recalled data in the currently selected trace. After making these selections, select Open... and use the file dialog to select the file you want to recall.

Recalling trace data into an already used Data Register overwrites the previous data. If the data register is displayed on any trace, the display is updated to reflect the new data.

The SCPI command

```
:MMEM:LOAD:TRAC:DATA D1|D2|D3|D4|D5|D6,<filename>
```

recalls data into a specified register, but does not display it in the selected trace. Use the command

```
:DISP:<meas>:TRAC<n>:FEED D1|D2|D3|D4|D5|D6
```

to display the register in the desired trace.

It is possible to recall trace data saved by other VXA measurements, or measurements made using the LTE, LTETDD, iDEN, or 89601 applications.

Key Path	Recall, Data (Import)
Mode	VSA, LTE, LTETDD, IDEN
Remote Command	:MMEMory:LOAD:TRACe:DATA D1 D2 D3 D4 D5 D6,<filename>[,CSV TXT SDF MAT4 MAT HDF5 BIN]
Example	:MMEM:LOAD:TRAC:DATA D1,"Trc1.txt",TXT
Notes	<p>The Open: dialog box has the following filter options when you are recalling trace data::</p> <ul style="list-style-type: none"> • CSV (Comma delimited) (*.csv) • SDF (Fast) (*.sdf;*.dat) • Text (Tab delimited) (*.txt) <p>The file must have the same format as that created by the Export Recorded Data command.</p> <p>The SCPI command has an optional file format parameter. If you do not include this parameter in the SCPI command, the file format is determined by the file name extension. If no file extension is recognized, the file is scanned to determine the format.</p> <p>If you are not licensed to recall a particular file type, then error -203.9010 is returned. If the file format cannot be determined or the file cannot be recalled successfully, then error -250.5290 is returned. If the recall is successful, then advisory 0.1600 is shown.</p>
State Saved	No
Readback	Data 1 Data 2 Data 3 Data 4 Data 5 Data 6

Data 1

Selects the Data 1 register as the destination for the imported data.

Key Path	Recall, Data (Import), Trace (to)
Mode	VSA, LTE, LTETDD, IDEN

Data 2

Selects the Data 2 register as the destination for the imported data.

Key Path	Recall, Data (Import), Trace (to)
Mode	VSA, LTE, LTETDD, IDEN

Data 3

Selects the Data 3 register as the destination for the imported data.

Key Path	Recall, Data (Import), Trace (to)
Mode	VSA, LTE, LTETDD, IDEN

Data 4

Selects the Data 4 register as the destination for the imported data.

Key Path	Recall, Data (Import), Trace (to)
Mode	VSA, LTE, LTETDD, IDEN

Data 5

Selects the Data 5 register as the destination for the imported data..

Key Path	Recall, Data (Import), Trace (to)
Mode	VSA, LTE, LTETDD, IDEN

Data 6

Selects the Data 6 register as the destination for the imported data.

Key Path	Recall, Data (Import), Trace (to)
Mode	VSA, LTE, LTETDD, IDEN

Display in Selected Trace

Enables you to select whether the recalled trace data is displayed in the current Trace.

Key Path	Recall, Data (Import), Trace (to)
----------	-----------------------------------

Mode	VSA, LTE, LTETDD, IDEN
State Saved	No

Signal Studio Setup

This key allows you to recall the Agilent Signal Studio setup file created on the Signal Studio (N7625B). This key is valid only for the Mod Analysis measurement. For E-TM test model signal, please use corresponding EVM setup file under My Documents\LTETDD\data\evmsetup.

For the supported carrier types, see the table below.

Signal Studio	Carrier Type
N7625B Signal Studio for 3GPP LTE TDD	Advanced LTE TDD(2009-03)
	Advanced LTE TDD(2009-12)
	Basic LTE TDD(2009-03)
	Basic LTE TDD(2009-12)

File Location and Extension

File location: "My Documents\LTETDD\data"

File type: xml

File extension: .scp

You need to place the Signal Studio Setup file created on N7625B in the above directory in advance. Pressing OPEN under the Import Data menu will open this directory from which you can select the setup file.

Example:

File Location: My Documents\LTETDD\data

File Name: Uplink PUSCH.scp

Key Path	Recall, Data
Mode	LTETDD
Remote Command	MMEemory:LOAD:SSSetup <string>
Example	MME:LOAD:SSS "Uplink PUSCH.scp"
Notes	Sets of parameters related to Signal Studio Setup are overwritten by the contents of the setup file.
Initial S/W Revision	A.06.00

89601 VSA Setup

Enables you to import the 89600 Vector Signal Analyzer Setup file created using the 89600 Vector Signal Analyzer Option BHE (LTE TDD). This key is valid only for the Mod Analysis measurement.

File Location and Extension

File location: “My Documents\LTETDD\data”

File type: text file

File extension: .set, .setx

Place the 89600 Vector Signal Analyzer Setup file that you saved on 89600 in the above directory. When you select OPEN under the Import Data menu, the directory opens enabling you to select your setup file.

Example:

File Location: My Documents\LTETDD\data

File Name: Uplink PRACH.set

Key Path	Recall, Data
Mode	LTETDD
Remote Command	MME ^M o ^R y:LOAD:VSAS ^S etup <string>
Example	MME:LOAD:VSAS "Uplink PRACH.set"
Notes	Sets of parameters related to Vector Signal Analyzer Setup are overwritten by the contents of the setup file.
Initial S/W Revision	A.06.00
Modified at S/W Revision	A.10.00

Masks

This key allows you to recall a preset mask file from the list. The preset mask file contains configuration for only Carrier, Offset, Limit settings and the preset profile BW. Any set of values not specified by the preset mask file will not be overwritten.

You cannot change or create the preset mask file since it is a binary file. This key is valid for the Spectrum Emission Mask and ACP measurements.

File location: “My Documents\LTETDD\data\masks”

Note that “My Documents” is an alias to a directory and its place differs depending on which user is logged in. At XSA start up, XSA will overwrite all of the limit mask files to the current user’s “My Documents\LTETDD\data\masks” each time.

File type: Binary

Filename: The filename follows the rule below, in which the word is connected with underscores.

<Measurement>_<Direction>_<Bandwidth>_<Condition>.mask

Where

<Measurement> Measurement the limit mask file is applied to: SEM or ACP

<Direction> Direction: BS (Downlink) or MS (Uplink).

<Bandwidth> Bandwidth

<Condition> Condition. It depends on the measurement.

File extension: .mask

Pressing OPEN under the Import Data menu will open the above directory from which you can select a mask file. When you change the Bandwidth or Direction, all Power Suite measurement parameters are reset to the hard coded preset parameters. Thus you must recall the appropriate preset mask file again after the change.

You cannot read the contents of the provided preset mask file since it is a binary file. Detailed contents of the file are provided by a PDF format file located in the same directory as the preset mask file.

Example:

File Location: My Documents/LTETDD/data/masks/SEM_MS

File Name: SEM_MS_15MHz_Add_NS04.mask

The following table shows the sets of variables imported to the ACP measurement.

Offset	Start Freq (MHz)	Stop Freq (MHz)	Res BW (Hz)	Meas BW	Rel Start	Rel Stop	Fail Mask
A	5	7.14	30k	1	-8	-25	Rel
B	7.14	10.57	30k	1	-25	-27	Rel
C	10.57	20	30k	1	-27	-50	Rel
D	20	25	30k	1	-50	-50	Rel
E	25	30	30k	1	-50	-50	Rel

Key Path	Recall, Data
Mode	LTETDD
Remote Command	MMEMemory:LOAD:MASK <string>
Example	MME:LOAD:MASK "ACP_BS\ACP_BS_3MHz_pairE-UTRA_CatA.mask"
Notes	Sets of parameters related to Limit, Carrier and Offset are overwritten by the contents of the preset mask file.
Initial S/W Revision	A.03.00

EVM Setup

This key allows you to recall EVM parameter setting to measure E-UTRA Test Model in 3GPP standard (36.141-810 6.1.1).

- E-UTRA Test Model 1.1 (E-TM1.1)
- E-UTRA Test Model 1.2 (E-TM1.2)
- E-UTRA Test Model 2 (E-TM2)
- E-UTRA Test Model 3.1 (E-TM3.1)

- E-UTRA Test Model 3.2 (E-TM3.2)
- E-UTRA Test Model 3.3 (E-TM3.3)

This key is valid for the Modulation Analysis and Conformance EVM measurements only.

File Location and Extension

File location: My Documents\LTETDD\data\evmsetup

Note that “My Documents” is an alias to a directory and its place differs depending on which user is logged in. At XSA start up, XSA will overwrite all of the EVM Setup files to the current user’s “My Documents\LTETDD\data\evmsetup” each time.

File type: binary

File extension: .evms

Pressing OPEN under the Import Data menu will open the above directory from which you can select an EVM Setup file. When you change the Bandwidth, parameters are reset to the hard coded preset parameters. Thus you must recall the appropriate EVM Setup file again after the change.

You cannot read the contents of the provided EVM Setup file since it is a binary file.

Example:

File Location: My Documents\LTETDD\data\evmsetup

Filename: TM3.1-BW1.4MHz.evms

Key Path	Recall, Data
Mode	LTETDD
Remote Command	MMEemory:LOAD:EVMSSetup <string>
Example	MMEM:LOAD:EVMS "TM2-BW15MHz.evms"
Notes	Sets of parameters related to EVM Setup are overwritten by the contents of the EVM Setup file.
Initial S/W Revision	A.03.00, A.08.00

Open...

When you press “Open”, the analyzer brings up a Windows dialog and a menu entitled “File Open.” This menu allows you to navigate to the various fields in the Windows dialog without using a keyboard or mouse. The Tab and Arrow keys can also be used for dialog navigation.

See "[From File...](#)" on page 2797 in Recall, State, for a full description of this dialog and menu.

Key Path	Recall, Data
Notes	The key location is mode-dependent and will vary. Brings up Open dialog for recalling a <mode specific> Save Type
Initial S/W Revision	Prior to A.02.00

Restart

The Restart function restarts the current sweep, or measurement, or set of averaged/held sweeps or measurements. If you are Paused, pressing Restart does a Resume.

The Restart function is accessed in several ways:

- Pressing the Restart key
- Sending the remote command INIT:IMMEDIATE
- Sending the remote command INIT:RESTART

See "[More Information](#)" on page 1304

Key Path	Front-panel key
Remote Command	:INITiate[:IMMEDIATE] :INITiate:RESTART
Example	:INIT:IMM :INIT:REST
Notes	:INITiate:RESTART and :INITiate:IMMEDIATE perform exactly the same function.
Couplings	Resets average/hold count k. For the first sweep overwrites all active (update=on) traces with new current data. For application modes, it resets other parameters as required by the measurement.
Status Bits/OPC dependencies	This is an Overlapped command. The STATus:OPERation register bits 0 through 8 are cleared. The STATus:QUESTionable register bit 9 (INTegrity sum) is cleared. The SWEEPING bit is set. The MEASURING bit is set.
Backwards Compatibility Notes	For Spectrum Analysis mode in ESA and PSA, the Restart hardkey and the INITiate:RESTART command restart trace averages (displayed average count reset to 1) for a trace in Clear Write, but did not restart Max Hold and Min Hold. In the X-Series, the Restart hardkey and the INITiate:RESTART command restart not only Trace Average, but MaxHold and MinHold traces as well. For wireless comms modes in ESA and PSA, the Restart hardkey and the INITiate:RESTART command restart every measurement, which includes all traces and numeric results. There is no change to this operation.
Initial S/W Revision	Prior to A.02.00

More Information

The **Restart** function first aborts the current sweep/measurement as quickly as possible. It then resets the sweep and trigger systems, sets up the measurement and initiates a new data measurement sequence with a new data acquisition (sweep) taken once the trigger condition is met.

If the analyzer is in the process of aligning when **Restart** is executed, the alignment finishes before the restart function is performed.

Even when set for Single operation, multiple sweeps may be taken when Restart is pressed (for example, when averaging/holding is on). Thus when we say that **Restart** "restarts a measurement," we may mean:

- It restarts the current sweep
- It restarts the current measurement
- It restarts the current set of sweeps if any trace is in Trace Average, Max Hold or Min Hold
- It restarts the current set of measurements if Averaging, or Max Hold, or Min Hold is on for the measurement
- depending on the current settings.

With **Average/Hold Number** (in **Meas Setup** menu) set to 1, or Averaging off, or no trace in Trace Average or Hold, a single sweep is equivalent to a single measurement. A single sweep is taken after the trigger condition is met; and the analyzer stops sweeping once that sweep has completed. However, with **Average/Hold Number** >1 and at least one trace set to **Trace Average, Max Hold, or Min Hold (SA Measurement)** or **Averaging on (most other measurements)**, multiple sweeps/data acquisitions are taken for a single measurement. The trigger condition must be met prior to each sweep. The sweep is stopped when the average count k equals the number N set for **Average/Hold Number**. A measurement average usually applies to all traces, marker results, and numeric results; but sometimes it only applies to the numeric results.

Once the full set of sweeps has been taken, the analyzer will go to idle state. To take one more sweep without resetting the average count, increment the average count by 1, by pressing the step up key while **Average/Hold Number** is the active function, or sending the remote command `CALC:AVER:TCON UP`.

Save

The Save menu lets you choose what you want to save and where you want to save it. Among the types of files you can save are **States**, **Traces**, and **Screen Images**. In addition, an Export (Data) option lets you save a number of data types as CSV files for easy import into Excel and other spreadsheet programs.

Key Path	Front-panel key
Mode	All
Notes	No remote command for this key specifically, but the :MMEM:STORe command is available for specific file types. An example is :MMEM:STOR:STATe <filename>.
Initial S/W Revision	Prior to A.02.00

State

The Save State menu lets you choose a register or file for saving the state.

The content of a state file includes all of the settings and data required to return the analyzer as closely as possible to the Mode it was in, with the exact settings which were in place, when the save occurred. The Mode settings in each state file include the settings that are affected by Mode Preset, as well as the additional settings affected by Restore Mode Defaults; all of the Mode's settings. In addition, all of the settings of the Input/Output system are included, even though they are outside of the Mode's state, because they are needed to restore the complete setup. Persistent System settings (for example, Verbose SCPI) are not affected by either Mode Preset or Restore Mode Defaults, nor are they included in a saved State file.

After the save completes, the message "File <filename> saved" or "State Register <register number> saved" is displayed.

For rapid saving, the State menu lists 16 registers to save to. Pressing a Register key initiates the save. You can also select a file to save to.

The default path for all State Files is:

My Documents\<<mode name>\state

where <mode name> is the parameter used to select the mode with the INST:SEL command (for example, SA for the Spectrum Analyzer).

Key Path	Save
Mode	All
Remote Command	:MMEMory:STORe:STATe <filename>
Example	MMEM:STOR:STATe "MyStateFile.state" This stores the current instrument state data in the file MyStateFile.state in the default directory.
Notes	Both single and double quotes are supported for any filename parameter over remote. After saving to a register, that register's menu key is updated with the date the time, unless a custom label has been entered for that key. After saving to a register, you remain in the Save State menu, so that you can see the Register key

update. After saving to a file, the analyzer automatically returns to the previous menu and any Save As dialog goes away.

Backwards Compatibility SCPI	:MMEMory:STORe:STATe 1,<filename>
Initial S/W Revision	Prior to A.02.00

To File . . .

When you press “To File”, the analyzer brings up a Windows dialog and a menu entitled “**Save As.**” This menu allows you to navigate to the various fields in the Windows dialog without using a keyboard or mouse. The Tab and Arrow keys can also be used for dialog navigation.

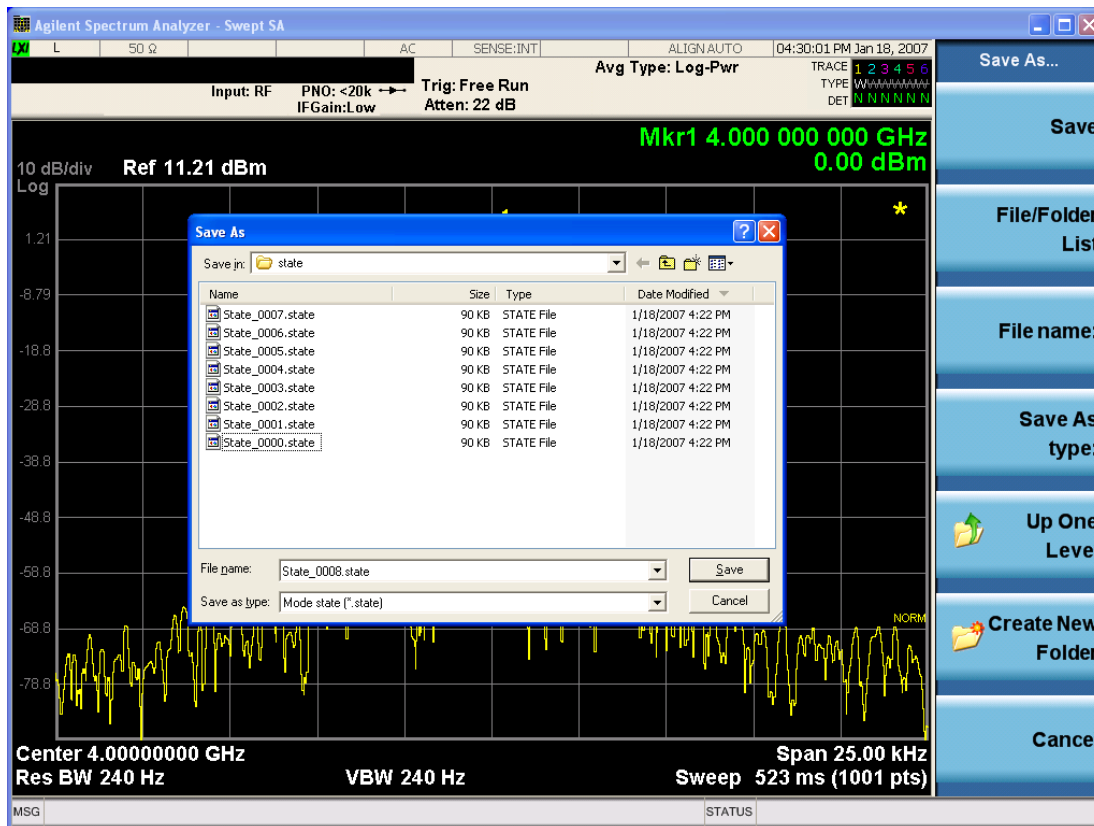

The Listed below

are the functions of the various fields in the dialog, and the corresponding softkeys:

Save

Performs the save to the specified file of the selected type. If the file already exists, a dialog will appear that allows you to replace the existing file by selecting OK, or you can Cancel the request. If you select OK, the file will be overwritten. Using the C: drive is strongly discouraged, since it runs the risk of being overwritten during an instrument software upgrade.

While the save is being performed, the floppy icon appears briefly in the Meas bar.

File/Folder List

Enables you to navigate to the center of the dialog that contains the list of files and folders. Once here you can get information about the file and use the tab keys to navigate to the other fields in the dialog, such as Save In.

Save In

The Save In field shows the path to which the file will be saved and allows you to change the path using the up and down arrow keys to navigate to other paths; the Enter key to open a directory; and the Backspace key to go back one directory. The **Save In field** defaults to the default path for this type of file and remembers the last path you used to save this type of file. There is no softkey for directly navigating to the Save In field but you can use left tab to get here from the File/Folder List.

User specified paths are remembered when you leave and return to a Mode and are reset back to the default using Restore Mode Defaults.

File Name

The File Name field is initially loaded with an automatically generated filename specific to the appropriate Save Type. The automatically generated filename is guaranteed not to conflict with any filename currently in the directory. You may replace or modify this filename using the File Name key. See the ["Quick Save " on page 2793](#) documentation for more on the automatic file naming algorithm.

When you press the File Name key the analyzer displays the Alpha Editor. Use the knob to choose the letter to add and the front-panel Enter key to add the letter to the file name. The BK character moves you back and the FW character moves you forward in the filename. The Select key on the front panel generates a space character. When you are done entering the filename press the Done softkey. This returns back to the **File Open** dialog and menu, but does not cause the save to occur.

Save As Type

This field shows the file suffix for the type of file you have selected to save. For example, if you navigated here while saving State, "Mode state (*.state)" is in the field. If you navigated here from saving Trace, ""Mode state (*.trace)" is in the field. If you navigated here while exporting a trace data file, "Trace Data (*.csv)" is in the field. For some file types, there is more than one choice in the dropdown, which you can select by using the up and down arrow keys and Enter.

Up One Level

This key corresponds to the icon of a folder with the up arrow that is in the tool bar of the dialog. When pressed, it causes the file and folder list to navigate up one level in the directory structure. The Backspace key does the same thing.

Create New Folder

This key corresponds to the icon of a folder with the "*" that is in the tool bar of the dialog. When pressed, a new folder is created in the current directory with the name **New Folder** and you can enter a new folder name using the Alpha Editor.

Cancel

This key corresponds to the Cancel selection in the dialog. It causes the current **Save As** request to be cancelled. The ESC key does the same thing.

Key Path	Save, State
Mode	All
Notes	Brings up Save As dialog for saving a State Save Type
Initial S/W Revision	Prior to A.02.00

Edit Register Names

You may enter a custom name on any of the Register keys, to help you remember what you are using that state to save. To do this, press the Edit Register Names key, choose the register whose name you wish to edit, and then enter the desired label using the Alpha Editor or an external PC keyboard.

The maximum number of characters that can be added is 30. In most cases, 30 characters will fit on two lines of the key.

See ["More Information" on page 1309](#)

Key Path	Save, State
Mode	All
Remote Command	:MMEMory:REGister:STATe:LABel <reg number>,"label" :MMEMory:REGister:STATe:LABel? <reg number>
Example	:MMEM:REG:STAT:LAB 1,"my label"
Notes	<reg number> is an integer from 1 to 16. If the SCPI specifies an invalid register number an error message is generated, -222,"Data out of range;Invalid register label number" "label" is a string from 0 to 30 characters in length. If a label exceeds 30 characters, an error message is generated, -150,"String data error;Label clipped to 30 characters" "label" of length 0 erases the custom label and restores the default (time and date) label. E.g.: :MMEM:REG:STAT:LAB 1,""
Dependencies	N9060A-7FP or N9060B-2FP license required to edit the register names. When the feature is not licensed, sending this command generates an error, -221,"Settings conflict;Option not available"
Preset	The names are unaffected by Preset or power cycle but are set to the default label (time and date) on a "Restore System Defaults->Misc"
Initial S/W Revision	A.11.00

More Information

When you edit one of the register names, the time and date field will be replaced by the custom name.

If you delete all the characters in the custom name, it restores the default (time and date).

The register names are stored within the state files, but they are not part of the instrument state; that is, once you have edited a register name, loading a new state will not change that register name. Another consequence of this is that the names will be persistent through a power cycle. Also, if a named state file is transferred to another analyzer, it will bring its custom name along with it.

If you try to edit the name of an empty register, the analyzer will first save the state to have a file to put the name in. If you load a named state file into an analyzer with older firmware it will ignore the metadata.

The *SAV and *RCL commands will not be affected by the custom register names, nor will the MMEM commands.

Register 1 thru Register 16

Selecting any one of these register menu keys causes the State of the currently active mode to be saved to the specified Register. The registers are provided for rapid saving and recalling, since you do not need to specify a filename or navigate to a file. Each of the register menu keys annotates whether it is empty or at what date and time it was last modified. In addition, you can use the Edit Register Names key to enter custom names for each register.

Although these 16 registers are the only registers available from the front panel, there are 128 state registers available in the instrument. Registers 17–128 are only available from the SCPI interface, using the *SAV command.

There is one set of 128 state registers in the instrument, not one set for each Mode. When a state is saved, the Mode it was saved from is saved with it; then when it is recalled, the instrument switches to that Mode.

After the save completes, the corresponding register menu key annotation is updated with the date and time and the message "Register <register number> saved" is displayed.

Key Path	Save, State
Mode	All
Example	*SAV 1
Range	1–16 from front panel, 1–128 from SCPI
Readback	Date and time with seconds resolution are displayed on the key OR A custom name of up to 30 characters entered using the Edit Register Names key OR “(empty)” if no prior save operation has been performed to this register.
Initial S/W Revision	Prior to A.02.00
Modified at S/W Revision	A.11.00

Register 1 thru Register 16

Selecting any one of these register menu keys causes the State of the currently active mode to be saved to the specified Register. The registers are provided for rapid saving and recalling, since you do not need to specify a filename or navigate to a file. Each of the register menu keys annotates whether it is empty or at what date and time it was last modified. In addition, you can use the Edit Register Names key to enter custom names for each register.

Although these 16 registers are the only registers available from the front panel, there are 128 state registers available in the instrument. Registers 17–128 are only available from the SCPI interface, using the *SAV command.

There is one set of 128 state registers in the instrument, not one set for each Mode. When a state is saved, the Mode it was saved from is saved with it; then when it is recalled, the instrument switches to that Mode.

After the save completes, the corresponding register menu key annotation is updated with the date and time and the message "Register <register number> saved" is displayed.

Key Path	Save, State
Mode	All
Example	*SAV 1
Range	1-16 from front panel, 1-128 from SCPI
Readback	Date and time with seconds resolution are displayed on the key OR A custom name of up to 30 characters entered using the Edit Register Names key OR "(empty)" if no prior save operation has been performed to this register.
Initial S/W Revision	Prior to A.02.00
Modified at S/W Revision	A.11.00

Data (Export)

Exporting a data file stores data from the current measurement to mass storage files. The Export Menu only contains data types that are supported by the current measurement.

Since the commonly exported data files are in .csv format, the data can be edited by you prior to importing. This allows you to export a data file, manipulate the data in Excel (the most common PC Application for manipulating .csv files) and then import it.

Selecting an Export Data menu key will not actually cause the exporting to occur, since the analyzer still needs to know where you wish to save the data. Pressing the Save As key in this menu brings up the Save As dialog and Save As menu that allows you to specify the destination file and directory. Once a filename has been selected or entered in the Open menu, the export will occur as soon as the Save key is pressed.

Key Path	Save
Mode	All
Notes	The menu is built from whatever data types are available for the mode. So the key locations in the sub menu will vary. No SCPI command directly controls the Data Type that this key controls. The Data Type is included in the MMEM:STORe commands.
Dependencies	If a file type is not used by a certain measurement, that type is grayed out for that measurement. The key for a file type will not show at all if there are no measurements in the Mode that support it.
Preset	Is not affected by a Preset or shutdown, but is reset during Restore Mode Defaults
Readback	The data type that is currently selected
Initial S/W Revision	Prior to A.02.00

Export Trace Data

Enables you to export trace data with (optional) associated headers. Selecting this key displays a menu that enables you to choose which Trace to save (default is the selected Trace) and whether or not to save headers with the data. The header information is used by the VXA application when saved trace data is recalled, and enables it to be displayed with the same formatting and scaling that it had when saved. If headers are not saved, the scaling and format are set to default values when the trace is recalled. After making these selections, press Save As... and use the file dialog to choose a file name and format for the saved data.

Trace data can be exported in several different formats. Text and comma-separated variable (CSV) formats are useful for viewing the data or importing it to a spreadsheet program. The other formats are binary and thus more compact. Trace data files can be recalled for viewing into other VXA, LTE, LTETDD, iDEN, or 89601 measurements.

Key Path	Save, Data (Export)
Mode	VSA, LTE, LTETDD, IDEN
Remote Command	:MMEMory:STORe:TRACe:DATA TRACE1 TRACE2 TRACE3 TRACE4 TRACE5 TRACE6, "<filename>" [,CSV TXT SDF MAT4 MAT HDF5 BIN[,OFF ON 0 1]]
Example	:MMEM:STOR:TRAC:DATA TRACE1, "TRC1.TXT", TXT, ON
Notes	<p>The Save As... dialog box has the following format options when you are saving trace data:</p> <ul style="list-style-type: none"> • CSV (Comma delimited) (*.csv) • SDF (Fast) (*.sdf;*.dat) • Text (Tab delimited) (*.txt) <p>File format saved depends on selection. The appropriate file extension is appended to the filename if it is not supplied by the user.</p> <p>If the SCPI command includes just a file name, the file format is determined by the filename extension, which must be one of the choices above. *.sdf or an unrecognized extension chooses the SDF fast format. If the optional file format enumerator is included in the command, then this determines the file format and the file extension is ignored. The optional binary parameter determines if file headers are saved. The default is ON. If file headers are not wanted, use the optional "OFF" parameter.</p> <p>The optional Boolean parameter determines whether headers are saved in the file. By default the headers are saved.</p> <p>If you are not licensed to save a particular file type, then error -203.9010 is returned. If an invalid file format is specified or the file cannot be saved successfully, then error -25x is returned. If the save is successful, then advisory 0.1500 is shown.</p>
State Saved	No
Readback	(Trace 1 Trace 2 Trace 3 Trace 4 Trace 5 Trace 6)(with without) headers

Trace 1

Selects the Trace 1 register as the destination for the imported data.

Key Path	Save, Data (Export), Trace
Mode	VSA, LTE, LTETDD, IDEN

Trace 2

Selects the Trace 2 register as the destination for the imported data.

Key Path	Save, Data (Export), Trace
Mode	VSA, LTE, LTETDD, IDEN

Trace 3

Selects the Trace 3 register as the destination for the imported data.

Key Path	Save, Data (Export), Trace
Mode	VSA, LTE, LTETDD, IDEN

Trace 4

Selects the Trace 4 register as the destination for the imported data.

Key Path	Save, Data (Export), Trace
Mode	VSA, LTE, LTETDD, IDEN

Include Header

Enables you to select whether or not the saved trace data includes header information describing scaling, formatting, etc.

Key Path	Save, Data (Export), Trace
Mode	VSA, LTE, LTETDD, IDEN
State Saved	No

Measurement Results

Pressing this key selects Meas Results as the data type to be exported.

The Meas Results file contains measurement result sets, plus information describing the current state of the analyzer, as detailed in ["Meas Results File Definition" on page 1314](#) and ["Meas Results File Example" on page 1316](#) below.

Key Path	Save, Data
Remote Command	:MMEMory:STORe:RESults <string>
Example	:MMEM:STOR:RES "MeasR_0000.csv"

Notes	<p>If the save is initiated via SCPI and the file already exists, the file will be overwritten.</p> <p>The SCPI command exports Spurious Emissions measurement results to the file specified as the parameter in the current path. The default path is My Documents\<current mode>\data\spur\results.<="" p=""><p>Using the C: drive is strongly discouraged, since it runs the risk of being overwritten during an instrument software upgrade.</p><p>The SCPI parameter is a quoted string that specifies the filename. Both single and double quotes are supported for any filename parameter over SCPI.</p></current></p>
Dependencies	<p>The current active measurement must be the Spurious Emissions measurement to use this command.</p>
Status Bits/OPC dependencies	<p>Sequential – waits for the previous measurement to complete</p>
Initial S/W Revision	<p>Prior to A.02.00</p>

Meas Results File Definition

The content of a Meas Results File is defined in this section.

The first lines in the file consist of identification and instrument configuration details, as follows.

- File ID string, which is “MeasResult”
- Measurement ID following Mode ID, which is “SA:SPUR” for example.
- Firmware rev and model number
- Option string
- Abs Start Limit
- Abs Stop Limit
- Abs Stop Limit Mode
- Auto Scaling
- Auto Sweep Time Rules
- Automatic Trigger Time
- Automatic Trigger Time State
- Average Mode
- Average Number
- Average State
- Detector 1
- Detector 2
- Electrical Atten

- Electrical Atten State
- External Array Trigger Delay
- External Array Trigger Delay State
- External Array Trigger Level
- External Array Trigger Slope
- Filter Type
- IF Gain Auto
- IF Gain State
- Internal Preamp
- Internal Preamp Band
- Line Trigger Delay
- Line Trigger Delay State
- Line Trigger Slope
- Meas Type
- Mechanical Atten
- MechanicalAttenStepEnum
- Peak Excursn
- Periodic Timer Period
- Periodic Timer Sync Source
- Periodic Timer Trigger Delay
- Periodic Timer Trigger Delay State
- Pk Threshold
- Points
- Points Mode
- Range State
- Ref Value
- Res BW
- Res BW Mode
- RFBurst Trigger Delay
- RFBurst Trigger Delay State
- RFBurst Trigger Level Abs

- RFBurst Trigger Level Rel
- RFBurst Trigger Level Type
- RFBurst Trigger Slope
- Scale/Div
- Spurious Report Mode
- SpurRangeStartFrequencyArray
- SpurRangeStopFrequencyArray
- Sweep Time
- Sweep Time Mode
- Trigger Holdoff
- Trigger Holdoff State
- TriggerSource
- Video BW
- Video BW Mode

The data above is followed in the file by a line containing “MeasResult1” to “MeasResult42”. This line forms a header for each set of measurement results, which appear in subsequent lines. Each line of Measurement Results consists of 42 comma-separated values, from the MeasResult1 value to the MeasResult42 value.

The MeasResult1 set in the file corresponds to the data returned by MEAS/READ/FETCH:SPURious1; the MeasResult2 set corresponds to the data returned by MEAS/READ/FETCH:SPURious2, and so on.

The exported file is in CSV format, with a .csv extension.

Meas Results File Example

When imported into Excel, a typical Meas Results file appears as shown in the example below.

NOTE: The following table omits the columns for MeasResult11 to MeasResult42, due to lack of space.

MeasResult	1	2	3	4	5	6	7	8	9	10
SA:SPUR										
A.10.53	N903 0A									
526 ALV ATP B1X B1Y B25 B40 BBA CR3 CRP DCF DDA DP2 DRD EA3 EDP EMC EP1 ERC ESC ESP EXM FSA LFE LNP MAT	1									

MPB NFE NUL P26 PFR PNC RTL RTS S40 SB1 SEC SM1 TVT YAS YAV											
Abs Start Limit	-50	-50	-50	-50	-50	-50	-50	-50	-50	-50	-50
Abs Stop Limit	-50	-50	-50	-50	-50	-50	-50	-50	-50	-50	-50
Abs Stop Limit Mode	TRUE	TRUE	TRUE	TRUE	TRUE	TRUE	TRUE	TRUE	TRUE	TRUE	TRUE
Auto Scaling	TRUE										
Auto Sweep Time Rules	Norm										
Automatic Trigger Time	0.1										
Automatic Trigger Time State	FALSE										
Average Mode	Exponential										
Average Number	10										
Average State	FALSE										
Detector 1	Peak	Peak	Peak	Peak	Peak	Peak	Peak	Peak	Peak	Peak	Peak
Detector 2	Off	Off	Off	Off	Off	Off	Off	Off	Off	Off	Off
Electrical Atten	0										
Electrical Atten State	FALSE										
External Array Trigger Delay	1.00 E-06	1.00 E-06									
External Array Trigger Delay State	FALSE	FALSE									
External Array Trigger Level	1.2	1.2									
External Array Trigger Slope	Positive	Positive									
Filter Type	Gaussian	Gaussian	Gaussian	Gaussian	Gaussian	Gaussian	Gaussian	Gaussian	Gaussian	Gaussian	Gaussian
IF Gain Auto	FALSE	FALSE	FALSE	FALSE	FALSE	FALSE	FALSE	FALSE	FALSE	FALSE	FALSE
IF Gain State	FALSE	FALSE	FALSE	FALSE	FALSE	FALSE	FALSE	FALSE	FALSE	FALSE	FALSE
Internal Preamp	FALSE										
Internal Preamp Band	Low										
Line Trigger Delay	1.00										

	E-06									
Line Trigger Delay State	FALSE									
Line Trigger Slope	Positive									
Meas Type	Examine									
Mechanical Atten	10									
MechanicalAtten StepEnum	S2dB									
Peak Excursn	6	6	6	6	6	6	6	6	6	6
Periodic Timer Period	0.02									
Periodic Timer Sync Source	None									
Periodic Timer Trigger Delay	1.00 E-06									
Periodic Timer Trigger Delay State	FALSE									
Pk Threshold	-90	-90	-90	-90	-90	-90	-90	-90	-90	-90
Points	601	601	601	601	601	601	601	601	601	601
Points Mode	FALSE	FALSE	FALSE	FALSE	FALSE	FALSE	FALSE	FALSE	FALSE	FALSE
Range State	TRUE	TRUE	TRUE	TRUE	TRUE	FALSE	FALSE	FALSE	FALSE	FALSE
Ref Value	0									
Res BW	1200000	510000	100000	100000	400000	300000	300000	300000	300000	300000
Res BW Mode	FALSE	FALSE	FALSE	FALSE	FALSE	TRUE	TRUE	TRUE	TRUE	TRUE
RFBurst Trigger Delay	1.00 E-06									
RFBurst Trigger Delay State	FALSE									
RFBurst Trigger Level Abs	-20									
RFBurst Trigger Level Rel	-6									
RFBurst Trigger Level Type	Absolute									
RFBurst Trigger Slope	Positive									
Scale/Div	10									

Spurious Report Mode	All									
SpurRangeStartFrequencyArray	1.92E+09	1.89E+09	2.1E+09	2.18E+09	8E+08	1.5E+09	1.5E+09	1.5E+09	1.5E+09	1.5E+09
SpurRangeStopFrequencyArray	1.98E+09	1.92E+09	2.1E+09	2.18E+09	1E+09	2.5E+09	2.5E+09	2.5E+09	2.5E+09	2.5E+09
Sweep Time	0.001	0.001	0.0012	0.00396	0.001	0.001	0.001	0.001	0.001	0.001
Sweep Time Mode	TRUE	TRUE	TRUE	TRUE	TRUE	TRUE	TRUE	TRUE	TRUE	TRUE
Trigger Holdoff	0.1									
Trigger Holdoff State	FALSE									
TriggerSource	Free									
Video BW	120000	51000	10000	10000	390000	300000	300000	300000	300000	300000
Video BW Mode	TRUE	TRUE	TRUE	TRUE	TRUE	TRUE	TRUE	TRUE	TRUE	TRUE
MeasResult1	MeasResult2	MeasResult3	MeasResult4	MeasResult5	MeasResult6	MeasResult7	MeasResult8	MeasResult9	MeasResult10	MeasResult11
19	-80.27209	-80.87862	-90.94577	-89.27086	-76.77856	9.91E+37	9.91E+37	9.91E+37	9.91E+37	9.91E+37
1	-78.28497	-80.93996	-91.00485	-90.56063	-76.33968					

Save As . . .

When you press “Save As”, the analyzer brings up a Windows dialog and a menu entitled “**Save As.**” This menu allows you to navigate to the various fields in the Windows dialog without using a keyboard or mouse. The Tab and Arrow keys can also be used for dialog navigation.

See "[To File . . .](#)" on page 2810 in Save, State for a full description of this dialog and menu.

The default path for saving files is:

For all of the Trace Data Files:

My Documents\`<mode name>`\data\traces

For all of the Limit Data Files:

My Documents\`<mode name>`\data\limits

For all of the Measurement Results Data Files:

My Documents\`<mode name>`\data\`<measurement name>`\results

For all of the Capture Buffer Data Files:

My Documents\`<mode name>`\data\captureBuffer

Key Path	Save, Data
Mode	All
Notes	The key location is mode-dependent and will vary. Brings up the Save As dialog for saving a <code><mode specific></code> Save Type. The save is performed immediately and does not wait until the measurement is complete.
Initial S/W Revision	Prior to A.02.00

Screen Image

Pressing Screen Image accesses a menu of functions that enable you to specify a format and location for the saved screen image. It brings up a menu that allows you to specify the color scheme of the Screen Image (Themes) or navigate to the Save As dialog to perform the actual save.

Screen Image files contain an exact representation of the analyzer display. They cannot be loaded back onto the analyzer, but they can be loaded into your PC for use in many popular applications.

The image to be saved is actually captured when the Save front panel key is pressed, and kept in temporary storage to be used if you ask for a Screen Image save. When the Screen Image key is pressed, a "thumbnail" of the captured image is displayed, as shown below:

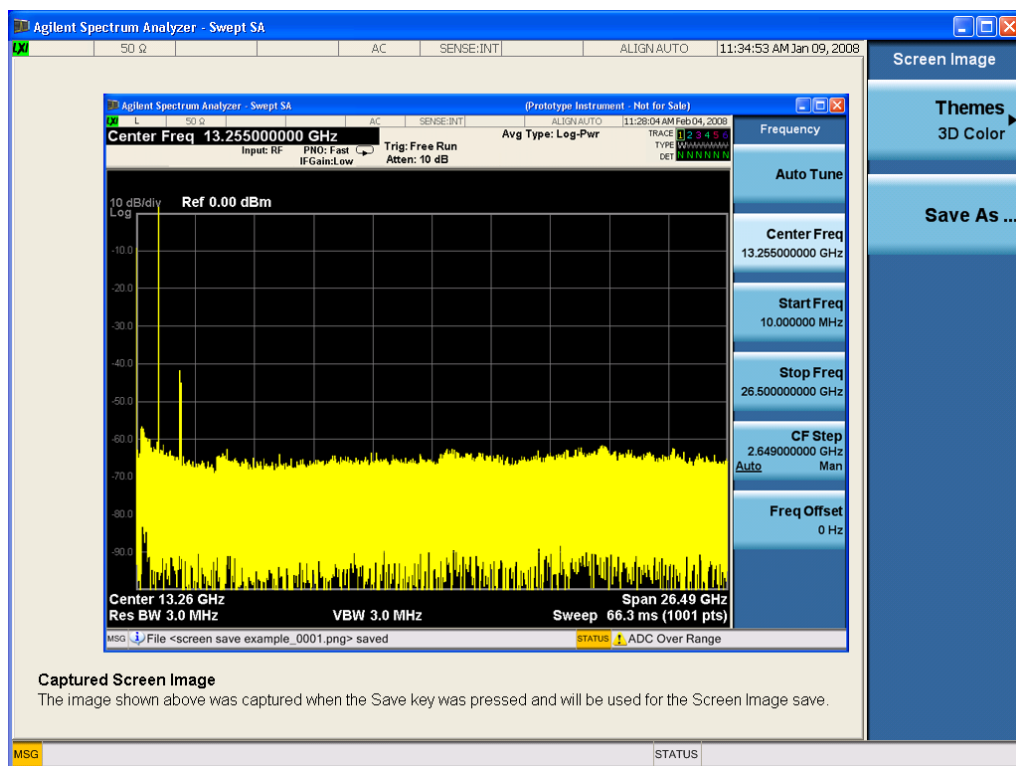

When you continue on into the Save As menu and complete the Screen Image save, the image depicted in the thumbnail is the one that gets saved, showing the menus that were on the screen before going into the Save menus. The save is performed immediately and does not wait until the measurement is complete.

After you have completed the save, the Quick Save front-panel key lets you quickly repeat the last save performed, using an auto-named file, with the current screen data.

NOTE For versions previous to A.01.55, if you initiate a screen image save by navigating through the Save menus, the image that is saved will contain the Save menu softkeys, not the menu and the active function that were on the screen when you first pressed the Save front panel key.

Key Path	Save
Mode	All
Remote Command	:MMEMory:STORe:SCReen <filename>
Example	:MMEM:STOR:SCR "myScreen.png" This stores the current screen image in the file MyScreenFile.png in the default directory.
Initial S/W Revision	Prior to A.02.00

Themes

Accesses a menu of functions that enable you to choose the theme to be used when saving the screen image.

The **Themes** option is the same as the **Themes** option under the **Display** and **Page Setup** dialogs. It allows you to choose between themes to be used when saving the screen image.

Key Path	Save, Screen Image
Remote Command	:MMEMory:STORe:SCReen:THEMe TDColor TDMonochrome FCOlor FMONochrome :MMEMory:STORe:SCReen:THEMe?
Example	:MMEM:STOR:SCR:THEM TDM
Preset	3D Color; Is not part of Preset, but is reset by Restore Misc Defaults or Restore System Defaults All and survives subsequent running of the modes.
Readback	3D Color 3D Mono Flat Color Flat Mono
Backwards Compatibility Notes	In ESA and PSA we offer the choice of "Reverse Bitmap" or "Reverse Metafile" when saving screen images. This is much like the "Flat Color" theme available in X-Series. Also, if you selected Reverse Bitmap AND a black & white screen image, that would be much like "Flat Monochrome". In other words, each of the X-Series themes has a similar screen image type in ESA/PSA. But they are not identical.
Initial S/W Revision	Prior to A.02.00

3D Color

Selects a standard color theme with each object filled, shaded and colored as designed.

Key Path	Save, Screen Image, Themes
Example	MMEM:STOR:SCR:THEM TDC
Readback	3D Color
Initial S/W Revision	Prior to A.02.00

3D Monochrome

Selects a format that is like 3D color but shades of gray are used instead of colors.

Key Path	Save, Screen Image, Themes
Example	MMEM:STOR:SCR:THEM TDM
Readback	3D Mono
Initial S/W Revision	Prior to A.02.00

Flat Color

Selects a format that is best when the screen is to be printed on an ink printer.

Key Path	Save, Screen Image, Themes
Example	MMEM:STOR:SCR:THEM FCOL
Readback	Flat Color
Initial S/W Revision	Prior to A.02.00

Flat Monochrome

Selects a format that is like Flat Color. But only black is used (no colors, not even gray), and no fill.

Key Path	Save, Screen Image, Themes
Example	MMEM:STOR:SCR:THEM FMON
Readback	Flat Mono
Initial S/W Revision	Prior to A.02.00

Save As...

When you press "Save As", the analyzer brings up a Windows dialog and a menu entitled "**Save As.**" This menu allows you to navigate to the various fields in the Windows dialog without using a keyboard or mouse. The Tab and Arrow keys can also be used for dialog navigation.

See "[To File . . .](#)" on page 2810 in Save, State for a full description of this dialog and menu.

The default path for Screen Images is

My Documents\<<mode name>\screen.

where <mode name> is the parameter used to select the mode with the INST:SEL command (for example, SA for the Spectrum Analyzer).

Key Path	Save, Screen Image
Notes	Brings up Save As dialog for saving a Screen Image Save Type
Initial S/W Revision	Prior to A.02.00

Mass Storage Catalog (Remote Command Only)

Key path	SCPI Only
Remote Command	:MMEMory:CATalog? [<directory_name>]
Notes	<p>The string must be a valid logical path.</p> <p>Queries disk usage information (drive capacity, free space available) and obtains a list of files and directories in a specified directory in the following format:</p> <p><numeric_value>,<numeric_value>,{<file_entry>}</p> <p>It returns two numeric parameters and as many strings as there are files and directories. The first parameter indicates the total amount of storage currently used in bytes. The second parameter indicates the total amount of storage available, also in bytes. The <file_entry> is a string. Each <file_entry> indicates the name, type, and size of one file in the directory list:</p> <p><file_name>,<file_type>,<file_size></p> <p>As the windows file system has an extension that indicates file type, <file_type> is always empty. <file_size> provides the size of the file in bytes. For directories, <file_entry> is surrounded by square brackets and both <file_type> and <file_size> are empty</p>
Initial S/W Revision	Prior to A.02.00

Mass Storage Change Directory (Remote Command Only)

Key path	SCPI Only
Remote Command	:MMEMory:CDIRectory [<directory_name>] :MMEMory:CDIRectory?
Notes	<p>The string must be a valid logical path.</p> <p>Changes the default directory for a mass memory file system. The <directory_name> parameter is a string. If no parameter is specified, the directory is set to the *RST value.</p> <p>At *RST, this value is set to the default user data storage area, that is defined as System.Environment.SpecialFolder.Personal.</p> <p>Query returns full path of the default directory.</p>
Initial S/W Revision	Prior to A.02.00

Mass Storage Copy (Remote Command Only)

Key path	SCPI Only
Remote Command	:MMEMory:COpy <string>,<string>[,<string>,<string>]
Notes	<p>The string must be a valid logical path.</p> <p>Copies an existing file to a new file or an existing directory to a new directory.</p> <p>Two forms of parameters are allowed. The first form has two parameters. In this form, the first parameter specifies the source, and the second parameter specifies the destination.</p> <p>The second form has four parameters. In this form, the first and third parameters specify the source. The second and fourth parameters specify the directories. The first pair of parameters specifies the source. The second pair specifies the destination. An error is generated if the source doesn't exist or the destination file already exists.</p> <p>This command will generate an "access denied" error if the destination is a restricted folder (e.g., C:\Windows) and the current user does not have Power User or Administrator privileges.</p>

Mass Storage Device Copy (Remote Command Only)

This command transfers data to/from a file and a peripheral device.

Key path	SCPI Only
Remote Command	:MMEMory:COpy:DEvice <source_string>,<dest_string>
Notes	<p>The strings must be a valid logical path or a valid device keyword. If the dest_string is a device keyword, the data is copied from the source file to the device. If the source_string is a device keyword, the data is copied to the source file from the device.</p> <p>Valid device keywords are:</p> <p>SNS (smart noise source)</p> <p>An error is generated if the file or device is not found.</p>

Mass Storage Delete (Remote Command Only)

Key path	SCPI Only
Remote Command	:MMEMory:DElete <file_name>[,<directory_name>]
Notes	<p>The string must be a valid logical path.</p> <p>Removes a file from the specified directory. The <file_name> parameter specifies the file name to be removed. This command will generate an "access denied" error if the file is in a restricted folder (e.g., C:\Windows) and the current user does not have Power User or Administrator privileges.</p>
Initial S/W Revision	Prior to A.02.00

Mass Storage Data (Remote Command Only)

Creates a file containing the specified data OR queries the data from an existing file.

Key path	SCPI Only
Remote Command	:MMEMory:DATA <file_name>, <data> :MMEMory:DATA? <file_name>
Notes	The string must be a valid logical path. The command form is MMEMory:DATA <file_name>,<data>. It loads <data> into the file <file_name>. <data> is in 488.2 block format. <file_name> is string data. The query form is MMEMory:DATA? <file_name> with the response being the associated <data> in block format.
Initial S/W Revision	Prior to A.02.00

Mass Storage Make Directory (Remote Command Only)

Key path	SCPI Only
Remote Command	:MMEMory:MDIRectory <directory_name>
Notes	The string must be a valid logical path. Creates a new directory. The <directory_name> parameter specifies the name to be created. This command will generate an “access denied” error if the new directory would be in a restricted folder (e.g., C:\Windows) and the current user does not have Power User or Administrator privileges.
Initial S/W Revision	Prior to A.02.00

Mass Storage Move (Remote Command Only)

Key path	SCPI Only
Remote Command	:MMEMory:MOVE <string>,<string>[,<string>,<string>]
Notes	The string must be a valid logical path. Moves an existing file to a new file or an existing directory to a new directory. Two forms of parameters are allowed. The first form has two parameters. In this form, the first parameter specifies the source, and the second parameter specifies the destination. The second form has four parameters. In this form, the first and third parameters specify the source. The second and fourth parameters specify the directories. The first pair of parameters specifies the source. The second pair specifies the destination. An error is generated if the source doesn't exist or the destination file already exists. This command will generate an “access denied” error if the destination is a restricted folder (e.g., C:\Windows) and the current user does not have Power User or Administrator privileges.
Initial S/W Revision	Prior to A.02.00

Mass Storage Remove Directory (Remote Command Only)

Key path	SCPI Only
Remote Command	:MMEMory:RDIRectory <directory_name>
Notes	<p>The string must be a valid logical path.</p> <p>Removes a directory. The <directory_name> parameter specifies the directory name to be removed. All files and directories under the specified directory shall also be removed.</p> <p>This command will generate an “access denied” error if the folder is a restricted folder (e.g., C:\Windows) or is in a restricted folder and the current user does not have Power User or Administrator privileges.</p>
Initial S/W Revision	Prior to A.02.00

Single (Single Measurement/Sweep)

Sets the analyzer for Single measurement operation. The single/continuous state is Meas Global, so the setting will affect all the measurements. If you are Paused, pressing Single does a Resume.

See ["More Information" on page 1327](#)

Key Path	Front-panel key
Example	:INIT:CONT OFF
Notes	See Cont key description.
Backwards Compatibility Notes	<p>For Spectrum Analysis mode in ESA and PSA, the Single hardkey and the INITiate:IMM switched from continuous measurement to single measurement and restarted sweeps and averages (displayed average count reset to 1), but did not restart Max Hold and Min Hold. In the X-Series, the Single hardkey and the INITiate:IMM command initiate a sweep/ measurement/ average sequence/hold sequence including MaxHold and MinHold.</p> <p>For Spectrum Analysis mode in ESA and PSA, the Single hardkey restarted the sweep regardless of whether or not you were in an active sweep or sweep sequence. In the X-Series, Restart does this but Single only restarts the sweep or sweep sequence if you are in the idle state.</p> <p>INIT[:IMM] in ESA & PSA Spectrum Analysis Mode does an implied ABORT. In some other PSA Modes, INIT[:IMM] is ignored if not in the idle state. . The X-Series follows the ESA/PSA SA Mode model, which may cause some Modes to have compatibility problems.</p>
Initial S/W Revision	Prior to A.02.00

More Information

See ["Restart" on page 2807](#) for details on the INIT:IMMEDIATE (Restart) function.

If you are already in single sweep, the INIT:CONT OFF command has no effect.

If you are already in Single Sweep, then pressing the Single key in the middle of a sweep does not restart the sweep or sequence. Similarly, pressing the Single key does not restart the sweep or sequence if the sweep is not in the idle state (for example, if you are taking a very slow sweep, or the analyzer is waiting for a trigger). Instead, it results in a message. "Already in Single, press Restart to initiate a new sweep or sequence". Even though pressing the Single key in the middle of a sweep does not restart the sweep, sending INIT:IMMEDIATE does reset it.

To take one more sweep without resetting the average count, increment the average count by 1, by pressing the step up key while **Average/Hold Number** is the active function, or sending the remote command CALC:AVER:TCON UP.

Source

There is no Source control functionality for this measurement. When this key is pressed, the screen either displays a blank menu, or the previously-selected menu remains unchanged.

Key Path	Front-panel key
----------	-----------------

Span X Scale

Span X Scale is unavailable in the Spurious Emissions measurement. When pressed, this key displays a blank menu.

Key Path	Front-panel key
Initial S/W Revision	Prior to A.02.00

Sweep/Control

Accesses the Sweep/Control menu keys used to set up and control the sweep time and source.

Key Path	Front-panel key
Initial S/W Revision	Prior to A.02.00

Sweep Setup

Sets the sweep functions that control the sweep state and time.

Key Path	Sweep/Control
Initial S/W Revision	Prior to A.02.00

Auto Sweep Time Rules

Switches the analyzer between normal and accuracy sweep states. Setting Auto Sweep Time to Accy will result in slower sweep times, usually about three times as long, but better amplitude accuracy for CW signals. The instrument amplitude accuracy specifications only apply when Auto Sweep Time is set to Accy.

Additional amplitude errors which occur when Auto Sweep Time is set to Norm are usually well under 0.1 dB, though this is not guaranteed. Because of the faster sweep times and still low errors, Norm is the preferred setting of Auto Sweep Time. Auto Sweep Time is set to Norm on a Preset or Auto Couple. This means that in the Preset or Auto Coupled state, instrument amplitude accuracy specifications do not apply.

Key Path	Sweep/Control, Sweep Setup
Mode	SA, WCDMA, C2K, WIMAX OFDMA, TD-SCDMA, 1xEV-DO, DVB-T/H, LTE, LTETDD, WLAN, MSR, LTEAFDD, LTEATDD
Remote Command	[:SENSe] :SPURious :SWEep :TIME :AUTO :RULes NORMal ACCuracy [:SENSe] :SPURious :SWEep :TIME :AUTO :RULes ?
Example	SPUR:SWE:TIME:AUTO:RUL ACC SPUR:SWE:TIME:AUTO:RUL ?
Notes	In Zero Span, this key is irrelevant and inaccessible (because the whole Sweep Setup menu is grayed out), however, Sweep Setup settings can be changed remotely with no error indication.
Preset	NORMal
State Saved	Saved in instrument state.
Range	Norm Accy
Initial S/W Revision	Prior to A.02.00
Modified at S/W Revision	A.03.00

Sweep Type

Sets the sweep type of the spurious measurement to either Auto or Swept. When in Auto, the selections of swept type of ranges are governed by the Best Speed Sweep Type Rule, and FFT analysis might be chosen for some ranges if it speeds up the measurement.

Key Path	Sweep/Control, Sweep Setup
Mode	SA, WCDMA, C2K, WIMAX OFDMA, TD-SCDMA, 1xEV-DO, DVB-T/H, LTE, LTETDD, WLAN, MSR, LTEAFDD, LTEATDD
Remote Command	[:SENSe] :SPURious [:RANGe] :ALL :SWEep :TYPE :AUTO OFF ON 0 1 [:SENSe] :SPURious [:RANGe] :ALL :SWEep :TYPE :AUTO?
Example	SPUR:ALL:SWE:TYPE:AUTO 1 SPUR:ALL:SWE:TYPE:AUTO?
Dependencies	This parameter is available only when option N9060A-7FP is installed.
Preset	ON
State Saved	Saved in instrument state.
Range	Auto Swept
Initial S/W Revision	A.11.00

Pause

Pauses a measurement after the current data acquisition is complete.

When paused, the label on the key changes to Resume. Pressing Resume resumes the measurement at the point it was at when paused.

See "[Pause/Resume](#)" on page 2703 for more information.

Key Path	Sweep/Control
Initial S/W Revision	Prior to A.02.00

Gate

Accesses a menu that enables you to control the gating function. The Gate functionality is used to view signals best viewed by qualifying them with other events.

Gate setup parameters are the same for all measurements – they do not change as you change measurements. Settings like these are called “Meas Global” and are unaffected by Meas Preset.

Note that Sweep Time autocoupling rules and annotation are changed by Gate being on.

Key Path	Sweep/Control
Scope	Meas Global
Readback	

The state and method of Gate, as [Off, LO] or [On, Video]. Note that for measurements that only support gated LO, the method is nonetheless read back, but always as LO.

Initial S/W Revision Prior to A.02.00

Gate On/Off

Turns the gate function on and off.

When the Gate Function is on, the selected Gate Method is used along with the gate settings and the signal at the gate source to control the sweep and video system with the gate signal. Not all measurements allow every type of Gate Methods.

When Gate is on, the annunciation in the measurement bar reflects that it is on and what method is used, as seen in the following "Gate: LO" annunciator graphic.

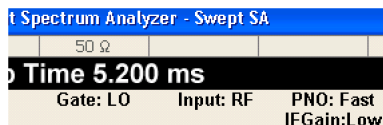

Key Path Sweep/Control, Gate

Remote Command [:SENSe]:SWEep:EGATe[:STATe] OFF|ON|0|1
[:SENSe]:SWEep:EGATe[:STATe]?

Example SWE:EGAT ON
SWE:EGAT?

Dependencies

The function is unavailable (grayed out) and Off when:

- Gate Method is LO or Video and FFT Sweep Type is manually selected.
- Gate Method is FFT and Swept Sweep Type is manually selected.
- Marker Count is ON.

The following are unavailable whenever Gate is on:

- FFT under Sweep Type when Method=LO or Video or Swept under Sweep Type when Method=FFT
- Marker Count

While Gate is on, the Auto Rules for Sweep Type are modified so that the choice agrees with the Gate Method: i.e., FFT for Method = FFT and Swept for Method = LO or Video.

The Gate softkey and all SCPI under the [:SENSe]:SWEep:EGATe SCPI node are grayed out when Source Mode is Tracking with an external source. This is because the Gate circuitry is used to sync the external source. If the Tracking Source is turned on, the Gate is turned off.

When in the ACP measurement:

- When Meas Method is RBW or FAST, this function is unavailable and the key is grayed out.
- Whenever Gate is on, Meas Method, RBW or FAST is unavailable and keys for those are grayed out.
- When Gate is on, Offset Res BW and Offset Video BW are ignored (if you set these values) and the

	measurement works as if all Offset Res BW and all Offset Video BW are coupled with the Res BW and the Video BW under the BW menu. When Gate is on, the Offset BW key in the Offset/Limit menu is grayed out.
Preset	Off LTETDD: On
State Saved	Saved in instrument state
Range	On Off
Backwards Compatibility SCPI	[:SENSe]:SWEep:TIME:GATE[:STATe] ESA compatibility
Backwards Compatibility Notes	In ESA, Trig Delay (On) and Gate (On) could not be active at the same time.. This dependency does not exist in PSA or in the X-Series.
Initial S/W Revision	Prior to A.02.00

Gate View On/Off

Turning on Gate View in the Swept SA measurement provides a single-window gate view display..

Turning on Gate View in other measurements shows the split-screen Gate View. In these measurements, when the Gate View is on, the regular view of the current measurement traces and results are reduced vertically to about 70% of the regular height. The Zero Span window, showing the positions of the Gate, is shown between the Measurement Bar and the reduced measurement window. By reducing the height of the measurement window, some of the annotation on the Data Display may not fit and is not shown.

Key Path	Sweep/Control, Gate
Remote Command	[:SENSe]:SWEep:EGATe:VIEW ON OFF 1 0 [:SENSe]:SWEep:EGATe:VIEW?
Example	SWE:EGAT:VIEW ON turns on the gate view.
Dependencies	In the Swept SA measurement: In Gate View, the regular Sweep Time key is grayed out . When pressed, the grayed out key puts up the informational message "Use Gate View Sweep Time in the Gate menu." In the other measurements: When you turn Gate View on, the lower window takes on the current state of the instrument. Upon leaving Gate View, the instrument takes on the state of the lower window. When you turn Gate View on, the upper window Sweep Time is set to the gate view sweep time.
Couplings	These couplings apply to the Swept SA measurement: <ul style="list-style-type: none"> • When Gate View is turned on, the instrument is set to Zero Span. • Gate View automatically turns off whenever a Span other than Zero is selected. • Gate View automatically turns off if you press the Last Span key while in Gate View, and the instrument returns to the Span it was in before entering Gate View (even if that is Zero Span). • When Gate View is turned on, the sweep time used is the gate view sweep time. This is set according to the rules in section "Gate View Setup " on page 2499 • When Gate View is turned off, Sweep Time is set to the normal Swept SA measurement sweep time.

- If Gate View is on and Gate is off, then turning on Gate turns off Gate View.

Preset	OFF
State Saved	Saved in instrument state
Range	On Off
Initial S/W Revision	Prior to A.02.00

A sample of the Gate View screen in the Swept SA measurement is shown in the following graphic :

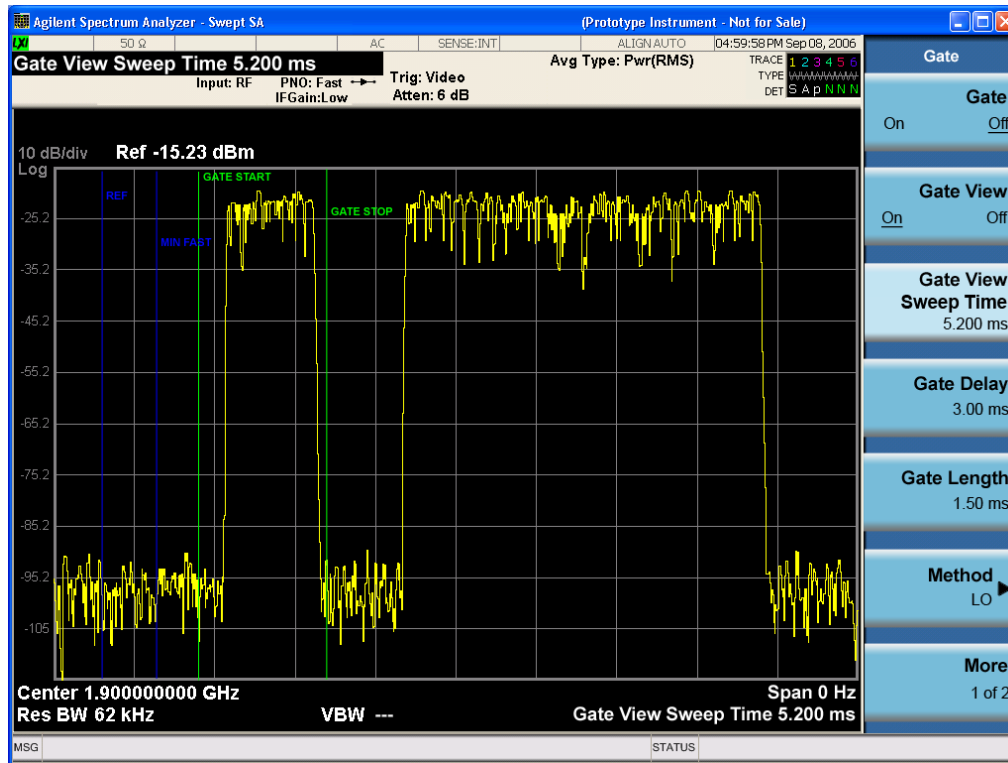

A sample of the Gate View screen in other measurements is shown in the following graphic . This example is for the ACP measurement:

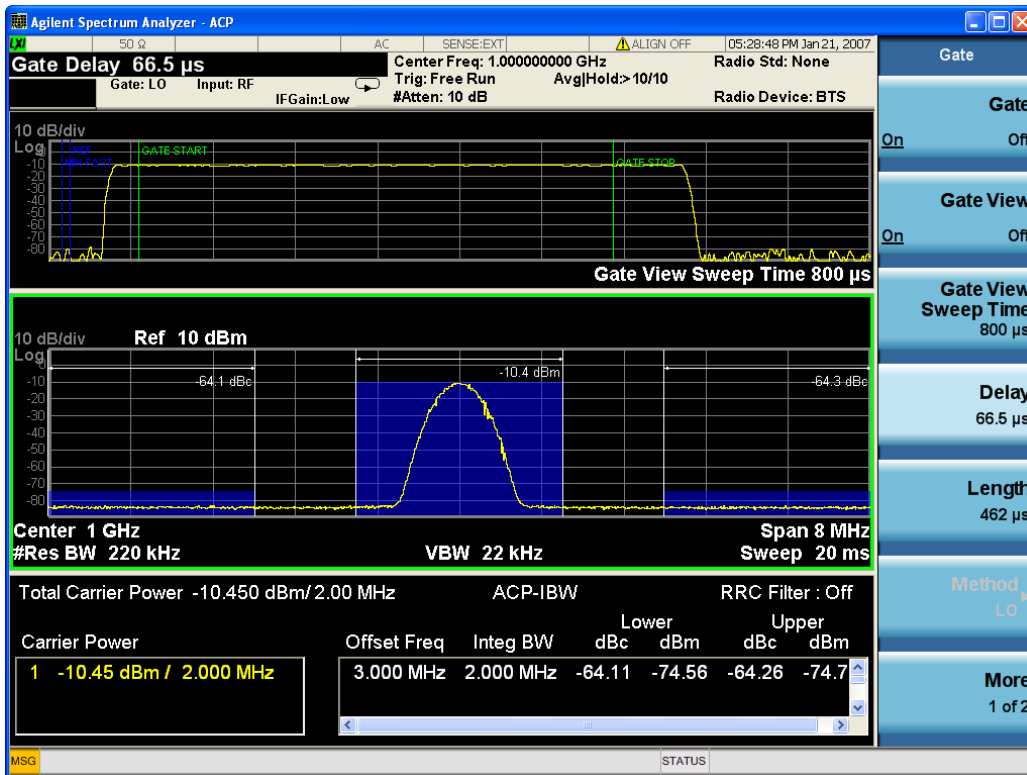

Turning Gate View off returns the analyzer to the Normal measurement view.

In the Swept SA, the normal measurement view is the single-window Swept SA view. When returning to this view, the Swept SA measurement returns to the Span it was in before entering **Gate View** (even if that is Zero Span).

The **Gate View** window is triggered from the Gate Source, with zero trigger delay. Also, when updating the **Gate View** window, the Gate itself must not operate. So it is internally shut off while the gate view window is being updated. For the Swept SA measurement, this means that the Gate is internally shut off whenever the gate view window is displayed. The measurement bar and softkeys continue to show the Trigger source for the main sweep window and give no indication that the Gate is shut off or that the Gate View window is triggered from the Gate Source.

When in **Gate View**, vertical lines are displayed in the Gate View window as follows:

- Green lines are displayed at the gate edges as follows: in Edge Gate, a line is shown for Delay and one for the end of the Gate period, defined by Length. In Level Gate a line is shown only for Delay. You can adjust the position of the green lines by adjusting the gate length and the gate delay. These lines update in the Gate View window as the active function changes, even if the window is not being updated. In Gated LO and Gated Video, these lines are positioned relative to the delay reference line (not relative to 0 time). In Gated FFT, their location is relative to the left edge of the screen.
- A blue line is displayed showing the delay reference, that is, the reference point for the Gate Delay within the Zero Span window. The blue line represents where (in time) the effective location of the gate start would be if the gate were programmed to zero delay.

- The second blue line is labeled "MIN FAST" as shown in the figure above because it represents the minimum Gate Delay for fast Gated LO operation. This line is only displayed in Gated LO. You cannot scroll (knob) or decrement (down key) the Gate Delay to less than that represented by the position of this line, it can only be set below this position manually, although once there it can be moved freely with the knob while below the line.
- A yellow line in the Gated Video case only, is displayed at Blength, where Blength is the display point (bucket) length for the swept trace, which is given by the sweep time for that trace divided by number of Points – 1. So it is referenced to 0 time, not to the delay reference. This line is labeled NEXT PT (it is not shown in the figure above because the figure above is for Gated LO).
- The yellow line represents the edge of a display point (bucket). Normally in Gated Video, the bucket length must be selected so that it exceeds the off time of the burst. There is another way to use the analyzer in Gated Video measurements, and that is to set the bucket width much shorter than the off time of the burst. Then use the Max Hold trace function to fill in "missing" buckets more slowly. This allows you to see some of the patterns of the Gated Video results earlier, though seeing a completely filled-in spectrum later.

Gate View Setup

Accesses a menu that enables you to setup parameters relevant to the Gate View

Key Path	Sweep/Control, Gate
Scope	Meas Global
Initial S/W Revision	A.10.00

Gate View Sweep Time

Controls the sweep time in the Gate View window. To provide an optimal view of the gate signal, the analyzer initializes Gate View Sweep Time based on the current settings of Gate Delay and Gate Length.

Key Path	Sweep/Control, Gate, Gate View Setup
Remote Command	[:SENSe] :SWEep:EGATe:TIME <time> [:SENSe] :SWEep:EGATe:TIME?
Example	SWE:EGAT:TIME 500 ms
Dependencies	Gate View Sweep Time is initialized: <ul style="list-style-type: none"> • On Preset (after initializing delay and length). • Every time the Gate Method is set/changed. <p>Additionally, in the Swept SA measurement, whenever you do a Preset, or leave Gate View, the analyzer remembers the Gate Delay and Gate Length settings. Then, when returning to Gate View, if the current Gate Delay and/or Gate Length do not match the remembered values Gate View Sweep Time is re-initialized.</p> <ol style="list-style-type: none"> 1. Compute the location of the "gate stop" line, which you know is at time $t = t_{min} + GateDelay + GateLength$.
Preset	519.3 μ s

	WiMAX OFDMA: 5 ms GSM/EDGE: 1 ms
State Saved	Saved in instrument state
Max	6000 s
Initial S/W Revision	Prior to A.02.00

Gate View Start Time

Controls the time at the left edge of the Gate View.

Key Path	Sweep/Control, Gate, Gate View Setup
Remote Command	[:SENSe] :SWEep:EGATe:VIEW:STARt <time> [:SENSe] :SWEep:EGATe:VIEW:STARt?
Example	SWE:EGAT:VIEW:STAR 10ms
Notes	Units of time are required or no units; otherwise an invalid suffix error message will be generated. See error -131.
Preset	0 ms
State Saved	Saved in instrument state
Min	0
Max	500 ms
Initial S/W Revision	A.10.00

Gate Delay

Controls the length of time from the time the gate condition goes True until the gate is turned on.

Key Path	Sweep/Control, Gate
Remote Command	[:SENSe] :SWEep:EGATe:DELay <time> [:SENSe] :SWEep:EGATe:DELay?
Example	SWE:EGAT:DELay 500ms SWE:EGAT:DELay?
Notes	Units of time are required or no units; otherwise an invalid suffix error message will be generated.
Preset	57.7 us WiMAX OFDMA: 71 us GSM/EDGE: 600 us WLAN: 500 us
State Saved	Saved in instrument state

Min	0.0 us
Max	100 s
Backwards Compatibility SCPI	[:SENSe]:SWEep:TIME:GATE:DELay ESA compatibility
Initial S/W Revision	Prior to A.02.00

Gate Length

Controls the length of time that the gate is on after it opens.

Key Path	Sweep/Control, Gate
Remote Command	[:SENSe]:SWEep:EGATe:LENGth <time> [:SENSe]:SWEep:EGATe:LENGth?
Example	SWE:EGAT:LENG 1 SWE:EGAT:LENG?
Notes	Units of time are required or no units; otherwise an invalid suffix error message will be generated.

Dependencies

Grayed out when Gate Method is set to FFT in which case the label changes to that shown below.



The key is also grayed out if Gate Control = Level.

Preset	461.6 us WiMAX OFDMA: 50 us GSM/EDGE: 200 us WLAN: 1.54 ms
State Saved	Saved in instrument state
Min	100 ns
Max	5 s
Backwards Compatibility SCPI	[:SENSe]:SWEep:TIME:GATE:LENGth ESA compatibility
Initial S/W Revision	Prior to A.02.00

Gate Source

The menus under the Gate Source key are the same as those under the Trigger key, with the exception that neither Free Run nor Video are available as Gate Source selections. However, a different SCPI command

is used to select the Gate Source (see table below) because you may independently set the Gate Source and the Trigger Source.

Any changes to the settings in the setup menus under each Gate Source selection key (for example: Trigger Level, Trigger Delay, etc.) also affect the corresponding settings under the Trigger menu keys. The SCPI commands used for these are the same for Trigger and Gate, since there is only one setting which affects both Gate and Trigger. Example: to set the Trigger Level for External 1 you use the command :TRIG:EXT1:LEV regardless of whether you are using External 1 as a Trigger Source or a Gate Source.

Key Path	Sweep/Control, Gate
Remote Command	[:SENSe] :SWEep:EGATe:SOURce EXTernal1 EXTernal2 LINE FRAME RFBurst [:SENSe] :SWEep:EGATe:SOURce?
Dependencies	In some models, there is no second External input. In these models, the External 2 key is blanked and the EXTernal2 parameter will generate a "Hardware missing; Not available for this model number" error.
Preset	EXTernal 1 GSM/EDGE, MSR: FRAME LTETDD: EXTernal 1When Direction is Downlink, FRAME when Direction is Uplink.
Backwards Compatibility Notes	In ESA, there is a single Gate input port. In PSA, the Gate Source may be taken from one of two specified input ports. In the X-Series, any Trigger Source can be a Gate Source.
Initial S/W Revision	Prior to A.02.00
Modified at S/W Revision	A.03.00, A.14.00

Line

Pressing this key, when it is not selected, selects the line signal as the trigger. A new sweep/measurement will start synchronized with the next cycle of the line voltage. Pressing this key, when it is already selected, access the line trigger setup menu.

Key Path	Trigger
Example	TRIG:SOUR LINE Swept SA measurement TRIG:<meas>:SOUR LINE Measurements other than Swept SA
Dependencies	Line trigger is not available when operating from a "dc power source", for example, when the instrument is powered from batteries.
State Saved	Saved in instrument state
Status Bits/OPC dependencies	The Status Operation Register bit 5 "Waiting for Trigger" is set at the same time as the Sweeping or Measuring bit is set. It is cleared when the trigger actually occurs (that is, after the trigger event occurs and all the applicable trigger criteria have been met). A corresponding pop-up message ("Waiting for trigger") is generated if no trigger signal appears after approximately 2 sec. This message goes away when a trigger signal appears.
Initial S/W Revision	Prior to A.02.00

Trig Slope

Controls the trigger polarity. It is set positive to trigger on a rising edge and negative to trigger on a falling edge.

Key Path	Trigger, Line
Remote Command	:TRIGger[:SEquence]:LINE:SLOPe POSitive NEGative :TRIGger[:SEquence]:LINE:SLOPe?
Example	TRIG:LINE:SLOP NEG
Preset	POSitive
State Saved	Saved in instrument state
Backwards Compatibility Notes	The legacy :TRIGger[:SEquence]:SLOPe command affects the slopes for the VID, LINE, EXT1, EXT2, and RFB triggers.
Initial S/W Revision	Prior to A.02.00

External 1

Pressing this key, when it is not selected, selects an external input signal as the trigger. A new sweep/measurement will start when the external trigger condition is met using the external 1 input connector on the rear panel.

Pressing this key, when it is already selected, accesses the external 1 trigger setup menu.

Key Path	Trigger
Example	TRIG:SOUR EXT1 Swept SA measurement TRIG:<meas>:SOUR EXT1 Measurements other than Swept SA
Dependencies	Grayed out if in use by Point Trigger in the Source Setup menu. Forced to Free Run if already selected and Point Trigger is set to External 1.
State Saved	Saved in instrument state
Status Bits/OPC dependencies	The Status Operation Register bit 5 "Waiting for Trigger" is set at the same time as the Sweeping or Measuring bit is set. It is cleared when the trigger actually occurs (that is, after the trigger event occurs and all the applicable trigger criteria have been met). A corresponding pop-up message ("Waiting for trigger") is generated if no trigger signal appears after approximately 2 sec. This message goes away when a trigger signal appears.
Initial S/W Revision	Prior to A.02.00

Trigger Level

Sets the value where the external 1 trigger input will trigger a new sweep/measurement.

Key Path	Trigger, External 1
Remote Command	:TRIGger[:SEquence]:EXTernal1:LEVel <level>

	:TRIGger[:SEquence]:EXTernal1:LEVel?
Example	TRIG:EXT1:LEV 0.4 V
Couplings	This same level is used for the Ext1 trigger source in the Trigger menu, for the Ext1 selection in the Periodic Timer sync source (in the Trigger menu and in the Gate Source menu), and also for the Ext1 selection in the Gate Source menu.
Preset	1.2 V
State Saved	Saved in instrument state
Min	-5 V
Max	5 V
Default Unit	V
Backwards Compatibility SCPI	:TRIGger[:SEquence]:EXTernal:LEVel For backward compatibility, the parameter EXTernal is mapped to EXTernal1
Backwards Compatibility SCPI	:TRIGger[:SEquence]:FRAMe:EXTernal1:LEVel
Initial S/W Revision	Prior to A.02.00

Trig Slope

Controls the trigger polarity. It is set positive to trigger on a rising edge and negative to trigger on a falling edge.

Key Path	Trigger, External 1
Remote Command	:TRIGger[:SEquence]:EXTernal1:SLOPe POSitive NEGative :TRIGger[:SEquence]:EXTernal1:SLOPe?
Example	TRIG:EXT1:SLOP NEG
Couplings	This same slope is used in the Ext1 selection for the trigger source in the Trigger menu and for the period timer sync source (in the Trigger menu and in the Gate Source menu).
Preset	POSitive
State Saved	Saved in instrument state
Backwards Compatibility SCPI	:TRIGger[:SEquence]:EXTernal:SLOPe For backward compatibility, the parameter EXTernal is mapped to EXTernal1
Backwards Compatibility SCPI	:TRIGger[:SEquence]:FRAMe:EXTernal1:SLOPe
Backwards Compatibility Notes	The legacy :TRIGger[:SEquence]:SLOPe command affects the slopes for the VID, LINE, EXT1, EXT2, and RFB triggers.
Initial S/W Revision	Prior to A.02.00

Zero Span Delay Comp On/Off

In zero span, there is a natural delay in the signal path, which comes from the RBW filter. This is usually desirable, as it allows you to trigger on events and also see those events, because the signal is delayed from the trigger event. However, in some cases it is desirable to eliminate this delay, so that trigger events line up exactly with the zero time point in zero span. You can use the Zero Span Delay Comp On/Off feature to enable or disable zero span delay compensation.

Key Path	Trigger, External 1
Remote Command	:TRIGger[:SEquence]:EXTernal1:DElay:COMPensation OFF ON 0 1 :TRIGger[:SEquence]:EXTernal1:DElay:COMPensation?
Example	TRIG:EXT1:DEL:COMP ON
Dependencies	No effect except in zero-span, but not locked out in nonzero spans. Blanked in modes that do not support zero-span measurements. If the SCPI command is sent when the key is blanked, an error is returned: -221, "Settings conflict; Feature not supported for this measurement" In analyzers shipping N9060A, this feature requires N9060A-7FP.
Preset	OFF
State Saved	Saved in instrument state
Initial S/W Revision	A.11.00

External 2

Pressing this key, when it is not selected, selects an external input signal as the trigger. A new sweep/measurement will start when the external trigger condition is met using the external 2 input connector. The external trigger 2 input connector is on the rear panel.

Pressing this key, when it is already selected, accesses the external 2 trigger setup menu.

Key Path	Trigger
Example	TRIG:SOUR EXT2 Swept SA measurement TRIG:<meas>:SOUR EXT2 Measurements other than Swept SA
Dependencies	In some models, there is no second External input. In these models, the External 2 key is blanked and the EXTernal2 parameter will generate a "Hardware missing; Not available for this model number" message. Grayed out if in use by Point Trigger in the Source Setup menu. Forced to Free Run if already selected and Point Trigger is set to External 2.
State Saved	Saved in instrument state
Status Bits/OPC dependencies	The Status Operation Register bit 5 "Waiting for Trigger" is set at the same time as the Sweeping or Measuring bit is set. It is cleared when the trigger actually occurs (that is, after the trigger event occurs and all the applicable trigger criteria have been met). A corresponding pop-up message ("Waiting for trigger") is generated if no trigger signal appears after approximately 2 sec. This message goes away when a trigger signal appears.

Initial S/W Revision	Prior to A.02.00
Modified at S/W Revision	A.03.00

Trigger Level

Sets the value where the external 2 trigger input will trigger a new sweep/measurement.

Key Path	Trigger, External 2
Remote Command	:TRIGger[:SEquence]:EXTernal2:LEVel :TRIGger[:SEquence]:EXTernal2:LEVel?
Example	TRIG:EXT2:LEV 1.1 V
Couplings	This same level is used for the Ext2 trigger source in the Trigger menu, for the Ext2 selection in the Periodic Timer sync source (in the Trigger menu and in the Gate Source menu), and also for the Ext2 selection in the Gate Source menu.
Preset	1.2 V
State Saved	Saved in instrument state
Min	-5 V
Max	5 V
Default Unit	V
Backwards Compatibility SCPI	:TRIGger[:SEquence]:FRAMe:EXTernal2:LEVel
Initial S/W Revision	Prior to A.02.00

Trig Slope

Controls the trigger polarity. It is set positive to trigger on a rising edge and negative to trigger on a falling edge.

Key Path	Trigger, External 2
Remote Command	:TRIGger[:SEquence]:EXTernal2:SLOPe POSitive NEGative :TRIGger[:SEquence]:EXTernal2:SLOPe?
Example	TRIG:EXT2:SLOP NEG
Couplings	This same slope is used in the Ext2 selection for the trigger source in the Trigger menu and for the period timer sync source (in the Trigger menu and in the Gate Source menu).
Preset	POSitive
State Saved	Saved in instrument state
Backwards Compatibility SCPI	:TRIGger[:SEquence]:FRAMe:EXTernal2:SLOPe
Backwards Compatibility Notes	The legacy :TRIGger[:SEquence]:SLOPe command affects the slopes for the VID, LINE, EXT1, EXT2, and RFB triggers.
Initial S/W Revision	Prior to A.02.00

Zero Span Delay Comp On/Off

In zero span, there is a natural delay in the signal path, which comes from the RBW filter. This is usually desirable, as it allows you to trigger on events and also see those events, because the signal is delayed from the trigger event. However, in some cases it is desirable to eliminate this delay, so that trigger events line up exactly with the zero time point in zero span. You can use the Zero Span Delay Comp On/Off feature to enable or disable zero span delay compensation.

Key Path	Trigger, External 2
Remote Command	:TRIGger[:SEquence]:EXTernal2:DElay:COMPensation OFF ON 0 1 :TRIGger[:SEquence]:EXTernal2:DElay:COMPensation?
Example	TRIG:EXT2:DEL:COMP ON
Dependencies	No effect except in zero-span, but not locked out in nonzero spans. Blanked in modes that do not support zero-span measurements. If the SCPI command is sent when the key is blanked, an error is returned: -221, "Settings conflict; Feature not supported for this measurement" In analyzers shipping N9060A, this feature requires N9060A-7FP.
Preset	OFF
State Saved	Saved in instrument state
Initial S/W Revision	A.11.00

RF Burst

Pressing this key, when it is not selected, selects the RF Burst as the trigger. A new sweep/measurement will start when an RF burst envelope signal is identified from the signal at the RF Input connector. Pressing this key, when it is already selected, accesses the RF Burst trigger setup menu.

In some models, a variety of burst trigger circuitry is available, resulting in various available burst trigger bandwidths. The analyzer automatically chooses the appropriate trigger path based on the hardware configuration and other settings of the analyzer.

Key Path	Trigger
Example	TRIG:SOUR RFB Swept SA measurement TRIG:<meas>:SOUR RFB Measurements other than Swept SA
State Saved	Saved in instrument state
Status Bits/OPC dependencies	The Status Operation Register bit 5 "Waiting for Trigger" is set at the same time as the Sweeping or Measuring bit is set. It is cleared when the trigger actually occurs (that is, after the trigger event occurs and all the applicable trigger criteria have been met). A corresponding pop-up message ("Waiting for trigger") is generated if no trigger signal appears after approximately 2 sec. This message goes away when a trigger signal appears.
Backwards Compatibility Notes	The legacy command: :TRIGger[:SEquence]:RFBurst:FSElectivity[:STATe] OFF ON 0 1

	is not supported in the X-Series, as the hardware to do Frequency Selective burst triggers does not exist in X-Series.
Initial S/W Revision	Prior to A.02.00
Modified at S/W Revision	A.04.00

Absolute Trigger Level

Sets the absolute trigger level for the RF burst envelope.

When using the External Mixing path, the Absolute Trigger Level is uncalibrated because the factory default was set to accommodate the expected IF levels for the RF path.

Key Path	Trigger, RF Burst
Scope	Meas Global
Remote Command	:TRIGger[:SEquence]:RFBurst:LEVel:ABSolute <ampl> :TRIGger[:SEquence]:RFBurst:LEVel:ABSolute?
Example	TRIG:RFB:LEV:ABS 10 dBm sets the trigger level of the RF burst envelope signal to the absolute level of 10 dBm
Notes	Sending this command does not switch the setting from relative to absolute; to switch it you need to send the :TRIGger[:SEquence]:RFBurst:LEVel:TYPE command, below. Amplitude Corrections are not taken into account by the Absolute Trigger Level. For example, if you have given yourself effective gain with an amplitude correction factor, the Absolute Trigger will not fire until you have set the trigger level that far below the displayed signal level, rather than simply to the displayed signal level. This is only true for Amplitude Corrections, not External Gain or Ref Level Offset functions. If mode is Bluetooth, the default value is -50 dBm.
Couplings	This same level is used for the RF Burst trigger source in the Trigger menu, for the RF Burst selection in the Periodic Timer sync source (in the Trigger menu and in the Gate Source menu), and also for the RF Burst selection in the Gate Source menu
Preset	-20 dBm
State Saved	Saved in instrument state
Min	-200 dBm
Max	100 dBm
Default Unit	depends on the current selected Y-Axis unit
Backwards Compatibility SCPI	:TRIGger[:SEquence]:FRAMe:RFBurst:LEVel:ABSolute
Initial S/W Revision	Prior to A.02.00
Modified at S/W Revision	A.04.00

Key Path	Trigger, RF Burst
Remote Command	:TRIGger[:SEquence]:RFBurst:LEVel:TYPE ABSolute RELative

	:TRIGger[:SEquence]:RFBurst:LEVel:TYPE?
Example	TRIG:RFB:LEV:TYPE REL sets the trigger level type of the RF burst trigger to Relative.
Preset	ABSolute
State Saved	Saved in instrument state
Initial S/W Revision	Prior to A.02.00
Modified at S/W Revision	A.04.00

Relative Trigger Level

Sets the relative trigger level for the RF burst envelope.

In some models, the relative burst trigger function is implemented in hardware. In other models, without the advanced triggering hardware required, the relative burst trigger function is implemented in software in some measurements, and is unavailable in other measurements.

When implemented in software, the relative RF Burst trigger function is implemented as follows:

1. The measurement starts with the absolute RF Burst trigger setting. If it cannot get a trigger with that level, auto trigger fires and the acquisition starts anyway. After the acquisition, the measurement searches for the peak in the acquired waveform and saves it.
2. Now, in the next cycle of the measurement, the measurement determines a new absolute RF Burst level based on the peak value from the first measurement and the Relative RF Burst Trigger Level (always 0 or negative dB) set by the user. The following formula is used:
3. absolute RF Burst level = peak level of the previous acquisition + relative RF Burst level
4. If the new absolute RF Burst level differs from the previous by more than 0.5 dB, the new level is sent to the hardware; otherwise it is not updated (to avoid slowing down the acquisition)

Steps 2 and 3 repeat for subsequent measurements.

Key Path	Trigger, RF Burst
Scope	Meas Global
Remote Command	:TRIGger[:SEquence]:RFBurst:LEVel:RELative <rel_ampl> :TRIGger[:SEquence]:RFBurst:LEVel:RELative?
Example	TRIG:RFB:LEV:REL -10 dB sets the trigger level of the RF burst envelope signal to the relative level of -10 dB
Notes	Sending this command does not switch the setting from absolute to relative; to switch it you need to send the :TRIGger[:SEquence]:RFBurst:LEVel:TYPE command, above. The relative trigger level is not available in some measurements. In those measurements the RELative parameter, and the :TRIGger[:SEquence]:RFBurst:LEVel:TYPE command (above), will generate an error if sent.
Dependencies	This key is grayed out and Absolute Trigger Level selected if the required hardware is not present in your analyzer and the current measurement does not support Relative triggering.

Preset	-6 dB GSM: -25 dB
State Saved	Saved in instrument state
Min	-45 dB
Max	0 dB
Default Unit	dB or dBc
Backwards Compatibility SCPI	:TRIGger[:SEquence]:RFBurst:LEVel This legacy command is aliased to :TRIGger[:SEquence]:RFBurst:LEVel:RELative because the PSA had ONLY relative burst triggering
Initial S/W Revision	Prior to A.02.00
Modified at S/W Revision	A.04.00

Trigger Slope

It is set positive to trigger on a rising edge and negative to trigger on a falling edge.

Key Path	Trigger, RF Burst
Remote Command	:TRIGger[:SEquence]:RFBurst:SLOPe POSitive NEGative :TRIGger[:SEquence]:RFBurst:SLOPe?
Example	TRIG:RFB:SLOP NEG
Couplings	This same slope is used in the RF Burst selection for the trigger source in the Trigger menu and for the period timer sync source (in the Trigger menu and in the Gate Source menu).
Preset	POSitive
State Saved	Saved in instrument state
Backwards Compatibility SCPI	:TRIGger[:SEquence]:FRAME:RFBurst:SLOPe
Backwards Compatibility Notes	The legacy :TRIGger[:SEquence]:SLOPe command affects the slopes for the VID, LINE, EXT1, EXT2, and RFB triggers.
Initial S/W Revision	Prior to A.02.00

Periodic Timer (Frame Trigger)

Pressing this key, when it is not selected, selects the internal periodic timer signal as the trigger. Triggering occurrences are set by the **Period** parameter, which is modified by the **Sync Source** and **Offset**. Pressing this key, when it is already selected, accesses the periodic timer trigger setup functions.

If you do not have a sync source selected (it is Off), then the internal timer will not be synchronized with any external timing events.

Key Path	Trigger
Example	TRIG:SOUR FRAM Swept SA measurement

	TRIG:< meas>:SOUR FRAM Measurements other than Swept SA
State Saved	Saved in instrument state
Readback	[Sync: <value of Sync Source>], for example, [Sync: External 1]
Status Bits/OPC dependencies	The Status Operation Register bit 5 "Waiting for Trigger" is set at the same time as the Sweeping or Measuring bit is set. It is cleared when the trigger actually occurs (that is, after the trigger event occurs and all the applicable trigger criteria have been met). A corresponding pop-up message ("Waiting for trigger") is generated if no trigger signal appears after approximately 2 sec. This message goes away when a trigger signal appears.
Initial S/W Revision	Prior to A.02.00

Periodic Timer Triggering:

This feature selects the internal periodic timer signal as the trigger. Trigger occurrences are set by the **Periodic Timer** parameter, which is modified by the **Sync Source** and **Offset**.

The figure below shows the action of the periodic timer trigger. Before reviewing the figure, we'll explain some uses for the periodic trigger.

A common application is measuring periodic burst RF signals for which a trigger signal is not easily available. For example, we might be measuring a TDMA radio which bursts every 20 ms. Let's assume that the 20 ms period is very consistent. Let's also assume that we do not have an external trigger source available that is synchronized with the period, and that the signal-to-noise ratio of the signal is not high enough to provide a clean RF burst trigger at all of the analysis frequencies. For example, we might want to measure spurious transmissions at an offset from the carrier that is larger than the bandwidth of the RF burst trigger. In this application, we can set the Periodic Timer to a 20.00 ms period and adjust the offset from that timer to position our trigger just where we want it. If we find that the 20.00 ms is not exactly right, we can adjust the period slightly to minimize the drift between the period timer and the signal to be measured.

A second way to use this feature would be to use **Sync Source** temporarily, instead of **Offset**. In this case, we might tune to the signal in a narrow span and use the RF Burst trigger to synchronize the periodic timer. Then we would turn the sync source off so that it would not miss-trigger. Miss-triggering can occur when we are tuned so far away from the RF burst trigger that it is no longer reliable.

A third example would be to synchronize to a signal that has a reference time element of much longer period than the period of interest. In some CDMA applications, it is useful to look at signals with a short periodicity, by synchronizing that periodicity to the "even-second clock" edge that happens every two seconds. Thus, we could connect the even-second clock trigger to Ext1 and use then Ext1 as the sync source for the periodic timer.

The figure below illustrates this third example. The top trace represents the even-second clock. It causes the periodic timer to synchronize with the leading edge shown. The analyzer trigger occurs at a time delayed by the accumulated offset from the period trigger event. The periodic timer continues to run, and triggers continue to occur, with a periodicity determined by the analyzer time base. The timer output (labeled "late event") will drift away from its ideal time due to imperfect matching between the time base of the signal being measured and the time base of the analyzer, and also because of imperfect setting of the

period parameter. But the synchronization is restored on the next even-second clock event. ("Accumulated offset" is described in the in the **Offset** function section.)

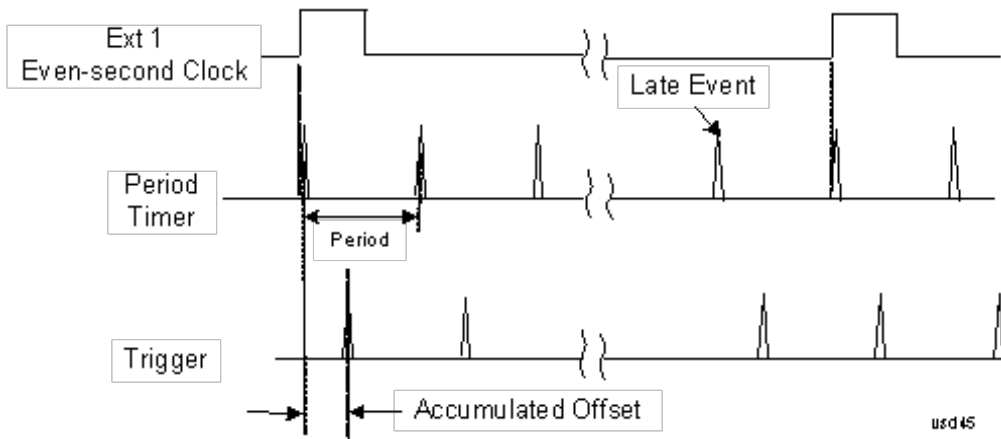

Period

Sets the period of the internal periodic timer clock. For digital communications signals, this is usually set to the frame period of your current input signal. In the case that sync source is not set to OFF, and the external sync source rate is changed for some reason, the periodic timer is synchronized at the every external synchronization pulse by resetting the internal state of the timer circuit.

Key Path	Trigger, Periodic Timer
Remote Command	:TRIGger[:SEquence]:FRAMe:PERiod <time> :TRIGger[:SEquence]:FRAMe:PERiod?
Example	TRIG:FRAM:PER 100 ms
Dependencies	The invalid data indicator turns on when the period is changed, until the next sweep/measurement completes.
Couplings	The same period is used in the Gate Source selection of the period timer.
Preset	20 ms GSM: 4.615383
State Saved	Saved in instrument state
Min	100.000 ns
Max	559.0000 ms
Default Unit	S
Initial S/W Revision	Prior to A.02.00

Offset

Adjusts the accumulated offset between the periodic timer events and the trigger event. Adjusting the accumulated offset is different than setting an offset, and requires explanation.

The periodic timer is usually not synchronized with any external events, so the timing of its output events has no absolute meaning. Since the timing relative to external events (RF signals) is important, you need to

be able to adjust (offset) it. However, you have no direct way to see when the periodic timer events occur. All that you can see is the trigger timing. When you want to adjust the trigger timing, you will be changing the internal offset between the periodic timer events and the trigger event. Because the absolute value of that internal offset is unknown, we will just call that the accumulated offset. Whenever the Offset parameter is changed, you are changing that accumulated offset. You can reset the displayed offset using Reset Offset Display. Changing the display does not change the value of the accumulated offset, and you can still make additional changes to accumulated offset.

To avoid ambiguity, we define that an increase in the "offset" parameter, either from the knob or the SCPI adjust command, serves to delay the timing of the trigger event.

Key Path	Trigger, Periodic Timer
Remote Command	:TRIGger[:SEquence]:FRAMe:OFFSet <time> :TRIGger[:SEquence]:FRAMe:OFFSet?
Example	TRIG:FRAM:OFFS 1.2 ms
Notes	<p>The front panel interface (for example, the knob), and this command, adjust the accumulated offset, which is shown on the active function display. However, the actual amount sent to the hardware each time the offset is updated is the delta value, that is, the current accumulated offset value minus the previous accumulated offset value. Note that the accumulated offset value is essentially arbitrary; it represents the accumulated offset from the last time the offset was zeroed (with the Reset Offset Display key).</p> <p>Note that this command does not change the period of the trigger waveform. Note also that Offset is used only when the sync source is set to OFF, otherwise delay is used, see section "Trig Delay" on page 470.</p> <p>An increase in the "offset" parameter, either from the knob or the SCPI adjust command, serves to delay the timing of the trigger event.</p>
Notes	<p>When the SCPI command is sent the value shown on the key (and the Active Function, if this happens to be the active function) is updated with the new value. However, the actual amount sent to the hardware is the delta value, that is, the current accumulated offset value minus the previous accumulated offset value.</p> <p>The SCPI query simply returns the value currently showing on the key.</p>
Dependencies	The invalid data indicator turns on when the offset is changed, until the next sweep/measurement completes.
Couplings	The same offset is used in the Gate Source selection of the period timer.
Preset	0 s
State Saved	Saved in instrument state
Min	-10.000 s
Max	10.000 s
Default Unit	S
Initial S/W Revision	Prior to A.02.00

Offset Adjust (Remote Command Only)

This remote command does not work at all like the related front panel keys. This command lets you advance the phase of the frame trigger by the amount you specify.

It does not change the period of the trigger waveform. If the command is sent multiple times, it advances the phase of the frame trigger an additional amount each time it is sent. Negative numbers are permitted.

Remote Command	:TRIGger[:SEquence]:FRAMe:ADJust <time>
Example	TRIG:FRAM:ADJ 1.2 ms
Notes	Note also that Offset is used only when the sync source is set to OFF, otherwise delay is used, see section "Trig Delay" on page 470 An increase in the "offset" parameter, either from the knob or the SCPI adjust command, serves to delay the timing of the trigger event.
Notes	The front panel interface (for example, the knob) and the :TRIG:FRAM:OFFS command adjust the accumulated offset, which is shown on the active function display. However, the actual amount sent to the hardware is the delta value, that is, the current offset value minus the previous offset value. When the SCPI command is sent the value shown on the key (and the Active Function, if this happens to be the active function) is updated by increasing it (or decreasing it if the value sent is negative) by the amount specified in the SCPI command. This is a "command only" SCPI command, with no query.
Dependencies	The invalid data indicator turns on when the offset is changed, until the next sweep/measurement completes.
Couplings	The same offset is used in the Gate Source selection of the period timer.
Preset	0 s
State Saved	Saved in instrument state
Min	-10.000 s
Max	10.000 s
Default Unit	S
Initial S/W Revision	Prior to A.02.00

Reset Offset Display

Resets the value of the periodic trigger offset display setting to 0.0 seconds. The current displayed trigger location may include an offset value defined with the Offset key. Pressing this key redefines the currently displayed trigger location as the new trigger point that is 0.0 s offset. The Offset key can then be used to add offset relative to this new timing.

Key Path	Trigger, Periodic Timer
Remote Command	:TRIGger[:SEquence]:FRAMe:OFFSet:DISPlay:RESet
Example	TRIG:FRAM:OFFS:DISP:RES
Initial S/W Revision	Prior to A.02.00

Sync Source

Selects a signal source for you to synchronize your periodic timer trigger to, otherwise you are triggering at some arbitrary location in the frame. Synchronization reduces the precision requirements on the setting of the period.

For convenience you may adjust the level and slope of the selected sync source in a conditional branch setup menu accessed from the Sync Source menu. Note that these settings match those in the **Trigger** and **Gate Source** menus; that is, each trigger source has only one value of level and slope, regardless of which menu it is accessed from.

Key Path	Trigger, Periodic Timer
Remote Command	:TRIGger[:SEquence]:FRAMe:SYNC EXTernal1 EXTernal2 RFBurst OFF :TRIGger[:SEquence]:FRAMe:SYNC?
Example	TRIG:FRAM:SYNC EXT2
Dependencies	In some models, there is no second External input. In these models, the External 2 key is blanked and the EXTERNAL2 parameter will generate a "Hardware missing; Not available for this model number" message.
Preset	Off GSM/EDGE, MSR,LTE,LTETDD: RFBurst
State Saved	Saved in instrument state
Readback	The current setting is read back to this key and it is also Readback to the previous Periodic Timer trigger key.
Backwards Compatibility SCPI	:TRIGger[:SEquence]:FRAMe:SYNC EXTernal For backward compatibility, the parameter EXTernal is mapped to EXTernal1
Initial S/W Revision	Prior to A.02.00
Modified at S/W Revision	A.03.00, A.14.00

Off

Turns off the sync source for your periodic trigger. With the sync source off, the timing will drift unless the signal source frequency is locked to the analyzer frequency reference.

Key Path	Trigger, Periodic Timer, Sync Source
Example	TRIG:FRAM:SYNC OFF
Readback	Off
Initial S/W Revision	Prior to A.02.00

External 1

Pressing this key, when it is not selected, selects an external input signal as the trigger. A new sweep/measurement will start when the external trigger condition is met using the external 1 input connector on the rear panel.

Pressing this key, when it is already selected, accesses the external 1 trigger setup menu.

Key Path	Trigger
Example	TRIG:SOUR EXT1 Swept SA measurement

	TRIG:<meas>:SOUR EXT1 Measurements other than Swept SA
Dependencies	Grayed out if in use by Point Trigger in the Source Setup menu. Forced to Free Run if already selected and Point Trigger is set to External 1.
State Saved	Saved in instrument state
Status Bits/OPC dependencies	The Status Operation Register bit 5 "Waiting for Trigger" is set at the same time as the Sweeping or Measuring bit is set. It is cleared when the trigger actually occurs (that is, after the trigger event occurs and all the applicable trigger criteria have been met). A corresponding pop-up message ("Waiting for trigger") is generated if no trigger signal appears after approximately 2 sec. This message goes away when a trigger signal appears.
Initial S/W Revision	Prior to A.02.00

Trigger Level

Sets the value where the external 1 trigger input will trigger a new sweep/measurement.

Key Path	Trigger, External 1
Remote Command	:TRIGger[:SEquence]:EXTernal1:LEVel <level> :TRIGger[:SEquence]:EXTernal1:LEVel?
Example	TRIG:EXT1:LEV 0.4 V
Couplings	This same level is used for the Ext1 trigger source in the Trigger menu, for the Ext1 selection in the Periodic Timer sync source (in the Trigger menu and in the Gate Source menu), and also for the Ext1 selection in the Gate Source menu.
Preset	1.2 V
State Saved	Saved in instrument state
Min	-5 V
Max	5 V
Default Unit	V
Backwards Compatibility SCPI	:TRIGger[:SEquence]:EXTernal:LEVel For backward compatibility, the parameter EXTernal is mapped to EXTernal1
Backwards Compatibility SCPI	:TRIGger[:SEquence]:FRAMe:EXTernal1:LEVel
Initial S/W Revision	Prior to A.02.00

Trig Slope

Controls the trigger polarity. It is set positive to trigger on a rising edge and negative to trigger on a falling edge.

Key Path	Trigger, External 1
Remote Command	:TRIGger[:SEquence]:EXTernal1:SLOPe POSitive NEGative

	:TRIGger[:SEquence]:EXTernal1:SLOPe?
Example	TRIG:EXT1:SLOP NEG
Couplings	This same slope is used in the Ext1 selection for the trigger source in the Trigger menu and for the period timer sync source (in the Trigger menu and in the Gate Source menu).
Preset	POSitive
State Saved	Saved in instrument state
Backwards Compatibility SCPI	:TRIGger[:SEquence]:EXTernal:SLOPe For backward compatibility, the parameter EXTernal is mapped to EXTernal1
Backwards Compatibility SCPI	:TRIGger[:SEquence]:FRAMe:EXTernal1:SLOPe
Backwards Compatibility Notes	The legacy :TRIGger[:SEquence]:SLOPe command affects the slopes for the VID, LINE, EXT1, EXT2, and RFB triggers.
Initial S/W Revision	Prior to A.02.00

External 2

Pressing this key, when it is not selected, selects an external input signal as the trigger. A new sweep/measurement will start when the external trigger condition is met using the external 2 input connector. The external trigger 2 input connector is on the rear panel.

Pressing this key, when it is already selected, accesses the external 2 trigger setup menu.

Key Path	Trigger
Example	TRIG:SOUR EXT2 Swept SA measurement TRIG:<meas>:SOUR EXT2 Measurements other than Swept SA
Dependencies	In some models, there is no second External input. In these models, the External 2 key is blanked and the EXTernal2 parameter will generate a "Hardware missing; Not available for this model number" message. Grayed out if in use by Point Trigger in the Source Setup menu. Forced to Free Run if already selected and Point Trigger is set to External 2.
State Saved	Saved in instrument state
Status Bits/OPC dependencies	The Status Operation Register bit 5 "Waiting for Trigger" is set at the same time as the Sweeping or Measuring bit is set. It is cleared when the trigger actually occurs (that is, after the trigger event occurs and all the applicable trigger criteria have been met). A corresponding pop-up message ("Waiting for trigger") is generated if no trigger signal appears after approximately 2 sec. This message goes away when a trigger signal appears.
Initial S/W Revision	Prior to A.02.00
Modified at S/W Revision	A.03.00

Trigger Level

Sets the value where the external 2 trigger input will trigger a new sweep/measurement.

Key Path	Trigger, External 2
Remote Command	:TRIGger[:SEquence]:EXTernal2:LEVel :TRIGger[:SEquence]:EXTernal2:LEVel?
Example	TRIG:EXT2:LEV 1.1 V
Couplings	This same level is used for the Ext2 trigger source in the Trigger menu, for the Ext2 selection in the Periodic Timer sync source (in the Trigger menu and in the Gate Source menu), and also for the Ext2 selection in the Gate Source menu.
Preset	1.2 V
State Saved	Saved in instrument state
Min	-5 V
Max	5 V
Default Unit	V
Backwards Compatibility SCPI	:TRIGger[:SEquence]:FRAMe:EXTernal2:LEVel
Initial S/W Revision	Prior to A.02.00

Trig Slope

Controls the trigger polarity. It is set positive to trigger on a rising edge and negative to trigger on a falling edge.

Key Path	Trigger, External 2
Remote Command	:TRIGger[:SEquence]:EXTernal2:SLOPe POSitive NEGative :TRIGger[:SEquence]:EXTernal2:SLOPe?
Example	TRIG:EXT2:SLOP NEG
Couplings	This same slope is used in the Ext2 selection for the trigger source in the Trigger menu and for the period timer sync source (in the Trigger menu and in the Gate Source menu).
Preset	POSitive
State Saved	Saved in instrument state
Backwards Compatibility SCPI	:TRIGger[:SEquence]:FRAMe:EXTernal2:SLOPe
Backwards Compatibility Notes	The legacy :TRIGger[:SEquence]:SLOPe command affects the slopes for the VID, LINE, EXT1, EXT2, and RFB triggers.
Initial S/W Revision	Prior to A.02.00

RF Burst

Pressing this key, when it is not selected, selects the RF Burst as the trigger. A new sweep/measurement will start when an RF burst envelope signal is identified from the signal at the RF Input connector. Pressing this key, when it is already selected, accesses the RF Burst trigger setup menu.

In some models, a variety of burst trigger circuitry is available, resulting in various available burst trigger bandwidths. The analyzer automatically chooses the appropriate trigger path based on the hardware configuration and other settings of the analyzer.

Key Path	Trigger
Example	TRIG:SOUR RFB Swept SA measurement TRIG:<meas>:SOUR RFB Measurements other than Swept SA
State Saved	Saved in instrument state
Status Bits/OPC dependencies	The Status Operation Register bit 5 "Waiting for Trigger" is set at the same time as the Sweeping or Measuring bit is set. It is cleared when the trigger actually occurs (that is, after the trigger event occurs and all the applicable trigger criteria have been met). A corresponding pop-up message ("Waiting for trigger") is generated if no trigger signal appears after approximately 2 sec. This message goes away when a trigger signal appears.
Backwards Compatibility Notes	The legacy command: :TRIGger[:SEquence]:RFBurst:FSElectivity[:STATe] OFF ON 0 1 is not supported in the X-Series, as the hardware to do Frequency Selective burst triggers does not exist in X-Series.
Initial S/W Revision	Prior to A.02.00
Modified at S/W Revision	A.04.00

Absolute Trigger Level

Sets the absolute trigger level for the RF burst envelope.

When using the External Mixing path, the Absolute Trigger Level is uncalibrated because the factory default was set to accommodate the expected IF levels for the RF path.

Key Path	Trigger, RF Burst
Scope	Meas Global
Remote Command	:TRIGger[:SEquence]:RFBurst:LEVel:ABSolute <ampl> :TRIGger[:SEquence]:RFBurst:LEVel:ABSolute?
Example	TRIG:RFB:LEV:ABS 10 dBm sets the trigger level of the RF burst envelope signal to the absolute level of 10 dBm
Notes	Sending this command does not switch the setting from relative to absolute; to switch it you need to send the :TRIGger[:SEquence]:RFBurst:LEVel:TYPE command, below. Amplitude Corrections are not taken into account by the Absolute Trigger Level. For example, if you have given yourself effective gain with an amplitude correction factor, the Absolute Trigger will not fire until you have set the trigger level that far below the displayed signal level, rather than simply to the displayed signal level. This is only true for Amplitude Corrections, not External Gain or Ref Level Offset functions. If mode is Bluetooth, the default value is -50 dBm.
Couplings	This same level is used for the RF Burst trigger source in the Trigger menu, for the RF Burst selection in the Periodic Timer sync source (in the Trigger menu and in the Gate Source menu), and also for the

	RF Burst selection in the Gate Source menu
Preset	-20 dBm
State Saved	Saved in instrument state
Min	-200 dBm
Max	100 dBm
Default Unit	depends on the current selected Y-Axis unit
Backwards Compatibility SCPI	:TRIGger[:SEquence]:FRAMe:RFBurst:LEVel:ABSolute
Initial S/W Revision	Prior to A.02.00
Modified at S/W Revision	A.04.00

Key Path	Trigger, RF Burst
Remote Command	:TRIGger[:SEquence]:RFBurst:LEVel:TYPE ABSolute RELative :TRIGger[:SEquence]:RFBurst:LEVel:TYPE?
Example	TRIG:RFB:LEV:TYPE REL sets the trigger level type of the RF burst trigger to Relative.
Preset	ABSolute
State Saved	Saved in instrument state
Initial S/W Revision	Prior to A.02.00
Modified at S/W Revision	A.04.00

Trigger Slope

It is set positive to trigger on a rising edge and negative to trigger on a falling edge.

Key Path	Trigger, RF Burst
Remote Command	:TRIGger[:SEquence]:RFBurst:SLOPe POSitive NEGative :TRIGger[:SEquence]:RFBurst:SLOPe?
Example	TRIG:RFB:SLOP NEG
Couplings	This same slope is used in the RF Burst selection for the trigger source in the Trigger menu and for the period timer sync source (in the Trigger menu and in the Gate Source menu).
Preset	POSitive
State Saved	Saved in instrument state
Backwards Compatibility SCPI	:TRIGger[:SEquence]:FRAMe:RFBurst:SLOPe
Backwards Compatibility Notes	The legacy :TRIGger[:SEquence]:SLOPe command affects the slopes for the VID, LINE, EXT1, EXT2, and RFB triggers.
Initial S/W Revision	Prior to A.02.00

Sync Holdoff

Sync Holdoff specifies the duration that the sync source signal must be kept false before the transition to true to be recognized as the sync timing. The periodic timer phase is aligned when the sync source signal becomes true, after the Holdoff time is satisfied.

A holdoff of 2 ms will work with most WiMAX signals, but there may be cases where the burst off duration is less than 1 ms and this value will need to be changed.

Key Path	Trigger, Periodic Timer
Remote Command	:TRIGger[:SEquence]:FRAMe:SYNC:HOLDoff <time> :TRIGger[:SEquence]:FRAMe:SYNC:HOLDoff? :TRIGger[:SEquence]:FRAMe:SYNC:HOLDoff:STATe OFF ON 0 1 :TRIGger[:SEquence]:FRAMe:SYNC:HOLDoff:STATe?
Preset	On, 1.000 ms
State Saved	Saved in instrument state
Min	0 ms
Max	+500 ms
Default Unit	s
Initial S/W Revision	Prior to A.02.00

Control Edge/Level

Sets the method of controlling the gating function from the gating signal.

Edge

In Edge triggering, the gate opens (after the Delay) on the selected edge (for example, positive) of the gate signal and closes on the alternate edge (for example, negative).

Level

In Level triggering, the gate opens (after the Delay) when the gate signal has achieved a certain level and stays open as long as that level is maintained.

Key Path	Sweep/Control, Gate
Remote Command	[:SENSe]:SWEep:EGATe:CONTRol EDGE LEVEl [:SENSe]:SWEep:EGATe:CONTRol?
Example	SWE:EGAT:CONT EDGE
Dependencies	If the Gate Method is FFT the Control key is grayed out and Edge is selected. If the Gate Source is TV, Frame or Line, the Control key is grayed out and Edge is selected.
Preset	EDGE
State Saved	Saved in instrument state
Backwards Compatibility SCPI	[:SENSe]:SWEep:TIME:GATE:TYPE ESA Compatibility
Initial S/W Revision	Prior to A.02.00

Gate Holdoff

Lets you increase or decrease the wait time after a gate event ends before the analyzer will respond to the next gate signal.

After any Gate event finishes, the analyzer must wait for the sweep system to settle before it can respond to another Gate signal. The analyzer calculates a "wait time," taking into account a number of factors, including RBW and Phase Noise Optimization settings. The goal is to achieve the same accuracy when gated as in ungated operation. The figure below illustrates this concept:

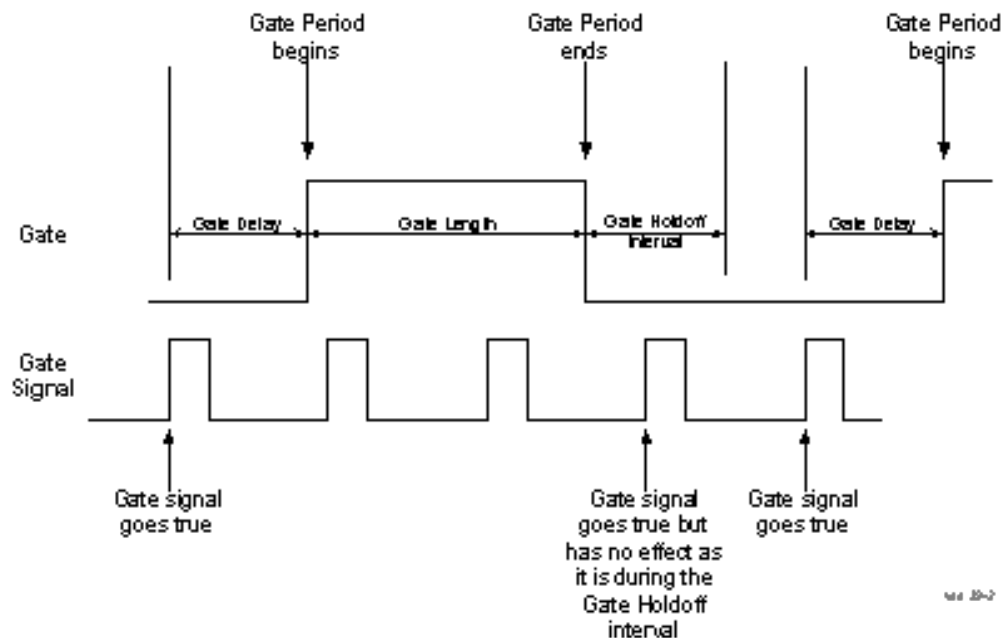

When Gate Holdoff is in Auto, the wait time calculated by the analyzer is used. When Gate Time is in Manual, the user may adjust the wait time, usually decreasing it in order to achieve greater speed, but at the risk of decreasing accuracy.

When the Method key is set to Video or FFT, the Gate Holdoff function has no effect.

In measurements that do not support Auto, the value shown when Auto is selected is "----" and the manually set holdoff is returned to a query.

Key Path	Sweep/Control, Gate
Remote Command	[:SENSe]:SWEep:EGATe:HOLDoff <time> [:SENSe]:SWEep:EGATe:HOLDoff? [:SENSe]:SWEep:EGATe:HOLDoff:AUTO OFF ON 0 1 [:SENSe]:SWEep:EGATe:HOLDoff:AUTO?
Example	SWE:EGAT:HOLD 0.0002 SWE:EGAT:HOLD? SWE:EGAT:HOLD:AUTO ON

SWE:EGAT:HOLD:AUTO?	
Couplings	<p>When Gate Holdoff is Auto, the Gate Holdoff key shows the value calculated by the analyzer for the wait time.</p> <p>Pressing the Gate Holdoff key while it is in Auto and not selected, causes the key to become selected and allows the user to adjust the value. If the value is adjusted, the setting changes to Man.</p> <p>Pressing the Gate Holdoff key, while it is in Auto and selected, does not change the value of Gate Holdoff, but causes the setting to change to Man. Now the user can adjust the value.</p> <p>Pressing the key while it is in Man and selected, cause the value to change back to Auto.</p> <p>Pressing the key while it is in Man and not selected, causes the key to become selected and allows the user to adjust the value.</p> <p>When Method is set to Video or FFT, the Gate Holdoff function has no effect.</p>
Preset	<p>Auto</p> <p>Auto/On</p>
State Saved	Saved in instrument state
Min	1 µsec
Max	1 sec
Initial S/W Revision	Prior to A.02.00

Gate Delay Compensation

This function allows you to select an RBW-dependent value by which to adjust the gate delay, to compensate for changes in the delay caused by RBW effects.

You can select between uncompensated operation and two types of compensation, Delay Until RBW Settled and Compensate for RBW Group Delay.

See ["More Information" on page 1361](#)

Key Path	Sweep/Control, Gate
Scope	Meas Global
Remote Command	<pre>[:SENSe] :SWEep:EGATe:DELAy:COMPensation:TYPE OFF SETTled GDELAy [:SENSe] :SWEep:EGATe:DELAy:COMPensation:TYPE?</pre>
Example	<pre>SWE:EGAT:DEL:COMP:TYPE SETT SWE:EGAT:DEL:COMP:TYPE?</pre>
Notes	<p>Although this function is Meas Global, there are some measurements that do not support this function. In those measurements the operation will be Uncompensated. Going into one of those measurements will not change the Meas Global selection; it will simply display the grayed-out menu key with “Uncompensated” showing as the selection. This is a non-forceful grayout, so the SCPI command is still accepted.</p> <p>If Gate Delay Compensation is not supported at all within a particular mode, the key is not displayed, and if the SCPI command is sent while in a measurement within that mode, an “Undefined Header” message is generated.</p> <p>Measurements that do not support this function include:</p>

Swept SA	
Preset	TD-SCDMA mode: Compensate for RBW Group Delay All other modes: Delay Until RBW Settled
State Saved	Saved in instrument state
Range	Uncompensated Delay Until RBW Settled Compensate for RBW Group Delay
Readback text	Uncompensated Settled Group Delay
Initial S/W Revision	Prior to A.02.00
Modified at S/W Revision	A.11.0

More Information

Selecting Uncompensated means that the actual gate delay is as you sets it.

Selecting Delay Until RBW Settled causes the gate delay to be increased above the user setting by an amount equal to $3.06/\text{RBW}$. This compensated delay causes the GATE START and GATE STOP lines on the display to move by the compensation amount, and the actual hardware gate delay to be increased by the same amount. All the other gate lines (for example, MIN FAST) are unaffected. If the RBW subsequently changes, the compensation is readjusted for the new RBW. The value shown on the Gate Delay key does NOT change.

Delay Until RBW Settled allows excellent measurements of gated signals, by allowing the IF to settle following any transient that affects the burst. Excellent measurements also require that the analysis region not extend into the region affected by the falling edge of the burst. Thus, excellent measurements can only be made over a width that declines with narrowing RBWs, which is achieved by decreasing the gate length below the user setting by an amount equal to $2.53/\text{RBW}$. Therefore, for general purpose compensation, you will still want to change the gate length with changes in RBW even if the gate delay is compensated. The compensated Gate Length is limited by the analyzer so that it will never go below 10% of the value shown on the Gate Length key, as otherwise the sweep times could get very long. Anytime the Gate Length and RBW values combine in such a way that this limiting takes place, a warning is displayed. For measurements which contain multiple sweeps with different RBW like SEM and SPUR, the smallest RBW is used for this limiting.

Selecting Compensate for RBW Group Delay causes the gate delay to be increased above the user setting by an amount equal to $1.81/\text{RBW}$. This compensated delay causes the GATE START, GATE STOP lines on the display to move by the compensation amount, and the actual hardware gate delay to be increased by the same amount. All the other gate lines (for example, MIN FAST) are unaffected. If the RBW subsequently changes, the compensation is readjusted for the new RBW. The value shown on the Gate Delay key does NOT change. Compensate for RBW Group Delay also includes gate length compensation; the gate length itself is adjusted as necessary to attempt to compensate for delay effects imposed by the RBW.

Compensate for RBW Group Delay is similar to Delay Until RBW Settled, but compensates for the group delay of the RBW filter, rather than the filter settling time. As the RBW gets narrow, this can allow the settling tail of the RBW to affect the beginning part of the gated measurement, and allow the beginning of the RBW settling transient to affect the end of the gated measurement. These two effects are symmetric

because the RBW response is symmetric. Because the gate length is not automatically compensated, some users might find this compensation to be more intuitive than compensation for RBW settling.

Min Fast Position Query (Remote Command Only)

This command queries the position of the MIN FAST line, relative to the delay reference (REF) line. See section "Gate View On/Off" on page 2496. If this query is sent while not in gate view, the MinFast calculation is performed based on the current values of the appropriate parameters and the result is returned. Knowing this value lets you set an optimal gate delay value for the current measurement setup.

Remote Command	<code>[:SENSe] :SWEep:EGATe:MINFast?</code>
Example	<code>SWE:EGAT:MIN?</code>
Initial S/W Revision	Prior to A.02.00

Gate Preset (Remote Command Only)

Presets the time-gated spectrum analysis capability.

This command sets gate parameter values to the ESA preset values, as follows:

Gate trigger type = edge

Gate polarity = positive

Gate delay = 1 us

Gate length = 1 us

Remote Command	<code>[:SENSe] :SWEep:TIME:GATE:PRESet</code> ESA Compatibility
Initial S/W Revision	Prior to A.02.00

Gate Level (Remote Command Only)

Sets the gate input transition point level for the external TRIGGER inputs on the front and rear panel. This is a legacy command for PSA compatibility. It is simply an alias to the equivalent trigger level command.

Remote Command	<code>[:SENSe] :SWEep:EGATe:EXTernal [1] 2 :LEVel <voltage></code> <code>[:SENSe] :SWEep:EGATe:EXTernal [1] 2 :LEVel?</code>
Notes	This command is simply an alias to <code>:TRIGger[:SEQUence]:EXTernal[1]2:LEVel</code> For details refer
Initial S/W Revision	Prior to A.02.00

Gate Polarity (Remote Command Only)

Sets the polarity for the gate signal. This setup is now done using the gate trigger's slope setting.

When Positive (Pos) is selected, a positive-going edge (Edge) or a high voltage (Level) will satisfy the gate condition, after the delay set with the Gate Delay key. When Negative (Neg) is selected, a negative-going edge (Edge) or a low voltage (Level) will satisfy the gate condition after the delay.

Remote Command	[:SENSe] :SWEep:EGATe:POLarity NEGative POSitive [:SENSe] :SWEep:EGATe:POLarity?
Example	SWE:EGAT:POL NEG SWE:EGAT:POL?
Preset	POSitive
State Saved	Saved in instrument state
Backwards Compatibility SCPI	[:SENSe] :SWEep:TIME:GATE:POLarity ESA compatibility
Initial S/W Revision	Prior to A.02.00

Remote Command	[:SENSe] :SWEep:TIME:GATE:LEVel HIGH LOW [:SENSe] :SWEep:TIME:GATE:LEVel? ESA compatibility
Preset	HIGH
Initial S/W Revision	Prior to A.02.00

Gate

Accesses a menu that enables you to control the gating function.

The Gate functionality is used to view signals best viewed by qualifying them with other events. See "[Gate](#)" on page 2495 for more details.

Key Path	Sweep/Control
Initial S/W Revision	A.03.00

12 Spurious Emissions Measurement
System

System

See ["System" on page 366](#)

Trace/Detector

Trace/Detector is unavailable in the Spurious Emissions measurement. When pressed, this key displays a blank menu.

Key Path	Front-panel key
Initial S/W Revision	Prior to A.02.00

Trigger

See ["Trigger" on page 438](#)

Free Run

See ["Free Run " on page 445](#)

Video

See ["Video \(IF Envelope\) " on page 446](#)

Trigger Level

See ["Trigger Level " on page 446](#)

Trig Slope

See ["Trig Slope " on page 447](#)

Trig Delay

See ["Trig Delay " on page 448](#)

Line

See ["Line " on page 2503](#)

Trig Slope

See ["Trig Slope " on page 2503](#)

Trig Delay

See ["Trig Delay " on page 450](#)

External 1

See ["External 1 " on page 2516](#)

Trigger Level

See ["Trigger Level " on page 2516](#)

Trig Slope

See ["Trig Slope " on page 2517](#)

Trig Delay

See ["Trig Delay " on page 453](#)

Zero Span Delay Comp

See ["Zero Span Delay Comp On/Off" on page 2505](#)

External 2

See ["External 2 "](#) on page 2518

Trigger Level

See ["Trigger Level "](#) on page 2518

Trig Slope

See ["Trig Slope "](#) on page 2519

Trig Delay

See ["Trig Delay "](#) on page 455

Zero Span Delay Comp

See ["Zero Span Delay Comp On/Off"](#) on page 2507

RF Burst

See ["RF Burst "](#) on page 2519

Absolute Trigger

See ["Absolute Trigger Level"](#) on page 2520

Relative Trigger

See ["Relative Trigger Level"](#) on page 2509

Trig Slope

See ["Trigger Slope "](#) on page 2521

Trig Delay

See ["Trig Delay "](#) on page 460

Periodic Timer

See ["Periodic Timer \(Frame Trigger\) "](#) on page 2511

Period

See ["Period "](#) on page 2512

Offset

See ["Offset "](#) on page 2513

Reset Offset Display

See ["Reset Offset Display "](#) on page 2515

Sync Source

See ["Sync Source "](#) on page 2515

Off

See ["Off "](#) on page 2516

External 1

See ["External 1 "](#) on page 2516

Trigger Level

See ["Trigger Level "](#) on page 2516

Trig Slope

See ["Trig Slope "](#) on page 2517

External 2

See ["External 2 "](#) on page 2518

Trigger Level

See ["Trigger Level "](#) on page 2518

Trig Slope

See ["Trig Slope "](#) on page 2519

RF Burst

See ["RF Burst "](#) on page 2519

Absolute Trigger

See ["Absolute Trigger Level"](#) on page 2520

Trig Slope

See ["Trigger Slope "](#) on page 2521

Trig Delay

See ["Trig Delay"](#) on page 470

Auto/Holdoff

See ["Auto/Holdoff "](#) on page 471

Auto Trig

See ["Auto Trig "](#) on page 471

Trig Holdoff

See ["Trig Holdoff "](#) on page 472

Holdoff Type

See "[Holdoff Type](#)" on page 472

User Preset

Accesses a menu that gives you the following three choices:

- User Preset – recalls a state previously saved using the Save User Preset function.
- User Preset All Modes – presets all of the modes in the analyzer
- Save User Preset– saves the current state for the current mode

Key Path	Front-panel key
Backwards Compatibility Notes	<p>User Preset is actually loading a state, and in legacy analyzers, it was possible to load a state without affecting the trace data, limit lines or correction data. Similarly it was possible to do a User Preset without affecting the trace data, limit lines or correction data.</p> <p>In the X-Series, “state” always includes all of this data; so whenever state is loaded, or User Preset is executed, all of the traces, limit lines and corrections are affected. Although this differs from previous behavior, it is desirable behavior, and should not cause adverse issues for users.</p> <p>On ESA and PSA, User Preset affected the entire instrument’s state. In the X-Series, User Preset only recalls the state for the active mode. There is a User Preset file for each mode. User Preset can never cause a mode switch as it can in legacy analyzers. If you want to recall all modes to their user preset file state, you will need to do a User Preset after mode switching into each mode.</p> <p>User Preset recalls mode state which can now include data like traces; whereas on ESA and PSA, User Preset did not affect data.</p>
Initial S/W Revision	Prior to A.02.00

User Preset

User Preset sets the state of the currently active mode back to the state that was previously saved for this mode using the Save User Preset menu key or the SCPI command, SYST:PRES:USER:SAV. It not only recalls the Mode Preset settings, but it also recalls all of the mode persistent settings, and the Input/Output system setting that existed at the time Save User Preset was executed.

If a Save User Preset has not been done at any time, User Preset recalls the default user preset file for the currently active mode. The default user preset files are created if, at power-on, a mode detects there is no user preset file. There will never be a scenario when there is no user preset file to restore. For each mode, the default user preset state is the same state that would be saved if a Save User Preset is performed in each mode right after doing a Restore Mode Default and after a Restore Input/Output Defaults.

The User Preset function does the following:

- Aborts the currently running measurement.
- Sets the mode State to the values defined by Save User Preset.
- Makes the saved measurement for the currently running mode the active measurement.
- Brings up the saved menu for the power-on mode.
- Clears the input and output buffers.
- Sets the Status Byte to 0.

Key Path	User Preset
Remote Command	:SYSTem:PRESet:USER
Example	:SYST:PRES:USER:SAVE:SYST:PRES:USER
Notes	:SYST:PRES:USER:SAVE is used to save the current state as the user preset state. Clears all pending OPC bits. The Status Byte is set to 0. Pressing the User Preset front-panel key while already in the User Preset menu will cause the User Preset to get executed
Couplings	A user preset will cause the currently running measurement to be aborted and cause the saved measurement to be active. Recalling a User Preset file has the same issues that recalling a Save State file has. Some settings may need to be limited and therefore re-coupled, since the capabilities of the mode may have changes when the User Preset file was last saved.
Initial S/W Revision	Prior to A.02.00

User Preset All Modes

Recalls all of the User Preset files for each mode, switches to the power-on mode, and activates the saved measurement from the power-on mode User Preset file.

NOTE

When the instrument is secured, all of the user preset files are converted back to their default user preset files.

The User Preset function does the following:

- Aborts the currently running measurement.
- Switches the Mode to the power-on mode.
- Restores the User Preset files for each mode.
- Makes the saved measurement for the power-on mode the active measurement.
- Brings up the saved menu for the power-on mode.
- Clears the input and output buffers.
- Sets the Status Byte to 0.

Key Path	User Preset
Remote Command	:SYSTem:PRESet:USER:ALL
Example	:SYST:PRES:USER:SAVE:SYST:PRES:USER:ALL
Notes	Clears all pending OPC bits. The Status Byte is set to 0. :SYST:PRES:USER:SAVE is used to save the current state as the user preset state.
Couplings	A user preset will cause the currently running measurement to be aborted, cause a mode switch to the power-on mode, and cause the saved measurement to be active in the power-on mode. Recalling a User Preset file has the same issues that recalling a Save State file has. Some settings may need to be limited and therefore re-coupled, since the capabilities of the mode may have changes when the User Preset file was last saved.
Initial S/W Revision	Prior to A.02.00

Save User Preset

Saves the currently active mode and its State. You can recall this User Preset file by pressing the User Preset menu key or sending the SYST:PRES:USER remote command. This same state is also saved by the Save State function.

Key Path	User Preset
Remote Command	:SYSTem:PRESet:USER:SAVE
Example	:SYST:PRES:USER:SAVE
Notes	:SYST:PRES:SAVE creates the same file as if the user requested a *SAV or a MMEM:STOR:STAT, except User Preset Save does not allow the user to specify the filename or the location of the file.
Initial S/W Revision	Prior to A.02.00

View/Display

Accesses a menu that includes keys that enables you to control the instrument display.

For details of available views, see [View Selection](#).

For details of remote commands associated with views, see [Range Table Selection \(SCPI only command\)](#).

Key Path	Front-panel key
Initial S/W Revision	Prior to A.02.00

Display

The Display menu is common to most measurements, and is used for configuring items on the display. Some Display menu settings apply to all the measurements in a mode, and some only to the current measurement. Those under the System Display Settings key apply to all measurements in all modes.

Key Path	Display
Key Path	View/Display
Initial S/W Revision	Prior to A.02.00

Annotation

Turns on and off various parts of the display annotation. The annotation is divided up into four categories:

1. Meas Bar: This is the measurement bar at the top of the screen. It does not include the settings panel or the Active Function. Turning off the Meas Bar turns off the settings panel and the Active Function. When the Meas Bar is off, the graticule area expands to fill the area formerly occupied by the Meas Bar.
2. Screen Annotation: this is the annotation and annunciation around the graticule, including any annotation on lines (such as the display line, the threshold line, etc.) This does NOT include the marker number or the N dB result. When off, the graticule expands to fill the entire graticule area.
3. Trace annotation: these are the labels on the traces, showing their detector (or their math mode).
4. Active Function annotation: this is the active function display in the meas bar, and all of the active function values displayed on softkeys.

See the figure below. Each type of annotation can be turned on and off individually.

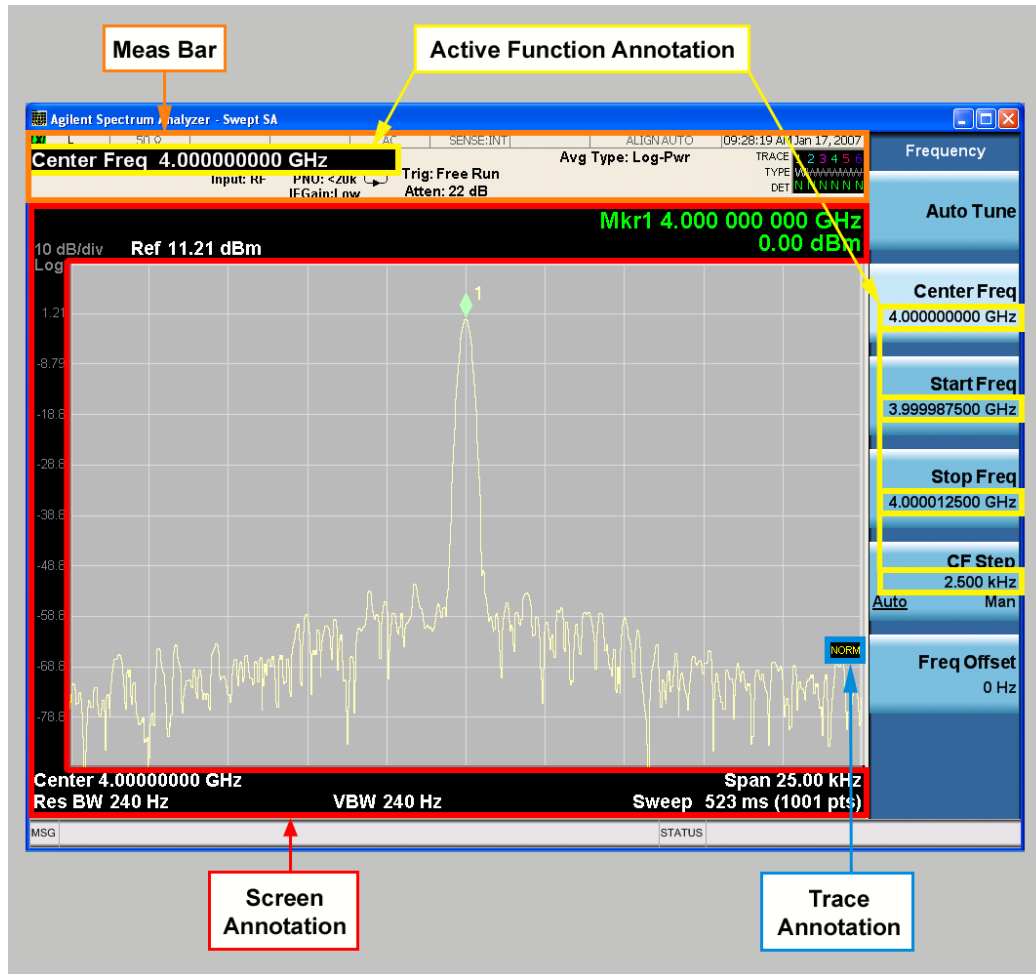

Key Path	View/Display, Display
Initial S/W Revision	Prior to A.02.00

Meas Bar On/Off

This function turns the Measurement Bar on and off, including the settings panel. When off, the graticule area expands to fill the area formerly occupied by the Measurement Bar.

Key Path	View/Display, Display, Annotation
Remote Command	:DISPlay:ANNOtation:MBAR[:STATe] OFF ON 0 1 :DISPlay:ANNOtation:MBAR[:STATe]?
Example	DISP:ANN:MBAR OFF
Dependencies	Grayed out and forced to OFF when System Display Settings, Annotation is set to Off.
Preset	On This should remain Off through a Preset when System DisplaySettings, Annotation is set to Off.
State Saved	Saved in instrument state.
Initial S/W Revision	Prior to A.02.00

Screen

This controls the display of the annunciation and annotation around the graticule, including any annotation on lines (such as the display line, the threshold line, etc.) and the y-axis annotation. This does NOT include marker annotation (or the N dB result). When off, the graticule expands to fill the entire graticule area, leaving only the 1.5% gap above the graticule as described in the Trace/Detector chapter.

Key Path	View/Display, Display, Annotation
Remote Command	:DISPlay:ANNotation:SCReen[:STATe] OFF ON 0 1 :DISPlay:ANNotation:SCReen[:STATe]?
Example	DISP:ANN:SCR OFF
Dependencies	Grayed-out and forced to OFF when System Display Settings, Annotation is set to Off.
Preset	On This should remain Off through a Preset when System DisplaySettings, Annotation is set to Off
State Saved	Saved in instrument state.
Initial S/W Revision	Prior to A.02.00

Active Function Values On/Off

Turns on and off the active function display in the Meas Bar, and all of the active function values displayed on the softkeys.

Note that all of the softkeys that have active functions have these numeric values blanked when this function is on. This is a security feature..

12 Spurious Emissions Measurement
View/Display

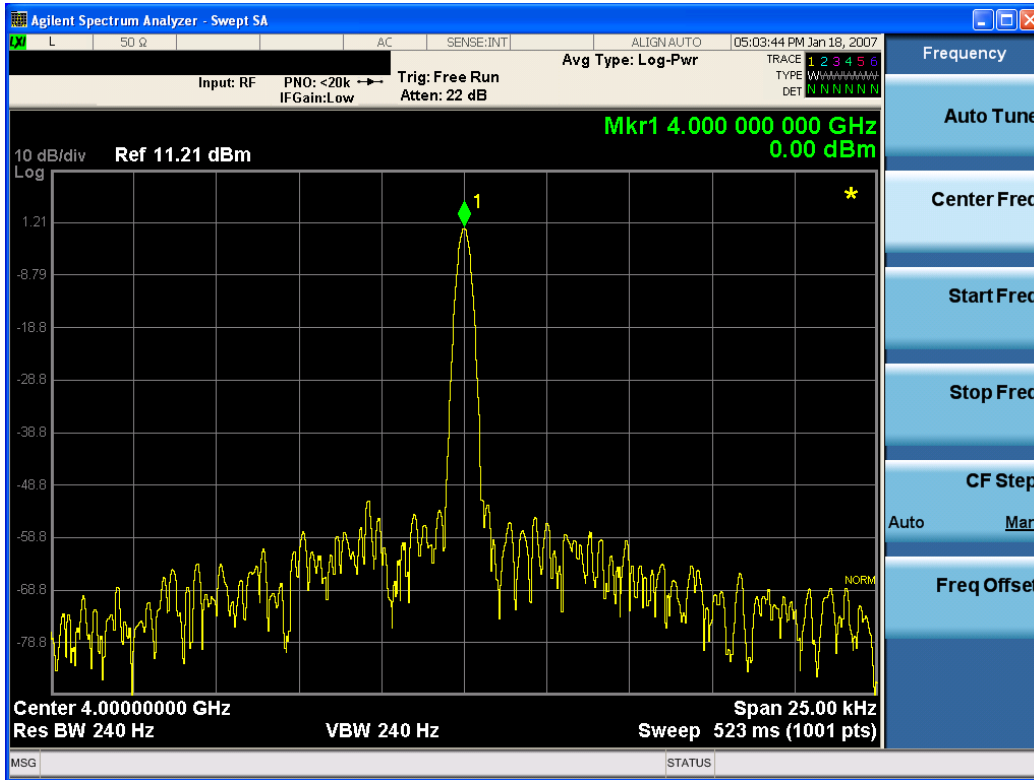

Key Path	View/Display, Display, Annotation
Remote Command	:DISPlay:ACTivefunc[:STATE] ON OFF 1 0 :DISPlay:ACTivefunc[:STATE]?
Example	DISP:ACT OFF
Dependencies	Grayed out and forced to OFF when System Display Settings, Annotation is set to Off.
Preset	On This should remain Off through a Preset when System DisplaySettings, Annotation is set to Off
State Saved	Saved in instrument state.
Initial S/W Revision	Prior to A.02.00

Title

Displays menu keys that enable you to change or clear a title on your display.

Key Path	View/Display, Display
Initial S/W Revision	Prior to A.02.00

Change Title

Writes a title into the "measurement name" field in the banner, for example, "Swept SA".

Press Change Title to enter a new title through the alpha editor. Press Enter or Return to complete the entry. Press ESC to cancel the entry and preserve your existing title.

The display title will replace the measurement name. It remains for this measurement until you press Change Title again, or you recall a state, or a Preset is performed. A title can also be cleared by pressing Title, Clear Title.

NOTE

Notice the inclusion of the <measurement> parameter in the command below. Because each measurement remembers the Display Title, the command must be qualified with the measurement name. For the Swept SA measurement this is not the case; no <measurement> parameter is used when changing the Display Title for the Swept SA measurement.

Key Path	View/Display, Display, Title
Mode	All
Remote Command	:DISPlay:<measurement>:ANNotation:TITLe:DATA <string> :DISPlay:<measurement>:ANNotation:TITLe:DATA?
Example	DISP:ANN:TITL:DATA "This Is My Title" This example is for the Swept SA measurement in the Spectrum Analyzer mode. The SANalyzer <measurement> name is not used. DISP:ACP:ANN:TITL:DATA "This Is My Title" This example is for Measurements other than Swept SA. Both set the title to: This Is My Title
Notes	Pressing this key cancels any active function. When a title is edited the previous title remains intact (it is not cleared) and the cursor goes at the end so that characters can be added or BKSP can be used to go back over previous characters.
Preset	No title (measurement name instead)
State Saved	Saved in instrument state.
Initial S/W Revision	Prior to A.02.00

Clear Title

Clears a title from the front-panel display. Once cleared, the title cannot be retrieved. After the title is cleared, the current Measurement Name replaces it in the title bar.

Key Path	View/Display, Display, Title
Example	The following commands clear the title and restore the measurement's original title: DISP:ANN:TITL:DATA "" This example is for the Swept SA measurement in the Spectrum Analyzer mode. The SANalyzer <measurement> name is not used. DISP:ACP:ANN:TITL:DATA "" This example is for ACP; in measurements other than Swept SA the measurement name is required.
Notes	Uses the :DISPlay:<measurement>:ANNotation:TITLe:DATA <string> command with an empty string (in the Swept SA, the <measurement> is omitted).
Preset	Performed on Preset.
Initial S/W Revision	Prior to A.02.00

Graticule

Pressing Graticule turns the display graticule On or Off. It also turns the graticule y-axis annotation on and off.

Key Path	View/Display, Display
Remote Command	:DISPlay:WINDow[1]:TRACe:GRATicule:GRID[:STATe] OFF ON 0 1 :DISPlay:WINDow[1]:TRACe:GRATicule:GRID[:STATe]?
Example	DISP:WIND:TRAC:GRAT:GRID OFF
Notes	The graticule is the set of horizontal and vertical lines that make up the grid/divisions for the x-axis and y-axis.
Preset	On
State Saved	Saved in instrument state
Initial S/W Revision	Prior to A.02.00

System Display Settings

These settings are "Mode Global" – they affect all modes and measurements and are reset only by Restore Misc Defaults or Restore System Defaults under System.

Key Path	View/Display, Display
Initial S/W Revision	Prior to A.02.00

Annotation Local Settings

This is a Mode Global override of the meas local annotation settings. When it is All Off, it forces ScreenAnnotation, Meas Bar, Trace, and Active Function Values settings to be OFF for all measurements in all modes. This provides the security based "annotation off" function of previous analyzers; hence it uses the legacy SCPI command.

When it is All Off, the Screen, Meas Bar, Trace, and Active Function Values keys under the Display, Annotation menu are grayed out and forced to Off. When Local Settings is selected, you are able to set the local annotation settings on a measurement by measurement basis.

Key Path	View/Display, Display, System Display Settings
Remote Command	:DISPlay:WINDow[1]:ANNotation[:ALL] OFF ON 0 1 :DISPlay:WINDow[1]:ANNotation[:ALL]?
Example	:DISP:WIND:ANN OFF
Preset	On (Set by Restore Misc Defaults)
State Saved	Not saved in instrument state.
Backwards Compatibility Notes	The WINDow parameter and optional subopcode is included for backwards compatibility but ignored – all windows are equally affected.
Initial S/W Revision	Prior to A.02.00

Themes

Accesses a menu of functions that enable you to choose the theme to be used when saving the screen image.

The **Themes** option is the same as the **Themes** option under the **Display** and **Page Setup** dialogs. It allows you to choose between themes to be used when saving the screen image.

Key Path	Save, Screen Image
Remote Command	:MMEMory:STORe:SCReen:THEMe TDColor TDMonochrome FCOLor FMONochrome :MMEMory:STORe:SCReen:THEMe?
Example	:MMEM:STOR:SCR:THEM TDM
Preset	3D Color; Is not part of Preset, but is reset by Restore Misc Defaults or Restore System Defaults All and survives subsequent running of the modes.
Readback	3D Color 3D Mono Flat Color Flat Mono
Backwards Compatibility Notes	In ESA and PSA we offer the choice of "Reverse Bitmap" or "Reverse Metafile" when saving screen images. This is much like the "Flat Color" theme available in X-Series. Also, if you selected Reverse Bitmap AND a black & white screen image, that would be much like "Flat Monochrome". In other words, each of the X-Series themes has a similar screen image type in ESA/PSA. But they are not identical.
Initial S/W Revision	Prior to A.02.00

3D Color

Selects a standard color theme with each object filled, shaded and colored as designed.

Key Path	Save, Screen Image, Themes
Example	MMEM:STOR:SCR:THEM TDC
Readback	3D Color
Initial S/W Revision	Prior to A.02.00

3D Monochrome

Selects a format that is like 3D color but shades of gray are used instead of colors.

Key Path	Save, Screen Image, Themes
Example	MMEM:STOR:SCR:THEM TDM
Readback	3D Mono
Initial S/W Revision	Prior to A.02.00

Flat Color

Selects a format that is best when the screen is to be printed on an ink printer.

Key Path	Save, Screen Image, Themes
Example	MMEM:STOR:SCR:THEM FCOL
Readback	Flat Color
Initial S/W Revision	Prior to A.02.00

Flat Monochrome

Selects a format that is like Flat Color. But only black is used (no colors, not even gray), and no fill.

Key Path	Save, Screen Image, Themes
Example	MMEM:STOR:SCR:THEM FMON
Readback	Flat Mono
Initial S/W Revision	Prior to A.02.00

Backlight

Accesses the display backlight on/off keys. This setting may interact with settings under the Windows "Power" menu.

When the backlight is off, pressing ESC, TAB, SPACE, ENTER, UP, DOWN, LEFT, RIGHT, DEL, BKSP, CTRL, or ALT turns the backlight on without affecting the application. Pressing any other key will turn backlight on and could potentially perform the action as well.

Key Path	View/Display, Display, System Display Settings
Remote Command	:DISPlay:BACKlight ON OFF :DISPlay:BACKlight?
Preset	ON (Set by Restore Misc Defaults)
Initial S/W Revision	Prior to A.02.00

Backlight Intensity

An active function used to set the backlight intensity. It goes from 0 to 100 where 100 is full on and 0 is off. This value is independent of the values set under the Backlight on/off key.

Key Path	View/Display, Display, System Display Settings
Remote Command	:DISPlay:BACKlight:INTensity <integer> :DISPlay:BACKlight:INTensity?
Example	DISP:BACK:INT 50

Preset	100 (Set by Restore Misc Defaults)
Min	0
Max	100
Initial S/W Revision	Prior to A.02.00

View Selection

Selects the desired view. The following views are available:

- **"Graph + Metrics" on page 1381** – The lower window displays a list of spurs detected in a measurement cycle. The upper window displays a trace of the range that contains the currently selected spur.
- **"Range Table" on page 1382** – The lower window displays settings of ranges. The upper window displays a trace of the currently selected range.
- **"All Ranges" on page 1385** – The lower window displays a list of spurs detected in a measurement cycle. The upper window displays a merged trace of all the ranges.

Key Path	View/Display
Mode	SA, WCDMA, C2K, 1xEV-DO, WIMAX OFDMA, TD-SCDMA, DVB-T/H, LTE, LTETDD, MSR, LTEAFDD, LTEATDD
Remote Command	:DISPlay:SPURious:VIEW[:SElect] RESult RANGe ALL :DISPlay:SPURious:VIEW[:SElect]?
Example	DISP:SPUR:VIEW RANG DISP:SPUR:VIEW?
Notes	You must be in cdma2000 mode, TD-SCDMA mode, W-CDMA mode, DVB-T/H mode, GSM/EDGE mode, LTE mode, LTE TDD mode, LTE-Advanced FDD/TDD mode, MSR or WiMAX mode to use this command. Use INSTRument:SElect to set the mode.
Preset	RESult
State Saved	No
Range	Graph + Metrics Range Table All Ranges
Initial S/W Revision	A.10.00
Modified at S/W Revision	A.11.00

Graph + Metrics

Select Graph + Metrics to view measurement results.

- The lower window displays a list of spurs detected in a measurement cycle. The currently selected spur, which is highlighted, can be changed by the Spur softkey in the Meas Setup menu.
- The upper window displays a trace of the range that contains the currently selected spur.

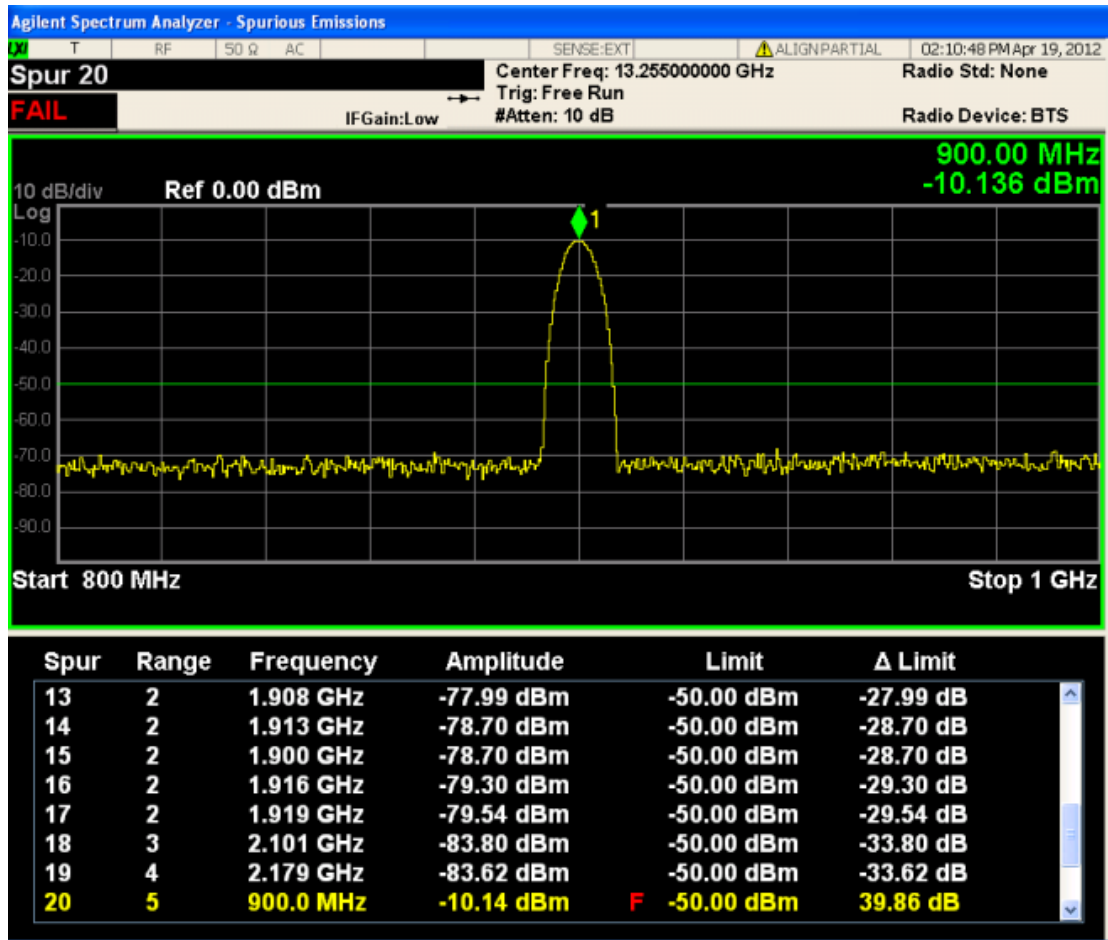

Result	Units	Min	Max
Spur	N/A	0	200
Range	N/A	1	20
Frequency	Hz	Analyzer Min	Analyzer Max
Amplitude	dBm	-150	50
Limit	dBm	-150	50

The spurs listed are within the current value of the Marker Peak Excursion setting of the absolute limit. All of the spurs listed passed. Any spur that has failed the absolute limit will have an 'F' beside it.

Range Table

Select Range Table to view range settings.

- The upper window displays a trace of the range specified by the Range key under Range Table in Meas Setup.
- The lower window displays the range setting.

All enabled range may not be displayed with the normal window arrangement. Even in that case, the instrument always displays the highlighted line in the table. When you zoom the lower window, all 20 ranges can be displayed.

When the range state is OFF, “---” appears, to indicate the range is inactive.

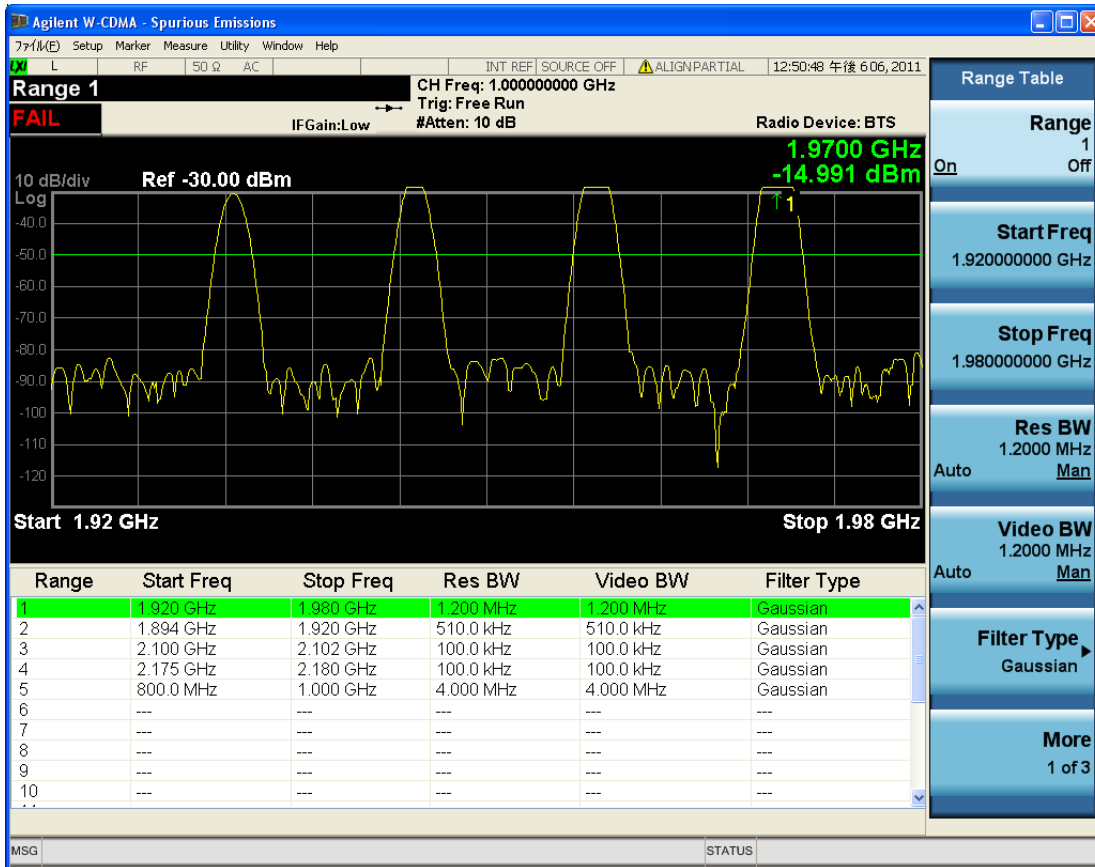

12 Spurious Emissions Measurement
View/Display

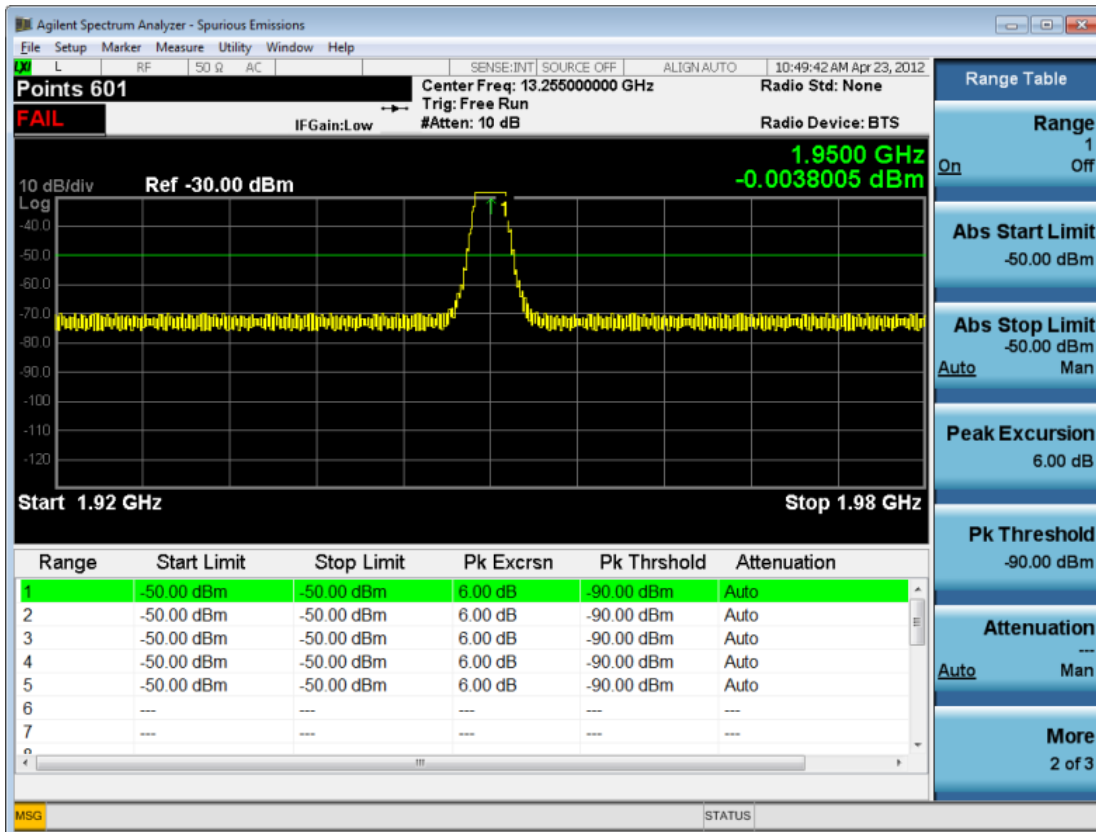

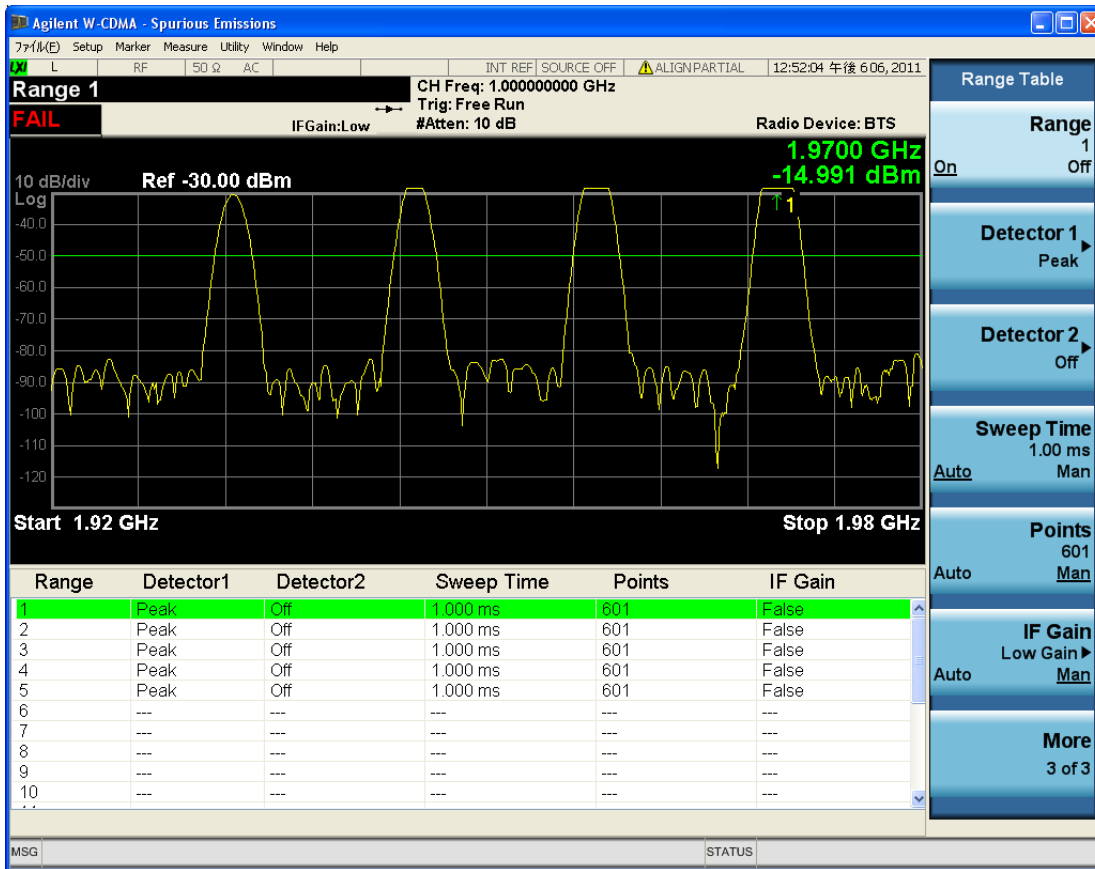

All Ranges

Select All Ranges to view measurement results for all the ranges.

- The upper window displays a merged trace of all the ranges.
- The lower window displays a list of spurs detected in a measurement cycle. The currently selected spur, which is highlighted, can be changed by the Spur softkey in the Meas Setup menu.

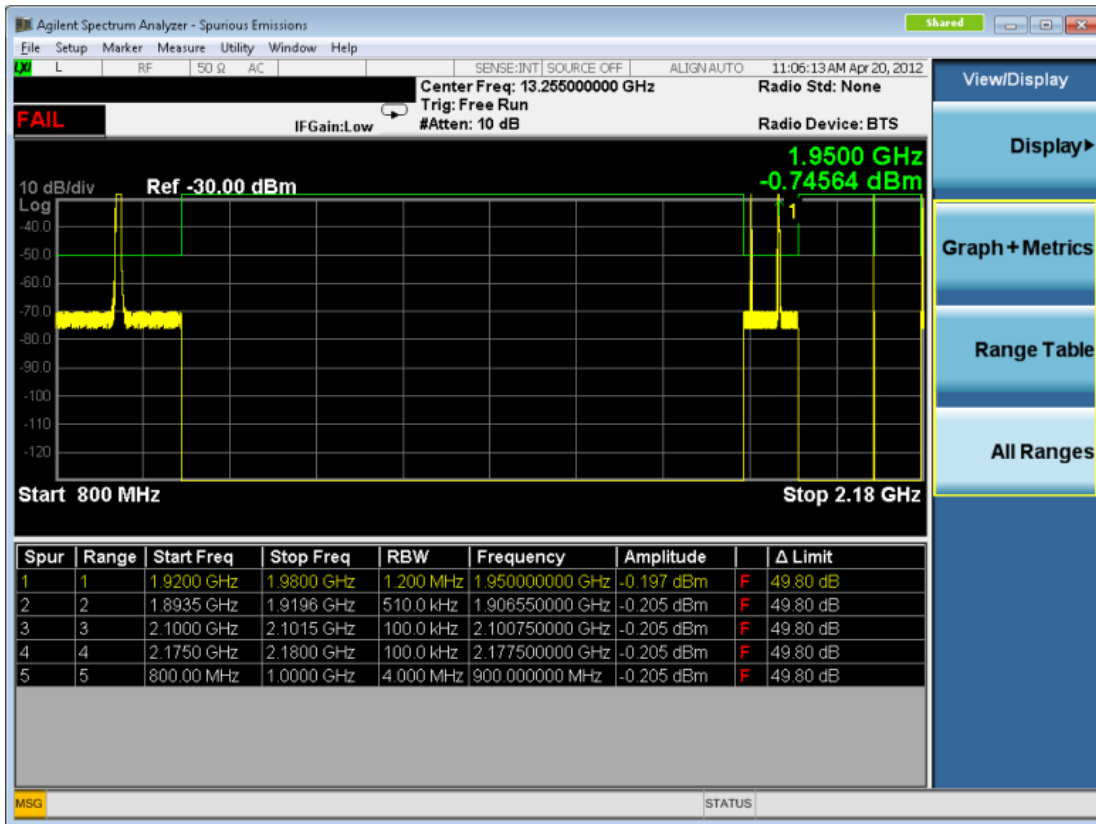

Range Table Selection (SCPI only command)

Switches contents of Range Table. There are three tables in the Range Table window, corresponding to each page of the Range Table menu. If the Range Table menu is displayed, this command changes the page of the Range Table menu too. Pressing the Range Table softkey always changes the current Range Table to 1.

Key Path	SCPI only
Mode	SA, WCDMA, C2K, 1xEV-DO, WIMAX OFDMA, TD-SCDMA, DVB-T/H, LTE, LTE TDD, WLAN, MSR, LTE FDD, LTE TDD
Remote Command	:DISPlay:SPURious:VIEW:RANGe:TABLE <integer> :DISPlay:SPURious:VIEW:RANGe:TABLE?
Example	DISP:SPUR:VIEW:RANG:TABL 2 DISP:SPUR:VIEW:RANG:TABL?
Notes	You must be in cdma2000 mode, TD-SCDMA mode, W-CDMA mode, DVB-T/H mode, GSM/EDGE mode, LTE mode, LTE TDD mode, WLAN mode, LTE-Advanced FDD/TDD mode, MSR or WiMAX mode to use this command. Use INSTRument:SElect to set the mode.
Preset	1
State Saved	No
Min	1
Max	3
Initial S/W Revision	A.10.00

13 Spectrum Emission Mask Measurement

The spectrum emission mask measures spurious signal levels in up to six pairs of offset frequencies and relates them to the carrier power. For measurement results and views, see ["View/Display" on page 1603](#).

This topic contains the following sections:

["Measurement Commands for Spectrum Emission Mask" on page 1390](#)

["Remote Command Results for Spectrum Emission Mask Measurement" on page 1391](#)

["Number of Offsets" on page 1411](#)

Measurement Commands for Spectrum Emission Mask

Offsets that are turned off (inactive) return -999.0 when their results are queried via SCPI.

```
:CONFigure:SEMask  
:CONFigure:SEMask:NDEFault  
:INITiate:SEMask  
:FETCh:SEMask[n]?  
:MEASure:SEMask[n]?  
:READ:SEMask[n]?
```

For more measurement related commands, see the SENSE subsystem, and the section "[Remote Measurement Functions](#)" on page 2770.

Remote Command Results for Spectrum Emission Mask Measurement

The following table describes the results returned by the FETCh, MEASure, and READ queries listed above, according to the index value n:

Modes	n	Return Value
All except MSR, WLAN, LTEAFDD, LTEATDD	1	<p>Meas Type: Total Power Reference</p> <p>Returns 82 comma-separated scalar results, in the following order:</p> <ol style="list-style-type: none"> 1. Reserved for the future use, returns -999.0 2. Absolute power at the center frequency (reference) area (dBm) 3. Reserved for the future use, returns -999.0 4. Reserved for the future use, returns -999.0 5. Peak frequency in the center frequency (reference) area (Hz) 6. Reserved for the future use, returns -999.0 7. Reserved for the future use, returns -999.0 8. Reserved for the future use, returns -999.0 9. Reserved for the future use, returns -999.0 10. Reserved for the future use, returns -999.0 11. Relative integrated power on the negative offset A (dBc) 12. Absolute integrated power on the negative offset A (dBm) 13. Relative peak power on the negative offset A (dBc) 14. Absolute peak power on the negative offset A (dBm) 15. Peak power offset frequency from the center or carrier edge frequency in the negative offset A, depending on Offset Frequency Define settings (Hz) 16. Relative integrated power on the positive offset A (dBc) 17. Absolute integrated power on the positive offset A (dBm) 18. Relative peak power on the positive offset A (dBc) 19. Absolute peak power on the positive offset A (dBm) 20. Peak power offset frequency from the center or carrier edge frequency in the positive offset A, depending on Offset Frequency Define settings (Hz) 21. Relative integrated power on the negative offset B (dBc) --- 69. Absolute peak power on the positive offset F (dBm) 70. Peak power offset frequency from the center or carrier edge frequency in the positive offset F, depending on Offset Frequency Define settings (Hz) 71. Minimum margin from limit line on the negative offset A (dB) 72. Minimum margin from limit line on the positive offset A (dB) 73. Minimum margin from limit line on the negative offset B (dB) 74. Minimum margin from limit line on the positive offset B (dB) 75. Minimum margin from limit line on the negative offset C (dB) 76. Minimum margin from limit line on the positive offset C (dB)

Modes	n	Return Value
		77. Minimum margin from limit line on the negative offset D (dB) 78. Minimum margin from limit line on the positive offset D (dB) 79. Minimum margin from limit line on the negative offset E (dB) 80. Minimum margin from limit line on the positive offset E (dB) 81. Minimum margin from limit line on the negative offset F (dB) 82. Minimum margin from limit line on the positive offset F (dB)
All except MSR, WLAN, LTEAFDD, LTEATDD	1	Meas Type: Power Spectral Density Reference Returns 82 comma-separated scalar results, in the following order: 1. Reserved for the future use, returns -999.0 2. Absolute power at the center frequency (reference) area (dBm/Hz) 3. Reserved for the future use, returns -999.0 4. Reserved for the future use, returns -999.0 5. Peak frequency in the center frequency (reference) area (Hz) 6. Reserved for the future use, returns -999.0 7. Reserved for the future use, returns -999.0 8. Reserved for the future use, returns -999.0 9. Reserved for the future use, returns -999.0 10. Reserved for the future use, returns -999.0 11. Relative integrated power on the negative offset A (dB) 12. Absolute integrated power on the negative offset A (dBm/Hz) 13. Relative peak power on the negative offset A (dB) 14. Absolute peak power on the negative offset A (dBm/Hz) 15. Peak power offset frequency from the center or carrier edge frequency in the negative offset A, depending on Offset Frequency Define settings (Hz) 16. Relative integrated power on the positive offset A (dB) 17. Absolute integrated power on the positive offset A (dBm/Hz) 18. Relative peak power on the positive offset A (dB) 19. Absolute peak power on the positive offset A (dBm/Hz) 20. Peak power offset frequency from the center or carrier edge frequency in the positive offset A, depending on Offset Frequency Define settings (Hz) 21. Relative integrated power on the negative offset B (dB) --- 69. Absolute peak power on the positive offset F (dBm/Hz) 70. Peak power offset frequency from the center or carrier edge frequency in the positive offset F, depending on Offset Frequency Define settings (Hz) 71. Minimum margin from limit line on the negative offset A (dB) 72. Minimum margin from limit line on the positive offset A (dB) 73. Minimum margin from limit line on the negative offset B (dB) 74. Minimum margin from limit line on the positive offset B (dB)

Modes	n	Return Value
		75. Minimum margin from limit line on the negative offset C (dB) 76. Minimum margin from limit line on the positive offset C (dB) 77. Minimum margin from limit line on the negative offset D (dB) 78. Minimum margin from limit line on the positive offset D (dB) 79. Minimum margin from limit line on the negative offset E (dB) 80. Minimum margin from limit line on the positive offset E (dB) 81. Minimum margin from limit line on the negative offset F (dB) 82. Minimum margin from limit line on the positive offset F (dB)
All except MSR, WLAN, LTEAFDD, LTEATDD	1	Meas Type: Spectrum Peak Reference Returns 82 comma-separated scalar results, in the following order: <ol style="list-style-type: none"> 1. Reserved for the future use, returns -999.0 2. Peak power at the center frequency (reference) area (dBm) 3. Reserved for the future use, returns -999.0 4. Reserved for the future use, returns -999.0 5. Peak frequency in the center frequency (reference) area (Hz) 6. Reserved for the future use, returns -999.0 7. Reserved for the future use, returns -999.0 8. Reserved for the future use, returns -999.0 9. Reserved for the future use, returns -999.0 10. Reserved for the future use, returns -999.0 11. Reserved for the future use, returns -999.0 12. Reserved for the future use, returns -999.0 13. Relative peak power on the negative offset A (dB) 14. Absolute peak power on the negative offset A (dBm) 15. Peak power offset frequency from the center or carrier edge frequency in the negative offset A, depending on Offset Frequency Define settings (Hz) 16. Reserved for the future use, returns -999.0 17. Reserved for the future use, returns -999.0 18. Relative peak power on the positive offset A (dB) 19. Absolute peak power on the positive offset A (dBm) 20. Peak power offset frequency from the center or carrier edge frequency in the positive offset A, depending on Offset Frequency Define settings (Hz) 21. Reserved for the future use, returns -999.0 --- 69. Absolute peak power on the positive offset F (dBm) 70. Peak power offset frequency from the center or carrier edge frequency in the positive offset F, depending on Offset Frequency Define settings (Hz) 71. Minimum margin from limit line on the negative offset A (dB) 72. Minimum margin from limit line on the positive offset A (dB)

Modes	n	Return Value
		73. Minimum margin from limit line on the negative offset B (dB) 74. Minimum margin from limit line on the positive offset B (dB) 75. Minimum margin from limit line on the negative offset C (dB) 76. Minimum margin from limit line on the positive offset C (dB) 77. Minimum margin from limit line on the negative offset D (dB) 78. Minimum margin from limit line on the positive offset D (dB) 79. Minimum margin from limit line on the negative offset E (dB) 80. Minimum margin from limit line on the positive offset E (dB) 81. Minimum margin from limit line on the negative offset F (dB) 82. Minimum margin from limit line on the positive offset F (dB)
MSR, LTEAFDD, LTEATDD	1	<p data-bbox="467 730 818 758">Meas Type: Total Power Reference</p> <p data-bbox="467 758 1419 821">Returns outer offset results when Non-Contiguous Meas Region is set to Outer, and returns inner offset results when it is set to Inner, in the following order.</p> <ol data-bbox="467 831 1419 1843" style="list-style-type: none"> <li data-bbox="467 831 1360 894">1. Total Absolute power of carriers of Measure Carrier On if available. Otherwise -999.0 is returned. <li data-bbox="467 905 1419 999">2. Absolute reference power. Absolute power at the left reference carrier if Power Ref type is "Left & Right Carriers." Absolute power at the reference carrier of the left sub-block if Power Ref type is "Max Power Carrier in Sub-block." (dBm) <li data-bbox="467 1010 1419 1104">3. Absolute power at the right reference carrier if Power Ref type is "Left & Right Carriers." Absolute power at the reference carrier of the right sub-block if Power Ref type is "Max Power Carrier in Sub-block." Otherwise -999.0 is returned. (dBm) <li data-bbox="467 1115 919 1142">4. Reserved for the future use, returns -999.0 <li data-bbox="467 1152 1419 1268">5. Peak frequency in the ref carrier channel spacing frequency range. Peak frequency in the left ref carrier frequency range if Power Ref Type is "Left & Right Carriers." Peak frequency in the ref carrier frequency range of the left sub-block if Power Ref type is "Max Power Carrier in Sub-block." <li data-bbox="467 1278 1419 1373">6. Peak frequency in the right ref carrier channel spacing frequency range if Power Ref type is "Left & Right Carriers." Peak frequency in the ref carrier frequency range of the right sub-block if Power Ref type is "Max Power Carrier in Sub-block." Otherwise -999.0 is returned. <li data-bbox="467 1383 919 1411">7. Reserved for the future use, returns -999.0 <li data-bbox="467 1421 919 1449">8. Reserved for the future use, returns -999.0 <li data-bbox="467 1459 919 1486">9. Reserved for the future use, returns -999.0 <li data-bbox="467 1497 932 1524">10. Reserved for the future use, returns -999.0 <li data-bbox="467 1535 1057 1562">11. Relative integrated power on the negative offset A (dBc) <li data-bbox="467 1572 1070 1600">12. Absolute integrated power on the negative offset A (dBm) <li data-bbox="467 1610 1003 1638">13. Relative peak power on the negative offset A (dBc) <li data-bbox="467 1648 1016 1675">14. Absolute peak power on the negative offset A (dBm) <li data-bbox="467 1686 1419 1749">15. Peak power offset frequency from the center or carrier edge frequency in the negative offset A, depending on Offset Frequency Define settings (Hz) <li data-bbox="467 1759 1049 1787">16. Relative integrated power on the positive offset A (dBc) <li data-bbox="467 1797 1062 1824">17. Absolute integrated power on the positive offset A (dBm)

Modes	n	Return Value
		18. Relative peak power on the positive offset A (dBc)
		19. Absolute peak power on the positive offset A (dBm)
		20. Peak power offset frequency from the center or carrier edge frequency in the positive offset A, depending on Offset Frequency Define settings (Hz)
		21. Relative integrated power on the negative offset B (dBc)

		69. Absolute peak power on the positive offset F (dBm)
		70. Peak power offset frequency from the center or carrier edge frequency in the positive offset F, depending on Offset Frequency Define settings (Hz)
		71. Minimum margin from limit line on the negative offset A (dB)
		72. Minimum margin from limit line on the positive offset A (dB)
		73. Minimum margin from limit line on the negative offset B (dB)
		74. Minimum margin from limit line on the positive offset B (dB)
		75. Minimum margin from limit line on the negative offset C (dB)
		76. Minimum margin from limit line on the positive offset C (dB)
		77. Minimum margin from limit line on the negative offset D (dB)
		78. Minimum margin from limit line on the positive offset D (dB)
		79. Minimum margin from limit line on the negative offset E (dB)
		80. Minimum margin from limit line on the positive offset E (dB)
		81. Minimum margin from limit line on the negative offset F (dB)
		82. Minimum margin from limit line on the positive offset F (dB)
MSR , LTEAFDD, LTEATDD	1	<p>Meas Type: Power Spectral Density Reference Returns outer offset results when Non-Contiguous Meas Region is set to Outer, and returns inner offset results when it is set to Inner, in the following order.</p> <ol style="list-style-type: none"> 1. Total Absolute power of carriers of Measure Carrier On if available. Otherwise -999.0 is returned. (dBm) 2. Absolute reference power. Absolute power at the left reference carrier if Power Ref type is "Left & Right Carriers." Absolute power at the reference carrier of the left sub-block if Power Ref type is "Max Power Carrier in Sub-block." (dBm/Hz) 3. Absolute power at the right reference carrier if Power Ref type is "Left & Right Carriers." Absolute power at the reference carrier of the right sub-block if Power Ref type is "Max Power Carrier in Sub-block." Otherwise -999.0 is returned. (dBm/Hz) 4. Reserved for the future use, returns -999.0 5. Peak frequency in the ref carrier channel spacing frequency range . Peak frequency in the left ref carrier frequency range if Power Ref type is "Left & Right Carriers." Peak frequency in the ref carrier frequency range of the left sub-block if Power Ref type is "Max Power Carrier in Sub-block." 6. Peak frequency in the right ref carrier channel spacing frequency range if Power Ref type is "Left & Right Carriers." Peak frequency in the ref carrier frequency range of the right sub-block if Power Ref type is "Max Power Carrier in Sub-block." Otherwise -999.0 is returned. 7. Reserved for the future use, returns -999.0

Modes	n	Return Value
		8. Reserved for the future use, returns -999.0
		9. Reserved for the future use, returns -999.0
		10. Reserved for the future use, returns -999.0
		11. Relative integrated power on the negative offset A (dBc)
		12. Absolute integrated power on the negative offset A (dBm/Hz)
		13. Relative peak power on the negative offset A (dBc)
		14. Absolute peak power on the negative offset A (dBm/Hz)
		15. Peak power offset frequency from the center or carrier edge frequency in the negative offset A, depending on Offset Frequency Define settings (Hz)
		16. Relative integrated power on the positive offset A (dBc)
		17. Absolute integrated power on the positive offset A (dBm/Hz)
		18. Relative peak power on the positive offset A (dBc)
		19. Absolute peak power on the positive offset A (dBm/Hz)
		20. Peak power offset frequency from the center or carrier edge frequency in the positive offset A, depending on Offset Frequency Define settings (Hz)
		21. Relative integrated power on the negative offset B (dBc)

		69. Absolute peak power on the positive offset F (dBm/Hz)
		70. Peak power offset frequency from the center or carrier edge frequency in the positive offset F, depending on Offset Frequency Define settings (Hz)
		71. Minimum margin from limit line on the negative offset A (dB)
		72. Minimum margin from limit line on the positive offset A (dB)
		73. Minimum margin from limit line on the negative offset B (dB)
		74. Minimum margin from limit line on the positive offset B (dB)
		75. Minimum margin from limit line on the negative offset C (dB)
		76. Minimum margin from limit line on the positive offset C (dB)
		77. Minimum margin from limit line on the negative offset D (dB)
		78. Minimum margin from limit line on the positive offset D (dB)
		79. Minimum margin from limit line on the negative offset E (dB)
		80. Minimum margin from limit line on the positive offset E (dB)
		81. Minimum margin from limit line on the negative offset F (dB)
		82. Minimum margin from limit line on the positive offset F (dB)
MSR, LTEAFDD, LTEATDD	1	<p>Meas Type: Spectrum Peak Reference</p> <p>Returns outer offset results when Non-Contiguous Meas Region is set to Outer, and returns inner offset results when it is set to Inner, in the following order.</p> <ol style="list-style-type: none"> 1. Total Absolute power of carriers of Measure Carrier On if available. Otherwise -999.0 is returned. (dBm) 2. Peak reference power. Peak power at the left reference carrier if Power Ref type is "Left & Right Carriers." Peak power at the reference carrier of the left sub-block if Power Ref type is "Max Power Carrier in Sub-block." (dBm)

Modes	n	Return Value
		3. Peak power at the right reference carrier if Power Ref type is "Left & Right Carriers." Peak power at the reference carrier of the right sub-block if Power Ref type is "Max Power Carrier in Sub-block." Otherwise -999.0 is returned. (dBm)
		4. Reserved for the future use, returns -999.0
		5. Peak frequency in the ref carrier channel spacing frequency range. Peak frequency in the left ref carrier frequency range if Power Ref type is "Left & Right Carriers." Peak frequency in the ref carrier frequency range of the left sub-block if Power Ref type is "Max Power Carrier in Sub-block."
		6. Peak frequency in the right ref carrier channel spacing frequency range if Power Ref type is "Left & Right Carriers." Peak frequency in the ref carrier frequency range of the right sub-block if Power Ref type is "Max Power Carrier in Sub-block." Otherwise -999.0 is returned.
		7. Reserved for the future use, returns -999.0
		8. Reserved for the future use, returns -999.0
		9. Reserved for the future use, returns -999.0
		10. Reserved for the future use, returns -999.0
		11. Relative integrated power on the negative offset A (dBc)
		12. Absolute integrated power on the negative offset A (dBm)
		13. Relative peak power on the negative offset A (dBc)
		14. Absolute peak power on the negative offset A (dBm)
		15. Peak power offset frequency from the center or carrier edge frequency in the negative offset A, depending on Offset Frequency Define settings (Hz)
		16. Relative integrated power on the positive offset A (dBc)
		17. Absolute integrated power on the positive offset A (dBm)
		18. Relative peak power on the positive offset A (dBc)
		19. Absolute peak power on the positive offset A (dBm)
		20. Peak power offset frequency from the center or carrier edge frequency in the positive offset A, depending on Offset Frequency Define settings (Hz)
		21. Relative integrated power on the negative offset B (dBc)

		69. Absolute peak power on the positive offset F (dBm)
		70. Peak power offset frequency from the center or carrier edge frequency in the positive offset F, depending on Offset Frequency Define settings (Hz)
		71. Minimum margin from limit line on the negative offset A (dB)
		72. Minimum margin from limit line on the positive offset A (dB)
		73. Minimum margin from limit line on the negative offset B (dB)
		74. Minimum margin from limit line on the positive offset B (dB)
		75. Minimum margin from limit line on the negative offset C (dB)
		76. Minimum margin from limit line on the positive offset C (dB)
		77. Minimum margin from limit line on the negative offset D (dB)
		78. Minimum margin from limit line on the positive offset D (dB)
		79. Minimum margin from limit line on the negative offset E (dB)
		80. Minimum margin from limit line on the positive offset E (dB)

Modes	n	Return Value
		81. Minimum margin from limit line on the negative offset F (dB)
		82. Minimum margin from limit line on the positive offset F (dB)
WLAN, with radio standard 802.11 ac (80 MHz + 80 MHz)	1	<p>Meas Type: Total Power Reference Returns 82 comma-separated scalar results, in the following order:</p> <ol style="list-style-type: none"> 1. Reserved for the future use, returns -999.0 2. Absolute reference power (dBm) 3. Absolute power of the carrier of which the frequency is indicated by Freq Segment 1 (dBm) 4. Absolute power of the carrier of which the frequency is indicated by Freq Segment 2 (dBm) 5. Peak frequency in the center frequency (reference) area (Hz) 6. Reserved for the future use, returns -999.0 7. Reserved for the future use, returns -999.0 8. Reserved for the future use, returns -999.0 9. Reserved for the future use, returns -999.0 10. Reserved for the future use, returns -999.0 11. Relative integrated power on the negative offset A (dBc) 12. Absolute integrated power on the negative offset A (dBm) 13. Relative peak power on the negative offset A (dBc) 14. Absolute peak power on the negative offset A (dBm) 15. Peak power offset frequency from the center or carrier edge frequency in the negative offset A, depending on Offset Frequency Define settings (Hz) 16. Relative integrated power on the positive offset A (dBc) 17. Absolute integrated power on the positive offset A (dBm) 18. Relative peak power on the positive offset A (dBc) 19. Absolute peak power on the positive offset A (dBm) 20. Peak power offset frequency from the center or carrier edge frequency in the positive offset A, depending on Offset Frequency Define settings (Hz) 21. Relative integrated power on the negative offset B (dBc) <p>---</p> <ol style="list-style-type: none"> 69. Absolute peak power on the positive offset F (dBm) 70. Peak power offset frequency from the center or carrier edge frequency in the positive offset F, depending on Offset Frequency Define settings (Hz) 71. Minimum margin from limit line on the negative offset A (dB) 72. Minimum margin from limit line on the positive offset A (dB) 73. Minimum margin from limit line on the negative offset B (dB) 74. Minimum margin from limit line on the positive offset B (dB) 75. Minimum margin from limit line on the negative offset C (dB) 76. Minimum margin from limit line on the positive offset C (dB) 77. Minimum margin from limit line on the negative offset D (dB) 78. Minimum margin from limit line on the positive offset D (dB)

Modes	n	Return Value
		79. Minimum margin from limit line on the negative offset E (dB)
		80. Minimum margin from limit line on the positive offset E (dB)
		81. Minimum margin from limit line on the negative offset F (dB)
		82. Minimum margin from limit line on the positive offset F (dB)
WLAN, with radio standard 802.11 ac (80 MHz + 80 MHz)	1	<p>Meas Type: Power Spectral Density Reference Returns 82 comma-separated scalar results, in the following order:</p> <ol style="list-style-type: none"> 1. Reserved for the future use, returns -999.0 2. Absolute reference power (dBm/Hz) 3. Absolute power of the carrier of which the frequency is indicated by Freq Segment 1 (dBm/Hz) 4. Absolute power of the carrier of which the frequency is indicated by Freq Segment 2 (dBm/Hz) 5. Peak frequency in the center frequency (reference) area (Hz) 6. Reserved for the future use, returns -999.0 7. Reserved for the future use, returns -999.0 8. Reserved for the future use, returns -999.0 9. Reserved for the future use, returns -999.0 10. Reserved for the future use, returns -999.0 11. Relative integrated power on the negative offset A (dB) 12. Absolute integrated power on the negative offset A (dBm/Hz) 13. Relative peak power on the negative offset A (dB) 14. Absolute peak power on the negative offset A (dBm/Hz) 15. Peak power offset frequency from the center or carrier edge frequency in the negative offset A, depending on Offset Frequency Define settings (Hz) 16. Relative integrated power on the positive offset A (dB) 17. Absolute integrated power on the positive offset A (dBm/Hz) 18. Relative peak power on the positive offset A (dB) 19. Absolute peak power on the positive offset A (dBm/Hz) 20. Peak power offset frequency from the center or carrier edge frequency in the positive offset A, depending on Offset Frequency Define settings (Hz) 21. Relative integrated power on the negative offset B (dB) --- 69. Absolute peak power on the positive offset F (dBm/Hz) 70. Peak power offset frequency from the center or carrier edge frequency in the positive offset F, depending on Offset Frequency Define settings (Hz) 71. Minimum margin from limit line on the negative offset A (dB) 72. Minimum margin from limit line on the positive offset A (dB) 73. Minimum margin from limit line on the negative offset B (dB) 74. Minimum margin from limit line on the positive offset B (dB) 75. Minimum margin from limit line on the negative offset C (dB) 76. Minimum margin from limit line on the positive offset C (dB)

Modes	n	Return Value
		77. Minimum margin from limit line on the negative offset D (dB) 78. Minimum margin from limit line on the positive offset D (dB) 79. Minimum margin from limit line on the negative offset E (dB) 80. Minimum margin from limit line on the positive offset E (dB) 81. Minimum margin from limit line on the negative offset F (dB) 82. Minimum margin from limit line on the positive offset F (dB)
All	2	Returns the displayed frequency domain spectrum trace data separated by comma. The number of data points is 2001.
All	3	Returns the displayed frequency domain absolute limit trace data separated by comma. The number of data points is 2001.
All	4	Returns the displayed frequency domain relative limit trace data separated by comma. The number of data points is 2001.
All (see details)	5	<p>Meas Type: Total Power Reference Returns comma-separated scalar values (in dBm) of the absolute integrated power of the segment frequencies. The length of the result depends on the number of available offset (See "Number of Offsets" on page 1411).</p> <ol style="list-style-type: none"> 1. Total power reference (dBm) 2. Reserved for the future use, returns -999.0 3. Absolute integrated power at negative offset frequency (A) 4. Absolute integrated power at positive offset frequency (A) <p>---</p> <ol style="list-style-type: none"> 25. Absolute integrated power at negative offset frequency (L) 26. Absolute integrated power at positive offset frequency (L) <p>In MSR and LTE-Advanced FDD/TDD mode. Returns outer offset results when Non-Contiguous Meas Region is set to Outer, and returns inner offset results when it is set to Inner, in the following order.</p> <ol style="list-style-type: none"> 1. Ref carrier power. Left ref carrier power if Power Ref type is "Left & Right Carriers." Ref carrier power of the left sub-block if Power Ref type is "Max Power Carrier in Sub-block." (dBm) 2. Right ref carrier power if Ref channel type is "Left & Right Carriers." Ref carrier power of the right sub-block if Power Ref type is "Max Power Carrier in Sub-block." Otherwise -999.0 is returned. (dBm) 3. Absolute integrated power at negative offset frequency (A) 4. Absolute integrated power at positive offset frequency (A) <p>---</p> <ol style="list-style-type: none"> 25. Absolute integrated power at negative offset frequency (L) 26. Absolute integrated power at positive offset frequency (L) <p>In WLAN mode. Returns 26 comma-separated scalar values (in dBm) of the absolute integrated power of the segment frequencies:</p> <ol style="list-style-type: none"> 1. Ref carrier power (dBm) 2. Reserved for the future use, returns -999.0

Modes	n	Return Value
		3. Absolute integrated power at negative offset frequency (A) 4. Absolute integrated power at positive offset frequency (A) --- 25. Absolute integrated power at negative offset frequency (L) 26. Absolute integrated power at positive offset frequency (L) If the result is not available, -999.0 is returned. The number of values returned is subject to change in future releases.
All (see details)	5	<p>Meas Type: Power Spectral Density Reference Returns comma-separated scalar values (in dBm/Hz) of the absolute integrated power of the segment frequencies. The length of the result depends on the number of available offset (See "Number of Offsets" on page 1411).</p> 1. Power spectral density reference (dBm/Hz) 2. Reserved for the future use, returns -999.0 3. Absolute integrated power at negative offset frequency (A) 4. Absolute integrated power at positive offset frequency (A) --- 25. Absolute integrated power at negative offset frequency (L) 26. Absolute integrated power at positive offset frequency (L)
		<p>In MSR and LTE-Advanced FDD/TDD mode. Returns outer offset results when Non-Contiguous Meas Region is set to Outer, and returns inner offset results when it is set to Inner, in the following order.</p> 1. Ref carrier power. Left ref carrier power if Power Ref type is "Left & Right Carriers" Ref carrier power of the left sub-block if Power Ref type is "Max Power Carrier in Sub-block." (dBm/Hz) 2. Right ref carrier power if Power Ref type is "Left & Right Carriers." Ref carrier power of the right sub-block if Power Ref type is "Max Power Carrier in Sub-block." Otherwise -999.0 is returned. (dBm/Hz) 3. Absolute integrated power at negative offset frequency (A) 4. Absolute integrated power at positive offset frequency (A) --- 25. Absolute integrated power at negative offset frequency (L) 26. Absolute integrated power at positive offset frequency (L)
		<p>In WLAN mode. Returns 26 comma-separated scalar values (in dBm/Hz) of the absolute integrated power of the segment frequencies:</p> 1. Ref carrier power (dBm/Hz) 2. Reserved for the future use, returns -999.0 3. Absolute integrated power at negative offset frequency (A) 4. Absolute integrated power at positive offset frequency (A) --- 25. Absolute integrated power at negative offset frequency (L)

Modes	n	Return Value
		<p>26. Absolute integrated power at positive offset frequency (L)</p> <p>If the result is not available, -999.0 is returned.</p> <p>The number of values returned is subject to change in future releases.</p>
All (see details)	5	<p>Meas Type: Spectrum Peak Reference</p> <p>Returns comma-separated scalar values (in dBm) of the absolute peak power of the segment frequencies. The length of the result depends on the number of available offset (See "Number of Offsets" on page 1411).</p> <ol style="list-style-type: none"> 1. Spectrum Peak Power reference (dBm) 2. Reserved for the future use, returns -999.0 3. Absolute peak power at negative offset frequency (A) 4. Absolute peak power at positive offset frequency (A) <p>---</p> <p>25. Absolute peak power at negative offset frequency (L)</p> <p>26. Absolute peak power at positive offset frequency (L)</p> <p>In MSR and LTE-Advanced FDD/TDD mode.</p> <p>Returns outer offset results when Non-Contiguous Meas Region is set to Outer, and returns inner offset results when it is set to Inner, in the following order.</p> <ol style="list-style-type: none"> 1. Spectrum Peak Power reference of ref carrier. Spectrum Peak Power reference of left ref carrier if Power Ref type is "Left & Right Carriers." Spectrum Peak Power reference of the left sub-block if Power Ref type is "Max Power Carrier in Sub-block." (dBm) 2. Spectrum Peak Power reference of right ref carrier power if Power Ref type is "Left & Right carriers." Spectrum Peak Power reference of the right sub-block if Power Ref type is "Max Power Carrier in Sub-block." Otherwise -999.0 is returned. (dBm) 3. Absolute peak power at negative offset frequency (A) 4. Absolute peak power at positive offset frequency (A) <p>---</p> <p>25. Absolute peak power at negative offset frequency (L)</p> <p>26. Absolute peak power at positive offset frequency (L)</p> <p>If the result is not available, -999.0 is returned.</p> <p>The number of values returned is subject to change in future releases.</p>
All	6	<p>Meas Type: Total Power Reference</p> <p>Returns comma-separated scalar values (in dBc) of the integrated power relative to the carrier at the segment frequencies. The length of the result depends on the number of available offset (See "Number of Offsets" on page 1411).</p> <p>When in the MSR and LTE-Advanced FDD/TDD mode, returns outer offset results when Non-Contiguous Meas Region is set to Outer, and returns inner offset results when it is set to Inner, in the following order.</p> <ol style="list-style-type: none"> 1. Reserved for the future use, returns -999.0 2. Reserved for the future use, returns -999.0 3. Relative integrated power at negative offset frequency (A)

Modes	n	Return Value
		<p>4. Relative integrated power at positive offset frequency (A)</p> <p>---</p> <p>25. Relative integrated power at negative offset frequency (L)</p> <p>26. Relative integrated power at positive offset frequency (L)</p> <p>If the result is not available, -999.0 is returned.</p> <p>The number of values returned is subject to change in future releases.</p>
All	6	<p>Meas Type: Power Spectral Density Reference</p> <p>Returns comma-separated scalar values (in dBc/Hz) of the integrated power relative to the carrier at the segment frequencies. The length of the result depends on the number of available offset (See "Number of Offsets" on page 1411).</p> <p>When in the MSR and LTE-Advanced FDD/TDD mode, returns outer offset results when Non-Contiguous Meas Region is set to Outer, and returns inner offset results when it is set to Inner, in the following order.</p> <p>Returns -999.0 for the offsets if in WLAN:</p> <ol style="list-style-type: none"> 1. Reserved for the future use, returns -999.0 2. Reserved for the future use, returns -999.0 3. Relative integrated power at negative offset frequency (A) 4. Relative integrated power at positive offset frequency (A) <p>---</p> <p>25. Relative integrated power at negative offset frequency (L)</p> <p>26. Relative integrated power at positive offset frequency (L)</p> <p>If the result is not available, -999.0 is returned.</p> <p>The number of values returned is subject to change in future releases.</p>
All	6	<p>Meas Type: Spectrum Peak Reference</p> <p>Returns comma-separated scalar values (in dB) of the integrated power relative to the carrier at the segment frequencies. The length of the result depends on the number of available offset (See "Number of Offsets" on page 1411).</p> <p>When in the MSR and LTE-Advanced FDD/TDD mode, returns outer offset results when Non-Contiguous Meas Region is set to Outer, and returns inner offset results when it is set to Inner, in the following order.</p> <ol style="list-style-type: none"> 1. Reserved for the future use, returns -999.0 2. Reserved for the future use, returns -999.0 3. Relative peak power at negative offset frequency (A) 4. Relative peak power at positive offset frequency (A) <p>---</p> <p>25. Relative peak power at negative offset frequency (L)</p> <p>26. Relative peak power at positive offset frequency (L)</p> <p>If the result is not available, -999.0 is returned.</p> <p>The number of values returned is subject to change in future releases.</p>
All	7	

Modes	n	Return Value
		<p>Returns comma-separated pass/fail test results (0=passed, or 1=failed) determined by testing the minimum margin point from the limit line that is determined each offset's Limits setting. The length of the result depends on the number of available offset (See "Number of Offsets" on page 1411).</p> <p>When in the MSR and LTE-Advanced FDD/TDD mode, returns outer offset results when Non-Contiguous Meas Region is set to Outer, and returns inner offset results when it is set to Inner, in the following order.</p> <ol style="list-style-type: none"> 1. Reserved for the future use, returns -999.0 2. Reserved for the future use, returns -999.0 3. At negative offset frequency (A) 4. At positive offset frequency (A) --- 25. At negative offset frequency (L) 26. At positive offset frequency (L) <p>The number of values returned is subject to change in future releases.</p>
All	8	<p>Offset Pass/Fail.</p> <p>Returns comma-separated pass/fail test results (0=passed, or 1=failed) determined by testing the minimum margin point from the limit line that is determined each offset's Limits setting. The length of the result depends on the number of available offset (See "Number of Offsets" on page 1411).</p> <p>When in the MSR and LTE-Advanced FDD/TDD mode, returns outer offset results when Non-Contiguous Meas Region is set to Outer, and returns inner offset results when it is set to Inner, in the following order.</p> <p>Note: These results (n=8) are the same as n=7 result.</p> <ol style="list-style-type: none"> 1. Reserved for the future use, returns -999.0 2. Reserved for the future use, returns -999.0 3. At negative offset frequency (A) 4. At positive offset frequency (A) --- 25. At negative offset frequency (L) 26. At positive offset frequency (L) <p>The number of values returned is subject to change in future releases.</p>
All	9	<p>Offset Peak Power Freq.</p> <p>Returns comma-separated scalar values of frequency (in Hz) that have peak power from center or carrier edge frequency in each offset, depending on Offset Frequency Define settings. The length of the result depends on the number of available offset (See "Number of Offsets" on page 1411).</p> <p>When in the MSR and LTE-Advanced FDD/TDD mode, returns outer offset results when Non-Contiguous Meas Region is set to Outer, and returns inner offset results when it is set to Inner, in the following order.</p> <ol style="list-style-type: none"> 1. Reserved for the future use, returns -999.0 2. Reserved for the future use, returns -999.0 3. Negative offset frequency (A)

Modes	n	Return Value
		<p>4. Positive offset frequency (A)</p> <p>---</p> <p>25. Negative offset frequency (L)</p> <p>26. Positive offset frequency (L)</p> <p>If the result is not available, -999.0 is returned.</p> <p>The number of values returned is subject to change in future releases.</p>
All	10	<p>Offset Abs Peak Power.</p> <p>Returns comma-separated scalar values (in dBm) of the absolute peak power of the segment frequencies. The length of the result depends on the number of available offset (See "Number of Offsets" on page 1411).</p> <p>When in the MSR and LTE-Advanced FDD/TDD mode, returns outer offset results when Non-Contiguous Meas Region is set to Outer, and returns inner offset results when it is set to Inner, in the following order.</p> <ol style="list-style-type: none"> 1. Reserved for the future use, returns -999.0 2. Reserved for the future use, returns -999.0 3. At negative offset frequency (A) 4. At positive offset frequency (A) <p>---</p> <ol style="list-style-type: none"> 25. At negative offset frequency (L) 26. At positive offset frequency (L) <p>If the result is not available, -999.0 is returned.</p> <p>The number of values returned is subject to change in future releases.</p>
All	11	<p>Offset Rel Peak Power.</p> <p>Returns comma-separated scalar values in dBc (dB if MeasType = PSD) of the peak power relative to the carrier at the segment frequencies. The length of the result depends on the number of available offset (See "Number of Offsets" on page 1411).</p> <p>When in the MSR and LTE-Advanced FDD/TDD mode, returns outer offset results when Non-Contiguous Meas Region is set to Outer, and returns inner offset results when it is set to Inner, in the following order.</p> <ol style="list-style-type: none"> 1. Reserved for the future use, returns -999.0 2. Reserved for the future use, returns -999.0 3. At negative offset frequency (A) 4. At positive offset frequency (A) <p>---</p> <ol style="list-style-type: none"> 25. At negative offset frequency (L) 26. At positive offset frequency (L) <p>If the result is not available, -999.0 is returned.</p> <p>The number of values returned is subject to change in future releases.</p>
All	12	<p>Returns the power result (the peak power of the signal in the ref channel) when Meas Type is Spectrum Peak reference. Otherwise, the value returned will be -999.0.</p> <p>When in the MSR and LTE-Advanced FDD/TDD mode, returns outer offset results when Non-</p>

Modes	n	Return Value
		Contiguous Meas Region is set to Outer, and returns inner offset results when it is set to Inner, in the following order.
MSR, LTEAFDD, LTEATDD only	13	<p>Meas Type: Total Power Reference Returns outer offset results when Non-Contiguous Meas Region is set to Outer, and returns inner offset results when it is set to Inner, in the following order.</p> <ol style="list-style-type: none"> 1. Total Absolute power of carriers of Measure Carrier On if Power Ref Type is “Max Power Carrier,” “Max Power Carrier in Sub-block,” or “RF Bandwidth.” Otherwise NaN (9.91E+37) is returned. (dBm) 2. Absolute reference power. Absolute power at the left reference carrier if Power Ref type is “Left & Right Carriers.” Absolute power at the reference carrier of the left sub-block if Power Ref type is “Max Power Carrier in Sub-block.” (dBm) 3. Absolute power at the right reference carrier if Power Ref type is “Left & Right Carriers.” Absolute power at the reference carrier of the right sub-block if Power Ref type is “Max Power Carrier in Sub-block.” Otherwise NaN (9.91E+37) is returned. (dBm) 4. Peak frequency in the measured ref carrier frequency range. Peak frequency in the left ref carrier frequency range if Power Ref type is “Left & Right Carriers.” Peak frequency in the ref carrier frequency range of the left sub-block if Power Ref type is “Max Power Carrier in Sub-block.” (Hz) 5. Peak frequency in the right ref carrier frequency range if Power Ref type is “Left & Right Carriers.” Peak frequency in the ref carrier frequency range of the right sub-block if Power Ref type is “Max Power Carrier in Sub-block.” Otherwise NaN (9.91E+37) is returned. (Hz) <p>If the result is not available, NaN (9.91E+37) is returned. The number of values returned is subject to change in future releases.</p>
MSR, LTEAFDD, LTEATDD only	13	<p>Meas Type: Power Spectral Density Reference Returns outer offset results when Non-Contiguous Meas Region is set to Outer, and returns inner offset results when it is set to Inner, in the following order.</p> <ol style="list-style-type: none"> 1. Total Absolute power of carriers of Measure Carrier On if Power Ref Type is “Max Power Carrier,” “Max Power Carrier in Sub-block,” or “RF Bandwidth.” Otherwise NaN (9.91E+37) is returned. (dBm) 2. Absolute reference power. Absolute power at the left reference carrier if Power Ref type is “Left & Right Carriers.” Absolute power at the reference carrier of the left sub-block if Power Ref type is “Max Power Carrier in Sub-block.” (dBm/Hz) 3. Absolute power at the right reference carrier if Power Ref type is “Left & Right Carriers.” Absolute power at the reference carrier of the right sub-block if Power Ref type is “Max Power Carrier in Sub-block.” Otherwise NaN (9.91E+37) is returned. (dBm/Hz) 4. Peak frequency in the measured ref carrier frequency range. Peak frequency in the left ref carrier frequency range if Power Ref type is “Left & Right Carriers.” Peak frequency in the ref carrier frequency range of the left sub-block if Power Ref type is “Max Power Carrier in Sub-block.” (Hz) 5. Peak frequency in the right ref carrier frequency range if Power Ref type is “Left & Right Carriers.” Peak frequency in the ref carrier frequency range of the right sub-block if Power Ref

Modes	n	Return Value
		<p>type is "Max Power Carrier in Sub-block." Otherwise NaN (9.91E+37) is returned. (Hz)</p> <p>If the result is not available, NaN (9.91E+37) is returned.</p> <p>The number of values returned is subject to change in future releases.</p>
MSR, LTEAFDD, LTEATDD only	13	<p>Meas Type: Power Spectrum Peak Reference</p> <p>Returns outer offset results when Non-Contiguous Meas Region is set to Outer, and returns inner offset results when it is set to Inner, in the following order.</p> <ol style="list-style-type: none"> 1. Total Absolute power of carriers of Measure Carrier On if Power Ref Type is "Max Power Carrier," "Max Power Carrier in Sub-block," or "RF Bandwidth." Otherwise NaN (9.91E+37) is returned. (dBm) 2. Peak reference power. Peak power at the left reference carrier if Power Ref type is "Left & Right Carriers." Peak power at the reference carrier of the left sub-block if Power Ref type is "Max Power Carrier in Sub-block." (dBm) 3. Peak power at the right reference carrier if Power Ref type is "Left & Right Carriers." Peak power at the reference carrier of the right sub-block if Power Ref type is "Max Power Carrier in Sub-block." Otherwise NaN (9.91E+37) is returned. (dBm) 4. Peak frequency in the measured ref carrier frequency range. Peak frequency in the left ref carrier frequency range if Power Ref type is "Left & Right Carriers." Peak frequency in the ref carrier frequency range of the left sub-block if Power Ref type is "Max Power Carrier in Sub-block." (Hz) 5. Peak frequency in the right ref carrier frequency range if Power Ref type is "Left & Right Carriers." Peak frequency in the ref carrier frequency range of the right sub-block if Power Ref type is "Max Power Carrier in Sub-block." Otherwise NaN (9.91E+37) is returned. (Hz) <p>If the result is not available, NaN (9.91E+37) is returned.</p> <p>The number of values returned is subject to change in future releases.</p>
All	14	<p>Meas Type: Total Power Reference</p> <p>Returns comma-separated scalar results, in the following order:</p> <p>When in the MSR and LTE-Advanced FDD/TDD mode, returns outer offset results when Non-Contiguous Meas Region is set to Outer, and returns inner offset results when it is set to Inner, in the following order.</p> <ol style="list-style-type: none"> 1. Relative integrated power on the negative offset A (dBc) 2. Absolute integrated power on the negative offset A (dBm) 3. Relative peak power on the negative offset A (dBc) 4. Absolute peak power on the negative offset A (dBm) 5. Peak power offset frequency from the center or carrier edge frequency in the negative offset A, depending on Offset Frequency Define settings (Hz) 6. Relative integrated power on the positive offset A (dBc) 7. Absolute integrated power on the positive offset A (dBm) 8. Relative peak power on the positive offset A (dBc) 9. Absolute peak power on the positive offset A (dBm)

Modes	n	Return Value
		<p>10. Peak power offset frequency from the center or carrier edge frequency in the positive offset A, depending on Offset Frequency Define settings (Hz)</p> <p>11. Relative integrated power on the negative offset B (dBc)</p> <p>---</p> <p>119. Absolute peak power on the positive offset L (dBm)</p> <p>120. Peak power offset frequency from the center or carrier edge frequency in the positive offset L, depending on Offset Frequency Define settings (Hz)</p> <p>If the result is not available, NaN (9.91E+37) is returned.</p> <p>The length of the result depends on the number of available offset (See "Number of Offsets" on page 1411).</p> <p>The number of values returned is subject to change in future releases.</p>
All	14	<p>Meas Type: Power Spectral Density Reference</p> <p>Returns comma-separated scalar results, in the following order:</p> <p>When in the MSR and LTE-Advanced FDD/TDD mode, returns outer offset results when Non-Contiguous Meas Region is set to Outer, and returns inner offset results when it is set to Inner, in the following order.</p> <ol style="list-style-type: none"> 1. Relative integrated power on the negative offset A (dB) 2. Absolute integrated power on the negative offset A (dBm/Hz) 3. Relative peak power on the negative offset A (dB) 4. Absolute peak power on the negative offset A (dBm/Hz) 5. Peak power offset frequency from the center or carrier edge frequency in the negative offset A, depending on Offset Frequency Define settings (Hz) 6. Relative integrated power on the positive offset A (dB) 7. Absolute integrated power on the positive offset A (dBm/Hz) 8. Relative peak power on the positive offset A (dB) 9. Absolute peak power on the positive offset A (dBm/Hz) 10. Peak power offset frequency from the center or carrier edge frequency in the positive offset A, depending on Offset Frequency Define settings (Hz) 11. Relative integrated power on the negative offset B (dB) <p>---</p> <p>119. Absolute peak power on the positive offset L (dBm/Hz)</p> <p>120. Peak power offset frequency from the center or carrier edge frequency in the positive offset L, depending on Offset Frequency Define settings (Hz)</p> <p>If the result is not available, NaN (9.91E+37) is returned.</p> <p>The length of the result depends on the number of available offset (See "Number of Offsets" on page 1411).</p> <p>The number of values returned is subject to change in future releases.</p>
All	14	<p>Meas Type: Spectrum Peak Reference</p> <p>Returns comma-separated scalar results, in the following order:</p>

Modes	n	Return Value
		<p>When in the MSR and LTE-Advanced FDD/TDD mode, returns outer offset results when Non-Contiguous Meas Region is set to Outer, and returns inner offset results when it is set to Inner, in the following order.</p> <ol style="list-style-type: none"> 1. Reserved for the future use, returns NaN (9.91E+37) 2. Reserved for the future use, returns NaN (9.91E+37) 3. Relative peak power on the negative offset A (dB) 4. Absolute peak power on the negative offset A (dBm) 5. Peak power offset frequency from the center or carrier edge frequency in the negative offset A, depending on Offset Frequency Define settings (Hz) 6. Reserved for the future use, returns NaN (9.91E+37) 7. Reserved for the future use, returns NaN (9.91E+37) 8. Relative peak power on the positive offset A (dB) 9. Absolute peak power on the positive offset A (dBm) 10. Peak power offset frequency from the center or carrier edge frequency in the positive offset A, depending on Offset Frequency Define settings (Hz) 11. Relative integrated power on the negative offset B (dB) <p>---</p> <ol style="list-style-type: none"> 119. Absolute peak power on the positive offset L (dBm) 120. Peak power offset frequency from the center or carrier edge frequency in the positive offset L, depending on Offset Frequency Define settings (Hz) <p>If the result is not available, NaN (9.91E+37) is returned.</p> <p>The length of the result depends on the number of available offset (See "Number of Offsets" on page 1411).</p> <p>The number of values returned is subject to change in future releases.</p>
All	15	<p>Meas Type: Total Power Reference</p> <p>Returns comma-separated scalar results, in the following order:</p> <p>When in the MSR and LTE-Advanced FDD/TDD mode, returns outer offset results when Non-Contiguous Meas Region is set to Outer, and returns inner offset results when it is set to Inner, in the following order.</p> <ol style="list-style-type: none"> 1. Minimum margin from limit line on the negative offset A (dB) 2. Minimum margin from limit line on the positive offset A (dB) 3. Minimum margin from limit line on the negative offset B (dB) 4. Minimum margin from limit line on the positive offset B (dB) <p>---</p> <ol style="list-style-type: none"> 23. Minimum margin from limit line on the negative offset L (dB) 24. Minimum margin from limit line on the positive offset L (dB) <p>If the result is not available, NaN (9.91E+37) is returned.</p> <p>The length of the result depends on the number of available offset (See "Number of Offsets" on page 1411).</p> <p>The number of values returned is subject to change in future releases.</p>
MSR, LTEAFDD,	16	

Modes	n	Return Value
LTEATDD only		Returns number of carriers comma-separated scalar results, in the following order: 1. Absolute power of carrier 1 (dBm) 2. Absolute power of carrier 2 (dBm) --- number of carriers-1. Absolute power of carrier (number of carriers)-1 (dBm) number of carriers. Absolute power of carrier (number of carriers)-1 (dBm) If Measure Carrier of the corresponding carrier is no, NaN (9.91E+37) is returned.
WLAN only	16	Returns two carriers comma-separated scalar results when the radio standard is 802.11 ac 80+80 MHz. And returns NaN otherwise. 1. Absolute power of carrier segment 1 (dBm) 2. Absolute power of carrier segment 2 (dBm)
MSR, LTEAFDD, LTEATDD only	17	Returns the displayed frequency domain combined limit trace data separated by comma. Combined trace is a mixed trace of both absolute limit trace and relative limit trace according to the fail mask condition. The number of data points is 2001.

Number of Offsets

The number of available offsets varies depending on the mode and option as below.

Mode	The number of available offsets
MSR, LTEAFDD, LTEATDD	12 (Offset A to L)
WLAN	12 (Offset A to L)
Other modes with option N9060A-7FP	12 (Offset A to L)
Other modes without option N9060A-7FP	6 (Offset A to F)

Key Path	Meas
Initial S/W Revision	Prior to A.02.00
Modified at S/W Revision	A.11.00, A.14.00

AMPTD Y Scale

Accesses a menu of functions that enable you to set the vertical scale parameters. The parameter values are measurement independent except all Attenuation values and Internal Preamp selections that are measurement global.

Key Path	Front-panel key
Initial S/W Revision	Prior to A.02.00

Ref Value

Sets the value for the absolute power reference. However, since Auto Scaling defaults to On, this value is automatically determined by the measurement result. When you set a value manually, Auto Scaling automatically changes to Off.

Key Path	AMPTD Y Scale
Mode	SA, WCDMA, C2K, WIMAX OFDMA, TD-SCDMA, 1xEVDO, DTMB (CTTB), DVB-T/H, ISDB-T, CMMB, LTE, LTETDD, Digital Cable TV, WLAN, MSR, LTEAFDD, LTEATDD
Remote Command	:DISPlay:SEMAsk:VIEW[1]:WINDow[1]:TRACe:Y[:SCALe]:RLEVel <real> :DISPlay:SEMAsk:VIEW[1]:WINDow[1]:TRACe:Y[:SCALe]:RLEVel?
Example	DISP:SEM:VIEW:WIND:TRAC:Y:RLEV 100 DISP:SEM:VIEW:WIND:TRAC:Y:RLEV?
Notes	You must be in the mode that includes SEM measurement to use this command. Use :INSTrument:SElect to set the mode.
Couplings	When the Auto Scaling is On, this value is automatically determined by the measurement result. When you set a value manually, Auto Scaling automatically changed to Off.
Preset	10.0 dBm
State Saved	Saved in instrument state.
Min	-250 dBm
Max	250 dBm
Initial S/W Revision	Prior to A.02.00
Modified at S/W Revision	A.02.00, A.03.00

Attenuation

This menu controls the attenuator functions and interactions between the attenuation system components.

There are two attenuator configurations in the X-Series. One is a dual attenuator configuration consisting of a mechanical attenuator and an optional electronic attenuator. The other configuration uses a single attenuator with combined mechanical and electronic sections that controls all the attenuation functions. Different models in the X-Series come with different configurations.

See "Dual Attenuator Configurations:" on page 1413

See "Single Attenuator Configuration:" on page 1414

Most Attenuation settings are the same for all measurements – they do not change as you change measurements. Settings like these are called “Meas Global” and are unaffected by Meas Preset.

Key Path	AMPTD Y Scale
Scope	Meas Global
Dependencies	In measurements that support the I/Q inputs, this key is unavailable when I/Q is the selected input, and is replaced by the Range key in that case.
Readback Line	Contains a summary in [] brackets of the current total attenuation. See the descriptions of the , " (Mech) Atten " on page 2736, and "Enable Elec Atten" on page 2737 keys for more detail on the contributors to the total attenuation. Note that when "Pre-Adjust for Min Clip" is on, this value can change at the start of every measurement.
Initial S/W Revision	Prior to A.02.00
Modified at S/W Revision	A.03.00

Dual Attenuator Configurations:

Configuration 1: Mechanical attenuator + optional electronic attenuator

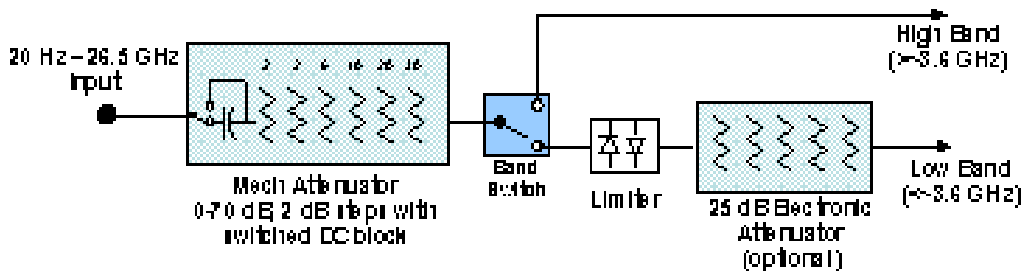

Configuration 2: Mechanical attenuator, no optional electronic attenuator

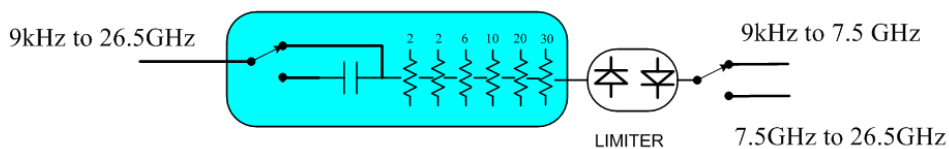

(note that Configuration 2 is not strictly speaking a dual-section attenuator, since there is no electronic section available. However, it behaves exactly like Configuration 1 without the Electronic Attenuator option EA3, therefore for the sake of this document it is grouped into the “Dual Attenuator” configuration)

Single Attenuator Configuration:

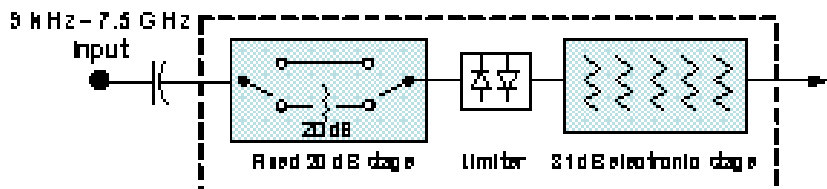

You can tell which attenuator configuration you have by pressing the Attenuation key, which (in most Modes) opens the Attenuation menu. If the first key in the Attenuation menu says Mech Atten you have the dual attenuator configuration. If the first key says Atten you have the single attenuator configuration.

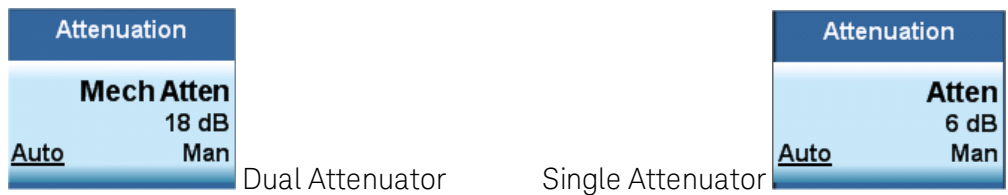

In the single attenuator configuration, you control the attenuation with a single control, as the fixed stage has only two states. In the dual attenuator configuration, both stages have significant range so you are given separate control of the mechanical and electronic attenuator stages.

When you have the dual attenuator configuration, you may still have only a single attenuator, because unless option EA3 (the Electronic Attenuator option) is available, and you purchase it, you will have only the mechanical attenuator.

(Mech) Atten

This key is labeled Mech Atten in dual attenuator models and Atten in single attenuator models. In the dual attenuator configuration, this key only affects the mechanical attenuator.

This key lets you modify the attenuation applied to the RF input signal path. This value is normally auto coupled to the Ref Level, the Internal Preamp Gain, any External Gain that is entered, and the Max Mixer Level, as described in the table below.

See ["Attenuator Configurations and Auto/Man" on page 1416](#)

Key Path	AMPTD Y Scale, Attenuation
Remote Command	<pre>[:SENSe]:POWer[:RF]:ATTenuation <rel_ampl> [:SENSe]:POWer[:RF]:ATTenuation? [:SENSe]:POWer[:RF]:ATTenuation:AUTO OFF ON 0 1 [:SENSe]:POWer[:RF]:ATTenuation:AUTO?</pre>
Example	<p>POW:ATT 20</p> <p>Dual attenuator configuration: sets the mechanical attenuator to 20 dB</p> <p>Single attenuator mode: sets the main attenuation to 20 dB (see below for definition of “main” attenuation).</p> <p>If the attenuator was in Auto, it sets it to Manual.</p>
Dependencies	Some measurements do not support the Auto setting of (Mech) Atten. In these measurements, the

Auto/Man selection is not available, and the Auto/Man line on the key disappears.

In dual attenuator configurations, when the electronic attenuator is enabled, the mechanical attenuator has no auto setting and the Auto/Man line on the key disappears. The state of Auto/Man is remembered and restored when the electronic attenuator is once again disabled. This is described in more detail in the ["Enable Elec Atten" on page 2737](#) key description.

See ["Attenuator Configurations and Auto/Man" on page 1416](#) for more information on the Auto/Man functionality of Attenuation.

Couplings

When (Mech) Atten is in Auto, it uses the following algorithm to determine a value:
 If the USB Preamp is connected to USB, use 0 dB.
 Otherwise, $Atten = ReferenceLevel + PreAmpGain + ExternalGain - RefLevelOffset - MaxMixerLevel + IF\ Gain$.
 Limit this value to be between 6 dB and the Max value. No value below 6 dB can ever be chosen by Auto.
 The resulting value is rounded up to the largest value possible given the attenuation step setting. That is, 50.01 dB would change to 60 dB (for a 10 dB attenuation step).
 The "IF Gain" term in the equation above is either 0 dB or +10 dB, depending on the settings of FFT IF Gain, Swept IF Gain, max Ref Level and the Auto/Man setting of Mech Atten.
 In External Mixing and BBIQ, where the Attenuator is not in the signal path, the Attenuator setting changes as described above when (Mech) Atten is in Auto, but no changes are made to the actual attenuator hardware setting until the input is changed back to the RF Input.

Preset The preset for Mech Attenuation is "Auto."
 The Auto value of attenuation is:
 CXA, EXA, MXA and PXA: 10 dB

State Saved Saved in instrument state

Min 0 dB
 The attenuation set by this key cannot be decreased below 6 dB with the knob or step keys. To get to a value below 6 dB it has to be directly entered from the keypad or via SCPI. This protects from adjusting the attenuation to a dangerously small value which can put the instrument at risk of damage to input circuitry. However, if the current mechanical attenuation is below 6 dB it can be increased with the knob and step keys, but not decreased.

Max CXA N9000A-503/507: 50 dB
 CXA N9000A-513/526: 70dB
 EXA: 60 dB
 MXA and PXA: 70 dB
 In the single attenuator configuration, the total of ATT and EATT cannot exceed 50 dB, so if the EATT is set to 24 dB first, the main attenuation cannot be greater than 26 dB and will be reduced accordingly; if the main attenuator is set to 40 dB first, EATT cannot be greater than 10 dB.

Initial S/W Revision Prior to A.02.00

Modified at S/W Revision A.03.00

Attenuator Configurations and Auto/Man

As described in the Attenuation key description, there are two distinct attenuator configurations available in the X-Series, the single attenuator and dual attenuator configurations. In dual attenuator configurations, we have the mechanical attenuation and the electronic attenuation, and the current total attenuation is the sum of the electronic + mechanical attenuation. In single attenuator configurations, we refer to the attenuation set using the (Mech) Atten key (or POW:ATT SCPI) as the “main” attenuation; and the attenuation that is set by the SCPI command POW:EATT as the “soft” attenuation (the POW:EATT command is honored even in the single attenuator configuration, for compatibility purposes). Then the current total attenuation is the sum of the main + soft attenuation. See the Elec Atten key description for more on “soft” attenuation.

In the dual attenuator configuration, when the electronic attenuator is enabled, there is no Auto/Man functionality for the mechanical attenuator, and the third line of the key label (the Auto/Man line) disappears:

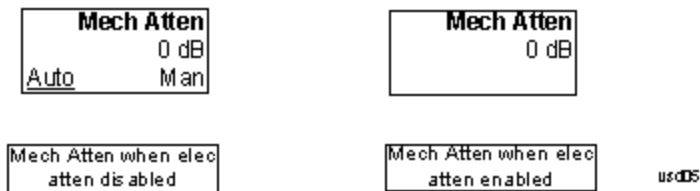

Enable Elec Atten

Enables the Electronic Attenuator.

The electronic attenuator offers finer steps than the mechanical attenuator, has no acoustical noise, is faster, and is less subject to wear. These advantages primarily aid in remote operation and are negligible for front panel use. See ["Using the Electronic Attenuator: Pros and Cons" on page 1418](#) for a detailed discussion of the pros and cons of using the electronic attenuator.

For the single attenuator configuration, for SCPI backwards compatibility, the “soft” attenuation feature replaces the dual attenuator configuration’s electronic attenuator. All the same couplings and limitations apply. See ["Attenuator Configurations and Auto/Man" on page 2737](#)

See ["More Information" on page 1417](#)

Key Path	AMPTD Y Scale, Attenuation
Remote Command	[:SENSe] : POWer [:RF] : EATTenuation : STATE OFF ON 0 1 [:SENSe] : POWer [:RF] : EATTenuation : STATE ?
Example	POW:EATT:STAT ON
Dependencies	This key only appears in Dual Attenuator models with an Electronic Attenuator installed. It does not appear in models with the Single Attenuator configuration, as in the single attenuator configuration there is no “electronic attenuator” there is only a single integrated attenuator (which has both a mechanical and electronic stage). However, in the single attenuator configuration, EATT SCPI commands are accepted for compatibility with other X-series instruments and set a “soft” attenuation as described in "Attenuator Configurations and Auto/Man" on page 2737 . The electronic attenuator (and the “soft” attenuation function provided in single attenuator configurations) is unavailable above 3.6 GHz. Therefore, if the Stop Frequency of the analyzer is > 3.6 GHz then the Enable Elec Atten key will be OFF and grayed out.

	<p>If the Internal Preamp is on, meaning it is set to Low Band or Full, the electronic attenuator (and the “soft” attenuation function provided in single attenuator configurations) is unavailable. In this case the Enable Elec Atten key will be OFF and grayed out.</p> <p>If either of the above is true, if the SCPI command is sent, an error indicating that the electronic attenuator is unavailable will be sent.</p> <p>If the electronic/soft Attenuator is enabled, then the Stop Freq of the analyzer is limited to 3.6 GHz and the Internal Preamp is unavailable.</p> <p>The SCPI-only “soft” electronic attenuation for the single-attenuator configuration is not available in all measurements; in particular, it is not available in the Swept SA measurement.</p>
Couplings	Enabling and disabling the Electronic Attenuator affects the setting of the Mechanical Attenuator (in dual attenuator configurations). This is described in more detail below this table.
Preset	OFF for Swept SA measurement; ON for all other measurements that support the electronic attenuator
State Saved	Saved in instrument state
Initial S/W Revision	Prior to A.02.00
Modified at S/W Revision	A.03.00

More Information

Mechanical Attenuator Transition Rules

When the Electronic Attenuator is enabled, the Mechanical Attenuator transitions to a state that has no Auto function. Below are the rules for transitioning the Mechanical Attenuator. NOTE that the information below ONLY applies to the dual attenuator configurations, and ONLY when the Electronic Attenuator is installed:

When the Electronic Attenuation is enabled from a disabled state:

- The Mechanical Attenuator is initialized to 10 dB (this is its optimal performance setting). You can then set it as desired with SCPI, numeric keypad, step keys, or knob, and it behaves as it normally would in manual mode
- The Auto/Man state of (Mech) Atten is saved
- The Auto/Man line on the (Mech) Atten key disappears and the auto rules are disabled
- The Electronic Attenuator is set to 10 dB less than the previous value of the Mechanical Attenuator, within the limitation that it must stay within the range of 0 to 24 dB of attenuation.

Examples in the dual attenuator configuration:

- Mech Atten at 20 dB. Elec Atten enabled, Mech Atten set to 10 dB, and Elec Atten set to 10 dB. New total attenuation equals the value before Elec Atten enabled.
- Mech Atten at 0 dB. Elec Atten enabled, Mech Atten set to 10 dB, and Elec Atten set to 0 dB. New total attenuation does not equal the value before Elec Atten enabled.
- Mech Atten at 40 dB. Elec Atten enabled, Mech Atten set to 10 dB, and Elec Atten set to 24 dB. New total attenuation does not equal the value before Elec Atten enabled.

When the Electronic Attenuation is disabled from an enabled state:

- The Elec Atten key is grayed out
- The Auto/Man state of (Mech) Atten is restored
- If now in Auto, (Mech) Atten recouples
- If now in Man, (Mech) Atten is set to the value of total attenuation that existed before the Elec Atten was disabled. The resulting value is rounded up to the smallest value possible given the (Mech) Atten Step setting - (That is, 57 dB changes to 58 dB when (Mech) Atten Step is 2 dB.)

Using the Electronic Attenuator: Pros and Cons

The electronic attenuator offers finer steps than the mechanical attenuator, has no acoustical noise, is faster, and is less subject to wear.

The “finer steps” advantage of the electronic attenuator is beneficial in optimizing the alignment of the analyzer dynamic range to the signal power in the front panel as well as remote use. Thus, you can achieve improved relative signal measurement accuracy. Compared to a mechanical attenuator with 2 dB steps, the 1 dB resolution of the electronic attenuator only gives better resolution when the odd-decibel steps are used. Those odd-decibel steps are less accurately calibrated than the even-decibel steps, so one tradeoff for this superior relative accuracy is reduced absolute amplitude accuracy.

Another disadvantage of the electronic attenuator is that the spectrum analyzer loses its “Auto” setting, making operation less convenient.

Also, the relationship between the dynamic range specifications (TOI, SHI, compression and noise) and instrument performance are less well-known with the electrical attenuator. With the mechanical attenuator, TOI, SHI and compression threshold levels increase dB-for-dB with increasing attenuation, and the noise floor does as well. With the electronic attenuator, there is an excess attenuation of about 1 to 3 dB between 0 and 3.6 GHz, making the effective TOI, SHI, and so forth, less well known. Excess attenuation is the actual attenuation relative to stated attenuation. Excess attenuation is accounted for in the analyzer calibration

Elec Atten

Controls the Electronic Attenuator in dual attenuator configurations. This key does not appear in single attenuator configurations, as the control of both the mechanical and electronic stages of the single attenuator is integrated into the single Atten key.

Key Path	AMPTD Y Scale, Attenuation
Remote Command	<code>[:SENSe] :POWer [:RF] :EATTenuation <rel_amp1></code> <code>[:SENSe] :POWer [:RF] :EATTenuation?</code>
Notes	Electronic Attenuation’s specification is defined only when Mechanical Attenuation is 6 dB.
Dependencies	This key only appears in Dual Attenuator models with an Electronic Attenuator installed. It does not appear in models with the Single Attenuator configuration, as in the single attenuator configuration there is no “electronic attenuator” there is only a single integrated attenuator (which has both a mechanical and electronic stage). However, in the single attenuator configuration, EATT SCPI commands are accepted for compatibility with other X-series instruments and set a “soft” attenuation as described in "Attenuator Configurations and Auto/Man" on page 2737 . The “soft” attenuation is treated as an addition to the “main” attenuation value set by the Atten softkey or the

	POW:ATT SCPI command and affects the total attenuation displayed on the Attenuation key and the Meas Bar. When Enable Elec Atten is off or grayed out, the Elec Atten key is grayed out.
Preset	0 dB
State Saved	Saved in instrument state
Min	0 dB
Max	Dual attenuator configuration: 24 dB Single attenuator configuration: the total of ATT and EATT cannot exceed 50 dB, so if the EATT is set to 24 dB first, the main attenuation cannot be greater than 26 dB and will be reduced accordingly; if the main attenuator is set to 40 dB first, EATT cannot be greater than 10 dB
Initial S/W Revision	Prior to A.02.00
Modified at S/W Revision	A.03.00

Adjust Atten for Min Clip

Sets the combination of mechanical and electronic attenuation and gain based on the current measured signal level so that clipping will be at a minimum.

This is an "immediate action" function, that is, it executes once, when the key is pressed.

This key is grayed out in measurements that do not support this functionality. The spectrum analyzer measurement, Swept SA, does not support this functionality.

Key Path	AMPTD Y Scale, Attenuation
Remote Command	<code>[:SENSe] :POWer [:RF] :RANGe:OPTimize IMMEDIATE</code>
Initial S/W Revision	Prior to A.02.00
Modified at S/W Revision	A.03.00

Pre-Adjust for Min Clip

If this function is on, it does the adjustment described under "[Adjust Atten for Min Clip](#)" on page 2740 each time a measurement restarts. Therefore, in Continuous measurement mode, it only executes before the first measurement.

In dual attenuator models, you can set Elec+Mech Atten, in which case both attenuators participate in the autoranging, or Elec Atten Only, in which case the mechanical attenuator does not participate in the autoranging. This latter case results in less wear on the mechanical attenuator and is usually faster.

This key is grayed out in measurements that do not support this functionality. The spectrum analyzer measurement, Swept SA, does not support this functionality.

Key Path	AMPTD Y Scale, Attenuation
Remote Command	<code>[:SENSe] :POWer [:RF] :RANGe:OPTimize:ATTenuation OFF ELECTRical COMBined</code>

	<code>[:SENSe] :POWer [:RF] :RANGe:OPTimize:ATTenuation?</code>
Notes	The SCPI parameter ELECtrical sets this function to On in single attenuator models. The SCPI parameter COMBined is mapped to ELECtrical in single attenuator models; if you send COMBined, it sets the function to On and returns ELEC to a query.
Dependencies	This key only appears in Dual Attenuator models with an Electronic Attenuator installed. In instruments with Dual Attenuator model, when Enable Elec Atten is off or grayed out, the Pre-Adjust for Min Clip key is grayed out.
Preset	OFF for Swept SA measurement; ON for all other measurements that support Pre-Adjust for Min Clip
State Saved	Saved in instrument state
Range	Dual attenuator models: Off Elec Atten Only Mech + Elec Atten Single attenuator models: Off On
Initial S/W Revision	Prior to A.02.00
Modified at S/W Revision	A.03.00

Remote Command	<code>[:SENSe] :POWer [:RF] :RANGe:AUTO ON OFF 1 0</code> <code>[:SENSe] :POWer [:RF] :RANGe:AUTO?</code>
Notes	ON aliases to "Elec Atten Only" (:POW:RANG:OPT:ATT ELEC) OFF aliases to "Off" (:POW:RANG:OPT:ATT OFF) The query :POW:RANG:AUTO? returns true if :POW:RANG:OPT:ATT is not "Off"
Initial S/W Revision	Prior to A.02.00

Off

Turns Pre-Adjust for Min Clip off. This is the default setting.

This key is grayed out in measurements that do not support this functionality. The spectrum analyzer measurement, Swept SA, does not support this functionality.

Key Path	AMPTD Y Scale, Attenuation, Pre-Adjust for Min Clip
Example	:POW:RANGe:OPT:ATT OFF
Initial S/W Revision	Prior to A.02.00

Elec Atten Only

Selects only the electric attenuator to participate in auto ranging. This offers less wear on the mechanical attenuator and is usually faster.

This key is grayed out in measurements that do not support this functionality. The spectrum analyzer measurement, Swept SA, does not support this functionality.

Key Path	AMPTD Y Scale, Attenuation, Pre-Adjust for Min Clip
Example	:POW:RANGe:OPT:ATT ELEC
Initial S/W Revision	Prior to A.02.00

Mech + Elec Atten

In dual attenuator models, this selects both attenuators participate in the autoranging.

This key is grayed out in measurements that do not support this functionality. The spectrum analyzer measurement, Swept SA, does not support this functionality.

Key Path	AMPTD Y Scale, Attenuation, Pre-Adjust for Min Clip
Example	:POW:RANGe:OPT:ATT COMB
Initial S/W Revision	Prior to A.02.00

(Mech) Atten Step

This controls the step size used when making adjustments to the input attenuation.

This key is labeled Mech Atten Step in dual attenuator models and Atten Step in single attenuator models. In the dual attenuator configuration, this key only affects the step size of the mechanical attenuator.

Key Path	AMPTD Y Scale, Attenuation
Remote Command	[[:SENSe]:POWer[:RF]:ATTenuation:STEP[:INCRement] 10 dB 2 dB [:SENSe]:POWer[:RF]:ATTenuation:STEP[:INCRement]?
Example	POW:ATT:STEP 2
Notes	Note this feature works like a 1-N choice from the front panel, but it takes a specific value (in dB) when used remotely. The only valid values are 2 and 10.
Dependencies	Blanked in CXA and EXA if option FSA (2 dB steps) is not present. If blanked, attempts to set it via SCPI will yield an error.
Couplings	When the attenuation step size changes, the current mechanical attenuation value is adjusted (if necessary) to be quantized to the new step size. That is, if step is set to 10 dB, mech atten is increased if necessary so it is a multiple of 10 dB
Preset	PXA and MXA: 2 dB EXA and CXA: 10 dB (2 dB with option FSA)
State Saved	Saved in instrument state
Initial S/W Revision	Prior to A.02.00
Modified at S/W Revision	A.03.00

Scale/Div

Sets the units-per-division of the vertical scale in the logarithmic display. When Auto Scaling is On, the scale per division value is automatically determined by the measurement result. When you set a value manually, Auto Scaling automatically changes to Off.

Key Path	AMPTD Y Scale
Mode	SA, WCDMA, C2K, WIMAX OFDMA, TD-SCDMA, 1xEVDO, DTMB (CTTB), DVB-T/H, ISDB-T, CMMB, LTE, LTETDD, Digital Cable TV, WLAN, MSR, LTEAFDD, LTEATDD
Remote Command	:DISPlay:SEMask:VIEW[1]:WINDow[1]:TRACe:Y[:SCALe]:PDIVision <rel_ampl> :DISPlay:SEMask:VIEW[1]:WINDow[1]:TRACe:Y[:SCALe]:PDIVision?
Example	DISP:SEM:VIEW:WIND:TRAC:Y:PDIV 15dB DISP:SEM:VIEW:WIND:TRAC:Y:PDIV?
Notes	You must be in the mode that includes SEM measurement to use this command. Use :INSTrument:SElect to set the mode.
Couplings	When the Auto Scaling is On, this value is automatically determined by the measurement result. When you set a value manually, Auto Scaling automatically changes to Off.
Preset	10 dB
State Saved	Saved in instrument state
Min	0.10 dB
Max	20.00 dB
Initial S/W Revision	Prior to A.02.00
Modified at S/W Revision	A.02.00, A.03.00

Presel Center

When this key is pressed, the centering of the preselector filter is adjusted to optimize the amplitude accuracy at the frequency of the selected marker. If the selected marker is not on when Presel Center is pressed, the analyzer will turn on the selected marker, perform a peak search, and then perform centering on the marker's center frequency. If the selected marker is already on and between the start and stop frequencies of the analyzer, the analyzer performs the preselector calibration on that marker's frequency. If the selected marker is already on, but outside the frequency range between Start Freq and Stop Freq, the analyzer will first perform a peak search, and then perform centering on the marker's center frequency.

The value displayed on the Presel Adjust key will change to reflect the new preselector tuning (see Presel Adjust).

A number of considerations should be observed to ensure proper operation. See ["Proper Preselector Operation" on page 1423](#).

Key Path	AMPTD Y Scale
Remote Command	[:SENSe]:POWer[:RF]:PCENter
Example	POW:PCEN
Notes	Note that the rules outlined above under the key description apply for the remote command as well

	as the key. The result of the command is dependent on marker position, and so forth. Any message shown by the key press is also shown in response to the remote command.
Dependencies	<ul style="list-style-type: none"> • Grayed out if the microwave preselector is off.) • If the selected marker's frequency is below Band 1, advisory message 0.5001 is generated and no action is taken. • Grayed out if entirely in Band 0. • Blank in models that do not include a preselector, such as option 503. If the SCPI is sent in these instruments, it is accepted without error, and the query always returns 0. • Grayed out in the Spectrogram View.
Couplings	<p>The active marker position determines where the centering will be attempted.</p> <p>If the analyzer is in a measurement such as averaging when centering is initiated, the act of centering the preselector will restart averaging but the first average trace will not be taken until the centering is completed.</p>
Status Bits/OPC dependencies	<p>When centering the preselector, *OPC will not return true until the process is complete and a subsequent measurement has completed, nor will results be returned to a READ or MEASure command.</p> <p>The Measuring bit should remain set while this command is operating and should not go false until the subsequent sweep/measurement has completed.</p>
Initial S/W Revision	Prior to A.02.00
Modified at S/W Revision	A.03.00

Proper Preselector Operation

A number of considerations should be observed to ensure proper operation:

1. If the selected marker is off, the analyzer will turn on a marker, perform a peak search, and adjust the preselector using the selected marker's frequency. It uses the "highest peak" peak search method unqualified by threshold or excursion, so that there is no chance of a 'no peak found' error. It continues with that peak, even if it is the peak of just noise. Therefore, for this operation to work properly, there should be a signal on screen in a preselected range for the peak search to find.
2. If the selected marker is already on, the analyzer will attempt the centering at that marker's frequency. There is no preselector for signals below about 3.6 GHz, therefore if the marker is on a signal below 3.6 GHz, no centering will be attempted and an advisory message generated
3. In some models, the preselector can be bypassed. If it is bypassed, no centering will be attempted in that range and a message will be generated.

Preselector Adjust

Allows you to manually adjust the preselector filter frequency to optimize its response to the signal of interest. This function is only available when **"Presel Center" on page 2743** is available.

For general purpose signal analysis, using Presel Center is recommended. Centering the filter minimizes the impact of long-term preselector drift. Presel Adjust can be used instead to manually optimize the

preselector. One application of manual optimization would be to peak the preselector response, which both optimizes the signal-to-noise ratio and minimizes amplitude variations due to small (short-term) preselector drifting.

Key Path	AMPTD Y Scale
Scope	Meas Global
Remote Command	[:SENSe] :POWer [:RF] :PADJust <freq> [:SENSe] :POWer [:RF] :PADJust?
Example	POW:PADJ 100KHz POW:PADJ?
Notes	The value on the key reads out to 0.1 MHz resolution.
Dependencies	<ul style="list-style-type: none"> • Grayed out if microwave preselector is off.) • Grayed out if entirely in Band 0. • Blank in models that do not include a preselector, such as option 503. If the SCPI is sent in these instruments, it is accepted without error, and the query always returns 0. • Grayed out in the Spectrogram View.
Preset	0 MHz
State Saved	The Presel Adjust value set by Presel Center, or by manually adjusting Presel Adjust, is not saved in instrument state, and does not survive a Preset or power cycle.
Min	-500 MHz
Max	500 MHz
Default Unit	Hz
Backwards Compatibility SCPI	[:SENSe] :POWer [:RF] :MW:PADJust [:SENSe] :POWer [:RF] :MMW:PADJust PSA had multiple preselectors, but the X-Series has only one. These commands simply alias to [:SENSe] :POWer [:RF] :PADJust
Initial S/W Revision	Prior to A.02.00
Modified at S/W Revision	A.03.00

Remote Command	[:SENSe] :POWer [:RF] :PADJust:PRESelector MWAVE MMWave EXTERNAL [:SENSe] :POWer [:RF] :PADJust:PRESelector?
Notes	PSA had multiple preselectors, and you could select which preselector to adjust. Since the X-Series has only one mm/uW preselector, the preselector selection softkey is no longer available. However, to provide backward compatibility, we accept the legacy remote commands. The command form has no effect, the query always returns MWAVE
Initial S/W Revision	Prior to A.02.00

μW Path Control

The μW Path Control functions include the μW Preselector Bypass (Option MPB) and Low Noise Path (Option LNP) controls in the High Band path circuits.

When the μW Preselector is bypassed, the user has better flatness, but will be subject to spurs from out of band interfering signals. When the Low Noise Path is enabled, the analyzer automatically switches around certain circuitry in the high frequency bands which can contribute to noise, when it is appropriate based on other analyzer settings.

For most applications, the preset state is Standard Path, which gives the best remote-control throughput, minimizes acoustic noise from switching and minimizes the risk of wear out in the hardware switches. For applications that utilize the wideband IF paths, the preset state is the μW Preselector Bypass path, if option MPB is present. This is because, when using a wideband IF such as the 140 MHz IF, the μW Preselector's bandwidth can be narrower than the available IF bandwidth, causing degraded amplitude flatness and phase linearity, so it is desirable to bypass the preselector in the default case.

Users may choose Low Noise Path Enable. It gives a lower noise floor, especially in the 21–26.5 GHz region, though without improving many measures of dynamic range, and without giving the best possible noise floor. The preamp, if purchased and used, gives better noise floor than does the Low Noise Path, however its compression threshold and third-order intercept are much poorer than that of the non-preamp Low Noise Path. There are some applications, typically for signals around –30 dBm, for which the third-order dynamic range of the standard path is good enough, but the noise floor is not low enough even with 0 dB input attenuation. When the third-order dynamic range of the preamp path is too little and the noise floor of the standard path is too high, the Low Noise Path can provide the best dynamic range.

Key Path	AMPTD Y Scale
Mode	SA, BASIC, PNOISE, VSA , LTE, LTETDD
Scope	Meas Global
Remote Command	[:SENSe] :POWer [:RF] :MW:PATH STD LNPath MPBypass FULL [:SENSe] :POWer [:RF] :MW:PATH?
Example	:POW:MW:PATH LNP Enables the Low Noise path
Notes	If a Presel Center is performed, the analyzer will momentarily switch to the Standard Path, regardless of the setting of μW Path Control The DC Block will always be switched in when the low noise path is switched in, to protect succeeding circuitry from DC. Note that this does not mean “when the low noise path is enabled” but when, based on the Low Noise Path rules, the path is actually switched in. This can happen when the selection is Low Noise Path Enable . In the case where the DC Block is switched in the analyzer is now AC coupled. However, if the user has selected DC coupling, the UI will still behave as though it were DC coupled, including all annunciation, warnings, status bits, and responses to SCPI queries. This is because, based on other settings, the analyzer could switch out the low noise path at any time and hence go back to being DC coupled. Alignment switching ignores the settings in this menu, and restores them when finished.
Dependencies	Unavailable in BBIQ and External Mixing
Preset	All modes other than IQ Analyzer mode and VXA: STD IQ Analyzer, VXA and WLAN mode: MPB option present and licensed: MPB

	MPB option not present and licensed: STD
State Saved	Save in instrument state
Readback	Value selected in the submenu
Initial S/W Revision	A.04.00
Modified at S/W Revision	A.10.00

Standard Path

This path gives the best remote-control throughput, minimizes acoustic noise from switching and minimizes the risk of wear in the hardware switches, particularly in remote test scenarios where both low band and high band setups will follow in rapid succession.

In this path, the bypass of the low band/high band switch and microwave preamp is never activated, which can cause some noise degradation but preserves the life of the bypass switch.

Key Path	AMPTD Y Scale, μ W Path Control
Example	:POW:MW:PATH STD
Readback Text	Standard Path
Initial S/W Revision	A.04.00

Low Noise Path Enable

You may choose Low Noise Path Enable, which gives a lower noise floor under some circumstances, particularly when operating in the 21–26.5 GHz region. With the Low Noise Path enabled, the low band/high band switch and microwave preamp are bypassed whenever all of the following are true:

- The analyzer is not in the Low Band, meaning:
- the start frequency is above 3.5 GHz and
- the stop frequency is above 3.6 GHz.
- the internal preamp is not installed or (if installed) is set to Off or Low Band

Note that this means that, when any part of a sweep is done in Low Band, the Low Noise Path is not used, whether or not the Low Noise Path Enable is selected in the user interface. Also, if the preamp is turned on, the Low Noise Path is not used, whether or not the Low Noise Path Enable is selected in the user interface. The only time the Low Noise Path is used is when Low Noise Path Enable is selected, the sweep is completely in High Band (> 3.6 GHz) and no preamp is in use.

See "[More Information](#)" on page 1427

Key Path	AMPTD Y Scale, μ W Path Control
Measurement	Swept SA
Example	:POW:MW:PATH LNP

Notes	<p>For measurements that use IQ acquisition, the low noise path is used when the Center Frequency is in High Band (> 3.6 GHz) and no preamp is in use.</p> <p>In other words, the rules above are modified to use only the center frequency to qualify which path to switch in.</p> <p>This is not the case for FFT's in the Swept SA measurement; they use the same rules as swept measurements.</p>
Dependencies	<p>Key is blanked if current mode does not support it.</p> <p>Key is grayed out if mode supports it but current measurement does not support it.</p> <p>Unless Option LNP is present and licensed, key is blank and if SCPI command sent, error -241, "Hardware missing; Option not installed" is generated.</p>
Readback Text	Low Noise Path Enable
Initial S/W Revision	A.04.00

More Information

The user should understand that the Low Noise Path, while giving improved DANL, has the disadvantage of decreased TOI performance and decreased gain compression performance relative to the standard path.

The user should also understand that the bypass switch is a mechanical switch and has finite life, so if the Low Noise Path is enabled, it is possible to cause frequent cycling of this switch by frequently changing analyzer settings such that the above conditions hold true only some of the time. A user making tests of this nature should consider opting for the Standard Path, which will never throw the bypass switch, at the expense of some degraded noise performance.

The low noise path is useful for situations where the signal level is so low that the analyzer performance is dominated by noise even with 0 dB attenuation, but still high enough that the preamp option would have excessive third-order intermodulation or compression. The preamp, if purchased and used, gives better noise floor than does the "Low Noise Path." However, its compression threshold and third-order intercept are much poorer than that of the non-preamp path. There are some applications, typically for signals around -30 dBm, for which the third-order dynamic range of the standard path is good enough, but the noise floor is not low enough even with 0 dB input attenuation. When the third-order dynamic range of the preamp path is too little and the noise floor of the standard path is too high, the Low Noise Path can provide the best dynamic range

The graph below illustrates the concept. It shows, in red, the performance of an analyzer at different attenuation settings, both with the preamp on and off, in a measurement that is affected by both analyzer noise and analyzer TOI. The green shows the best available dynamic range, offset by 0.5 dB for clarity. The blue shows how the best available dynamic range improves for moderate signal levels with the low noise path switched in. In this illustration, the preamp improves the noise floor by 15 dB while degrading the third-order intercept by 30 dB, and the low noise path reduces loss by 8 dB. The attenuator step size is 2 dB.

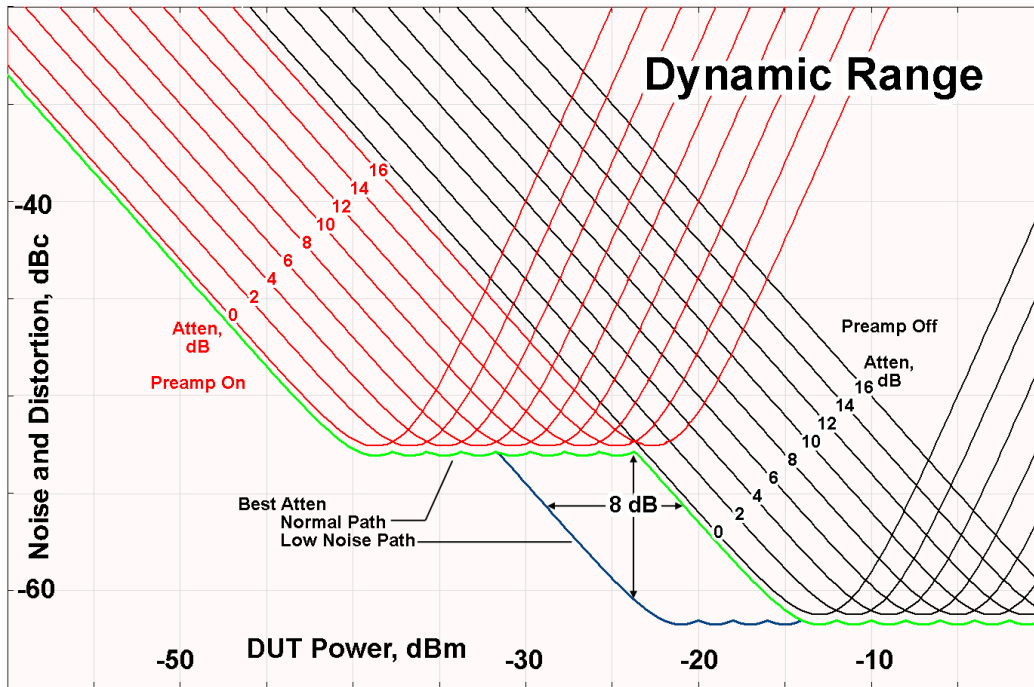

There are other times where selecting the low noise path improves performance, too. Compression-limited measurements such as finding the nulls in a pulsed-RF spectrum can profit from the low noise path in a way similar to the TOI-limited measurement illustrated. Accuracy can be improved when the low noise path allows the optimum attenuation to increase from a small amount like 0, 2 or 4 dB to a larger amount, giving better return loss at the analyzer input. Harmonic measurements, such as second and third harmonic levels, are much improved using the low noise path because of the superiority of that path for harmonic (though not intermodulation) distortion performance.

µW Preselector Bypass

This key toggles the preselector bypass switch for band 1 and higher. When the microwave preselector is on, the signal path is preselected. When the microwave preselector is off, the signal path is not preselected. The preselected path is the normal path for the analyzer.

The preselector is a tunable bandpass filter which prevents signals away from the frequency of interest from combining in the mixer to generate in-band spurious signals (images). The consequences of using a preselector filter are its limited bandwidth, the amplitude and phase ripple in its passband, and any amplitude and phase instability due to center frequency drift.

Option MPB or pre-selector bypass provides an unpreselected input mixer path for certain X-Series signal analyzers with frequency ranges above 3.6 GHz. This signal path allows a wider bandwidth and less amplitude variability, which is an advantage when doing modulation analysis and broadband signal analysis. The disadvantage is that, without the preselector, image signals will be displayed. Another disadvantage of bypassing the preselector is increased LO emission levels at the front panel input port.

Image responses are separated from the real signal by twice the 1st IF. For IF Paths of 10 MHz and 25 MHz, the 1st IF is 322.5 MHz, so the image response and the real signal will be separated by 645 MHz. The 1st IF will be different for other IF Path settings. When viewing a real signal and its corresponding image response in internal mixing, the image response will be to the left of the real signal.

Also, the image response and the real signal typically have the same amplitude and exhibit the same shape factor.

However, if Option FS1, Fast Sweep Capability, is enabled, the image response in the Swept SA measurement will appear lower in amplitude and have a much wider shape factor compared to the real signal.

Key Path	AMPTD Y Scale, μ W Path Control
Example	:POW:MW:PATH MPB
Dependencies	Key is blanked if current mode does not support it. Key is grayed out if mode supports it but current measurement does not support it. Key is blank unless Option MPB is present and licensed. If SCPI command sent when MPB not present, error -241, "Hardware missing; Option not installed" is generated.
Readback Text	μ W Preselector Bypass
Initial S/W Revision	A.04.00

Remote Command	[:SENSe] :POWer [:RF] :MW:PRESelector [:STATe] ON OFF 0 1 [:SENSe] :POWer [:RF] :MW:PRESelector [:STATe] ?
Example	:POW:MW:PRES OFF Bypasses the microwave preselector
Notes	The ON parameter sets the STD path (:POW:MW:PATH STD) The OFF parameter sets path MPB (:POW:MW:PATH MPB)
Preset	ON

Internal Preamp

Accesses a menu of keys that control the internal preamps. Turning on the preamp gives a better noise figure, but a poorer TOI to noise floor dynamic range. You can optimize this setting for your particular measurement.

The instrument takes the preamp gain into account as it sweeps. If you sweep outside of the range of the preamp the instrument will also account for that. The displayed result will always reflect the correct gain.

For some measurements, when the preamp is on and any part of the displayed frequency range is below the lowest frequency for which the preamp has specifications, a warning condition message appears in the status line. For example ,for a preamp with a 9 kHz lowest specified frequency: "Preamp: Accy unspec'd below 9 kHz".

Key Path	AMPTD Y Scale
Scope	Meas Global
Remote Command	[:SENSe] :POWer [:RF] :GAIN [:STATe] OFF ON 0 1 [:SENSe] :POWer [:RF] :GAIN [:STATe] ?
Dependencies	Preamp is not available on all hardware platforms. If the preamp is not present or is unlicensed, the

	key is not shown. The preamp is not available when the electronic/soft attenuator is enabled.
--	--

Couplings	<p>The act of connecting the U7227A USB Preamplifier to one of the analyzer's USB ports will cause the Internal Preamp to be switched on. When this happens an informational message will be generated: "Internal Preamp turned on for optimal operation with USB Preamp." Note that if the Internal Preamp was already on, there will be no change to the setting, but if it was Off it will be switched On, to Full Range.</p> <p>Note that this same action occurs when the SA mode is selected while the USB Preamp is connected to one of the analyzer's USB ports, if it is the first time that the SA mode has run since powerup, or if the last time the SA mode was running the USB Preamp was NOT connected.</p> <p>Subsequently disconnecting the USB Preamp from USB does not change the Internal Preamp setting nor restore the previous setting.</p>
Preset	OFF
State Saved	Saved in instrument state
Initial S/W Revision	Prior to A.02.00
Modified at S/W Revision	A.14.00

Key Path	AMPTD Y Scale, Internal Preamp
Scope	Meas Global
Remote Command	[:SENSe]:POWer[:RF]:GAIN:BAND LOW FULL [:SENSe]:POWer[:RF]:GAIN:BAND?
Dependencies	<p>Preamp is not available on all hardware platforms. If the preamp is not present or is unlicensed, the key is not shown.</p> <p>If a POW:GAIN:BAND FULL command is sent when a low band preamp is available, the preamp band parameter is to LOW instead of FULL, and an "Option not installed" message is generated.</p>
Preset	LOW
State Saved	Saved in instrument state
Initial S/W Revision	Prior to A.02.00

Off

Turns the internal preamp off

Key Path	AMPTD Y Scale, Internal Preamp
Example	:POW:GAIN OFF
Readback	Off
Initial S/W Revision	Prior to A.02.00

Low Band

Sets the internal preamp to use only the low band.

The frequency range of the installed (optional) low-band preamp is displayed in square brackets on the Low Band key label.

Key Path	AMPTD Y Scale, Internal Preamp
Example	:POW:GAIN ON :POW:GAIN:BAND LOW
Readback	Low Band
Initial S/W Revision	Prior to A.02.00

Full Range

Sets the internal preamp to use its full range. The low band (0–3.6 GHz or 0–3GHz, depending on the model) is supplied by the low band preamp and the frequencies above low band are supplied by the high band preamp.

The frequency range of the installed (optional) preamp is displayed in square brackets on the Full Range key label. If the high band option is not installed the Full Range key does not appear.

Key Path	AMPTD Y Scale, Internal Preamp
Example	:POW:GAIN ON :POW:GAIN:BAND FULL
Readback	Full Range
Initial S/W Revision	Prior to A.02.00

Ref Position

Positions the reference level at the top, center or bottom of the Y scale display. Changing the reference position does not affect the reference level value.

Key Path	AMPTD Y Scale
Mode	SA, WCDMA, C2K, WIMAX OFDMA, TD-SCDMA, 1xEVDO, DTMB (CTTB), DVB-T/H, ISDB-T, CMMB, LTE, LTE-TDD, Digital Cable TV, WLAN, MSR, LTEAFDD, LTEATDD
Remote Command	:DISPlay:SEMask:VIEW[1]:WINDow[1]:TRACe:Y[:SCALe]:RPOSition TOP CENTer BOTTom :DISPlay:SEMask:VIEW[1]:WINDow[1]:TRACe:Y[:SCALe]:RPOSition?
Example	DISP:SEM:VIEW:WIND:TRAC:Y:RPOS BOTT DISP:SEM:VIEW:WIND:TRAC:Y:RPOS?
Notes	You must be in the mode that includes SEM measurement to use this command. Use :INSTrument:SElect to set the mode.
Preset	TOP

State Saved	Saved in instrument state
Range	Top Ctr Bot
Initial S/W Revision	Prior to A.02.00
Modified at S/W Revision	A.02.00, A.03.00

Auto Scaling

Toggles the Auto Scaling function between On and Off.

When Auto Scaling is On and the Restart front-panel key is pressed, the analyzer automatically determines the scale per division and reference values based on the measurement results. When you set a value to either Scale/Div or Ref Value manually, Auto Scaling automatically changes to Off.

Key Path	AMPTD Y Scale
Mode	SA, WCDMA, C2K, WIMAX OFDMA, TD-SCDMA, 1xEVDO, DTMB (CTTB), DVB-T/H, ISDB-T, CMMB, LTE, LTEFDD, Digital Cable TV, WLAN, MSR, LTEAFDD, LTEATDD
Remote Command	:DISPlay:SEMask:VIEW[1]:WINDow[1]:TRACe:Y[:SCALE]:COUPle 0 1 ON OFF :DISPlay:SEMask:VIEW[1]:WINDow[1]:TRACe:Y[:SCALE]:COUPle?
Example	DISP:SEM:VIEW:WIND:TRAC:Y:COUP OFF DISP:SEM:VIEW:WIND:TRAC:Y:COUP?
Notes	You must be in the mode that includes SEM measurement to use this command. Use :INSTrument:SElect to set the mode.
Couplings	When Auto Scaling is On, upon pressing the Restart front-panel key, this function automatically determines the scale per division and reference values based on the measurement results. When you set a value to either Scale/Div or Ref Value manually, Auto Scaling automatically changes to Off.
Preset	ON
State Saved	Saved in instrument state
Range	On Off
Initial S/W Revision	Prior to A.02.00
Modified at S/W Revision	A.02.00, A.03.00

Auto Couple

The Auto Couple feature provides a quick and convenient way to automatically couple multiple instrument settings. This helps ensure accurate measurements and optimum dynamic range. When the Auto Couple feature is activated, either from the front panel or remotely, all parameters of the current measurement that have an Auto/Manual mode are set to Auto mode and all measurement settings dependent on (or coupled to) the Auto/Man parameters are automatically adjusted for optimal performance.

However, the Auto Couple key actions are confined to the current measurement only. It does not affect other measurements in the mode, and it does not affect markers, marker functions, or trace or display attributes.

See "[More Information](#)" on page 1433

Key Path	Front-panel key
Remote Command	:COUPle ALL NONE
Example	:COUP ALL
Notes	:COUPle ALL puts all Auto/Man parameters in Auto mode (equivalent to pressing the Auto Couple key). :COUPLE NONE puts all Auto/Man parameters in manual mode. It decouples all the coupled instrument parameters and is not recommended for making measurements.
Initial S/W Revision	Prior to A.02.00

More Information

There are two types of functions that have Auto/Manual modes.

Auto/Man Active Function keys

An Auto/Man toggle key controls the binary state associated with an instrument parameter by toggling between Auto (where the parameter is automatically coupled to the other parameters it is dependent upon) and Man (where the parameter is controlled independent of the other parameters), as well as making the parameter the active function. The current mode is indicated on the softkey with either Auto or Man underlined as illustrated below.



Auto/Man 1-of-N keys

An Auto/Man 1-of-N key allows you to manually pick from a list of parameter values, or place the function in Auto, in which case the value is automatically selected (and indicated) as shown below. If in Auto, Auto is underlined on the calling key. If in manual operation, manual is indicated on the calling key. But the calling key does not actually toggle the function, it simply opens the menu.

13 Spectrum Emission Mask Measurement
Auto Couple

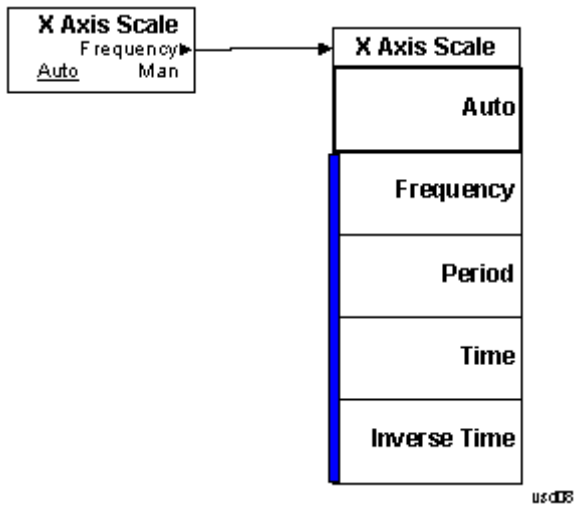

BW

Accesses a menu of functions that enable you to select the type of filter for the measurement.

Key Path	Front-panel key
Initial S/W Revision	Prior to A.02.00
Modified at S/W Revision	A.03.00

Filter Type

Selects the type of bandwidth filter that is used in Carrier and Offsets.

When Gaussian or Flattop is selected, selected filter is applied to carriers and all offsets.

When Auto Sense is selected, filter type is automatically selected for each carriers and offsets, so that measurement speed and accuracy is optimized.

Key Path	BW
Mode	SA, WCDMA, C2K, WIMAX OFDMA, TD-SCDMA, 1xEVDO, DVB-T/H, DTMB (CTTB), ISDB-T, CMMB, LTE, LTE-TDD, Digital Cable TV, WLAN, MSR, LTEAFDD, LTEATDD
Remote Command	[:SENSe] :SEMask :BANDwidth :SHAPE ASENse GAUSSian FLATtop [:SENSe] :SEMask :BANDwidth :SHAPE?
Example	SEM:BAND:SHAP GAUS SEM:BAND:SHAP?
Couplings	See the description above
Preset	ASENse
State Saved	Saved in instrument state
Range	Auto Sense (each offset and carrier) Gaussian (all offsets and carriers) Flattop (all offsets and carriers)
Initial S/W Revision	A.03.00

Cont (Continuous Measurement/Sweep)

Sets the analyzer for Continuous measurement operation. The single/continuous state is Meas Global so the setting will affect all measurements. If you are Paused, pressing Cont does a Resume.

Key Path	Front-panel key
Remote Command	:INITiate:CONTinuous OFF ON 0 1 :INITiate:CONTinuous?
Example	:INIT:CONT 0 puts analyzer in Single measurement operation. :INIT:CONT 1 puts analyzer in Continuous measurement operation
Preset	ON (Note that SYST:PRESet sets INIT:CONT to ON but *RST sets INIT:CONT to OFF)
State Saved	Saved in instrument state
Backwards Compatibility Notes	For Spectrum Analysis mode in ESA and PSA, there is no Cont hardkey, instead there is a Sweep Single/Cont key. In these analyzers, switching the Sweep Single/Cont key from Single to Cont restarts averages (displayed average count reset to 1), but does not restart Max Hold and Min Hold. The X-Series has Single and Cont keys in place of the SweepSingleCont key. In the X-Series, if in single measurement, the Cont key (and INIT:CONT ON) switches to continuous measurement, but never restarts a measurement and never resets a sweep.
Initial S/W Revision	Prior to A.02.00

In Swept SA Measurement (Spectrum Analysis Mode):

The analyzer takes repetitive sweeps, averages, measurements, etc., when in Continuous mode. When the average count reaches the Average/Hold Number the count stops incrementing, but the analyzer keeps sweeping. See the Trace/Detector section for the averaging formula used both before and after the Average/Hold Number is reached. The trigger condition must be met prior to each sweep. The type of trace processing for multiple sweeps, is set under the Trace/Detector key, with choices of Trace Average, Max Hold, or Min Hold.

In Other Measurements/Modes:

With Avg/Hold Num (in the Meas Setup menu) set to Off or set to On with a value of 1, a sweep is taken after the trigger condition is met; and the analyzer continues to take new sweeps after the current sweep has completed and the trigger condition is again met. However, with Avg/Hold Num set to On with a value >1, multiple sweeps (data acquisitions) are taken for the measurement. The trigger condition must be met prior to each sweep. The sweep is not stopped when the average count k equals the number N set for Avg/Hold Num is reached, but the number k stops incrementing. A measurement average usually applies to all traces, marker results, and numeric results. But sometimes it only applies to the numeric results.

If the analyzer is in Single measurement, pressing the Cont key does not change k and does not cause the sweep to be reset; the only action is to put the analyzer into Continuous measurement operation.

If it is already in continuous sweep:

the INIT:CONT 1 command has no effect

the INIT:CONT 0 command will place the analyzer in Single Sweep but will have no effect on the current sequence until $k = N$, at which point the current sequence will stop and the instrument will go to the idle state.

13 Spectrum Emission Mask Measurement
File

File

See "File" on page 360

FREQ Channel

Accesses a menu of keys that allow you to control the Frequency and Channel parameters of the instrument.

Some features in the Frequency menu are the same for all measurements – they do not change as you change measurements. Settings like these are called “Meas Global” and are unaffected by Meas Preset. For example, the Center Freq setting is the same for all measurements – it does not change as you change measurements.

Key Path	Front-panel key
Initial S/W Revision	Prior to A.02.00

Center Freq

Sets the frequency that corresponds to the horizontal center of the graticule (when frequency Scale Type is set to linear). While adjusting the Center Frequency the Span is held constant, which means that both Start Frequency and Stop Frequency will change.

Pressing Center Freq also sets the frequency entry mode to Center/Span. In Center/Span mode, the center frequency and span values are displayed below the graticule, and the default active function in the Frequency menu is Center Freq.

The center frequency setting is the same for all measurements within a mode, that is, it is Meas Global. Some modes are also able to share a Mode Global center frequency value. If this is the case, the Mode will have a Global Settings key in its Mode Setup menu.

The Center Freq function sets (and queries) the Center Frequency for the currently selected input. If your analyzer has multiple inputs, and you select another input, the Center Freq changes to the value for that input. SCPI commands are available to directly set the Center Freq for a specific input.

Center Freq is remembered as you go from input to input. Thus you can set a Center Freq of 10 GHz with the RF Input selected, change to BBIQ and set a Center Freq of 20 MHz, then switch to External Mixing and set a Center Freq of 60 GHz, and when you go back to the RF Input the Center Freq will go back to 10 GHz; back to BBIQ and it is 20 MHz; back to External Mixing and it is 60 GHz.

See ["RF Center Freq" on page 1442](#)

See [Ext Mix Center Freq](#)

See ["I/Q Center Freq" on page 1444](#)

See ["Center Frequency Presets" on page 1440](#)

Key Path	FREQ Channel
Scope	Meas Global
Remote Command	[:SENSe] :FREQuency :CENTer <freq> [:SENSe] :FREQuency :CENTer?

Example	FREQ:CENT 50 MHz FREQ:CENT UP changes the center frequency to 150 MHz if you use FREQ:CENT:STEP 100 MHz to set the center frequency step size to 100 MHz FREQ:CENT?
Notes	This command sets either the RF or I/Q Center Frequency depending on the selected input. For RF input it is equivalent to FREQ:RF:CENT For I/Q input it is equivalent to FREQ:IQ:CENT Preset and Max values are dependent on Hardware Options (5xx) If no terminator (e.g. MHz) is sent the terminator Hz is used. If a terminator with unit other than Frequency is used, an invalid suffix error message is generated.
Dependencies	The Center Frequency can be limited by Start or Stop Freq limits, if the Span is so large that Start or Stop reach their limit.
Couplings	When operating in “swept span”, any value of the Center Frequency or Span that is within the frequency range of the analyzer is allowed when the value is being set through the front panel numeric key pad or the SCPI command. The other parameter is forced to a different value if needed, to keep the Start and the Stop Frequencies within the analyzer’s frequency range
Preset	Depends on instrument maximum frequency, mode, measurement, and selected input. See "Center Frequency Presets" on page 1440 and "RF Center Freq" on page 1442 and Ext Mix Center Freq and "I/Q Center Freq" on page 1444 .
State Saved	Saved in instrument state
Min	Depends on instrument maximum frequency, mode, measurement, and selected input.. See "Center Frequency Presets" on page 1440 and "RF Center Freq" on page 1442 and "I/Q Center Freq" on page 1444 .
Max	Depends on instrument maximum frequency, mode, measurement, and selected input.. See "Center Frequency Presets" on page 1440 and "RF Center Freq" on page 1442 and "I/Q Center Freq" on page 1444 .
Default Unit	Hz
Status Bits/OPC	Non-overlapped
Dependencies	
Initial S/W Revision	Prior to A.02.00

Center Frequency Presets

The following table provides the Center Frequency Presets for the Spectrum Analyzer mode, and the Max Freq, for the various frequency options:

Freq Option	CF after Mode Preset	Stop Freq after Mode Preset	Max Freq (can't tune)

			above)
503 (all but N9000A)	1.805 GHz	3.6 GHz	3.7 GHz
503 (N9000A)	1.505 GHz	3.0 GHz	3.08 GHz
507 (all but N9000A)	3.505 GHz	7.0 GHz	7.1 GHz
507 (N9000A)	3.755 GHz	7.5 GHz	7.58 GHz
508 (all but N9038A)	1.805 GHz	3.6 GHz	8.5 GHz
508 (N9038A)	4.205 GHz	8.4 GHz	8.5 GHz
513	6.805 GHz	13.6 GHz	13.8 GHz
526 (all but N9000A and N9038A)	13.255 GHz	26.5 GHz	27.0 GHz
526 (N9000A)	13.255 GHz	26.5 GHz	26.55 GHz
526 (N9038A)	1.805 GHz	3.6 GHz	27.0 GHz
532	16.005 GHz	32.0 GHz	32.5 GHz
543	21.505 GHz	43.0 GHz	TBD
544	22.005 GHz	44.0 GHz	44.5 GHz
550	25.005 GHz	50.0 GHz	51 GHz

Input 2:

Model	CF after Mode Preset	Stop Freq after Mode Preset	Max Freq (can't tune above)
N9000A opt C75	0.7505GHz	1.5 GHz	1.58 GHz
N9038A	505 MHz	1 GHz	1.000025 GHz

Tracking Generator Frequency Limits (N9000A only):

Tracking Generator Option	Min Freq (clips to this freq when turn TG on and	If above this Freq, Stop Freq clipped to this Freq when	Max Freq (can't tune above) while TG

	can't tune below while TG on)	TG turned on	on
T03	9 kHz	3.0 GHz	3.08 GHz
T06	9 kHz	6.0 GHz	6.05 GHz

The following table shows the Center Frequency Presets for modes other than Spectrum Analyzer:

Mode	CF Preset for RF
WCDMA	1 GHz
WIMAXOFDMA,	1 GHz
BASIC	1 GHz
ADEMOD	1 GHz
VSA	1 GHz
TDSCDMA	1 GHz
PNOISE	1 GHz
LTE	1 GHz
LTETDD	1 GHz
MSR	1 GHz
GSM	935.2 MHz
NFIGURE	1.505 GHz

RF Center Freq

SCPI command for specifying the RF Center Frequency. This command will set the Center Frequency to be used when the RF input is selected, even if the RF input is not the input that is selected at the time the command is sent. Note that the Center Freq function in the Frequency menu on the front panel always applies to the currently selected input.

Scope	Meas Global
Remote Command	[:SENSe] :FREQuency:RF:CENTer <freq> [:SENSe] :FREQuency:RF:CENTer?
Example	FREQ:RF:CENT 30 MHz
Notes	This command is the same in all modes, but the parameter is Measurement Global. So the value is independent in each mode and common across all the measurements in the mode.
Dependencies	If the electronic/soft attenuator is enabled, any attempt to set Center Frequency such that the Stop Frequency would be >3.6 GHz fails and results in an advisory message. If the equivalent SCPI command is sent, this same message is generated as part of a “-221, Settings conflict” warning. If Source Mode is set to Tracking, and the Max or Min Center Freq is therefore limited by the limits of the source, a warning message is generated, “Data out of range;clipped to source max/min” if these limits are exceeded. Note that for an external source, these limits can be affected by the settings of

	Source Numerator, Source Denominator and Power Sweep.
Preset	See table above
State Saved	Saved in instrument state.
Min	-79.999995 MHz, unless Source Mode is set to Tracking, in which case it is limited by the minimum frequency of the Source
Max	See table above. Basically instrument maximum frequency - 5 Hz. Note that, if the Source Mode is set to Tracking, the effective instrument maximum frequency may be limited by the source maximum frequency. If the knob or step keys are being used, also depends on the value of the other three interdependent parameters Span, Start Frequency and Stop Frequency
Initial S/W Revision	Prior to A.02.00
Modified at S/W Revision	A.03.00

Ext Mix Center Freq

SCPI command for specifying the External Mixer Center Frequency. This command will set the Center Frequency to be used when the External Mixer is selected, even if the External Mixer input is not the input which is selected at the time the command is sent. Note that the Center Freq function in the Frequency menu on the front panel always applies to the currently selected input.

Scope	Meas Global
Remote Command	<code>[:SENSe] :FREQuency:EMIXer:CENTer <freq></code> <code>[:SENSe] :FREQuency:EMIXer:CENTer?</code>
Example	<code>:FREQ:EMIX:CENT 60 GHz</code> <code>:FREQ:EMIX:CENT?</code>
Notes	This command is the same in all modes, but the parameter is Measurement Global. So the value is independent in each mode and common across all the measurements in the mode.
Couplings	When returning to External Mixing after having been switched to one of the other inputs (e.g., RF), you will come back into the settings that you had when you left External Mixing. So you will come back to the band you were in with the Center Frequency that you had. However, Span is not an input-dependent parameter, therefore you will bring the span over from the other input. Therefore, the analyzer comes back with the span from the previous input, limited as necessary by the current mixer setup.
Preset	When a Mode Preset is performed while in External Mixing, the Start frequency of the current Mode is set to the nominal Min Freq of the lowest harmonic range in the Harmonic Table for the current mixer setup. Similarly, the Stop frequency of the current Mode is set to the nominal Max Freq of the highest harmonic range in the Harmonic Table. The Center Freq thus presets to the point arithmetically equidistant from these two frequencies. If the current measurement has a limited Span available to it, and cannot achieve the Span shown in the table ($\text{Span} = \text{Stop Freq} - \text{Start Freq}$), the analyzer uses the maximum Span the measurement allows, and still sets the Center Freq to the midpoint of the Start and Stop Freq values in the Harmonic Table.

	When Restore Input/Output Defaults is performed, the mixer presets to the 11970A, whose Start and Stop frequencies are 26.5 and 40 GHz respectively. The center of these two frequencies is 33.25 GHz. Therefore, after a Restore Input/Output Defaults, if you go into External Mixing and do a Mode Preset while in the Spectrum Analyzer Mode, the resulting Center Freq is 33.25 GHz.
State Saved	Saved in instrument state.
Min	The minimum frequency in the currently selected mixer band + 5 Hz
Max	The maximum frequency in the currently selected mixer band – 5 Hz If the knob or step keys are being used, also depends on the value of the other three interdependent parameters Span, Start Frequency and Stop Frequency
Initial S/W Revision	A.08.01

I/Q Center Freq

SCPI command for specifying the I/Q Center Frequency. This command will set the Center Frequency to be used when the I/Q input is selected, even if the I/Q input is not the input which is selected at the time the command is sent. Note that the Center Freq function in the Frequency menu on the front panel always applies to the currently selected input.

Scope	Meas Global
Remote Command	<code>[:SENSe] :FREQuency:IQ:CENTer <freq></code> <code>[:SENSe] :FREQuency:IQ:CENTer?</code>
Example	FREQ:IQ:CENT: 30 MHz
Notes	This command is the same in all modes, but the parameter is Measurement Global. So the value is independent in each mode and common across all the measurements in the mode.
Preset	0 Hz
State Saved	Saved in instrument state.
Min	-40.049995 MHz
Max	40.049995 MHz
Initial S/W Revision	Prior to A.02.00

CF Step

Changes the step size for the center frequency and start and stop frequency functions. Once a step size has been selected and the center frequency function is active, the step keys (and the UP|DOWN parameters for Center Frequency from remote commands) change the center frequency by the step-size value. The step size function is useful for finding harmonics and sidebands beyond the current frequency span of the analyzer.

Note that the start and stop frequencies also step by the CF Step value.

Key Path	FREQ Channel
Remote Command	[:SENSe]:FREQuency:CENTer:STEP[:INCRement] <freq> [:SENSe]:FREQuency:CENTer:STEP[:INCRement]? [:SENSe]:FREQuency:CENTer:STEP:AUTO OFF ON 0 1 [:SENSe]:FREQuency:CENTer:STEP:AUTO?
Example	FREQ:CENT:STEP:AUTO ON FREQ:CENT:STEP 500 MHz FREQ:CENT UP increases the current center frequency value by 500 MHz FREQ:CENT:STEP? FREQ:CENT:STEP:AUTO?
Notes	Preset and Max values are depending on Hardware Options (503, 507, 508, 513, 526)
Notes	Preset and Max values are dependent on Hardware Options (5xx)
Dependencies	Freq Offset is not available in External Mixing. In this case the Freq Offset key is grayed out and shows a value of zero. It will once again be available, and show the previously set value, when you return to the RF Input.
Dependencies	Span, RBW, Center frequency If the electronic/soft attenuator is enabled, any attempt to change the value of the center frequency >3.6 GHz by pressing the Up-arrow key, fails and results in an advisory message. If the equivalent SCPI command is sent, this same message is generated as part of a “-221, Settings conflict” warning.
Couplings	When auto-coupled in a non-zero span, the center frequency step size is set to 10% of the span. When auto-coupled in zero span, the center frequency step size is set to the equivalent -3 dB RBW value.
Preset	Auto ADEMOD: 1 MHz ON
State Saved	Saved in instrument state
Min	– (the maximum frequency of the instrument). That is, 27 GHz max freq instrument has a CF step range of +/- 27 GHz. Note that this is the maximum frequency given the current settings of the instrument, so in External Mixing, for example, it is the maximum frequency of the current mixer band.
Max	The maximum frequency of the instrument. That is, 27 GHz max freq instrument has a CF step range of +/- 27 GHz. Note that this is the maximum frequency given the current settings of the instrument, so in External Mixing, for example, it is the maximum frequency of the current mixer band.
Default Unit	Hz
Status Bits/OPC dependencies	non-overlapped
Initial S/W Revision	Prior to A.02.00
Modified at S/W Revision	A.03.00

Input/Output

See "[Input/Output](#)" on page 224

Marker

Accesses a menu that enables you to select, set up and control the markers for the current measurement. If there are no active markers, Marker selects marker 1, sets it to Normal and places it at the center of the display. You can turn on and control up to 12 markers.

Key Path	Front-panel key
Initial S/W Revision	Prior to A.02.00

Select Marker

Displays 12 markers available for selection.

Key Path	Marker
Initial S/W Revision	Prior to A.02.00

Marker Type

Sets the marker control mode to Normal and Off. If the selected marker is Off, pressing Marker sets it to Normal and places it at the center of the screen on the trace determined by the Marker Trace rules. At the same time, Marker X Axis Value appears on the Active Function area. The marker X axis value entered in the active function area will display the marker value to its full entered precision. If the current control mode for the measurement is Off, there is no active function and the active function is turned off.

Key Path	Marker
Mode	SA, WCDMA, C2K, WIMAX OFDMA, TD-SCDMA, 1xEVDO, DTMB (CTTB), DVB-T/H, ISDB-T, CMMB, LTE, LTE-TDD, Digital Cable TV, WLAN, MSR, LTEAFDD, LTEATDD
Remote Command	:CALCulate:SEMask:MARKer[1] 2 ... 12:MODE POSITION OFF :CALCulate:SEMask:MARKer[1] 2 ... 12:MODE?
Example	CALC:SEM:MARK:MODE POS CALC:SEM:MARK:MODE?
Notes	If the selected marker is Off, pressing Marker sets it to Normal and places it at the center of the screen on the trace determined by the Marker Trace rules. At the same time, Marker X Axis Value appears on the Active Function area. Default Active Function: the active function for the selected marker's current control mode. Note that if the current control mode is Off, there is no active function and the active function is turned off. Active Function Display: the marker X axis value entered in the active function area will display the marker value to its full entered precision.
Preset	OFF OFF OFF OFF OFF OFF OFF OFF OFF OFF OFF OFF
State Saved	Saved in instrument state
Range	Normal Off
Initial S/W Revision	Prior to A.02.00
Modified at S/W Revision	A.02.00, A.03.00

Couple Markers

When this function is true, moving any marker causes an equal X Axis movement of every other marker that is not Off. By “equal X Axis movement” we mean that we preserve the difference between each marker’s X Axis value (in the fundamental x-axis units of the trace that marker is on) and the X Axis value of the marker being moved (in the same fundamental x-axis units).

Key Path	Marker
Mode	SA, WCDMA, C2K, WIMAX OFDMA, TD-SCDMA, 1xEVDO, DTMB (CTTB), DVB-T/H, ISDB-T, CMMB, LTE, LTETDD, Digital Cable TV, WLAN, MSR, LTEAFDD, LTEATDD
Remote Command	:CALCulate:SEMask:MARKer:COUPle[:STATe] ON OFF 1 0 :CALCulate:SEMask:MARKer:COUPle[:STATe]?
Example	CALC:SEM:MARK:COUP ON CALC:SEM:MARK:COUP?
Preset	OFF
State Saved	Saved in instrument state
Range	On Off
Initial S/W Revision	Prior to A.02.00
Modified at S/W Revision	A.02.00, A.03.00

All Markers Off

Turns all active markers off in all views.

Key Path	Marker
Mode	SA, WCDMA, C2K, WIMAX OFDMA, TD-SCDMA, 1xEVDO, DTMB (CTTB), DVB-T/H, ISDB-T, CMMB, LTE, LTETDD, Digital Cable TV, WLAN, MSR, LTEAFDD, LTEATDD
Remote Command	:CALCulate:SEMask:MARKer:AOFF
Example	CALC:SEM:MARK:AOFF
Initial S/W Revision	Prior to A.02.00
Modified at S/W Revision	A.02.00, A.03.00

Marker X Axis Value (Remote Command Only)

Sets the marker X Axis value in the current marker X Axis Scale unit. It has no effect if the control mode is Off, but is the SCPI equivalent of entering an X value if the control mode is Normal.

Mode	SA, WCDMA, C2K, WIMAX OFDMA, TD-SCDMA, 1xEVDO, DTMB (CTTB), DVB-T/H ISDB-T, CMMB, LTE, LTETDD, Digital Cable TV, WLAN, MSR, LTEAFDD, LTEATDD
Remote Command	:CALCulate:SEMask:MARKer[1] 2 ... 12:X <freq>

	:CALCulate:SEMask:MARKer[1] 2 ... 12:X?
Example	CALC:SEM:MARK3:X 1.0 GHz CALC:SEM:MARK3:X?
Notes	<p>If no suffix is sent it will use the fundamental units for the current marker X Axis Scale. If a suffix is sent that does not match the current marker X Axis Scale unit, an error "Invalid suffix" will be generated.</p> <p>The query returns the marker's absolute X Axis value if the control mode is Normal. The query is returned in the fundamental units for the current marker X Axis scale. If the marker is Off the response is not a number.</p> <p>When a Marker is turned on, it is placed center of the screen on the trace. Therefore the default value depends on instrument condition, although the Preset/Default is defined as 1.5 GHz.</p>
Preset	After a preset, , all Markers are turned OFF, , so a Marker X Axis Value query will return a not a number (NAN).
State Saved	No
Min	-9.9E+37
Max	9.9E+37
Initial S/W Revision	Prior to A.02.00
Modified at S/W Revision	A.02.00, A.03.00

Marker X Axis Position (Remote Command Only)

Sets the marker X position in trace points. It has no effect if the control mode is Off, but is the SCPI equivalent of entering a value if the control mode is Normal, except in trace points rather than X Axis Scale units. The entered value is immediately translated into the current X Axis Scale units for setting the value of the marker.

Mode	SA, WCDMA, C2K, WIMAX OFDMA, TD-SCDMA, 1xEVDO, DTMB (CTTB), DVB-T/H, ISDB-T, CMMB, LTE, LTE-TDD, Digital Cable TV, WLAN, MSR, LTEAFDD, LTEATDD
Remote Command	:CALCulate:SEMask:MARKer[1] 2 ... 12:X:POsition <real> :CALCulate:SEMask:MARKer[1] 2 ... 12:X:POsition?
Example	CALC:SEM:MARK10:X:POS 1001 CALC:SEM:MARK10:X:POS?
Notes	<p>The query returns the marker's absolute X Axis value in trace points if the control mode is Normal. The value is returned as a real number, not an integer, corresponding to the translation from X Axis Scale units to trace points . If the marker is Off the response is not a number.</p> <p>When a Marker is turned on, it is placed center of the screen on the trace. Therefore the default value depends on the instrument condition although the Preset/Default is defined as 6507 (this value might be the expected value when all the offsets are on).</p>
Preset	After a preset, , all Markers are turned OFF, , so a Marker X Axis Value query will return a not a number (NAN).
State Saved	No

Min	-9.9E+37
Max	9.9E+37
Initial S/W Revision	Prior to A.02.00
Modified at S/W Revision	A.02.00, A.03.00

Marker Y Axis Value (Remote Command Only)

Returns the marker Y Axis value in the current marker Y Axis unit.

Mode	SA, WCDMA, C2K, WIMAX OFDMA, TD-SCDMA, 1xEVDO, DTMB (CTTB), DVB-T/H, ISDB-T, CMMB, LTE, LTE-TDD, Digital Cable TV, WLAN, MSR, LTEAFDD, LTEATDD
Remote Command	:CALCulate:SEMask:MARKer[1] 2 ... 12:Y?
Example	CALC:SEM:MARK11:Y 10 dBm CALC:SEM:MARK11:Y?
Notes	Since the result value is always calculated from acquisition data, the default value is arbitrary, although the Preset/Default values is defined.
Preset	Result dependent on markers setup and signal source
State Saved	No
Backwards Compatibility SCPI	:CALCulate:SEMask:MARKer[1] 2 ... 12:FUNction:RESult?
Initial S/W Revision	Prior to A.02.00
Modified at S/W Revision	A.02.00, A.03.00

Marker Function

There are no 'Marker Functions' supported in Spectrum Emission Mask so this front-panel key displays a blank menu when pressed.

Key Path	Front-panel key
Initial S/W Revision	Prior to A.02.00

Marker To

There is no 'Marker To' functionality supported in Spectrum Emission Mask so this front-panel key displays a blank menu when pressed.

Key Path	Front-panel key
Initial S/W Revision	Prior to A.02.00

Meas

The information in this section is common to all measurements. For key and remote command information for a specific measurement, refer to the section that describes the measurement of interest.

Measurements available under the Meas key are specific to the current Mode.

When viewing Help for measurements, note the following:

NOTE

Operation for some keys differs between measurements. The information displayed in Help pertains to the current measurement. To see how a key operates in a different measurement, exit Help (press the Cancel Esc key), select the measurement, then reenter Help (press the Help key) and press that key.

Key Path	Front-panel key
Initial S/W Revision	Prior to A.02.00

Remote Measurement Functions

This section contains the following topics:

"Measurement Group of Commands" on page 2771

"Current Measurement Query (Remote Command Only)" on page 2773

"Limit Test Current Results (Remote Command Only)" on page 2773

"Data Query (Remote Command Only)" on page 2773

"Calculate/Compress Trace Data Query (Remote Command Only)" on page 2774

"Calculate Peaks of Trace Data (Remote Command Only)" on page 2779

Hardware-Accelerated Fast Power Measurement (Remote Command Only)

"Format Data: Numeric Data (Remote Command Only)" on page 2780

"Format Data: Byte Order (Remote Command Only)" on page 2781

Initial S/W Revision	Prior to A.02.00
----------------------	------------------

Measurement Group of Commands

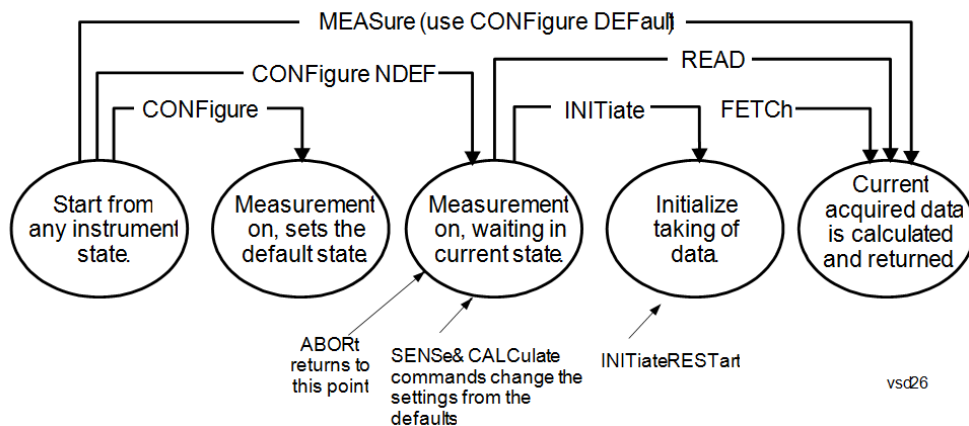

Measure Commands:

:MEASure:<measurement>[n]?

This is a fast single-command way to make a measurement using the factory default instrument settings. These are the settings and units that conform to the Mode Setup settings (e.g. radio standard) that you have currently selected.

- Stops the current measurement (if any) and sets up the instrument for the specified measurement using the factory defaults
- Initiates the data acquisition for the measurement
- Blocks other SCPI communication, waiting until the measurement is complete before returning results.
- If the function does averaging, it is turned on and the number of averages is set to 10.
- After the data is valid it returns the scalar results, or the trace data, for the specified measurement. The type of data returned may be defined by an [n] value that is sent with the command.
- The scalar measurement results will be returned if the optional [n] value is not included, or is set to 1. If the [n] value is set to a value other than 1, the selected trace data results will be returned. See each command for details of what types of scalar results or trace data results are available.
- ASCII is the default format for the data output. (Older versions of Spectrum Analysis and Phase Noise mode measurements only use ASCII.) The binary data formats should be used for handling large blocks of data since they are smaller and faster than the ASCII format. Refer to the FORMat:DATA command for more information.

If you need to change some of the measurement parameters from the factory default settings you can set up the measurement with the CONFigure command. Use the commands in the SENSe:<measurement> and CALCulate:<measurement> subsystems to change the settings. Then you can use the READ? command to initiate the measurement and query the results.

If you need to repeatedly make a given measurement with settings other than the factory defaults, you can use the commands in the SENSe:<measurement> and CALCulate:<measurement> subsystems to set up the measurement. Then use the READ? command to initiate the measurement and query results.

Measurement settings persist if you initiate a different measurement and then return to a previous one. Use READ:<measurement>? if you want to use those persistent settings. If you want to go back to the default settings, use MEASure:<measurement>?.

Configure Commands:

:CONFigure:<measurement>

This command stops the current measurement (if any) and sets up the instrument for the specified measurement using

the factory default instrument settings. It does not initiate the taking of measurement data unless INIT:CONTInuous is ON. If you change any measurement settings after using the CONFigure command, the READ command can be used to initiate a measurement without changing the settings back to their defaults.

In the Swept SA measurement in Spectrum Analyzer mode the CONFigure command also turns the averaging function on and sets the number of averages to 10 for all measurements.

:CONFigure: <measurement>: NDEFault stops the current measurement and changes to the specified measurement. It does not change the settings to the defaults. It does not initiate the taking of measurement data unless INIT:CONTInuous is ON.

The CONFigure? query returns the current measurement name.

The CONFigure:CATalog? query returns a quoted string of all licensed measurement names in the current mode. For example, "SAN, CHP, OBW, ACP, PST, TXP, SPUR, SEM, LIST".

Fetch Commands:

:FETCh:<measurement>[n]?

This command puts selected data from the most recent measurement into the output buffer. Use FETCh if you have already made a good measurement and you want to return several types of data (different [n] values, for example, both scalars and trace data) from a single measurement. FETCh saves you the time of re-making the measurement. You can only FETCh results from the measurement that is currently active, it will not change to a different measurement. An error message is reported if a measurement other than the current one is specified.

If you need to get new measurement data, use the READ command, which is equivalent to an INITiate followed by a FETCh.

The scalar measurement results will be returned if the optional [n] value is not included, or is set to 1. If the [n] value is set to a value other than 1, the selected trace data results will be returned. See each command for details of what types of scalar results or trace data results are available. The binary data formats should be used for handling large blocks of data since they are smaller and transfer faster than the ASCII format. (FORMat:DATA)

FETCh may be used to return results other than those specified with the original READ or MEASure command that you sent.

INITiate Commands:

:INITiate:<measurement>

This command is not available for measurements in all the instrument modes:

- Initiates a trigger cycle for the specified measurement, but does not output any data. You must then use the FETCh<meas> command to return data. If a measurement other than the current one is specified, the instrument will switch to that measurement and then initiate it.
- For example, suppose you have previously initiated the ACP measurement, but now you are running the channel power measurement. If you send INIT:ACP? it will change from channel power to ACP and will initiate an ACP measurement.
- Does not change any of the measurement settings. For example, if you have previously started the ACP measurement and you send INIT:ACP? it will initiate a new ACP measurement using the same instrument settings as the last time ACP was run.
- If your selected measurement is currently active (in the idle state) it triggers the measurement, assuming the trigger conditions are met. Then it completes one trigger cycle. Depending upon the measurement and the number of averages, there may be multiple data acquisitions, with multiple trigger events, for one full trigger cycle. It also holds off additional commands on GPIB until the acquisition is complete.

READ Commands:

:READ:<measurement>[n]?

- Does not preset the measurement to the factory default settings. For example, if you have previously initiated the ACP
-

measurement and you send READ:ACP? it will initiate a new measurement using the same instrument settings.

- Initiates the measurement and puts valid data into the output buffer. If a measurement other than the current one is specified, the instrument will switch to that measurement before it initiates the measurement and returns results.
 - For example, suppose you have previously initiated the ACP measurement, but now you are running the channel power measurement. Then you send READ:ACP? It will change from channel power back to ACP and, using the previous ACP settings, will initiate the measurement and return results.
 - Blocks other SCPI communication, waiting until the measurement is complete before returning the results
 - If the optional [n] value is not included, or is set to 1, the scalar measurement results will be returned. If the [n] value is set to a value other than 1, the selected trace data results will be returned. See each command for details of what types of scalar results or trace data results are available. The binary data formats should be used when handling large blocks of data since they are smaller and faster than the ASCII format. (FORMat:DATA)
-

Initial S/W Revision	Prior to A.02.00
----------------------	------------------

Current Measurement Query (Remote Command Only)

This command returns the name of the measurement that is currently running.

Remote Command	:CONFigure?
-----------------------	-------------

Example	CONF?
----------------	-------

Initial S/W Revision	Prior to A.02.00
----------------------	------------------

Limit Test Current Results (Remote Command Only)

Queries the status of the current measurement limit testing. It returns a 0 if the measured results pass when compared with the current limits. It returns a 1 if the measured results fail any limit tests.

Remote Command	:CALCulate:CLIMits:FAIL?
-----------------------	--------------------------

Example	CALC:CLIM:FAIL? queries the current measurement to see if it fails the defined limits. Returns a 0 or 1: 0 it passes, 1 it fails.
----------------	--

Initial S/W Revision	Prior to A.02.00
----------------------	------------------

Data Query (Remote Command Only)

Returns the designated measurement data for the currently selected measurement and subopcode.

n = any valid subopcode for the current measurement. See the measurement command results table for your current measurement, for information about what data is returned for the subopcodes.

This command uses the data setting specified by the FORMat:BORDER and FORMat:DATA commands and can return real or ASCII data. (See the format command descriptions under Input/Output in the Analyzer Setup section.)

Remote Command	:CALCulate:DATA[n]?
Notes	The return trace depends on the measurement. In CALCulate:<meas>:DATA[n], n is any valid subopcode for the current measurement. It returns the same data as the FETCH:<measurement>? query where <measurement> is the current measurement.
Initial S/W Revision	Prior to A.02.00

Calculate/Compress Trace Data Query (Remote Command Only)

Returns compressed data for the currently selected measurement and sub-opcode [n].

n = any valid sub-opcode for that measurement. See the MEASure:<measurement>? command description of your specific measurement for information on the data that can be returned.

The data is returned in the current Y Axis Unit of the analyzer. The command is used with a sub-opcode <n> (default=1) to specify the trace. With trace queries, it is best if the analyzer is not sweeping during the query. Therefore, it is generally advisable to be in Single Sweep, or Update=Off.

This command is used to compress or decimate a long trace to extract and return only the desired data. A typical example would be to acquire N frames of GSM data and return the mean power of the first burst in each frame. The command can also be used to identify the best curve fit for the data.

Remote Command	:CALCulate:DATA<n>:COMPRESS? BLOCK CFIT MAXimum MINimum MEAN DMEan RMS RMSCubed SAMPLE SDEVIation PPHase [,<soffset> [,<length>[,<roffset>[,<rlimit>]]]]
Example	To query the mean power of a set of GSM bursts: Supply a signal that is a set of GSM bursts. Select the IQ Waveform measurement (in IQ Analyzer Mode). Set the sweep time to acquire at least one burst. Set the triggers such that acquisition happens at a known position relative to a burst. Then query the mean burst levels using, CALC:DATA2:COMP? MEAN, 24e-6, 526e-6 (These parameter values correspond to GSM signals, where 526e-6 is the length of the burst in the slot and you just want 1 burst.)
Notes	The command supports 5 parameters. Note that the last 4 (<soffset>, <length>, <roffset>, <rlimit>) are optional. But these optional parameters must be entered in the specified order. For example, if you want to specify <length>, then you must also specify <soffset>. See details below for a definition of each of these parameters. This command uses the data in the format specified by FORMat:DATA, returning either binary or ASCII data.
Initial S/W Revision	Prior to A.02.00

- BLOCK or block data - returns all the data points from the region of the trace data that you specify. For example, it could be used to return the data points of an input signal over several timeslots, excluding the portions of the trace data that you do not want. (This is x,y pairs for trace data and I,Q pairs for complex data.)

- CFIT or curve fit - applies curve fitting routines to the data. <soffset> and <length> are required to define the data that you want. <roffset> is an optional parameter for the desired order of the curve equation. The query will return the following values: the x-offset (in seconds) and the curve coefficients ((order + 1) values).

MIN, MAX, MEAN, DME, RMS, RMSC, SAMP, SDEV and PPH return one data value for each specified region (or <length>) of trace data, for as many regions as possible until you run out of trace data (using <roffset> to specify regions). Or they return the number of regions you specify (using <rlimit>) ignoring any data beyond that.

- MINimum - returns the minimum data point (y value) for the specified region(s) of trace data. For I/Q trace data, the minimum magnitude of the I/Q pairs is returned.
- MAXimum - returns the maximum data point (y value) for the specified region(s) of trace data. For I/Q trace data, the maximum magnitude of the I/Q pairs is returned.
- MEAN - returns a single value that is the arithmetic mean of the data point values (in dB/ dBm) for the specified region(s) of trace data. For I/Q trace data, the mean of the magnitudes of the I/Q pairs is returned. See the following equations.

NOTE If the original trace data is in dB, this function returns the arithmetic mean of those log values, not log of the mean power which is a more useful value. The mean of the log is the better measurement technique when measuring CW signals in the presence of noise. The mean of the power, expressed in dB, is useful in power measurements such as Channel Power. To achieve the mean of the power, use the RMS option.

Equation 1

Mean Value of Data Points for Specified Region(s)

$$MEAN = \frac{1}{n} \sum_{X_i \in \text{region}(s)} X_i$$

where X_i is a data point value, and n is the number of data points in the specified region(s).

Equation 2

Mean Value of I/Q Data Pairs for Specified Region(s)

$$MEAN = \frac{1}{n} \sum_{X_i \in \text{region}(s)} |X_i|$$

where $|X_i|$ is the magnitude of an I/Q pair, and n is the number of I/Q pairs in the specified region(s).

- DMEan - returns a single value that is the mean power (in dB/ dBm) of the data point values for the specified region(s) of trace data. See the following equation:

Equation 3

DMEan Value of Data Points for Specified Region(s)

$$\text{DME} = 10 \times \log_{10} \left(\frac{1}{n} \sum_{X_i \in \text{region}(s)} 10^{\frac{X_i}{10}} \right)$$

- RMS - returns a single value that is the average power on a root-mean-squared voltage scale (arithmetic rms) of the data point values for the specified region(s) of trace data. See the following equation.

NOTE For I/Q trace data, the rms of the magnitudes of the I/Q pairs is returned. See the following equation. This function is very useful for I/Q trace data. However, if the original trace data is in dB, this function returns the rms of the log values which is not usually needed.

Equation 4

RMS Value of Data Points for Specified Region(s)

$$\text{RMS} = \sqrt{\frac{1}{n} \sum_{X_i \in \text{region}(s)} X_i^2}$$

where X_i is a data point value, and n is the number of data points in the specified region(s).

Equation 5

RMS Value of I/Q Data Pairs for Specified Region(s)

$$\text{RMS} = \sqrt{\frac{1}{n} \sum_{X_i \in \text{region}(s)} X_i X_i^*}$$

where X_i is the complex value representation of an I/Q pair, X_i^* its conjugate complex number, and n is the number of I/Q pairs in the specified region(s).

Once you have the rms value for a region of trace data (linear or I/Q), you may want to calculate the mean power. You must convert this rms value (peak volts) to power in dBm:

$$10 \times \log[10 \times (\text{rms value})^2]$$

- SAMPLe - returns the first data value (x,y pair) for the specified region(s) of trace data. For I/Q trace data, the first I/Q pair is returned.
- SDEViation - returns a single value that is the arithmetic standard deviation for the data point values for the specified region(s) of trace data. See the following equation.
- For I/Q trace data, the standard deviation of the magnitudes of the I/Q pairs is returned. See the following equation.

Equation 6

Standard Deviation of Data Point Values for Specified Region(s)

$$\text{SDEV} = \sqrt{\frac{1}{n} \sum_{X_i \in \text{region}(s)} (X_i - \bar{X})^2}$$

where X_i is a data point value, \bar{X} is the arithmetic mean of the data point values for the specified region (s), and n is the number of data points in the specified region(s).

$$\text{SDEV} = \sqrt{\frac{1}{n} \sum_{X_i \in \text{region}(s)} (|X_i| - \bar{X})^2}$$

where $|X_i|$ is the magnitude of an I/Q pair, \bar{X} is the mean of the magnitudes for the specified region(s), and n is the number of data points in the specified region(s).

- PPHase - returns the x,y pairs of both rms power (dBm) and arithmetic mean phase (radian) for every specified region and frequency offset (Hz). The number of pairs is defined by the specified number of regions. This parameter can be used for I/Q vector ($n=0$) in Waveform (time domain) measurement and all parameters are specified by data point in PPHase.

The rms power of the specified region may be expressed as:

$$\text{Power} = 10 \times \log [10 \times (\text{RMS I/Q value})] + 10.$$

The RMS I/Q value (peak volts) is:

$$\sqrt{\frac{1}{n} \sum_{X_i \in \text{region}} X_i X_i^*}$$

where X_i is the complex value representation of an I/Q pair, X_i^* its conjugate complex number, and n is the number of I/Q pairs in the specified region.

The arithmetic mean phase of the specified region may be expressed as:

$$\frac{1}{n} \sum_{Y_i \in \text{region}} Y_i$$

where Y_i is the unwrapped phase of I/Q pair with applying frequency correction and n is the number of I/Q pairs in the specified region.

The frequency correction is made by the frequency offset calculated by the arithmetic mean of every specified region's frequency offset. Each frequency offset is calculated by the least square method against the unwrapped phase of I/Q pair.

Sample Trace Data - Constant Envelope

(See below for explanation of variables.)

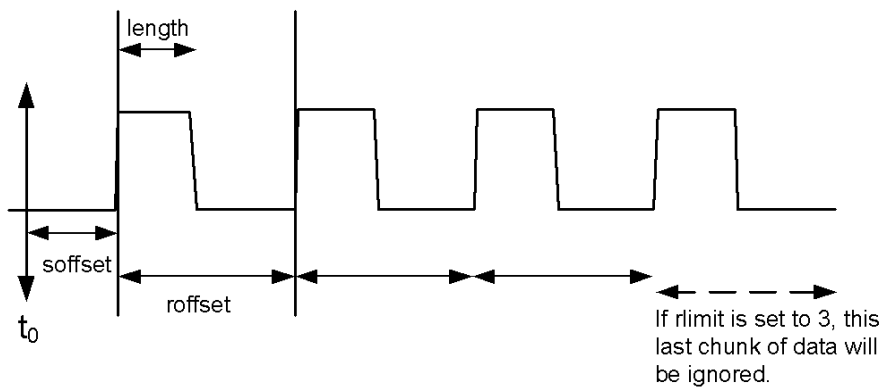

Sample Trace Data - Not Constant Envelope

(See below for explanation of variables.)

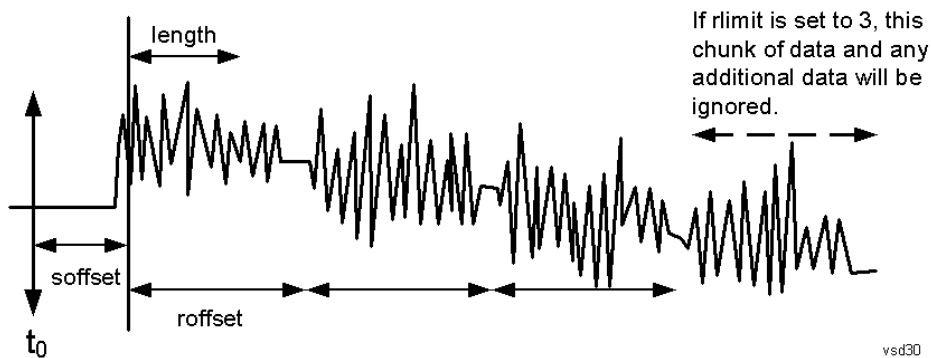

<soffset> - start offset is an optional real number. (It is in seconds for time-domain traces, and is a dimensionless index 0 to $N_{\text{points}} - 1$, for frequency-domain traces). It specifies the amount of data at the beginning of the trace that will be ignored before the decimation process starts. It is the time or frequency change from the start of the trace to the point where you want to start using the data. The default value is zero.

<length> - is an optional real number. (It is in seconds for time-domain traces, and is a dimensionless index 0 to $N_{\text{points}} - 1$, for frequency-domain traces). It defines how much data will be compressed into one value. This parameter has a default value equal to the current trace length.

<roffset> - repeat offset is an optional real number. (It is in seconds for time-domain traces, and is a dimensionless index 0 to $N_{\text{points}} - 1$, for frequency-domain traces). It defines the beginning of the next field of trace elements to be compressed. This is relative to the beginning of the previous field. This parameter has a default value equal to the <length> variable. Note that this parameter is used for a completely different purpose when curve fitting (see CFIT above).

<rlimit> - repeat limit is an optional integer. It specifies the number of data items that you want returned. It will ignore any additional items beyond that number. You can use the Start offset and the Repeat limit to pick out exactly what part of the data you want to use. The default value is all the data.

Calculate Peaks of Trace Data (Remote Command Only)

Returns a list of all the peaks for the currently selected measurement and sub-opcode [n]. The peaks must meet the requirements of the peak threshold and excursion values.

n = any valid sub-opcode for the current measurement. See the MEASure:<measurement> command description of your specific measurement for information on the data that can be returned.

The command can only be used with specific sub-opcodes with measurement results that are trace data. Both real and complex traces can be searched, but complex traces are converted to magnitude in dBm. In many measurements the sub-opcode n=0, is the raw trace data which cannot be searched for peaks. And Sub-opcode n=1, is often calculated results values which also cannot be searched for peaks.

This command uses the data setting specified by the FORMat:BORDER and FORMat:DATA commands and can return real or ASCII data. If the format is set to INT,32, it returns REAL,32 data.

The command has four types of parameters:

- Threshold (in dBm)
- Excursion (in dB)
- Sorting order (amplitude, frequency, time)
- Optional in some measurements: Display line use (all, > display line, < display line)

Remote Command	<p>For Swept SA measurement:</p> <pre>:CALCulate:DATA[1] 2 ... 6:PEAKs? <threshold>,<excursion>[,AMPLitude FREQuency TIME[,ALL GTDLLine LTDLine]]</pre> <p>For most other measurements:</p> <pre>:CALCulate:DATA[1] 2 ... 6:PEAKs? <threshold>,<excursion>[,AMPLitude FREQuency TIME]</pre>
-----------------------	---

Example	<p>Example for Swept SA measurement in Spectrum Analyzer Mode:</p> <p>CALC:DATA4:PEAK? -40, 10, FREQ, GTDL This will identify the peaks of trace 4 that are above -40 dBm, with excursions of at least 10 dB. The peaks are returned in order of increasing frequency, starting with the lowest frequency. Only the peaks that are above the display line are returned.</p> <p>Query Results 1:</p> <p>With FORMat:DATA REAL, 32 selected, it returns a list of floating-point numbers. The first value in the list is the number of peak points that are in the following list. A peak point consists of two values: a peak amplitude followed by its corresponding frequency (or time).</p> <p>If no peaks are found the peak list will consist of only the number of peaks, (0).</p>
----------------	---

Notes	<p><n> - is the trace that will be used</p> <p><threshold> - is the level below which trace data peaks are ignored. Note that the threshold value is required and is always used as a peak criterion. To effectively disable the threshold criterion for this command, provide a substantially low threshold value such as -200 dBm. Also note that the threshold value used in this command is independent of and has no effect on the threshold value stored under the Peak Criteria menu.</p> <p><excursion> - is the minimum amplitude variation (rise and fall) required for a signal to be identified as peak. Note that the excursion value is required and is always used as a peak criterion. To effectively disable the excursion criterion for this command, provide the minimum value of 0.0 dB. Also note that the excursion value used in this command is independent of and has no effect on the</p>
--------------	---

excursion value stored under the Peak Criteria menu.

Values must be provided for threshold and excursion. The sorting and display line parameters are optional (defaults are AMPLitude and ALL).

Note that there is always a Y-axis value for the display line, regardless of whether the display line state is on or off. It is the current Y-axis value of the display line which is used by this command to determine whether a peak should be reported

Sorting order:

AMPLitude - lists the peaks in order of descending amplitude, with the highest peak first (default if optional parameter not sent)

FREQUency - lists the peaks in order of occurrence, left to right across the x-axis.

TIME - lists the peaks in order of occurrence, left to right across the x-axis.

Peaks vs. Display Line:

ALL - lists all of the peaks found (default if optional parameter not sent).

GTDLine (greater than display line) - lists all of the peaks found above the display line.

LTDLine (less than display line) - lists all of the peaks found below the display line.

Initial S/W Revision Prior to A.02.00

Format Data: Numeric Data (Remote Command Only)

This command specifies the format of the trace data input and output. It specifies the formats used for trace data during data transfer across any remote port. It affects only the data format for setting and querying trace data for the :TRACe[:DATA], TRACe[:DATA]?, :CALCulate:DATA[n]? and FETCh:SANalyzer [n]? commands and queries.

Remote Command :FORMat[:TRACe][:DATA] ASCii|INTeger,32|REAL,32 |REAL,64
:FORMat[:TRACe][:DATA]?

Notes The query response is:
ASCii: ASC,8
REAL,32: REAL,32
REAL,64: REAL,64
INTeger,32: INT,32

When the numeric data format is REAL or ASCii, data is output in the current Y Axis unit. When the data format is INTeger, data is output in units of m dBm (.001 dBm).

The INT,32 format returns binary 32-bit integer values in internal units (m dBm), in a definite length block.

Dependencies Sending a data format spec with an invalid number (for example, INT,48) generates no error. The analyzer simply uses the default (8 for ASCii, 32 for INTeger, 32 for REAL).

Sending data to the analyzer which does not conform to the current FORMat specified, results in an error. Sending ASCII data when a definite block is expected generates message -161 "Invalid Block Data" and sending a definite block when ASCII data is expected generates message -121 "Invalid Character in Number".

Preset ASCii

Backwards Compatibility Notes Note that the INT,32 format is only applicable to the command, TRACe:DATA. This preserves backwards compatibility for the Swept SA measurement. For all other commands/queries which honor FORMat:DATA, if INT,32 is sent the analyzer will behave as though it were set to REAL,32.

Initial S/W Revision Prior to A.02.00

The specs for each output type follow:

ASCIi - Amplitude values are in ASCII, in the current Y Axis Unit, one ASCII character per digit, values separated by commas, each value in the form:

SX.YYYYYEsZZ

Where:

S = sign (+ or -)

X = one digit to left of decimal point

Y = 5 digits to right of decimal point

E = E, exponent header

s = sign of exponent (+ or -)

ZZ = two digit exponent

REAL,32 - Binary 32-bit real values in the current Y Axis Unit, in a definite length block.

REAL,64 - Binary 64-bit real values in the current Y Axis Unit, in a definite length block.

Format Data: Byte Order (Remote Command Only)

This command selects the binary data byte order for data transfer and other queries. It controls whether binary data is transferred in normal or swapped mode. This command affects only the byte order for setting and querying trace data for the :TRACe[:DATA], TRACe[:DATA]? , :CALCulate:DATA[n]? and FETCh:SANalyzer[n]? commands and queries.

By definition any command that says it uses FORMat:DATA uses any format supported by FORMat:DATA.

The NORMal order is a byte sequence that begins with the most significant byte (MSB) first, and ends with the least significant byte (LSB) last in the sequence: 1|2|3|4. SWAPped order is when the byte sequence begins with the LSB first, and ends with the MSB last in the sequence: 4|3|2|1.

Remote Command	:FORMat:BORDER NORMal SWAPped :FORMat:BORDER?
Preset	NORMal
Initial S/W Revision	Prior to A.02.00

Meas Setup

Displays the setup menu for the currently selected measurement.

Key Path	Front-panel key
Initial S/W Revision	Prior to A.02.00

Avg/Hold Num

Toggles averaging On or Off in addition to enabling you to set the number of measurement averages used to calculate the measurement result. The average is displayed at the end of each sweep. After the specified number of average counts, the average mode (termination control) setting determines the average action.

In the remote mode, use the Average State command to turn averaging on or off.

Key Path	Meas Setup
Mode	SA, WCDMA, C2K, WIMAX OFDMA, TD-SCDMA, 1xEVDO, DTMB (CTTB), DVB-T/H, ISDB-T, CMMB, LTE, LTE-TDD, Digital Cable TV, WLAN, MSR, LTEAFDD, LTEATDD
Remote Command	[:SENSe]:SEMask:AVERage:COUNT <integer> [:SENSe]:SEMask:AVERage:COUNT? [:SENSe]:SEMask:AVERage[:STATe] ON OFF 1 0 [:SENSe]:SEMask:AVERage[:STATe]?
Example	SEM:AVER:COUN 100 SEM:AVER:COUN? SEM:AVER ON SEM:AVER?
Notes	You must be in the mode that includes SEM measurement to use this command. Use :INSTrument:SElect to set the mode.
Preset	10 OFF
State Saved	Saved in instrument state.
Min	1
Max	10000
Initial S/W Revision	Prior to A.02.00
Modified at S/W Revision	A.02.00, A.03.00

Meas Type

Accesses a menu that enables you to select one of the following measurement reference types:

- Total Pwr Ref – Sets the reference to the total carrier power and the measured data is shown in dBc and dBm.
- PSD Ref – Sets the reference to the mean power spectral density of the carrier and the measured data is shown in dB and dBm/Hz.
- Spectrum Peak Ref – Sets the reference to the spectrum peak power of the carrier and the measured data is shown in dB and dBm.

Key Path	Meas Setup
Mode	SA, WCDMA, C2K, WIMAX OFDMA, TD-SCDMA, 1xEVDO, DTMB (CTTB), DVB-T/H, ISDB-T, CMMB, LTE, LTEFDD, Digital Cable TV, WLAN, MSR, LTEAFDD, LTEATDD
Remote Command	[:SENSe] :SEMAsk:TYPE PSDRef TPRef SPRef [:SENSe] :SEMAsk:TYPE?
Example	SEM:TYPE PSDR SEM:TYPE?
Notes	You must be in the mode that includes SEM measurement to use this command. Use :INSTRument:SElect to set the mode.
Preset	SA, , WCDMA, , C2K, , TD-SCDMA, , 1xEVDO, , DTMB (CTTB), , DVB-T/H, , ISDB-T, , CMMB, , LTE, , LTEFDD, , Digital Cable TV, , MSR, , LTEAFDD, , LTEATDD: TPref WIMAX OFDMA, WLAN: SPRef
State Saved	Saved in instrument state.
Range	Total Pwr Ref PSD Ref Spectrum Peak Ref
Initial S/W Revision	Prior to A.02.00
Modified at S/W Revision	A.02.00, A.03.00

Ref Channel

Accesses a menu that enables you to set up the measurement parameters used to calculate the power in the reference channel.

Key Path	Meas Setup
Initial S/W Revision	Prior to A.02.00

Integ BW

Specifies the integration bandwidth used to calculate the power in the reference channel.

Key Path	Meas Setup, Ref Channel
Mode	SA, WCDMA, C2K, WIMAX OFDMA, TD-SCDMA, 1xEVDO, DTMB (CTTB), DVB-T/H, ISDB-T, CMMB, LTE, LTEFDD, Digital Cable TV, WLAN
Remote Command	[:SENSe] :SEMAsk:BANDwidth[1] 2:INTEgration <bandwidth> [:SENSe] :SEMAsk:BANDwidth[1] 2:INTEgration?

Example	SEM:BAND:INT 10 MHz SEM:BAND:INT?
Notes	10% . 100% of Channel Span Parameter Value Bandwidth sub op code, 1 is for BTS, 2 for MS. Default is BTS. You must be in the mode that includes SEM measurement to use this command. Use :INSTrument:SElect to set the mode.
Dependencies	For MSR and LTE-Advanced FDD/TDD mode, this key is blank.
Couplings	Cannot be higher than the channel Span. If lower than 1/10 of channel Span, then the channel Span is reduced to be 10 times the Integ BW.
Preset	SA: 3.84 MHz WCDMA: 3.84 MHz 3.84 MHz C2K: 1.23 MHz 1.23 MHz WIMAX OFDMA: 10 MHz 10 MHz TD-SCDMA: 1.28 MHz 1.28 MHz 1xEVDO: 1.23MHz DTMB (CTTB): 7.56MHz DVB-T/H: 7.61MHz ISDB-T: 5.6MHz CMMB: 7.512MHz LTE: 4.515MHz 4.5MHz LTETDD: 4.515MHz 4.5MHz Digital Cable TV: 6.9MHz WLAN: if Radio Std is 802.11a/g(OFDM/DSSS-OFDM)/802.11n(20 MHz)/ 802.11ac (20 MHz): 18 MHz if Radio Std is 802.11b/g(DSSS/CCK/PBCC): 22 MHz if Radio Std is 802.11n(40MHz)/ 802.11ac (40 MHz): 38 MHz if Radio Std is 802.11ac (80 MHz): 78 MHz if Radio Std is 802.11ac (160 MHz): 158 MHz if Radio Std is 802.11ac (80 MHz + 80 MHz): 78 MHz
State Saved	Saved in instrument state.
Min	1 kHz
Max	645 MHz
Initial S/W Revision	Prior to A.02.00
Modified at S/W Revision	A.02.00, A.03.00

Span

Specifies the span used to calculate the power in the reference channel.

Key Path	Meas Setup, Ref Channel
----------	-------------------------

Mode	SA, WCDMA, C2K, WIMAX OFDMA, TD-SCDMA, 1xEVDO, DTMB (CTTB), DVB-T/H, ISDB-T, LTE, LTETDD, CMMB, Digital Cable TV, WLAN
Remote Command	[:SENSe] :SEMAsk:FREQuency [1] 2 :SPAN <freq> [:SENSe] :SEMAsk:FREQuency [1] 2 :SPAN?
Example	SEM:FREQ:SPAN 3MHz SEM:FREQ:SPAN?
Notes	Frequency sub op code, 1 is for BTS, 2 for MS. Default is BTS. You must be in the mode that includes SEM measurement to use this command. Use :INSTrument:SElect to set the mode.
Dependencies	For MSR and LTE-Advanced FDD/TDD mode, this key is blank.
Couplings	Range 1 kHz to 50 MHz (although restricted by Integ BW). If you set the channel Span lower than channel Integ BW, they will both track each other. As you increase the channel Span, the Integ BW will also increase if it is less than 1/10 of the channel Span. For WLAN 802.11ac (80 + 80 MHz), the channel span is coupled with the difference between the center frequencies of the two carriers. When the difference is either less than 80 MHz or greater than 565 MHz, a “setting conflict” error message is displayed. Chan Span = Carrier Spacing + Chan IntegBW;
Preset	SA: 5.0 MHz WCDMA: 5.0 MHz 5.0 MHz C2K: 1.25 MHz 1.25 MHz WIMAX OFDMA: 10 MHz 10 MHz TD-SCDMA: 1.6 MHz 1.6 MHz 1xEVDO: 1.25 MHz DTMB (CTTB): 10 MHz DVB-T/H: 10 MHz ISDB-T: 8 MHz CMMB: 10 MHz LTE: 5 MHz LTETDD: 5 MHz Digital Cable TV: 10 MHz WLAN: if Radio Std is 802.11a/g(OFDM/DSSS-OFDM)/802.11n(20 MHz)/ 802.11ac (20 MHz): 18 MHz if Radio Std is 802.11b/g(DSSS/CCK/PBCC): 22 MHz if Radio Std is 802.11n(40MHz)/ 802.11ac (40 MHz): 38 MHz if Radio Std is 802.11ac (80 MHz): 78 MHz if Radio Std is 802.11ac (160 MHz): 158 MHz if Radio Std is 802.11ac (80 MHz + 80 MHz): 240 MHz
State Saved	Saved in instrument state.
Min	1 kHz
Max	645 MHz
Initial S/W Revision	Prior to A.02.00
Modified at S/W Revision	A.02.00, A.03.00

Sweep Time

Sets the sweep time used to calculate the power in the reference channel. Sweep Time can be set manually or put in auto mode.

Key Path	Meas Setup, Ref Channel
Mode	SA, WCDMA, C2K, WIMAX OFDMA, TD-SCDMA, 1xEVDO, DTMB (CTTB), DVB-T/H, ISDB-T, CMMB, LTE, LTE-TDD, Digital Cable TV, WLAN, MSR, LTEAFDD, LTEATDD
Remote Command	[:SENSe]:SEMask:SWEep[1] 2:TIME <time> [:SENSe]:SEMask:SWEep[1] 2:TIME? [:SENSe]:SEMask:SWEep[1] 2:TIME:AUTO OFF 0 ON 1 [:SENSe]:SEMask:SWEep[1] 2:TIME:AUTO?
Example	SEM:SWE:TIME 9ms SEM:SWE:TIME? SEM:SWE:TIME:AUTO OFF SEM:SWE:TIME:AUTO?
Notes	Sub op code, 1 is for BTS, 2 for MS. Default is BTS. You must be in the mode that includes SEM measurement to use this command. Use :INSTrument:SElect to set the mode.
Couplings	When the time is set manually, Auto is set to OFF. Value is coupled with Channel Detector selection, Channel Resolution BW, Channel Video BW if the state is Auto. When set to Auto, the Sweep Time is automatically calculated
Preset	Automatically calculated ON
State Saved	Saved in instrument state.
Min	1 ms
Max	4000 s
Initial S/W Revision	Prior to A.02.00
Modified at S/W Revision	A.02.00, A.03.00

Res BW

Sets the resolution bandwidth used to calculate the power in the reference channel. The Channel Resolution BW can be set manually or put in to auto mode.

MSR Auto RBW:

In the MSR resolution bandwidth is predefined for each radio format. When carriers are configured with multiple radio formats, the narrowest RBW is selected.

LTE	1.4 MHz	13
	3 MHz	27
	5 MHz	47
	10 MHz	91
	15 MHz	150
	20 MHz	180
W-CDMA		75
GSM		30

In LTE-Advanced FDD/TDD, the resolution bandwidth is predefined based on the corresponding bandwidth of the single LTE carrier, which is listed above. When ResBW mode is Auto, the narrowest RBW is selected.

Key Path	Meas Setup, Ref Channel
Mode	SA, WCDMA, C2K, WIMAX OFDMA, TD-SCDMA, 1xEVDO, DTMB (CTTB), DVB-T/H, ISDB-T, CMMB, LTE, LTE-TDD, Digital Cable TV, WLAN, MSR, LTEAFDD, LTEATDD
Remote Command	<pre>[:SENSe]:SEMAsk:BANDwidth[1] 2[:RESolution] <bandwidth> [:SENSe]:SEMAsk:BANDwidth[1] 2[:RESolution]? [:SENSe]:SEMAsk:BANDwidth[1] 2[:RESolution]:AUTO OFF ON 1 0 [:SENSe]:SEMAsk:BANDwidth[1] 2[:RESolution]:AUTO?</pre>
Example	<pre>SEM:BAND 100 kHz SEM:BAND? SEM:BAND:AUTO ON SEM:BAND:AUTO?</pre>
Notes	<p>Bandwidth sub op code, 1 is for BTS, 2 for MS. Default is BTS.</p> <p>You must be in the mode that includes SEM measurement to use this command. Use :INSTrument:SElect to set the mode.</p>
Couplings	<p>When Res BW is set manually, Channel Resolution BW Mode is set to MANual.</p> <p>Value is coupled with Channel Detector selection, Channel Sweep Time, Channel Video BW.</p> <p>When set to Auto, the resolution bandwidth is automatically calculated.</p>
Preset	<pre>SA: 100 kHz WCDMA: 75 kHz C2K: 24 kHz WIMAX OFDMA: 100 kHz TD-SCDMA: 30 kHz 1xEVDO: 30.0 kHz DTMB (CTTB): 3.9 kHz DVB-T/H: 3.9 kHz ISDB-T: 10 kHz CMMB: 3.9 kHz</pre>

	LTE, , LTETDD, , MSR, , LTEAFDD, , LTEATDD:Auto (47 kHz) Digital Cable TV: 3.9 kHz WLAN: 100 kHz ON
State Saved	Saved in instrument state.
Min	1 Hz
Max	8 MHz
Backwards Compatibility SCPI	[:SENSe] :SEMAsk:BWIDth[1] 2 [:RESolution]
Initial S/W Revision	Prior to A.02.00
Modified at S/W Revision	A.02.00, A.03.00

Video BW

Sets the video bandwidth used to calculate the power in the reference channel. The Channel Video BW can be set manually or put in to auto mode.

Key Path	Meas Setup, Ref Channel
Mode	SA, WCDMA, C2K, WIMAX OFDMA, TD-SCDMA, 1xEVDO, DTMB (CTTB), DVB-T/H, ISDB-T, CMMB, LTE, LTETDD, Digital Cable TV, WLAN, MSR, LTEAFDD, LTEATDD
Remote Command	[:SENSe] :SEMAsk:BANDwidth[1] 2:VIDeo <bandwidth> [:SENSe] :SEMAsk:BANDwidth[1] 2:VIDeo? [:SENSe] :SEMAsk:BANDwidth[1] 2:VIDeo:AUTO OFF ON 1 0 [:SENSe] :SEMAsk:BANDwidth[1] 2:VIDeo:AUTO?
Example	SEM:BAND:VID 100 kHz SEM:BAND:VID? SEM:BAND:VID:AUTO ON SEM:BAND:VID:AUTO?
Notes	Bandwidth sub op code, 1 is for BTS, 2 for MS. Default is BTS. You must be in the mode that includes SEM measurement to use this command. Use :INSTrument:SElect to set the mode.
Couplings	When Video BW is set manually, Channel Video BW Mode is set to MANual Value is coupled with Channel Detector selection, Channel Sweep Time, Channel Resolution BW. When set to Auto, the video bandwidth is automatically calculated.
Preset	SA: 100 kHz WCDMA: 75 kHz C2K: 24 kHz WIMAX OFDMA: 30 kHz TD-SCDMA: 300 kHz 1xEVDO: 300.0 kHz

	DTMB (CTTB): 39 kHz DVB-T/H: 39 kHz ISDB-T: 1 kHz CMMB: 39 kHz LTE, MSR, LTEAFDD, LTEATDD: Auto LTETDD: Auto Digital Cable TV: 39 kHz WLAN: Auto ON
State Saved	Saved in instrument state.
Min	1 Hz
Max	50 MHz
Backwards Compatibility SCPI	[:SENSe] : SEMask : BWIDth [1] 2 : VIDEo
Initial S/W Revision	Prior to A.02.00
Modified at S/W Revision	A.02.00, A.03.00

VBW/RBW

Sets the Video BW/Resolution BW Ratio to calculate the Channel Resolution BW and Channel Video BW. The VBW/RBW Ratio can be set manually or put in to auto mode.

Key Path	Meas Setup, Ref Channel
Mode	SA, WCDMA, C2K, WIMAX OFDMA, TD-SCDMA mode, 1xEVDO, DTMB (CTTB), DVB-T/H, ISDB-T, CMMB, LTE, LTETDD, Digital Cable TV, WLAN, MSR, LTEAFDD, LTEATDD
Remote Command	[:SENSe] : SEMask : BANDwidth [1] 2 : VIDEo : RATio <real> [:SENSe] : SEMask : BANDwidth [1] 2 : VIDEo : RATio [:SENSe] : SEMask : BANDwidth [1] 2 : VIDEo : RATio : AUTO OFF ON 1 0 [:SENSe] : SEMask : BANDwidth [1] 2 : VIDEo : RATio : AUTO ?
Example	SEM:BAND:VID:RAT 0.1 SEM:BAND:VID:RAT? SEM:BAND:VID:RAT:AUTO ON SEM:BAND:VID:RAT:AUTO?
Notes	Bandwidth sub op code, 1 is for BTS, 2 for MS. Default is BTS. You must be in the mode that includes SEM measurement to use this command. Use :INSTrument:SElect to set the mode.
Couplings	When Video BW/Res BW is set manually, Channel VBW/RBW Ratio Mode is set to MANual When set to Auto, the VBW/RBW Ratio is automatically calculated.
Preset	SA, WCDMA, C2K: 1.0 WIMAX OFDMA: 0.3

	TD-SCDMA: 10 1xEVDO: 10.0 DTMB (CTTB): 10 DVB-T/H: 10 ISDB-T: 0.1 CMMB: 10 LTE, MSR: Auto LTEAFDD,LTEATDD:Auto LTETDD: Auto Digital Cable TV: 10 WLAN: Auto ON
State Saved	Saved in instrument state.
Min	0.00001
Max	3000000
Backwards Compatibility SCPI	[:SENSe] :SEMask:BWIDth [1] 2 :VIDeo:RATio
Initial S/W Revision	Prior to A.02.00
Modified at S/W Revision	A.02.00, A.03.00

Power Ref (for the modes except MSR and LTE-Advanced FDD/TDD)

Sets the power reference in the carrier that will be used to compute the relative values for the offsets.

Key Path	Meas Setup, Ref Channel
Initial S/W Revision	Prior to A.02.00

Total Power

Sets the power in the carrier (ref channel) that is used to compute the relative power values for the offsets. When the state is set to auto, this value is set to the measured carrier reference power. When set to manual, the result takes on the last measured value, or can be manually entered.

For WLAN 802.11ac (80 MHz + 80 MHz), the higher of the power readouts of the two carriers is used for computing the relative power values for the offset.

Key Path	Meas Setup, Ref Channel, Power Ref
Mode	SA, WCDMA, C2K, WIMAX OFDMA, TD-SCDMA, 1xEVDO, DTMB (CTTB), DVB-T/H, ISDB-T, CMMB, LTE, LTETDD, Digital Cable TV, WLAN, MSR, LTEAFDD, LTEATDD
Remote Command	[:SENSe] :SEMask:CARRier [:POWER] <real> [:SENSe] :SEMask:CARRier [:POWER] ?

	<code>[:SENSe] :SEMAsk :CARRier :AUTO [:STATe] OFF ON 1 0</code>
	<code>[:SENSe] :SEMAsk :CARRier :AUTO [:STATe] ?</code>
Example	SEM:CARR 100dBm SEM:CARR? SEM:CARR:AUTO OFF SEM:CARR:AUTO?
Notes	The min and max values given are for Meas Type = Total Pwr Ref. You must be in the mode that includes SEM measurement to use this command. Use :INSTrument:SElect to set the mode.. This BAF SCPI command is available in all the Meas Type case. This BAF SCPI command is not available in MSR and LTE-Advanced FDD/TDD mode.
Dependencies	This "Total Power Ref" parameter is coupled with the "Meas Type" parameter. The softkey is active when Meas Type is set to Total Power Ref. Otherwise, it is grayed out.
Preset	Measured carrier reference power
State Saved	Saved in instrument state.
Min	-200 dBm
Max	200 dBm
Initial S/W Revision	Prior to A.02.00
Modified at S/W Revision	A.02.00, A.03.00

PSD

Sets the power spectral density in the carrier that is used to compute the relative power spectral density values for the offsets when Meas Type is set to PSD Ref. When the state is set to auto, this will be set to the measured carrier power spectral density.

For WLAN 802.11ac (80 MHz + 80 MHz), the higher of the power density readouts of the two carriers is used for computing the relative PSD values for the offset.

Key Path	Meas Setup, Ref Chan, Power Ref
Mode	SA, WCDMA, C2K , WIMAX OFDMA, TD-SCDMA, 1xEVDO, DTMB (CTTB), DVB-T/H, ISDB-T, CMMB, LTE, LTE-TDD, Digital Cable TV, WLAN, MSR, LTEAFDD, LTEATDD
Remote Command	<code>[:SENSe] :SEMAsk :CARRier :CPSD <real></code> <code>[:SENSe] :SEMAsk :CARRier :CPSD ?</code>
Example	SEM:CARR:CPSD -80 SEM:CARR:CPSD?
Notes	Although the default value is defined, the value is recalculated by the measurement result just after completing the measurement. Carrier sub op code. 1 for BTS, 2 for MS. Default is BTS. You must be in the mode that includes SEM measurement to use this command. Use :INSTrument:SElect to set the mode.

Dependencies	See Couplings
Couplings	This "PSD" parameter is coupled with the "Meas Type" parameter. The key will be active if the Meas Type is set to PSD. Otherwise, it is grayed out.
Preset	Measured carrier PSD reference power
State Saved	Saved in instrument state.
Min	-200
Max	200
Initial S/W Revision	Prior to A.02.00
Modified at S/W Revision	A.02.00, A.03.00

Spectrum Peak

Sets the spectrum peak power in the carrier that is used to compute the relative power spectral density values for the offsets when Meas Type is set to Spectrum Peak. When the state is set to auto, this is set to the measured carrier spectrum peak power. When set to manual, the result takes on the last measured value, or can be manually entered

Key Path	Meas Setup, Ref Channel, Power Ref
Mode	SA, WCDMA, C2K, WIMAX OFDMA, TD-SCDMA, 1xEVDO, DTMB (CTTB), DVB-T/H, ISDB-T, CMMB, LTE, LTE-TDD, Digital Cable TV, WLAN
Remote Command	<code>[:SENSe] :SEMAsk :CARRier :PEAK [:POWER] <real></code> <code>[:SENSe] :SEMAsk :CARRier :PEAK [:POWER] ?</code>
Example	<code>SEM:CARR:PEAK -80</code> <code>SEM:CARR:PEAK:POWER?</code>
Notes	Although the default value is defined, the value is recalculated by the measurement result just after completing the measurement. Carrier sub op code. 1 for BTS, 2 for MS. Default is BTS. You must be in the mode that includes SEM measurement to use this command. Use <code>:INSTrument:SElect</code> to set the mode.
Dependencies	See Couplings
Couplings	This "Spectrum Peak Ref" parameter is coupled with the "Meas Type" parameter. This softkey is active when the "Meas Type" is set to "Spectrum Peak Ref". Otherwise, grayout.
Preset	Measured carrier Spectrum Peak reference power
State Saved	Saved in instrument state.
Min	-200
Max	200
Initial S/W Revision	Prior to A.02.00
Modified at S/W Revision	A.02.00, A.03.00

Offset/Limits

Accesses a menu that enables you to set up the measurement parameters for offset pairs. For example, you can assign the start and stop frequencies, select the resolution bandwidth, and set the sweep time. When in the MSR and LTE-Advanced FDD/TDD mode, the softkey label changes to Outer Offset/Limits.

Key Path	Meas Setup
Initial S/W Revision	Prior to A.02.00
Modified at S/W Revision	A.14.00

Select Offset

Selects the offset (upper and lower) and displays the memory selection menu that enables you to store a set of parameter values for the offset, such as Start Freq, Stop Freq, Sweep Time, Res BW, Meas BW, Abs Start, and Abs Stop. Only one selection at a time is shown on this menu key label.

Key Path	Meas Setup, Offset/Limits
Mode	SA, WCDMA, C2K, WIMAX OFDMA, TD-SCDMA, 1xEVDO, DTMB (CTTB), DVB-T/H, ISDB-T, CMMB, LTE, LTE-TDD, Digital Cable TV, WLAN, MSR, LTEAFDD, LTEATDD
Preset	A
Range	MSR, LTEATDD, LTEAFDD, WLAN: A B C D E F G H I J K L Other modes without option N9060A-7FP: A B C D E F Other modes with option N9060A-7FP: A B C D E F G H I J K L
Initial S/W Revision	Prior to A.02.00
Modified at S/W Revision	A.02.00, A.03.00, A.10.00, A.11.00, A.14.00

Start Freq

Specifies the start frequency for the currently selected offset. Also enables you to toggle that offset between On and Off.

Missing values are not permitted; that is, if you want to change values 2 and 6, you must send all values up to 6. Subsequent values will remain as they were. The query for this parameter always returns 12 values.

Key Path	Meas Setup, Offset/Limits
Mode	SA, WCDMA, C2K, WIMAX OFDMA, TD-SCDMA, 1xEVDO, DTMB (CTTB), DVB-T/H, ISDB-T, CMMB, LTE, LTE-TDD, Digital Cable TV, WLAN, MSR, LTEAFDD, LTEATDD
Remote Command	[:SENSE] :SEMAsk:OFFSet [1] 2 [:OUTer] :LIST:FREQuency:STARt <freq>, ... [:SENSE] :SEMAsk:OFFSet [1] 2 [:OUTer] :LIST:FREQuency:STARt? [:SENSE] :SEMAsk:OFFSet [1] 2 [:OUTer] :LIST:STATE ON OFF 1 0, ... [:SENSE] :SEMAsk:OFFSet [1] 2 [:OUTer] :LIST:STATE?
Example	SEM:OFFS2:LIST:FREQ:STAR 2.515 MHz, , 2.715 MHz, , 3.515 MHz, , 4.00 MHz, , 8.00 MHz, , 12.50 MHz

	<p>SEM:OFFS2:LIST:FREQ:STAR? SEM:OFFS:LIST:STAT ON, , ON, , ON, , OFF, , OFF, , OFF SEM:OFFS:LIST:STAT?</p>
Notes	<p>Comma separated list of values. OFFSet1 is for BTS, 2 for MS. Default is BTS. You must be in the mode that includes SEM measurement to use this command. Use :INSTrument:SElect to set the mode.</p>
Couplings	<p>Coupled to Stop Freq. When the start freq goes above the stop freq, the stop freq is automatically adjusted to the start freq plus 100 Hz. If the current mode is DVB-T/H, this value will be modified automatically according to the limit type and the output power of the transmitter which is less or more than 25 W. If the current mode is ISDB-T, this value will be modified automatically according to the limit type.</p>
Preset	<p>For modes (except MSR, , LTEAFDD, , LTEATDD and WLAN) without option N9060A-7FP, , the preset value is as follows. SA: 2.515 MHz, , 2.715 MHz, , 3.515 MHz, , 4.00 MHz, , 8.00 MHz, , 12.50 MHz WCDMA: 2.515 MHz, , 2.715 MHz, , 3.515 MHz, , 4.000 MHz, , 8.000 MHz, , 12.50 MHz 2.515MHz, , 4.000 MHz, , 7.500 MHz, , 8.500 MHz, , 12.5 MHz, , 15 MHz C2K: 750.0 kHz, , 780.0 kHz, , 1.980 MHz, , 3.25 MHz, , 7.0 MHz, , 7.0 MHz 885 kHz, , 1.980 MHz, , 2.250 MHz, , 8.0 MHz, , 12.0 MHz, , 12.0 MHz WIMAX OFDMA: 4.75 MHz, 5.45 MHz, 9.75 MHz, 14.75 MHz, 19.75 MHz, 24.75 MHz 4.75 MHz, 5.45 MHz, 9.75 MHz, 14.75 MHz, 19.75 MHz, 24.75 MHz TD-SCDMA: 81 5kHz, 1015 kHz, 1815 kHz, 2.3 MHz, , , 2.3 MHz, , 2.3 MHz 815 kHz, 1.8 MHz, 2.9 MHz, , 2.9 MHz, 2.9 MHz, , 2.9 MHz 1xEVDO: 750.0 kHz, , 780.0 kHz, , 1.98 MHz, , 3.25 MHz, , 7 MHz, , 7 MHz 885.0 kHz, , 1.98 MHz, , 1.98 MHz, , 1.98 MHz, , 1.98 MHz DTMB (CTTB): 3.8 MHz, , 4.2 MHz, , 6 MHz, , 6 MHz, , 6 MHz, 6 MHz 6MHz, , 6MHz, , 6MHz, , 6MHz, , 6MHz, , 6MHz DVB-T/H: 3.81 MHz, , 4.2 MHz, , 6 MHz, , 6 MHz, , 6 MHz, , 6 MHz 6MHz, , 6MHz, , 6MHz, , 6MHz, , 6MHz ISDB-T: 2.79 MHz, , 2.86 MHz, , 3.0 MHz, , 4.36 MHz, , 6 MHz, , 6 MHz 6MHz, , 6MHz, , 6MHz, , 6MHz, , 6MHz, , 6MHz CMMB: 3.8 MHz, , 4.2 MHz, , 8.0 MHz, , 6 MHz, , 6 MHz, , 6 MHz 6MHz, , 6MHz, , 6MHz, , 6MHz, , 6MHz LTE, , LTETDD: 50 kHz, , 5.05 MHz, , 10.5 MHz, , 15.00 MHz, , 30 MHz, , 40 MHz 15.00 kHz, 1.5 MHz, 5.5 MHz, 6.5 MHz, 10 MHz, 20MHz Digital Cable TV: 3.8 MHz, , 4.2 MHz, , 6 MHz, , 6 MHz, , 6 MHz, , 6 MHz 6MHz, , 6MHz, , 6MHz, , 6MHz, , 6MHz, , 6MHz When option N9060A-7FP is installed in these modes, the preset value of Offset G ~ L is the same as the Offset F value. ----- WLAN: if Radio Std is 802.11a/g(OFDM/DSSS-OFDM)/802.11n(20MHz): 9 MHz, , 11 MHz, , 20 MHz, , 30</p>

MHz, , 50 MHz, , 216 MHz, , 216 MHz, , 216 MHz, , 216 MHz, , 216 MHz, , 216 MHz, , 216 MHz

if Radio Std is 802.11b/g(DSSS/CCK/PBCC): 11 MHz, , 22 MHz, , 50 MHz, , 70 MHz, , 90 MHz, ,
100 MHz, , 100 MHz, , 100 MHz, , 100 MHz, , 100 MHz, , 100 MHz

if Radio Std is 802.11n(20MHz): 9 MHz, , 11 MHz, , 20 MHz, , 30 MHz, , 50 MHz, , 100 MHz, , 100
MHz, , 100 MHz, , 100 MHz, , 100 MHz, , 100 MHz

if Radio Std is 802.11n(40MHz): 19 MHz, , 21 MHz, , 40 MHz, , 60 MHz, , 100 MHz, , 200 MHz, ,
200 MHz, , 200 MHz, , 200 MHz, , 200 MHz, , 200 MHz

if Radio Std is 802.11ac(20MHz): 9 MHz, , 11 MHz, , 20 MHz, , 30 MHz, , 30 MHz, , 30 MHz, , 30
MHz, , 30 MHz, , 30 MHz, , 30 MHz, , 30 MHz

if Radio Std is 802.11ac(40MHz): 19 MHz, , 21 MHz, , 40 MHz, , 60 MHz, , 60 MHz, , 60 MHz, , 60
MHz, , 60 MHz, , 60 MHz, , 60 MHz, , 60 MHz

if Radio Std is 802.11ac(80MHz): 39 MHz, , 41 MHz, , 80 MHz, , 120 MHz, , 120 MHz, , 120 MHz, ,
120 MHz, , 120 MHz, , 120 MHz, , 120 MHz, , 120 MHz

if Radio Std is 802.11ac(160MHz): 79 MHz, , 81 MHz, , 160 MHz, , 240 MHz, , 240 MHz, , 240
MHz, , 240 MHz, , 240 MHz, , 240 MHz, , 240 MHz, , 240 MHz

if Radio Std is 802.11ac(80 MHz + 80MHz): 0 MHz, , 40 MHz, , 79 MHz, , 159 MHz, , 161 MHz, ,
200 MHz, , 240 MHz, , 240 MHz, , 240 MHz, , 240 MHz, , 240 MHz

MSR:15 kHz, , 215kHz, , 1.015MHz, , 1.5MHz, , 10.5MHz, , 15.00MHz, , 30MHz, , 30MHz, ,
30MHz, , 30MHz, , 30MHz, , 30MHz | 15kHz, , 215kHz, , 1.015MHz, , 1.5MHz, , 10.5MHz, ,
15.00MHz, , 30MHz, , 30MHz, , 30MHz, , 30MHz, , 30MHz, , 30MHz

LTEAFDD, , LTEATDD: 50 kHz, , 5.05 MHz, , 10.5 MHz, , 15.00 MHz, , 30 MHz, , 40 MHz, , 40
MHz, 40 MHz, 40 MHz, 40 MHz, 40 MHz, 40 MHz | 15.00 kHz, 1.5 MHz, 5.5 MHz, 6.5 MHz, 10
MHz, 20MHz, , 20MHz, , 20MHz, , 20MHz, , 20MHz, , 20MHz

For modes (except MSR, , LTEAFDD, , LTEATDD and WLAN) without option N9060A-7FP, , the
preset value is as follows.

SA: ON, ON, ON, ON, ON, OFF

WCDMA: ON, , ON, , ON, , ON, , OFF|ON, , ON, , ON, , OFF, , OFF

C2K: ON, , ON, , ON, , OFF, , OFF, , OFF|ON, , ON, , OFF, , OFF, , OFF, , OFF

WIMAX OFDMA: ON, , ON, , ON, , OFF, , OFF, , OFF|ON, , ON, , ON, , OFF, , OFF, , OFF

TD-SCDMA: ON, , ON, , ON, , ON, , OFF, , OFF|ON, , ON, , ON, , OFF, , OFF, , OFF

1xEVDO: ON, , ON, , ON, , OFF, , OFF, , OFF| ON, , ON, , OFF, , OFF, , OFF, , OFF

DTMB (CTTB), , DVB-T/H, , CMMB, , Digital Cable TV: ON, , ON, , ON, , OFF, , OFF, , OFF

ISDB-T: ON, ON, ON, ON, OFF, OFF

LTE, , LTETDD: ON, , ON, , ON, , OFF, , OFF, , OFF|ON, ON, ON, ON, OFF, OFF

When option N9060A-7FP is installed in these modes, , the preset value of Offset G ~ L is the same
as the Offset F value.

WLAN:

if Radio Std is 802.11b/g(DSSS/CCK/PBCC): ON, , ON, , OFF, , OFF, , OFF, , OFF, , OFF, ,
OFF, , OFF, , OFF, , OFF

if Radio Std is 802.11a/g(OFDM/DSSS-OFDM)/802.11n(20MHz/40MHz): ON, , ON, , ON, , ON, ,
OFF, , OFF, , OFF, , OFF, , OFF, , OFF, , OFF, , OFF

if Radio Std is 802.11ac (20 MHz/ 40 MHz/ 80 MHz/ 160 MHz): ON, , ON, , ON, , ON, , OFF, , OFF, ,
OFF, , OFF, , OFF, , OFF, , OFF, , OFF

	if Radio Std is 802.11ac (80 MHz + 80 MHz): ON, , ON, , ON, , ON, , ON, , ON, , OFF, , OFF, , OFF, , OFF, , OFF MSR:ON, , ON, , ON, , ON, , ON, , OFF, , OFF, , OFF, , OFF, , OFF, , OFF, , OFF ON, , ON, , ON, , ON, , ON, , OFF, , OFF, , OFF, , OFF, , OFF, , OFF, , OFF LTEAFDD, , LTEATDD: ON, , ON, , ON, , OFF, , OFF, , OFF, , OFF, , OFF, , OFF, , OFF, , OFF, , OFF ON, , ON, , ON, , ON, , OFF, , OFF, , OFF, , OFF, , OFF, , OFF, , OFF, , OFF
State Saved	Saved in instrument state.
Min	0 Hz
Max	499.9999 MHz
Initial S/W Revision	Prior to A.02.00
Modified at S/W Revision	A.02.00, A.03.00, A.10.00, A.11.00, A.14.00

Stop Freq

Specifies the stop frequency for the currently selected offset.

Missing values are not permitted; that is, if you want to change values 2 and 6, you must send all values up to 6. Subsequent values will remain as they were. The query for this parameter always returns 12 values.

Key Path	Meas Setup, Offset/Limits
Mode	SA, WCDMA, C2K, WIMAX OFDMA, TD-SCDMA, 1xEVDO, DTMB (CTTB), DVB-T/H, ISDB-T, CMMB, LTE, LTE-TDD, Digital Cable TV, WLAN, MSR, LTEAFDD, LTEATDD
Remote Command	[:SENSe] :SEMAsk:OFFSet [1] 2 [:OUTer] :LIST:FREQuency:STOP <freq>, ... [:SENSe] :SEMAsk:OFFSet [1] 2 [:OUTer] :LIST:FREQuency:STOP?
Example	SEM:OFFS:LIST:FREQ:STOP 2.715 MHz, , 3.515 MHz, , 4.00 MHz, , 8.00 MHz, , 12.50 MHz, , 15.0 MHz SEM:OFFS:LIST:FREQ:STOP?
Notes	Comma separated list of values. OFFSet1 is for BTS, 2 for MS. Default is BTS. You must be in the mode that includes SEM measurement to use this command. Use :INSTrument:SElect to set the mode.
Couplings	Coupled to Start Freq. When the stop freq goes below the start freq, the start freq is automatically adjusted to the stop freq minus 100 Hz. If the current mode is DVB-T/H, this value will be modified automatically according to the limit type and the output power of the transmitter which is less or more than 25 W. If the current mode is ISDB-T, this value will be modified automatically according to the limit type.
Preset	For modes (except MSR, , LTEAFDD, , LTEATDD and WLAN) without option N9060A-7FP, , the preset value is as follows. SA: 2.715 MHz, , 3.515 MHz, , 4.00 MHz, , 8.00 MHz, , 12.50 MHz, , 15.0 MHz WCDMA:2.715 MHz, , 3.515 MHz, , 4.000 MHz, , 8.000 MHz, , 12.50 MHz, , 15.0 MHz 3.485 MHz, , 7.500 MHz, , 8.500 MHz, , 12.00 MHz, , 15.00 MHz, , 18.0 MHz

C2K: 780.0kHz, 1.980 MHz, 4.0 MHz, 4.0 MHz, 12.0 MHz, 12.0 MHz|1.980 MHz, 4.0 MHz, 4.0 MHz, 11.5 MHz, 14.5 MHz, 14.5 MHz

WIMAX OFDMA: 5.45 MHz, 9.75 MHz, 14.75 MHz, 19.75 MHz, 24.75 MHz, 29.75 MHz |5.45 MHz, 9.75 MHz, 14.75 MHz, 19.75 MHz, 24.75 MHz, 29.75 MHz

TD-SCDMA:

1015 kHz, 1815kHz, 2.3 MHz, 4 MHz, 4 MHz, 4 MHz |1.8 MHz, 2385 kHz, 3.5 MHz, 3.5 MHz, 3.5 MHz, 3.5 MHz

1xEVDO: 780.0 kHz, 1.98 MHz, 4.0 MHz, 4.0 MHz, 12 MHz, 12 MHz |1.98 MHz, 4.0 MHz, 4.0 MHz, 4.0 MHz, 4.0 MHz

DTMB (CTTB): 4.2 MHz, 6 MHz, 12 MHz, 12 MHz, 12 MHz, 12 MHz |12 MHz, 12 MHz, 12 MHz, 12 MHz, 12 MHz, 12 MHz

DVB-T/H: 4.2 MHz, 6 MHz, 12 MHz, 12 MHz, 12 MHz, 12 MHz |12 MHz, 12 MHz, 12 MHz, 12 MHz, 12 MHz, 12 MHz

ISDB-T: 2.86 MHz, 3.0 MHz, 4.36 MHz, 15.0 MHz, 15.0 MHz, 15.0 MHz |15MHz, 15MHz, 15MHz, 15MHz, 15MHz, 15MHz

CMMB: 4.2 MHz, 8.0 MHz, 12.0 MHz, 12.0 MHz, 12.0 MHz, 12.0 MHz |12 MHz, 12 MHz, 12 MHz, 12 MHz, 12 MHz, 12 MHz

LTE, LTETDD: 5.05 MHz, 10.05 MHz, 15 MHz, 30 MHz, 40 MHz, 50 MHz |985.0 kHz, 4.50 MHz, 5.5001 MHz, 9.50 MHz, 20 MHz, 40 MHz

Digital Cable TV: 4.2 MHz, 6.0 MHz, 12.0 MHz, 12.0 MHz, 12.0 MHz, 12.0 MHz, 12 MHz, 12 MHz, 12 MHz, 12 MHz, 12 MHz, 12 MHz

When option N9060A-7FP is installed in these modes, the preset value of Offset G ~ L is the same as the Offset F value.

WLAN:

if Radio Std is 802.11a/g(OFDM/DSSS-OFDM)/802.11n(20MHz): 11 MHz, 20 MHz, 30 MHz, 50 MHz, 100 MHz, 250 MHz, 250 MHz, 250 MHz, 250 MHz, 250 MHz, 250 MHz, 250 MHz, 250 MHz

if Radio Std is 802.11b/g(DSSS/CCK/PBCC): 22 MHz, 50 MHz, 70 MHz, 90 MHz, 100 MHz, 120 MHz, 120 MHz, 120 MHz, 120 MHz, 120 MHz, 120 MHz, 120 MHz

if Radio Std is 802.11n(20MHz): 11 MHz, 20 MHz, 30 MHz, 50 MHz, 100 MHz, 200 MHz, 200 MHz, 200 MHz, 200 MHz, 200 MHz, 200 MHz, 200 MHz

if Radio Std is 802.11n(40MHz): 21 MHz, 40 MHz, 60 MHz, 100 MHz, 200 MHz, 300 MHz, 300 MHz, 300 MHz, 300 MHz, 300 MHz, 300 MHz, 300 MHz

if Radio Std is 802.11ac(20MHz): 11 MHz, 20 MHz, 30 MHz, 50 MHz, 50 MHz, 50 MHz, 50 MHz, 50 MHz, 50 MHz, 50 MHz, 50 MHz, 50 MHz

if Radio Std is 802.11ac(40MHz): 21 MHz, 40 MHz, 60 MHz, 100 MHz, 100 MHz, 100 MHz, 100 MHz, 100 MHz, 100 MHz, 100 MHz, 100 MHz

if Radio Std is 802.11ac(80MHz): 41 MHz, 80 MHz, 120 MHz, 200 MHz, 200 MHz, 200 MHz, 200 MHz, 200 MHz, 200 MHz, 200 MHz, 200 MHz, 200 MHz

if Radio Std is 802.11ac(160MHz): 81 MHz, 160 MHz, 240 MHz, 400 MHz, 400 MHz, 400 MHz, 400 MHz, 400 MHz, 400 MHz, 400 MHz, 400 MHz

if Radio Std is 802.11ac(80 MHz + 80MHz): 40 MHz, 79 MHz, 81 MHz, 161 MHz, 200 MHz, 240 MHz, 260 MHz, 260 MHz, 260 MHz, 260 MHz, 260 MHz, 260 MHz

MSR: 215kHz, 1.015MHz, 1.5MHz, 10.5MHz, 50MHz, 50MHz, 50MHz, 50MHz, 50MHz, 50MHz

	50MHz, , 50MHz, , 50MHz LTEAFDD, , LTEATDD: 5.05 MHz, , 10.05 MHz, , 15 MHz, , 30 MHz, , 40 MHz, , 50 MHz, , 50 MHz, , 50 MHz, , 50 MHz, , 50 MHz, , 50 MHz 985.0 kHz, , 4.50 MHz, , 5.5001 MHz, , 9.50 MHz, 20 MHz, , 40 MHz, , 40 MHz, , 40 MHz, , 40 MHz, , 40 MHz, , 40 MHz, , 40 MHz
State Saved	Saved in instrument state.
Min	100 Hz
Max	500 MHz
Initial S/W Revision	Prior to A.02.00
Modified at S/W Revision	A.02.00, A.03.00, A.10.00, A.11.00, A.14.00

Sweep Time

Specifies the sweep time for the currently selected offset and enables you to toggle the Sweep Time mode between Auto and Man.

Missing values are not permitted; that is, if you want to change values 2 and 6, you must send all values up to 6. Subsequent values will remain as they were. The query for this parameter always returns 12 values.

Key Path	Meas Setup, Offset/Limits
Mode	SA, WCDMA, C2K, WIMAX OFDMA, TD-SCDMA, 1xEVDO, DTMB (CTTB), DVB-T/H, ISDB-T, CMMB, LTE, LTE-TDD, Digital Cable TV, WLAN, MSR, LTEAFDD, LTEATDD
Remote Command	[:SENSe] :SEMask:OFFSet [1] 2 [:OUTer] :LIST:SWEep:TIME <time>, ... [:SENSe] :SEMask:OFFSet [1] 2 [:OUTer] :LIST:SWEep:TIME? [:SENSe] :SEMask:OFFSet [1] 2 [:OUTer] :LIST:SWEep:TIME:AUTO ON OFF 1 0, ... [:SENSe] :SEMask:OFFSet [1] 2 [:OUTer] :LIST:SWEep:TIME:AUTO?
Example	SEM:OFFS2:LIST:SWE:TIME 1.0 ms, , 3.4 ms, , 2.08 ms, , 1.0 ms, , 1.0 ms, , 1.0 ms SEM:OFFS2:LIST:SWE:TIME? SEM:OFFS2:LIST:SWE:TIME:AUTO ON, , ON, , ON, , OFF, , OFF SEM:OFFS2:LIST:SWE:TIME:AUTO?
Notes	Comma separated list of values. OFFSet1 is for BTS, 2 for MS. Default is BTS. You must be in the mode that includes SEM measurement to use this command. Use :INSTrument:SElect to set the mode.
Couplings	When the sweep time is set manually, Sweep Time Mode is set to MANual. If the current mode is DVB-T/H, this value will be modified automatically according to the output power of the transmitter which is less or more than 25W. If the current mode is ISDB-T, this value will be modified automatically according to the limit type.
Preset	Automatically calculated Modes (except MSR, , LTEAFDD, , LTEATDD and WLAN) without option N9060A-7FP: ON, ON, ON, ON, ON, ON

	Modes (except MSR, , LTEAFDD, , LTEATDD and WLAN) with option N9060A-7FP: ON, ON, ON, ON, ON, ON, ON, ON, ON, ON, ON, ON, ON, ON, ON, ON WLAN: ON, ON, ON, ON, ON, ON, ON, ON, ON, , ON, ON, ON, ON, ON MSR: ON,ON,ON,ON,ON,ON,ON,ON,ON,ON,ON,ON,ON,ON,ON,ON LTEAFDD, , LTEATDD: ON, ON, ON, ON, ON, ON, ON, ON, ON, ON, ON, ON ON, ON, ON, ON, ON, ON, ON, ON, ON, ON, ON, ON
State Saved	Saved in instrument state.
Min	1 ms
Max	4000 s
Backwards Compatibility SCPI	[:SENSE] :SEMAsk:OFFSet [1] 2 :LIST:SWEep [:TIME]
Initial S/W Revision	Prior to A.02.00
Modified at S/W Revision	A.02.00, A.03.00, A.10.00, A.11.00, A.14.00

Offset Side

Specifies which offset side to measure.

You can turn off (not use) specific offsets with [:SENSE]:SEMAsk:OFFSet[n][:OUTer]:LIST:STATe.

- **BOTH** – Both of the negative (lower) and positive (upper) sidebands
- **NEGative** – Negative (lower) sideband only
- **POSitive** – Positive (upper) sideband only

Missing values are not permitted; that is, if you want to change values 2 and 6, you must send all values up to 6. Subsequent values will remain as they were. The query for this parameter always returns 12 values.

The figure below shows the relation between the negative/positive offset side setups and the upper/lower results in the MSR and LTE-Advanced FDD/TDD.

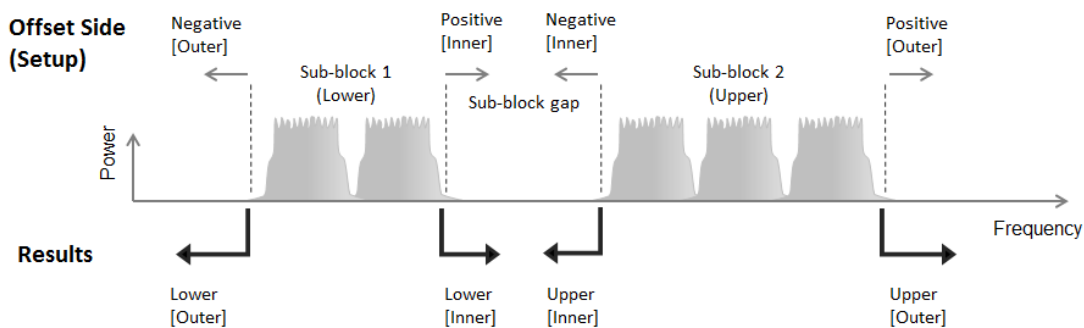

Key Path	Meas Setup, Offset/Limits
Mode	SA, WCDMA, C2K, WIMAX OFDMA, TD-SCDMA, 1xEVDO, DTMB (CTTB), DVB-T/H, ISDB-T, CMMB, LTE, LTE-TDD, Digital Cable TV, WLAN, MSR, LTEAFDD, LTEATDD
Remote Command	[:SENSE] :SEMAsk:OFFSet [1] 2 [:OUTer] :LIST:SIDE BOTH NEGative

	POSitive, ... [:SENSe]:SEMask:OFFSet[1] 2[:OUTer]:LIST:SIDE?
Example	SEM:OFFS:LIST:SIDE BOTH, , NEG, , NEG, , POS, , POS, , POS SEM:OFFS:LIST:SIDE?
Notes	Comma separated list of values. OFFSet1 is for BTS, 2 for MS. Default is BTS. You must be in the mode that includes SEM measurement to use this command. Use :INSTrument:SElect to set the mode.
Preset	Modes (except MSR, , LTEAFDD, , LTEATDD and WLAN) without option N9060A-7FP: BOTH, , BOTH, , BOTH, , BOTH, , BOTH Modes (except MSR, , LTEAFDD, , LTEATDD and WLAN) with option N9060A-7FP: BOTH, , BOTH, , BOTH, , BOTH, , BOTH, , BOTH, , BOTH, , BOTH, , BOTH, , BOTH, , BOTH MSR: BOTH, , BOTH, , BOTH, , BOTH, , BOTH, , BOTH, , BOTH, , BOTH, , BOTH, , BOTH, , BOTH, , BOTH LTEAFDD, LTEATDD: BOTH, , BOTH, , BOTH, , BOTH, , BOTH, , BOTH, , BOTH, , BOTH, , BOTH, , BOTH, , BOTH, , BOTH BOTH, , BOTH, , BOTH, , BOTH, , BOTH, , BOTH, , BOTH, , BOTH, , BOTH, , BOTH, , BOTH WLAN: BOTH, , BOTH, , BOTH, , BOTH, , BOTH, , BOTH, , BOTH, , BOTH, , BOTH, , BOTH, , BOTH, , BOTH
State Saved	Saved in instrument state.
Range	Neg Both Pos
Initial S/W Revision	Prior to A.02.00
Modified at S/W Revision	A.02.00, A.03.00, A.10.00, A.11.00, A.14.00

Res BW

Specifies which Resolution BW filter to use when measuring the currently selected offset.

Offset Res BW Mode allows the instrument to determine the optimum Resolution BW filter to use when measuring the currently selected offset.. When changing the Meas BW parameter, if the Res BW needs to be changed to adhere to the rule

$(N \times \text{Res BW}) \leq (\text{Stop freq of the offset} - \text{Start freq of the offset})$,

where N is the multiplier, this setting will automatically be changed to manual.

Missing values are not permitted; that is, if you want to change values 2 and 6, you must send all values up to 6. Subsequent values will remain as they were. The query for this parameter always returns 12 values.

Key Path	Meas Setup, Offset/Limits
Mode	SA, WCDMA, C2K, WIMAX OFDMA, TD-SCDMA, 1xEVDO mode, DTMB (CTTB), DVB-T/H, ISDB-T, CMMB, LTE, LTE-TDD, Digital Cable TV, WLAN, MSR, LTEAFDD, LTEATDD
Remote Command	[:SENSe]:SEMask:OFFSet[1] 2[:OUTer]:LIST:BANDwidth[:RESolution] <bandwidth>, ... [:SENSe]:SEMask:OFFSet[1] 2[:OUTer]:LIST:BANDwidth[:RESolution]?

	<pre>[:SENSe] :SEMAsk:OFFSet [1] 2 [:OUTer] :LIST:BAWdwidth [:RESolution] :AUTO OFF ON 1 0, ... [:SENSe] :SEMAsk:OFFSet [1] 2 [:OUTer] :LIST:BAWdwidth [:RESolution] :AUTO?</pre>
Example	<pre>SEM:OFFS2:LIST:BAWd 30.0 kHz, , 30.0 kHz, , 30.0 kHz, , 1.00 MHz, 1.00 MHz, , 1.00 MHz SEM:OFFS2:LIST:BAWd? SEM:OFFS:LIST:BAWd:AUTO 1,1,1,1,1,1 SEM:OFFS:LIST:BAWd:AUTO?</pre>
Notes	<p>Comma separated list of values.</p> <p>OFFSet1 is for BTS, 2 for MS. Default is BTS.</p> <p>You must be in the mode that includes SEM measurement to use this command. Use :INSTrument:SElect to set the mode.</p>
Couplings	<p>Coupled to Start and Stop offset and Meas BW multiplier. This parameter must adhere to the rule (N x Res BW) <= (Stop freq of the offset - Start freq of the offset), where N is the multiplier. If the multiplier is changed, the Res BW will be changed to ensure this. When set manually, Res BW Coupling is set to manual.</p> <p>The resolution bandwidth is coupled to the offset width determined by the start frequency and stop frequency.</p>
Preset	<p>For modes (except MSR, , LTEAFDD, , LTEATDD and WLAN) without option N9060A-7FP, , the preset value is as follows.</p> <p>SA: 30.0 kHz, , 30.0 kHz, , 30.0 kHz, , 1.00 MHz, 1.00 MHz, , 1.00 MHz</p> <p>WCDMA: 30.00 kHz, , 30.00 kHz, , 30.00 kHz, , 100.00 kHz, , 1.000 MHz, , 1.00 MHz 30.00 kHz, , 1.000 MHz, , 1.000 MHz, , 1.000 MHz, , 1.000 MHz, , 1.00 MHz</p> <p>C2K: 3.00 kHz, , 30.00 kHz, , 30.00 kHz, , 6.2 kHz, , 1.000 MHz, , 1.00 MHz 30.00 kHz, , 30.00 kHz, , 6.2 kHz, , 1.000 MHz, , 1.000 MHz, , 1.00 MHz</p> <p>WIMAX OFDMA: 100 KHz, , 100 KHz, , 100 KHz, , 100 KHz, , 100 KHz, , 100 KHz 100 KHz, , 100 KHz, , 100 KHz, , 100 KHz, , 100 KHz</p> <p>TD-SCDMA: 30 kHz, , 30 kHz, , 30 kHz, , 50 kHz, , 1 MHz, , 1 MHz 30 kHz, , 30 kHz, , 50 kHz, , 1 MHz, , 1 MHz, , 1 MHz</p> <p>1xEVDO: 30.00 kHz, , 30.00 kHz, , 30.00 kHz, , 6.2 kHz, , 1.000 MHz, , 1.000 MHz 30.00 kHz, , 30.00 kHz, , 30.00 kHz, , 30.00 kHz, , 30.00 kHz</p> <p>DTMB (CTTB), , DVB-T/H, , CMMB, , Digital Cable TV: 3.9 kHz, , 3.9 kHz, , 3.9 kHz, , 3.9 kHz, , 3.9 kHz, , 3.9 kHz 30.00 kHz, , 1.000 MHz, , 1.000 MHz, , 1.000 MHz, , 1.000 MHz, , 1.00 MHz</p> <p>ISDB-T: 10.0 kHz, , 10.0 kHz, , 10.0 kHz, , 10.0 kHz, , 10. kHz, , 10.0 kHz 30.00 kHz, , 1.000 MHz, , 1.000 MHz, , 1.000 MHz, , 1.000 MHz, , 1.00 MHz</p> <p>LTE, , LTETDD: 51 kHz, , 100 kHz, , 1.0 MHz, , 1.0 MHz, 1.0 MHz, , 1.0 MHz 15.0 kHz, , 510 kHz, 1.0 MHz, 1.0 MHz, 1.0 MHz, 1.0 MHz</p> <p>When option N9060A-7FP is installed in these modes, , the preset value of Offset G ~ L is the same as the Offset F value.</p> <p>-----</p> <p>WLAN: 100 KHz, , 100 KHz, , 100 KHz, , 100 KHz, , 100 KHz, , 100 KHz, , 100 KHz, , 100 KHz, , 100 KHz, , 100 KHz, , 100 KHz</p> <p>MSR: 30kHz, , 30kHz, , 30kHz, , 1.0MHz, 1.0MHz, , 1.0MHz, , 1.0MHz, , 1.0MHz, , 1.0MHz, , 1.0MHz, , 1.0MHz 30kHz, , 30kHz, , 30kHz, , 1.0MHz, 1.0MHz, , 1.0MHz, , 1.0MHz, , 1.0MHz, , 1.0MHz, , 1.0MHz</p>

Example	SEM:OFFS2:LIST:BAND:IMUL 1,1,1,1,1,1 SEM:OFFS2:LIST:BAND:IMUL?
Notes	Comma separated list of values. OFFSet1 is for BTS, 2 for MS. Default is BTS. You must be in the mode that includes SEM measurement to use this command. Use :INSTrument:SElect to set the mode.
Couplings	This parameter must adhere to the rule (N x Res BW) <= (Stop freq of the offset - Start freq of the offset), where N is the multiplier. If the Res Bw is changed, the multiplier will be changed to ensure this.
Preset	For modes (except MSR, , LTEAFDD, , LTEATDD and WLAN) without option N9060A-7FP, , the preset value is as follows. SA: 1, 1, 1, 1, 1, 1 WCDMA: 1, , 1, , 1, , 10, , 1, , 1 1, , 1, , 1, , 1, , 1 C2K: 10, 1, 1, 1, 1, 1 1, 1, 1, 1, 1, 1 WIMAX OFDMA, , 1xEVDO: 1, , 1, , 1, , 1, , 1 1, , 1, , 1, , 1, , 1 TD-SCDMA:1, , 1, , 1, , 20, , 1, , 1 1, , 1, , 20, , 1, , 1, , 1 DTMB (CTTB), , DVB-T/H, , ISDB-T, , CMMB, , Digital Cable TV: 1, , 1, , 1, , 1, , 1 1, , 1, , 1, , 1, , 1 LTE, , LTETDD: 2, , 1, , 1, , 1, , 1, , 1 2, , 2, , 1, , 1, , 1, , 1 When option N9060A-7FP is installed in these modes, , the preset value of Offset G ~ L is the same as the Offset F value. ----- WLAN: 1, 1, 1, 1, 1, 1, 1, 1, 1, 1, 1, 1 MSR: 1, , 1, , 1, , 1, , 1, , 1, , 1, , 1, , 1, , 1 1, , 1, , 1, , 1, , 1, , 1, , 1, , 1, , 1, , 1 LTEAFDD, , LTEATDD: 2, , 1, , 1, , 1, , 1, , 1, , 1, , 1, , 1, , 1 2, , 2, , 1, , 1, , 1, , 1, , 1, , 1, , 1, , 1 1, , 1, , 1
State Saved	Saved in instrument state.
Min	1
Max	1000
Backwards Compatibility SCPI	[:SENSe] :SEMAsk:OFFSet [1] 2 :LIST:BWIDth:IMULti
Initial S/W Revision	Prior to A.02.00
Modified at S/W Revision	A.02.00, A.03.00, A.10.00, A.11.00, A.14.00

Video BW

Changes the analyzer post-detection filter.

Missing values are not permitted; that is, if you want to change values 2 and 6, you must send all values up to 6. Subsequent values will remain as they were. The query for this parameter always returns 12 values.

Key Path	Meas Setup, Offset/Limits
-----------------	---------------------------

Mode	SA, WCDMA, C2K, WIMAXOFDMA, TD-SCDMA, 1xEVDO, DTMB (CTTB), DVB-T/H, ISDB-T, CMMB, LTE, LTE-TDD, Digital Cable TV, WLAN, MSR, LTEAFDD, LTEATDD
Remote Command	[:SENSe]:SEMask:OFFSet [1] 2 [:OUTer]:LIST:BANDwidth:VIDeo <freq>, ... [:SENSe]:SEMask:OFFSet [1] 2 [:OUTer]:LIST:BANDwidth:VIDeo? [:SENSe]:SEMask:OFFSet [1] 2 [:OUTer]:LIST:BANDwidth:VIDeo:AUTO OFF ON 0 1, ... [:SENSe]:SEMask:OFFSet [1] 2 [:OUTer]:LIST:BANDwidth:VIDeo:AUTO?
Example	SEM:OFFS2:LIST:BAND:VID 3.00 kHz, , 3.00 kHz, , 3.00 kHz, , 100.0 kHz, 100.0 kHz, , 100.0 kHz SEM:OFFS2:LIST:BAND:VID? SEM:OFFS2:LIST:BAND:VID:AUTO ON, , ON, , ON, , ON, , ON, , ON SEM:OFFS2:LIST:BAND:VID:AUTO?
Notes	Comma separated list of values. OFFSet1 is for BTS, 2 for MS. Default is BTS. You must be in the mode that includes SEM measurement to use this command. Use :INSTrument:SElect to set the mode.
Preset	ISDB-T: 1.0kHz, , 1.0kHz, , 1.0kHz, , 1.0kHz, , 1.0kHz, , 1.0kHz Other than ISDB-T: Automatically Calculated Modes (except MSR, , LTEAFDD, , LTEATDD, , WLAN, , ISDB-T) without option N9060A-7FP: ON, , ON, , ON, , ON, , ON ON, , ON, , ON, , ON, , ON Modes (except MSR, , LTEAFDD, , LTEATDD, , WLAN, , ISDB-T) with option N9060A-7FP:ON, , ON, , ON, , ON, , ON, , ON, , ON, , ON, , ON, , ON, , ON ON, , ON, , ON, , ON, , ON, , ON, , ON, , ON, , ON ----- MSR, , LTEAFDD, , LTEATDD: ON, , ON, , ON, , ON, , ON, , ON, , ON, , ON, , ON, , ON ON, , ON, , ON, , ON, , ON, , ON, , ON, , ON, , ON, , ON, , ON WLAN: ON, , ON, , ON, , ON, , ON, , ON, , ON, , ON, , ON, , ON, , ON ON, , ON, , ON, , ON, , ON, , ON, , ON, , ON, , ON ISDB-T: OFF, , OFF, , OFF, , OFF, , OFF OFF, , OFF, , OFF, , OFF, , OFF, , OFF
State Saved	Saved in instrument state.
Min	1 Hz
Max	50 MHz
Backwards Compatibility SCPI	[:SENSe]:SEMask:OFFSet [1] 2 :LIST:BWIDth:VIDeo
Initial S/W Revision	Prior to A.02.00
Modified at S/W Revision	A.02.00, A.03.00, A.10.00, A.11.00, A.14.00

VBW/RBW

Selects the ratio between the video and resolution bandwidths.

Missing values are not permitted; that is, if you want to change values 2 and 6, you must send all values up to 6. Subsequent values will remain as they were. The query for this parameter always returns 12 values.

Key Path	Meas Setup, Offset/Limits
Mode	SA, WCDMA, C2K, WIMAX OFDMA, TD-SCDMA, 1xEVDO, DTMB (CTTB), DVB-T/H, ISDB-T, CMMB, LTE, LTETDD, Digital Cable TV, WLAN, MSR, LTEAFDD, LTEATDD
Remote Command	<pre>[:SENSe] :SEMAsk:OFFSet [1] 2 [:OUTer] :LIST:BA NDwidth:VIDeo:RATio <real> , ... [:SENSe] :SEMAsk:OFFSet [1] 2 [:OUTer] :LIST:BA NDwidth:VIDeo:RATio ? [:SENSe] :SEMAsk:OFFSet [1] 2 [:OUTer] :LIST:BA NDwidth:VIDeo:RATio :AUTO OFF ON 0 1 , ... [:SENSe] :SEMAsk:OFFSet [1] 2 [:OUTer] :LIST:BA NDwidth:VIDeo:RATio :AUTO ?</pre>
Example	<pre>SEM:OFFS2:LIST:BA ND:VID:RAT 0.1 , , 0.1 , , 0.1 , , 0.1 , , 0.1 , , 0.1 SEM:OFFS2:LIST:BA ND:VID:RAT ? SEM:OFFS2:LIST:BA ND:VID:RAT:AUTO ON , , ON , , ON , , ON , , ON , , ON SEM:OFFS2:LIST:BA ND:VID:RAT:AUTO ?</pre>
Notes	<p>Comma separated list of values.</p> <p>OFFSet1 is for BTS, 2 for MS. Default is BTS.</p> <p>You must be in the mode that includes SEM measurement to use this command. Use :INSTrument:SElect to set the mode.</p>
Preset	<p>For modes (except MSR, , LTEAFDD, , LTEATDD and WLAN) without option N9060A-7FP, , the preset value is as follows.</p> <p>SA, , WCDMA, , C2K, , LTE, , LTETDD: 0.01, , 0.01, , 0.01, , 0.01, , 0.01, , 0.01 0.01, , 0.01, , 0.01, , 0.01, , 0.01, , 0.01</p> <p>WIMAX OFDMA: 0.3, , 0.3, , 0.3, , 0.3, , 0.3, , 0.3</p> <p>TD-SCDMA: 10, , 10, , 10, , 10, , 1, , 1 10, , 10, , 10, , 1, , 1, , 1</p> <p>1xEVDO: 10, , 10, , 10, , 10, , 10, , 10 10, , 10, , 10, , 10, , 10, , 10</p> <p>DTMB (CTTB), , DVB-T/H, , CMMB, , Digital Cable TV: 10, , 10, , 10, , 10, , 10, , 10 10, , 10, , 10, , 10, , 10, , 10</p> <p>ISDB-T: 0.1, , 0.1, , 0.1, , 0.1, , 0.1, , 0.1 10, , 10, , 10, , 10, , 10, , 10</p> <p>When option N9060A-7FP is installed in these modes, , the preset value of Offset G ~ L is the same as the Offset F value.</p> <p>-----</p> <p>WLAN: 0.3, , 0.3, , 0.3, , 0.3, , 0.3, , 0.3, , 0.3, , 0.3, , 0.3, , 0.3, , 0.3</p> <p>MSR, , LTEAFDD, , LTEATDD: 0.01, , 0.01, , 0.01, , 0.01, , 0.01, , 0.01, , 0.01, , 0.01, , 0.01, , 0.01, , 0.01, , 0.01, , 0.01 0.01, , 0.01, , 0.01, , 0.01, , 0.01, , 0.01, , 0.01, , 0.01, , 0.01, , 0.01, , 0.01, , 0.01, , 0.01, , 0.01</p> <p>Modes (except MSR, , LTEAFDD, , LTEATDD and WLAN) without option N9060A-7FP: OFF, , OFF, , OFF, , OFF, , OFF, , OFF OFF, , OFF, , OFF, , OFF, , OFF, , OFF, , OFF, , OFF</p> <p>Modes (except MSR, , LTEAFDD, , LTEATDD and WLAN) with option N9060A-7FP: OFF, , OFF, , OFF, , OFF, , OFF, , OFF, , OFF, , OFF, , OFF, , OFF, , OFF, , OFF OFF, , OFF, , OFF, , OFF, , OFF, , OFF, , OFF, , OFF, , OFF, , OFF, , OFF, , OFF, , OFF, , OFF, , OFF, , OFF, , OFF</p> <p>MSR, , LTEAFDD, , LTEATDD: OFF, , OFF, , OFF, , OFF, , OFF, , OFF, , OFF, , OFF, , OFF, , OFF, , OFF, , OFF, , OFF OFF, , OFF, , OFF, , OFF, , OFF, , OFF, , OFF, , OFF, , OFF, , OFF, , OFF, , OFF, , OFF, , OFF, , OFF</p> <p>WLAN: OFF, , OFF, , OFF, , OFF, , OFF, , OFF, , OFF, , OFF, , OFF, , OFF, , OFF, , OFF, , OFF OFF, , OFF, , OFF, , OFF, , OFF, , OFF, , OFF, , OFF, , OFF, , OFF, , OFF, , OFF, , OFF, , OFF, , OFF, , OFF</p>

State Saved	Saved in instrument state.
Min	0.00001
Max	3000000
Initial S/W Revision	Prior to A.02.00
Modified at S/W Revision	A.02.00, A.03.00, A.10.00, A.11.00, A.14.00

Limits

Accesses a menu that enables you to set the power limits for start and stop frequencies of the selected offsets.

Key Path	Meas Setup
Initial S/W Revision	Prior to A.02.00

Select Offset

Selects the offset (upper and lower) and displays the memory selection menu that enables you to store a set of parameter values for the offset, such as Start Freq, Stop Freq, Sweep Time, Res BW, Meas BW, Abs Start, and Abs Stop. Only one selection at a time is shown on this menu key label.

Key Path	Meas Setup, Offset/Limits
Mode	SA, WCDMA, C2K, WIMAX OFDMA, TD-SCDMA, 1xEVDO, DTMB (CTTB), DVB-T/H, ISDB-T, CMMB, LTE, LTE-TDD, Digital Cable TV, WLAN, MSR, LTEAFDD, LTEATDD
Preset	A
Range	MSR, LTEATDD, LTEAFDD, WLAN: A B C D E F G H J K L Other modes without option N9060A-7FP: A B C D E F Other modes with option N9060A-7FP: A B C D E F G H J K L
Initial S/W Revision	Prior to A.02.00
Modified at S/W Revision	A.02.00, A.03.00, A.10.00, A.11.00, A.14.00

Abs Start

Sets the absolute power level limit at the start frequency for the selected offset. The absolute power level limit ranges from -200 to +50 dBm.

The fail condition for each offset channel is set remotely by [:SENSe]:SEMAsk:OFFSet[n]
[:OUTer]:LIST:TEST.

You can turn off (not use) specific offset channels remotely with [:SENSe]:SEMAsk:OFFSet[n]
[:OUTer]:LIST:STATe.

The SCPI query returns values currently set to the absolute power test limits.

Missing values are not permitted; that is, if you want to change values 2 and 6, you must send all values up to 6. Subsequent values will remain as they were. The query for this parameter always returns 12 values.

Key Path	Meas Setup, Offset/Limit, Limits
Mode	SA, WCDMA, C2K, WIMAX OFDMA, TD-SCDMA, 1xEVDO, DTMB (CTTB), DVB-T/H, ISDB-T, CMMB, LTE, LTETDD, Digital Cable TV, WLAN, MSR, LTEAFDD, LTEATDD
Remote Command	[:SENSe] :SEMAsk:OFFSet [1] 2 [:OUTer] :LIST:STARt:ABSolute <real>, ... [:SENSe] :SEMAsk:OFFSet [1] 2 [:OUTer] :LIST:STARt:ABSolute?
Example	SEM:OFFS2:LIST:STAR:ABS -12.50 dBm, , -12.50 dBm, , -24.50 dBm, , -11.50 dBm, , -11.50 dBm, , -11.50 dBm SEM:OFFS2:LIST:STAR:ABS?
Notes	Comma separated list of values. OFFSet1 is for BTS, 2 for MS. Default is BTS. You must be in the mode that includes SEM measurement to use this command. Use :INSTrument:SElect to set the mode.
Couplings	If the current mode is DVB-T/H, this value will be modified automatically according to the limit type and the output power of the transmitter which is less or more than 25W. If the current mode is ISDB-T, this value will be modified automatically according to the limit type.
Preset	For modes (except MSR, , LTEAFDD, , LTEATDD and WLAN) without option N9060A-7FP, , the preset value is as follows. SA, , WIMAX OFDMA: -14.00 dBm, , -14.00 dBm, , -26.00 dBm, , -13.00 dBm, , -13.00 dBm, , -13.00 dBm WCDMA: -12.50 dBm, , -12.50 dBm, , -24.50 dBm, , -11.50 dBm, , -11.50 dBm, , -11.50 dBm -69.6 dBm, , -54.3 dBm, , -54.3 dBm, , -54.3 dBm, , -54.3 dBm C2K: -27.00 dBm, , -27.00 dBm, , -27.00 dBm, , -46.00 dBm, , -13.00 dBm, , -13.00 dBm -70.13 dBm, , -70.13 dBm, , -35.00 dBm, , -13.00 dBm, , -13.00 dBm, , -13.00 dBm TD-SCDMA: -28 dBm, , -28 dBm, , -36 dBm, , -21 dBm, , -21 dBm, , -21 dBm -71.3 dBm, , -71.3 dBm, , -56.07 dBm, , -56.07 dBm, , -56.07 dBm, , -56.07 dBm 1xEVDO: -27.0dBm, , -27.00 dBm, , -27.00 dBm, , -46.00 dBm, , -13.00 dBm, , -13.00 dBm -70.13 dBm, , -70.13 dBm, , -70.13 dBm, , -70.13 dBm, , -70.13 dBm, , -70.13 dBm DTMB (CTTB): -14.0 dBm, , -14.0 dBm, , -26.0 dBm, , -13.0 dBm, , -13.0 dBm, , -13.0 dBm -13.0 dBm, , -13.0 dBm, , -13.0 dBm, , -13.0 dBm, , -13.0 dBm, , -13.0 dBm DVB-T/H: 11.2 dBm, , -29 dBm, , -41 dBm, , -66 dBm, , -82 dBm, , -82 dBm -82 dBm, , -82 dBm, , -82 dBm, , -82 dBm, , -82 dBm ISDB-T, , CMMB, , Digital Cable TV: 50.0 dBm, , 50.0 dBm, , 50.0 dBm, , 50.0 dBm, , 50.0 dBm, , 50.0 dBm 50.0 dBm, , 50.0 dBm, , 50.0 dBm, , 50.0 dBm, , 50.0 dBm, , 50.0 dBm LTE, , LTETDD: -5.5 dBm, , -12.5 dBm, , -15.0 dBm, , -15.0 dBm, , -15.0 dBm, , -15.0 dBm -13.5 dBm, , -8.5 dBm, , -11.5 dBm, , -23.5 dBm, , -23.5 dBm, , -23.5 dBm When option N9060A-7FP is installed in these modes, , the preset value of Offset G ~ L is the same as the Offset F value. ----- WLAN: if Radio Std is 802.11a/g(OFDM/DSSS-OFDM): 16.00 dBm, , -4.00 dBm, , -12.00 dBm, , -

24.00 dBm, , -24.00 dBm, , -24.00 dBm, , -24.00 dBm, , -24.00 dBm, , -24.00 dBm, , -24.00 dBm, , -24.00 dBm
 if Radio Std is 802.11b/g(DSSS/CCK/PBCC): -10 dBm, , -30 dBm, , -30 dBm, , -30 dBm, , -30 dBm, , -30 dBm, , -30 dBm, , -30 dBm, , -30 dBm, , -30 dBm, , -30 dBm
 if Radio Std is 802.11n(20MHz) or 802.11ac(20MHz): 16.00 dBm, , -4.00 dBm, , -12.00 dBm, , -63.00 dBm, , -63.00 dBm, , -63.00 dBm, , -63.00 dBm, , -63.00 dBm, , -63.00 dBm, , -63.00 dBm, , -63.00 dBm
 if Radio Std is 802.11n(40MHz) or 802.11ac(40MHz): 16.00 dBm, , -4.00 dBm, , -12.00 dBm, , -66.00 dBm, , -66.00 dBm, , -66.00 dBm, , -66.00 dBm, , -66.00 dBm, , -66.00 dBm, , -66.00 dBm, , -66.00 dBm
 if Radio Std is 802.11ac(80MHz/160MHz): 16.00 dBm, , -4.00 dBm, , -12.00 dBm, , -69.00 dBm, , -69.00 dBm, , -69.00 dBm, , -69.00 dBm, , -69.00 dBm, , -69.00 dBm, , -69.00 dBm, , -69.00 dBm
 if Radio Std is 802.11ac (80 MHz + 80 MHz): -69.00 dBm, , -69.00 dBm, , -69.00 dBm, , -69.00 dBm, , -69.00 dBm, , -69.00 dBm, , -69.00 dBm, , -69.00 dBm, , -69.00 dBm
 MSR: -12.5 dBm, , -12.5 dBm, , -24.5 dBm, , -11.5 dBm, , -15.0 dBm, , -15.0 dBm, , -15.0 dBm, , -15.0 dBm, , -15.0 dBm, , -12.5 dBm, , -12.5 dBm, , -24.5 dBm, , -11.5 dBm, , -15.0 dBm, , -15.0 dBm, , -15.0 dBm, , -15.0 dBm, , -15.0 dBm, , -15.0 dBm, , -15.0 dBm
 LTEAFDD, , LTEATDD: -5.5 dBm, , -12.5 dBm, , -15.0 dBm, , -15.0 dBm, , -15.0 dBm, , -15.0 dBm, , -15.0 dBm, , -15.0 dBm, , -15.0 dBm, , -13.5 dBm, , -8.5 dBm, , -11.5 dBm, , -23.5 dBm, , -23.5 dBm, , -23.5 dBm, , -23.5 dBm, , -23.5 dBm, , -23.5 dBm, , -23.5 dBm, , -23.5 dBm, , -23.5 dBm

State Saved	Saved in instrument state.
Min	-200 dBm
Max	50 dBm
Initial S/W Revision	Prior to A.02.00
Modified at S/W Revision	A.02.00, A.03.00, A.10.00, A.11.00, A.14.00

Abs Stop

Sets the absolute power level limit at the stop frequency for the selected offset. The absolute power level limit ranges from -200 to +50 dBm. You can also toggle this function between couple and manual. If set to Couple, the Abs Stop power level limit is coupled to Abs Start to result in a flat limit line. If set to Man, Abs Start and Abs Stop take different values to result in a sloped limit line.

The SCPI query returns values currently set to the offset stop absolute power limits.

Missing values are not permitted; that is, if you want to change values 2 and 6, you must send all values up to 6. Subsequent values will remain as they were. The query for this parameter always returns 12 values.

Key Path	Meas Setup, Offset/Limits, Limits
Mode	SA, WCDMA, C2K, WIMAX OFDMA, TD-SCDMA, 1xEVDO, DTMB (CTTB), DVB-T/H, ISDB-T, CMMB, LTE, LTE-TDD, Digital Cable TV, WLAN, MSR, LTEAFDD, LTEATDD

Remote Command	<pre>[:SENSe] :SEMAsk:OFFSet [1] 2 [:OUTer] :LIST:STOP:ABSolute <real>, ... [:SENSe] :SEMAsk:OFFSet [1] 2 [:OUTer] :LIST:STOP:ABSolute? [:SENSe] :SEMAsk:OFFSet [1] 2 [:OUTer] :LIST:STOP:ABSolute:COUPle ON OFF 1 0, ... [:SENSe] :SEMAsk:OFFSet [1] 2 [:OUTer] :LIST:STOP:ABSolute:COUPle?</pre>
Example	<pre>SEM:OFFS:LIST:STOP:ABS -12.50 dBm, , -24.50 dBm, , -24.50 dBm, , -11.50 dBm, , -11.50 dBm, , -11.50 dBm SEM:OFFS1:LIST:STOP:ABS? SEM:OFFS:LIST:STOP:ABS:COUP ON, , OFF, , ON, , ON, , ON, , ON SEM:OFFS:LIST:STOP:ABS:COUP?</pre>
Notes	<p>Comma separated list of values. OFFSet1 is for BTS, 2 for MS. Default is BTS. You must be in the mode that includes SEM measurement to use this command. Use :INSTrument:SElect to set the mode.</p>
Couplings	<p>Coupled to Abs Start if "Auto" is selected, that is, the Stop value is equal to the Start value. If the current mode is DVB-T/H, this value will be modified automatically according to the limit type and the output power of the transmitter which is less or more than 25W. If the current mode is ISDB-T, this value will be modified automatically according to the limit type.</p>
Preset	<p>For modes (except MSR, , LTEAFDD, , LTEATDD and WLAN) without option N9060A-7FP, , the preset value is as follows.</p> <pre>SA, , WIMAX OFDMA: -14.00 dBm, , -26.00 dBm, , -26.00 dBm, , -13.00 dBm, , -13.00 dBm, , - 13.00 dBm WCDMA: -12.50 dBm, , -24.50 dBm, , -24.50 dBm, , -11.50 dBm, , -11.50 dBm, , -11.50 dBm - 69.6 dBm, , -54.3 dBm, , -54.3 dBm, , -54.3 dBm, , -54.3 dBm, , -54.3 dBm C2K: -27.00 dBm, , -27.00 dBm, , -27.00 dBm, , -46.00 dBm, , -13.00 dBm, , -13.00 dBm - 70.13 dBm, , -70.13 dBm, , -35.00 dBm, , -13.00 dBm, , -13.00 dBm, , -13.00 dBm TD-SCDMA: -28 dBm, , -36 dBm, , -36 dBm, , -21 dBm, , -21 dBm, , -21 dBm -71.3 dBm, , -71.3 dBm, , -56.07 dBm, , -56.07 dBm, , -56.07 dBm, , -56.07 dBm 1xEVDO: -27dBm, , -27.00 dBm, , -27.00 dBm, , -46.00 dBm, , -13.00 dBm, , -13.00 dBm - 70.13 dBm, , -70.13 dBm, , -70.13 dBm, , -70.13 dBm, , -70.13 dBm, , -70.13 dBm DTMB (CTTB): -14.0 dBm, , -26.0 dBm, , -26.0 dBm, , -13.0 dBm, , -13.0 dBm, , -13.0 dBm - 13.0 dBm, , -13.0 dBm, , -13.0 dBm, , -13.0 dBm, , -13.0 dBm, , -13.0 dBm DVB-T/H: -29 dBm, , -41 dBm, , -66 dBm, , -82 dBm, , -82 dBm, , -82 dBm -82 dBm, , -82 dBm, , -82 dBm, , -82 dBm, , -82 dBm, , -82 dBm, ISDB-TCMMB, , Digital Cable TV: 50.0 dBm, , 50.0 dBm, , 50.0 dBm, , 50.0 dBm, , 50.0 dBm 50.0 dBm, , 50.0 dBm, , 50.0 dBm, , 50.0 dBm, , 50.0 dBm, , 50.0 dBm LTE, , LTETDD:-12.5 dBm, , -12.5 dBm, , -15.0 dBm, , -15.0 dBm, , -15.0 dBm, , -15.0 dBm - 13.5 dBm, , -8.5 dBm, , -11.5 dBm, , -23.5 dBm, , -23.5 dBm, , -23.5 dBm When option N9060A-7FP is installed in these modes, , the preset value of Offset G ~ L is the same as the Offset F value. ----- WLAN:</pre>

when frequency changed to above 5GHz:

0 dB, -20.00 dB, -28.00 dB, -40.00 dB, -40.00 dB, -40.00 dB, -40.00 dB, -40.00 dB, -40.00 dB, -40.00 dB, -40.00 dB, -40.00 dB

Preset

For modes (except MSR, LTEAFDD, LTEATDD and WLAN) without option N9060A-7FP, the preset value is as follows.

SA: -30.00 dB, -30.00 dB, -30.00 dB, -30.00 dB, -30.00 dB, -30.00 dB

WCDMA: -30.00 dB, -30.00 dB, -30.00 dB, -30.00 dB, -30.00 dB, -30.00 dB, -30.00 dB, -30.00 dB, -33.73 dB, -34.00 dB, -37.50 dB, -47.50 dB, -47.50 dB, -47.50 dB

C2K: -45.00 dB, -45.00 dB, -55.00 dB, -55.00 dB, -55.00 dB, -55.00 dB, -55.00 dB, -55.00 dB, -42.00 dB, -54.00 dB, -54.00 dB, -54.00 dB, -54.00 dB, -54.00 dB

WIMAX OFDMA: 0 dB, -25 dB, -32 dB, -50 dB, -50 dB, -50 dB

TD-SCDMA: -54.00 dB, -54.00 dB, -62.00 dB, -47.00 dB, -47.00 dB, -47.00 dB, -47.00 dB, -47.00 dB, -49.00 dB, -44.00 dB, -44.00 dB, -44.00 dB, -44.00 dB, -44.00 dB

1xEVDO: -45dBc, -45.00 dB, -55.00 dB, -55.00 dB, -55.00 dB, -55.00 dB, -55.00 dB, -55.00 dB, -42dBc, -54.00 dB, -54.00 dB, -54.00 dB, -54.00 dB, -54.00 dB

DTMB (CTTB): -32.8 dB, -83 dB, -95 dB, -120 dB, -120 dB, -120 dB, -120 dB, -120 dB, -120 dB, -120 dB, -120 dB, -120 dB, -120 dB, -120 dB, -120 dB

DVB-T/H: -30 dB, -30 dB, -30 dB, -30 dB, -30 dB, -30 dB, -30 dB, -30 dB, -30 dB, -30 dB, -30 dB, -30 dB, -30 dB, -30 dB, -30 dB

ISDB-T: -27.4 dB, -47.4 dB, -54.4 dB, XXX, 50 dB, 50 dB, 50 dB, 50 dB, 50 dB, 50 dB, 50 dB, 50 dB, 50 dB, 50 dB, 50 dB; XXX is coupled with the total power reference, it is -57.4 dB when $P \leq 0.025 W$, -67.4 dB when $P = 0.25 W$, $-(73.4 + 10 \log P)$ dB when $0.25 W < P < 2.5 W$ or $0.025 W < P < 0.25 W$, -77.4 dB when $P > 2.5 W$.

CMMB: -37 dB, -72 dB, -84 dB, -90 dB, -90 dB, -90 dB, -90 dB, -90 dB, -90 dB, -90 dB, -90 dB, -90 dB, -90 dB, -90 dB, -90 dB

LTE, LTEATDD: 0 dB, 0 dB, 0 dB, 0 dB, 0 dB, 0 dB, 0 dB, 0 dB, 0 dB, 0 dB, 0 dB, 0 dB, 0 dB, 0 dB, 0 dB

Digital Cable TV: 0 dB, 0 dB, 0 dB, 0 dB, 0 dB, 0 dB, 0 dB, 0 dB, 0 dB, 0 dB, 0 dB, 0 dB, 0 dB, 0 dB, 0 dB

When option N9060A-7FP is installed in these modes, the preset value of Offset G ~ L is the same as the Offset F value.

WLAN:

if Radio Std is 802.11a/g(OFDM/DSSS-OFDM): 0 dB, -20.00 dB, -28.00 dB, -40.00 dB, -40.00 dB, -47.00 dB, -47.00 dB, -47.00 dB, -47.00 dB, -47.00 dB, -47.00 dB, -47.00 dB, -47.00 dB, -47.00 dB, -47.00 dB

if Radio Std is 802.11b/g(DSSS/CCK/PBCC): -30 dB, -50 dB, -50 dB, -50 dB, -50 dB, -50 dB, -50 dB, -50 dB, -50 dB, -50 dB, -50 dB, -50 dB, -50 dB, -50 dB, -50 dB

if Radio Std is 802.11n(20MHz/40MHz): 0 dB, -20.00 dB, -28.00 dB, -45.00 dB, -45.00 dB, -45.00 dB, -45.00 dB, -45.00 dB, -45.00 dB, -45.00 dB, -45.00 dB, -45.00 dB, -45.00 dB, -45.00 dB, -45.00 dB

if Radio Std is 802.11ac (20 MHz/ 40 MHz/ 80 MHz/ 160 MHz): 0 dB, -20.00 dB, -28.00 dB, -40.00 dB, -40.00 dB, -40.00 dB, -40.00 dB, -40.00 dB, -40.00 dB, -40.00 dB, -40.00 dB, -40.00 dB, -40.00 dB, -40.00 dB, -40.00 dB

if Radio Std is 802.11ac(80 MHz + 80MHz): -40.00 dB, -28.00 dB, -20 dB, 0 dB, -20 dB, -28 dB, -40 dB, -40 dB, -40.00 dB, -40.00 dB, -40.00 dB, -40.00 dB, -40.00 dB, -40.00 dB, -40.00 dB

MSR, LTEAFDD, LTEATDD: 0 dB, 0 dB, 0 dB, 0 dB, 0 dB, 0 dB, 0 dB, 0 dB, 0 dB, 0 dB, 0 dB, 0 dB, 0 dB, 0 dB, 0 dB

	0 dB, , 0 dB 0 dB, , 0 dB, , 0 dB, , 0 dB, , 0 dB, , 0 dB, , 0 dB, , 0 dB, , 0 dB, , 0 dB, , 0 dB
State Saved	Saved in instrument state.
Min	-200 dB
Max	50 dB
Initial S/W Revision	Prior to A.02.00
Modified at S/W Revision	A.02.00, A.03.00, A.10.00, A.11.00, A.14.00

Rel Stop

Sets a relative power level limit at the stop frequency for the selected offset. The relative power level limit ranges from -200 to +50 dBc.

The fail condition is set remotely by [:SENSe]:SEMask:OFFSet[n][:OUTer]:LIST:TEST for each offset channel.

You can turn off (not use) specific offset channels remotely with [:SENSe]:SEMask:OFFSet[n][:OUTer]:LIST:STATe.

The SCPI query returns values currently set to the offset stop relative power limits.

Missing values are not permitted; that is, if you want to change values 2 and 6, you must send all values up to 6. Subsequent values will remain as they were. The query for this parameter always returns 12 values.

Key Path	Meas Setup, Offset/Limits, Limits
Mode	SA, WCDMA, C2K, WIMAX OFDMA, TD-SCDMA, 1xEVDO, DTMB (CTTB), DVB-T/H, ISDB-T, CMMB, LTE, LTE-TDD, Digital Cable TV, WLAN, MSR, LTEAFDD, LTEATDD
Remote Command	[:SENSe]:SEMask:OFFSet[1] 2[:OUTer]:LIST:STOP:RCARrier <rel_ampl>, ... [:SENSe]:SEMask:OFFSet[1] 2[:OUTer]:LIST:STOP:RCARrier? [:SENSe]:SEMask:OFFSet[1] 2[:OUTer]:LIST:STOP:RCARrier:COUPle ON OFF 1 0, ... [:SENSe]:SEMask:OFFSet[1] 2[:OUTer]:LIST:STOP:RCARrier:COUPle?
Example	SEM:OFFS:LIST:STOP:RCAR -30, , -30, , -30, , -30, , -30, , -30 SEM:OFFS:LIST:STOP:RCAR? SEM:OFFS:LIST:STOP:RCAR:COUP ON, , ON, , ON, , ON, , ON SEM:OFFS:LIST:STOP:RCAR:COUP?
Notes	Comma separated list of values. OFFSet1 is for BTS, 2 for MS. Default is BTS. You must be in the mode that includes SEM measurement to use this command. Use :INSTrument:SElect to set the mode.
Couplings	Coupled to Rel Start if "Auto" is selected, that is, Start is made the same as Stop. If the current mode is DVB-T/H, this value will be modified automatically according to the limit type and the output power of the transmitter which is less or more than 25W. If the current mode is ISDB-T, this value will be modified automatically according to the limit type.

If the current mode is WLAN and radio std is 802.11n, Rel Stop limits will be set to following values when frequency changed to above 5GHz:
-20.00 dB, -28.00 dB, -40.00 dB, -40.00 dB, -40.00 dB, -40.00 dB, -40.00 dB, -40.00 dB, -40.00 dB, -40.00 dB, -40.00 dB, -40.00 dB

Preset

For modes (except MSR, , LTEAFDD, , LTEATDD and WLAN) without option N9060A-7FP, , the preset value is as follows.
SA: -30.00 dB, , -30.00 dB, , -30.00 dB, , -30.00 dB, , -30.00 dB, , -30.00 dB
WCDMA: -30.00 dB, , -30.00 dB, , -30.00 dB, , -30.00 dB, , -30.00 dB, , -30.00 dB|-48.28 dB, , -37.50 dB, , -47.50 dB, , -47.50 dB, , -47.50 dB, , -47.50 dB
C2K: -45.00 dB, , -45.00 dB, , -55.00 dB, , -55.00 dB, , -55.00 dB, , -55.00 dB|-42.00 dB, , -54.00 dB, , -54.00 dB, , -54.00 dB, , -54.00 dB, , -54.00 dB
WIMAX OFDMA: -25 dB, , -32 dB, , -50 dB, , -50 dB, , -50 dB, , -50 dB
TD-SCDMA: -54.00 dB, , -62.00 dB, , -62.00 dB, , -47.00 dB, , -47.00 dB, , -47.00 dB|-49.00 dB, , -58.945 dB, , -44.00 dB, , -44.00 dB, , -44.00 dB, , -44.00 dB
1xEVDO: -45dB, , -45.00 dB, , -55.00 dB, , -55.00 dB, , -55.00 dB, , -55.00 dB|-42dB, , -54.00 dB, , -54.00 dB, , -54.00 dB, , -54.00 dB
DTMB (CTTB): -83 dB, , -95 dB, , -120 dB, , -120 dB, , -120 dB, , -120 dB|-120 dB, , -120 dB, , -120 dB, , -120 dB, , -120 dB
DVB-T/H: -73 dB, , -85 dB, , -110 dB, , -126 dB, , -126 dB, , -126 dB|-126 dB, , -126 dB, , -126 dB, , -126 dB, , -126 dB
ISDB-T: -47.4 dB, , -54.4 dB, , XXX, , 50 dB, , 50 dB, , 50 dB |50 dB, , 50 dB, , 50 dB, , 50 dB, , 50 dB, , 50 dB; XXX is coupled with the total power reference P, it is -57.4 dB when $P \leq 0.025$ W, , -67.4 dB when $P = 0.25$ W, , $-(73.4 + 10 \log P)$ dB when 0.25 W < $P \leq 2.5$ W or 0.025 W < $P < 0.25$ W, , -77.4 dB when $P > 2.5$ W.
CMMB: -72 dB, , -84 dB, , -90 dB, , -90 dB, , -90 dB, , -90 dB|-90 dB, , -90 dB, , -90 dB, , -90 dB, , -90 dB
LTE, , LTETDD: 0 dB, , 0 dB, , 0 dB, , 0 dB, , 0 dB, , 0 dB
Digital Cable TV: 0 dB, , 0 dB, , 0 dB, , 0 dB, , 0 dB, , 0 dB |0 dB, , 0 dB, , 0 dB, , 0 dB, , 0 dB, , 0 dB
When option N9060A-7FP is installed in these modes, , the preset value of Offset G ~ L is the same as the Offset F value.

WLAN:
if Radio Std is 802.11a/g(OFDM/DSSS-OFDM): -20.00 dB, , -28.00 dB, , -40.00 dB, , -40.00 dB, , -47.00 dB, , -47.00 dB, , -47.00 dB, , -47.00 dB, , -47.00 dB, , -47.00 dB, , -47.00 dB, , -47.00 dB
if Radio Std is 802.11b/g(DSSS/CCK/PBCC): -30 dB, , -50 dB, , -50 dB, , -50 dB, , -50 dB, , -50 dB, , -50 dB, , -50 dB, , -50 dB, , -50 dB
if Radio Std is 802.11n(20MHz/40MHz): -20.00 dB, , -28.00 dB, , -45.00 dB, , -45.00 dB, , -45.00 dB, , -45.00 dB, , -45.00 dB, , -45.00 dB, , -45.00 dB, , -45.00 dB, , -45.00 dB
if Radio Std is 802.11ac (20 MHz/ 40 MHz/ 80 MHz/ 160 MHz): -20.00 dB, , -28.00 dB, , -40.00 dB, , -40.00 dB, , -40.00 dB, , -40.00 dB, , -40.00 dB, , -40.00 dB, , -40.00 dB, , -40.00 dB, , -40.00 dB, , -40.00 dB
if Radio Std is 802.11ac(80 MHz + 80MHz): -28.00 dB, , -20.00 dB, , 0 dB, , -20.00 dB, , -28.00

- OR checks against both limits, failing if either of the limits is broken.
- AND will only display a fail if both of the limits are broken.

The absolute or relative power limit value for each offset channel can be set remotely with [:SENSe]:SEMask:OFFSet[n][:OUTer]:LIST:ABSolute or [:SENSe]:SEMask:OFFSet[n][:OUTer]:LIST:RCARrier.

You can turn off (not use) specific offset channels remotely with [:SENSe]:SEMask:OFFSet[n][:OUTer]:LIST:STATe.

Missing values are not permitted; that is, if you want to change values 2 and 6, you must send all values up to 6. Subsequent values will remain as they were. The query for this parameter always returns 12 values.

Key Path	Meas Setup, Offset/Limits, Limits
Mode	SA, WCDMA, C2K, WIMAX OFDMA, TD-SCDMA, 1xEVDO, DTMB (CTTB), DVB-T/H, ISDB-T, CMMB, LTE, LTE-TDD, Digital Cable TV, WLAN, MSR, LTEAFDD, LTEATDD
Remote Command	[:SENSe]:SEMask:OFFSet[1] 2[:OUTer]:LIST:TEST ABSolute AND OR RELative, ... [:SENSe]:SEMask:OFFSet[1] 2[:OUTer]:LIST:TEST?
Example	SEM:OFFS:LIST:TEST ABS, , ABS, , ABS, , ABS, , ABS SEM:OFFS:LIST:TEST?
Notes	Comma separated list of values. You must be in the mode that includes SEM measurement to use this command. Use :INSTrument:SElect to set the mode.
Couplings	None If the current mode is DVB-T/H, this value will be modified automatically according to the limit type and the output power of the transmitter which is less or more than 25W.
Preset	For modes (except MSR, LTEAFDD, , LTEATDD and WLAN) without option N9060A-7FP, , the preset value is as follows. SA: ABS, ABS, ABS, ABS, ABS, ABS WCDMA: ABS, , ABS, , ABS, , ABS, , ABS AND, , AND, , AND, , AND, , AND C2K: REL, , REL, , REL, , ABS, , REL, , REL AND, , AND, , ABS, , REL, , REL, , REL WIMAX OFDMA: REL, , REL, , REL, , REL, , REL REL, , REL, , REL, , REL, , REL TD-SCDMA: ABS, , ABS, , ABS, , ABS, , ABS AND, , AND, , AND, , AND, , AND 1xEVDO: REL, , REL, , REL, , ABS, , REL, , REL AND, , AND, , AND, , OR, , AND, , AND DTMB (CTTB), ISDB-T, CMMB: REL, , REL, , REL, , REL, , REL REL, , REL, , REL, , REL, , REL, , REL DVB-T/H: ABS, , ABS, , ABS, , ABS, , ABS ABS, , ABS, , ABS, , ABS, , ABS LTE, , LTDTDD: ABS, , ABS, , ABS, , ABS, , ABS Digital Cable TV: REL, , REL, , REL, , REL, , REL REL, , REL, , REL, , REL, , REL When option N9060A-7FP is installed in these modes, , the preset value of Offset G ~ L is the same as the Offset F value. ----- WLAN:

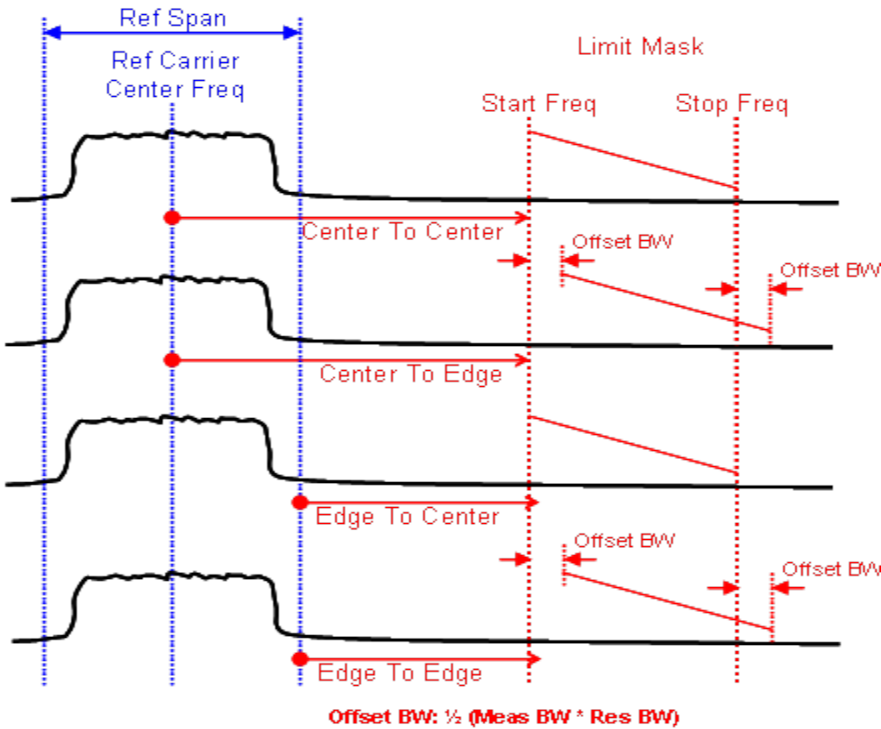
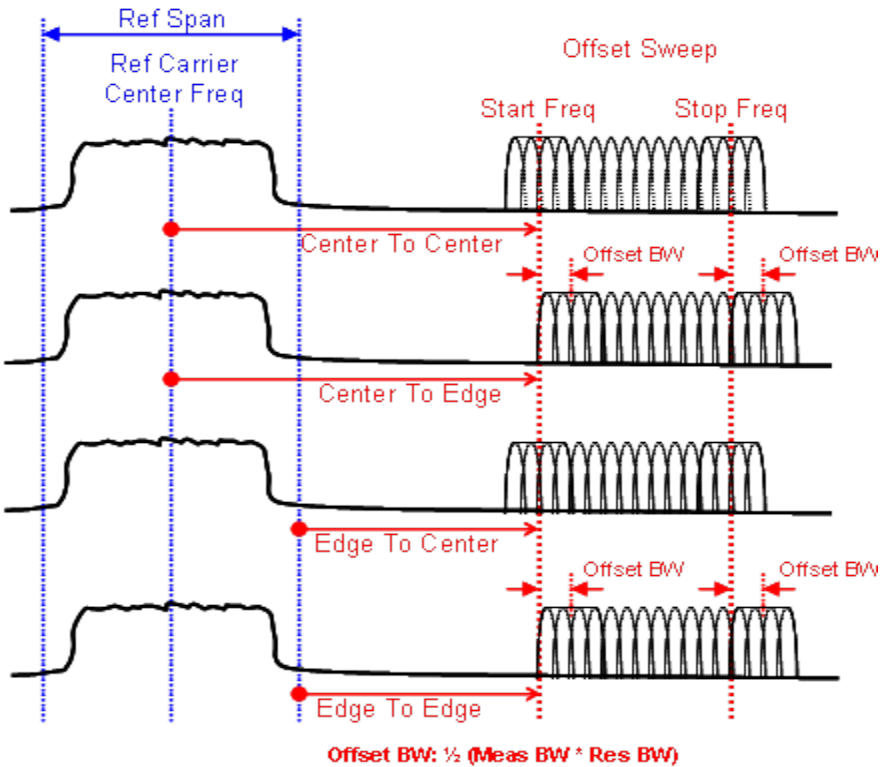

Key Path	Meas Setup, Offset/Limits
Mode	SA, WCDMA, C2K, WIMAX OFDMA, TD-SCDMA, 1xEVDO, DVB-T/H, DTMB (CTTB), ISDB-T, CMMB, LTE, LTETDD, Digital Cable TV, WLAN
Remote Command	[:SENSe] :SEMAsk:OFFSet [1] 2 :TYPE CTOCenter CTOEdge ETOCenter ETOEdge [:SENSe] :SEMAsk:OFFSet [1] 2 :TYPE?
Example	SEM:OFFS:TYPE ETOC SEM:OFFS:TYPE?
Notes	You must be in the mode that includes SEM measurements to use this command. Use :INSTrument:SElect to set the mode. For the MSR and LTE-Advanced FDD/TDD mode, see Offset Freq Define (Only for MSR and LTE-Advanced FDD/TDD) .
Preset	SA, , WCDMA, , WIMAX OFDMA, , TD-SCDMA, , DVB-T/H, , DTMB (CTTB), , ISDB-T, , CMMB, , Digital Cable TV: CTOC C2K: CTOE 1xEVDO: CTOE LTE: ETOC LTETDD: ETOC
State Saved	Saved in instrument state.
Range	Carrier Center To Meas BW Center Carrier Center To Meas BW Edge Carrier Edge To Meas BW Center Carrier Edge To Meas BW Edge
Initial S/W Revision	A.03.00

Method

Sets the measurement method:

- **Integ BW**—enables you to set the channel integration bandwidth.
- **RRC Weight**—selects Root Raised Cosine (RRC) filtering of the carriers. The α value (rolloff) for the filter is set to the value of the Filter Alpha parameter.

Key Path	Meas Setup
Mode	SA, WCDMA, WIMAX OFDMA, TD-SCDMA, DTMB (CTTB), DVB-T/H, ISDB-T, CMMB, LTE, LTETDD, Digital Cable TV, WLAN, MSR, LTEAFDD, LTEATDD
Remote Command	[:SENSe] :SEMAsk:FILTEr [:RRC] [:STATe] OFF ON 0 1 [:SENSe] :SEMAsk:FILTEr [:RRC] [:STATe] ?
Example	SEM:FILT ON SEM:FILT?
Notes	For the C2K and 1xEVDO mode, this key is not available. 1 ON = RRC Weight, 0 OFF = IntegBW You must be in the mode that includes SEM measurement to use this command. Use

	:INSTRument:SElect to set the mode.
Dependencies	WLAN: RRC Weight is not supported when the radio standard is WLAN 802.11ac (80+80MHz).
Preset	SA, , WIMAX OFDMA, , DVB-T/H, , ISDB-T, , CMMB, , LTE, , LTETDD, , WLAN, , MSR, , LTEAFDD, , LTEATDD: OFF WCDMA, , TD-SCDMA, , DTMB (CTTB), , Digital Cable TV: ON
State Saved	Saved in instrument state.
Range	RRCWeight IntegBW
Initial S/W Revision	Prior to A.02.00
Modified at S/W Revision	A.02.00, A.03.00

Filter Alpha

Sets the alpha value for the RRC Filter.

Key Path	Meas Setup
Mode	SA, WCDMA, WIMAX OFDMA, TD-SCDMA, DTMB (CTTB), DVB-T/H, ISDB-T, CMMB, LTE, LTETDD, Digital Cable TV, MSR, LTEAFDD, LTEATDD
Remote Command	[:SENSe] :SEMAsk:FILTer [:RRC] :ALPHa <real> [:SENSe] :SEMAsk:FILTer [:RRC] :ALPHa?
Example	SEM:FILT:ALPH 0.3 SEM:FILT:ALPH?
Notes	For the C2K and 1xEVDO mode, this key is not available. You must be in the mode that includes SEM measurement to use this command. Use :INSTRument:SElect to set the mode.
Preset	0.22 DTMB (CTTB): 0.05 Digital Cable TV: 0.15
State Saved	Saved in instrument state.
Min	0.01
Max	1.0
Initial S/W Revision	Prior to A.02.00
Modified at S/W Revision	A.02.00, A.03.00

Meas Preset

Restores all the measurement parameters to their default values.

Key Path	Meas Setup
Mode	SA, WCDMA, C2K, WIMAX OFDMA, TD-SCDMA, 1xEVDO, DTMB (CTTB), DVB-T/H, ISDB-T, CMMB,

	LTE, LTE-TDD, Digital Cable TV, WLAN, MSR, LTE-A FDD, LTE-A TDD
Remote Command	:CONFigure:SEMask
Example	CONF:SEM
Notes	You must be in the mode that includes SEM measurement to use this command. Use :INSTrument:SElect to set the mode.
Couplings	Selecting Meas Preset will restore all measurement parameters to their default values.
Initial S/W Revision	Prior to A.02.00
Modified at S/W Revision	A.02.00, A.03.00

Mode

See "Mode" on page 316

Mode Preset

Returns the active mode to a known state.

Mode Preset does the following for the currently active mode:

- Aborts the currently running measurement.
- Brings up the default menu for the mode, with no active function.
- Sets measurement Global settings to their preset values for the active mode only.
- Activates the default measurement.
- Brings up the default menu for the mode.
- Clears the input and output buffers.
- Sets Status Byte to 0.

Mode Preset does not:

- Cause a mode switch
- Affect mode persistent settings
- Affect system settings

See "[How-To Preset](#)" on page 1507 for more information.

Key Path	Front-panel key
Remote Command	:SYSTem:PRESet
Example	:SYST:PRES
Notes	*RST is preferred over :SYST:PRES for remote operation. *RST does a Mode Preset, as done by the :SYST:PRES command, and it sets the measurement mode to Single measurement rather than Continuous for optimal remote control throughput. Clears all pending OPC bits. The Status Byte is set to 0.
Couplings	A Mode Preset aborts the currently running measurement, activates the default measurement, and gets the mode to a consistent state with all of the default couplings set.
Backwards Compatibility Notes	In the X-Series, the legacy "Factory Preset" has been replaced with Mode Preset, which only presets the currently active mode, not the entire instrument. In the X-Series, the way to preset the entire instrument is by using System, Restore System Defaults All, which behaves essentially the same way as restore System Defaults does on ESA and PSA. There is also no "Preset Type" as there is on the PSA. There is a green Mode Preset front-panel key that does a Mode Preset and a white-with-green-letters User Preset front-panel key that does a User Preset. The old PRESet:TYPE command is ignored (without generating an error), and SYST:PRES without a parameter does a Mode Preset, which should cover most backward code compatibility issues. The settings and correction data under the Input/Output front-panel key (examples: Input Z Corr, Ext Amp Gain, etc.) are no longer part of any Mode, so they will not be preset by a Mode Preset. They are preset using Restore Input/Output Defaults, Restore System Defaults All. Note that because User Preset does a Recall State, and all of these settings are saved in State, they ARE recalled when using

	User Preset.
Initial S/W Revision	Prior to A.02.00

How-To Preset

The table below shows all possible presets, their corresponding SCPI commands and front-panel access (key paths). Instrument settings depend on the current measurement context. Some settings are local to the current measurement, some are global (common) across all the measurements in the current mode, and some are global to all the available modes. In a similar way, restoring the settings to their preset state can be done within the different contexts.

Auto Couple - is a measurement local key. It sets all Auto/Man parameter couplings in the measurement to Auto. Any Auto/Man selection that is local to other measurements in the mode will not be affected.

Meas Preset - is a measurement local key. Meas Preset resets all the variables local to the current measurement except the persistent ones.

Mode Preset - resets all the current mode's measurement local and measurement global variables except the persistent ones.

Restore Mode Defaults - resets ALL the Mode variables (and all the Meas global and Meas local variables), including the persistent ones.

Type Of Preset	SCPI Command	Front Panel Access
Auto Couple	:COUPlE ALL	Auto Couple front-panel key
Meas Preset	:CONFIgure:<Measurement>	Meas Setup Menu
Mode Preset	:SYSTem:PRESet	Mode Preset (green key)
Restore Mode Defaults	:INSTrument:DEFault	Mode Setup Menu
Restore All Mode Defaults	:SYSTem:DEFault MODEs	System Menu; Restore System Default Menu
*RST	*RST	not possible (Mode Preset with Single)
Restore Input/Output Defaults	:SYSTem:DEFault INPut	System Menu; Restore System Default Menu
Restore Power On Defaults	:SYSTem:DEFault PON	System Menu; Restore System Default Menu
Restore Alignment Defaults	:SYSTem:DEFault ALIGn	System Menu; Restore System Default Menu
Restore Miscellaneous Defaults	:SYSTem:DEFault MISC	System Menu; Restore System Default Menu
Restore All System Defaults	:SYSTem:DEFault [ALL] :SYSTem:PRESet:PERSistent	System Menu; Restore System Default Menu
User Preset	:SYSTem:PRESet:USER	User Preset Menu
User Preset All Modes	:SYSTem:PRESet:USER:ALL	User Preset Menu

Power On Mode Preset	:SYSTem:PON:TYPE MODE	System Menu
Power On User Preset	:SYSTem:PON:TYPE USER	System Menu
Power On Last State	:SYSTem:PON:TYPE LAST	System Menu

Preset Type (Remote Command Only)

As stated in the Backward Compatibility section, to be compatible with ESA/PSA the PRESet:TYPE command will be implemented as a no-op.

Mode	All
Remote Command	:SYSTem:PRESet:TYPE FACTory MODE USER :SYSTem:PRESet:TYPE?
Example	:SYST:PRESet:TYPE FACT
Notes	This command is supported for backward compatibility only. It is a no-op which does not change the behavior of any preset operation.
Preset	This is unaffected by Preset but is set to Mode on a "Restore System Defaults->All"
State Saved	No
Initial S/W Revision	Prior to A.02.00

Mode Setup

See ["Mode Setup" on page 347](#)

Peak Search

There is no 'Peak Search' supported in Spectrum Emission Mask so this front-panel key displays a blank menu when pressed.

Key Path	Front-panel key
Initial S/W Revision	Prior to A.02.00

Print

See "Print" on page 365

Quick Save

The Quick Save front-panel key repeats the most recent save that was performed from the Save menu, with the following exceptions:

- Register saves are not remembered as Saves for the purpose of the Quick Save function
- If the current measurement does not support the last non-register save that was performed, an informational message is generated, “File type not supported for this measurement”

Quick Save repeats the last type of qualified save (that is, a save qualified by the above criteria) in the last save directory by creating a unique filename using the Auto File Naming algorithm described below.

If Quick Save is pressed after startup and before any qualified Save has been performed, the Quick Save function performs a Screen Image save using the current settings for Screen Image saves (current theme, current directory), which then becomes the “last save” for the purpose of subsequent Quick Saves.

The Auto File Naming feature automatically generates a file name for use when saving a file. The filename consists of a prefix and suffix separated by a dot, as is standard for the Windows® file system. A default prefix exists for each of the available file types:

Type	Default Prefix	Menu
State	State_	(Save/Recall)
Trace + State	State_	(Save/Recall)
Screen	Screen_	(Save/Recall)
Amplitude Corrections	Ampcor_	(Import/Export)
Traces	Trace_	(Import/Export)
Limit Lines	LLine_	(Import/Export)
Measurement Result	MeasR_	(Import/Export)
Capture Buffer	CapBuf_	(Import/Export)

A four digit number is appended to the prefix to create a unique file name. The numbering sequence starts at 0000 within each Mode for each file type and updates incrementally to 9999, then wraps to 0000 again. It remembers where it was through a Mode Preset and when leaving and returning to the Mode. It is reset by Restore Misc Defaults and Restore System Defaults and subsequent running of the instrument application. So, for example, the first auto file name generated for State files is State_0000.state. The next is State_0001, and so forth.

One of the key features of Auto File Name is that we guarantee that the Auto File Name will never conflict with an existing file. The algorithm looks for the next available number. If it gets to 9999, then it looks for holes. If it find no holes, that is no more numbers are available, it gives an error.

For example, if when we get to State_0010.state there is already a State_0010.state file in the current directory, it advances the counter to State_0011.state to ensure that no conflict will exist (and then it verifies that State_0011.state also does not exist in the current directory and advances again if it does, and so forth).

If you enter a file name for a given file type, then the prefix becomes the filename you entered instead of the default prefix, followed by an underscore. The last four letters (the suffix) are the 4-digit number.

For example, if you save a measurement results file as “fred.csv”, then the next auto file name chosen for a measurement results save will be fred_0000.csv.

NOTE Although 0000 is used in the example above, the number that is used is actually the current number in the Meas Results sequence, that is, the number that would have been used if you had not entered your own file name.

NOTE If the filename you entered ends with _dddd, where d=any number, making it look just like an auto file name, then the next auto file name picks up where you left off with the suffix being dddd + 1.

Key Path	Front-panel key
Notes	No remote command for this key specifically.
Initial S/W Revision	Prior to A.02.00

Recall

In the LTE TDD mode, four types of recall functions are available under the Data menu: “Limit Mask”, “E-UTRA Test Model”, “Signal Studio Setup” and “Vector Signal Analyzer”. “Limit Mask” enables setting of a preset limit mask for Power Suite-based measurements, and currently it is available for the SEM/ACP measurements with the LTE TDD mode. Recalling “E-UTRA Test Model” sets complicated RB settings for each Test Model for the Modulation Analysis and Conformance EVM measurements. Recalling “Signal Studio Setup” or “89600 Vector Signal Analyzer” enables you to recall parameters which have been set and saved on the external platform.

Key Path	Front Panel
Mode	LTETDD
Initial S/W Revision	Prior to A.02.00
Modified at S/W Revision	A.06.00

State

The Recall State menu lets you choose a register or file from which to recall the state.

The content of a state file includes all of the settings and data required to return the analyzer as closely as possible to the Mode it was in, with the exact settings that were in place, when the save occurred. The Mode settings in each state file include the settings that are affected by Mode Preset, as well as the additional settings affected by Restore Mode Defaults; all of the Mode’s settings. In addition, all of the settings of the Input/Output system are included, even though they are outside of the Mode’s state, because they are needed to restore the complete setup. Persistent System settings (for example, GPIB address) are not affected by either a Mode Preset or Restore Mode Defaults, nor are they included in a saved State file.

Since each state file is only for one Mode, the settings for other Modes are unaffected when it is loaded. Recall State will cause a mode switch if the state being recalled is not from the current active mode.

After the recall completes, the message "File <filename> recalled" or “Recalled State Register <register number>” is displayed.

For rapid recalls, the State menu lists 16 registers that you can choose from to recall. Pressing a Register key initiates the recall. You can also select a file from which to recall.

The default path for all State Files is:

My Documents\<<mode name>\state

where <mode name> is the parameter used to select the mode with the INST:SEL command (for example, SA for the Spectrum Analyzer).

See "[More Information](#)" on page 1515.

Key Path	Recall
Mode	All

Remote Command	:MMEMory:LOAD:STATe <filename>
Example	:MMEM:LOAD:STAT "myState.state" This recalls the file myState.state on the default path
Example	MMEM:LOAD:STAT "MyStateFile.state" This loads the state file data (on the default file directory path) into the instrument state.
Notes	<p>When you pick a file to recall, the analyzer first verifies that the file is recallable in the current instrument by checking the software version and model number of the instrument. If everything matches, a full recall proceeds by aborting the currently running measurement, clearing any pending operations, and then loading the State from the saved state file. You can open state files from any mode, so recalling a State file switches to the mode that was active when the save occurred. After switching to the mode of the saved state file, mode settings and data (if any for the mode) are loaded with values from the saved file. The saved measurement of the mode becomes the newly active measurement and the data relevant to the measurement (if there is any) is recalled.</p> <p>If there is a mismatch between file version or model number or instrument version or model number, the recall function tries to recall as much as possible and returns a warning message. It may limit settings that differ based on model number, licensing or version number.</p> <p>After recalling the state, the Recall State function does the following:</p> <ul style="list-style-type: none"> • Makes the saved measurement for the mode the active measurement. • Clears the input and output buffers. • Status Byte is set to 0. • Executes a *CLS <p>If the file specified is empty an error is generated. If the specified file does not exist, another error is generated. If there is a mismatch between the file and the proper file type, an error is generated. If there is a mismatch between file version or model number or instrument version or model number, a warning is displayed. Then it returns to the State menu and File Open dialog goes away.</p> <p>After the Recall, the analyzer exits the Recall menu and returns to the previous menu.</p>
Backwards Compatibility SCPI	:MMEMory:LOAD:STATe 1,<filename> For backwards compatibility, the above syntax is supported. The "1" is simply ignored.
Initial S/W Revision	Prior to A.02.00

More Information

In measurements that support saving Traces, for example, Swept SA, the Trace data is saved along with the State in the State file. When recalling the State, the Trace data is recalled as well. Traces are recalled exactly as they were stored, including the writing mode and update and display modes. If a Trace was updating and visible when the State was saved, it will come back updating and visible, and its data will be rewritten right away. When you use State to save and recall traces, any trace whose data must be preserved should be placed in View or Blank mode before saving.

The following table describes the Trace Save and Recall possibilities:

You want to recall state and one trace's data, leaving other traces unaffected.	Save Trace+State from 1 trace. Make sure that no other traces are updating (they should all be in View	On Recall, specify the trace you want to load the one trace's data into. This trace will load in View.
---	---	--

	or Blank mode) when the save is performed.	All other traces' data will be unaffected, although their trace mode will be as it was when the state save was performed.
You want to recall all traces	Save Trace+State from ALL traces.	On Recall, all traces will come back in View (or Blank if they were in Blank or Background when saved)
You want all traces to load exactly as they were when saved.	Save State	On recall, all traces' mode and data will be exactly as they were when saved. Any traces that were updating will have their data immediately overwritten.

From File...

When you press “From File”, the analyzer brings up a Windows dialog and a menu entitled “File Open.” This menu allows you to navigate to the various fields in the Windows dialog without using a keyboard or mouse. The Tab and Arrow keys can also be used for dialog navigation.

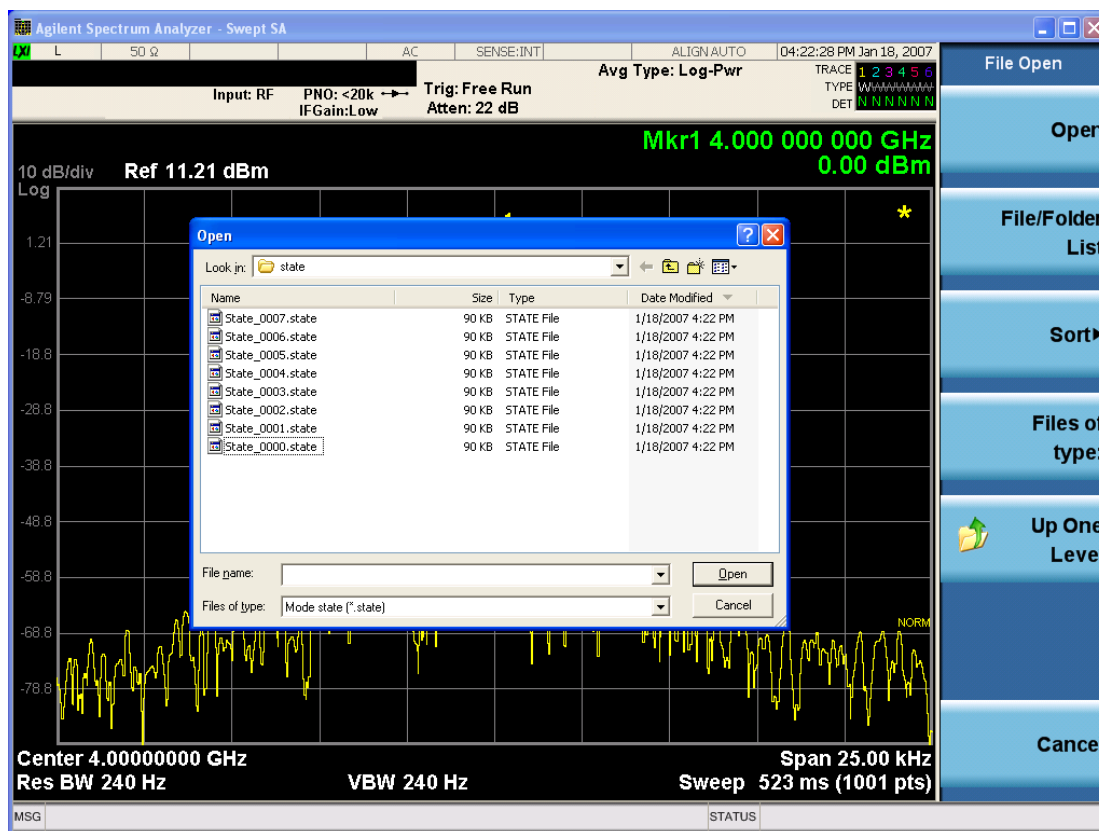

Listed below are the functions of the various fields in the dialog, and the corresponding softkeys:

Open

Performs the recall of the specified file. While the recall is being performed, the floppy icon appears briefly in the Meas bar.

File/Folder List

Enables you to navigate to the center of the dialog that contains the list of files and folders. Once here you can get information about the file and use the tab keys to navigate to the other fields in the dialog, such as Look In.

Look In

The Look In field shows the path from which the file will be recalled and allows you to change the path using the up and down arrow keys to navigate to other paths; the Enter key to open a directory; and the Backspace key to go back one directory. The **Look In field** first uses the last path from the Save As dialog **Save In:** path for that same file type. There is no softkey for directly navigating to the Look In field, but you can use the left tab to get here from the File/Folder List.

User specified paths are remembered when you leave and return to a Mode and are reset back to the default using Restore Mode Defaults.

Sort

Accesses a menu that enables you to sort the files within the File Open dialog. Only one sorting type can be selected at a time and the sorting happens immediately. The sorting types are By Date, By Name, By extension, and By Size.

Files of Type

This field shows the file suffix for the type of file you have selected to recall. For example, if you navigated here while recalling State, "Mode state (*.state)" is in the field. If you navigated here while recalling Trace, ""Mode state (*.trace)" is in the field. If you navigated here while importing a trace data file, "Trace Data (*.csv)" is in the field. For some file types, there is more than one choice in the dropdown menu, which you can select by using the up and down arrow keys and Enter.

Up One Level

This key corresponds to the icon of a folder with the up arrow that is in the tool bar of the dialog. When pressed, it causes the file and folder list to navigate up one level in the directory structure. The Backspace key does the same thing.

Cancel

This key corresponds to the Cancel selection in the dialog. It causes the current **Open** request to be cancelled. The ESC key does the same thing.

Key Path	Recall, State
Notes	Brings up the Open dialog for recalling a State Save Type
Initial S/W Revision	Prior to A.02.00

Edit Register Names

You may enter a custom name on any of the Register keys, to help you remember what you are using that state to save. To do this, press the Edit Register Names key, choose the register whose name you wish to edit, and then enter the desired label using the Alpha Editor or an external PC keyboard.

The maximum number of characters that can be added is 30. In most cases, 30 characters will fit on two lines of the key.

For more information and the SCPI command, see Edit Register Names under the Save, State function.

Key Path	Recall, State
Mode	All
Dependencies	N9060A-7FP or N9060B-2FP license required to edit the register names. When the feature is not licensed, sending the SCPI command generates an error, -221, "Settings conflict;Option not available"
Initial S/W Revision	A.11.00

Register 1 thru Register 16

Selecting any one of these register keys causes the State of the mode from the specified Register to be recalled. Each of the register keys annotates whether it is empty or at what date and time it was last modified. In addition, you can use the Edit Register Names key under Save, State to enter custom names for each register.

Registers are shared by all modes, so recalling from any one of the registers will cause a mode switch to the mode that was active when the save to the Register occurred.

Although these 16 registers are the only registers available from the front panel, there are 128 state registers available in the instrument. Registers 17-128 are only available from the SCPI interface, using the *RCL command.

After the recall completes, the message "Register <register number> recalled" appears in the message bar. If you are in the Spectrum Analyzer Mode, and you are recalling a register that was saved in the Spectrum Analyzer Mode, then after the recall, you will still be in the Recall Register menu. If the Recall causes you to switch modes, then after the Recall, you will be in the Frequency menu.

If a requested register is empty an error is generated.

Key Path	Recall, State
Example	*RCL 1
Range	1-16 from front panel, 1-128 from SCPI
Readback	Date and time with seconds resolution are displayed on the key OR A custom name of up to 30 characters entered using the Save, State,Edit Register Names key OR “(empty)” if no prior save operation has been performed to this register.
Initial S/W Revision	Prior to A.02.00
Modified at S/W Revision	Prior to A.11.00

Register 1 thru Register 16

Selecting any one of these register keys causes the State of the mode from the specified Register to be recalled. Each of the register keys annotates whether it is empty or at what date and time it was last modified. In addition, you can use the Edit Register Names key under Save, State to enter custom names for each register.

Registers are shared by all modes, so recalling from any one of the registers will cause a mode switch to the mode that was active when the save to the Register occurred.

Although these 16 registers are the only registers available from the front panel, there are 128 state registers available in the instrument. Registers 17–128 are only available from the SCPI interface, using the *RCL command.

After the recall completes, the message "Register <register number> recalled" appears in the message bar. If you are in the Spectrum Analyzer Mode, and you are recalling a register that was saved in the Spectrum Analyzer Mode, then after the recall, you will still be in the Recall Register menu. If the Recall causes you to switch modes, then after the Recall, you will be in the Frequency menu.

If a requested register is empty an error is generated.

Key Path	Recall, State
Example	*RCL 1
Range	1–16 from front panel, 1–128 from SCPI
Readback	Date and time with seconds resolution are displayed on the key OR A custom name of up to 30 characters entered using the Save, State, Edit Register Names key OR “(empty)” if no prior save operation has been performed to this register.
Initial S/W Revision	Prior to A.02.00
Modified at S/W Revision	Prior to A.11.00

Recall

In the LTE TDD mode, four types of recall functions are available under the Data menu: “Limit Mask”, “E-UTRA Test Model”, “Signal Studio Setup” and “Vector Signal Analyzer”. “Limit Mask” enables setting of a preset limit mask for Power Suite-based measurements, and currently it is available for the SEM/ACP measurements with the LTE TDD mode. Recalling “E-UTRA Test Model” sets complicated RB settings for each Test Model for the Modulation Analysis and Conformance EVM measurements. Recalling “Signal Studio Setup” or “89600 Vector Signal Analyzer” enables you to recall parameters which have been set and saved on the external platform.

Key Path	Front Panel
Mode	LTETDD
Initial S/W Revision	Prior to A.02.00
Modified at S/W Revision	A.06.00

Import Trace Data

Enables you to import previously saved trace data into a Data Register and optionally display it. Selecting this key displays a menu that enables you to select the destination data register, and also enables you to choose whether or not to display the recalled data in the currently selected trace. After making these selections, select Open... and use the file dialog to select the file you want to recall.

Recalling trace data into an already used Data Register overwrites the previous data. If the data register is displayed on any trace, the display is updated to reflect the new data.

The SCPI command

```
:MMEM:LOAD:TRAC:DATA D1|D2|D3|D4|D5|D6,<filename>
```

recalls data into a specified register, but does not display it in the selected trace. Use the command

```
:DISP:<meas>:TRAC<n>:FEED D1|D2|D3|D4|D5|D6
```

to display the register in the desired trace.

It is possible to recall trace data saved by other VXA measurements, or measurements made using the LTE, LTETDD, iDEN, or 89601 applications.

Key Path	Recall, Data (Import)
Mode	VSA, LTE, LTETDD, IDEN
Remote Command	:MMEMory:LOAD:TRACe:DATA D1 D2 D3 D4 D5 D6,<filename>[,CSV TXT SDF MAT4 MAT HDF5 BIN]
Example	:MMEM:LOAD:TRAC:DATA D1,"Trc1.txt",TXT
Notes	<p>The Open: dialog box has the following filter options when you are recalling trace data::</p> <ul style="list-style-type: none"> • CSV (Comma delimited) (*.csv) • SDF (Fast) (*.sdf;*.dat) • Text (Tab delimited) (*.txt) <p>The file must have the same format as that created by the Export Recorded Data command.</p> <p>The SCPI command has an optional file format parameter. If you do not include this parameter in the SCPI command, the file format is determined by the file name extension. If no file extension is recognized, the file is scanned to determine the format.</p> <p>If you are not licensed to recall a particular file type, then error -203.9010 is returned. If the file format cannot be determined or the file cannot be recalled successfully, then error -250.5290 is returned. If the recall is successful, then advisory 0.1600 is shown.</p>
State Saved	No
Readback	Data 1 Data 2 Data 3 Data 4 Data 5 Data 6

Data 1

Selects the Data 1 register as the destination for the imported data.

Key Path	Recall, Data (Import), Trace (to)
Mode	VSA, LTE, LTETDD, IDEN

Data 2

Selects the Data 2 register as the destination for the imported data.

Key Path	Recall, Data (Import), Trace (to)
Mode	VSA, LTE, LTETDD, IDEN

Data 3

Selects the Data 3 register as the destination for the imported data.

Key Path	Recall, Data (Import), Trace (to)
Mode	VSA, LTE, LTETDD, IDEN

Data 4

Selects the Data 4 register as the destination for the imported data.

Key Path	Recall, Data (Import), Trace (to)
Mode	VSA, LTE, LTETDD, IDEN

Data 5

Selects the Data 5 register as the destination for the imported data..

Key Path	Recall, Data (Import), Trace (to)
Mode	VSA, LTE, LTETDD, IDEN

Data 6

Selects the Data 6 register as the destination for the imported data.

Key Path	Recall, Data (Import), Trace (to)
Mode	VSA, LTE, LTETDD, IDEN

Display in Selected Trace

Enables you to select whether the recalled trace data is displayed in the current Trace.

Key Path	Recall, Data (Import), Trace (to)
----------	-----------------------------------

Mode	VSA, LTE, LTETDD, IDEN
State Saved	No

Signal Studio Setup

This key allows you to recall the Agilent Signal Studio setup file created on the Signal Studio (N7625B). This key is valid only for the Mod Analysis measurement. For E-TM test model signal, please use corresponding EVM setup file under My Documents\LTETDD\data\evmsetup.

For the supported carrier types, see the table below.

Signal Studio	Carrier Type
N7625B Signal Studio for 3GPP LTE TDD	Advanced LTE TDD(2009-03)
	Advanced LTE TDD(2009-12)
	Basic LTE TDD(2009-03)
	Basic LTE TDD(2009-12)

File Location and Extension

File location: "My Documents\LTETDD\data"

File type: xml

File extension: .scp

You need to place the Signal Studio Setup file created on N7625B in the above directory in advance. Pressing OPEN under the Import Data menu will open this directory from which you can select the setup file.

Example:

File Location: My Documents\LTETDD\data

File Name: Uplink PUSCH.scp

Key Path	Recall, Data
Mode	LTETDD
Remote Command	MMEemory:LOAD:SSSetup <string>
Example	MME:LOAD:SSS "Uplink PUSCH.scp"
Notes	Sets of parameters related to Signal Studio Setup are overwritten by the contents of the setup file.
Initial S/W Revision	A.06.00

89601 VSA Setup

Enables you to import the 89600 Vector Signal Analyzer Setup file created using the 89600 Vector Signal Analyzer Option BHE (LTE TDD). This key is valid only for the Mod Analysis measurement.

File Location and Extension

File location: “My Documents\LTETDD\data”

File type: text file

File extension: .set, .setx

Place the 89600 Vector Signal Analyzer Setup file that you saved on 89600 in the above directory. When you select OPEN under the Import Data menu, the directory opens enabling you to select your setup file.

Example:

File Location: My Documents\LTETDD\data

File Name: Uplink PRACH.set

Key Path	Recall, Data
Mode	LTETDD
Remote Command	MMEMory:LOAD:VSASetup <string>
Example	MMEM:LOAD:VSAS "Uplink PRACH.set"
Notes	Sets of parameters related to Vector Signal Analyzer Setup are overwritten by the contents of the setup file.
Initial S/W Revision	A.06.00
Modified at S/W Revision	A.10.00

Masks

This key allows you to recall a preset mask file from the list. The preset mask file contains configuration for only Carrier, Offset, Limit settings and the preset profile BW. Any set of values not specified by the preset mask file will not be overwritten.

You cannot change or create the preset mask file since it is a binary file. This key is valid for the Spectrum Emission Mask and ACP measurements.

File location: “My Documents\LTETDD\data\masks”

Note that “My Documents” is an alias to a directory and its place differs depending on which user is logged in. At XSA start up, XSA will overwrite all of the limit mask files to the current user’s “My Documents\LTETDD\data\masks” each time.

File type: Binary

Filename: The filename follows the rule below, in which the word is connected with underscores.

<Measurement>_<Direction>_<Bandwidth>_<Condition>.mask

Where

<Measurement> Measurement the limit mask file is applied to: SEM or ACP

<Direction> Direction: BS (Downlink) or MS (Uplink).

<Bandwidth> Bandwidth

<Condition> Condition. It depends on the measurement.

File extension: .mask

Pressing OPEN under the Import Data menu will open the above directory from which you can select a mask file. When you change the Bandwidth or Direction, all Power Suite measurement parameters are reset to the hard coded preset parameters. Thus you must recall the appropriate preset mask file again after the change.

You cannot read the contents of the provided preset mask file since it is a binary file. Detailed contents of the file are provided by a PDF format file located in the same directory as the preset mask file.

Example:

File Location: My Documents/LTETDD/data/masks/SEM_MS

File Name: SEM_MS_15MHz_Add_NS04.mask

The following table shows the sets of variables imported to the ACP measurement.

Offset	Start Freq (MHz)	Stop Freq (MHz)	Res BW (Hz)	Meas BW	Rel Start	Rel Stop	Fail Mask
A	5	7.14	30k	1	-8	-25	Rel
B	7.14	10.57	30k	1	-25	-27	Rel
C	10.57	20	30k	1	-27	-50	Rel
D	20	25	30k	1	-50	-50	Rel
E	25	30	30k	1	-50	-50	Rel

Key Path	Recall, Data
Mode	LTETDD
Remote Command	MMEemory:LOAD:MASK <string>
Example	MMEM:LOAD:MASK "ACP_BS\ACP_BS_3MHz_pairE-UTRA_CatA.mask"
Notes	Sets of parameters related to Limit, Carrier and Offset are overwritten by the contents of the preset mask file.
Initial S/W Revision	A.03.00

EVM Setup

This key allows you to recall EVM parameter setting to measure E-UTRA Test Model in 3GPP standard (36.141-810 6.1.1).

- E-UTRA Test Model 1.1 (E-TM1.1)
- E-UTRA Test Model 1.2 (E-TM1.2)
- E-UTRA Test Model 2 (E-TM2)
- E-UTRA Test Model 3.1 (E-TM3.1)

- E-UTRA Test Model 3.2 (E-TM3.2)
- E-UTRA Test Model 3.3 (E-TM3.3)

This key is valid for the Modulation Analysis and Conformance EVM measurements only.

File Location and Extension

File location: My Documents\LTETDD\data\evmsetup

Note that “My Documents” is an alias to a directory and its place differs depending on which user is logged in. At XSA start up, XSA will overwrite all of the EVM Setup files to the current user’s “My Documents\LTETDD\data\evmsetup” each time.

File type: binary

File extension: .evms

Pressing OPEN under the Import Data menu will open the above directory from which you can select an EVM Setup file. When you change the Bandwidth, parameters are reset to the hard coded preset parameters. Thus you must recall the appropriate EVM Setup file again after the change.

You cannot read the contents of the provided EVM Setup file since it is a binary file.

Example:

File Location: My Documents\LTETDD\data\evmsetup

Filename: TM3.1-BW1.4MHz.evms

Key Path	Recall, Data
Mode	LTETDD
Remote Command	MMEemory:LOAD:EVMSSetup <string>
Example	MMEM:LOAD:EVMS "TM2-BW15MHz.evms"
Notes	Sets of parameters related to EVM Setup are overwritten by the contents of the EVM Setup file.
Initial S/W Revision	A.03.00, A.08.00

Open...

When you press “Open”, the analyzer brings up a Windows dialog and a menu entitled “File Open.” This menu allows you to navigate to the various fields in the Windows dialog without using a keyboard or mouse. The Tab and Arrow keys can also be used for dialog navigation.

See "[From File...](#)" on page 2797 in Recall, State, for a full description of this dialog and menu.

Key Path	Recall, Data
Notes	The key location is mode-dependent and will vary. Brings up Open dialog for recalling a <mode specific> Save Type
Initial S/W Revision	Prior to A.02.00

Restart

The Restart function restarts the current sweep, or measurement, or set of averaged/held sweeps or measurements. If you are Paused, pressing Restart does a Resume.

The Restart function is accessed in several ways:

- Pressing the Restart key
- Sending the remote command INIT:IMMEDIATE
- Sending the remote command INIT:RESTART

See "[More Information](#)" on page 1526

Key Path	Front-panel key
Remote Command	:INITiate[:IMMEDIATE] :INITiate:RESTART
Example	:INIT:IMM :INIT:REST
Notes	:INITiate:RESTART and :INITiate:IMMEDIATE perform exactly the same function.
Couplings	Resets average/hold count k. For the first sweep overwrites all active (update=on) traces with new current data. For application modes, it resets other parameters as required by the measurement.
Status Bits/OPC dependencies	This is an Overlapped command. The STATUS:OPERATION register bits 0 through 8 are cleared. The STATUS:QUESTIONABLE register bit 9 (INTEGRITY sum) is cleared. The SWEEPING bit is set. The MEASURING bit is set.
Backwards Compatibility Notes	For Spectrum Analysis mode in ESA and PSA, the Restart hardkey and the INITiate:RESTART command restart trace averages (displayed average count reset to 1) for a trace in Clear Write, but did not restart Max Hold and Min Hold. In the X-Series, the Restart hardkey and the INITiate:RESTART command restart not only Trace Average, but MaxHold and MinHold traces as well. For wireless comms modes in ESA and PSA, the Restart hardkey and the INITiate:RESTART command restart every measurement, which includes all traces and numeric results. There is no change to this operation.
Initial S/W Revision	Prior to A.02.00

More Information

The **Restart** function first aborts the current sweep/measurement as quickly as possible. It then resets the sweep and trigger systems, sets up the measurement and initiates a new data measurement sequence with a new data acquisition (sweep) taken once the trigger condition is met.

If the analyzer is in the process of aligning when **Restart** is executed, the alignment finishes before the restart function is performed.

Even when set for Single operation, multiple sweeps may be taken when Restart is pressed (for example, when averaging/holding is on). Thus when we say that **Restart** "restarts a measurement," we may mean:

- It restarts the current sweep
- It restarts the current measurement
- It restarts the current set of sweeps if any trace is in Trace Average, Max Hold or Min Hold
- It restarts the current set of measurements if Averaging, or Max Hold, or Min Hold is on for the measurement
- depending on the current settings.

With **Average/Hold Number** (in **Meas Setup** menu) set to 1, or Averaging off, or no trace in Trace Average or Hold, a single sweep is equivalent to a single measurement. A single sweep is taken after the trigger condition is met; and the analyzer stops sweeping once that sweep has completed. However, with **Average/Hold Number** >1 and at least one trace set to **Trace Average, Max Hold, or Min Hold (SA Measurement)** or **Averaging on (most other measurements)**, multiple sweeps/data acquisitions are taken for a single measurement. The trigger condition must be met prior to each sweep. The sweep is stopped when the average count k equals the number N set for **Average/Hold Number**. A measurement average usually applies to all traces, marker results, and numeric results; but sometimes it only applies to the numeric results.

Once the full set of sweeps has been taken, the analyzer will go to idle state. To take one more sweep without resetting the average count, increment the average count by 1, by pressing the step up key while **Average/Hold Number** is the active function, or sending the remote command `CALC:AVER:TCON UP`.

Save

The Save menu lets you choose what you want to save and where you want to save it. Among the types of files you can save are **States**, **Traces**, and **Screen Images**. In addition, an Export (Data) option lets you save a number of data types as CSV files for easy import into Excel and other spreadsheet programs.

Key Path	Front-panel key
Mode	All
Notes	No remote command for this key specifically, but the :MMEM:STORe command is available for specific file types. An example is :MMEM:STOR:STATe <filename>.
Initial S/W Revision	Prior to A.02.00

State

The Save State menu lets you choose a register or file for saving the state.

The content of a state file includes all of the settings and data required to return the analyzer as closely as possible to the Mode it was in, with the exact settings which were in place, when the save occurred. The Mode settings in each state file include the settings that are affected by Mode Preset, as well as the additional settings affected by Restore Mode Defaults; all of the Mode's settings. In addition, all of the settings of the Input/Output system are included, even though they are outside of the Mode's state, because they are needed to restore the complete setup. Persistent System settings (for example, Verbose SCPI) are not affected by either Mode Preset or Restore Mode Defaults, nor are they included in a saved State file.

After the save completes, the message "File <filename> saved" or "State Register <register number> saved" is displayed.

For rapid saving, the State menu lists 16 registers to save to. Pressing a Register key initiates the save. You can also select a file to save to.

The default path for all State Files is:

My Documents\<<mode name>\state

where <mode name> is the parameter used to select the mode with the INST:SEL command (for example, SA for the Spectrum Analyzer).

Key Path	Save
Mode	All
Remote Command	:MMEMory:STORe:STATe <filename>
Example	MMEM:STOR:STATe "MyStateFile.state" This stores the current instrument state data in the file MyStateFile.state in the default directory.
Notes	Both single and double quotes are supported for any filename parameter over remote. After saving to a register, that register's menu key is updated with the date the time, unless a custom label has been entered for that key. After saving to a register, you remain in the Save State menu, so that you can see the Register key

update. After saving to a file, the analyzer automatically returns to the previous menu and any Save As dialog goes away.

Backwards Compatibility SCPI	:MMEMory:STORe:STATe 1,<filename>
Initial S/W Revision	Prior to A.02.00

To File . . .

When you press “To File”, the analyzer brings up a Windows dialog and a menu entitled “**Save As.**” This menu allows you to navigate to the various fields in the Windows dialog without using a keyboard or mouse. The Tab and Arrow keys can also be used for dialog navigation.

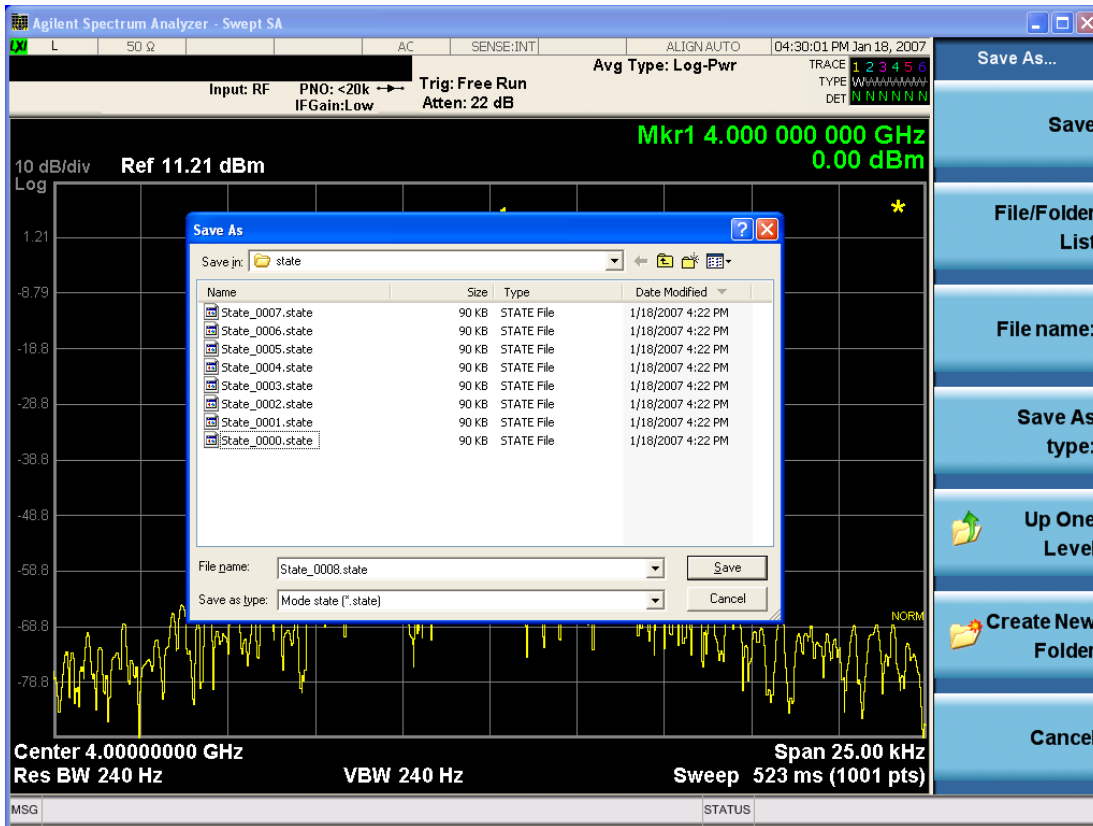

The Listed below

are the functions of the various fields in the dialog, and the corresponding softkeys:

Save

Performs the save to the specified file of the selected type. If the file already exists, a dialog will appear that allows you to replace the existing file by selecting OK, or you can Cancel the request. If you select OK, the file will be overwritten. Using the C: drive is strongly discouraged, since it runs the risk of being overwritten during an instrument software upgrade.

While the save is being performed, the floppy icon appears briefly in the Meas bar.

File/Folder List

Enables you to navigate to the center of the dialog that contains the list of files and folders. Once here you can get information about the file and use the tab keys to navigate to the other fields in the dialog, such as Save In.

Save In

The Save In field shows the path to which the file will be saved and allows you to change the path using the up and down arrow keys to navigate to other paths; the Enter key to open a directory; and the Backspace key to go back one directory. The **Save In field** defaults to the default path for this type of file and remembers the last path you used to save this type of file. There is no softkey for directly navigating to the Save In field but you can use left tab to get here from the File/Folder List.

User specified paths are remembered when you leave and return to a Mode and are reset back to the default using Restore Mode Defaults.

File Name

The File Name field is initially loaded with an automatically generated filename specific to the appropriate Save Type. The automatically generated filename is guaranteed not to conflict with any filename currently in the directory. You may replace or modify this filename using the File Name key. See the ["Quick Save " on page 2793](#) documentation for more on the automatic file naming algorithm.

When you press the File Name key the analyzer displays the Alpha Editor. Use the knob to choose the letter to add and the front-panel Enter key to add the letter to the file name. The BK character moves you back and the FW character moves you forward in the filename. The Select key on the front panel generates a space character. When you are done entering the filename press the Done softkey. This returns back to the **File Open** dialog and menu, but does not cause the save to occur.

Save As Type

This field shows the file suffix for the type of file you have selected to save. For example, if you navigated here while saving State, "Mode state (*.state)" is in the field. If you navigated here from saving Trace, ""Mode state (*.trace)" is in the field. If you navigated here while exporting a trace data file, "Trace Data (*.csv)" is in the field. For some file types, there is more than one choice in the dropdown, which you can select by using the up and down arrow keys and Enter.

Up One Level

This key corresponds to the icon of a folder with the up arrow that is in the tool bar of the dialog. When pressed, it causes the file and folder list to navigate up one level in the directory structure. The Backspace key does the same thing.

Create New Folder

This key corresponds to the icon of a folder with the "*" that is in the tool bar of the dialog. When pressed, a new folder is created in the current directory with the name **New Folder** and you can enter a new folder name using the Alpha Editor.

Cancel

This key corresponds to the Cancel selection in the dialog. It causes the current **Save As** request to be cancelled. The ESC key does the same thing.

Key Path	Save, State
Mode	All
Notes	Brings up Save As dialog for saving a State Save Type
Initial S/W Revision	Prior to A.02.00

Edit Register Names

You may enter a custom name on any of the Register keys, to help you remember what you are using that state to save. To do this, press the Edit Register Names key, choose the register whose name you wish to edit, and then enter the desired label using the Alpha Editor or an external PC keyboard.

The maximum number of characters that can be added is 30. In most cases, 30 characters will fit on two lines of the key.

See ["More Information" on page 1531](#)

Key Path	Save, State
Mode	All
Remote Command	:MMEMory:REGister:STATe:LABel <reg number>,"label" :MMEMory:REGister:STATe:LABel? <reg number>
Example	:MMEM:REG:STAT:LAB 1,"my label"
Notes	<reg number> is an integer from 1 to 16. If the SCPI specifies an invalid register number an error message is generated, -222,"Data out of range;Invalid register label number" "label" is a string from 0 to 30 characters in length. If a label exceeds 30 characters, an error message is generated, -150,"String data error;Label clipped to 30 characters" "label" of length 0 erases the custom label and restores the default (time and date) label. E.g.: :MMEM:REG:STAT:LAB 1,""
Dependencies	N9060A-7FP or N9060B-2FP license required to edit the register names. When the feature is not licensed, sending this command generates an error, -221,"Settings conflict;Option not available"
Preset	The names are unaffected by Preset or power cycle but are set to the default label (time and date) on a "Restore System Defaults->Misc"
Initial S/W Revision	A.11.00

More Information

When you edit one of the register names, the time and date field will be replaced by the custom name.

If you delete all the characters in the custom name, it restores the default (time and date).

The register names are stored within the state files, but they are not part of the instrument state; that is, once you have edited a register name, loading a new state will not change that register name. Another consequence of this is that the names will be persistent through a power cycle. Also, if a named state file is transferred to another analyzer, it will bring its custom name along with it.

If you try to edit the name of an empty register, the analyzer will first save the state to have a file to put the name in. If you load a named state file into an analyzer with older firmware it will ignore the metadata.

The *SAV and *RCL commands will not be affected by the custom register names, nor will the MMEM commands.

Register 1 thru Register 16

Selecting any one of these register menu keys causes the State of the currently active mode to be saved to the specified Register. The registers are provided for rapid saving and recalling, since you do not need to specify a filename or navigate to a file. Each of the register menu keys annotates whether it is empty or at what date and time it was last modified. In addition, you can use the Edit Register Names key to enter custom names for each register.

Although these 16 registers are the only registers available from the front panel, there are 128 state registers available in the instrument. Registers 17–128 are only available from the SCPI interface, using the *SAV command.

There is one set of 128 state registers in the instrument, not one set for each Mode. When a state is saved, the Mode it was saved from is saved with it; then when it is recalled, the instrument switches to that Mode.

After the save completes, the corresponding register menu key annotation is updated with the date and time and the message "Register <register number> saved" is displayed.

Key Path	Save, State
Mode	All
Example	*SAV 1
Range	1–16 from front panel, 1–128 from SCPI
Readback	Date and time with seconds resolution are displayed on the key OR A custom name of up to 30 characters entered using the Edit Register Names key OR "(empty)" if no prior save operation has been performed to this register.
Initial S/W Revision	Prior to A.02.00
Modified at S/W Revision	A.11.00

Register 1 thru Register 16

Selecting any one of these register menu keys causes the State of the currently active mode to be saved to the specified Register. The registers are provided for rapid saving and recalling, since you do not need to specify a filename or navigate to a file. Each of the register menu keys annotates whether it is empty or at what date and time it was last modified. In addition, you can use the Edit Register Names key to enter custom names for each register.

Although these 16 registers are the only registers available from the front panel, there are 128 state registers available in the instrument. Registers 17–128 are only available from the SCPI interface, using the *SAV command.

There is one set of 128 state registers in the instrument, not one set for each Mode. When a state is saved, the Mode it was saved from is saved with it; then when it is recalled, the instrument switches to that Mode.

After the save completes, the corresponding register menu key annotation is updated with the date and time and the message "Register <register number> saved" is displayed.

Key Path	Save, State
Mode	All
Example	*SAV 1
Range	1–16 from front panel, 1–128 from SCPI
Readback	Date and time with seconds resolution are displayed on the key OR A custom name of up to 30 characters entered using the Edit Register Names key OR “(empty)” if no prior save operation has been performed to this register.
Initial S/W Revision	Prior to A.02.00
Modified at S/W Revision	A.11.00

Data (Export)

Exporting a data file stores data from the current measurement to mass storage files. The Export Menu only contains data types that are supported by the current measurement.

Since the commonly exported data files are in .csv format, the data can be edited by you prior to importing. This allows you to export a data file, manipulate the data in Excel (the most common PC Application for manipulating .csv files) and then import it.

Selecting an Export Data menu key will not actually cause the exporting to occur, since the analyzer still needs to know where you wish to save the data. Pressing the Save As key in this menu brings up the Save As dialog and Save As menu that allows you to specify the destination file and directory. Once a filename has been selected or entered in the Open menu, the export will occur as soon as the Save key is pressed.

Key Path	Save
Mode	All
Notes	The menu is built from whatever data types are available for the mode. So the key locations in the sub menu will vary. No SCPI command directly controls the Data Type that this key controls. The Data Type is included in the MMEM:STORe commands.
Dependencies	If a file type is not used by a certain measurement, that type is grayed out for that measurement. The key for a file type will not show at all if there are no measurements in the Mode that support it.
Preset	Is not affected by a Preset or shutdown, but is reset during Restore Mode Defaults
Readback	The data type that is currently selected
Initial S/W Revision	Prior to A.02.00

Export Trace Data

Enables you to export trace data with (optional) associated headers. Selecting this key displays a menu that enables you to choose which Trace to save (default is the selected Trace) and whether or not to save headers with the data. The header information is used by the VXA application when saved trace data is recalled, and enables it to be displayed with the same formatting and scaling that it had when saved. If headers are not saved, the scaling and format are set to default values when the trace is recalled. After making these selections, press Save As... and use the file dialog to choose a file name and format for the saved data.

Trace data can be exported in several different formats. Text and comma-separated variable (CSV) formats are useful for viewing the data or importing it to a spreadsheet program. The other formats are binary and thus more compact. Trace data files can be recalled for viewing into other VXA, LTE, LTETDD, iDEN, or 89601 measurements.

Key Path	Save, Data (Export)
Mode	VSA, LTE, LTETDD, IDEN
Remote Command	:MMEMory:STORe:TRACe:DATA TRACE1 TRACE2 TRACE3 TRACE4 TRACE5 TRACE6, "<filename>" [,CSV TXT SDF MAT4 MAT HDF5 BIN[,OFF ON 0 1]]
Example	:MMEM:STOR:TRAC:DATA TRACE1, "TRC1.TXT", TXT, ON
Notes	<p>The Save As... dialog box has the following format options when you are saving trace data:</p> <ul style="list-style-type: none"> • CSV (Comma delimited) (*.csv) • SDF (Fast) (*.sdf;*.dat) • Text (Tab delimited) (*.txt) <p>File format saved depends on selection. The appropriate file extension is appended to the filename if it is not supplied by the user.</p> <p>If the SCPI command includes just a file name, the file format is determined by the filename extension, which must be one of the choices above. *.sdf or an unrecognized extension chooses the SDF fast format. If the optional file format enumerator is included in the command, then this determines the file format and the file extension is ignored. The optional binary parameter determines if file headers are saved. The default is ON. If file headers are not wanted, use the optional "OFF" parameter.</p> <p>The optional Boolean parameter determines whether headers are saved in the file. By default the headers are saved.</p> <p>If you are not licensed to save a particular file type, then error -203.9010 is returned. If an invalid file format is specified or the file cannot be saved successfully, then error -25x is returned. If the save is successful, then advisory 0.1500 is shown.</p>
State Saved	No
Readback	(Trace 1 Trace 2 Trace 3 Trace 4 Trace 5 Trace 6)(with without) headers

Trace 1

Selects the Trace 1 register as the destination for the imported data.

Key Path	Save, Data (Export), Trace
Mode	VSA, LTE, LTETDD, IDEN

Trace 2

Selects the Trace 2 register as the destination for the imported data.

Key Path	Save, Data (Export), Trace
Mode	VSA, LTE, LTETDD, IDEN

Trace 3

Selects the Trace 3 register as the destination for the imported data.

Key Path	Save, Data (Export), Trace
Mode	VSA, LTE, LTETDD, IDEN

Trace 4

Selects the Trace 4 register as the destination for the imported data.

Key Path	Save, Data (Export), Trace
Mode	VSA, LTE, LTETDD, IDEN

Include Header

Enables you to select whether or not the saved trace data includes header information describing scaling, formatting, etc.

Key Path	Save, Data (Export), Trace
Mode	VSA, LTE, LTETDD, IDEN
State Saved	No

Measurement Results

Pressing this key selects Meas Results as the data type to be exported.

The Meas Results file contains information that describes the current state of the analyzer. It is detailed in ["Meas Results File Contents" on page 1536](#) below.

Key Path	Save, Data
Remote Command	:MMEMory:STORe:RESults <string>
Example	:MMEM:STOR:RES "MeasR_0000.csv"
Notes	If the save is initiated via SCPI and the file already exists, the file will be overwritten.

	<p>The SCPI command exports Spectrum Emission Mask measurement results to the file specified as the parameter in the current path. The default path is My Documents\ current mode>\data\SEM\results.</p> <p>Using the C: drive is strongly discouraged, since it runs the risk of being overwritten during an instrument software upgrade.</p> <p>The SCPI parameter is a quoted string that specifies the filename. Both single and double quotes are supported for any filename parameter over SCPI.</p>
Dependencies	The current active measurement must be the Spectrum Emission Mask measurement to use this command.
Status Bits/OPC dependencies	Sequential – waits for the previous measurement to complete
Initial S/W Revision	Prior to A.02.00

Meas Results File Contents

A Meas Results File contains measurement results with the following information.

- File ID string, which is “MeasResult”
- Measurement ID following Mode ID, which is “SA:SEM” for example.
- Firmware rev and model number
- Option string
- Automatic Trigger Time
- Automatic Trigger Time State
- Center Frequency
- ChanIntegBW
- ChannelDetector
- ChannelDetectorState
- ChanPwrRefAuto
- ChanResBW
- ChanResBWAUTO
- ChanSpan
- ChanSweepTime
- ChanSweepTimeAuto
- ChanVbwRbwRatio
- ChanVbwRbwRatioAuto
- ChanVideoBW

- ChanVideoBWAuto
- Electrical Atten
- Electrical Atten Bypass
- Electrical Atten State
- External1 Trigger Delay
- External1 Trigger Delay State
- External1 Trigger Level
- External1 Trigger Slope
- External2 Trigger Delay
- External2 Trigger Delay State
- External2 Trigger Level
- External2 Trigger Slope
- FilterAlpha
- Internal Preamp
- Internal Preamp Band
- Line Trigger Delay
- Line Trigger Delay State
- Line Trigger Slope
- Mechanical Atten
- Mechanical Atten Auto
- OffsetDetector
- OffsetDetectorState
- OffsetLimitAbsStartBTS
- OffsetLimitAbsStartMS
- OffsetLimitAbsStopBTS
- OffsetLimitAbsStopMS
- OffsetLimitFailMaskBTS
- OffsetLimitFailMaskMS
- OffsetLimitRelStartBTS
- OffsetLimitRelStartMS
- OffsetLimitRelStopBTS

- OffsetLimitRelStopMS
- OffsetMeasBWBTs
- OffsetMeasBWMS
- OffsetResolutionBWAUTOBTs
- OffsetResolutionBWAUTOMS
- OffsetResolutionBWBTs
- OffsetResolutionBWMS
- OffsetSideBTs
- OffsetSideMS
- OffsetStartFrequencyBTs
- OffsetStartFrequencyMS
- OffsetStateBTs
- OffsetStateMS
- OffsetStopFrequencyBTs
- OffsetStopFrequencyMS
- OffsetSweepTimeAUTOBTs
- OffsetSweepTimeAUTOMS
- OffsetSweepTimeBTs
- OffsetSweepTimeMS
- OffsetVbwRbwRatioAUTOBTs
- OffsetVbwRbwRatioAUTOMS
- OffsetVbwRbwRatioBTs
- OffsetVbwRbwRatioMS
- OffsetVideoBWAUTOBTs
- OffsetVideoBWAUTOMS
- OffsetVideoBWBTs
- OffsetVideoBWMS
- PeakReference
- Periodic Timer Period
- Periodic Timer Sync Source
- Periodic Timer Trigger Delay

- Periodic Timer Trigger Delay State
- PowerReference
- PSDReference
- Radio Device
- RFBurst Trigger Delay
- RFBurst Trigger Delay State
- RFBurst Trigger Level Abs
- RFBurst Trigger Level Rel
- RFBurst Trigger Level Type
- RFBurst Trigger Slope
- RrcFilter
- SemAverageNumber
- SemAverageState
- TotalAtten
- Trigger Holdoff
- Trigger Holdoff State
- TriggerSource
- Video Trigger Delay
- Video Trigger Delay State
- Video Trigger Level
- Video Trigger Slope
- ViewSelection

The file contains these data followed by MeasResult1 to MeasResult12 that flag the start of the measurement results. Each line of Measurement Results consists of twelve comma separated values from MeasResult1 value to MeasResult12 value. MeasResult1 contains the same results as MEAS/READ/FETCH:SEMask1; MeasResult2, MEAS/READ/FETCH:SEMask2; MeasResult3, MEAS/READ/FETCH:SEMask3;... (continues in the same manner)

The exported file is in CSV format, with a.csv extension. The Meas Results file, when imported into Excel, shows the following data:

MeasResult	
SA:SEM	
A.10.53	N90 30A

526 ALV ATP	1		
B1X B1Y B25			
B40 BBA CR3			
CRP DCF DDA			
DP2 DRD EA3			
EDP EMC EP1			
ERC ESC ESP			
EXM FSA LFE			
LNP MAT			
MPB NFE			
NUL P26 PFR			
PNC RTL RTS			
S40 SB1 SEC			
SM1 TVT YAS			
YAV			
Automatic Trigger Time	0.1		
Automatic Trigger Time State	FALS	E	
Center Frequency	1.33	E+10	
ChanIntegBW	384 000 0	384 000 0	
ChannelDetector	Average		
ChannelDetectorState	TRUE		
ChanPwrRefAuto	TRUE		
ChanResBW	100 000	100 000	
ChanResBWAuto	FALS E	FALS E	
ChanSpan	500 000 0	500 000 0	
ChanSweepTime	0.00 250 7	0.00 250 7	
ChanSweepTimeAuto	TRUE	TRUE	
ChanVbwRbwRatio	1	1	

ChanVbwRbw RatioAuto	FALS E	FALS E
ChanVideoBW	100 000	100 000
ChanVideoBW Auto	TRUE	TRUE
Electrical Atten	0	
Electrical Atten Bypass	TRUE	
Electrical Atten State	FALS E	
External1 Trigger Delay	1.00 E-06	
External1 Trigger Delay State	FALS E	
External1 Trigger Level	1.2	
External1 Trigger Slope	Posit ive	
External2 Trigger Delay	1.00 E-06	
External2 Trigger Delay State	FALS E	
External2 Trigger Level	1.2	
External2 Trigger Slope	Posit ive	
FilterAlpha	0.22	
Internal Preamp	FALS E	
Internal Preamp Band	Low	
Line Trigger Delay	1.00 E-06	
Line Trigger Delay State	FALS E	
Line Trigger Slope	Posit ive	
Mechanical Atten	10	

Mechanical Atten Auto	TRUE					
OffsetDetector	Peak					
OffsetDetectorState	TRUE					
OffsetLimitsStartBTS	-14	-14	-26	-13	-13	-13
OffsetLimitsStartMS	-14	-14	-26	-13	-13	-13
OffsetLimitsStopBTS	-14	-26	-26	-13	-13	-13
OffsetLimitsStopMS	-14	-26	-26	-13	-13	-13
OffsetLimitFailMaskBTS	ABSolute	ABSolute	ABSolute	ABSolute	ABSolute	ABSolute
OffsetLimitFailMaskMS	ABSolute	ABSolute	ABSolute	ABSolute	ABSolute	ABSolute
OffsetLimitRelStartBTS	-30	-30	-30	-30	-30	-30
OffsetLimitRelStartMS	-30	-30	-30	-30	-30	-30
OffsetLimitRelStopBTS	-30	-30	-30	-30	-30	-30
OffsetLimitRelStopMS	-30	-30	-30	-30	-30	-30
OffsetMeasureWBTS	1	1	1	1	1	1
OffsetMeasureWMS	1	1	1	1	1	1
OffsetResolutionBWAutoBTS	FALSE	FALSE	FALSE	FALSE	FALSE	FALSE
OffsetResolutionBWAutoMS	FALSE	FALSE	FALSE	FALSE	FALSE	FALSE
OffsetResolutionBWAutoBTS	300000	300000	300000	1000000	100000	100000
OffsetResolutionBWAutoMS	300000	300000	300000	1000000	100000	100000
OffsetSideBTS	Both	Both	Both	Both	Both	Both
OffsetSideMS	Both	Both	Both	Both	Both	Both

OffsetStartFrequencyBTS	251 500 0	271 500 0	351 500 0	4000000	800 000 0	125 000 00
OffsetStartFrequencyMS	251 500 0	271 500 0	351 500 0	4000000	800 000 0	125 000 00
OffsetStateBTS	TRUE	TRUE	TRUE	TRUE	TRUE	FALSE
OffsetStateMS	TRUE	TRUE	TRUE	TRUE	TRUE	FALSE
OffsetStopFrequencyBTS	271 500 0	351 500 0	400 000 0	8000000	125 000 00	150 000 00
OffsetStopFrequencyMS	271 500 0	351 500 0	400 000 0	8000000	125 000 00	150 000 00
OffsetSweepTimeAutoBTS	TRUE	TRUE	TRUE	TRUE	TRUE	TRUE
OffsetSweepTimeAutoMS	TRUE	TRUE	TRUE	TRUE	TRUE	TRUE
OffsetSweepTimeBTS	0.01 733 3	0.06 932	0.04 202 7	0.002053	0.00 225 3	0.00 125 3
OffsetSweepTimeMS	0.01 733 3	0.06 932	0.04 202 7	0.002053	0.00 225 3	0.00 125 3
OffsetVbwRbwRatioAutoBTS	FALSE	FALSE	FALSE	FALSE	FALSE	FALSE
OffsetVbwRbwRatioAutoMS	FALSE	FALSE	FALSE	FALSE	FALSE	FALSE
OffsetVbwRbwRatioBTS	0.01	0.01	0.01	0.01	0.01	0.01
OffsetVbwRbwRatioMS	0.01	0.01	0.01	0.01	0.01	0.01
OffsetVideoBWAutoBTS	TRUE	TRUE	TRUE	TRUE	TRUE	TRUE
OffsetVideoBWAutoMS	TRUE	TRUE	TRUE	TRUE	TRUE	TRUE
OffsetVideoBW BTS	300	300	300	10000	100 00	100 00
OffsetVideoBW MS	300	300	300	10000	100 00	100 00

PeakReference	- 82.9 957
Periodic Timer Period	0.02
Periodic Timer Sync Source	None
Periodic Timer Trigger Delay	1.00 E-06
Periodic Timer Trigger Delay State	FALS E
PowerReference	- 73.6 966
PSDReference	- 139. 54
Radio Device	Bts
RFBurst Trigger Delay	1.00 E-06
RFBurst Trigger Delay State	FALS E
RFBurst Trigger Level Abs	-20
RFBurst Trigger Level Rel	-6
RFBurst Trigger Level Type	Absol ute
RFBurst Trigger Slope	Posit ive
RrcFilter	FALS E
SemAverageN umber	10
SemAverageS tate	FALS E
TotalAtten	10

Trigger Holdoff	0.1											
Trigger Holdoff State	FALS E											
TriggerSource	Free											
Video Trigger Delay	1.00 E-06											
Video Trigger Delay State	FALS E											
Video Trigger Level	-25											
Video Trigger Slope	Posit ive											
Video Selection	AbsP wrFr eq											
MeasResult1	Meas Resul t2	Meas Resul t3	Meas Resul t4	MeasResu lt5	Meas Resul t6	Meas Resul t7	Meas Resul t8	Meas Resul t9	Meas Result 10	Meas Result 11	Meas Result 12	
-999	-	-13	999	-	-999	-999	-999	-999	-999	-999	-999	
	78.8			73.6966								
	935			3340998								
	9			79								
-	-	-13	999	-999	-999	-999	-999	-999	-999	-999		
73.6966334	78.9											
099879	523											
	5											

Save As . . .

When you press “Save As”, the analyzer brings up a Windows dialog and a menu entitled “**Save As.**” This menu allows you to navigate to the various fields in the Windows dialog without using a keyboard or mouse. The Tab and Arrow keys can also be used for dialog navigation.

See ["To File . . ." on page 2810](#) in Save, State for a full description of this dialog and menu.

The default path for saving files is:

For all of the Trace Data Files:

My Documents\`<mode name>`\data\traces

For all of the Limit Data Files:

My Documents\`<mode name>`\data\limits

For all of the Measurement Results Data Files:

My Documents\`<mode name>`\data\`<measurement name>`\results

For all of the Capture Buffer Data Files:

My Documents\`<mode name>`\data\captureBuffer

Key Path	Save, Data
Mode	All
Notes	The key location is mode-dependent and will vary. Brings up the Save As dialog for saving a <code><mode specific></code> Save Type. The save is performed immediately and does not wait until the measurement is complete.
Initial S/W Revision	Prior to A.02.00

Screen Image

Pressing Screen Image accesses a menu of functions that enable you to specify a format and location for the saved screen image. It brings up a menu that allows you to specify the color scheme of the Screen Image (Themes) or navigate to the Save As dialog to perform the actual save.

Screen Image files contain an exact representation of the analyzer display. They cannot be loaded back onto the analyzer, but they can be loaded into your PC for use in many popular applications.

The image to be saved is actually captured when the Save front panel key is pressed, and kept in temporary storage to be used if you ask for a Screen Image save. When the Screen Image key is pressed, a "thumbnail" of the captured image is displayed, as shown below:

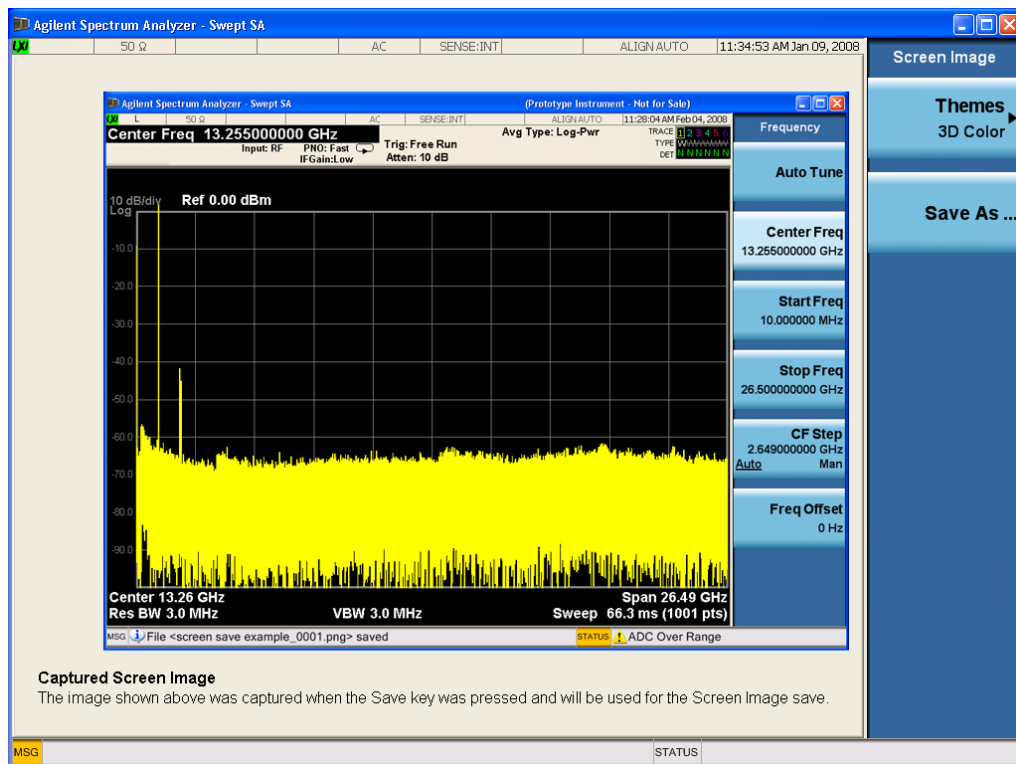

When you continue on into the Save As menu and complete the Screen Image save, the image depicted in the thumbnail is the one that gets saved, showing the menus that were on the screen before going into the Save menus. The save is performed immediately and does not wait until the measurement is complete.

After you have completed the save, the Quick Save front-panel key lets you quickly repeat the last save performed, using an auto-named file, with the current screen data.

NOTE For versions previous to A.01.55, if you initiate a screen image save by navigating through the Save menus, the image that is saved will contain the Save menu softkeys, not the menu and the active function that were on the screen when you first pressed the Save front panel key.

Key Path	Save
Mode	All
Remote Command	:MMEMory:STORe:SCReen <filename>
Example	:MMEM:STOR:SCR "myScreen.png" This stores the current screen image in the file MyScreenFile.png in the default directory.
Initial S/W Revision	Prior to A.02.00

Themes

Accesses a menu of functions that enable you to choose the theme to be used when saving the screen image.

The **Themes** option is the same as the **Themes** option under the **Display** and **Page Setup** dialogs. It allows you to choose between themes to be used when saving the screen image.

Key Path	Save, Screen Image
Remote Command	:MMEMory:STORe:SCReen:THEMe TDColor TDMonochrome FColor FMONochrome :MMEMory:STORe:SCReen:THEMe?
Example	:MMEM:STOR:SCR:THEM TDM
Preset	3D Color; Is not part of Preset, but is reset by Restore Misc Defaults or Restore System Defaults All and survives subsequent running of the modes.
Readback	3D Color 3D Mono Flat Color Flat Mono
Backwards Compatibility Notes	In ESA and PSA we offer the choice of "Reverse Bitmap" or "Reverse Metafile" when saving screen images. This is much like the "Flat Color" theme available in X-Series. Also, if you selected Reverse Bitmap AND a black & white screen image, that would be much like "Flat Monochrome". In other words, each of the X-Series themes has a similar screen image type in ESA/PSA. But they are not identical.
Initial S/W Revision	Prior to A.02.00

3D Color

Selects a standard color theme with each object filled, shaded and colored as designed.

Key Path	Save, Screen Image, Themes
Example	MMEM:STOR:SCR:THEM TDC
Readback	3D Color
Initial S/W Revision	Prior to A.02.00

3D Monochrome

Selects a format that is like 3D color but shades of gray are used instead of colors.

Key Path	Save, Screen Image, Themes
Example	MMEM:STOR:SCR:THEM TDM
Readback	3D Mono
Initial S/W Revision	Prior to A.02.00

Flat Color

Selects a format that is best when the screen is to be printed on an ink printer.

Key Path	Save, Screen Image, Themes
Example	MMEM:STOR:SCR:THEM FCOL
Readback	Flat Color
Initial S/W Revision	Prior to A.02.00

Flat Monochrome

Selects a format that is like Flat Color. But only black is used (no colors, not even gray), and no fill.

Key Path	Save, Screen Image, Themes
Example	MMEM:STOR:SCR:THEM FMON
Readback	Flat Mono
Initial S/W Revision	Prior to A.02.00

Save As...

When you press "Save As", the analyzer brings up a Windows dialog and a menu entitled "**Save As.**" This menu allows you to navigate to the various fields in the Windows dialog without using a keyboard or mouse. The Tab and Arrow keys can also be used for dialog navigation.

See "[To File . . .](#)" on page 2810 in Save, State for a full description of this dialog and menu.

The default path for Screen Images is

My Documents\<<mode name>\screen.

where <mode name> is the parameter used to select the mode with the INST:SEL command (for example, SA for the Spectrum Analyzer).

Key Path	Save, Screen Image
Notes	Brings up Save As dialog for saving a Screen Image Save Type
Initial S/W Revision	Prior to A.02.00

Mass Storage Catalog (Remote Command Only)

Key path	SCPI Only
Remote Command	:MMEMory:CATalog? [<directory_name>]
Notes	<p>The string must be a valid logical path.</p> <p>Queries disk usage information (drive capacity, free space available) and obtains a list of files and directories in a specified directory in the following format:</p> <p><numeric_value>,<numeric_value>,{<file_entry>}</p> <p>It returns two numeric parameters and as many strings as there are files and directories. The first parameter indicates the total amount of storage currently used in bytes. The second parameter indicates the total amount of storage available, also in bytes. The <file_entry> is a string. Each <file_entry> indicates the name, type, and size of one file in the directory list:</p> <p><file_name>,<file_type>,<file_size></p> <p>As the windows file system has an extension that indicates file type, <file_type> is always empty. <file_size> provides the size of the file in bytes. For directories, <file_entry> is surrounded by square brackets and both <file_type> and <file_size> are empty</p>
Initial S/W Revision	Prior to A.02.00

Mass Storage Change Directory (Remote Command Only)

Key path	SCPI Only
Remote Command	:MMEMory:CDIRectory [<directory_name>] :MMEMory:CDIRectory?
Notes	<p>The string must be a valid logical path.</p> <p>Changes the default directory for a mass memory file system. The <directory_name> parameter is a string. If no parameter is specified, the directory is set to the *RST value.</p> <p>At *RST, this value is set to the default user data storage area, that is defined as System.Environment.SpecialFolder.Personal.</p> <p>Query returns full path of the default directory.</p>
Initial S/W Revision	Prior to A.02.00

Mass Storage Copy (Remote Command Only)

Key path	SCPI Only
Remote Command	:MMEMory:COpy <string>,<string>[,<string>,<string>]
Notes	<p>The string must be a valid logical path.</p> <p>Copies an existing file to a new file or an existing directory to a new directory.</p> <p>Two forms of parameters are allowed. The first form has two parameters. In this form, the first parameter specifies the source, and the second parameter specifies the destination.</p> <p>The second form has four parameters. In this form, the first and third parameters specify the source. The second and fourth parameters specify the directories. The first pair of parameters specifies the source. The second pair specifies the destination. An error is generated if the source doesn't exist or the destination file already exists.</p> <p>This command will generate an "access denied" error if the destination is a restricted folder (e.g., C:\Windows) and the current user does not have Power User or Administrator privileges.</p>

Mass Storage Device Copy (Remote Command Only)

This command transfers data to/from a file and a peripheral device.

Key path	SCPI Only
Remote Command	:MMEMory:COpy:DEvice <source_string>,<dest_string>
Notes	<p>The strings must be a valid logical path or a valid device keyword. If the dest_string is a device keyword, the data is copied from the source file to the device. If the source_string is a device keyword, the data is copied to the source file from the device.</p> <p>Valid device keywords are:</p> <p>SNS (smart noise source)</p> <p>An error is generated if the file or device is not found.</p>

Mass Storage Delete (Remote Command Only)

Key path	SCPI Only
Remote Command	:MMEMory:DElete <file_name>[,<directory_name>]
Notes	<p>The string must be a valid logical path.</p> <p>Removes a file from the specified directory. The <file_name> parameter specifies the file name to be removed. This command will generate an "access denied" error if the file is in a restricted folder (e.g., C:\Windows) and the current user does not have Power User or Administrator privileges.</p>
Initial S/W Revision	Prior to A.02.00

Mass Storage Data (Remote Command Only)

Creates a file containing the specified data OR queries the data from an existing file.

Key path	SCPI Only
Remote Command	:MMEMory:DATA <file_name>, <data> :MMEMory:DATA? <file_name>
Notes	The string must be a valid logical path. The command form is MMEMory:DATA <file_name>,<data>. It loads <data> into the file <file_name>. <data> is in 488.2 block format. <file_name> is string data. The query form is MMEMory:DATA? <file_name> with the response being the associated <data> in block format.
Initial S/W Revision	Prior to A.02.00

Mass Storage Make Directory (Remote Command Only)

Key path	SCPI Only
Remote Command	:MMEMory:MDIRectory <directory_name>
Notes	The string must be a valid logical path. Creates a new directory. The <directory_name> parameter specifies the name to be created. This command will generate an “access denied” error if the new directory would be in a restricted folder (e.g., C:\Windows) and the current user does not have Power User or Administrator privileges.
Initial S/W Revision	Prior to A.02.00

Mass Storage Move (Remote Command Only)

Key path	SCPI Only
Remote Command	:MMEMory:MOVE <string>,<string>[,<string>,<string>]
Notes	The string must be a valid logical path. Moves an existing file to a new file or an existing directory to a new directory. Two forms of parameters are allowed. The first form has two parameters. In this form, the first parameter specifies the source, and the second parameter specifies the destination. The second form has four parameters. In this form, the first and third parameters specify the source. The second and fourth parameters specify the directories. The first pair of parameters specifies the source. The second pair specifies the destination. An error is generated if the source doesn't exist or the destination file already exists. This command will generate an “access denied” error if the destination is a restricted folder (e.g., C:\Windows) and the current user does not have Power User or Administrator privileges.
Initial S/W Revision	Prior to A.02.00

Mass Storage Remove Directory (Remote Command Only)

Key path	SCPI Only
Remote Command	<code>:MMEMory:RDIRectory <directory_name></code>
Notes	<p>The string must be a valid logical path.</p> <p>Removes a directory. The <directory_name> parameter specifies the directory name to be removed. All files and directories under the specified directory shall also be removed.</p> <p>This command will generate an “access denied” error if the folder is a restricted folder (e.g., C:\Windows) or is in a restricted folder and the current user does not have Power User or Administrator privileges.</p>
Initial S/W Revision	Prior to A.02.00

Single (Single Measurement/Sweep)

Sets the analyzer for Single measurement operation. The single/continuous state is Meas Global, so the setting will affect all the measurements. If you are Paused, pressing Single does a Resume.

See ["More Information" on page 1553](#)

Key Path	Front-panel key
Example	:INIT:CONT OFF
Notes	See Cont key description.
Backwards Compatibility Notes	<p>For Spectrum Analysis mode in ESA and PSA, the Single hardkey and the INITiate:IMM switched from continuous measurement to single measurement and restarted sweeps and averages (displayed average count reset to 1), but did not restart Max Hold and Min Hold. In the X-Series, the Single hardkey and the INITiate:IMM command initiate a sweep/ measurement/ average sequence/hold sequence including MaxHold and MinHold.</p> <p>For Spectrum Analysis mode in ESA and PSA, the Single hardkey restarted the sweep regardless of whether or not you were in an active sweep or sweep sequence. In the X-Series, Restart does this but Single only restarts the sweep or sweep sequence if you are in the idle state.</p> <p>INIT[:IMM] in ESA & PSA Spectrum Analysis Mode does an implied ABORt. In some other PSA Modes, INIT[:IMM] is ignored if not in the idle state. . The X-Series follows the ESA/PSA SA Mode model, which may cause some Modes to have compatibility problems.</p>
Initial S/W Revision	Prior to A.02.00

More Information

See ["Restart" on page 2807](#) for details on the INIT:IMMediate (Restart) function.

If you are already in single sweep, the INIT:CONT OFF command has no effect.

If you are already in Single Sweep, then pressing the Single key in the middle of a sweep does not restart the sweep or sequence. Similarly, pressing the Single key does not restart the sweep or sequence if the sweep is not in the idle state (for example, if you are taking a very slow sweep, or the analyzer is waiting for a trigger). Instead, it results in a message. "Already in Single, press Restart to initiate a new sweep or sequence". Even though pressing the Single key in the middle of a sweep does not restart the sweep, sending INIT:IMMediate does reset it.

To take one more sweep without resetting the average count, increment the average count by 1, by pressing the step up key while **Average/Hold Number** is the active function, or sending the remote command CALC:AVER:TCON UP.

Source

There is no Source control functionality for this measurement. When this key is pressed, the screen either displays a blank menu, or the previously-selected menu remains unchanged.

Key Path	Front-panel key
----------	-----------------

Span X Scale

Accesses a menu of functions that enable you to set the horizontal scale parameters.

Key Path	Front-panel key
Initial S/W Revision	A.11.00

Ref Value

Sets the X reference value.

Key Path	SPAN X Scale
Mode	BASIC, PNOISE, WCDMA, C2K, GSM, WIMAXOFDMA, TDSCDMA, 1XEVDO, DVB, DTMB, ISDBT, CMMB, LTE, LTETDD, DCTV, WLAN, MSR, LTEAFDD, LTEATDD
Remote Command	:DISPlay:SEMask:VIEW[1]:WINDow[1]:TRACe:X[:SCALE]:RLEVel <freq> :DISPlay:SEMask:VIEW[1]:WINDow[1]:TRACe:X[:SCALE]:RLEVel?
Example	DISP:SEM:VIEW:WIND:TRAC:X:RLEV 10 DISP:SEM:VIEW:WIND:TRAC:X:RLEV?
Notes	You must be in the mode that includes SEM measurement to use this command. Use :INSTrument:SElect to set the mode.
Couplings	If Auto Scaling is set to On, this value is automatically determined by the measurement result. When you set this value manually, Auto Scaling automatically changes to Off.
Preset	1.0 GHz
State Saved	Saved in instrument state.
Min	-1000 GHz
Max	1000 GHz
Default Unit	Hz
Initial S/W Revision	A.11.00

Scale/Div

Sets the horizontal scale.

Key Path	SPAN X Scale
Mode	BASIC, PNOISE, WCDMA, C2K, GSM, WIMAXOFDMA, TDSCDMA, 1XEVDO, DVB, DTMB, ISDBT, CMMB, LTE, LTETDD, DCTV, WLAN, MSR, LTEAFDD, LTEATDD
Remote Command	:DISPlay:SEMask:VIEW[1]:WINDow[1]:TRACe:X[:SCALE]:PDIVision <freq> :DISPlay:SEMask:VIEW[1]:WINDow[1]:TRACe:X[:SCALE]:PDIVision ?
Example	DISP:SEM:VIEW:WIND:TRAC:X:PDIV 500 DISP:SEM:VIEW:WIND:TRAC:X:PDIV?

Notes	You must be in a mode that includes the SEM measurement to use this command. Use INSTRUMENT:SElect to set the mode.
Couplings	If Auto Scaling is set to On, this value is automatically determined by the measurement result. When you set this value manually, Auto Scaling automatically changes to Off.
Preset	Automatically Calculated
State Saved	Yes Saved in instrument state.
Min	1 Hz
Max	10.0 GHz
Initial S/W Revision	A.11.00

Ref Position

Sets the reference position for the X axis to Left, Center or Right.

Key Path	SPAN X Scale
Mode	BASIC, PNOISE, WCDMA, C2K, GSM, WIMAXOFDMA, TDSCDMA, 1XEVD0, DVB, DTMB, ISDBT, CMMB, LTE, LTETDD, DCTV, WLAN, MSR, LTEAFDD, LTEATDD
Remote Command	:DISPlay:SEMask:VIEW[1]:WINDow[1]:TRACe:X[:SCALE]:RPOsition LEFT CENTER RIGHT :DISPlay:SEMask:VIEW[1]:WINDow[1]:TRACe:X[:SCALE]:RPOsition?
Example	DISP:SEM:VIEW:WIND:TRAC:X:RPOS LEFT DISP:SEM:VIEW:WIND:TRAC:X:RPOS?
Notes	You must be in a mode that includes the SEM measurement to use this command. Use INSTRUMENT:SElect to set the mode.
Preset	CENTER
State Saved	Yes Saved in instrument state.
Range	Left Ctr Right
Initial S/W Revision	A.11.00

Auto Scaling

Toggles the scale coupling function between On and Off.

Key Path	SPAN X Scale
Mode	BASIC, PNOISE, WCDMA, C2K, GSM, WIMAXOFDMA, TDSCDMA, 1XEVD0, DVB, DTMB, ISDBT, CMMB, LTE, LTETDD, DCTV, WLAN, MSR, LTEAFDD, LTEATDD
Remote Command	:DISPlay:SEMask:VIEW[1]:WINDow[1]:TRACe:X[:SCALE]:COUPlE 0 1 OFF ON :DISPlay:SEMask:VIEW[1]:WINDow[1]:TRACe:X[:SCALE]:COUPlE?
Example	DISP:SEM:VIEW:WIND:TRAC:X:COUP ON

DISP:SEM:VIEW:WIND:TRAC:X:COUP?	
Notes	You must be in a mode that includes the SEM measurement to use this command. Use INSTRument:SElect to set the mode.
Couplings	When Auto Scaling is On and the Restart front-panel key is pressed, this function automatically determines the scale per division and reference values based on the measurement results. When you set a value to either Scale/Div or Ref Value manually, Auto Scaling automatically changes to Off.
Preset	1
State Saved	Yes Saved in instrument state.
Range	On Off
Initial S/W Revision	A.11.00

Sweep/Control

Displays a menu that enables you to set up and control the sweep time, gate method, and source of the current measurement. See ["Sweep/Control" on page 2703](#) for more information.

Key Path	Front-panel key
Initial S/W Revision	Prior to A.02.00

Pause

Pauses a measurement after the current data acquisition is complete. When Paused, the label on the key changes to Resume. Pressing the Resume key resumes the measurement at the point it was at when paused. See ["Pause/Resume" on page 2703](#) for more details.

Key Path	Sweep/Control
Initial S/W Revision	Prior to A.02.00

Gate

Accesses a menu that enables you to control the gating function. The Gate functionality is used to view signals best viewed by qualifying them with other events.

Gate setup parameters are the same for all measurements – they do not change as you change measurements. Settings like these are called “Meas Global” and are unaffected by Meas Preset.

Note that Sweep Time autocoupling rules and annotation are changed by Gate being on.

Key Path	Sweep/Control
Scope	Meas Global
Readback	The state and method of Gate, as [Off, LO] or [On, Video]. Note that for measurements that only support gated LO, the method is nonetheless read back, but always as LO.
Initial S/W Revision	Prior to A.02.00

Gate On/Off

Turns the gate function on and off.

When the Gate Function is on, the selected Gate Method is used along with the gate settings and the signal at the gate source to control the sweep and video system with the gate signal. Not all measurements allow every type of Gate Methods.

When Gate is on, the annunciation in the measurement bar reflects that it is on and what method is used, as seen in the following "Gate: LO" annunciator graphic.

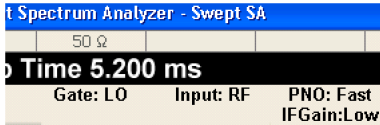

Key Path	Sweep/Control, Gate
Remote Command	[:SENSe] :SWEep:EGATe [:STATe] OFF ON 0 1 [:SENSe] :SWEep:EGATe [:STATe] ?
Example	SWE:EGAT ON SWE:EGAT?
Dependencies	<p>The function is unavailable (grayed out) and Off when:</p> <ul style="list-style-type: none"> • Gate Method is LO or Video and FFT Sweep Type is manually selected. • Gate Method is FFT and Swept Sweep Type is manually selected. • Marker Count is ON. <p>The following are unavailable whenever Gate is on:</p> <ul style="list-style-type: none"> • FFT under Sweep Type when Method=LO or Video or Swept under Sweep Type when Method=FFT • Marker Count <p>While Gate is on, the Auto Rules for Sweep Type are modified so that the choice agrees with the Gate Method: i.e., FFT for Method = FFT and Swept for Method = LO or Video.</p> <p>The Gate softkey and all SCPI under the [:SENSe]:SWEep:EGATe SCPI node are grayed out when Source Mode is Tracking with an external source. This is because the Gate circuitry is used to sync the external source. If the Tracking Source is turned on, the Gate is turned off.</p> <p>When in the ACP measurement:</p> <ul style="list-style-type: none"> • When Meas Method is RBW or FAST, this function is unavailable and the key is grayed out. • Whenever Gate is on, Meas Method, RBW or FAST is unavailable and keys for those are grayed out. • When Gate is on, Offset Res BW and Offset Video BW are ignored (if you set these values) and the measurement works as if all Offset Res BW and all Offset Video BW are coupled with the Res BW and the Video BW under the BW menu. When Gate is on, the Offset BW key in the Offset/Limit menu is grayed out.
Preset	Off LTETDD: On
State Saved	Saved in instrument state
Range	On Off
Backwards Compatibility SCPI	[:SENSe] :SWEep:TIME:GATE[:STATe] ESA compatibility
Backwards Compatibility Notes	In ESA, Trig Delay (On) and Gate (On) could not be active at the same time.. This dependency does not exist in PSA or in the X-Series.
Initial S/W Revision	Prior to A.02.00

Gate View On/Off

Turning on Gate View in the Swept SA measurement provides a single-window gate view display..

Turning on Gate View in other measurements shows the split-screen Gate View. In these measurements, when the Gate View is on, the regular view of the current measurement traces and results are reduced vertically to about 70% of the regular height. The Zero Span window, showing the positions of the Gate, is shown between the Measurement Bar and the reduced measurement window. By reducing the height of the measurement window, some of the annotation on the Data Display may not fit and is not shown.

Key Path	Sweep/Control, Gate
Remote Command	[:SENSe] :SWEep:EGATe:VIEW ON OFF 1 0 [:SENSe] :SWEep:EGATe:VIEW?
Example	SWE:EGAT:VIEW ON turns on the gate view.
Dependencies	In the Swept SA measurement: In Gate View, the regular Sweep Time key is grayed out . When pressed, the grayed out key puts up the informational message "Use Gate View Sweep Time in the Gate menu." In the other measurements: When you turn Gate View on, the lower window takes on the current state of the instrument. Upon leaving Gate View, the instrument takes on the state of the lower window. When you turn Gate View on, the upper window Sweep Time is set to the gate view sweep time.
Couplings	These couplings apply to the Swept SA measurement: <ul style="list-style-type: none"> • When Gate View is turned on, the instrument is set to Zero Span. • Gate View automatically turns off whenever a Span other than Zero is selected. • Gate View automatically turns off if you press the Last Span key while in Gate View, and the instrument returns to the Span it was in before entering Gate View (even if that is Zero Span). • When Gate View is turned on, the sweep time used is the gate view sweep time. This is set according to the rules in section "Gate View Setup" on page 2499 • When Gate View is turned off, Sweep Time is set to the normal Swept SA measurement sweep time. • If Gate View is on and Gate is off, then turning on Gate turns off Gate View.
Preset	OFF
State Saved	Saved in instrument state
Range	On Off
Initial S/W Revision	Prior to A.02.00

A sample of the Gate View screen in the Swept SA measurement is shown in the following graphic :

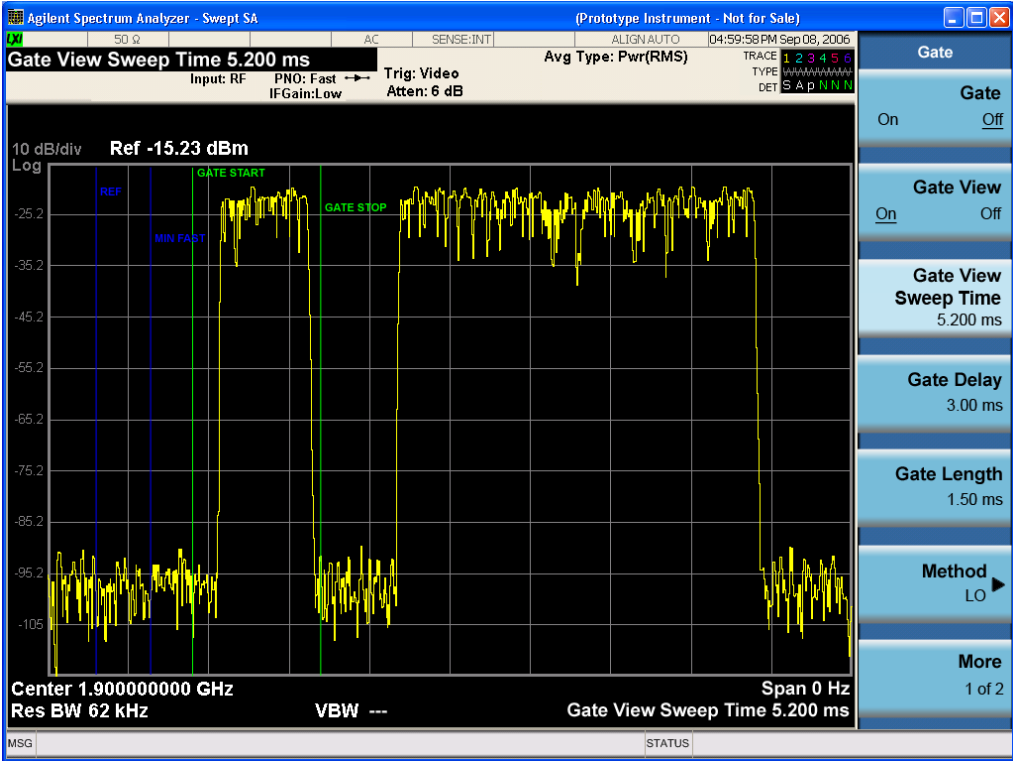

A sample of the Gate View screen in other measurements is shown in the following graphic. This example is for the ACP measurement:

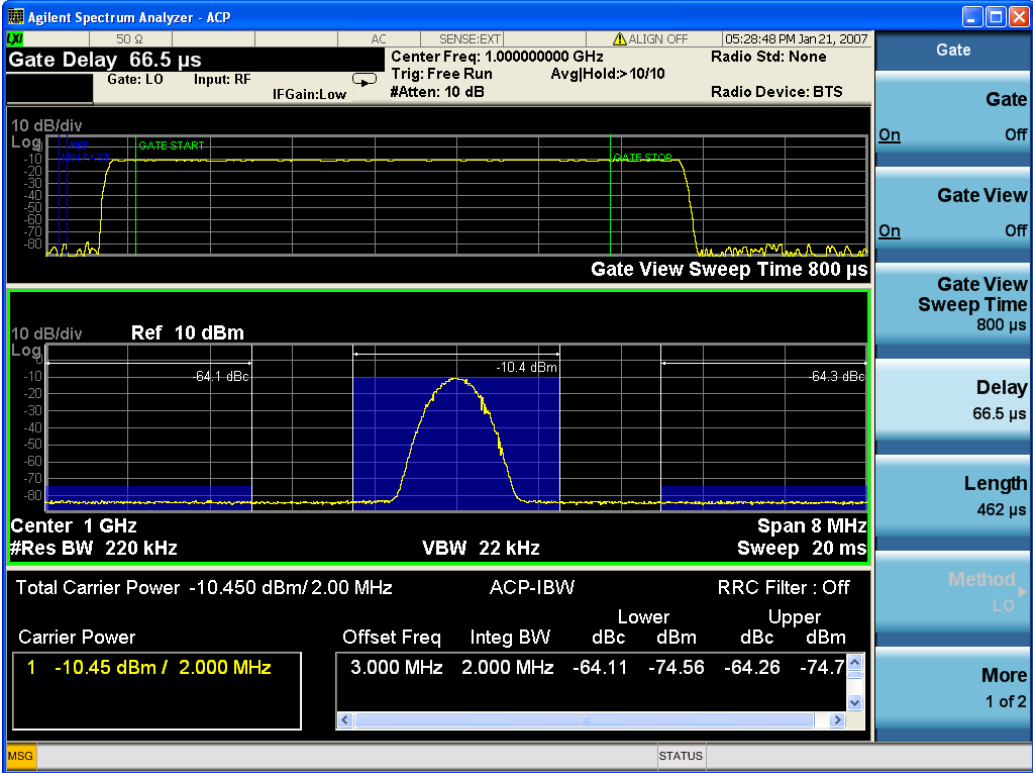

Turning Gate View off returns the analyzer to the Normal measurement view.

In the Swept SA, the normal measurement view is the single-window Swept SA view. When returning to this view, the Swept SA measurement returns to the Span it was in before entering **Gate View** (even if that is Zero Span).

The **Gate View** window is triggered from the Gate Source, with zero trigger delay. Also, when updating the **Gate View** window, the Gate itself must not operate. So it is internally shut off while the gate view window is being updated. For the Swept SA measurement, this means that the Gate is internally shut off whenever the gate view window is displayed. The measurement bar and softkeys continue to show the Trigger source for the main sweep window and give no indication that the Gate is shut off or that the Gate View window is triggered from the Gate Source.

When in **Gate View**, vertical lines are displayed in the Gate View window as follows:

- Green lines are displayed at the gate edges as follows: in Edge Gate, a line is shown for Delay and one for the end of the Gate period, defined by Length. In Level Gate a line is shown only for Delay. You can adjust the position of the green lines by adjusting the gate length and the gate delay. These lines update in the Gate View window as the active function changes, even if the window is not being updated. In Gated LO and Gated Video, these lines are positioned relative to the delay reference line (not relative to 0 time). In Gated FFT, their location is relative to the left edge of the screen.
- A blue line is displayed showing the delay reference, that is, the reference point for the Gate Delay within the Zero Span window. The blue line represents where (in time) the effective location of the gate start would be if the gate were programmed to zero delay.
-
- The second blue line is labeled "MIN FAST" as shown in the figure above because it represents the minimum Gate Delay for fast Gated LO operation. This line is only displayed in Gated LO. You cannot scroll (knob) or decrement (down key) the Gate Delay to less than that represented by the position of this line, it can only be set below this position manually, although once there it can be moved freely with the knob while below the line.
- A yellow line in the Gated Video case only, is displayed at Blength, where Blength is the display point (bucket) length for the swept trace, which is given by the sweep time for that trace divided by number of Points – 1. So it is referenced to 0 time, not to the delay reference. This line is labeled NEXT PT (it is not shown in the figure above because the figure above is for Gated LO).
- The yellow line represents the edge of a display point (bucket). Normally in Gated Video, the bucket length must be selected so that it exceeds the off time of the burst. There is another way to use the analyzer in Gated Video measurements, and that is to set the bucket width much shorter than the off time of the burst. Then use the Max Hold trace function to fill in "missing" buckets more slowly. This allows you to see some of the patterns of the Gated Video results earlier, though seeing a completely filled-in spectrum later.

Gate View Setup

Accesses a menu that enables you to setup parameters relevant to the Gate View

Key Path	Sweep/Control, Gate
Scope	Meas Global
Initial S/W Revision	A.10.00

Gate View Sweep Time

Controls the sweep time in the Gate View window. To provide an optimal view of the gate signal, the analyzer initializes Gate View Sweep Time based on the current settings of Gate Delay and Gate Length.

Key Path	Sweep/Control, Gate, Gate View Setup
Remote Command	[:SENSe] :SWEep:EGATe:TIME <time> [:SENSe] :SWEep:EGATe:TIME?
Example	SWE:EGAT:TIME 500 ms
Dependencies	Gate View Sweep Time is initialized: <ul style="list-style-type: none"> • On Preset (after initializing delay and length). • Every time the Gate Method is set/changed. <p>Additionally, in the Swept SA measurement, whenever you do a Preset, or leave Gate View, the analyzer remembers the Gate Delay and Gate Length settings. Then, when returning to Gate View, if the current Gate Delay and/or Gate Length do not match the remembered values Gate View Sweep Time is re-initialized.</p> <ol style="list-style-type: none"> 1. Compute the location of the "gate stop" line, which you know is at time $t = t_{min} + \text{GateDelay} + \text{GateLength}$.
Preset	519.3 μ s WiMAX OFDMA: 5 ms GSM/EDGE: 1 ms
State Saved	Saved in instrument state
Max	6000 s
Initial S/W Revision	Prior to A.02.00

Gate View Start Time

Controls the time at the left edge of the Gate View.

Key Path	Sweep/Control, Gate, Gate View Setup
Remote Command	[:SENSe] :SWEep:EGATe:VIEW:STARt <time> [:SENSe] :SWEep:EGATe:VIEW:STARt?
Example	SWE:EGAT:VIEW:STAR 10ms
Notes	Units of time are required or no units; otherwise an invalid suffix error message will be generated. See error -131.
Preset	0 ms
State Saved	Saved in instrument state
Min	0
Max	500 ms
Initial S/W Revision	A.10.00

Gate Delay

Controls the length of time from the time the gate condition goes True until the gate is turned on.

Key Path	Sweep/Control, Gate
Remote Command	[:SENSe] :SWEep:EGATe:DELay <time> [:SENSe] :SWEep:EGATe:DELay?
Example	SWE:EGAT:DELay 500ms SWE:EGAT:DELay?
Notes	Units of time are required or no units; otherwise an invalid suffix error message will be generated.
Preset	57.7 us WiMAX OFDMA: 71 us GSM/EDGE: 600 us WLAN: 500 us
State Saved	Saved in instrument state
Min	0.0 us
Max	100 s
Backwards Compatibility SCPI	[:SENSe] :SWEep:TIME:GATE:DELay ESA compatibility
Initial S/W Revision	Prior to A.02.00

Gate Length

Controls the length of time that the gate is on after it opens.

Key Path	Sweep/Control, Gate
Remote Command	[:SENSe] :SWEep:EGATe:LENGth <time> [:SENSe] :SWEep:EGATe:LENGth?
Example	SWE:EGAT:LENG 1 SWE:EGAT:LENG?
Notes	Units of time are required or no units; otherwise an invalid suffix error message will be generated.
Dependencies	<p>Grayed out when Gate Method is set to FFT in which case the label changes to that shown below.</p>  <p>The key is also grayed out if Gate Control = Level.</p>
Preset	461.6 us

	WiMAX OFDMA: 50 us GSM/EDGE: 200 us WLAN: 1.54 ms
State Saved	Saved in instrument state
Min	100 ns
Max	5 s
Backwards Compatibility SCPI	[:SENSe]:SWEep:TIME:GATE:LENGth ESA compatibility
Initial S/W Revision	Prior to A.02.00

Gate Source

The menus under the Gate Source key are the same as those under the Trigger key, with the exception that neither Free Run nor Video are available as Gate Source selections. However, a different SCPI command is used to select the Gate Source (see table below) because you may independently set the Gate Source and the Trigger Source.

Any changes to the settings in the setup menus under each Gate Source selection key (for example: Trigger Level, Trigger Delay, etc.) also affect the corresponding settings under the Trigger menu keys. The SCPI commands used for these are the same for Trigger and Gate, since there is only one setting which affects both Gate and Trigger. Example: to set the Trigger Level for External 1 you use the command :TRIG:EXT1:LEV regardless of whether you are using External 1 as a Trigger Source or a Gate Source.

Key Path	Sweep/Control, Gate
Remote Command	[:SENSe]:SWEep:EGATe:SOURce EXTernal1 EXTernal2 LINE FRAME RFBurst [:SENSe]:SWEep:EGATe:SOURce?
Dependencies	In some models, there is no second External input. In these models, the External 2 key is blanked and the EXTernal2 parameter will generate a “Hardware missing; Not available for this model number” error.
Preset	EXTernal 1 GSM/EDGE, MSR: FRAME LTETDD: EXTernal 1When Direction is Downlink, FRAME when Direction is Uplink.
Backwards Compatibility Notes	In ESA, there is a single Gate input port. In PSA, the Gate Source may be taken from one of two specified input ports. In the X-Series, any Trigger Source can be a Gate Source.
Initial S/W Revision	Prior to A.02.00
Modified at S/W Revision	A.03.00, A.14.00

Line

Pressing this key, when it is not selected, selects the line signal as the trigger. A new sweep/measurement will start synchronized with the next cycle of the line voltage. Pressing this key, when it is already selected, access the line trigger setup menu.

Key Path	Trigger
Example	TRIG:SOUR LINE Swept SA measurement TRIG:<meas>:SOUR LINE Measurements other than Swept SA
Dependencies	Line trigger is not available when operating from a "dc power source", for example, when the instrument is powered from batteries.
State Saved	Saved in instrument state
Status Bits/OPC dependencies	The Status Operation Register bit 5 "Waiting for Trigger" is set at the same time as the Sweeping or Measuring bit is set. It is cleared when the trigger actually occurs (that is, after the trigger event occurs and all the applicable trigger criteria have been met). A corresponding pop-up message ("Waiting for trigger") is generated if no trigger signal appears after approximately 2 sec. This message goes away when a trigger signal appears.
Initial S/W Revision	Prior to A.02.00

Trig Slope

Controls the trigger polarity. It is set positive to trigger on a rising edge and negative to trigger on a falling edge.

Key Path	Trigger, Line
Remote Command	:TRIGger[:SEquence]:LINE:SLOPe POSitive NEGative :TRIGger[:SEquence]:LINE:SLOPe?
Example	TRIG:LINE:SLOP NEG
Preset	POSitive
State Saved	Saved in instrument state
Backwards Compatibility Notes	The legacy :TRIGger[:SEquence]:SLOPe command affects the slopes for the VID, LINE, EXT1, EXT2, and RFB triggers.
Initial S/W Revision	Prior to A.02.00

External 1

Pressing this key, when it is not selected, selects an external input signal as the trigger. A new sweep/measurement will start when the external trigger condition is met using the external 1 input connector on the rear panel.

Pressing this key, when it is already selected, accesses the external 1 trigger setup menu.

Key Path	Trigger
Example	TRIG:SOUR EXT1 Swept SA measurement TRIG:<meas>:SOUR EXT1 Measurements other than Swept SA
Dependencies	Grayed out if in use by Point Trigger in the Source Setup menu. Forced to Free Run if already selected and Point Trigger is set to External 1.
State Saved	Saved in instrument state
Status Bits/OPC dependencies	The Status Operation Register bit 5 "Waiting for Trigger" is set at the same time as the Sweeping or Measuring bit is set. It is cleared when the trigger actually occurs (that is, after the trigger event occurs and all the applicable trigger criteria have been met). A corresponding pop-up message ("Waiting for trigger") is generated if no trigger signal appears after approximately 2 sec. This message goes away when a trigger signal appears.
Initial S/W Revision	Prior to A.02.00

Trigger Level

Sets the value where the external 1 trigger input will trigger a new sweep/measurement.

Key Path	Trigger, External 1
Remote Command	:TRIGger[:SEquence]:EXTernal1:LEVel <level> :TRIGger[:SEquence]:EXTernal1:LEVel?
Example	TRIG:EXT1:LEV 0.4 V
Couplings	This same level is used for the Ext1 trigger source in the Trigger menu, for the Ext1 selection in the Periodic Timer sync source (in the Trigger menu and in the Gate Source menu), and also for the Ext1 selection in the Gate Source menu.
Preset	1.2 V
State Saved	Saved in instrument state
Min	-5 V
Max	5 V
Default Unit	V
Backwards Compatibility SCPI	:TRIGger[:SEquence]:EXTernal:LEVel For backward compatibility, the parameter EXTernal is mapped to EXTernal1
Backwards Compatibility SCPI	:TRIGger[:SEquence]:FRAME:EXTernal1:LEVel
Initial S/W Revision	Prior to A.02.00

Trig Slope

Controls the trigger polarity. It is set positive to trigger on a rising edge and negative to trigger on a falling edge.

Key Path	Trigger, External 1
Remote Command	:TRIGger[:SEquence]:EXTernal1:SLOPe POSitive NEGative :TRIGger[:SEquence]:EXTernal1:SLOPe?
Example	TRIG:EXT1:SLOP NEG
Couplings	This same slope is used in the Ext1 selection for the trigger source in the Trigger menu and for the period timer sync source (in the Trigger menu and in the Gate Source menu).
Preset	POSitive
State Saved	Saved in instrument state
Backwards Compatibility SCPI	:TRIGger[:SEquence]:EXTernal:SLOPe For backward compatibility, the parameter EXTernal is mapped to EXTernal1
Backwards Compatibility SCPI	:TRIGger[:SEquence]:FRAMe:EXTernal1:SLOPe
Backwards Compatibility Notes	The legacy :TRIGger[:SEquence]:SLOPe command affects the slopes for the VID, LINE, EXT1, EXT2, and RFB triggers.
Initial S/W Revision	Prior to A.02.00

Zero Span Delay Comp On/Off

In zero span, there is a natural delay in the signal path, which comes from the RBW filter. This is usually desirable, as it allows you to trigger on events and also see those events, because the signal is delayed from the trigger event. However, in some cases it is desirable to eliminate this delay, so that trigger events line up exactly with the zero time point in zero span. You can use the Zero Span Delay Comp On/Off feature to enable or disable zero span delay compensation.

Key Path	Trigger, External 1
Remote Command	:TRIGger[:SEquence]:EXTernal1:DELay:COMPensation OFF ON 0 1 :TRIGger[:SEquence]:EXTernal1:DELay:COMPensation?
Example	TRIG:EXT1:DEL:COMP ON
Dependencies	No effect except in zero-span, but not locked out in nonzero spans. Blanked in modes that do not support zero-span measurements. If the SCPI command is sent when the key is blanked, an error is returned: -221, "Settings conflict; Feature not supported for this measurement" In analyzers shipping N9060A, this feature requires N9060A-7FP.
Preset	OFF
State Saved	Saved in instrument state
Initial S/W Revision	A.11.00

External 2

Pressing this key, when it is not selected, selects an external input signal as the trigger. A new sweep/measurement will start when the external trigger condition is met using the external 2 input

connector. The external trigger 2 input connector is on the rear panel.

Pressing this key, when it is already selected, accesses the external 2 trigger setup menu.

Key Path	Trigger
Example	TRIG:SOUR EXT2 Swept SA measurement TRIG:<meas>:SOUR EXT2 Measurements other than Swept SA
Dependencies	In some models, there is no second External input. In these models, the External 2 key is blanked and the EXTernal2 parameter will generate a "Hardware missing; Not available for this model number" message. Grayed out if in use by Point Trigger in the Source Setup menu. Forced to Free Run if already selected and Point Trigger is set to External 2.
State Saved	Saved in instrument state
Status Bits/OPC dependencies	The Status Operation Register bit 5 "Waiting for Trigger" is set at the same time as the Sweeping or Measuring bit is set. It is cleared when the trigger actually occurs (that is, after the trigger event occurs and all the applicable trigger criteria have been met). A corresponding pop-up message ("Waiting for trigger") is generated if no trigger signal appears after approximately 2 sec. This message goes away when a trigger signal appears.
Initial S/W Revision	Prior to A.02.00
Modified at S/W Revision	A.03.00

Trigger Level

Sets the value where the external 2 trigger input will trigger a new sweep/measurement.

Key Path	Trigger, External 2
Remote Command	:TRIGger[:SEquence]:EXTernal2:LEVel :TRIGger[:SEquence]:EXTernal2:LEVel?
Example	TRIG:EXT2:LEV 1.1 V
Couplings	This same level is used for the Ext2 trigger source in the Trigger menu, for the Ext2 selection in the Periodic Timer sync source (in the Trigger menu and in the Gate Source menu), and also for the Ext2 selection in the Gate Source menu.
Preset	1.2 V
State Saved	Saved in instrument state
Min	-5 V
Max	5 V
Default Unit	V
Backwards Compatibility SCPI	:TRIGger[:SEquence]:FRAMe:EXTernal2:LEVel
Initial S/W Revision	Prior to A.02.00

Trig Slope

Controls the trigger polarity. It is set positive to trigger on a rising edge and negative to trigger on a falling edge.

Key Path	Trigger, External 2
Remote Command	:TRIGger[:SEquence]:EXternal2:SLOPe POSitive NEGative :TRIGger[:SEquence]:EXternal2:SLOPe?
Example	TRIG:EXT2:SLOP NEG
Couplings	This same slope is used in the Ext2 selection for the trigger source in the Trigger menu and for the period timer sync source (in the Trigger menu and in the Gate Source menu).
Preset	POSitive
State Saved	Saved in instrument state
Backwards Compatibility SCPI	:TRIGger[:SEquence]:FRAMe:EXternal2:SLOPe
Backwards Compatibility Notes	The legacy :TRIGger[:SEquence]:SLOPe command affects the slopes for the VID, LINE, EXT1, EXT2, and RFB triggers.
Initial S/W Revision	Prior to A.02.00

Zero Span Delay Comp On/Off

In zero span, there is a natural delay in the signal path, which comes from the RBW filter. This is usually desirable, as it allows you to trigger on events and also see those events, because the signal is delayed from the trigger event. However, in some cases it is desirable to eliminate this delay, so that trigger events line up exactly with the zero time point in zero span. You can use the Zero Span Delay Comp On/Off feature to enable or disable zero span delay compensation.

Key Path	Trigger, External 2
Remote Command	:TRIGger[:SEquence]:EXternal2:DELAy:COMPensation OFF ON 0 1 :TRIGger[:SEquence]:EXternal2:DELAy:COMPensation?
Example	TRIG:EXT2:DEL:COMP ON
Dependencies	No effect except in zero-span, but not locked out in nonzero spans. Blanked in modes that do not support zero-span measurements. If the SCPI command is sent when the key is blanked, an error is returned: -221, "Settings conflict; Feature not supported for this measurement" In analyzers shipping N9060A, this feature requires N9060A-7FP.
Preset	OFF
State Saved	Saved in instrument state
Initial S/W Revision	A.11.00

RF Burst

Pressing this key, when it is not selected, selects the RF Burst as the trigger. A new sweep/measurement will start when an RF burst envelope signal is identified from the signal at the RF Input connector. Pressing this key, when it is already selected, accesses the RF Burst trigger setup menu.

In some models, a variety of burst trigger circuitry is available, resulting in various available burst trigger bandwidths. The analyzer automatically chooses the appropriate trigger path based on the hardware configuration and other settings of the analyzer.

Key Path	Trigger
Example	TRIG:SOUR RFB Swept SA measurement TRIG:<meas>:SOUR RFB Measurements other than Swept SA
State Saved	Saved in instrument state
Status Bits/OPC dependencies	The Status Operation Register bit 5 "Waiting for Trigger" is set at the same time as the Sweeping or Measuring bit is set. It is cleared when the trigger actually occurs (that is, after the trigger event occurs and all the applicable trigger criteria have been met). A corresponding pop-up message ("Waiting for trigger") is generated if no trigger signal appears after approximately 2 sec. This message goes away when a trigger signal appears.
Backwards Compatibility Notes	The legacy command: :TRIGger[:SEQuence]:RFBurst:FSElectivity[:STATe] OFF ON 0 1 is not supported in the X-Series, as the hardware to do Frequency Selective burst triggers does not exist in X-Series.
Initial S/W Revision	Prior to A.02.00
Modified at S/W Revision	A.04.00

Absolute Trigger Level

Sets the absolute trigger level for the RF burst envelope.

When using the External Mixing path, the Absolute Trigger Level is uncalibrated because the factory default was set to accommodate the expected IF levels for the RF path.

Key Path	Trigger, RF Burst
Scope	Meas Global
Remote Command	:TRIGger[:SEQuence]:RFBurst:LEVel:ABSolute <ampl> :TRIGger[:SEQuence]:RFBurst:LEVel:ABSolute?
Example	TRIG:RFB:LEV:ABS 10 dBm sets the trigger level of the RF burst envelope signal to the absolute level of 10 dBm
Notes	Sending this command does not switch the setting from relative to absolute; to switch it you need to send the :TRIGger[:SEQuence]:RFBurst:LEVel:TYPE command, below. Amplitude Corrections are not taken into account by the Absolute Trigger Level. For example, if you have given yourself effective gain with an amplitude correction factor, the Absolute Trigger will not fire until you have set the trigger level that far below the displayed signal level, rather than simply to

	the displayed signal level. This is only true for Amplitude Corrections, not External Gain or Ref Level Offset functions. If mode is Bluetooth, the default value is -50 dBm.
Couplings	This same level is used for the RF Burst trigger source in the Trigger menu, for the RF Burst selection in the Periodic Timer sync source (in the Trigger menu and in the Gate Source menu), and also for the RF Burst selection in the Gate Source menu
Preset	-20 dBm
State Saved	Saved in instrument state
Min	-200 dBm
Max	100 dBm
Default Unit	depends on the current selected Y-Axis unit
Backwards Compatibility SCPI	:TRIGger[:SEquence]:FRAME:RFBurst:LEVel:ABSolute
Initial S/W Revision	Prior to A.02.00
Modified at S/W Revision	A.04.00

Key Path	Trigger, RF Burst
Remote Command	:TRIGger[:SEquence]:RFBurst:LEVel:TYPE ABSolute RELative :TRIGger[:SEquence]:RFBurst:LEVel:TYPE?
Example	TRIG:RFB:LEV:TYPE REL sets the trigger level type of the RF burst trigger to Relative.
Preset	ABSolute
State Saved	Saved in instrument state
Initial S/W Revision	Prior to A.02.00
Modified at S/W Revision	A.04.00

Relative Trigger Level

Sets the relative trigger level for the RF burst envelope.

In some models, the relative burst trigger function is implemented in hardware. In other models, without the advanced triggering hardware required, the relative burst trigger function is implemented in software in some measurements, and is unavailable in other measurements.

When implemented in software, the relative RF Burst trigger function is implemented as follows:

1. The measurement starts with the absolute RF Burst trigger setting. If it cannot get a trigger with that level, auto trigger fires and the acquisition starts anyway. After the acquisition, the measurement searches for the peak in the acquired waveform and saves it.

2. Now, in the next cycle of the measurement, the measurement determines a new absolute RF Burst level based on the peak value from the first measurement and the Relative RF Burst Trigger Level (always 0 or negative dB) set by the user. The following formula is used:
 3. absolute RF Burst level = peak level of the previous acquisition + relative RF Burst level
 4. If the new absolute RF Burst level differs from the previous by more than 0.5 dB, the new level is sent to the hardware; otherwise it is not updated (to avoid slowing down the acquisition)
- Steps 2 and 3 repeat for subsequent measurements.

Key Path	Trigger, RF Burst
Scope	Meas Global
Remote Command	:TRIGger[:SEquence]:RFBurst:LEVel:RELative <rel_ampl> :TRIGger[:SEquence]:RFBurst:LEVel:RELative?
Example	TRIG:RFB:LEV:REL -10 dB sets the trigger level of the RF burst envelope signal to the relative level of -10 dB
Notes	Sending this command does not switch the setting from absolute to relative; to switch it you need to send the :TRIGger[:SEquence]:RFBurst:LEVel:TYPE command, above. The relative trigger level is not available in some measurements. In those measurements the RELative parameter, and the :TRIGger[:SEquence]:RFBurst:LEVel:TYPE command (above), will generate an error if sent.
Dependencies	This key is grayed out and Absolute Trigger Level selected if the required hardware is not present in your analyzer and the current measurement does not support Relative triggering.
Preset	-6 dB GSM: -25 dB
State Saved	Saved in instrument state
Min	-45 dB
Max	0 dB
Default Unit	dB or dBc
Backwards Compatibility SCPI	:TRIGger[:SEquence]:RFBurst:LEVel This legacy command is aliased to :TRIGger[:SEquence]:RFBurst:LEVel:RELative because the PSA had ONLY relative burst triggering
Initial S/W Revision	Prior to A.02.00
Modified at S/W Revision	A.04.00

Trigger Slope

It is set positive to trigger on a rising edge and negative to trigger on a falling edge.

Key Path	Trigger, RF Burst
Remote Command	:TRIGger[:SEquence]:RFBurst:SLOPe Positive NEGative :TRIGger[:SEquence]:RFBurst:SLOPe?

Example	TRIG:RFB:SLOP NEG
Couplings	This same slope is used in the RF Burst selection for the trigger source in the Trigger menu and for the period timer sync source (in the Trigger menu and in the Gate Source menu).
Preset	POSitive
State Saved	Saved in instrument state
Backwards Compatibility SCPI	:TRIGger[:SEquence]:FRAMe:RFBurst:SLOPe
Backwards Compatibility Notes	The legacy :TRIGger[:SEquence]:SLOPe command affects the slopes for the VID, LINE, EXT1, EXT2, and RFB triggers.
Initial S/W Revision	Prior to A.02.00

Periodic Timer (Frame Trigger)

Pressing this key, when it is not selected, selects the internal periodic timer signal as the trigger. Triggering occurrences are set by the **Period** parameter, which is modified by the **Sync Source** and **Offset**. Pressing this key, when it is already selected, accesses the periodic timer trigger setup functions.

If you do not have a sync source selected (it is Off), then the internal timer will not be synchronized with any external timing events.

Key Path	Trigger
Example	TRIG:SOUR FRAM Swept SA measurement TRIG:<meas>:SOUR FRAM Measurements other than Swept SA
State Saved	Saved in instrument state
Readback	[Sync: <value of Sync Source>], for example, [Sync: External 1]
Status Bits/OPC dependencies	The Status Operation Register bit 5 "Waiting for Trigger" is set at the same time as the Sweeping or Measuring bit is set. It is cleared when the trigger actually occurs (that is, after the trigger event occurs and all the applicable trigger criteria have been met). A corresponding pop-up message ("Waiting for trigger") is generated if no trigger signal appears after approximately 2 sec. This message goes away when a trigger signal appears.
Initial S/W Revision	Prior to A.02.00

Periodic Timer Triggering:

This feature selects the internal periodic timer signal as the trigger. Trigger occurrences are set by the **Periodic Timer** parameter, which is modified by the **Sync Source** and **Offset**.

The figure below shows the action of the periodic timer trigger. Before reviewing the figure, we'll explain some uses for the periodic trigger.

A common application is measuring periodic burst RF signals for which a trigger signal is not easily available. For example, we might be measuring a TDMA radio which bursts every 20 ms. Let's assume that the 20 ms period is very consistent. Let's also assume that we do not have an external trigger source

available that is synchronized with the period, and that the signal-to-noise ratio of the signal is not high enough to provide a clean RF burst trigger at all of the analysis frequencies. For example, we might want to measure spurious transmissions at an offset from the carrier that is larger than the bandwidth of the RF burst trigger. In this application, we can set the Periodic Timer to a 20.00 ms period and adjust the offset from that timer to position our trigger just where we want it. If we find that the 20.00 ms is not exactly right, we can adjust the period slightly to minimize the drift between the period timer and the signal to be measured.

A second way to use this feature would be to use **Sync Source** temporarily, instead of **Offset**. In this case, we might tune to the signal in a narrow span and use the RF Burst trigger to synchronize the periodic timer. Then we would turn the sync source off so that it would not miss-trigger. Miss-triggering can occur when we are tuned so far away from the RF burst trigger that it is no longer reliable.

A third example would be to synchronize to a signal that has a reference time element of much longer period than the period of interest. In some CDMA applications, it is useful to look at signals with a short periodicity, by synchronizing that periodicity to the "even-second clock" edge that happens every two seconds. Thus, we could connect the even-second clock trigger to Ext1 and use then Ext1 as the sync source for the periodic timer.

The figure below illustrates this third example. The top trace represents the even-second clock. It causes the periodic timer to synchronize with the leading edge shown. The analyzer trigger occurs at a time delayed by the accumulated offset from the period trigger event. The periodic timer continues to run, and triggers continue to occur, with a periodicity determined by the analyzer time base. The timer output (labeled "late event") will drift away from its ideal time due to imperfect matching between the time base of the signal being measured and the time base of the analyzer, and also because of imperfect setting of the period parameter. But the synchronization is restored on the next even-second clock event. ("Accumulated offset" is described in the in the **Offset** function section.)

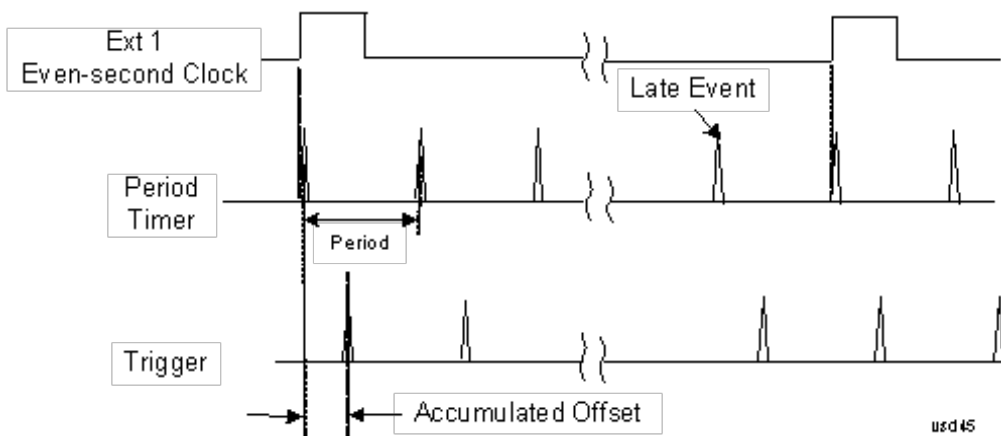

Period

Sets the period of the internal periodic timer clock. For digital communications signals, this is usually set to the frame period of your current input signal. In the case that sync source is not set to OFF, and the external sync source rate is changed for some reason, the periodic timer is synchronized at the every external synchronization pulse by resetting the internal state of the timer circuit.

Key Path	Trigger, Periodic Timer
Remote Command	:TRIGger[:SEquence]:FRAMe:PERIOD <time>

	:TRIGger[:SEquence]:FRAMe:PERiod?
Example	TRIG:FRAM:PER 100 ms
Dependencies	The invalid data indicator turns on when the period is changed, until the next sweep/measurement completes.
Couplings	The same period is used in the Gate Source selection of the period timer.
Preset	20 ms GSM: 4.615383
State Saved	Saved in instrument state
Min	100.000 ns
Max	559.0000 ms
Default Unit	S
Initial S/W Revision	Prior to A.02.00

Offset

Adjusts the accumulated offset between the periodic timer events and the trigger event. Adjusting the accumulated offset is different than setting an offset, and requires explanation.

The periodic timer is usually not synchronized with any external events, so the timing of its output events has no absolute meaning. Since the timing relative to external events (RF signals) is important, you need to be able to adjust (offset) it. However, you have no direct way to see when the periodic timer events occur. All that you can see is the trigger timing. When you want to adjust the trigger timing, you will be changing the internal offset between the periodic timer events and the trigger event. Because the absolute value of that internal offset is unknown, we will just call that the accumulated offset. Whenever the Offset parameter is changed, you are changing that accumulated offset. You can reset the displayed offset using Reset Offset Display. Changing the display does not change the value of the accumulated offset, and you can still make additional changes to accumulated offset.

To avoid ambiguity, we define that an increase in the "offset" parameter, either from the knob or the SCPI adjust command, serves to delay the timing of the trigger event.

Key Path	Trigger, Periodic Timer
Remote Command	:TRIGger[:SEquence]:FRAMe:OFFSet <time> :TRIGger[:SEquence]:FRAMe:OFFSet?
Example	TRIG:FRAM:OFFS 1.2 ms
Notes	The front panel interface (for example, the knob), and this command, adjust the accumulated offset, which is shown on the active function display. However, the actual amount sent to the hardware each time the offset is updated is the delta value, that is, the current accumulated offset value minus the previous accumulated offset value. Note that the accumulated offset value is essentially arbitrary; it represents the accumulated offset from the last time the offset was zeroed (with the Reset Offset Display key). Note that this command does not change the period of the trigger waveform. Note also that Offset is used only when the sync source is set to OFF, otherwise delay is used, see section "Trig Delay" on page 470.

	An increase in the "offset" parameter, either from the knob or the SCPI adjust command, serves to delay the timing of the trigger event.
Notes	When the SCPI command is sent the value shown on the key (and the Active Function, if this happens to be the active function) is updated with the new value. However, the actual amount sent to the hardware is the delta value, that is, the current accumulated offset value minus the previous accumulated offset value. The SCPI query simply returns the value currently showing on the key.
Dependencies	The invalid data indicator turns on when the offset is changed, until the next sweep/measurement completes.
Couplings	The same offset is used in the Gate Source selection of the period timer.
Preset	0 s
State Saved	Saved in instrument state
Min	-10.000 s
Max	10.000 s
Default Unit	S
Initial S/W Revision	Prior to A.02.00

Offset Adjust (Remote Command Only)

This remote command does not work at all like the related front panel keys. This command lets you advance the phase of the frame trigger by the amount you specify.

It does not change the period of the trigger waveform. If the command is sent multiple times, it advances the phase of the frame trigger an additional amount each time it is sent. Negative numbers are permitted.

Remote Command	:TRIGger[:SEquence]:FRAMe:ADJust <time>
Example	TRIG:FRAM:ADJ 1.2 ms
Notes	Note also that Offset is used only when the sync source is set to OFF, otherwise delay is used, see section " Trig Delay " on page 470 An increase in the "offset" parameter, either from the knob or the SCPI adjust command, serves to delay the timing of the trigger event.
Notes	The front panel interface (for example, the knob) and the :TRIG:FRAM:OFFS command adjust the accumulated offset, which is shown on the active function display. However, the actual amount sent to the hardware is the delta value, that is, the current offset value minus the previous offset value. When the SCPI command is sent the value shown on the key (and the Active Function, if this happens to be the active function) is updated by increasing it (or decreasing it if the value sent is negative) by the amount specified in the SCPI command. This is a "command only" SCPI command, with no query.
Dependencies	The invalid data indicator turns on when the offset is changed, until the next sweep/measurement completes.
Couplings	The same offset is used in the Gate Source selection of the period timer.
Preset	0 s

State Saved	Saved in instrument state
Min	-10.000 s
Max	10.000 s
Default Unit	S
Initial S/W Revision	Prior to A.02.00

Reset Offset Display

Resets the value of the periodic trigger offset display setting to 0.0 seconds. The current displayed trigger location may include an offset value defined with the Offset key. Pressing this key redefines the currently displayed trigger location as the new trigger point that is 0.0 s offset. The Offset key can then be used to add offset relative to this new timing.

Key Path	Trigger, Periodic Timer
Remote Command	:TRIGger[:SEquence]:FRAMe:OFFSet:DISPlay:RESet
Example	TRIG:FRAM:OFFS:DISP:RES
Initial S/W Revision	Prior to A.02.00

Sync Source

Selects a signal source for you to synchronize your periodic timer trigger to, otherwise you are triggering at some arbitrary location in the frame. Synchronization reduces the precision requirements on the setting of the period.

For convenience you may adjust the level and slope of the selected sync source in a conditional branch setup menu accessed from the Sync Source menu. Note that these settings match those in the **Trigger** and **Gate Source** menus; that is, each trigger source has only one value of level and slope, regardless of which menu it is accessed from.

Key Path	Trigger, Periodic Timer
Remote Command	:TRIGger[:SEquence]:FRAMe:SYNC EXTernal1 EXTernal2 RFBurst OFF :TRIGger[:SEquence]:FRAMe:SYNC?
Example	TRIG:FRAM:SYNC EXT2
Dependencies	In some models, there is no second External input. In these models, the External 2 key is blanked and the EXTernal2 parameter will generate a "Hardware missing; Not available for this model number" message.
Preset	Off GSM/EDGE, MSR,LTE,LTETDD: RFBurst
State Saved	Saved in instrument state
Readback	The current setting is read back to this key and it is also Readback to the previous Periodic Timer trigger key.

Backwards Compatibility SCPI	:TRIGger[:SEquence]:FRAMe:SYNC EXTernal
Initial S/W Revision	Prior to A.02.00
Modified at S/W Revision	A.03.00, A.14.00

Off

Turns off the sync source for your periodic trigger. With the sync source off, the timing will drift unless the signal source frequency is locked to the analyzer frequency reference.

Key Path	Trigger, Periodic Timer, Sync Source
Example	TRIG:FRAM:SYNC OFF
Readback	Off
Initial S/W Revision	Prior to A.02.00

External 1

Pressing this key, when it is not selected, selects an external input signal as the trigger. A new sweep/measurement will start when the external trigger condition is met using the external 1 input connector on the rear panel.

Pressing this key, when it is already selected, accesses the external 1 trigger setup menu.

Key Path	Trigger
Example	TRIG:SOUR EXT1 Swept SA measurement TRIG:<meas>:SOUR EXT1 Measurements other than Swept SA
Dependencies	Grayed out if in use by Point Trigger in the Source Setup menu. Forced to Free Run if already selected and Point Trigger is set to External 1.
State Saved	Saved in instrument state
Status Bits/OPC dependencies	The Status Operation Register bit 5 "Waiting for Trigger" is set at the same time as the Sweeping or Measuring bit is set. It is cleared when the trigger actually occurs (that is, after the trigger event occurs and all the applicable trigger criteria have been met). A corresponding pop-up message ("Waiting for trigger") is generated if no trigger signal appears after approximately 2 sec. This message goes away when a trigger signal appears.
Initial S/W Revision	Prior to A.02.00

Trigger Level

Sets the value where the external 1 trigger input will trigger a new sweep/measurement.

Key Path	Trigger, External 1
Remote Command	:TRIGger[:SEquence]:EXTErnal1:LEVel <level> :TRIGger[:SEquence]:EXTErnal1:LEVel?
Example	TRIG:EXT1:LEV 0.4 V
Couplings	This same level is used for the Ext1 trigger source in the Trigger menu, for the Ext1 selection in the Periodic Timer sync source (in the Trigger menu and in the Gate Source menu), and also for the Ext1 selection in the Gate Source menu.
Preset	1.2 V
State Saved	Saved in instrument state
Min	-5 V
Max	5 V
Default Unit	V
Backwards Compatibility SCPI	:TRIGger[:SEquence]:EXTErnal:LEVel For backward compatibility, the parameter EXTErnal is mapped to EXTErnal1
Backwards Compatibility SCPI	:TRIGger[:SEquence]:FRAME:EXTErnal1:LEVel
Initial S/W Revision	Prior to A.02.00

Trig Slope

Controls the trigger polarity. It is set positive to trigger on a rising edge and negative to trigger on a falling edge.

Key Path	Trigger, External 1
Remote Command	:TRIGger[:SEquence]:EXTErnal1:SLOPe POSitive NEGative :TRIGger[:SEquence]:EXTErnal1:SLOPe?
Example	TRIG:EXT1:SLOP NEG
Couplings	This same slope is used in the Ext1 selection for the trigger source in the Trigger menu and for the period timer sync source (in the Trigger menu and in the Gate Source menu).
Preset	POSitive
State Saved	Saved in instrument state
Backwards Compatibility SCPI	:TRIGger[:SEquence]:EXTErnal:SLOPe For backward compatibility, the parameter EXTErnal is mapped to EXTErnal1
Backwards Compatibility SCPI	:TRIGger[:SEquence]:FRAME:EXTErnal1:SLOPe
Backwards Compatibility Notes	The legacy :TRIGger[:SEquence]:SLOPe command affects the slopes for the VID, LINE, EXT1, EXT2, and RFB triggers.
Initial S/W Revision	Prior to A.02.00

External 2

Pressing this key, when it is not selected, selects an external input signal as the trigger. A new sweep/measurement will start when the external trigger condition is met using the external 2 input connector. The external trigger 2 input connector is on the rear panel.

Pressing this key, when it is already selected, accesses the external 2 trigger setup menu.

Key Path	Trigger
Example	TRIG:SOUR EXT2 Swept SA measurement TRIG:<meas>:SOUR EXT2 Measurements other than Swept SA
Dependencies	In some models, there is no second External input. In these models, the External 2 key is blanked and the EXTernal2 parameter will generate a "Hardware missing; Not available for this model number" message. Grayed out if in use by Point Trigger in the Source Setup menu. Forced to Free Run if already selected and Point Trigger is set to External 2.
State Saved	Saved in instrument state
Status Bits/OPC dependencies	The Status Operation Register bit 5 "Waiting for Trigger" is set at the same time as the Sweeping or Measuring bit is set. It is cleared when the trigger actually occurs (that is, after the trigger event occurs and all the applicable trigger criteria have been met). A corresponding pop-up message ("Waiting for trigger") is generated if no trigger signal appears after approximately 2 sec. This message goes away when a trigger signal appears.
Initial S/W Revision	Prior to A.02.00
Modified at S/W Revision	A.03.00

Trigger Level

Sets the value where the external 2 trigger input will trigger a new sweep/measurement.

Key Path	Trigger, External 2
Remote Command	:TRIGger[:SEquence]:EXTernal2:LEVel :TRIGger[:SEquence]:EXTernal2:LEVel?
Example	TRIG:EXT2:LEV 1.1 V
Couplings	This same level is used for the Ext2 trigger source in the Trigger menu, for the Ext2 selection in the Periodic Timer sync source (in the Trigger menu and in the Gate Source menu), and also for the Ext2 selection in the Gate Source menu.
Preset	1.2 V
State Saved	Saved in instrument state
Min	-5 V
Max	5 V
Default Unit	V
Backwards Compatibility SCPI	:TRIGger[:SEquence]:FRAMe:EXTernal2:LEVel
Initial S/W Revision	Prior to A.02.00

Trig Slope

Controls the trigger polarity. It is set positive to trigger on a rising edge and negative to trigger on a falling edge.

Key Path	Trigger, External 2
Remote Command	:TRIGger[:SEQuence]:EXTernal2:SLOPe POSitive NEGative :TRIGger[:SEQuence]:EXTernal2:SLOPe?
Example	TRIG:EXT2:SLOP NEG
Couplings	This same slope is used in the Ext2 selection for the trigger source in the Trigger menu and for the period timer sync source (in the Trigger menu and in the Gate Source menu).
Preset	POSitive
State Saved	Saved in instrument state
Backwards Compatibility SCPI	:TRIGger[:SEQuence]:FRAMe:EXTernal2:SLOPe
Backwards Compatibility Notes	The legacy :TRIGger[:SEQuence]:SLOPe command affects the slopes for the VID, LINE, EXT1, EXT2, and RFB triggers.
Initial S/W Revision	Prior to A.02.00

RF Burst

Pressing this key, when it is not selected, selects the RF Burst as the trigger. A new sweep/measurement will start when an RF burst envelope signal is identified from the signal at the RF Input connector. Pressing this key, when it is already selected, accesses the RF Burst trigger setup menu.

In some models, a variety of burst trigger circuitry is available, resulting in various available burst trigger bandwidths. The analyzer automatically chooses the appropriate trigger path based on the hardware configuration and other settings of the analyzer.

Key Path	Trigger
Example	TRIG:SOUR RFB Swept SA measurement TRIG:< meas>:SOUR RFB Measurements other than Swept SA
State Saved	Saved in instrument state
Status Bits/OPC dependencies	The Status Operation Register bit 5 "Waiting for Trigger" is set at the same time as the Sweeping or Measuring bit is set. It is cleared when the trigger actually occurs (that is, after the trigger event occurs and all the applicable trigger criteria have been met). A corresponding pop-up message ("Waiting for trigger") is generated if no trigger signal appears after approximately 2 sec. This message goes away when a trigger signal appears.
Backwards Compatibility Notes	The legacy command: :TRIGger[:SEQuence]:RFBurst:FSElectivity[:STATe] OFF ON 0 1 is not supported in the X-Series, as the hardware to do Frequency Selective burst triggers does not exist in X-Series.

Initial S/W Revision	Prior to A.02.00
Modified at S/W Revision	A.04.00

Absolute Trigger Level

Sets the absolute trigger level for the RF burst envelope.

When using the External Mixing path, the Absolute Trigger Level is uncalibrated because the factory default was set to accommodate the expected IF levels for the RF path.

Key Path	Trigger, RF Burst
Scope	Meas Global
Remote Command	:TRIGger[:SEquence]:RFBurst:LEVel:ABSolute <ampl> :TRIGger[:SEquence]:RFBurst:LEVel:ABSolute?
Example	TRIG:RFB:LEV:ABS 10 dBm sets the trigger level of the RF burst envelope signal to the absolute level of 10 dBm
Notes	Sending this command does not switch the setting from relative to absolute; to switch it you need to send the :TRIGger[:SEquence]:RFBurst:LEVel:TYPE command, below. Amplitude Corrections are not taken into account by the Absolute Trigger Level. For example, if you have given yourself effective gain with an amplitude correction factor, the Absolute Trigger will not fire until you have set the trigger level that far below the displayed signal level, rather than simply to the displayed signal level. This is only true for Amplitude Corrections, not External Gain or Ref Level Offset functions. If mode is Bluetooth, the default value is -50 dBm.
Couplings	This same level is used for the RF Burst trigger source in the Trigger menu, for the RF Burst selection in the Periodic Timer sync source (in the Trigger menu and in the Gate Source menu), and also for the RF Burst selection in the Gate Source menu
Preset	-20 dBm
State Saved	Saved in instrument state
Min	-200 dBm
Max	100 dBm
Default Unit	depends on the current selected Y-Axis unit
Backwards Compatibility SCPI	:TRIGger[:SEquence]:FRAME:RFBurst:LEVel:ABSolute
Initial S/W Revision	Prior to A.02.00
Modified at S/W Revision	A.04.00

Key Path	Trigger, RF Burst
Remote Command	:TRIGger[:SEquence]:RFBurst:LEVel:TYPE ABSolute RELative :TRIGger[:SEquence]:RFBurst:LEVel:TYPE?

Example	TRIG:RFB:LEV:TYPE REL sets the trigger level type of the RF burst trigger to Relative.
Preset	ABSolute
State Saved	Saved in instrument state
Initial S/W Revision	Prior to A.02.00
Modified at S/W Revision	A.04.00

Trigger Slope

It is set positive to trigger on a rising edge and negative to trigger on a falling edge.

Key Path	Trigger, RF Burst
Remote Command	:TRIGger[:SEquence]:RFBurst:SLOPe POSitive NEGative :TRIGger[:SEquence]:RFBurst:SLOPe?
Example	TRIG:RFB:SLOP NEG
Couplings	This same slope is used in the RF Burst selection for the trigger source in the Trigger menu and for the period timer sync source (in the Trigger menu and in the Gate Source menu).
Preset	POSitive
State Saved	Saved in instrument state
Backwards Compatibility SCPI	:TRIGger[:SEquence]:FRAME:RFBurst:SLOPe
Backwards Compatibility Notes	The legacy :TRIGger[:SEquence]:SLOPe command affects the slopes for the VID, LINE, EXT1, EXT2, and RFB triggers.
Initial S/W Revision	Prior to A.02.00

Sync Holdoff

Sync Holdoff specifies the duration that the sync source signal must be kept false before the transition to true to be recognized as the sync timing. The periodic timer phase is aligned when the sync source signal becomes true, after the Holdoff time is satisfied.

A holdoff of 2 ms will work with most WiMAX signals, but there may be cases where the burst off duration is less than 1 ms and this value will need to be changed.

Key Path	Trigger, Periodic Timer
Remote Command	:TRIGger[:SEquence]:FRAME:SYNC:HOLDoff <time> :TRIGger[:SEquence]:FRAME:SYNC:HOLDoff? :TRIGger[:SEquence]:FRAME:SYNC:HOLDoff:STATE OFF ON 0 1 :TRIGger[:SEquence]:FRAME:SYNC:HOLDoff:STATE?
Preset	On, 1.000 ms

State Saved	Saved in instrument state
Min	0 ms
Max	+500 ms
Default Unit	s
Initial S/W Revision	Prior to A.02.00

Control Edge/Level

Sets the method of controlling the gating function from the gating signal.

Edge

In Edge triggering, the gate opens (after the Delay) on the selected edge (for example, positive) of the gate signal and closes on the alternate edge (for example, negative).

Level

In Level triggering, the gate opens (after the Delay) when the gate signal has achieved a certain level and stays open as long as that level is maintained.

Key Path	Sweep/Control, Gate
Remote Command	[:SENSe] :SWEep:EGATe:CONTRol EDGE LEVe1 [:SENSe] :SWEep:EGATe:CONTRol?
Example	SWE:EGAT:CONT EDGE
Dependencies	If the Gate Method is FFT the Control key is grayed out and Edge is selected. If the Gate Source is TV, Frame or Line, the Control key is grayed out and Edge is selected.
Preset	EDGE
State Saved	Saved in instrument state
Backwards Compatibility SCPI	[:SENSe] :SWEep:TIME:GATE:TYPE ESA Compatibility
Initial S/W Revision	Prior to A.02.00

Gate Holdoff

Lets you increase or decrease the wait time after a gate event ends before the analyzer will respond to the next gate signal.

After any Gate event finishes, the analyzer must wait for the sweep system to settle before it can respond to another Gate signal. The analyzer calculates a "wait time," taking into account a number of factors, including RBW and Phase Noise Optimization settings. The goal is to achieve the same accuracy when gated as in ungated operation. The figure below illustrates this concept:

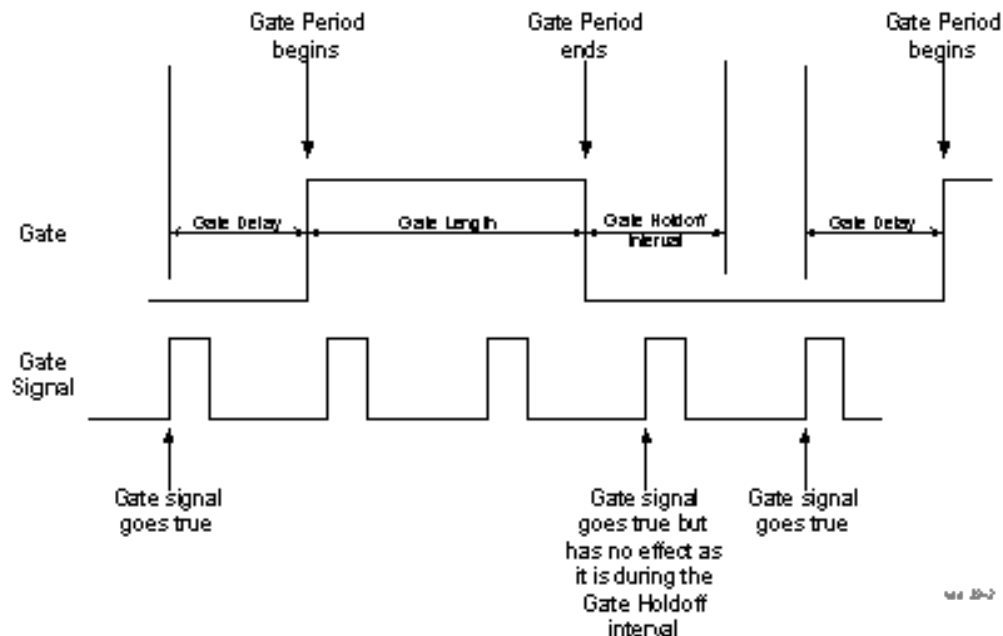

When Gate Holdoff is in Auto, the wait time calculated by the analyzer is used. When Gate Time is in Manual, the user may adjust the wait time, usually decreasing it in order to achieve greater speed, but at the risk of decreasing accuracy.

When the Method key is set to Video or FFT, the Gate Holdoff function has no effect.

In measurements that do not support Auto, the value shown when Auto is selected is “---” and the manually set holdoff is returned to a query.

Key Path	Sweep/Control, Gate
Remote Command	<pre>[:SENSe] :SWEep:EGATe:HOLDoff <time> [:SENSe] :SWEep:EGATe:HOLDoff? [:SENSe] :SWEep:EGATe:HOLDoff:AUTO OFF ON 0 1 [:SENSe] :SWEep:EGATe:HOLDoff:AUTO?</pre>
Example	<pre>SWE:EGAT:HOLD 0.0002 SWE:EGAT:HOLD? SWE:EGAT:HOLD:AUTO ON SWE:EGAT:HOLD:AUTO?</pre>
Couplings	<p>When Gate Holdoff is Auto, the Gate Holdoff key shows the value calculated by the analyzer for the wait time.</p> <p>Pressing the Gate Holdoff key while it is in Auto and not selected, causes the key to become selected and allows the user to adjust the value. If the value is adjusted, the setting changes to Man.</p> <p>Pressing the Gate Holdoff key, while it is in Auto and selected, does not change the value of Gate Holdoff, but causes the setting to change to Man. Now the user can adjust the value.</p> <p>Pressing the key while it is in Man and selected, cause the value to change back to Auto.</p> <p>Pressing the key while it is in Man and not selected, causes the key to become selected and allows the user to adjust the value.</p>

	When Method is set to Video or FFT, the Gate Holdoff function has no effect.
Preset	Auto Auto/On
State Saved	Saved in instrument state
Min	1 μ sec
Max	1 sec
Initial S/W Revision	Prior to A.02.00

Gate Delay Compensation

This function allows you to select an RBW-dependent value by which to adjust the gate delay, to compensate for changes in the delay caused by RBW effects.

You can select between uncompensated operation and two types of compensation, Delay Until RBW Settled and Compensate for RBW Group Delay.

See "[More Information](#)" on page 1588

Key Path	Sweep/Control, Gate
Scope	Meas Global
Remote Command	[:SENSe] :SWEep:EGATe:DELaY:COMPensation:TYPE OFF SETTled GDELaY [:SENSe] :SWEep:EGATe:DELaY:COMPensation:TYPE?
Example	SWE:EGAT:DEL:COMP:TYPE SETT SWE:EGAT:DEL:COMP:TYPE?
Notes	Although this function is Meas Global, there are some measurements that do not support this function. In those measurements the operation will be Uncompensated. Going into one of those measurements will not change the Meas Global selection; it will simply display the grayed-out menu key with "Uncompensated" showing as the selection. This is a non-forceful grayout, so the SCPI command is still accepted. If Gate Delay Compensation is not supported at all within a particular mode, the key is not displayed, and if the SCPI command is sent while in a measurement within that mode, an "Undefined Header" message is generated. Measurements that do not support this function include: Swept SA
Preset	TD-SCDMA mode: Compensate for RBW Group Delay All other modes: Delay Until RBW Settled
State Saved	Saved in instrument state
Range	Uncompensated Delay Until RBW Settled Compensate for RBW Group Delay
Readback text	Uncompensated Settled Group Delay
Initial S/W Revision	Prior to A.02.00
Modified at S/W Revision	A.11.0

More Information

Selecting Uncompensated means that the actual gate delay is as you sets it.

Selecting Delay Until RBW Settled causes the gate delay to be increased above the user setting by an amount equal to $3.06/\text{RBW}$. This compensated delay causes the GATE START and GATE STOP lines on the display to move by the compensation amount, and the actual hardware gate delay to be increased by the same amount. All the other gate lines (for example, MIN FAST) are unaffected. If the RBW subsequently changes, the compensation is readjusted for the new RBW. The value shown on the Gate Delay key does NOT change.

Delay Until RBW Settled allows excellent measurements of gated signals, by allowing the IF to settle following any transient that affects the burst. Excellent measurements also require that the analysis region not extend into the region affected by the falling edge of the burst. Thus, excellent measurements can only be made over a width that declines with narrowing RBWs, which is achieved by decreasing the gate length below the user setting by an amount equal to $2.53/\text{RBW}$. Therefore, for general purpose compensation, you will still want to change the gate length with changes in RBW even if the gate delay is compensated. The compensated Gate Length is limited by the analyzer so that it will never go below 10% of the value shown on the Gate Length key, as otherwise the sweep times could get very long. Anytime the Gate Length and RBW values combine in such a way that this limiting takes place, a warning is displayed. For measurements which contain multiple sweeps with different RBW like SEM and SPUR, the smallest RBW is used for this limiting.

Selecting Compensate for RBW Group Delay causes the gate delay to be increased above the user setting by an amount equal to $1.81/\text{RBW}$. This compensated delay causes the GATE START, GATE STOP lines on the display to move by the compensation amount, and the actual hardware gate delay to be increased by the same amount. All the other gate lines (for example, MIN FAST) are unaffected. If the RBW subsequently changes, the compensation is readjusted for the new RBW. The value shown on the Gate Delay key does NOT change. Compensate for RBW Group Delay also includes gate length compensation; the gate length itself is adjusted as necessary to attempt to compensate for delay effects imposed by the RBW.

Compensate for RBW Group Delay is similar to Delay Until RBW Settled, but compensates for the group delay of the RBW filter, rather than the filter settling time. As the RBW gets narrow, this can allow the settling tail of the RBW to affect the beginning part of the gated measurement, and allow the beginning of the RBW settling transient to affect the end of the gated measurement. These two effects are symmetric because the RBW response is symmetric. Because the gate length is not automatically compensated, some users might find this compensation to be more intuitive than compensation for RBW settling.

Min Fast Position Query (Remote Command Only)

This command queries the position of the MIN FAST line, relative to the delay reference (REF) line. See section ["Gate View On/Off" on page 2496](#). If this query is sent while not in gate view, the MinFast calculation is performed based on the current values of the appropriate parameters and the result is returned. Knowing this value lets you set an optimal gate delay value for the current measurement setup.

Remote Command	<code>[:SENSe] :SWEep:EGATe:MINFast?</code>
Example	<code>SWE:EGAT:MIN?</code>
Initial S/W Revision	Prior to A.02.00

Gate Preset (Remote Command Only)

Presets the time-gated spectrum analysis capability.

This command sets gate parameter values to the ESA preset values, as follows:

Gate trigger type = edge

Gate polarity = positive

Gate delay = 1 us

Gate length = 1 us

Remote Command	<code>[[:SENSe]:SWEep:TIME:GATE:PRESet</code> ESA Compatibility
Initial S/W Revision	Prior to A.02.00

Gate Level (Remote Command Only)

Sets the gate input transition point level for the external TRIGGER inputs on the front and rear panel. This is a legacy command for PSA compatibility. It is simply an alias to the equivalent trigger level command.

Remote Command	<code>[[:SENSe]:SWEep:EGATE:EXTernal[1] 2:LEVel <voltage></code> <code>[[:SENSe]:SWEep:EGATE:EXTernal[1] 2:LEVel?</code>
Notes	This command is simply an alias to <code>:TRIGger[:SEQUence]:EXTernal[1] 2:LEVel</code> For details refer
Initial S/W Revision	Prior to A.02.00

Gate Polarity (Remote Command Only)

Sets the polarity for the gate signal. This setup is now done using the gate trigger's slope setting.

When Positive (Pos) is selected, a positive-going edge (Edge) or a high voltage (Level) will satisfy the gate condition, after the delay set with the Gate Delay key. When Negative (Neg) is selected, a negative-going edge (Edge) or a low voltage (Level) will satisfy the gate condition after the delay.

Remote Command	<code>[[:SENSe]:SWEep:EGATE:POLarity NEGative POSitive</code> <code>[[:SENSe]:SWEep:EGATE:POLarity?</code>
Example	<code>SWE:EGAT:POL NEG</code> <code>SWE:EGAT:POL?</code>
Preset	POSitive
State Saved	Saved in instrument state
Backwards Compatibility SCPI	<code>[[:SENSe]:SWEep:TIME:GATE:POLarity</code> ESA compatibility
Initial S/W Revision	Prior to A.02.00

13 Spectrum Emission Mask Measurement
Sweep/Control

Remote Command	<code>[:SENSe] :SWEep:TIME:GATE:LEVel HIGH LOW</code> <code>[:SENSe] :SWEep:TIME:GATE:LEVel?</code> ESA compatibility
Preset	HIGH
Initial S/W Revision	Prior to A.02.00

System

See "System" on page 366

Trace/Detector

Accesses a menu of functions that enable you to control trace and detector for the current measurement.

Key Path	Front-panel key
Initial S/W Revision	Prior to A.02.00

Trace Type

Allows you to select the type of trace for the current measurement. The menu contains a 1-of-N selection of the trace type (Clear Write, Average, Max Hold, Min Hold).

Key Path	Trace/Detector
Mode	SA, WCDMA, C2K, WIMAX OFDMA, TD-SCDMA, 1xEVDO, DTMB (CTTB), DVB-T/H, ISDB-T, CMMB, LTE, LTEFDD, Digital Cable TV, WLAN, MSR, LTEAFDD, LTEATDD
Remote Command	:TRACe:SEMAsk:TYPE WRITe AVERAge MAXHold MINHold :TRACe:SEMAsk:TYPE?
Example	TRAC:SEM:TYPE MINH TRAC:SEM:TYPE?
Notes	WRITe = Clear Write AVERAge = Average MAXHold = Maximum Hold MINHold = Minimum Hold
Couplings	When Detector setting is "Auto" ([:SENSe]:SEMAsk:DETEctor:AUTO?), Detector ([:SENSe]:SEMAsk:DETEctor[:FUNCTion]?) switches aligning with the switch of this parameter: "NORMal" with WRITe (Clear Write), "AVERAge" with AVERAge, "POSitive (peak)" with MAXHold, and "NEGative (peak)" with MINHold.
Preset	AVERAge
State Saved	Saved in instrument state.
Range	WRITe AVERAge MAXHold MINHold
Initial S/W Revision	Prior to A.02.00
Modified at S/W Revision	A.02.00, A.03.00

Chan Detector

Accesses a menu of functions that enable you to control the detectors for reference channel. The following choices are available:

- Auto—the detector selected depends on marker functions, trace functions, average type, and the trace averaging function.
- Normal—the detector determines the peak of the CW-like signals, and it yields alternating maximums and minimums of noise-like signals. This is also referred to as Rosenfell detection.

- Average—the detector determines the average of the signal within the sweep points. The averaging method depends upon the Average Type selection (voltage, power or log scales).
- Peak—the detector determines the maximum of the signal within the sweep points.
- Sample—the detector indicates the instantaneous level of the signal at the center of the sweep points represented by each display point.
- Negative Peak—the detector determines the minimum of the signal within the sweep points.

Key Path	Trace/Detector
Initial S/W Revision	Prior to A.02.00

Chan Detector Auto

Sets the detector to the default detection mode for the reference channel. This mode is dependent upon the current reference channel conditions.

Key Path	Trace/Detector
Mode	SA, WCDMA, C2K, WIMAX OFDMA, TD-SCDMA, 1xEVDO, DTMB (CTTB), DVB-T/H, ISDB-T, CMMB, LTE, LTE-TDD, Digital Cable TV, WLAN, MSR, LTEAFDD, LTEATDD
Remote Command	[:SENSe] :SEMAsk:DETEctor:CARRier:AUTO ON OFF 1 0 [:SENSe] :SEMAsk:DETEctor:CARRier:AUTO?
Example	SEM:DET:CARR:AUTO OFF SEM:DET:CARR:AUTO?
Notes	See Couplings in the Trace Type section. You must be in the mode that includes SEM measurement to use this command. Use :INSTrument:SElect to set the mode.
Preset	ON
State Saved	Saved in instrument state
Range	On Off
Initial S/W Revision	Prior to A.02.00
Modified at S/W Revision	A.02.00, A.03.00

Chan Detector Selection

Selects the detector mode for the reference channel.

Key Path	Trace/Detector
Mode	SA, WCDMA, C2K, WIMAX OFDMA, TD-SCDMA, 1xEVDO, DTMB (CTTB), DVB-T/H, ISDB-T, CMMB, LTE, LTE-TDD, Digital Cable TV, WLAN, MSR, LTEAFDD, LTEATDD
Remote Command	[:SENSe] :SEMAsk:DETEctor:CARRier[:FUNction] AVERAge NEGative NORMal POSitive SAMPlE [:SENSe] :SEMAsk:DETEctor:CARRier[:FUNction]?

Example	SEM:DET:CARR NEG SEM:DET:CARR?
Notes	When you manually select a detector (instead of selecting Auto), that detector is used regardless of other analyzer settings. Note: This detector setting affects the reference channel. There is not a per trace detector. You must be in the mode that includes SEM measurement to use this command. Use :INSTrument:SElect to set the mode.
Couplings	See Couplings in the Trace Type section.
Preset	AVERage
State Saved	Saved in instrument state.
Range	Normal Average Peak Sample Negative Peak
Initial S/W Revision	Prior to A.02.00
Modified at S/W Revision	A.02.00, A.03.00

Offset Detector

Accesses a menu of functions that enable you to control the detector for offsets. The following choices are available.

- Auto– the detector selected depends on marker functions, trace functions, average type, and the trace averaging function.
- Normal–the detector determines the peak of the CW-like signals, and it yields alternating maximums and minimums of noise-like signals. This is also referred to as Rosenfell detection.
- Average–the detector determines the average of the signal within the sweep points. The averaging method depends upon the Average Type selection (voltage, power or log scales).
- Peak–the detector determines the maximum of the signal within the sweep points.
- Sample–the detector indicates the instantaneous level of the signal at the center of the sweep points represented by each display point.
- Negative Peak–the detector determines the minimum of the signal within the sweep points.

Key Path	Trace/Detector
Initial S/W Revision	Prior to A.02.00

Offset Detector Auto

Sets the detector to the default detection mode for the offsets. This mode is dependent upon the current signal conditions of the offsets.

Key Path	Trace/Detector
Mode	SA, WCDMA, C2K, WIMAX OFDMA, TD-SCDMA, 1xEVDO, DTMB (CTTB), DVB-T/H, ISDB-T, CMMB,

	LTE, LTE-TDD, Digital Cable TV, WLAN, MSR, LTEAFDD, LTEATDD
Remote Command	[:SENSe] :SEMAsk:DETEctor:OFFSet:AUTO ON OFF 1 0 [:SENSe] :SEMAsk:DETEctor:OFFSet:AUTO?
Example	SEM:DET:OFFS:AUTO OFF SEM:DET:OFFS:AUTO?
Notes	See Couplings in the Trace Type section. You must be in the mode that includes SEM measurement to use this command. Use :INSTrument:SElect to set the mode.
Preset	ON
State Saved	Saved in instrument state.
Range	On Off
Initial S/W Revision	Prior to A.02.00
Modified at S/W Revision	A.02.00, A.03.00

Offset Detector Selection

Selects the detector mode for the offsets.

Key Path	Trace/Detector
Mode	SA, WCDMA, C2K, WIMAX OFDMA, TD-SCDMA, 1xEVDO, DTMB (CTTB), DVB-T/H, ISDB-T, CMMB, LTE, LTE-TDD, Digital Cable TV, WLAN, MSR, LTEAFDD, LTEATDD
Remote Command	[:SENSe] :SEMAsk:DETEctor:OFFSet[:FUNction] AVERAge NEGAtive NORMAl POSitive SAMPlE [:SENSe] :SEMAsk:DETEctor:OFFSet[:FUNction]?
Example	SEM:DET:OFFS AVER SEM:DET:OFFS?
Notes	When you manually select a detector (instead of selecting Auto), that detector is used regardless of other analyzer settings. Note: This detector setting has effects all offsets. There is not a per trace detector. You must be in the mode that includes SEM measurement to use this command. Use :INSTrument:SElect to set the mode.
Couplings	See Couplings in the Trace Type section.
Preset	POSitive
State Saved	Saved in instrument state.
Range	Normal Average Peak Sample Negative Peak
Initial S/W Revision	Prior to A.02.00
Modified at S/W Revision	A.02.00, A.03.00

Trigger

See ["Trigger" on page 438](#)

Free Run

See ["Free Run " on page 445](#)

Video

See ["Video \(IF Envelope\) " on page 446](#)

Trigger Level

See ["Trigger Level " on page 446](#)

Trig Slope

See ["Trig Slope " on page 447](#)

Trig Delay

See ["Trig Delay " on page 448](#)

Line

See ["Line " on page 2503](#)

Trig Slope

See ["Trig Slope " on page 2503](#)

Trig Delay

See ["Trig Delay " on page 450](#)

External 1

See ["External 1 " on page 2516](#)

Trigger Level

See ["Trigger Level " on page 2516](#)

Trig Slope

See ["Trig Slope " on page 2517](#)

Trig Delay

See ["Trig Delay " on page 453](#)

Zero Span Delay Comp

See ["Zero Span Delay Comp On/Off" on page 2505](#)

External 2

See ["External 2 "](#) on page 2518

Trigger Level

See ["Trigger Level "](#) on page 2518

Trig Slope

See ["Trig Slope "](#) on page 2519

Trig Delay

See ["Trig Delay "](#) on page 455

Zero Span Delay Comp

See ["Zero Span Delay Comp On/Off"](#) on page 2507

RF Burst

See ["RF Burst "](#) on page 2519

Absolute Trigger

See ["Absolute Trigger Level"](#) on page 2520

Relative Trigger

See ["Relative Trigger Level"](#) on page 2509

Trig Slope

See ["Trigger Slope "](#) on page 2521

Trig Delay

See ["Trig Delay "](#) on page 460

Periodic Timer

See ["Periodic Timer \(Frame Trigger\) "](#) on page 2511

Period

See ["Period "](#) on page 2512

Offset

See ["Offset "](#) on page 2513

Reset Offset Display

See ["Reset Offset Display "](#) on page 2515

Sync Source

See "[Sync Source](#) " on page 2515

Off

See "[Off](#) " on page 2516

External 1

See "[External 1](#) " on page 2516

Trigger Level

See "[Trigger Level](#) " on page 2516

Trig Slope

See "[Trig Slope](#) " on page 2517

External 2

See "[External 2](#) " on page 2518

Trigger Level

See "[Trigger Level](#) " on page 2518

Trig Slope

See "[Trig Slope](#) " on page 2519

RF Burst

See "[RF Burst](#) " on page 2519

Absolute Trigger

See "[Absolute Trigger Level](#)" on page 2520

Trig Slope

See "[Trigger Slope](#) " on page 2521

Trig Delay

See "[Trig Delay](#)" on page 470

Auto/Holdoff

See "[Auto/Holdoff](#) " on page 471

Auto Trig

See "[Auto Trig](#) " on page 471

Trig Holdoff

See "[Trig Holdoff](#) " on page 472

Holdoff Type

See "Holdoff Type" on page 472

User Preset

Accesses a menu that gives you the following three choices:

- User Preset – recalls a state previously saved using the Save User Preset function.
- User Preset All Modes – presets all of the modes in the analyzer
- Save User Preset– saves the current state for the current mode

Key Path	Front-panel key
Backwards Compatibility Notes	<p>User Preset is actually loading a state, and in legacy analyzers, it was possible to load a state without affecting the trace data, limit lines or correction data. Similarly it was possible to do a User Preset without affecting the trace data, limit lines or correction data.</p> <p>In the X-Series, “state” always includes all of this data; so whenever state is loaded, or User Preset is executed, all of the traces, limit lines and corrections are affected. Although this differs from previous behavior, it is desirable behavior, and should not cause adverse issues for users.</p> <p>On ESA and PSA, User Preset affected the entire instrument’s state. In the X-Series, User Preset only recalls the state for the active mode. There is a User Preset file for each mode. User Preset can never cause a mode switch as it can in legacy analyzers. If you want to recall all modes to their user preset file state, you will need to do a User Preset after mode switching into each mode.</p> <p>User Preset recalls mode state which can now include data like traces; whereas on ESA and PSA, User Preset did not affect data.</p>
Initial S/W Revision	Prior to A.02.00

User Preset

User Preset sets the state of the currently active mode back to the state that was previously saved for this mode using the Save User Preset menu key or the SCPI command, SYST:PRES:USER:SAV. It not only recalls the Mode Preset settings, but it also recalls all of the mode persistent settings, and the Input/Output system setting that existed at the time Save User Preset was executed.

If a Save User Preset has not been done at any time, User Preset recalls the default user preset file for the currently active mode. The default user preset files are created if, at power-on, a mode detects there is no user preset file. There will never be a scenario when there is no user preset file to restore. For each mode, the default user preset state is the same state that would be saved if a Save User Preset is performed in each mode right after doing a Restore Mode Default and after a Restore Input/Output Defaults.

The User Preset function does the following:

- Aborts the currently running measurement.
- Sets the mode State to the values defined by Save User Preset.
- Makes the saved measurement for the currently running mode the active measurement.
- Brings up the saved menu for the power-on mode.
- Clears the input and output buffers.
- Sets the Status Byte to 0.

Key Path	User Preset
Remote Command	:SYSTem:PRESet:USER
Example	:SYST:PRES:USER:SAVE:SYST:PRES:USER
Notes	:SYST:PRES:USER:SAVE is used to save the current state as the user preset state. Clears all pending OPC bits. The Status Byte is set to 0. Pressing the User Preset front-panel key while already in the User Preset menu will cause the User Preset to get executed
Couplings	A user preset will cause the currently running measurement to be aborted and cause the saved measurement to be active. Recalling a User Preset file has the same issues that recalling a Save State file has. Some settings may need to be limited and therefore re-coupled, since the capabilities of the mode may have changes when the User Preset file was last saved.
Initial S/W Revision	Prior to A.02.00

User Preset All Modes

Recalls all of the User Preset files for each mode, switches to the power-on mode, and activates the saved measurement from the power-on mode User Preset file.

NOTE

When the instrument is secured, all of the user preset files are converted back to their default user preset files.

The User Preset function does the following:

- Aborts the currently running measurement.
- Switches the Mode to the power-on mode.
- Restores the User Preset files for each mode.
- Makes the saved measurement for the power-on mode the active measurement.
- Brings up the saved menu for the power-on mode.
- Clears the input and output buffers.
- Sets the Status Byte to 0.

Key Path	User Preset
Remote Command	:SYSTem:PRESet:USER:ALL
Example	:SYST:PRES:USER:SAVE:SYST:PRES:USER:ALL
Notes	Clears all pending OPC bits. The Status Byte is set to 0. :SYST:PRES:USER:SAVE is used to save the current state as the user preset state.
Couplings	A user preset will cause the currently running measurement to be aborted, cause a mode switch to the power-on mode, and cause the saved measurement to be active in the power-on mode. Recalling a User Preset file has the same issues that recalling a Save State file has. Some settings may need to be limited and therefore re-coupled, since the capabilities of the mode may have changes when the User Preset file was last saved.
Initial S/W Revision	Prior to A.02.00

Save User Preset

Saves the currently active mode and its State. You can recall this User Preset file by pressing the User Preset menu key or sending the SYST:PRES:USER remote command. This same state is also saved by the Save State function.

Key Path	User Preset
Remote Command	:SYSTem:PRESet:USER:SAVE
Example	:SYST:PRES:USER:SAVE
Notes	:SYST:PRES:SAVE creates the same file as if the user requested a *SAV or a MMEM:STOR:STAT, except User Preset Save does not allow the user to specify the filename or the location of the file.
Initial S/W Revision	Prior to A.02.00

View/Display

Accesses a menu of functions that enable you to control the instrument display.

The following keys select how the results are displayed:

- **Abs Pwr Freq**—displays the absolute power levels in dBm and the corresponding frequencies in the text window.
- **Rel Pwr Freq**—displays the relative power levels in dBc and the corresponding frequencies in the text window.
- **Integrated Power**—displays the absolute and relative power levels integrated throughout the bandwidths between the start and stop frequencies in the text window.
- **Carrier Info** —displays the carrier configuration information with measure powers. (Only available in MSR and LTE-Advanced FDD/TDD)

"View Selection by Name (Remote Command Only)" on page 1603

"Views Selection by Number (Remote Command only)" on page 1604

View Selection by Name (Remote Command Only)

Key Path	View/Display
Mode	SA, WCDMA, C2K, WIMAX OFDMA, TD-SCDMA, 1xEVDO, DTMB (CTTB), DVB-T/H, ISDB-T, CMMB, LTE, LTE-TDD, Digital Cable TV, WLAN, MSR, LTEAFDD, LTEATDD
Remote Command	:DISPlay:SEMask:VIEW[:SElect] APFReq RPFReq IPOWer CINformation :DISPlay:SEMask:VIEW[:SElect]?
Example	DISP:SEM:VIEW IPOW DISP:SEM:VIEW?
Notes	You must be in the mode that includes SEM measurement to use this command. Use :INSTrument:SElect to set the mode.
Dependencies	In the SA mode, when "Radio Standard" is set to WLAN, IPOWer is not available and the key is grayed out. CINformation is available only in MSR and LTE-Advanced FDD/TDD mode, otherwise the key is blank.
Preset	SA, , WCDMA, , C2K, , TD-SCDMA, , 1xEVDO, , DTMB (CTTB), , DVB-T/H, , ISDB-T, , CMMB, , LTE, , LTE-TDD, , Digital Cable TV, , MSR, , LTEAFDD, , LTEATDD: APFReq WIMAX OFDMA, WLAN: RPFReq
State Saved	Saved in instrument state.
Range	Abs Pwr & Freq Rel Pwr & Freq Integrated Power Carrier Info
Initial S/W Revision	Prior to A.02.00
Modified at S/W Revision	A.02.00, A.03.00, A.10.00

Views Selection by Number (Remote Command only)

The following numerical selections determine how the results are displayed:

1. displays the absolute power levels in dBm and the corresponding frequencies in the text window.
2. displays the relative power levels in dBc and the corresponding frequencies in the text window.
3. displays the absolute and relative power levels integrated throughout the bandwidths between the start and stop frequencies in the text window.
4. displays the carrier info table. (Only available in MSR and LTE-Advanced FDD/TDD)

Mode	SA, WCDMA, C2K, WIMAX OFDMA, TD-SCDMA, 1xEVDO, DTMB (CTTB), DVB-T/H, ISDB-T, CMMB, LTE, LTETDD, Digital Cable TV, WLAN, MSR, LTEAFDD, LTEATDD
Remote Command	:DISPlay:SEMask:VIEW:NSElect <integer> :DISPlay:SEMask:VIEW:NSElect?
Example	DISP:SEM:VIEW:NSEL 2 DISP:SEM:VIEW:NSEL?
Notes	In the SA mode, when "Radio Standard" is set to WLAN, Option 3 is not available. Option 4 is available only in MSR and LTE-Advanced FDD/TDD mode. You must be in the mode that includes SEM measurement to use this command. Use :INSTrument:SElect to set the mode.
Preset	SA, , WCDMA, , C2K, , TD-SCDMA, , 1xEVDO, , DTMB (CTTB), , DVB-T/H, , ISDB-T, , CMMB, , LTE, , LTETDD, , Digital Cable TV, , MSR, , LTEAFDD, , LTEATDD: 1 WIMAX OFDMA, WLAN: 2
State Saved	Saved in instrument state.
Min	1
Max	MSR, LTEAFDD, LTEATDD: 4 Other modes: 3
Initial S/W Revision	Prior to A.02.00
Modified at S/W Revision	A.02.00, A.03.00, A.10.00

Key Path	Front-panel key
Initial S/W Revision	Prior to A.02.00

Display

The Display menu is common to most measurements, and is used for configuring items on the display. Some Display menu settings apply to all the measurements in a mode, and some only to the current measurement. Those under the System Display Settings key apply to all measurements in all modes.

Key Path	Display
-----------------	---------

Key Path	View/Display
Initial S/W Revision	Prior to A.02.00

Annotation

Turns on and off various parts of the display annotation. The annotation is divided up into four categories:

1. Meas Bar: This is the measurement bar at the top of the screen. It does not include the settings panel or the Active Function. Turning off the Meas Bar turns off the settings panel and the Active Function. When the Meas Bar is off, the graticule area expands to fill the area formerly occupied by the Meas Bar.
2. Screen Annotation: this is the annotation and annunciation around the graticule, including any annotation on lines (such as the display line, the threshold line, etc.) This does NOT include the marker number or the N dB result. When off, the graticule expands to fill the entire graticule area.
3. Trace annotation: these are the labels on the traces, showing their detector (or their math mode).
4. Active Function annotation: this is the active function display in the meas bar, and all of the active function values displayed on softkeys.

See the figure below. Each type of annotation can be turned on and off individually.

13 Spectrum Emission Mask Measurement
View/Display

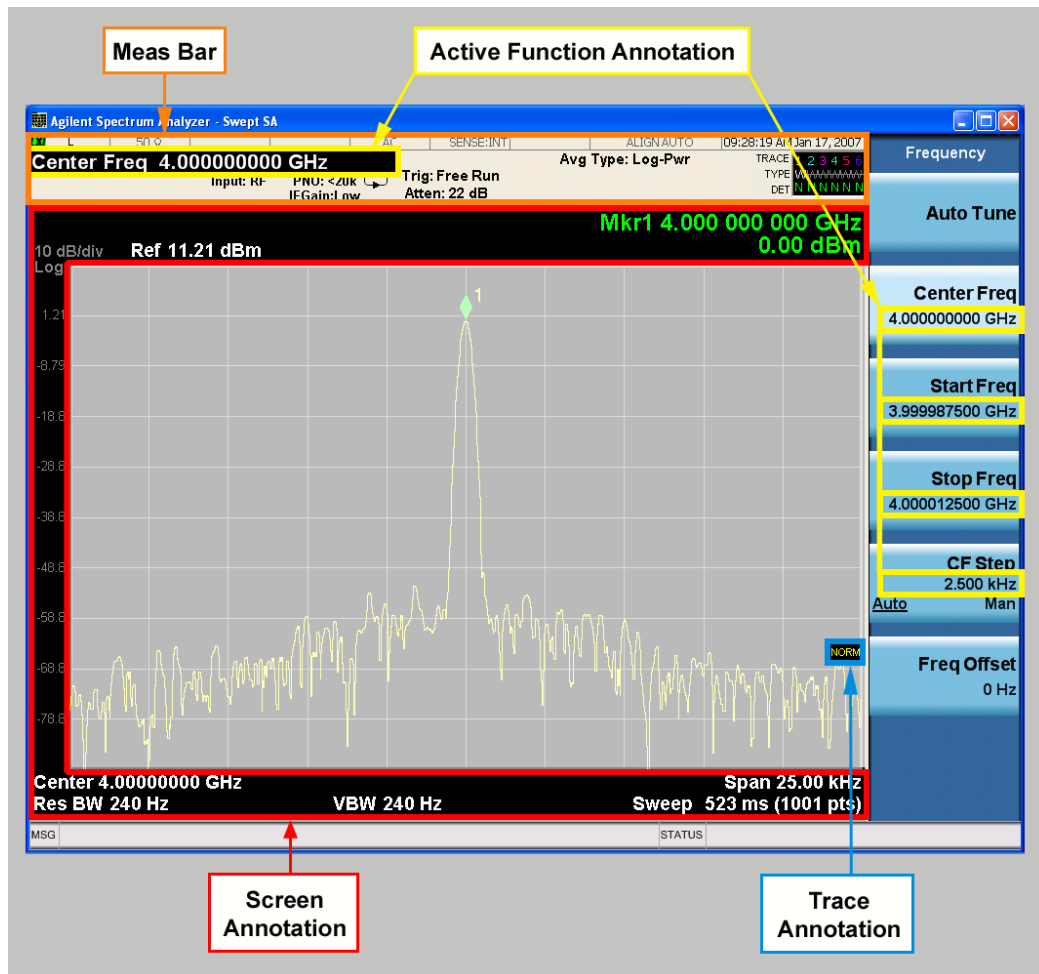

Key Path	View/Display, Display
Initial S/W Revision	Prior to A.02.00

Meas Bar On/Off

This function turns the Measurement Bar on and off, including the settings panel. When off, the graticule area expands to fill the area formerly occupied by the Measurement Bar.

Key Path	View/Display, Display, Annotation
Remote Command	:DISPlay:ANNOtation:MBAR[:STATe] OFF ON 0 1 :DISPlay:ANNOtation:MBAR[:STATe]?
Example	DISP:ANN:MBAR OFF
Dependencies	Grayed out and forced to OFF when System Display Settings, Annotation is set to Off.
Preset	On This should remain Off through a Preset when System Display Settings, Annotation is set to Off.
State Saved	Saved in instrument state.
Initial S/W Revision	Prior to A.02.00

Screen

This controls the display of the annunciation and annotation around the graticule, including any annotation on lines (such as the display line, the threshold line, etc.) and the y-axis annotation. This does NOT include marker annotation (or the N dB result). When off, the graticule expands to fill the entire graticule area, leaving only the 1.5% gap above the graticule as described in the Trace/Detector chapter.

Key Path	View/Display, Display, Annotation
Remote Command	:DISPlay:ANNotation:SCReen[:STATe] OFF ON 0 1 :DISPlay:ANNotation:SCReen[:STATe]?
Example	DISP:ANN:SCR OFF
Dependencies	Grayed-out and forced to OFF when System Display Settings, Annotation is set to Off.
Preset	On This should remain Off through a Preset when System DisplaySettings, Annotation is set to Off
State Saved	Saved in instrument state.
Initial S/W Revision	Prior to A.02.00

Active Function Values On/Off

Turns on and off the active function display in the Meas Bar, and all of the active function values displayed on the softkeys.

Note that all of the softkeys that have active functions have these numeric values blanked when this function is on. This is a security feature..

13 Spectrum Emission Mask Measurement View/Display

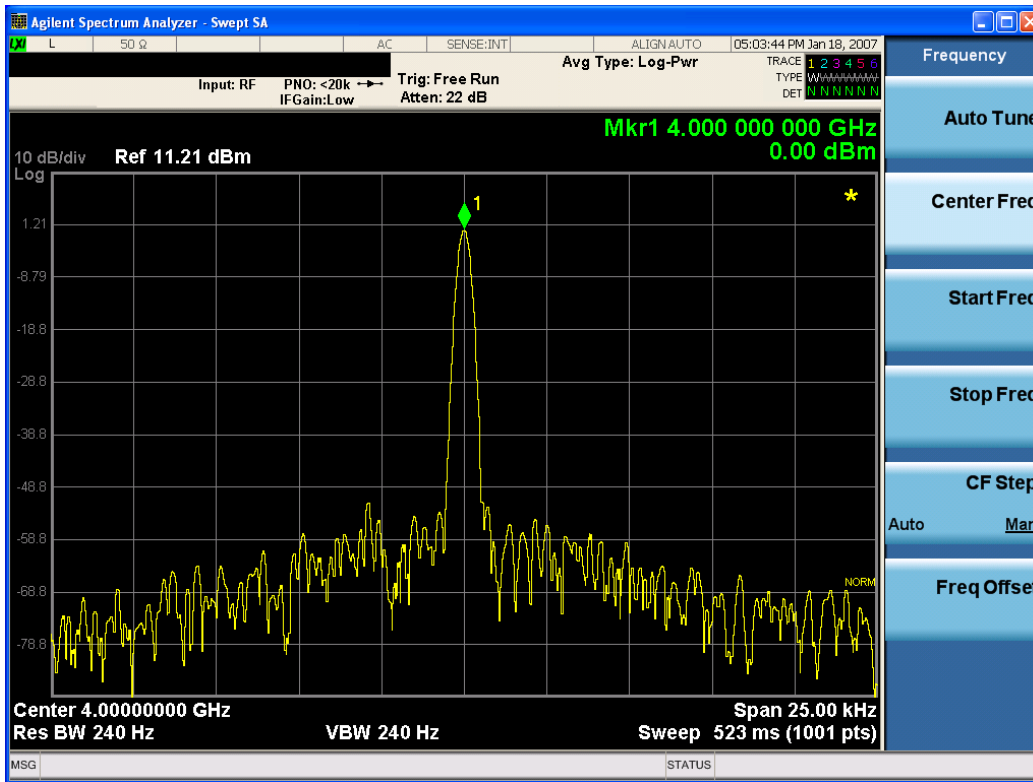

Key Path	View/Display, Display, Annotation
Remote Command	:DISPlay:ACTivefunc[:STATE] ON OFF 1 0 :DISPlay:ACTivefunc[:STATE] ?
Example	DISP:ACT OFF
Dependencies	Grayed out and forced to OFF when System Display Settings, Annotation is set to Off.
Preset	On This should remain Off through a Preset when System DisplaySettings, Annotation is set to Off
State Saved	Saved in instrument state.
Initial S/W Revision	Prior to A.02.00

Title

Displays menu keys that enable you to change or clear a title on your display.

Key Path	View/Display, Display
Initial S/W Revision	Prior to A.02.00

Change Title

Writes a title into the "measurement name" field in the banner, for example, "Swept SA".

Press Change Title to enter a new title through the alpha editor. Press Enter or Return to complete the entry. Press ESC to cancel the entry and preserve your existing title.

The display title will replace the measurement name. It remains for this measurement until you press Change Title again, or you recall a state, or a Preset is performed. A title can also be cleared by pressing Title, Clear Title.

NOTE

Notice the inclusion of the <measurement> parameter in the command below. Because each measurement remembers the Display Title, the command must be qualified with the measurement name. For the Swept SA measurement this is not the case; no <measurement> parameter is used when changing the Display Title for the Swept SA measurement.

Key Path	View/Display, Display, Title
Mode	All
Remote Command	:DISPlay:<measurement>:ANNotation:TITLe:DATA <string> :DISPlay:<measurement>:ANNotation:TITLe:DATA?
Example	DISP:ANN:TITL:DATA "This Is My Title" This example is for the Swept SA measurement in the Spectrum Analyzer mode. The SANalyzer <measurement> name is not used. DISP:ACP:ANN:TITL:DATA "This Is My Title" This example is for Measurements other than Swept SA. Both set the title to: This Is My Title
Notes	Pressing this key cancels any active function. When a title is edited the previous title remains intact (it is not cleared) and the cursor goes at the end so that characters can be added or BKSP can be used to go back over previous characters.
Preset	No title (measurement name instead)
State Saved	Saved in instrument state.
Initial S/W Revision	Prior to A.02.00

Clear Title

Clears a title from the front-panel display. Once cleared, the title cannot be retrieved. After the title is cleared, the current Measurement Name replaces it in the title bar.

Key Path	View/Display, Display, Title
Example	The following commands clear the title and restore the measurement's original title: DISP:ANN:TITL:DATA "" This example is for the Swept SA measurement in the Spectrum Analyzer mode. The SANalyzer <measurement> name is not used. DISP:ACP:ANN:TITL:DATA "" This example is for ACP; in measurements other than Swept SA the measurement name is required.
Notes	Uses the :DISPlay:<measurement>:ANNotation:TITLe:DATA <string> command with an empty string (in the Swept SA, the <measurement> is omitted).
Preset	Performed on Preset.
Initial S/W Revision	Prior to A.02.00

Graticule

Pressing Graticule turns the display graticule On or Off. It also turns the graticule y-axis annotation on and off.

Key Path	View/Display, Display
Remote Command	:DISPlay:WINDow[1]:TRACe:GRATicule:GRID[:STATe] OFF ON 0 1 :DISPlay:WINDow[1]:TRACe:GRATicule:GRID[:STATe]?
Example	DISP:WIND:TRAC:GRAT:GRID OFF
Notes	The graticule is the set of horizontal and vertical lines that make up the grid/divisions for the x-axis and y-axis.
Preset	On
State Saved	Saved in instrument state
Initial S/W Revision	Prior to A.02.00

System Display Settings

These settings are "Mode Global" – they affect all modes and measurements and are reset only by Restore Misc Defaults or Restore System Defaults under System.

Key Path	View/Display, Display
Initial S/W Revision	Prior to A.02.00

Annotation Local Settings

This is a Mode Global override of the meas local annotation settings. When it is All Off, it forces ScreenAnnotation, Meas Bar, Trace, and Active Function Values settings to be OFF for all measurements in all modes. This provides the security based "annotation off" function of previous analyzers; hence it uses the legacy SCPI command.

When it is All Off, the Screen, Meas Bar, Trace, and Active Function Values keys under the Display, Annotation menu are grayed out and forced to Off. When Local Settings is selected, you are able to set the local annotation settings on a measurement by measurement basis.

Key Path	View/Display, Display, System Display Settings
Remote Command	:DISPlay:WINDow[1]:ANNOtation[:ALL] OFF ON 0 1 :DISPlay:WINDow[1]:ANNOtation[:ALL]?
Example	:DISP:WIND:ANN OFF
Preset	On (Set by Restore Misc Defaults)
State Saved	Not saved in instrument state.
Backwards Compatibility Notes	The WINDow parameter and optional subopcode is included for backwards compatibility but ignored – all windows are equally affected.
Initial S/W Revision	Prior to A.02.00

Themes

Accesses a menu of functions that enable you to choose the theme to be used when saving the screen image.

The **Themes** option is the same as the **Themes** option under the **Display** and **Page Setup** dialogs. It allows you to choose between themes to be used when saving the screen image.

Key Path	Save, Screen Image
Remote Command	:MMEMory:STORe:SCReen:THEMe TDColor TDMonochrome FCOLor FMONochrome :MMEMory:STORe:SCReen:THEMe?
Example	:MMEM:STOR:SCR:THEM TDM
Preset	3D Color; Is not part of Preset, but is reset by Restore Misc Defaults or Restore System Defaults All and survives subsequent running of the modes.
Readback	3D Color 3D Mono Flat Color Flat Mono
Backwards Compatibility Notes	In ESA and PSA we offer the choice of "Reverse Bitmap" or "Reverse Metafile" when saving screen images. This is much like the "Flat Color" theme available in X-Series. Also, if you selected Reverse Bitmap AND a black & white screen image, that would be much like "Flat Monochrome". In other words, each of the X-Series themes has a similar screen image type in ESA/PSA. But they are not identical.
Initial S/W Revision	Prior to A.02.00

3D Color

Selects a standard color theme with each object filled, shaded and colored as designed.

Key Path	Save, Screen Image, Themes
Example	MMEM:STOR:SCR:THEM TDC
Readback	3D Color
Initial S/W Revision	Prior to A.02.00

3D Monochrome

Selects a format that is like 3D color but shades of gray are used instead of colors.

Key Path	Save, Screen Image, Themes
Example	MMEM:STOR:SCR:THEM TDM
Readback	3D Mono
Initial S/W Revision	Prior to A.02.00

Flat Color

Selects a format that is best when the screen is to be printed on an ink printer.

Key Path	Save, Screen Image, Themes
Example	MMEM:STOR:SCR:THEM FCOL
Readback	Flat Color
Initial S/W Revision	Prior to A.02.00

Flat Monochrome

Selects a format that is like Flat Color. But only black is used (no colors, not even gray), and no fill.

Key Path	Save, Screen Image, Themes
Example	MMEM:STOR:SCR:THEM FMON
Readback	Flat Mono
Initial S/W Revision	Prior to A.02.00

Backlight

Accesses the display backlight on/off keys. This setting may interact with settings under the Windows "Power" menu.

When the backlight is off, pressing ESC, TAB, SPACE, ENTER, UP, DOWN, LEFT, RIGHT, DEL, BKSP, CTRL, or ALT turns the backlight on without affecting the application. Pressing any other key will turn backlight on and could potentially perform the action as well.

Key Path	View/Display, Display, System Display Settings
Remote Command	:DISPlay:BACKlight ON OFF :DISPlay:BACKlight?
Preset	ON (Set by Restore Misc Defaults)
Initial S/W Revision	Prior to A.02.00

Backlight Intensity

An active function used to set the backlight intensity. It goes from 0 to 100 where 100 is full on and 0 is off. This value is independent of the values set under the Backlight on/off key.

Key Path	View/Display, Display, System Display Settings
Remote Command	:DISPlay:BACKlight:INTensity <integer> :DISPlay:BACKlight:INTensity?
Example	DISP:BACK:INT 50

Preset	100 (Set by Restore Misc Defaults)
Min	0
Max	100
Initial S/W Revision	Prior to A.02.00

Abs Pwr Freq

Sets the display to the Absolute Peak Power and Frequency view. The views differ depending on the setting of the measurement type (Meas Type) under the Measurement Setup menu.

"Abs Peak Pwr & Freq (Total Pwr Ref)" on page 1613

"Abs Peak Pwr & Freq (PSD Ref)" on page 1615

"Abs Peak Pwr & Freq (Spectrum Pk Ref)" on page 1617

Abs Peak Pwr & Freq (Total Pwr Ref)

This view consists of the following two windows:

"Trace Window" on page 1615

"Results Window " on page 1615

13 Spectrum Emission Mask Measurement
View/Display

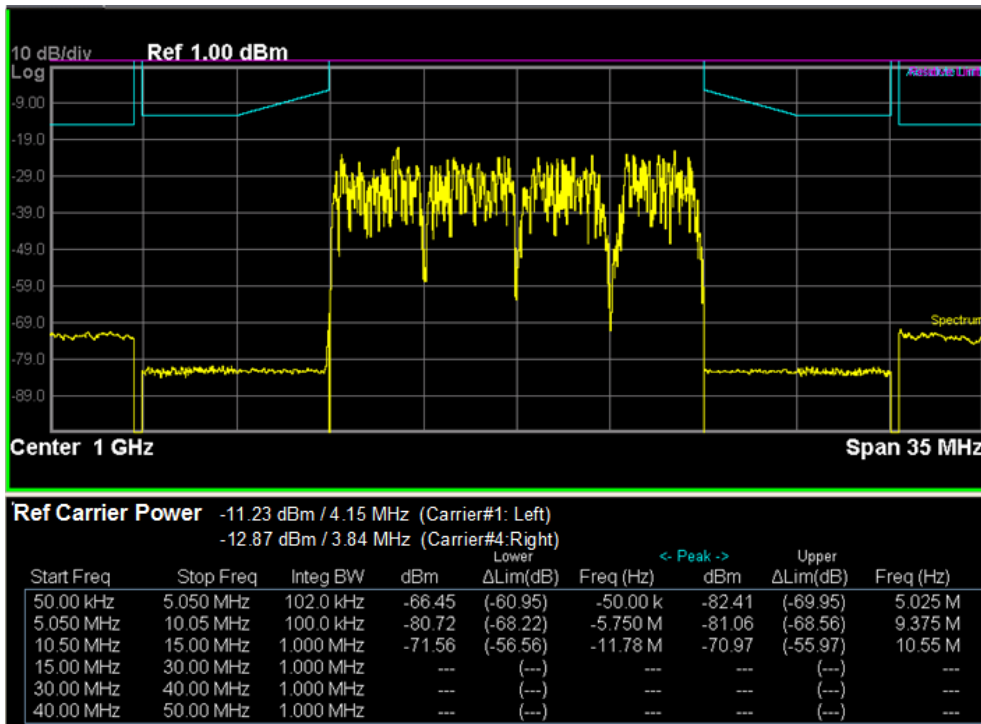
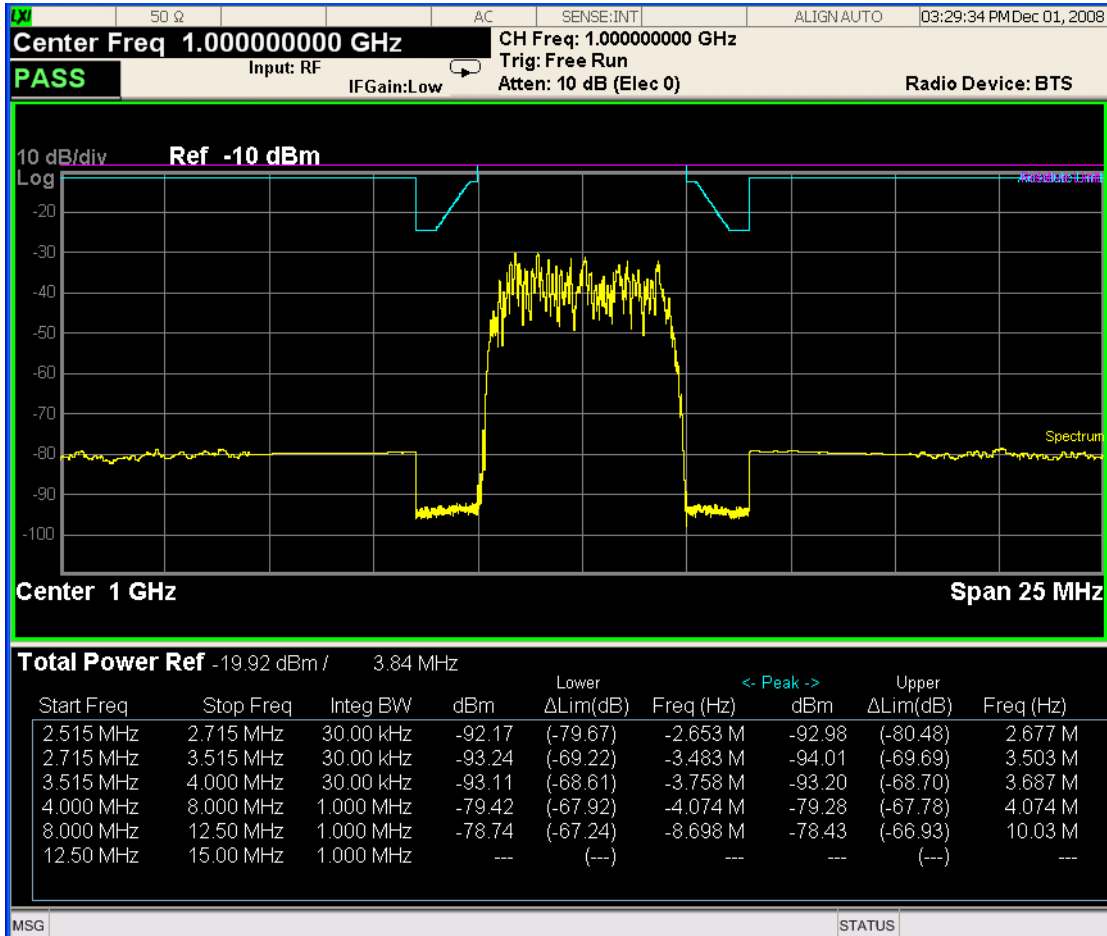

Trace Window

Corresponding Trace	yellow - Combined trace from carrier and each offset
---------------------	--

Results Window

Name	Corresponding Results
Total Pwr Ref	n=1 2nd element Absolute power at the reference area. Channel Integration Bandwidth
Start (Hz)	Start frequency for offset
Stop (Hz)	Stop frequency for offset
Meas BW (Hz)	Measurement bandwidth for offset
Lower Peak (dBm)	Absolute peak power on minimum margin point of the negative offset
Lower Δ lim (dB)	Minimum margin from limit line which is decided by Fail Mask setting on the negative offset
Lower Freq (Hz)	Frequency on minimum margin point of the negative offset
Upper Peak (dBm)	Absolute peak power on minimum margin point of the positive offset
Upper Δ lim (dB)	Minimum margin from limit line which is decided by Fail Mask setting on the positive offset
Upper Freq (Hz)	Frequency on minimum margin point of the positive offset

Abs Peak Pwr & Freq (PSD Ref)

This view consists of the following two windows:

"Trace Window" on page 1617

"Results Window " on page 1617

13 Spectrum Emission Mask Measurement
View/Display

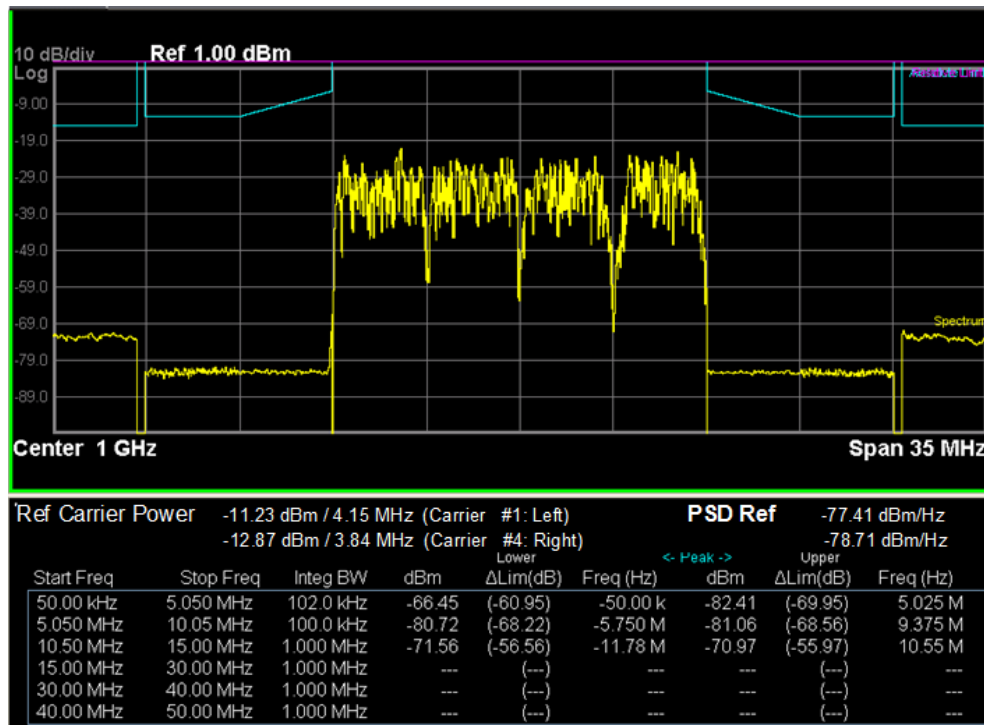
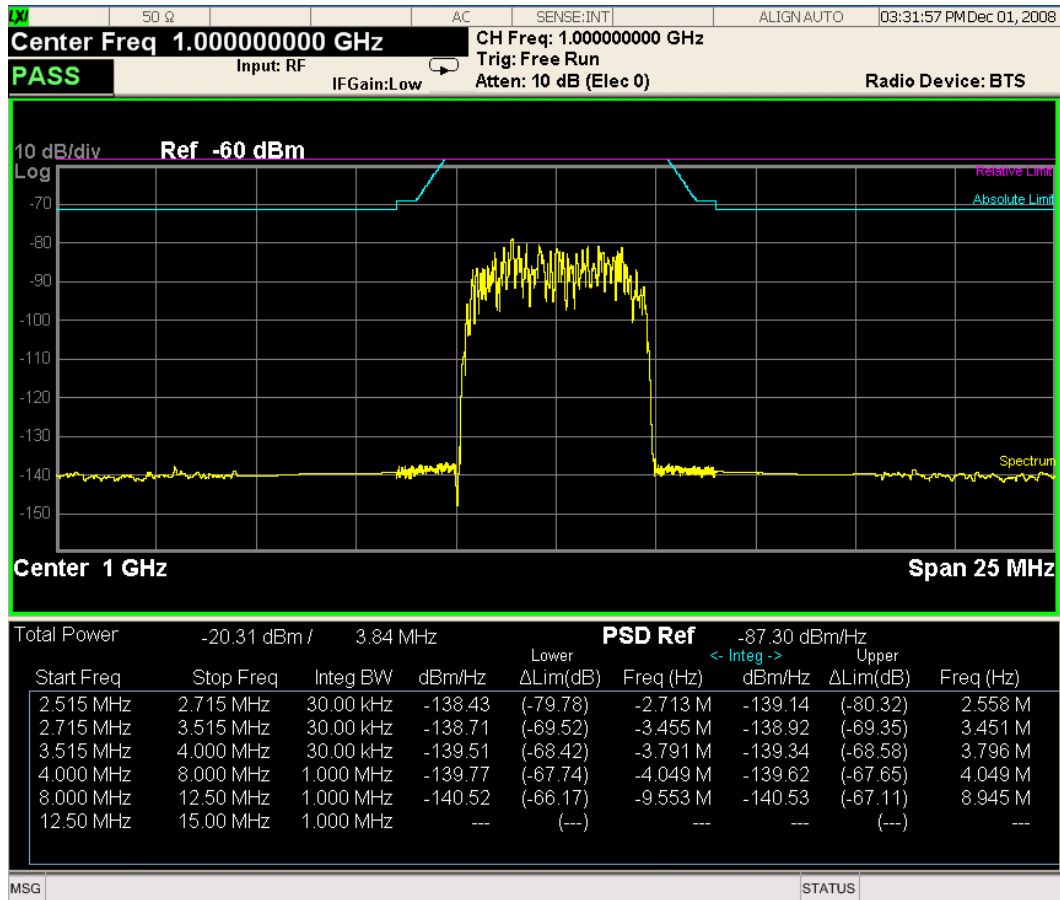

Trace Window

Corresponding Trace	yellow - Combined trace from carrier and each offset
---------------------	--

Results Window

Name	Corresponding Results
Total Pwr	n=1 2nd element Absolute power at the reference area.
	Channel Integration Bandwidth
PSD Ref	n=5 1st element Power spectral density reference at the reference area
Start (Hz)	Start frequency for offset
Stop (Hz)	Stop frequency for offset
Meas BW (Hz)	Measurement bandwidth for offset
Lower (dBm/Hz)	Absolute power spectrum density of the negative offset
Lower Δ lim (dB)	Minimum margin from limit line which is decided by Fail Mask setting on the negative offset
Lower Freq (Hz)	Frequency on minimum margin point of the negative offset
Upper (dBm/Hz)	Absolute power spectrum density of the positive offset
Upper Δ lim (dB)	Minimum margin from limit line which is decided by Fail Mask setting on the positive offset
Upper Freq (Hz)	Frequency on minimum margin point of the positive offset

Abs Peak Pwr & Freq (Spectrum Pk Ref)

This view consists of the following two windows:

"Trace Window" on page 1617

"Results Window " on page 1617

13 Spectrum Emission Mask Measurement
View/Display

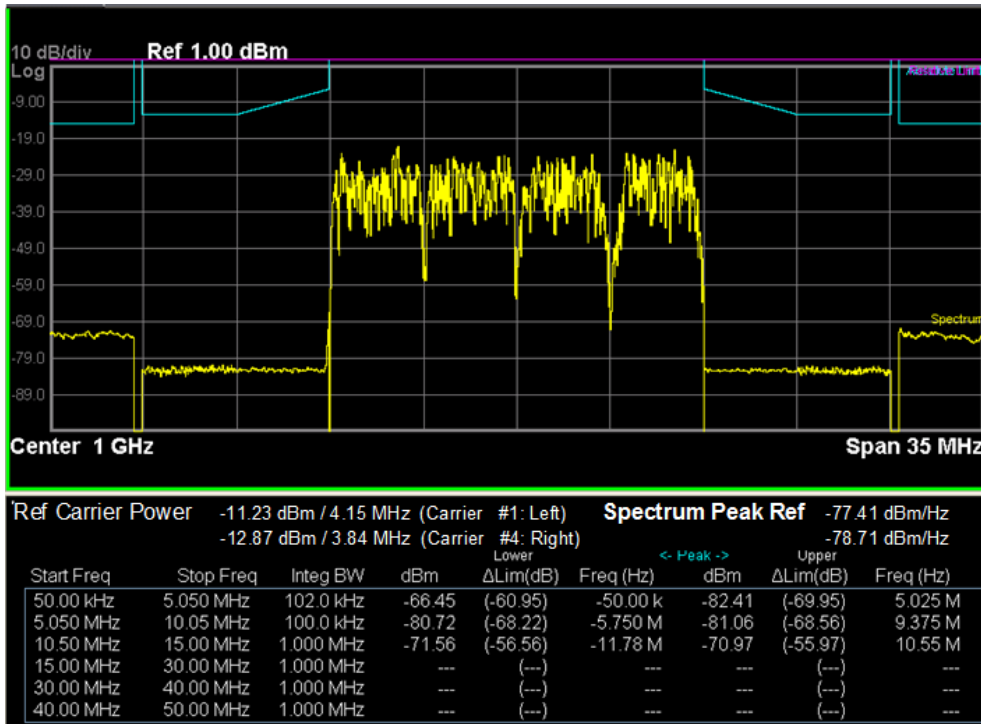
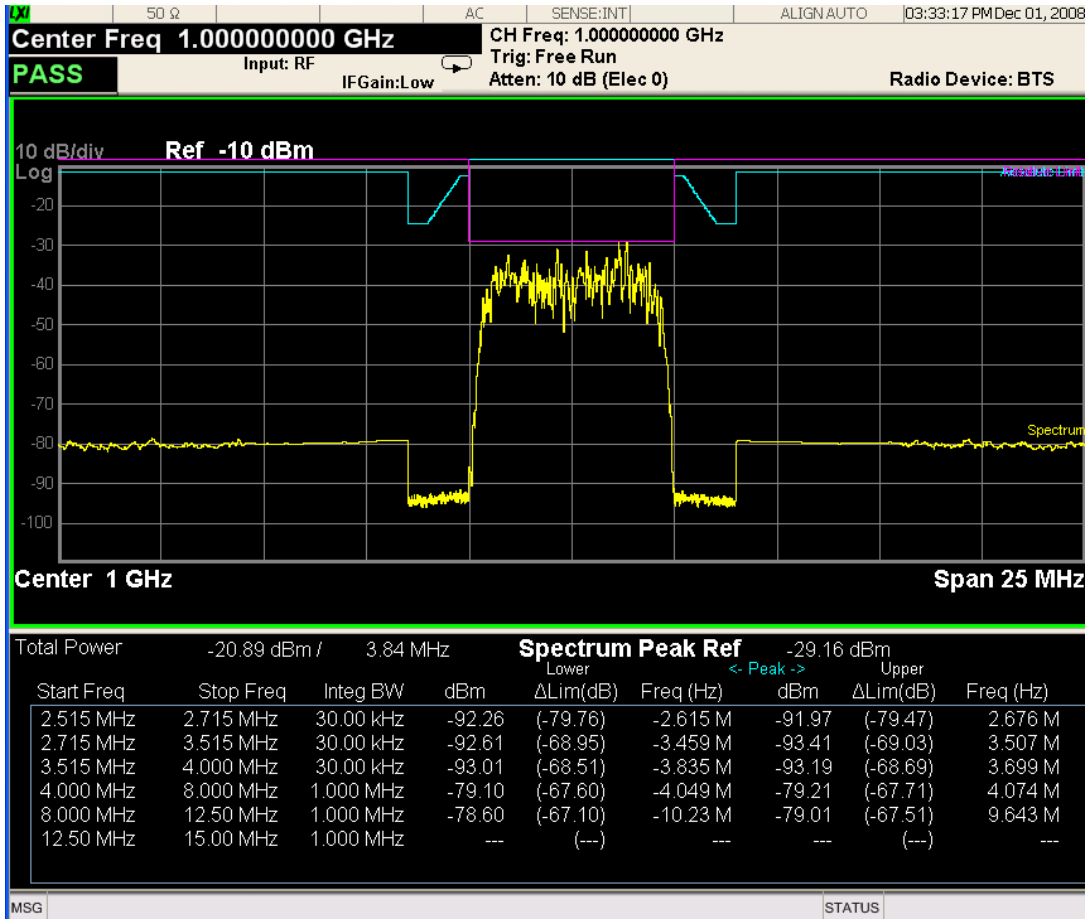

Trace Window

Corresponding Trace	yellow - Combined trace from carrier and each offset
---------------------	--

Results Window

Name	Corresponding Results
Total Pwr	Absolute power at the reference area. Channel Integration Bandwidth
Spectrum Peak Ref	n=5 1st element Spectrum peak power reference at the reference area
Start (Hz)	Start frequency for offset
Stop (Hz)	Stop frequency for offset
Meas BW (Hz)	Measurement bandwidth for offset
Lower(dBm)	Absolute peak power on minimum margin point of the negative offset
Lower Δ lim (dB)	Minimum margin from limit line which is decided by Fail Mask setting on the negative offset
Lower Freq (Hz)	Frequency on minimum margin point of the negative offset
Upper (dBm)	Absolute peak power on minimum margin point of the positive offset
Upper Δ lim (dB)	Minimum margin from limit line which is decided by Fail Mask setting on the positive offset
Upper Freq (Hz)	Frequency on minimum margin point of the positive offset

Key Path	View/Display
Initial S/W Revision	Prior to A.02.00

Rel Pwr Freq

Sets the display to the Relative Peak Power and Frequency view. The views differ depending on the setting of the measurement type (Meas Type) under the Measurement Setup menu.

"Rel Peak Pwr & Freq (Total Pwr Ref)" on page 1619

"Rel Peak Pwr & Freq (PSD Ref)" on page 1621

"Rel Peak Pwr & Freq (Spectrum Pk Ref)" on page 1622

Rel Peak Pwr & Freq (Total Pwr Ref)

This view consists of the following two windows:

"Trace Window" on page 1620

"Results Window" on page 1620

13 Spectrum Emission Mask Measurement
View/Display

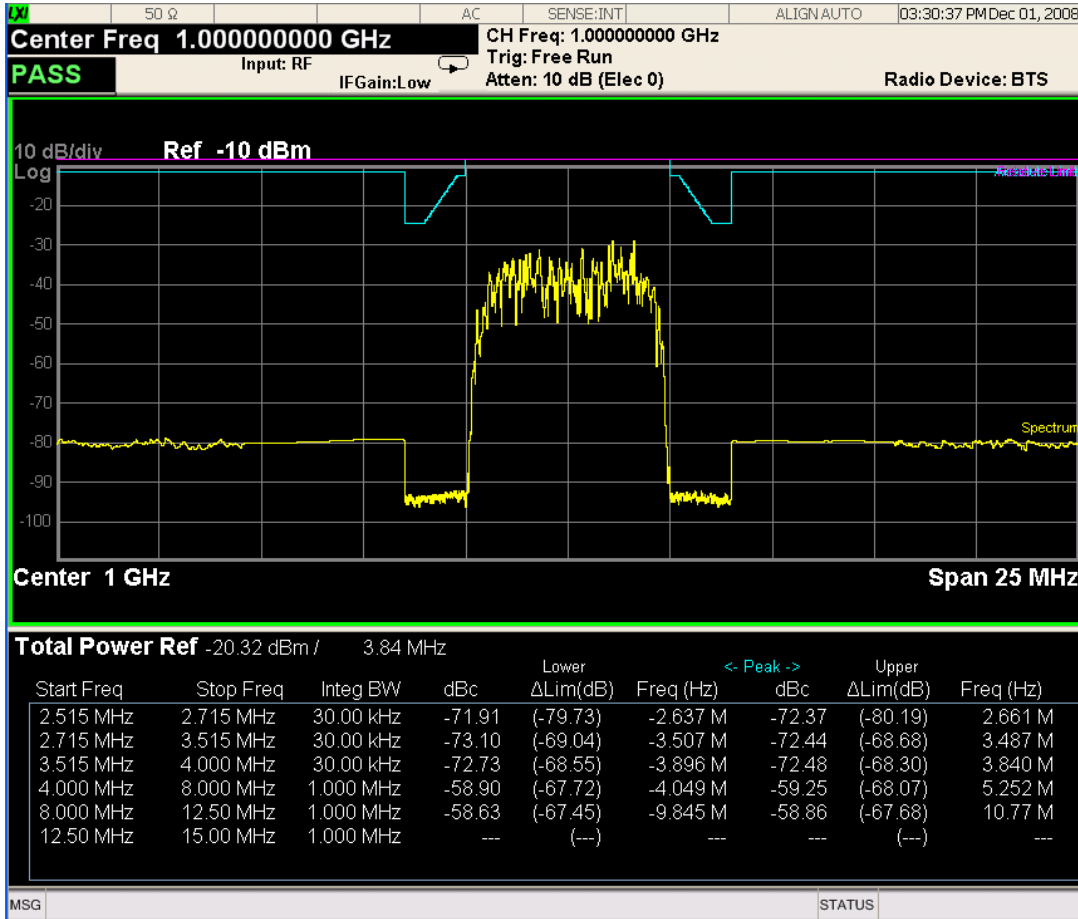

Trace Window

Corresponding Trace	yellow - Combined trace from carrier and each offset
---------------------	--

Results Window

Name	Corresponding Results
Total Pwr Ref	n=1 2nd element Absolute power at the reference area.
	Channel Integration Bandwidth
Start (Hz)	Start frequency for offset
Stop (Hz)	Stop frequency for offset
Meas BW (Hz)	Measurement bandwidth for offset
Lower Peak (dBc)	Relative peak power on minimum margin point of the negative offset
Lower ΔLim (dB)	Minimum margin from limit line which is decided by Fail Mask setting on the negative offset

Name	Corresponding Results
Lower Freq (Hz)	Frequency on minimum margin point of the negative offset
Upper Peak (dBc)	Relative peak power on minimum margin point of the positive offset
Upper ΔLim (dB)	Minimum margin from limit line which is decided by Fail Mask setting on the positive offset
Upper Freq (Hz)	Frequency on minimum margin point of the positive offset

Rel Peak Pwr & Freq (PSD Ref)

This view consists of the following two windows:

"Trace Window" on page 1621

"Results Window" on page 1622

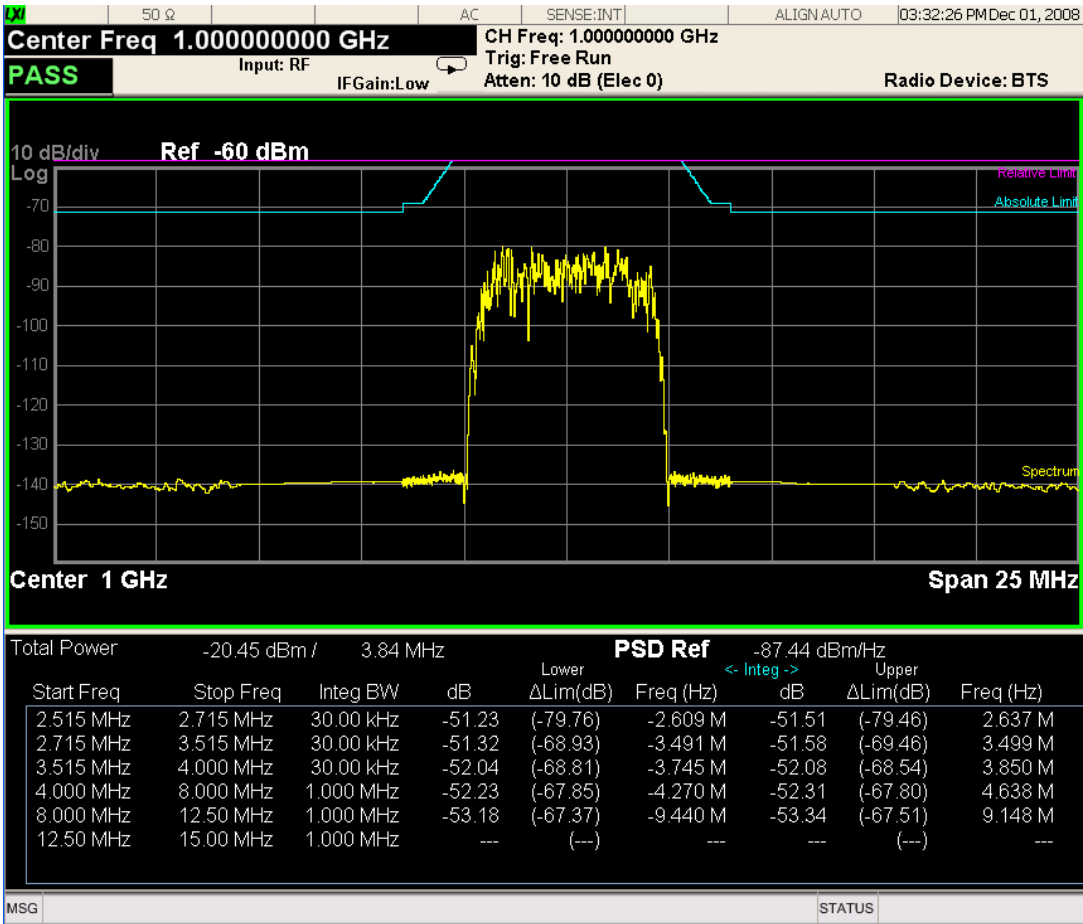

Trace Window

Corresponding Trace	yellow - Combined trace from carrier and each offset
---------------------	--

Results Window

Name	Corresponding Results
Total Pwr	n=1 2nd element Absolute power at the reference area.
	Channel Integration Bandwidth
PSD Ref	n=5 1st element Power spectral density reference at the reference area
Start (Hz)	Start frequency for offset
Stop (Hz)	Stop frequency for offset
Meas BW (Hz)	Measurement bandwidth for offset
Lower (dB)	Relative power spectrum density of the negative offset
Lower Δ Lim (dB)	Minimum margin from limit line which is decided by Fail Mask setting on the negative offset
Lower Freq (Hz)	Frequency on minimum margin point of the negative offset
Upper (dB)	Relative power spectrum density of the positive offset
Upper Δ Lim (dB)	Minimum margin from limit line which is decided by Fail Mask setting on the positive offset
Upper Freq (Hz)	Frequency on minimum margin point of the positive offset

Rel Peak Pwr & Freq (Spectrum Pk Ref)

This view consists of the following two windows:

"Trace Window" on page 1620

"Results Window" on page 1620

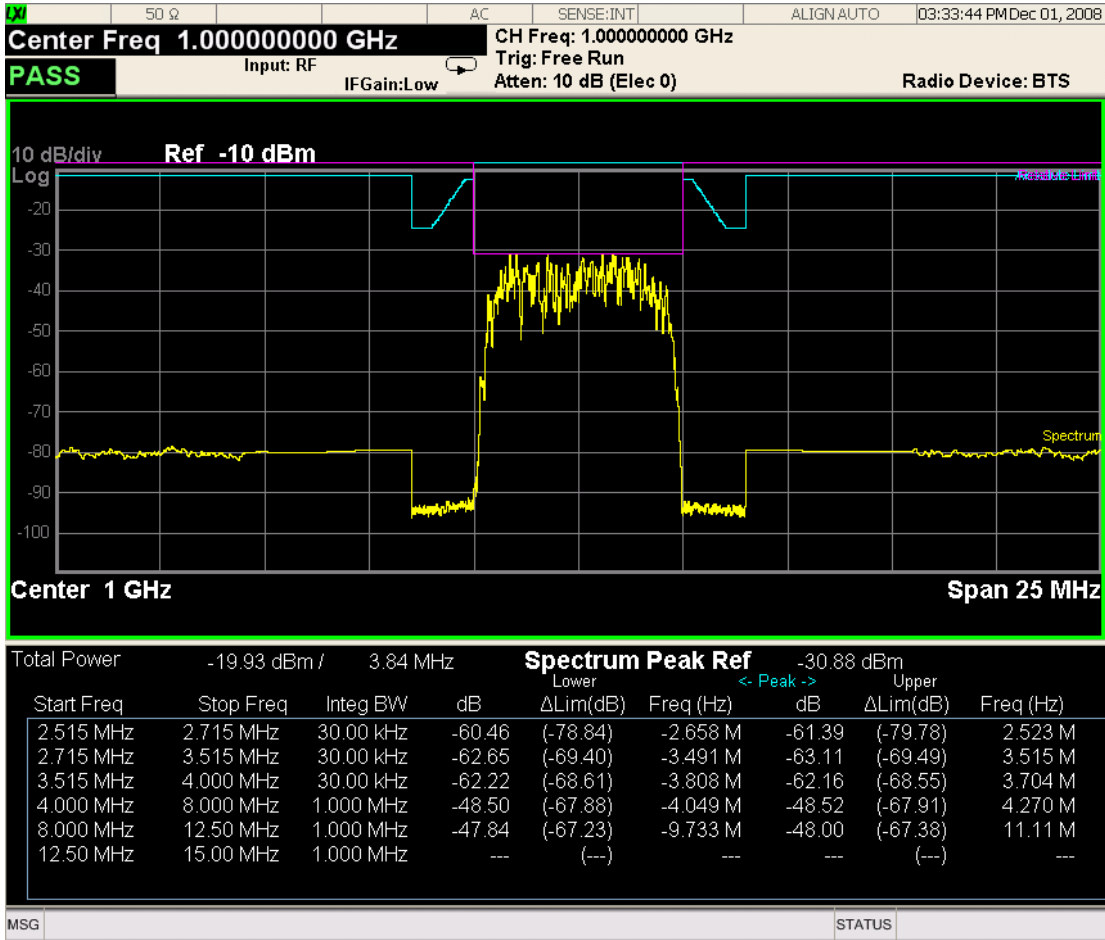

Trace Window

Corresponding Trace	yellow - Combined trace from carrier and each offset
---------------------	--

Results Window

Name	Corresponding Results
Total Pwr	Absolute power at the reference area.
	Channel Integration Bandwidth
Spectrum Peak Ref	n=5 1st element Spectrum peak power reference at the reference area
Start (Hz)	Start frequency for offset
Stop (Hz)	Stop frequency for offset
Meas BW (Hz)	Measurement bandwidth for offset
Lower Peak (dB)	Relative peak power on minimum margin point of the negative offset
Lower ΔLim (dB)	Minimum margin from limit line which is decided by Fail Mask setting

Name	Corresponding Results
	on the negative offset
Lower Freq (Hz)	Frequency on minimum margin point of the negative offset
Upper Peak (dB)	Relative peak power on minimum margin point of the positive offset
Upper Δ Lim (dB)	Minimum margin from limit line which is decided by Fail Mask setting on the positive offset
Upper Freq (Hz)	Frequency on minimum margin point of the positive offset

Key Path	View/Display
Initial S/W Revision	Prior to A.02.00

Integrated Power

Sets the display to the Integrated Power view. The views differ depending on the setting of the measurement type (Meas Type) under the Measurement Setup menu.

"Integrated Power (Total Pwr Ref)" on page 1624

"Integrated Power (PSD Ref)" on page 1627

"Integrated Power (Spectrum Pk Ref)" on page 1630

Integrated Power (Total Pwr Ref)

"Trace Window" on page 1626

"Results Window" on page 1626

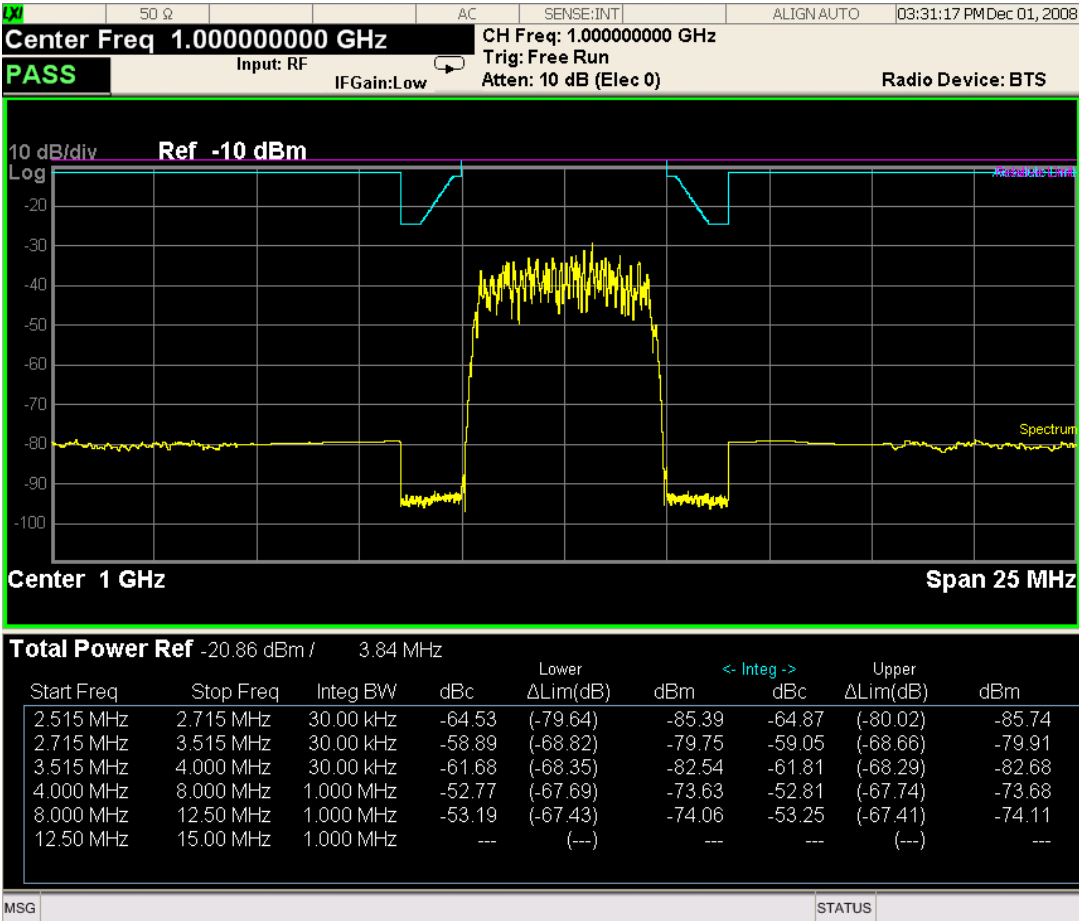

For WLAN 802.11 ac (80 + 80 MHz), power readouts of both of the carriers are displayed in the lower result window.

13 Spectrum Emission Mask Measurement
View/Display

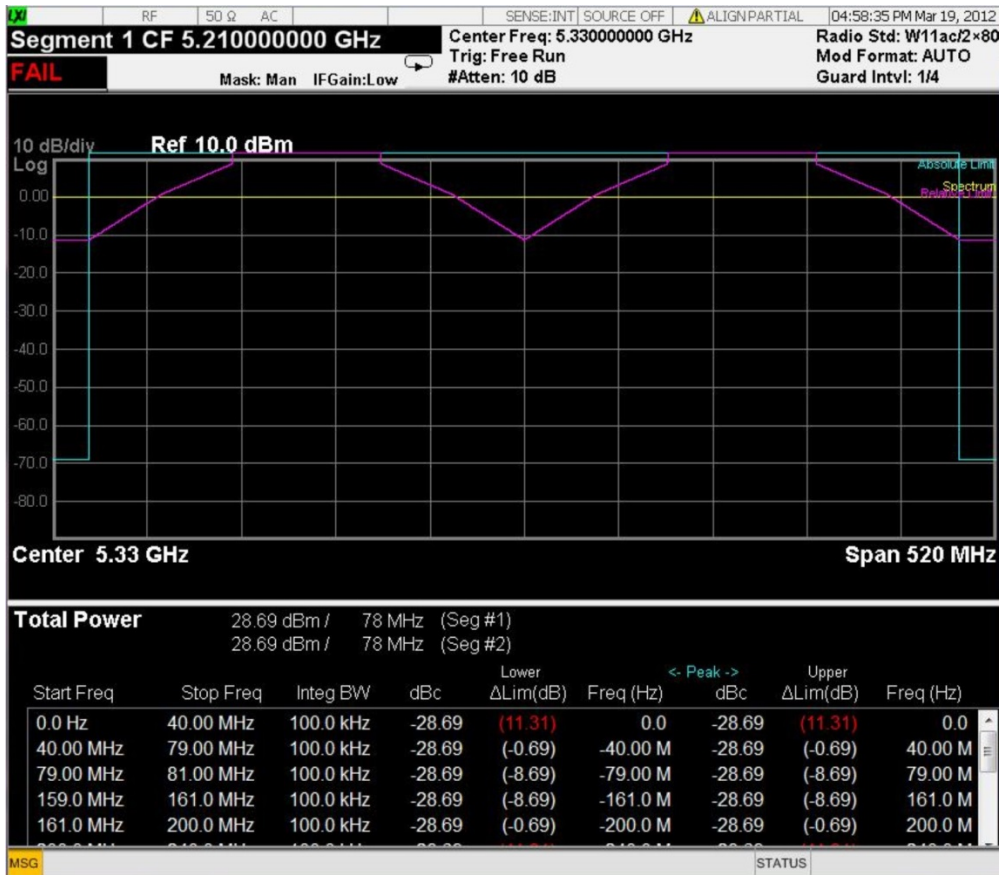

Trace Window

Corresponding Trace yellow - Combined trace from carrier and each offset

Results Window

Name	Corresponding Results
Total Pwr Ref	n=1 2nd element Absolute power at the reference area.
	Channel Integration Bandwidth
Start (Hz)	Start frequency for offset
Stop (Hz)	Stop frequency for offset
Meas BW (Hz)	Measurement bandwidth for offset
Lower Integ (dBc)	Relative integrated power on the negative offset
Lower ΔLim (dB)	Minimum margin from limit line which is decided by Fail Mask setting on the negative offset
Lower Integ (dBm)	Absolute integrated power on the negative offset

Name	Corresponding Results
Upper Integ (dBc)	Relative integrated power on the positive offset
Upper ΔLim (dB)	Minimum margin from limit line which is decided by Fail Mask setting on the positive offset
Upper Integ (dBm)	Absolute integrated power on the positive offset

Integrated Power (PSD Ref)

"Trace Window" on page 1629

"Results Window" on page 1629

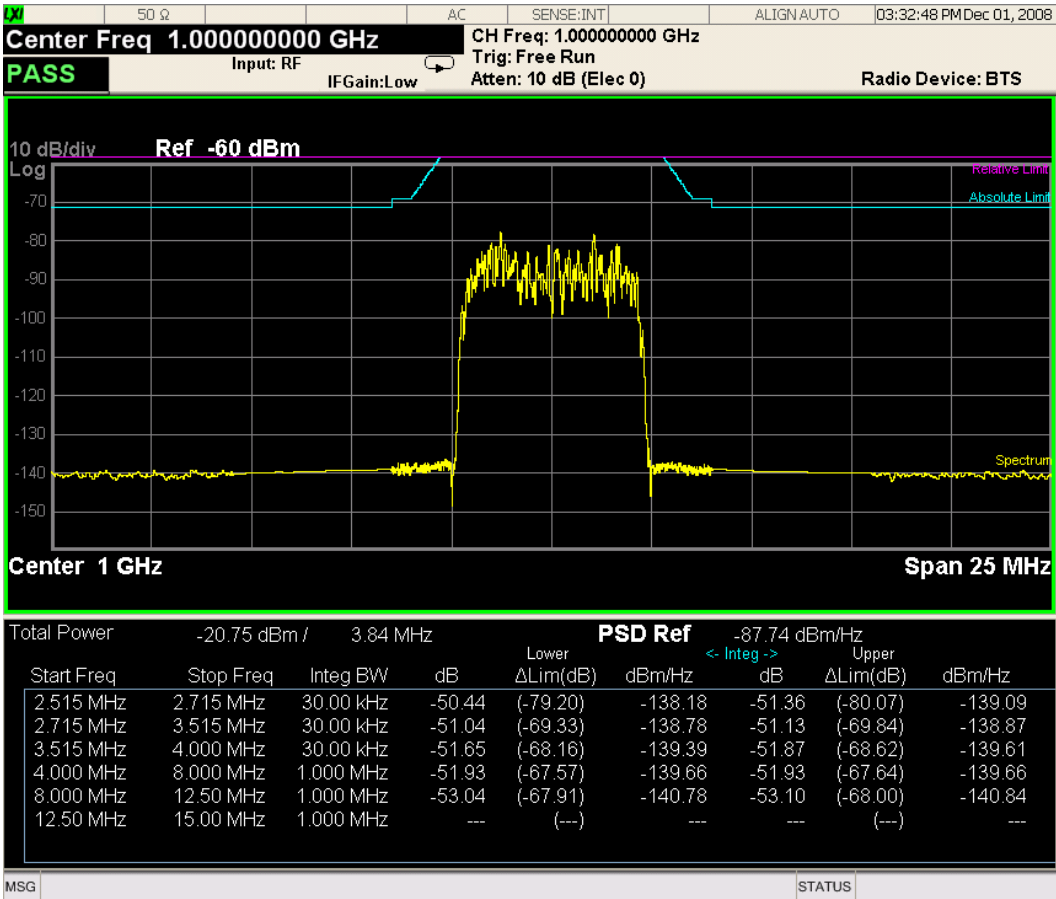

13 Spectrum Emission Mask Measurement View/Display



For WLAN 802.11ac (80 + 80 MHz), power readouts of both of the carriers are displayed in the lower result window.

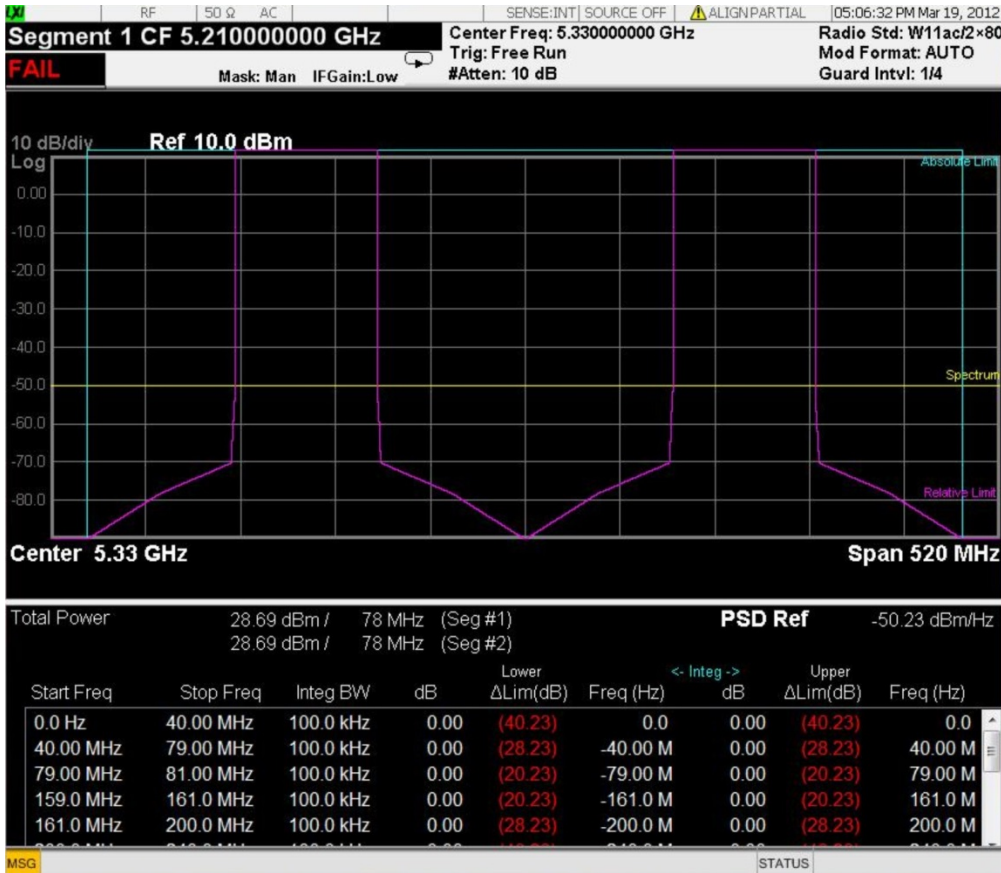

Trace Window

Corresponding Trace yellow - Combined trace from carrier and each offset

Results Window

Name	Corresponding Results
Total Pwr	n=1 2nd element Absolute power at the reference area. Channel Integration Bandwidth
PSD Ref	n=5 1st element Power spectral density reference at the reference area
Start (Hz)	Start frequency for offset
Stop (Hz)	Stop frequency for offset
Meas BW (Hz)	Measurement bandwidth for offset
Lower (dB)	Relative power spectrum density of the negative offset
Lower ΔLim (dB)	Minimum margin from limit line which is decided by Fail Mask setting on the negative offset

Name	Corresponding Results
Lower (dBm/Hz)	Absolute power spectrum density of the negative offset
Upper (dB)	Relative power spectrum density of the positive offset
Upper ΔLim (dB)	Minimum margin from limit line which is decided by Fail Mask setting on the positive offset
Upper (dBm/Hz)	Absolute power spectrum density of the negative offset

Integrated Power (Spectrum Pk Ref)

"Trace Window" on page 1626

"Results Window" on page 1626

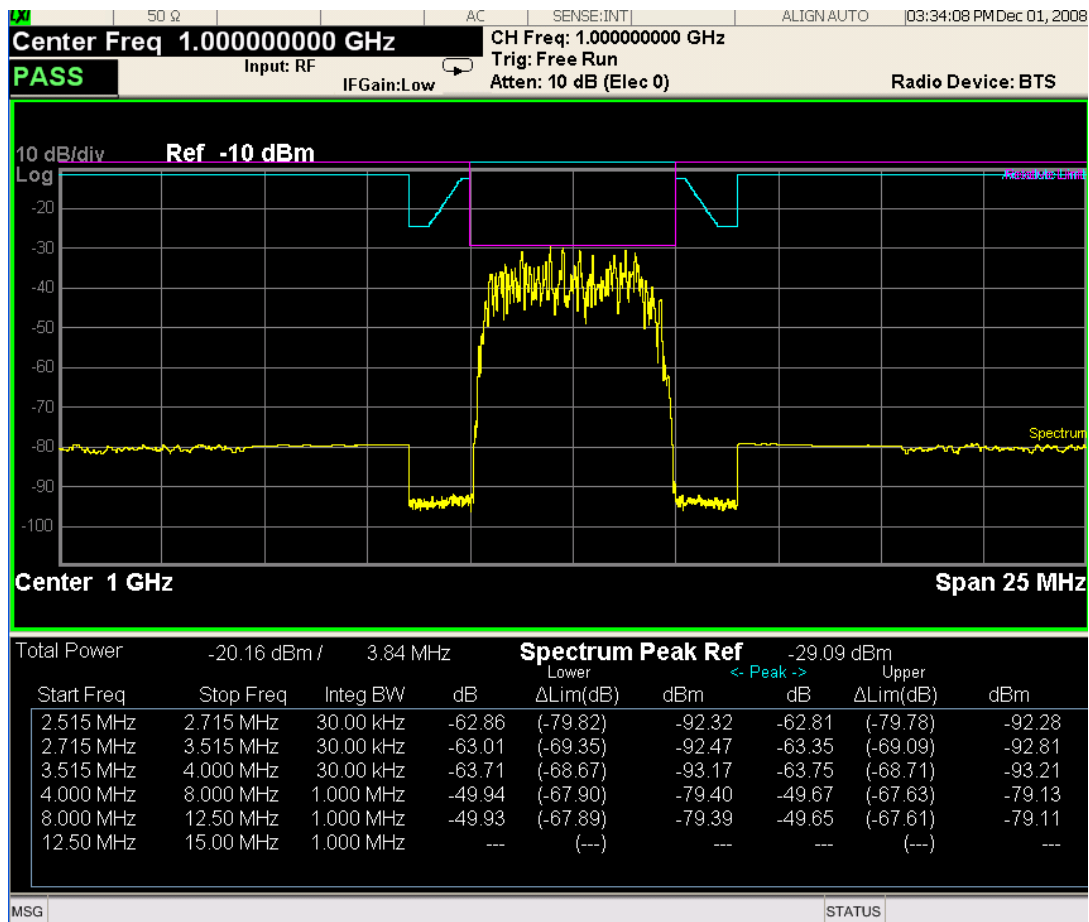

For WLAN 802.11ac (80 + 80 MHz), power readouts of both of the carriers are displayed in the lower result window.

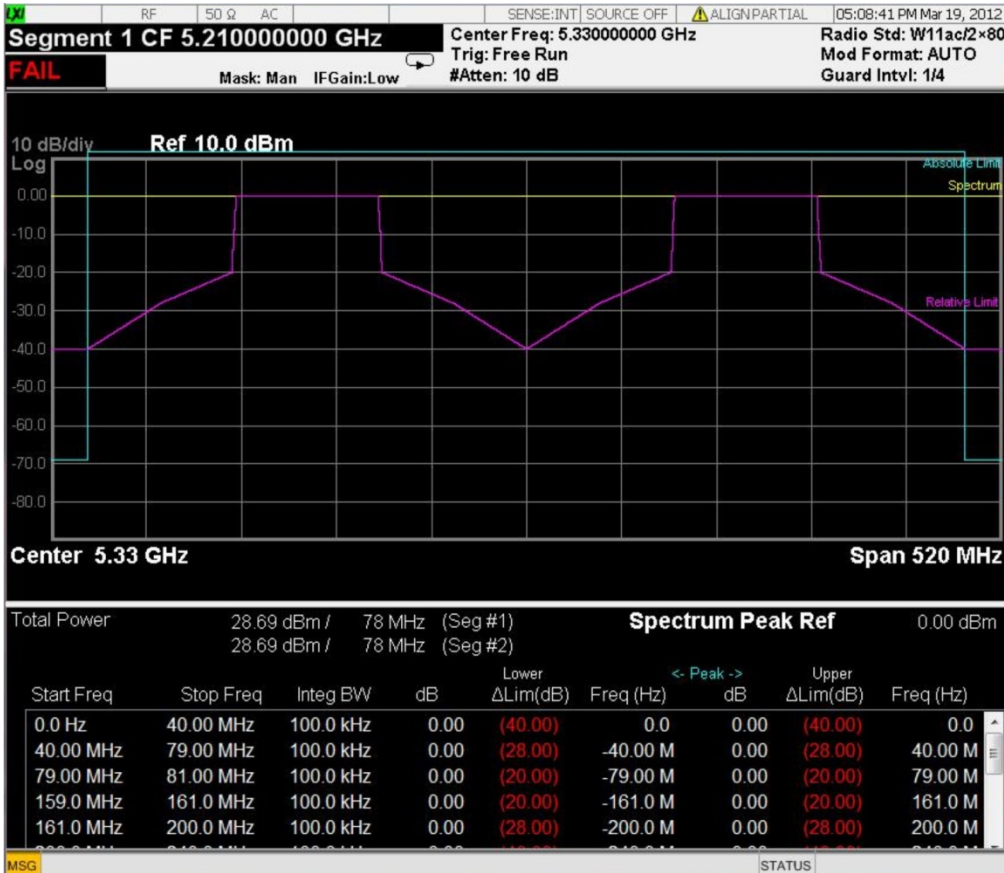

Trace Window

Corresponding Trace yellow - Combined trace from carrier and each offset

Results Window

Name	Corresponding Results
Total Pwr	Absolute power at the reference area.
	Channel Integration Bandwidth
Spectrum Peak Ref	n=5 1st element Peak power at the reference area
Start (Hz)	Start frequency for offset
Stop (Hz)	Stop frequency for offset
Meas BW (Hz)	Measurement bandwidth for offset
Lower Peak (dB)	Relative peak power on minimum margin point of the negative offset
Lower Δlim (dB)	Minimum margin from limit line which is decided by Fail Mask setting on the negative offset

Name	Corresponding Results
Lower Peak (dBm)	Absolute peak power on minimum margin point of the negative offset
Upper Peak (dB)	Relative peak power on minimum margin point of the positive offset
Upper Δ lim (dB)	Minimum margin from limit line which is decided by Fail Mask setting on the positive offset
Upper Peak (dBm)	Absolute peak power on minimum margin point of the positive offset

Key Path	View/Display
Initial S/W Revision	Prior to A.02.00

Limit Lines

Toggles the limit lines display function for the spectrum emission mask measurements On and Off.

Key Path	View/Display
Mode	SA, WCDMA, C2K, WIMAX OFDMA, TD-SCDMA, 1xEVDO, DTMB (CTTB), DVB-T/H, ISDB-T, CMMB, LTE, LTE-TDD, Digital Cable TV, WLAN, MSR, LTEAFDD, LTEATDD
Remote Command	:CALCulate:SEMask:LLINe:STATe ON OFF 1 0 :CALCulate:SEMask:LLINe:STATe?
Example	CALC:SEM:LLIN:STAT OFF CALC:SEM:LLIN:STAT?
Notes	You must be in the mode that includes SEM measurement to use this command. Use :INSTrument:SElect to set the mode.
Preset	ON
State Saved	Saved in instrument state.
Range	On Off
Initial S/W Revision	Prior to A.02.00
Modified at S/W Revision	A.02.00, A.03.00

14 Transmit On/Off Power Measurement Functions

This measurement is designed for testing Transmit On/Off power for the E-UTRA TDD BS, E-UTRA TDD UE and E-UTRA FDD UE. You must be in the LTE or LTETDD or LTEATDD or LTEAFDD mode to use these commands.

For the measurement results and views, see ["View/Display" on page 1772](#).

This topic contains the following sections.

["Remote Commands for Transmit On/Off power" on page 1634](#)

["Measurement Results for Transmit On/Off power Measurement" on page 1635](#)

Remote Commands for Transmit On/Off power

The following commands are used to retrieve the measurement results:

`:CONFigure:PVTime`

`:CONFigure:PVTime:NDEFault`

`:INITiate:PVTime`

`:FETCh:PVTime[n]?`

`:READ:PVTime[n]?`

`:MEASure:PVTime[n]?`

For more measurement related commands, see the SENSE subsystem, and the section "[Remote Measurement Functions](#)" on page 2770.

Measurement Results for Transmit On/Off power Measurement

For each result, the following heading is used to represent its format and precision.

#.Result Name (type of number) [unit] <explanation>

Type of number includes double, float and integer.

Index n	Results Returned
0	Returns unprocessed I/Q trace data as a series of comma-separated trace point values, in volts. The I values are listed first in each pair, using 0 through the even-indexed values. The Q values are odd-indexed values.
n=1 (or not specified)	<p>Returns the following comma-separated scalar results:</p> <ol style="list-style-type: none"> 1. Sample time is a floating point number representing the time between samples of displayed trace which you can get by using the trace queries (n=2, 3, ...). 2. Number of samples is the number of data points in the displayed trace. This number is useful when performing a query on the signal (i.e. when n=2, 3, ...). 3. On Power/ Mean Power of First SRS Symbol is the mean power (in dBm) of the active part in the range specified by Analysis Time Slot and Measured Time Slots in the most recently acquired data, or in the last data acquired at the end of a set of averages. For LTETDD, When Direction is Uplink and Measure Dual SRS is selected, this result will be the mean power of the first SRS symbol. 4. Burst width is the width of the first set of continuous active slots in the range specified by Analysis Time slot and Measured Time Slots. 5. Trigger Diff is the time difference between the position of the trigger line and the start point of the start slot specified by Analysis Time Slot. 6. Ramp up time is the time difference between 10% and 90% voltage points (relative to peak) on the positive slope of the burst, here burst has the same meaning in Burst width. 7. Ramp down time is the time difference between 90% and 10% voltage points (relative to peak) on the negative slope of the burst, here burst has the same meaning in Burst width. 8. Off power/Off power before is the mean power measured during the transmitter OFF period, When Direction is Uplink, this result is the OFF power during the sub-frame prior to the active subframe. 9. Maximum power is the maximum peak level in the range specified by Analysis Time Slot and Measured Time Slots (in dBm). 10. Minimum power is the minimum peak level in the range specified by Analysis Time Slot and Measured Time Slots (in dBm). 11. Actual sample time is the a floating point number representing the time between samples of uncompressed I/Q trace data, which could be get by using trace query(n=0). 12. Actual number of samples is the number of data points in the uncompressed I/Q trace data, which could be get by using trace query(n=0). 13. Off power after This result is Uplink only. It is the OFF power during the sub-frame following the active subframe. When Direction is not Uplink, the value will be NaN (9.91 E 37). 14. Mean Power of Second SRS Symbol. For LTETDD, When Direction is Uplink and Measure Dual SRS is selected, this result will be the mean power of the second SRS symbol. When Direction is not Uplink and Meas DualSRS is not selected, the value will be NaN (9.91 E 37).
2	<p>Measured Trace data</p> <p>This returns comma-separated floating point numbers representing the Measured Trace data (in dBm).</p>
3	Measured Max Hold Trace data

Index n	Results Returned
4	<p>This returns comma-separated floating point numbers representing the Measured Max Hold Trace data (in dBm).</p> <p>Measured Min Hold Trace data</p> <p>This returns comma-separated floating point numbers representing the Measured Min Hold Trace data (in dBm).</p>
5	<p>Averaged absolute power of the slots</p> <p>This returns at most 20 comma-separated float values representing the averaged absolute power of each time slot (in dBm). For the inactive slot, the value will be NaN (9.91 E 37)..</p> <ol style="list-style-type: none"> 1. Averaged absolute power of TS0 2. Averaged absolute power of TS1 3. Averaged absolute power of DwPTS 4. Averaged absolute power of UpPTS 5. Averaged absolute power of TS4 6. Averaged absolute power of TS5 7. Averaged absolute power of TS6 8. Averaged absolute power of TS7 9. Averaged absolute power of TS8 10. Averaged absolute power of TS9 11. Averaged absolute power of TS10 12. Averaged absolute power of TS11 13. Averaged absolute power of TS12 (if the Uplink-downlink configuration indicates it is 5ms periodicity, it is 2nd DwPTS) 14. Averaged absolute power of TS13(if the Uplink-downlink configuration indicates it is 5ms periodicity, it is 2nd UpPTS) 15. Averaged absolute power of TS14 16. Averaged absolute power of TS15 17. Averaged absolute power of TS16 18. Averaged absolute power of TS17 19. Averaged absolute power of TS18 20. Averaged absolute power of TS19
6	<p>Width of the slots</p> <p>This returns 20 comma-separated float values representing the width of each time slot (in us). For the inactive slot, the value will be NaN(9.91E37).</p> <ol style="list-style-type: none"> 1. Active signal width of TS0 2. Active signal width of TS1 3. Active signal width of DwPTS 4. Active signal width of UpPTS 5. Active signal width of TS4 6. Active signal width of TS5

Index n	Results Returned
	<p>7. Active signal width of TS6</p> <p>8. Active signal width of TS7</p> <p>9. Active signal width of TS8</p> <p>10. Active signal width of TS9</p> <p>11. Active signal width of TS10</p> <p>12. Active signal width of TS11</p> <p>13. Active signal width of TS12 (if the Uplink-downlink configuration indicates it is 5ms periodicity, it is 2nd DwPTS)</p> <p>14. Active signal width of TS13(if the Uplink-downlink configuration indicates it is 5ms periodicity, it is 2nd UpPTS)</p> <p>15. Active signal width of TS14</p> <p>16. Active signal width of TS15</p> <p>17. Active signal width of TS16</p> <p>18. Active signal width of TS17</p> <p>19. Active signal width of TS18</p> <p>20. Active signal width of TS19</p>
7	<p>Averaged absolute power of the subframes</p> <p>This returns 10 comma-separated float values, for active subframe, it represents mean power (in dBm) of each subframe excluding any transient time, for inactive subframe, it represents the OFF power. For subframes not included in the specified measure interval, the value will be NaN(9.91E37). For special subframes in LTETDD, when Direction is Downlink,it will be the mean power in DwPTS, when Direction is Uplink, it will be the mean power of UpPTS.</p> <p>1. Averaged absolute power of Subframe 0</p> <p>2. Averaged absolute power of Subframe 1</p> <p>3. Averaged absolute power of Subframe 2</p> <p>4. Averaged absolute power of Subframe 3</p> <p>5. Averaged absolute power of Subframe 4</p> <p>6. Averaged absolute power of Subframe 5</p> <p>7. Averaged absolute power of Subframe 6</p> <p>8. Averaged absolute power of Subframe 7</p> <p>9. Averaged absolute power of Subframe 8</p> <p>10. Averaged absolute power of Subframe 9</p>
8	<p>Averaged Width of the subframes</p> <p>This returns 10 comma-separated float values representing burst width (in us) of each subframe. For special subframes in LTETDD, when Direction is Downlink,it will be the burst width of DwPTS, when Direction is Uplink, it will be the burst width of UpPTS.</p> <p>For the inactive subframe, the value will be NaN(9.91E37)</p> <p>1. Active signal width of Subframe 0</p> <p>2. Active signal width of Subframe 1</p>

Index n	Results Returned
	3. Active signal width of Subframe 2
	4. Active signal width of Subframe 3
	5. Active signal width of Subframe 4
	6. Active signal width of Subframe 5
	7. Active signal width of Subframe 6
	8. Active signal width of Subframe 7
	9. Active signal width of Subframe 8
	10. Active signal width of Subframe 9

Key Path	Front-panel key
Initial S/W Revision	A.03.00

Amplitude (AMPTD) Y Scale

The AMPLITUDE Y Scale key accesses the menu to set the desired vertical scale and associated settings.

Key Path	Front-panel key
Initial S/W Revision	A.03.00

Ref Value

Sets the power reference.

Key Path	AMPTD Y Scale
----------	---------------

Ref Value (Burst View)

Sets the absolute power reference.

Key Path	AMPTD Y Scale
Mode	LTETDD, LTE, LTEATDD, LTEAFDD
Remote Command	:DISPlay:PVTime:VIEW[1]:WINDow[1]:TRACe:Y[:SCALe]:RLEVel <real> :DISPlay:PVTime:VIEW[1]:WINDow[1]:TRACe:Y[:SCALe]:RLEVel?
Example	DISP:PVT:VIEW:WIND:TRAC:Y:SCAL:RLEV 5dbm DISP:PVT:VIEW:WIND:TRAC:Y:SCAL:RLEV?
Couplings	When Y Auto Scale is set to On, this value is automatically determined by the measurement result. When you set this value manually, Y Auto Scale is automatically set to Off.
Preset	10.00
State Saved	Saved in instrument state.
Min	-250.0
Max	250.0
Initial S/W Revision	A.03.00

Ref Value (Rise & Fall view)

Allows you to set the absolute power reference.

Key Path	AMPTD Y Scale
Mode	LTETDD, LTE, LTEATDD, LTEAFDD
Remote Command	:DISPlay:PVTime:VIEW2:WINDow[1] 2:TRACe:Y[:SCALe]:RLEVel <real> :DISPlay:PVTime:VIEW2:WINDow[1] 2:TRACe:Y[:SCALe]:RLEVel?
Example	DISP:PVT:VIEW:WIND:TRAC:Y:SCAL:RLEV 5

	DISP:PVT:VIEW:WIND:TRAC:Y:SCAL:RLEV?
Couplings	When Y Auto Scaling is On, this value is automatically determined by the measurement result. When the user sets this value manually, Y Auto Scaling automatically changes to Off.
Preset	0.00 dBm
State Saved	Saved in instrument state.
Min	-250.0
Max	250.0
Initial S/W Revision	A.03.00

Attenuation

This menu controls the attenuator functions and interactions between the attenuation system components.

There are two attenuator configurations in the X-Series. One is a dual attenuator configuration consisting of a mechanical attenuator and an optional electronic attenuator. The other configuration uses a single attenuator with combined mechanical and electronic sections that controls all the attenuation functions. Different models in the X-Series come with different configurations.

See ["Dual Attenuator Configurations:" on page 1640](#)

See ["Single Attenuator Configuration:" on page 1641](#)

Most Attenuation settings are the same for all measurements – they do not change as you change measurements. Settings like these are called “Meas Global” and are unaffected by Meas Preset.

Key Path	AMPTD Y Scale
Scope	Meas Global
Dependencies	In measurements that support the I/Q inputs, this key is unavailable when I/Q is the selected input, and is replaced by the Range key in that case.
Readback Line	Contains a summary in [] brackets of the current total attenuation. See the descriptions of the , " (Mech) Atten " on page 2736, and " Enable Elec Atten " on page 2737 keys for more detail on the contributors to the total attenuation. Note that when "Pre-Adjust for Min Clip" is on, this value can change at the start of every measurement.
Initial S/W Revision	Prior to A.02.00
Modified at S/W Revision	A.03.00

Dual Attenuator Configurations:

Configuration 1: Mechanical attenuator + optional electronic attenuator

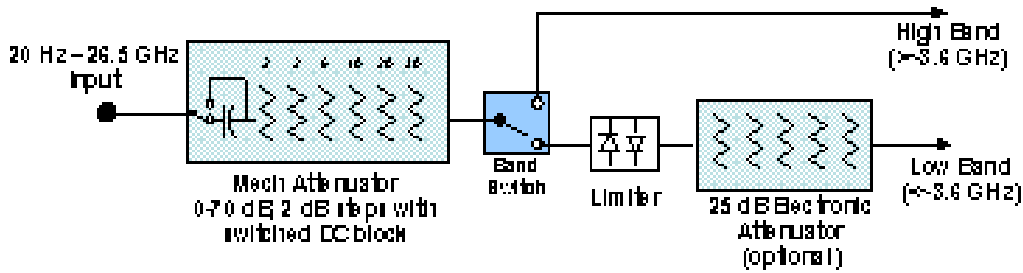

Configuration 2: Mechanical attenuator, no optional electronic attenuator

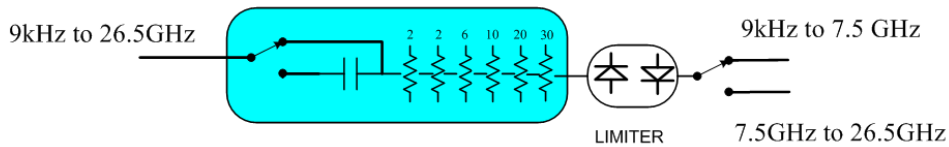

(note that Configuration 2 is not strictly speaking a dual-section attenuator, since there is no electronic section available. However, it behaves exactly like Configuration 1 without the Electronic Attenuator option EA3, therefore for the sake of this document it is grouped into the “Dual Attenuator” configuration)

Single Attenuator Configuration:

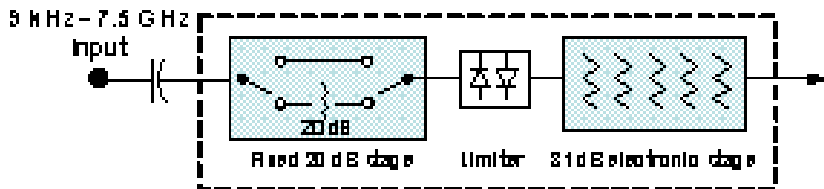

You can tell which attenuator configuration you have by pressing the Attenuation key, which (in most Modes) opens the Attenuation menu. If the first key in the Attenuation menu says Mech Atten you have the dual attenuator configuration. If the first key says Atten you have the single attenuator configuration.

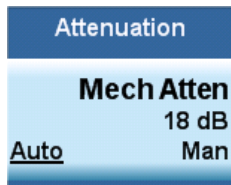

Dual Attenuator

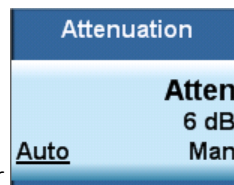

Single Attenuator

In the single attenuator configuration, you control the attenuation with a single control, as the fixed stage has only two states. In the dual attenuator configuration, both stages have significant range so you are given separate control of the mechanical and electronic attenuator stages.

When you have the dual attenuator configuration, you may still have only a single attenuator, because unless option EA3 (the Electronic Attenuator option) is available, and you purchase it, you will have only the mechanical attenuator.

(Mech) Atten

This key is labeled Mech Atten in dual attenuator models and Atten in single attenuator models. In the dual attenuator configuration, this key only affects the mechanical attenuator.

This key lets you modify the attenuation applied to the RF input signal path. This value is normally auto coupled to the Ref Level, the Internal Preamp Gain, any External Gain that is entered, and the Max Mixer Level, as described in the table below.

See "[Attenuator Configurations and Auto/Man](#)" on page 1643

Key Path	AMPTD Y Scale, Attenuation
Remote Command	<pre>[:SENSe] :POWer [:RF] :ATTenuation <rel_ampl> [:SENSe] :POWer [:RF] :ATTenuation? [:SENSe] :POWer [:RF] :ATTenuation:AUTO OFF ON 0 1 [:SENSe] :POWer [:RF] :ATTenuation:AUTO?</pre>
Example	<p>POW:ATT 20</p> <p>Dual attenuator configuration: sets the mechanical attenuator to 20 dB</p> <p>Single attenuator mode: sets the main attenuation to 20 dB (see below for definition of “main” attenuation).</p> <p>If the attenuator was in Auto, it sets it to Manual.</p>
Dependencies	<p>Some measurements do not support the Auto setting of (Mech) Atten. In these measurements, the Auto/Man selection is not available, and the Auto/Man line on the key disappears.</p> <p>In dual attenuator configurations, when the electronic attenuator is enabled, the mechanical attenuator has no auto setting and the Auto/Man line on the key disappears. The state of Auto/Man is remembered and restored when the electronic attenuator is once again disabled. This is described in more detail in the "Enable Elec Atten" on page 2737 key description.</p> <p>See "Attenuator Configurations and Auto/Man" on page 1643 for more information on the Auto/Man functionality of Attenuation.</p>
Couplings	<p>When (Mech) Atten is in Auto, it uses the following algorithm to determine a value:</p> <p>If the USB Preamp is connected to USB, use 0 dB.</p> <p>Otherwise, $Atten = ReferenceLevel + PreAmpGain + ExternalGain - RefLevelOffset - MaxMixerLevel + IF\ Gain$.</p> <p>Limit this value to be between 6 dB and the Max value. No value below 6 dB can ever be chosen by Auto.</p> <p>The resulting value is rounded up to the largest value possible given the attenuation step setting. That is, 50.01 dB would change to 60 dB (for a 10 dB attenuation step).</p> <p>The “IF Gain” term in the equation above is either 0 dB or +10 dB, depending on the settings of FFT IF Gain, Swept IF Gain, max Ref Level and the Auto/Man setting of Mech Atten.</p> <p>In External Mixing and BBIQ, where the Attenuator is not in the signal path, the Attenuator setting changes as described above when (Mech) Atten is in Auto, but no changes are made to the actual attenuator hardware setting until the input is changed back to the RF Input.</p>
Preset	<p>The preset for Mech Attenuation is “Auto.”</p> <p>The Auto value of attenuation is:</p> <p>CXA, EXA, MXA and PXA: 10 dB</p>

State Saved	Saved in instrument state
Min	0 dB The attenuation set by this key cannot be decreased below 6 dB with the knob or step keys. To get to a value below 6 dB it has to be directly entered from the keypad or via SCPI. This protects from adjusting the attenuation to a dangerously small value which can put the instrument at risk of damage to input circuitry. However, if the current mechanical attenuation is below 6 dB it can be increased with the knob and step keys, but not decreased.
Max	CXA N9000A-503/507: 50 dB CXA N9000A-513/526: 70dB EXA: 60 dB MXA and PXA: 70 dB In the single attenuator configuration, the total of ATT and EATT cannot exceed 50 dB, so if the EATT is set to 24 dB first, the main attenuation cannot be greater than 26 dB and will be reduced accordingly; if the main attenuator is set to 40 dB first, EATT cannot be greater than 10 dB.
Initial S/W Revision	Prior to A.02.00
Modified at S/W Revision	A.03.00

Attenuator Configurations and Auto/Man

As described in the Attenuation key description, there are two distinct attenuator configurations available in the X-Series, the single attenuator and dual attenuator configurations. In dual attenuator configurations, we have the mechanical attenuation and the electronic attenuation, and the current total attenuation is the sum of the electronic + mechanical attenuation. In single attenuator configurations, we refer to the attenuation set using the (Mech) Atten key (or POW:ATT SCPI) as the “main” attenuation; and the attenuation that is set by the SCPI command POW:EATT as the “soft” attenuation (the POW:EATT command is honored even in the single attenuator configuration, for compatibility purposes). Then the current total attenuation is the sum of the main + soft attenuation. See the Elec Atten key description for more on “soft” attenuation.

In the dual attenuator configuration, when the electronic attenuator is enabled, there is no Auto/Man functionality for the mechanical attenuator, and the third line of the key label (the Auto/Man line) disappears:

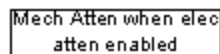
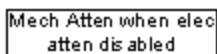
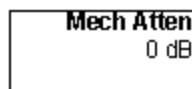
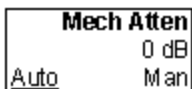

usdB

Enable Elec Atten

Enables the Electronic Attenuator.

The electronic attenuator offers finer steps than the mechanical attenuator, has no acoustical noise, is faster, and is less subject to wear. These advantages primarily aid in remote operation and are negligible

for front panel use. See ["Using the Electronic Attenuator: Pros and Cons" on page 1645](#) for a detailed discussion of the pros and cons of using the electronic attenuator.

For the single attenuator configuration, for SCPI backwards compatibility, the “soft” attenuation feature replaces the dual attenuator configuration’s electronic attenuator. All the same couplings and limitations apply. See ["Attenuator Configurations and Auto/Man" on page 2737](#)

See ["More Information" on page 1644](#)

Key Path	AMPTD Y Scale, Attenuation
Remote Command	[:SENSe] :POWer [:RF] :EATTenuation:STATe OFF ON 0 1 [:SENSe] :POWer [:RF] :EATTenuation:STATe?
Example	POW:EATT:STAT ON
Dependencies	<p>This key only appears in Dual Attenuator models with an Electronic Attenuator installed. It does not appear in models with the Single Attenuator configuration, as in the single attenuator configuration there is no “electronic attenuator” there is only a single integrated attenuator (which has both a mechanical and electronic stage). However, in the single attenuator configuration, EATT SCPI commands are accepted for compatibility with other X-series instruments and set a “soft” attenuation as described in "Attenuator Configurations and Auto/Man" on page 2737.</p> <p>The electronic attenuator (and the “soft” attenuation function provided in single attenuator configurations) is unavailable above 3.6 GHz. Therefore, if the Stop Frequency of the analyzer is > 3.6 GHz then the Enable Elec Atten key will be OFF and grayed out.</p> <p>If the Internal Preamp is on, meaning it is set to Low Band or Full, the electronic attenuator (and the “soft” attenuation function provided in single attenuator configurations) is unavailable. In this case the Enable Elec Atten key will be OFF and grayed out.</p> <p>If either of the above is true, if the SCPI command is sent, an error indicating that the electronic attenuator is unavailable will be sent.</p> <p>If the electronic/soft Attenuator is enabled, then the Stop Freq of the analyzer is limited to 3.6 GHz and the Internal Preamp is unavailable.</p> <p>The SCPI-only “soft” electronic attenuation for the single-attenuator configuration is not available in all measurements; in particular, it is not available in the Swept SA measurement.</p>
Couplings	Enabling and disabling the Electronic Attenuator affects the setting of the Mechanical Attenuator (in dual attenuator configurations). This is described in more detail below this table.
Preset	OFF for Swept SA measurement; ON for all other measurements that support the electronic attenuator
State Saved	Saved in instrument state
Initial S/W Revision	Prior to A.02.00
Modified at S/W Revision	A.03.00

More Information

Mechanical Attenuator Transition Rules

When the Electronic Attenuator is enabled, the Mechanical Attenuator transitions to a state that has no Auto function. Below are the rules for transitioning the Mechanical Attenuator. NOTE that the information

below ONLY applies to the dual attenuator configurations, and ONLY when the Electronic Attenuator is installed:

When the Electronic Attenuation is enabled from a disabled state:

- The Mechanical Attenuator is initialized to 10 dB (this is its optimal performance setting). You can then set it as desired with SCPI, numeric keypad, step keys, or knob, and it behaves as it normally would in manual mode
- The Auto/Man state of (Mech) Atten is saved
- The Auto/Man line on the (Mech) Atten key disappears and the auto rules are disabled
- The Electronic Attenuator is set to 10 dB less than the previous value of the Mechanical Attenuator, within the limitation that it must stay within the range of 0 to 24 dB of attenuation.

Examples in the dual attenuator configuration:

- Mech Atten at 20 dB. Elec Atten enabled, Mech Atten set to 10 dB, and Elec Atten set to 10 dB. New total attenuation equals the value before Elec Atten enabled.
- Mech Atten at 0 dB. Elec Atten enabled, Mech Atten set to 10 dB, and Elec Atten set to 0 dB. New total attenuation does not equal the value before Elec Atten enabled.
- Mech Atten at 40 dB. Elec Atten enabled, Mech Atten set to 10 dB, and Elec Atten set to 24 dB. New total attenuation does not equal the value before Elec Atten enabled.

When the Electronic Attenuation is disabled from an enabled state:

- The Elec Atten key is grayed out
- The Auto/Man state of (Mech) Atten is restored
- If now in Auto, (Mech) Atten recouples
- If now in Man, (Mech) Atten is set to the value of total attenuation that existed before the Elec Atten was disabled. The resulting value is rounded up to the smallest value possible given the (Mech) Atten Step setting - (That is, 57 dB changes to 58 dB when (Mech) Atten Step is 2 dB.)

Using the Electronic Attenuator: Pros and Cons

The electronic attenuator offers finer steps than the mechanical attenuator, has no acoustical noise, is faster, and is less subject to wear.

The “finer steps” advantage of the electronic attenuator is beneficial in optimizing the alignment of the analyzer dynamic range to the signal power in the front panel as well as remote use. Thus, you can achieve improved relative signal measurement accuracy. Compared to a mechanical attenuator with 2 dB steps, the 1 dB resolution of the electronic attenuator only gives better resolution when the odd-decibel steps are used. Those odd-decibel steps are less accurately calibrated than the even-decibel steps, so one tradeoff for this superior relative accuracy is reduced absolute amplitude accuracy.

Another disadvantage of the electronic attenuator is that the spectrum analyzer loses its “Auto” setting, making operation less convenient.

Also, the relationship between the dynamic range specifications (TOI, SHI, compression and noise) and instrument performance are less well-known with the electrical attenuator. With the mechanical

attenuator, TOI, SHI and compression threshold levels increase dB-for-dB with increasing attenuation, and the noise floor does as well. With the electronic attenuator, there is an excess attenuation of about 1 to 3 dB between 0 and 3.6 GHz, making the effective TOI, SHI, and so forth, less well known. Excess attenuation is the actual attenuation relative to stated attenuation. Excess attenuation is accounted for in the analyzer calibration

Elec Atten

Controls the Electronic Attenuator in dual attenuator configurations. This key does not appear in single attenuator configurations, as the control of both the mechanical and electronic stages of the single attenuator is integrated into the single Atten key.

Key Path	AMPTD Y Scale, Attenuation
Remote Command	[:SENSe] :POWer [:RF] :EATTenuation <rel_ampl> [:SENSe] :POWer [:RF] :EATTenuation?
Notes	Electronic Attenuation's specification is defined only when Mechanical Attenuation is 6 dB.
Dependencies	This key only appears in Dual Attenuator models with an Electronic Attenuator installed. It does not appear in models with the Single Attenuator configuration, as in the single attenuator configuration there is no "electronic attenuator" there is only a single integrated attenuator (which has both a mechanical and electronic stage). However, in the single attenuator configuration, EATT SCPI commands are accepted for compatibility with other X-series instruments and set a "soft" attenuation as described in "Attenuator Configurations and Auto/Man" on page 2737 . The "soft" attenuation is treated as an addition to the "main" attenuation value set by the Atten softkey or the POW:ATT SCPI command and affects the total attenuation displayed on the Attenuation key and the Meas Bar. When Enable Elec Atten is off or grayed out, the Elec Atten key is grayed out.
Preset	0 dB
State Saved	Saved in instrument state
Min	0 dB
Max	Dual attenuator configuration: 24 dB Single attenuator configuration: the total of ATT and EATT cannot exceed 50 dB, so if the EATT is set to 24 dB first, the main attenuation cannot be greater than 26 dB and will be reduced accordingly; if the main attenuator is set to 40 dB first, EATT cannot be greater than 10 dB
Initial S/W Revision	Prior to A.02.00
Modified at S/W Revision	A.03.00

Adjust Atten for Min Clip

Sets the combination of mechanical and electronic attenuation and gain based on the current measured signal level so that clipping will be at a minimum.

This is an "immediate action" function, that is, it executes once, when the key is pressed.

This key is grayed out in measurements that do not support this functionality. The spectrum analyzer measurement, Swept SA, does not support this functionality.

Key Path	AMPTD Y Scale, Attenuation
Remote Command	[:SENSe] :POWer [:RF] :RANGe:OPTimize IMMEDIATE
Initial S/W Revision	Prior to A.02.00
Modified at S/W Revision	A.03.00

Pre-Adjust for Min Clip

If this function is on, it does the adjustment described under "[Adjust Atten for Min Clip](#)" on page 2740 each time a measurement restarts. Therefore, in Continuous measurement mode, it only executes before the first measurement.

In dual attenuator models, you can set Elec+Mech Atten, in which case both attenuators participate in the autoranging, or Elec Atten Only, in which case the mechanical attenuator does not participate in the autoranging. This latter case results in less wear on the mechanical attenuator and is usually faster.

This key is grayed out in measurements that do not support this functionality. The spectrum analyzer measurement, Swept SA, does not support this functionality.

Key Path	AMPTD Y Scale, Attenuation
Remote Command	[:SENSe] :POWer [:RF] :RANGe:OPTimize:ATTenuation OFF ELECTrical COMBined [:SENSe] :POWer [:RF] :RANGe:OPTimize:ATTenuation?
Notes	The SCPI parameter ELECTrical sets this function to On in single attenuator models. The SCPI parameter COMBined is mapped to ELECTrical in single attenuator models; if you send COMBined, it sets the function to On and returns ELEC to a query.
Dependencies	This key only appears in Dual Attenuator models with an Electronic Attenuator installed. In instruments with Dual Attenuator model, when Enable Elec Atten is off or grayed out, the Pre-Adjust for Min Clip key is grayed out.
Preset	OFF for Swept SA measurement; ON for all other measurements that support Pre-Adjust for Min Clip
State Saved	Saved in instrument state
Range	Dual attenuator models: Off Elec Atten Only Mech + Elec Atten Single attenuator models: Off On
Initial S/W Revision	Prior to A.02.00
Modified at S/W Revision	A.03.00

Remote Command	[:SENSe] :POWer [:RF] :RANGe:AUTO ON OFF 1 0 [:SENSe] :POWer [:RF] :RANGe:AUTO?
Notes	ON aliases to "Elec Atten Only" (:POW:RANG:OPT:ATT ELEC)

	OFF aliases to "Off" (:POW:RANG:OPT:ATT OFF) The query :POW:RANG:AUTO? returns true if :POW:RANG:OPT:ATT is not "Off"
Initial S/W Revision	Prior to A.02.00

Off

Turns Pre-Adjust for Min Clip off. This is the default setting.

This key is grayed out in measurements that do not support this functionality. The spectrum analyzer measurement, Swept SA, does not support this functionality.

Key Path	AMPTD Y Scale, Attenuation, Pre-Adjust for Min Clip
Example	:POW:RANGe:OPT:ATT OFF
Initial S/W Revision	Prior to A.02.00

Elec Atten Only

Selects only the electric attenuator to participate in auto ranging. This offers less wear on the mechanical attenuator and is usually faster.

This key is grayed out in measurements that do not support this functionality. The spectrum analyzer measurement, Swept SA, does not support this functionality.

Key Path	AMPTD Y Scale, Attenuation, Pre-Adjust for Min Clip
Example	:POW:RANGe:OPT:ATT ELEC
Initial S/W Revision	Prior to A.02.00

Mech + Elec Atten

In dual attenuator models, this selects both attenuators participate in the autoranging.

This key is grayed out in measurements that do not support this functionality. The spectrum analyzer measurement, Swept SA, does not support this functionality.

Key Path	AMPTD Y Scale, Attenuation, Pre-Adjust for Min Clip
Example	:POW:RANGe:OPT:ATT COMB
Initial S/W Revision	Prior to A.02.00

(Mech) Atten Step

This controls the step size used when making adjustments to the input attenuation.

This key is labeled Mech Atten Step in dual attenuator models and Atten Step in single attenuator models. In the dual attenuator configuration, this key only affects the step size of the mechanical attenuator.

Key Path	AMPTD Y Scale, Attenuation
Remote Command	<code>[:SENSe] :POWer [:RF] :ATTenuation :STEP [:INCRement] 10 dB 2 dB</code> <code>[:SENSe] :POWer [:RF] :ATTenuation :STEP [:INCRement] ?</code>
Example	POW:ATT:STEP 2
Notes	Note this feature works like a 1-N choice from the front panel, but it takes a specific value (in dB) when used remotely. The only valid values are 2 and 10.
Dependencies	Blanked in CXA and EXA if option FSA (2 dB steps) is not present. If blanked, attempts to set it via SCPI will yield an error.
Couplings	When the attenuation step size changes, the current mechanical attenuation value is adjusted (if necessary) to be quantized to the new step size. That is, if step is set to 10 dB, mech atten is increased if necessary so it is a multiple of 10 dB
Preset	PXA and MXA: 2 dB EXA and CXA: 10 dB (2 dB with option FSA)
State Saved	Saved in instrument state
Initial S/W Revision	Prior to A.02.00
Modified at S/W Revision	A.03.00

Scale/Div

Allows you to enter a numeric value to change the vertical display sensitivity.

Key Path	AMPTD Y Scale
----------	---------------

Scale/Div(Burst View)

Allows you to enter a numeric value to change the vertical display sensitivity.

Key Path	AMPTD Y Scale
Mode	LTETDD, LTE, LTEATDD, LTEAFDD
Remote Command	<code>:DISPlay:PVTime:VIEW[1]:WINDow[1]:TRACe:Y[:SCALe]:PDIVision <rel_ampl></code> <code>:DISPlay:PVTime:VIEW[1]:WINDow[1]:TRACe:Y[:SCALe]:PDIVision?</code>
Example	DISP:PVT:VIEW:WIND:TRAC:Y:PDIV 5 dB DISP:PVT:VIEW:WIND:TRAC:Y:PDIV?
Couplings	When the Auto Scale is On, this value is automatically determined by the measurement result. When you set a value manually, Auto Scale automatically changes to Off.
Preset	10.00 dB

State Saved	Saved in instrument state.
Min	0.10 dB
Max	20.00 dB
Initial S/W Revision	A.03.00

Scale/Div (Rise & Fall view)

Allows you to enter a numeric value to change the vertical display sensitivity.

Parameter Name	Y Scale/Div
Key Path	AMPTD Y Scale
Parameter Type	Float32 A6
Mode	LTETDD, LTE, LTEATDD, LTEAFDD
Remote Command	:DISPlay:PVTime:VIEW2:WINDow[1] 2:TRACe:Y[:SCALe]:PDIVision <rel_ampl> :DISPlay:PVTime:VIEW2:WINDow[1] 2:TRACe:Y[:SCALe]:PDIVision?
Example	DISP:PVT:VIEW:WIND:TRAC:Y:PDIV 10 DISP:PVT:VIEW:WIND:TRAC:Y:PDIV?
Couplings	When Y Auto Scaling is On, this value is automatically determined by the measurement result. When the user sets this value manually, Y Auto Scaling automatically changes to Off.
Preset	10.00
Force Restart	No
State Saved	Saved in instrument state.
Min	0.1
Max	20.0
Test MIN/MAX/DEF	Yes
Resolution	0.1
Knob Increment	0.1 dB
Test UP/DOWN	1, 2, 5, 10 ...
Unit Terminator Key	dB
Annotation	<value> dB/ left upper of graph
Initial S/W Revision	A.03.00
Softkey Label	Scale/Div

Presel Center

When this key is pressed, the centering of the preselector filter is adjusted to optimize the amplitude accuracy at the frequency of the selected marker. If the selected marker is not on when Presel Center is pressed, the analyzer will turn on the selected marker, perform a peak search, and then perform centering on the marker's center frequency. If the selected marker is already on and between the start and stop

frequencies of the analyzer, the analyzer performs the preselector calibration on that marker's frequency. If the selected marker is already on, but outside the frequency range between Start Freq and Stop Freq, the analyzer will first perform a peak search, and then perform centering on the marker's center frequency.

The value displayed on the Presel Adjust key will change to reflect the new preselector tuning (see Presel Adjust).

A number of considerations should be observed to ensure proper operation. See ["Proper Preselector Operation" on page 1651](#).

Key Path	AMPTD Y Scale
Remote Command	[:SENSe] :POWer [:RF] :PCENter
Example	POW:PCEN
Notes	Note that the rules outlined above under the key description apply for the remote command as well as the key. The result of the command is dependent on marker position, and so forth. Any message shown by the key press is also shown in response to the remote command.
Dependencies	<ul style="list-style-type: none"> • Grayed out if the microwave preselector is off.) • If the selected marker's frequency is below Band 1, advisory message 0.5001 is generated and no action is taken. • Grayed out if entirely in Band 0. • Blank in models that do not include a preselector, such as option 503. If the SCPI is sent in these instruments, it is accepted without error, and the query always returns 0. • Grayed out in the Spectrogram View.
Couplings	<p>The active marker position determines where the centering will be attempted.</p> <p>If the analyzer is in a measurement such as averaging when centering is initiated, the act of centering the preselector will restart averaging but the first average trace will not be taken until the centering is completed.</p>
Status Bits/OPC dependencies	<p>When centering the preselector, *OPC will not return true until the process is complete and a subsequent measurement has completed, nor will results be returned to a READ or MEASure command.</p> <p>The Measuring bit should remain set while this command is operating and should not go false until the subsequent sweep/measurement has completed.</p>
Initial S/W Revision	Prior to A.02.00
Modified at S/W Revision	A.03.00

Proper Preselector Operation

A number of considerations should be observed to ensure proper operation:

1. If the selected marker is off, the analyzer will turn on a marker, perform a peak search, and adjust the preselector using the selected marker's frequency. It uses the "highest peak" peak search method unqualified by threshold or excursion, so that there is no chance of a 'no peak found' error. It continues with that peak, even if it is the peak of just noise. Therefore, for this operation to work properly, there should be a signal on screen in a preselected range for the peak search to find.

- If the selected marker is already on, the analyzer will attempt the centering at that marker's frequency. There is no preselector for signals below about 3.6 GHz, therefore if the marker is on a signal below 3.6 GHz, no centering will be attempted and an advisory message generated
- In some models, the preselector can be bypassed. If it is bypassed, no centering will be attempted in that range and a message will be generated.

Preselector Adjust

Allows you to manually adjust the preselector filter frequency to optimize its response to the signal of interest. This function is only available when "Presel Center" on page 2743 is available.

For general purpose signal analysis, using Presel Center is recommended. Centering the filter minimizes the impact of long-term preselector drift. Presel Adjust can be used instead to manually optimize the preselector. One application of manual optimization would be to peak the preselector response, which both optimizes the signal-to-noise ratio and minimizes amplitude variations due to small (short-term) preselector drifting.

Key Path	AMPTD Y Scale
Scope	Meas Global
Remote Command	<code>[:SENSe] :POWeR [:RF] :PADJust <freq></code> <code>[:SENSe] :POWeR [:RF] :PADJust?</code>
Example	POW:PADJ 100KHz POW:PADJ?
Notes	The value on the key reads out to 0.1 MHz resolution.
Dependencies	<ul style="list-style-type: none"> • Grayed out if microwave preselector is off.) • Grayed out if entirely in Band 0. • Blank in models that do not include a preselector, such as option 503. If the SCPI is sent in these instruments, it is accepted without error, and the query always returns 0. • Grayed out in the Spectrogram View.
Preset	0 MHz
State Saved	The Presel Adjust value set by Presel Center, or by manually adjusting Presel Adjust, is not saved in instrument state, and does not survive a Preset or power cycle.
Min	-500 MHz
Max	500 MHz
Default Unit	Hz
Backwards Compatibility SCPI	<code>[:SENSe] :POWeR [:RF] :MW :PADJust</code> <code>[:SENSe] :POWeR [:RF] :MMW :PADJust</code> PSA had multiple preselectors, but the X-Series has only one. These commands simply alias to <code>[:SENSe] :POWeR [:RF] :PADJust</code>
Initial S/W Revision	Prior to A.02.00
Modified at S/W Revision	A.03.00

Remote Command	<code>[:SENSe] :POWer [:RF] :PADJust:PRESelector MWAVE MMWave EXternal</code> <code>[:SENSe] :POWer [:RF] :PADJust:PRESelector?</code>
Notes	PSA had multiple preselectors, and you could select which preselector to adjust. Since the X-Series has only one mm/uW preselector, the preselector selection softkey is no longer available. However, to provide backward compatibility, we accept the legacy remote commands. The command form has no effect, the query always returns MWAVE
Initial S/W Revision	Prior to A.02.00

μW Path Control

The μW Path Control functions include the μW Preselector Bypass (Option MPB) and Low Noise Path (Option LNP) controls in the High Band path circuits.

When the μW Preselector is bypassed, the user has better flatness, but will be subject to spurs from out of band interfering signals. When the Low Noise Path is enabled, the analyzer automatically switches around certain circuitry in the high frequency bands which can contribute to noise, when it is appropriate based on other analyzer settings.

For most applications, the preset state is Standard Path, which gives the best remote-control throughput, minimizes acoustic noise from switching and minimizes the risk of wear out in the hardware switches. For applications that utilize the wideband IF paths, the preset state is the μW Preselector Bypass path, if option MPB is present. This is because, when using a wideband IF such as the 140 MHz IF, the μW Preselector's bandwidth can be narrower than the available IF bandwidth, causing degraded amplitude flatness and phase linearity, so it is desirable to bypass the preselector in the default case.

Users may choose Low Noise Path Enable. It gives a lower noise floor, especially in the 21–26.5 GHz region, though without improving many measures of dynamic range, and without giving the best possible noise floor. The preamp, if purchased and used, gives better noise floor than does the Low Noise Path, however its compression threshold and third-order intercept are much poorer than that of the non-preamp Low Noise Path. There are some applications, typically for signals around –30 dBm, for which the third-order dynamic range of the standard path is good enough, but the noise floor is not low enough even with 0 dB input attenuation. When the third-order dynamic range of the preamp path is too little and the noise floor of the standard path is too high, the Low Noise Path can provide the best dynamic range.

Key Path	AMPTD Y Scale
Mode	SA, BASIC, PNOISE, VSA , LTE, LTETDD
Scope	Meas Global
Remote Command	<code>[:SENSe] :POWer [:RF] :MW:PATH STD LNPath MPBypass FULL</code> <code>[:SENSe] :POWer [:RF] :MW:PATH?</code>
Example	<code>:POW:MW:PATH LNP</code> Enables the Low Noise path
Notes	If a Presel Center is performed, the analyzer will momentarily switch to the Standard Path, regardless of the setting of μW Path Control The DC Block will always be switched in when the low noise path is switched in, to protect succeeding circuitry from DC. Note that this does not mean “when the low noise path is enabled” but

	<p>when, based on the Low Noise Path rules, the path is actually switched in. This can happen when the selection is Low Noise Path Enable . In the case where the DC Block is switched in the analyzer is now AC coupled. However, if the user has selected DC coupling, the UI will still behave as though it were DC coupled, including all annunciation, warnings, status bits, and responses to SCPI queries. This is because, based on other settings, the analyzer could switch out the low noise path at any time and hence go back to being DC coupled.</p> <p>Alignment switching ignores the settings in this menu, and restores them when finished.</p>
Dependencies	Unavailable in BBIQ and External Mixing
Preset	<p>All modes other than IQ Analyzer mode and VXA: STD</p> <p>IQ Analyzer, VXA and WLAN mode:</p> <p>MPB option present and licensed: MPB</p> <p>MPB option not present and licensed: STD</p>
State Saved	Save in instrument state
Readback	Value selected in the submenu
Initial S/W Revision	A.04.00
Modified at S/W Revision	A.10.00

Standard Path

This path gives the best remote-control throughput, minimizes acoustic noise from switching and minimizes the risk of wear in the hardware switches, particularly in remote test scenarios where both low band and high band setups will follow in rapid succession.

In this path, the bypass of the low band/high band switch and microwave preamp is never activated, which can cause some noise degradation but preserves the life of the bypass switch.

Key Path	AMPTD Y Scale, μ W Path Control
Example	:POW:MW:PATH STD
Readback Text	Standard Path
Initial S/W Revision	A.04.00

Low Noise Path Enable

You may choose Low Noise Path Enable, which gives a lower noise floor under some circumstances, particularly when operating in the 21–26.5 GHz region. With the Low Noise Path enabled, the low band/high band switch and microwave preamp are bypassed whenever all of the following are true:

- The analyzer is not in the Low Band, meaning:
- the start frequency is above 3.5 GHz and
- the stop frequency is above 3.6 GHz.
- the internal preamp is not installed or (if installed) is set to Off or Low Band

Note that this means that, when any part of a sweep is done in Low Band, the Low Noise Path is not used, whether or not the Low Noise Path Enable is selected in the user interface. Also, if the preamp is turned on, the Low Noise Path is not used, whether or not the Low Noise Path Enable is selected in the user interface. The only time the Low Noise Path is used is when Low Noise Path Enable is selected, the sweep is completely in High Band (> 3.6 GHz) and no preamp is in use.

See "[More Information](#)" on page 1655

Key Path	AMPTD Y Scale, μ W Path Control
Measurement	Swept SA
Example	:POW:MW:PATH LNP
Notes	<p>For measurements that use IQ acquisition, the low noise path is used when the Center Frequency is in High Band (> 3.6 GHz) and no preamp is in use.</p> <p>In other words, the rules above are modified to use only the center frequency to qualify which path to switch in.</p> <p>This is not the case for FFT's in the Swept SA measurement; they use the same rules as swept measurements.</p>
Dependencies	<p>Key is blanked if current mode does not support it.</p> <p>Key is grayed out if mode supports it but current measurement does not support it.</p> <p>Unless Option LNP is present and licensed, key is blank and if SCPI command sent, error -241, "Hardware missing; Option not installed" is generated.</p>
Readback Text	Low Noise Path Enable
Initial S/W Revision	A.04.00

More Information

The user should understand that the Low Noise Path, while giving improved DANL, has the disadvantage of decreased TOI performance and decreased gain compression performance relative to the standard path.

The user should also understand that the bypass switch is a mechanical switch and has finite life, so if the Low Noise Path is enabled, it is possible to cause frequent cycling of this switch by frequently changing analyzer settings such that the above conditions hold true only some of the time. A user making tests of this nature should consider opting for the Standard Path, which will never throw the bypass switch, at the expense of some degraded noise performance.

The low noise path is useful for situations where the signal level is so low that the analyzer performance is dominated by noise even with 0 dB attenuation, but still high enough that the preamp option would have excessive third-order intermodulation or compression. The preamp, if purchased and used, gives better noise floor than does the "Low Noise Path." However, its compression threshold and third-order intercept are much poorer than that of the non-preamp path. There are some applications, typically for signals around -30 dBm, for which the third-order dynamic range of the standard path is good enough, but the noise floor is not low enough even with 0 dB input attenuation. When the third-order dynamic range of the preamp path is too little and the noise floor of the standard path is too high, the Low Noise Path can provide the best dynamic range

The graph below illustrates the concept. It shows, in red, the performance of an analyzer at different attenuation settings, both with the preamp on and off, in a measurement that is affected by both analyzer

noise and analyzer TOI. The green shows the best available dynamic range, offset by 0.5 dB for clarity. The blue shows how the best available dynamic range improves for moderate signal levels with the low noise path switched in. In this illustration, the preamp improves the noise floor by 15 dB while degrading the third-order intercept by 30 dB, and the low noise path reduces loss by 8 dB. The attenuator step size is 2 dB.

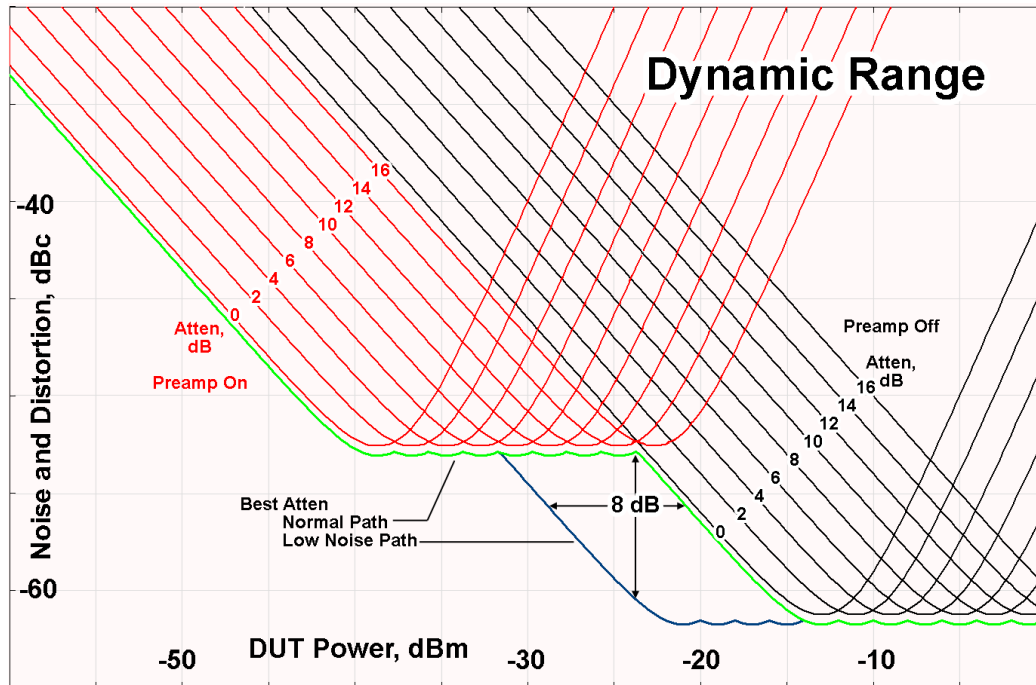

There are other times where selecting the low noise path improves performance, too. Compression-limited measurements such as finding the nulls in a pulsed-RF spectrum can profit from the low noise path in a way similar to the TOI-limited measurement illustrated. Accuracy can be improved when the low noise path allows the optimum attenuation to increase from a small amount like 0, 2 or 4 dB to a larger amount, giving better return loss at the analyzer input. Harmonic measurements, such as second and third harmonic levels, are much improved using the low noise path because of the superiority of that path for harmonic (though not intermodulation) distortion performance.

μW Preselector Bypass

This key toggles the preselector bypass switch for band 1 and higher. When the microwave preselector is on, the signal path is preselected. When the microwave preselector is off, the signal path is not preselected. The preselected path is the normal path for the analyzer.

The preselector is a tunable bandpass filter which prevents signals away from the frequency of interest from combining in the mixer to generate in-band spurious signals (images). The consequences of using a preselector filter are its limited bandwidth, the amplitude and phase ripple in its passband, and any amplitude and phase instability due to center frequency drift.

Option MPB or pre-selector bypass provides an unpreselected input mixer path for certain X-Series signal analyzers with frequency ranges above 3.6 GHz. This signal path allows a wider bandwidth and less amplitude variability, which is an advantage when doing modulation analysis and broadband signal analysis. The disadvantage is that, without the preselector, image signals will be displayed. Another disadvantage of bypassing the preselector is increased LO emission levels at the front panel input port.

Image responses are separated from the real signal by twice the 1st IF. For IF Paths of 10 MHz and 25 MHz, the 1st IF is 322.5 MHz, so the image response and the real signal will be separated by 645 MHz. The 1st IF will be different for other IF Path settings. When viewing a real signal and its corresponding image response in internal mixing, the image response will be to the left of the real signal.

Also, the image response and the real signal typically have the same amplitude and exhibit the same shape factor.

However, if Option FS1, Fast Sweep Capability, is enabled, the image response in the Swept SA measurement will appear lower in amplitude and have a much wider shape factor compared to the real signal.

Key Path	AMPTD Y Scale, μ W Path Control
Example	:POW:MW:PATH MPB
Dependencies	Key is blanked if current mode does not support it. Key is grayed out if mode supports it but current measurement does not support it. Key is blank unless Option MPB is present and licensed. If SCPI command sent when MPB not present, error -241, "Hardware missing; Option not installed" is generated.
Readback Text	μ W Preselector Bypass
Initial S/W Revision	A.04.00

Remote Command	[:SENSe] :POWer [:RF] :MW:PRESelector [:STATe] ON OFF 0 1 [:SENSe] :POWer [:RF] :MW:PRESelector [:STATe] ?
Example	:POW:MW:PRES OFF Bypasses the microwave preselector
Notes	The ON parameter sets the STD path (:POW:MW:PATH STD) The OFF parameter sets path MPB (:POW:MW:PATH MPB)
Preset	ON

Internal Preamp

Accesses a menu of keys that control the internal preamps. Turning on the preamp gives a better noise figure, but a poorer TOI to noise floor dynamic range. You can optimize this setting for your particular measurement.

The instrument takes the preamp gain into account as it sweeps. If you sweep outside of the range of the preamp the instrument will also account for that. The displayed result will always reflect the correct gain.

For some measurements, when the preamp is on and any part of the displayed frequency range is below the lowest frequency for which the preamp has specifications, a warning condition message appears in the status line. For example, for a preamp with a 9 kHz lowest specified frequency: "Preamp: Accy unspc'd below 9 kHz".

Key Path	AMPTD Y Scale
----------	---------------

Scope	Meas Global
Remote Command	[:SENSe] :POWer [:RF] :GAIN [:STATe] OFF ON 0 1 [:SENSe] :POWer [:RF] :GAIN [:STATe] ?
Dependencies	Preamp is not available on all hardware platforms. If the preamp is not present or is unlicensed, the key is not shown. The preamp is not available when the electronic/soft attenuator is enabled.
Couplings	The act of connecting the U7227A USB Preamplifier to one of the analyzer's USB ports will cause the Internal Preamp to be switched on. When this happens an informational message will be generated: "Internal Preamp turned on for optimal operation with USB Preamp." Note that if the Internal Preamp was already on, there will be no change to the setting, but if it was Off it will be switched On, to Full Range. Note that this same action occurs when the SA mode is selected while the USB Preamp is connected to one of the analyzer's USB ports, if it is the first time that the SA mode has run since powerup, or if the last time the SA mode was running the USB Preamp was NOT connected. Subsequently disconnecting the USB Preamp from USB does not change the Internal Preamp setting nor restore the previous setting.
Preset	OFF
State Saved	Saved in instrument state
Initial S/W Revision	Prior to A.02.00
Modified at S/W Revision	A.14.00

Key Path	AMPTD Y Scale, Internal Preamp
Scope	Meas Global
Remote Command	[:SENSe] :POWer [:RF] :GAIN :BAND LOW FULL [:SENSe] :POWer [:RF] :GAIN :BAND ?
Dependencies	Preamp is not available on all hardware platforms. If the preamp is not present or is unlicensed, the key is not shown. If a POW:GAIN:BAND FULL command is sent when a low band preamp is available, the preamp band parameter is to LOW instead of FULL, and an "Option not installed" message is generated.
Preset	LOW
State Saved	Saved in instrument state
Initial S/W Revision	Prior to A.02.00

Off

Turns the internal preamp off

Key Path	AMPTD Y Scale, Internal Preamp
----------	--------------------------------

Example	:POW:GAIN OFF
Readback	Off
Initial S/W Revision	Prior to A.02.00

Low Band

Sets the internal preamp to use only the low band.

The frequency range of the installed (optional) low-band preamp is displayed in square brackets on the Low Band key label.

Key Path	AMPTD Y Scale, Internal Preamp
Example	:POW:GAIN ON :POW:GAIN:BAND LOW
Readback	Low Band
Initial S/W Revision	Prior to A.02.00

Full Range

Sets the internal preamp to use its full range. The low band (0–3.6 GHz or 0–3GHz, depending on the model) is supplied by the low band preamp and the frequencies above low band are supplied by the high band preamp.

The frequency range of the installed (optional) preamp is displayed in square brackets on the Full Range key label. If the high band option is not installed the Full Range key does not appear.

Key Path	AMPTD Y Scale, Internal Preamp
Example	:POW:GAIN ON :POW:GAIN:BAND FULL
Readback	Full Range
Initial S/W Revision	Prior to A.02.00

Ref Position

Sets the display reference position to the top, center, or bottom of the display.

Key Path	AMPTD Y Scale
----------	---------------

Ref Position(Burst View)

Allows you to set the display reference position to the top, center, or bottom of the display.

Key Path	AMPTD Y Scale, More
Mode	LTETDD, LTE, LTEATDD, LTEAFDD
Remote Command	:DISPlay:PVTime:VIEW[1]:WINDow[1]:TRACe:Y[:SCALe]:RPOSition TOP CENTer BOTTom :DISPlay:PVTime:VIEW[1]:WINDow[1]:TRACe:Y[:SCALe]:RPOSition?
Example	:DISP:PVT:VIEW:WIND:TRAC:Y:SCAL:RPOS CENT :DISP:PVT:VIEW:WIND:TRAC:Y:SCAL:RPOS?
Preset	TOP
State Saved	Saved in instrument state.
Range	Top Ctr Bot
Initial S/W Revision	A.03.00

Ref Position (Rise & Fall view)

Allows you to set the display reference position to Top, Center, or Bottom.

Key Path	AMPTD Y Scale
Mode	LTETDD, LTE, LTEATDD, LTEAFDD
Remote Command	:DISPlay:PVTime:VIEW2:WINDow[1] 2:TRACe:Y[:SCALe]:RPOSition TOP CENTer BOTTom :DISPlay:PVTime:VIEW2:WINDow[1] 2:TRACe:Y[:SCALe]:RPOSition?
Example	DISP:PVT:VIEW:WIND:TRAC:Y:RPOS CENT DISP:PVT:VIEW:WIND:TRAC:Y:RPOS?
Preset	TOP
State Saved	Saved in instrument state.
Range	Top Ctr Bot
Initial S/W Revision	A.03.00

Auto Scale

Allows you to toggle the Y axis Auto Scale function between On and Off.

Key Path	AMPTD Y Scale
----------	---------------

Auto Scale(Burst View)

Allows you to toggle the Y axis Auto Scale function between On and Off.

Key Path	AMPTD Y Scale, More
----------	---------------------

Mode	LTETDD, LTE, LTEATDD, LTEAFDD
Remote Command	:DISPlay:PVTTime:VIEW[1]:WINDow[1]:TRACe:Y[:SCALe]:COUPle 0 1 OFF ON :DISPlay:PVTTime:VIEW[1]:WINDow[1]:TRACe:Y[:SCALe]:COUPle?
Example	:DISP:PVT:VIEW:WIND:TRAC:Y:COUP ON :DISP:PVT:VIEW:WIND:TRAC:Y:COUP?
Couplings	When Auto Scale is On, and you press the Restart front-panel key, this function automatically determines the scale per division and reference values based on the measurement results. When you manually set a value for the Y Rel Value or Y Scale/Div, this parameter is automatically set to Off.
Preset	ON
State Saved	Saved in instrument state.
Range	On Off
Initial S/W Revision	A.03.00

Auto Scale (Rise & Fall view)

Allows you to toggle the Y-axis auto scaling function between On and Off.

Key Path	AMPTD Y Scale
Mode	LTETDD, LTE, LTEATDD, LTEAFDD
Remote Command	:DISPlay:PVTTime:VIEW2:WINDow[1] 2:TRACe:Y[:SCALe]:COUPle 0 1 OFF ON :DISPlay:PVTTime:VIEW2:WINDow[1] 2:TRACe:Y[:SCALe]:COUPle?
Example	DISP:PVT:VIEW:WIND:TRAC:Y:COUP 0 DISP:PVT:VIEW:WIND:TRAC:Y:COUP?
Couplings	When Auto Scale is On, and you press the Restart front-panel key, this function automatically determines the scale per division and reference values based on the measurement results. When you manually set a value for the Y Rel Value or Y Scale/Div, this parameter is automatically set to Off.
Preset	ON
State Saved	Saved in instrument state.
Range	On Off
Initial S/W Revision	A.03.00

Auto Couple

The Auto Couple feature provides a quick and convenient way to automatically couple multiple instrument settings. This helps ensure accurate measurements and optimum dynamic range. When the Auto Couple feature is activated, either from the front panel or remotely, all parameters of the current measurement that have an Auto/Manual mode are set to Auto mode and all measurement settings dependent on (or coupled to) the Auto/Man parameters are automatically adjusted for optimal performance.

However, the Auto Couple key actions are confined to the current measurement only. It does not affect other measurements in the mode, and it does not affect markers, marker functions, or trace or display attributes.

See ["More Information" on page 1662](#)

Key Path	Front-panel key
Remote Command	:COUPLe ALL NONE
Example	:COUP ALL
Notes	:COUPLe ALL puts all Auto/Man parameters in Auto mode (equivalent to pressing the Auto Couple key). :COUPLE NONE puts all Auto/Man parameters in manual mode. It decouples all the coupled instrument parameters and is not recommended for making measurements.
Initial S/W Revision	Prior to A.02.00

More Information

There are two types of functions that have Auto/Manual modes.

Auto/Man Active Function keys

An Auto/Man toggle key controls the binary state associated with an instrument parameter by toggling between Auto (where the parameter is automatically coupled to the other parameters it is dependent upon) and Man (where the parameter is controlled independent of the other parameters), as well as making the parameter the active function. The current mode is indicated on the softkey with either Auto or Man underlined as illustrated below.



Auto/Man 1-of-N keys

An Auto/Man 1-of-N key allows you to manually pick from a list of parameter values, or place the function in Auto, in which case the value is automatically selected (and indicated) as shown below. If in Auto, Auto is underlined on the calling key. If in manual operation, manual is indicated on the calling key. But the calling key does not actually toggle the function, it simply opens the menu.

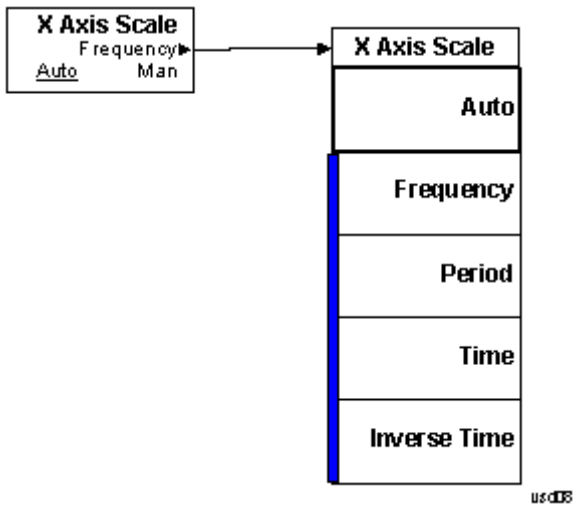

BW

This key allows you to set the Bandwidth of the signal being measured.

Preset To Standard	Info BW	Notes
1.4 MHz (6 RB)	1.5 MHz	
3.0 MHz (15 RB)	3.0 MHz	
5.0 MHz (25 RB)	5.0 MHz	
10.0 MHz (50 RB)	10.0 MHz	Need B25 opt
15.0 MHz (75 RB)	25.0 MHz	Need B25 opt
20.0 MHz (100 RB)	25.0 MHz	Need B25 opt

Bandwidth	BS Info BW	UE Info BW	Notes
1.4 MHz (6 RB)	1.095 MHz	1.08 MHz	Need B40 or wider
3.0 MHz (15 RB)	2.715 MHz	2.7 MHz	Need B40 or wider
5.0 MHz (25 RB)	4.515 MHz	4.5 MHz	Need B40 or wider
10.0 MHz (50 RB)	9.015 MHz	9.0 MHz	Need B40 or wider
15.0 MHz (75 RB)	13.515 MHz	13.5 MHz	Need B40 or wider
20.0 MHz (100 RB)	18.015 MHz	18.0 MHz	Need B40 or wider

Key Path	BW
Mode	LTETDD, LTE
Remote Command	[:SENSe] :PVTime :BANDwidth <freq> [:SENSe] :PVTime :BANDwidth?
Example	PVT:BAND 6.0 MHz PVT:BAND?
Couplings	This parameter is coupled with Preset to Standard in Mode Setup Menu. The relationship is in the table above.
Preset	5.0 MHz on B25 4.515MHz on B40
State Saved	Saved in instrument state.
Min	10 Hz
Max	Hardware Dependent: No Option = 10 MHz Option B25 = 25 MHz Option B40 = 40 MHz Option B85 = 85 MHz

Option B1A = 125 MHz
Option B1X = 140 MHz
Option B1Y = 160 MHz

Initial S/W Revision A.03.00

Modified at S/W Revision A.13.00

Cont (Continuous Measurement/Sweep)

Sets the analyzer for Continuous measurement operation. The single/continuous state is Meas Global so the setting will affect all measurements. If you are Paused, pressing Cont does a Resume.

Key Path	Front-panel key
Remote Command	:INITiate:CONTinuous OFF ON 0 1 :INITiate:CONTinuous?
Example	:INIT:CONT 0 puts analyzer in Single measurement operation. :INIT:CONT 1 puts analyzer in Continuous measurement operation
Preset	ON (Note that SYST:PRESet sets INIT:CONT to ON but *RST sets INIT:CONT to OFF)
State Saved	Saved in instrument state
Backwards Compatibility Notes	For Spectrum Analysis mode in ESA and PSA, there is no Cont hardkey, instead there is a Sweep Single/Cont key. In these analyzers, switching the Sweep Single/Cont key from Single to Cont restarts averages (displayed average count reset to 1), but does not restart Max Hold and Min Hold. The X-Series has Single and Cont keys in place of the SweepSingleCont key. In the X-Series, if in single measurement, the Cont key (and INIT:CONT ON) switches to continuous measurement, but never restarts a measurement and never resets a sweep.
Initial S/W Revision	Prior to A.02.00

In Swept SA Measurement (Spectrum Analysis Mode):

The analyzer takes repetitive sweeps, averages, measurements, etc., when in Continuous mode. When the average count reaches the Average/Hold Number the count stops incrementing, but the analyzer keeps sweeping. See the Trace/Detector section for the averaging formula used both before and after the Average/Hold Number is reached. The trigger condition must be met prior to each sweep. The type of trace processing for multiple sweeps, is set under the Trace/Detector key, with choices of Trace Average, Max Hold, or Min Hold.

In Other Measurements/Modes:

With Avg/Hold Num (in the Meas Setup menu) set to Off or set to On with a value of 1, a sweep is taken after the trigger condition is met; and the analyzer continues to take new sweeps after the current sweep has completed and the trigger condition is again met. However, with Avg/Hold Num set to On with a value >1, multiple sweeps (data acquisitions) are taken for the measurement. The trigger condition must be met prior to each sweep. The sweep is not stopped when the average count k equals the number N set for Avg/Hold Num is reached, but the number k stops incrementing. A measurement average usually applies to all traces, marker results, and numeric results. But sometimes it only applies to the numeric results.

If the analyzer is in Single measurement, pressing the Cont key does not change k and does not cause the sweep to be reset; the only action is to put the analyzer into Continuous measurement operation.

If it is already in continuous sweep:

the INIT:CONT 1 command has no effect

the INIT:CONT 0 command will place the analyzer in Single Sweep but will have no effect on the current sequence until $k = N$, at which point the current sequence will stop and the instrument will go to the idle state.

14 Transmit On/Off Power Measurement Functions
File

File

See "File" on page 360

FREQ Channel

Accesses a menu of keys that allow you to control the Frequency and Channel parameters of the instrument.

Some features in the Frequency menu are the same for all measurements – they do not change as you change measurements. Settings like these are called “Meas Global” and are unaffected by Meas Preset. For example, the Center Freq setting is the same for all measurements – it does not change as you change measurements.

Key Path	Front-panel key
Initial S/W Revision	Prior to A.02.00

Center Freq

Sets the frequency that corresponds to the horizontal center of the graticule (when frequency Scale Type is set to linear). While adjusting the Center Frequency the Span is held constant, which means that both Start Frequency and Stop Frequency will change.

Pressing Center Freq also sets the frequency entry mode to Center/Span. In Center/Span mode, the center frequency and span values are displayed below the graticule, and the default active function in the Frequency menu is Center Freq.

The center frequency setting is the same for all measurements within a mode, that is, it is Meas Global. Some modes are also able to share a Mode Global center frequency value. If this is the case, the Mode will have a Global Settings key in its Mode Setup menu.

The Center Freq function sets (and queries) the Center Frequency for the currently selected input. If your analyzer has multiple inputs, and you select another input, the Center Freq changes to the value for that input. SCPI commands are available to directly set the Center Freq for a specific input.

Center Freq is remembered as you go from input to input. Thus you can set a Center Freq of 10 GHz with the RF Input selected, change to BBIQ and set a Center Freq of 20 MHz, then switch to External Mixing and set a Center Freq of 60 GHz, and when you go back to the RF Input the Center Freq will go back to 10 GHz; back to BBIQ and it is 20 MHz; back to External Mixing and it is 60 GHz.

See ["RF Center Freq" on page 1672](#)

See [Ext Mix Center Freq](#)

See ["I/Q Center Freq" on page 1674](#)

See ["Center Frequency Presets" on page 1670](#)

Key Path	FREQ Channel
Scope	Meas Global
Remote Command	[:SENSe] :FREQuency :CENTer <freq> [:SENSe] :FREQuency :CENTer?

Example	FREQ:CENT 50 MHz FREQ:CENT UP changes the center frequency to 150 MHz if you use FREQ:CENT:STEP 100 MHz to set the center frequency step size to 100 MHz FREQ:CENT?
Notes	This command sets either the RF or I/Q Center Frequency depending on the selected input. For RF input it is equivalent to FREQ:RF:CENT For I/Q input it is equivalent to FREQ:IQ:CENT Preset and Max values are dependent on Hardware Options (5xx) If no terminator (e.g. MHz) is sent the terminator Hz is used. If a terminator with unit other than Frequency is used, an invalid suffix error message is generated.
Dependencies	The Center Frequency can be limited by Start or Stop Freq limits, if the Span is so large that Start or Stop reach their limit.
Couplings	When operating in “swept span”, any value of the Center Frequency or Span that is within the frequency range of the analyzer is allowed when the value is being set through the front panel numeric key pad or the SCPI command. The other parameter is forced to a different value if needed, to keep the Start and the Stop Frequencies within the analyzer’s frequency range
Preset	Depends on instrument maximum frequency, mode, measurement, and selected input. See "Center Frequency Presets" on page 1670 and "RF Center Freq" on page 1672 and Ext Mix Center Freq and "I/Q Center Freq" on page 1674 .
State Saved	Saved in instrument state
Min	Depends on instrument maximum frequency, mode, measurement, and selected input.. See "Center Frequency Presets" on page 1670 and "RF Center Freq" on page 1672 and "I/Q Center Freq" on page 1674 .
Max	Depends on instrument maximum frequency, mode, measurement, and selected input.. See "Center Frequency Presets" on page 1670 and "RF Center Freq" on page 1672 and "I/Q Center Freq" on page 1674 .
Default Unit	Hz
Status Bits/OPC	Non-overlapped
Dependencies	
Initial S/W Revision	Prior to A.02.00

Center Frequency Presets

The following table provides the Center Frequency Presets for the Spectrum Analyzer mode, and the Max Freq, for the various frequency options:

Freq Option	CF after Mode Preset	Stop Freq after Mode Preset	Max Freq (can't tune

			above)
503 (all but N9000A)	1.805 GHz	3.6 GHz	3.7 GHz
503 (N9000A)	1.505 GHz	3.0 GHz	3.08 GHz
507 (all but N9000A)	3.505 GHz	7.0 GHz	7.1 GHz
507 (N9000A)	3.755 GHz	7.5 GHz	7.58 GHz
508 (all but N9038A)	1.805 GHz	3.6 GHz	8.5 GHz
508 (N9038A)	4.205 GHz	8.4 GHz	8.5 GHz
513	6.805 GHz	13.6 GHz	13.8 GHz
526 (all but N9000A and N9038A)	13.255 GHz	26.5 GHz	27.0 GHz
526 (N9000A)	13.255 GHz	26.5 GHz	26.55 GHz
526 (N9038A)	1.805 GHz	3.6 GHz	27.0 GHz
532	16.005 GHz	32.0 GHz	32.5 GHz
543	21.505 GHz	43.0 GHz	TBD
544	22.005 GHz	44.0 GHz	44.5 GHz
550	25.005 GHz	50.0 GHz	51 GHz

Input 2:

Model	CF after Mode Preset	Stop Freq after Mode Preset	Max Freq (can't tune above)
N9000A opt C75	0.7505GHz	1.5 GHz	1.58 GHz
N9038A	505 MHz	1 GHz	1.000025 GHz

Tracking Generator Frequency Limits (N9000A only):

Tracking Generator Option	Min Freq (clips to this freq when turn TG on and	If above this Freq, Stop Freq clipped to this Freq when	Max Freq (can't tune above) while TG

	can't tune below while TG on)	TG turned on	on
T03	9 kHz	3.0 GHz	3.08 GHz
T06	9 kHz	6.0 GHz	6.05 GHz

The following table shows the Center Frequency Presets for modes other than Spectrum Analyzer:

Mode	CF Preset for RF
WCDMA	1 GHz
WIMAXOFDMA,	1 GHz
BASIC	1 GHz
ADEMOD	1 GHz
VSA	1 GHz
TDSCDMA	1 GHz
PNOISE	1 GHz
LTE	1 GHz
LTETDD	1 GHz
MSR	1 GHz
GSM	935.2 MHz
NFIGURE	1.505 GHz

RF Center Freq

SCPI command for specifying the RF Center Frequency. This command will set the Center Frequency to be used when the RF input is selected, even if the RF input is not the input that is selected at the time the command is sent. Note that the Center Freq function in the Frequency menu on the front panel always applies to the currently selected input.

Scope	Meas Global
Remote Command	<code>[:SENSe] :FREQuency:RF:CENTer <freq></code> <code>[:SENSe] :FREQuency:RF:CENTer?</code>
Example	FREQ:RF:CENT 30 MHz
Notes	This command is the same in all modes, but the parameter is Measurement Global. So the value is independent in each mode and common across all the measurements in the mode.
Dependencies	If the electronic/soft attenuator is enabled, any attempt to set Center Frequency such that the Stop Frequency would be >3.6 GHz fails and results in an advisory message. If the equivalent SCPI command is sent, this same message is generated as part of a “-221, Settings conflict” warning. If Source Mode is set to Tracking, and the Max or Min Center Freq is therefore limited by the limits of the source, a warning message is generated, “Data out of range;clipped to source max/min” if these limits are exceeded. Note that for an external source, these limits can be affected by the settings of

	Source Numerator, Source Denominator and Power Sweep.
Preset	See table above
State Saved	Saved in instrument state.
Min	-79.999995 MHz, unless Source Mode is set to Tracking, in which case it is limited by the minimum frequency of the Source
Max	See table above. Basically instrument maximum frequency - 5 Hz. Note that, if the Source Mode is set to Tracking, the effective instrument maximum frequency may be limited by the source maximum frequency. If the knob or step keys are being used, also depends on the value of the other three interdependent parameters Span, Start Frequency and Stop Frequency
Initial S/W Revision	Prior to A.02.00
Modified at S/W Revision	A.03.00

Ext Mix Center Freq

SCPI command for specifying the External Mixer Center Frequency. This command will set the Center Frequency to be used when the External Mixer is selected, even if the External Mixer input is not the input which is selected at the time the command is sent. Note that the Center Freq function in the Frequency menu on the front panel always applies to the currently selected input.

Scope	Meas Global
Remote Command	<code>[:SENSe] :FREQuency:EMIXer:CENTer <freq></code> <code>[:SENSe] :FREQuency:EMIXer:CENTer?</code>
Example	<code>:FREQ:EMIX:CENT 60 GHz</code> <code>:FREQ:EMIX:CENT?</code>
Notes	This command is the same in all modes, but the parameter is Measurement Global. So the value is independent in each mode and common across all the measurements in the mode.
Couplings	When returning to External Mixing after having been switched to one of the other inputs (e.g., RF), you will come back into the settings that you had when you left External Mixing. So you will come back to the band you were in with the Center Frequency that you had. However, Span is not an input-dependent parameter, therefore you will bring the span over from the other input. Therefore, the analyzer comes back with the span from the previous input, limited as necessary by the current mixer setup.
Preset	When a Mode Preset is performed while in External Mixing, the Start frequency of the current Mode is set to the nominal Min Freq of the lowest harmonic range in the Harmonic Table for the current mixer setup. Similarly, the Stop frequency of the current Mode is set to the nominal Max Freq of the highest harmonic range in the Harmonic Table. The Center Freq thus presets to the point arithmetically equidistant from these two frequencies. If the current measurement has a limited Span available to it, and cannot achieve the Span shown in the table (Span=Stop Freq - Start Freq), the analyzer uses the maximum Span the measurement allows, and still sets the Center Freq to the midpoint of the Start and Stop Freq values in the Harmonic Table.

	<p>When Restore Input/Output Defaults is performed, the mixer presets to the 11970A, whose Start and Stop frequencies are 26.5 and 40 GHz respectively. The center of these two frequencies is 33.25 GHz.</p> <p>Therefore, after a Restore Input/Output Defaults, if you go into External Mixing and do a Mode Preset while in the Spectrum Analyzer Mode, the resulting Center Freq is 33.25 GHz.</p>
State Saved	Saved in instrument state.
Min	The minimum frequency in the currently selected mixer band + 5 Hz
Max	<p>The maximum frequency in the currently selected mixer band – 5 Hz</p> <p>If the knob or step keys are being used, also depends on the value of the other three interdependent parameters Span, Start Frequency and Stop Frequency</p>
Initial S/W Revision	A.08.01

I/Q Center Freq

SCPI command for specifying the I/Q Center Frequency. This command will set the Center Frequency to be used when the I/Q input is selected, even if the I/Q input is not the input which is selected at the time the command is sent. Note that the Center Freq function in the Frequency menu on the front panel always applies to the currently selected input.

Scope	Meas Global
Remote Command	<pre>[:SENSe] :FREQuency:IQ:CENTer <freq></pre> <pre>[:SENSe] :FREQuency:IQ:CENTer?</pre>
Example	FREQ:IQ:CENT: 30 MHz
Notes	This command is the same in all modes, but the parameter is Measurement Global. So the value is independent in each mode and common across all the measurements in the mode.
Preset	0 Hz
State Saved	Saved in instrument state.
Min	-40.049995 MHz
Max	40.049995 MHz
Initial S/W Revision	Prior to A.02.00

CF Step

Changes the step size for the center frequency and start and stop frequency functions. Once a step size has been selected and the center frequency function is active, the step keys (and the UP|DOWN parameters for Center Frequency from remote commands) change the center frequency by the step-size value. The step size function is useful for finding harmonics and sidebands beyond the current frequency span of the analyzer.

Note that the start and stop frequencies also step by the CF Step value.

Key Path	FREQ Channel
Remote Command	[:SENSe]:FREQuency:CENTer:STEP[:INCRement] <freq> [:SENSe]:FREQuency:CENTer:STEP[:INCRement]? [:SENSe]:FREQuency:CENTer:STEP:AUTO OFF ON 0 1 [:SENSe]:FREQuency:CENTer:STEP:AUTO?
Example	FREQ:CENT:STEP:AUTO ON FREQ:CENT:STEP 500 MHz FREQ:CENT UP increases the current center frequency value by 500 MHz FREQ:CENT:STEP? FREQ:CENT:STEP:AUTO?
Notes	Preset and Max values are depending on Hardware Options (503, 507, 508, 513, 526)
Notes	Preset and Max values are dependent on Hardware Options (5xx)
Dependencies	Freq Offset is not available in External Mixing. In this case the Freq Offset key is grayed out and shows a value of zero. It will once again be available, and show the previously set value, when you return to the RF Input.
Dependencies	Span, RBW, Center frequency If the electronic/soft attenuator is enabled, any attempt to change the value of the center frequency >3.6 GHz by pressing the Up-arrow key, fails and results in an advisory message. If the equivalent SCPI command is sent, this same message is generated as part of a “-221, Settings conflict” warning.
Couplings	When auto-coupled in a non-zero span, the center frequency step size is set to 10% of the span. When auto-coupled in zero span, the center frequency step size is set to the equivalent -3 dB RBW value.
Preset	Auto ADEMOD: 1 MHz ON
State Saved	Saved in instrument state
Min	– (the maximum frequency of the instrument). That is, 27 GHz max freq instrument has a CF step range of +/- 27 GHz. Note that this is the maximum frequency given the current settings of the instrument, so in External Mixing, for example, it is the maximum frequency of the current mixer band.
Max	The maximum frequency of the instrument. That is, 27 GHz max freq instrument has a CF step range of +/- 27 GHz. Note that this is the maximum frequency given the current settings of the instrument, so in External Mixing, for example, it is the maximum frequency of the current mixer band.
Default Unit	Hz
Status Bits/OPC dependencies	non-overlapped
Initial S/W Revision	Prior to A.02.00
Modified at S/W Revision	A.03.00

14 Transmit On/Off Power Measurement Functions
Input/Output

Input/Output

See "[Input/Output](#)" on page 224

Marker

Accesses the menu that allows you to select, set up, and control the markers for the current measurement. Sets the marker control mode as described under Normal, Delta, and Off, below. All interactions and dependencies detailed under the softkey description are enforced when the remote command is sent.

See Marker in the "Common Measurement Functions" for more information.

Key Path	Front-panel key
Initial S/W Revision	A.03.00

Select Marker

Accesses menus that allows you to select one or more markers

Key Path	Marker, Properties
Initial S/W Revision	A.03.00

Marker Type

Sets the marker control mode. If the selected marker is Off, pressing Marker sets it to Normal and places it at the center of the screen on the trace determined by the Marker Trace rules. At the same time, the reference value of the selected marker appears on the Active Function area.

Active Function Display: Marker X-axis value

Default Active Function: the active function for the selected marker's current control mode. If the current control mode is Off, there is no active function and the active function is turned off.

The marker X axis value entered in the active function area will display the marker value to its full entered precision.

Key Path	Marker
Mode	LTETDD, LTE, LTEATDD, LTEAFDD
Remote Command	:CALCulate:PVTime:MARKer[1] 2 ... 12:MODE POSITION DELTA OFF :CALCulate:PVTime:MARKer[1] 2 ... 12:MODE?
Example	:CALC:PVT:MARK:MODE OFF :CALC:PVT:MARK:MODE?
Notes	If the selected marker is Off, pressing Marker sets it to Normal and places it at the center of the screen on the trace determined by the Marker Trace rules. At the same time, Marker X Axis Value appears in the Active Function area. Default Active Function: the active function for the selected marker's current control mode. Note that if the current control mode is Off, there is no active function and the active function is turned off. Active Function Display: the marker X axis value entered in the active function area will display the

	marker value to its fully entered precision.
Preset	OFF
State Saved	Saved in instrument state.
Range	Normal Delta Off
Initial S/W Revision	A.03.00

Properties

Accesses a menu that allows you to set marker properties and to access the marker trace menu.

Key Path	Marker
Initial S/W Revision	A.03.00

Select Marker

Accesses menus that allows you to select one or more markers

Key Path	Marker, Properties
Initial S/W Revision	A.03.00

Relative To

Selects the marker that the selected marker will be relative to, which is referred to as its “reference marker”.

Key Path	Marker, Properties
Mode	LTETDD, LTE, LTEATDD, LTEAFDD
Remote Command	:CALCulate:PVTTime:MARKer[1] 2 ... 12:REFerence <integer> :CALCulate:PVTTime:MARKer[1] 2 ... 12:REFerence?
Example	:CALC:PVT:MARK5:REF 1 :CALC:PVT:MARK5:REF?
Notes	When queried, a single value will be returned - the specified marker number’s relative marker.
Preset	2 3 4 5 6 7 8 9 10 11 12 1
State Saved	Saved in instrument state.
Min	1
Max	12
Initial S/W Revision	A.03.00

Marker Trace

Assigns the specified marker to the designated trace.

Key Path	Marker, Properties
Mode	LTETDD, LTE, LTEATDD, LTEAFDD
Remote Command	:CALCulate:PVTime:MARKer[1] 2 ... 12:TRACe RFENvelope MAXHold MINHold :CALCulate:PVTime:MARKer[1] 2 ... 12:TRACe?
Example	:CALC:PVT:MARK:TRAC MINH :CALC:PVT:MARK:TRAC?
Preset	RFENvelope
State Saved	Saved in instrument state.
Range	RF Envelope Max Hold RF Envelope Min Hold RF Envelope
Initial S/W Revision	A.03.00

Couple Marker

When this function is invoked, moving any marker causes an “equal X Axis movement” of every other marker which is active. By “equal X Axis movement” we mean that the difference between each marker’s X Axis value (in the fundamental x-axis units of the trace that marker is on) is preserved, as is the X Axis value of the marker being moved (in the same fundamental X-axis units).

NOTE This may result in markers going off screen.

Key Path	Marker, More
Mode	LTETDD, LTE, LTEATDD, LTEAFDD
Remote Command	:CALCulate:PVTime:MARKer:COUPle[:STATE] ON OFF 1 0 :CALCulate:PVTime:MARKer:COUPle[:STATE]?
Example	CALC:PVT:MARK:COUP ON CALC:PVT:MARK:COUP?
Preset	OFF
State Saved	Saved in instrument state.
Range	On Off
Initial S/W Revision	A.03.00

All Markers Off

Turns all markers Off.

Key Path	Marker, More
----------	--------------

Mode	LTETDD, LTE, LTEATDD, LTEAFDD
Remote Command	:CALCulate:PVTTime:MARKer:AOff
Example	:CALC:PVT:MARK:AOff
Initial S/W Revision	A.03.00

Marker X Axis Value (Remote Command Only)

Sets the marker X Axis value in the current marker X Axis Scale unit. It has no effect if the control mode is Off, but is the SCPI equivalent of entering an X value, if the control mode is Normal or Delta.

Mode	LTETDD, LTE, LTEATDD, LTEAFDD
Remote Command	:CALCulate:PVTTime:MARKer[1] 2 ... 12:X <real> :CALCulate:PVTTime:MARKer[1] 2 ... 12:X?
Example	:CALC:PVT:MARK3:X 0 :CALC:PVT:MARK3:X?
Notes	If no suffix is sent, it will use the fundamental units for the current marker X Axis Scale. If a suffix is sent that does not match the current marker X Axis Scale unit, an "Invalid suffix" error will be generated. The query returns the marker's absolute X Axis value if the control mode is Normal, or the offset from the marker's reference marker, if the control mode is Delta. The query is returned in the fundamental units for the current marker X Axis scale: seconds. If the marker is off the response is not a number (NAN).
Couplings	Max value would be changed by Meas Interval in 6.3.2 in epsg1129241.
Preset	After a preset, all markers are turned OFF, so a Marker X Axis Value query will return a not a number (NAN).
State Saved	No
Min	-9.9E+37
Max	9.9E+37
Initial S/W Revision	A.03.00

Marker X Axis Position (Remote Command only)

Sets the marker X position in trace points. This allows you to enter a value in trace points rather than in X Axis Scale units. The entered value is immediately converted into the current X Axis Scale unit for setting the value of the marker. It has no effect if the control mode is Off, but is the SCPI equivalent of entering an X value, if the control mode is Normal or Delta.

Mode	LTETDD, LTE, LTEATDD, LTEAFDD
Remote Command	:CALCulate:PVTTime:MARKer[1] 2 ... 12:X:POSition <real> :CALCulate:PVTTime:MARKer[1] 2 ... 12:X:POSition?
Example	:CALC:PVT:MARK10:X:POS 500

	:CALC:PVT:MARK10:X:POS?
Notes	A query returns the marker's absolute X Axis value in trace points, if the control mode is Normal, or the offset from the marker's reference marker in trace points, if the control mode is Delta. If the marker is Off the response is not a number (NAN).
Preset	After a preset, all markers are turned Off, so a Marker X Axis Value query will return a not a number (NAN).
State Saved	No
Min	-9.9E+37
Max	9.9E+37
Initial S/W Revision	A.03.00

Marker Y Axis Value (Remote Command only)

Returns the marker Y Axis value in the current marker Y Axis unit.

The “result” of a marker is the value that is displayed on the second line of the Marker Result block. To properly interpret the returned value, you must also know how the analyzer's Y-Axis Unit is set, as described below.

A marker can have up to two results, only one of which is displayed or returned in a query, as follows:

- Absolute result: every marker has an absolute result. For Normal and Delta markers, the Y-axis value of the trace point the marker is currently On. The absolute result is displayed in the result block or returned as a query, unless the marker control mode is Delta.
- Relative result: if a marker's control mode is Delta, the relative result is displayed in the result block or returned in a query. This is the ratio of the Absolute Result of a delta marker to the Absolute Result of its reference marker. The ratio is expressed in dB.

Mode	LTETDD, LTE, LTEATDD, LTEAFDD
Remote Command	:CALCulate:PVTTime:MARKer[1] 2 ... 12:Y?
Example	:CALC:PVT:MARK11:Y 0 :CALC:PVT:MARK11:Y?
Notes	The query returns the marker Y-axis result. If the marker is Off the response is not a number (NAN).
Preset	0
State Saved	No
Initial S/W Revision	A.03.00

Maker State (Remote Command Only)

Sets or queries the state of a marker. Setting a marker which is Off to state On, or 1, puts it in Normal mode and places it at the center of the screen.

14 Transmit On/Off Power Measurement Functions
Marker

Mode	LTETDD, LTE, LTEATDD, LTEAFDD
Remote Command	:CALCulate:PVTTime:MARKer[1] 2 ... 12:STATe OFF ON 0 1 :CALCulate:PVTTime:MARKer[1] 2 ... 12:STATe?
Example	:CALC:PVT:MARK3:STATE ON :CALC:PVT:MARK3:STATE?
Preset	OFF
State Saved	Saved in instrument state.
Range	On Off
Initial S/W Revision	A.03.00

Marker Fctn

There are no 'Marker Functions' supported in transmit On/Off Power measurement. Pressing this key will display a blank menu.

Key Path	Front-panel key
Initial S/W Revision	A.03.00

Marker To

There is no 'Marker To' functionality supported in Transmit On/Off Power measurement so this front-panel key will display a blank menu when pressed

Key Path	Front-panel key
Initial S/W Revision	A.03.00

Meas

The information in this section is common to all measurements. For key and remote command information for a specific measurement, refer to the section that describes the measurement of interest.

Measurements available under the Meas key are specific to the current Mode.

When viewing Help for measurements, note the following:

NOTE

Operation for some keys differs between measurements. The information displayed in Help pertains to the current measurement. To see how a key operates in a different measurement, exit Help (press the Cancel Esc key), select the measurement, then reenter Help (press the Help key) and press that key.

Key Path	Front-panel key
Initial S/W Revision	Prior to A.02.00

Remote Measurement Functions

This section contains the following topics:

"Measurement Group of Commands" on page 2771

"Current Measurement Query (Remote Command Only)" on page 2773

"Limit Test Current Results (Remote Command Only)" on page 2773

"Data Query (Remote Command Only)" on page 2773

"Calculate/Compress Trace Data Query (Remote Command Only)" on page 2774

"Calculate Peaks of Trace Data (Remote Command Only)" on page 2779

Hardware-Accelerated Fast Power Measurement (Remote Command Only)

"Format Data: Numeric Data (Remote Command Only)" on page 2780

"Format Data: Byte Order (Remote Command Only)" on page 2781

Initial S/W Revision	Prior to A.02.00
----------------------	------------------

Measurement Group of Commands

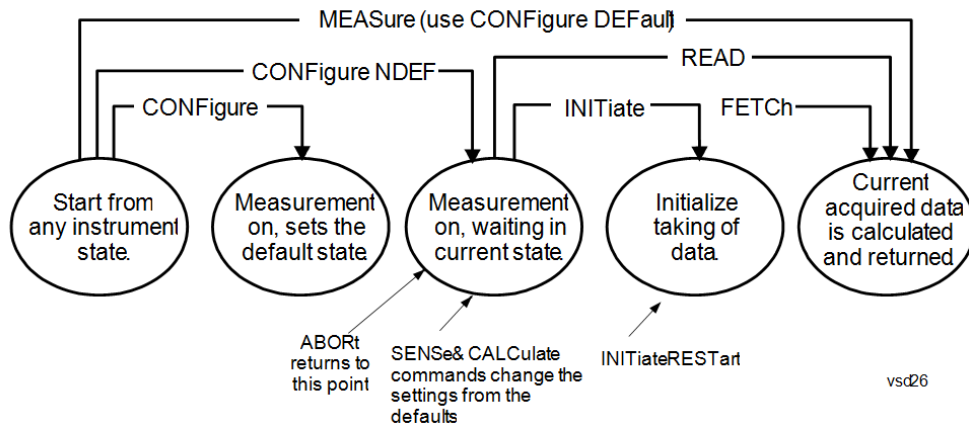

Measure Commands:

:MEASure:<measurement>[n]?

This is a fast single-command way to make a measurement using the factory default instrument settings. These are the settings and units that conform to the Mode Setup settings (e.g. radio standard) that you have currently selected.

- Stops the current measurement (if any) and sets up the instrument for the specified measurement using the factory defaults
- Initiates the data acquisition for the measurement
- Blocks other SCPI communication, waiting until the measurement is complete before returning results.
- If the function does averaging, it is turned on and the number of averages is set to 10.
- After the data is valid it returns the scalar results, or the trace data, for the specified measurement. The type of data returned may be defined by an [n] value that is sent with the command.
- The scalar measurement results will be returned if the optional [n] value is not included, or is set to 1. If the [n] value is set to a value other than 1, the selected trace data results will be returned. See each command for details of what types of scalar results or trace data results are available.
- ASCII is the default format for the data output. (Older versions of Spectrum Analysis and Phase Noise mode measurements only use ASCII.) The binary data formats should be used for handling large blocks of data since they are smaller and faster than the ASCII format. Refer to the FORMat:DATA command for more information.

If you need to change some of the measurement parameters from the factory default settings you can set up the measurement with the CONFIgure command. Use the commands in the SENSE:<measurement> and CALCulate:<measurement> subsystems to change the settings. Then you can use the READ? command to initiate the measurement and query the results.

If you need to repeatedly make a given measurement with settings other than the factory defaults, you can use the commands in the SENSE:<measurement> and CALCulate:<measurement> subsystems to set up the measurement. Then use the READ? command to initiate the measurement and query results.

Measurement settings persist if you initiate a different measurement and then return to a previous one. Use READ:<measurement>? if you want to use those persistent settings. If you want to go back to the default settings, use MEASure:<measurement>?.

Configure Commands:

:CONFIgure:<measurement>

This command stops the current measurement (if any) and sets up the instrument for the specified measurement using

the factory default instrument settings. It does not initiate the taking of measurement data unless INIT:CONTInuous is ON. If you change any measurement settings after using the CONFigure command, the READ command can be used to initiate a measurement without changing the settings back to their defaults.

In the Swept SA measurement in Spectrum Analyzer mode the CONFigure command also turns the averaging function on and sets the number of averages to 10 for all measurements.

:CONFigure: <measurement>: NDEFault stops the current measurement and changes to the specified measurement. It does not change the settings to the defaults. It does not initiate the taking of measurement data unless INIT:CONTInuous is ON.

The CONFigure? query returns the current measurement name.

The CONFigure:CATalog? query returns a quoted string of all licensed measurement names in the current mode. For example, "SAN, CHP, OBW, ACP, PST, TXP, SPUR, SEM, LIST".

Fetch Commands:

:FETCh:<measurement>[n]?

This command puts selected data from the most recent measurement into the output buffer. Use FETCh if you have already made a good measurement and you want to return several types of data (different [n] values, for example, both scalars and trace data) from a single measurement. FETCh saves you the time of re-making the measurement. You can only FETCh results from the measurement that is currently active, it will not change to a different measurement. An error message is reported if a measurement other than the current one is specified.

If you need to get new measurement data, use the READ command, which is equivalent to an INITiate followed by a FETCh.

The scalar measurement results will be returned if the optional [n] value is not included, or is set to 1. If the [n] value is set to a value other than 1, the selected trace data results will be returned. See each command for details of what types of scalar results or trace data results are available. The binary data formats should be used for handling large blocks of data since they are smaller and transfer faster than the ASCII format. (FORMat:DATA)

FETCh may be used to return results other than those specified with the original READ or MEASure command that you sent.

INITiate Commands:

:INITiate:<measurement>

This command is not available for measurements in all the instrument modes:

- Initiates a trigger cycle for the specified measurement, but does not output any data. You must then use the FETCh<meas> command to return data. If a measurement other than the current one is specified, the instrument will switch to that measurement and then initiate it.
 - For example, suppose you have previously initiated the ACP measurement, but now you are running the channel power measurement. If you send INIT:ACP? it will change from channel power to ACP and will initiate an ACP measurement.
 - Does not change any of the measurement settings. For example, if you have previously started the ACP measurement and you send INIT:ACP? it will initiate a new ACP measurement using the same instrument settings as the last time ACP was run.
 - If your selected measurement is currently active (in the idle state) it triggers the measurement, assuming the trigger conditions are met. Then it completes one trigger cycle. Depending upon the measurement and the number of averages, there may be multiple data acquisitions, with multiple trigger events, for one full trigger cycle. It also holds off additional commands on GPIB until the acquisition is complete.
-

READ Commands:

:READ:<measurement>[n]?

- Does not preset the measurement to the factory default settings. For example, if you have previously initiated the ACP
-

measurement and you send READ:ACP? it will initiate a new measurement using the same instrument settings.

- Initiates the measurement and puts valid data into the output buffer. If a measurement other than the current one is specified, the instrument will switch to that measurement before it initiates the measurement and returns results.
 - For example, suppose you have previously initiated the ACP measurement, but now you are running the channel power measurement. Then you send READ:ACP? It will change from channel power back to ACP and, using the previous ACP settings, will initiate the measurement and return results.
 - Blocks other SCPI communication, waiting until the measurement is complete before returning the results
 - If the optional [n] value is not included, or is set to 1, the scalar measurement results will be returned. If the [n] value is set to a value other than 1, the selected trace data results will be returned. See each command for details of what types of scalar results or trace data results are available. The binary data formats should be used when handling large blocks of data since they are smaller and faster than the ASCII format. (FORMat:DATA)
-

Initial S/W Revision	Prior to A.02.00
----------------------	------------------

Current Measurement Query (Remote Command Only)

This command returns the name of the measurement that is currently running.

Remote Command	:CONFigure?
-----------------------	-------------

Example	CONF?
----------------	-------

Initial S/W Revision	Prior to A.02.00
----------------------	------------------

Limit Test Current Results (Remote Command Only)

Queries the status of the current measurement limit testing. It returns a 0 if the measured results pass when compared with the current limits. It returns a 1 if the measured results fail any limit tests.

Remote Command	:CALCulate:CLIMits:FAIL?
-----------------------	--------------------------

Example	CALC:CLIM:FAIL? queries the current measurement to see if it fails the defined limits. Returns a 0 or 1: 0 it passes, 1 it fails.
----------------	--

Initial S/W Revision	Prior to A.02.00
----------------------	------------------

Data Query (Remote Command Only)

Returns the designated measurement data for the currently selected measurement and subopcode.

n = any valid subopcode for the current measurement. See the measurement command results table for your current measurement, for information about what data is returned for the subopcodes.

This command uses the data setting specified by the FORMat:BORDER and FORMat:DATA commands and can return real or ASCII data. (See the format command descriptions under Input/Output in the Analyzer Setup section.)

Remote Command	:CALCulate:DATA[n]?
Notes	The return trace depends on the measurement. In CALCulate:<meas>:DATA[n], n is any valid subopcode for the current measurement. It returns the same data as the FETCH:<measurement>? query where <measurement> is the current measurement.
Initial S/W Revision	Prior to A.02.00

Calculate/Compress Trace Data Query (Remote Command Only)

Returns compressed data for the currently selected measurement and sub-opcode [n].

n = any valid sub-opcode for that measurement. See the MEASure:<measurement>? command description of your specific measurement for information on the data that can be returned.

The data is returned in the current Y Axis Unit of the analyzer. The command is used with a sub-opcode <n> (default=1) to specify the trace. With trace queries, it is best if the analyzer is not sweeping during the query. Therefore, it is generally advisable to be in Single Sweep, or Update=Off.

This command is used to compress or decimate a long trace to extract and return only the desired data. A typical example would be to acquire N frames of GSM data and return the mean power of the first burst in each frame. The command can also be used to identify the best curve fit for the data.

Remote Command	:CALCulate:DATA<n>:COMPRESS? BLOCK CFIT MAXimum MINimum MEAN DMEan RMS RMSCubed SAMPLE SDEVIation PPHase [,<soffset> [,<length>[,<roffset>[,<rlimit>]]]]
Example	To query the mean power of a set of GSM bursts: Supply a signal that is a set of GSM bursts. Select the IQ Waveform measurement (in IQ Analyzer Mode). Set the sweep time to acquire at least one burst. Set the triggers such that acquisition happens at a known position relative to a burst. Then query the mean burst levels using, CALC:DATA2:COMP? MEAN, 24e-6, 526e-6 (These parameter values correspond to GSM signals, where 526e-6 is the length of the burst in the slot and you just want 1 burst.)
Notes	The command supports 5 parameters. Note that the last 4 (<soffset>, <length>, <roffset>, <rlimit>) are optional. But these optional parameters must be entered in the specified order. For example, if you want to specify <length>, then you must also specify <soffset>. See details below for a definition of each of these parameters. This command uses the data in the format specified by FORMat:DATA, returning either binary or ASCII data.
Initial S/W Revision	Prior to A.02.00

- BLOCK or block data - returns all the data points from the region of the trace data that you specify. For example, it could be used to return the data points of an input signal over several timeslots, excluding the portions of the trace data that you do not want. (This is x,y pairs for trace data and I,Q pairs for complex data.)

- CFIT or curve fit - applies curve fitting routines to the data. <soffset> and <length> are required to define the data that you want. <roffset> is an optional parameter for the desired order of the curve equation. The query will return the following values: the x-offset (in seconds) and the curve coefficients ((order + 1) values).

MIN, MAX, MEAN, DME, RMS, RMSC, SAMP, SDEV and PPH return one data value for each specified region (or <length>) of trace data, for as many regions as possible until you run out of trace data (using <roffset> to specify regions). Or they return the number of regions you specify (using <rlimit>) ignoring any data beyond that.

- MINimum - returns the minimum data point (y value) for the specified region(s) of trace data. For I/Q trace data, the minimum magnitude of the I/Q pairs is returned.
- MAXimum - returns the maximum data point (y value) for the specified region(s) of trace data. For I/Q trace data, the maximum magnitude of the I/Q pairs is returned.
- MEAN - returns a single value that is the arithmetic mean of the data point values (in dB/ dBm) for the specified region(s) of trace data. For I/Q trace data, the mean of the magnitudes of the I/Q pairs is returned. See the following equations.

•

NOTE If the original trace data is in dB, this function returns the arithmetic mean of those log values, not log of the mean power which is a more useful value. The mean of the log is the better measurement technique when measuring CW signals in the presence of noise. The mean of the power, expressed in dB, is useful in power measurements such as Channel Power. To achieve the mean of the power, use the RMS option.

Equation 1

Mean Value of Data Points for Specified Region(s)

$$\text{MEAN} = \frac{1}{n} \sum_{X_i \in \text{region}(s)} X_i$$

where X_i is a data point value, and n is the number of data points in the specified region(s).

Equation 2

Mean Value of I/Q Data Pairs for Specified Region(s)

$$\text{MEAN} = \frac{1}{n} \sum_{X_i \in \text{region}(s)} |X_i|$$

where $|X_i|$ is the magnitude of an I/Q pair, and n is the number of I/Q pairs in the specified region(s).

- DMEan - returns a single value that is the mean power (in dB/ dBm) of the data point values for the specified region(s) of trace data. See the following equation:

Equation 3

DMEan Value of Data Points for Specified Region(s)

$$\text{DME} = 10 \times \log_{10} \left(\frac{1}{n} \sum_{X_i \in \text{region}(s)} 10^{\frac{X_i}{10}} \right)$$

- RMS - returns a single value that is the average power on a root-mean-squared voltage scale (arithmetic rms) of the data point values for the specified region(s) of trace data. See the following equation.

NOTE For I/Q trace data, the rms of the magnitudes of the I/Q pairs is returned. See the following equation. This function is very useful for I/Q trace data. However, if the original trace data is in dB, this function returns the rms of the log values which is not usually needed.

Equation 4

RMS Value of Data Points for Specified Region(s)

$$\text{RMS} = \sqrt{\frac{1}{n} \sum_{X_i \in \text{region}(s)} X_i^2}$$

where X_i is a data point value, and n is the number of data points in the specified region(s).

Equation 5

RMS Value of I/Q Data Pairs for Specified Region(s)

$$\text{RMS} = \sqrt{\frac{1}{n} \sum_{X_i \in \text{region}(s)} X_i X_i^*}$$

where X_i is the complex value representation of an I/Q pair, X_i^* its conjugate complex number, and n is the number of I/Q pairs in the specified region(s).

Once you have the rms value for a region of trace data (linear or I/Q), you may want to calculate the mean power. You must convert this rms value (peak volts) to power in dBm:

$$10 \times \log[10 \times (\text{rms value})^2]$$

- SAMPLe - returns the first data value (x,y pair) for the specified region(s) of trace data. For I/Q trace data, the first I/Q pair is returned.
- SDEViation - returns a single value that is the arithmetic standard deviation for the data point values for the specified region(s) of trace data. See the following equation.
- For I/Q trace data, the standard deviation of the magnitudes of the I/Q pairs is returned. See the following equation.

Equation 6

Standard Deviation of Data Point Values for Specified Region(s)

$$\text{SDEV} = \sqrt{\frac{1}{n} \sum_{X_i \in \text{region}(s)} (X_i - \bar{X})^2}$$

where X_i is a data point value, \bar{X} is the arithmetic mean of the data point values for the specified region (s), and n is the number of data points in the specified region(s).

$$\text{SDEV} = \sqrt{\frac{1}{n} \sum_{X_i \in \text{region}(s)} (|X_i| - \bar{X})^2}$$

where $|X_i|$ is the magnitude of an I/Q pair, \bar{X} is the mean of the magnitudes for the specified region(s), and n is the number of data points in the specified region(s).

- PPHase - returns the x,y pairs of both rms power (dBm) and arithmetic mean phase (radian) for every specified region and frequency offset (Hz). The number of pairs is defined by the specified number of regions. This parameter can be used for I/Q vector ($n=0$) in Waveform (time domain) measurement and all parameters are specified by data point in PPHase.

The rms power of the specified region may be expressed as:

$$\text{Power} = 10 \times \log [10 \times (\text{RMS I/Q value})] + 10.$$

The RMS I/Q value (peak volts) is:

$$\sqrt{\frac{1}{n} \sum_{X_i \in \text{region}} X_i X_i^*}$$

where X_i is the complex value representation of an I/Q pair, X_i^* its conjugate complex number, and n is the number of I/Q pairs in the specified region.

The arithmetic mean phase of the specified region may be expressed as:

$$\frac{1}{n} \sum_{Y_i \in \text{region}} Y_i$$

where Y_i is the unwrapped phase of I/Q pair with applying frequency correction and n is the number of I/Q pairs in the specified region.

The frequency correction is made by the frequency offset calculated by the arithmetic mean of every specified region's frequency offset. Each frequency offset is calculated by the least square method against the unwrapped phase of I/Q pair.

Sample Trace Data - Constant Envelope

(See below for explanation of variables.)

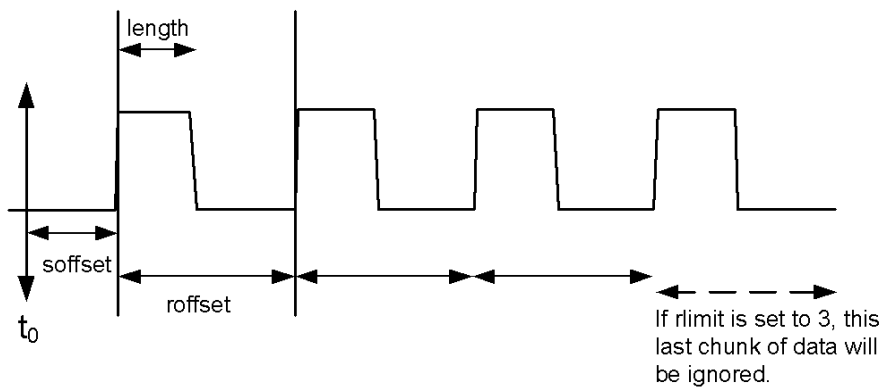

Sample Trace Data - Not Constant Envelope

(See below for explanation of variables.)

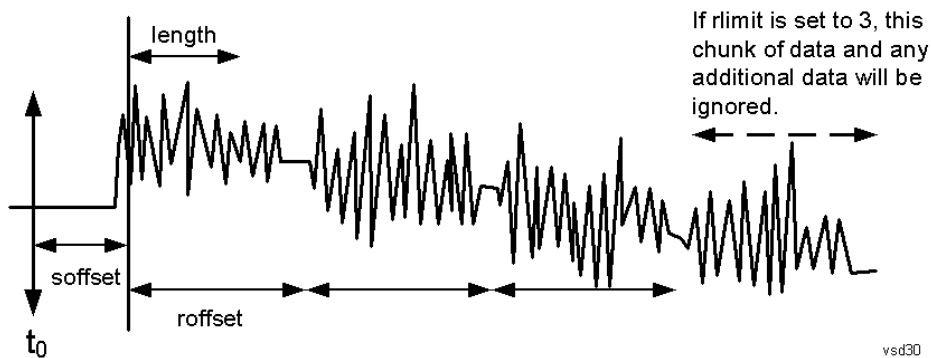

<soffset> - start offset is an optional real number. (It is in seconds for time-domain traces, and is a dimensionless index 0 to Npoints - 1, for frequency-domain traces). It specifies the amount of data at the beginning of the trace that will be ignored before the decimation process starts. It is the time or frequency change from the start of the trace to the point where you want to start using the data. The default value is zero.

<length> - is an optional real number. (It is in seconds for time-domain traces, and is a dimensionless index 0 to Npoints - 1, for frequency-domain traces). It defines how much data will be compressed into one value. This parameter has a default value equal to the current trace length.

<roffset> - repeat offset is an optional real number. (It is in seconds for time-domain traces, and is a dimensionless index 0 to Npoints - 1, for frequency-domain traces). It defines the beginning of the next field of trace elements to be compressed. This is relative to the beginning of the previous field. This parameter has a default value equal to the <length> variable. Note that this parameter is used for a completely different purpose when curve fitting (see CFIT above).

<rlimit> - repeat limit is an optional integer. It specifies the number of data items that you want returned. It will ignore any additional items beyond that number. You can use the Start offset and the Repeat limit to pick out exactly what part of the data you want to use. The default value is all the data.

Calculate Peaks of Trace Data (Remote Command Only)

Returns a list of all the peaks for the currently selected measurement and sub-opcode [n]. The peaks must meet the requirements of the peak threshold and excursion values.

n = any valid sub-opcode for the current measurement. See the MEASure:<measurement> command description of your specific measurement for information on the data that can be returned.

The command can only be used with specific sub-opcodes with measurement results that are trace data. Both real and complex traces can be searched, but complex traces are converted to magnitude in dBm. In many measurements the sub-opcode n=0, is the raw trace data which cannot be searched for peaks. And Sub-opcode n=1, is often calculated results values which also cannot be searched for peaks.

This command uses the data setting specified by the FORMat:BORDER and FORMat:DATA commands and can return real or ASCII data. If the format is set to INT,32, it returns REAL,32 data.

The command has four types of parameters:

- Threshold (in dBm)
- Excursion (in dB)
- Sorting order (amplitude, frequency, time)
- Optional in some measurements: Display line use (all, > display line, < display line)

Remote Command	<p>For Swept SA measurement:</p> <pre>:CALCulate:DATA[1] 2 ... 6:PEAKs? <threshold>,<excursion>[,AMPLitude FREQuency TIME[,ALL GTDLine LTDLine]]</pre> <p>For most other measurements:</p> <pre>:CALCulate:DATA[1] 2 ... 6:PEAKs? <threshold>,<excursion>[,AMPLitude FREQuency TIME]</pre>
-----------------------	--

Example	<p>Example for Swept SA measurement in Spectrum Analyzer Mode:</p> <p>CALC:DATA4:PEAK? -40, 10, FREQ, GTDL This will identify the peaks of trace 4 that are above -40 dBm, with excursions of at least 10 dB. The peaks are returned in order of increasing frequency, starting with the lowest frequency. Only the peaks that are above the display line are returned.</p> <p>Query Results 1:</p> <p>With FORMat:DATA REAL, 32 selected, it returns a list of floating-point numbers. The first value in the list is the number of peak points that are in the following list. A peak point consists of two values: a peak amplitude followed by its corresponding frequency (or time).</p> <p>If no peaks are found the peak list will consist of only the number of peaks, (0).</p>
----------------	---

Notes	<p><n> - is the trace that will be used</p> <p><threshold> - is the level below which trace data peaks are ignored. Note that the threshold value is required and is always used as a peak criterion. To effectively disable the threshold criterion for this command, provide a substantially low threshold value such as -200 dBm. Also note that the threshold value used in this command is independent of and has no effect on the threshold value stored under the Peak Criteria menu.</p> <p><excursion> - is the minimum amplitude variation (rise and fall) required for a signal to be identified as peak. Note that the excursion value is required and is always used as a peak criterion. To effectively disable the excursion criterion for this command, provide the minimum value of 0.0 dB. Also note that the excursion value used in this command is independent of and has no effect on the</p>
--------------	---

excursion value stored under the Peak Criteria menu.

Values must be provided for threshold and excursion. The sorting and display line parameters are optional (defaults are AMPLitude and ALL).

Note that there is always a Y-axis value for the display line, regardless of whether the display line state is on or off. It is the current Y-axis value of the display line which is used by this command to determine whether a peak should be reported

Sorting order:

AMPLitude - lists the peaks in order of descending amplitude, with the highest peak first (default if optional parameter not sent)

FREQUency - lists the peaks in order of occurrence, left to right across the x-axis.

TIME - lists the peaks in order of occurrence, left to right across the x-axis.

Peaks vs. Display Line:

ALL - lists all of the peaks found (default if optional parameter not sent).

GTDLine (greater than display line) - lists all of the peaks found above the display line.

LTDLine (less than display line) - lists all of the peaks found below the display line.

Initial S/W Revision Prior to A.02.00

Format Data: Numeric Data (Remote Command Only)

This command specifies the format of the trace data input and output. It specifies the formats used for trace data during data transfer across any remote port. It affects only the data format for setting and querying trace data for the :TRACe[:DATA], TRACe[:DATA]?, :CALCulate:DATA[n]? and FETCh:SANalyzer [n]? commands and queries.

Remote Command	:FORMat[:TRACe][:DATA] ASCii INTeger,32 REAL,32 REAL,64 :FORMat[:TRACe][:DATA]?
Notes	The query response is: ASCii: ASC,8 REAL,32: REAL,32 REAL,64: REAL,64 INTeger,32: INT,32 When the numeric data format is REAL or ASCii, data is output in the current Y Axis unit. When the data format is INTeger, data is output in units of m dBm (.001 dBm). The INT,32 format returns binary 32-bit integer values in internal units (m dBm), in a definite length block.
Dependencies	Sending a data format spec with an invalid number (for example, INT,48) generates no error. The analyzer simply uses the default (8 for ASCii, 32 for INTeger, 32 for REAL). Sending data to the analyzer which does not conform to the current FORMat specified, results in an error. Sending ASCII data when a definite block is expected generates message -161 "Invalid Block Data" and sending a definite block when ASCII data is expected generates message -121 "Invalid Character in Number".
Preset	ASCii
Backwards Compatibility Notes	Note that the INT,32 format is only applicable to the command, TRACe:DATA. This preserves backwards compatibility for the Swept SA measurement. For all other commands/queries which honor FORMat:DATA, if INT,32 is sent the analyzer will behave as though it were set to REAL,32.
Initial S/W Revision	Prior to A.02.00

The specs for each output type follow:

AScii - Amplitude values are in ASCII, in the current Y Axis Unit, one ASCII character per digit, values separated by commas, each value in the form:

SX.YYYYYEsZZ

Where:

S = sign (+ or -)

X = one digit to left of decimal point

Y = 5 digits to right of decimal point

E = E, exponent header

s = sign of exponent (+ or -)

ZZ = two digit exponent

REAL,32 - Binary 32-bit real values in the current Y Axis Unit, in a definite length block.

REAL,64 - Binary 64-bit real values in the current Y Axis Unit, in a definite length block.

Format Data: Byte Order (Remote Command Only)

This command selects the binary data byte order for data transfer and other queries. It controls whether binary data is transferred in normal or swapped mode. This command affects only the byte order for setting and querying trace data for the :TRACe[:DATA], TRACe[:DATA]? , :CALCulate:DATA[n]? and FETCh:SANalyzer[n]? commands and queries.

By definition any command that says it uses FORMat:DATA uses any format supported by FORMat:DATA.

The NORMal order is a byte sequence that begins with the most significant byte (MSB) first, and ends with the least significant byte (LSB) last in the sequence: 1|2|3|4. SWAPped order is when the byte sequence begins with the LSB first, and ends with the MSB last in the sequence: 4|3|2|1.

Remote Command	:FORMat:BORDER NORMal SWAPped :FORMat:BORDER?
Preset	NORMal
Initial S/W Revision	Prior to A.02.00

Meas Setup

Accesses the measurement setup menu for the current measurement.

Key Path	Front-panel key
Initial S/W Revision	A.03.00

Avg/Hold Num

Used to specify the number of data acquisitions that will be averaged. After the specified number of average counts, the averaging mode (termination control) setting determines the averaging action.

- On - Sets measurement averaging on.
- Off - Sets measurement averaging off.

Key Path	Meas Setup
Mode	LTETDD, LTE, LTEATDD, LTEAFDD
Remote Command	[:SENSe]:PVT:AVERage:COUNT <integer> [:SENSe]:PVT:AVERage:COUNT? [:SENSe]:PVT:AVERage[:STATe] OFF ON 0 1 [:SENSe]:PVT:AVERage[:STATe]?
Example	:SENS:PVT:AVER:COUN 10 :SENS:PVT:AVER:COUN? :SENS:PVT:AVER:STAT OFF :SENS:PVT:AVER:STAT?
Preset	10 OFF
State Saved	Saved in instrument state.
Min	1
Max	10000
Initial S/W Revision	A.03.00

Avg Mode

Selects the type of termination control used for the averaging function. This determines the averaging action after the specified number of data acquisitions (average count) is reached.

KEY:Exponential SCPI:EXPonential	After the average count is reached, each successive data acquisition is exponentially weighted and combined with the existing average.
KEY:Repeat SCPI:REPeat	After reaching the average count, the averaging is reset and a new average is started. The default value is Exp.

Key Path	Meas Setup
Mode	LTETDD, LTE, LTEATDD, LTEAFDD
Remote Command	[:SENSe] :PVTime :AVERage :TCONtrol EXPonential REPeat [:SENSe] :PVTime :AVERage :TCONtrol ?
Example	:SENS:PVT:AVER:TCON REP :SENS:PVT:AVER:TCON?
Preset	REPeat
State Saved	Saved in instrument state.
Range	Exp Repeat
Initial S/W Revision	A.03.00

Avg Type

Specifies the type of trace and result averaging to use.

KEY:Pwr Avg (RMS) SCPI:RMS POWer	True power averaging that is equivalent to taking the RMS value of the voltage. It is the most accurate type of averaging.
KEY:Log-Pwr Avg (Video) SCPI:LOG LPOWer	Simulates the traditional spectrum analyzer type of averaging by averaging the log of the power.

Key Path	Meas Setup
Mode	LTETDD, LTE, LTEATDD, LTEAFDD
Remote Command	[:SENSe] :PVTime :AVERage :TYPE LOG LPOWer RMS POWer [:SENSe] :PVTime :AVERage :TYPE ?
Example	:SENS:PVT:AVER:TYPE RMS :SENS:PVT:AVER:TYPE?
Preset	RMS
State Saved	Saved in instrument state.
Range	Pwr Avg (RMS) Log-Pwr Avg(Video)
Initial S/W Revision	A.03.00

Ramp Time Length

This parameter indicates the searching window length from which the ramp on and down is searched. If it is set shorter than actual ramp time, the ramp may be lost.

Key Path	Meas Setup
----------	------------

Mode	LTETDD, LTE, LTEATDD, LTEAFDD
Remote Command	[:SENSe] :PVTime:RAMP:SEARch:LENGth <time> [:SENSe] :PVTime:RAMP:SEARch:LENGth?
Example	PVT:RAMP:SEAR:LENG 1.0 PVT:RAMP:SEAR:LENG?
Preset	17.0 us
State Saved	Saved in instrument state.
Min	1.0 us
Max	100.0 us
Initial S/W Revision	A.07.00

IF Gain

Accesses the menu that sets ranging in the digital IF when acquiring an I/Q time record.

See "[More Information about IF Gain](#)" on page 1699.

NOTE

This function is not affected by RF Input Range attenuation.

Key Path	Meas Setup
Initial S/W Revision	A.03.00

More Information about IF Gain

To take full advantage of the RF dynamic range of the analyzer, you can manually turn on or turn off a switched digital IF amplifier. When it is turned on, the signal will get approximately 10 dB of gain.

- Setting IF Gain to Man and selecting High Gain will turn on the digital IF amplifier and get an extra 10 dB gain.
- Setting IF Gain to Auto will activate the Auto rules for IF Gain.

These settings affect sensitivity and IF overloads.

IF Gain Auto

Activates the Auto Rules for IF Gain. When Auto is active, the IF Gain is set to High Gain under any of the following conditions:

- the input attenuator is set to 0 dB
- the preamp is turned On
- the Max Mixer Level is -20 dBm or lower

For other settings, Auto sets IF Gain to Off.

Key Path	Meas Setup,IF Gain
Mode	LTETDD, LTE, LTEATDD, LTEAFDD
Remote Command	[:SENSe] :PVTime:IF:GAIN:AUTO [:STATe] ON OFF 1 0 [:SENSe] :PVTime:IF:GAIN:AUTO [:STATe] ?
Example	PVT:IF:GAIN:AUTO ON PVT:IF:GAIN:AUTO?
Couplings	When either the auto attenuation is active (for example, with an electrical attenuator), or the optimize mechanical attenuator range is requested, the IF Gain setting is changed using the following rule. The Auto selection sets IF Gain On under any of the following conditions: <ul style="list-style-type: none"> • the input attenuator is set to 0 dB • the preamp is turned on, • the Max Mixer Level is -20 dBm or lower. For other settings, Auto sets IF Gain to Off.
Preset	OFF
State Saved	Saved in instrument state.
Range	Auto Man
Initial S/W Revision	A.03.00

IF Gain State

Selects the range of IF gain.

- On sets the high gain option, which allows for better noise level measurements.
- Off sets low gain when measuring large signals.

When this parameter is changed manually from front panel, IF Gain Auto will become Man.

Key Path	Meas Setup, IF Gain
Mode	LTETDD, LTE, LTEATDD, LTEAFDD
Remote Command	[:SENSe] :PVTime:IF:GAIN [:STATe] ON OFF 1 0 [:SENSe] :PVTime:IF:GAIN [:STATe] ?
Example	PVT:IF:GAIN ON PVT:IF:GAIN?
Notes	where ON = high gain OFF = low gain
Preset	OFF
State Saved	Saved in instrument state.
Range	Low Gain (Best for Large Signals) High Gain (Best Noise Level)
Readback Text	Low Gain High Gain
Initial S/W Revision	A.03.00

Limits

Accesses the setup menu for the measurement ramp up, ramp down time and threshold for off power.

Please note, whether the pass/fail shown in measurement bar(at upper-left corner of screen) will be pass or fail is just determined by the threshold listed in Limits menu, they are Max Ramp Up Time, Max Ramp Down Time, Downlink Off Power and Uplink Off Power. If and only if ramp up time, ramp down time and off power (downlink or uplink) measured are all less than Max Ramp Up Time, Max Ramp Down Time and Off Power

(downlink or uplink) separately, the Pass/Fail flag is set to pass(green), otherwise Pass/Fail flag is set to fail(red). The limit mask shown on screen is just to indicate which part is active burst and which part is inactive burst, the mask is nothing to do with the Pass/Fail criteria.

Key Path	Meas Setup
Initial S/W Revision	A.03.00

Max Ramp Down Time

It used as threshold which can judge whether the real measured ramp down time can be passed or not. If real measured ramp down time exceeds Max Ramp Down Time, then ramp down time measurement fails, otherwise, it passes.

Key Path	Meas Setup, More, Limits
Mode	LTETDD, LTE
Remote Command	<code>[:SENSE] :PVTime:LIMit:RAMP:DRTtime <time></code> <code>[:SENSe] :PVTime:LIMit:RAMP:DRTtime? [:SENSe] :PVTime:LIMit:RAMP:DRTtime?</code>
Example	<code>PVT:LIM:RAMP:DRT 17.0e-6</code> <code>PVT:LIM:RAMP:DRT?</code>
Couplings	While Downlink is selected, the default value is 17us, and while Uplink is selected, the default value is 20.0us.
Preset	17.0 us
State Saved	No
Min	1.0 us
Max	100.0 us
Initial S/W Revision	A.03.00

Max Ramp Up Time

It used as threshold which can judge whether the real measured ramp up time can be passed or not. If real measured ramp up time exceeds Max Ramp Up Time, then ramp up time measurement fails, otherwise, it passes.

Key Path	Meas Setup, More, Limits
Mode	LTETDD, LTE, LTEATDD, LTEAFDD
Remote Command	[:SENSe] :PVTime:LIMit:RAMP:URTime <time> [:SENSe] :PVTime:LIMit:RAMP:URTime?
Example	PVT:LIM:RAMP:URT 17.0e-6 PVT:LIM:RAMP:URT?
Couplings	While Downlink is selected, the default value is 17us, and while Uplink is selected, the default value is 20.0us.
Preset	17.0 us
State Saved	No
Min	1.0 us
Max	100.0 us
Initial S/W Revision	A.03.00

Downlink Off Power

It is used as threshold in downlink which can judge whether the real measured off power can be passed or not. If real measured off power exceeds Downlink Off Power, then off power measurement fails, otherwise, it passes. Please note, the unit of this parameter is dBm/MHz.

Key Path	Meas Setup, More, Limits
Mode	LTETDD, LTE, LTEATDD, LTEAFDD
Remote Command	[:SENSe] :PVTime:LIMit:POFF:DLINK <real> [:SENSe] :PVTime:LIMit:POFF:DLINK? [:SENSe] :PVTime:LIMit:POFF:DLINK?
Example	PVT:LIM:POFF:DLIN -89.0 PVT:LIM:POFF:DLIN?
Preset	-85.00
State Saved	Saved in instrument state.
Min	-150.00
Max	0.00
Initial S/W Revision	A.04.00

Uplink Off Power

It is used as threshold in uplink which can judge whether the real measured off power can be passed or not. If real measured off power exceeds Uplink Off Power, then off power measurement fails, otherwise, it passes. Please note, the unit of this parameter is dBm.

Key Path	Meas Setup, More, Limits
----------	--------------------------

Mode	LTETDD, LTE, LTEATDD, LTEAFDD
Remote Command	[:SENSe] :PVTime:LIMit:POFF:ULINK <real> [:SENSe] :PVTime:LIMit:POFF:ULINK?
Example	PVT:LIM:POFF:ULIN -50.0 PVT:LIM:POFF:ULIN?
Preset	-50.00
State Saved	Saved in instrument state.
Min	-150.00 dBm
Max	0.00 dBm
Initial S/W Revision	A.04.00

Threshold

Accesses the setup menu to set the thresholds used to find ramp up and ramp down part in burst signal.

Key Path	Meas Setup
Initial S/W Revision	A.03.00

Ramp Up Start Level

It specifies the relative power level to active slots average power level at which the ramp-up starts.

Key Path	Meas Setup, More, Threshold
Mode	LTETDD, LTE, LTEATDD, LTEAFDD
Remote Command	[:SENSe] :PVTime:THReshold:UP:STARt <rel_ampl> [:SENSe] :PVTime:THReshold:UP:STARt?
Example	PVT:THR:UP:STAR -50.0 PVT:THR:UP:STAR?
Preset	-20.000 dB
State Saved	Saved in instrument state.
Min	-120.000 dB
Max	0.000 dB
Initial S/W Revision	A.03.00

Ramp Up End Level

It specifies the relative power level to active slots average power level at which the ramp-up ends.

Key Path	Meas Setup, More, Threshold
Mode	LTETDD, LTE, LTEATDD, LTEAFDD
Remote Command	[:SENSe] :PVTime:THReshold:UP:END <rel_ampl> [:SENSe] :PVTime:THReshold:UP:END?
Example	PVT:THR:UP:END -50.0 PVT:THR:UP:END?
Preset	-0.915 dB
State Saved	Saved in instrument state.
Min	-120.000 dB
Max	0.000 dB
Initial S/W Revision	A.03.00

Ramp Down Start Level

It specifies the relative power level to active slots average power level at which the ramp-down starts.

Key Path	Meas Setup, More, Threshold
Mode	LTETDD, LTE, LTEATDD, LTEAFDD
Remote Command	[:SENSe] :PVTime:THReshold:DOWN:STARt <rel_ampl> [:SENSe] :PVTime:THReshold:DOWN:STARt?
Example	PVT:THR:DOWN:STAR -50.0 PVT:THR:DOWN:STAR?
Preset	-0.915 dB
State Saved	Saved in instrument state.
Min	-120.000 dB
Max	0.000 dB
Initial S/W Revision	A.03.00

Ramp Down End Level

It specifies the relative power level to active slots average power level at which the ramp-down ends.

Key Path	Meas Setup, More, Threshold
Mode	LTETDD, LTE, LTEATDD, LTEAFDD
Remote Command	[:SENSe] :PVTime:THReshold:DOWN:END <rel_ampl> [:SENSe] :PVTime:THReshold:DOWN:END?
Example	PVT:THR:DOWN:END -50.0 PVT:THR:DOWN:END?

Preset	-20.000 dB
State Saved	Saved in instrument state.
Min	-120.000 dB
Max	0.000 dB
Initial S/W Revision	A.03.00

Noise Correction

Sets the noise floor correction function to On or Off. On enables measurement noise correction when the measured power in the reference channel or any offset is close to the noise floor of the analyzer. Off turns these corrections off.

Key Path	Meas Setup
Mode	LTETDD, LTE, LTEATDD, LTEAFDD
Remote Command	[:SENSe] :PVTime:CORRection:NOISe [:AUTO] OFF ON 0 1 [:SENSe] :PVTime:CORRection:NOISe [:AUTO] ?
Example	PVT:CORR:NOIS OFF PVT:CORR:NOIS?
Preset	0
State Saved	Saved in instrument state.
Range	On Off
Initial S/W Revision	A.03.00

Meas Preset

Returns parameters for the current measurement to those set by the factory.

Key Path	Meas Setup, More
Mode	LTETDD, LTE, LTEATDD, LTEAFDD
Remote Command	:CONFigure:PVTime
Example	:CONF:PVT
Initial S/W Revision	A.03.00

14 Transmit On/Off Power Measurement Functions
Mode

Mode

See "[Mode](#)" on page 316

Mode Preset

Returns the active mode to a known state.

Mode Preset does the following for the currently active mode:

- Aborts the currently running measurement.
- Brings up the default menu for the mode, with no active function.
- Sets measurement Global settings to their preset values for the active mode only.
- Activates the default measurement.
- Brings up the default menu for the mode.
- Clears the input and output buffers.
- Sets Status Byte to 0.

Mode Preset does not:

- Cause a mode switch
- Affect mode persistent settings
- Affect system settings

See "[How-To Preset](#)" on page 1708 for more information.

Key Path	Front-panel key
Remote Command	:SYSTem:PRESet
Example	:SYST:PRES
Notes	*RST is preferred over :SYST:PRES for remote operation. *RST does a Mode Preset, as done by the :SYST:PRES command, and it sets the measurement mode to Single measurement rather than Continuous for optimal remote control throughput. Clears all pending OPC bits. The Status Byte is set to 0.
Couplings	A Mode Preset aborts the currently running measurement, activates the default measurement, and gets the mode to a consistent state with all of the default couplings set.
Backwards Compatibility Notes	In the X-Series, the legacy "Factory Preset" has been replaced with Mode Preset, which only presets the currently active mode, not the entire instrument. In the X-Series, the way to preset the entire instrument is by using System, Restore System Defaults All, which behaves essentially the same way as restore System Defaults does on ESA and PSA. There is also no "Preset Type" as there is on the PSA. There is a green Mode Preset front-panel key that does a Mode Preset and a white-with-green-letters User Preset front-panel key that does a User Preset. The old PRESet:TYPE command is ignored (without generating an error), and SYST:PRES without a parameter does a Mode Preset, which should cover most backward code compatibility issues. The settings and correction data under the Input/Output front-panel key (examples: Input Z Corr, Ext Amp Gain, etc.) are no longer part of any Mode, so they will not be preset by a Mode Preset. They are preset using Restore Input/Output Defaults, Restore System Defaults All. Note that because User Preset does a Recall State, and all of these settings are saved in State, they ARE recalled when using

	User Preset.
Initial S/W Revision	Prior to A.02.00

How-To Preset

The table below shows all possible presets, their corresponding SCPI commands and front-panel access (key paths). Instrument settings depend on the current measurement context. Some settings are local to the current measurement, some are global (common) across all the measurements in the current mode, and some are global to all the available modes. In a similar way, restoring the settings to their preset state can be done within the different contexts.

Auto Couple - is a measurement local key. It sets all Auto/Man parameter couplings in the measurement to Auto. Any Auto/Man selection that is local to other measurements in the mode will not be affected.

Meas Preset - is a measurement local key. Meas Preset resets all the variables local to the current measurement except the persistent ones.

Mode Preset - resets all the current mode's measurement local and measurement global variables except the persistent ones.

Restore Mode Defaults - resets ALL the Mode variables (and all the Meas global and Meas local variables), including the persistent ones.

Type Of Preset	SCPI Command	Front Panel Access
Auto Couple	:COUPle ALL	Auto Couple front-panel key
Meas Preset	:CONFigure:<Measurement>	Meas Setup Menu
Mode Preset	:SYSTem:PRESet	Mode Preset (green key)
Restore Mode Defaults	:INSTrument:DEFault	Mode Setup Menu
Restore All Mode Defaults	:SYSTem:DEFault MODes	System Menu; Restore System Default Menu
*RST	*RST	not possible (Mode Preset with Single)
Restore Input/Output Defaults	:SYSTem:DEFault INPUt	System Menu; Restore System Default Menu
Restore Power On Defaults	:SYSTem:DEFault PON	System Menu; Restore System Default Menu
Restore Alignment Defaults	:SYSTem:DEFault ALIGN	System Menu; Restore System Default Menu
Restore Miscellaneous Defaults	:SYSTem:DEFault MISC	System Menu; Restore System Default Menu
Restore All System Defaults	:SYSTem:DEFault [ALL] :SYSTem:PRESet:PERsistent	System Menu; Restore System Default Menu
User Preset	:SYSTem:PRESet:USER	User Preset Menu
User Preset All Modes	:SYSTem:PRESet:USER:ALL	User Preset Menu

Power On Mode Preset	:SYSTem:PON:TYPE MODE	System Menu
Power On User Preset	:SYSTem:PON:TYPE USER	System Menu
Power On Last State	:SYSTem:PON:TYPE LAST	System Menu

Preset Type (Remote Command Only)

As stated in the Backward Compatibility section, to be compatible with ESA/PSA the PRESet:TYPE command will be implemented as a no-op.

Mode	All
Remote Command	:SYSTem:PRESet:TYPE FACTory MODE USER :SYSTem:PRESet:TYPE?
Example	:SYST:PRESet:TYPE FACT
Notes	This command is supported for backward compatibility only. It is a no-op which does not change the behavior of any preset operation.
Preset	This is unaffected by Preset but is set to Mode on a "Restore System Defaults->All"
State Saved	No
Initial S/W Revision	Prior to A.02.00

Mode Setup

See "[Mode Setup](#)" on page 347

Peak Search

Places the selected marker on the trace point with the maximum y-axis value for that marker's trace. Pressing Peak Search with the selected marker off causes the selected marker to be set to Normal, then a peak search is immediately performed.

Key Path	Front-panel key
Mode	LTETDD, LTE,, LTEATDD, LTEAFDD
Remote Command	:CALCulate:PVTime:MARKer[1] 2 ... 12:MAXimum
Example	CALC:PVT:MARK2:MAX
Initial S/W Revision	A.03.00

14 Transmit On/Off Power Measurement Functions
Print

Print

See ["Print" on page 365](#)

Quick Save

The Quick Save front-panel key repeats the most recent save that was performed from the Save menu, with the following exceptions:

- Register saves are not remembered as Saves for the purpose of the Quick Save function
- If the current measurement does not support the last non-register save that was performed, an informational message is generated, “File type not supported for this measurement”

Quick Save repeats the last type of qualified save (that is, a save qualified by the above criteria) in the last save directory by creating a unique filename using the Auto File Naming algorithm described below.

If Quick Save is pressed after startup and before any qualified Save has been performed, the Quick Save function performs a Screen Image save using the current settings for Screen Image saves (current theme, current directory), which then becomes the “last save” for the purpose of subsequent Quick Saves.

The Auto File Naming feature automatically generates a file name for use when saving a file. The filename consists of a prefix and suffix separated by a dot, as is standard for the Windows® file system. A default prefix exists for each of the available file types:

Type	Default Prefix	Menu
State	State_	(Save/Recall)
Trace + State	State_	(Save/Recall)
Screen	Screen_	(Save/Recall)
Amplitude Corrections	Ampcor_	(Import/Export)
Traces	Trace_	(Import/Export)
Limit Lines	LLine_	(Import/Export)
Measurement Result	MeasR_	(Import/Export)
Capture Buffer	CapBuf_	(Import/Export)

A four digit number is appended to the prefix to create a unique file name. The numbering sequence starts at 0000 within each Mode for each file type and updates incrementally to 9999, then wraps to 0000 again. It remembers where it was through a Mode Preset and when leaving and returning to the Mode. It is reset by Restore Misc Defaults and Restore System Defaults and subsequent running of the instrument application. So, for example, the first auto file name generated for State files is State_0000.state. The next is State_0001, and so forth.

One of the key features of Auto File Name is that we guarantee that the Auto File Name will never conflict with an existing file. The algorithm looks for the next available number. If it gets to 9999, then it looks for holes. If it find no holes, that is no more numbers are available, it gives an error.

For example, if when we get to State_0010.state there is already a State_0010.state file in the current directory, it advances the counter to State_0011.state to ensure that no conflict will exist (and then it verifies that State_0011.state also does not exist in the current directory and advances again if it does, and so forth).

If you enter a file name for a given file type, then the prefix becomes the filename you entered instead of the default prefix, followed by an underscore. The last four letters (the suffix) are the 4-digit number.

For example, if you save a measurement results file as “fred.csv”, then the next auto file name chosen for a measurement results save will be fred_0000.csv.

NOTE

Although 0000 is used in the example above, the number that is used is actually the current number in the Meas Results sequence, that is, the number that would have been used if you had not entered your own file name.

NOTE

If the filename you entered ends with _dddd, where d=any number, making it look just like an auto file name, then the next auto file name picks up where you left off with the suffix being dddd + 1.

Key Path	Front-panel key
Notes	No remote command for this key specifically.
Initial S/W Revision	Prior to A.02.00

Recall

In the LTE TDD mode, four types of recall functions are available under the Data menu: “Limit Mask”, “E-UTRA Test Model”, “Signal Studio Setup” and “Vector Signal Analyzer”. “Limit Mask” enables setting of a preset limit mask for Power Suite-based measurements, and currently it is available for the SEM/ACP measurements with the LTE TDD mode. Recalling “E-UTRA Test Model” sets complicated RB settings for each Test Model for the Modulation Analysis and Conformance EVM measurements. Recalling “Signal Studio Setup” or “89600 Vector Signal Analyzer” enables you to recall parameters which have been set and saved on the external platform.

Key Path	Front Panel
Mode	LTETDD
Initial S/W Revision	Prior to A.02.00
Modified at S/W Revision	A.06.00

State

The Recall State menu lets you choose a register or file from which to recall the state.

The content of a state file includes all of the settings and data required to return the analyzer as closely as possible to the Mode it was in, with the exact settings that were in place, when the save occurred. The Mode settings in each state file include the settings that are affected by Mode Preset, as well as the additional settings affected by Restore Mode Defaults; all of the Mode’s settings. In addition, all of the settings of the Input/Output system are included, even though they are outside of the Mode’s state, because they are needed to restore the complete setup. Persistent System settings (for example, GPIB address) are not affected by either a Mode Preset or Restore Mode Defaults, nor are they included in a saved State file.

Since each state file is only for one Mode, the settings for other Modes are unaffected when it is loaded. Recall State will cause a mode switch if the state being recalled is not from the current active mode.

After the recall completes, the message "File <filename> recalled" or “Recalled State Register <register number>” is displayed.

For rapid recalls, the State menu lists 16 registers that you can choose from to recall. Pressing a Register key initiates the recall. You can also select a file from which to recall.

The default path for all State Files is:

My Documents\<<mode name>\state

where <mode name> is the parameter used to select the mode with the INST:SEL command (for example, SA for the Spectrum Analyzer).

See "[More Information](#)" on page 1716.

Key Path	Recall
Mode	All

Remote Command	:MMEMory:LOAD:STATe <filename>
Example	:MMEM:LOAD:STAT "myState.state" This recalls the file myState.state on the default path
Example	MMEM:LOAD:STAT "MyStateFile.state" This loads the state file data (on the default file directory path) into the instrument state.
Notes	<p>When you pick a file to recall, the analyzer first verifies that the file is recallable in the current instrument by checking the software version and model number of the instrument. If everything matches, a full recall proceeds by aborting the currently running measurement, clearing any pending operations, and then loading the State from the saved state file. You can open state files from any mode, so recalling a State file switches to the mode that was active when the save occurred. After switching to the mode of the saved state file, mode settings and data (if any for the mode) are loaded with values from the saved file. The saved measurement of the mode becomes the newly active measurement and the data relevant to the measurement (if there is any) is recalled.</p> <p>If there is a mismatch between file version or model number or instrument version or model number, the recall function tries to recall as much as possible and returns a warning message. It may limit settings that differ based on model number, licensing or version number.</p> <p>After recalling the state, the Recall State function does the following:</p> <ul style="list-style-type: none"> • Makes the saved measurement for the mode the active measurement. • Clears the input and output buffers. • Status Byte is set to 0. • Executes a *CLS <p>If the file specified is empty an error is generated. If the specified file does not exist, another error is generated. If there is a mismatch between the file and the proper file type, an error is generated. If there is a mismatch between file version or model number or instrument version or model number, a warning is displayed. Then it returns to the State menu and File Open dialog goes away.</p> <p>After the Recall, the analyzer exits the Recall menu and returns to the previous menu.</p>
Backwards Compatibility SCPI	:MMEMory:LOAD:STATe 1,<filename> For backwards compatibility, the above syntax is supported. The "1" is simply ignored.
Initial S/W Revision	Prior to A.02.00

More Information

In measurements that support saving Traces, for example, Swept SA, the Trace data is saved along with the State in the State file. When recalling the State, the Trace data is recalled as well. Traces are recalled exactly as they were stored, including the writing mode and update and display modes. If a Trace was updating and visible when the State was saved, it will come back updating and visible, and its data will be rewritten right away. When you use State to save and recall traces, any trace whose data must be preserved should be placed in View or Blank mode before saving.

The following table describes the Trace Save and Recall possibilities:

You want to recall state and one trace's data, leaving other traces unaffected.	Save Trace+State from 1 trace. Make sure that no other traces are updating (they should all be in View	On Recall, specify the trace you want to load the one trace's data into. This trace will load in View.
---	---	--

	or Blank mode) when the save is performed.	All other traces' data will be unaffected, although their trace mode will be as it was when the state save was performed.
You want to recall all traces	Save Trace+State from ALL traces.	On Recall, all traces will come back in View (or Blank if they were in Blank or Background when saved)
You want all traces to load exactly as they were when saved.	Save State	On recall, all traces' mode and data will be exactly as they were when saved. Any traces that were updating will have their data immediately overwritten.

From File...

When you press “From File”, the analyzer brings up a Windows dialog and a menu entitled “File Open.” This menu allows you to navigate to the various fields in the Windows dialog without using a keyboard or mouse. The Tab and Arrow keys can also be used for dialog navigation.

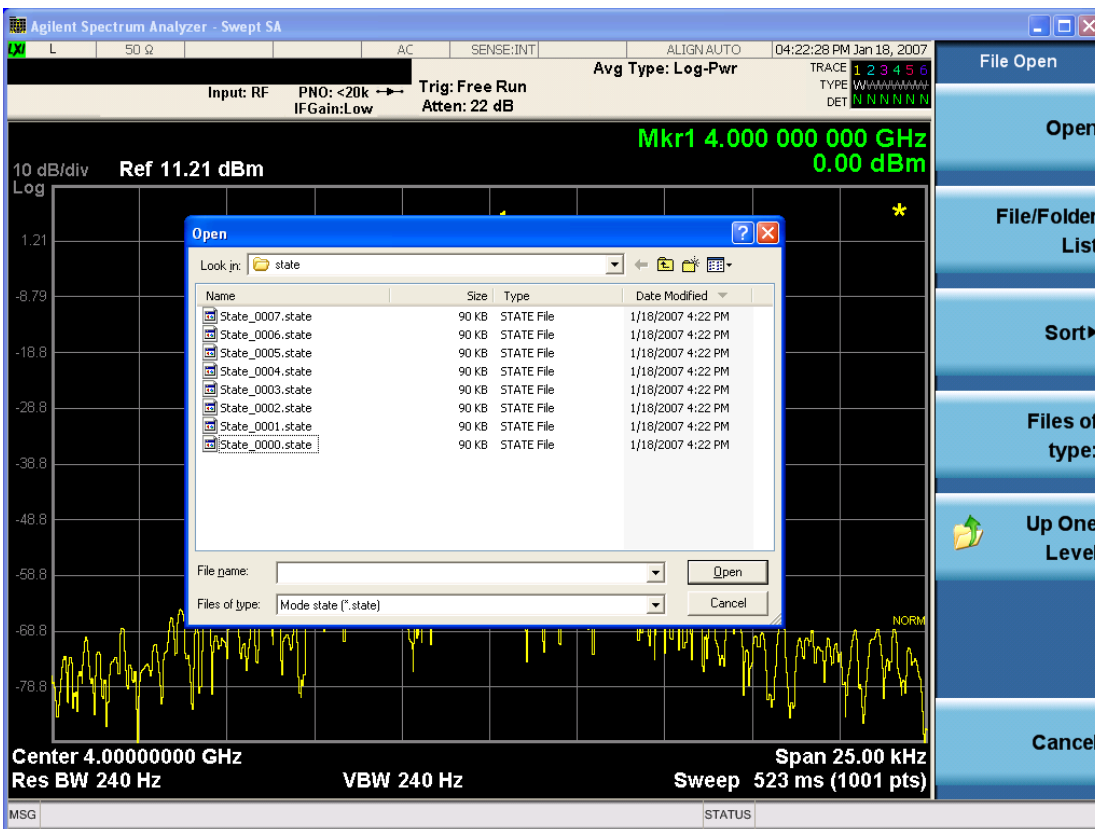

Listed below are the functions of the various fields in the dialog, and the corresponding softkeys:

Open

Performs the recall of the specified file. While the recall is being performed, the floppy icon appears briefly in the Meas bar.

File/Folder List

Enables you to navigate to the center of the dialog that contains the list of files and folders. Once here you can get information about the file and use the tab keys to navigate to the other fields in the dialog, such as Look In.

Look In

The Look In field shows the path from which the file will be recalled and allows you to change the path using the up and down arrow keys to navigate to other paths; the Enter key to open a directory; and the Backspace key to go back one directory. The **Look In field** first uses the last path from the Save As dialog **Save In:** path for that same file type. There is no softkey for directly navigating to the Look In field, but you can use the left tab to get here from the File/Folder List.

User specified paths are remembered when you leave and return to a Mode and are reset back to the default using Restore Mode Defaults.

Sort

Accesses a menu that enables you to sort the files within the File Open dialog. Only one sorting type can be selected at a time and the sorting happens immediately. The sorting types are By Date, By Name, By extension, and By Size.

Files of Type

This field shows the file suffix for the type of file you have selected to recall. For example, if you navigated here while recalling State, "Mode state (*.state)" is in the field. If you navigated here while recalling Trace, ""Mode state (*.trace)" is in the field. If you navigated here while importing a trace data file, "Trace Data (*.csv)" is in the field. For some file types, there is more than one choice in the dropdown menu, which you can select by using the up and down arrow keys and Enter.

Up One Level

This key corresponds to the icon of a folder with the up arrow that is in the tool bar of the dialog. When pressed, it causes the file and folder list to navigate up one level in the directory structure. The Backspace key does the same thing.

Cancel

This key corresponds to the Cancel selection in the dialog. It causes the current **Open** request to be cancelled. The ESC key does the same thing.

Key Path	Recall, State
Notes	Brings up the Open dialog for recalling a State Save Type
Initial S/W Revision	Prior to A.02.00

Edit Register Names

You may enter a custom name on any of the Register keys, to help you remember what you are using that state to save. To do this, press the Edit Register Names key, choose the register whose name you wish to edit, and then enter the desired label using the Alpha Editor or an external PC keyboard.

The maximum number of characters that can be added is 30. In most cases, 30 characters will fit on two lines of the key.

For more information and the SCPI command, see Edit Register Names under the Save, State function.

Key Path	Recall, State
Mode	All
Dependencies	N9060A-7FP or N9060B-2FP license required to edit the register names. When the feature is not licensed, sending the SCPI command generates an error, -221, "Settings conflict;Option not available"
Initial S/W Revision	A.11.00

Register 1 thru Register 16

Selecting any one of these register keys causes the State of the mode from the specified Register to be recalled. Each of the register keys annotates whether it is empty or at what date and time it was last modified. In addition, you can use the Edit Register Names key under Save, State to enter custom names for each register.

Registers are shared by all modes, so recalling from any one of the registers will cause a mode switch to the mode that was active when the save to the Register occurred.

Although these 16 registers are the only registers available from the front panel, there are 128 state registers available in the instrument. Registers 17-128 are only available from the SCPI interface, using the *RCL command.

After the recall completes, the message "Register <register number> recalled" appears in the message bar. If you are in the Spectrum Analyzer Mode, and you are recalling a register that was saved in the Spectrum Analyzer Mode, then after the recall, you will still be in the Recall Register menu. If the Recall causes you to switch modes, then after the Recall, you will be in the Frequency menu.

If a requested register is empty an error is generated.

Key Path	Recall, State
Example	*RCL 1
Range	1-16 from front panel, 1-128 from SCPI
Readback	Date and time with seconds resolution are displayed on the key OR A custom name of up to 30 characters entered using the Save, State,Edit Register Names key OR “(empty)” if no prior save operation has been performed to this register.
Initial S/W Revision	Prior to A.02.00
Modified at S/W Revision	Prior to A.11.00

Register 1 thru Register 16

Selecting any one of these register keys causes the State of the mode from the specified Register to be recalled. Each of the register keys annotates whether it is empty or at what date and time it was last modified. In addition, you can use the Edit Register Names key under Save, State to enter custom names for each register.

Registers are shared by all modes, so recalling from any one of the registers will cause a mode switch to the mode that was active when the save to the Register occurred.

Although these 16 registers are the only registers available from the front panel, there are 128 state registers available in the instrument. Registers 17–128 are only available from the SCPI interface, using the *RCL command.

After the recall completes, the message "Register <register number> recalled" appears in the message bar. If you are in the Spectrum Analyzer Mode, and you are recalling a register that was saved in the Spectrum Analyzer Mode, then after the recall, you will still be in the Recall Register menu. If the Recall causes you to switch modes, then after the Recall, you will be in the Frequency menu.

If a requested register is empty an error is generated.

Key Path	Recall, State
Example	*RCL 1
Range	1–16 from front panel, 1–128 from SCPI
Readback	Date and time with seconds resolution are displayed on the key OR A custom name of up to 30 characters entered using the Save, State, Edit Register Names key OR “(empty)” if no prior save operation has been performed to this register.
Initial S/W Revision	Prior to A.02.00
Modified at S/W Revision	Prior to A.11.00

Recall

In the LTE TDD mode, four types of recall functions are available under the Data menu: “Limit Mask”, “E-UTRA Test Model”, “Signal Studio Setup” and “Vector Signal Analyzer”. “Limit Mask” enables setting of a preset limit mask for Power Suite-based measurements, and currently it is available for the SEM/ACP measurements with the LTE TDD mode. Recalling “E-UTRA Test Model” sets complicated RB settings for each Test Model for the Modulation Analysis and Conformance EVM measurements. Recalling “Signal Studio Setup” or “89600 Vector Signal Analyzer” enables you to recall parameters which have been set and saved on the external platform.

Key Path	Front Panel
Mode	LTETDD
Initial S/W Revision	Prior to A.02.00
Modified at S/W Revision	A.06.00

Import Trace Data

Enables you to import previously saved trace data into a Data Register and optionally display it. Selecting this key displays a menu that enables you to select the destination data register, and also enables you to choose whether or not to display the recalled data in the currently selected trace. After making these selections, select Open... and use the file dialog to select the file you want to recall.

Recalling trace data into an already used Data Register overwrites the previous data. If the data register is displayed on any trace, the display is updated to reflect the new data.

The SCPI command

```
:MMEM:LOAD:TRAC:DATA D1|D2|D3|D4|D5|D6,<filename>
```

recalls data into a specified register, but does not display it in the selected trace. Use the command

```
:DISP:<meas>:TRAC<n>:FEED D1|D2|D3|D4|D5|D6
```

to display the register in the desired trace.

It is possible to recall trace data saved by other VXA measurements, or measurements made using the LTE, LTETDD, iDEN, or 89601 applications.

Key Path	Recall, Data (Import)
Mode	VSA, LTE, LTETDD, IDEN
Remote Command	:MMEMory:LOAD:TRACe:DATA D1 D2 D3 D4 D5 D6,<filename>[,CSV TXT SDF MAT4 MAT HDF5 BIN]
Example	:MMEM:LOAD:TRAC:DATA D1,"Trc1.txt",TXT
Notes	<p>The Open: dialog box has the following filter options when you are recalling trace data::</p> <ul style="list-style-type: none"> • CSV (Comma delimited) (*.csv) • SDF (Fast) (*.sdf;*.dat) • Text (Tab delimited) (*.txt) <p>The file must have the same format as that created by the Export Recorded Data command.</p> <p>The SCPI command has an optional file format parameter. If you do not include this parameter in the SCPI command, the file format is determined by the file name extension. If no file extension is recognized, the file is scanned to determine the format.</p> <p>If you are not licensed to recall a particular file type, then error -203.9010 is returned. If the file format cannot be determined or the file cannot be recalled successfully, then error -250.5290 is returned. If the recall is successful, then advisory 0.1600 is shown.</p>
State Saved	No
Readback	Data 1 Data 2 Data 3 Data 4 Data 5 Data 6

Data 1

Selects the Data 1 register as the destination for the imported data.

Key Path	Recall, Data (Import), Trace (to)
Mode	VSA, LTE, LTETDD, IDEN

Data 2

Selects the Data 2 register as the destination for the imported data.

Key Path	Recall, Data (Import), Trace (to)
Mode	VSA, LTE, LTETDD, IDEN

Data 3

Selects the Data 3 register as the destination for the imported data.

Key Path	Recall, Data (Import), Trace (to)
Mode	VSA, LTE, LTETDD, IDEN

Data 4

Selects the Data 4 register as the destination for the imported data.

Key Path	Recall, Data (Import), Trace (to)
Mode	VSA, LTE, LTETDD, IDEN

Data 5

Selects the Data 5 register as the destination for the imported data..

Key Path	Recall, Data (Import), Trace (to)
Mode	VSA, LTE, LTETDD, IDEN

Data 6

Selects the Data 6 register as the destination for the imported data.

Key Path	Recall, Data (Import), Trace (to)
Mode	VSA, LTE, LTETDD, IDEN

Display in Selected Trace

Enables you to select whether the recalled trace data is displayed in the current Trace.

Key Path	Recall, Data (Import), Trace (to)
----------	-----------------------------------

Mode	VSA, LTE, LTETDD, IDEN
State Saved	No

Signal Studio Setup

This key allows you to recall the Agilent Signal Studio setup file created on the Signal Studio (N7625B). This key is valid only for the Mod Analysis measurement. For E-TM test model signal, please use corresponding EVM setup file under My Documents\LTETDD\data\evmsetup.

For the supported carrier types, see the table below.

Signal Studio	Carrier Type
N7625B Signal Studio for 3GPP LTE TDD	Advanced LTE TDD(2009-03)
	Advanced LTE TDD(2009-12)
	Basic LTE TDD(2009-03)
	Basic LTE TDD(2009-12)

File Location and Extension

File location: "My Documents\LTETDD\data"

File type: xml

File extension: .scp

You need to place the Signal Studio Setup file created on N7625B in the above directory in advance. Pressing OPEN under the Import Data menu will open this directory from which you can select the setup file.

Example:

File Location: My Documents\LTETDD\data

File Name: Uplink PUSCH.scp

Key Path	Recall, Data
Mode	LTETDD
Remote Command	MMEMory:LOAD:SSSetup <string>
Example	MMEM:LOAD:SSS "Uplink PUSCH.scp"
Notes	Sets of parameters related to Signal Studio Setup are overwritten by the contents of the setup file.
Initial S/W Revision	A.06.00

89601 VSA Setup

Enables you to import the 89600 Vector Signal Analyzer Setup file created using the 89600 Vector Signal Analyzer Option BHE (LTE TDD). This key is valid only for the Mod Analysis measurement.

File Location and Extension

File location: "My Documents\LTETDD\data"

File type: text file

File extension: .set, .setx

Place the 89600 Vector Signal Analyzer Setup file that you saved on 89600 in the above directory. When you select OPEN under the Import Data menu, the directory opens enabling you to select your setup file.

Example:

File Location: My Documents\LTETDD\data

File Name: Uplink PRACH.set

Key Path	Recall, Data
Mode	LTETDD
Remote Command	MME ^M o ^R y:LOAD:VSAS ^E tup <string>
Example	MME:LOAD:VSAS "Uplink PRACH.set"
Notes	Sets of parameters related to Vector Signal Analyzer Setup are overwritten by the contents of the setup file.
Initial S/W Revision	A.06.00
Modified at S/W Revision	A.10.00

Masks

This key allows you to recall a preset mask file from the list. The preset mask file contains configuration for only Carrier, Offset, Limit settings and the preset profile BW. Any set of values not specified by the preset mask file will not be overwritten.

You cannot change or create the preset mask file since it is a binary file. This key is valid for the Spectrum Emission Mask and ACP measurements.

File location: "My Documents\LTETDD\data.masks"

Note that "My Documents" is an alias to a directory and its place differs depending on which user is logged in. At XSA start up, XSA will overwrite all of the limit mask files to the current user's "My Documents\LTETDD\data.masks" each time.

File type: Binary

Filename: The filename follows the rule below, in which the word is connected with underscores.

<Measurement>_<Direction>_<Bandwidth>_<Condition>.mask

Where

<Measurement> Measurement the limit mask file is applied to: SEM or ACP

<Direction> Direction: BS (Downlink) or MS (Uplink).

<Bandwidth> Bandwidth

<Condition> Condition. It depends on the measurement.

File extension: .mask

Pressing OPEN under the Import Data menu will open the above directory from which you can select a mask file. When you change the Bandwidth or Direction, all Power Suite measurement parameters are reset to the hard coded preset parameters. Thus you must recall the appropriate preset mask file again after the change.

You cannot read the contents of the provided preset mask file since it is a binary file. Detailed contents of the file are provided by a PDF format file located in the same directory as the preset mask file.

Example:

File Location: My Documents/LTETDD/data/masks/SEM_MS

File Name: SEM_MS_15MHz_Add_NS04.mask

The following table shows the sets of variables imported to the ACP measurement.

Offset	Start Freq (MHz)	Stop Freq (MHz)	Res BW (Hz)	Meas BW	Rel Start	Rel Stop	Fail Mask
A	5	7.14	30k	1	-8	-25	Rel
B	7.14	10.57	30k	1	-25	-27	Rel
C	10.57	20	30k	1	-27	-50	Rel
D	20	25	30k	1	-50	-50	Rel
E	25	30	30k	1	-50	-50	Rel

Key Path	Recall, Data
Mode	LTETDD
Remote Command	MMEemory:LOAD:MASK <string>
Example	MMEemory:LOAD:MASK "ACP_BS\ACP_BS_3MHz_pairE-UTRA_CatA.mask"
Notes	Sets of parameters related to Limit, Carrier and Offset are overwritten by the contents of the preset mask file.
Initial S/W Revision	A.03.00

EVM Setup

This key allows you to recall EVM parameter setting to measure E-UTRA Test Model in 3GPP standard (36.141-810 6.1.1).

- E-UTRA Test Model 1.1 (E-TM1.1)
- E-UTRA Test Model 1.2 (E-TM1.2)
- E-UTRA Test Model 2 (E-TM2)
- E-UTRA Test Model 3.1 (E-TM3.1)

- E-UTRA Test Model 3.2 (E-TM3.2)
- E-UTRA Test Model 3.3 (E-TM3.3)

This key is valid for the Modulation Analysis and Conformance EVM measurements only.

File Location and Extension

File location: My Documents\LTETDD\data\evmsetup

Note that “My Documents” is an alias to a directory and its place differs depending on which user is logged in. At XSA start up, XSA will overwrite all of the EVM Setup files to the current user’s “My Documents\LTETDD\data\evmsetup” each time.

File type: binary

File extension: .evms

Pressing OPEN under the Import Data menu will open the above directory from which you can select an EVM Setup file. When you change the Bandwidth, parameters are reset to the hard coded preset parameters. Thus you must recall the appropriate EVM Setup file again after the change.

You cannot read the contents of the provided EVM Setup file since it is a binary file.

Example:

File Location: My Documents\LTETDD\data\evmsetup

Filename: TM3.1-BW1.4MHz.evms

Key Path	Recall, Data
Mode	LTETDD
Remote Command	MMEMOry:LOAD:EVMSetup <string>
Example	MMEM:LOAD:EVMS "TM2-BW15MHz.evms"
Notes	Sets of parameters related to EVM Setup are overwritten by the contents of the EVM Setup file.
Initial S/W Revision	A.03.00, A.08.00

Open...

When you press “Open”, the analyzer brings up a Windows dialog and a menu entitled “File Open.” This menu allows you to navigate to the various fields in the Windows dialog without using a keyboard or mouse. The Tab and Arrow keys can also be used for dialog navigation.

See "[From File...](#)" on page 2797 in Recall, State, for a full description of this dialog and menu.

Key Path	Recall, Data
Notes	The key location is mode-dependent and will vary. Brings up Open dialog for recalling a <mode specific> Save Type
Initial S/W Revision	Prior to A.02.00

Restart

The Restart function restarts the current sweep, or measurement, or set of averaged/held sweeps or measurements. If you are Paused, pressing Restart does a Resume.

The Restart function is accessed in several ways:

- Pressing the Restart key
- Sending the remote command INIT:IMMEDIATE
- Sending the remote command INIT:RESTART

See "[More Information](#)" on page 1727

Key Path	Front-panel key
Remote Command	:INITiate[:IMMEDIATE] :INITiate:RESTART
Example	:INIT:IMM :INIT:REST
Notes	:INITiate:RESTART and :INITiate:IMMEDIATE perform exactly the same function.
Couplings	Resets average/hold count k. For the first sweep overwrites all active (update=on) traces with new current data. For application modes, it resets other parameters as required by the measurement.
Status Bits/OPC dependencies	This is an Overlapped command. The STATUS:OPERation register bits 0 through 8 are cleared. The STATUS:QUESTIONable register bit 9 (INTEgrity sum) is cleared. The SWEEPING bit is set. The MEASURING bit is set.
Backwards Compatibility Notes	For Spectrum Analysis mode in ESA and PSA, the Restart hardkey and the INITiate:RESTART command restart trace averages (displayed average count reset to 1) for a trace in Clear Write, but did not restart Max Hold and Min Hold. In the X-Series, the Restart hardkey and the INITiate:RESTART command restart not only Trace Average, but MaxHold and MinHold traces as well. For wireless comms modes in ESA and PSA, the Restart hardkey and the INITiate:RESTART command restart every measurement, which includes all traces and numeric results. There is no change to this operation.
Initial S/W Revision	Prior to A.02.00

More Information

The **Restart** function first aborts the current sweep/measurement as quickly as possible. It then resets the sweep and trigger systems, sets up the measurement and initiates a new data measurement sequence with a new data acquisition (sweep) taken once the trigger condition is met.

If the analyzer is in the process of aligning when **Restart** is executed, the alignment finishes before the restart function is performed.

Even when set for Single operation, multiple sweeps may be taken when Restart is pressed (for example, when averaging/holding is on). Thus when we say that **Restart** "restarts a measurement," we may mean:

- It restarts the current sweep
- It restarts the current measurement
- It restarts the current set of sweeps if any trace is in Trace Average, Max Hold or Min Hold
- It restarts the current set of measurements if Averaging, or Max Hold, or Min Hold is on for the measurement
- depending on the current settings.

With **Average/Hold Number** (in **Meas Setup** menu) set to 1, or Averaging off, or no trace in Trace Average or Hold, a single sweep is equivalent to a single measurement. A single sweep is taken after the trigger condition is met; and the analyzer stops sweeping once that sweep has completed. However, with **Average/Hold Number** >1 and at least one trace set to **Trace Average, Max Hold, or Min Hold (SA Measurement)** or **Averaging on (most other measurements)**, multiple sweeps/data acquisitions are taken for a single measurement. The trigger condition must be met prior to each sweep. The sweep is stopped when the average count k equals the number N set for **Average/Hold Number**. A measurement average usually applies to all traces, marker results, and numeric results; but sometimes it only applies to the numeric results.

Once the full set of sweeps has been taken, the analyzer will go to idle state. To take one more sweep without resetting the average count, increment the average count by 1, by pressing the step up key while **Average/Hold Number** is the active function, or sending the remote command CALC:AVER:TCON UP.

Save

The Save menu lets you choose what you want to save and where you want to save it. Among the types of files you can save are **States**, **Traces**, and **Screen Images**. In addition, an Export (Data) option lets you save a number of data types as CSV files for easy import into Excel and other spreadsheet programs.

Key Path	Front-panel key
Mode	All
Notes	No remote command for this key specifically, but the :MMEM:STORe command is available for specific file types. An example is :MMEM:STOR:STATe <filename>.
Initial S/W Revision	Prior to A.02.00

State

The Save State menu lets you choose a register or file for saving the state.

The content of a state file includes all of the settings and data required to return the analyzer as closely as possible to the Mode it was in, with the exact settings which were in place, when the save occurred. The Mode settings in each state file include the settings that are affected by Mode Preset, as well as the additional settings affected by Restore Mode Defaults; all of the Mode's settings. In addition, all of the settings of the Input/Output system are included, even though they are outside of the Mode's state, because they are needed to restore the complete setup. Persistent System settings (for example, Verbose SCPI) are not affected by either Mode Preset or Restore Mode Defaults, nor are they included in a saved State file.

After the save completes, the message "File <filename> saved" or "State Register <register number> saved" is displayed.

For rapid saving, the State menu lists 16 registers to save to. Pressing a Register key initiates the save. You can also select a file to save to.

The default path for all State Files is:

My Documents\<>mode name>\state

where <mode name> is the parameter used to select the mode with the INST:SEL command (for example, SA for the Spectrum Analyzer).

Key Path	Save
Mode	All
Remote Command	:MMEMory:STORe:STATe <filename>
Example	MMEM:STOR:STATe "MyStateFile.state" This stores the current instrument state data in the file MyStateFile.state in the default directory.
Notes	Both single and double quotes are supported for any filename parameter over remote. After saving to a register, that register's menu key is updated with the date the time, unless a custom label has been entered for that key. After saving to a register, you remain in the Save State menu, so that you can see the Register key

update. After saving to a file, the analyzer automatically returns to the previous menu and any Save As dialog goes away.

Backwards Compatibility SCPI :MMEMory:STORe:STATe 1,<filename>

For backwards compatibility, the above syntax is supported. The "1" is simply ignored. The command is sequential.

Initial S/W Revision Prior to A.02.00

To File . . .

When you press “To File”, the analyzer brings up a Windows dialog and a menu entitled “Save As.” This menu allows you to navigate to the various fields in the Windows dialog without using a keyboard or mouse. The Tab and Arrow keys can also be used for dialog navigation.

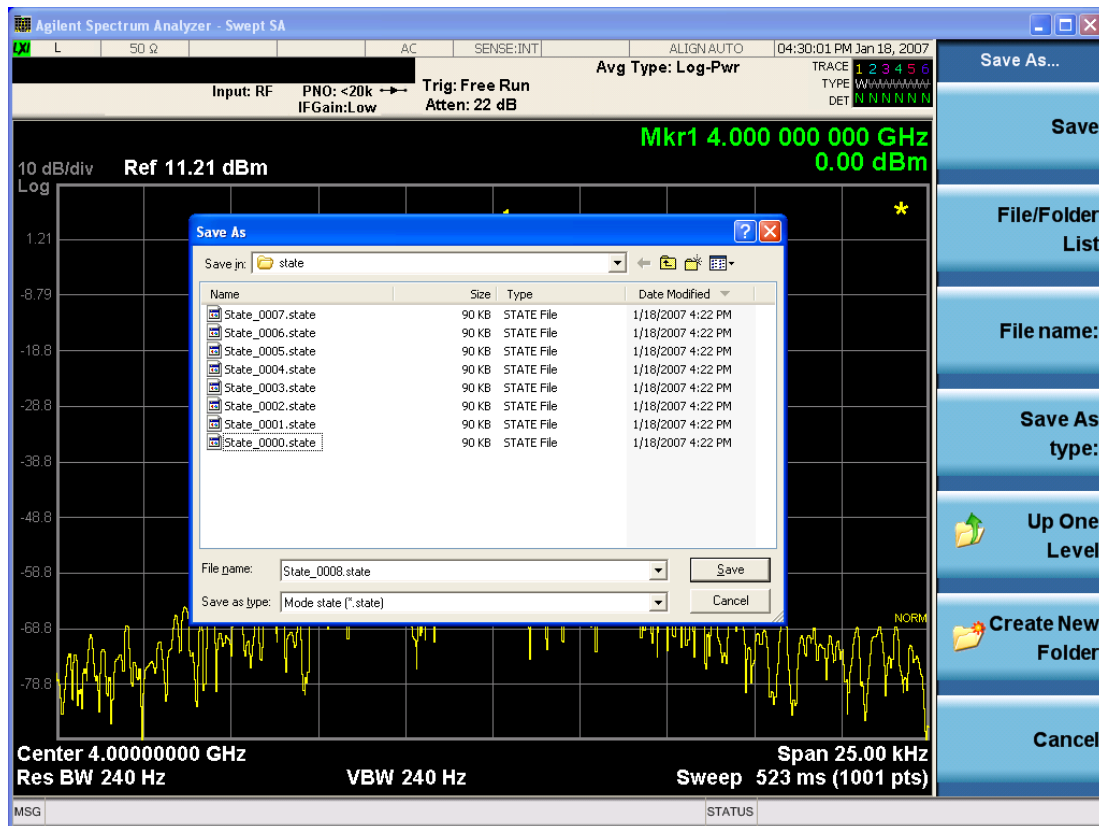

The Listed below

are the functions of the various fields in the dialog, and the corresponding softkeys:

Save

Performs the save to the specified file of the selected type. If the file already exists, a dialog will appear that allows you to replace the existing file by selecting OK, or you can Cancel the request. If you select OK, the file will be overwritten. Using the C: drive is strongly discouraged, since it runs the risk of being overwritten during an instrument software upgrade.

While the save is being performed, the floppy icon appears briefly in the Meas bar.

File/Folder List

Enables you to navigate to the center of the dialog that contains the list of files and folders. Once here you can get information about the file and use the tab keys to navigate to the other fields in the dialog, such as Save In.

Save In

The Save In field shows the path to which the file will be saved and allows you to change the path using the up and down arrow keys to navigate to other paths; the Enter key to open a directory; and the Backspace key to go back one directory. The **Save In field** defaults to the default path for this type of file and remembers the last path you used to save this type of file. There is no softkey for directly navigating to the Save In field but you can use left tab to get here from the File/Folder List.

User specified paths are remembered when you leave and return to a Mode and are reset back to the default using Restore Mode Defaults.

File Name

The File Name field is initially loaded with an automatically generated filename specific to the appropriate Save Type. The automatically generated filename is guaranteed not to conflict with any filename currently in the directory. You may replace or modify this filename using the File Name key. See the ["Quick Save " on page 2793](#) documentation for more on the automatic file naming algorithm.

When you press the File Name key the analyzer displays the Alpha Editor. Use the knob to choose the letter to add and the front-panel Enter key to add the letter to the file name. The BK character moves you back and the FW character moves you forward in the filename. The Select key on the front panel generates a space character. When you are done entering the filename press the Done softkey. This returns back to the **File Open** dialog and menu, but does not cause the save to occur.

Save As Type

This field shows the file suffix for the type of file you have selected to save. For example, if you navigated here while saving State, "Mode state (*.state)" is in the field. If you navigated here from saving Trace, ""Mode state (*.trace)" is in the field. If you navigated here while exporting a trace data file, "Trace Data (*.csv)" is in the field. For some file types, there is more than one choice in the dropdown, which you can select by using the up and down arrow keys and Enter.

Up One Level

This key corresponds to the icon of a folder with the up arrow that is in the tool bar of the dialog. When pressed, it causes the file and folder list to navigate up one level in the directory structure. The Backspace key does the same thing.

Create New Folder

This key corresponds to the icon of a folder with the "*" that is in the tool bar of the dialog. When pressed, a new folder is created in the current directory with the name **New Folder** and you can enter a new folder name using the Alpha Editor.

Cancel

This key corresponds to the Cancel selection in the dialog. It causes the current **Save As** request to be cancelled. The ESC key does the same thing.

Key Path	Save, State
Mode	All
Notes	Brings up Save As dialog for saving a State Save Type
Initial S/W Revision	Prior to A.02.00

Edit Register Names

You may enter a custom name on any of the Register keys, to help you remember what you are using that state to save. To do this, press the Edit Register Names key, choose the register whose name you wish to edit, and then enter the desired label using the Alpha Editor or an external PC keyboard.

The maximum number of characters that can be added is 30. In most cases, 30 characters will fit on two lines of the key.

See ["More Information" on page 1732](#)

Key Path	Save, State
Mode	All
Remote Command	:MMEMory:REGister:STATe:LABel <reg number>,"label" :MMEMory:REGister:STATe:LABel? <reg number>
Example	:MMEM:REG:STAT:LAB 1,"my label"
Notes	<reg number> is an integer from 1 to 16. If the SCPI specifies an invalid register number an error message is generated, -222,"Data out of range;Invalid register label number" "label" is a string from 0 to 30 characters in length. If a label exceeds 30 characters, an error message is generated, -150,"String data error;Label clipped to 30 characters" "label" of length 0 erases the custom label and restores the default (time and date) label. E.g.: :MMEM:REG:STAT:LAB 1,""
Dependencies	N9060A-7FP or N9060B-2FP license required to edit the register names. When the feature is not licensed, sending this command generates an error, -221,"Settings conflict;Option not available"
Preset	The names are unaffected by Preset or power cycle but are set to the default label (time and date) on a "Restore System Defaults->Misc"
Initial S/W Revision	A.11.00

More Information

When you edit one of the register names, the time and date field will be replaced by the custom name.

If you delete all the characters in the custom name, it restores the default (time and date).

The register names are stored within the state files, but they are not part of the instrument state; that is, once you have edited a register name, loading a new state will not change that register name. Another consequence of this is that the names will be persistent through a power cycle. Also, if a named state file is transferred to another analyzer, it will bring its custom name along with it.

If you try to edit the name of an empty register, the analyzer will first save the state to have a file to put the name in. If you load a named state file into an analyzer with older firmware it will ignore the metadata.

The *SAV and *RCL commands will not be affected by the custom register names, nor will the MMEM commands.

Register 1 thru Register 16

Selecting any one of these register menu keys causes the State of the currently active mode to be saved to the specified Register. The registers are provided for rapid saving and recalling, since you do not need to specify a filename or navigate to a file. Each of the register menu keys annotates whether it is empty or at what date and time it was last modified. In addition, you can use the Edit Register Names key to enter custom names for each register.

Although these 16 registers are the only registers available from the front panel, there are 128 state registers available in the instrument. Registers 17–128 are only available from the SCPI interface, using the *SAV command.

There is one set of 128 state registers in the instrument, not one set for each Mode. When a state is saved, the Mode it was saved from is saved with it; then when it is recalled, the instrument switches to that Mode.

After the save completes, the corresponding register menu key annotation is updated with the date and time and the message "Register <register number> saved" is displayed.

Key Path	Save, State
Mode	All
Example	*SAV 1
Range	1–16 from front panel, 1–128 from SCPI
Readback	Date and time with seconds resolution are displayed on the key OR A custom name of up to 30 characters entered using the Edit Register Names key OR “(empty)” if no prior save operation has been performed to this register.
Initial S/W Revision	Prior to A.02.00
Modified at S/W Revision	A.11.00

Register 1 thru Register 16

Selecting any one of these register menu keys causes the State of the currently active mode to be saved to the specified Register. The registers are provided for rapid saving and recalling, since you do not need to specify a filename or navigate to a file. Each of the register menu keys annotates whether it is empty or at what date and time it was last modified. In addition, you can use the Edit Register Names key to enter custom names for each register.

Although these 16 registers are the only registers available from the front panel, there are 128 state registers available in the instrument. Registers 17–128 are only available from the SCPI interface, using the *SAV command.

There is one set of 128 state registers in the instrument, not one set for each Mode. When a state is saved, the Mode it was saved from is saved with it; then when it is recalled, the instrument switches to that Mode.

After the save completes, the corresponding register menu key annotation is updated with the date and time and the message "Register <register number> saved" is displayed.

Key Path	Save, State
Mode	All
Example	*SAV 1
Range	1-16 from front panel, 1-128 from SCPI
Readback	Date and time with seconds resolution are displayed on the key OR A custom name of up to 30 characters entered using the Edit Register Names key OR "(empty)" if no prior save operation has been performed to this register.
Initial S/W Revision	Prior to A.02.00
Modified at S/W Revision	A.11.00

Data (Export)

Exporting a data file stores data from the current measurement to mass storage files. The Export Menu only contains data types that are supported by the current measurement.

Since the commonly exported data files are in .csv format, the data can be edited by you prior to importing. This allows you to export a data file, manipulate the data in Excel (the most common PC Application for manipulating .csv files) and then import it.

Selecting an Export Data menu key will not actually cause the exporting to occur, since the analyzer still needs to know where you wish to save the data. Pressing the Save As key in this menu brings up the Save As dialog and Save As menu that allows you to specify the destination file and directory. Once a filename has been selected or entered in the Open menu, the export will occur as soon as the Save key is pressed.

Key Path	Save
Mode	All
Notes	The menu is built from whatever data types are available for the mode. So the key locations in the sub menu will vary. No SCPI command directly controls the Data Type that this key controls. The Data Type is included in the MMEM:STORe commands.
Dependencies	If a file type is not used by a certain measurement, that type is grayed out for that measurement. The key for a file type will not show at all if there are no measurements in the Mode that support it.
Preset	Is not affected by a Preset or shutdown, but is reset during Restore Mode Defaults
Readback	The data type that is currently selected
Initial S/W Revision	Prior to A.02.00

Export Trace Data

Enables you to export trace data with (optional) associated headers. Selecting this key displays a menu that enables you to choose which Trace to save (default is the selected Trace) and whether or not to save headers with the data. The header information is used by the VXA application when saved trace data is recalled, and enables it to be displayed with the same formatting and scaling that it had when saved. If headers are not saved, the scaling and format are set to default values when the trace is recalled. After making these selections, press Save As... and use the file dialog to choose a file name and format for the saved data.

Trace data can be exported in several different formats. Text and comma-separated variable (CSV) formats are useful for viewing the data or importing it to a spreadsheet program. The other formats are binary and thus more compact. Trace data files can be recalled for viewing into other VXA, LTE, LTETDD, iDEN, or 89601 measurements.

Key Path	Save, Data (Export)
Mode	VSA, LTE, LTETDD, IDEN
Remote Command	:MMEMory:STORe:TRACe:DATA TRACE1 TRACE2 TRACE3 TRACE4 TRACE5 TRACE6, "<filename>"[,CSV TXT SDF MAT4 MAT HDF5 BIN[,OFF ON 0 1]]
Example	:MMEM:STOR:TRAC:DATA TRACE1, "TRC1.TXT", TXT, ON
Notes	<p>The Save As... dialog box has the following format options when you are saving trace data:</p> <ul style="list-style-type: none"> • CSV (Comma delimited) (*.csv) • SDF (Fast) (*.sdf;*.dat) • Text (Tab delimited) (*.txt) <p>File format saved depends on selection. The appropriate file extension is appended to the filename if it is not supplied by the user.</p> <p>If the SCPI command includes just a file name, the file format is determined by the filename extension, which must be one of the choices above. *.sdf or an unrecognized extension chooses the SDF fast format. If the optional file format enumerator is included in the command, then this determines the file format and the file extension is ignored. The optional binary parameter determines if file headers are saved. The default is ON. If file headers are not wanted, use the optional "OFF" parameter.</p> <p>The optional Boolean parameter determines whether headers are saved in the file. By default the headers are saved.</p> <p>If you are not licensed to save a particular file type, then error -203.9010 is returned. If an invalid file format is specified or the file cannot be saved successfully, then error -25x is returned. If the save is successful, then advisory 0.1500 is shown.</p>
State Saved	No
Readback	(Trace 1 Trace 2 Trace 3 Trace 4 Trace 5 Trace 6)(with without) headers

Trace 1

Selects the Trace 1 register as the destination for the imported data.

Key Path	Save, Data (Export), Trace
Mode	VSA, LTE, LTETDD, IDEN

Trace 2

Selects the Trace 2 register as the destination for the imported data.

Key Path	Save, Data (Export), Trace
Mode	VSA, LTE, LTETDD, IDEN

Trace 3

Selects the Trace 3 register as the destination for the imported data.

Key Path	Save, Data (Export), Trace
Mode	VSA, LTE, LTETDD, IDEN

Trace 4

Selects the Trace 4 register as the destination for the imported data.

Key Path	Save, Data (Export), Trace
Mode	VSA, LTE, LTETDD, IDEN

Include Header

Enables you to select whether or not the saved trace data includes header information describing scaling, formatting, etc.

Key Path	Save, Data (Export), Trace
Mode	VSA, LTE, LTETDD, IDEN
State Saved	No

Measurement Results

Pressing this key selects Meas Results as the data type to be exported. Pressing the key a second time brings up the Meas Results menu, which allows you to select which **Meas Result** to save. In the Swept SA measurement, there are three types of Measurement Results files: Peak Table, Marker Table and Spectrogram.

See "[Meas Results File Contents](#)" on page 1737.

See "[Marker Table](#)" on page 1737.

See "[Peak Table](#)" on page 1740.

See "[Spectrogram](#)" on page 1743

Remote Command	:MMEMory:STORe:RESults:MTABle PTABle SPEctrogram <filename>
Example	:MMEM:STOR:RES:MTAB "myResults.csv" Saves the results from the current marker table to the file myResults.csv in the current path. :MMEM:STOR:RES:PTAB "myResults.csv" Saves the results from the current peak table to the file myResults.csv in the current path. :MMEM:STOR:RES:SPEC "myResults.csv" Saves the results from the current Spectrogram display to the file myResults.csv in the current path. The default path is My Documents\SA\data\SAN\results
Notes	If the save is initiated via SCPI, and the file already exists, the file will be overwritten. Using the C: drive is strongly discouraged, since it runs the risk of being overwritten during an instrument software upgrade. Both single and double quotes are supported for any filename parameter over SCPI.
Dependencies	If a save of Marker Table results is requested and the Marker Table is not on, no file is saved and a message is generated If a save of Peak Table results is requested and the Peak Table is not on, no file is saved and a message is generated If a save of Spectrogram results is requested and the Spectrogram is not on, no file is saved and a message is generated. The Spectrogram choice only appears if option EDP is licensed.
Preset	Not part of Preset, but is reset to Peak Table by Restore Mode Defaults. Survives a shutdown.
Initial S/W Revision	Prior to A.02.00

Meas Results File Contents

All files are .csv files. The following section details the data in each file type.

Marker Table

This section discusses the Marker Table Meas Results file format.

Imagine that, at the point where a Marker Table Meas Result is requested, the following screen is showing:

14 Transmit On/Off Power Measurement Functions
Save

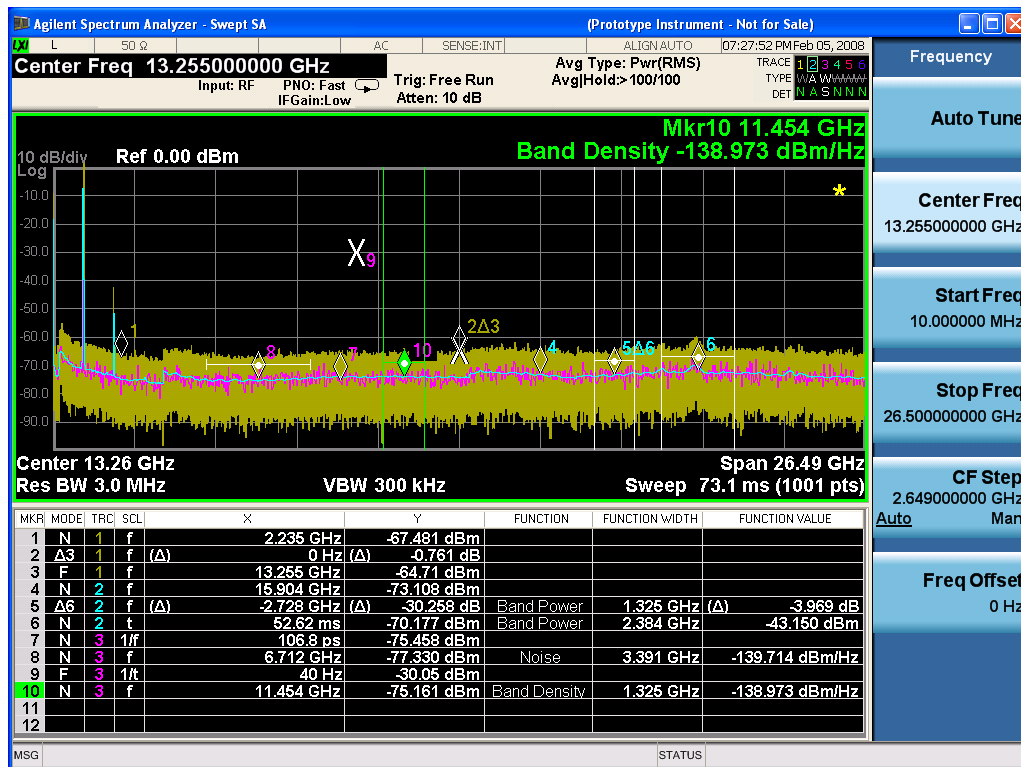

Then the Meas Results file, when opened, would show the following data:

MeasurementResult	
Swept SA	
A.01.40_R0017	N9020A
526 B25 PFR	1
P26 EA3	
Result Type	Marker Table
Ref Level	0
Number of Points	1001
Sweep Time	0.0662666 67
Start Frequency	10000000
Stop Frequency	26500000 000
Average Count	0
Average Type	LogPower (Video)
RBW	3000000

RBW Filter	Gaussian
RBW Filter BW	3dB
VBW	3000000
Sweep Type	Swept
X Axis Scale	Lin
PreAmp State	Off
PreAmp Band	Low
Trigger Source	Free
Trigger Level	1.2
Trigger Slope	Positive
Trigger Delay	1.00E-06
Phase Noise Optimization	Fast
Swept If Gain	Low
FFT If Gain	Autorange
RF Coupling	AC
FFT Width	411900
Ext Ref	10000000
Input	RF
RF Calibrator	Off
Attenuation	10
Ref Level Offset	0
External Gain	0
X Axis Units	Hz
Y Axis Units	dBm

DATA									
MKR	MODE	TR C	SCL	X	Y	FUNCTI ON	FUNCTIO N WIDTH	FUNCTI ON VALUE	FUNCTI ON UNIT
1	Normal	1	Freque ncy	2.2350E+09	- 67.481	Off	0.0000E+00	0	None
2	Delta3	1	Freque ncy	0.0000E+00	- 0.761	Off	0.0000E+00	0	None
3	Fixed	1	Freque ncy	1.3255E+10	- 64.71	Off	0.0000E+00	0	None
4	Normal	2	Freque ncy	1.5904E+10	- 73.1	Off	0.0000E+00	0	None

08									
5	Delta7	2	Frequency	-2.7280E+09	-30.258	Band Power	1.3250E+06	-3.969	dB
6	Normal	2	Time	5.2620E-02	-70.177	Band Power	2.3840E+06	-43.15	dBm
7	Normal	3	Period	1.0680E-10	-75.458	Off	0.0000E+00	0	None
8	Normal	3	Frequency	6.7120E+09	-77.33	Noise	3.3910E+06	-139.714	dBm/Hz
9	Fixed	3	Inverse Time	4.0000E+01	-30.05	Off	0.0000E+00	0	None
10	Normal	3	Frequency	1.1454E+10	-75.161	Band Density	1.3250E+06	-138.973	dBm/Hz
11	Off	1	Frequency	0.0000E+00	0	Off	0.0000E+00	0	None
12	Off	1	Frequency	0.0000E+00	0	Off	0.0000E+00	0	None

The numbers appear in the file exactly as they appear onscreen. If it says 11.454 GHz onscreen, then in the file it is 11.454E+09.

The metadata header is very similar to the metadata used in the trace data .csv files. See Trace File Contents. The only new information concerns the 1-of-N fields in the marker table itself.

Peak Table

This section discusses the Peak Table Meas Results file format.

Imagine that, at the point where a Marker Table Meas Result is requested, the following screen is showing:

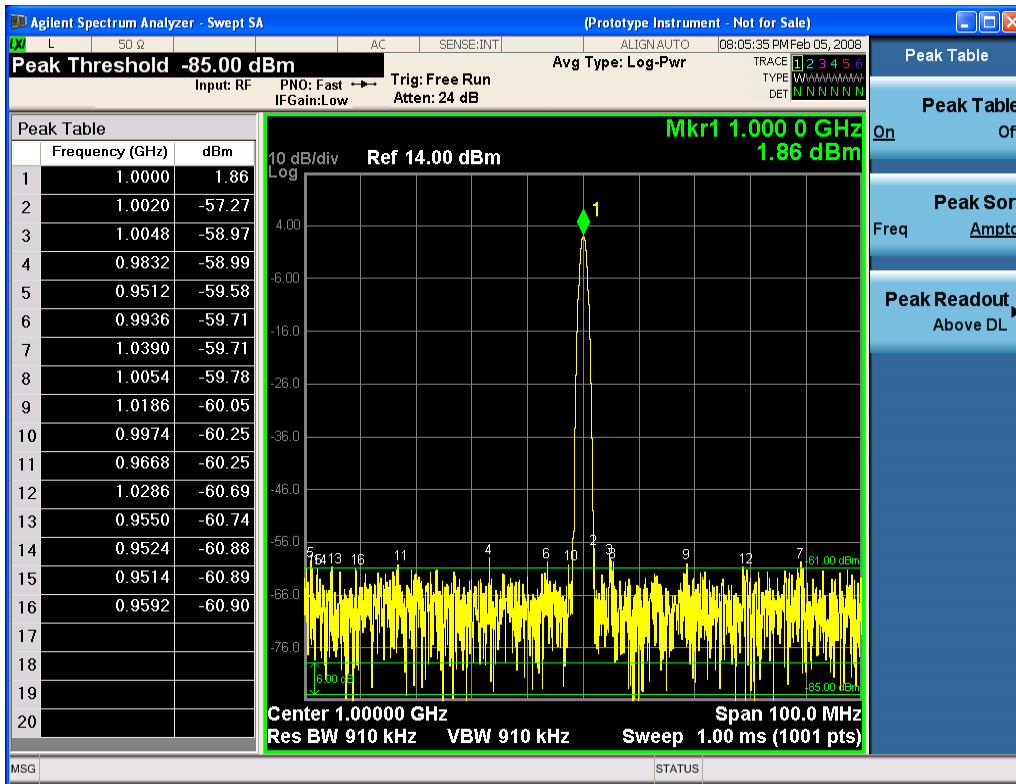

Then the Meas Results file, when opened, would show the header data (the same as for the Marker Table except that the Result Type is Peak Table) ending with a few fields of specific interest to Peak Table users:

- Peak Threshold
- Peak Threshold State (On|Off)
- Peak Excursion
- Peak Excursion State (On|Off)
- Display Line
- Peak Readout (All|AboveDL|BelowDL)
- Peak Sort (Freq|Amptd)

These fields are then followed by the data for the Peak Table itself.

Note that the label for the Frequency column changes to Time in 0 span.

Here is what the table for the above display looks like:

MeasurementResult	
Swept SA	
A.01.40_R0017	N9020A
526 B25 PFR P26 EA3	1

14 Transmit On/Off Power Measurement Functions
Save

Result Type	Peak Table
Ref Level	0
Number of Points	1001
Sweep Time	0.066266667
Start Frequency	10000000
Stop Frequency	26500000000
Average Count	0
Average Type	LogPower(Video)
RBW	3000000
RBW Filter	Gaussian
RBW Filter BW	3dB
VBW	3000000
Sweep Type	Swept
X Axis Scale	Lin
PreAmp State	Off
PreAmp Band	Low
Trigger Source	Free
Trigger Level	1.2
Trigger Slope	Positive
Trigger Delay	1.00E-06
Phase Noise Optimization	Fast
Swept If Gain	Low
FFT If Gain	Autorange
RF Coupling	AC
FFT Width	411900
Ext Ref	10000000
Input	RF
RF Calibrator	Off
Attenuation	10
Ref Level Offset	0
External Gain	0
X Axis Units	Hz
Y Axis Units	dBm
Peak Threshold	-85
Peak Threshold State	On
Peak Excursion	6
Peak Excursion State	On

Display Line	-61	
Peak Readout	AboveDL	
Peak Sort	Amptd	
DATA		
Peak	Frequency	Amplitude
1	1.0000E+06	1.86
2	1.0020E+06	-57.27
3	1.0048E+06	-58.97
4	9.8320E+05	-58.99
5	9.5120E+05	-59.58
6	9.9360E+05	-59.71
7	1.0390E+06	-59.71
8	1.0054E+06	-59.78
9	1.1086E+06	-60.05
10	9.9740E+05	-60.25
11	9.6680E+05	-60.25
12	1.0286E+06	-60.69
13	9.5500E+05	-60.74
14	9.5240E+05	-60.88
15	9.5140E+05	-60.89
16	9.5920E+05	-60.90
17		
18		
19		
20		

Spectrogram

This section discusses the Spectrogram Results file format. The Spectrogram choice only appears if option EDP is licensed.

The Spectrogram results are the same as a Trace data export, except that instead of having just one trace's data, all 300 traces appear one after the other.

Each trace has its own data mark; the data for Spectrogram Trace 0 follows the row marked DATA, the data for Spectrogram Trace 1 follows the row marked DATA1, for Spectrogram Trace 2 follows the row marked DATA2, and so on.

Each DATA row has a timestamp in the second column (as of firmware revision A.11.01). So, for example, if Trace 0 had a relative start time of 1729.523 sec, then the first DATA row would look like this:

DATA,1729.523

And if Trace 13 had a relative start time of 100.45 sec, then the fourteenth data row would look like:

DATA13,100.453

To find the absolute time for the relative timestamps of each trace, the last row before the first DATA row gives the absolute start time of the Spectrogram, in the form YYYYMMDDHHMMSS

So, for example, if the absolute start time is 13:23:45:678 on January 30, 2012, this row would look like:

Start Time,20120130132345678

NOTE

The resolution of the absolute time stored is 1 ms, which matches up with the fact that the fastest sweep time is also 1 ms. However, there is no specification for the absolute accuracy of the clock in the analyzer, nor is there any facility provided to allow the user to set this time to any particular degree of accuracy.

Traces that have not yet been filled in the Spectrogram display are empty; there is no DATA header for them. The file ends after the last non-empty trace.

Imagine that, at the point where a Spectrogram Meas Result is requested, the following screen is showing:



For the purpose of this example, we have set the Average/Hold Number to 10, thus we have only traces 0 thru 10. The Spectrogram was started at 02:28:08:700 pm on April 25, 2012 (that is, 700 ms after 2:28:08 pm), although the screen dump itself shows a different time, as it was taken ten minutes after the

Spectrogram data. Trace 0 is showing a start time of 5.30 seconds, meaning 5.3 seconds after the Spectrogram started (trace 10 has a start time of 0, as it was the first trace taken but has now rolled up into the tenth trace slot).

The Meas Results file, when opened, shows the header data and ten traces of trace data. Below is an extract from the result file for the above display. Note the start time of 20120425142808700 showing in the last row before the first DATA row, and the relative time of 5.299231048 showing in the first DATA row:

Result Type	Spectrogram
MeasResult	
Swept SA	
A.11.00.01	N9020A
503 508 513 526 ALL ALV B1C B1X B25 B2X B40 BAB BBA CR3 CRP DP2 DRD EA3 EDP EMC EP1 ERC ESC ESP EXM FSA HBA K03 LFE MPB P03 P08 P13 P26 PFR RTL RTS S40 SB1 SEC SM1 UK6 YAS YAV	1
Segment	0
Number of Points	1001
Sweep Time	0.523333333
Start Frequency	5999984415
Stop Frequency	6000009415
Average Count	0
Average Type	LogPower(Video)
RBW	240
RBW Filter	Gaussian
RBW Filter BW	3dB
VBW	240
Sweep Type	Swept
X Axis Scale	Lin
PreAmp State	Off
PreAmp Band	Low
Trigger Source	Free
Trigger Level	1.2
Trigger Slope	Positive
Trigger Delay	0
Phase Noise Optimization	Wide
Swept If Gain	Low
FFT If Gain	Autorange
RF Coupling	AC

14 Transmit On/Off Power Measurement Functions
Save

Result Type	Spectrogram
FFT Width	411900
Ext Ref	10000000
Input	RF
RF Calibrator	Off
Attenuation	14
Ref Level Offset	0
External Gain	0
Trace Type	Clearwrite
Detector	Normal
Trace Math	Off
Trace Math Oper1	Trace5
Trace Math Oper2	Trace6
Trace Math Offset	0
Trace Name	Trace1
X Axis Units	Hz
Y Axis Units	dBm
Start Time	20120425142808700
DATA	5.299231048
5999984415	-76.34749519
5999984440	-77.28097006
5999984465	-75.32317869
5999984490	-73.64417681
5999984515	-72.67154604

- o
- o
- o

6000009315	-77.94423277
6000009340	-79.51829697
6000009365	-78.46108961
6000009390	-78.46108957
6000009415	-76.59570596
DATA2	4.708697055
5999984415	-80.98197882
5999984440	-80.98197879

5999984465	-75.83142132
5999984490	-74.02712079
5999984515	-73.57213005

- o
- o
- o

6000009315	-75.9183103
6000009340	-79.53787488
6000009365	-78.82602191
6000009390	-78.82602188
6000009415	-76.37486709
DATA10	0
5999984415	-75.56751112
5999984440	-75.76485645
5999984465	-76.67718717
5999984490	-78.79238489
5999984515	-83.72680212

- o
- o
- o

6000009315	-71.3942461
6000009340	-72.28308332
6000009365	-73.92684489
6000009390	-75.45548832
6000009415	-75.17904815

Save As . . .

When you press “Save As”, the analyzer brings up a Windows dialog and a menu entitled “**Save As.**” This menu allows you to navigate to the various fields in the Windows dialog without using a keyboard or mouse. The Tab and Arrow keys can also be used for dialog navigation.

See "[To File . . .](#)" on page 2810 in Save, State for a full description of this dialog and menu.

The default path for saving files is:

For all of the Trace Data Files:

My Documents\<<mode name>\data\traces

For all of the Limit Data Files:

My Documents\<<mode name>\data\limits

For all of the Measurement Results Data Files:

My Documents\<<mode name>\data\<<measurement name>\results

For all of the Capture Buffer Data Files:

My Documents\<<mode name>\data\captureBuffer

Key Path	Save, Data
Mode	All
Notes	The key location is mode-dependent and will vary. Brings up the Save As dialog for saving a <mode specific> Save Type. The save is performed immediately and does not wait until the measurement is complete.
Initial S/W Revision	Prior to A.02.00

Screen Image

Pressing Screen Image accesses a menu of functions that enable you to specify a format and location for the saved screen image. It brings up a menu that allows you to specify the color scheme of the Screen Image (Themes) or navigate to the Save As dialog to perform the actual save.

Screen Image files contain an exact representation of the analyzer display. They cannot be loaded back onto the analyzer, but they can be loaded into your PC for use in many popular applications.

The image to be saved is actually captured when the Save front panel key is pressed, and kept in temporary storage to be used if you ask for a Screen Image save. When the Screen Image key is pressed, a "thumbnail" of the captured image is displayed, as shown below:

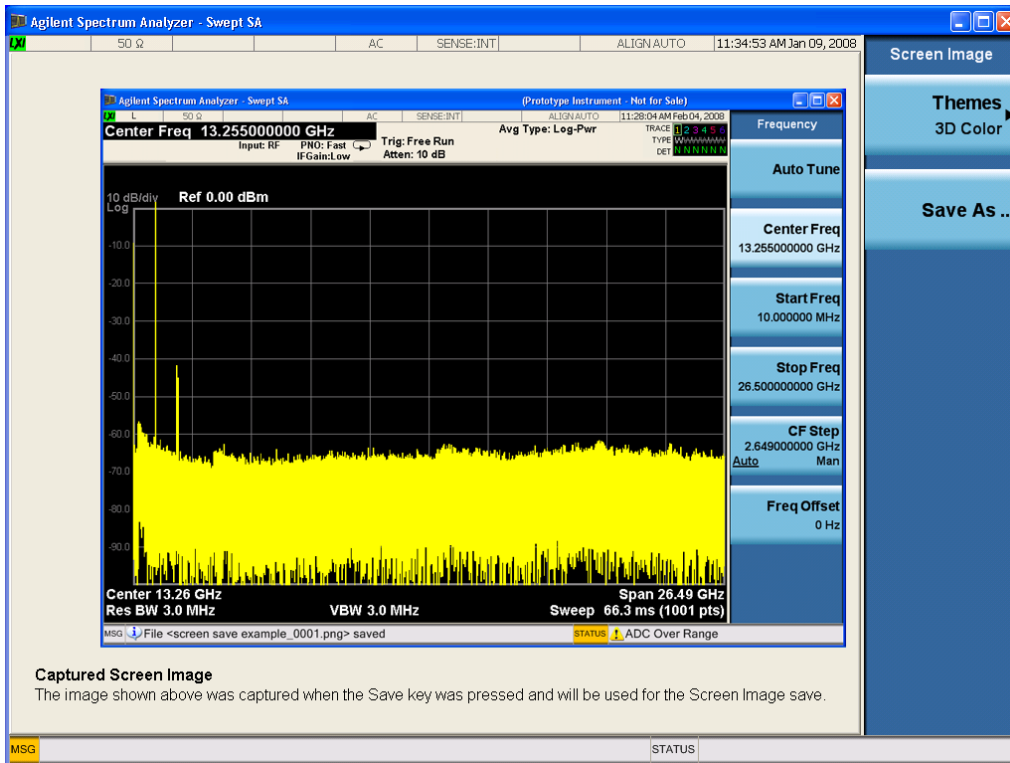

When you continue on into the Save As menu and complete the Screen Image save, the image depicted in the thumbnail is the one that gets saved, showing the menus that were on the screen before going into the Save menus. The save is performed immediately and does not wait until the measurement is complete.

After you have completed the save, the Quick Save front-panel key lets you quickly repeat the last save performed, using an auto-named file, with the current screen data.

NOTE

For versions previous to A.01.55, if you initiate a screen image save by navigating through the Save menus, the image that is saved will contain the Save menu softkeys, not the menus and the active function that were on the screen when you first pressed the Save front panel key.

Key Path	Save
Mode	All
Remote Command	:MMEMory:STORe:SCReem <filename>
Example	:MMEM:STOR:SCR "myScreen.png" This stores the current screen image in the file MyScreenFile.png in the default directory.
Initial S/W Revision	Prior to A.02.00

Themes

Accesses a menu of functions that enable you to choose the theme to be used when saving the screen image.

The **Themes** option is the same as the **Themes** option under the **Display** and **Page Setup** dialogs. It allows you to choose between themes to be used when saving the screen image.

Key Path	Save, Screen Image
Remote Command	:MMEMory:STORe:SCReen:THEMe TDColor TDMonochrome FCOLor FMONochrome :MMEMory:STORe:SCReen:THEMe?
Example	:MMEM:STOR:SCR:THEM TDM
Preset	3D Color; Is not part of Preset, but is reset by Restore Misc Defaults or Restore System Defaults All and survives subsequent running of the modes.
Readback	3D Color 3D Mono Flat Color Flat Mono
Backwards Compatibility Notes	In ESA and PSA we offer the choice of "Reverse Bitmap" or "Reverse Metafile" when saving screen images. This is much like the "Flat Color" theme available in X-Series. Also, if you selected Reverse Bitmap AND a black & white screen image, that would be much like "Flat Monochrome". In other words, each of the X-Series themes has a similar screen image type in ESA/PSA. But they are not identical.
Initial S/W Revision	Prior to A.02.00

3D Color

Selects a standard color theme with each object filled, shaded and colored as designed.

Key Path	Save, Screen Image, Themes
Example	MMEM:STOR:SCR:THEM TDC
Readback	3D Color
Initial S/W Revision	Prior to A.02.00

3D Monochrome

Selects a format that is like 3D color but shades of gray are used instead of colors.

Key Path	Save, Screen Image, Themes
Example	MMEM:STOR:SCR:THEM TDM
Readback	3D Mono
Initial S/W Revision	Prior to A.02.00

Flat Color

Selects a format that is best when the screen is to be printed on an ink printer.

Key Path	Save, Screen Image, Themes
-----------------	----------------------------

Example	MMEM:STOR:SCR:THEM FCOL
Readback	Flat Color
Initial S/W Revision	Prior to A.02.00

Flat Monochrome

Selects a format that is like Flat Color. But only black is used (no colors, not even gray), and no fill.

Key Path	Save, Screen Image, Themes
Example	MMEM:STOR:SCR:THEM FMON
Readback	Flat Mono
Initial S/W Revision	Prior to A.02.00

Save As...

When you press "Save As", the analyzer brings up a Windows dialog and a menu entitled "**Save As.**" This menu allows you to navigate to the various fields in the Windows dialog without using a keyboard or mouse. The Tab and Arrow keys can also be used for dialog navigation.

See "[To File . . .](#)" on page 2810 in Save, State for a full description of this dialog and menu.

The default path for Screen Images is

My Documents\`<mode name>`\screen.

where `<mode name>` is the parameter used to select the mode with the INST:SEL command (for example, SA for the Spectrum Analyzer).

Key Path	Save, Screen Image
Notes	Brings up Save As dialog for saving a Screen Image Save Type
Initial S/W Revision	Prior to A.02.00

Mass Storage Catalog (Remote Command Only)

Key path	SCPI Only
Remote Command	:MMEMory:CATalog? [<code><directory_name></code>]
Notes	<p>The string must be a valid logical path.</p> <p>Queries disk usage information (drive capacity, free space available) and obtains a list of files and directories in a specified directory in the following format:</p> <p><code><numeric_value>,<numeric_value>,{<file_entry>}</code></p> <p>It returns two numeric parameters and as many strings as there are files and directories. The first parameter indicates the total amount of storage currently used in bytes. The second parameter</p>

	<p>indicates the total amount of storage available, also in bytes. The <file_entry> is a string. Each <file_entry> indicates the name, type, and size of one file in the directory list: <file_name>,<file_type>,<file_size></p> <p>As the windows file system has an extension that indicates file type, <file_type> is always empty. <file_size> provides the size of the file in bytes. For directories, <file_entry> is surrounded by square brackets and both <file_type> and <file_size> are empty</p>
Initial S/W Revision	Prior to A.02.00

Mass Storage Change Directory (Remote Command Only)

Key path	SCPI Only
Remote Command	:MMEMory:CDIRectory [<directory_name>] :MMEMory:CDIRectory?
Notes	<p>The string must be a valid logical path.</p> <p>Changes the default directory for a mass memory file system. The <directory_name> parameter is a string. If no parameter is specified, the directory is set to the *RST value.</p> <p>At *RST, this value is set to the default user data storage area, that is defined as System.Environment.SpecialFolder.Personal.</p> <p>Query returns full path of the default directory.</p>
Initial S/W Revision	Prior to A.02.00

Mass Storage Copy (Remote Command Only)

Key path	SCPI Only
Remote Command	:MMEMory:COPY <string>,<string>[,<string>,<string>]
Notes	<p>The string must be a valid logical path.</p> <p>Copies an existing file to a new file or an existing directory to a new directory.</p> <p>Two forms of parameters are allowed. The first form has two parameters. In this form, the first parameter specifies the source, and the second parameter specifies the destination.</p> <p>The second form has four parameters. In this form, the first and third parameters specify the source. The second and fourth parameters specify the directories. The first pair of parameters specifies the source. The second pair specifies the destination. An error is generated if the source doesn't exist or the destination file already exists.</p> <p>This command will generate an "access denied" error if the destination is a restricted folder (e.g., C:\Windows) and the current user does not have Power User or Administrator privileges.</p>

Mass Storage Device Copy (Remote Command Only)

This command transfers data to/from a file and a peripheral device.

Key path	SCPI Only
Remote Command	:MMEMory:COpy:DEvice <source_string>,<dest_string>
Notes	The strings must be a valid logical path or a valid device keyword. If the dest_string is a device keyword, the data is copied from the source file to the device. If the source_string is a device keyword, the data is copied to the source file from the device. Valid device keywords are: SNS (smart noise source) An error is generated if the file or device is not found.

Mass Storage Delete (Remote Command Only)

Key path	SCPI Only
Remote Command	:MMEMory:DElete <file_name>[,<directory_name>]
Notes	The string must be a valid logical path. Removes a file from the specified directory. The <file_name> parameter specifies the file name to be removed. This command will generate an “access denied” error if the file is in a restricted folder (e.g., C:\Windows) and the current user does not have Power User or Administrator privileges.
Initial S/W Revision	Prior to A.02.00

Mass Storage Data (Remote Command Only)

Creates a file containing the specified data OR queries the data from an existing file.

Key path	SCPI Only
Remote Command	:MMEMory:DATA <file_name>,<data> :MMEMory:DATA? <file_name>
Notes	The string must be a valid logical path. The command form is MMEMory:DATA <file_name>,<data>. It loads <data> into the file <file_name>. <data> is in 488.2 block format. <file_name> is string data. The query form is MMEMory:DATA? <file_name> with the response being the associated <data> in block format.
Initial S/W Revision	Prior to A.02.00

Mass Storage Make Directory (Remote Command Only)

Key path	SCPI Only
Remote Command	:MMEMory:MDIRectory <directory_name>
Notes	The string must be a valid logical path. Creates a new directory. The <directory_name> parameter specifies the name to be created.

	This command will generate an “access denied” error if the new directory would be in a restricted folder (e.g., C:\Windows) and the current user does not have Power User or Administrator privileges.
Initial S/W Revision	Prior to A.02.00

Mass Storage Move (Remote Command Only)

Key path	SCPI Only
Remote Command	:MMEMory:MOVE <string>,<string>[,<string>,<string>]
Notes	<p>The string must be a valid logical path.</p> <p>Moves an existing file to a new file or an existing directory to a new directory.</p> <p>Two forms of parameters are allowed. The first form has two parameters. In this form, the first parameter specifies the source, and the second parameter specifies the destination.</p> <p>The second form has four parameters. In this form, the first and third parameters specify the source. The second and fourth parameters specify the directories. The first pair of parameters specifies the source. The second pair specifies the destination. An error is generated if the source doesn't exist or the destination file already exists.</p> <p>This command will generate an “access denied” error if the destination is a restricted folder (e.g., C:\Windows) and the current user does not have Power User or Administrator privileges.</p>
Initial S/W Revision	Prior to A.02.00

Mass Storage Remove Directory (Remote Command Only)

Key path	SCPI Only
Remote Command	:MMEMory:RDIRECTory <directory_name>
Notes	<p>The string must be a valid logical path.</p> <p>Removes a directory. The <directory_name> parameter specifies the directory name to be removed. All files and directories under the specified directory shall also be removed.</p> <p>This command will generate an “access denied” error if the folder is a restricted folder (e.g., C:\Windows) or is in a restricted folder and the current user does not have Power User or Administrator privileges.</p>
Initial S/W Revision	Prior to A.02.00

Single (Single Measurement/Sweep)

Sets the analyzer for Single measurement operation. The single/continuous state is Meas Global, so the setting will affect all the measurements. If you are Paused, pressing Single does a Resume.

See ["More Information" on page 1755](#)

Key Path	Front-panel key
Example	:INIT:CONT OFF
Notes	See Cont key description.
Backwards Compatibility Notes	<p>For Spectrum Analysis mode in ESA and PSA, the Single hardkey and the INITiate:IMM switched from continuous measurement to single measurement and restarted sweeps and averages (displayed average count reset to 1), but did not restart Max Hold and Min Hold. In the X-Series, the Single hardkey and the INITiate:IMM command initiate a sweep/ measurement/ average sequence/hold sequence including MaxHold and MinHold.</p> <p>For Spectrum Analysis mode in ESA and PSA, the Single hardkey restarted the sweep regardless of whether or not you were in an active sweep or sweep sequence. In the X-Series, Restart does this but Single only restarts the sweep or sweep sequence if you are in the idle state.</p> <p>INIT[:IMM] in ESA & PSA Spectrum Analysis Mode does an implied ABORT. In some other PSA Modes, INIT[:IMM] is ignored if not in the idle state. . The X-Series follows the ESA/PSA SA Mode model, which may cause some Modes to have compatibility problems.</p>
Initial S/W Revision	Prior to A.02.00

More Information

See ["Restart" on page 2807](#) for details on the INIT:IMMEDIATE (Restart) function.

If you are already in single sweep, the INIT:CONT OFF command has no effect.

If you are already in Single Sweep, then pressing the Single key in the middle of a sweep does not restart the sweep or sequence. Similarly, pressing the Single key does not restart the sweep or sequence if the sweep is not in the idle state (for example, if you are taking a very slow sweep, or the analyzer is waiting for a trigger). Instead, it results in a message. "Already in Single, press Restart to initiate a new sweep or sequence". Even though pressing the Single key in the middle of a sweep does not restart the sweep, sending INIT:IMMEDIATE does reset it.

To take one more sweep without resetting the average count, increment the average count by 1, by pressing the step up key while **Average/Hold Number** is the active function, or sending the remote command CALC:AVER:TCON UP.

Source

There is no Source control functionality for this measurement. When this key is pressed, the screen either displays a blank menu, or the previously-selected menu remains unchanged.

Key Path	Front-panel key
----------	-----------------

SPAN X Scale

Accesses a menu of functions that enable you set the horizontal scale parameters.

Key Path	Front-panel key
Initial S/W Revision	A.03.00

Ref Value

Allows you to set the display X reference value.

Key Path	SPAN X Scale
----------	--------------

Ref Value(Burst View)

Allows you to set the display X reference value.

Key Path	SPAN X Scale
Mode	LTETDD, LTE, LTEATDD, LTEAFDD
Remote Command	:DISPlay:PVTime:VIEW[1]:WINDow[1]:TRACe:X[:SCALE]:RLEVel <time> :DISPlay:PVTime:VIEW[1]:WINDow[1]:TRACe:X[:SCALE]:RLEVel?
Example	DISP:PVT:VIEW:WIND:TRACE:X:RLEV 1s DISP:PVT:VIEW:WIND:TRACE:X:RLEV?
Notes	If X Auto Scale is On, this value is automatically determined by the measurement result. When a value is set manually, X Auto Scale is automatically set to Off.
Couplings	See Notes
Preset	0 s
State Saved	Saved in instrument state.
Min	-10.0 s
Max	10.00 s
Initial S/W Revision	A.03.00

Ref Value(Rise & Fall view)

Allows you to set the display X reference value.

Key Path	SPAN X Scale
Mode	LTETDD, LTE, LTEATDD, LTEAFDD
Remote Command	:DISPlay:PVTime:VIEW2:WINDow[1] 2:TRACe:X[:SCALE]:RLEVel <time> :DISPlay:PVTime:VIEW2:WINDow[1] 2:TRACe:X[:SCALE]:RLEVel?

Example	DISP:PVT:VIEW2:WIND2:TRAC:X:RLEV 1 DISP:PVT:VIEW2:WIND2:TRAC:X:RLEV?
Notes	If X Auto Scale is On, this value is automatically determined by the measurement result. When a value is set manually, X Auto Scale is automatically set to Off.
Couplings	See Notes
Preset	0 s
State Saved	Saved in instrument state.
Min	-10.0 s
Max	10.00 s
Initial S/W Revision	A.03.00

Scale/Div

Allows you to set the display X scale/division value.

Key Path	SPAN X Scale
----------	--------------

Scale/Div(Burst View)

Allows you to set the display X scale/division value.

Key Path	SPAN X Scale
Mode	LTETDD, LTE, LTEATDD, LTEAFDD
Remote Command	:DISPlay:PVTtime:VIEW[1]:WINDow[1]:TRACe:X[:SCALe]:PDIVision <time> :DISPlay:PVTtime:VIEW[1]:WINDow[1]:TRACe:X[:SCALe]:PDIVision?
Example	:DISP:PVT:VIEW:WIND:TRACE:X:PDIV 1ms :DISP:PVT:VIEW:WIND:TRACE:X:PDIV?
Notes	If X Auto Scale is set to On, this value is automatically determined by the measurement result. When a value is set manually, X Auto Scale is automatically set to Off.
Couplings	See Notes
Preset	1.0 ms
State Saved	Saved in instrument state.
Min	1.00 ns
Max	1.00 s
Initial S/W Revision	A.03.00
MIN/MAX/DEF Support	Yes

Scale/Div(Rise & Fall View)

Allows you to set the display X scale/division value.

Key Path	SPAN X Scale
Mode	LTETDD, LTE, LTEATDD, LTEAFDD
Remote Command	:DISPlay:PVTime:VIEW2:WINDow[1] 2:TRACe:X[:SCALe]:PDIVision <time> :DISPlay:PVTime:VIEW2:WINDow[1] 2:TRACe:X[:SCALe]:PDIVision?
Example	DISP:PVT:VIEW2:WIND2:TRAC:X:PDIV 1ms DISP:PVT:VIEW2:WIND2:TRAC:X:PDIV?
Notes	If X Auto Scale is set to On, this value is automatically determined by the measurement result. When a value is set manually, X Auto Scale is automatically set to Off.
Couplings	See Notes
Preset	4.0 us
State Saved	Saved in instrument state.
Min	1.00 ns
Max	1.00 s
Initial S/W Revision	A.03.00
MIN/MAX/DEF Support	Yes

Ref Position

Allows you to set the X reference position to the left, center, or right of the display.

Key Path	SPAN X Scale
----------	--------------

Ref Position(Burst View)

Allows you to set the X reference position to the left, center, or right of the display.

Key Path	SPAN X Scale
Mode	LTETDD, LTE, LTEATDD, LTEAFDD
Remote Command	:DISPlay:PVTime:VIEW[1]:WINDow[1]:TRACe:X[:SCALe]:RPOsition LEFT CENTer RIGHT :DISPlay:PVTime:VIEW[1]:WINDow[1]:TRACe:X[:SCALe]:RPOsition?
Example	:DISP:PVT:VIEW:WIND:TRACE:X:RPOS LEFT :DISP:PVT:VIEW:WIND:TRACE:X:RPOS?
Preset	LEFT
State Saved	Saved in instrument state.
Range	Left Ctr Right
Initial S/W Revision	A.03.00

Ref Position(Rise & Fall View)

Allows you to set the X reference position to the left, center, or right of the display.

Key Path	SPAN X Scale
Mode	LTETDD, LTE, LTEATDD, LTEAFDD
Remote Command	:DISPlay:PVTime:VIEW2:WINDow[1] 2:TRACe:X[:SCALe]:RPOSition LEFT CENTer RIGHT :DISPlay:PVTime:VIEW2:WINDow[1] 2:TRACe:X[:SCALe]:RPOSition?
Example	DISP:PVT:VIEW2:WIND2:TRAC:X:RPOS LEFT DISP:PVT:VIEW2:WIND2:TRAC:X:RPOS?
Preset	CENTER
State Saved	Saved in instrument state.
Range	Left Ctr Right
Initial S/W Revision	A.03.00

Auto Scale

Allows you to toggle the X Auto Scale function between On and Off.

Key Path	SPAN X Scale
----------	--------------

Auto Scale(Burst View)

Allows you to toggle the X Auto Scale function between On and Off.

Key Path	SPAN X Scale
Mode	LTETDD, LTE, LTEATDD, LTEAFDD
Remote Command	:DISPlay:PVTime:VIEW[1]:WINDow[1]:TRACe:X[:SCALe]:COUPlE 0 1 OFF ON :DISPlay:PVTime:VIEW[1]:WINDow[1]:TRACe:X[:SCALe]:COUPlE?
Example	:DISP:PVT:VIEW:WIND:TRAC:X:COUP OFF :DISP:PVT:VIEW:WIND:TRAC:X:COUP?
Notes	Upon pressing the Restart front-panel key, the scale coupling function automatically determines the scale per division and reference values, based on the measurement results, if this parameter is set to On. When you manually set a value to either X Rel Value or X Scale/Div, X Auto Scale is automatically set to Off.
Couplings	See Notes
Preset	ON
State Saved	Saved in instrument state.

Range	On Off
Initial S/W Revision	A.03.00

Auto Scale(Rise & Fall View)

Allows you to toggle the X Auto Scale function between On and Off.

Key Path	SPAN X Scale
Mode	LTETDD, LTE, LTEATDD, LTEAFDD
Remote Command	:DISPlay:PVTtime:VIEW2:WINDow[1] 2:TRACe:X[:SCALe]:COUPle 0 1 OFF ON :DISPlay:PVTtime:VIEW2:WINDow[1] 2:TRACe:X[:SCALe]:COUPle?
Example	DISP:PVT:VIEW2:WIND2:TRAC:X:COUP OFF DISP:PVT:VIEW2:WIND2:TRAC:X:COUP?
Notes	Upon pressing the Restart front-panel key, the scale coupling function automatically determines the scale per division and reference values, based on the measurement results, if this parameter is set to On. When you manually set a value to either X Rel Value or X Scale/Div, X Auto Scale is automatically set to Off.
Couplings	See Notes
Preset	ON
State Saved	Saved in instrument state.
Range	On Off
Initial S/W Revision	A.03.00

Sweep/Control

Operation of this key is identical across several measurements. For details about this key, see "[Sweep/Control](#)" on page 2703 in the "Common Measurement Functions".

NOTE Gate function is not supported in Transmit On/Off Power measurement.

Key Path	Sweep/Control
Mode	LTETDD, LTE, LTEATDD, LTEAFDD

Abort (Remote Command Only)

This command is used to stop the current measurement. It aborts the current measurement as quickly as possible, resets the sweep and trigger systems, and puts the measurement into an "idle" state. If the analyzer is in the process of aligning when ABORT is sent, the alignment finishes before the abort function is performed. So ABORT does not abort an alignment.

If the analyzer is set for Continuous measurement, it sets up the measurement and initiates a new data measurement sequence with a new data acquisition (sweep) taken once the trigger condition is met.

If the analyzer is set for Single measurement, it remains in the "idle" state until an :INIT:IMM command is received.

Parameter Name	Abort Measurement
Key Type	No equivalent front-panel key.
Remote Command	:ABORT
Example	:ABOR
Notes	If :INITiate:CONTinuous is ON, then a new continuous measurement will start immediately; with sweep (data acquisition) occurring once the trigger condition has been met. If :INITiate:CONTinuous is OFF, then :INITiate:IMMediate is used to start a single measurement; with sweep (data acquisition) occurring once the trigger condition has been met.
Dependencies	For continuous measurement, ABORT is equivalent to the Restart key. Not all measurements support the abort command.
Status Bits/OPC dependencies	The STATus:OPERation register bits 0 through 8 are cleared. The STATus:QUEStionable register bit 9 (INTegrity sum) is cleared. Since all the bits that feed into OPC are cleared by the ABORT, the ABORT will cause the *OPC query to return true.
Initial S/W Revision	Prior to A.02.00

System

See "System" on page 366

Trace/Detector

Accesses a menu that allows you to control trace settings.

NOTE Max/Min Hold Traces will be held during the averaging cycle.

Key Path	Front-panel key
Initial S/W Revision	A.03.00

Max Hold Trace

This key allows you to make the Max Hold Trace visible or invisible in the display..

Key Path	Trace/Detector
Mode	LTETDD, LTE, LTEATDD, LTEAFDD
Remote Command	:DISPlay:PVTime:VIEW[1]:WINDow[1]:TRACe:MAXHold[:STATe] ON OFF 1 0 :DISPlay:PVTime:VIEW[1]:WINDow[1]:TRACe:MAXHold[:STATe]?
Example	:DISP:PVT:VIEW:WIND:TRAC:MAXH ON :DISP:PVT:VIEW:WIND:TRAC:MAXH?
Couplings	While Rise & Fall view is selected, this key will be grayed out. Rise & Fall view will not support trace max/min hold.
Preset	OFF
State Saved	Saved in instrument state.
Range	On Off
Initial S/W Revision	A.03.00

Min Hold Trace

This key allows you to make the Min Hold Trace visible or invisible in the display.

Key Path	Trace/Detector
Mode	LTETDD, LTE, LTEATDD, LTEAFDD
Remote Command	:DISPlay:PVTime:VIEW[1]:WINDow[1]:TRACe:MINHold[:STATe] ON OFF 1 0 :DISPlay:PVTime:VIEW[1]:WINDow[1]:TRACe:MINHold[:STATe]?
Example	:DISP:PVT:VIEW:WIND:TRAC:MINH ON :DISP:PVT:VIEW:WIND:TRAC:MINH?
Couplings	While Rise & Fall view is selected, this key will be grayed out. Rise & Fall view will not support trace max/min hold.
Preset	OFF

State Saved	Saved in instrument state.
Range	On Off
Initial S/W Revision	A.03.00

Trigger

See ["Trigger" on page 438](#)

Free Run

See ["Free Run " on page 445](#)

Video

See ["Video \(IF Envelope\) " on page 446](#)

Trigger Level

See ["Trigger Level " on page 446](#)

Trig Slope

See ["Trig Slope " on page 447](#)

Trig Delay

See ["Trig Delay " on page 448](#)

External 1

See ["External 1 " on page 2516](#)

Trigger Level

See ["Trigger Level " on page 2516](#)

Trig Slope

See ["Trig Slope " on page 2517](#)

Trig Delay

See ["Trig Delay " on page 453](#)

Zero Span Delay Comp

See ["Zero Span Delay Comp On/Off" on page 2505](#)

External 2

See ["External 2 " on page 2518](#)

Trigger Level

See ["Trigger Level " on page 2518](#)

Trig Slope

See ["Trig Slope " on page 2519](#)

Trig Delay

See ["Trig Delay "](#) on page 455

Zero Span Delay Comp

See ["Zero Span Delay Comp On/Off"](#) on page 2507

RF Burst

See ["RF Burst "](#) on page 2519

Absolute Trigger

See ["Absolute Trigger Level"](#) on page 2520

Relative Trigger

See ["Relative Trigger Level"](#) on page 2509

Trig Slope

See ["Trigger Slope "](#) on page 2521

Trig Delay

See ["Trig Delay "](#) on page 460

Periodic Timer

See ["Periodic Timer \(Frame Trigger\) "](#) on page 2511

Period

See ["Period "](#) on page 2512

Offset

See ["Offset "](#) on page 2513

Offset Adjust (Remote Command Only)

See ["Offset Adjust \(Remote Command Only\)"](#) on page 2514

Reset Offset Display

See ["Reset Offset Display "](#) on page 2515

Sync Source

See ["Sync Source "](#) on page 2515

Off

See ["Off "](#) on page 2516

External 1

See ["External 1 "](#) on page 2516

Trigger Level

See ["Trigger Level "](#) on page 2516

Trig Slope

See ["Trig Slope "](#) on page 2517

External 2

See ["External 2 "](#) on page 2518

Trigger Level

See ["Trigger Level "](#) on page 2518

Trig Slope

See ["Trig Slope "](#) on page 2519

RF Burst

See ["RF Burst "](#) on page 2519

Absolute Trigger

See ["Absolute Trigger Level"](#) on page 2520

Trig Slope

See ["Trigger Slope "](#) on page 2521

Trig Delay

See ["Trig Delay"](#) on page 470

Auto/Holdoff

See ["Auto/Holdoff "](#) on page 471

Auto Trig

See ["Auto Trig "](#) on page 471

Trig Holdoff

See ["Trig Holdoff "](#) on page 472

Holdoff Type

See ["Holdoff Type"](#) on page 472

User Preset

Accesses a menu that gives you the following three choices:

- User Preset – recalls a state previously saved using the Save User Preset function.
- User Preset All Modes – presets all of the modes in the analyzer
- Save User Preset– saves the current state for the current mode

Key Path	Front-panel key
Backwards Compatibility Notes	<p>User Preset is actually loading a state, and in legacy analyzers, it was possible to load a state without affecting the trace data, limit lines or correction data. Similarly it was possible to do a User Preset without affecting the trace data, limit lines or correction data.</p> <p>In the X-Series, “state” always includes all of this data; so whenever state is loaded, or User Preset is executed, all of the traces, limit lines and corrections are affected. Although this differs from previous behavior, it is desirable behavior, and should not cause adverse issues for users.</p> <p>On ESA and PSA, User Preset affected the entire instrument’s state. In the X-Series, User Preset only recalls the state for the active mode. There is a User Preset file for each mode. User Preset can never cause a mode switch as it can in legacy analyzers. If you want to recall all modes to their user preset file state, you will need to do a User Preset after mode switching into each mode.</p> <p>User Preset recalls mode state which can now include data like traces; whereas on ESA and PSA, User Preset did not affect data.</p>
Initial S/W Revision	Prior to A.02.00

User Preset

User Preset sets the state of the currently active mode back to the state that was previously saved for this mode using the Save User Preset menu key or the SCPI command, SYST:PRES:USER:SAV. It not only recalls the Mode Preset settings, but it also recalls all of the mode persistent settings, and the Input/Output system setting that existed at the time Save User Preset was executed.

If a Save User Preset has not been done at any time, User Preset recalls the default user preset file for the currently active mode. The default user preset files are created if, at power-on, a mode detects there is no user preset file. There will never be a scenario when there is no user preset file to restore. For each mode, the default user preset state is the same state that would be saved if a Save User Preset is performed in each mode right after doing a Restore Mode Default and after a Restore Input/Output Defaults.

The User Preset function does the following:

- Aborts the currently running measurement.
- Sets the mode State to the values defined by Save User Preset.
- Makes the saved measurement for the currently running mode the active measurement.
- Brings up the saved menu for the power-on mode.
- Clears the input and output buffers.
- Sets the Status Byte to 0.

Key Path	User Preset
Remote Command	:SYSTem:PRESet:USER
Example	:SYST:PRES:USER:SAVE:SYST:PRES:USER
Notes	:SYST:PRES:USER:SAVE is used to save the current state as the user preset state. Clears all pending OPC bits. The Status Byte is set to 0. Pressing the User Preset front-panel key while already in the User Preset menu will cause the User Preset to get executed
Couplings	A user preset will cause the currently running measurement to be aborted and cause the saved measurement to be active. Recalling a User Preset file has the same issues that recalling a Save State file has. Some settings may need to be limited and therefore re-coupled, since the capabilities of the mode may have changes when the User Preset file was last saved.
Initial S/W Revision	Prior to A.02.00

User Preset All Modes

Recalls all of the User Preset files for each mode, switches to the power-on mode, and activates the saved measurement from the power-on mode User Preset file.

NOTE

When the instrument is secured, all of the user preset files are converted back to their default user preset files.

The User Preset function does the following:

- Aborts the currently running measurement.
- Switches the Mode to the power-on mode.
- Restores the User Preset files for each mode.
- Makes the saved measurement for the power-on mode the active measurement.
- Brings up the saved menu for the power-on mode.
- Clears the input and output buffers.
- Sets the Status Byte to 0.

Key Path	User Preset
Remote Command	:SYSTem:PRESet:USER:ALL
Example	:SYST:PRES:USER:SAVE:SYST:PRES:USER:ALL
Notes	Clears all pending OPC bits. The Status Byte is set to 0. :SYST:PRES:USER:SAVE is used to save the current state as the user preset state.
Couplings	A user preset will cause the currently running measurement to be aborted, cause a mode switch to the power-on mode, and cause the saved measurement to be active in the power-on mode. Recalling a User Preset file has the same issues that recalling a Save State file has. Some settings may need to be limited and therefore re-coupled, since the capabilities of the mode may have changes when the User Preset file was last saved.
Initial S/W Revision	Prior to A.02.00

Save User Preset

Saves the currently active mode and its State. You can recall this User Preset file by pressing the User Preset menu key or sending the SYST:PRES:USER remote command. This same state is also saved by the Save State function.

Key Path	User Preset
Remote Command	:SYSTem:PRESet:USER:SAVE
Example	:SYST:PRES:USER:SAVE
Notes	:SYST:PRES:SAVE creates the same file as if the user requested a *SAV or a MMEM:STOR:STAT, except User Preset Save does not allow the user to specify the filename or the location of the file.
Initial S/W Revision	Prior to A.02.00

View/Display

Opens the View menu for the current measurement. The available views are specific to the current measurement selected under the Meas key.

All Soft Keys in the “View/Display” menu work regardless of which result window currently has the focus.

For example, the scroll function works on the lower numeric result window even if the upper RF Envelope window currently has the focus.

The View/Display menu includes two View Selection keys as shown below, which allow you to select the desired view of the measurement.

View	Name	Description
1	Burst (SCPI: ALL)	View Burst envelope, the length of burst can be determined by slot number in mode setup.
2	Rise & Fall (SCPI: BOTH)	Zooms in on the rising and falling portions of the burst being tested.

View Selection by name

Key Path	View/Display
Mode	LTETDD, LTE, LTEATDD, LTEAFDD
Remote Command	:DISPlay:PVTime:VIEW[:SElect] ALL BOTH :DISPlay:PVTime:VIEW[:SElect]?
Example	DISP:PVT:VIEW:SEL ALL DISP:PVT:VIEW:SEL?
Preset	ALL
State Saved	Saved in instrument state.
Range	Burst Rise & Fall
Initial S/W Revision	A.03.00

Mode	LTETDD, LTE, LTEATDD, LTEAFDD
Remote Command	:DISPlay:PVTime:VIEW:NSElect <integer> :DISPlay:PVTime:VIEW:NSElect?
Example	DISP:PVT:VIEW:NSEL 2 DISP:PVT:VIEW:NSEL?
Notes	1: Burst 2: Rise & Fall You must be in the LTETDD or LTE or LTE-Advanced FDD/TDD mode to use this command. Use INSTRument:SElect to set the mode.
Preset	1
State Saved	Saved in instrument state.

Min	1
Max	2
Initial S/W Revision	A.03.00

Display

The Display menu is common to most measurements, and is used for configuring items on the display. Some Display menu settings apply to all the measurements in a mode, and some only to the current measurement. Those under the System Display Settings key apply to all measurements in all modes.

Key Path	Display
Key Path	View/Display
Initial S/W Revision	Prior to A.02.00

Annotation

Turns on and off various parts of the display annotation. The annotation is divided up into four categories:

1. Meas Bar: This is the measurement bar at the top of the screen. It does not include the settings panel or the Active Function. Turning off the Meas Bar turns off the settings panel and the Active Function. When the Meas Bar is off, the graticule area expands to fill the area formerly occupied by the Meas Bar.
2. Screen Annotation: this is the annotation and annunciation around the graticule, including any annotation on lines (such as the display line, the threshold line, etc.) This does NOT include the marker number or the N dB result. When off, the graticule expands to fill the entire graticule area.
3. Trace annotation: these are the labels on the traces, showing their detector (or their math mode).
4. Active Function annotation: this is the active function display in the meas bar, and all of the active function values displayed on softkeys.

See the figure below. Each type of annotation can be turned on and off individually.

14 Transmit On/Off Power Measurement Functions
View/Display

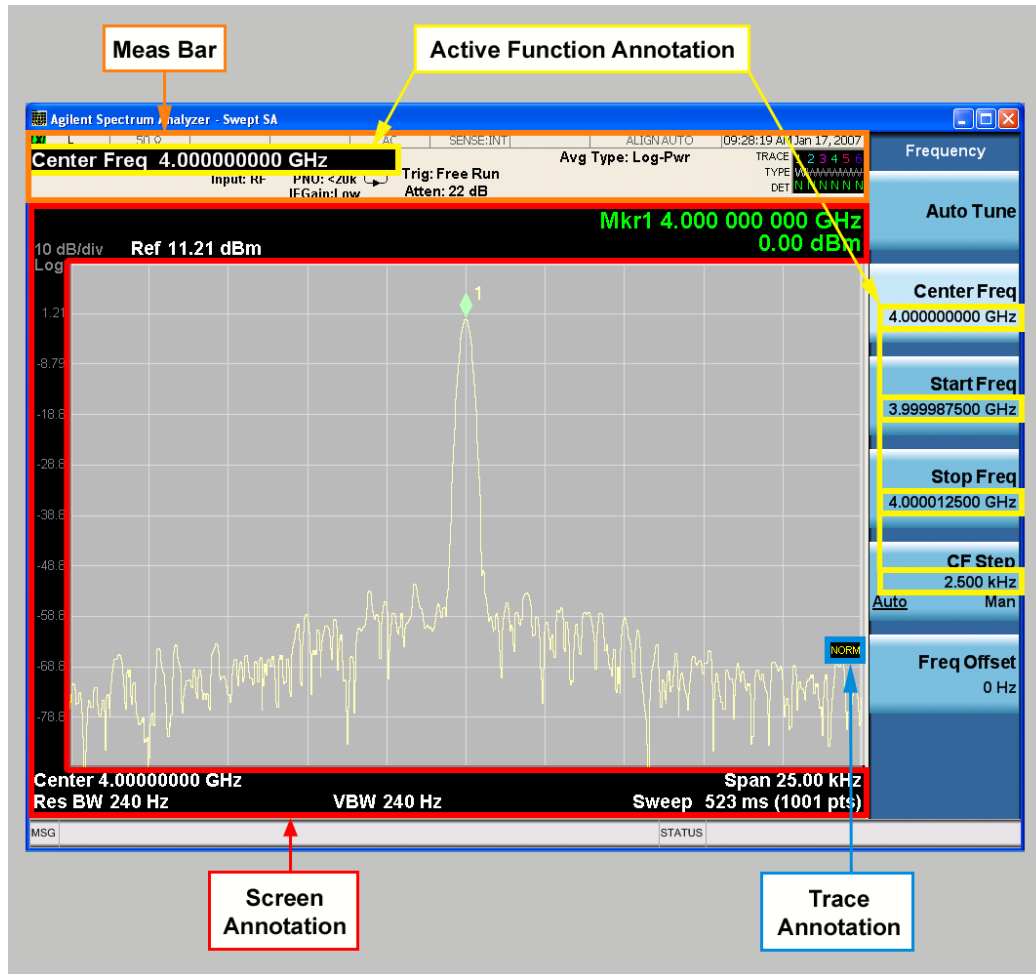

Key Path	View/Display, Display
Initial S/W Revision	Prior to A.02.00

Meas Bar On/Off

This function turns the Measurement Bar on and off, including the settings panel. When off, the graticule area expands to fill the area formerly occupied by the Measurement Bar.

Key Path	View/Display, Display, Annotation
Remote Command	:DISPlay:ANNOtation:MBAR[:STATe] OFF ON 0 1 :DISPlay:ANNOtation:MBAR[:STATe]?
Example	DISP:ANN:MBAR OFF
Dependencies	Grayed out and forced to OFF when System Display Settings, Annotation is set to Off.
Preset	On This should remain Off through a Preset when System DisplaySettings, Annotation is set to Off.
State Saved	Saved in instrument state.
Initial S/W Revision	Prior to A.02.00

Screen

This controls the display of the annunciation and annotation around the graticule, including any annotation on lines (such as the display line, the threshold line, etc.) and the y-axis annotation. This does NOT include marker annotation (or the N dB result). When off, the graticule expands to fill the entire graticule area, leaving only the 1.5% gap above the graticule as described in the Trace/Detector chapter.

Key Path	View/Display, Display, Annotation
Remote Command	:DISPlay:ANNotation:SCReen[:STATe] OFF ON 0 1 :DISPlay:ANNotation:SCReen[:STATe]?
Example	DISP:ANN:SCR OFF
Dependencies	Grayed-out and forced to OFF when System Display Settings, Annotation is set to Off.
Preset	On This should remain Off through a Preset when System DisplaySettings, Annotation is set to Off
State Saved	Saved in instrument state.
Initial S/W Revision	Prior to A.02.00

Active Function Values On/Off

Turns on and off the active function display in the Meas Bar, and all of the active function values displayed on the softkeys.

Note that all of the softkeys that have active functions have these numeric values blanked when this function is on. This is a security feature..

14 Transmit On/Off Power Measurement Functions
View/Display

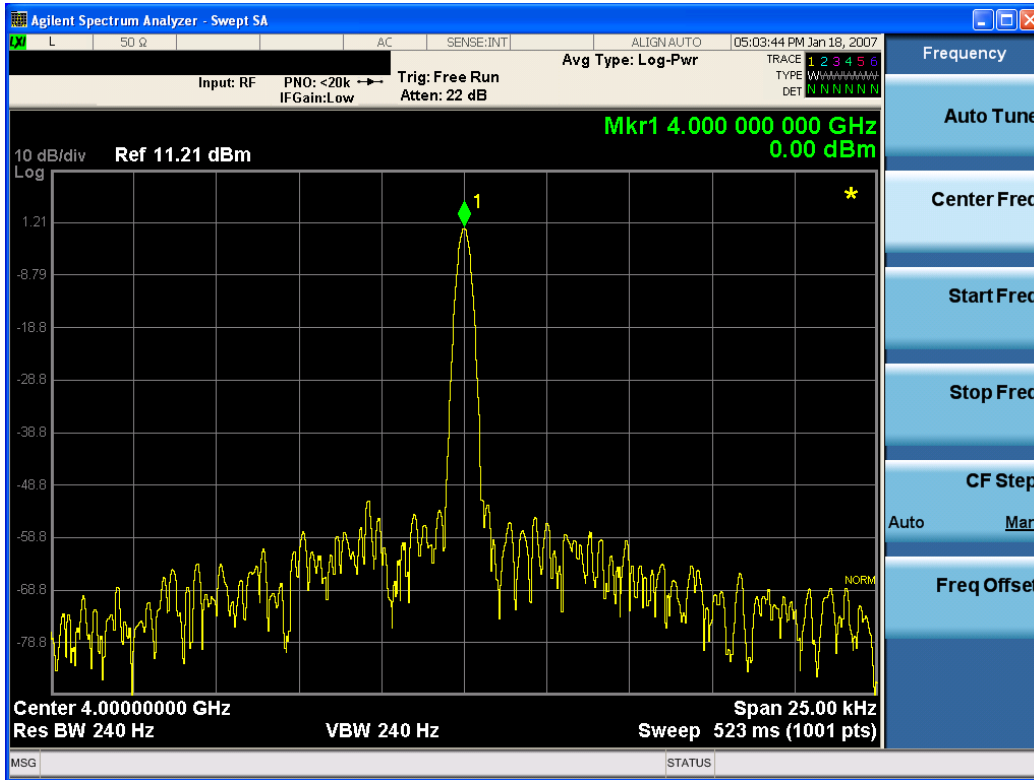

Key Path	View/Display, Display, Annotation
Remote Command	:DISPlay:ACTivefunc[:STATE] ON OFF 1 0 :DISPlay:ACTivefunc[:STATE]?
Example	DISP:ACT OFF
Dependencies	Grayed out and forced to OFF when System Display Settings, Annotation is set to Off.
Preset	On This should remain Off through a Preset when System DisplaySettings, Annotation is set to Off
State Saved	Saved in instrument state.
Initial S/W Revision	Prior to A.02.00

Title

Displays menu keys that enable you to change or clear a title on your display.

Key Path	View/Display, Display
Initial S/W Revision	Prior to A.02.00

Change Title

Writes a title into the "measurement name" field in the banner, for example, "Swept SA".

Press Change Title to enter a new title through the alpha editor. Press Enter or Return to complete the entry. Press ESC to cancel the entry and preserve your existing title.

The display title will replace the measurement name. It remains for this measurement until you press Change Title again, or you recall a state, or a Preset is performed. A title can also be cleared by pressing Title, Clear Title.

NOTE

Notice the inclusion of the <measurement> parameter in the command below. Because each measurement remembers the Display Title, the command must be qualified with the measurement name. For the Swept SA measurement this is not the case; no <measurement> parameter is used when changing the Display Title for the Swept SA measurement.

Key Path	View/Display, Display, Title
Mode	All
Remote Command	:DISPlay:<measurement>:ANNotation:TITLe:DATA <string> :DISPlay:<measurement>:ANNotation:TITLe:DATA?
Example	DISP:ANN:TITL:DATA "This Is My Title" This example is for the Swept SA measurement in the Spectrum Analyzer mode. The SANalyzer <measurement> name is not used. DISP:ACP:ANN:TITL:DATA "This Is My Title" This example is for Measurements other than Swept SA. Both set the title to: This Is My Title
Notes	Pressing this key cancels any active function. When a title is edited the previous title remains intact (it is not cleared) and the cursor goes at the end so that characters can be added or BKSP can be used to go back over previous characters.
Preset	No title (measurement name instead)
State Saved	Saved in instrument state.
Initial S/W Revision	Prior to A.02.00

Clear Title

Clears a title from the front-panel display. Once cleared, the title cannot be retrieved. After the title is cleared, the current Measurement Name replaces it in the title bar.

Key Path	View/Display, Display, Title
Example	The following commands clear the title and restore the measurement's original title: DISP:ANN:TITL:DATA "" This example is for the Swept SA measurement in the Spectrum Analyzer mode. The SANalyzer <measurement> name is not used. DISP:ACP:ANN:TITL:DATA "" This example is for ACP; in measurements other than Swept SA the measurement name is required.
Notes	Uses the :DISPlay:<measurement>:ANNotation:TITLe:DATA <string> command with an empty string (in the Swept SA, the <measurement> is omitted).
Preset	Performed on Preset.
Initial S/W Revision	Prior to A.02.00

Graticule

Pressing Graticule turns the display graticule On or Off. It also turns the graticule y-axis annotation on and off.

Key Path	View/Display, Display
Remote Command	:DISPlay:WINDow[1]:TRACe:GRATicule:GRID[:STATe] OFF ON 0 1 :DISPlay:WINDow[1]:TRACe:GRATicule:GRID[:STATe]?
Example	DISP:WIND:TRAC:GRAT:GRID OFF
Notes	The graticule is the set of horizontal and vertical lines that make up the grid/divisions for the x-axis and y-axis.
Preset	On
State Saved	Saved in instrument state
Initial S/W Revision	Prior to A.02.00

System Display Settings

These settings are "Mode Global" – they affect all modes and measurements and are reset only by Restore Misc Defaults or Restore System Defaults under System.

Key Path	View/Display, Display
Initial S/W Revision	Prior to A.02.00

Annotation Local Settings

This is a Mode Global override of the meas local annotation settings. When it is All Off, it forces ScreenAnnotation, Meas Bar, Trace, and Active Function Values settings to be OFF for all measurements in all modes. This provides the security based "annotation off" function of previous analyzers; hence it uses the legacy SCPI command.

When it is All Off, the Screen, Meas Bar, Trace, and Active Function Values keys under the Display, Annotation menu are grayed out and forced to Off. When Local Settings is selected, you are able to set the local annotation settings on a measurement by measurement basis.

Key Path	View/Display, Display, System Display Settings
Remote Command	:DISPlay:WINDow[1]:ANNotation[:ALL] OFF ON 0 1 :DISPlay:WINDow[1]:ANNotation[:ALL]?
Example	:DISP:WIND:ANN OFF
Preset	On (Set by Restore Misc Defaults)
State Saved	Not saved in instrument state.
Backwards Compatibility Notes	The WINDow parameter and optional subopcode is included for backwards compatibility but ignored – all windows are equally affected.
Initial S/W Revision	Prior to A.02.00

Themes

Accesses a menu of functions that enable you to choose the theme to be used when saving the screen image.

The **Themes** option is the same as the **Themes** option under the **Display** and **Page Setup** dialogs. It allows you to choose between themes to be used when saving the screen image.

Key Path	Save, Screen Image
Remote Command	:MMEMory:STORe:SCReen:THEMe TDColor TDMonochrome FCOLOR FMONochrome :MMEMory:STORe:SCReen:THEMe?
Example	:MMEM:STOR:SCR:THEM TDM
Preset	3D Color; Is not part of Preset, but is reset by Restore Misc Defaults or Restore System Defaults All and survives subsequent running of the modes.
Readback	3D Color 3D Mono Flat Color Flat Mono
Backwards Compatibility Notes	In ESA and PSA we offer the choice of "Reverse Bitmap" or "Reverse Metafile" when saving screen images. This is much like the "Flat Color" theme available in X-Series. Also, if you selected Reverse Bitmap AND a black & white screen image, that would be much like "Flat Monochrome". In other words, each of the X-Series themes has a similar screen image type in ESA/PSA. But they are not identical.
Initial S/W Revision	Prior to A.02.00

3D Color

Selects a standard color theme with each object filled, shaded and colored as designed.

Key Path	Save, Screen Image, Themes
Example	MMEM:STOR:SCR:THEM TDC
Readback	3D Color
Initial S/W Revision	Prior to A.02.00

3D Monochrome

Selects a format that is like 3D color but shades of gray are used instead of colors.

Key Path	Save, Screen Image, Themes
Example	MMEM:STOR:SCR:THEM TDM
Readback	3D Mono
Initial S/W Revision	Prior to A.02.00

Flat Color

Selects a format that is best when the screen is to be printed on an ink printer.

Key Path	Save, Screen Image, Themes
Example	MMEM:STOR:SCR:THEM FCOL
Readback	Flat Color
Initial S/W Revision	Prior to A.02.00

Flat Monochrome

Selects a format that is like Flat Color. But only black is used (no colors, not even gray), and no fill.

Key Path	Save, Screen Image, Themes
Example	MMEM:STOR:SCR:THEM FMON
Readback	Flat Mono
Initial S/W Revision	Prior to A.02.00

Backlight

Accesses the display backlight on/off keys. This setting may interact with settings under the Windows "Power" menu.

When the backlight is off, pressing ESC, TAB, SPACE, ENTER, UP, DOWN, LEFT, RIGHT, DEL, BKSP, CTRL, or ALT turns the backlight on without affecting the application. Pressing any other key will turn backlight on and could potentially perform the action as well.

Key Path	View/Display, Display, System Display Settings
Remote Command	:DISPlay:BACKlight ON OFF :DISPlay:BACKlight?
Preset	ON (Set by Restore Misc Defaults)
Initial S/W Revision	Prior to A.02.00

Backlight Intensity

An active function used to set the backlight intensity. It goes from 0 to 100 where 100 is full on and 0 is off. This value is independent of the values set under the Backlight on/off key.

Key Path	View/Display, Display, System Display Settings
Remote Command	:DISPlay:BACKlight:INTensity <integer> :DISPlay:BACKlight:INTensity?
Example	DISP:BACK:INT 50

Preset	100 (Set by Restore Misc Defaults)
Min	0
Max	100
Initial S/W Revision	Prior to A.02.00

Burst View

This view shows power vs. time and mask result for a LTE-modulated burst. The view has two windows:

- "RF Envelope window" on page 1781 (upper)
- "Result Metrics window" on page 1782 (lower)

For the associated Remote Commands, see the subtopics under "View/Display" on page 1772.

The figure below shows an example of the Burst View.

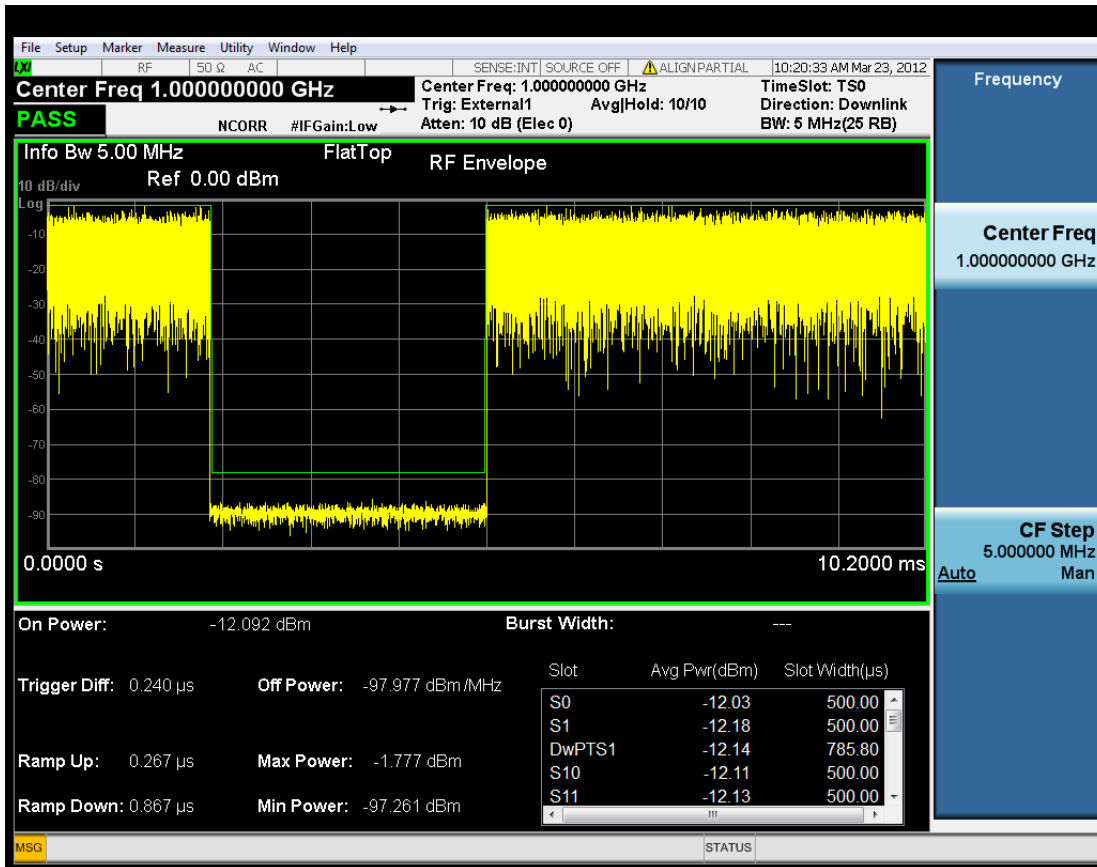

RF Envelope window

This table illustrates the details of RF envelope window:

Marker Operation	Yes
Corresponding Trace	Yellow: Signal wave form, n=2, 3, 4 White: Trigger line Red: Burst lines Blue: Ramp up/down lines Green: Limit Mask Line

Result Metrics window

This table illustrates the details of metrics window when Direction is Downlink:

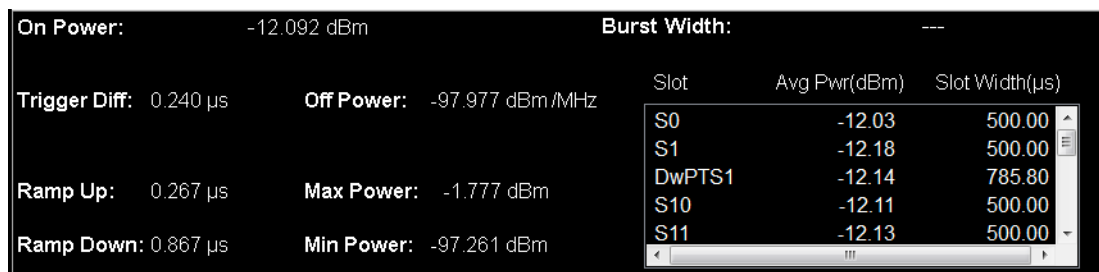

Name	Corresponding Results	Display Format
On Power	n=1 3rd	99.999 dBm
Burst Width	n=1 4th	99.999 ms
Trigger Diff	n=1 5th	99.999 us
Ramp Up	n=1 6th	99.999 us
Ramp Down	n=1 7th	99.999 us
Off Power	n=1 8th	99.999 dBm
Max Power	n=1 9th	99.999 dBm
Min Power	n=1 10th	99.999 dBm
Slot	N/A	AAA
Avg Pwr	n=7	99.99 dBm
Slot width	n=8	99.99 us

NOTE Slot/AvgPwr/SlotWidth section only displays measure results for active slot within display range.

This table illustrates the details of metrics window when Direction is Uplink and Meas DualSRS is not selected

On Power:	-10.962 dBm	Burst Width:	0.071 ms
Trigger Diff:	---	Off Power Before:	-90.046 dBm
		Off Power After:	-90.124 dBm
Ramp Up:	0.200 μ s	Max Power:	-7.197 dBm
Ramp Down:	0.133 μ s	Min Power:	-140.573 dBm

Subframe	Avg Pwr(dBm)	Burst Width(μ s)
---	---	---

Name	Corresponding Results	Display Format
On Power	n=1 3rd	99.999 dBm
Burst Width	n=1 4th	99.999 ms
Trigger Diff	n=1 5th	99.999 us
Ramp Up	n=1 6th	99.999 us
Ramp Down	n=1 7th	99.999 us
Off Power Before	n=1 8th	99.999 dBm
Off Power After	n=1 13th	99.999 dBm
Max Power	n=1 9th	99.999 dBm
Min Power	n=1 10th	99.999 dBm
Subframe	N/A	AAA
Avg Pwr	n=7	99.99 dBm
Burst width	n=8	99.99 us

NOTE Subframe/AvgPwr/SlotWidth section displays measure results for all subframes within display range.

When Direction is Uplink and Meas DualSRS is selected, the mean power for SRS1 and SRS2 are listed separately:

Mean Power(SRS1):	-11.117 dBm	Burst Width:	0.167 ms
Mean Power(SRS2):	-11.109 dBm		
Trigger Diff:	0.078 μ s	Off Power Before:	-87.359 dBm
		Off Power After:	-87.268 dBm
Ramp Up:	0.156 μ s	Max Power:	-7.154 dBm
Ramp Down:	0.133 μ s	Min Power:	-136.037 dBm

Subframe	Avg Pwr(dBm)	Burst Width(μ s)
---	---	---

Name	Corresponding Results	Display Format
Mean Power for SRS1	n=1 3rd	99.999 dBm
Mean Power for SRS2	n=1 14th	99.999 dBm
Burst Width	n=1 4th	99.999 ms
Trigger Diff	n=1 5th	99.999 us

Ramp Up	n=1 6th	99.999 us
Ramp Down	n=1 7th	99.999 us
Off Power Before	n=1 8th	99.999 dBm
Off Power After	n=1 13th	99.999 dBm
Max Power	n=1 9th	99.999 dBm
Min Power	n=1 10th	99.999 dBm
Subframe	N/A	AAA
Avg Pwr	n=7	99.99 dBm
Burst width	n=8	99.99 us

NOTE Subframe/AvgPwr/SlotWidth section displays measure results for all subframes within display range.

Key Path	Front-panel key
Initial S/W Revision	A.03.00

Trigger Lines

Turns the trigger lines On or Off. Please note, Trigger Lines are just supported in RF Envelop window of Burst view.

Key Path	View/Display,Burst
Mode	LTETDD, LTE, LTEATDD, LTEAFDD
Remote Command	:DISPlay:PVTime:VIEW[1]:WINDow[1]:TRIGger[:STATe] ON OFF 1 0 :DISPlay:PVTime:VIEW[1]:WINDow[1]:TRIGger[:STATe]?
Example	:DISP:PVT:VIEW:WIND:TRIG ON :DISP:PVT:VIEW:WIND:TRIG?
Preset	OFF
State Saved	Saved in instrument state.
Range	On Off
Initial S/W Revision	A.03.00

Burst Lines

Turns the burst lines On or Off. The burst line will indicate where is the detected burst start and burst end. Please note, Burst Lines are just supported in RF Envelop window of Burst view.

Key Path	View/Display
----------	--------------

Mode	LTETDD, LTE, LTEATDD, LTEAFDD
Remote Command	:DISPlay:PVTime:VIEW[1]:WINDow[1]:BLINes[:STATe] ON OFF 1 0 :DISPlay:PVTime:VIEW[1]:WINDow[1]:BLINes[:STATe]?
Example	:DISP:PVT:VIEW:WIND:BLIN ON :DISP:PVT:VIEW:WIND:BLIN?
Preset	OFF
State Saved	Saved in instrument state.
Range	On Off
Initial S/W Revision	A.03.00

Limit Mask

Turns the limit mask On or Off. Please note, Trigger Lines are just supported in RF Envelop window of Burst view.

The limit mask shown on screen is just to indicate which part of signal is active burst and which part is inactive burst, the mask is nothing to do with the Pass/Fail(shown at the upper-left corner of screen) criteria. Regarding the Pass/Fail criteria, please refer to Limits section "[Limits](#)" on page 1701.

Key Path	View/Display, Burst
Mode	LTETDD, LTE, LTEATDD, LTEAFDD
Remote Command	:DISPlay:PVTime:VIEW[1]:WINDow[1]:LIMit:MASK OFF ON 0 1 :DISPlay:PVTime:VIEW[1]:WINDow[1]:LIMit:MASK?
Example	DISP:PVT:VIEW:WIND:LIM:MASK 1 DISP:PVT:VIEW:WIND:LIM:MASK?
Notes	This parameter only hides or shows the limit mask line on the display.
Preset	ON
State Saved	Saved in instrument state.
Range	On Off
Initial S/W Revision	A.03.00

Rise & Fall View

This view has three windows:

Rising RF Envelope Window.	The parameters of this window are identical to those of the RF Window in the " Burst View " on page 1781.
Falling RF Envelope Window.	The parameters of this window are identical to those of the RF Window in the " Burst View " on page 1781.
Numeric Results Window.	The parameters of this window are identical to those of the Numeric Results Window in the " Burst View " on page 1781.

The figure below shows an example of the Rise & Fall View.

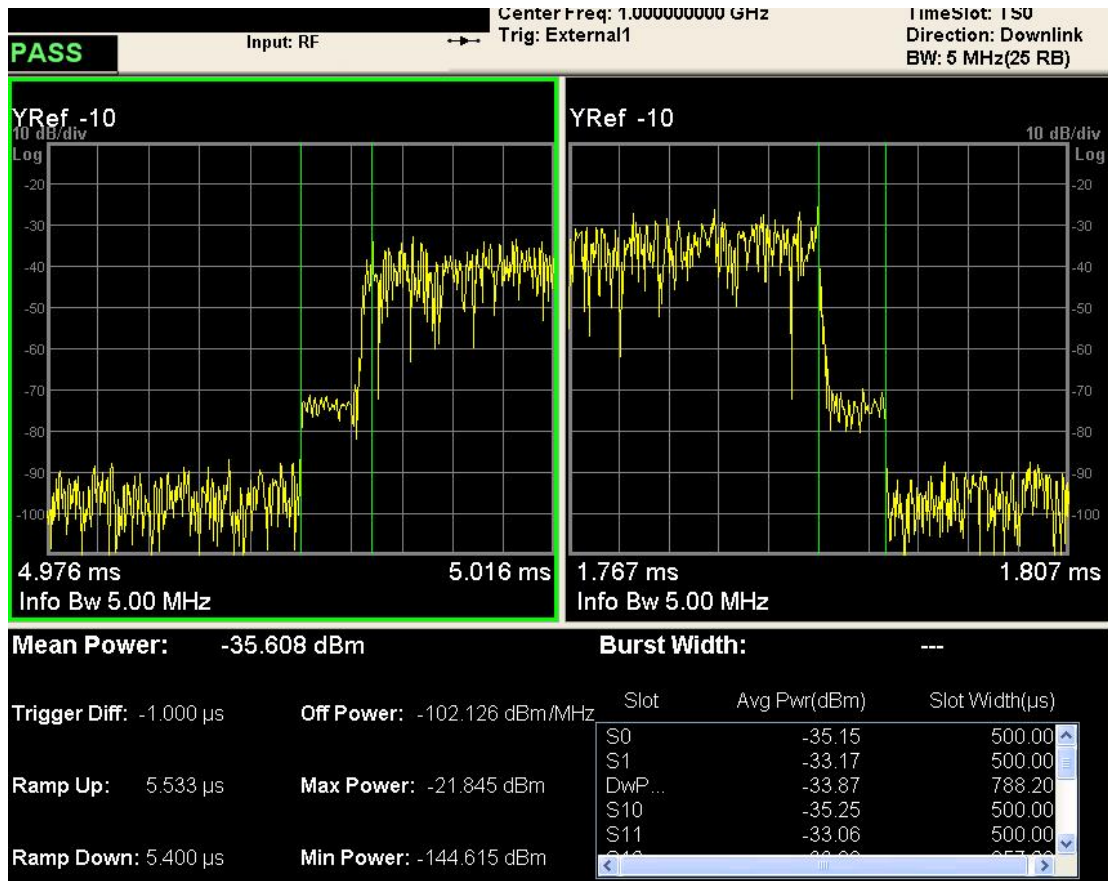

Key Path	View/Display
Mode	LTETDD, LTE, LTEATDD, LTEAFDD
Initial S/W Revision	Prior to A.02.00

Ramp Lines

Turns the ramp lines On or Off.

Key Path	View/Display
Mode	LTETDD, LTE, LTEATDD, LTEAFDD
Remote Command	:DISPlay:PVTime:RAMP[:STATE] OFF ON 0 1 :DISPlay:PVTime:RAMP[:STATE]?
Example	:DISP:PVT:RAMP ON :DISP:PVT:RAMP?

Preset	OFF
State Saved	Saved in instrument state.
Range	On Off
Initial S/W Revision	A.03.00

Scroll

Accesses the Scroll menu, which contains features that enable you to navigate the display.

Key Path	View/Display
Initial S/W Revision	A.03.00

Prev Page

Moves the display one page back to the previous page of the result metrics window.

Key Path	View/Display, Scroll
Mode	LTETDD, LTE, LTEATDD, LTEAFDD
Initial S/W Revision	A.03.00

Next Page

Moves the display one page forward to the next page of the result metrics window.

Key Path	View/Display, Scroll
Mode	LTETDD, LTE, LTEATDD, LTEAFDD
Initial S/W Revision	A.03.00

Scroll Up

Moves one line upward from the current line of the result metrics window.

Pressing the up arrow hard key has the same effect as this function, if no active function is shown. If an active function is shown, the up arrow hard key controls the active function, but has no effect on line movement.

Scroll up soft key and up arrow hard key will only effective when Metrics window is focused.

Key Path	View/Display, Scroll
Mode	LTETDD, LTE, LTEATDD, LTEAFDD
Initial S/W Revision	A.03.00

Scroll Down

Moves one line downward from the current line of the result metrics window.

Pressing the down arrow hard key has the same effect as this function, if no active function is shown. If an active function is shown, the up arrow hard key controls the active function, but has no effect on line movement, as the Scroll Down function does.

The scroll down soft key and down arrow hard key are only effective when the Metrics window is focused.

Key Path	View/Display, Scroll
Mode	LTETDD, LTE, LTEATDD, LTEAFDD
Initial S/W Revision	A.03.00

First Page

Moves the display to the first page of the result metrics window.

Key Path	View/Display, Scroll
Mode	LTETDD, LTE, LTEATDD, LTEAFDD
Initial S/W Revision	A.03.00

Last Page

Moves the display to the last page of the result metrics window.

Key Path	View/Display, Scroll
Mode	LTETDD, LTE, LTEATDD, LTEAFDD
Initial S/W Revision	A.03.00

Display

Invokes the Display menu. All measurements have the same Display menu and the same functionality for each key under the Display menu. Refer to ["Display" on page 2848](#) in the "Common Measurement Functions" for more information.

15 LTE Modulation Analysis Measurement

This section contains the following topics:

["Description" on page 1790](#)

["Remote Commands" on page 1791](#)

["Remote SCPI Results" on page 1792](#)

Description

The LTE modulation analysis measurement enables you to measure LTE signals according to 3GPP TS 36.211. The measurement supports all LTE bandwidths plus all modulation formats and sequences for both downlink (OFDMA) and uplink (SC-FDMA) analysis. Once you have configured the measurement you can use these commands to initiate the measurement and retrieve the measurement results.

All of the scalar results for this measurement are contained in two tables: the Error Summary and Frame Summary; and each have an equivalent subopcode that is used to obtain the remote results. You can obtain the measurement results by either visually inspecting the corresponding summary trace on the display, or by using CALC:DATA queries that return descriptions of the corresponding summary trace.

Remote Commands

```
:CONFigure:EVM
:FETCh:EVM[n]?
:INITiate:EVM
:MEASure:EVM[n]?
:READ:EVM[n]?
:CALCulate:EVM:DATA<n>:TABLe:STRing?
:CALCulate:EVM:DATA<n>:TABLe:NAMes?
:CALCulate:EVM:DATA<n>:TABLe:UNIT?
:CALC:EVM:DATA4:TABL:STR? "FreqErr"
```

See ["Remote SCPI Commands and Data Queries" on page 2861](#) for more measurement SCPI commands.

Also see ["Data" on page 2297](#) for more measurement SCPI commands.

Remote SCPI Results

These standard remote results are also available thru the CALC:DATA<n> set of queries, where <n> is a reference to the trace number. The results assigned to each trace vary depending on which tests are enabled. As an example, with the default trace layout, the results in the Error Summary results are returned by CALC:EVM:DATA4:TABL:STR?

See the following section: "[Remote SCPI Commands and Data Queries](#)" on page 2861.

Note "CALC:EVM:DATA4:TABL:STR?" can be executed without input parameter. It will return the Error Summary trace, in the same order as results displayed on GUI. However, the order of the returned results are not fixed release by release when more results are added in this trace. For example, Channel Power was inserted in the middle of Error Summary trace in XA13, so the order of following results were not kept. To achieve backward compatibility, this command must be executed with a correct input parameter.

The following table denotes the LTE Modulation Analysis specific results returned from the (FETCh|MEASure|READ):EVM commands, indexed by subopcode. MEASure:EVM<n> performs the equivalent of CONF:EVM;INIT:IMM:FETCh:EVM<n>. This gets you the default measurement, which is a 5 MHz downlink with auto detection of allocations. Note that valid results are only returned if the Symbols/Errors trace is being computed. It must be selected though it is not necessary for it to be shown in the current Layout. Some table results are string data, rather than numeric. As FETCh|MEASure|READ can only return numeric data, NaN is returned as a placeholder for string data. To get the full table data, including string results (with numbers in ASCII format) use the CALC:EVM:DATA<n>:TABL:STR? query. Use the associated CALC:EVM:DATA<n>:TABL queries to get information about names and units for the table data.

N	Results Returned (Downlink)
Not specified or n=1	Returns comma-separated scalar results, corresponding exactly to the items returned in the Error Summary: 1. EVM (%rms) 2. String result (EVM Sym Time Adjust). NaN returned 3. EVM Pk (%) 4. EVM Pk Index 5. EVM Peak Sub Car Index 6. Data EVM (%rms) – Not available when Detection is Manual and no User is added. 7. 3GPP-defined QPSK EVM (%rms) 8. 3GPP-defined 16QAM EVM (%rms) 9. 3GPP-defined 64QAM EVM (%rms) 10. RS EVM (%rms) 11. RS Tx. Power (dBm). 12. OFDM Sym. Tx. Power (dBm). 13. Freq Error (Hz) 14. Sync Corr (%) 15. String Result (Sync Type). NaN returned. 16. Common Tracking Error (%rms) 17. Symbol Clock Error (ppm)

N	Results Returned (Downlink)
	18. Time Offset (s) 19. IQ Offset (dB) 20. IQ Gain Imbalance (dB) 21. IQ Quad Error (deg) 22. IQ Timing Skew (s) 23. String result (CP Length Mode). NaN returned. 24. String result (Cell ID). NaN returned. 25. String result (Cell ID Group/Sector). NaN returned. 26. String result (RS-OS / PRS). NaN returned. 27. Reference Signal Rx Power (Avg). 28. Reference Signal Rx Quality (dB). 29. Received Signal Strength Indicator (dBm) 30. Channel Power (dBm)
n=2	If the table has not been selected to appear on any trace, timeout will occur. Returns the results of the Frame Summary table in numeric format, with NaN in place of string results. Since this table changes depending on the Channel Profile Setup, the data names and units must be determined at run time by using CALC:EVM:DATA<k>:TABL queries

N	Results Returned (Uplink)
Not specified or n=1	Returns comma-separated scalar results, corresponding exactly to the items returned in the Error Summary: 1. EVM (%rms) 2. String result (EVM Sym Time Adjust). NaN returned 3. EVM Pk (%) 4. EVM Pk Index 5. EVM Peak Sub Car Index 6. Data EVM (%rms) – Not available when Detection is Manual and no User is added. 7. 3GPP-defined QPSK EVM (%rms) 8. 3GPP-defined 16QAM EVM (%rms) 9. 3GPP-defined 64QAM EVM (%rms) 10. RS EVM (%rms) 11. NaN returned. 12. NaN returned. 13. Freq Error (Hz) 14. Sync Corr (%) 15. String Result (Sync Type). NaN returned. 16. Common Tracking Error (%rms) 17. Symbol Clock Error (ppm) 18. Time Offset (s)

N	Results Returned (Uplink)
	19. IQ Offset (dB) 20. IQ Gain Imbalance (dB) 21. IQ Quad Error (deg) 22. IQ Timing Skew (s) 23. String result (CP Length Mode). NaN returned. 24. Channel Power (dBm) 25. String result (In-band Emissions Result). NaN returned. 26. In-band Emissions worst Margin (dB) 27. In-band Emissions worst Slot 28. In-band Emissions worst RB 29. String result (Spectral Flatness Result). NaN returned. 30. Spectral Flatness worst Margin (dB) 31. Spectral Flatness worst Slot 32. Spectral Flatness worst Subcarrier If the table has not been selected to appear on any trace, timeout will occur.
n=2	Returns the results of the Frame Summary table in numeric format, with NaN in place of string results. Since this table changes depending on the Channel Profile Setup, the data names and units must be determined at run time by using CALC:EVM:DATA<k>:TABL queries

For more results defined for READ and FETCh, see the following section: "[Remote SCPI Commands and Data Queries](#)" on page 2861.

Because the results of MEASure, READ, or FETCh queries are statically defined, you should use the following query:

```
CALCulate:EVM:DATA<n>:TABLe:STRing?
```

as this provides both string and numeric results (numeric formatted as ASCII), and the queries

```
CALCulate:EVM:DATA<n>:TABLe:NAMes?
```

```
CALCulate:EVM:DATA<n>:TABLe:UNIT?
```

to obtain lists of descriptive data names and associated units. For table results that can change dynamically, such as the Frame Summary, these provide the only possible way to interpret remote table data, since static tabulations such as those above will not suffice.

As an example of the above commands, if you have performed CONF:EVM;INIT:IMM;FORM ASCII, then the following commands will return results similar to those shown in the columns below. The FORM ASCII command dictates that the FETC results will be returned as ASCII in a comma-separated list. The CALC:EVM:DATA<n>:TABL query responses are a comma-separated list enclosed in quotes (i.e., they are a single string).

FETC:EVM1	CALC:EVM:DATA4 :TABL:STR?	CALC:EVM:DATA4 :TABL:UNIT?	CALC:EVM:DATA4 :TABL:NAM?
-----------	------------------------------	-------------------------------	------------------------------

9.2223893260E+01	92.22389326	%rms	EVM
9.9100000000E+37	EVM Window End		EVMSymTimeAdj
4.2397593130E+02	423.9759313	%rms	EVMPeak
6.0000000000E+00	6	sym	EVMPeakIdx
2.1000000000E+01	21	subcar	EVMPeakSubcarIdx
8.6673950980E+01	86.67395098	%rms	DataEVM
7.6970986550E+01	76.97098655	%rms	RSEVM
6.6970986550E+01	66.97098655	%rms	3GPPEVMQPSK
9.6673950980E+01	96.67395098	%rms	3GPPEVM16QAM
2.8573950980E+01	28.57395098	%rms	3GPPEVM64QAM
3.9100000000E+01	3.91	dBm/subcar	RSTP
-20.4500000000E+01	-20.45	dBm	OSTP
8.4413310460E+02	844.1331046	Hz	FreqErr
1.0699478450E-01	0.106994784	%	SyncCorr
9.9100000000E+37	P-SS		SyncType
1.6618317400E+01	16.6183174	%rms	CTE
4.2218131000E+02	422.18131	ppm	SymClkErr
3.4869991450E-03	0.003486999	sec	TimeOffset
-2.2683995020E+01	-22.68399502	dB	IQOffset
-1.1367356920E-01	-0.113673569	dB	IQGainImb
-3.6632873820E-01	-0.366328738	deg	IQQuadErr
-2.6630113160E-09	-2.66E-09	sec	IQTimingSkew
9.9100000000E+37	Normal(auto)		CpLengthMode
9.9100000000E+37	503 (auto)		CellId
9.9100000000E+37	167/2 (auto)		CellIdGroupSector
9.9100000000E+37	Custom		RSPRS
-1.003800000000E+01	-10.038	dBm	RSRP
-6.4700000000E+00	-6.47	dB	RSRQ
-2.0050000000E+01	-20.05	dBm	RSSI
-3.613801427E+00	-3.61380142693588	dBm	ChannelPower
9.9100000000E+37	PASS		InbandEmissions
3.38484E+01	33.848	dB	InbandEmissionsWorstMargin
2	2		InbandEmissionsWorstSlot
18	18		InbandEmissionsWorstRB
9.9100000000E+37	FAIL		SpectralFlatness
-3.915E+00	-3.915	dB	SpectralFlatnessWorstMargin
2	2		SpectralFlatnessWorstSlot
-8	-8		SpectralFlatnessWorstSubcarrier

In addition, if just the “FreqErr” result is desired, you can obtain it using the command:

```
CALC:EVM:DATA4:TABL:STR? “FreqErr”
```

For the example data above, the response will be:

```
“844.1331046”
```

Key Path	Meas
Mode	LTE, LTETDD
Initial S/W Revision	Prior to A.02.00
Modified at S/W Revision	A.03.00, A.06.00, A.11.00, A.13.00

AMPTD Y Scale (Amplitude)

Accesses a menu that enables you to control input signal conditioning as well as the Y-scaling of trace data. Input signal conditioning actually affects the input signal and the associated measurement quality, whereas Y-scaling is non-destructive of data. Even if the data is scaled so as to be clipped or completely off the display, the marker readouts are still correct and accurate data can still be retrieved via SCPI.

Key Path	Front Panel
Initial S/W Revision	Prior to A.02.00

Y Auto Scale

Changes the Y reference value and Scale per Division so the full trace is displayed without clipping.

Key Path	AMPTD Y Scale
Mode	VSA, LTE, LTETDD, IDEN, LTEAFDD, LTEATDD
Measurement	<meas>:=VECTor ADEMod DDEMod W11A W11B EVM IPOWER IDEMod MOTotalk
Remote Command	:DISPlay:<meas>:TRACe [1] 2 . . . 4 : Y [: SCALe] : AUTO : ONCE
Example	:DISP:VECT:TRAC1:Y:AUTO:ONCE
Initial S/W Revision	Prior to A.02.00
Modified at S/W Revision	A.02.00

Range

Represents the amplitude of the largest sinusoidal signal that could be present within the IF without being clipped by the ADC. For signals with high peak-to-rms ratios, the range may need to exceed the rms signal power by a fair amount to avoid clipping.

Key Path	AMPTD Y Scale
Mode	VSA, LTE, LTETDD, IDEN
Remote Command	[: SENSE] : POWER [: RF] : RANGE <real> [: SENSE] : POWER [: RF] : RANGE ?
Example	POW:RANG 25 POW:RANG ?
Notes	The parameter is interpreted as dBm
Preset	20
State Saved	Saved in instrument state.
Min	depends on model and preamp options
Max	depends on model and preamp options
Initial S/W Revision	Prior to A.02.00
Modified at S/W Revision	A.02.00

μW Path Control

The μW Path Control functions include the μW Preselector Bypass (Option MPB) and Low Noise Path (Option LNP) controls in the High Band path circuits.

When the μW Preselector is bypassed, the user has better flatness, but will be subject to spurs from out of band interfering signals. When the Low Noise Path is enabled, the analyzer automatically switches around certain circuitry in the high frequency bands which can contribute to noise, when it is appropriate based on other analyzer settings.

For most applications, the preset state is Standard Path, which gives the best remote-control throughput, minimizes acoustic noise from switching and minimizes the risk of wear out in the hardware switches. For applications that utilize the wideband IF paths, the preset state is the μW Preselector Bypass path, if option MPB is present. This is because, when using a wideband IF such as the 140 MHz IF, the μW Preselector's bandwidth can be narrower than the available IF bandwidth, causing degraded amplitude flatness and phase linearity, so it is desirable to bypass the preselector in the default case.

Users may choose Low Noise Path Enable. It gives a lower noise floor, especially in the 21–26.5 GHz region, though without improving many measures of dynamic range, and without giving the best possible noise floor. The preamp, if purchased and used, gives better noise floor than does the Low Noise Path, however its compression threshold and third-order intercept are much poorer than that of the non-preamp Low Noise Path. There are some applications, typically for signals around –30 dBm, for which the third-order dynamic range of the standard path is good enough, but the noise floor is not low enough even with 0 dB input attenuation. When the third-order dynamic range of the preamp path is too little and the noise floor of the standard path is too high, the Low Noise Path can provide the best dynamic range.

Key Path	AMPTD Y Scale
Mode	SA, BASIC, PNOISE, VSA , LTE, LTETDD
Scope	Meas Global
Remote Command	[:SENSe] :POWer [:RF] :MW:PATH STD LNPath MPBypass FULL [:SENSe] :POWer [:RF] :MW:PATH?
Example	:POW:MW:PATH LNP Enables the Low Noise path
Notes	If a Presel Center is performed, the analyzer will momentarily switch to the Standard Path, regardless of the setting of μW Path Control The DC Block will always be switched in when the low noise path is switched in, to protect succeeding circuitry from DC. Note that this does not mean “when the low noise path is enabled” but when, based on the Low Noise Path rules, the path is actually switched in. This can happen when the selection is Low Noise Path Enable . In the case where the DC Block is switched in the analyzer is now AC coupled. However, if the user has selected DC coupling, the UI will still behave as though it were DC coupled, including all annunciation, warnings, status bits, and responses to SCPI queries. This is because, based on other settings, the analyzer could switch out the low noise path at any time and hence go back to being DC coupled. Alignment switching ignores the settings in this menu, and restores them when finished.
Dependencies	Unavailable in BBIQ and External Mixing
Preset	All modes other than IQ Analyzer mode and VXA: STD IQ Analyzer, VXA and WLAN mode:

	MPB option present and licensed: MPB MPB option not present and licensed: STD
State Saved	Save in instrument state
Readback	Value selected in the submenu
Initial S/W Revision	A.04.00
Modified at S/W Revision	A.10.00

Standard Path

This path gives the best remote-control throughput, minimizes acoustic noise from switching and minimizes the risk of wear in the hardware switches, particularly in remote test scenarios where both low band and high band setups will follow in rapid succession.

In this path, the bypass of the low band/high band switch and microwave preamp is never activated, which can cause some noise degradation but preserves the life of the bypass switch.

Key Path	AMPTD Y Scale, μ W Path Control
Example	:POW:MW:PATH STD
Readback Text	Standard Path
Initial S/W Revision	A.04.00

Low Noise Path Enable

You may choose Low Noise Path Enable, which gives a lower noise floor under some circumstances, particularly when operating in the 21–26.5 GHz region. With the Low Noise Path enabled, the low band/high band switch and microwave preamp are bypassed whenever all of the following are true:

- The analyzer is not in the Low Band, meaning:
- the start frequency is above 3.5 GHz and
- the stop frequency is above 3.6 GHz.
- the internal preamp is not installed or (if installed) is set to Off or Low Band

Note that this means that, when any part of a sweep is done in Low Band, the Low Noise Path is not used, whether or not the Low Noise Path Enable is selected in the user interface. Also, if the preamp is turned on, the Low Noise Path is not used, whether or not the Low Noise Path Enable is selected in the user interface. The only time the Low Noise Path is used is when Low Noise Path Enable is selected, the sweep is completely in High Band (> 3.6 GHz) and no preamp is in use.

See "[More Information](#)" on page 1800

Key Path	AMPTD Y Scale, μ W Path Control
Measurement	Swept SA

Example	:POW:MW:PATH LNP
Notes	<p>For measurements that use IQ acquisition, the low noise path is used when the Center Frequency is in High Band (> 3.6 GHz) and no preamp is in use.</p> <p>In other words, the rules above are modified to use only the center frequency to qualify which path to switch in.</p> <p>This is not the case for FFT's in the Swept SA measurement; they use the same rules as swept measurements.</p>
Dependencies	<p>Key is blanked if current mode does not support it.</p> <p>Key is grayed out if mode supports it but current measurement does not support it.</p> <p>Unless Option LNP is present and licensed, key is blank and if SCPI command sent, error -241, "Hardware missing; Option not installed" is generated.</p>
Readback Text	Low Noise Path Enable
Initial S/W Revision	A.04.00

More Information

The user should understand that the Low Noise Path, while giving improved DANL, has the disadvantage of decreased TOI performance and decreased gain compression performance relative to the standard path.

The user should also understand that the bypass switch is a mechanical switch and has finite life, so if the Low Noise Path is enabled, it is possible to cause frequent cycling of this switch by frequently changing analyzer settings such that the above conditions hold true only some of the time. A user making tests of this nature should consider opting for the Standard Path, which will never throw the bypass switch, at the expense of some degraded noise performance.

The low noise path is useful for situations where the signal level is so low that the analyzer performance is dominated by noise even with 0 dB attenuation, but still high enough that the preamp option would have excessive third-order intermodulation or compression. The preamp, if purchased and used, gives better noise floor than does the "Low Noise Path." However, its compression threshold and third-order intercept are much poorer than that of the non-preamp path. There are some applications, typically for signals around -30 dBm, for which the third-order dynamic range of the standard path is good enough, but the noise floor is not low enough even with 0 dB input attenuation. When the third-order dynamic range of the preamp path is too little and the noise floor of the standard path is too high, the Low Noise Path can provide the best dynamic range

The graph below illustrates the concept. It shows, in red, the performance of an analyzer at different attenuation settings, both with the preamp on and off, in a measurement that is affected by both analyzer noise and analyzer TOI. The green shows the best available dynamic range, offset by 0.5 dB for clarity. The blue shows how the best available dynamic range improves for moderate signal levels with the low noise path switched in. In this illustration, the preamp improves the noise floor by 15 dB while degrading the third-order intercept by 30 dB, and the low noise path reduces loss by 8 dB. The attenuator step size is 2 dB.

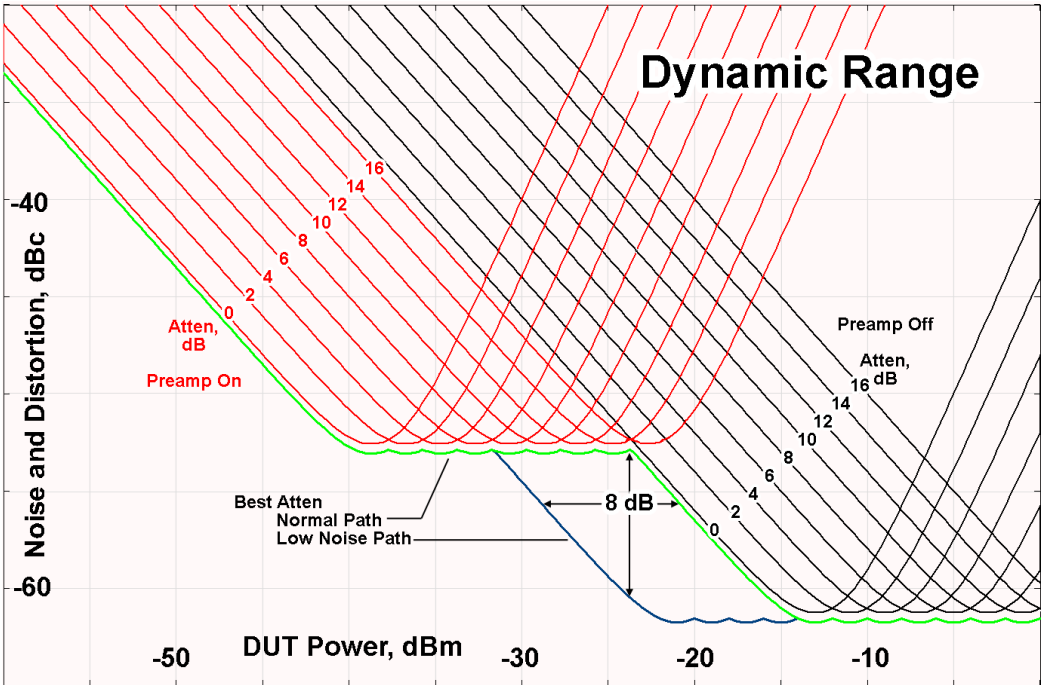

There are other times where selecting the low noise path improves performance, too. Compression-limited measurements such as finding the nulls in a pulsed-RF spectrum can profit from the low noise path in a way similar to the TOI-limited measurement illustrated. Accuracy can be improved when the low noise path allows the optimum attenuation to increase from a small amount like 0, 2 or 4 dB to a larger amount, giving better return loss at the analyzer input. Harmonic measurements, such as second and third harmonic levels, are much improved using the low noise path because of the superiority of that path for harmonic (though not intermodulation) distortion performance.

µW Preselector Bypass

This key toggles the preselector bypass switch for band 1 and higher. When the microwave preselector is on, the signal path is preselected. When the microwave preselector is off, the signal path is not preselected. The preselected path is the normal path for the analyzer.

The preselector is a tunable bandpass filter which prevents signals away from the frequency of interest from combining in the mixer to generate in-band spurious signals (images). The consequences of using a preselector filter are its limited bandwidth, the amplitude and phase ripple in its passband, and any amplitude and phase instability due to center frequency drift.

Option MPB or pre-selector bypass provides an unpreselected input mixer path for certain X-Series signal analyzers with frequency ranges above 3.6 GHz. This signal path allows a wider bandwidth and less amplitude variability, which is an advantage when doing modulation analysis and broadband signal analysis. The disadvantage is that, without the preselector, image signals will be displayed. Another disadvantage of bypassing the preselector is increased LO emission levels at the front panel input port.

Image responses are separated from the real signal by twice the 1st IF. For IF Paths of 10 MHz and 25 MHz, the 1st IF is 322.5 MHz, so the image response and the real signal will be separated by 645 MHz. The 1st IF will be different for other IF Path settings. When viewing a real signal and its corresponding image response in internal mixing, the image response will be to the left of the real signal.

Also, the image response and the real signal typically have the same amplitude and exhibit the same shape factor.

However, if Option FS1, Fast Sweep Capability, is enabled, the image response in the Swept SA measurement will appear lower in amplitude and have a much wider shape factor compared to the real signal.

Key Path	AMPTD Y Scale, μ W Path Control
Example	:POW:MW:PATH MPB
Dependencies	Key is blanked if current mode does not support it. Key is grayed out if mode supports it but current measurement does not support it. Key is blank unless Option MPB is present and licensed. If SCPI command sent when MPB not present, error -241, "Hardware missing; Option not installed" is generated.
Readback Text	μ W Preselector Bypass
Initial S/W Revision	A.04.00

Remote Command	[:SENSe] :POWer [:RF] :MW:PRESelector [:STATe] ON OFF 0 1 [:SENSe] :POWer [:RF] :MW:PRESelector [:STATe] ?
Example	:POW:MW:PRES OFF Bypasses the microwave preselector
Notes	The ON parameter sets the STD path (:POW:MW:PATH STD) The OFF parameter sets path MPB (:POW:MW:PATH MPB)
Preset	ON

Select Trace

Displays a menu that enables you to select the trace that is to receive the action of all successive trace-specific commands like scaling, assignment of trace data, and so on. The selected trace is outlined in green and is always visible. While the Select Trace menu is showing, each visible trace is annotated in the middle with its own trace number, as shown in the following figure. The trace number annotations disappear when any other menu is showing.

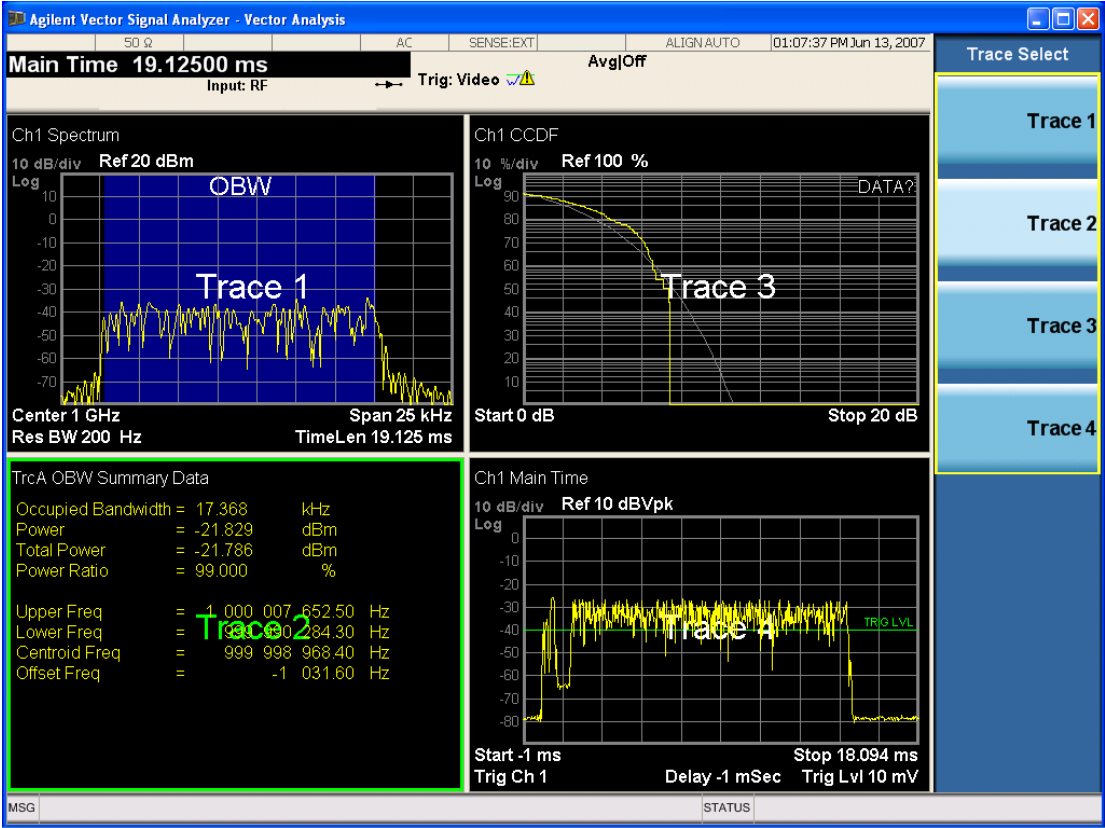

Grid 2x2 layout showing trace annotations when Trace Select dialog is active

This softkey also appears in the X and Y scaling menus. There is only one selected trace at any time. If you change which trace is selected, that change is reflected in this softkey/menu wherever it appears. Other ways to select a trace include use of the Next Window key, clicking within a trace window with a mouse cursor, and issuing a trace-specific SCPI command.

There is no SCPI command associated with this function. Instead, SCPI commands that are trace-specific have an index on the TRACe node that determines the selected trace. Using such a command has the side effect that the trace addressed by the SCPI command becomes the selected trace for any front panel interaction.

Key Path	Trace/Detector or Span X Scale or AMPTD Y Scale
Mode	VSA, LTE, LTETDD, IDEN,LTEAFDD,LTEATDD
Notes	No SCPI. Front panel only.
Couplings	Affects any trace-specific commands
Range	Trace 1 Trace 2 Trace 3 Trace 4 Trace 5 Trace 6
Readback Text	Trace <n>
Initial S/W Revision	Prior to A.02.00
Modified at S/W Revision	A.02.00

Couple Ref to Range

When Couple Ref to Range is on, Y scaling is adjusted when the Range changes. For example, on traces with Y units of dBm, the reference value changes by the same amount in dB as the Range does. On a trace with Y units of Volts, the Per Division setting changes by a factor of approximately 1.25 when the Range changes by 2 dB. This function can be turned on or off for each individual trace.

Key Path	AMPTD Y Scale
Mode	VSA, LTE, LTETDD, IDEN, LTEAFDD, LTEATDD
Measurement	<meas>:=VECTor ADEMod DDEMod W11A W11B EVM IPOWER IDEMod MOTotalk
Remote Command	:DISPlay:<meas>:TRACe [1] 2 . . . 4 : Y [: SCALE] : RLEVel : AUTO OFF ON 0 1 :DISPlay:<meas>:TRACe [1] 2 . . . 4 : Y [: SCALE] : RLEVel : AUTO?
Example	DISP:VECT:TRAC1:Y:RLEV:AUTO ON DISP:VECT:TRAC1:Y:RLEV:AUTO?
Notes	Range coupling is not available for Phase and Group delay traces.
Preset	1
State Saved	Saved in instrument state.
Range	On Off
Initial S/W Revision	Prior to A.02.00
Modified at S/W Revision	A.02.00

Y Reference Value

Controls the Y value of the selected trace at the Reference Position. It has no effect on hardware input settings.

See "[Y Reference: Position](#)" on page 1805 for more details.

Key Path	AMPTD Y Scale
Mode	VSA, LTE, LTETDD, IDEN, LTEAFDD, LTEATDD
Measurement	<meas>:=VECTor ADEMod DDEMod W11A W11B EVM IPOWER IDEMod MOTotalk
Remote Command	:DISPlay:<meas>:TRACe [1] 2 . . . 4 : Y [: SCALE] : RLEVel <real> :DISPlay:<meas>:TRACe [1] 2 . . . 4 : Y [: SCALE] : RLEVel?
Example	DISP:VECT:TRAC:Y:RLEV 20 DISP:VECT:TRAC:Y:RLEV?
Couplings	None. This does not affect any hardware input settings.
Preset	Depends on trace
State Saved	Saved in instrument state.
Min	-9.9E+37
Max	9.9E+37
Initial S/W Revision	Prior to A.02.00
Modified at S/W Revision	A.02.00

Y Scale Per Division

Controls the Y scale per division of the selected trace.

Key Path	AMPTD Y Scale
Mode	VSA, LTE, LTETDD, IDEN, LTEAFDD, LTEATDD
Measurement	<meas>:=VECTor ADEMod DDEMod W11A W11B EVM IPOWER IDEMod MOTotalk
Remote Command	:DISPlay:<meas>:TRACe[1] 2 ...4:Y[:SCALe]:PDIVision <real> :DISPlay:<meas>:TRACe[1] 2 ...4:Y[:SCALe]:PDIVision?
Example	DISP:VECT:TRAC:Y:PDIV 10 DISP:VECT:TRAC:Y:PDIV?
Couplings	None.
Preset	Depends on trace
State Saved	Saved in instrument state.
Min	-9.9E+37
Max	9.9E+37
Initial S/W Revision	Prior to A.02.00
Modified at S/W Revision	A.02.00

Y Reference: Position

Sets the position of the reference line for Y scaling for the selected trace. It can be set to the top, bottom, or center of the grid.

Key Path	AMPTD Y Scale
Mode	VSA, LTE, LTETDD, IDEN, LTEAFDD, LTEATDD
Measurement	<meas>:=VECTor ADEMod DDEMod W11A W11B EVM IPOWER IDEMod MOTotalk
Remote Command	:DISPlay:<meas>:TRACe[1] 2 ...4:Y[:SCALe]:RPOSition TOP CENTER BOTTOm :DISPlay:<meas>:TRACe[1] 2 ...4:Y[:SCALe]:RPOSition?
Example	DISP:VECT:TRAC1:Y:RPOS TOP DISP:VECT:TRAC1:Y:RPOS?
Couplings	Changing trace format or data can affect this. Each format "remembers" its reference position.
Preset	Depends on trace format and trace data. Top for LogMag or most LinearMag traces, middle for Real, Imaginary, Vector displays, Eye diagrams, Phase, Delay, Bottom for Linear Mag EVM.
State Saved	Saved in instrument state.
Range	Top Ctr Bottom
Initial S/W Revision	Prior to A.02.00
Modified at S/W Revision	A.02.00

Reference Line

Controls whether the Y reference line is visible or not.

Key Path	AMPTD Y Scale
Mode	VSA, LTE, LTETDD, IDEN, LTEAFDD, LTEATDD
Measurement	<meas>:=VECTor ADEMod DDEMod W11A W11B EVM IPOWER IDEMod MOTotalk
Remote Command	:DISPlay:<meas>:TRACe[1] 2 ...4:RLINe OFF ON 0 1 :DISPlay:<meas>:TRACe[1] 2 ...4:RLINe?
Example	DISP:VECT:TRAC1:RLIN ON DISP:VECT:TRAC1:RLIN?
Preset	OFF
State Saved	Saved in instrument state.
Initial S/W Revision	Prior to A.02.00
Modified at S/W Revision	A.02.00

Y Unit Preference

Displays a menu that enables you to set the preferred Y unit for the selected trace. You can select Peak, RMS, Power units, or an automatic selection. The automatic selection uses Power units for frequency domain data and Peak units for time domain data.

Key Path	AMPTD Y Scale
Mode	VSA, LTE, LTETDD, IDEN, LTEAFDD, LTEATDD
Measurement	<meas>:=VECTor ADEMod DDEMod W11A W11B EVM IPOWER IDEMod MOTotalk
Remote Command	:DISPlay:<meas>:TRACe[1] 2 ...4:Y:UNIT:PREFeRence AUTO PEAK RMS POWER MRMS :DISPlay:<meas>:TRACe[1] 2 ...4:Y:UNIT:PREFeRence?
Example	DISP:VECT:TRAC1:Y:UNIT:PREF PEAK DISP:VECT:TRAC1:Y:UNIT:PREF?
Preset	AUTO
State Saved	Saved in instrument state.
Range	AUTO PEAK RMS POW MRMS
Readback Text	Auto Peak RMS Power mRMS
Initial S/W Revision	Prior to A.02.00
Modified at S/W Revision	A.02.00

The following SCPI only command can be used to determine exactly which Y unit was chosen based on the setting of the above:

Key Path	AMPTD Y Scale
Mode	VSA, LTE, LTETDD, IDEN
Measurement	<meas>:=VECTor ADEMod DDEMod W11A W11B EVM IPOWER IDEMod MOTotalk
Remote Command	:DISPlay:<meas>:TRACe[1] 2 ...4:Y:UNIT?
Example	DISP:VECT:TRAC1:Y:UNIT?
Initial S/W Revision	Prior to A.02.00
Modified at S/W Revision	A.02.00

Y Log Ratio

Enabled if the Trace Format is set to LogMag (Linear Unit). In this format type, you set the Y Log Ratio instead of Y Scale Per Division to determine Y scaling. It sets the ratio of the top of the Y axis to the bottom.

Key Path	AMPTD Y Scale
Mode	VSA, LTE, LTETDD, IDEN, LTEAFDD, LTEATDD
Measurement	<meas>:=VECTor ADEMod DDEMod W11A W11B EVM IPOWER IDEMod MOTotalk
Remote Command	:DISPlay:<meas>:TRACe[1] 2 ...4:Y:LRATio <real> :DISPlay:<meas>:TRACe[1] 2 ...4:Y:LRATio?
Example	DISP:VECT:TRAC1:Y:LRAT 10000 DISP:VECT:TRAC1:Y:LRAT?
Notes	This is grayed out if the trace format is not Log Mag (linear unit).
Preset	100000
State Saved	Saved in instrument state.
Min	1.001
Max	100e6
Initial S/W Revision	Prior to A.02.00
Modified at S/W Revision	A.02.00

Vector Horiz Center

Sets the position of the origin for Vector trace formats such as I-Q and Constellation. When using one of these formats, you set the vertical (imaginary) axis scaling with the Y Reference Value, Y Reference Position, and Y Scale Per Division properties. The scaling of the horizontal axis is set to maintain an aspect ratio of 1:1.

Key Path	AMPTD Y Scale
Mode	VSA, LTE, LTETDD, IDEN, LTEAFDD, LTEATDD
Measurement	<meas>:=VECTor ADEMod DDEMod W11A W11B EVM IPOWER IDEMod MOTotalk
Remote Command	:DISPlay:<meas>:TRACe[1] 2 ...4:VHCenter <real>

	:DISPlay:<meas>:TRACe[1] 2 ...4:VHCenter?
Example	DISP:DDEM:TRAC1:VHC 0.2 DISP:DDEM:TRAC1:VHC?
Preset	0
State Saved	Saved in instrument state.
Min	-9.9e37
Max	9.9e37
Initial S/W Revision	Prior to A.02.00
Modified at S/W Revision	A.02.00

Copy Y Scale

Copies the following Y scaling information from the selected trace to another:

- Y reference Position
- Y Reference Value
- Y Unit Preference
- Vector Horiz Center
- Couple Ref to Range
- Y Log Ratio
- Y Reference Line

This is a front-panel only function.

Key Path	AMPTD Y Scale, Y Axis Scaling
Mode	VSA, LTE, LTETDD, IDEN, LTEAFDD, LTEATDD
Initial S/W Revision	Prior to A.02.00
Modified at S/W Revision	A.02.00

Auto Couple

The Auto Couple feature provides a quick and convenient way to automatically couple multiple instrument settings. This helps ensure accurate measurements and optimum dynamic range. When the Auto Couple feature is activated, either from the front panel or remotely, all parameters of the current measurement that have an Auto/Manual mode are set to Auto mode and all measurement settings dependent on (or coupled to) the Auto/Man parameters are automatically adjusted for optimal performance.

However, the Auto Couple key actions are confined to the current measurement only. It does not affect other measurements in the mode, and it does not affect markers, marker functions, or trace or display attributes.

See ["More Information" on page 1809](#)

Key Path	Front-panel key
Remote Command	:COUPle ALL NONE
Example	:COUP ALL
Notes	:COUPle ALL puts all Auto/Man parameters in Auto mode (equivalent to pressing the Auto Couple key). :COUPLE NONE puts all Auto/Man parameters in manual mode. It decouples all the coupled instrument parameters and is not recommended for making measurements.
Initial S/W Revision	Prior to A.02.00

More Information

There are two types of functions that have Auto/Manual modes.

Auto/Man Active Function keys

An Auto/Man toggle key controls the binary state associated with an instrument parameter by toggling between Auto (where the parameter is automatically coupled to the other parameters it is dependent upon) and Man (where the parameter is controlled independent of the other parameters), as well as making the parameter the active function. The current mode is indicated on the softkey with either Auto or Man underlined as illustrated below.



Auto/Man 1-of-N keys

An Auto/Man 1-of-N key allows you to manually pick from a list of parameter values, or place the function in Auto, in which case the value is automatically selected (and indicated) as shown below. If in Auto, Auto is underlined on the calling key. If in manual operation, manual is indicated on the calling key. But the calling key does not actually toggle the function, it simply opens the menu.

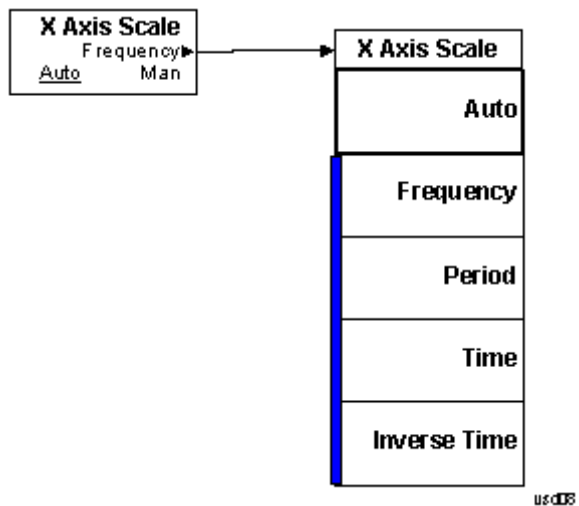

BW (Bandwidth)

Displays a menu that enables you to control the resolution bandwidth of the spectrum measurement result, as well as the shape of the resolution bandwidth filter (controlled by the FFT windowing function).

Key Path	Front Panel
Mode	VSA, LTE, LTETDD, IDEN
Initial S/W Revision	Prior to A.02.00
Modified at S/W Revision	A.02.00

FFT Window

Displays a menu that enables you to choose the Window function that is applied to the time data prior to the FFT calculation used for Spectrum and PSD displays. Four windows are available.

Window name	Common usage	Normalized ENBW (Hz-s)
Uniform	Transient or self-windowing signals, signals that are periodic within a time record length.	1.0
Hanning	Frequency resolution	1.5
Gaussian	High dynamic range	2.21536
Flat Top	High amplitude accuracy	3.8194

The normalized ENBW is the equivalent noise bandwidth, that is, the width of a rectangular filter that passes the same amount of white noise as the window. It is used to define the resolution bandwidth.

Key Path	BW
Mode	VSA, LTE, LTETDD, IDEN
Measurement	<meas>:=VECTor ADEMod DDEMod W11A W11B EVM IPOWER IDEMod MOTotalk
Remote Command	[:SENSe] :<meas>:FFT:WINDow[:TYPE] UNIFORM HANNing GAUSSian FLATtop [:SENSe] :<meas>:FFT:WINDow[:TYPE] ?
Example	VECT:FFT:WIND GAUS VECT:FFT:WIND?
Couplings	See Res BW and Res BW Coupling
Preset	FLAT
State Saved	Saved in instrument state.
Range	Uniform Hanning Gaussian (High Dyn Rng) Flat Top (High Amptd Accy)
Readback Text	Uniform Hanning Gaussian Flat Top
Initial S/W Revision	Prior to A.02.00
Modified at S/W Revision	A.02.00

Cont (Continuous Measurement/Sweep)

Sets the analyzer for Continuous measurement operation. The single/continuous state is Meas Global so the setting will affect all measurements. If you are Paused, pressing Cont does a Resume.

Key Path	Front-panel key
Remote Command	:INITiate:CONTinuous OFF ON 0 1 :INITiate:CONTinuous?
Example	:INIT:CONT 0 puts analyzer in Single measurement operation. :INIT:CONT 1 puts analyzer in Continuous measurement operation
Preset	ON (Note that SYST:PRESet sets INIT:CONT to ON but *RST sets INIT:CONT to OFF)
State Saved	Saved in instrument state
Backwards Compatibility Notes	For Spectrum Analysis mode in ESA and PSA, there is no Cont hardkey, instead there is a Sweep Single/Cont key. In these analyzers, switching the Sweep Single/Cont key from Single to Cont restarts averages (displayed average count reset to 1), but does not restart Max Hold and Min Hold. The X-Series has Single and Cont keys in place of the SweepSingleCont key. In the X-Series, if in single measurement, the Cont key (and INIT:CONT ON) switches to continuous measurement, but never restarts a measurement and never resets a sweep.
Initial S/W Revision	Prior to A.02.00

In Swept SA Measurement (Spectrum Analysis Mode):

The analyzer takes repetitive sweeps, averages, measurements, etc., when in Continuous mode. When the average count reaches the Average/Hold Number the count stops incrementing, but the analyzer keeps sweeping. See the Trace/Detector section for the averaging formula used both before and after the Average/Hold Number is reached. The trigger condition must be met prior to each sweep. The type of trace processing for multiple sweeps, is set under the Trace/Detector key, with choices of Trace Average, Max Hold, or Min Hold.

In Other Measurements/Modes:

With Avg/Hold Num (in the Meas Setup menu) set to Off or set to On with a value of 1, a sweep is taken after the trigger condition is met; and the analyzer continues to take new sweeps after the current sweep has completed and the trigger condition is again met. However, with Avg/Hold Num set to On with a value >1, multiple sweeps (data acquisitions) are taken for the measurement. The trigger condition must be met prior to each sweep. The sweep is not stopped when the average count k equals the number N set for Avg/Hold Num is reached, but the number k stops incrementing. A measurement average usually applies to all traces, marker results, and numeric results. But sometimes it only applies to the numeric results.

If the analyzer is in Single measurement, pressing the Cont key does not change k and does not cause the sweep to be reset; the only action is to put the analyzer into Continuous measurement operation.

If it is already in continuous sweep:

the INIT:CONT 1 command has no effect

15 LTE Modulation Analysis Measurement
Cont (Continuous Measurement/Sweep)

the INIT:CONT 0 command will place the analyzer in Single Sweep but will have no effect on the current sequence until $k = N$, at which point the current sequence will stop and the instrument will go to the idle state.

File

See "File" on page 360

FREQ Channel

Displays a menu that enables you to set center frequency, start frequency, stop frequency, and center frequency step. Pressing the Freq hardkey changes the active function to Center Frequency.

The frequency parameters for any vector measurement consist of two pairs of properties: Center Frequency and Span or Start Frequency and Stop Frequency. These behave much as they do in any other application, but there is the additional constraint that the span is limited to much less than the center frequency range.

If you change center frequency, the start and stop frequencies change by the same amount.

If you change span, start frequency and stop frequency are changed by 1/2 the span change.

If you change start frequency, stop frequency remains fixed and span and center frequency are refigured accordingly. Changing stop frequency has similar behavior.

Limits:

If you change the start frequency such that it equals or exceeds the stop frequency, the new start frequency is accepted if possible and the stop frequency is set to min span above the start. Similarly if you attempt to set the stop below the start, the start frequency moves to a min span below the new stop frequency.

If you reduce the start frequency beyond a max span below the stop, the stop frequency is "dragged along" such that it is a max span above the new start frequency, and similarly increasing the stop frequency drags the start frequency along if you attempt to increase the span beyond the maximum.

Stop frequency can be 1/2 span above the maximum center frequency, but frequency-domain traces are blanked above the maximum center frequency.

Start frequency can be 1/2 span below the minimum center frequency, but frequency-domain traces are blanked below the minimum center frequency.

Key Path	Front Panel
Mode	VSA, LTE, LTETDD, IDEN
Initial S/W Revision	Prior to A.02.00
Modified at S/W Revision	A.02.00

Center Freq

Sets the frequency of the display Center.

Key Path	FREQ Channel
Mode	VSA, LTE, LTETDD, IDEN
Remote Command	[:SENSe] :FREQuency:CENTer <freq> [:SENSe] :FREQuency:CENTer?
Example	FREQ:CENT 985 MHZ FREQ:CENT?

Couplings	Start Freq, Stop Freq, and Span. See " FREQ Channel " on page 1816 for more details.
Preset	1 GHz
State Saved	Saved in instrument state.
Min	0 Hz
Max	Depends on frequency range option.
Initial S/W Revision	Prior to A.02.00
Modified at S/W Revision	A.02.00

Start Freq

Sets the frequency of the display Start.

Key Path	FREQ Channel
Mode	VSA, IDEN
Remote Command	<code>[:SENSe] :FREQuency:STARt <freq></code> <code>[:SENSe] :FREQuency:STARt?</code>
Example	FREQ:STAR 980 MHz FREQ:STAR?
Couplings	Stop Freq, Center Freq, and Span. See " FREQ Channel " on page 1816 for more details.
Preset	Depends on span option. It is 1/2 max span below 1 GHz.
State Saved	Saved in instrument state.
Min	-9.9e37
Max	9.9e37
Initial S/W Revision	Prior to A.02.00
Modified at S/W Revision	A.02.00

Stop Freq

Sets the frequency of the display Stop.

Key Path	FREQ Channel
Mode	VSA, IDEN
Remote Command	<code>[:SENSe] :FREQuency:STOP <freq></code> <code>[:SENSe] :FREQuency:STOP?</code>
Example	FREQ:STOP 990 MHz FREQ:STOP?
Couplings	Start Freq, Center Freq, and Span. See " FREQ Channel " on page 1816 for more details.
Preset	Depends on span option. It is 1/2 max span above 1 GHz.

State Saved	Saved in instrument state.
Min	-9.9e37
Max	9.9e37
Initial S/W Revision	Prior to A.02.00
Modified at S/W Revision	A.02.00

CF Step

Sets the amount the center frequency changes if it is the active function when you press the Up or Down arrow key. Note: the start and stop frequency also changes by the amount of the CF Step if the Up/Down arrow keys are used to change them; but the key is mainly used in connection with stepping the center frequency, so the legacy key name has been retained. The step size in Auto mode is 1/10th the span. It can be set to any value in manual mode.

Key Path	FREQ Channel
Mode	VSA, LTE, LTETDD, IDEN
Remote Command	[:SENSe]:FREQuency:CENTer:STEP[:INCRement] <freq> [:SENSe]:FREQuency:CENTer:STEP[:INCRement]? [:SENSe]:FREQuency:CENTer:STEP:AUTO OFF ON 0 1 [:SENSe]:FREQuency:CENTer:STEP:AUTO?
Example	FREQ:CENT:STEP 1 MHZ FREQ:CENT:STEP? FREQ:CENT:STEP:AUTO ON FREQ:CENT:STEP:AUTO?
Couplings	1/10th Span when auto is turned on.
Preset	Depends on span option; 1/10th default span.
State Saved	Saved in instrument state.
Min	-9.9e37
Max	9.9e37
Initial S/W Revision	Prior to A.02.00
Modified at S/W Revision	A.02.00

Input/Output

See "Input/Output" on page 224

Marker

Displays the Marker menu. A marker can be placed on a trace to precisely determine the value of the trace data at the marker position. Markers can also be used in pairs to read the difference (or delta) between two data points. They can also be used to make power calculations over a band of frequencies or a time interval. See "[Marker Function](#)" on page 1838 for more details.

The functions in this menu include a 1-of-N selection of the control mode **Normal**, **Delta**, **Fixed**, or **Off** for the selected marker. The control mode is described below.

Pressing **Marker** always makes the selected maker's X position the active function.

If the currently selected marker is **Off**, pressing **Marker** sets it to **Normal** mode and places it at the center of the screen on the currently selected trace.

As a convenience, if there are no markers displayed on the current trace, pressing the marker hardkey (whenever the marker menu is already showing) selects the lowest numbered marker that is currently off and turns it on in normal mode on the selected trace. In other words, pressing the Marker hardkey twice always turns on a marker on the selected trace if none was turned on before.

Key Path	Front Panel
Mode	VSA, LTE, LTETDD, IDEN,LTEAFDD,LTEATDD
Initial S/W Revision	Prior to A.02.00
Modified at S/W Revision	A.02.00

Select Marker

Specifies the selected marker. The selected marker is the one that is affected by the marker position and properties settings, peak search, and other marker functions. Several menus have a Select Marker key for convenience. Marker selection using any one of these is reflected in all others, in other words, there is only one selected marker for the whole measurement. If all markers are off, then marker 1 becomes the selected marker.

As a convenience, if no markers are displayed on the selected trace, selecting a marker that is off automatically turns it on in normal mode on the selected trace.

There is no SCPI function for selecting a marker. Instead, SCPI functions can explicitly include the index of the marker for which they are to apply. (Most SCPI marker functions that affect the state of a marker also make it the selected marker for front panel commands.)

Key Path	Marker or Marker> or Marker Function or Peak Search
Mode	VSA, LTE, LTETDD, IDEN,LTEAFDD,LTEATDD
State Saved	No
Range	1 2 3 4 5 6 7 8 9 10 11 12
Initial S/W Revision	Prior to A.02.00
Modified at S/W Revision	A.02.00

Control Mode

Pressing **Normal**, **Delta**, **Fixed**, or **Off** sets the control mode of the selected marker. The current control mode is shown by highlighting the appropriate key.

The SCPI command in the table below selects the marker and sets the marker control mode as described under "**Normal (Position)**" on page 1831, "**Delta**" on page 1832, "**Fixed**" on page 1833 and "**Off**" on page 1833. All interactions and dependencies detailed under the key description are enforced when the remote command is sent.

Key Path	Marker
Mode	VSA, LTE, LTETDD, IDEN,LTEAFDD,LTEATDD
Measurement	<meas>:=VECTor ADEMod DDEMod W11A W11B EVM IPOWER IDEMod MOTotalk
Remote Command	:CALCulate:<meas>:MARKer[1] 2 ...12:MODE POSition DELTA FIXEd =OFF :CALCulate:<meas>:MARKer[1] 2 ...12:MODE?
Example	CALC:VECT:MARK1:MODE POS CALC:VECT:MARK1:MODE?
Couplings	When Delta mode is selected or when the mode is changed from Delta to Off, the marker relative to the selected marker can be affected as described in the text descriptions below.
Preset	=OFF
State Saved	Saved in instrument state.
Range	Normal Delta Fixed Off
Initial S/W Revision	Prior to A.02.00
Modified at S/W Revision	A.02.00

Marker Properties

Accesses a menu of common marker properties.

Key Path	Marker
Mode	VSA, LTE, LTETDD, IDEN,LTEAFDD,LTEATDD
Initial S/W Revision	Prior to A.02.00

Select Marker

Specifies the selected marker. The selected marker is the one that is affected by the marker position and properties settings, peak search, and other marker functions. Several menus have a Select Marker key for convenience. Marker selection using any one of these is reflected in all others, in other words, there is only one selected marker for the whole measurement. If all markers are off, then marker 1 becomes the selected marker.

As a convenience, if no markers are displayed on the selected trace, selecting a marker that is off automatically turns it on in normal mode on the selected trace.

There is no SCPI function for selecting a marker. Instead, SCPI functions can explicitly include the index of the marker for which they are to apply. (Most SCPI marker functions that affect the state of a marker also make it the selected marker for front panel commands.)

Key Path	Marker or Marker> or Marker Function or Peak Search
Mode	VSA, LTE, LTETDD, IDEN,LTEAFDD,LTEATDD
State Saved	No
Range	1 2 3 4 5 6 7 8 9 10 11 12
Initial S/W Revision	Prior to A.02.00
Modified at S/W Revision	A.02.00

Relative To

Enables you to specify which marker is used as a reference for the selected marker when the selected marker's control mode is set to Delta. By default, the reference marker is numerically one higher than the selected marker, that is, marker 1 is relative to marker 2, marker 2 to marker 3, and so on. Marker 12 by default is relative to marker 1. This key enables you to change the reference marker from the default. Note that a marker cannot be made relative to itself.

Key Path	Marker, Properties
Mode	VSA, LTE, LTETDD, IDEN,LTEAFDD,LTEATDD
Measurement	<meas>:=VECTor ADEMod DDEMod W11A W11B EVM IPOWER IDEMod MOTotalk
Remote Command	:CALCulate:<meas>:MARKer[1] 2 ...12:REFerence <integer> :CALCulate:<meas>:MARKer[1] 2 ...12:REFerence?
Example	CALC:VECT:MARK2:REF 4 CALC:VECT:MARK2:REF?
Notes	The reference marker cannot be the same value as the selected marker, that is, a marker cannot be relative to itself. The currently selected marker is not an available choice in the relative to selection (i.e., the selected marker appears grayed out). When queried, a single value is returned (the specified marker numbers relative marker).
Couplings	See " Coupling of Delta and Reference Markers " on page 1833. The old reference remains as it was.
Preset	2 3 4 5 6 7 8 9 10 11 12 1
State Saved	Saved in instrument state.
Range	1 2 3 4 5 6 7 8 9 10 11 12
Initial S/W Revision	Prior to A.02.00
Modified at S/W Revision	A.02.00

Complex Format

Determines the format for the readout when a marker is placed on a complex display (vector or constellation). The choices are to read out in rectangular or polar coordinates. The readout format applies

to the marker display and marker table only; there is no SCPI for reading out the marker value in polar form.

Key Path	Marker, Properties
Mode	VSA, LTE, LTETDD, IDEN,LTEAFDD,LTEATDD
Measurement	<meas>:=VECTor ADEMod DDEMod W11A W11B EVM IPOWER IDEMod MOTotalk
Remote Command	:CALCulate:<meas>:MARKer[1] 2 ...12:CFORmat RECTangular POLar :CALCulate:<meas>:MARKer[1] 2 ...12:CFORmat?
Example	CALC:VECT:MARK1:CFOR RECT CALC:VECT:MARK1:CFOR?
Preset	RECT
State Saved	Saved in instrument state.
Range	Rect Polar
Initial S/W Revision	Prior to A.02.00
Modified at S/W Revision	A.02.00

Marker Trace

Enables you to determine the trace to which a marker is assigned. By default, when a marker is turned on it is assigned to the currently selected trace. You can change that assignment using this control.

Key Path	Marker, Properties
Mode	VSA, LTE, LTETDD, IDEN,LTEAFDD,LTEATDD
Measurement	<meas>:=VECTor ADEMod DDEMod W11A W11B EVM IPOWER IDEMod MOTotalk
Remote Command	:CALCulate:<meas>:MARKer[1] 2 ...12:TRACe <integer> :CALCulate:<meas>:MARKer[1] 2 ...12:TRACe?
Example	CALC:VECT:MARK3:TRAC 2 CALC:VECT:MARK3:TRAC?
Couplings	See " Coupling of Delta and Reference Markers " on page 1833.
Preset	Marker is assigned to currently selected trace when turned on.
State Saved	Saved in instrument state.
Range	Trace 1 Trace2 Trace 3 Trace 4
Min	1
Max	4
Initial S/W Revision	Prior to A.02.00
Modified at S/W Revision	A.02.00

Marker Count

Enables the frequency counter algorithm on the selected marker. This algorithm can more precisely determine the frequency of a peak. The marker must be on a frequency domain trace, with data coming from hardware. Place the marker on a peak and enable the frequency counter. The marker readout then shows the calculated frequency rather than the marker X position. Only one marker can be counted at any time. Turning on marker count for any marker turns it off for all other markers.

Key Path	Marker, Properties
Mode	VSA, IDEN,LTEAFDD,LTEATDD
Measurement	<meas>:=VECTor ADEMod DDEMod W11A W11B EVM IPOWER IDEMod MOTotalk
Remote Command	:CALCulate:<meas>:MARKer[1] 2 ...12:FCOUNT[:STATe] OFF ON 0 1 :CALCulate:<meas>:MARKer[1] 2 ...12:FCOUNT[:STATe]?
Example	CALC:VECT:MARK:FCO ON CALC:VECT:MARK:FCO?
Notes	Marker must be on a frequency-domain trace and data must be live, not recorded or simulated.
Preset	OFF
State Saved	Saved in instrument state.
Range	Off On
Initial S/W Revision	Prior to A.02.00
Modified at S/W Revision	A.02.00

The frequency counter result must be read back with the following SCPI command. The Marker X query command only gets the marker's data point position, which is not as accurate as the frequency counter result.

Mode	VSA, IDEN,LTEAFDD,LTEATDD
Measurement	<meas>:=VECTor ADEMod DDEMod W11A W11B EVM IPOWER IDEMod MOTotalk
Remote Command	:CALCulate:<meas>:MARKer[1] 2 ...12:FCOUNT:X?
Example	CALC:VECT:MARK:FCO:X?
Notes	Query only. If the marker counter result is unavailable, NaN is returned.
Initial S/W Revision	Prior to A.02.00
Modified at S/W Revision	A.02.00

Marker Table

Displays the marker data display window below the measurement window. For each marker that is on, information is displayed in the data display window, which includes the marker number, control mode, trace number, X axis scale, X axis value, and the Y-axis result. Additional information is shown for markers that have marker functions turned on.

Key Path	Marker
Mode	VSA, LTE, LTETDD, IDEN,LTEAFDD,LTEATDD
Measurement	<meas>:=VECTor ADEMod DDEMod W11A W11B EVM IPOWER IDEMod MOTotalk
Remote Command	:CALCulate:<meas>:MARKer:TABLE[:STATe] OFF ON 0 1 :CALCulate:<meas>:MARKer:TABLE[:STATe]?
Example	CALC:VECT:MARK:TABL ON CALC:VECT:MARK:TABL?
Preset	OFF
State Saved	No
Range	Off On
Initial S/W Revision	Prior to A.02.00
Modified at S/W Revision	A.02.00

Marker Position

Selects which data point in a trace to read out with the marker (or where to locate a fixed marker). The marker position is primarily set in terms of the domain units, not trace points (although it can be set in terms of points via SCPI). The default active function when you press a marker hard key is the X position for the currently selected marker. The exception to this is when the selected marker is fixed. In that case there is no default active function (to prevent inadvertently changing a fixed marker's location).

Marker position is not defined when a marker's control mode is Off. When a marker is turned on in Normal or Delta mode, its X (and Z) values are set to the center of the trace data. If a marker is turned on in Fixed mode, its position is set so that it appears in the middle of the trace grid.

The Marker Position key branches to the Marker Position menu, which enables you to set any position variable relevant to the selected marker's control mode and trace format.

For Normal and Delta markers, usually only Marker X is available. Marker Z is available for trace data with 2-dimensional domain. For Fixed markers, Y can also be set. If the trace format is Vector or Constellation, **Marker Y** controls the real (horizontal axis) value and **Marker Y Imag** controls the imaginary (vertical axis) value. The key (or the keys below it) is grayed out if the selected marker is off.

Key Path	Marker
Mode	VSA, LTE, LTETDD, IDEN,LTEAFDD,LTEATDD
Initial S/W Revision	Prior to A.02.00
Modified at S/W Revision	A.02.00

Marker X

Sets the selected marker's X Axis value position in the current X Axis Scale unit. If the control mode is Off, the SCPI command has no affect other than to cause the marker to become selected. Note that the X value can change if the marker is moved to a trace with a different domain.

The Marker X position is absolute if the marker control mode is Normal or Fixed. If the control mode is Delta, then the X position is relative to the reference marker. The valid X positions are the actual data points in the trace; the marker cannot be located between points. If a SCPI command attempts to place the marker between two points, the X value snaps to the closest point.

Note that for Vector or Constellation format, the X axis is perpendicular to the screen (because the screen axes are used to show the real and imaginary parts of the Y value), so adjusting the X value in this case only causes the marker to move horizontally if the real Y value changes. For Fixed markers on a trace with one of these formats, adjusting the X value does not cause horizontal motion of the marker at all. Instead, use the Marker X and Marker Y (imag) controls to move the marker horizontally and vertically.

Key Path	Marker, Marker Position
Mode	VSA, LTE, LTETDD, IDEN, LTEAFDD, LTEATDD
Measurement	<meas>:=VECTor ADEMod DDEMod W11A W11B EVM IPOWER IDEMod MOTotalk
Remote Command	:CALCulate:<meas>:MARKer[1] 2 ...12:X <real> :CALCulate:<meas>:MARKer[1] 2 ...12:X?
Example	CALC:VECT:MARK:X 0.325 CALC:VECT:MARK:X?
Notes	Marker X does not go outside the bounds of the data unless it is Fixed. If you attempt to set it to a value outside the bounds, it is clipped at the closest limit and error -222 Data Out of Range is generated. If suffix is sent, it must match the X units for the trace the marker is on. Otherwise, error -138, "Suffix not allowed" is generated. If you try to read or set the position of a Delta marker, remember that the position is in relative units.
Couplings	See "Coupling of Delta and Reference Markers" on page 1833 . See also: "Couple Markers" on page 1830
Preset	None until marker is turned on.
State Saved	Saved in instrument state.
Min	Depends on trace data
Max	Depends on trace data
Initial S/W Revision	Prior to A.02.00
Modified at S/W Revision	A.02.00

SCPI only X position commands

Via SCPI, the marker position can also be set or queried in trace points. In this case, the position setting or reading is absolute regardless of control mode.

NOTE

The entered value in Trace Points is immediately translated into the current domain units for setting the value of the marker. The marker's value in domain units, NOT trace points, is preserved if a change is made to the X Axis scale settings. Thus, if you use this command to place a marker on point 500, which happens at that time to correspond to 13 GHz, and then you change the Start Frequency so that point 500 is no longer 13 GHz, the marker stays at 13 GHz, NOT at point 500.

If the trace the marker is on has a 2-dimensional domain, then the points are numbered in the following way:

Starting at the minimum X and Z position, this point is numbered 0. Each time you increment the point number, increment the X value to the next available value. When X reaches the maximum X position, then reset X to the minimum and increment the Z value. Then continue incrementing the X position in the same manner as before.

Note that for symbol tables, which have no axes, incrementing the X position in points moves the marker consecutively through all table entries.

Mode	VSA, LTE, LTETDD, IDEN,LTEAFDD,LTEATDD
Measurement	<meas>:=VECTor ADEMod DDEMod W11A W11B EVM IPOWER IDEMod MOTotalk
Remote Command	:CALCulate:<meas>:MARKer[1] 2 ...12[:X]:POSition <real> :CALCulate:<meas>:MARKer[1] 2 ...12[:X]:POSition?
Example	CALC:VECT:MARK:POS 25 CALC:VECT:MARK:POS?
Notes	When a marker control mode is changed from off to any other mode, the X position is set to mid-screen.
Couplings	See "Coupling of Delta and Reference Markers" on page 1833 . See also: "Couple Markers" on page 1830
Preset	None until marker is turned on.
State Saved	Saved in instrument state.
Min	Depends on trace data
Max	Depends on trace data
Initial S/W Revision	Prior to A.02.00
Modified at S/W Revision	A.02.00

Marker X Unit can be queried via SCPI

Mode	VSA, LTE, LTETDD, IDEN,LTEAFDD,LTEATDD
Measurement	<meas>:=VECTor ADEMod DDEMod W11A W11B EVM IPOWER IDEMod MOTotalk
Remote Command	:CALCulate:<meas>:MARKer[1] 2 ...12:X:UNIT?
Example	CALC:VECT:MARK:X:UNIT?
Notes	Query Only
Initial S/W Revision	Prior to A.02.00
Modified at S/W Revision	A.02.00

Marker Z

Sets the selected markers Z Axis value in the current Z Axis Scale unit for markers on traces with a 2-dimensional domain. In each case the marker that is addressed becomes the selected marker. It has no

affect (other than to cause the marker to become selected) if the control mode is **Off** or if the trace has no Z domain. Note that the Z value can change or become irrelevant if the marker is moved to a trace with a different Z domain or no Z domain.

Note that this Z value is affected if the SCPI command to set marker point position is used.

Key Path	Marker, Marker Position
Mode	VSA, LTE, LTETDD, IDEN, LTEAFDD, LTEATDD
Measurement	<meas>:=VECTor ADEMod DDEMod W11A W11B EVM IPOWER IDEMod MOTotalk
Remote Command	:CALCulate:<meas>:MARKer[1] 2 ...12:Z <real> :CALCulate:<meas>:MARKer[1] 2 ...12:Z?
Example	CALC:OFDM:MARK:Z 12 CALC:OFDM:MARK:Z?
Notes	Marker Z does not go outside the bounds of the data unless it is Fixed. If you attempt to set it to a value outside the bounds it is clipped at the closest limit, and error -222 Data Out of Range is generated. If suffix is sent, it must match the Z units for the trace the marker is on. Otherwise, error -138, "Suffix not allowed" is generated.
Couplings	See "Coupling of Delta and Reference Markers" on page 1833 . See also: "Couple Markers" on page 1830
Preset	None until marker is turned on.
State Saved	Saved in instrument state.
Min	Depends on trace data
Max	Depends on trace data
Initial S/W Revision	Prior to A.02.00
Modified at S/W Revision	A.02.00

Marker Z Unit can be queried via SCPI.

Mode	VSA, LTE, LTETDD, IDEN, LTEAFDD, LTEATDD
Measurement	<meas>:=VECTor ADEMod DDEMod W11A W11B EVM IPOWER IDEMod MOTotalk
Remote Command	:CALCulate:<meas>:MARKer[1] 2 ...12:Z:UNIT?
Example	CALC:OFDM:MARK:Z:UNIT?
Notes	Query Only
Initial S/W Revision	Prior to A.02.00
Modified at S/W Revision	A.02.00

Marker Y

Enables you to set or read back the selected marker's Y Axis value in the current Y Axis Scale unit. Setting the Y value has no affect (other than to cause the marker to become selected) if the control mode is other

than fixed. The query form generates an error if the control mode is Off. Note that the Y value can change if the Y-axis units change, either from a change in format of the trace the marker is on or if the marker is moved to a different trace.

If the selected marker is on a trace that is displayed with Vector or Constellation format, this function controls only the real part of the Y value (i.e., the horizontal axis value). Use the **Marker Y (imag)** control to change the imaginary (vertical) value. Marker Y and Marker Y Imag always set or get the rectangular form of Y, regardless of whether the marker readout is polar or rectangular.

Key Path	Marker, Marker Position
Mode	VSA, LTE, LTETDD, IDEN, LTEAFDD, LTEATDD
Measurement	<meas>:=VECTor ADEMod DDEMod W11A W11B EVM IPOWER IDEMod MOTotalk
Remote Command	:CALCulate:<meas>:MARKer[1] 2 ...12:Y[:REAL] <real> :CALCulate:<meas>:MARKer[1] 2 ...12:Y[:REAL]?
Example	CALC:VECT:MARK2:Y 0.325 CALC:VECT:MARK2:Y?
Notes	You cannot set Y unless the marker type is fixed. If the marker becomes fixed after a marker function is turned on, it is set to whatever the Y value was when the marker became fixed. If suffix is sent, it must match the Y units for the trace the marker is on. Otherwise, error -138, "Suffix not allowed" is generated.
Couplings	Changes if marker is relative to a Delta marker that is turned on or re-zeroed (see "Coupling of Delta and Reference Markers" on page 1833).
Preset	None until marker is turned on.
State Saved	Saved in instrument state.
Min	-9.9E+37
Max	9.9E+37
Initial S/W Revision	Prior to A.02.00
Modified at S/W Revision	A.02.00

Marker Y Unit can be queried via SCPI.

Mode	VSA, LTE, LTETDD, IDEN, LTEAFDD, LTEATDD
Measurement	<meas>:=VECTor ADEMod DDEMod W11A W11B EVM IPOWER IDEMod MOTotalk
Remote Command	:CALCulate:<meas>:MARKer[1] 2 ...12:Y:UNIT?
Example	CALC:VECT:MARK:Y:UNIT?
Notes	Query Only
Initial S/W Revision	Prior to A.02.00
Modified at S/W Revision	A.02.00

Marker Y Imag (Imaginary)

Enables you to set or read back the selected marker's quadrature (imaginary) Y value in the current Y Axis Scale unit. It has no affect (other than to cause the marker to become selected) if the control mode is other than fixed or if the current trace format is not complex (Vector or Constellation). The query form generates an error if it is used for a marker that is not on a complex trace. Marker Y Imag is not affected by whether the marker readout is polar or rectangular.

Key Path	Marker, Marker Position
Mode	VSA, LTE, LTETDD, IDEN, LTEAFDD, LTEATDD
Measurement	<meas>:=VECTor ADEMod DDEMod W11A W11B EVM IPOWER IDEMod MOTotalk
Remote Command	:CALCulate:<meas>:MARKer[1] 2 ...12:Y:IMAGinary <real> :CALCulate:<meas>:MARKer[1] 2 ...12:Y:IMAGinary?
Example	CALC:DDEM:MARK1:Y:IMAG 0.435 CALC:DDEM:MARK1:Y:IMAG?
Notes	Grayed out unless the marker is fixed and on a vector display. If suffix is sent, it must match the Y units for the trace the marker is on. Otherwise, an Invalid Suffix error is generated. Otherwise, error -138, "Suffix not allowed" is generated. If query is sent while the marker is on a trace whose format is not vector or constellation, NaN (9.91E+37) is returned.
Preset	None until marker is turned on.
State Saved	Saved in instrument state.
Min	Depends on trace format
Max	Depends on trace format
Initial S/W Revision	Prior to A.02.00
Modified at S/W Revision	A.02.00

Couple Markers

Affects all currently displayed markers. In general, when coupling is turned on then all Normal or Delta markers with the same (or equivalent) domain as the selected marker move in the same manner as the selected marker. Coupling is relative between markers on the same trace (so that their relative positions in the domain are maintained). Coupling can be absolute between markers on different traces that have equivalent domains. That is, they have the same position in the domain, if possible. (As an example of equivalent domains, demodulated symbol positions can be derived from time by using the current symbol rate). When you move the selected marker, then others on related traces track it. This enables you to correlate different measurement results. For example, you can place a marker at a particular symbol time on an error vector magnitude display, have tracking markers on the symbol table and pre-demod time trace showing you the symbol value, and the actual time-varying signal value at the same point in time.

Absolute coupling is performed only for the lowest numbered Normal or Delta marker on each trace. All other markers on a trace couple relatively. When you turn on marker coupling, the subset of markers that have the same domain as the selected marker track it and all other markers remain at their current location. The absolutely coupled markers within this subset is moved at this time to match the domain setting of the selected marker, with the relatively coupled markers following accordingly to maintain offsets within their respective traces. Those markers with different domains remain at their current

location. When you select a marker with a different domain than the previously selected marker, then the subset of markers with that domain go through the same procedure.

Any marker that coupling would move outside its range of X values, remains at the closest limiting value until the selected marker moves in such a way as to bring the coupled X value back into range. If the coupled markers are on data that do not have the same domain resolution, then they are positioned as close to each other as possible.

If markers change mode or trace, or trace data is changed below them, the coupling rules are immediately applied to the new set.

Key Path	Marker
Mode	VSA, LTE, LTETDD, IDEN, LTEAFDD, LTEATDD
Measurement	<meas>:=VECTor ADEMod DDEMod W11A W11B EVM IPOWER IDEMod MOTotalk
Remote Command	:CALCulate:<meas>:MARKer:COUPlE[:STATe] OFF ON 0 1 :CALCulate:<meas>:MARKer:COUPlE[:STATe]?
Example	CALC:VECT:MARK:COUP ON CALC:VECT:MARK:COUP?
Preset	OFF
State Saved	Saved in instrument state.
Range	Off On
Initial S/W Revision	Prior to A.02.00
Modified at S/W Revision	A.02.00

All Markers Off

Turns all markers off and sets the selected marker to 1.

Key Path	Marker
Mode	VSA, LTE, LTETDD, IDEN, LTEAFDD, LTEATDD
Measurement	<meas>:=VECTor ADEMod DDEMod W11A W11B EVM IPOWER IDEMod MOTotalk
Remote Command	:CALCulate:<meas>:MARKer:AOff
Example	CALC:VECT:MARK:AOff:
Initial S/W Revision	Prior to A.02.00
Modified at S/W Revision	A.02.00

Normal (Position)

Reports the trace data value (Y value) at a particular point on a trace. The marker's absolute X (and Z) position is specified by you in displayed units. The marker symbol appears on the trace at the specified position and tracks the absolute Y value at that position as it changes from scan to scan. The absolute Y value is displayed in the marker readout area. In older instruments this was called Position mode, and the designation can still be used for backward compatibility.

For Control Mode SCPI command information see: ["Control Mode" on page 1821](#)

Key Path	Marker
Mode	VSA, LTE, LTETDD, IDEN,LTEAFDD,LTEATDD
Initial S/W Revision	Prior to A.02.00
Modified at S/W Revision	A.02.00

Delta

Reports the difference between Y values at two points. A delta marker is relative to an associated reference marker on the same trace. (The reference marker can be set on the Marker, Properties, Relative To menu). The reference marker is usually fixed, but can also be normal or delta. The X (and Z) position of a delta marker is specified as an offset from the reference marker position. The delta marker symbol tracks the absolute Y value just like a normal marker, but the marker readout displays the difference between the absolute Y values of the delta marker and its reference marker (absolute units are used even if the reference is itself a delta marker). Usually this is a straight difference in the current displayed units. For example, if the trace format is LogMag (dBm), the delta marker displays the difference in dB, thus showing a power ratio. But if the trace format is Real, then the delta marker shows a voltage difference, not a ratio. Exceptions for this are:

- When the trace format is **Linear Mag** or **Log Mag (linear unit)** the delta marker displays a voltage ratio or (if the Y Axis unit is Power) a power ratio, rather than a difference.
- When either the marker or its reference has a marker function turned on, the delta marker always displays a ratio or its decibel equivalent. See ["Marker Function" on page 1838](#) for more details on how delta markers work with marker functions. The type of ratio calculated (power or voltage) depends on the delta marker units; the reference marker value is converted as needed so it has compatible units.
- When the trace format is **Wrap Phase**, the delta marker readout is constrained to the wrapped phase display range, which is usually $(-180, +180]$ degrees. For example, if the absolute phase at marker 1 is 170 deg and its reference has phase of -170 deg, the delta does not show 340 deg, but -20 deg. Note that the Wrap Phase display range can be changed (see ["Phase/Trellis Offset" on page 2334](#)).

There is no current support for calculating deltas across traces (and this cannot be done at all unless the traces have the same domain and ranges).

By default, the reference marker for marker 1 is marker 2; for marker 2 is 3 and so on, but the reference marker can be changed. See ["Relative To" on page 1822](#).

For coupling rules, see ["Coupling of Delta and Reference Markers" on page 1833](#).

For Control Mode SCPI command information see: ["Control Mode" on page 1821](#)

Key Path	Marker
Mode	VSA, LTE, LTETDD, IDEN,LTEAFDD,LTEATDD
Initial S/W Revision	Prior to A.02.00
Modified at S/W Revision	A.02.00

Fixed

Mainly used as reference markers for Delta markers. A fixed marker's X and Y Axis values can be directly or indirectly specified by you, and they remain fixed once specified, in other words, they do not follow the trace data value. These markers are represented on the display by an "X" rather than a diamond. If a marker is changed from off to fixed, the X and Y (and Z) values are chosen to put it in the center of the display. If the marker is changed from some other type to fixed, the current X and Z values of the marker remain unchanged. The Y value is taken from the current trace data value and must be changed manually thereafter.

For Control Mode SCPI command information see: ["Control Mode" on page 1821](#)

Key Path	Marker
Mode	VSA, LTE, LTETDD, IDEN,LTEAFDD,LTEATDD
Initial S/W Revision	Prior to A.02.00
Modified at S/W Revision	A.02.00

Off

Turning a marker off makes it invisible, and also its annotation.

Turning a marker on (i.e., changing its control mode from Off to any other control mode) assigns the marker to the currently selected trace.

For Control Mode SCPI command information see: ["Control Mode" on page 1821](#)

Key Path	Marker
Mode	VSA, LTE, LTETDD, IDEN,LTEAFDD,LTEATDD
Initial S/W Revision	Prior to A.02.00
Modified at S/W Revision	A.02.00

Coupling of Delta and Reference Markers

The following coupling rules apply from the front panel and also if the equivalent SCPI commands are sent.

Pressing the Delta key causes the selected marker to become a delta marker if it is not already. Also, the selected marker's reference is affected as follows:

- If the reference marker was off, it is turned on as a fixed marker.
- The reference marker is moved to the trace of the selected marker and set to the same position as the selected marker.
- If the delta marker has a marker function turned on, the reference marker takes on the same function (with the same band limits).

Exception: Pressing Delta when the selected marker's mode is not yet Delta does not move or change a reference marker that is already turned on (Normal, Delta, or Fixed) and on the same trace as the selected

marker. It merely changes the selected marker's mode to Delta and shows the current offset between it and the reference. If you press Delta again (when the selected marker is already in Delta mode) then the reference is moved and modified as described above.

When a delta marker is changed to any other control mode, if its reference marker is fixed then the reference marker is also turned off.

If you move a delta marker to a different trace, it is forced to Normal mode and if its reference is fixed, the reference is turned off.

A delta marker is forced to Normal mode if you turn its reference off or if you move its reference to another trace. (In the latter case the reference is not turned off even if it is fixed.)

If you change the selected marker's reference (using the Marker, Properties, Relative To), the selected marker is forced to Delta mode. This change of the selected marker to Delta mode causes its new reference's control mode and position to change as described above.

Marker -> (Marker To)

Provides access to some convenient functions for copying the marker position to a number of frequency and Y-axis scaling parameters. These functions are available from the front panel only. No SCPI is provided, because you can already read the marker position via SCPI and then set any frequency or scaling parameter accordingly, with full accuracy.

Pressing the Marker -> hardkey always makes the selected marker's X position the active function.

If the selected marker is off, pressing the Marker -> hardkey turns on the selected marker in normal mode on the currently selected trace.

Key Path	Front Panel
Mode	VSA, LTE, LTETDD, IDEN,LTEAFDD,LTEATDD
Initial S/W Revision	Prior to A.02.00
Modified at S/W Revision	A.02.00

Mkr -> CF (Center Frequency)

Sets the center frequency equal to the selected marker's absolute frequency. The marker must be on a frequency-domain trace. The absolute marker frequency is used regardless of whether its control mode is Normal, Delta, or Fixed.

If the currently selected marker is not on when this key is pressed, it is turned on at the center of the screen as a normal type marker.

Key Path	Marker To
Mode	VSA, LTE, LTETDD, IDEN,LTEAFDD,LTEATDD
Initial S/W Revision	Prior to A.02.00
Modified at S/W Revision	A.02.00

Mkr -> CF Step

Sets the center frequency step size equal to the selected marker's frequency. The marker must be on a frequency-domain trace. The absolute marker frequency is used regardless of whether its control mode is Normal, Delta, or Fixed.

If the currently selected marker is not on when this key is pressed, it is turned on at the center of the screen as a normal type marker.

Key Path	Marker To
Mode	VSA, LTE, LTETDD, IDEN,LTEAFDD,LTEATDD
Initial S/W Revision	Prior to A.02.00
Modified at S/W Revision	A.02.00

Mkr -> Start

Sets the start frequency equal to the selected marker's frequency. The marker must be on a frequency-domain trace. The absolute marker frequency is used regardless of whether its control mode is Normal, Delta, or Fixed.

If the currently selected marker is not on when this key is pressed, it is turned on at the center of the screen as a normal type marker.

Key Path	Marker To
Mode	VSA, LTE, LTETDD, IDEN,LTEAFDD,LTEATDD
Initial S/W Revision	Prior to A.02.00
Modified at S/W Revision	A.02.00

Mkr -> Stop

Sets the stop frequency equal to the selected marker's frequency. The marker must be on a frequency-domain trace. The absolute marker frequency is used regardless of whether its control mode is Normal, Delta, or Fixed.

If the currently selected marker is not on when this key is pressed, it is turned on at the center of the screen as a normal type marker.

Key Path	Marker To
Mode	VSA, LTE, LTETDD, IDEN,LTEAFDD,LTEATDD
Initial S/W Revision	Prior to A.02.00
Modified at S/W Revision	A.02.00

Mkr Delta -> Span

Sets the start and stop frequencies equal to the selected marker's frequency and that of its reference. That is, the measurement span is "zoomed in" so that the selected marker and its associated reference appear on the extreme left and right of the display. The marker must be on a frequency-domain trace and its control mode must be Delta.

Key Path	Marker To
Mode	VSA, LTE, LTETDD, IDEN,LTEAFDD,LTEATDD
Initial S/W Revision	Prior to A.02.00
Modified at S/W Revision	A.02.00

Mkr -> Ref Lvl

Sets the Y axis reference value equal to the selected marker's Y value. For example, if the reference position is at the top of the screen, the whole trace is moved up so that the marker appears at the top of

the screen. Note that this is a display scaling function only. The input range remains the same.

Key Path	Marker To
Mode	VSA, LTE, LTETDD, IDEN,LTEAFDD,LTEATDD
Initial S/W Revision	Prior to A.02.00
Modified at S/W Revision	A.02.00

Counter -> CF (Center Frequency)

Sets the frequency of the marker counter to the center frequency. The marker counter function must be on.

Key Path	Marker To
Mode	VSA, IDEN,LTEAFDD,LTEATDD
Initial S/W Revision	Prior to A.02.00
Modified at S/W Revision	A.02.00

Mkr Delta -> CF (Center Frequency)

Sets the center frequency equal to the difference in frequency between the selected Delta marker and its reference. The marker must be on a frequency-domain trace and the selected marker's control mode must be Delta.

Key Path	Marker To
Mode	VSA, LTE, LTETDD, IDEN,LTEAFDD,LTEATDD
Initial S/W Revision	Prior to A.02.00
Modified at S/W Revision	A.02.00

Marker Function

Accesses a menu of selectable marker functions for VSA based measurements.

Marker Functions perform post-processing operations on marker data. Band Functions are Marker Functions that enable you to define a band of frequencies around the marker. The band defines the region of data used for the numerical calculations. These marker functions also enable you to perform mathematical calculations on trace and marker data and report the results of these calculations in place of the normal marker result.

Unlike regular markers, marker function markers are not placed directly on the trace. They are placed at a location that is relative to the result of the function calculation.

The Marker Function menu provides access to power calculations in bands of frequencies or time intervals centered on a marker. It also enables you to make calculations like carrier to noise by combining delta markers with marker functions. Marker functions are generally available for time and frequency domain traces, and not for others. If the marker function calculation is undefined for particular trace data, then "---" is shown in place of a number in the result display and marker table, and CALC:<meas>:MARK[n]:Y? returns 9.91E+37 (NaN).

Pressing Marker Function always makes the selected marker's X position the active function.

If the selected marker is off, pressing the Marker Function hardkey turns on the selected marker in normal mode on the currently selected trace.

Key Path	Front Panel
Mode	VSA, LTE, LTETDD, IDEN,LTEAFDD,LTEATDD
Measurement	<meas>:=VECTor ADEMod DDEMod W11A W11B EVM IPOWER IDEMod MOTotalk
Remote Command	:CALCulate:<meas>:MARKer[1] 2 ...12:FUNCTION BPOWer BDENsity =OFF :CALCulate:<meas>:MARKer[1] 2 ...12:FUNCTION?
Example	CALC:VECT:MARK1:FUNC BPOW CALC:VECT:MARK1:FUNC?
Notes	:CALC:<meas>:MARK1:FUNC? returns the current function type for marker 1. To return the result, use :CALC:<meas>:MARK1:Y?
Preset	=OFF
State Saved	Saved in instrument state.
Range	Band Power Band Density Off
Initial S/W Revision	Prior to A.02.00
Modified at S/W Revision	A.02.00

Select Marker

Specifies the selected marker. The selected marker is the one that is affected by the marker position and properties settings, peak search, and other marker functions. Several menus have a Select Marker key for convenience. Marker selection using any one of these is reflected in all others, in other words, there is only

one selected marker for the whole measurement. If all markers are off, then marker 1 becomes the selected marker.

As a convenience, if no markers are displayed on the selected trace, selecting a marker that is off automatically turns it on in normal mode on the selected trace.

There is no SCPI function for selecting a marker. Instead, SCPI functions can explicitly include the index of the marker for which they are to apply. (Most SCPI marker functions that affect the state of a marker also make it the selected marker for front panel commands.)

Key Path	Marker or Marker> or Marker Function or Peak Search
Mode	VSA, LTE, LTETDD, IDEN,LTEAFDD,LTEATDD
State Saved	No
Range	1 2 3 4 5 6 7 8 9 10 11 12
Initial S/W Revision	Prior to A.02.00
Modified at S/W Revision	A.02.00

Band/Interval Power

Turns on the Band/Interval Power function for the selected marker. This function calculates the power within the band centered on the marker. The function works generally with frequency spectra, PSD, and time traces. On traces where band power is undefined, the result display shows "---" and CALC:<meas>:MARK[n]:Y? returns 9.91E+37 (NaN), although the band interval can still be defined.

Frequency-domain data

If the marker is on a frequency-domain trace, the result is total power within the band. This is true whether the underlying trace data is a power spectrum or power spectral density.

Time-domain data

If the marker is on a time-domain trace, the result is average power within the time interval, that is, the power at each time sample in the time interval is calculated, the powers are summed and the total divided by the number of samples.

Key Path	Marker Function
Mode	VSA, LTE, LTETDD, IDEN,LTEAFDD,LTEATDD
Initial S/W Revision	Prior to A.02.00
Modified at S/W Revision	A.02.00

Band Power Calculation

Shows results in dBm, dBVrms, Watts, Volts RMS Squared or Volts RMS. The table below shows the choice of display units if **Band Power Calculation** is set to **Mean**, depending on the current format and Y units of the trace the marker is on.

Trace data type	Trace Format	Y Unit	Result format
Spectrum, PSD, Time record	LogMag (dB)	Auto, Power	dBm
		Peak, RMS	dBVrms
		mRMS	dBmVrms
	Linear Mag, Real, Imag, Log Mag (lin)	Auto, Peak, RMS, mRMS	Vrms^2
	Linear Mag, Real, Imag, Log Mag(lin)	Power	W
	Wrap Phase, Unwrap Phase, Delay	Any	Vrms^2
	Vector, Constellation, Eye, Trellis	Any	blanked
Dimensionless (e.g., Frequency response, Impulse response, various Demodulation error types)	LogMag (dB)	Any	dBrms
	Linear Mag, Real, Imag, Wrap Phase, Unwrap Phase, Delay, Log Mag (lin)	Any	rms^2
General dimensions(e.g., Hz, %)	LogMag (dB)	Any	dB<unit>rms
	Linear Mag, Real, Imag, Wrap Phase, Unwrap Phase, Delay, Log Mag (lin)	Any	<unit>rms^2

If the **Band Power Calculation** is set to **RMS**, then the readout unit does not depend on trace format or Y unit. For Spectrums, PS, and Time record traces, the displayed unit is "Vrms". For general units, the unit abbreviation is shown followed by "rms".

The Band Power Calculation only controls the readout format for Normal and Fixed markers. For Delta markers, see "[Band Power and Delta Markers](#)" on page 1844.

Key Path	Marker Function, Band/Interval Power
Mode	VSA, LTE, LTETDD, IDEN, LTEAFDD, LTEATDD
Measurement	<meas>:=VECTor ADEMod DDEMod W11A W11B EVM IPOWER IDEMod MOTotalk
Remote Command	:CALCulate:<meas>:MARKer[1] 2 ...12:FUNCTION:BPOWER:CTYPe MEAN RMS :CALCulate:<meas>:MARKer[1] 2 ...12:FUNCTION:BPOWER:CTYPe?
Example	CALC:VECT:MARK1:FUNC:BPOW:CTYP MEAN CALC:VECT:MARK1:FUNC:BPOW:CTYP?
Preset	MEAN
State Saved	Saved in instrument state.
Range	Mean RMS
Initial S/W Revision	Prior to A.02.00
Modified at S/W Revision	A.02.00

Band/Interval Density

Calculates the average power density within the band centered on the marker. The function works generally with frequency spectra, PSD, and time traces. On traces where band power cannot reasonably be defined, the result display shows "---" and CALC:<meas>:MARK[n]:Y? returns NaN (9.91E+37), although the band interval can still be defined.

Frequency-domain data

If the marker is on a frequency-domain trace, the result is the band power (as computed above) divided by the bandwidth over which it is measured. This is true whether the underlying trace data is a power spectrum or power spectral density.

Time-domain data

If the marker is on a time-domain trace, the result is average power within the time interval (as computed above) divided by the equivalent noise bandwidth of the span.

Key Path	Marker Function
Mode	VSA, LTE, LTETDD, IDEN,LTEAFDD,LTEATDD
Initial S/W Revision	Prior to A.02.00
Modified at S/W Revision	A.02.00

Band Density Calculation

Turns on the Band/Interval Density function for the selected marker. If the selected marker is off, it is turned on in **Normal** marker mode and is located at the center of the screen.

If **Band/Interval Density** is selected while in the **Marker Function Off** state, the **Band Span** or **Interval Span** is initialized to 5% of the screen width.

If the detector mode for the detector on the marker's trace is set to Auto, the average detector is selected. If the Average type is set to Auto, Power Averaging is selected. Other choices for the detector or Average type usually cause measurement inaccuracy.

A band/interval density calculation result can be shown in dBm/Hz, Volts RMS Squared, or Volts RMS. The following table shows the choice of display units if **Band Density Calculation** is set to **Mean**, depending on the current format of the trace the marker is on.

Trace data type	Trace Format	Result format
Spectrum, PSD, Time record	LogMag (dB)	dBm/Hz
	Linear Mag, Real, Imag, Wrap Phase, Unwrap Phase, Delay, Log Mag (lin)	Vrms^2/Hz
Dimensionless (e.g., Frequency response, Impulse response, various Demodulation error types)	LogMag (dB)	dBrms/Hz
	Linear Mag, Real, Imag, Wrap Phase, Unwrap Phase, Delay, Log Mag (lin)	rms^2/Hz

General dimensions (e.g., Hz, %)	LogMag (dB)	dB<unit>rms/Hz
	Linear Mag, Real, Imag, Wrap Phase, Unwrap Phase, Delay, Log Mag (lin)	<unit>rms^2/Hz

If the **Band Density Calculation** is set to **RMS**, then the readout unit does not depend on trace format. For Spectrum, PSD, and Time record traces, the displayed unit is "Vrms/rtHz". For general units, the unit abbreviation is shown followed by "rms/rtHz".

The Band Density Calculation only controls the readout format for Normal and Fixed markers. For Delta markers, see ["Band Power and Delta Markers" on page 1844](#).

Key Path	Marker Function, Band/Interval Power
Mode	VSA, LTE, LTETDD, IDEN,LTEAFDD,LTEATDD
Measurement	<meas>:=VECTor ADEMod DDEMod W11A W11B EVM IPOWER IDEMod MOTotalk
Remote Command	:CALCulate:<meas>:MARKer[1] 2 ...12:FUNCTion:BDENsity:CTYPe MEAN RMS :CALCulate:<meas>:MARKer[1] 2 ...12:FUNCTion:BDENsity:CTYPe?
Example	CALC:VECT:MARK1:FUNC:BDEN:CTYP RMS CALC:VECT:MARK1:FUNC:BDEN:CTYP?
Preset	MEAN
State Saved	Saved in instrument state.
Range	Mean RMS
Initial S/W Revision	Prior to A.02.00
Modified at S/W Revision	A.02.00

Band Adjust

Enables you to define the bandwidth around the marker. The band is always centered on the marker position. Entering the menu always sets Band/Interval Span as the active function.

Key Path	Marker Function
Mode	VSA, LTE, LTETDD, IDEN,LTEAFDD,LTEATDD
Initial S/W Revision	Prior to A.02.00
Modified at S/W Revision	A.02.00

Band/Interval Center

Enables you to define the center of the band. That is, it enables you to adjust the marker position in absolute units (regardless of whether the marker mode is Normal or Delta).

Key Path	Marker Function, Band Adjust
----------	------------------------------

Mode	VSA, LTE, LTETDD, IDEN, LTEAFDD, LTEATDD
Measurement	<meas>:=VECTor ADEMod DDEMod W11A W11B EVM IPOWER IDEMod MOTotalk
Remote Command	:CALCulate:<meas>:MARKer[1] 2 ...12:FUNction:BAND:CENTer <real> :CALCulate:<meas>:MARKer[1] 2 ...12:FUNction:BAND:CENTer?
Example	CALC:VECT:MARK2:FUNC:BAND:CENT 1.23E+09 CALC:VECT:MARK2:FUNC:BAND:CENT?
Preset	Center of screen
State Saved	Saved in instrument state.
Min	-9.9E+37
Max	9.9E+37
Initial S/W Revision	Prior to A.02.00
Modified at S/W Revision	A.02.00

Band/Interval Span

Sets the width of the span for the selected marker. This function defines the span of frequencies or time. The marker position does not change when you adjust the span.

Key Path	Marker Function, Band Adjust
Mode	VSA, LTE, LTETDD, IDEN, LTEAFDD, LTEATDD
Measurement	<meas>:=VECTor ADEMod DDEMod W11A W11B EVM IPOWER IDEMod MOTotalk
Remote Command	:CALCulate:<meas>:MARKer[1] 2 ...12:FUNction:BAND:SPAN <real> :CALCulate:<meas>:MARKer[1] 2 ...12:FUNction:BAND:SPAN?
Example	CALC:VECT:MARK2:FUNC:BAND:SPAN 1.23E+06 CALC:VECT:MARK2:FUNC:BAND:SPAN?
Preset	When marker turned on, 1/20th of current span or displayed time length.
State Saved	Saved in instrument state.
Min	-9.9E+37
Max	9.9E+37
Initial S/W Revision	Prior to A.02.00
Modified at S/W Revision	A.02.00

Band/Interval Left

Enables you to adjust the left side of the band. In order to remain centered in the band, the marker position must also change as you change the left edge. The right edge is unaffected.

Key Path	Marker Function, Band Adjust
----------	------------------------------

Mode	VSA, LTE, LTETDD, IDEN, LTEAFDD, LTEATDD
Measurement	<meas>:=VECTor ADEMod DDEMod W11A W11B EVM IPOWER IDEMod MOTotalk
Remote Command	:CALCulate:<meas>:MARKer[1] 2 ...12:FUNction:BAND:LEFT <real> :CALCulate:<meas>:MARKer[1] 2 ...12:FUNction:BAND:LEFT?
Example	CALC:VECT:MARK2:FUNC:BAND:LEFT 1.23E+06 CALC:VECT:MARK2:FUNC:BAND:LEFT?
Couplings	Changes marker X to keep the marker centered in the band.
Preset	When marker turned on, 1/40th of current span or displayed time length left of the marker position.
State Saved	Saved in instrument state.
Min	-9.9E+37
Max	9.9E+37
Initial S/W Revision	Prior to A.02.00
Modified at S/W Revision	A.02.00

Band/Interval Right

Enables you to adjust the right side of the band. In order to remain centered in the band, the marker position must also change as you change the right edge. The left edge is unaffected.

Key Path	Marker Function, Band Adjust
Mode	VSA, LTE, LTETDD, IDEN, LTEAFDD, LTEATDD
Measurement	<meas>:=VECTor ADEMod DDEMod W11A W11B EVM IPOWER IDEMod MOTotalk
Remote Command	:CALCulate:<meas>:MARKer[1] 2 ...12:FUNction:BAND:RIGHT <real> :CALCulate:<meas>:MARKer[1] 2 ...12:FUNction:BAND:RIGHT?
Example	CALC:VECT:MARK2:FUNC:BAND:RIGHT 1.23E+06 CALC:VECT:MARK2:FUNC:BAND:RIGHT?
Couplings	Changes marker X to keep the marker centered in the band.
Preset	When marker turned on, 1/40th of current span or displayed time length right of the marker position.
State Saved	Saved in instrument state.
Min	-9.9E+37
Max	9.9E+37
Initial S/W Revision	Prior to A.02.00
Modified at S/W Revision	A.02.00

Band Power and Delta Markers

When either a Delta marker or its reference has a band power function turned on, the Delta marker readout always shows a ratio calculation. This enables you to perform common calculations like carrier to noise ratio or adjacent channel power ratio. The form of the ratio depends on the main marker function

calculation type (Mean or RMS). If the main marker function calculation type is Mean, then when you change the marker to Delta the result is a power ratio. If the main marker function calculation type is RMS, then the Delta marker result is a voltage ratio. (If the main marker band power function is off, then the form of the ratio depends on the reference marker calculation type: If it is Mean you get a power ratio and if it is RMS you get a voltage ratio.)

For example, if the main marker function is Band/Interval Power with a calculation type of Mean and the reference marker function is Band/Interval Power with a calculation type of RMS, then the Delta marker shows the ratio of the main marker “Band/Interval Power Mean” value to the reference marker “Band/Interval Power Mean” (not RMS) value.

A dimensionless ratio (for example, Volt/Volt or Watt/Watt) is shown with units of "x". The marker function calculation type indicates whether the ratio is voltage or power (see above). A dimensionless power ratio is shown with units of dB if the trace format is Log Mag (dB).

If the reference marker function is Band/Interval Density and the main marker is either Band/Interval Power or its function is turned off, then the ratio is not dimensionless, but has units of Hz (or dB-Hz) for power calculations or rtHz for voltage calculations. When the main marker function is Band/Interval Density and the reference is either Band/interval Power or its function is off, the units are /Hz (or dB/Hz) for power calculations or /rtHz for voltage calculations.

Key Path	Marker Function
Mode	VSA, LTE, LTETDD, IDEN,LTEAFDD,LTEATDD
Initial S/W Revision	Prior to A.02.00
Modified at S/W Revision	A.02.00

Meas

The information in this section is common to all measurements. For key and remote command information for a specific measurement, refer to the section that describes the measurement of interest.

Measurements available under the Meas key are specific to the current Mode.

When viewing Help for measurements, note the following:

NOTE

Operation for some keys differs between measurements. The information displayed in Help pertains to the current measurement. To see how a key operates in a different measurement, exit Help (press the Cancel Esc key), select the measurement, then reenter Help (press the Help key) and press that key.

Key Path	Front-panel key
Initial S/W Revision	Prior to A.02.00

Remote Measurement Functions

This section contains the following topics:

["Measurement Group of Commands" on page 2771](#)

["Current Measurement Query \(Remote Command Only\)" on page 2773](#)

["Limit Test Current Results \(Remote Command Only\)" on page 2773](#)

["Data Query \(Remote Command Only\)" on page 2773](#)

["Calculate/Compress Trace Data Query \(Remote Command Only\)" on page 2774](#)

["Calculate Peaks of Trace Data \(Remote Command Only\)" on page 2779](#)

[Hardware-Accelerated Fast Power Measurement \(Remote Command Only\)](#)

["Format Data: Numeric Data \(Remote Command Only\)" on page 2780](#)

["Format Data: Byte Order \(Remote Command Only\)" on page 2781](#)

Initial S/W Revision	Prior to A.02.00
----------------------	------------------

Measurement Group of Commands

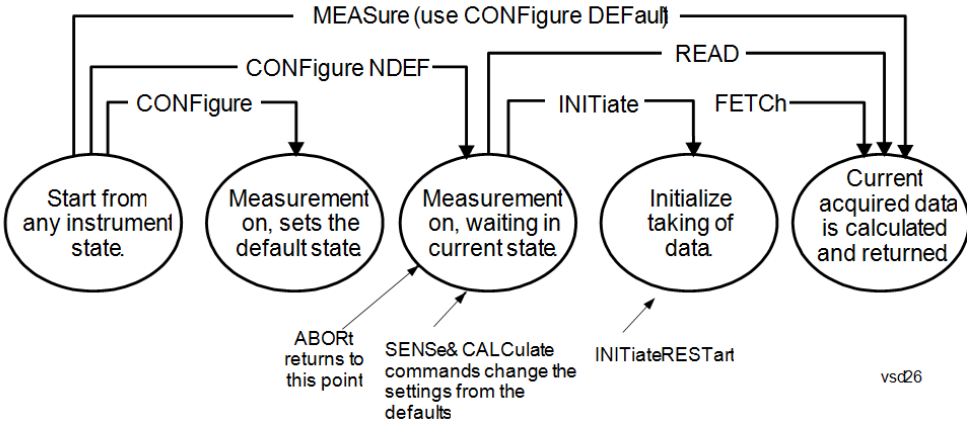

Measure Commands:

:MEASure:<measurement>[n]?

This is a fast single-command way to make a measurement using the factory default instrument settings. These are the settings and units that conform to the Mode Setup settings (e.g. radio standard) that you have currently selected.

- Stops the current measurement (if any) and sets up the instrument for the specified measurement using the factory defaults
- Initiates the data acquisition for the measurement
- Blocks other SCPI communication, waiting until the measurement is complete before returning results.
- If the function does averaging, it is turned on and the number of averages is set to 10.
- After the data is valid it returns the scalar results, or the trace data, for the specified measurement. The type of data returned may be defined by an [n] value that is sent with the command.
- The scalar measurement results will be returned if the optional [n] value is not included, or is set to 1. If the [n] value is set to a value other than 1, the selected trace data results will be returned. See each command for details of what types of scalar results or trace data results are available.
- ASCII is the default format for the data output. (Older versions of Spectrum Analysis and Phase Noise mode measurements only use ASCII.) The binary data formats should be used for handling large blocks of data since they are smaller and faster than the ASCII format. Refer to the FORMat:DATA command for more information.

If you need to change some of the measurement parameters from the factory default settings you can set up the measurement with the CONFIgure command. Use the commands in the SENSe:<measurement> and CALCulate:<measurement> subsystems to change the settings. Then you can use the READ? command to initiate the measurement and query the results.

If you need to repeatedly make a given measurement with settings other than the factory defaults, you can use the commands in the SENSe:<measurement> and CALCulate:<measurement> subsystems to set up the measurement. Then use the READ? command to initiate the measurement and query results.

Measurement settings persist if you initiate a different measurement and then return to a previous one. Use READ:<measurement>? if you want to use those persistent settings. If you want to go back to the default settings, use MEASure:<measurement>?.

Configure Commands:

:CONFIgure:<measurement>

This command stops the current measurement (if any) and sets up the instrument for the specified measurement using

the factory default instrument settings. It does not initiate the taking of measurement data unless INIT:CONTinuous is ON. If you change any measurement settings after using the CONFigure command, the READ command can be used to initiate a measurement without changing the settings back to their defaults.

In the Swept SA measurement in Spectrum Analyzer mode the CONFigure command also turns the averaging function on and sets the number of averages to 10 for all measurements.

:CONFigure: <measurement>: NDEFault stops the current measurement and changes to the specified measurement. It does not change the settings to the defaults. It does not initiate the taking of measurement data unless INIT:CONTinuous is ON.

The CONFigure? query returns the current measurement name.

The CONFigure:CATalog? query returns a quoted string of all licensed measurement names in the current mode. For example, "SAN, CHP, OBW, ACP, PST, TXP, SPUR, SEM, LIST".

Fetch Commands:

:FETCh:<measurement>[n]?

This command puts selected data from the most recent measurement into the output buffer. Use FETCh if you have already made a good measurement and you want to return several types of data (different [n] values, for example, both scalars and trace data) from a single measurement. FETCh saves you the time of re-making the measurement. You can only FETCh results from the measurement that is currently active, it will not change to a different measurement. An error message is reported if a measurement other than the current one is specified.

If you need to get new measurement data, use the READ command, which is equivalent to an INITiate followed by a FETCh.

The scalar measurement results will be returned if the optional [n] value is not included, or is set to 1. If the [n] value is set to a value other than 1, the selected trace data results will be returned. See each command for details of what types of scalar results or trace data results are available. The binary data formats should be used for handling large blocks of data since they are smaller and transfer faster than the ASCII format. (FORMat:DATA)

FETCh may be used to return results other than those specified with the original READ or MEASure command that you sent.

INITiate Commands:

:INITiate:<measurement>

This command is not available for measurements in all the instrument modes:

- Initiates a trigger cycle for the specified measurement, but does not output any data. You must then use the FETCh<meas> command to return data. If a measurement other than the current one is specified, the instrument will switch to that measurement and then initiate it.
 - For example, suppose you have previously initiated the ACP measurement, but now you are running the channel power measurement. If you send INIT:ACP? it will change from channel power to ACP and will initiate an ACP measurement.
 - Does not change any of the measurement settings. For example, if you have previously started the ACP measurement and you send INIT:ACP? it will initiate a new ACP measurement using the same instrument settings as the last time ACP was run.
 - If your selected measurement is currently active (in the idle state) it triggers the measurement, assuming the trigger conditions are met. Then it completes one trigger cycle. Depending upon the measurement and the number of averages, there may be multiple data acquisitions, with multiple trigger events, for one full trigger cycle. It also holds off additional commands on GPIB until the acquisition is complete.
-

READ Commands:

:READ:<measurement>[n]?

- Does not preset the measurement to the factory default settings. For example, if you have previously initiated the ACP
-

measurement and you send READ:ACP? it will initiate a new measurement using the same instrument settings.

- Initiates the measurement and puts valid data into the output buffer. If a measurement other than the current one is specified, the instrument will switch to that measurement before it initiates the measurement and returns results.
 - For example, suppose you have previously initiated the ACP measurement, but now you are running the channel power measurement. Then you send READ:ACP? It will change from channel power back to ACP and, using the previous ACP settings, will initiate the measurement and return results.
 - Blocks other SCPI communication, waiting until the measurement is complete before returning the results
 - If the optional [n] value is not included, or is set to 1, the scalar measurement results will be returned. If the [n] value is set to a value other than 1, the selected trace data results will be returned. See each command for details of what types of scalar results or trace data results are available. The binary data formats should be used when handling large blocks of data since they are smaller and faster than the ASCII format. (FORMat:DATA)
-

Initial S/W Revision	Prior to A.02.00
----------------------	------------------

Current Measurement Query (Remote Command Only)

This command returns the name of the measurement that is currently running.

Remote Command	:CONFigure?
-----------------------	-------------

Example	CONF?
----------------	-------

Initial S/W Revision	Prior to A.02.00
----------------------	------------------

Limit Test Current Results (Remote Command Only)

Queries the status of the current measurement limit testing. It returns a 0 if the measured results pass when compared with the current limits. It returns a 1 if the measured results fail any limit tests.

Remote Command	:CALCulate:CLIMits:FAIL?
-----------------------	--------------------------

Example	CALC:CLIM:FAIL? queries the current measurement to see if it fails the defined limits. Returns a 0 or 1: 0 it passes, 1 it fails.
----------------	--

Initial S/W Revision	Prior to A.02.00
----------------------	------------------

Data Query (Remote Command Only)

Returns the designated measurement data for the currently selected measurement and subopcode.

n = any valid subopcode for the current measurement. See the measurement command results table for your current measurement, for information about what data is returned for the subopcodes.

This command uses the data setting specified by the FORMat:BORDER and FORMat:DATA commands and can return real or ASCII data. (See the format command descriptions under Input/Output in the Analyzer Setup section.)

Remote Command	:CALCulate:DATA[n]?
Notes	The return trace depends on the measurement. In CALCulate:<meas>:DATA[n], n is any valid subopcode for the current measurement. It returns the same data as the FETCH:<measurement>? query where <measurement> is the current measurement.
Initial S/W Revision	Prior to A.02.00

Calculate/Compress Trace Data Query (Remote Command Only)

Returns compressed data for the currently selected measurement and sub-opcode [n].

n = any valid sub-opcode for that measurement. See the MEASure:<measurement>? command description of your specific measurement for information on the data that can be returned.

The data is returned in the current Y Axis Unit of the analyzer. The command is used with a sub-opcode <n> (default=1) to specify the trace. With trace queries, it is best if the analyzer is not sweeping during the query. Therefore, it is generally advisable to be in Single Sweep, or Update=Off.

This command is used to compress or decimate a long trace to extract and return only the desired data. A typical example would be to acquire N frames of GSM data and return the mean power of the first burst in each frame. The command can also be used to identify the best curve fit for the data.

Remote Command	:CALCulate:DATA<n>:COMPress? BLOCk CFIT MAXimum MINimum MEAN DMEan RMS RMSCubed SAMple SDEViation PPHase [,<soffset> [,<length>[,<roffset>[,<rlimit>]]]]
Example	To query the mean power of a set of GSM bursts: Supply a signal that is a set of GSM bursts. Select the IQ Waveform measurement (in IQ Analyzer Mode). Set the sweep time to acquire at least one burst. Set the triggers such that acquisition happens at a known position relative to a burst. Then query the mean burst levels using, CALC:DATA2:COMP? MEAN, 24e-6, 526e-6 (These parameter values correspond to GSM signals, where 526e-6 is the length of the burst in the slot and you just want 1 burst.)
Notes	The command supports 5 parameters. Note that the last 4 (<soffset>, <length>, <roffset>, <rlimit>) are optional. But these optional parameters must be entered in the specified order. For example, if you want to specify <length>, then you must also specify <soffset>. See details below for a definition of each of these parameters. This command uses the data in the format specified by FORMat:DATA, returning either binary or ASCII data.
Initial S/W Revision	Prior to A.02.00

- BLOCk or block data - returns all the data points from the region of the trace data that you specify. For example, it could be used to return the data points of an input signal over several timeslots, excluding the portions of the trace data that you do not want. (This is x,y pairs for trace data and I,Q pairs for complex data.)

- CFIT or curve fit - applies curve fitting routines to the data. <soffset> and <length> are required to define the data that you want. <roffset> is an optional parameter for the desired order of the curve equation. The query will return the following values: the x-offset (in seconds) and the curve coefficients ((order + 1) values).

MIN, MAX, MEAN, DME, RMS, RMSC, SAMP, SDEV and PPH return one data value for each specified region (or <length>) of trace data, for as many regions as possible until you run out of trace data (using <roffset> to specify regions). Or they return the number of regions you specify (using <rlimit>) ignoring any data beyond that.

- MINimum - returns the minimum data point (y value) for the specified region(s) of trace data. For I/Q trace data, the minimum magnitude of the I/Q pairs is returned.
- MAXimum - returns the maximum data point (y value) for the specified region(s) of trace data. For I/Q trace data, the maximum magnitude of the I/Q pairs is returned.
- MEAN - returns a single value that is the arithmetic mean of the data point values (in dB/ dBm) for the specified region(s) of trace data. For I/Q trace data, the mean of the magnitudes of the I/Q pairs is returned. See the following equations.

-

NOTE

If the original trace data is in dB, this function returns the arithmetic mean of those log values, not log of the mean power which is a more useful value. The mean of the log is the better measurement technique when measuring CW signals in the presence of noise. The mean of the power, expressed in dB, is useful in power measurements such as Channel Power. To achieve the mean of the power, use the RMS option.

Equation 1

Mean Value of Data Points for Specified Region(s)

$$\text{MEAN} = \frac{1}{n} \sum_{X_i \in \text{region}(s)} X_i$$

where X_i is a data point value, and n is the number of data points in the specified region(s).

Equation 2

Mean Value of I/Q Data Pairs for Specified Region(s)

$$\text{MEAN} = \frac{1}{n} \sum_{X_i \in \text{region}(s)} |X_i|$$

where $|X_i|$ is the magnitude of an I/Q pair, and n is the number of I/Q pairs in the specified region(s).

- DMEan - returns a single value that is the mean power (in dB/ dBm) of the data point values for the specified region(s) of trace data. See the following equation:

Equation 3

DMEan Value of Data Points for Specified Region(s)

$$DME = 10 \times \log_{10} \left(\frac{1}{n} \sum_{X_i \in \text{region}(s)} 10^{\frac{X_i}{10}} \right)$$

- RMS - returns a single value that is the average power on a root-mean-squared voltage scale (arithmetic rms) of the data point values for the specified region(s) of trace data. See the following equation.

NOTE

For I/Q trace data, the rms of the magnitudes of the I/Q pairs is returned. See the following equation. This function is very useful for I/Q trace data. However, if the original trace data is in dB, this function returns the rms of the log values which is not usually needed.

Equation 4

RMS Value of Data Points for Specified Region(s)

$$RMS = \sqrt{\frac{1}{n} \sum_{X_i \in \text{region}(s)} X_i^2}$$

where X_i is a data point value, and n is the number of data points in the specified region(s).

Equation 5

RMS Value of I/Q Data Pairs for Specified Region(s)

$$RMS = \sqrt{\frac{1}{n} \sum_{X_i \in \text{region}(s)} X_i X_i^*}$$

where X_i is the complex value representation of an I/Q pair, X_i^* its conjugate complex number, and n is the number of I/Q pairs in the specified region(s).

Once you have the rms value for a region of trace data (linear or I/Q), you may want to calculate the mean power. You must convert this rms value (peak volts) to power in dBm:

$$10 \times \log[10 \times (\text{rms value})^2]$$

- SAMPlE - returns the first data value (x,y pair) for the specified region(s) of trace data. For I/Q trace data, the first I/Q pair is returned.
- SDEViation - returns a single value that is the arithmetic standard deviation for the data point values for the specified region(s) of trace data. See the following equation.
- For I/Q trace data, the standard deviation of the magnitudes of the I/Q pairs is returned. See the following equation.

Equation 6

Standard Deviation of Data Point Values for Specified Region(s)

$$\text{SDEV} = \sqrt{\frac{1}{n} \sum_{X_i \in \text{region}(s)} (X_i - \bar{X})^2}$$

where X_i is a data point value, \bar{X} is the arithmetic mean of the data point values for the specified region (s), and n is the number of data points in the specified region(s).

$$\text{SDEV} = \sqrt{\frac{1}{n} \sum_{X_i \in \text{region}(s)} (|X_i| - \bar{X})^2}$$

where $|X_i|$ is the magnitude of an I/Q pair, \bar{X} is the mean of the magnitudes for the specified region(s), and n is the number of data points in the specified region(s).

- PPHase - returns the x,y pairs of both rms power (dBm) and arithmetic mean phase (radian) for every specified region and frequency offset (Hz). The number of pairs is defined by the specified number of regions. This parameter can be used for I/Q vector ($n=0$) in Waveform (time domain) measurement and all parameters are specified by data point in PPHase.

The rms power of the specified region may be expressed as:

$$\text{Power} = 10 \times \log [10 \times (\text{RMS I/Q value})] + 10.$$

The RMS I/Q value (peak volts) is:

$$\sqrt{\frac{1}{n} \sum_{X_i \in \text{region}} X_i X_i^*}$$

where X_i is the complex value representation of an I/Q pair, X_i^* its conjugate complex number, and n is the number of I/Q pairs in the specified region.

The arithmetic mean phase of the specified region may be expressed as:

$$\frac{1}{n} \sum_{Y_i \in \text{region}} Y_i$$

where Y_i is the unwrapped phase of I/Q pair with applying frequency correction and n is the number of I/Q pairs in the specified region.

The frequency correction is made by the frequency offset calculated by the arithmetic mean of every specified region's frequency offset. Each frequency offset is calculated by the least square method against the unwrapped phase of I/Q pair.

Sample Trace Data - Constant Envelope

(See below for explanation of variables.)

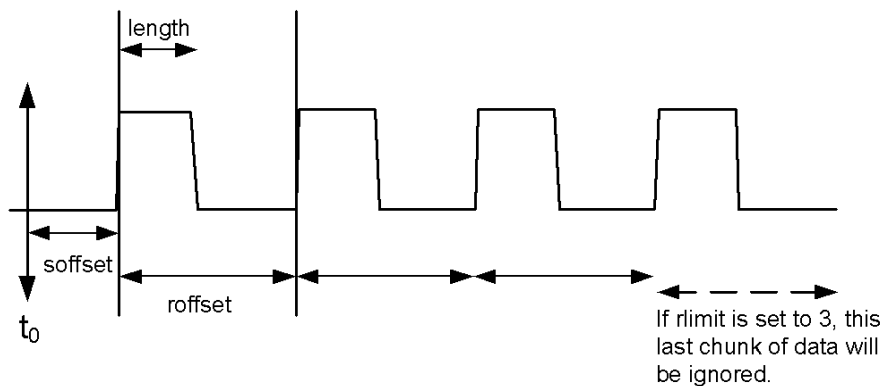

Sample Trace Data - Not Constant Envelope

(See below for explanation of variables.)

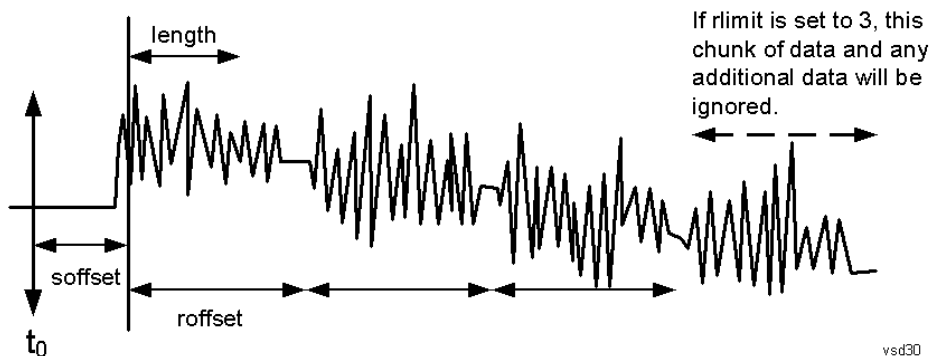

<soffset> - start offset is an optional real number. (It is in seconds for time-domain traces, and is a dimensionless index 0 to Npoints - 1, for frequency-domain traces). It specifies the amount of data at the beginning of the trace that will be ignored before the decimation process starts. It is the time or frequency change from the start of the trace to the point where you want to start using the data. The default value is zero.

<length> - is an optional real number. (It is in seconds for time-domain traces, and is a dimensionless index 0 to Npoints - 1, for frequency-domain traces). It defines how much data will be compressed into one value. This parameter has a default value equal to the current trace length.

<roffset> - repeat offset is an optional real number. (It is in seconds for time-domain traces, and is a dimensionless index 0 to Npoints - 1, for frequency-domain traces). It defines the beginning of the next field of trace elements to be compressed. This is relative to the beginning of the previous field. This parameter has a default value equal to the <length> variable. Note that this parameter is used for a completely different purpose when curve fitting (see CFIT above).

<rlimit> - repeat limit is an optional integer. It specifies the number of data items that you want returned. It will ignore any additional items beyond that number. You can use the Start offset and the Repeat limit to pick out exactly what part of the data you want to use. The default value is all the data.

Calculate Peaks of Trace Data (Remote Command Only)

Returns a list of all the peaks for the currently selected measurement and sub-opcode [n]. The peaks must meet the requirements of the peak threshold and excursion values.

n = any valid sub-opcode for the current measurement. See the MEASure:<measurement> command description of your specific measurement for information on the data that can be returned.

The command can only be used with specific sub-opcodes with measurement results that are trace data. Both real and complex traces can be searched, but complex traces are converted to magnitude in dBm. In many measurements the sub-opcode n=0, is the raw trace data which cannot be searched for peaks. And Sub-opcode n=1, is often calculated results values which also cannot be searched for peaks.

This command uses the data setting specified by the FORMat:BORDER and FORMat:DATA commands and can return real or ASCII data. If the format is set to INT,32, it returns REAL,32 data.

The command has four types of parameters:

- Threshold (in dBm)
- Excursion (in dB)
- Sorting order (amplitude, frequency, time)
- Optional in some measurements: Display line use (all, > display line, < display line)

Remote Command	<p>For Swept SA measurement:</p> <pre>:CALCulate:DATA[1] 2 ... 6:PEAKs? <threshold>,<excursion>[,AMPLitude FREQuency TIME[,ALL GTDLline LTDLine]]</pre> <p>For most other measurements:</p> <pre>:CALCulate:DATA[1] 2 ... 6:PEAKs? <threshold>,<excursion>[,AMPLitude FREQuency TIME]</pre>
-----------------------	---

Example	<p>Example for Swept SA measurement in Spectrum Analyzer Mode:</p> <p>CALC:DATA4:PEAK? -40, 10, FREQ, GTDL This will identify the peaks of trace 4 that are above -40 dBm, with excursions of at least 10 dB. The peaks are returned in order of increasing frequency, starting with the lowest frequency. Only the peaks that are above the display line are returned.</p> <p>Query Results 1:</p> <p>With FORMat:DATA REAL, 32 selected, it returns a list of floating-point numbers. The first value in the list is the number of peak points that are in the following list. A peak point consists of two values: a peak amplitude followed by its corresponding frequency (or time).</p> <p>If no peaks are found the peak list will consist of only the number of peaks, (0).</p>
----------------	---

Notes	<p><n> - is the trace that will be used</p> <p><threshold> - is the level below which trace data peaks are ignored. Note that the threshold value is required and is always used as a peak criterion. To effectively disable the threshold criterion for this command, provide a substantially low threshold value such as -200 dBm. Also note that the threshold value used in this command is independent of and has no effect on the threshold value stored under the Peak Criteria menu.</p> <p><excursion> - is the minimum amplitude variation (rise and fall) required for a signal to be identified as peak. Note that the excursion value is required and is always used as a peak criterion. To effectively disable the excursion criterion for this command, provide the minimum value of 0.0 dB. Also note that the excursion value used in this command is independent of and has no effect on the</p>
--------------	---

excursion value stored under the Peak Criteria menu.

Values must be provided for threshold and excursion. The sorting and display line parameters are optional (defaults are AMPLitude and ALL).

Note that there is always a Y-axis value for the display line, regardless of whether the display line state is on or off. It is the current Y-axis value of the display line which is used by this command to determine whether a peak should be reported

Sorting order:

AMPLitude - lists the peaks in order of descending amplitude, with the highest peak first (default if optional parameter not sent)

FREQuency - lists the peaks in order of occurrence, left to right across the x-axis.

TIME - lists the peaks in order of occurrence, left to right across the x-axis.

Peaks vs. Display Line:

ALL - lists all of the peaks found (default if optional parameter not sent).

GTDLine (greater than display line) - lists all of the peaks found above the display line.

LTDLine (less than display line) - lists all of the peaks found below the display line.

Initial S/W Revision Prior to A.02.00

Format Data: Numeric Data (Remote Command Only)

This command specifies the format of the trace data input and output. It specifies the formats used for trace data during data transfer across any remote port. It affects only the data format for setting and querying trace data for the :TRACe[:DATA], TRACe[:DATA]?, :CALCulate:DATA[n]? and FETCh:SANalyzer [n]? commands and queries.

Remote Command :FORMat [:TRACe] [:DATA] ASCii|INTeger, 32|REAL, 32 |REAL, 64
:FORMat [:TRACe] [:DATA] ?

Notes The query response is:
ASCii: ASC,8
REAL,32: REAL,32
REAL,64: REAL,64
INTeger,32: INT,32

When the numeric data format is REAL or ASCii, data is output in the current Y Axis unit. When the data format is INTeger, data is output in units of m dBm (.001 dBm).

The INT,32 format returns binary 32-bit integer values in internal units (m dBm), in a definite length block.

Dependencies Sending a data format spec with an invalid number (for example, INT,48) generates no error. The analyzer simply uses the default (8 for ASCii, 32 for INTeger, 32 for REAL).

Sending data to the analyzer which does not conform to the current FORMat specified, results in an error. Sending ASCII data when a definite block is expected generates message -161 "Invalid Block Data" and sending a definite block when ASCII data is expected generates message -121 "Invalid Character in Number".

Preset ASCii

Backwards Compatibility Notes Note that the INT,32 format is only applicable to the command, TRACe:DATA. This preserves backwards compatibility for the Swept SA measurement. For all other commands/queries which honor FORMat:DATA, if INT,32 is sent the analyzer will behave as though it were set to REAL,32.

Initial S/W Revision Prior to A.02.00

The specs for each output type follow:

ASCIi - Amplitude values are in ASCII, in the current Y Axis Unit, one ASCII character per digit, values separated by commas, each value in the form:

SX.YYYYYEsZZ

Where:

S = sign (+ or -)

X = one digit to left of decimal point

Y = 5 digits to right of decimal point

E = E, exponent header

s = sign of exponent (+ or -)

ZZ = two digit exponent

REAL,32 - Binary 32-bit real values in the current Y Axis Unit, in a definite length block.

REAL,64 - Binary 64-bit real values in the current Y Axis Unit, in a definite length block.

Format Data: Byte Order (Remote Command Only)

This command selects the binary data byte order for data transfer and other queries. It controls whether binary data is transferred in normal or swapped mode. This command affects only the byte order for setting and querying trace data for the :TRACe[:DATA], TRACe[:DATA]? , :CALCulate:DATA[n]? and FETCh:SANalyzer[n]? commands and queries.

By definition any command that says it uses FORMat:DATA uses any format supported by FORMat:DATA.

The NORMal order is a byte sequence that begins with the most significant byte (MSB) first, and ends with the least significant byte (LSB) last in the sequence: 1|2|3|4. SWAPPed order is when the byte sequence begins with the LSB first, and ends with the MSB last in the sequence: 4|3|2|1.

Remote Command	:FORMat:BORDER NORMal SWAPPed :FORMat:BORDER?
Preset	NORMal
Initial S/W Revision	Prior to A.02.00

Meas Setup

Accesses a menu of keys that select measurement functions for VSA based measurements.

Key Path	Front Panel
Mode	VSA, LTE, LTETDD, IDEN, LTEAFDD, LTEATDD
Initial S/W Revision	Prior to A.02.00
Modified at S/W Revision	A.02.00

Avg Number

Enables you to turn averaging on or off, and set the number of scans (time records) whose measurement results are averaged. Averaging can be done over spectrum results (RMS) or over time records (Time). A third kind of pseudo averaging displays the maximum value seen at each spectral line over the specified number of scans. See ["Average Type" on page 1860](#) for a more detailed description of how measurement results are averaged. For RMS or Time averaging, the process is similar. Each time an averaged result is displayed, it is the sum of the individual results taken since measurement restart, divided by the number of scans. (For Max averaging, there is no actual summation or division.) The Measurement Bar shows the number of scans and the Avg number setting. For example, if 4 scans have been taken and the Avg Number is 10, the Meas Bar shows "4/10". The measurement continues to take new scans until the number of scans is equal to the Avg Number setting, at which time the measurement stops if Sweep control is in Single Mode. Otherwise, the measurement continues, and the Average Mode setting determines how successive scans are added to the averaged result. See ["Average Mode" on page 1859](#) for details.

Key Path	Meas Setup, More
Mode	VSA, LTE, LTETDD, IDEN, LTEAFDD, LTEATDD
Measurement	<meas>:=VECTor ADEMod DDEMod W11A W11B EVM IPOWER IDEMod MOTotalk
Remote Command	[:SENSe] : <meas> : AVERAge : COUNT <integer> [:SENSe] : <meas> : AVERAge : COUNT? [:SENSe] : <meas> : AVERAge [:STATe] OFF ON 0 1 [:SENSe] : <meas> : AVERAge [:STATe] ?
Example	VECT: AVER: COUN 20 VECT: AVER: COUN? VECT: AVER ON VECT: AVER?
Notes	If an averaged measurement is idle because the scan count is equal to the Avg Number and the Avg Number is increased, the measurement resumes until the new number of averages is satisfied.
Preset	10 OFF IPOWER: ON
State Saved	Saved in instrument state.
Min	1

Max	2147483647
Initial S/W Revision	Prior to A.02.00
Modified at S/W Revision	A.02.00

Average Mode

Determines what happens when the Sweep Mode is Continuous and the number of scans processed exceeds the Average Number (see "[Avg Number](#)" on page 1858). If the Sweep Control is in Single mode, this setting has no affect.

When averaging is on and the number of scans is less than or equal to the Avg Number setting, a linear average is calculated as explained in the Avg Number topic. After the scan count exceeds the Avg Number setting, the measurement continues to take new scans. The Measurement Bar average indicator shows ">N/N" where N is the Avg Number.

If Average Mode is Exp then new results are averaged in exponentially. In other words, each succeeding average is the weighted sum of the previous average, weighted by $(N-1)/N$, and the new measurement, weighted by $1/N$, where N is the Average Number setting. (For Max averaging, no weighting occurs; the result continues to be the max value seen at each spectral line for every previous scan since measurement restart.)

If Average Mode is Repeat, then the average buffer is cleared after the average counter reaches the Average Number setting, and the average counter is reset to 0. Then a new set of averages is taken. The measurement bar therefore continues to show "k/N" in the average indicator, where k is the number of scans since the last time the average buffer was cleared and N is the Avg Number. The averaged result is the sum of the last k results divided by k. (For Max averaging, no sum or division takes place, but the buffer is cleared as stated above. The averaged result is the max value seen over the last k scans.)

Key Path	Meas Setup
Mode	VSA, LTE, LTETDD, IDEN, LTEAFDD, LTEATDD
Measurement	<meas>:=VECTor ADEMod DDEMod W11A W11B EVM IPOWER IDEMod MOTotalk
Remote Command	[:SENSe] :<meas>:AVERage:TCONtrol EXPonential REPeat [:SENSe] :<meas>:AVERage:TCONtrol?
Example	VECT:AVER:TCON EXP VECT:AVER:TCON?
Preset	EXP
State Saved	Saved in instrument state.
Range	Exp Repeat
Initial S/W Revision	Prior to A.02.00
Modified at S/W Revision	A.02.00

Average Setup

Accesses a menu enabling you to set Averaging parameters for all VSA based measurements.

Key Path	Meas Setup
Mode	VSA, LTE, LTETDD, IDEN, LTEAFDD, LTEATDD
Initial S/W Revision	Prior to A.02.00
Modified at S/W Revision	A.02.00

Average Type

Enables you to select the type of averaging. The following table shows what measurement results are averaged for each average type. This applies in the Vector Measurement.

Average Type	Measurement result averaged.
RMS	Spectrum, PSD: Power is averaged for each spectral line (i.e., this is a mean-square average of voltage). For the Spectrum result only, if the display transform is linear or real, the RMS result is displayed.
Time	Main Time: Individual time samples in the current time record are averaged vectorially (not RMS) with corresponding points in previous time records. See Main Time for more details.
Max	Spectrum, PSD: Not strictly an average. For each spectral line, power from the current measurement is compared to the average buffer value and the maximum is kept in the average buffer.

Some measurement results are inherently averaged, and are not affected by the Average controls. These are: CCDF, CDF, and PDF. They average continuously until the next measurement restart.

Key Path	Meas Setup, Average Setup
Mode	VSA, LTE, LTETDD, IDEN, LTEAFDD, LTEATDD
Measurement	<meas>:=VECTor ADEMod DDEMod W11A W11B EVM IPOWER IDEMod MOTotalk
Remote Command	[:SENSe] :<meas>:AVERage:TYPE RMS TIME MAXimum [:SENSe] :<meas>:AVERage:TYPE?
Example	VECT:AVER:TYPE RMS VECT:AVER:TYPE?
Preset	RMS
State Saved	Saved in instrument state.
Range	RMS Time Max
Initial S/W Revision	Prior to A.02.00
Modified at S/W Revision	A.02.00

Fast Average

Controls the display of average data. If fast averaging is off, then the display is updated after each time record is processed. If fast averaging is on, then the display is only updated after every M records, where M

is the Update Rate (see ["Update Rate" on page 1861](#)). For example, if the fast average count is 10, then the running average is only displayed every 10th time record.

Key Path	Meas Setup, Average Setup
Mode	VSA, LTE, LTETDD, IDEN, LTEAFDD, LTEATDD
Measurement	<meas>:=VECTor ADEMod DDEMod W11A W11B EVM IPOWER IDEMod MOTotalk
Remote Command	[:SENSe] :<meas>:AVERage:FAST OFF ON 0 1 [:SENSe] :<meas>:AVERage:FAST?
Example	VECT:AVER:FAST ON VECT:AVER:FAST?
Preset	OFF
State Saved	Saved in instrument state.
Range	On Off
Initial S/W Revision	Prior to A.02.00
Modified at S/W Revision	A.02.00

Update Rate

Controls how often the display updates when fast averaging is turned on. If the Fast Averaging State is MAX then the display is updated only after the full Average Count is reached. Otherwise, the display is updated whenever the average count is a multiple of the Update Rate.

Key Path	Meas Setup, More, Average Setup
Mode	VSA, LTE, LTETDD, IDEN, LTEAFDD, LTEATDD
Measurement	<meas>:=VECTor ADEMod DDEMod W11A W11B EVM IPOWER IDEMod MOTotalk
Remote Command	[:SENSe] :<meas>:AVERage:FAST:URATe <integer> [:SENSe] :<meas>:AVERage:FAST:URATe? [:SENSe] :<meas>:AVERage:FAST:URATe:AUTO OFF ON 0 1 [:SENSe] :<meas>:AVERage:FAST:URATe:AUTO?
Example	VECT:AVER:FAST:URAT 20 VECT:AVER:FAST:URAT? VECT:AVER:FAST:URAT:AUTO ON VECT:AVER:FAST:URAT:AUTO?
Preset	10 ON
State Saved	Saved in instrument state.
Min	1
Max	2147483647
Initial S/W Revision	Prior to A.02.00
Modified at S/W Revision	A.02.00

Sync/Format Setup (Downlink)

Displays a menu of commonly used sync/format setup parameters when Direction is set to Downlink.

Key Path	Meas Setup
Mode	LTE, LTETDD
Initial S/W Revision	Prior to A.02.00
Modified at S/W Revision	A.03.00

Sync/Format Setup (Downlink)

Displays a menu of commonly used sync/format setup parameters when Direction is set to Downlink.

Key Path	Meas Setup
Mode	LTE, LTETDD
Initial S/W Revision	Prior to A.02.00
Modified at S/W Revision	A.03.00

Sync Type

Selects the Sync Type.

- PSS – Selects Primary Sync Signal for Sync Type
- C-RS – Selects Cell-specific reference signal for Sync Type

Sync Type sets the channel or signal to be used for synchronization.

The LTE demodulator can be set to use either the Primary Sync signal (P-SS) or the Cell-specific reference signal (C-RS) to synchronize the downlink signal.

This synchronization is performed at the frame level. For smaller scale adjustments (such as at the symbol or slot level), see the EVM Minimization parameter.

P-SS is normally used for downlink synchronization. However, when P-SS is impaired in some way (for example, P-SS has a different Cell ID from RS), C-RS can be used for synchronization so that the signal can be demodulated.

NOTE

S-SS must be present in the time capture (Raw Main Time) for demodulation to occur, since finding S-SS is the only way to distinguish between the beginning and the middle of a frame.

When Sync Type is set to C-RS:

The Error Summary data result SyncCorr shows which C-RS antenna port's reference signal was used for synchronization to the right of the correlation value.

Auto detection of Cell ID and Custom RS-PRS are not supported.

The reference C-RS port must be specified, since the demodulator does not automatically search the input signal for all C-RS antenna ports when Sync Type is set to C-RS.

Key Path	Meas Setup, Sync/Format Setup
Mode	LTE, LTETDD
Remote Command	[:SENSe] :EVM:DLINk:SYNC:TYPE PSS RS [:SENSe] :EVM:DLINk:SYNC:TYPE?
Example	EVM:DLIN:SYNC:TYPE PSS EVM:DLIN:SYNC:TYPE?
Dependencies	When Sync Type is set to C-RS, auto detection of Cell ID and Custom RS-PRS are not supported.
Preset	PSS
State Saved	Saved in instrument state.
Range	P-SS C-RS
Initial S/W Revision	Prior to A.02.00
Modified at S/W Revision	A.03.00, A.13.00

P-SS

Selects P-SS Sync Type.

P-SS is the Primary Synchronization signal for an LTE downlink frame. The center 72 subcarriers (6 RB wide) are allocated to P-SS, but only the center 62 subcarriers are used. The unused subcarriers (the outer five on each side) are set to zero power during P-SS transmission. P-SS is not present in an uplink frame.

For FDD frame type 1, P-SS is present in the last symbol of slots 0 and 11 in every frame.

For TDD frame type 2, P-SS is present in the third symbol of slots 2 and 12 in every frame.

NOTE

See **"Edit Control Channels" on page 1898** for information on setting P-SS Power Boost.

P-SS is transmitted as a Zadoff-Chu sequence and thus appears as irregularly spaced points on a circle in the IQ Meas constellation diagram.

Key Path	Meas Setup, Sync/Format Setup, Sync Type
Mode	LTE, LTETDD
Initial S/W Revision	Prior to A.02.00
Modified at S/W Revision	A.03.00

C-RS

Selects C-RS (Cell-specific Ref Signal) Sync Type.

C-RS is the downlink Cell-specific Reference Signal and is used for "EVM Minimization" on page 2223 and Equalizer Training, and it can be used for synchronization. The reference signal is also used as the power level reference for the rest of the signal. See "Edit Control Channels" on page 1898 for more information.

The modulation type of C-RS is QPSK.

Key Path	Meas Setup, Sync/Format Setup, Sync Type
Mode	LTE, LTETDD
Initial S/W Revision	Prior to A.02.00
Modified at S/W Revision	A.03.00, A.13.00

RS-PRS

Sets the RS-PRS.

- 3GPP – The demodulator will expect the RS pseudorandom sequence to follow the formula given in the LTE standard in Section 6.10.1.1 of 3GPP TS 36.211.
- CUSTOm – The demodulator will autodetect the RS sequence (including non-standard sequences). Since the RS points can only be in certain positions, the demodulator will assume that the point closest to the measured point is the desired reference signal point and will calculate the EVM and other metrics using the assumed reference signal constellation point.

RS-PRS specifies whether or not the demodulator should expect the reference signal sequence to adhere to the standard.

NOTE

When Sync Type is set to RS, autodetecting of a Custom RS-PRS is not supported since the demodulator needs to know the RS-PRS to be able to synchronize the signal using RS.

When RS-PRS is set to Custom and any of the antenna port signals are phase delayed by more than 45 degrees, the demodulator will autodetect a different RS-PRS. This will cause equalization to be incorrect and demodulation will fail. To ensure correct demodulation of signals containing an antenna port transmission with a phase rotation of more than 45 degrees, set RS-PRS to 3GPP to enable RS-PRS to be determined by Cell ID according to the standard.

Key Path	Meas Setup, Sync/Format Setup
Mode	LTE, LTETDD
Remote Command	[:SENSe] :EVM:DLINK:SYNC:RSPRs GPP CUSTOm [:SENSe] :EVM:DLINK:SYNC:RSPRs?
Example	EVM:DLIN:SYNC:RSPR CUSTOm EVM:DLIN:SYNC:RSPR?
Dependencies	When Sync Type for Downlink is set to RS, the Custom selection is disabled and the softkey is grayed out.
Preset	GPP

State Saved	Saved in instrument state.
Range	3GPP Custom
Initial S/W Revision	Prior to A.02.00
Modified at S/W Revision	A.03.00

Cell ID

Autodetects the Cell ID from the SSCH content or to manually select the Cell ID.

Cell ID sets the physical (PHY) layer Cell Identity. This PHY-layer Cell ID determines the Cell ID Group and Cell ID Sector. There are 168 possible Cell ID groups and 3 possible Cell ID sectors; therefore, there are $3 * 168 = 504$ possible PHY-layer Cell IDs. When Cell ID is set to Auto, the analyzer will automatically detect the Cell ID. When Cell ID is set to Manual, the PHY-layer Cell ID must be specified for successful demodulation.

The physical layer Cell ID can be calculated from the following formula:

$$\text{PHY-layer Cell ID} = 3 * (\text{Cell ID Group}) + \text{Cell ID Sector}$$

When Sync Type is set to RS, the Cell ID Auto selection will be disabled, and Cell ID must be specified manually. This is because the demodulator needs to know the values of the RS sequence to use for synchronization and because Cell ID determines these values. See "[RS-PRS](#)" on page 1864 for more information.

NOTE

Cell ID Sector and Group information can be found on the Error Summary trace.

Only cell-specific reference signals are supported by the LTE demod (MBSFN and UE-specific reference signals are not supported).

Cell ID Sector determines the Zadoff-Chu Root Index used to generate the Primary Synchronization Signal (P-SS):

- Cell ID sector 0 = ZC Root Index 25
- Cell ID sector 1 = ZC Root Index 29
- Cell ID sector 2 = ZC Root Index 34

Normally, the same sequence used to generate P-SS is used to generate RS, but a custom RS can be used by setting RS-PRS to Custom.

Key Path	Meas Setup, Sync/Format Setup
Mode	LTE, LTETDD
Remote Command	[:SENSe] :EVM:DLINK:SYNC:CID <integer> [:SENSe] :EVM:DLINK:SYNC:CID? [:SENSe] :EVM:DLINK:SYNC:CID:AUTO OFF ON 0 1 [:SENSe] :EVM:DLINK:SYNC:CID:AUTO?
Example	EVM:DLIN:SYNC:CID 0

	EVM:DLIN:SYNC:CID? EVM:DLIN:SYNC:CID:AUTO ON
Dependencies	When Sync Type for Downlink is set to RS, the Cell ID Auto selection is disabled and Cell ID must be specified manually.
Preset	0 ON
State Saved	Saved in instrument state.
Min	0
Max	503
Initial S/W Revision	Prior to A.02.00
Modified at S/W Revision	A.03.00

Tx Antenna

Displays a menu of C-RS Ports parameters.

Key Path	Meas Setup
Mode	LTE, LTETDD
Initial S/W Revision	Prior to A.02.00
Modified at S/W Revision	A.03.00

Number of C-RS Ports

Selects the number of C-RS Ports.

- ANT1 – 1 Port
- ANT2 – 2 Ports
- ANT4 – 4 Ports

Number of C-RS Ports specifies the number of C-RS (Cell-specific RS) antenna ports there are for the current LTE signal, and thus determines how many C-RS antenna port signals the demodulator searches for.

NOTE

When RS-PRS is set to Custom and any of the C-RS antenna port signals are phase delayed by more than 45 degrees, the demodulator will autodetect a different RS-PRS. This will cause equalization to be incorrect and demodulation will fail. To ensure correct demodulation of signals containing an antenna port transmission with a phase rotation of more than 45 degrees, set RS-PRS to 3GPP to enable RS-PRS to be determined by Cell ID according to the standard.

Key Path	Meas Setup, Sync/Format Setup
Mode	LTE, LTETDD
Remote Command	[:SENSe] :EVM:DLINK:SYNC:ANTenna:NUMBER ANT1 ANT2 ANT4

	[:SENSe] :EVM:DLINk:SYNC:ANTenna:NUMBer?
Example	EVM:DLIN:SYNC:ANT:NUMB ANT1
Dependencies	When Sync Type for Downlink is set to C-RS, the Custom selection is disabled and the softkey is grayed out.
Preset	ANT1
State Saved	Saved in instrument state.
Range	1 Port 2 Ports 4 Ports
Initial S/W Revision	Prior to A.02.00
Modified at S/W Revision	A.03.00, A.13.00

1 Port

Selects one C-RS Port.

Key Path	Meas Setup, Sync/Format Setup, TX Antenna, Num of C-RS Ports
Mode	LTE, LTETDD
Initial S/W Revision	Prior to A.02.00
Modified at S/W Revision	A.03.00, A.13.00

2 Ports

Selects two C-RS Ports.

Key Path	Meas Setup, Sync/Format Setup, TX Antenna, Num of C-RS Ports
Mode	LTE, LTETDD
Initial S/W Revision	Prior to A.02.00
Modified at S/W Revision	A.03.00, A.13.00

4 Ports

Selects four C-RS Ports.

Key Path	Meas Setup, Sync/Format Setup, TX Antenna, Num of C-RS Ports
Mode	LTE, LTETDD
Initial S/W Revision	Prior to A.02.00
Modified at S/W Revision	A.03.00, A.13.00

Reference C-RS Port

Selects which Reference C-RS Port to use.

- P0 – C-RS Port 0
- P1 – C-RS Port 1
- P2 – C-RS Port 2
- P3 – C-RS Port 3

Reference C-RS Port determines which C-RS path to use for synchronization and initial equalization and to show on certain non-MIMO traces (listed below). This parameter determines the transmitted Cell-specific RS antenna port.

Auto/Man selection enables you to specify whether the analyzer uses auto-detection or manual mode to determine the reference C-RS antenna port.

- Auto - The demodulator searches for the strongest C-RS antenna port signal and uses that C-RS port as the reference.
- Man – Selected C-RS port is used as the reference.

C-RS metrics for other C-RS/Rx paths are expressed relative to the C-RS metrics for the reference C-RS/Rx path. For example, when C-RS port 0 and Rx0 (Measurement Channel 1) are selected, the C-RS0/Rx0 section of the MIMO Info Table will show 0 dB for RSPwr and the other C-RS/Rx paths' RSPwr will be expressed in dB relative to this 0 dB point.

NOTE

In the absence of cross-channel paths (when connecting directory to the transmitter), make sure that the specified C-RS path is present; otherwise, the signal will not be demodulated.
The Sync Type parameter affects how the reference C-RS path must be specified.

NOTE

- Sync Type = P-SS (note: Input Signal must contain P-SS)

NOTE

-Ref C-RS Port is Man: the demodulator will use the specified reference C-RS antenna port (which must be present on the Input Signal).
-Ref C-RS Port is Auto: the demodulator will automatically detect the strongest C-RS port signal to sue for the reference C-RS port.

NOTE

- Sync Type = RS: reference path auto detection is not supported and the reference C-RS path must be specified manually.

This parameter also determines which C-RS path results are shown on the following traces:

- Eq Chan Freq Resp
- Eq Chan Freq Resp Diff
- Eq Impulse Response
- Common Tracking Error
- Inst Eq Chan Freq Resp
- Inst Eq Chan Freq Resp Diff
- Freq Err per Slot

To view show information for all detected antenna port signals, use the MIMO traces (Trace > Data > MIMO).

NOTE

P-SS and S-SS must be present in the time capture (Raw Main Time) for successful demodulation to occur. For example, for two-channel transmit diversity signal that has P-SS and S-SS transmitted only on antenna 2, the demodulator can analyze antenna 2 without antenna 1 connected, but not vice versa.

Key Path	Meas Setup, Sync/Format Setup, Tx Antenna
Mode	LTE, LTETDD
Remote Command	[:SENSe] :EVM:DLINK:SYNC:ANTenna:PORT P0 P1 P2 P3 [:SENSe] :EVM:DLINK:SYNC:ANTenna:PORT? [:SENSe] :EVM:DLINK:SYNC:ANTenna:PORT:AUTO OFF ON 0 1 [:SENSe] :EVM:DLINK:SYNC:ANTenna:PORT:AUTO?
Example	EVM:DLIN:SYNC:ANT:PORT P0 EVM:DLIN:SYNC:ANT:PORT?
Dependencies	When Number of C-RS Ports is One, only Port 0 is enabled and the others are disabled. When Number of C-RS Ports is two, Port 0 and Port 1 are enabled and the others are disabled. When Number of C-RS Ports is four, all Ports are enabled.
Preset	P0 ON
State Saved	Saved in instrument state.
Range	Port 0 Port 1 Port 2 Port 3
Initial S/W Revision	Prior to A.02.00
Modified at S/W Revision	A.03.00, A.13.00

Port 0

Selects Port 0 for the Reference C-RS Port.

Key Path	Meas Setup, Sync/Format Setup, TX Antenna, Reference C-RS Port
Mode	LTE, LTETDD
Initial S/W Revision	Prior to A.02.00
Modified at S/W Revision	A.03.00, A.13.00

Port 1

Selects Port 1 for the Reference C-RS Port.

Key Path	Meas Setup, Sync/Format Setup, TX Antenna, Reference C-RS Port
Mode	LTE, LTETDD
Initial S/W Revision	Prior to A.02.00
Modified at S/W Revision	A.03.00, A.13.00

Port 2

Selects Port 2 for the Reference C-RS Port.

Key Path	Meas Setup, Sync/Format Setup, TX Antenna, Reference C-RS Port
Mode	LTE, LTETDD
Initial S/W Revision	Prior to A.02.00
Modified at S/W Revision	A.03.00, A.13.00

Port 3

Selects Port 3 for the Reference C-RS Port.

Key Path	Meas Setup, Sync/Format Setup, TX Antenna, Reference C-RS Port
Mode	LTE, LTETDD
Initial S/W Revision	Prior to A.02.00
Modified at S/W Revision	A.03.00, A.13.00

Antenna Detect Threshold

Sets the Antenna Detection Threshold.

Antenna Detection Threshold sets the threshold for transmit antenna port signal detection. The average RS power from a Tx antenna port has to be above the Antenna Detection Threshold to be detected by the demodulator. The threshold is specified relative to the average RS subcarrier power level of the reference antenna path selected.

For example, a combination of the transmissions from Ports 0–3 are being received, Antenna Detection Threshold is set to –10 dB, Reference Tx Antenna Port is set to Port 1. The demodulator will set the detection threshold 10 dB below the average RS power level of the reference antenna path (Tx1). Any other antenna port transmission paths with an average RS power level that is at or below this threshold will not be detected nor included in demodulation results. However, any undetected transmissions will affect EVM since they will not be equalized and will act as noise.

NOTE

Include Inactive Antenna Paths can be used to show information about all Tx paths on the MIMO trace.

Key Path	Meas Setup, Sync/Format Setup, Tx Antenna,
Mode	LTE, LTETDD
Remote Command	[:SENSe] :EVM:DLINK:SYNC:ANTenna:DETECT:THRshold <rel_ampl> [:SENSe] :EVM:DLINK:SYNC:ANTenna:DETECT:THRshold?
Example	EVM:DLIN:SYNC:ANT:DET:THR -10 EVM:DLIN:SYNC:ANT:DET:THR?
Dependencies	This parameter is disabled when Number of C-RS Ports is One.

Preset	-10
State Saved	Saved in instrument state.
Min	-100 dB
Max	100 dB
Initial S/W Revision	Prior to A.02.00
Modified at S/W Revision	A.03.00

P-SS/S-SS Antenna Port

Selects the Antenna Port that is transmitting P-SS/S-SS when the Number of C-RS Ports is set to 2 Antennas or 4 Antennas.

When All Ports is selected, the Power Boost value for P-SS and S-SS entered in Downlink Control Channel Properties is assumed to be split equally among the transmit antennas.

For example, when P-SS Power Boost = 0.6 dB and P-SS/S-SS Antenna Port is set to All Ports for a four antenna port signal, the demodulator will expect P-SS power on each antenna port to be 0.6 dB – 6.02 dB = –5.38 dB.

Otherwise, when Port 0, Port 1, Port 2, or Port 3 is selected, the entire power specified by the P-SS and S-SS Power Boost parameter is assumed to be transmitted on the selected antenna port.

- PORT0 – Port 0
- PORT1 – Port 1
- PORT2 – Port 2
- PORT3 – Port 3
- APORts – All Ports

Key Path	Meas Setup, Sync/Format Setup, Tx Antenna
Mode	LTE, LTETDD
Remote Command	[:SENSe] :EVM:DLINK:SYNC:SS:ANTenna:PORT P0 P1 P2 P3 APORts [:SENSe] :EVM:DLINK:SYNC:SS:ANTenna:PORT?
Example	EVM:DLIN:SYNC:SS:ANT:PORT P0 EVM:DLIN:SYNC:SS:ANT:PORT?
Dependencies	Disabled when Number of C-RS Ports is One.
Preset	P0
State Saved	Saved in instrument state.
Range	Port 0 Port 1 Port 2 Port 3 All Ports
Initial S/W Revision	A.03.00

Port 0

Selects Port 0.

Key Path	Meas Setup, Sync/Format Setup, Tx Antenna, P-SS/S-SS Ant
Mode	LTE, LTETDD
Initial S/W Revision	A.03.00

Port 1

Selects Port 1.

Key Path	Meas Setup, Sync/Format Setup, Tx Antenna, P-SS/S-SS Ant
Mode	LTE, LTETDD
Initial S/W Revision	A.03.00

Port 2

Selects Port 2.

Key Path	Meas Setup, Sync/Format Setup, Tx Antenna, P-SS/S-SS Ant
Mode	LTE, LTETDD
Dependencies	Disabled when Number of C-RS Ports is Two.
Initial S/W Revision	A.03.00

Port 3

Selects Port 3.

Key Path	Meas Setup, Sync/Format Setup, Tx Antenna, P-SS/S-SS Ant
Mode	LTE, LTETDD
Dependencies	Disabled when Number of C-RS Ports is Two.
Initial S/W Revision	A.03.00

All Ports

Selects All Ports.

Key Path	Meas Setup, Sync/Format Setup, Tx Antenna, P-SS/S-SS Ant
Mode	LTE, LTETDD
Initial S/W Revision	A.03.00

Include Inactive Antenna Paths

Selects whether or not inactive antenna paths are included in the result.

- Include – All Tx/Rx antenna paths are shown on the MIMO traces whether or not the path is present.
- Exclude – Only Tx/Rx antenna paths that have an average RS power above the antenna detection threshold will be shown on the MIMO traces.

Key Path	Meas Setup, Sync/Format Setup, Tx Antenna
Mode	LTE, LTETDD
Remote Command	[:SENSe] :EVM:DLINk:SYNC:ANTenna:INACTive:PATHs INCLude EXCLude [:SENSe] :EVM:DLINk:SYNC:ANTenna:INACTive:PATHs?
Example	EVM:DLIN:SYNC:ANT:INAC:PATH INCL EVM:DLIN:SYNC:ANT:INAC:PATH?
Preset	EXCLude
State Saved	Saved in instrument state.
Range	Inclue Exclue
Initial S/W Revision	A.06.00

MIMO Decoding

Determines the MIMO decoding method.

- NONE – No decoding
- GPPMimo – Selects 3GPP MIMO decoding

MIMO Decoding determines how much of the transmit chain is decoded by the demodulator. The selection of this parameter directly affects what values are shown on the IQ Meas trace and all other traces that depend on the IQ Meas data (error vector traces).

MIMO Decoding applies to multi-antenna signals only.

3GPP MIMO Decoding

When 3GPP MIMO Decoding is selected, the data points shown on the IQ Meas trace are equivalent to the data points before precoding was applied in the transmit chain. In other words, the demodulator will undo MIMO precoding and show the results on IQ Meas. Although the data points are mapped onto "subcarriers" when being shown on the layer traces, the data points do not have a one-to-one correspondence to the subcarrier that they are mapped onto. For instance, when there is a frequency null that affects a subcarrier, there will be several (depending on the precoding) data points in IQ Meas that are affected. Another way of looking at this is that each subcarrier contains information from multiple data points after precoding is performed (this does not apply to RS, P-SS, and S-SS which do not undergo precoding).

For channels that undergo transmit diversity, the demodulator will undo transmit diversity precoding, undo codeword-to-layer mapping, and show the resulting codeword data points in their respective resource elements, copied on all layer traces. That is, constellation points on layer traces for transmit diversity-precoded channels will be the same for all layer traces.

When a signal uses Tx Diversity, the amount of data transmitted is not increased, but the reliability of the signal is increased by transmitting multiple copies of the data.

In two Tx Antenna mode, each antenna port transmission carries enough information to determine all the data.

In four Tx Antenna mode, each antenna port transmission only carries enough information to determine half the data. Any data that cannot be determined from the detected antenna ports will be considered part of Non-Alloc signals and shown as blanks on the Symbol Table (unless the Non-Alloc parameter is selected; then the data will be shown as gray zeros).

For channels that undergo spatial multiplexing, the demodulator will only undo Spatial Multiplexing precoding and show the layer data points in their respective resource elements on the appropriate layer traces.

For precoded channels, subcarrier points on the layer traces do not have a one-to-one correspondence to on-air subcarriers. Rather, each subcarrier point is actually the demodulated value of a codeword data point that was present prior to the codeword-to-layer mapping at the transmitter.

NOTE For LTE signals that contain more than one layer, the P-SS and S-SS subcarriers from the P-SS/S-SS Antenna Port are copied to all layer traces. RS subcarriers from all Tx antenna ports are copied to their respective subcarrier/symbol locations in all layer traces.

No Decoding

When No Decoding is selected, no decoding or cross-channel equalization will be performed on the measured IQ data. This means that, for LTE signals that have been precoded (multi-antenna signals), subcarrier points shown on measured IQ traces (IQ Meas and IQ MEas Time) will actually be an addition of multiple modulation points, resulting in non-standard constellations.

For example, in a two antenna port signal, there will be subcarrier points that are an addition of two QPSK points. The resulting diagram will be a 9QAM constellation. These are effectively the points that were transmitted on the OFDM subcarriers.

Reference antenna path equalization will still be performed when Equalizer Training is enabled (set to RS or RS+Data).

The No Decoding selection is useful for the case that you have four antenna signals, and you want to isolate channel effects from transmit chain effects (filters, mixers, etc.). You could connect each transmit port directly to your measurement instrument with identical cables. That way, any observed anomalies will come primarily from the RF transmit chain.

NOTE When No Decoding is selected, EVM results will not be relevant since the ideal symbol points (shown on the IQ Ref and IQ Ref Time), which are used to compute EVM, will still be standard constellation points and hence may not match the non-standard constellation points of IQ Meas arising due to No Decoding.

Key Path	Meas Setup, Sync/Format Setup
Mode	LTE, LTETDD
Remote Command	[:SENSe] :EVM:DLINK:SYNC:MIMO:DECoding NONE GPPMimo [:SENSe] :EVM:DLINK:SYNC:MIMO:DECoding?
Example	EVM:DLIN:SYNC:MIMO:DEC NONE

	EVM:DLIN:SYNC:MIMO:DEC?
Notes	The selection “JEQualizer” is removed at A.06.00. For backward compatibility, when it is sent, this parameter is set to GPPM, the Preset value.
Preset	3GPP MIMO
State Saved	Saved in instrument state.
Range	None 3GPP MIMO
Initial S/W Revision	A.03.00
Modified at S/W Revision	A.06.00

PDSCH Cell Specific Ratio

Determines PDSCH cell-specific ratio ρ_B/ρ_A or cell-specific parameter PB. (3GPP TS 36.213 V8.5.0 5.2) PDSCH cell-specific ratio specifies the power ratio between PDSCH resource elements and cell-specific reference signal elements.

- R1 – Cell-specific ratio ρ_B/ρ_A = always 1 (0 dB)
- PB0 – Cell-specific parameter PB = 0
- PB1 – Cell-specific parameter PB = 1
- PB2 – Cell-specific Parameter PB = 2
- PB3 – Cell-specific parameter PB = 3

When PB(x) is selected, the LTE parameter PB will be set to (x), and the ratio ρ_B/ρ_A will be determined from Table 5.2–2 in 3GPP TS.36.213.

When R1 is selected, the cell-specific ratio ρ_B/ρ_A will be set to 1.

Key Path	Meas Setup, Sync/Format Setup
Mode	LTE, LTETDD
Remote Command	[:SENSe] :EVM:DLINk:PDSCh:CSRatio R1 PB0 PB1 PB2 PB3 [:SENSe] :EVM:DLINk:PDSCh:CSRatio?
Example	EVM:DLIN:PDSC:CSR R1 EVM:DLIN:PDSC:CSR?
Preset	$\rho_B/\rho_A = 1$
State Saved	Saved in instrument state.
Range	$\rho_B/\rho_A = 1$ PB = 0 PB = 1 PB = 2 PB = 3
Initial S/W Revision	A.03.00

Sync/Format Setup (Uplink)

Displays a menu of commonly used sync/format setup parameters when Direction is set to Uplink.

Key Path	Meas Setup
Mode	LTE, LTETDD
Initial S/W Revision	Prior to A.02.00
Modified at S/W Revision	A.03.00

Sync Type (Uplink)

Selects the Sync Type to use.

- RS – Selects PUSCH DM-RS as the Sync Type
- PUCCh – Selects PUCCH DM-RS as the Sync Type
- SRS – Selects S-RS as the Sync Type
- PRACH – Selects PRACH as the Sync Type

Sync Type sets the channel or signal to use for synchronization.

The demodulator can use PUSCH DM-RS, PUCCH DM-RS, S-RS, or PRACH for synchronization. Only the channels or signals that are defined for the current user (by selecting the Active to On for that signal in the User Mapping Editor) will be available as synchronization options.

Note that PUSCH, PUCCH, PUSCH DM-RS, PUCCH DM-RS, and SRS powers in the User Mapping Editor are specified relative to the 0 dB level determined by the power of the channel chosen for synchronization. For example, when:

- Sync Type is set to PUCCH DM-RS
- PUCCH DMRS Power (dB) = 3 dB
- PUSCH Power (dB) = 1.2 dB,

the demodulator will set the 0 dB level to be 3 dB below the average power of PUCCH DM-RS and expect PUSCH average power to be 1.2 dB above the 0 dB level, which is equivalent to 1.8 dB below the average PUCCH DM-RS power.

Sync Type also determines which channel's Sync Slot parameter is used for frame boundary calculation.

Key Path	Meas Setup, Sync/Format Setup
Mode	LTE, LTETDD
Remote Command	[:SENSe] :EVM:ULINK:SYNC:TYPE RS PUCCh SRS PRACH [:SENSe] :EVM:ULINK:SYNC:TYPE?
Example	EVM:ULIN:SYNC:TYPE RS EVM:ULIN:SYNC:TYPE?
Dependencies	Only the channels or signals that are defined for the current user (by turn on Active for that signal in the LTE Allocation Editor) are available as synchronization options. For example, if a user does not have a PUCCH allocation defined, the PUCCH DM-RS synchronization option is disabled

Preset	RS
State Saved	Saved in instrument state.
Range	PUSCH DM-RS PUCCH DM-RS S-RS PRACH
Initial S/W Revision	Prior to A.02.00
Modified at S/W Revision	A.03.00

PUSCH DM-RS

Selects PUSCH DM-RS as the Sync Type.

Key Path	Meas Setup, Sync/Format Setup, Sync Type
Mode	LTE, LTETDD
Initial S/W Revision	Prior to A.02.00
Modified at S/W Revision	A.03.00

PUCCH DM-RS

Selects PUCCH DM-RS as the Sync Type.

Key Path	Meas Setup, Sync/Format Setup, Sync Type
Mode	LTE, LTETDD
Initial S/W Revision	Prior to A.02.00
Modified at S/W Revision	A.03.00

S-RS

Selects S-RS as the Sync Type.

Key Path	Meas Setup, Sync/Format Setup, Sync Type
Mode	LTE, LTETDD
Initial S/W Revision	A.03.00

PRACH

Selects PRACH as the Sync Type.

Key Path	Meas Setup, Sync/Format Setup, Sync Type
Mode	LTE, LTETDD
Initial S/W Revision	A.03.00

Half Subcarrier Shift

Sets the state of Half Carrier Shift. When Half Subcarrier Shift is selected, the demodulator expects the uplink signal to comply with the LTE standard regarding subcarrier shift and phase reset. The LTE standard requires that the uplink subcarriers be spaced on either side of DC by half the subcarrier spacing. When this is done, a phase reset is also needed after each symbol.

To demodulate a signal that does not shift the subcarriers by half the subcarrier spacing (and therefore does not need a phase reset), set this parameter to OFF.

To demodulate a signal that conforms to the half subcarrier shift, but does not reset the phase each symbol, set this parameter to OFF. The signal will then be demodulated correctly, but will show a frequency offset error of 7.5 KHz.

Background

Downlink signals have an odd number of subcarriers, and the middle subcarrier, located at DC, is discarded, since it is generally difficult to recover the data from a DC subcarrier. In contrast, uplink signals have one less subcarrier than the corresponding downlink signal and are shifted down in frequency by half the subcarrier spacing such that the subcarriers are symmetric about DC causing less bandwidth to be wasted.

Key Path	Meas Setup, Sync/Format Setup
Mode	LTE, LTETDD
Remote Command	[:SENSe] :EVM:ULINK:SYNC:HSSHift OFF ON 0 1 [:SENSe] :EVM:ULINK:SYNC:HSSHift?
Example	EVM:ULIN:SYNC:HSSH ON EVM:ULIN:SYNC:HSSH?
Preset	ON
State Saved	Saved in instrument state.
Initial S/W Revision	Prior to A.02.00
Modified at S/W Revision	A.03.00

PUSCH DFT Swap

Sets the state of PUSCH DFT Swap. PUSCH DFT Swap influences how data is mapped to the subcarriers in the Physical Uplink Shared Channel after a discrete Fourier transform is performed. It can be turned on or off to provide two different interpretation of how data should be mapped to resource elements in PUSCH channels.

Key Path	Meas Setup, Sync/Format Setup
Mode	LTE, LTETDD
Remote Command	[:SENSe] :EVM:ULINK:SYNC:PDSwap OFF ON 0 1 [:SENSe] :EVM:ULINK:SYNC:PDSwap?
Example	EVM:ULIN:SYNC:PDSW ON EVM:ULIN:SYNC:PDSW?

Preset	OFF
State Saved	Saved in instrument state.
Initial S/W Revision	Prior to A.02.00
Modified at S/W Revision	A.03.00

Meas Time Setup

Displays a menu of commonly used measurement time setup parameters.

Key Path	Meas Setup
Mode	LTE, LTETDD
Initial S/W Revision	Prior to A.02.00
Modified at S/W Revision	A.03.00

Result Length

Sets the maximum result length for analysis.

Result Length determines how many slots will be available for demodulation. Measurement Interval and Measurement Offset specify what part of the result length is demodulated.

The result data starts where the analysis boundary is found and ends after the amount of data specified by Result Length.

The length of the time capture (contained in Search Time) is longer than the result length by approximately the length of the Analysis Start Boundary (frame = 10 ms, slot = 0.5 ms, etc.) to enable for location of the analysis boundary within the time capture.

NOTE

For downlink, an entire slot containing S-SS must be present in the time capture (Raw Main Time) for demodulation to occur.

For LTETDD, the maximum Result Length is 40 slots when Direction is set to Downlink, for Uplink, the maximum Result Length is 20 slots.

Key Path	Meas Setup, Meas Time Setup
Mode	LTE, LTETDD
Remote Command	<code>[:SENSE] :EVM:TIME:RESult:LENGth <integer></code> <code>[:SENSE] :EVM:TIME:RESult:LENGth?</code>
Example	<code>EVM:TIME:RES:LENG 20</code> <code>EVM:TIME:RES:LENG?</code>
Preset	20 slots
State Saved	Saved in instrument state.
Min	1 slot

Max	LTE: 20 slots LTETDD: 40 slots for Downlink, 20 slots for Uplink
Initial S/W Revision	Prior to A.02.00
Modified at S/W Revision	A.03.00

Meas Offset Slot

Sets the Meas Offset Slot.

Measurement Offset Slot specifies the offset from the Analysis Start Boundary to the beginning of the Measurement Interval (the data sent to the demodulator), and can be specified in slots + symbols-times.

Key Path	Meas Setup, Meas Time Setup
Mode	LTE, LTETDD
Remote Command	[:SENSe] :EVM:TIME:OFFSet:SLOT <integer> [:SENSe] :EVM:TIME:OFFSet:SLOT?
Example	EVM:TIME:OFFS:SLOT 0 EVM:TIME:OFFS:SLOT?
Couplings	Max value determined by Result Length (refer to "Result Length" on page 1879)
Preset	0 slots
State Saved	Saved in instrument state.
Min	0 slots
Max	Determined by Result Length (refer to "Result Length" on page 1879)
Max	Determined by Result Length (refer to "Result Length" on page 1879)
Initial S/W Revision	Prior to A.02.00
Modified at S/W Revision	A.03.00

Meas Offset Symbol

Sets the Meas Offset Symbol.

Measurement Offset Symbol specifies the offset from the Analysis Start Boundary to the beginning of the Measurement Interval (the data sent to the demodulator), and can be specified in slots + symbols-times.

Key Path	Meas Setup, Meas Time Setup
Mode	LTE, LTETDD
Remote Command	[:SENSe] :EVM:TIME:OFFSet:SYMBOL <integer> [:SENSe] :EVM:TIME:OFFSet:SYMBOL?
Example	EVM:TIME:OFFS:SYMB 0 EVM:TIME:OFFS:SYMB?

Preset	0 symbols
State Saved	Saved in instrument state.
Min	0 symbols
Max	6 symbols
Initial S/W Revision	Prior to A.02.00
Modified at S/W Revision	A.03.00

Meas Interval Slot

Sets the Meas Interval Slot.

Measurement Interval determines how much data is sent to the demodulator, and can be specified in slots + symbols-times. The beginning of the measurement interval is specified as an offset from the Analysis Start Boundary. The offset is specified by the Measurement Offset parameter.

NOTE

The Time Offset data result in the Error Summary trace shows the distance from the beginning of the Search Time trace to the beginning of the measurement interval.

Key Path	Meas Setup, Meas Time Setup
Mode	LTE, LTETDD
Remote Command	<code>[:SENSe] :EVM:TIME:INTerval:SLOT <integer></code> <code>[:SENSe] :EVM:TIME:INTerval:SLOT?</code>
Example	<code>EVM:TIME:INT:SLOT 1</code> <code>EVM:TIME:INT:SLOT?</code>
Couplings	Max value determined by Result Length (refer to "Result Length" on page 1879)
Preset	LTE: 6 slots LTETDD: 6 slots
State Saved	Saved in instrument state.
Min	0 slots
Max	Determined by Result Length (refer to "Result Length" on page 1879)
Initial S/W Revision	Prior to A.02.00
Modified at S/W Revision	A.03.00

Meas Interval Symbol

Sets the Meas Interval Symbol.

Measurement Interval determines how much data after the measurement offset is sent to the demodulator, and can be specified in slots + symbols-times.

Key Path	Meas Setup, Meas Time Setup
----------	-----------------------------

Mode	LTE, LTETDD
Remote Command	[:SENSe] :EVM:TIME:INTerval:SYMBOL <integer> [:SENSe] :EVM:TIME:INTerval:SYMBOL?
Example	EVM:TIME:INT:SYMB 0 EVM:TIME:INT:SYMB?
Preset	0 symbols
State Saved	Saved in instrument state.
Min	0 symbols
Max	6 symbols
Initial S/W Revision	Prior to A.02.00
Modified at S/W Revision	A.03.00

Analysis Start Boundary

Sets the Analysis Start Boundary. Analysis Start Boundary specifies the alignment boundary of the Result Length time data. To ensure that this alignment can be achieved, the total amount of data acquired by the analyzer is equal to the Result Length plus the length of the alignment boundary specified by Analysis Start Boundary. For example, if Analysis Start Boundary were set to Half-Frame, the total acquisition will be equal to ResultLength + 10 slots (and the Measurement Interval will start at a Half-Frame boundary).

Once the Result Length is located within the time capture, Measurement Offset and Measurement Interval determine the data that is to be analyzed. This data is also displayed on the Time trace.

This parameter cannot be set to Slot for downlink signals since MIMO Decoding must be applied beginning at a subframe boundary.

NOTE

Since uplink signals do not contain a separate synchronization channel, the demodulator cannot determine the frame boundary exactly unless there is a unique slot in a user mapping and that unique slot is present within the Search Time data.

Key Path	Meas Setup, Meas Time Setup
Mode	LTE, LTETDD
Remote Command	[:SENSe] :EVM:TIME:ASBoundary FRAME HALF SUB SLOT [:SENSe] :EVM:TIME:ASBoundary?
Example	EVM:TIME:ASB FRAM EVM:TIME:ASB?
Dependencies	When Direction is set to Downlink, SLOT cannot be selected and the softkey is grayed out. When Direction is changed to Downlink from Uplink, this parameter is set to FRAME.
Preset	FRAME
State Saved	Saved in instrument state.
Range	Frame Half-Frame Subframe Slot
Initial S/W Revision	Prior to A.02.00
Modified at S/W Revision	A.03.00

Frame

Selects Frame as Analysis Start Boundary.

Key Path	Meas Setup, Meas Time Setup, Analysis Start Boundary
Mode	LTE, LTETDD
Initial S/W Revision	Prior to A.02.00
Modified at S/W Revision	A.03.00

Half-Frame

Selects Half-Frame as Analysis Start Boundary.

Key Path	Meas Setup, Meas Time Setup, Analysis Start Boundary
Mode	LTE, LTETDD
Initial S/W Revision	Prior to A.02.00
Modified at S/W Revision	A.03.00

Subframe

Selects Subframe as Analysis Start Boundary.

Key Path	Meas Setup, Meas Time Setup, Analysis Start Boundary
Mode	LTE, LTETDD
Initial S/W Revision	Prior to A.02.00
Modified at S/W Revision	A.03.00

Slot

Selects Slot as Analysis Start Boundary. This selection is available when Direction is Uplink.

Key Path	Meas Setup, Meas Time Setup, Analysis Start Boundary
Mode	LTE, LTETDD
Initial S/W Revision	Prior to A.02.00
Modified at S/W Revision	A.03.00

Chan Profile Setup (Downlink)

Displays a menu of commonly used channel profile setup parameters when Direction is Downlink.

Key Path	Meas Setup
Mode	LTE, LTETDD
Initial S/W Revision	Prior to A.02.00
Modified at S/W Revision	A.03.00

Chan Profile Setup (Downlink)

Displays a menu of commonly used channel profile setup parameters when Direction is Downlink.

Key Path	Meas Setup
Mode	LTE, LTETDD
Initial S/W Revision	Prior to A.02.00
Modified at S/W Revision	A.03.00

Detection

Determines whether or not the user allocations will be autodetected.

Downlink:

When enabled, the demodulator can perform power based auto detection or can auto detect allocations by decoding PDCCH. See the ["RB Auto Detect Mode" on page 1885](#) for more information.

Uplink:

When enabled, PUSCH, PUCCH, SRS, and PRACH allocations can be autodetected when the necessary parameters are defined.

NOTE

The LTE demodulator can perform sync slot auto detection or user-assigned auto detection for uplink signals.

To configure automatic sync slot detection, select the Auto Sync parameter on the User Mapping Editor.

To configure user-assigned auto detection, set the Auto Sync to OFF for a channel and define a sync slot with associated Per-slot Parameters (in the User Mapping Editor) to be used for initial synchronization.

User-assigned auto detection results in faster measurements than automatic sync slot detection.

Key Path	Meas Setup, Chan Profile Setup
Mode	LTE, LTETDD
Remote Command	<code>[:SENSe] :EVM:PROFile:AUTO[:DETECT] OFF ON 0 1</code> <code>[:SENSe] :EVM:PROFile:AUTO[:DETECT] ?</code>
Example	EVM:PROF:AUTO ON EVM:PROF:AUTO?
Couplings	This parameter is the same for Downlink and Uplink When Direction is Downlink, this parameter is coupled to the Include User (Downlink) menu. This menu is context sensitive and when Auto Include is on the user can include QPSK, 16QAM or 64QAM channels. When Off the user can include any of the user defined PDSCH channels.

	When direction is Uplink, this parameter is coupled to the Include User (Uplink) menu. This menu is context sensitive and when Auto Include is On the user can include channels from the Auto Detected User. When Off the user can include channels from ONE of the user defined Users.
Preset	ON
State Saved	Saved in instrument state.
Initial S/W Revision	Prior to A.02.00
Modified at S/W Revision	A.03.00

RB Auto Detect Mode

Sets the level of auto detection that the LTE demodulator uses. There are two levels of auto detection, described as follows:

- **POWer** - Power Based, User allocations are detected using codeword power levels and MIMO parameters. Detected allocations are grouped according to modulation type (QPSK, 16QAM, or 64QAM). The codeword powers (needed for EVM calculations) and Precoding type are not autodetected and need to be specified. When SpMux is selected as the precoding type, No. Layers, No. Codewords, CDD, and Codebook Idx must also be specified, and these parameters are assumed to apply to all autodetected PDSCH channels.
- **DECode** - Decoded PDCCH, User allocations are determined by decoding PDCCH.

NOTE

The demodulator can be configured to autodetect 3GPP-defined codeword power levels when Auto Detect Power Levels is On. When codeword power levels are not autodetected, they must be specified using the CW0/1 Power parameters in the User Mapping Editor for each expected user allocation. The number of expected user allocations is set by Number of Expected DL Users and by selecting the individual users.

Key Path	Meas Setup, Chan Profile Setup
Mode	LTE, LTETDD
Remote Command	<code>[:SENSe] :EVM:DLINK:PROFile:AUTO[:DETect]:MODE POWer DECode</code> <code>[:SENSe] :EVM:DLINK:PROFile:AUTO[:DETect]:MODE?</code>
Example	<code>EVM:DLIN:PROF:AUTO:MODE POW</code> <code>EVM:DLIN:PROF:AUTO:MODE?</code>
Dependencies	Available when Detection is Auto.
Preset	POWer
State Saved	Saved in instrument state.
Range	Power Based Decoded PDCCH
Initial S/W Revision	A.06.00

Auto Detect Power Levels In Power Mode

Selects whether or not power levels are autodetected when Detection is Auto and RB Auto Detect Mode is Power-based.

- ON - Detected allocations are grouped according to modulation type (QPSK, 16QAM, or 64QAM).
- The codeword power levels are detected also.
- OFF - The codeword power levels for each user allocation need to be specified for EVM calculations to be correct.

The power levels are detected as one of the levels specified by the standard in 3GPP TS 36.331, section 6.3.2 under the PDSCH-Config parameter.

These power levels are -6 dB, -4.77 dB, -3 dB, -1.77 dB, 0 dB, 1 dB, 2 dB, and 3 dB.

Key Path	Meas Setup, Chan Profile Setup, RB Auto Detect Mode, Power Based
Mode	LTE, LTETDD
Remote Command	[:SENSe] :EVM:DLINK:PROFile:AUTO[:DETECT]:POWER:PMODE OFF ON 0 1 [:SENSe] :EVM:DLINK:PROFile:AUTO[:DETECT]:POWER:PMODE?
Example	EVM:DLIN:PROF:AUTO:POW:PMOD ON EVM:DLIN:PROF:AUTO:POW:PMOD?
Notes	When you enter the Edit User Mapping form, the RB Auto Detect Mode selection that you set before entering the form appears. You can switch the mode between Decoded PDCCH and Power Based on the Editor, however, the Auto Detect Power Levels state on the form and its softkey are still for the mode you set before entering the form and do not change even if you change the mode.
Dependencies	Available when Detection is Auto and RB Auto Detect Mode is Power based.
Preset	ON
State Saved	Saved in instrument state.
Range	On Off
Initial S/W Revision	A.14.00

Auto Detect Power Levels

Selects whether or not power levels are autodetected.

- ON - Detects the relative PDSCH power level for each user allocation (PA). RB Auto Detect Mode must be set to Decoded PDCCH for power levels to be autodetected.
- OFF - The codeword power levels for each user allocation need to be specified for EVM calculations to be correct. The Expected Num. of Users parameter determines the number of users listed in the LTE Allocation Editor for which the power levels can be defined.

The power levels are detected as one of the levels specified by the standard in 3GPP TS 36.331, section 6.3.2 under the PDSCH-Config parameter.

These power levels are -6 dB, -4.77 dB, -3 dB, -1.77 dB, 0 dB, 1 dB, 2 dB, and 3 dB.

The autodetected power levels (P_A(n)) can be viewed on the DL Decode Info trace.

Key Path	Meas Setup, Chan Profile Setup, RB Auto Detect Mode, Decoded PDCCH
Mode	LTE, LTETDD
Remote Command	[:SENSe] :EVM:DLINK:PROFile:AUTO[:DETECT]:POWer OFF ON 0 1 [:SENSe] :EVM:DLINK:PROFile:AUTO[:DETECT]:POWer?
Example	EVM:DLIN:PROF:AUTO:POW ON EVM:DLIN:PROF:AUTO:POW?
Notes	When you enter the Edit User Mapping form, the RB Auto Detect Mode selection that you set before entering the form appears. You can switch the mode between Decoded PDCCH and Power Based on the Editor, however, the Auto Detect Power Levels state on the form and its softkey are still for the mode you set before entering the form and do not change even if you change the mode.
Dependencies	Available when Detection is Auto and RB Auto Detect Mode is Decoded PDCCH.
Preset	ON
State Saved	Saved in instrument state.
Range	On Off
Initial S/W Revision	A.06.00

Round to Standard Values

Determines whether the measured, relative power levels for PDSCH allocations are detected as one of the standard values or assumed to be equal to the measured power level.

When on, the power levels are detected as the closest standard power level. Standard power levels are specified in 3GPP TS 36.331, section 6.3.2 under the PDSCH-Config parameter. These power levels are -6 dB, -4.77 dB, -3 dB, -1.77 dB, 0 dB, 1 dB, 2 dB, and 3 dB. When off, the measured power levels are used as the actual power levels.

Key Path	Meas Setup, Chan Profile Setup
Mode	LTE, LTETDD
Remote Command	[:SENSe] :EVM:DLINK:PROFile:AUTO[:DETECT]:POWer:ROUND OFF ON 0 1 [:SENSe] :EVM:DLINK:PROFile:AUTO[:DETECT]:POWer:ROUND?
Example	EVM:DLIN:PROF:AUTO:POW:ROUN ON EVM:DLIN:PROF:AUTO:POW:ROUN?
Dependencies	Available when the following conditions are met. Direction: Downlink Detection: Auto RB Auto Detect Mode: Decoded PDCCH Auto Detect Power Levels: On.
Preset	ON
State Saved	Saved in instrument state.
Range	On Off
Initial S/W Revision	A.10.00

Number of Expected DL Users

Specifies the number of user allocations from 1 to 50 when RB Auto Detect Mode is set to Decoded PDCCH.

Other user allocations detected from PDCCH will be shown on traces and included in calculations, but only the number of users specified with this key will be included in the Composite Include menu where they can be excluded from traces and calculations.

When Auto Detect Power levels is set to OFF, PDSCH Decoded User Power Boost must be specified. This parameter limits the number of PDSCH user allocations for which codeword power levels can be manually defined. When there are more user allocations found in the signal than are specified by this parameter, any additional user allocation will be assumed to have a PDSCH power level of 0 dB.

Key Path	Meas Setup, Chan Profile Setup
Mode	LTE, LTETDD
Remote Command	[:SENSe] :EVM:DLINK:PROFile:EUSers:COUNT <integer> [:SENSe] :EVM:DLINK:PROFile:EUSers:COUNT?
Example	EVM:DLIN:PROF:EUS:COUN 1 EVM:DLIN:PROF:EUS:COUN?
Dependencies	Available when Detection is Auto and RB Auto Detect Mode is Decoded PDCCH.
Preset	3
State Saved	Saved in instrument state.
Min	0
Max	50
Initial S/W Revision	A.06.00

Composite Include

Displays a menu that enables the inclusion or exclusion of all channels.

Key Path	Meas Setup, Chan Profile Setup
Mode	LTE, LTETDD
Initial S/W Revision	Prior to A.02.00
Modified at S/W Revision	A.03.00

Include All

Turns On all Downlink channels.

Key Path	Meas Setup, Chan Profile Setup, Composite Include
----------	---

Mode	LTE, LTETDD
Remote Command	[:SENSe] :EVM:DLINk:PROFile:INCLude:ALL
Example	EVM:DLIN:PROFile:INCL:ALL
Couplings	Turns On the following parameters <ul style="list-style-type: none"> • Include P-SCH • Include S-SCH • Include PBCH • Include PCFICH • Include PHICH • Include RS • Include PDCCH • All Users under the Include Users (Downlink) Menu
Initial S/W Revision	Prior to A.02.00
Modified at S/W Revision	A.03.00

Exclude All

Turns Off all Downlink channels.

Key Path	Meas Setup, Chan Profile Setup, Composite Include
Mode	LTE, LTETDD
Remote Command	[:SENSe] :EVM:DLINk:PROFile:EXCLude:ALL
Example	EVM:DLIN:PROF:EXCL:ALL
Couplings	Turns Off the following parameters <ul style="list-style-type: none"> • Include P-SCH • Include S-SCH • Include PBCH • Include PCFICH • Include PHICH • Include RS • Include PDCCH • Include Non Allocation • All Users under the Include Users (Downlink) Menu
Initial S/W Revision	Prior to A.02.00
Modified at S/W Revision	A.03.00

Include Channels

Displays a menu that enables you to determine which channels should be included in the results.

Key Path	Meas Setup, Chan Profile Setup
Mode	LTE, LTETDD
Initial S/W Revision	Prior to A.02.00
Modified at S/W Revision	A.03.00

Include P-SS

Includes the Primary Synchronization Channel in the results.

Key Path	Meas Setup, Chan Profile Setup, Include Channels
Mode	LTE, LTETDD
Remote Command	[:SENSe] :EVM:DLINK:PROFile:PSS INCLude EXCLude [:SENSe] :EVM:DLINK:PROFile:PSS?
Example	EVM:DLIN:PROF:PSS INCL EVM:DLIN:PROF:PSS?
Couplings	This parameter is set to Include when Downlink Include All is selected and set to Exclude when Downlink Exclude All is selected.
Preset	INCLude
State Saved	Saved in instrument state.
Range	Include Exclude
Initial S/W Revision	Prior to A.02.00
Modified at S/W Revision	A.03.00

Include S-SS

Includes the Secondary Synchronization Channel in the results.

Key Path	Meas Setup, Chan Profile Setup, Include Channels
Mode	LTE, LTETDD
Remote Command	[:SENSe] :EVM:DLINK:PROFile:SSS INCLude EXCLude [:SENSe] :EVM:DLINK:PROFile:SSS?
Example	EVM:DLIN:PROF:SSS INCL EVM:DLIN:PROF:SSS?
Couplings	This parameter is set to Include when Downlink Include All is selected and set to Exclude when Downlink Exclude All is selected.
Preset	INCLude
State Saved	Saved in instrument state.
Range	Include Exclude
Initial S/W Revision	Prior to A.02.00
Modified at S/W Revision	A.03.00

Include PBCH

Includes PBCH in the results.

Key Path	Meas Setup, Chan Profile Setup, Include Channels
Mode	LTE, LTETDD
Remote Command	[:SENSe] :EVM:DLINk:PROFile:PBCH INCLude EXCLude [:SENSe] :EVM:DLINk:PROFile:PBCH?
Example	EVM:DLIN:PROF:PBCH INCL EVM:DLIN:PROF:PBCH?
Couplings	This parameter is set to Include when Downlink Include All is selected and set to Exclude when Downlink Exclude All is selected.
Preset	INCLude
State Saved	Saved in instrument state.
Range	Include Exclude
Initial S/W Revision	Prior to A.02.00
Modified at S/W Revision	A.03.00

Include PCFICH

Includes PCFICH in the results.

Key Path	Meas Setup, Chan Profile Setup, Include Channels
Mode	LTE, LTETDD
Remote Command	[:SENSe] :EVM:DLINk:PROFile:PCFich INCLude EXCLude [:SENSe] :EVM:DLINk:PROFile:PCFich?
Example	EVM:DLIN:PROF:PCF INCL EVM:DLIN:PROF:PCF?
Couplings	This parameter is set to Include when Downlink Include All is selected and set to Exclude when Downlink Exclude All is selected.
Preset	INCLude
State Saved	Saved in instrument state.
Range	Include Exclude
Initial S/W Revision	Prior to A.02.00
Modified at S/W Revision	A.03.00

Include PHICH

Includes PHICH in the results.

Key Path	Meas Setup, Chan Profile Setup, Include Channels
Mode	LTE, LTETDD
Remote Command	[:SENSe] :EVM:DLINK:PROFile:PHICH INCLude EXCLude [:SENSe] :EVM:DLINK:PROFile:PHICH?
Example	EVM:DLIN:PROF:PHIC INCL EVM:DLIN:PROF:PHIC?
Couplings	This parameter is set to Include when Downlink Include All is selected and set to Exclude when Downlink Exclude All is selected.
Preset	INCLude
State Saved	Saved in instrument state.
Range	Include Exclude
Initial S/W Revision	Prior to A.02.00
Modified at S/W Revision	A.03.00

Include C-RS

Includes RS in the results.

Key Path	Meas Setup, Chan Profile Setup, Include Channels
Mode	LTE, LTETDD
Remote Command	[:SENSe] :EVM:DLINK:PROFile:RS INCLude EXCLude [:SENSe] :EVM:DLINK:PROFile:RS?
Example	EVM:DLIN:PROF:RS INCL EVM:DLIN:PROF:RS?
Couplings	This parameter is set to Include when Downlink Include All is selected and set to Exclude when Downlink Exclude All is selected.
Preset	INCLude
State Saved	Saved in instrument state.
Range	Include Exclude
Initial S/W Revision	Prior to A.02.00
Modified at S/W Revision	A.03.00, A.13.00

Include PDCCH

Includes PDCCH in the results.

Key Path	Meas Setup, Chan Profile Setup, Include Channels
Mode	LTE, LTETDD
Remote Command	[:SENSe] :EVM:DLINK:PROFile:PDCCh INCLude EXCLude

	<code>[:SENSe] :EVM:DLINk:PROFile:PDCCh?</code>
Example	EVM:DLIN:PROF:PDCC INCL EVM:DLIN:PROF:PDCC?
Couplings	This parameter is set to Include when Downlink Include All is selected and set to Exclude when Downlink Exclude All is selected.
Preset	INCLude
State Saved	Saved in instrument state.
Range	Include Exclude
Initial S/W Revision	Prior to A.02.00
Modified at S/W Revision	A.03.00

Include P-RS

Includes the Position Reference Channel in the results.

Key Path	Meas Setup, Chan Profile Setup, Include Channels
Mode	LTE, LTETDD
Remote Command	<code>[:SENSe] :EVM:DLINk:PROFile:PRS INCLude EXCLude</code> <code>[:SENSe] :EVM:DLINk:PROFile:PRS?</code>
Example	EVM:DLIN:PROF:PRS INCL EVM:DLIN:PROF:PRS?
Dependencies	Available when P-RS Active is On. Otherwise, this key is grayed out.
Couplings	This parameter is set to Include when Downlink Include All is selected and set to Exclude when Downlink Exclude All is selected.
Preset	EXCLude
State Saved	Saved in instrument state.
Range	Include Exclude
Initial S/W Revision	A.11.00

Include MBSFN -RS

Includes the MBSFN-RS channel in the results.

Key Path	Meas Setup, Chan Profile Setup, Include Channels
Mode	LTE, LTETDD
Remote Command	<code>[:SENSe] :EVM:DLINk:PROFile:MBSFn INCLude EXCLude</code> <code>[:SENSe] :EVM:DLINk:PROFile:MBSFn?</code>
Example	EVM:DLIN:PROF:MBSF INCL EVM:DLIN:PROF:MBSF?

Dependencies	Available when MBSFN Active is On. Otherwise, this key is grayed out.
Couplings	This parameter is set to Include when Downlink Include All is selected and set to Exclude when Downlink Exclude All is selected.
Preset	EXCLude
State Saved	Saved in instrument state.
Range	Include Exclude
Initial S/W Revision	A.11.00

Include PMCH

Includes the PMCH channel in the results.

Key Path	Meas Setup, Chan Profile Setup, Include Channels
Mode	LTE, LTETDD
Remote Command	[:SENSe] :EVM:DLINk:PROFile:PMCH INCLude EXCLude [:SENSe] :EVM:DLINk:PROFile:PMCH?
Example	EVM:DLIN:PROF:PMCH INCL EVM:DLIN:PROF:PMCH?
Dependencies	Available when MBSFN Active is On. Otherwise, this key is grayed out.
Couplings	This parameter is set to Include when Downlink Include All is selected and set to Exclude when Downlink Exclude All is selected.
Preset	EXCLude
State Saved	Saved in instrument state.
Range	Include Exclude
Initial S/W Revision	A.11.00

Include Non Allocation

Includes the inactive signals in the results.

Key Path	Meas Setup, Chan Profile Setup, Include Channels
Mode	LTE, LTETDD
Remote Command	[:SENSe] :EVM:PROFile:NALLocation INCLude EXCLude [:SENSe] :EVM:PROFile:NALLocation?
Example	EVM:PROF:NALL EXCL EVM:PROF:NALL?
Couplings	This parameter is same for Downlink and Uplink When either Downlink Exclude All or Uplink Exclude All is selected, this parameter is set to Exclude.
Preset	EXCLude

State Saved	Saved in instrument state.
Range	Include Exclude
Initial S/W Revision	Prior to A.02.00
Modified at S/W Revision	A.03.00

Include Users (Downlink)

Displays a menu that enables you to determine which PDSCH channels should be included in the results.

When set to Include, the corresponding user mapping is displayed on appropriate traces. When set to Exclude, only the Frame Summary trace will display the user mapping.

Key Path	Meas Setup, Chan Profile Setup
Mode	LTE, LTETDD
Initial S/W Revision	Prior to A.02.00
Modified at S/W Revision	A.03.00

User

Indexes the currently defined Users.

Key Path	Meas Setup, Chan Profile Setup, Include Users
Mode	LTE, LTETDD
Dependencies	Available when Detection is Manual. You need to set allocations to the user in advance. Otherwise, this key is grayed out.
Couplings	Max value determined by the number of Users the user has configured
Preset	0
State Saved	Saved in instrument state.
Min	1
Max	Determined by the number of Users the user has configured
Initial S/W Revision	Prior to A.02.00
Modified at S/W Revision	A.03.00

Include PDSCH

Includes the user defined channel PDSCH in the results.

Key Path	Meas Setup, Chan Profile Setup, Include Users
Mode	LTE, LTETDD
Remote Command	<code>[:SENSe] :EVM:DLINK:PROFile:USER<n>:PDSch INCLude EXCLude</code>

	[:SENSe] :EVM:DLINK:PROFile:USER<n>:PDSC?
Example	EVM:DLIN:PROF:USER1:PDSC EXCL EVM:DLIN:PROF:USER1:PDSC?
Dependencies	The range of sub op code <n> values is determined by the number of Users the user has configured. If the user attempts to remotely set or query a sub op code that is out of range, this will result in an error message. Available when Detection is Manual. You need to set allocations to the user in advance. Otherwise, this key is grayed out.
Couplings	This parameter is set to Include when Downlink Include All is selected and set to Exclude when Downlink Exclude All is selected.
Preset	EXCLude
State Saved	Saved in instrument state.
Range	Include Exclude
Initial S/W Revision	Prior to A.02.00
Modified at S/W Revision	A.03.00

Include Decoded PDSCH

Includes the user defined channel Decoded PDSCH in the results.

Key Path	Meas Setup, Chan Profile Setup, Include Users
Mode	LTE, LTETDD
Remote Command	[:SENSe] :EVM:DLINK:PROFile:USER<n>:DECodeD:PDSC INCLude EXCLude [:SENSe] :EVM:DLINK:PROFile:USER<n>:DECodeD:PDSC?
Example	EVM:DLIN:PROF:USER1:DEC:PDSC EXCL EVM:DLIN:PROF:USER1:DEC:PDSC?
Dependencies	The range of sub op code <n> values is determined by the Number of Expected DL Users the user has configured. If the user attempts to remotely set or query a sub op code that is out of range, this will result in an error message. Available When Detection is Auto, RB Auto Detect Mode is Decoded PDCCH, User and Decoded PDSCH are available.
Couplings	This parameter is set to Include when Downlink Include All is selected, and set to Exclude when Downlink Exclude All is selected.
Preset	INCLude
State Saved	Saved in instrument state.
Range	Include Exclude
Initial S/W Revision	A.06.00

Include QPSK

Includes channels using QPSK Mod Type in the results.

Key Path	Meas Setup, Chan Profile Setup, Include Users
Mode	LTE, LTETDD
Remote Command	[:SENSe] :EVM:DLINK:PROFile:QPSK INCLude EXCLude [:SENSe] :EVM:DLINK:PROFile:QPSK?
Example	EVM:DLIN:PROF:QPSK INCL EVM:DLIN:PROF:QPSK?
Dependencies	Enabled when PDSCH Detection is Auto.
Couplings	This parameter is set to Include when Downlink Include All is selected and set to Exclude when Downlink Exclude All is selected.
Preset	INCLude
State Saved	Saved in instrument state.
Range	Include Exclude
Initial S/W Revision	Prior to A.02.00
Modified at S/W Revision	A.03.00

Include 16QAM

Includes channels using 16QAM Mod Type in the results.

Key Path	Meas Setup, Chan Profile Setup, Include Users
Mode	LTE, LTETDD
Remote Command	[:SENSe] :EVM:DLINK:PROFile:QAM16 INCLude EXCLude [:SENSe] :EVM:DLINK:PROFile:QAM16?
Example	EVM:DLIN:PROF:QAM16 INCL EVM:DLIN:PROF:QAM16?
Dependencies	Enabled when PDSCH Detection is Auto.
Couplings	This parameter is set to Include when Downlink Include All is selected and set to Exclude when Downlink Exclude All is selected.
Preset	INCLude
State Saved	Saved in instrument state.
Range	Include Exclude
Initial S/W Revision	Prior to A.02.00
Modified at S/W Revision	A.03.00

Include 64QAM

Includes channels using 64QAM Mod Type in the results.

Key Path	Meas Setup, Chan Profile Setup, Include Users
----------	---

Mode	LTE, LTETDD
Remote Command	[:SENSe] :EVM:DLINk:PROFile:QAM64 INCLude EXCLude [:SENSe] :EVM:DLINk:PROFile:QAM64?
Example	EVM:DLIN:PROF:QAM64 INCL EVM:DLIN:PROF:QAM64?
Dependencies	Enabled when Downlink Detection is Auto.
Couplings	This parameter is set to Include when Downlink Include All is selected and set to Exclude when Downlink Exclude All is selected.
Preset	INCLude
State Saved	Saved in instrument state.
Range	Include Exclude
Initial S/W Revision	Prior to A.02.00
Modified at S/W Revision	A.03.00

Edit Control Channels

Displays a dialog that enables you to edit the Downlink Control Channel parameters. When a parameter is selected, the corresponding softkeys will appear.

You can set the Power Boost parameter for P-SS, S-SS, PBCH, PCFICH, RS, PDCCH, and PHICH. There are also several other PDCCH and PHICH parameters.

Power Boost (for all physical channels except PHICH) specifies the expected average subcarrier power of a channel. When there are multiple antenna ports, the Power Boost value is split equally over all antenna ports.

For example, PBCH Power Boost is set to 0 dB. For a single-antenna signal, the expected average subcarrier power of PBCH would be 0 dB, but for a two-antenna signal, the expected average subcarrier power of PBCH per antenna port would be -3 dB.

This is done so that specifying a channel's Power Boost parameter is like specifying the average power of the channel being transmitted from the base station regardless of the number of transmit antennas.

NOTE When P-SS/S-SS Antenna Port is set to Port 0-3, the P-SS/S-SS Power Boost parameter specifies the expected average subcarrier power of P-SS/S-SS on the specified antenna port (in other words, the value is not split across all antenna ports). However, when P-SS/S-SS Antenna Port is set to All Port, then the Power Boost value is split across all antenna ports like the other channels.

Other power boost parameters are expressed relative to the 0 dB level set by RS Power Boost. A value of 2.5 dB for RS Power Boost specifies that the 0 dB level is set to be 2.5 dB below the measured RS power level.

For example, setting PBCH Power Boost to 0.5 dB for a single-antenna signal when RS Power Boost is set to 2.5 dB tells the demodulator to expect the PBCH power level to be 0.5 dB above the 0 dB level (which is 2.0 dB below the measured RS power level).

- Use Tab key to select a parameter field to edit. The rotary knob can be also used to select a parameter field as it has two functions: value adjustment (default) and field navigation. Use Enter key to toggle the function.
- In order to apply or discard changes, select OK button or Cancel button on the editor to show the corresponding softkeys and press either of them. These softkeys also appear by pressing Cancel (Esc) key when the active function is disabled.

NOTE

If Help is open when you select this key, the dialog and menu does not appear. Close Help by pressing **Cancel (Esc)**, then select this key. After the menu has changed, press the green **Help** key to see Help for the dialog and keys. Close Help when you are ready to edit the parameters.

Key Path	Meas Setup, Chan Profile Setup, More
Mode	LTE, LTETDD
Initial S/W Revision	Prior to A.02.00
Modified at S/W Revision	A.03.00

P-SS Power Boost

Sets the Power Boost value for the P-SS.

Key Path	Meas Setup, Chan Profile Setup, Edit Control Channels, P-SS
Mode	LTE, LTETDD
Remote Command	[:SENSe] :EVM:DLINk:PROFile:PSS:PWRBoost <rel_ampl> [:SENSe] :EVM:DLINk:PROFile:PSS:PWRBoost?
Example	EVM:DLIN:PROF:PSS:PWRB 0.65 EVM:DLIN:PROF:PSS:PWRB?
Notes	Changes to this parameter willChanges to this parameter will not be applied until Update Changes command is sent. See " RB Parameter Manager (Downlink) " on page 2012 section for more details.
Dependencies	Grayed out when Auto Detect Control Channel Power Levels is ON.
Preset	0 dB
State Saved	Saved in instrument state.
Min	-100 dB
Max	100 dB
Initial S/W Revision	Prior to A.02.00
Modified at S/W Revision	A.03.00, A.04.20

S-SS Power Boost

Sets the Power Boost value for the S-SS.

Key Path	Meas Setup, Chan Profile Setup, Edit Control Channels, S-SS
----------	---

Mode	LTE, LTETDD
Remote Command	[:SENSe] :EVM:DLINK:PROFile:SSS:PWRBoost <rel_ampl> [:SENSe] :EVM:DLINK:PROFile:SSS:PWRBoost?
Example	EVM:DLIN:PROF:SSS:PWRB 0.65 EVM:DLIN:PROF:SSS:PWRB?
Notes	Changes to this parameter will not be applied until Update Changes command is sent. See "RB Parameter Manager (Downlink)" on page 2012 section for more details.
Dependencies	Grayed out when Auto Detect Control Channel Power Levels is ON.
Preset	0 dB
State Saved	Saved in instrument state.
Min	-100 dB
Max	100 dB
Initial S/W Revision	Prior to A.02.00
Modified at S/W Revision	A.03.00, A.04.20

PBCH Power Boost

Sets the Power Boost value for the PBCH.

Key Path	Meas Setup, Chan Profile Setup, Edit Control Channels, PBCH
Mode	LTE, LTETDD
Remote Command	[:SENSe] :EVM:DLINK:PROFile:PBCH:PWRBoost <rel_ampl> [:SENSe] :EVM:DLINK:PROFile:PBCH:PWRBoost?
Example	EVM:DLIN:PROF:PBCH:PWRB 0 EVM:DLIN:PROF:PBCH:PWRB?
Notes	Changes to this parameter will not be applied until Update Changes command is sent. See "RB Parameter Manager (Downlink)" on page 2012 section for more details.
Dependencies	Grayed out when Auto Detect Control Channel Power Levels is ON.
Preset	0 dB
State Saved	Saved in instrument state.
Min	-100 dB
Max	100 dB
Initial S/W Revision	Prior to A.02.00
Modified at S/W Revision	A.03.00, A.04.20

PCFICH Power Boost

Sets the Power Boost value for the PCFICH.

Key Path	Meas Setup, Chan Profile Setup, Edit Control Channels, PCFICH
Mode	LTE, LTETDD
Remote Command	[:SENSe] :EVM:DLINk:PROFile:PCFich:PWRBoost <rel_ampl> [:SENSe] :EVM:DLINk:PROFile:PCFich:PWRBoost?
Example	EVM:DLIN:PROF:PCF:PWRB 0 EVM:DLIN:PROF:PCF:PWRB?
Notes	Changes to this parameter will not be applied until Update Changes command is sent. See "RB Parameter Manager (Downlink)" on page 2012 section for more details.
Dependencies	Grayed out when Auto Detect Control Channel Power Levels is ON.
Preset	0 dB
State Saved	Saved in instrument state.
Min	-100 dB
Max	100 dB
Initial S/W Revision	Prior to A.02.00
Modified at S/W Revision	A.03.00, A.04.20

C-RS Power Boost

Sets the Power Boost value for the C-RS.

The 0 dB level is set by C-RS Power Boost. A value of 2.5 dB for C-RS Power Boost specifies that the 0 dB level is set to be 2.5 dB below the measured C-RS power level. Other Power Boosts (P-SS, S-SS, PBCH, PCFICH, PDCCH and PHICH) are set relative to the 0 dB level. For example, setting PBCH Power Boost to 0.5 dB when C-RS Power Boost is set to 2.5 dB tells the demodulator to expect the average PBCH power level to be 0.5 dB above the 0 dB level (which is 2.5 dB below the measured C-RS power level).

Key Path	Meas Setup, Chan Profile Setup, Edit Control Channels, C-RS
Mode	LTE, LTETDD
Remote Command	[:SENSe] :EVM:DLINk:PROFile:RS:PWRBoost <rel_ampl> [:SENSe] :EVM:DLINk:PROFile:RS:PWRBoost?
Example	EVM:DLIN:PROF:RS:PWRB 2.50 EVM:DLIN:PROF:RS:PWRB?
Notes	Changes to this parameter will not be applied until Update Changes command is sent. See "RB Parameter Manager (Downlink)" on page 2012 section for more details.
Preset	0 dB
State Saved	Saved in instrument state.
Min	-100 dB
Max	100 dB
Initial S/W Revision	Prior to A.02.00
Modified at S/W Revision	A.03.00, A.04.20, A.13.00

Auto Detect Control Channel Power Levels

Selects whether or not power levels are autodetected for control channels: P-SS, S-SS, PBCH, PCFICH, PDCCH and PHICH.

- ON – The power levels are auto detected for downlink control channels : P-SS, S-SS, PBCH, PCFICH, PDCCH and PHICH.
- OFF - The power boosts for downlink control channels need to be specified for EVM calculations to be correct.

Key Path	Meas Setup, Chan Profile, Edit Control Channels
Mode	LTE, LTETDD
Remote Command	[:SENSe] :EVM:DLINk:PROFile:AUTO[:DETEct]:CCPower OFF ON 0 1 [:SENSe] :EVM:DLINk:PROFile:AUTO[:DETEct]:CCPower?
Example	EVM:DLIN:PROF:AUTO:CCP ON EVM:DLIN:PROF:AUTO:CCP?
Preset	ON
State Saved	Saved in instrument state.
Range	On Off
Initial S/W Revision	A.14.00

PDCCH

Displays a menu that enables the configuration of PDCCH parameters.

Key Path	Meas Setup, Chan Profile Setup, Edit Control Channels
Mode	LTE, LTETDD
Initial S/W Revision	Prior to A.02.00
Modified at S/W Revision	A.03.00

PDCCH Power Boost

Sets the Power Boost value for the PDCCH.

When RB Auto Detect Mode is set to Decoded PDCCH, PDCCH power boost (see the section Edit Control Channels for description of Power Boost parameters) can be auto detected by specifying a starting value in this parameter and setting the granularity of the search in the PDCCH Power Boost Step. The demodulator will detect PDCCH power as

$$\text{PDCCH power} = (\text{PDCCH Power Boost} + k * \text{PDCCH Power Boost Step})$$

where k in the range $-10 \text{ dB} \leq k * \text{PDCCH Power Boost Step} \leq 10 \text{ dB}$ is the value that brings the equation closest to the actual PDCCH power.

Key Path	Meas Setup, Chan Profile Setup, Edit Control Channels
Mode	LTE, LTETDD
Remote Command	[:SENSe] :EVM:DLINk:PROFile:PDCCCh:PWRBoost <rel_ampl> [:SENSe] :EVM:DLINk:PROFile:PDCCCh:PWRBoost?
Example	EVM:DLIN:PROF:PDCC:PWRB 0 EVM:DLIN:PROF:PDCC:PWRB?
Notes	Changes to this parameter will not be applied until Update Changes command is sent. See " RB Parameter Manager (Downlink) " on page 2012 section for more details.
Dependencies	Grayed out when Auto Detect Control Channel Power Levels is ON.
Preset	0 dB
State Saved	Saved in instrument state.
Min	-100 dB
Max	100 dB
Initial S/W Revision	Prior to A.02.00
Modified at S/W Revision	A.03.00, A.04.20

PDCCH Power Boost Step (+/- Increments (dB))

Sets the Power Boost Step value for the PDCCH. See section "[PDCCH Power Boost](#)" on page 1902 for more details.

Key Path	Meas Setup, Chan Profile Setup, Edit Control Channels
Mode	LTE, LTETDD
Remote Command	[:SENSe] :EVM:DLINk:PROFile:PDCCCh:PWRBoost:STEP <rel_ampl> [:SENSe] :EVM:DLINk:PROFile:PDCCCh:PWRBoost:STEP?
Example	EVM:DLIN:PROF:PDCC:PWRB:STEP 0 EVM:DLIN:PROF:PDCC:PWRB:STEP?
Notes	Changes to this parameter will not be applied until Update Changes command is sent. See " RB Parameter Manager (Downlink) " on page 2012 for more details.
Dependencies	Available when Auto Detect Control Channel Power Levels is OFF, Detection is Auto and RB Auto Detect Mode is Decoded PDCCH, or Auto Detect Control Channel Power Levels is OFF, Detection is Auto and PDCCH Decoding is other than NONE.
Preset	1 dB
State Saved	Saved in instrument state.
Min	-100 dB
Max	100 dB
Initial S/W Revision	A.10.00

PDCCH Allocation Auto Detect

Determines whether or not the number of PDCCH symbols is autodetected. When On, the analyzer will autodetect the PDCCH allocations by decoding PCFICH.

To view the detected number of PDCCH allocations per subframe, use the # PDCCH SymPerSubframe data result on the DL Decode Info summary table.

Key Path	Meas Setup, Chan Profile Setup, Edit Control Channels Alloc
Mode	LTE, LTETDD
Remote Command	[:SENSe]:EVM:DLINk:PROFile:PDCCh:ALLocation:AUTO[:DETECT] OFF ON 0 1 [:SENSe]:EVM:DLINk:PROFile:PDCCh:ALLocation:AUTO[:DETECT]?
Example	EVM:DLIN:PROF:PDCC:ALL:AUTO 1 EVM:DLIN:PROF:PDCC:ALL:AUTO?
Notes	Changes to this parameter will not be applied until Update Changes command is sent. See " RB Parameter Manager (Downlink) " on page 2012 section for more details.
Preset	ON
State Saved	Saved in instrument state.
Range	On Off
Initial S/W Revision	A.06.00

PDCCH Allocation Constant

Selects whether or not all the Subframes will use PDCCH Allocation Subframe 0 value.

Key Path	Meas Setup, Chan Profile Setup, Edit Control Channels
Mode	LTE
Remote Command	[:SENSe]:EVM:DLINk:PROFile:PDCCh:ALLocation:CONStant OFF ON 0 1 [:SENSe]:EVM:DLINk:PROFile:PDCCh:ALLocation:CONStant?
Example	EVM:DLIN:PROF:PDCC:ALL:CONS ON EVM:DLIN:PROF:PDCC:ALL:CONS?
Notes	Changes to this parameter will not be applied until Update Changes command is sent. See " RB Parameter Manager (Downlink) " on page 2012 section for more details.
Dependencies	LTE FDD only. Available when PDCCH Allocation Auto Detect is Off.
Couplings	When this parameter is On, all Subframes will use PDCCH Allocation Subframe 0 value.
Preset	ON
State Saved	Saved in instrument state.
Initial S/W Revision	Prior to A.02.00
Modified at S/W Revision	A.03.00

PDCCH Allocation Subframe 0

Sets the PDCCH Allocation (Symbols per Subframe) for Subframe 0.

Key Path	Meas Setup, Chan Profile Setup, Edit Control Channels
Mode	LTE, LTETDD
Remote Command	[:SENSe] :EVM:DLINk:PROFile:PDCCh:ALLocation:SUBFrame0:SYMBOLs <integer> [:SENSe] :EVM:DLINk:PROFile:PDCCh:ALLocation:SUBFrame0:SYMBOLs?
Example	EVM:DLIN:PROF:PDCC:ALL:SUBF0:SYMB 1 EVM:DLIN:PROF:PDCC:ALL:SUBF0:SYMB?
Notes	Changes to this parameter will not be applied until Update Changes command is sent. See " RB Parameter Manager (Downlink) " on page 2012 section for more details.
Dependencies	When PDCCH Allocation Constant is On, all subframes will use this value. Available when PDCCH Allocation Auto Detect is Off.
Preset	3
State Saved	Saved in instrument state.
Min	0
Max	3 – Bandwidth 3 MHz, 5 MHz, 10 MHz, 15 MHz, 20 MHz 4 – Bandwidth 1.4 MHz
Initial S/W Revision	Prior to A.02.00
Modified at S/W Revision	A.03.00

PDCCH Allocation Subframe 1

Sets the PDCCH Allocation (Symbols per Subframe) for Subframe 1.

Key Path	Meas Setup, Chan Profile Setup, Edit Control Channels
Mode	LTE, LTETDD
Remote Command	[:SENSe] :EVM:DLINk:PROFile:PDCCh:ALLocation:SUBFrame1:SYMBOLs <integer> [:SENSe] :EVM:DLINk:PROFile:PDCCh:ALLocation:SUBFrame1:SYMBOLs?
Example	EVM:DLIN:PROF:PDCC:ALL:SUBF1:SYMB 1 EVM:DLIN:PROF:PDCC:ALL:SUBF1:SYMB?
Notes	Changes to this parameter will not be applied until Update Changes command is sent. See " RB Parameter Manager (Downlink) " on page 2012 section for more details.
Dependencies	Available when both PDCCH Allocation Auto Detect and PDCCH Allocation Constant are OFF.
Preset	3
State Saved	Saved in instrument state.
Min	0
Max	3 – Bandwidth 3 MHz, 5 MHz, 10 MHz, 15 MHz, 20 MHz 4 – Bandwidth 1.4 MHz
Initial S/W Revision	Prior to A.02.00
Modified at S/W Revision	A.03.00

PDCCH Allocation Subframe 2

Sets the PDCCH Allocation (Symbols per Subframe) for Subframe 2.

Key Path	Meas Setup, Chan Profile Setup, Edit Control Channels
Mode	LTE, LTETDD
Remote Command	[:SENSe]:EVM:DLINK:PROFile:PDCCh:ALLocation:SUBFrame2:SYMBOLs <integer> [:SENSe]:EVM:DLINK:PROFile:PDCCh:ALLocation:SUBFrame2:SYMBOLs?
Example	EVM:DLIN:PROF:PDCC:ALL:SUBF2:SYMB 1 EVM:DLIN:PROF:PDCC:ALL:SUBF2:SYMB?
Notes	Changes to this parameter will not be applied until Update Changes command is sent. See " RB Parameter Manager (Downlink) " on page 2012 section for more details.
Dependencies	Available when both PDCCH Allocation Auto Detect and PDCCH Allocation Constant are OFF.
Preset	3
State Saved	Saved in instrument state.
Min	0
Max	3 – Bandwidth 3 MHz, 5 MHz, 10 MHz, 15 MHz, 20 MHz 4 – Bandwidth 1.4 MHz
Initial S/W Revision	Prior to A.02.00
Modified at S/W Revision	A.03.00

PDCCH Allocation Subframe 3

Sets the PDCCH Allocation (Symbols per Subframe) for Subframe 3.

Key Path	Meas Setup, Chan Profile Setup, Edit Control Channels
Mode	LTE, LTETDD
Remote Command	[:SENSe]:EVM:DLINK:PROFile:PDCCh:ALLocation:SUBFrame3:SYMBOLs <integer> [:SENSe]:EVM:DLINK:PROFile:PDCCh:ALLocation:SUBFrame3:SYMBOLs?
Example	EVM:DLIN:PROF:PDCC:ALL:SUBF3:SYMB 1 EVM:DLIN:PROF:PDCC:ALL:SUBF3:SYMB?
Notes	Changes to this parameter will not be applied until Update Changes command is sent. See " RB Parameter Manager (Downlink) " on page 2012 section for more details.
Dependencies	Available when both PDCCH Allocation Auto Detect and PDCCH Allocation Constant are OFF.
Preset	3
State Saved	Saved in instrument state.
Min	0
Max	3 – Bandwidth 3 MHz, 5 MHz, 10 MHz, 15 MHz, 20 MHz 4 – Bandwidth 1.4 MHz
Initial S/W Revision	Prior to A.02.00
Modified at S/W Revision	A.03.00

PDCCH Allocation Subframe 4

Sets the PDCCH Allocation (Symbols per Subframe) for Subframe 4.

Key Path	Meas Setup, Chan Profile Setup, Edit Control Channels
Mode	LTE, LTETDD
Remote Command	[:SENSe] :EVM:DLINk:PROFile:PDCCh:ALLocation:SUBFrame4:SYMBOLs <integer> [:SENSe] :EVM:DLINk:PROFile:PDCCh:ALLocation:SUBFrame4:SYMBOLs?
Example	EVM:DLIN:PROF:PDCC:ALL:SUBF4:SYMB 1 EVM:DLIN:PROF:PDCC:ALL:SUBF4:SYMB?
Notes	Changes to this parameter will not be applied until Update Changes command is sent. See " RB Parameter Manager (Downlink) " on page 2012 section for more details.
Dependencies	Available when both PDCCH Allocation Auto Detect and PDCCH Allocation Constant are OFF.
Preset	3
State Saved	Saved in instrument state.
Min	0
Max	3 – Bandwidth 3 MHz, 5 MHz, 10 MHz, 15 MHz, 20 MHz 4 – Bandwidth 1.4 MHz
Initial S/W Revision	Prior to A.02.00
Modified at S/W Revision	A.03.00

PDCCH Allocation Subframe 5

Sets the PDCCH Allocation (Symbols per Subframe) for Subframe 5.

Key Path	Meas Setup, Chan Profile Setup, Edit Control Channels
Mode	LTE, LTETDD
Remote Command	[:SENSe] :EVM:DLINk:PROFile:PDCCh:ALLocation:SUBFrame5:SYMBOLs <integer> [:SENSe] :EVM:DLINk:PROFile:PDCCh:ALLocation:SUBFrame5:SYMBOLs?
Example	EVM:DLIN:PROF:PDCC:ALL:SUBF5:SYMB 1 EVM:DLIN:PROF:PDCC:ALL:SUBF5:SYMB?
Notes	Changes to this parameter will not be applied until Update Changes command is sent. See " RB Parameter Manager (Downlink) " on page 2012 section for more details.
Dependencies	Available when both PDCCH Allocation Auto Detect and PDCCH Allocation Constant are OFF.
Preset	3
State Saved	Saved in instrument state.
Min	0
Max	3 – Bandwidth 3 MHz, 5 MHz, 10 MHz, 15 MHz, 20 MHz 4 – Bandwidth 1.4 MHz
Initial S/W Revision	Prior to A.02.00
Modified at S/W Revision	A.03.00

PDCCH Allocation Subframe 6

Sets the PDCCH Allocation (Symbols per Subframe) for Subframe 6.

Key Path	Meas Setup, Chan Profile Setup, Edit Control Channels
Mode	LTE, LTETDD
Remote Command	[:SENSe]:EVM:DLINK:PROFile:PDCCh:ALLocation:SUBFrame6:SYMBOLs <integer> [:SENSe]:EVM:DLINK:PROFile:PDCCh:ALLocation:SUBFrame6:SYMBOLs?
Example	EVM:DLIN:PROF:PDCC:ALL:SUBF6:SYMB 1 EVM:DLIN:PROF:PDCC:ALL:SUBF6:SYMB?
Notes	Changes to this parameter will not be applied until Update Changes command is sent. See " RB Parameter Manager (Downlink) " on page 2012 section for more details.
Dependencies	Available when both PDCCH Allocation Auto Detect and PDCCH Allocation Constant are OFF.
Preset	3
State Saved	Saved in instrument state.
Min	0
Max	3 – Bandwidth 3 MHz, 5 MHz, 10 MHz, 15 MHz, 20 MHz 4 – Bandwidth 1.4 MHz
Initial S/W Revision	Prior to A.02.00
Modified at S/W Revision	A.03.00

PDCCH Allocation Subframe 7

Sets the PDCCH Allocation (Symbols per Subframe) for Subframe 7.

Key Path	Meas Setup, Chan Profile Setup, Edit Control Channels
Mode	LTE, LTETDD
Remote Command	[:SENSe]:EVM:DLINK:PROFile:PDCCh:ALLocation:SUBFrame7:SYMBOLs <integer> [:SENSe]:EVM:DLINK:PROFile:PDCCh:ALLocation:SUBFrame7:SYMBOLs?
Example	EVM:DLIN:PROF:PDCC:ALL:SUBF7:SYMB 1 EVM:DLIN:PROF:PDCC:ALL:SUBF7:SYMB?
Notes	Changes to this parameter will not be applied until Update Changes command is sent. See " RB Parameter Manager (Downlink) " on page 2012 section for more details.
Dependencies	Available when both PDCCH Allocation Auto Detect and PDCCH Allocation Constant are OFF.
Preset	3
State Saved	Saved in instrument state.
Min	0
Max	3 – Bandwidth 3 MHz, 5 MHz, 10 MHz, 15 MHz, 20 MHz 4 – Bandwidth 1.4 MHz
Initial S/W Revision	Prior to A.02.00
Modified at S/W Revision	A.03.00

PDCCH Allocation Subframe 8

Sets the PDCCH Allocation (Symbols per Subframe) for Subframe 8.

Key Path	Meas Setup, Chan Profile Setup, Edit Control Channels
Mode	LTE, LTETDD
Remote Command	[:SENSe] :EVM:DLINk:PROFile:PDCCh:ALLocation:SUBFrame8:SYMBOLs <integer> [:SENSe] :EVM:DLINk:PROFile:PDCCh:ALLocation:SUBFrame8:SYMBOLs?
Example	EVM:DLIN:PROF:PDCC:ALL:SUBF8:SYMB 1 EVM:DLIN:PROF:PDCC:ALL:SUBF8:SYMB?
Notes	Changes to this parameter will not be applied until Update Changes command is sent. See " RB Parameter Manager (Downlink) " on page 2012 section for more details.
Dependencies	Available when both PDCCH Allocation Auto Detect and PDCCH Allocation Constant are OFF.
Preset	3
State Saved	Saved in instrument state.
Min	0
Max	3 – Bandwidth 3 MHz, 5 MHz, 10 MHz, 15 MHz, 20 MHz 4 – Bandwidth 1.4 MHz
Initial S/W Revision	Prior to A.02.00
Modified at S/W Revision	A.03.00

PDCCH Allocation Subframe 9

Sets the PDCCH Allocation (Symbols per Subframe) for Subframe 9.

Key Path	Meas Setup, Chan Profile Setup, Edit Control Channels
Mode	LTE, LTETDD
Remote Command	[:SENSe] :EVM:DLINk:PROFile:PDCCh:ALLocation:SUBFrame9:SYMBOLs <integer> [:SENSe] :EVM:DLINk:PROFile:PDCCh:ALLocation:SUBFrame9:SYMBOLs?
Example	EVM:DLIN:PROF:PDCC:ALL:SUBF9:SYMB 1 EVM:DLIN:PROF:PDCC:ALL:SUBF9:SYMB?
Notes	Changes to this parameter will not be applied until Update Changes command is sent. See " RB Parameter Manager (Downlink) " on page 2012 section for more details.
Dependencies	Available when both PDCCH Allocation Auto Detect and PDCCH Allocation Constant are OFF.
Preset	3
State Saved	Saved in instrument state.
Min	0
Max	3 – Bandwidth 3 MHz, 5 MHz, 10 MHz, 15 MHz, 20 MHz 4 – Bandwidth 1.4 MHz
Initial S/W Revision	Prior to A.02.00
Modified at S/W Revision	A.03.00

PHICH

Displays a menu that enables configuration of PHICH parameters.

Key Path	Meas Setup, Chan Profile Setup, Edit Control Channels
Mode	LTE, LTETDD
Initial S/W Revision	Prior to A.02.00
Modified at S/W Revision	A.03.00

PHICH Power Boost

Sets the Power Boost value for the PHICH.

PHICH power boost specifies the BPSK symbol power of each PHICH sequence (unlike the Power Boost for the other channels, which are per-subcarrier). Since each PHICH sequence can potentially have a different BPSK symbol power, provision has been made to auto-detect it by specifying a starting value in this parameter and setting the granularity of the search in the PHICH Power Boost Step. The demodulator will detect each PHICH sequence's BPSK symbol power as

$$\text{PHICH power} = (\text{PHICH Power Boost} + k * \text{PHICH Power Boost Step})$$

where k in the range $-10 \text{ dB} \leq k * \text{PHICH Power Boost Step} \leq 10 \text{ dB}$ is the value that brings the equation closest to the actual PHICH BPSK symbol power. Note that setting the PHICH Power Boost Step to 0 dB effective turns off auto-detection of power.

Key Path	Meas Setup, Chan Profile Setup, Edit Control Channels
Mode	LTE, LTETDD
Remote Command	<code>[:SENSe] :EVM:DLINK:PROFile:PHICH:PWRBoost <rel_ampl></code> <code>[:SENSe] :EVM:DLINK:PROFile:PHICH:PWRBoost?</code>
Example	<code>EVM:DLIN:PROF:PHIC:PWRB 0</code> <code>EVM:DLIN:PROF:PHIC:PWRB?</code>
Notes	Changes to this parameter will not be applied until Update Changes command is sent. See " RB Parameter Manager (Downlink) " on page 2012 section for more details.
Dependencies	Grayed out when Auto Detect Control Channel Power Levels is ON.
Preset	0 dB
State Saved	Saved in instrument state.
Min	-100 dB
Max	100 dB
Initial S/W Revision	Prior to A.02.00
Modified at S/W Revision	A.03.00
Modified at S/W Revision	A.04.20

PHICH Power Boost Step (+/- Increments (dB))

Sets the Power Boost Step value for the PHICH. See ["PHICH Power Boost" on page 1910](#) for details.

Key Path	Meas Setup, Chan Profile Setup, Edit Control Channels
Mode	LTE, LTE-TDD
Remote Command	[:SENSe] :EVM:DLINk:PROFile:PHICH:PWRBoost:STEP <rel_amp1>+ [:SENSe] :EVM:DLINk:PROFile:PHICH:PWRBoost:STEP?
Example	EVM:DLIN:PROF:PHIC:PWRB:STEP 0 EVM:DLIN:PROF:PHIC:PWRB:STEP?
Notes	Changes to this parameter will not be applied until Update Changes command is sent. See "RB Parameter Manager (Downlink)" on page 2012 section for more details.
Dependencies	Grayed out when Auto Detect Control Channel Power Levels is ON.
Preset	1 dB
State Saved	Saved in instrument state.
Min	-100 dB
Max	100 dB
Initial S/W Revision	A.03.00, A.04.20

Despread IQ Orthogonal Sequence Index

Determines the state of Despread IQ Orthogonal Sequence Index.

When set to OFF, displays the PHICH constellation points as received. These points are the summation of all weighted PHICH sequences within the same PHICH group.

When set to ON, the traces to show PHICH constellation points after despreading. Despreading arbitrarily remaps the demodulated values of individual PHICH sequences onto the I and Q values of the subcarriers containing those sequences.

EVM measurements are always calculated from PHICH IQ points before despreading.

Each PHICH can take on values in the set $\{-1, 0, 1\}$ which is translated as $\{\text{NACK, Inactive, ACK}\}$.

PHICH mapping for Normal CP Length		
Subcarrier in a PHICH group	Re{{Subcarrier x}} value	Imag{{Subcarrier x}} value
Subcarrier 0	PHICH0	PHICH4
Subcarrier 1	PHICH1	PHICH5
Subcarrier 2	PHICH2	PHICH6
Subcarrier 3	PHICH3	PHICH7

PHICH mapping for Extended CP Length		
Subcarrier in a PHICH group	Re{{Subcarrier x}} value	Imag{{Subcarrier x}} value

Subcarrier 0	PHICH0	PHICH2
Subcarrier 1	PHICH1	PHICH3

Each PHICH subcarrier IQ point represents the values for the two PHICHs determined by the tables above. The image below provides a quick reference to the actual PHICH values for each constellation point in the form (I,Q).

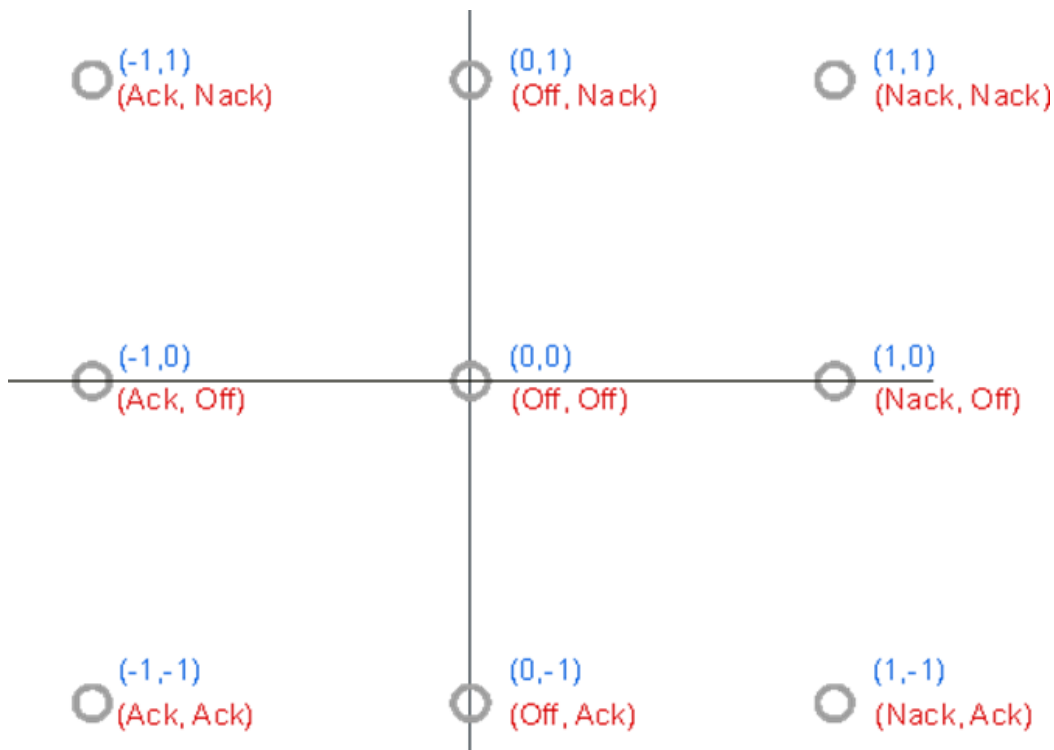

For example, the Subcarrier 1 IQ point in a PHICH group is at (1,0). For a signal with Normal PHICH duration, Subcarrier 1 contains the values for PHICH1 and PHICH5; therefore, PHICH1=Nack and PHICH5=Off.

The PHICH sequence values are mapped to the hex digits in the following order for each PHICH group:

- For Extended CP, the order is PHICH index {{0, 2, 1, 3}}

When the Symbol Table format is shown in binary, the same mapping order and values are used, but the even-indexed hex digits are truncated to two bits.

The actual ACK/NACK/Inactive information contained in PHICH can also be viewed in the DL Decode Info table.

Key Path	Meas Setup, Chan Profile Setup, Edit Control Channels
Mode	LTE, LTETDD
Remote Command	[:SENSe] :EVM:DLINK:PROfile:PHICH:DESPread OFF ON 0 1 [:SENSe] :EVM:DLINK:PROfile:PHICH:DESPread?

Example	EVM:DLIN:PROF:PHIC:DESP OFF EVM:DLIN:PROF:PHIC:DESP?
Notes	Changes to this parameter will not be applied until Update Changes command is sent. See " RB Parameter Manager (Downlink) " on page 2012 section for more details.
Preset	OFF
State Saved	Saved in instrument state.
Initial S/W Revision	Prior to A.02.00
Modified at S/W Revision	A.03.00

PHICH Allocation (Ng)

Selects the Ng value used in computing the number of resource element groups. Allocation (Ng) is a higher layer parameter configured from the set (1/6, 1/2, 1, 2) that determines the number of PHICH groups per subframe.

- ADETect - Allocation (Ng) will be detected from PBCH.
- R1BY6 - Ng = 1/6
- R1BY2 - Ng = 1/2
- R1 - Ng = 1
- R2 - Ng = 2

The number of PHICH groups in a subframe is given by the equation for NgroupPHICH in Section 6.9 of 3GPP TS 36.211.

Key Path	Meas Setup, Chan Profile Setup, Edit Control Channels
Mode	LTE, LTETDD
Remote Command	[:SENSE] :EVM:DLINK:PROF:PHIC:ALLOCATION:RATIO ADETect R1BY6 R1BY2 R1 R2 [:SENSE] :EVM:DLINK:PROF:PHIC:ALLOCATION:RATIO?
Example	EVM:DLIN:PROF:PHIC:ALL:RAT R1 EVM:DLIN:PROF:PHIC:ALL:RAT?
Notes	Changes to this parameter will not be applied until Update Changes command is sent. See " RB Parameter Manager (Downlink) " on page 2012 section for more details.
Dependencies	Available when Direction is Downlink.
Preset	ADETect
State Saved	Saved in instrument state.
Range	Auto Detect Ng 1/6 Ng 1/2 Ng 1 Ng 2
Initial S/W Revision	Prior to A.02.00
Modified at S/W Revision	A.03.00, A.06.00

Auto Detect

When Auto Detect is selected, Allocation (Ng) will be detected from PBCH.

Key Path	Meas Setup, Chan Profile Setup, Edit Control Channels
Mode	LTE, LTETDD
Initial S/W Revision	A.06.00

Ng 1/6

Selects 1/6 for the Ng value used in computing the number of resource element groups.

Key Path	Meas Setup, Chan Profile Setup, Edit Control Channels
Mode	LTE, LTETDD
Initial S/W Revision	Prior to A.02.00
Modified at S/W Revision	A.03.00

Ng 1/2

Selects 1/2 for the Ng value used in computing the number of resource element groups.

Key Path	Meas Setup, Chan Profile Setup, Edit Control Channels
Mode	LTE, LTETDD
Initial S/W Revision	Prior to A.02.00
Modified at S/W Revision	A.03.00

Ng 1

Selects 1 for the Ng value used in computing the number of resource element groups.

Key Path	Meas Setup, Chan Profile Setup, Edit Control Channels
Mode	LTE, LTETDD
Initial S/W Revision	Prior to A.02.00
Modified at S/W Revision	A.03.00

Ng 2

Selects 2 for the Ng value used in computing the number of resource element groups.

Key Path	Meas Setup, Chan Profile Setup, Edit Control Channels
Mode	LTE, LTETDD
Initial S/W Revision	Prior to A.02.00
Modified at S/W Revision	A.03.00

PHICH Duration

Selects the number of symbols used in each PHICH subframe.

PHICH duration is a higher layer parameter configured either as Normal or Extended that tells the demodulator how many symbols per subframe are used by PHICH.

- ADEtect - PHICH Duration can be autodetected from PBCH
- NORMal - There are 8 PHICH sequences in one PHICH group
- EXTended - There are 4 PHICH sequences in one PHICH group

Key Path	Meas Setup, Chan Profile Setup, Edit Control Channels
Mode	LTE, LTETDD
Remote Command	[:SENSE] :EVM:DLINK:PROFile:PHICH:DURation ADEtect NORMal EXTended [:SENSE] :EVM:DLINK:PROFile:PHICH:DURation?
Example	EVM:DLIN:PROF:PHIC:DUR NORM EVM:DLIN:PROF:PHIC:DUR?
Notes	Changes to this parameter will not be applied until Update Changes command is sent. See " RB Parameter Manager (Downlink) " on page 2012 section for more details.
Dependencies	Available when Direction is Downlink.
Preset	ADEtect
State Saved	Saved in instrument state.
Range	Auto Detect Normal Extended
Initial S/W Revision	Prior to A.02.00
Modified at S/W Revision	A.03.00, A.06.00

Auto Detect

When Auto Detect is selected, PHICH Duration can be autodetected from PBCH

Key Path	Meas Setup, Chan Profile Setup, Edit Control Channels, PHICH Duration
Mode	LTE, LTETDD
Initial S/W Revision	A.06.00

Normal

Selects Normal for the PHICH duration.

Key Path	Meas Setup, Chan Profile Setup, Edit Control Channels, PHICH Duration
Mode	LTE, LTETDD
Initial S/W Revision	Prior to A.02.00
Modified at S/W Revision	A.03.00

Extended

Selects Extended for the PHICH duration.

Key Path	Meas Setup, Chan Profile Setup, Edit Control Channels, PHICH Duration
Mode	LTE, LTETDD
Initial S/W Revision	Prior to A.02.00
Modified at S/W Revision	A.03.00

M_i Definition

Selects which specification the factor M_i is set to. The factor M_i is originally defined in 3GPP TS36.211 Table 6.9–1 and it is used to specify the number of PHICH groups which may vary between downlink subframes.

The M_i parameter determines how many PHICH groups are in each downlink subframe for TDD mode. The values for M_i depend on the uplink-downlink configuration and are given by Table 6.9–1 in 3GPP TS 36.211. However, 3GPP TS 36.141, section 6.1.2.6 specifies that M_i must be set to 1 when performing E-TM tests. This is to provide consistency between FDD and TDD test results.

- STD - Standard, the expected values of M_i are given by Table 6.9–1 in 3GPP TS36.211
- ETM - E-TM, M_i is expected to equal 1 in all downlink subframes

Key Path	Meas Setup, Chan Profile Setup, Edit Control Channels
Mode	LTETDD
Remote Command	[:SENSe] :EVM:DLINk:PROFile:PHICh:MIDefinition STD ETM [:SENSe] :EVM:DLINk:PROFile:PHICh:MIDefinition?
Example	EVM:DLIN:PROF:PHIC:MI STD
Notes	LTE TDD only. Changes to this parameter will not be applied until Update Changes command is sent. See " RB Parameter Manager (Downlink) " on page 2012 section for more details.
Dependencies	Available when Direction is Downlink. LTE TDD only.
Preset	STD
State Saved	Saved in instrument state.
Range	Standard E-TM
Initial S/W Revision	A.06.00

P- RS

Displays a menu that enables configuration of Positioning Reference Signals (P-RS) parameters.

P-RS parameters are transmitted on antenna port 6 at regularly spaced time and frequency locations. The measurement will provide support for analysis of P-RS transmitted on normal subframes. P-RS transmitted on MBSFN subframes will not be analyzed.

Key Path	Meas Setup, Chan Profile Setup, Edit Control Channels
Mode	LTE, LTETDD
Initial S/W Revision	A.11.00

P-RS Active

Selects whether or not the position reference signal exists in the input signal.

Key Path	Meas Setup, Chan Profile Setup, Edit Control Channels
Mode	LTE, LTETDD
Remote Command	[:SENSe] :EVM:DLINk:PROFile:PRS:ACTive OFF ON 0 1 [:SENSe] :EVM:DLINk:PROFile:PRS:ACTive?
Example	EVM:DLIN:PROF:PRS:ACT OFF EVM:DLIN:PROF:PRS:ACT?
Notes	Changes to this parameter will not be applied until Update Changes command is sent. See " RB Parameter Manager (Downlink) " on page 2012 section for more details.
Preset	OFF
State Saved	Saved in instrument state.
Range	On Off
Initial S/W Revision	A.11.00

P-RS Bandwidth

Sets the Bandwidth of the position reference signal, its unit is RBs.

Key Path	Meas Setup, Chan Profile Setup, Edit Control Channels
Mode	LTE, LTETDD
Remote Command	[:SENSe] :EVM:DLINk:PROFile:PRS:BANDwidth B1M4 B3M B5M B10M B15M B20M [:SENSe] :EVM:DLINk:PROFile:PRS:BANDwidth?
Example	EVM:DLIN:PROF:PRS:BAND B10M EVM:DLIN:PROF:PRS:BAND?
Notes	Changes to this parameter will not be applied until Update Changes command is sent. See " RB Parameter Manager (Downlink) " on page 2012 section for more details.
Dependencies	Available when P-RS Active is On. It is needed to set P-RS Active to On in advance. Otherwise, this key is grayed out.
Preset	B5M

State Saved	Saved in instrument state.
Range	1.4 MHz (6 RB) 3 MHz (15 RB) 5 MHz (25 RB) 10 MHz (50 RB) 15 MHz (75 RB) 20 MHz (100 RB)
Initial S/W Revision	A.11.00

P-RS Power Boost

Sets the Power Boost value for the P-RS channel.

Key Path	Meas Setup, Chan Profile Setup, Edit Control Channels
Mode	LTE, LTETDD
Remote Command	[:SENSe] :EVM:DLINK:PROFile:PRS:PWRBoost <rel_ampl> [:SENSe] :EVM:DLINK:PROFile:PRS:PWRBoost?
Example	EVM:DLIN:PROF:PRS:PWRB 2.0 EVM:DLIN:PROF:PRS:PWRB?
Notes	Changes to this parameter will not be applied until Update Changes command is sent. See " RB Parameter Manager (Downlink) " on page 2012 section for more details.
Dependencies	Available when P-RS Active is On, grayed out other wise.
Preset	0.0 dB
State Saved	Saved in instrument state.
Min	-100 dB
Max	100 dB
Initial S/W Revision	A.11.00

P-RS Config Index

Sets the configuration index of the position reference signal.

Key Path	Meas Setup, Chan Profile Setup, Edit Control Channels
Mode	LTE, LTETDD
Remote Command	[:SENSe] :EVM:DLINK:PROFile:PRS:INDex <integer> [:SENSe] :EVM:DLINK:PROFile:PRS:INDex?
Example	EVM:DLIN:PROF:PRS:IND 160 EVM:DLIN:PROF:PRS:IND?
Notes	Changes to this parameter will not be applied until Update Changes command is sent. See " RB Parameter Manager (Downlink) " on page 2012 section for more details.
Dependencies	Available when P-RS Active is On. Otherwise, this key is grayed out.
Preset	0
State Saved	Saved in instrument state.

Min	0
Max	2399
Initial S/W Revision	A.11.00

N_{PRS}

Sets the number of consecutive downlink subframes that the position reference signal shall be transmitted.

Key Path	Meas Setup, Chan Profile Setup, Edit Control Channels
Mode	LTE, LTETDD
Remote Command	[:SENSe] :EVM:DLINk:PROFile:PRS:SUBFrame:NUMBER N1 N2 N4 N6 [:SENSe] :EVM:DLINk:PROFile:PRS:SUBFrame:NUMBER?
Example	EVM:DLIN:PROF:PRS:SUBF:NUMB N6 EVM:DLIN:PROF:PRS:SUBF:NUMB?
Notes	Changes to this parameter will not be applied until Update Changes command is sent. See " RB Parameter Manager (Downlink) " on page 2012 section for more details. N1 means the consecutive downlink subframes number is 1. N2 means the consecutive downlink subframes number is 2. N4 means the consecutive downlink subframes number is 4. N6 means the consecutive downlink subframes number is 6.
Dependencies	Available when P-RS Active is On. Otherwise, this key is grayed out.
Preset	N1
State Saved	Saved in instrument state.
Range	N1 N2 N4 N6
Initial S/W Revision	A.11.00

MBSFN

Displays a menu that enables configuration of MBSFN parameters.

Key Path	Meas Setup, Chan Profile Setup, Edit Control Channels
Mode	LTE, LTETDD
Initial S/W Revision	A.11.00

MBSFN Active

Selects whether or not the MBSFN signal exists for this downlink user in the input signal.

Key Path	Meas Setup, Chan Profile Setup, Edit Control Channels
----------	---

Mode	LTE, LTETDD
Remote Command	[:SENSe] :EVM:DLINK:PROFile:MBSFn:ACTive OFF ON 0 1 [:SENSe] :EVM:DLINK:PROFile:MBSFn:ACTive?
Example	EVM:DLIN:PROF:MBSF:ACT OFF EVM:DLIN:PROF:MBSF:ACT?
Notes	Changes to this parameter will not be applied until Update Changes command is sent. See " RB Parameter Manager (Downlink) " on page 2012 section for more details.
Preset	OFF
State Saved	Saved in instrument state.
Range	On Off
Initial S/W Revision	A.11.00

MBSFN Area ID

Sets a value for Multimedia Broadcast Multicast Service Single Frequency Network Reference Signal (MBSFN) Area ID which identifies the MBSFN Area . It is used for the scrambling of the MBSFN Reference Signals and the Physical Multicast Channel (PMCH).

Key Path	Meas Setup, Chan Profile Setup, Edit Control Channels
Mode	LTE, LTETDD
Remote Command	[:SENSe] :EVM:DLINK:PROFile:MBSFn:AID <integer> [:SENSe] :EVM:DLINK:PROFile:MBSFn:AID?
Example	EVM:DLIN:PROF:MBSF:AID 1 EVM:DLIN:PROF:MBSF:AID?
Notes	Changes to this parameter will not be applied until Update Changes command is sent. See " RB Parameter Manager (Downlink) " on page 2012 section for more details.
Dependencies	Available when MBSFN Active is On. Otherwise, this key is grayed out.
Preset	0
State Saved	Saved in instrument state.
Min	0
Max	255
Initial S/W Revision	A.11.00

Non-MBSFN Region Length

Sets a value for Non-MBSFN region's symbol number.

A subset of the downlink subframes in a radio frame on a carrier supporting PDSCH transmission can be configured as MBSFN subframes by higher layers. Each MBSFN subframe is divided into a non-MBSFN region and an MBSFN region.

-The non-MBSFN region spans the first one or two OFDM symbols in an MBSFN. Transmission in the non-MBSFN region shall use the same cyclic prefix length as used for subframe 0.

-The MBSFN region in an MBSFN subframe is defined as the OFDM symbols not used for the non-MBSFN region.

Key Path	Meas Setup, Chan Profile Setup, Edit Control Channels
Mode	LTE, LTETDD
Remote Command	[:SENSE] :EVM:DLINK:PROFile:MBSFn:NMRLength <integer> [:SENSE] :EVM:DLINK:PROFile:MBSFN:NMRLength?
Example	EVM:DLIN:PROF:MBSF:NMRL 2 EVM:DLIN:PROF:MBSF:NMRL?
Notes	Changes to this parameter will not be applied until Update Changes command is sent. See " RB Parameter Manager (Downlink) " on page 2012 section for more details.
Dependencies	Available when MBSFN Active is On, grayed out otherwise.
Preset	1
State Saved	Saved in instrument state.
Min	1
Max	2
Initial S/W Revision	A.11.00

MBSFN-RS Power Boost (dB)

Sets the Power Boost value for MBSFN-RS channel.

Key Path	Meas Setup, Chan Profile Setup, Edit Control Channels
Mode	LTE, LTETDD
Remote Command	[:SENSE] :EVM:DLINK:PROFile:MBSFn:PWRBoost <rel_ampl> [:SENSE] :EVM:DLINK:PROFile:MBSFn:PWRBoost?
Example	EVM:DLIN:PROF:MBSF:PWRB 10.0 EVM:DLIN:PROF:MBSF:PWRB?
Notes	Changes to this parameter will not be applied until Update Changes command is sent. See " RB Parameter Manager (Downlink) " on page 2012 section for more details.
Dependencies	Available when MBSFN-RS Active is On. Otherwise, this key is grayed out.
Preset	0.0 dB
State Saved	Saved in instrument state.
Min	-100 dB
Max	100 dB
Initial S/W Revision	A.11.00

MBSFN Subframe1

The MBSFN subframe configuration defines subframes that are reserved for MBSFN in downlink. Sets Subframe1 to be reserved for MBSFN in downlink when Detection is Manual.

Key Path	Meas Setup, Chan Profile Setup, Edit Control Channels
Mode	LTE
Remote Command	[:SENSe] :EVM:DLINK:PROFile:MBSFn:SUBFrame1:ACTive OFF ON 0 1 [:SENSe] :EVM:DLINK:PROFile:MBSFn:SUBFrame1:ACTive?
Example	EVM:DLIN:PROF:MBSF:SUBF1:ACT ON EVM:DLIN:PROF:MBSF:SUBF1:ACT?
Notes	Changes to this parameter will not be applied until Update Changes command is sent. See " RB Parameter Manager (Downlink) " on page 2012 section for more details.
Dependencies	Available when the Mode is LTE. Available when MBSFN Active is On. Otherwise, this key is grayed out.
Preset	OFF
State Saved	Saved in instrument state.
Range	On Off
Initial S/W Revision	A.11.00

MBSFN Subframe2

Sets Subframe2 to be reserved for MBSFN in downlink when Detection is Manual.

Key Path	Meas Setup, Chan Profile Setup, Edit Control Channels
Mode	LTE
Remote Command	[:SENSe] :EVM:DLINK:PROFile:MBSFn:SUBFrame2:ACTive OFF ON 0 1 [:SENSe] :EVM:DLINK:PROFile:MBSFn:SUBFrame2:ACTive?
Example	EVM:DLIN:PROF:MBSF:SUBF2:ACT ON EVM:DLIN:PROF:MBSF:SUBF2:ACT?
Notes	Changes to this parameter will not be applied until Update Changes command is sent. See " RB Parameter Manager (Downlink) " on page 2012 section for more details.
Dependencies	Available when the Mode is LTE. Available when MBSFN Active is On. Otherwise, this key is grayed out.
Preset	OFF
State Saved	Saved in instrument state.
Range	On Off
Initial S/W Revision	A.11.00

MBSFN Subframe3

Sets Subframe3 to be reserved for MBSFN in downlink when Detection is Manual.

Key Path	Meas Setup, Chan Profile Setup, Edit Control Channels
Mode	LTE, LTETDD
Remote Command	[:SENSe] :EVM:DLINk:PROFile:MBSFn:SUBFrame3:ACTive OFF ON 0 1 [:SENSe] :EVM:DLINk:PROFile:MBSFn:SUBFrame3:ACTive?
Example	EVM:DLIN:PROF:MBSF:SUBF3:ACT ON EVM:DLIN:PROF:MBSF:SUBF3:ACT?
Notes	Changes to this parameter will not be applied until Update Changes command is sent. See " RB Parameter Manager (Downlink) " on page 2012 section for more details.
Dependencies	Available when MBSFN Active is On. Otherwise, this key is grayed out.
Preset	OFF
State Saved	Saved in instrument state.
Range	On Off
Initial S/W Revision	A.11.00

MBSFN Subframe4

Sets Subframe4 to be reserved for MBSFN in downlink when Detection is Manual.

Key Path	Meas Setup, Chan Profile Setup, Edit Control Channels
Mode	LTETDD
Remote Command	[:SENSe] :EVM:DLINk:PROFile:MBSFn:SUBFrame4:ACTive OFF ON 0 1 [:SENSe] :EVM:DLINk:PROFile:MBSFn:SUBFrame4:ACTive?
Example	EVM:DLIN:PROF:MBSF:SUBF4:ACT ON EVM:DLIN:PROF:MBSF:SUBF4:ACT?
Notes	Changes to this parameter will not be applied until Update Changes command is sent. See " RB Parameter Manager (Downlink) " on page 2012 section for more details.
Dependencies	Available when Mode is LTETDD. Available when MBSFN Active is On. Otherwise, this key is grayed out.
Preset	OFF
State Saved	Saved in instrument state.
Range	On Off
Initial S/W Revision	A.11.00

MBSFN Subframe6

Sets Subframe6 to be reserved for MBSFN in downlink when Detection is Manual.

Key Path	Meas Setup, Chan Profile Setup, Edit Control Channels
Mode	LTE
Remote Command	[:SENSe] :EVM:DLINk:PROFile:MBSFn:SUBFrame6:ACTive OFF ON 0 1 [:SENSe] :EVM:DLINk:PROFile:MBSFn:SUBFrame6:ACTive?
Example	EVM:DLIN:PROF:MBSF:SUBF6:ACT ON EVM:DLIN:PROF:MBSF:SUBF6:ACT?
Notes	Changes to this parameter will not be applied until Update Changes command is sent. See " RB Parameter Manager (Downlink) " on page 2012 section for more details.
Dependencies	Available when Mode is LTE. Available when MBSFN Active is On. Otherwise, this key is grayed out.
Preset	OFF
State Saved	Saved in instrument state.
Range	On Off
Initial S/W Revision	A.11.00

MBSFN Subframe7

Sets Subframe7 to be reserved for MBSFN in downlink when Detection is Manual.

Key Path	Meas Setup, Chan Profile Setup, Edit Control Channels
Mode	LTE, LTETDD
Remote Command	[:SENSe] :EVM:DLINk:PROFile:MBSFn:SUBFrame7:ACTive OFF ON 0 1 [:SENSe] :EVM:DLINk:PROFile:MBSFn:SUBFrame7:ACTive?
Example	EVM:DLIN:PROF:MBSF:SUBF7:ACT ON EVM:DLIN:PROF:MBSF:SUBF7:ACT?
Notes	Changes to this parameter will not be applied until Update Changes command is sent. See " RB Parameter Manager (Downlink) " on page 2012 section for more details.
Dependencies	Available when MBSFN Active is On. Otherwise, this key is grayed out.
Preset	OFF
State Saved	Saved in instrument state.
Range	On Off
Initial S/W Revision	A.11.00

MBSFN Subframe8

Sets Subframe8 to be reserved for MBSFN in downlink when Detection is Manual.

Key Path	Meas Setup, Chan Profile Setup, Edit Control Channels
Mode	LTE, LTETDD

Remote Command	[:SENSE] :EVM:DLINK:PROF:Profile:MBSFn:SUBFrame8:ACTive OFF ON 0 1 [:SENSE] :EVM:DLINK:PROF:Profile:MBSFn:SUBFrame8:ACTive?
Example	EVM:DLIN:PROF:MBSF:SUBF8:ACT ON EVM:DLIN:PROF:MBSF:SUBF8:ACT?
Notes	Changes to this parameter will not be applied until Update Changes command is sent. See " RB Parameter Manager (Downlink) " on page 2012 section for more details.
Dependencies	Available when MBSFN Active is On. Otherwise, this key is grayed out.
Preset	OFF
State Saved	Saved in instrument state.
Range	On Off
Initial S/W Revision	A.11.00

MBSFN Subframe9

Sets Subframe9 to be reserved for MBSFN in downlink when Detection is Manual.

Key Path	Meas Setup, Chan Profile Setup, Edit Control Channels
Mode	LTETDD
Remote Command	[:SENSE] :EVM:DLINK:PROF:Profile:MBSFn:SUBFrame9:ACTive OFF ON 0 1 [:SENSE] :EVM:DLINK:PROF:Profile:MBSFn:SUBFrame9:ACTive?
Example	EVM:DLIN:PROF:MBSF:SUBF9:ACT ON EVM:DLIN:PROF:MBSF:SUBF9:ACT?
Notes	Changes to this parameter will not be applied until Update Changes command is sent. See " RB Parameter Manager (Downlink) " on page 2012 section for more details.
Dependencies	Available when Mode is LTETDD. Available when MBSFN Active is On. Otherwise, this key is grayed out.
Preset	OFF
State Saved	Saved in instrument state.
Range	On Off
Initial S/W Revision	A.11.00

PMCH

Displays a menu that enables configuration of PMCH parameters.

Key Path	Meas Setup, Chan Profile Setup, Edit Control Channels
Mode	LTE, LTETDD
Initial S/W Revision	A.11.00

Auto Detect PMCH Power Boost

Sets the Power Boost value for the PMCH Channel when Detection is Auto.

Key Path	Meas Setup, Chan Profile Setup, Edit Control Channels
Mode	LTE, LTETDD
Remote Command	[:SENSe] :EVM:DLINK:PROFile:AUTO:PMCH:PWRBoost <rel_ampl> [:SENSe] :EVM:DLINK:PROFile:AUTO:PMCH:PWRBoost?
Example	EVM:DLIN:PROF:AUTO:PMCH:PWRB 3.0 EVM:DLIN:PROF:AUTO:PMCH:PWRB?
Notes	Changes to this parameter will not be applied until Update Changes command is sent. See "RB Parameter Manager (Downlink)" on page 2012 section for more details.
Dependencies	Available when Detection is Auto and when MBSFN-RS Active is On. Otherwise, this key is grayed out.
Preset	0.0 dB
State Saved	Saved in instrument state.
Min	-100 dB
Max	100 dB
Initial S/W Revision	A.11.00

PMCH Active

Describes if PMCH channel presents in Subframe1~Subframe9.

Key Path	Meas Setup, Chan Profile Setup, Edit Control Channels
Initial S/W Revision	A.11.00

PMCH Subframe1 Active

Sets weather or not PMCH channel presents in Subframe1 when Detection is Manual.

Key Path	Meas Setup, Chan Profile Setup, Edit Control Channels
Mode	LTE
Remote Command	[:SENSe] :EVM:DLINK:PROFile:PMCH:SUBFrame1:ACTive OFF ON 0 1 [:SENSe] :EVM:DLINK:PROFile:PMCH:SUBFrame1:ACTive?
Example	EVM:DLIN:PROF:PMCH:SUBF1:ACT ON EVM:DLIN:PROF:PMCH:SUBF1:ACT?
Notes	Changes to this parameter will not be applied until Update Changes command is sent. See "RB Parameter Manager (Downlink)" on page 2012 section for more details.
Dependencies	Available when Mode is LTE. Available when MBSFN Active is On and MBSFN Subframe1 is On. Otherwise, this key is grayed out.

Preset	OFF
State Saved	Saved in instrument state.
Range	On Off
Initial S/W Revision	A.11.00

PMCH Subframe2 Active

Sets whether or not PMCH channel presents in Subframe2 when Detection is Manual.

Key Path	Meas Setup, Chan Profile Setup, Edit Control Channels
Mode	LTE
Remote Command	<code>[:SENSe] :EVM:DLINk:PROFile:PMCH:SUBFrame2:ACTive OFF ON 0 1</code> <code>[:SENSe] :EVM:DLINk:PROFile:PMCH:SUBFrame2:ACTive?</code>
Example	<code>EVM:DLIN:PROF:PMCH:SUBF2:ACT ON</code> <code>EVM:DLIN:PROF:PMCH:SUBF2:ACT?</code>
Notes	Changes to this parameter will not be applied until Update Changes command is sent. See " RB Parameter Manager (Downlink) " on page 2012 section for more details.
Dependencies	Available when Mode is LTE. Available when MBSFN Active is On and MBSFN Subframe2 is On. Otherwise, this key is grayed out.
Preset	OFF
State Saved	Saved in instrument state.
Range	On Off
Initial S/W Revision	A.11.00

PMCH Subframe3 Active

Sets whether or not PMCH channel presents in Subframe3 when Detection is Manual.

Key Path	Meas Setup, Chan Profile Setup, Edit Control Channels
Mode	LTE, LTE-TDD
Remote Command	<code>[:SENSe] :EVM:DLINk:PROFile:PMCH:SUBFrame3:ACTive OFF ON 0 1</code> <code>[:SENSe] :EVM:DLINk:PROFile:PMCH:SUBFrame3:ACTive?</code>
Example	<code>EVM:DLIN:PROF:PMCH:SUBF3:ACT ON</code> <code>EVM:DLIN:PROF:PMCH:SUBF3:ACT?</code>
Notes	Changes to this parameter will not be applied until Update Changes command is sent. See " RB Parameter Manager (Downlink) " on page 2012 section for more details.
Dependencies	Available when MBSFN Active is On and MBSFN Subframe3 is On. Otherwise, this key is grayed out.
Preset	OFF

State Saved	Saved in instrument state.
Range	On Off
Initial S/W Revision	A.11.00

PMCH Subframe4 Active

Sets weather or not PMCH channel presents in Subframe4 when Detection is Manual.

Key Path	Meas Setup, Chan Profile Setup, Edit Control Channels
Mode	LTETDD
Remote Command	[:SENSe] :EVM:DLINK:PROFile:PMCH:SUBFrame4:ACTive OFF ON 0 1 [:SENSe] :EVM:DLINK:PROFile:PMCH:SUBFrame4:ACTive?
Example	EVM:DLIN:PROF:PMCH:SUBF4:ACT ON EVM:DLIN:PROF:PMCH:SUBF4:ACT?
Notes	Changes to this parameter will not be applied until Update Changes command is sent. See " RB Parameter Manager (Downlink) " on page 2012 section for more details.
Dependencies	Available when mode is LTETDD. Available when MBSFN Active is On and MBSFN Subframe4 is On. Otherwise, this key is grayed out.
Preset	OFF
State Saved	Saved in instrument state.
Range	On Off
Initial S/W Revision	A.11.00

PMCH Subframe6 Active

Sets weather or not PMCH channel presents in Subframe6 when Detection is Manual.

Key Path	Meas Setup, Chan Profile Setup, Edit Control Channels
Mode	LTE
Remote Command	[:SENSe] :EVM:DLINK:PROFile:PMCH:SUBFrame6:ACTive OFF ON 0 1 [:SENSe] :EVM:DLINK:PROFile:PMCH:SUBFrame6:ACTive?
Example	EVM:DLIN:PROF:PMCH:SUBF6:ACT ON EVM:DLIN:PROF:PMCH:SUBF6:ACT?
Notes	Changes to this parameter will not be applied until Update Changes command is sent. See " RB Parameter Manager (Downlink) " on page 2012 section for more details.
Dependencies	Available when Mode is LTE. Available when MBSFN Active is On and MBSFN Subframe6 is On. Otherwise, this key is grayed out.
Preset	OFF
State Saved	Saved in instrument state.

Range	On Off
Initial S/W Revision	A.11.00

PMCH Subframe7 Active

Sets whether or not PMCH channel presents in Subframe7 when Detection is Manual.

Key Path	Meas Setup, Chan Profile Setup, Edit Control Channels
Mode	LTE, LTETDD
Remote Command	[:SENSe] :EVM:DLINk:PROFile:PMCH:SUBFrame7:ACTive OFF ON 0 1 [:SENSe] :EVM:DLINk:PROFile:PMCH:SUBFrame7:ACTive?
Example	EVM:DLIN:PROF:PMCH:SUBF7:ACT ON EVM:DLIN:PROF:PMCH:SUBF7:ACT?
Notes	Changes to this parameter will not be applied until Update Changes command is sent. See " RB Parameter Manager (Downlink) " on page 2012 section for more details.
Dependencies	Available when MBSFN Active is On and MBSFN Subframe7 is On. Otherwise, this key is grayed out.
Preset	OFF
State Saved	Saved in instrument state.
Range	On Off
Initial S/W Revision	A.11.00

PMCH Subframe8 Active

Sets whether or not PMCH channel presents in Subframe8 when Detection is Manual.

Key Path	Meas Setup, Chan Profile Setup, Edit Control Channels
Mode	LTE, LTETDD
Remote Command	[:SENSe] :EVM:DLINk:PROFile:PMCH:SUBFrame8:ACTive OFF ON 0 1 [:SENSe] :EVM:DLINk:PROFile:PMCH:SUBFrame8:ACTive?
Example	EVM:DLIN:PROF:PMCH:SUBF8:ACT ON EVM:DLIN:PROF:PMCH:SUBF8:ACT?
Notes	Changes to this parameter will not be applied until Update Changes command is sent. See " RB Parameter Manager (Downlink) " on page 2012 section for more details.
Dependencies	Available when MBSFN Active is On and MBSFN Subframe8 is On. Otherwise, this key is grayed out.
Preset	OFF
State Saved	Saved in instrument state.
Range	On Off
Initial S/W Revision	A.11.00

PMCH Subframe9 Active

Sets whether or not PMCH channel presents in Subframe9 when Detection is Manual.

Key Path	Meas Setup, Chan Profile Setup, Edit Control Channels
Mode	LTETDD
Remote Command	[:SENSe] :EVM:DLINK:PROFile:PMCH:SUBFrame9:ACTive OFF ON 0 1 [:SENSe] :EVM:DLINK:PROFile:PMCH:SUBFrame9:ACTive?
Example	EVM:DLIN:PROF:PMCH:SUBF9:ACT ON EVM:DLIN:PROF:PMCH:SUBF9:ACT?
Notes	Changes to this parameter will not be applied until Update Changes command is sent. See " RB Parameter Manager (Downlink) " on page 2012 section for more details.
Dependencies	Available when mode is LTETDD. Available when MBSFN Active is On and MBSFN Subframe9 is On. Otherwise, this key is grayed out.
Preset	OFF
State Saved	Saved in instrument state.
Range	On Off
Initial S/W Revision	A.11.00

PMCH Power Boost

Sets PMCH's Power Boost for Subframe 1 ~ 9.

Key Path	Meas Setup, Chan Profile Setup, Edit Control Channels
Initial S/W Revision	A.11.00

PMCH Subframe1 Power Boost

Sets PMCH's Power Boost for Subframe1 when Detection is Manual.

Key Path	Meas Setup, Chan Profile Setup, Edit Control Channels
Mode	LTE
Remote Command	[:SENSe] :EVM:DLINK:PROFile:PMCH:SUBFrame1:PWRBoost <rel_amp> [:SENSe] :EVM:DLINK:PROFile:PMCH:SUBFrame1:PWRBoost?
Example	EVM:DLIN:PROF:PMCH:SUBF1:PWRB 6.0 EVM:DLIN:PROF:PMCH:SUBF1:PWRB?
Notes	Changes to this parameter will not be applied until Update Changes command is sent. See " RB Parameter Manager (Downlink) " on page 2012 section for more details.
Dependencies	Available when Mode is LTE. Available when MBSFN Active is On , MBSFN Subframe1 is On and PMCH Subframe1 is On. Otherwise, this key is grayed out.

Preset	0.0 dB
State Saved	Saved in instrument state.
Min	-100 dB
Max	100 dB
Initial S/W Revision	A.11.00

PMCH Subframe2 Power Boost

Sets PMCH's Power Boost for Subframe2 when Detection is Manual.

Key Path	Meas Setup, Chan Profile Setup, Edit Control Channels
Mode	LTE
Remote Command	[:SENSe] :EVM:DLINk:PROFile:PMCH:SUBFrame2:PWRBoost <rel_ampl> [:SENSe] :EVM:DLINk:PROFile:PMCH:SUBFrame2:PWRBoost?
Example	EVM:DLIN:PROF:PMCH:SUBF2:PWRB 6.0 EVM:DLIN:PROF:PMCH:SUBF2:PWRB?
Notes	Changes to this parameter will not be applied until Update Changes command is sent. See " RB Parameter Manager (Downlink) " on page 2012 section for more details.
Dependencies	Available when Mode is LTE. Available when MBSFN Active is On , MBSFN Subframe2 is On and PMCH Subframe2 is On. Otherwise, this key is grayed out.
Preset	0.0 dB
State Saved	Saved in instrument state.
Min	-100 dB
Max	100 dB
Initial S/W Revision	A.11.00

PMCH Subframe3 Power Boost

Sets PMCH's Power Boost for Subframe3 when Detection is Manual.

Key Path	Meas Setup, Chan Profile Setup, Edit Control Channels
Mode	LTE, LTETDD
Remote Command	[:SENSe] :EVM:DLINk:PROFile:PMCH:SUBFrame3:PWRBoost <rel_ampl> [:SENSe] :EVM:DLINk:PROFile:PMCH:SUBFrame3:PWRBoost?
Example	EVM:DLIN:PROF:PMCH:SUBF3:PWRB 6.0 EVM:DLIN:PROF:PMCH:SUBF3:PWRB?
Notes	Changes to this parameter will not be applied until Update Changes command is sent. See " RB Parameter Manager (Downlink) " on page 2012 section for more details.
Dependencies	Available when MBSFN Active is On , MBSFN Subframe3 is On and PMCH Subframe3 is On.

	Otherwise, this key is grayed out.
Preset	0.0 dB
State Saved	Saved in instrument state.
Min	-100 dB
Max	100 dB
Initial S/W Revision	A.11.00

PMCH Subframe4 Power Boost

Sets PMCH's Power Boost for Subframe4 when Detection is Manual.

Key Path	Meas Setup, Chan Profile Setup, Edit Control Channels
Mode	LTETDD
Remote Command	[:SENSe] :EVM:DLINk:PROFile:PMCH:SUBFrame4:PWRBoost <rel_ampl> [:SENSe] :EVM:DLINk:PROFile:PMCH:SUBFrame4:PWRBoost?
Example	EVM:DLIN:PROF:PMCH:SUBF4:PWRB 6.0 EVM:DLIN:PROF:PMCH:SUBF4:PWRB?
Notes	Changes to this parameter will not be applied until Update Changes command is sent. See " RB Parameter Manager (Downlink) " on page 2012 section for more details.
Dependencies	Available when Mode is LTETDD. Available when MBSFN Active is On , MBSFN Subframe4 is On and PMCH Subframe4 is On. Otherwise, this key is grayed out.
Preset	0.0 dB
State Saved	Saved in instrument state.
Min	-100 dB
Max	100 dB
Initial S/W Revision	A.11.00

PMCH Subframe6 Power Boost

Sets PMCH's Power Boost for Subframe6 when Detection is Manual.

Key Path	Meas Setup, Chan Profile Setup, Edit Control Channels
Mode	LTE
Remote Command	[:SENSe] :EVM:DLINk:PROFile:PMCH:SUBFrame6:PWRBoost <rel_ampl> [:SENSe] :EVM:DLINk:PROFile:PMCH:SUBFrame6:PWRBoost?
Example	EVM:DLIN:PROF:PMCH:SUBF6:PWRB 6.0 EVM:DLIN:PROF:PMCH:SUBF6:PWRB?
Notes	Changes to this parameter will not be applied until Update Changes command is sent. See " RB Parameter Manager (Downlink) " on page 2012 section for more details.

Dependencies	Available when Mode is LTE. Available when MBSFN Active is On , MBSFN Subframe6 is On and PMCH Subframe6 is On. Otherwise, this key is grayed out.
Preset	0.0 dB
State Saved	Saved in instrument state.
Min	-100 dB
Max	100 dB
Initial S/W Revision	A.11.00

PMCH Subframe7 Power Boost

Sets PMCH's Power Boost for Subframe7 when Detection is Manual.

Key Path	Meas Setup, Chan Profile Setup, Edit Control Channels
Mode	LTE, LTETDD
Remote Command	<code>[:SENSe] :EVM:DLINk:PROFile:PMCH:SUBFrame7:PWRBoost <rel_ampl></code> <code>[:SENSe] :EVM:DLINk:PROFile:PMCH:SUBFrame7:PWRBoost?</code>
Example	EVM:DLIN:PROF:PMCH:SUBF7:PWRB 6.0 EVM:DLIN:PROF:PMCH:SUBF7:PWRB?
Notes	Changes to this parameter will not be applied until Update Changes command is sent. See " RB Parameter Manager (Downlink) " on page 2012 section for more details.
Dependencies	Available when MBSFN Active is On , MBSFN Subframe7 is On and PMCH Subframe7 is On. Otherwise, this key is grayed out.
Preset	0.0 dB
State Saved	Saved in instrument state.
Min	-100 dB
Max	100 dB
Initial S/W Revision	A.11.00

PMCH Subframe8 Power Boost

Sets PMCH's Power Boost for Subframe8 when Detection is Manual.

Key Path	Meas Setup, Chan Profile Setup, Edit Control Channels
Mode	LTE, LTETDD
Remote Command	<code>[:SENSe] :EVM:DLINk:PROFile:PMCH:SUBFrame8:PWRBoost <rel_ampl></code> <code>[:SENSe] :EVM:DLINk:PROFile:PMCH:SUBFrame8:PWRBoost?</code>
Example	EVM:DLIN:PROF:PMCH:SUBF8:PWRB 6.0 EVM:DLIN:PROF:PMCH:SUBF8:PWRB?
Notes	Changes to this parameter will not be applied until Update Changes command is sent. See " RB "

	Parameter Manager (Downlink)" on page 2012 section for more details.
Dependencies	Available when MBSFN Active is On , MBSFN Subframe8 is On and PMCH Subframe8 is On. Otherwise, this key is grayed out.
Preset	0.0 dB
State Saved	Saved in instrument state.
Min	-100 dB
Max	100 dB
Initial S/W Revision	A.11.00

PMCH Subframe9 Power Boost

Sets PMCH's Power Boost for Subframe9 when Detection is Manual.

Key Path	Meas Setup, Chan Profile Setup, Edit Control Channels
Mode	LTETDD
Remote Command	[:SENSe] :EVM:DLINK:PROFile:PMCH:SUBFrame9:PWRBoost <rel_ampl> [:SENSe] :EVM:DLINK:PROFile:PMCH:SUBFrame9:PWRBoost?
Example	EVM:DLIN:PROF:PMCH:SUBF9:PWRB 6.0 EVM:DLIN:PROF:PMCH:SUBF9:PWRB?
Notes	Changes to this parameter will not be applied until Update Changes command is sent. See " RB Parameter Manager (Downlink)" on page 2012 section for more details.
Dependencies	Available when Mode is LTETDD. Available when MBSFN Active is On , MBSFN Subframe9 is On and PMCH Subframe9 is On. Otherwise, this key is grayed out.
Preset	0.0 dB
State Saved	Saved in instrument state.
Min	-100 dB
Max	100 dB
Initial S/W Revision	A.11.00

PMCH Mod Type

Selects PMCH channel's Modulation Type for Subframe 1 ~9.

Key Path	Meas Setup, Chan Profile Setup, Edit Control Channels, PMCH
Initial S/W Revision	A.11.00

PMCH Subframe1 Mod Type

Selects PMCH channel's Modulation Type for Subframe1 when Detection is Manual.

Key Path	Meas Setup, Chan Profile Setup, Edit Control Channels
Mode	LTE
Remote Command	[:SENSe]:EVM:DLINk:PROFile:PMCH:SUBFrame1:MODulation:TYPE QPSK QAM16 QAM64 [:SENSe]:EVM:DLINk:PROFile:PMCH:SUBFrame1:MODulation:TYPE?
Example	EVM:DLIN:PROF:PMCH:SUBF1:MOD:TYPE QAM16 EVM:DLIN:PROF:PMCH:SUBF1:MOD:TYPE?
Notes	Changes to this parameter will not be applied until Update Changes command is sent. See " RB Parameter Manager (Downlink) " on page 2012 section for more details.
Dependencies	Available when Mode is LTE. Available when MBSFN Active is On , MBSFN Subframe1 is On and PMCH Subframe1 is On. Otherwise, this key is grayed out.
Preset	QPSK
State Saved	Saved in instrument state.
Range	QPSK 16QAM 64QAM
Initial S/W Revision	A.11.00

PMCH Subframe2 Mod Type

Selects PMCH channel's Modulation Type for Subframe2 when Detection is Manual.

Key Path	Meas Setup, Chan Profile Setup, Edit Control Channels
Mode	LTE
Remote Command	[:SENSe]:EVM:DLINk:PROFile:PMCH:SUBFrame2:MODulation:TYPE QPSK QAM16 QAM64 [:SENSe]:EVM:DLINk:PROFile:PMCH:SUBFrame2:MODulation:TYPE?
Example	EVM:DLIN:PROF:PMCH:SUBF2:MOD:TYPE QAM16 EVM:DLIN:PROF:PMCH:SUBF2:MOD:TYPE?
Notes	Changes to this parameter will not be applied until Update Changes command is sent. See " RB Parameter Manager (Downlink) " on page 2012 section for more details.
Dependencies	Available when Mode is LTE. Available when MBSFN Active is On , MBSFN Subframe2 is On and PMCH Subframe2 is On. Otherwise, this key is grayed out.
Preset	QPSK
State Saved	Saved in instrument state.
Range	QPSK 16QAM 64QAM
Initial S/W Revision	A.11.00

PMCH Subframe3 Mod Type

Selects PMCH channel's Modulation Type for Subframe3 when Detection is Manual.

Key Path	Meas Setup, Chan Profile Setup, Edit Control Channels
Mode	LTE, LTETDD
Remote Command	[:SENSe] :EVM:DLINk:PROFile:PMCH:SUBFrame3:MODulation:TYPE QPSK QAM16 QAM64 [:SENSe] :EVM:DLINk:PROFile:PMCH:SUBFrame3:MODulation:TYPE?
Example	EVM:DLIN:PROF:PMCH:SUBF3:MOD:TYPE QAM16 EVM:DLIN:PROF:PMCH:SUBF3:MOD:TYPE?
Notes	Changes to this parameter will not be applied until Update Changes command is sent. See " RB Parameter Manager (Downlink) " on page 2012 section for more details.
Dependencies	Available when MBSFN Active is On , MBSFN Subframe3 is On and PMCH Subframe3 is On. Otherwise, this key is grayed out.
Preset	QPSK
State Saved	Saved in instrument state.
Range	QPSK 16QAM 64QAM
Initial S/W Revision	A.11.00

PMCH Subframe4 Mod Type

Selects PMCH channel's Modulation Type for Subframe4 when Detection is Manual.

Key Path	Meas Setup, Chan Profile Setup, Edit Control Channels
Mode	LTETDD
Remote Command	[:SENSe] :EVM:DLINk:PROFile:PMCH:SUBFrame4:MODulation:TYPE QPSK QAM16 QAM64 [:SENSe] :EVM:DLINk:PROFile:PMCH:SUBFrame4:MODulation:TYPE?
Example	EVM:DLIN:PROF:PMCH:SUBF4:MOD:TYPE QAM16 EVM:DLIN:PROF:PMCH:SUBF4:MOD:TYPE?
Notes	Changes to this parameter will not be applied until Update Changes command is sent. See " RB Parameter Manager (Downlink) " on page 2012 section for more details.
Dependencies	Available when Mode is LTETDD. Available when MBSFN Active is On , MBSFN Subframe4 is On and PMCH Subframe4 is On. Otherwise, this key is grayed out.
Preset	QPSK
State Saved	Saved in instrument state.
Range	QPSK 16QAM 64QAM
Initial S/W Revision	A.11.00

PMCH Subframe6 Mod Type

Selects PMCH channel's Modulation Type for Subframe6 when Detection is Manual.

Key Path	Meas Setup, Chan Profile Setup, Edit Control Channels
Mode	LTE
Remote Command	[:SENSe]:EVM:DLINk:PROFile:PMCH:SUBFrame6:MODulation:TYPE QPSK QAM16 QAM64 [:SENSe]:EVM:DLINk:PROFile:PMCH:SUBFrame6:MODulation:TYPE?
Example	EVM:DLIN:PROF:PMCH:SUBF6:MOD:TYPE QAM16 EVM:DLIN:PROF:PMCH:SUBF6:MOD:TYPE?
Notes	Changes to this parameter will not be applied until Update Changes command is sent. See " RB Parameter Manager (Downlink) " on page 2012 section for more details.
Dependencies	Available when Mode is LTE. Available when MBSFN Active is On , MBSFN Subframe6 is On and PMCH Subframe6 is On. Otherwise, this key is grayed out.
Preset	QPSK
State Saved	Saved in instrument state.
Range	QPSK 16QAM 64QAM
Initial S/W Revision	A.11.00

PMCH Subframe7 Mod Type

Selects PMCH channel's Modulation Type for Subframe7 when Detection is Manual.

Key Path	Meas Setup, Chan Profile Setup, Edit Control Channels
Mode	LTE, LTETDD
Remote Command	[:SENSe]:EVM:DLINk:PROFile:PMCH:SUBFrame7:MODulation:TYPE QPSK QAM16 QAM64 [:SENSe]:EVM:DLINk:PROFile:PMCH:SUBFrame7:MODulation:TYPE?
Example	EVM:DLIN:PROF:PMCH:SUBF7:MOD:TYPE QAM16 EVM:DLIN:PROF:PMCH:SUBF7:MOD:TYPE?
Notes	Changes to this parameter will not be applied until Update Changes command is sent. See " RB Parameter Manager (Downlink) " on page 2012 section for more details.
Dependencies	Available when MBSFN Active is On , MBSFN Subframe7 is On and PMCH Subframe7 is On. Otherwise, this key is grayed out.
Preset	QPSK
State Saved	Saved in instrument state.
Range	QPSK 16QAM 64QAM
Initial S/W Revision	A.11.00

PMCH Subframe8 Mod Type

Selects PMCH channel's Modulation Type for Subframe8 when Detection is Manual.

Key Path	Meas Setup, Chan Profile Setup, Edit Control Channels
Mode	LTE, LTETDD
Remote Command	[:SENSe] :EVM:DLINK:PROFile:PMCH:SUBFrame8:MODulation:TYPE QPSK QAM16 QAM64 [:SENSe] :EVM:DLINK:PROFile:PMCH:SUBFrame8:MODulation:TYPE?
Example	EVM:DLIN:PROF:PMCH:SUBF8:MOD:TYPE QAM16 EVM:DLIN:PROF:PMCH:SUBF8:MOD:TYPE?
Notes	Changes to this parameter will not be applied until Update Changes command is sent. See " RB Parameter Manager (Downlink) " on page 2012 section for more details.
Dependencies	Available when MBSFN Active is On , MBSFN Subframe8 is On and PMCH Subframe8 is On. Otherwise, this key is grayed out.
Preset	QPSK
State Saved	Saved in instrument state.
Range	QPSK 16QAM 64QAM
Initial S/W Revision	A.11.00

PMCH Subframe9 Mod Type

Selects PMCH channel's Modulation Type for Subframe9 when Detection is Manual.

Key Path	Meas Setup, Chan Profile Setup, Edit Control Channels
Mode	LTETDD
Remote Command	[:SENSe] :EVM:DLINK:PROFile:PMCH:SUBFrame9:MODulation:TYPE QPSK QAM16 QAM64 [:SENSe] :EVM:DLINK:PROFile:PMCH:SUBFrame9:MODulation:TYPE?
Example	EVM:DLIN:PROF:PMCH:SUBF9:MOD:TYPE QAM16 EVM:DLIN:PROF:PMCH:SUBF9:MOD:TYPE?
Notes	Changes to this parameter will not be applied until Update Changes command is sent. See " RB Parameter Manager (Downlink) " on page 2012 section for more details.
Dependencies	Available when Mode is LTETDD. Available when MBSFN Active is On, MBSFN Subframe9 is On and PMCH Subframe9 is On. Otherwise, this key is grayed out.
Preset	QPSK
State Saved	Saved in instrument state.
Range	QPSK 16QAM 64QAM
Initial S/W Revision	A.11.00

Edit User Mapping (Downlink)

Displays the LTE Allocation Editor that enables you to edit the Downlink channel parameters. When a parameter is selected, the corresponding softkeys will appear.

- Use Tab key to select a parameter field to edit. The rotary knob can be also used to select a parameter field as it has two functions: value adjustment (default) and field navigation. Use Enter key to toggle the function.
- In order to apply or discard changes, select OK button or Cancel button on the editor to show the corresponding softkeys and press either of them. These softkeys also appear by pressing Cancel (Esc) key when the active function is disabled.

NOTE

If Help is open when you select this key, the dialog and menu does not appear. Close Help by pressing **Cancel (Esc)**, then select this key. After the menu has changed, press the green **Help** key to see Help for the dialog and keys. Close Help when you are ready to edit the parameters.

Key Path	Meas Setup, Chan Profile Setup
Mode	LTE, LTETDD
Initial S/W Revision	Prior to A.02.00
Modified at S/W Revision	A.03.00, A.06.00

This table lists all the parameters available to set up downlink PDSCH user allocations.

Parameter	Description
Detection	When Auto, the demodulator will autodetect PDSCH user allocations. The only parameter needed is Power Boost (for EVM calculations). RB Autodetect groups resource blocks that contain the same modulation type into a user so that there are three possible users: QPSK, QAM16, and QAM64.
RB Auto Detect Mode	Specifies how the LTE demodulator detects user allocations when Detection is Auto.
Auto Detect Power Levels	Selects whether or not power levels are autodetected. Enabled only when RB Auto Detect is On and RB Auto Detect Mode is Decoded PDCCH.
Auto Detect Power Levels in Power Mode	Selects whether or not power levels are autodetected when Detection is Auto and RB Auto Detect Mode is Power-based.
Use Per Antenna EPRE	Determines whether the EPRE is interpreted as energy per antenna port or the sum total of energies contributed by all antenna ports involved. When it is On, EPRE is interpreted as energy per antenna port.
Multi-Frame Analysis	When On, the demodulator enables user to setup PDSCH allocations for two continuous frames. This parameter needs to be set to On when the signal under analysis is complied with E-UTRA TDD Test Models defined in 3GPP TS36.141 6.1.1 V8.2.0.
Show Mapping	Specifies which frame's allocation will be shown in RB Mapping diagram when Multi-Frame Analysis is On.
Include	When this check box is selected, the corresponding user mapping is displayed on appropriate traces. When cleared, only the Frame Summary trace will display the user mapping.

Add	Adds a user mapping.
Delete	Deletes the selected user mapping.
RNTI	Sets the radio network temporary identifier for the user. Enabled only when Detection is manual.
UE-RS Active	Selects whether the UE-specific reference signal is present in the signal under test. Enabled only when Detection is manual.
UE-RS Include	Selects whether the UE-specific reference signal is included in the analysis results. Enabled only when UE-RS Active is On and Detection is manual.
UE-RS Power	Specifies the power boost for the UE-specific reference signal. Enabled only when Detection is manual.
UE-RS Port	Specifies on which logical antenna port UE-RS is transmitted for the selected PDSCH user allocation.
UE-RS nSCID	Specifies downlink user's scrambling identity value nSCID.
Precoding Parameters	
Precoding	Specifies the type of shared channel precoding method that the demodulator should expect.
Number of layers	Specifies the number of layers. It's less than or equal to the number of antenna ports used for transmission of the physical channel.
Number of codewords	Specifies the number of codewords.
CDD	Specifies whether precoding will be done with or without CDD (cyclic delay diversity) for spatial multiplexing.
Codebook Index	Specifies the Codebook index for spatial multiplexing precoding.
PDSCH Per-allocation Parameters	
Couple	Certain parameters can be coupled across all RB allocation groups for a user or can be set independently for each RB allocation group. Selecting the checkbox next to a parameter will couple that parameter across all RB allocation groups.
RB Start	Specifies the RB start boundary of the current allocation group for the current user.
RB End	Specifies the RB end boundary of the current allocation group for the current user.
Slot Start	Specifies the slot start boundary of the current allocation group for the current user.
Slot End	Specifies the slot end boundary of the current allocation group for the current user.
Allocation EPRE	Sets the EPRE value for the selected Allocation.
Codeword 0 Mod Type	Modulation type for codeword 0: QPSK, QAM16, or QAM64.
Codeword 1 Mod Type	Modulation type for codeword 1: QPSK, QAM16, or QAM64.
Codeword 0 Power Boost	The power of the subcarriers relative to the 0 dB level determined by the RS power level for codeword 0. See "Chan Profile Setup (Downlink)" on page 1884 for more information.
Codeword 1 Power Boost	The power of the subcarriers relative to the 0 dB level determined by the RS power level for codeword 1. See "Chan Profile Setup (Downlink)" on page 1884 for more information.

Frame Index	Specifies which frame of the current allocation for the current user belongs to.
Add	Adds an allocation to the selected user.
Delete	Deletes the selected allocation.

Use Per Antenna EPRE

Determines whether the EPRE is interpreted as energy per antenna port or the sum total of energies contributed by all antenna ports involved . When it is On, EPRE is interpreted as energy per antenna port.

Key Path	Meas Setup, Chan Profile Setup, Edit User Mapping
Mode	LTE, LTETDD
Remote Command	[:SENSe] :EVM:DLINK:PROFile:EPRE:PANTenna OFF ON 0 1 [:SENSe] :EVM:DLINK:PROFile:EPRE:PANTenna?
Example	EVM:DLINK:PROF:EPRE:PANT ON EVM:DLINK:PROF:EPRE:PANT?
Notes	Changes to this parameter will not be applied until Update Changes command is sent. See Section "RB Parameter Manager (Downlink)" on page 2012, "RB Parameter Manager (Downlink)" on page 2012 section for more details.
Preset	ON
State Saved	Saved in instrument state.
Initial S/W Revision	A.11.00

Multi-Frame Analysis

Determines whether or not the Multi-Frame Analysis is selected.

When On, the demodulator sets PDSCH allocations for two continuous frames. This parameter needs to be set to On when the signal under analysis is complied with E-UTRA TDD Test Models defined in 3GPP TS36.141 6.1.1 V8.2.0.

NOTE

Multi-Frame Analysis is only available for LTETDD downlink and only enabled when detection is manual.

Key Path	Meas Setup, Chan Profile Setup, Edit User Mapping, Detection
Mode	LTETDD
Remote Command	[:SENSe] :EVM:PROFile:MFANalysis OFF ON 0 1 [:SENSe] :EVM:PROFile:MFANalysis?
Example	EVM:PROF:MFAN ON EVM:PROF:MFAN?
Notes	Changes to this parameter will not be applied until Update Changes command is sent. See "RB Parameter Manager (Downlink)" on page 2012 section for more details.

Dependencies	Available only for LTETDD downlink. Enabled when Detection is Manual and Input Channel is 1.
Preset	OFF
State Saved	Saved in instrument state.
Initial S/W Revision	Prior to A.02.00
Modified at S/W Revision	A.03.00

Show Mapping

Selects which frame's allocations you want to see in RB mapping diagram when Multi Frame Analysis is On.

Key Path	Meas Setup, Chan Profile Setup, Edit User Mapping, Detection
Mode	LTETDD
Remote Command	[:SENSe] :EVM:PROFile:SMAPping[:SElect] F0 F1 [:SENSe] :EVM:PROFile:SMAPping[:SElect] ?
Example	EVM:PROF:SMAP F0 EVM:PROF:SMAP?
Notes	Changes to this parameter will not be applied until Update Changes command is sent. See " RB Parameter Manager (Downlink) " on page 2012 section for more details.
Dependencies	Available only for LTETDD downlink. Enabled when Multi-Frame Analysis is ON.
Preset	F0
State Saved	Saved in instrument state.
Range	F0 F1
Initial S/W Revision	Prior to A.02.00
Modified at S/W Revision	A.03.00

Frame 0

Selects Frame 0 for Show Mapping For to be used by all the Allocations when Multi-Frame Analysis is On.

Key Path	Meas Setup, Chan Profile Setup, Edit User Mapping, Detection, Show Mapping
Mode	LTETDD
Initial S/W Revision	Prior to A.02.00
Modified at S/W Revision	A.03.00

Frame 1

Selects Frame 1 for Show Mapping For to be used by all the Allocations when Multi-Frame Analysis is On.

Key Path	Meas Setup, Chan Profile Setup, Edit User Mapping, Detection, Show Mapping
Mode	LTETDD
Initial S/W Revision	Prior to A.02.00
Modified at S/W Revision	A.03.00

Add Allocation

Adds a new Allocation after the currently selected Allocation and the new entry becomes the selected Allocation. The new Allocation will have the parameters set to the default values.

Key Path	Meas Setup, Chan Profile Setup, Edit User Mapping, Allocation
Mode	LTE, LTETDD
Remote Command	[:SENSe] :EVM:DLInk:PROFile:USER<n>:PDSCh:ADD:ALlocation
Example	EVM:DLIN:PROF:USER1:PDSC:ADD:ALL
Notes	Changes to this parameter will not be applied until Update Changes command is sent. See " RB Parameter Manager (Downlink) " on page 2012 section for more details.
Dependencies	The range of sub op code <n> values is determined by the number of Users the user has configured. The new Allocation will be added at the end of the currently defined Allocation. Disabled once the number of Allocations reaches to 250 (max).
Initial S/W Revision	Prior to A.02.00
Modified at S/W Revision	A.03.00

Delete Allocation

Deletes the currently selected Allocation.

Key Path	Meas Setup, Chan Profile Setup, Edit User Mapping, Allocation
Mode	LTE, LTETDD
Remote Command	[:SENSe] :EVM:DLInk:PROFile:USER<n>:PDSCh:RBALloc<m>:DElete
Example	EVM:DLIN:PROF:USER1:PDSC:RBAL1:DEL
Notes	Changes to this parameter will not be applied until Update Changes command is sent. See " RB Parameter Manager (Downlink) " on page 2012 section for more details.
Dependencies	Disabled when there is only one Allocation. The range of sub op code <n> values is determined by the number of Users the user has configured. The range of sub op code <m> values is determined by the number of Allocations the user has configured. . Max value for n=50. Max Value for m=250. If the user attempts to delete a Slot that does not exist, an error message will be generated.
Backwards Compatibility SCPI	[:SENSe] :EVM:DLInk:PROFile:USER<n>:PDSCh:ALlocation<m>:DElete (Max value for n=50 and m=50)
Initial S/W Revision	Prior to A.02.00
Modified at S/W Revision	A.03.00, A.06.00

Include PDSCH

Determines whether or not the PDSCH is included in the results.

Key Path	Meas Setup, Chan Profile Setup, Edit User Mapping
Mode	LTE, LTETDD
Couplings	This parameter provides the Include/Exclude status of the currently selected User, therefore the SCPI commands associated with this parameter will change as the User is changed. When Detection is Auto; when selected User is QPSK, refer to "Include QPSK" on page 1896 when selected User is 16QAM, refer to "Include 16QAM" on page 1897 when selected User is 64QAM, refer to "Include 64QAM" on page 1897 When Detection is Manual, refer to "Include PDSCH" on page 1895
Preset	EXCLude
State Saved	Saved in instrument state.
Range	Include Exclude
Modified at S/W Revision	A.03.00

RNTI

Sets downlink user's radio network temporary identifier.

Key Path	Meas Setup, Chan Profile Setup, Edit User Mapping
Mode	LTE, LTETDD
Remote Command	[:SENSe] :EVM:DLINk:PROFile:USER<n>:RNTI <integer> [:SENSe] :EVM:DLINk:PROFile:USER<n>:RNTI?
Example	EVM:DLIN:PROF:USER1:RNTI 1 EVM:DLIN:PROF:USER1:RNTI?
Notes	Changes to this parameter will not be applied until Update Changes command is sent. See "RB Parameter Manager (Downlink)" on page 2012 section for more details.
Dependencies	The range of sub op code <n> values is determined by the number of Users the user has configured. If the user attempts to remotely set or query a sub op code that is out of range, this will result in an error message. Available when Detection is Manual, UE-RS Active is On and UE-RS Port is Port5.
Preset	0
State Saved	Saved in instrument state.
Min	0
Max	65535
Initial S/W Revision	A.06.00
Modified at S/W Revision	A.13.00

Auto Detect RNTI for QPSK

Sets radio network temporary identifier for the QPSK modulation when Detection is Auto.

Key Path	Meas Setup, Chan Profile Setup, Edit User Mapping
Mode	LTE, LTE-TDD
Remote Command	[:SENSe] :EVM:DLINk:PROFile:QPSK:RNTI <integer> [:SENSe] :EVM:DLINk:PROFile:QPSK:RNTI?
Example	EVM:DLIN:PROF:QPSK:RNTI 1 EVM:DLIN:PROF:QPSK:RNTI?
Notes	Changes to this parameter will not be applied until Update Changes command is sent. See " RB Parameter Manager (Downlink) " on page 2012 for more details.
Dependencies	Available when Detection is Auto, RB Auto Detect Mode is Power Based, UE-RS Active is On, and UE-RS Port is Port5.
Preset	0
State Saved	Saved in instrument state.
Min	0
Max	65535
Initial S/W Revision	A.10.00
Modified at S/W Revision	A.13.00

Auto Detect RNTI for 16QAM

Sets radio network temporary identifier for the 16QAM modulation when Detection is Auto.

Key Path	Meas Setup, Chan Profile Setup, Edit User Mapping
Mode	LTE, LTETDD
Remote Command	[:SENSe] :EVM:DLINk:PROFile:QAM16:RNTI <integer> [:SENSe] :EVM:DLINk:PROFile:QAM16:RNTI?
Example	EVM:DLIN:PROF:QAM16:RNTI 1 EVM:DLIN:PROF:QAM16:RNTI?
Notes	Changes to this parameter will not be applied until Update Changes command is sent. See " RB Parameter Manager (Downlink) " on page 2012 for more details.
Dependencies	Available when Detection is Auto, RB Auto Detect Mode is Power Based, UE-RS Active is On, and UE-RS Port is Port5.
Preset	0
State Saved	Saved in instrument state.
Min	0
Max	65535
Initial S/W Revision	A.10.00
Modified at S/W Revision	A.13.00

Auto Detect RNTI for 64QAM

Sets radio network temporary identifier for the 64QAM modulation when Detection is Auto.

Key Path	Meas Setup, Chan Profile Setup, Edit User Mapping
Mode	LTE, LTETDD
Remote Command	[:SENSe] :EVM:DLINk:PROFile:QAM64:RNTI <integer> [:SENSe] :EVM:DLINk:PROFile:QAM64:RNTI?
Example	EVM:DLIN:PROF:QAM64:RNTI 1 EVM:DLIN:PROF:QAM64:RNTI?
Notes	Changes to this parameter will not be applied until Update Changes command is sent. See " RB Parameter Manager (Downlink) " on page 2012 for more details.
Dependencies	Available when Detection is Auto, RB Auto Detect Mode is Power Based, UE-RS Active is On, and UE-RS Port is Port5.
Preset	0
State Saved	Saved in instrument state.
Min	0
Max	65535
Initial S/W Revision	A.10.00
Modified at S/W Revision	A.13.00

UE-RS Active

Selects whether or not the UE specific reference signal exists for this downlink user in the input signal.

Key Path	Meas Setup, Chan Profile Setup, Edit User Mapping
Mode	LTE, LTETDD
Remote Command	[:SENSe] :EVM:DLINk:PROFile:USER<n>:UERS:ACTive OFF ON 0 1 [:SENSe] :EVM:DLINk:PROFile:USER<n>:UERS:ACTive?
Example	EVM:DLIN:PROF:USER1:UERS:ACT OFF EVM:DLIN:PROF:USER1:UERS:ACT?
Notes	Changes to this parameter will not be applied until Update Changes command is sent. See " RB Parameter Manager (Downlink) " on page 2012 section for more details.
Dependencies	Available when Detection is Manual. All softkeys for UE-RS parameters are grayed out when this parameter is set to OFF.
Preset	OFF
State Saved	Saved in instrument state.
Range	On Off
Initial S/W Revision	A.06.00
Modified at S/W Revision	A.13.00

Auto Detect UE-RS Active for QPSK

Selects whether or not the UE specific reference signal exists for the QPSK modulation when Detection is Auto.

Key Path	Meas Setup, Chan Profile Setup, Edit User Mapping
Mode	LTE, LTE-TDD
Remote Command	[:SENSE] :EVM:DLINK:PROF:QPSK:UERS:ACTive OFF ON 0 1 [:SENSE] :EVM:DLINK:PROF:QPSK:UERS:ACTive?
Example	EVM:DLIN:PROF:QPSK:UERS:ACT OFF EVM:DLIN:PROF:QPSK:UERS:ACT?
Notes	Changes to this parameter will not be applied until Update Changes command is sent. See "RB Parameter Manager (Downlink)" on page 2012 for more details.
Dependencies	Available when Detection is Auto. All softkeys for UE-RS parameters are grayed out when this parameter is set to OFF.
Preset	OFF
State Saved	Saved in instrument state.
Range	On Off
Initial S/W Revision	A.10.00
Modified at S/W Revision	A.13.00

Auto Detect UE-RS Active for 16QAM

Selects whether or not the UE specific reference signal exists for the 16QAM modulation when Detection is Auto.

Key Path	Meas Setup, Chan Profile Setup, Edit User Mapping
Mode	LTE, LTETDD
Remote Command	[:SENSe] :EVM:DLINK:PROFile:QAM16:UERS:ACTive OFF ON 0 1 [:SENSe] :EVM:DLINK:PROFile:QAM16:UERS:ACTive?
Example	EVM:DLIN:PROF:QAM16:UERS:ACT OFF EVM:DLIN:PROF:QAM16:UERS:ACT?
Notes	Changes to this parameter will not be applied until Update Changes command is sent. See "RB Parameter Manager (Downlink)" on page 2012 for more details.
Dependencies	Available when Detection is Auto. All softkeys for UE-RS parameters are grayed out when this parameter is set to OFF.
Preset	OFF
State Saved	Saved in instrument state.
Range	On Off
Initial S/W Revision	A.10.00
Modified at S/W Revision	A.13.00

Auto Detect UE-RS Active for 64QAM

Selects whether or not the UE specific reference signal exists for 64QAM modulation when Detection is Auto.

Key Path	Meas Setup, Chan Profile Setup, Edit User Mapping
Mode	LTE, LTETDD
Remote Command	[:SENSe] :EVM:DLINk:PROFile:QAM64:UERS:ACTive OFF ON 0 1 [:SENSe] :EVM:DLINk:PROFile:QAM64:UERS:ACTive?
Example	EVM:DLIN:PROF:QAM64:UERS:ACT OFF EVM:DLIN:PROF:QAM64:UERS:ACT?
Notes	Changes to this parameter will not be applied until Update Changes command is sent. See " RB Parameter Manager (Downlink) " on page 2012 for more details.
Dependencies	Available when Detection is Auto. All softkeys for UE-RS parameters are grayed out when this parameter is set to OFF.
Preset	OFF
State Saved	Saved in instrument state.
Range	On Off
Initial S/W Revision	A.10.00
Modified at S/W Revision	A.13.00

Include UE-RS

Includes the user defined channel PDSCH's UE specific reference signal in the results.

Key Path	Meas Setup, Chan Profile Setup, Include Users
Mode	LTE, LTETDD
Remote Command	[:SENSe] :EVM:DLINk:PROFile:USER<n>:UERS INCLude EXCLude [:SENSe] :EVM:DLINk:PROFile:USER<n>:UERS?
Example	EVM:DLIN:PROF:USER1:UERS EXCL EVM:DLIN:PROF:USER1:UERS?
Notes	Changes to this parameter will not be applied until Update Changes command is sent. See " RB Parameter Manager (Downlink) " on page 2012 section for more details.
Dependencies	The range of sub op code <n> values is determined by the number of Users the user has configured. If the user attempts to remotely set or query a sub op code that is out of range, this will result in an error message. Available when UE-RS Active is ON and Detection is Manual.
Couplings	This parameter is set to Include when Downlink Include All is selected and set to Exclude when Downlink Exclude All is selected.
Preset	EXCLude
State Saved	Saved in instrument state.

15 LTE Modulation Analysis Measurement
Meas Setup

Range	Include Exclude
Initial S/W Revision	A.06.00
Modified at S/W Revision	A.13.00

Auto Detect Include UE-RS for QPSK

Includes UE specific reference signal for the QPSK modulation in the results when Detection is Auto.

Key Path	Meas Setup, Chan Profile Setup, Include Users
Mode	LTE, LTETDD
Remote Command	[:SENSe] :EVM:DLINk:PROFile:QPSK:UERS INCLude EXCLude [:SENSe] :EVM:DLINk:PROFile:QPSK:UERS?
Example	EVM:DLIN:PROF:QPSK:UERS EXCL EVM:DLIN:PROF:QPSK:UERS?
Dependencies	Available when UE-RS Active is ON and Detection is Auto.
Couplings	This parameter is set to Include when Downlink Include All is selected and set to Exclude when Downlink Exclude All is selected.
Preset	EXCLude
State Saved	Saved in instrument state.
Range	Include Exclude
Initial S/W Revision	A.10.00
Modified at S/W Revision	A.13.00

Auto Detect Include UE-RS for 16QAM

Includes UE specific reference signal for the 16QAM modulation in the results when Detection is Auto.

Key Path	Meas Setup, Chan Profile Setup, Include Users
Mode	LTE, LTETDD
Remote Command	[:SENSe] :EVM:DLINK:PROFile:QAM16:UERS INCLude EXCLude [:SENSe] :EVM:DLINK:PROFile:QAM16:UERS?
Example	EVM:DLIN:PROF:QAM16:UERS EXCL EVM:DLIN:PROF:QAM16:UERS?
Dependencies	Available when UE-RS Active is ON and Detection is Auto.
Couplings	This parameter is set to Include when Downlink Include All is selected and set to Exclude when Downlink Exclude All is selected.
Preset	EXCLude
State Saved	Saved in instrument state.
Range	Include Exclude
Initial S/W Revision	A.10.00
Modified at S/W Revision	A.13.00

Auto Detect Include UE-RS for 64QAM

Includes UE specific reference signal for the 64QAM modulation in the results when Detection is Auto.

Key Path	Meas Setup, Chan Profile Setup, Include Users
Mode	LTE, LTETDD
Remote Command	[:SENSe] :EVM:DLINk:PROFile:QAM64:UERS INCLude EXCLude [:SENSe] :EVM:DLINk:PROFile:QAM64:UERS?
Example	EVM:DLIN:PROF:QAM64:UERS EXCL EVM:DLIN:PROF:QAM64:UERS?
Dependencies	Available when UE-RS Active is ON and Detection is Auto.
Couplings	This parameter is set to Include when Downlink Include All is selected and set to Exclude when Downlink Exclude All is selected.
Preset	EXCLude
State Saved	Saved in instrument state.
Range	Include Exclude
Initial S/W Revision	A.10.00
Modified at S/W Revision	A.13.00

UE-RS Power Boost

Sets the Power Boost value for the specified user. Power Boost value specifies the average power for the UE-specific reference signal.

The average power of the UE-RS power is relative to the 0 dB level determined by the cell-specific RS power level.

Key Path	Meas Setup, Chan Profile Setup, Edit User Mapping
Mode	LTE, LTETDD
Remote Command	[:SENSe] :EVM:DLINk:PROFile:USER<n>:UERS:PWRBoost <rel_ampl> [:SENSe] :EVM:DLINk:PROFile:USER<n>:UERS:PWRBoost?
Example	EVM:DLIN:PROF:USER1:UERS:PWRB 0 EVM:DLIN:PROF:USER1:UERS:PWRB?
Notes	Changes to this parameter will not be applied until Update Changes command is sent. See " RB Parameter Manager (Downlink) " on page 2012 section for more details.
Dependencies	The range of sub op code <n> values is determined by the number of Users the user has configured. Max value for n=50. If the user attempts to remotely set or query a sub op code that is out of range, this will result in an error message. available when Detection is Manual.
Preset	0 dB

15 LTE Modulation Analysis Measurement
Meas Setup

State Saved	Saved in instrument state.
Min	-100 dB
Max	100 dB
Initial S/W Revision	A.06.00
Modified at S/W Revision	A.13.00

Auto Detect UE-RS Power Boost for QPSK

Determines the Power Boost value for the QPSK modulation when Detection is Auto. Power Boost value specifies the average power for the UE-specific reference signal. The average power of the UE-RS power is relative to the 0 dB level determined by the cell-specific RS power level.

Key Path	Meas Setup, Chan Profile Setup, Edit User Mapping
Mode	LTE, LTETDD
Remote Command	[:SENSE] :EVM:DLINK:PROFile:QPSK:UERS:PWRBoost <rel_ampl> [:SENSE] :EVM:DLINK:PROFile:QPSK:UERS:PWRBoost?
Example	EVM:DLIN:PROF:QPSK:UERS:PWRB 0 EVM:DLIN:PROF:QPSK:UERS:PWRB?
Notes	Changes to this parameter will not be applied until Update Changes command is sent. See " RB Parameter Manager (Downlink) " on page 2012 for more details.
Dependencies	Available when Detection is Auto.
Preset	0 dB
State Saved	Saved in instrument state.
Min	-100 dB
Max	100 dB
Initial S/W Revision	A.10.00
Modified at S/W Revision	A.13.00

Auto Detect UE-RS Power Boost for 16QAM

Determine the Power Boost value for the 16QAM modulation when Detection is Auto. Power Boost value specifies the average power for the UE-specific reference signal. The average power of the UE-RS power is relative to the 0 dB level determined by the cell-specific RS power level.

Key Path	Meas Setup, Chan Profile Setup, Edit User Mapping
Mode	LTE, LTETDD
Remote Command	[:SENSe] :EVM:DLINk:PROFile:QAM16:UERS:PWRBoost <rel_ampl> [:SENSe] :EVM:DLINk:PROFile:QAM16:UERS:PWRBoost?
Example	EVM:DLIN:PROF:QAM16:UERS:PWRB 0 EVM:DLIN:PROF:QAM16:UERS:PWRB?
Notes	Changes to this parameter will not be applied until Update Changes command is sent. See " RB Parameter Manager (Downlink) " on page 2012 for more details.
Dependencies	Available when Detection is Auto.
Preset	0 dB
State Saved	Saved in instrument state.
Min	-100 dB
Max	100 dB
Initial S/W Revision	A.10.00
Modified at S/W Revision	A.13.00

Auto Detect UE-RS Power Boost for 64QAM

Determines the Power Boost value for the 64QAM modulation when Detectio is Auto. Power Boost value specifies the average power for the UE-specific reference signal. The average power of the UE-RS power is relative to the 0 dB level determined by the cell-specific RS power level.

Key Path	Meas Setup, Chan Profile Setup, Edit User Mapping
Mode	LTE, LTETDD
Remote Command	[:SENSe] :EVM:DLINK:PROFile:QAM64:UERS:PWRBoost <rel_ampl> [:SENSe] :EVM:DLINK:PROFile:QAM64:UERS:PWRBoost?
Example	EVM:DLIN:PROF:QAM64:UERS:PWRB 0 EVM:DLIN:PROF:QAM64:UERS:PWRB?
Notes	Changes to this parameter will not be applied until Update Changes command is sent. See " RB Parameter Manager (Downlink) " on page 2012 for more details.
Dependencies	Available when Detection is Auto.
Preset	0 dB
State Saved	Saved in instrument state.
Min	-100 dB
Max	100 dB
Initial S/W Revision	A.10.00
Modified at S/W Revision	A.13.00

UE-RS Port

Specifies on which logical antenna port UE-RS is transmitted for the selected PDSCH user allocation when Detectin is Manual.

Key Path	Meas Setup, Chan Profile Setup, Edit User Mapping
Mode	LTE, LTETDD
Remote Command	[:SENSe] :EVM:DLINK:PROFile:USER<n>:UERS:PORT P5 P7 P8 [:SENSe] :EVM:DLINK:PROFile:USER<n>:UERS:PORT?
Example	EVM:DLIN:PROF:USER1:UERS:PORT P5 EVM:DLIN:PROF:USER1:UERS:PORT?
Notes	Changes to this parameter will not be applied until Update Changes command is sent. See " RB Parameter Manager (Downlink) " on page 2012 for more details.
Dependencies	The range of sub op code <n> values is determined by the number of Users the user has configured. Max value for n= 50 If the user attempts to remotely set or query a sub op code that is out of range, this will result in an error message. Enabled when Detection is Manual, and UE-RS Active is On

15 LTE Modulation Analysis Measurement
Meas Setup

Preset	P5
State Saved	Saved in instrument state.
Range	P5 P7 P8
Initial S/W Revision	A.10.00
Modified at S/W Revision	A.13.00

Auto Detect UE-RS Port for QPSK

Specifies on which logical antenna port UE-RS is transmitted for the QPSK modulation when Detection is Auto.

Key Path	Meas Setup, Chan Profile Setup, Edit User Mapping
Mode	LTE, LTETDD
Remote Command	[:SENSe] :EVM:DLINk:PROFile:QPSK:UERS:PORT P5 P7 P8 [:SENSe] :EVM:DLINk:PROFile:QPSK:UERS:PORT?
Example	EVM:DLIN:PROF:QPSK:UERS:PORT P5 EVM:DLIN:PROF:QPSK:UERS:PORT?
Notes	Changes to this parameter will not be applied until Update Changes command is sent. See " RB Parameter Manager (Downlink) " on page 2012 for more details.
Dependencies	Enabled when Detection is Auto, and UE-RS Active is On
Preset	P5
State Saved	Saved in instrument state.
Range	P5 P7 P8
Initial S/W Revision	A.10.00
Modified at S/W Revision	A.13.00

Auto Detect UE-RS Port for 16QAM

Specifies on which logical antenna port UE-RS is transmitted for the 16QAM modulation when Detection is Auto.

Key Path	Meas Setup, Chan Profile Setup, Edit User Mapping
Mode	LTE, LTETDD
Remote Command	[:SENSe] :EVM:DLINk:PROFile:QAM16:UERS:PORT P5 P7 P8 [:SENSe] :EVM:DLINk:PROFile:QAM16:UERS:PORT?
Example	EVM:DLIN:PROF:QAM16:UERS:PORT P5 EVM:DLIN:PROF:QAM16:UERS:PORT?
Notes	Changes to this parameter will not be applied until Update Changes command is sent. See " RB Parameter Manager (Downlink) " on page 2012 for more details.
Dependencies	Enabled when Detection is Auto, and UE-RS Active is On
Preset	P5
State Saved	Saved in instrument state.
Range	P5 P7 P8
Initial S/W Revision	A.10.00
Modified at S/W Revision	A.13.00

Auto Detect UE-RS Port for 64QAM

Specifies on which logical antenna port UE-RS is transmitted for the 64QAM modulation when Detection is Auto.

Key Path	Meas Setup, Chan Profile Setup, Edit User Mapping
Mode	LTE, LTETDD
Remote Command	[:SENSe] :EVM:DLINk:PROFile:QAM64:UERS:PORT P5 P7 P8 [:SENSe] :EVM:DLINk:PROFile:QAM64:UERS:PORT?
Example	EVM:DLIN:PROF:QAM64:UERS:PORT P5 EVM:DLIN:PROF:QAM64:UERS:PORT?
Notes	Changes to this parameter will not be applied until Update Changes command is sent. See " RB Parameter Manager (Downlink) " on page 2012 for more details.
Dependencies	Enabled when Detection is Auto, and UE-RS Active is On.
Preset	P5
State Saved	Saved in instrument state.
Range	P5 P7 P8
Initial S/W Revision	A.10.00
Modified at S/W Revision	A.13.00

UE-RS n_{SCID}

Specifies downlink user's scrambling identity value n_{SCID} when Detection is Manual.

Key Path	Meas Setup, Chan Profile Setup, Edit User Mapping
Mode	LTE, LTETDD
Remote Command	[:SENSe] :EVM:DLINk:PROFile:USER<n>:UERS:SCID <integer> [:SENSe] :EVM:DLINk:PROFile:USER<n>:UERS:SCID?
Example	EVM:DLIN:PROF:USER1:UERS:SCID 0 EVM:DLIN:PROF:USER1:UERS:SCID?
Notes	Changes to this parameter will not be applied until Update Changes command is sent. See " RB Parameter Manager (Downlink) " on page 2012 for more details.
Dependencies	The range of sub op code <n> values is determined by the number of Users the user has configured. If the user attempts to remotely set or query a sub op code that is out of range, this will result in an error message. Available when Detection is Manual and UE-RS Active is On and UE-RS Port is not Port5.
Preset	0
State Saved	Saved in instrument state.
Min	0
Max	1
Initial S/W Revision	A.10.00
Modified at S/W Revision	A.13.00

Auto Detect UE-RS n_{SCID} for QPSK

Specifies scrambling identity value n_{SCID} for the QPSK modulation when Detection is Auto.

Key Path	Meas Setup, Chan Profile Setup, Edit User Mapping
Mode	LTE, LTE-TDD
Remote Command	[:SENSe] :EVM:DLINk:PROFile:QPSK:UERS:SCID <integer> [:SENSe] :EVM:DLINk:PROFile:QPSK:UERS:SCID?
Example	EVM:DLIN:PROF:QPSK:UERS:SCID 0 EVM:DLIN:PROF:QPSK:UERS:SCID?
Notes	Changes to this parameter will not be applied until Update Changes command is sent. See " RB Parameter Manager (Downlink) " on page 2012 for more details.
Dependencies	Available when Detection is Auto, RB Auto Detect Mode is Power Based, UE-RS Active is On, and UE-RS Port is not Port5.
Preset	0
State Saved	Saved in instrument state.
Min	0
Max	1
Initial S/W Revision	A.10.00
Modified at S/W Revision	A.13.00

Auto Detect UE-RS n_{SCID} for 16QAM

Specifies scrambling identity value n_{SCID} for the 16QAM modulation when Detection is Auto.

Key Path	Meas Setup, Chan Profile Setup, Edit User Mapping
Mode	LTE, LTETDD
Remote Command	[:SENSe] :EVM:DLINK:PROFile:QAM16:UERS:SCID <integer> [:SENSe] :EVM:DLINK:PROFile:QAM16:UERS:SCID?
Example	EVM:DLIN:PROF:QAM16:UERS:SCID 0 EVM:DLIN:PROF:QAM16:UERS:SCID?
Notes	Changes to this parameter will not be applied until Update Changes command is sent. See " RB Parameter Manager (Downlink) " on page 2012 for more details.
Dependencies	Available when Detection is Auto, RB Auto Detect Mode is Power Based, UE-RS Active is On, and UE-RS Port is not Port5.
Preset	0
State Saved	Saved in instrument state.
Min	0
Max	1
Initial S/W Revision	A.10.00
Modified at S/W Revision	A.13.00

Auto Detect UE-RS n_{SCID} for 64QAM

Specifies scrambling identity value n_{SCID} for the 64QAM modulation when Detection is Auto.

Key Path	Meas Setup, Chan Profile Setup, Edit User Mapping
Mode	LTE, LTE-TDD
Remote Command	[:SENSe] :EVM:DLINk:PROFile:QAM64:UERS:SCID <integer> [:SENSe] :EVM:DLINk:PROFile:QAM64:UERS:SCID?
Example	EVM:DLIN:PROF:QAM64:UERS:SCID 0 EVM:DLIN:PROF:QAM64:UERS:SCID?
Notes	Changes to this parameter will not be applied until Update Changes command is sent. See " RB Parameter Manager (Downlink) " on page 2012 for more details.
Dependencies	Available when Detection is Auto, RB Auto Detect Mode is Power Based, UE-RS Active is On, and UE-RS Port is not Port5.
Preset	0
State Saved	Saved in instrument state.
Min	0
Max	1
Initial S/W Revision	A.10.00
Modified at S/W Revision	A.13.00

Downlink Allocation Parameters

Sets downlink allocation parameters.

Key Path	Meas Setup, Chan Profile Setup, Edit User Mapping
----------	---

Allocation RB Start

Sets the Resource Block start boundary of the selected Allocation.

Key Path	Meas Setup, Chan Profile Setup, Edit User Mapping, RB Start
Mode	LTE, LTE-TDD
Remote Command	[:SENSe] :EVM:DLINk:PROFile:USER<n>:PDSCh:RBALloc<m>:RB:STARt <integer> [:SENSe] :EVM:DLINk:PROFile:USER<n>:PDSCh:RBALloc<m>:RB:STARt?
Example	EVM:DLIN:PROF:USER1:PDSC:RBAL1:RB:STAR 0 EVM:DLIN:PROF:USER1:PDSC:RBAL1:RB:STAR?
Notes	Changes to this parameter will not be applied until Update Changes command is sent. See " RB Parameter Manager (Downlink) " on page 2012 section for more details.
Dependencies	The range of sub op code <n> values is determined by the number of Users the user has configured. The range of sub op code <m> values is determined by the number of Allocations the user has

	configured. Max value for n=50. Max Value for m=250. If the user attempts to remotely set or query a sub op code that is out of range, this will result in an error message.
Couplings	If the user attempts to set a RB Start value greater than the RB End value, both values are set to the RB Start value or clipped to the min or max value if the entered value is out of range
Preset	0
State Saved	Saved in instrument state.
Min	0
Max	5 - Bandwidth 1.4 MHz 14 - Bandwidth 3 MHz 24 - Bandwidth 5 MHz 49 - Bandwidth 10 MHz 74 - Bandwidth 15 MHz 99 - Bandwidth 20 MHz
Backwards Compatibility SCPI	[:SENSe]:EVM:DLINK:PROFile:USER<n>:PDsch:ALlocation<m>:RB:START (Max value for n=50 and m=50)
Initial S/W Revision	Prior to A.02.00
Modified at S/W Revision	A.03.00, A.06.00

Allocation RB End

Sets the Resource Block stop boundary of the selected Allocation.

Key Path	Meas Setup, Chan Profile Setup, Edit User Mapping, RB End
Mode	LTE, LTE-TDD
Remote Command	[:SENSe]:EVM:DLINK:PROFile:USER<n>:PDsch:RBALloc<m>:RB:END <integer> [:SENSe]:EVM:DLINK:PROFile:USER<n>:PDsch:RBALloc<m>:RB:END?
Example	EVM:DLIN:PROF:USER1:PDSC:RBAL1:RB:END 0 EVM:DLIN:PROF:USER1:PDSC:RBAL1:RB:END?
Notes	Changes to this parameter will not be applied until Update Changes command is sent. See " RB Parameter Manager (Downlink) " on page 2012 section for more details.
Dependencies	The range of sub op code <n> values is determined by the number of Users the user has configured. The range of sub op code <m> values is determined by the number of Allocations the user has configured. If the user attempts to remotely set or query a sub op code that is out of range, this will result in an error message.
Couplings	If the user attempts to set a RB End value less than the RB Start value, both values are set to the RB End value or clipped to the min or max value if the entered value is out of range
Preset	0
State Saved	Saved in instrument state.

Min	0
Max	5 - Bandwidth 1.4 MHz 14 - Bandwidth 3 MHz 24 - Bandwidth 5 MHz 49 - Bandwidth 10 MHz 74 - Bandwidth 15 MHz 99 - Bandwidth 20 MHz
Backwards Compatibility SCPI	[:SENSe]:EVM:DLINk:PROFile:USER<n>:PDSCh:ALLocation<m>:RB:END (Max value for n=50 and m=50)
Initial S/W Revision	Prior to A.02.00
Modified at S/W Revision	A.03.00, A.06.00

Allocation Slot Start

Sets the Slot start boundary of the selected Allocation.

Key Path	Meas Setup, Chan Profile Setup, Edit User Mapping, Slot Start
Mode	LTE, LTE-TDD
Remote Command	[:SENSe]:EVM:DLINk:PROFile:USER<n>:PDSCh:RBALloc<m>:SLOT:STARt <integer> [:SENSe]:EVM:DLINk:PROFile:USER<n>:PDSCh:RBALloc<m>:SLOT:STARt?
Example	EVM:DLIN:PROF:USER1:PDSC:RBAL1:SLOT:STAR 0 EVM:DLIN:PROF:USER1:PDSC:RBAL1:SLOT:STAR?
Notes	Changes to this parameter will not be applied until Update Changes command is sent. See "RB Parameter Manager (Downlink)" on page 2012 section for more details.
Dependencies	The range of sub op code <n> values is determined by the number of Users the user has configured. The range of sub op code <m> values is determined by the number of Allocations the user has configured. Max value for n=50. Max Value for m=250. If the user attempts to remotely set or query a sub op code that is out of range, this will result in an error message.
Couplings	If the user attempts to set a Slot Start value greater than the Slot End value, both values are set to the Slot Start value or clipped to the min or max value if the entered value is out of range
Preset	0
State Saved	Saved in instrument state.
Min	0
Max	19
Backwards Compatibility SCPI	[:SENSe]:EVM:DLINk:PROFile:USER<n>:PDSCh:ALLocation<m>:SLOT:STARt (Max value for n=50 and m=50)
Initial S/W Revision	Prior to A.02.00
Modified at S/W Revision	A.03.00, A.06.00

Allocation Slot End

Sets the Slot end boundary of the selected Allocation.

Key Path	Meas Setup, Chan Profile Setup, Edit User Mapping, Slot End
Mode	LTE, LTETDD
Remote Command	[:SENSe] :EVM:DLINK:PROFile:USER<n>:PDSC:RBALloc<m>:SLOT:END <integer> [:SENSe] :EVM:DLINK:PROFile:USER<n>:PDSC:RBALloc<m>:SLOT:END?
Example	EVM:DLIN:PROF:USER1:PDSC:RBAL1:SLOT:END 1 EVM:DLIN:PROF:USER1:PDSC:RBAL1:SLOT:END?
Notes	Changes to this parameter will not be applied until Update Changes command is sent. See "RB Parameter Manager (Downlink)" on page 2012 section for more details.
Dependencies	The range of sub op code <n> values is determined by the number of Users the user has configured. The range of sub op code <m> values is determined by the number of Allocations the user has configured. If the user attempts to remotely set or query a sub op code that is out of range, this will result in an error message.
Couplings	If the user attempts to set a Slot End value less than the Slot Start value, both values are set to the Slot End value or clipped to the min or max value if the entered value is out of range
Preset	0
State Saved	Saved in instrument state.
Min	0
Max	19
Backwards Compatibility SCPI	[:SENSe] :EVM:DLINK:PROFile:USER<n>:PDSC:ALLocation<m>:SLOT:END (Max value for n=50 and m=50)
Initial S/W Revision	Prior to A.02.00
Modified at S/W Revision	A.03.00, A.06.00

Allocation EPRE

Sets the EPRE value for the selected Allocation.

Key Path	Meas Setup, Chan Profile Setup, Edit User Mapping
Mode	LTE, LTETDD
Remote Command	[:SENSe] :EVM:DLINK:PROFile:USER<n>:PDSC:RBALloc<m>:EPRE <rel_amp1> [:SENSe] :EVM:DLINK:PROFile:USER<n>:PDSC:RBALloc<m>:EPRE?
Example	EVM:DLIN:PROF:USER1:PDSC:RBAL1:EPRE 0 EVM:DLIN:PROF:USER1:PDSC:RBAL1:EPRE?
Notes	Changes to this parameter will not be applied until Update Changes command is sent. See Section "RB Parameter Manager (Downlink)" on page 2012 , "RB Parameter Manager (Downlink)" on page 2012 section for more details.
Dependencies	The range of sub op code <n> values is determined by the number of Users the user has configured.

	<p>The range of sub op code <m> values is determined by the number of Allocations the user has configured.</p> <p>Max value for n=50. Max Value for m=250.</p> <p>If the user attempts to remotely set or query a sub op code that is out of range, this will result in an error message.</p> <p>Enabled when Detection is Manual, Use "Per Antenna" EPRE is ON and EPRE Couple is OFF.</p>
Preset	0 dB
State Saved	Saved in instrument state.
Min	-100 dB
Max	100 dB
Initial S/W Revision	A.11.00

Allocation Mod Type for Codeword 0

Selects the Modulation Type for the selected Allocation.

Key Path	Meas Setup, Chan Profile Setup, Edit User Mapping, Mod Type
Mode	LTE, TLTEDD
Remote Command	<pre>[:SENSe]:EVM:DLInk:PROFile:USER<n>:PDSCh:RBALloc<m>:MODulation:TYPE QPSK QAM16 QAM64</pre> <pre>[:SENSe]:EVM:DLInk:PROFile:USER<n>:PDSCh:RBALloc<m>:MODulation:TYPE?</pre>
Example	<pre>EVM:DLIN:PROF:USER1:PDSC:RBAL1:MOD:TYPE QPSK EVM:DLIN:PROF:USER1:PDSC:RBAL1:MOD:TYPE?</pre>
Notes	Changes to this parameter will not be applied until Update Changes command is sent. See " RB Parameter Manager (Downlink) " on page 2012 section for more details.
Dependencies	<p>The range of sub op code <n> values is determined by the number of Users the user has configured.</p> <p>The range of sub op code <m> values is determined by the number of Allocations the user has configured.</p> <p>Max value for n=50. Max Value for m=250.</p> <p>If the user attempts to remotely set or query a sub op code that is out of range, this will result in an error message.</p> <p>Enabled when Mod Type Couple is OFF and Codeword 0 Enable is ON.</p>
Preset	QPSK
State Saved	Saved in instrument state.
Range	QPSK 16QAM 64QAM
Backwards Compatibility SCPI	<pre>[:SENSe]:EVM:DLInk:PROFile:USER<n>:PDSCh:ALLocation<m>:MODulation:TYPE QPSK QAM16 QAM64 (Max value for n=50 and m=50)</pre>
Initial S/W Revision	Prior to A.02.00
Modified at S/W Revision	A.03.00, A.06.00

Allocation Mod Type for Codeword 1

Selects the Modulation Type of Codeword 1 for the selected Allocation.

Key Path	Meas Setup, Chan Profile Setup, Edit User Mapping, Mod Type
Mode	LTE, LTETDD
Remote Command	[:SENSe] :EVM:DLINK:PROFile:USER<n>:PDSCh:RBALloc<m>:CWONe:MODulation:TYPE QPSK QAM16 QAM64 [:SENSe] :EVM:DLINK:PROFile:USER<n>:PDSCh:RBALloc<m>:CWONe:MODulation:TYPE?
Example	EVM:DLIN:PROF:USER1:PDSC:RBAL1:CWON:MOD:TYPE QPSK EVM:DLIN:PROF:USER1:PDSC:RBAL1:CWON:MOD:TYPE?
Notes	Changes to this parameter will not be applied until Update Changes command is sent. See " RB Parameter Manager (Downlink) " on page 2012 section for more details.
Dependencies	Always grayed out since this instrument supports only one RF input.
Preset	QPSK
State Saved	Saved in instrument state.
Range	QPSK 16QAM 64QAM
Backwards Compatibility SCPI	[:SENSe] :EVM:DLINK:PROFile:USER<n>:PDSCh:ALLocation<m>:CWONe:MODulation:TYPE QPSK QAM16 QAM64 (Max value for n=50 and m=50)
Initial S/W Revision	A.03.00, A.06.00

QPSK

Selects QPSK for the Modulation Type of the selected Allocation.

Key Path	Meas Setup, Chan Profile Setup, Edit User Mapping, Mod Type
Mode	LTE, LTETDD
Initial S/W Revision	Prior to A.02.00
Modified at S/W Revision	A.03.00

16QAM

Selects 16QAM for the Modulation Type of the selected Allocation.

Key Path	Meas Setup, Chan Profile Setup, Edit User Mapping, Mod Type
Mode	LTE, LTETDD
Initial S/W Revision	Prior to A.02.00
Modified at S/W Revision	A.03.00

64QAM

Selects 64QAM for the Modulation Type of the selected Allocation.

Key Path	Meas Setup, Chan Profile Setup, Edit User Mapping, Mod Type
Mode	LTE, LTETDD
Initial S/W Revision	Prior to A.02.00
Modified at S/W Revision	A.03.00

Allocation Power Boost for Codeword 0

Sets the Power Boost value for the selected Allocation.

Key Path	Meas Setup, Chan Profile Setup, Edit User Mapping
Mode	LTE, LTETDD
Remote Command	[:SENSe] :EVM:DLINk:PROFile:USER<n>:PDSCh:RBALloc<m>:PWRBoost <rel_ampl> [:SENSe] :EVM:DLINk:PROFile:USER<n>:PDSCh:RBALloc<m>:PWRBoost?
Example	EVM:DLIN:PROF:USER1:PDSC:RBAL1:PWRB 0 EVM:DLIN:PROF:USER1:PDSC:RBAL1:PWRB?
Notes	Changes to this parameter will not be applied until Update Changes command is sent. See "RB Parameter Manager (Downlink)" on page 2012 section for more details.
Dependencies	The range of sub op code <n> values is determined by the number of Users the user has configured. The range of sub op code <m> values is determined by the number of Allocations the user has configured. Max value for n=50. Max Value for m=250. If the user attempts to remotely set or query a sub op code that is out of range, this will result in an error message. Enabled when Detection is Manual, Use "Per-antenna" EPRE is OFF, Codeword 0 Enable is ON and Power Boost Couple is OFF.
Preset	0 dB
State Saved	Saved in instrument state.
Min	-100 dB
Max	100 dB
Backwards Compatibility SCPI	[:SENSe] :EVM:DLINk:PROFile:USER<n>:PDSCh:ALLocation<m>:PWRBoost (Max value for n=50 and m=50)
Initial S/W Revision	Prior to A.02.00
Modified at S/W Revision	A.03.00, A.04.20, A.06.00

Allocation Power Boost for Codeword 1

Sets the Power Boost value of Codeword 1 for the selected Allocation.

Key Path	Meas Setup, Chan Profile Setup, Edit User Mapping
Mode	LTE, LTETDD
Remote Command	[:SENSe] :EVM:DLINK:PROFile:USER<n>:PDSC:RBALloc<m>:CWONe:PWRBoost <rel_ampl> [:SENSe] :EVM:DLINK:PROFile:USER<n>:PDSC:RBALloc<m>:CWONe:PWRBoost?
Example	EVM:DLIN:PROF:USER1:PDSC:RBAL1:CWON:PWRB 0 EVM:DLIN:PROF:USER1:PDSC:RBAL1:CWON:PWRB?
Notes	Changes to this parameter will not be applied until Update Changes command is sent. See " RB Parameter Manager (Downlink) " on page 2012 section for more details.
Dependencies	Always grayed out since this instrument supports only one RF input.
Preset	0 dB
State Saved	Saved in instrument state.
Min	-100 dB
Max	100 dB
Backwards Compatibility SCPI	[:SENSe] :EVM:DLINK:PROFile:USER<n>:PDSC:ALLocation<m>:CWONe:PWRBoost (Max value for n=50 and m=50)
Initial S/W Revision	A.03.00
Modified at S/W Revision	A.04.20, A.06.00

Allocation Frame Index

Specifies the Frame Index for the selected Allocation.

Key Path	Meas Setup, Chan Profile Setup, Edit User Mapping, Frame Index
Mode	LTETDD
Remote Command	[:SENSe] :EVM:DLINK:PROFile:USER<n>:PDSC:RBALloc<m>:FINdex F0 F1 [:SENSe] :EVM:DLINK:PROFile:USER<n>:PDSC:RBALloc<m>:FINdex?
Example	EVM:DLIN:PROF:USER1:PDSC:RBAL1:FIND F0 EVM:DLIN:PROF:USER1:PDSC:RBAL1:FIND?
Notes	Changes to this parameter will not be applied until Update Changes command is sent. See " RB Parameter Manager (Downlink) " on page 2012 section for more details.
Dependencies	The range of sub op code <n> values is determined by the number of Users the user has configured. The range of sub op code <m> values is determined by the number of Allocations the user has configured. Max value for n=50. Max Value for m=250. If the user attempts to remotely set or query a sub op code that is out of range, this will result in an error message. Enabled only for the LTE TDD mode. Enabled when Detection is Manual, Multi -Frame Analysis is ON, and Frame Index Couple is OFF.

Preset	F0
State Saved	Saved in instrument state.
Range	F0 F1
Backwards Compatibility SCPI	[:SENSe]:EVM:DLINK:PROFile:USER<n>:PDSCh:ALLocation<m>:FINDeX F0 F1 (Max value for n=50 and m=50)
Initial S/W Revision	Prior to A.02.00
Modified at S/W Revision	A.03.00, A.06.00

PDSCH Common Mod Type

Selects the Modulation Type for all the Allocations when Mod Type Couple is On.

Key Path	Meas Setup, Chan Profile Setup, Edit User Mapping, Mod Type
Mode	LTE, LTE-TDD
Remote Command	[:SENSe]:EVM:DLINK:PROFile:USER<n>:PDSCh:MODulation:TYPE QPSK QAM16 QAM64 [:SENSe]:EVM:DLINK:PROFile:USER<n>:PDSCh:MODulation:TYPE?
Example	EVM:DLIN:PROF:USER1:PDSC:MOD:TYPE QPSK EVM:DLIN:PROF:USER1:PDSC:MOD:TYPE?
Notes	Changes to this parameter will not be applied until Update Changes command is sent. See "RB Parameter Manager (Downlink)" on page 2012 section for more details.
Dependencies	The range of sub op code <n> values is determined by the number of Users the user has configured. Max value for n= 50 If the user attempts to remotely set or query a sub op code that is out of range, this will result in an error message. Enabled when Detection is Manual, Codeword 0 Enable is ON and Mod Type Couple is ON.
Preset	QPSK
State Saved	Saved in instrument state.
Range	QPSK 16QAM 64QAM
Initial S/W Revision	Prior to A.02.00
Modified at S/W Revision	A.03.00

Common Mod Type for Codeword 1

Selects the Modulation Type for Codeword 1 for all the Allocations when Mod Type Couple is On.

Key Path	Meas Setup, Chan Profile Setup, Edit User Mapping, Mod Type
Mode	LTE, LTETDD
Remote Command	[:SENSe] :EVM:DLINk:PROFile:USER<n>:PDSC:CWONe:MODulation:TYPE QPSK QAM16 QAM64 [:SENSe] :EVM:DLINk:PROFile:USER<n>:PDSC:CWONe:MODulation:TYPE?
Example	EVM:DLIN:PROF:USER1:PDSC:CWON:MOD:TYPE QPSK EVM:DLIN:PROF:USER1:PDSC:CWON:MOD:TYPE?
Notes	Changes to this parameter will not be applied until Update Changes command is sent. See " RB Parameter Manager (Downlink) " on page 2012 section for more details.
Dependencies	Always grayed out since this instrument supports only one RF input.
Preset	QPSK
State Saved	Saved in instrument state.
Range	QPSK 16QAM 64QAM
Initial S/W Revision	A.03.00

QPSK

Selects QPSK for the Modulation Type for all the Allocations when Mod Type Couple is On.

Key Path	Meas Setup, Chan Profile Setup, Edit User Mapping, Mod Type
Mode	LTE, LTETDD
Initial S/W Revision	Prior to A.02.00
Modified at S/W Revision	A.03.00

16QAM

Selects 16QAM for the Modulation Type for all the Allocations when Mod Type Couple is On.

Key Path	Meas Setup, Chan Profile Setup, Edit User Mapping, Mod Type
Mode	LTE, LTETDD
Initial S/W Revision	Prior to A.02.00
Modified at S/W Revision	A.03.00

64QAM

Selects 64QAM for the Modulation Type for all the Allocations when Mod Type Couple is On.

Key Path	Meas Setup, Chan Profile Setup, Edit User Mapping, Mod Type
Mode	LTE, LTETDD
Initial S/W Revision	Prior to A.02.00
Modified at S/W Revision	A.03.00

Mod Type Couple

Determines whether or not all the Allocations will use the Common Mod Type value.

Key Path	Meas Setup, Chan Profile Setup, Edit User Mapping, Mod Type
Mode	LTE, LTETDD
Remote Command	[:SENSe] :EVM:DLINk:PROFile:USER<n>:PDSCh:MODulation:TYPE:COUPle OFF ON 0 1 [:SENSe] :EVM:DLINk:PROFile:USER<n>:PDSCh:MODulation:TYPE:COUPle?
Example	EVM:DLIN:PROF:USER1:PDSC:MOD:TYPE:COUP ON EVM:DLIN:PROF:USER1:PDSC:MOD:TYPE:COUP?
Notes	Changes to this parameter will not be applied until Update Changes command is sent. See " RB Parameter Manager (Downlink) " on page 2012 section for more details.
Dependencies	The range of sub op code <n> values is determined by the number of Users the user has configured. Max value for n=50. If the user attempts to remotely set or query a sub op code that is out of range, this will result in an error message. Enabled when Detection is Manual and Codeword 0 Enable is ON.
Preset	ON
State Saved	Saved in instrument state.
Initial S/W Revision	Prior to A.02.00
Modified at S/W Revision	A.03.00

Mod Type Couple for Codeword 1

Determines whether or not all the Allocations will use the Common Mod Type value for Codeword 1.

Key Path	Meas Setup, Chan Profile Setup, Edit User Mapping, Mod Type
Mode	LTE, LTETDD
Remote Command	[:SENSe] :EVM:DLINK:PROFile:USER<n>:PDSCh:CWONe:MODulation:TYPE:COUPle OFF ON 0 1 [:SENSe] :EVM:DLINK:PROFile:USER<n>:PDSCh:CWONe:MODulation:TYPE:COUPle?
Example	EVM:DLIN:PROF:USER1:PDSC:CWON:MOD:TYPE:COUP ON EVM:DLIN:PROF:USER1:PDSC:CWON:MOD:TYPE:COUP?
Notes	Changes to this parameter will not be applied until Update Changes command is sent. See " RB Parameter Manager (Downlink) " on page 2012 section for more details.
Dependencies	Always grayed out since this instrument supports only one RF input.
Preset	ON
State Saved	Saved in instrument state.
Initial S/W Revision	A.03.00

PDSCH Common Power Boost

See "[Edit User Mapping \(Downlink\)](#)" on page 1939

Key Path	Meas Setup, Chan Profile Setup, Edit User Mapping
----------	---

Common EPRE

Sets the EPRE value for all the Allocations when EPRE Couple is On.

The average power per antenna port is relative to the 0 dB level of the RS power when its value is 0 dB.

Key Path	Meas Setup, Chan Profile Setup, Edit User Mapping
Mode	LTE, LTETDD
Remote Command	[:SENSe] :EVM:DLINK:PROFile:USER<n>:PDSCh:EPRE <rel_amp> [:SENSe] :EVM:DLINK:PROFile:USER<n>:PDSCh:EPRE?
Example	EVM:DLIN:PROF:USER1:PDSC:EPRE 0 EVM:DLIN:PROF:USER1:PDSC:EPRE?
Notes	Changes to this parameter will not be applied until Update Changes command is sent. See Section " RB Parameter Manager (Downlink) " on page 2012, " RB Parameter Manager (Downlink) " on page 2012 section for more details.
Dependencies	The range of sub op code <n> values is determined by the number of Users the user has configured Max value for n=50.

	If the user attempts to remotely set or query a sub op code that is out of range, this will result in an error message. Enabled when Detection is Manual, EPRE Couple is ON, and Use "Per Antenna" EPRE is On.
Preset	0 dB
State Saved	Saved in instrument state.
Min	-100 dB
Max	100 dB
Initial S/W Revision	A.11.00

Auto Detect PDSCH QPSK for EPRE

Sets the EPRE value for PDSCH QPSK Mod Type when Detection is Auto and Use “Per Antenna” EPRE is On.

Key Path	Meas Setup, Chan Profile Setup, Edit User Mapping, tab
Mode	LTE, LTETDD
Remote Command	[:SENSe] :EVM:DLINk:PROFile:AUTO:PDSC:h:QPSK:EPRE <rel_amp1> [:SENSe] :EVM:DLINk:PROFile:AUTO:PDSC:h:QPSK:EPRE?
Example	EVM:DLIN:PROF:AUTO:PDSC:QPSK:EPRE 0 EVM:DLIN:PROF:AUTO:PDSC:QPSK:EPRE?
Notes	Changes to this parameter will not be applied until Update Changes command is sent. See Section "RB Parameter Manager (Downlink)" on page 2012 , "RB Parameter Manager (Downlink)" on page 2012 section for more details.
Dependencies	Enabled when Detection is Auto, and Use “Per Antenna” EPRE is On.
Preset	0
State Saved	Saved in instrument state.
Min	-100
Max	100
Initial S/W Revision	A.11.00

Auto Detect PDSCH 16QAM for EPRE

Sets the EPRE value for PDSCH 16QAM Mod Type when Detection is Auto, and Use “Per Antenna” EPRE is On.

Key Path	Meas Setup, Chan Profile Setup, Edit User Mapping, tab
Mode	LTE, LTE-TDD
Remote Command	[:SENSE] :EVM:DLINK:PROF:FILE:AUTO:PDSC:QAM16:EPRE <rel_amp1> [:SENSE] :EVM:DLINK:PROF:FILE:AUTO:PDSC:QAM16:EPRE?
Example	EVM:DLIN:PROF:AUTO:PDSC:QAM16:EPRE 0 EVM:DLIN:PROF:AUTO:PDSC:QAM16:EPRE?
Notes	Changes to this parameter will not be applied until Update Changes command is sent. See Section "RB Parameter Manager (Downlink)" on page 2012 , "RB Parameter Manager (Downlink)" on page 2012 section for more details.
Dependencies	Enabled when Detection is Auto, and Use “Per Antenna” EPRE is On.
Preset	0
State Saved	Saved in instrument state.
Min	-100
Max	100
Initial S/W Revision	A.11.00

Auto Detect PDSCH 64QAM for EPRE

Sets the EPRE value for PDSCH 64QAM Mod Type when Detection is Auto, and Use "Per Antenna" EPRE is On.

Key Path	Meas Setup, Chan Profile Setup, Edit User Mapping, tab
Mode	LTE, LTETDD
Remote Command	[:SENSe] :EVM:DLINK:PROFile:AUTO:PDSC:QAM64:EPRE <rel_ampl> [:SENSe] :EVM:DLINK:PROFile:AUTO:PDSC:QAM64:EPRE?
Example	EVM:DLIN:PROF:AUTO:PDSC:QAM64:EPRE 0 EVM:DLIN:PROF:AUTO:PDSC:QAM64:EPRE?
Notes	Changes to this parameter will not be applied until Update Changes command is sent. See Section "RB Parameter Manager (Downlink)" on page 2012 , "RB Parameter Manager (Downlink)" on page 2012 section for more details.
Dependencies	Enabled when Detection is Auto Auto , and Use "Per Antenna" EPRE is On.
Preset	0
State Saved	Saved in instrument state.
Min	-100
Max	100
Initial S/W Revision	A.11.00

Common Power Boost for Codeword 0

Sets the Power Boost value for all the Allocations when Power Boost Couple is On.

Power Boost value specifies the average power for the codeword symbols.

The average power of the codeword modulation symbols $d(q)(i)$ is relative to the 0 dB level determined by the RS power level.

Key Path	Meas Setup, Chan Profile Setup, Edit User Mapping, Power Boost
Mode	LTE, LTETDD
Remote Command	[:SENSe] :EVM:DLINK:PROFile:USER<n>:PDSC:PWRBoost <rel_ampl> [:SENSe] :EVM:DLINK:PROFile:USER<n>:PDSC:PWRBoost?
Example	EVM:DLIN:PROF:USER1:PDSC:PWRB 0 EVM:DLIN:PROF:USER1:PDSC:PWRB?
Notes	Changes to this parameter will not be applied until Update Changes command is sent. See "RB Parameter Manager (Downlink)" on page 2012 section for more details.
Dependencies	The range of sub op code <n> values is determined by the number of Users the user has configured Max value for n=50. If the user attempts to remotely set or query a sub op code that is out of range, this will result in an error message. Enabled when Detection is Manual, Use "Per-antenna" EPRE is OFF, Power Boost Couple is ON, and

	Codeword 0 Enable is ON.
Preset	0 dB
State Saved	Saved in instrument state.
Min	-100 dB
Max	100 dB
Initial S/W Revision	Prior to A.02.00
Modified at S/W Revision	A.03.00, A.04.20

Auto Detect PDSCH QPSK Power Boost

Sets the Power Boost value for PDSCH QPSK Mod Type when Detection is Auto.

Key Path	Meas Setup, Chan Profile Setup, Edit User Mapping, tab
Mode	LTE, LTETDD
Remote Command	[:SENSe] :EVM:DLINk:PROFile:AUTO:PDSC:h:QPSK:PWRBoost <rel_ampl> [:SENSe] :EVM:DLINk:PROFile:AUTO:PDSC:h:QPSK:PWRBoost?
Example	EVM:DLIN:PROF:AUTO:PDSC:QPSK:PWRB 0 EVM:DLIN:PROF:AUTO:PDSC:QPSK:PWRB?
Notes	Changes to this parameter will not be applied until Update Changes command is sent. See " RB Parameter Manager (Downlink) " on page 2012 section for more details.
Dependencies	Enabled when Detection is Auto, Use "Per-antenna" EPRE is OFF and Auto Detect Codeword 0 for QPSK QAM16 QAM64 is ON.
Preset	0
State Saved	Saved in instrument state.
Min	-100
Max	100
Initial S/W Revision	A.03.00, A.04.20

Auto Detect PDSCH 16QAM Power Boost

Sets the Power Boost value for PDSCH 16QAM Mod Type when Detection is Auto.

Key Path	Meas Setup, Chan Profile Setup, Edit User Mapping, tab
Mode	LTE, LTE-TDD
Remote Command	[:SENSE] :EVM:DLINK:PROF:FILE:AUTO:PDSC:QAM16:PWRBoost <rel_ampl> [:SENSE] :EVM:DLINK:PROF:FILE:AUTO:PDSC:QAM16:PWRBoost?
Example	EVM:DLIN:PROF:AUTO:PDSC:QAM16:PWRB 0 EVM:DLIN:PROF:AUTO:PDSC:QAM16:PWRB?
Notes	Changes to this parameter will not be applied until Update Changes command is sent. See " RB Parameter Manager (Downlink) " on page 2012 section for more details.
Dependencies	Enabled when Detection is Auto, Use "Per-antenna" EPRE is OFF and Auto Detect Codeword 0 for QPSK QAM16 QAM64 is ON.
Preset	0
State Saved	Saved in instrument state.
Min	-100
Max	100
Initial S/W Revision	A.03.00, A.04.20

Auto Detect PDSCH 64QAM Power Boost

Sets the Power Boost value for PDSCH 64QAM Mod Type when Detection is Auto.

Key Path	Meas Setup, Chan Profile Setup, Edit User Mapping, tab
Mode	LTE, LTETDD
Remote Command	[:SENSe] :EVM:DLINK:PROFile:AUTO:PDSC:QAM64:PWRBoost <rel_ampl> [:SENSe] :EVM:DLINK:PROFile:AUTO:PDSC:QAM64:PWRBoost?
Example	EVM:DLIN:PROF:AUTO:PDSC:QAM64:PWRB 0 EVM:DLIN:PROF:AUTO:PDSC:QAM64:PWRB?
Notes	Changes to this parameter will not be applied until Update Changes command is sent. See " RB Parameter Manager (Downlink) " on page 2012 section for more details.
Dependencies	Enabled when Detection is Auto, Use "Per-antenna" EPRE is OFF and Auto Detect Codeword 0 for QPSK QAM16 QAM64 is ON.
Preset	0
State Saved	Saved in instrument state.
Min	-100
Max	100
Initial S/W Revision	A.03.00, A.04.20

Common Power Boost for Codeword 1

Sets the Power Boost value for Codeword 1 for all the Allocations when Power Boost Couple is On.

Key Path	Meas Setup, Chan Profile Setup, Edit User Mapping, Power Boost
Mode	LTE, LTETDD
Remote Command	[:SENSe] :EVM:DLINK:PROFile:USER<n>:PDSC:CWONe:PWRBoost <rel_ampl> [:SENSe] :EVM:DLINK:PROFile:USER<n>:PDSC:CWONe:PWRBoost?
Example	EVM:DLIN:PROF:USER1:PDSC:CWON:PWRB 0 EVM:DLIN:PROF:USER1:PDSC:CWON:PWRB?
Notes	Changes to this parameter will not be applied until Update Changes command is sent. See " RB Parameter Manager (Downlink) " on page 2012 section for more details.
Dependencies	Always grayed out since this instrument supports only one RF input.
Preset	0 dB
State Saved	Saved in instrument state.
Min	-100 dB
Max	100 dB
Initial S/W Revision	A.03.00, A.04.20

Auto Detect PDSCH QPSK Power Boost for Codeword 1

Sets the Power Boost value for PDSCH QPSK Mod Type for Codeword 1 when Detection is Auto.

Key Path	Meas Setup, Chan Profile Setup, Edit User Mapping, tab
Mode	LTE, LTE-TDD
Remote Command	[:SENSe] :EVM:DLINk:PROFile:AUTO:PDSC:h:QPSK:CWONe:PWRBoost <rel_ampl> [:SENSe] :EVM:DLINk:PROFile:AUTO:PDSC:h:QPSK:CWONe:PWRBoost?
Example	EVM:DLIN:PROF:AUTO:PDSC:QPSK:CWON:PWRB 0 EVM:DLIN:PROF:AUTO:PDSC:QPSK:CWON:PWRB?
Notes	Changes to this parameter will not be applied until Update Changes command is sent. See " RB Parameter Manager (Downlink) " on page 2012 section for more details.
Dependencies	Always grayed out since this instrument supports only one RF input.
Preset	0
State Saved	Saved in instrument state.
Min	-100
Max	100
Initial S/W Revision	A.03.00, A.04.20

Auto Detect PDSCH 16QAM Power Boost for Codeword 1

Sets the Power Boost value for PDSCH 16QAM Mod Type for Codeword 1 when Detection is Auto.

Key Path	Meas Setup, Chan Profile Setup, Edit User Mapping, tab
Mode	LTE, LTETDD
Remote Command	[:SENSe] :EVM:DLINK:PROFile:AUTO:PDSC:h:QAM16:CWONe:PWRBoost <rel_ampl> [:SENSe] :EVM:DLINK:PROFile:AUTO:PDSC:h:QAM16:CWONe:PWRBoost?
Example	EVM:DLIN:PROF:AUTO:PDSC:QAM16:CWON:PWRB 0 EVM:DLIN:PROF:AUTO:PDSC:QAM16:CWON:PWRB?
Notes	Changes to this parameter will not be applied until Update Changes command is sent. See " RB Parameter Manager (Downlink) " on page 2012 section for more details.
Dependencies	Always grayed out since this instrument supports only one RF input.
Preset	0
State Saved	Saved in instrument state.
Min	-100
Max	100
Initial S/W Revision	A.03.00, A.04.20

Auto Detect PDSCH 64QAM Power Boost for Codeword 1

Sets the Power Boost value for PDSCH 64QAM Mod Type for Codeword 1 when Detection is Auto.

Key Path	Meas Setup, Chan Profile Setup, Edit User Mapping, tab
Mode	LTE, LTETDD
Remote Command	[:SENSe] :EVM:DLINk:PROFile:AUTO:PDSC:h:QAM64:CWONe:PWRBoost <rel_ampl> [:SENSe] :EVM:DLINk:PROFile:AUTO:PDSC:h:QAM64:CWONe:PWRBoost?
Example	EVM:DLIN:PROF:AUTO:PDSC:QAM64:CWON:PWRB 0 EVM:DLIN:PROF:AUTO:PDSC:QAM64:CWON:PWRB?
Notes	Changes to this parameter will not be applied until Update Changes command is sent. See "RB Parameter Manager (Downlink)" on page 2012 section for more details.
Dependencies	Always grayed out since this instrument supports only one RF input.
Preset	0
State Saved	Saved in instrument state.
Min	-100
Max	100
Initial S/W Revision	A.03.00, A.04.20

Decoded EPRE

Sets the EPRE value for the specified user.

Key Path	Meas Setup, Chan Profile Setup, Edit User Mapping, EPRE
Mode	LTE, LTETDD
Remote Command	[:SENSe] :EVM:DLINk:PROFile:USER<n>:DECoded:PDSC:h:EPRE <rel_ampl> [:SENSe] :EVM:DLINk:PROFile:USER<n>:DECoded:PDSC:h:EPRE?
Example	EVM:DLIN:PROF:USER1:DEC:PDSC:EPRE 0 EVM:DLIN:PROF:USER1:DEC:PDSC:EPRE?
Notes	Changes to this parameter will not be applied until Update Changes command is sent. See Section "RB Parameter Manager (Downlink)" on page 2012 , "RB Parameter Manager (Downlink)" on page 2012 section for more details.
Dependencies	The range of sub op code <n> values is determined by the number of Users the user has configured Max value for n=50. If the user attempts to remotely set or query a sub op code that is out of range, this will result in an error message. Available when all the following conditions are met. Direction is Downlink. Detection is Auto. RB Auto Detect Mode is Decoded PDCCH.

	Use "Per Antenna" EPRE is On. Auto-detect Power Levels is Off.
Preset	0 dB
State Saved	Saved in instrument state.
Min	-100 dB
Max	100 dB
Initial S/W Revision	A.11.00

Decoded User Power Boost for Codeword 0

Sets the Power Boost value for the specified user.

Key Path	Meas Setup, Chan Profile Setup, Edit User Mapping, Power Boost
Mode	LTE, LTETDD
Remote Command	[:SENSe] :EVM:DLINK:PROFile:USER<n>:DECodEd:PDSCh:CWZero:PWRBoost <rel_ ampl> [:SENSe] :EVM:DLINK:PROFile:USER<n>:DECodEd:PDSCh:CWZero:PWRBoost?
Example	EVM:DLIN:PROF:USER1:DEC:PDSC:CWZ:PWRB 0 EVM:DLIN:PROF:USER1:DEC:PDSC:CWZ:PWRB?
Notes	Changes to this parameter will not be applied until Update Changes command is sent. See " RB Parameter Manager (Downlink) " on page 2012 section for more details.
Dependencies	The range of sub op code <n> values is determined by the number of Users the user has configured Max value for n=50. If the user attempts to remotely set or query a sub op code that is out of range, this will result in an error message. Available when all the following conditions are met. Direction is Downlink. Detection is Auto. RB Auto Detect Mode is Decoded PDCCH. Auto-detect Power Levels is OFF. Use "Pre-antenna" EPRE is OFF. Codeword 0 Enable for Decoded User is ON.
Preset	0 dB
State Saved	Saved in instrument state.
Min	-100 dB
Max	100 dB
Initial S/W Revision	A.06.00

Decoded User Power Boost for Codeword 1

Sets the Power Boost value for the specified user.

Key Path	Meas Setup, Chan Profile Setup, Edit User Mapping, Power Boost
Mode	LTE, LTETDD
Remote Command	[:SENSe] :EVM:DLINk:PROFile:USER<n>:DECoded:PDSCh:CWONe:PWRBoost <rel_ ampl> [:SENSe] :EVM:DLINk:PROFile:USER<n>:DECoded:PDSCh:CWONe:PWRBoost?
Example	EVM:DLIN:PROF:USER1:DEC:PDSC:CWON:PWRB 0
Notes	Changes to this parameter will not be applied until Update Changes command is sent. See " RB Parameter Manager (Downlink) " on page 2012 section for more details.
Dependencies	The range of sub op code <n> values is determined by the number of Users the user has configured Max value for n=50. If the user attempts to remotely set or query a sub op code that is out of range, this will result in an error message. Available when all the following conditions are met. Direction is Downlink. Detection is Auto. RB Auto Detect Mode is Decoded PDCCH. Auto-detect Power Levels is OFF. Use "Pre-antenna" EPRE is OFF. Codeword 1 Enable for Decoded User is ON.
Preset	0 dB
State Saved	Saved in instrument state.
Min	-100 dB
Max	100 dB
Initial S/W Revision	A.06.00

Power Boost Couple

Determines whether or not all the Allocations will use the Common Power Boost value.

Key Path	Meas Setup, Chan Profile Setup, Edit User Mapping, Power Boost
Mode	LTE, LTETDD
Remote Command	[:SENSe] :EVM:DLINk:PROFile:USER<n>:PDSCh:PWRBoost:COUPle OFF ON 0 1 [:SENSe] :EVM:DLINk:PROFile:USER<n>:PDSCh:PWRBoost:COUPle?
Example	EVM:DLIN:PROF:USER1:PDSC:PWRB:COUP 0 EVM:DLIN:PROF:USER1:PDSC:PWRB:COUP?
Notes	Changes to this parameter will not be applied until Update Changes command is sent. See " RB Parameter Manager (Downlink) " on page 2012 section for more details.
Dependencies	The range of sub op code <n> values is determined by the number of Users the user has configured. Max value for n=50. If the user attempts to remotely set or query a sub op code that is out of range, this will result in an

	error message. Enabled when Detection is Manual, Use "Per-antenna" EPRE is OFF and Codeword 0 Enable is ON.
Preset	ON
State Saved	Saved in instrument state.
Initial S/W Revision	Prior to A.02.00
Modified at S/W Revision	A.03.00

Couple for EPRE

Determines whether or not all the Allocations will use the EPRE value.

Key Path	Meas Setup, Chan Profile Setup, Edit User Mapping
Mode	LTE, LTETDD
Remote Command	[:SENSe] :EVM:DLINk:PROFile:USER<n>:PDSch:EPRE:COUPle OFF ON 0 1 [:SENSe] :EVM:DLINk:PROFile:USER<n>:PDSch:EPRE:COUPle?
Example	EVM:DLIN:PROF:USER1:PDSC:EPRE:COUP 0 EVM:DLIN:PROF:USER1:PDSC:EPRE:COUP?
Notes	Changes to this parameter will not be applied until Update Changes command is sent. See Section "RB Parameter Manager (Downlink)" on page 2012 , "RB Parameter Manager (Downlink)" on page 2012 section for more details.
Dependencies	The range of sub op code <n> values is determined by the number of Users the user has configured. Max value for n=50. If the user attempts to remotely set or query a sub op code that is out of range, this will result in an error message. Enabled when Use "Per Antenna" EPRE is On and Detection is Manual.
Preset	ON
State Saved	Saved in instrument state.
Initial S/W Revision	A.11.00

Power Boost Couple for Codeword 1

Determines whether or not all the Allocations will use the Common Power Boost value for Codeword 1.

Key Path	Meas Setup, Chan Profile Setup, Edit User Mapping, Power Boost
Mode	LTE, LTETDD
Remote Command	[:SENSe] :EVM:DLINk:PROFile:USER<n>:PDSch:CWONe:PWRBoost:COUPle OFF ON 0 1 [:SENSe] :EVM:DLINk:PROFile:USER<n>:PDSch:CWONe:PWRBoost:COUPle?
Example	EVM:DLIN:PROF:USER1:PDSC:CWON:PWRB:COUP 0 EVM:DLIN:PROF:USER1:PDSC:CWON:PWRB:COUP?

Notes	Changes to this parameter will not be applied until Update Changes command is sent. See " RB Parameter Manager (Downlink) " on page 2012 section for more details.
Dependencies	Always grayed out since this instrument supports only one RF input.
Preset	ON
State Saved	Saved in instrument state.
Initial S/W Revision	A.03.00

Codeword

Enables Codeword 0 and Codeword 1.

Key Path	Meas Setup, Chan Profile Setup, Edit User Mapping
----------	---

Codeword 0 Enable

Enables parameters for Codeword 0 and includes Codeword 0 in the analysis when Detection is Manual.

Key Path	Meas Setup, Chan Profile Setup, Edit User Mapping
Mode	LTE, LTETDD
Remote Command	[:SENSe] :EVM:DLINK:PROFile:USER1 50:PDsch:CWZero:ENABle ON OFF 0 1 [:SENSe] :EVM:DLINK:PROFile:USER1 50:PDsch:CWZero:ENABle?
Example	EVM:DLIN:PROF:USER1:PDSC:CWZ:ENAB ON EVM:DLIN:PROF:USER1:PDSC:CWZ:ENAB?
Notes	Changes to this parameter will not be applied until Update Changes command is sent. See " RB Parameter Manager (Downlink) " on page 2012 section for more details.
Dependencies	Enabled when Detection is Manual.
Preset	ON
State Saved	Saved in instrument state.
Initial S/W Revision	A.03.00

Auto Detect Codeword 0 Enable for QPSK

Enables parameters for Codeword 0 for QPSK modulation when Detection is Auto.

Key Path	Meas Setup, Chan Profile Setup, Edit User Mapping
Mode	LTE, LTETDD
Remote Command	<pre>[:SENSe] :EVM:DLINK:PROFile:AUTO:PDSCh:QPSK:CWZero:ENABle ON OFF 0 1</pre> <pre>[:SENSe] :EVM:DLINK:PROFile:AUTO:PDSCh:QPSK:CWZero:ENABle?</pre>
Example	<pre>EVM:DLIN:PROF:AUTO:PDSC:QPSK:CWZ:ENAB ON</pre> <pre>EVM:DLIN:PROF:AUTO:PDSC:QPSK:CWZ:ENAB?</pre>
Notes	Changes to this parameter will not be applied until Update Changes command is sent. See " RB Parameter Manager (Downlink) " on page 2012 section for more details.
Dependencies	Enabled when Detection is Auto.
Preset	ON
State Saved	Saved in instrument state.
Initial S/W Revision	A.03.00

Auto Detect Codeword 0 Enable for 16QAM

Enables parameters for Codeword 0 for 16QAM modulation when Detection is Auto.

Key Path	Meas Setup, Chan Profile Setup, Edit User Mapping
Mode	LTE, LTETDD
Remote Command	[:SENSe] :EVM:DLINK:PROFile:AUTO:PDSC:QAM16:CWZero:ENABle ON OFF 0 1 [:SENSe] :EVM:DLINK:PROFile:AUTO:PDSC:QAM16:CWZero:ENABle?
Example	EVM:DLIN:PROF:AUTO:PDSC:QAM16:CWZ:ENAB ON EVM:DLIN:PROF:AUTO:PDSC:QAM16:CWZ:ENAB?
Notes	Changes to this parameter will not be applied until Update Changes command is sent. See " RB Parameter Manager (Downlink) " on page 2012 section for more details.
Dependencies	Enabled when Detection is Auto.
Preset	ON
State Saved	Saved in instrument state.
Initial S/W Revision	A.03.00

Auto Detect Codeword 0 Enable for 64QAM

Enables parameters for Codeword 0 for 64QAM modulation when Detection is Auto.

Key Path	Meas Setup, Chan Profile Setup, Edit User Mapping
Mode	LTE, LTETDD
Remote Command	[:SENSe] :EVM:DLINK:PROFile:AUTO:PDSC:QAM64:CWZero:ENABle ON OFF 0 1 [:SENSe] :EVM:DLINK:PROFile:AUTO:PDSC:QAM64:CWZero:ENABle?
Example	EVM:DLIN:PROF:AUTO:PDSC:QAM64:CWZ:ENAB ON EVM:DLIN:PROF:AUTO:PDSC:QAM64:CWZ:ENAB?
Notes	Changes to this parameter will not be applied until Update Changes command is sent. See " RB Parameter Manager (Downlink) " on page 2012 section for more details.
Dependencies	Enabled when Detection is Auto.
Preset	ON
State Saved	Saved in instrument state.
Initial S/W Revision	A.03.00

Codeword 1 Enable

Enables parameters for Codeword 1 and includes Codeword 1 in the analysis when Detection is Manual.

Key Path	Meas Setup, Chan Profile Setup, Edit User Mapping
Mode	LTE, LTETDD
Remote Command	[:SENSe] :EVM:DLINK:PROFile:USER1 50:PDSC:CWONe:ENABle ON OFF 0 1 [:SENSe] :EVM:DLINK:PROFile:USER1 50:PDSC:CWONe:ENABle?
Example	EVM:DLIN:PROF:USER1:PDSC:CWON ON
Notes	Changes to this parameter will not be applied until Update Changes command is sent. See " RB Parameter Manager (Downlink) " on page 2012 section for more details.
Dependencies	Always grayed out since this instrument supports only one RF input.
Preset	ON
State Saved	Saved in instrument state.
Initial S/W Revision	A.03.00

Auto Detect Codeword 1 Enable for QPSK

Enables parameters for Codeword 1 for QPSK modulation when Detection is Auto.

Key Path	Meas Setup, Chan Profile Setup, Edit User Mapping
Mode	LTE, LTETDD
Remote Command	[:SENSe] :EVM:DLINk:PROFile:AUTO:PDSC:h:QPSK:CWONe:ENABle ON OFF 0 1 [:SENSe] :EVM:DLINk:PROFile:AUTO:PDSC:h:QPSK:CWONe:ENABle?
Example	EVM:DLIN:PROF:AUTO:PDSC:QPSK:CWON:ENAB ON EVM:DLIN:PROF:AUTO:PDSC:QPSK:CWON:ENAB?
Notes	Changes to this parameter will not be applied until Update Changes command is sent. See " RB Parameter Manager (Downlink) " on page 2012 section for more details.
Dependencies	Always grayed out since this instrument supports only one RF input.
Preset	ON
State Saved	Saved in instrument state.
Initial S/W Revision	A.03.00

Auto Detect Codeword 1 Enable for 16QAM

Enables parameters for Codeword 1 for 16QAM modulation when Detection is Auto.

Key Path	Meas Setup, Chan Profile Setup, Edit User Mapping
Mode	LTE, LTETDD
Remote Command	[:SENSe] :EVM:DLINK:PROFile:AUTO:PDSC:h:QAM16:CWONe:ENABle ON OFF 0 1 [:SENSe] :EVM:DLINK:PROFile:AUTO:PDSC:h:QAM16:CWONe:ENABle?
Example	EVM:DLIN:PROF:AUTO:PDSC:QAM16:CWON:ENAB ON EVM:DLIN:PROF:AUTO:PDSC:QAM16:CWON:ENAB?
Notes	Changes to this parameter will not be applied until Update Changes command is sent. See " RB Parameter Manager (Downlink) " on page 2012 section for more details.
Dependencies	Always grayed out since this instrument supports only one RF input.
Preset	ON
State Saved	Saved in instrument state.
Initial S/W Revision	A.03.00

Auto Detect Codeword 1 Enable for 64QAM

Enables parameters for Codeword 1 for 64QAM modulation when Detection is Auto.

Key Path	Meas Setup, Chan Profile Setup, Edit User Mapping
Mode	LTE, LTETDD
Remote Command	[:SENSe] :EVM:DLINk:PROFile:AUTO:PDSC:h:QAM64:CWONe:ENABle ON OFF 0 1 [:SENSe] :EVM:DLINk:PROFile:AUTO:PDSC:h:QAM64:CWONe:ENABle?
Example	EVM:DLIN:PROF:AUTO:PDSC:QAM64:CWON:ENAB ON EVM:DLIN:PROF:AUTO:PDSC:QAM64:CWON:ENAB?
Notes	Changes to this parameter will not be applied until Update Changes command is sent. See " RB Parameter Manager (Downlink) " on page 2012 section for more details.
Dependencies	Always grayed out since this instrument supports only one RF input.
Preset	ON
State Saved	Saved in instrument state.
Initial S/W Revision	A.03.00

Codeword 0 Enable for Decoded User

Enables parameters for Codeword 0 and includes Codeword 0 in the analysis.

Key Path	Meas Setup, Chan Profile Setup, Edit User Mapping
Mode	LTE, LTETDD
Remote Command	[:SENSe] :EVM:DLINk:PROFile:USER<n>:DECoded:PDSC:h:CWZero:ENABle ON OFF 0 1 [:SENSe] :EVM:DLINk:PROFile:USER<n>:DECoded:PDSC:h:CWZero:ENABle?
Example	EVM:DLIN:PROF:USER1:DEC:PDSC:CWZ:ENAB ON EVM:DLIN:PROF:USER1:DEC:PDSC:CWZ:ENAB?
Notes	Changes to this parameter will not be applied until Update Changes command is sent. See " RB Parameter Manager (Downlink) " on page 2012 section for more details.
Dependencies	Available when Detection is Auto, RB Auto Detect Mode is Decoded PDCCH and Auto Detect Power Levels is Off.
Preset	ON
State Saved	Saved in instrument state.
Range	On Off
Initial S/W Revision	A.06.00

Codeword 1 Enable for Decoded User

Enables parameters for Codeword 1 and includes Codeword 1 in the analysis.

Key Path	Meas Setup, Chan Profile Setup, Edit User Mapping
Mode	LTE, LTETDD
Remote Command	[:SENSe] :EVM:DLINk:PROFile:USER<n>:DECoded:PDSC:CWONe:ENABle ON OFF 0 1 [:SENSe] :EVM:DLINk:PROFile:USER<n>:DECoded:PDSC:CWONe:ENABle?
Example	EVM:DLIN:PROF:USER1:DEC:PDSC:CWON:ENAB ON EVM:DLIN:PROF:USER1:DEC:PDSC:CWON:ENAB?
Notes	Changes to this parameter will not be applied until Update Changes command is sent. See " RB Parameter Manager (Downlink) " on page 2012 section for more details.
Dependencies	Available when Detection is Auto, RB Auto Detect Mode is Decoded PDCCH, and Auto-detect Power Levels is Off.
Preset	ON
State Saved	Saved in instrument state.
Range	On Off
Initial S/W Revision	A.06.00

Common Frame Index

Select the Frame Index for all the Allocations when Frame Index Couple is On.

Key Path	Meas Setup, Chan Profile Setup, Edit User Mapping, Frame Index
Mode	LTETDD
Remote Command	[:SENSe] :EVM:DLINk:PROFile:USER<n>:PDSC:FINDeX F0 F1 [:SENSe] :EVM:DLINk:PROFile:USER<n>:PDSC:FINDeX?
Example	EVM:DLIN:PROF:USER1:PDSC:FIND F0 EVM:DLIN:PROF:USER1:PDSC:FIND?
Notes	Changes to this parameter will not be applied until Update Changes command is sent. See " RB Parameter Manager (Downlink) " on page 2012 section for more details.
Dependencies	The range of sub op code <n> values is determined by the number of Users the user has configured. Max value for n= 50 If the user attempts to remotely set or query a sub op code that is out of range, this will result in an error message. Enabled when all the following conditions are met. Detection is Manual. Multi-Frame Analysis is ON. Frame Index Couple is ON.
Preset	F0
State Saved	Saved in instrument state.
Range	F0 F1

Initial S/W Revision	Prior to A.02.00
Modified at S/W Revision	A.03.00

Frame 0

Selects Frame 0 for the Frame Index for all the Allocations when Frame Index Couple is On.

Key Path	Meas Setup, Chan Profile Setup, Edit User Mapping, Frame Index
Mode	LTETDD
Initial S/W Revision	Prior to A.02.00
Modified at S/W Revision	A.03.00

Frame 1

Selects Frame 1 for the Frame Index for all the Allocations when Frame Index Couple is On.

Key Path	Meas Setup, Chan Profile Setup, Edit User Mapping, Frame Index
Mode	LTETDD
Initial S/W Revision	Prior to A.02.00
Modified at S/W Revision	A.03.00

Frame Index Couple

Sets all the Allocations to use the Common Frame Index value.

Key Path	Meas Setup, Chan Profile Setup, Edit User Mapping, Frame Index
Mode	LTETDD
Remote Command	[:SENSe] :EVM:DLINk:PROFile:USER<n>:PDSCh:FINDex:COUPle OFF ON 0 1 [:SENSe] :EVM:DLINk:PROFile:USER<n>:PDSCh:FINDex:COUPle?
Example	EVM:DLIN:PROF:USER1:PDSC:FIND:COUP ON EVM:DLIN:PROF:USER1:PDSC:FIND:COUP?
Notes	Changes to this parameter will not be applied until Update Changes command is sent. See " RB Parameter Manager (Downlink) " on page 2012 section for more details.
Dependencies	The range of sub op code <n> values is determined by the number of Users the user has configured. Max value for n=50. If the user attempts to remotely set or query a sub op code that is out of range, this will result in an error message. Enabled when the Mode is LTE TDD, Detection is Manual, and Multi-Frame Analysis is ON.
Preset	ON
State Saved	Saved in instrument state.

Initial S/W Revision	Prior to A.02.00
Modified at S/W Revision	A.03.00

Add User

Adds a new User and the new entry becomes the selected User. The new User will contain as default one Allocation that has the associated parameters set to the default values.

Key Path	Meas Setup, Chan Profile Setup, Edit User Mapping, PDSCH
Mode	LTE, LTETDD
Remote Command	[:SENSe] :EVM:DLINK:PROFile:ADD:USER
Example	EVM:DLIN:PROF:ADD:USER
Notes	Changes to this parameter will not be applied until Update Changes command is sent. See " RB Parameter Manager (Downlink) " on page 2012 section for more details.
Dependencies	The new User will be added at the end of the currently defined Users. Disabled once the number of Users reaches to 50, the max number.
Initial S/W Revision	Prior to A.02.00
Modified at S/W Revision	A.03.00

Delete User

Deletes the current selected User.

Key Path	Meas Setup, Chan Profile Setup, Edit User Mapping, PDSCH
Mode	LTE, LTETDD
Remote Command	[:SENSe] :EVM:DLINK:PROFile:USER<n>:DELeTe
Example	EVM:DLIN:PROF:USER1:DEL
Notes	Changes to this parameter will not be applied until Update Changes command is sent. See " RB Parameter Manager (Downlink) " on page 2012 section for more details.
Dependencies	Disabled when there is only one User. The range of sub op code <n> values is determined by the number of Users the user has configured. If the user attempts to remotely delete a sub op code that is out of range, this will result in an error message.
Initial S/W Revision	Prior to A.02.00
Modified at S/W Revision	A.03.00

Precoding Parameters

Sets up precoding parameters for PDSCH.

Key Path	Meas Setup, Chan Profile Setup, Edit User Mapping
----------	---

Precoding

Selects the Precoding method for each User when Detection is Manual.

This parameter specifies the type of MIMO precoding performed on the current user's data. The possible choices are Off, Transmit Diversity (TxDiv) and Spatial Multiplexing (SpMux).

- OFF - Off
- TXDiversity - Tx Diversity
- SMULTiplex - Spatial Multiplexing

When SpMux is selected, the parameters Number of Layers, Number of Codewords, CDD, and Codebook Index must also be specified.

NOTE

RB Auto Detection can detect allocations of either SpMux or TxDiv, but not both. When Detection is Auto, this parameter determines which type of Precoding the demodulator looks for.

Key Path	Meas Setup, Chan Profile Setup, Edit User Mapping
Mode	LTE, LTE-TDD
Remote Command	[:SENSe] :EVM:DLINK:PROFile:USER1 50:PDSCh:PRECoding OFF TXDiversity SMULTiplex [:SENSe] :EVM:DLINK:PROFile:USER1 50:PDSCh:PRECoding?
Example	EVM:DLIN:PROF:USER1:PDSC:PREC TXD EVM:DLIN:PROF:USER1:PDSC:PREC?
Notes	Changes to this parameter will not be applied until Update Changes command is sent. See " RB Parameter Manager (Downlink) " on page 2012 section for more details.
Dependencies	Enabled when Detection is Manual and Number of C-RS Ports is set to more than 1.
Preset	TXDiversity
State Saved	Saved in instrument state.
Range	Off Tx Diversity Spatial Multiplexing
Initial S/W Revision	A.03.00
Modified at S/W Revision	A.10.00

Auto Detect Precoding

Selects the Precoding method when Detection is Auto.

Key Path	Meas Setup, Chan Profile Setup, Edit User Mapping
Mode	LTE, LTETDD
Remote Command	[:SENSe] :EVM:DLINK:PROFile:AUTO:PDSC:PRECoding OFF TXDiversity SMULtiplex [:SENSe] :EVM:DLINK:PROFile:AUTO:PDSC:PRECoding?
Example	EVM:DLIN:PROF:AUTO:PDSC:PREC TXD EVM:DLIN:PROF:AUTO:PDSC:PREC?
Notes	Changes to this parameter will not be applied until Update Changes command is sent. See " RB Parameter Manager (Downlink) " on page 2012 section for more details.
Dependencies	Enabled when Detection is Auto, Detection Mode is Power Based, and Number of C-RS Ports is set to more than 1.
Preset	TXDiversity
State Saved	Saved in instrument state.
Range	Off Tx Diversity Spatial Multiplexing
Initial S/W Revision	A.03.00
Modified at S/W Revision	A.10.00

Number of Layers

Sets the number of layers when Detection is Manual.

Key Path	Meas Setup, Channel Profile Setup, Edit User Mapping
Mode	LTE, LTETDD
Remote Command	[:SENSe] :EVM:DLINK:PROFile:USER1 50:PDSC:NLAYers <integer> [:SENSe] :EVM:DLINK:PROFile:USER1 50:PDSC:NLAYers?
Example	EVM:DLIN:PROF:USER1:PDSC:NLAY 1 EVM:DLIN:PROF:USER1:PDSC:NLAY?
Notes	Changes to this parameter will not be applied until Update Changes command is sent. See " RB Parameter Manager (Downlink) " on page 2012 section for more details. Always 1 since this instrument supports only one RF input.
Dependencies	Enabled only when Detection is Manual, Number of C-RS Ports is more than 1 and Precoding is set to Spatial Multiplexing.
Couplings	Coupled with Number of C-RS Ports, Precoding.
Preset	1
State Saved	Saved in instrument state.
Min	1
Max	4
Initial S/W Revision	A.03.00

Auto Detect Number of Layers

Sets the number of layers when Detection is Auto.

Key Path	Meas Setup, Channel Profile Setup, Edit User Mapping
Mode	LTE, LTETDD
Remote Command	[:SENSe] :EVM:DLINK:PROFile:AUTO:PDSC:NLAYers <integer> [:SENSe] :EVM:DLINK:PROFile:AUTO:PDSC:NLAYers?
Example	EVM:DLIN:PROF:AUTO:PDSC:NLAY 1 EVM:DLIN:PROF:AUTO:PDSC:NLAY?
Notes	Changes to this parameter will not be applied until Update Changes command is sent. See " RB Parameter Manager (Downlink) " on page 2012 section for more details. Always 1 since this instrument supports only one RF input.
Dependencies	Enabled only when Detection is Auto, Number of C-RS Ports is more than 1 and Auto Detect Precoding is set to Spatial Multiplexing.
Couplings	Coupled with Number of C-RS Ports, Precoding
Preset	1
State Saved	Saved in instrument state.
Min	1
Max	4
Initial S/W Revision	A.03.00

Number of Codewords

Sets the number of codewords when Detection is Manual.

Key Path	Meas Setup, Channel Profile Setup, Edit User Mapping
Mode	LTE, LTETDD
Remote Command	[:SENSe] :EVM:DLINK:PROFile:USER1 50:PDSC:NCODewords <integer> [:SENSe] :EVM:DLINK:PROFile:USER1 50:PDSC:NCODewords?
Example	EVM:DLIN:PROF:USER1:PDSC:NCOD 1 EVM:DLIN:PROF:USER1:PDSC:NCOD?
Notes	Changes to this parameter will not be applied until Update Changes command is sent. See " RB Parameter Manager (Downlink) " on page 2012 section for more details.
Dependencies	Always grayed out since this instrument supports only one RF input.
Couplings	Coupled with Precoding.
Preset	1
State Saved	Saved in instrument state.

Min	1
Max	2
Initial S/W Revision	A.03.00

Auto Detect Number of Codewords

Sets the number of codewords when Detection is Auto.

Key Path	Meas Setup, Channel Profile Setup, Edit User Mapping
Mode	LTE, LTETDD
Remote Command	[:SENSe] :EVM:DLINk:PROFile:AUTO:PDSC:h:NCODewords <integer> [:SENSe] :EVM:DLINk:PROFile:AUTO:PDSC:h:NCODewords?
Example	EVM:DLIN:PROF:AUTO:PDSC:NCOD 1 EVM:DLIN:PROF:AUTO:PDSC:NCOD?
Notes	Changes to this parameter will not be applied until Update Changes command is sent. See " RB Parameter Manager (Downlink) " on page 2012 section for more details.
Dependencies	Always grayed out since this instrument supports only one RF input.
Couplings	Coupled with Precoding
Preset	1
State Saved	Saved in instrument state.
Min	1
Max	2
Initial S/W Revision	A.03.00

Precoding CDD

Sets whether precoding will be done without cyclic delay diversity (CDD) or with large delay CDD for spatial multiplexing when Detection is Manual.

Key Path	Meas Setup, Channel Profile Setup, Edit User Mapping
Mode	LTE, LTETDD
Remote Command	[:SENSe] :EVM:DLINk:PROFile:USER1 50:PDSC:h:CDD WOCDD LDCDD [:SENSe] :EVM:DLINk:PROFile:USER1 50:PDSC:h:CDD?
Example	EVM:DLIN:PROF:USER1:PDSC:CDD WOCDD EVM:DLIN:PROF:USER1:PDSC:CDD?
Notes	Changes to this parameter will not be applied until Update Changes command is sent. See " RB Parameter Manager (Downlink) " on page 2012 section for more details.
Dependencies	Always grayed out since this instrument supports only one RF input.
Preset	WOCDD
State Saved	Saved in instrument state.
Range	Without CDD Large Delay CDD
Initial S/W Revision	A.03.00

Auto Detect Precoding CDD

Determines whether precoding will be done without cyclic delay diversity (CDD) or with large delay CDD for spatial multiplexing when Detection is Auto.

Key Path	Meas Setup, Channel Profile Setup, Edit User Mapping
Mode	LTE, LTE-TDD
Remote Command	[:SENSe] :EVM:DLINk:PROFile:AUTO:PDSC:h:CDD WOCDD LDCDD [:SENSe] :EVM:DLINk:PROFile:AUTO:PDSC:h:CDD?
Example	EVM:DLIN:PROFile:AUTO:PDSC:CDD WOCDD EVM:DLIN:PROFile:AUTO:PDSC:CDD?
Notes	Changes to this parameter will not be applied until Update Changes command is sent. See " RB Parameter Manager (Downlink) " on page 2012 section for more details.
Dependencies	Always grayed out since this instrument supports only one RF input.
Preset	WOCDD
State Saved	Saved in instrument state.
Range	Without CDD Large Delay CDD
Initial S/W Revision	A.03.00

Codebook Index

Sets the Codebook Index number for spatial multiplexing precoding when Detection is Manual.

Key Path	Meas Setup, Channel Profile Setup, Edit User Mapping
Mode	LTE, LTE-TDD
Remote Command	[:SENSe] :EVM:DLINk:PROFile:USER1 50:PDSC:h:CBINdex <integer> [:SENSe] :EVM:DLINk:PROFile:USER1 50:PDSC:h:CBINdex?
Example	EVM:DLIN:PROF:USER1:PDSC:CBIN 1 EVM:DLIN:PROF:USER1:PDSC:CBIN?
Notes	Changes to this parameter will not be applied until Update Changes command is sent. See " RB Parameter Manager (Downlink) " on page 2012 section for more details.
Dependencies	Max value of this parameter depends on Number of C-RS Ports. When Number of C-RS Ports is set to 2, Max value is 3. When Number of C-RS Ports is set to 4, Max value is 15. Enabled only when all the following conditions are met. UE-RS Active: Off Detection: Manual Number of C-RS Ports: More than 1 Precoding Spatial Multiplexing
Couplings	Coupled with Number of C-RS Ports

15 LTE Modulation Analysis Measurement
Meas Setup

Preset	0
State Saved	Saved in instrument state.
Min	0
Max	3 - when Number of C-RS Ports is set to 2 15 - when Number of C-RS Ports is set to 4
Initial S/W Revision	A.03.00

Auto Detect Codebook Index

Sets the Codebook Index number for spatial multiplexing precoding when Detection is Auto.

Key Path	Meas Setup, Channel Profile Setup, Edit User Mapping
Mode	LTE, LTETDD
Remote Command	[:SENSe] :EVM:DLINk:PROFile:AUTO:PDSC:CBINdex <integer> [:SENSe] :EVM:DLINk:PROFile:AUTO:PDSC:CBINdex?
Example	EVM:DLIN:PROF:AUTO:PDSC:CBIN 1 EVM:DLIN:PROF:AUTO:PDSC:CBIN?
Notes	Changes to this parameter will not be applied until Update Changes command is sent. See " RB Parameter Manager (Downlink) " on page 2012 section for more details.
Dependencies	Max value of this parameter depends on Number of C-RS Ports. When Number of C-RS Ports is set to 2, Max value is 3. When Number of C-RS Ports is set to 4, Max value is 15. Enabled only when all the following conditions are met. UE-RS Active: Off Detection: Auto Number of C-RS Ports: More than 1 Precoding Spatial Multiplexing
Couplings	Coupled with Number of C-RS Ports
Preset	0
State Saved	Saved in instrument state.
Min	0
Max	3 - when Number of C-RS Ports is set to 2 15 - when Number of C-RS Ports is set to 4
Initial S/W Revision	A.03.00

OK/Cancel

Displays a menu that enables the changes to the parameters on the dialog to be applied or cancelled.

Mode	LTE, LTETDD
Initial S/W Revision	Prior to A.02.00
Modified at S/W Revision	A.03.00

OK

Applies all changes made to the parameters on the dialog then exits the dialog.

Mode	LTE, LTETDD
Initial S/W Revision	Prior to A.02.00
Modified at S/W Revision	A.03.00

Cancel

Cancels all changes made to the parameters on the dialog then exits the dialog.

Mode	LTE, LTETDD
Initial S/W Revision	Prior to A.02.00
Modified at S/W Revision	A.03.00

RB Parameter Manager (Downlink)

Reduces the time it takes to configure channel profile related parameters with SCPI commands.

The SCPI command parameters shown below are managed in this scheme.

Note that changes to the parameters are not applied until the Update Changes command is sent. See ["Update Changes \(Downlink\)" on page 2015](#) section for more details.

[SENSe]:EVM:DLINK:PROFile:ADD:USER
[SENSe]:EVM:DLINK:PROFile:AUTO:PDsch:CBIndex
[SENSe]:EVM:DLINK:PROFile:AUTO:PDsch:CDD
[SENSe]:EVM:DLINK:PROFile:AUTO:PDsch:NCODewords
[SENSe]:EVM:DLINK:PROFile:AUTO:PDsch:NLAYers
[SENSe]:EVM:DLINK:PROFile:AUTO:PDsch:PRECoding
[SENSe]:EVM:DLINK:PROFile:AUTO:PDsch:QAM16:CWONe:ENABle
[SENSe]:EVM:DLINK:PROFile:AUTO:PDsch:QAM16:CWONe:PWRBoost
[SENSe]:EVM:DLINK:PROFile:AUTO:PDsch:QAM16:CWZero:ENABle
[SENSe]:EVM:DLINK:PROFile:AUTO:PDsch:QAM16:PWRBoost
[SENSe]:EVM:DLINK:PROFile:AUTO:PDsch:QAM64:CWONe:ENABle
[SENSe]:EVM:DLINK:PROFile:AUTO:PDsch:QAM64:CWONe:PWRBoost
[SENSe]:EVM:DLINK:PROFile:AUTO:PDsch:QAM64:CWZero:ENABle
[SENSe]:EVM:DLINK:PROFile:AUTO:PDsch:QAM64:PWRBoost
[SENSe]:EVM:DLINK:PROFile:AUTO:PDsch:QPSK:CWONe:ENABle
[SENSe]:EVM:DLINK:PROFile:AUTO:PDsch:QPSK:CWONe:PWRBoost
[SENSe]:EVM:DLINK:PROFile:AUTO:PDsch:QPSK:CWZero:ENABle
[SENSe]:EVM:DLINK:PROFile:AUTO:PDsch:QPSK:PWRBoost
[SENSe]:EVM:DLINK:PROFile:EPRE:PANTenna
[SENSe]:EVM:DLINK:PROFile:USER1 50:PDsch:RBALloc1 250:EPRE
[SENSe]:EVM:DLINK:PROFile:USER1 50:PDsch:EPRE:COUPLE
[SENSe]:EVM:DLINK:PROFile:USER1 50:PDsch:EPRE
[SENSe]:EVM:DLINK:PROFile:AUTO:PDsch:QPSK:EPRE

```
[SENSe]:EVM:DLINK:PROFile:AUTO:PDSCh:QAM16:EPRE
```

```
[SENSe]:EVM:DLINK:PROFile:AUTO:PDSCh:QAM64:EPRE
```

```
[SENSe]:EVM:DLINK:PROFile:USER1|50:DECoded:PDSCh:EPRE
```

```
[SENSe]:EVM:DLINK:PROFile:PBCH:PWRBoost
```

```
[SENSe]:EVM:DLINK:PROFile:PCFich:PWRBoost
```

```
[SENSe]:EVM:DLINK:PROFile:PDCCh:ALLocation:AUTO:DETECT
```

```
[SENSe]:EVM:DLINK:PROFile:PDCCh:ALLocation:CONSTant
```

```
[SENSe]:EVM:DLINK:PROFile:PDCCh:ALLocation:SUBFrame(0:9):SYMBOLS
```

```
[SENSe]:EVM:DLINK:PROFile:PDCCh:PWRBoost
```

```
[SENSe]:EVM:DLINK:PROFile:PDCCh:PWRBoost:STEP <rel_ampl>
```

```
[SENSe]:EVM:DLINK:PROFile:PHICH:ALLocation:RATio
```

```
[SENSe]:EVM:DLINK:PROFile:PHICH:DESPread
```

```
[SENSe]:EVM:DLINK:PROFile:PHICH:DURation
```

```
[SENSe]:EVM:DLINK:PROFile:PHICH:PWRBoost
```

```
[SENSe]:EVM:DLINK:PROFile:PHICH:PWRBoost:STEP
```

```
[SENSe]:EVM:DLINK:PROFile:PSS:PWRBoost
```

```
[SENSe]:EVM:DLINK:PROFile:RS:PWRBoost
```

```
[SENSe]:EVM:DLINK:PROFile:SSS:PWRBoost
```

```
[SENSe]:EVM:DLINK:PROFile:PRS:ACTive
```

```
[SENSe]:EVM:DLINK:PROFile:PRS:PWRBoost
```

```
[SENSe]:EVM:DLINK:PROFile:PRS:INDEX
```

```
[SENSe]:EVM:DLINK:PROFile:PRS:SUBFrame:NUMBER
```

```
[SENSe]:EVM:DLINK:PROFile:MBSFn:ACTive
```

```
[SENSe]:EVM:DLINK:PROFile:MBSFn:AID
```

```
[SENSe]:EVM:DLINK:PROFile:MBSFn:NMRLength
```

```
[SENSe]:EVM:DLINK:PROFile:MBSFn:PWRBoost
```

```
[SENSe]:EVM:DLINK:PROFile:MBSFn:SUBFrame(1:4,6:9):ACTive
```

```
[SENSe]:EVM:DLINK:PROFile:AUTO:PMCH:PWRBoost
```

```
[SENSe]:EVM:DLINK:PROFile:PMCH:SUBFrame(1:4,6:9):ACTive
```

```
[SENSe]:EVM:DLINK:PROFile:PMCH:SUBFrame(1:4,6:9):PWRBoost
```

```
[SENSe]:EVM:DLINK:PROFile:PMCH:SUBFrame(1:4,6:9):MODulation:TYPE
```

```
[SENSe]:EVM:DLINK:PROFile:USER(1:50):DECoded:PDSCh:CWZero:PWRBoost
```

```
[SENSe]:EVM:DLINK:PROFile:USER(1:50):DECoded:PDSCh:CWONe:ENABle
```

```
[SENSe]:EVM:DLINK:PROFile:USER(1:50):DECoded:PDSCh:CWONe:PWRBoost
```

```
[SENSe]:EVM:DLINK:PROFile:USER(1:50):DELete
```

```
[SENSe]:EVM:DLINK:PROFile:USER(1:50):PDSCh:ADD:ALLocation
```

```
[SENSe]:EVM:DLINK:PROFile:USER(1:50):PDSCh:RBALloc(1:50):CWONe:MODulation:TYPE
```

[.SENSe]:EVM:DLINK:PROFile:USER(1:50):PDSCh:RBALloc(1:50):CWONe:PWRBoost
[.SENSe]:EVM:DLINK:PROFile:USER(1:50):PDSCh:RBALloc(1:50):DELeTe
[.SENSe]:EVM:DLINK:PROFile:USER(1:50):PDSCh:RBALloc(1:50):MODulation:TYPE
[.SENSe]:EVM:DLINK:PROFile:USER(1:50):PDSCh:RBALloc(1:50):PWRBoost
[.SENSe]:EVM:DLINK:PROFile:USER(1:50):PDSCh:RBALloc(1:50):RB:END
[.SENSe]:EVM:DLINK:PROFile:USER(1:50):PDSCh:RBALloc(1:50):RB:START
[.SENSe]:EVM:DLINK:PROFile:USER(1:50):PDSCh:RBALloc(1:50):SLOT:END
[.SENSe]:EVM:DLINK:PROFile:USER(1:50):PDSCh:RBALloc(1:50):SLOT:START
[.SENSe]:EVM:DLINK:PROFile:USER(1:50):PDSCh:CBINdex
[.SENSe]:EVM:DLINK:PROFile:USER(1:50):PDSCh:CDD
[.SENSe]:EVM:DLINK:PROFile:USER(1:50):PDSCh:CWONe:ENABLE
[.SENSe]:EVM:DLINK:PROFile:USER(1:50):PDSCh:CWONe:MODulation:TYPE
[.SENSe]:EVM:DLINK:PROFile:USER(1:50):PDSCh:CWONe:MODulation:TYPE:COUPlE
[.SENSe]:EVM:DLINK:PROFile:USER(1:50):PDSCh:CWONe:PWRBoost
[.SENSe]:EVM:DLINK:PROFile:USER(1:50):PDSCh:CWONe:PWRBoost:COUPlE
[.SENSe]:EVM:DLINK:PROFile:USER(1:50):PDSCh:CWZero:ENABLE
[.SENSe]:EVM:DLINK:PROFile:USER(1:50):PDSCh:MODulation:TYPE
[.SENSe]:EVM:DLINK:PROFile:USER(1:50):PDSCh:MODulation:TYPE:COUPlE
[.SENSe]:EVM:DLINK:PROFile:USER(1:50):PDSCh:NCODewords
[.SENSe]:EVM:DLINK:PROFile:USER(1:50):PDSCh:NLAYers
[.SENSe]:EVM:DLINK:PROFile:USER(1:50):PDSCh:PRECoding
[.SENSe]:EVM:DLINK:PROFile:USER(1:50):PDSCh:PWRBoost
[.SENSe]:EVM:DLINK:PROFile:USER(1:50):PDSCh:PWRBoost:COUPlE
[.SENSe]:EVM:DLINK:PROFile:USER(1:50):RNTI
[.SENSe]:EVM:DLINK:PROFile:USER(1:50):UERS:ACTive
[.SENSe]:EVM:DLINK:PROFile:USER(1:50):UERS:PWRBoost

This feature supports following operations:

- ["Update Changes \(Downlink\)" on page 2015](#) command, which applies pending changes to parameters.
- ["Ignore Changes \(Downlink\)" on page 2015](#) command, which discards pending changes to parameters.
- ["Clear Changes \(Downlink\)" on page 2015](#) command, which clears all existing RB mapping information for downlink.

The Update Changes and Ignore Changes commands behave similarly to the OK and Cancel buttons on user interface dialogs, respectively.

For example, to clear existing RB mapping information and configure one user with one allocation with RB End set to 49, send the following sequence in order. Note that the Clear Changes command is not required just after mode preset since there is no RB mapping information by default.

```
[ :SENSe]:EVM:DLINK:PROFile:CLEAR
```

```
[ :SENSe]:EVM:DLINK:PROFile:ADD:USER
```

```
[ :SENSe]:EVM:DLINK:PROFile:USER1:PDSCCh:ADD:ALLocation
```

```
[ :SENSe]:EVM:DLINK:PROFile:USER1:PDSCCh:RBALloc1:RB:END 49
```

```
[ :SENSe]:EVM:DLINK:PROFile:UPDate
```

Update Changes (Downlink)

SCPI Only. This command updates changes sent after last UPDate or preset.

Mode	LTE, LTETDD
Remote Command	[:SENSe]:EVM:DLINK:PROFile:UPDate
Example	EVM:DLIN:PROF:UPD
Initial S/W Revision	A.03.00

Clear Changes (Downlink)

SCPI Only. This command clears allocated resource blocks and deletes all Users.

Mode	LTE, LTETDD
Remote Command	[:SENSe]:EVM:DLINK:PROFile:CLEAR
Example	EVM:DLIN:PROF:CLE
Initial S/W Revision	A.03.00

Ignore Changes (Downlink)

SCPI Only. This command ignores (clears) changes which are not updated.

Mode	LTE, LTETDD
Remote Command	[:SENSe]:EVM:DLINK:PROFile:IGNore
Example	EVM:DLIN:PROF:IGN
Initial S/W Revision	A.03.00

Count Number of Users (Downlink)

SCPI Only. This command returns the number of added users.

Mode	LTE, LTETDD
------	-------------

Remote Command	[:SENSe] :EVM:DLINk:PROFile:COUNT?
Example	EVM:DLIN:PROF:COUN?
Initial S/W Revision	A.03.00

Count Number of PDSCH Allocations (Downlink)

SCPI Only. This command returns the number of added PDSCH allocations.

Mode	LTE, LTETDD
Remote Command	[:SENSe] :EVM:DLINk:PROFile:USER<n>:PDSC:COUNT?
Example	EVM:DLIN:PROF:USER2:PDSC:COUN?
Dependencies	The range of sub op code <n> values is determined by the number of Users the user has configured. If the user attempts to remotely set or query a sub op code that is out of range, this will result in an error message.
Initial S/W Revision	A.03.00

Copy Auto -> Manual

Copies all autodetected allocations into the Resource Block Editor.

For downlink, when Copy Auto -> Manual is pressed, each autodetected modulation group will be assigned to a user. When RB Auto Detect Mode is set to Power Based, User_01 will contain resource blocks with QPSK; User_02 will contain resource blocks with 16QAM; and User_03 will contain resource blocks with 64QAM.

When RB Auto Detect Mode is set to Decode PDCCH, the user allocations will be copied into the LTE Allocation Editor as manual allocations.

For uplink, when Copy Auto -> Manual is pressed, User_01, which contains all autodetected channels, will be copied into the LTE Allocation Editor.

This key is useful when you have two signals with identical allocations, where one has a fairly good SNR, but the other has a low SNR. In this case, RB Auto Detect may detect the allocations for the noisy signal incorrectly. To work around this, you can recall the clean signal, autodetect allocations, and press Copy Auto -> Manual. Then you can recall the noisy signal and don't need to rely on auto detection.

Note that existing manual user mappings will be overwritten when you press this button.

Key Path	Meas Setup, Chan Profile Setup
Mode	LTE, LTETDD
Remote Command	[:SENSe] :EVM:PROFile:COPY [:IMMediate]
Example	EVM:PROF:COPY
Notes	Available when Detection is Auto.
Initial S/W Revision	A.06.00

Chan Profile Setup (Uplink)

Displays a menu of commonly used channel profile setup parameters when Direction is set to Uplink.

Key Path	Meas Setup
Mode	LTE, LTE-TDD
Initial S/W Revision	Prior to A.02.00
Modified at S/W Revision	A.03.00

Detection

Determines whether or not the user allocations will be autodetected.

Downlink:

When enabled, the demodulator can perform power based auto detection or can auto detect allocations by decoding PDCCH. See the ["RB Auto Detect Mode" on page 1885](#) for more information.

Uplink:

When enabled, PUSCH, PUCCH, SRS, and PRACH allocations can be autodetected when the necessary parameters are defined.

NOTE

The LTE demodulator can perform sync slot auto detection or user-assigned auto detection for uplink signals.

To configure automatic sync slot detection, select the Auto Sync parameter on the User Mapping Editor.

To configure user-assigned auto detection, set the Auto Sync to OFF for a channel and define a sync slot with associated Per-slot Parameters (in the User Mapping Editor) to be used for initial synchronization. User-assigned auto detection results in faster measurements than automatic sync slot detection.

Key Path	Meas Setup, Chan Profile Setup
Mode	LTE, LTE-TDD
Remote Command	<code>[:SENSe] :EVM:PROFile:AUTO[:DETECT] OFF ON 0 1</code> <code>[:SENSe] :EVM:PROFile:AUTO[:DETECT] ?</code>
Example	EVM:PROF:AUTO ON EVM:PROF:AUTO?
Couplings	This parameter is the same for Downlink and Uplink When Direction is Downlink, this parameter is coupled to the Include User (Downlink) menu. This menu is context sensitive and when Auto Include is on the user can include QPSK, 16QAM or 64QAM channels. When Off the user can include any of the user defined PDSCH channels. When direction is Uplink, this parameter is coupled to the Include User (Uplink) menu. This menu is context sensitive and when Auto Include is On the user can include channels from the Auto Detected User. When Off the user can include channels from ONE of the user defined Users.
Preset	ON
State Saved	Saved in instrument state.
Initial S/W Revision	Prior to A.02.00
Modified at S/W Revision	A.03.00

Auto Detect Power Levels

Selects whether or not power levels are auto detected when Direction is Uplink.

When this parameter is set to on, the LTE demodulator will detect the relative uplink channel power levels for PUCCH, PUSCH, SRS and PRACH. When this parameter is set to off, the power levels for uplink channels will need to be specified.

Key Path	Meas Setup, Chan Profile Setup
Mode	LTE, LTETDD
Remote Command	[:SENSe] :EVM:ULINk:PROFile:AUTO [:DETeCt] :POWeR OFF ON 0 1 [:SENSe] :EVM:ULINk:PROFile:AUTO [:DETeCt] :POWeR?
Example	EVM:ULIN:PROF:AUTO:POW ON EVM:ULIN:PROF:AUTO:POW?
Dependencies	Available when Direction is Uplink and Detection is Auto.
Preset	OFF
State Saved	Saved in instrument state.
Range	On Off
Initial S/W Revision	A.10.00

Include Non Allocation

Includes inactive signals in the results.

Please refer to ["Include Non Allocation" on page 1894](#) for more details.

Key Path	Meas Setup, Chan Profile Setup
Mode	LTE, LTETDD

Composite Include (Uplink)

Displays a menu that enables inclusion or exclusion of all channels.

Key Path	Meas Setup, Chan Profile Setup
Mode	LTE, LTETDD
Initial S/W Revision	Prior to A.02.00
Modified at S/W Revision	A.03.00

Include All

Turns On all Uplink channels.

Key Path	Meas Setup, Chan Profile Setup, Composite Include
Mode	LTE, LTETDD
Remote Command	[:SENSe] :EVM:ULINk:PROFile:INCLude:ALL
Example	EVM:ULIN:PROF:INCL:ALL
Initial S/W Revision	Prior to A.02.00
Modified at S/W Revision	A.03.00

Exclude All

Turns Off all Uplink channels.

Key Path	Meas Setup, Chan Profile Setup, Composite Include
Mode	LTE, LTETDD
Remote Command	[:SENSe] :EVM:ULINk:PROFile:EXCLude:ALL
Example	EVM:ULIN:PROF:EXCLude:ALL
Couplings	Turns Off the following parameters if its state is On. <ul style="list-style-type: none"> • Include PUSCH • Include PUSCH DMRS • Include PUCCH • Include PUCCH DMRS • Include PRACH • Include S-RS Include Non Allocation
Initial S/W Revision	Prior to A.02.00
Modified at S/W Revision	A.03.00

Include Users (Uplink)

Displays a menu that enables you to determine which Uplink channels should be included in the results.

When Include is selected, the channel is displayed on applicable traces and also used in the process of Error Summary calculations. When Exclude is selected, only the Frame Summary trace will display information about this user's channel.

Key Path	Meas Setup, Chan Profile Setup, Include Users
Mode	LTE, LTETDD
Couplings	The Users shown on this softpanel are dependant on the number of Users defined. This menu will only display User1 when Detection is Auto. When Detection is Man, it will display all the defined Users
Initial S/W Revision	Prior to A.02.00
Modified at S/W Revision	A.03.00

User

Indexes the currently defined Users.

Key Path	Meas Setup, Chan Profile Setup, Include Users
Mode	LTE, LTETDD
Dependencies	Enabled when Detection is Manual.
Couplings	Max value determined by the number of Uplink Users the user has configured
Preset	0
State Saved	Saved in instrument state.
Min	1
Max	Determined by the number of Uplink Users the user has configured
Initial S/W Revision	Prior to A.02.00
Modified at S/W Revision	A.03.00

Include PUSCH

Includes PUSCH in the results.

Key Path	Meas Setup, Chan Profile Setup, Include Users
Mode	LTE, LTETDD
Remote Command	[:SENSe] :EVM:ULINk:PROFile:USER<n>:PUSCh INCLude EXCLude [:SENSe] :EVM:ULINk:PROFile:USER<n>:PUSCh?
Example	EVM:ULIN:PROF:USER1:PUSC INCL EVM:ULIN:PROF:USER1:PUSC?
Dependencies	The range of sub op code <n> values is determined by the number of Users the user has configured. If the user attempts to remotely set or query a sub op code that is out of range, this will result in an error message. Disabled when Detection is Auto, PUSCH Active is OFF or no slot is added. Only one user can be included at the same time.
Couplings	This parameter is set to Exclude when Uplink Exclude All is selected. When this parameter is set to Include, PUSCH of the other users and PRACH of all users are set to Exclude.
Preset	EXCLude
State Saved	Saved in instrument state.
Range	Include Exclude
Initial S/W Revision	Prior to A.02.00
Modified at S/W Revision	A.03.00

Include Auto Detect PUSCH

Includes Auto Detected PUSCH in the results.

Key Path	Meas Setup, Chan Profile Setup, Include Users
Mode	LTE, LTETDD
Remote Command	[:SENSe] :EVM:ULINK:PROFile:AUTO:PUSCh INCLude EXCLude [:SENSe] :EVM:ULINK:PROFile:AUTO:PUSCh?
Example	EVM:ULIN:PROF:AUTO:PUSC INCL EVM:ULIN:PROF:AUTO:PUSC?
Dependencies	Enabled when Detection is Auto and Auto Detect PUSCH Active is ON.
Couplings	This parameter is set to Exclude when Uplink Exclude All is selected. When this parameter is set to Include, Auto Detect PRACH is set to Exclude.
Preset	INCLude
State Saved	Saved in instrument state.
Range	Include Exclude
Initial S/W Revision	Prior to A.02.00
Modified at S/W Revision	A.03.00

Include PUSCH DMRS

Includes PUSCH DMRS in the results.

Key Path	Meas Setup, Chan Profile Setup, Include Users
Mode	LTE, LTETDD
Remote Command	[:SENSe] :EVM:ULINK:PROFile:USER<n>:PUSCh:DMRS INCLude EXCLude [:SENSe] :EVM:ULINK:PROFile:USER<n>:PUSCh:DMRS?
Example	EVM:ULIN:PROF:USER1:PUSC:DMRS INCL EVM:ULIN:PROF:USER1:PUSC:DMRS?
Dependencies	The range of sub op code <n> values is determined by the number of Users the user has configured. If the user attempts to remotely set or query a sub op code that is out of range, this will result in an error message. Enabled when Detection is Manual. Only one user can be included at the same time.
Couplings	This parameter is set to Exclude when Uplink Exclude All is selected. When this parameter is set to Include, PUSCH DMRS of the other users and PRACH of all users are set to Exclude.
Preset	EXCLude
State Saved	Saved in instrument state.
Range	Include Exclude

15 LTE Modulation Analysis Measurement
Meas Setup

Initial S/W Revision	Prior to A.02.00
Modified at S/W Revision	A.03.00

Include Auto Detect PUSCH DMRS

Includes Auto Detected PUSCH DMRS in the results.

Key Path	Meas Setup, Chan Profile Setup, Include Users
Mode	LTE, LTETDD
Remote Command	[:SENSe] :EVM:ULINk:PROFile:AUTO:PUSCh:DMRS INCLude EXCLude [:SENSe] :EVM:ULINk:PROFile:AUTO:PUSCh:DMRS?
Example	EVM:ULIN:PROF:AUTO:PUSC:DMRS INCL EVM:ULIN:PROF:AUTO:PUSC:DMRS?
Dependencies	Enabled when Detection is Auto.
Couplings	This parameter is set to Exclude when Uplink Exclude All is selected. When this parameter is set to Include, Auto Detect PRACH is set to Exclude.
Preset	INCLUDE
State Saved	Saved in instrument state.
Range	Include Exclude
Initial S/W Revision	Prior to A.02.00
Modified at S/W Revision	A.03.00

Include PUCCH

Includes PUCCH in the results.

Key Path	Meas Setup, Chan Profile Setup, Include Users
Mode	LTE, LTETDD
Remote Command	[:SENSe] :EVM:ULINk:PROFile:USER<n>:PUCCh INCLude EXCLude [:SENSe] :EVM:ULINk:PROFile:USER<n>:PUCCh?
Example	EVM:ULIN:PROF:USER1:PUCCL INCL EVM:ULIN:PROF:USER1:PUCCL?
Dependencies	The range of sub op code <n> values is determined by the number of Users the user has configured. If the user attempts to remotely set or query a sub op code that is out of range, this will result in an error message. Enabled when PUCCH Active is ON, one or more slots are added, and Detection is Manual. Only one user can be included at the same time.
Couplings	This parameter is set to Exclude when Uplink Exclude All is selected. When this parameter is set to Include, PUCCH of another user, PUSCH, PRACH and S-RS are set to Exclude.
Preset	EXCLude
State Saved	Saved in instrument state.
Range	Include Exclude

15 LTE Modulation Analysis Measurement
Meas Setup

Initial S/W Revision	Prior to A.02.00
Modified at S/W Revision	A.03.00

Include Auto Detect PUCCH

Includes Auto Detected PUCCH in the results.

Key Path	Meas Setup, Chan Profile Setup, Include Users
Mode	LTE, LTETDD
Remote Command	[:SENSe] :EVM:ULINK:PROFile:AUTO:PUCCh INCLude EXCLude [:SENSe] :EVM:ULINK:PROFile:AUTO:PUCCh?
Example	EVM:ULIN:PROF:AUTO:PUCCL INCL EVM:ULIN:PROF:AUTO:PUCCL?
Dependencies	Enabled when Detection is Auto and Auto Detect PUCCH Active is ON.
Couplings	This parameter is set to Exclude when Uplink Exclude All is selected. When this parameter is set to Include, Auto Detect PRACH is set to Exclude.
Preset	EXCLude
State Saved	Saved in instrument state.
Range	Include Exclude
Initial S/W Revision	Prior to A.02.00
Modified at S/W Revision	A.03.00

Include PUCCH DMRS

Includes PUCCH DMRS in the results.

Key Path	Meas Setup, Chan Profile Setup, Include Users
Mode	LTE, LTETDD
Remote Command	[:SENSe] :EVM:ULINK:PROFile:USER<n>:PUCCh:DMRS INCLude EXCLude [:SENSe] :EVM:ULINK:PROFile:USER<n>:PUCCh:DMRS?
Example	EVM:ULIN:PROF:USER1:PUCCL:DMRS INCL EVM:ULIN:PROF:USER1:PUCCL:DMRS?
Dependencies	The range of sub op code <n> values is determined by the number of Users the user has configured. If the user attempts to remotely set or query a sub op code that is out of range, this will result in an error message. Enabled when Detection is Manual. Only one user can be included at the same time.
Couplings	This parameter is set to Exclude when Uplink Exclude All is selected. When this parameter is set to Include, PUCCH DMRS of the other users and PRACH of all users are set to Exclude.
Preset	EXCLude
State Saved	Saved in instrument state.
Range	Include Exclude

15 LTE Modulation Analysis Measurement
Meas Setup

Initial S/W Revision	Prior to A.02.00
Modified at S/W Revision	A.03.00

Include Auto Detect PUCCH DMRS

Includes Auto Detected PUSCH DMRS in the results.

Key Path	Meas Setup, Chan Profile Setup, Include Users
Mode	LTE, LTETDD
Remote Command	[:SENSe] :EVM:ULINk:PROFile:AUTO:PUCCh:DMRS INCLude EXCLude [:SENSe] :EVM:ULINk:PROFile:AUTO:PUCCh:DMRS?
Example	EVM:ULIN:PROF:AUTO:PUCCh:DMRS INCL EVM:ULIN:PROF:AUTO:PUCCh:DMRS?
Dependencies	Enabled when Detection is Auto.
Couplings	This parameter is set to Exclude when Uplink Exclude All is selected. When this parameter is set to Include, Auto Detect PRACH is set to Exclude.
Preset	EXCLude
State Saved	Saved in instrument state.
Range	Include Exclude
Initial S/W Revision	Prior to A.02.00
Modified at S/W Revision	A.03.00

Include PRACH

Includes PRACH in the results.

Key Path	Meas Setup, Chan Profile Setup, Include Users
Mode	LTE, LTETDD
Remote Command	[:SENSe] :EVM:ULINk:PROFile:USER<n>:PRACH INCLude EXCLude [:SENSe] :EVM:ULINk:PROFile:USER<n>:PRACH?
Example	EVM:ULIN:PROF:USER1:PRACH INCL EVM:ULIN:PROF:USER1:PRACH?
Dependencies	The range of sub op code <n> values is determined by the number of Users the user has configured. If the user attempts to remotely set or query a sub op code that is out of range, this will result in an error message. Enabled when Direction is Manual and PRACH Active is ON.
Couplings	This parameter is set to Exclude when Uplink Exclude All is selected. When this parameter is set to Include, PUSCH, PUCCH and S-RS are set to Exclude.
Preset	EXCLude
State Saved	Saved in instrument state.
Range	Include Exclude
Initial S/W Revision	A.03.00

Include Auto Detect PRACH

Includes Auto Detected PRACH in the results.

Key Path	Meas Setup, Chan Profile Setup, Include Users
Mode	LTE, LTETDD
Remote Command	[:SENSe] :EVM:ULINk:PROFile:AUTO:PRACH INCLude EXCLude [:SENSe] :EVM:ULINk:PROFile:AUTO:PRACH?
Example	EVM:ULIN:PROF:AUTO:PRAC INCL EVM:ULIN:PROF:AUTO:PRAC?
Dependencies	Enabled when Detection is Auto and Auto Detect PRACH Active is ON.
Couplings	This parameter is set to Exclude when Uplink Exclude All is selected. When this parameter is set to Include, Auto Detect PUCCH, Auto Detect PUSCH and Auto Detect S-RS are set to Exclude.
Preset	EXCLude
State Saved	Saved in instrument state.
Range	Include Exclude
Initial S/W Revision	A.03.00

Include S-RS

Includes S-RS in the results.

Key Path	Meas Setup, Chan Profile Setup, Include Users
Mode	LTE, LTETDD
Remote Command	[:SENSe] :EVM:ULINk:PROFile:USER<n>:SRS INCLude EXCLude [:SENSe] :EVM:ULINk:PROFile:USER<n>:SRS?
Example	EVM:ULIN:PROF:USER1:SRS INCL EVM:ULIN:PROF:USER1:SRS?
Dependencies	The range of sub op code <n> values is determined by the number of Users the user has configured. If the user attempts to remotely set or query a sub op code that is out of range, this will result in an error message. Enabled when Detection is Manual and S-RS Active is ON.
Couplings	This parameter is set to Exclude when Uplink Exclude All is selected. When this parameter is set to Include, PRACH is set to Exclude.
Preset	EXCLude
State Saved	Saved in instrument state.
Range	Include Exclude
Initial S/W Revision	A.03.00

Include Auto Detect S-RS

Includes Auto Detected S-RS in the results.

Key Path	Meas Setup, Chan Profile Setup, Include Users
Mode	LTE, LTETDD
Remote Command	[:SENSe] :EVM:ULINk:PROFile:AUTO:SRS INCLude EXCLude [:SENSe] :EVM:ULINk:PROFile:AUTO:SRS?
Example	EVM:ULIN:PROF:AUTO:SRS INCL EVM:ULIN:PROF:AUTO:SRS?
Dependencies	Enabled when Detection is Auto and Auto Detect S-RS Active is ON.
Couplings	This parameter is set to Exclude when Uplink Exclude All is selected. When this parameter is set to Include, Auto Detect PRACH is set to Exclude.
Preset	EXCLude
State Saved	Saved in instrument state.
Range	Include Exclude
Initial S/W Revision	A.03.00

Edit User Mapping (Uplink)

Displays the LTE Allocation Editor that enables you to edit the Downlink channel parameters. When a parameter is selected, the corresponding softkeys will appear.

- Use Tab key to select a parameter field to edit. The rotary knob can be also used to select a parameter field as it has two functions: value adjustment (default) and field navigation. Use Enter key to toggle the function.
- In order to apply or discard changes, select OK button or Cancel button on the editor to show the corresponding softkeys and press either of them. These softkeys also appear by pressing Cancel (Esc) key when the active function is disabled.

NOTE

If Help is open when you select this key, the dialog and menu does not appear. Close Help by pressing **Cancel (Esc)**, then select this key. After the menu has changed, press the green **Help** key to see Help for the dialog and keys. Close Help when you are ready to edit the parameters.

Key Path	Meas Setup, Chan Profile Setup, More
Mode	LTE, LTETDD
Initial S/W Revision	Prior to A.02.00
Modified at S/W Revision	A.03.00, A.06.00

This table lists all the parameters available to set up uplink user PUSCH, PUCCH, PRACH and S-RS user Parameters.

Parameter	Description
Detection	<p>When enabled, the demodulator can autodetect PUSCH, PUCCH, PRACH or S-RS when a sync slot is specified. A unique sync slot is necessary for determining the frame boundary, but not for successful demodulation.</p> <p>To specify a unique sync slot for PUSCH, make sure the PUSCH tab is active, then specify the Channel Parameters and Per-slot parameters for the sync slot.</p> <p>To specify a unique slot for PUCCH, make sure the PUCCH tab is active, then specify the Sync Slot number and the Per-subframe parameters for the PUCCH sync slot.</p> <p>To specify a unique slot for S-RS, make sure the S-RS tab is active, then specify the Sync Slot number for the S-RS sync.</p>
Auto Detect Power Levels	Selects whether or not power levels are auto detected. Enabled only when Detection is Auto.
Cell ID	Sets the uplink user's physical-layer Cell ID.
RNTI	Sets the uplink user's radio network temporary identifier.
Frame Number	Sets uplink user's System Frame Number.
Group Hopping	Determines whether group hopping is enabled. This parameter is available to be set only if DMRS Parameters is selected. Enabling group hopping disables sequence hopping.
Seq Hopping	Determines whether sequence hopping is enabled. This parameter is available to be set only if DMRS Parameters is selected. Enabling sequence hopping disables group hopping.
Include PUSCH	When selected, PUSCH for the selected user is displayed on appropriate traces. When cleared, only the "Frame Summary" on page 2312 trace will display information about this user's PUSCH channel.
Include PUCCH	When selected, PUCCH for the selected user is displayed on appropriate traces. When cleared, only the "Frame Summary" on page 2312 trace will display information about this user's PUCCH channel.
Include PRACH	When selected, PRACH for the selected user is displayed on appropriate traces. When cleared, only the "Frame Summary" on page 2312 trace will display information about this user's PRACH.
Include S-RS	When selected, S-RS for the selected user is displayed on appropriate traces. When cleared, only the "Frame Summary" on page 2312 trace will display information about this user's S-RS.
Add	Adds a user allocation.
Delete	Deletes the selected user allocation.
PUSCH Channel Parameters	
DMRS Parameters	Selecting this parameter causes DMRS Group, DMRS Seq, and DMRS Cyclic Shift to be set automatically using the following three parameters.
nDMRS(1)	Specifies the value of nDMRS(1) used by the selected user mapping.
nDMRS(2)	Specifies the value of nDMRS(2) used by the selected user mapping.
Δ SS	Specifies the value of Δ SS used by the selected user mapping.
Frequency Hopping	Sets the frequency hopping or disables frequency hopping. This key is used in combination with Frequency Hopping Mode.
Frequency Hopping	Sets the frequency hopping. This key is used in combination with Frequency Hopping.

Mode	
Hopping Offset	Specifies the value of Hopping Offset (NRBHO). Hopping Offset is the offset used for PUSCH frequency hopping, expressed in number of resource blocks (set by higher layer). (3GPP TS 36.211 V8.5.0 5.3.4)
Number of Sub-bands	Specifies the value of number of sub-bands (Nsb.). (3GPP TS 36.211 V8.5.0 5.3.4)
PUSCH Per-Slot Parameters	
Couple	Selecting the checkbox next to a parameter will couple that parameter across all RB allocation groups for a user.
RB Start	Specifies the RB start boundary.
RB End	Specifies the RB end boundary.
Mod Type	Modulation type: QPSK, QAM16, or QAM64.
Power (dB)	Sets the PUCCH average power level relative to the 0 dB point set by the PUCCH DMRS Power.
DMRS Group (u)	Specifies the DMRS Group (u) for a slot.
DMRS Seq (v)	Specifies the DMRS Sequence (v) for a slot.
DMRS Cyclic Shift	Specifies the DMRS Cyclic Shift for a slot.
DMRS Power (dB)	Specifies the value to set DMRS Power equal to for a slot. PUSCH power is set relative to the 0 dB point determined by this parameter. For example, setting DMRS Power = 2 dB and PUSCH Power = 0.1 dB means that the demodulator will expect PUSCH average power level to be 1.9 dB below the average DMRS power level.
CUR_TX_NB	CUURRENT_TX_NB specifies whether or not allocation is mirrored.
Add	
Add	Adds a slot allocation.
Delete	
Delete	Deletes the selected slot allocation.
Slot Up	
Slot Up	Moves the selected slot allocation up in time (increasing slot number) to the closest available slot allocation for a user.
Slot Down	
Slot Down	Moves the selected slot allocation down in time (decreasing slot number) to the closest available slot allocation for a user.
PUCCH Channel Parameters	
DMRS Parameters	Selecting this parameter causes DMRS Group, DMRS Seq, and DMRS Cyclic Shift of PUCCH to be set automatically using the following six parameters.
NRB(2)	Specifies the value of NRB(2) used by the selected user mapping, NRB(2) indicates the bandwidth reserved for PUCCH 2/2a/2b, expressed in multiples of NSCRB.
NCS (1)	Specifies the value of NCS (1) used by the selected user mapping, NCS (1) indicates the number of cyclic shifts used for PUCCH formats 1/1a/1b in a resource block with a mix of formats 1/1a/1b and 2/2a/2b.
nPUCCH(2)	Specifies the value of nPUCCH(2) used by the selected user mapping, nPUCCH(2) indicates the resource index for PUCCH formats 2/2a/2b

Δ shiftPUCCH	Specifies the value of Δ shiftPUCCH used by the selected user mapping
Format/ nPUCCH(1)	Enables auto detection of PUCCH Format and nPUCCH(1) for all subframes. This is useful when the format and/or nPUCCH(1) value is different for each subframe.
PUCCH Per-Subframe Parameters	
First RB	<p>Sets the RB index of the selected user's PUCCH allocation for this slot. The next or previous (see Notes below) slot's PUCCH allocation will automatically be set according to the LTE standard (mirrored in frequency).</p> <p>For example, in a 5 MHz LTE signal (25 RBs), when Slot 0 contains a PUCCH allocation at RB 0, Slot 1 will be set to have a PUCCH allocation at RB 24.</p> <p>Notes</p> <p>A user can only have one RB allocated to PUCCH per slot.</p> <p>When Auto Detection is selected and Sync Slot is odd, this parameter sets the RB index for the second slot in a PUCCH subframe, causing the previous (instead of the next) slot to contain a mirrored PUCCH allocation for the current user.</p>
Format	Sets the PUCCH type. Supported types are Type1, Type 1a, Type 1b, Type 2, Type 2a, Type 2b, Type 1 Short, Type 1a Short, Type 1b Short.
Cyclic Shift	Sets PUCCH cyclic shift.
OS	Sets the Orthogonal Sequence index for PUCCH.
Power (dB)	Sets the PUCCH average power level relative to the 0 dB point set by the PUCCH DMRS Power.
DMRS Group (u)	Sets the group number for the PUCCH demodulation reference signal (DMRS).
DMRS Power (dB)	<p>Sets the power level for the PUCCH demodulation reference signal (DMRS) during the selected subframe. PUCCH Power is set relative to the 0 dB point determined by this parameter.</p> <p>For example, setting DMRS Power = 2 dB and PUCCH Power = 0.1 dB means that the demodulator will expect PUCCH average power level to be 1.9 dB below the average DMRS power level.</p>
nPUCCH(1)	Specifies the value of nPUCCH(1) used by the selected user mapping, nPUCCH(1) indicates the resource index for PUCCH formats 1/1a/1b
Add	Adds a subframe allocation.
Delete	Deletes the selected subframe allocation.
Subframe Up	Moves the selected subframe allocation up in time (increasing subframe number) to the closest available subframe allocation for a user.
Subframe Down	Moves the selected subframe allocation down in time (decreasing subframe number) to the closest available subframe allocation for a user.
PRACH Channel Parameters (3GPP TS 36.211 5.7)	
Resource Block Offset	Sets offset for first physical resource block occupied by PRACH resource considered (nRAPRB).
Configuration Index	Sets PRACH Configuration Index to give frame structure.
Logical Root	Sets Logical Root Sequence Index to give root Zadoff-Chu sequence order.

Seq Index	
Cyclic Shift Set	Sets Unrestricted or Restricted to give NCS (Number of Cyclic Shifts) for PRACH preamble sequence generation. Value of NCS will be determined by this selection and NCS Configuration.
NCS Configuration	Sets a value to give NCS (Number of Cyclic Shifts) PRACH preamble sequence generation. Value of NCS will be determined by this value and Cyclic Shift Set.
Preamble Index	Sets a value to give cyclic shift for PRACH preamble sequence generation.
Sync Resource (TDD only)	For a specific combination of PRACH configuration index and UL/DL configuration, there will be one or multiple random access resources for UE to use, this parameter sets the index of corresponding random access resource used as synchronization reference for measurement algorithm. 3GPP TS 36.211 V8.5.0 5.7 listed the random access preamble mapping in Table 5.7.1-4.
Power	Sets the PRACH average power level relative to the 0 dB point set by the PRACH Power.
S-RS Channel Parameters (3GPP TS 36.211 5.5.3)	
Cyclic Shift	Sets nSRSCS value to get Cyclic Shift alpha.
BW Config	Sets S-RS Bandwidth Configuration (CSRS).
BW	Sets S-RS Bandwidth (BSRS).
Tx Comb	Sets Transmission Comb (kTC) of S-RS.
Hopping BW	Sets S-RS Hopping Bandwidth.
Freq Domain Position	Sets S-RS Frequency Domain Position (nRRC).
Subframe Config	Sets S-RS Subframe Configuration.
Power	Sets the S-RS average power level relative to the 0 dB point set by the S-RS Power.
MaxUp PTS	Enables you to give the value of srsMaxUpPts to indicate whether or not mSRS,0 reconfiguration is enabled for UpPTS
Config Index	Sets S-RS Configuration Index (ISRS). (3GPP TS 36.213 V8.5.0 8.2 Table 8.2-1~2)

Add User

Adds a new User and the new entry becomes the selected User. The new User will have all parameters of its channels set to the default values.

Key Path	Meas Setup, Chan Profile Setup, Edit User Mapping, Users
Mode	LTE, LTETDD
Remote Command	[:SENSe] :EVM:ULINk:PROFile:ADD:USER
Example	EVM:ULIN:PROF:ADD:USER
Notes	Changes to this parameter will not be applied until Update Changes command is sent. See " RB Parameter Manager (Uplink) " on page 2178 section for more details.
Dependencies	The new User will be added at the end of the currently defined Users. Disabled once the number of Slots reaches to 50, the max number.

Initial S/W Revision	Prior to A.02.00
Modified at S/W Revision	A.03.00

Delete User

Deletes the current selected User.

Key Path	Meas Setup, Chan Profile Setup, Edit User Mapping, User
Mode	LTE, LTETDD
Remote Command	[:SENSe] :EVM:ULINk:PROFile:USER<n>:DELeTe
Example	EVM:ULIN:PROF:USER1:DEL
Notes	Once a User is deleted, subsequent Users will be renumbered to keep User numbering sequential
Notes	Changes to this parameter will not be applied until Update Changes command is sent. See " RB Parameter Manager (Uplink) " on page 2178 section for more details.
Dependencies	The range of sub op code (n) values is determined by the number of Users the user has configured. If the user attempts to remotely delete a sub op code that is out of range, this will result in an error message. Disabled when there is only one User.
Initial S/W Revision	Prior to A.02.00
Modified at S/W Revision	A.03.00

Cell ID

Sets uplink user's physical-layer Cell ID when Detection is Man.

Key Path	Meas Setup, Chan Profile Setup, Edit User Mapping
Mode	LTE, LTETDD
Remote Command	[:SENSe] :EVM:ULINk:PROFile:USER<n>:CID <integer> [:SENSe] :EVM:ULINk:PROFile:USER<n>:CID?
Example	EVM:ULIN:PROF:USER1:CID 1 EVM:ULIN:PROF:USER1:CID?
Notes	Changes to this parameter will not be applied until Update Changes command is sent. See " RB Parameter Manager (Uplink) " on page 2178 section for more details.
Dependencies	The range of sub op code <n> values is determined by the number of Users the user has configured. If the user attempts to remotely set or query a sub op code that is out of range, this will result in an error message Enabled when Detection is Manual.
Preset	0
State Saved	Saved in instrument state.
Min	0

Max	503
Initial S/W Revision	Prior to A.02.00
Modified at S/W Revision	A.03.00

Auto Detect Cell ID

Sets uplink user's physical-layer Cell ID when Detection is Auto.

Key Path	Meas Setup, Chan Profile Setup, Edit User Mapping, Cell ID
Mode	LTE, LTETDD
Remote Command	[:SENSe] :EVM:ULINK:PROFile:AUTO:CID <integer> [:SENSe] :EVM:ULINK:PROFile:AUTO:CID?
Example	EVM:ULIN:PROF:AUTO:CID 1 EVM:ULIN:PROF:AUTO:CID?
Notes	Changes to this parameter will not be applied until Update Changes command is sent. See " RB Parameter Manager (Uplink) " on page 2178 section for more details.
Dependencies	Enabled when Detection is Auto.
Preset	0
State Saved	Saved in instrument state.
Min	0
Max	503
Initial S/W Revision	Prior to A.02.00
Modified at S/W Revision	A.03.00

RNTI

Sets uplink user's radio network temporary identifier.

Key Path	Meas Setup, Chan Profile Setup, Edit User Mapping
Mode	LTE, LTETDD
Remote Command	[:SENSe] :EVM:ULINK:PROFile:USER<n>:RNTI <integer> [:SENSe] :EVM:ULINK:PROFile:USER<n>:RNTI?
Example	EVM:ULIN:PROF:USER1:RNTI 1 EVM:ULIN:PROF:USER1:RNTI?
Notes	Changes to this parameter will not be applied until Update Changes command is sent. See " RB Parameter Manager (Uplink) " on page 2178 section for more details.
Dependencies	The range of sub op code <n> values is determined by the number of Users the user has configured. If the user attempts to remotely set or query a sub op code that is out of range, this will result in an error message. Available when Direction is Uplink and Detection is Manual.
Preset	0
State Saved	Saved in instrument state.
Min	0
Max	65535
Initial S/W Revision	A.06.00

Auto Detect RNTI

Sets uplink user's radio network temporary identifier.

Key Path	Meas Setup, Chan Profile Setup, Edit User Mapping
Mode	LTE, LTETDD
Remote Command	[:SENSe] :EVM:ULINK:PROFile:AUTO:RNTI <integer> [:SENSe] :EVM:ULINK:PROFile:AUTO:RNTI?
Example	EVM:ULIN:PROF:AUTO:RNTI 1 EVM:ULIN:PROF:AUTO:RNTI?
Notes	Changes to this parameter will not be applied until Update Changes command is sent. See " RB Parameter Manager (Uplink) " on page 2178 section for more details.
Dependencies	Available when Direction is Uplink and Detection is Auto.
Preset	0
State Saved	Saved in instrument state.
Min	0
Max	65535
Initial S/W Revision	A.06.00

System Frame Number

Sets uplink user's System Frame Number when Detection is Man.

Key Path	Meas Setup, Chan Profile Setup, Edit User Mapping
Mode	LTE, LTETDD
Remote Command	[:SENSe] :EVM:ULINK:PROFile:USER<n>:SFNumber <integer> [:SENSe] :EVM:ULINK:PROFile:USER<n>:SFNumber?
Example	EVM:ULIN:PROF:USER1:SFN 0 EVM:ULIN:PROF:USER1:SFN?
Notes	Changes to this parameter will not be applied until Update Changes command is sent. See " RB Parameter Manager (Uplink) " on page 2178 section for more details.
Dependencies	The range of sub op code <n> values is determined by the number of Users the user has configured. If the user attempts to remotely set or query a sub op code that is out of range, this will result in an error message. Enabled when Detection is Manual.
Preset	0
State Saved	Saved in instrument state.
Min	0
Max	1023
Initial S/W Revision	A.03.00

Auto Detect System Frame Number

Sets uplink user's System Frame Number when Detection is Auto.

Key Path	Meas Setup, Chan Profile Setup, Edit User Mapping
Mode	LTE, LTETDD
Remote Command	[:SENSe] :EVM:ULINK:PROFile:AUTO:SFNumber <integer> [:SENSe] :EVM:ULINK:PROFile:AUTO:SFNumber?
Example	EVM:ULIN:PROF:AUTO:SFN 0 EVM:ULIN:PROF:AUTO:SFN?
Notes	Changes to this parameter will not be applied until Update Changes command is sent. See " RB Parameter Manager (Uplink) " on page 2178 section for more details.
Dependencies	Enabled when Detection is Auto.
Preset	0
State Saved	Saved in instrument state.
Min	0
Max	1023
Initial S/W Revision	A.03.00

Group Hopping

Determines if Group Hopping is enabled when Detection is Manual.

Key Path	Meas Setup, Chan Profile Setup, Edit User Mapping, Group Hopping
Mode	LTE, LTETDD
Remote Command	[:SENSe] :EVM:ULINK:PROFile:USER<n>:HOPPing:GROup OFF ON 0 1 [:SENSe] :EVM:ULINK:PROFile:USER<n>:HOPPing:GROup?
Example	EVM:ULIN:PROF:USER1:HOPP:GRO OFF EVM:ULIN:PROF:USER1:HOPP:GRO?
Notes	Changes to this parameter will not be applied until Update Changes command is sent. See " RB Parameter Manager (Uplink) " on page 2178 section for more details.
Dependencies	Enabled when Detection is Manual.
Couplings	Enabling Group Hopping disables Sequence Hopping.
Preset	OFF
State Saved	Saved in instrument state.
Initial S/W Revision	Prior to A.02.00
Modified at S/W Revision	A.03.00

Auto Detect Group Hopping

Determines if Group Hopping is enabled when Detection is Auto.

Key Path	Meas Setup, Chan Profile Setup, Edit User Mapping, Group Hopping
Mode	LTE, LTETDD
Remote Command	[:SENSe] :EVM:ULINK:PROFile:AUTO:HOPPing:GROup OFF ON 0 1 [:SENSe] :EVM:ULINK:PROFile:AUTO:HOPPing:GROup?
Example	EVM:ULIN:PROF:AUTO:HOPP:GRO OFF EVM:ULIN:PROF:USER1:HOPP:GRO?
Notes	Changes to this parameter will not be applied until Update Changes command is sent. See " RB Parameter Manager (Uplink) " on page 2178 section for more details.
Dependencies	Enabled when Detection is Auto
Couplings	Enabling Group Hopping disables Sequence Hopping.
Preset	OFF
State Saved	Saved in instrument state.
Initial S/W Revision	Prior to A.02.00
Modified at S/W Revision	A.03.00

Seq Hopping

Determines if Seq Hopping is enabled when Detection is Manual.

Key Path	Meas Setup, Chan Profile Setup, Edit User Mapping, Seq Hopping
Mode	LTE, LTETDD
Remote Command	[:SENSe] :EVM:ULINK:PROFile:USER<n>:HOPPing:SEQuence OFF ON 0 1 [:SENSe] :EVM:ULINK:PROFile:USER<n>:HOPPing:SEQuence?
Example	EVM:ULIN:PROF:USER1:HOPP:SEQ OFF EVM:ULIN:PROF:USER1:HOPP:SEQ?
Notes	Changes to this parameter will not be applied until Update Changes command is sent. See " RB Parameter Manager (Uplink) " on page 2178 section for more details.
Dependencies	The range of sub op code <n> values is determined by the number of Users the user has configured. Enabled when Detection is Manual.
Couplings	Enabling Sequence Hopping disables Group Hopping.
Preset	OFF
State Saved	Saved in instrument state.
Initial S/W Revision	Prior to A.02.00
Modified at S/W Revision	A.03.00

Auto Detect Seq Hopping

Determines if Seq Hopping is enabled when Detection is Auto.

Key Path	Meas Setup, Chan Profile Setup, Edit User Mapping, Seq Hopping
Mode	LTE, LTETDD
Remote Command	[:SENSe] :EVM:ULINk:PROFile:AUTO:HOPPing:SEQuence OFF ON 0 1 [:SENSe] :EVM:ULINk:PROFile:AUTO:HOPPing:SEQuence?
Example	EVM:ULIN:PROF:AUTO:HOPP:SEQ OFF EVM:ULIN:PROF:AUTO:HOPP:SEQ?
Notes	Changes to this parameter will not be applied until Update Changes command is sent. See "RB Parameter Manager (Uplink)" on page 2178 section for more details.
Dependencies	Enabled when Detection is Auto.
Couplings	Enabling Sequence Hopping disables Group Hopping.
Preset	OFF
State Saved	Saved in instrument state.
Initial S/W Revision	Prior to A.02.00
Modified at S/W Revision	A.03.00

Include PUSCH

Refer to sections ["Include PUSCH " on page 2020](#) and ["Include Auto Detect PUSCH " on page 2021](#).

Mode	LTE, LTETDD
Initial S/W Revision	Prior to A.02.00
Modified at S/W Revision	A.03.00

PUSCH Active

Selects whether or not PUSCH exists in the input signal when Detection is Manual.

Key Path	Meas Setup, Chan Profile Setup, Edit User Mapping
Mode	LTE, LTETDD
Remote Command	[:SENSe] :EVM:ULINk:PROFile:USER1 50:PUSCh:ACTive OFF ON 0 1 [:SENSe] :EVM:ULINk:PROFile:USER1 50:PUSCh:ACTive?
Example	EVM:ULIN:PROF:USER1:PUSC:ACT OFF EVM:ULIN:PROF:USER1:PUSC:ACT?
Notes	Changes to this parameter will not be applied until Update Changes command is sent. See "RB Parameter Manager (Uplink)" on page 2178 section for more details.
Dependencies	Enabled when Detection is Manual. All softkeys for PUSCH parameters are grayed out when this parameter is set to OFF.

15 LTE Modulation Analysis Measurement
Meas Setup

Preset	OFF
State Saved	Saved in instrument state.
Initial S/W Revision	A.03.00

Auto Detect PUSCH Active

Selects whether or not PUSCH exists in the input signal when Detection is Auto.

Key Path	Meas Setup, Chan Profile Setup, Edit User Mapping
Mode	LTE, LTETDD
Remote Command	[:SENSe] :EVM:ULINK:PROFile:AUTO:PUSCh:ACTive OFF ON 0 1 [:SENSe] :EVM:ULINK:PROFile:AUTO:PUSCh:ACTive?
Example	EVM:ULIN:PROF:AUTO:PUSC:ACT OFF EVM:ULIN:PROF:AUTO:PUSC:ACT?
Notes	Changes to this parameter will not be applied until Update Changes command is sent. See " RB Parameter Manager (Uplink) " on page 2178 section for more details.
Dependencies	Enabled when Detection is Auto.
Preset	ON
State Saved	Saved in instrument state.
Initial S/W Revision	A.03.00

DMRS Params

Determines if all DMRS parameters are common to all Slots or if they are to be defined on a per Slot basis when Detection is Manual.

Enabling this parameter causes DMRS Group, DMRS Seq, and DMRS Cyclic Shift to be set automatically using nDMRS(1), nDMRS(2) and Δ SS.

Key Path	Meas Setup, Chan Profile Setup, Edit User Mapping, PUSCH, DMRS Params
Mode	LTE, LTETDD
Remote Command	[:SENSe] :EVM:ULINK:PROFile:USER<n>:PUSCh:DMRS:PARams OFF ON 0 1 [:SENSe] :EVM:ULINK:PROFile:USER<n>:PUSCh:DMRS:PARams?
Example	EVM:ULIN:PROF:USER1:PUSC:DMRS:PAR OFF EVM:ULIN:PROF:USER1:PUSC:DMRS:PAR?
Notes	Changes to this parameter will not be applied until Update Changes command is sent. See " RB Parameter Manager (Uplink) " on page 2178 section for more details.
Dependencies	The range of sub op code <n> values is determined by the number of Users the user has configured. If the user attempts to remotely set or query a sub op code that is out of range, this will result in an error message. When this parameter is on, n DMRS (1), n DMRS (2) and Δ SS are enabled and DMRS Group (u), DMRS Seq (v) and DMRS Cyclic Shift are disabled. When this parameter is off, n DMRS (1), n DMRS (2) and Δ SS are disabled and DMRS Group (u), DMRS Seq (v) and DMRS Cyclic Shift are enabled.
Preset	ON
State Saved	Saved in instrument state.

15 LTE Modulation Analysis Measurement
Meas Setup

Initial S/W Revision	Prior to A.02.00
Modified at S/W Revision	A.03.00

Auto Detect DMRS Params

Determines if all DMRS parameters to be used are common to all Slots or if they are to be defined on a per Slot basis when Detection is Auto.

Key Path	Meas Setup, Chan Profile Setup, Edit User Mapping, PUSCH, DMRS Params
Mode	LTE, LTETDD
Remote Command	[:SENSe] :EVM:ULINk:PROFile:AUTO:PUSCh:DMRS:PARams OFF ON 0 1 [:SENSe] :EVM:ULINk:PROFile:AUTO:PUSCh:DMRS:PARams?
Example	EVM:ULIN:PROF:AUTO:PUSC:DMRS:PAR OFF EVM:ULIN:PROF:AUTO:PUSC:DMRS:PAR?
Notes	Changes to this parameter will not be applied until Update Changes command is sent. See " RB Parameter Manager (Uplink) " on page 2178 section for more details.
Dependencies	When this parameter is on n DMRS (1), n DMRS (2) and Δ SS are enabled and DMRS Group (u), DMRS Seq (v) and DMRS Cyclic Shift are disabled. When this parameter is off, n DMRS (1), n DMRS (2) and Δ SS are disabled and DMRS Group (u), DMRS Seq (v) and DMRS Cyclic Shift are enabled.
Preset	ON
State Saved	Saved in instrument state.
Initial S/W Revision	Prior to A.02.00
Modified at S/W Revision	A.03.00

n DMRS (1)

Sets the value of nDMRS(1) used by the selected user mapping when Detection is Manual.

Key Path	Meas Setup, Chan Profile Setup, Edit User Mapping, PUSCH, n DMRS (1)
Mode	LTE, LTETDD
Remote Command	[:SENSe] :EVM:ULINk:PROFile:USER<n>:PUSCh:DMRS:ONE <integer> [:SENSe] :EVM:ULINk:PROFile:USER<n>:PUSCh:DMRS:ONE?
Example	EVM:ULIN:PROF:USER1:PUSC:DMRS:ONE 1 EVM:ULIN:PROF:USER1:PUSC:DMRS:ONE?
Notes	Changes to this parameter will not be applied until Update Changes command is sent. See " RB Parameter Manager (Uplink) " on page 2178 section for more details.
Dependencies	The range of sub op code <n> values is determined by the number of Users the user has configured. Max value for n = 50. If the user attempts to remotely set or query a sub op code that is out of range, this will result in an error message. Enabled when Detection is Manual, DMRS Params is On, and PUSCH Active is ON.
Preset	0
State Saved	Saved in instrument state.

15 LTE Modulation Analysis Measurement
Meas Setup

Min	0
Max	10
Initial S/W Revision	Prior to A.02.00
Modified at S/W Revision	A.03.00

Auto Detect n DMRS (1)

Sets the value of nDMRS(1) used by the selected user mapping when Detection is Auto.

Key Path	Meas Setup, Chan Profile Setup, Edit User Mapping, PUSCH, n DMRS (1)
Mode	LTE, LTETDD
Remote Command	[:SENSe] :EVM:ULINk:PROFile:AUTO:PUSCh:DMRS:ONE <integer> [:SENSe] :EVM:ULINk:PROFile:AUTO:PUSCh:DMRS:ONE?
Example	EVM:ULIN:PROF:AUTO:PUSC:DMRS:ONE 1 EVM:ULIN:PROF:AUTO:PUSC:DMRS:ONE?
Notes	Changes to this parameter will not be applied until Update Changes command is sent. See " RB Parameter Manager (Uplink) " on page 2178 section for more details.
Dependencies	If the user attempts to remotely set or query a sub op code that is out of range, this will result in an error message. Enabled when Detection is Auto, Auto Detect DMRS Params is On, and Auto Detect PUSCH Active is ON.
Preset	0
State Saved	Saved in instrument state.
Min	0
Max	10
Initial S/W Revision	Prior to A.02.00
Modified at S/W Revision	A.03.00

n DMRS (2)

Sets the value of nDMRS(2) used by the selected user mapping when Detection is Manual.

Key Path	Meas Setup, Chan Profile Setup, Edit User Mapping, PUSCH, n DMRS (2)
Mode	LTE, LTETDD
Remote Command	[:SENSe] :EVM:ULINk:PROFile:USER<n>:PUSCh:DMRS:TWO <integer> [:SENSe] :EVM:ULINk:PROFile:USER<n>:PUSCh:DMRS:TWO?
Example	EVM:ULIN:PROF:USER1:PUSC:DMRS:TWO 1 EVM:ULIN:PROF:USER1:PUSC:DMRS:TWO?
Notes	Changes to this parameter will not be applied until Update Changes command is sent. See " RB Parameter Manager (Uplink) " on page 2178 section for more details.
Dependencies	The range of sub op code <n> values is determined by the number of Users the user has configured. Max value for n = 50. If the user attempts to remotely set or query a sub op code that is out of range, this will result in an error message. Enabled when Detection is Manual, DMRS Params is On, and PUSCH Active is ON.
Preset	0
State Saved	Saved in instrument state.

15 LTE Modulation Analysis Measurement
Meas Setup

Min	0
Max	10
Initial S/W Revision	Prior to A.02.00
Modified at S/W Revision	A.03.00

Auto Detect n DMRS (2)

Sets the value of nDMRS(2) used by the selected user mapping when Detection is Auto.

Key Path	Meas Setup, Chan Profile Setup, Edit User Mapping, PUSCH, n DMRS (2)
Mode	LTE, LTETDD
Remote Command	[:SENSe] :EVM:ULINK:PROFile:AUTO:PUSCh:DMRS:TWO <integer> [:SENSe] :EVM:ULINK:PROFile:AUTO:PUSCh:DMRS:TWO?
Example	EVM:ULIN:PROF:AUTO:PUSC:DMRS:TWO 1 EVM:ULIN:PROF:AUTO:PUSC:DMRS:TWO?
Notes	Changes to this parameter will not be applied until Update Changes command is sent. See " RB Parameter Manager (Uplink) " on page 2178 section for more details.
Dependencies	If the user attempts to remotely set or query a sub op code that is out of range, this will result in an error message. Enabled when Detection is Auto and Auto Detect DMRS Params is On, and Auto Detect PUSCH Active is ON.
Preset	0
State Saved	Saved in instrument state.
Min	0
Max	10
Initial S/W Revision	Prior to A.02.00
Modified at S/W Revision	A.03.00

Δ SS (Delta SS)

Sets the value of Delta SS used by the selected user mapping when Detection is Manual.

Key Path	Meas Setup, Chan Profile Setup, Edit User Mapping, PUSCH, Δ SS
Mode	LTE, LTETDD
Remote Command	[:SENSe] :EVM:ULINK:PROFile:USER<n>:PUSCh:DSS <integer> [:SENSe] :EVM:ULINK:PROFile:USER<n>:PUSCh:DSS?
Example	EVM:ULIN:PROF:USER1:PUSC:DSS 1 EVM:ULIN:PROF:USER1:PUSC:DSS?
Notes	Changes to this parameter will not be applied until Update Changes command is sent. See " RB Parameter Manager (Uplink) " on page 2178 section for more details.
Dependencies	The range of sub op code <n> values is determined by the number of Users the user has configured. Max value for n = 50. If the user attempts to remotely set or query a sub op code that is out of range, this will result in an error message. Enabled when Detection is Manual, DMRS Params is On, and PUSCH Active is ON.
Preset	0

15 LTE Modulation Analysis Measurement
Meas Setup

State Saved	Saved in instrument state.
Min	0
Max	29
Initial S/W Revision	Prior to A.02.00
Modified at S/W Revision	A.03.00

Auto Detect Δ SS (Delta SS)

Sets the value of Delta SS used by the selected user mapping when Detection is Auto.

Key Path	Meas Setup, Chan Profile Setup, Edit User Mapping, PUSCH, Δ SS
Mode	LTE, LTE-TDD
Remote Command	[:SENSe] :EVM:ULInk:PROFile:AUTO:PUSCh:DSS <integer> [:SENSe] :EVM:ULInk:PROFile:AUTO:PUSCh:DSS?
Example	EVM:ULIN:PROF:AUTO:PUSC:DSS 1 EVM:ULIN:PROF:AUTO:PUSC:DSS?
Notes	Changes to this parameter will not be applied until Update Changes command is sent. See " RB Parameter Manager (Uplink) " on page 2178 section for more details.
Dependencies	If the user attempts to remotely set or query a sub op code that is out of range, this will result in an error message. Enabled when Detection is Auto, Auto Detect DMRS Params is On, and Auto Detect PUSCH Active is ON.
Preset	0
State Saved	Saved in instrument state.
Min	0
Max	29
Initial S/W Revision	Prior to A.02.00
Modified at S/W Revision	A.03.00

Frequency Hopping

Selects the frequency hopping type or disables frequency hopping. (3GPP TS 36.211 5.3.4)

The following table shows the combination and its corresponding Freq Hopping selection.

Note that "Type 1, +1/4" and "Type 1, -1/4" are available only when Bandwidth is set to more than or equal to 10MHz.

		Frequency Hopping				
		Off	Type1, +1/4	Type 1, -1/4	Type 1, +1/2	Type 2
Frequency Hopping Mode	Intra- SF	OFF	T1ISF00	T1ISF01	T1ISF10	T2ISF
	Intra/Inter-SF	OFF	T1IISF00	T1IISF01	T1IISF10	T2IISF

Frequency Hopping SCPI Command

Key Path	SCPI Only
Mode	LTE, LTETDD
Remote Command	[[:SENSe]:EVM:ULINk:PROFile:USER<n>:PUSCh: FHOPping OFF T1ISF00 T1IISF00 T1ISF01 T1IISF01 T1ISF10 T1IISF10 T2ISF T2IISF [:SENSe]:EVM:ULINk:PROFile:USER<n>:PUSCh:FHOPping?
Example	EVM:ULIN:PROF:USER1:PUSC:FHOP OFF EVM:ULIN:PROF:USER1:PUSC:FHOP?
Notes	Changes to this parameter will not be applied until Update Changes command is sent. See " RB Parameter Manager (Uplink) " on page 2178 for more details.
Dependencies	The range of sub op code <n> values is determined by the number of Users the user has configured. If the user attempts to remotely set or query a sub op code that is out of range, this will result in an error message. Available when Detection is Manual.
Preset	OFF
State Saved	Saved in instrument state.
Initial S/W Revision	A.03.00
Modified at S/W Revision	A.06.00

Auto Detect Frequency Hopping SCPI Command

Selects the frequency hopping type or disables frequency hopping when Detection is Auto. (3GPP TS 36.211 5.3.4)

Key Path	SCPI only
Mode	LTE, LTETDD
Remote Command	[:SENSe] :EVM:ULINK:PROFile:AUTO:PUSCh:FHOpping OFF T1ISF00 T1IISF00 T1ISF01 T1IISF01 T1ISF10 T1IISF10 T2ISF T2IISF [:SENSe] :EVM:ULINK:PROFile:AUTO:PUSCh:FHOpping?
Example	EVM:ULIN:PROF:AUTO:PUSC:FHOP T2IISF EVM:ULIN:PROF:AUTO:PUSC:FHOP?
Notes	Changes to this parameter will not be applied until Update Changes command is sent. See " RB Parameter Manager (Uplink) " on page 2178 section for more details.
Dependencies	Available when Detection is Auto and Auto Detect PUSCH Active is ON.
Preset	OFF
State Saved	Saved in instrument state.
Range	Off Type1 InterSF00 Type1 IntraInterSF00 Type1 InterSF01 Type1 IntraInterSF01 Type1 InterSF10 Type1 IntraInterSF10 Type2 InterSF Type2 IntraInterSF
Initial S/W Revision	A.03.00
Modified at S/W Revision	A.06.00

Frequency Hopping

Selects frequency hopping or disables frequency hopping. (3GPP TS 36.211 V8.5.0 5.3.4)

Key Path	Meas Setup, Chan Profile Setup, Edit User Mapping
Mode	LTE, LTETDD
Notes	Changes to this parameter will not be applied until Update Changes command is sent. See " RB Parameter Manager (Uplink) " on page 2178 section for more details.
Dependencies	Available when PUSCH Active is ON. "Type 1, +1/4" and "Type 1, -1/4" are enabled only when Bandwidth is set to more than or equal to 10MHz.
Preset	OFF
State Saved	Saved in instrument state.
Range	OFF Type 1, +1/4 Type 1, -1/4 Type 1, +1/2 Type 2
Initial S/W Revision	A.03.00
Modified at S/W Revision	A.06.00

Frequency Hopping Mode

Selects the frequency hopping mode. (3GPP TS 36.211 V8.5.0 5.3.4)

Key Path	Meas Setup, Chan Profile Setup, Edit User Mapping
Mode	LTE, LTETDD
Notes	Changes to this parameter will not be applied until the Update Changes command is sent. See " RB Parameter Manager (Uplink) " on page 2178 section for more details.
Dependencies	Available when PUSCH Active is ON.
Preset	OFF
State Saved	Saved in instrument state.
Range	Inter-SF Intra/Inter-SF
Initial S/W Revision	A.03.00
Modified at S/W Revision	A.06.00

Hopping Offset (N_{RB}^{HO})

Sets the value of Hopping Offset (NRBHO) when Detection is Manual. Hopping Offset is the offset used for PUSCH frequency hopping, expressed in number of resource blocks. (3GPP TS 36.211 V8.5.0 5.3.4).

Key Path	Meas Setup, Chan Profile Setup, Edit User Mapping, PUSCH
Mode	LTE, LTETDD
Remote Command	[:SENSe] :EVM:ULINk:PROFile:USER<n>:PUSCh:NRBHo:<integer> [:SENSe] :EVM:ULINk:PROFile:USER<n>:PUSCh:NRBHo?
Example	EVM:ULIN:PROF:USER1:PUSC:NRBH 1 EVM:ULIN:PROF:USER1:PUSC:NRBH?
Notes	Changes to this parameter will not be applied until Update Changes command is sent. See " RB Parameter Manager (Uplink) " on page 2178 section for more details.
Dependencies	The range of sub op code <n> values is determined by the number of Users the user has configured. If the user attempts to remotely set or query a sub op code that is out of range, this will result in an error message. Enabled when Detection is Manual, Frequency Hopping is not OFF, and PUSCH Active is ON.
Couplings	Hopping Offset should always be less than or equal to the total RB number of the selected Bandwidth.
Preset	0
State Saved	Saved in instrument state.
Min	0
Max	6 - Bandwidth 1.4 MHz 15 - Bandwidth 3 MHz 25 - Bandwidth 5 MHz 50 - Bandwidth 10 MHz 75 - Bandwidth 15 MHz

15 LTE Modulation Analysis Measurement
Meas Setup

	100 - Bandwidth 20 MHz
Initial S/W Revision	A.03.00
Modified at S/W Revision	A.06.00

Auto Detect Hopping Offset (N_{RB}^{HO})

Sets the value of Hopping Offset (NRBHO) when Detection is Auto. Hopping Offset is the offset used for PUSCH frequency hopping, expressed in number of resource blocks. (3GPP TS 36.211 V8.5.0 5.3.4).

Key Path	Meas Setup, Chan Profile Setup, Edit User Mapping, PUSCH
Mode	LTE, LTE-TDD
Remote Command	[:SENSe] :EVM:ULINK:PROFile:AUTO:PUSCh:NRBHo <integer> [:SENSe] :EVM:ULINK:PROFile:AUTO:PUSCh:NRBHo?
Example	EVM:ULIN:PROF:AUTO:PUSC:NRBH 1 EVM:ULIN:PROF:AUTO:PUSC:NRBH?
Notes	Changes to this parameter will not be applied until Update Changes command is sent. See " RB Parameter Manager (Uplink) " on page 2178 section for more details.
Dependencies	Enabled when Detection is Auto, Auto Detect Frequency Hopping is not OFF, and Auto Detect PUSCH Active is ON.
Couplings	Hopping Offset should always be less than or equal to the total RB number of the selected Bandwidth.
Preset	0
State Saved	Saved in instrument state.
Min	0
Max	6 - Bandwidth 1.4 MHz 15 - Bandwidth 3 MHz 25 - Bandwidth 5 MHz 50 - Bandwidth 10 MHz 75 - Bandwidth 15 MHz 100 - Bandwidth 20 MHz
Initial S/W Revision	A.03.00
Modified at S/W Revision	A.06.00

Number of sub-bands (N_{sb})

Sets the number of sub-bands (Nsb) when Detection is Manual. (3GPP TS 36.211 V8.5.0 5.3.4).

Key Path	Meas Setup, Chan Profile Setup, Edit User Mapping, PUSCH
Mode	LTE, LTE-TDD
Remote Command	[:SENSe] :EVM:ULINK:PROFile:USER<n>:PUSCh:NSB <integer> [:SENSe] :EVM:ULINK:PROFile:USER<n>:PUSCh:NSB?
Example	EVM:ULIN:PROF:USER1:PUSC:NSB 1 EVM:ULIN:PROF:USER1:PUSC:NSB?
Notes	Changes to this parameter will not be applied until Update Changes command is sent. See " RB Parameter Manager (Uplink) " on page 2178 section for more details.
Dependencies	The range of sub op code <n> values is determined by the number of Users the user has configured.

	If the user attempts to remotely set or query a sub op code that is out of range, this will result in an error message. Enabled when Detection is Manual, Frequency Hopping is set to either Type2InterSF or Type2InterIntraSF, and PUSCH Active is ON.
Couplings	Nsb should always be less than or equal to the total RB number of the selected Bandwidth.
Preset	1
State Saved	Saved in instrument state.
Min	1
Max	4
Initial S/W Revision	A.03.00
Modified at S/W Revision	A.06.00, A.10.00

Auto Detect Number of Sub-bands (N_{sb})

Sets the Number of Sub-bands (Nsb) when Detection is Auto. (3GPP TS 36.211 V8.5.0 5.3.4).

Key Path	Meas Setup, Chan Profile Setup, Edit User Mapping, PUSCH
Mode	LTE, LTETDD
Remote Command	[:SENSe] :EVM:ULINK:PROFile:AUTO:PUSCh:NSB <integer> [:SENSe] :EVM:ULINK:PROFile:AUTO:PUSCh:NSB?
Example	EVM:ULIN:PROF:AUTO:PUSC:NSB 1 EVM:ULIN:PROF:AUTO:PUSC:NSB?
Notes	Changes to this parameter will not be applied until Update Changes command is sent. See " RB Parameter Manager (Uplink) " on page 2178 section for more details.
Dependencies	Enabled when Detection is Auto, Auto Detect Frequency Hopping is set to either Type2InterSF or Type2InterIntraSF, and Auto Detect PUSCH Active is ON.
Couplings	Nsb should always be less than or equal to the total RB number of the selected Bandwidth.
Preset	1
State Saved	Saved in instrument state.
Min	1
Max	4
Initial S/W Revision	A.03.00
Modified at S/W Revision	A.06.00, A.10.00

PUSCH Sync Slot

Sets the Sync Slot for all PUSCH Slots when Detection is Manual.

Sync Slot specifies the index of the slot to use for initial synchronization when PUSCH is selected as the Sync Type. The demodulator searches for the slot with the characteristics specified in Per-slot Parameters and the slot that matches the Per-slot Parameters with the highest correlation will be assigned the slot number given in the Sync Slot parameter.

When Sync Slot is set to Auto, the demod algorithm may automatically determine the best time slot to synchronize to. This approach simplifies parameter entry and provides easier setup. However, the complexity of the algorithm makes it rather slow and prone to errors in the presence of noise.

Key Path	Meas Setup, Chan Profile Setup, Edit User Mapping
Mode	LTE, LTETDD
Remote Command	[:SENSe] :EVM:ULINK:PROFile:USER<n>:PUSCh:SSLot:<integer> [:SENSe] :EVM:ULINK:PROFile:USER<n>:PUSCh:SSLot? [:SENSe] :EVM:ULINK:PROFile:USER<n>:PUSCh:SSLot:AUTO OFF ON 0 1 [:SENSe] :EVM:ULINK:PROFile:USER<n>:PUSCh:SSLot:AUTO?
Example	EVM:ULIN:PROF:USER1:PUSC:SSL 1

	EVM:ULIN:PROF:USER1:PUSC:SSL? EVM:ULIN:PROF:USER1:PUSC:SSL:AUTO 1 EVM:ULIN:PROF:USER1:PUSC:SSL:AUTO?
Notes	Changes to this parameter will not be applied until Update Changes command is sent. See " RB Parameter Manager (Uplink) " on page 2178 section for more details.
Dependencies	The range of sub op code <n> values is determined by the number of Users the user has configured. Max value for n=50. If the user attempts to remotely set or query a sub op code that is out of range, this will result in an error message. PUSCH Sync Slot is enabled when PUSCH Active is ON, Detection is Manual and PUSCH Sync Slot Auto is OFF. PUSCH Sync Slot Auto is enabled when PUSCH Active is ON and Detection is Manual
Preset	0 ON
State Saved	Saved in instrument state.
Min	0
Max	19
Initial S/W Revision	Prior to A.02.00
Modified at S/W Revision	A.03.00

Auto Detect PUSCH Sync Slot

Sets the Sync Slot for all PUSCH Slots when Detection is Auto.

Key Path	Meas Setup, Chan Profile Setup, Edit User Mapping
Mode	LTE, LTETDD
Remote Command	[:SENSe] :EVM:ULINK:PROFile:AUTO:PUSCh:SSLot <integer> [:SENSe] :EVM:ULINK:PROFile:AUTO:PUSCh:SSLot? [:SENSe] :EVM:ULINK:PROFile:AUTO:PUSCh:SSLot:AUTO OFF ON 0 1 [:SENSe] :EVM:ULINK:PROFile:AUTO:PUSCh:SSLot:AUTO?
Example	EVM:ULIN:PROF:AUTO:PUSC:SSL 1 EVM:ULIN:PROF:AUTO:PUSC:SSL? EVM:ULIN:PROF:AUTO:PUSC:SSL:AUTO 1 EVM:ULIN:PROF:AUTO:PUSC:SSL:AUTO?
Notes	Changes to this parameter will not be applied until Update Changes command is sent. See " RB Parameter Manager (Uplink) " on page 2178 section for more details.
Dependencies	Auto Detect PUSCH Sync Slot is enabled when Auto Detect PUSCH Active is ON, Detection is Auto and Auto Detect PUSCH Sync Slot Auto is OFF. Auto Detect PUSCH Sync Slot Auto is enabled when Auto Detect PUSCH Active is ON and Detection is Auto.
Preset	0 ON
State Saved	Saved in instrument state.
Min	0
Max	19
Initial S/W Revision	Prior to A.02.00
Modified at S/W Revision	A.03.00

PUSCH Couple

Selecting the checkbox next to a parameter in the PUSCH Per-slot Parameters area will couple that parameter across all RB allocation.

Key Path	Meas Setup, Chan Profile Setup, Edit User Mapping
----------	---

Common RB Start

Specifies the RB start boundary when Couple is On.

Key Path	Meas Setup, Chan Profile Setup, Edit User Mapping, PUSCH
----------	--

RB Start

Sets the Start Resource Block for all the PUSCH Slots when RB Start Couple is On and when Detection is Manual.

Key Path	Meas Setup, Chan Profile Setup, Edit User Mapping, PUSCH, RB Start
Mode	LTE, LTETDD
Remote Command	[:SENSe] :EVM:ULINk:PROFile:USER<n>:PUSCh:RB:STARt <integer> [:SENSe] :EVM:ULINk:PROFile:USER<n>:PUSCh:RB:STARt?
Example	EVM:ULIN:PROF:USER1:PUSC:RB:STAR 0 EVM:ULIN:PROF:USER1:PUSC:RB:STAR?
Notes	Changes to this parameter will not be applied until Update Changes command is sent. See " RB Parameter Manager (Uplink) " on page 2178 section for more details.
Dependencies	The range of sub op code <n> values is determined by the number of Users the user has configured. Max value for n = 50. If the user attempts to remotely set or query a sub op code that is out of range, this will result in an error message. Enabled when Detection is Manual, RB Start Couple is ON, and PUSCH Active is ON.
Couplings	If the user attempts to set a RB Start value greater than the RB Stop value, both values will be set to the RB Start value or clipped to the min or max value if the entered value is out of range
Preset	0
State Saved	Saved in instrument state.
Min	0
Max	5 – Bandwidth 1.4 MHz 14 – Bandwidth 3 MHz 24 – Bandwidth 5 MHz 49 – Bandwidth 10 MHz 74 – Bandwidth 15 MHz 99 – Bandwidth 20 MHz
Initial S/W Revision	Prior to A.02.00
Modified at S/W Revision	A.03.00

Auto Detect RB Start

Sets the Start Resource Block for all the PUSCH Slots when Detection is Auto.

Key Path	Meas Setup, Chan Profile Setup, Edit User Mapping, PUSCH, RB Start
Mode	LTE, LTETDD
Remote Command	[:SENSe] :EVM:ULINk:PROFile:AUTO:PUSCh:RB:STARt <integer> [:SENSe] :EVM:ULINk:PROFile:AUTO:PUSCh:RB:STARt?
Example	EVM:ULIN:PROF:AUTO:PUSC:RB:STAR 0 EVM:ULIN:PROF:AUTO:PUSC:RB:STAR?
Notes	Changes to this parameter will not be applied until Update Changes command is sent. See " RB Parameter Manager (Uplink) " on page 2178 section for more details.
Dependencies	Enabled when Detection is Auto and Auto Detect PUSCH Auto Sync Slot is OFF, and Auto Detect PUSCH Active is ON.
Couplings	If the user attempts to set a RB Start value greater than the RB Stop value, both values will be set to the RB Start value or clipped to the min or max value if the entered value is out of range
Preset	0
State Saved	Saved in instrument state.
Min	0
Max	5 – Bandwidth 1.4 MHz 14 – Bandwidth 3 MHz 24 – Bandwidth 5 MHz 49 – Bandwidth 10 MHz 74 – Bandwidth 15 MHz 99 – Bandwidth 20 MHz
Initial S/W Revision	Prior to A.02.00
Modified at S/W Revision	A.03.00

RB Start Couple

Determines whether or not all the PUSCH Slots will use the Common RB Start value.

Key Path	Meas Setup, Chan Profile Setup, Edit User Mapping, PUSCH, Couple Power Boost
Mode	LTE, LTETDD
Remote Command	[:SENSe] :EVM:ULINk:PROFile:USER<n>:PUSCh:RB:STARt:COUPle OFF ON 0 1 [:SENSe] :EVM:ULINk:PROFile:USER<n>:PUSCh:RB:STARt:COUPle?
Example	EVM:ULIN:PROF:USER1:PUSC:RB:STAR:COUP ON EVM:ULIN:PROF:USER1:PUSC:RB:STAR:COUP?
Notes	Changes to this parameter will not be applied until Update Changes command is sent. See " RB Parameter Manager (Uplink) " on page 2178 section for more details.

Dependencies	The range of sub op code <n> values is determined by the number of Users the user has configured. Max value for n = 50. If the user attempts to remotely set or query a sub op code that is out of range, this will result in an error message. Enabled when Detection is Manual, and PUSCH Active is ON.
Preset	ON
State Saved	Saved in instrument state.
Initial S/W Revision	Prior to A.02.00
Modified at S/W Revision	A.03.00

Common RB End

Specifies the RB end boundary.

Key Path	Meas Setup, Chan Profile Setup, Edit User Mapping, PUSCH
----------	--

RB End

Sets the End Resource Block for all the PUSCH Slots when RB End Couple is On and when Detection is Manual.

Key Path	Meas Setup, Chan Profile Setup, Edit User Mapping, PUSCH, RB End
Mode	LTE, LTETDD
Remote Command	[:SENSe] :EVM:ULINK:PROFile:USER<n>:PUSCh:RB:END <integer> [:SENSe] :EVM:ULINK:PROFile:USER<n>:PUSCh:RB:END?
Example	EVM:ULIN:PROF:USER1:PUSC:RB:END 0 EVM:ULIN:PROF:USER1:PUSC:RB:END?
Notes	Changes to this parameter will not be applied until Update Changes command is sent. See " RB Parameter Manager (Uplink) " on page 2178 section for more details.
Dependencies	The range of sub op code <n> values is determined by the number of Users the user has configured. Max value for n = 50. If the user attempts to remotely set or query a sub op code that is out of range, this will result in an error message. Enabled when Detection is Manual, RB End Couple is ON, and PUSCH Active is ON.
Couplings	If the user attempts to set a RB End value less than the RB Start value, both values will be set to the RB End value or clipped to the min or max value if the entered value is out of range
Preset	0
State Saved	Saved in instrument state.
Min	0
Max	5 – Bandwidth 1.4 MHz 14 – Bandwidth 3 MHz

	24 - Bandwidth 5 MHz
	49 - Bandwidth 10 MHz
	74 - Bandwidth 15 MHz
	99 - Bandwidth 20 MHz
Initial S/W Revision	Prior to A.02.00
Modified at S/W Revision	A.03.00

Auto Detect RB End

Sets the End Resource Block for all the PUSCH Slots when Detection is Auto.

Key Path	Meas Setup, Chan Profile Setup, Edit User Mapping, PUSCH, RB End
Mode	LTE, LTETDD
Remote Command	[:SENSe] :EVM:ULINK:PROFile:AUTO:PUSCh:RB:END <integer> [:SENSe] :EVM:ULINK:PROFile:AUTO:PUSCh:RB:END?
Example	EVM:ULIN:PROF:AUTO:PUSC:RB:END 0 EVM:ULIN:PROF:AUTO:PUSC:RB:END?
Notes	Changes to this parameter will not be applied until Update Changes command is sent. See " RB Parameter Manager (Uplink) " on page 2178 section for more details.
Dependencies	Enabled when Detection is Auto, Auto Detect PUSCH Auto Sync Slot is OFF, and Auto Detect PUSCH Active is ON.
Couplings	If the user attempts to set a RB End value less than the RB Start value, both values will be set to the RB End value or clipped to the min or max value if the entered value is out of range
Preset	0
State Saved	Saved in instrument state.
Min	0
Max	5 – Bandwidth 1.4 MHz 14 – Bandwidth 3 MHz 24 – Bandwidth 5 MHz 49 – Bandwidth 10 MHz 74 – Bandwidth 15 MHz 99 – Bandwidth 20 MHz
Initial S/W Revision	Prior to A.02.00
Modified at S/W Revision	A.03.00

RB End Couple

Determines whether or not all the PUSCH Slots will use the Common RB Start value.

Key Path	Meas Setup, Chan Profile Setup, Edit User Mapping, PUSCH, Couple Power Boost
Mode	LTE, LTETDD
Remote Command	[:SENSe] :EVM:ULINK:PROFile:USER<n>:PUSCh:RB:END:COUple OFF ON 0 1 [:SENSe] :EVM:ULINK:PROFile:USER<n>:PUSCh:RB:END:COUple?
Example	EVM:ULIN:PROF:USER1:PUSC:RB:END:COUP ON EVM:ULIN:PROF:USER1:PUSC:RB:END:COUP?
Notes	Changes to this parameter will not be applied until Update Changes command is sent. See " RB Parameter Manager (Uplink) " on page 2178 section for more details.
Dependencies	The range of sub op code <n> values is determined by the number of Users the user has configured.

	<p>Max value for n = 50.</p> <p>If the user attempts to remotely set or query a sub op code that is out of range, this will result in an error message.</p> <p>Enabled when Detection is Manual, and PUSCH Active is ON.</p>
Preset	ON
State Saved	Saved in instrument state.
Initial S/W Revision	Prior to A.02.00
Modified at S/W Revision	A.03.00

Common Mod Type

Selects the Modulation Type for all the PUSCH Slots when Mod Type Couple is On and Detection is Manual.

Key Path	Meas Setup, Chan Profile Setup, Edit User Mapping, PUSCH, Mod Type
Mode	LTE, LTETDD
Remote Command	<pre>[:SENSe]:EVM:ULink:PROFile:USER<n>:PUSCh:MODulation:TYPE QPSK QAM16 QAM64</pre> <pre>[:SENSe]:EVM:ULink:PROFile:USER<n>:PUSCh:MODulation:TYPE?</pre>
Example	<pre>EVM:ULIN:PROF:USER1:PUSC:MOD:TYPE QPSK</pre> <pre>EVM:ULIN:PROF:USER1:PUSC:MOD:TYPE?</pre>
Notes	Changes to this parameter will not be applied until Update Changes command is sent. See " RB Parameter Manager (Uplink) " on page 2178 section for more details.
Dependencies	<p>The range of sub op code <n> values is determined by the number of Users the user has configured. Max value for n=50.</p> <p>If the user attempts to remotely set or query a sub op code that is out of range, this will result in an error message.</p> <p>Enabled when Mod Type Couple is On, Detection is Manual, and PUSCH Active is ON.</p>
Preset	QPSK
State Saved	Saved in instrument state.
Range	QPSK 16QAM 64QAM
Initial S/W Revision	Prior to A.02.00
Modified at S/W Revision	A.03.00

Auto Detect Mod Type

Selects the Modulation Type for all the PUSCH Slots when Detection is Auto.

Key Path	Meas Setup, Chan Profile Setup, Edit User Mapping, PUSCH, Mod Type
Mode	LTE, LTETDD
Remote Command	[:SENSe] :EVM:ULINK:PROFile:AUTO:PUSCh:MODulation:TYPE QPSK QAM16 QAM64 [:SENSe] :EVM:ULINK:PROFile:AUTO:PUSCh:MODulation:TYPE?
Example	EVM:ULIN:PROF:AUTO:PUSC:MOD:TYPE QPSK EVM:ULIN:PROF:AUTO:PUSC:MOD:TYPE?
Notes	Changes to this parameter will not be applied until Update Changes command is sent. See " RB Parameter Manager (Uplink) " on page 2178 section for more details.
Dependencies	Always grayed out.
Preset	QPSK
State Saved	Saved in instrument state.
Range	QPSK 16QAM 64QAM
Initial S/W Revision	Prior to A.02.00
Modified at S/W Revision	A.03.00

QPSK

Selects QPSK for the Modulation Type for all the PUSCH Slots when Mod Type Couple is On.

Key Path	Meas Setup, Chan Profile Setup, Edit User Mapping, PUSCH, Mod Type
Mode	LTE, LTETDD
Initial S/W Revision	Prior to A.02.00
Modified at S/W Revision	A.03.00

16QAM

Selects 16QAM for the Modulation Type for all the PUSCH Slots when Mod Type Couple is On.

Key Path	Meas Setup, Chan Profile Setup, Edit User Mapping, PUSCH, Couple Mod Type
Mode	LTE, LTETDD
Initial S/W Revision	Prior to A.02.00
Modified at S/W Revision	A.03.00

64QAM

Selects 64QAM for the Modulation Type for all the PUSCH Slots when Mod Type Couple is On.

Key Path	Meas Setup, Chan Profile Setup, Edit User Mapping, PUSCH,Couple Mod Type
Mode	LTE, LTETDD
Initial S/W Revision	Prior to A.02.00
Modified at S/W Revision	A.03.00

Mod Type Couple

Determines whether or not all the PUSCH Slots will use the Common Mod Type value.

Key Path	Meas Setup, Chan Profile Setup, Edit User Mapping, PUSCH, Couple Mod Type
Mode	LTE, LTETDD
Remote Command	[:SENSe] :EVM:ULINk:PROFile:USER<n>:PUSCh:MODulation:TYPE:COUPle OFF ON 0 1 [:SENSe] :EVM:ULINk:PROFile:USER<n>:PUSCh:MODulation:TYPE:COUPle?
Example	EVM:ULIN:PROF:USER1:PUSC:MOD:TYPE:COUP ON EVM:ULIN:PROF:USER1:PUSC:MOD:TYPE:COUP?
Notes	Changes to this parameter will not be applied until Update Changes command is sent. See " RB Parameter Manager (Uplink) " on page 2178 section for more details.
Dependencies	The range of sub op code <n> values is determined by the number of Users the user has configured. Max value for n = 50. If the user attempts to remotely set or query a sub op code that is out of range, this will result in an error message. Enabled when Detection is Manual and PUSCH Active is ON.
Preset	ON
State Saved	Saved in instrument state.
Initial S/W Revision	Prior to A.02.00
Modified at S/W Revision	A.03.00

Common Power Boost

Sets the PUSCH average power level relative to the 0 dB set by the PUSCH DMRS Power.

Key Path	Meas Setup, Chan Profile Setup, Edit User Mapping, PUSCH
----------	--

Power Boost

Sets the Power Boost value for all the PUSCH Slots when Power Boost Couple is On and Detection is Manual.

Power Boost sets the PUSCH average power level relative to the 0 dB point set by the PUSCH DMRS Power.

Key Path	Meas Setup, Chan Profile Setup, Edit User Mapping, PUSCH, Couple Power
Mode	LTE, LTETDD
Remote Command	[:SENSe] :EVM:ULINk:PROFile:USER<n>:PUSCh:PWRBoost <rel_ampl> [:SENSe] :EVM:ULINk:PROFile:USER<n>:PUSCh:PWRBoost?
Example	EVM:ULIN:PROF:USER1:PUSC:PWRB 0 EVM:ULIN:PROF:USER1:PUSC:PWRB?
Notes	Changes to this parameter will not be applied until Update Changes command is sent. See " RB Parameter Manager (Uplink) " on page 2178 section for more details.
Dependencies	The range of sub op code <n> values is determined by the number of Users the user has configured. Max value for n = 50. If the user attempts to remotely set or query a sub op code that is out of range, this will result in an error message. Enabled when Detection is Manual, Power Boost Couple is On, and PUSCH Active is ON.
Preset	0 dB
State Saved	Saved in instrument state.
Min	-100 dB
Max	100 dB
Initial S/W Revision	Prior to A.02.00
Modified at S/W Revision	A.03.00, A.04.20

Auto Detect Power Boost

Sets the Power Boost value for all the PUSCH Slots when Detection is Auto.

Key Path	Meas Setup, Chan Profile Setup, Edit User Mapping, PUSCH,Couple Power
Mode	LTE, LTETDD
Remote Command	[:SENSe] :EVM:ULINk:PROFile:AUTO:PUSCh:PWRBoost <rel_ampl> [:SENSe] :EVM:ULINk:PROFile:AUTO:PUSCh:PWRBoost?
Example	EVM:ULIN:PROF:AUTO:PUSC:PWRB 0 EVM:ULIN:PROF:AUTO:PUSC:PWRB?
Notes	Changes to this parameter will not be applied until Update Changes command is sent. See " RB Parameter Manager (Uplink) " on page 2178 section for more details.
Dependencies	Enabled when Detection is Auto and Auto Detect PUSCH Active is ON.
Preset	0 dB
State Saved	Saved in instrument state.
Min	-100 dB
Max	100 dB
Initial S/W Revision	Prior to A.02.00
Modified at S/W Revision	A.03.00, A.04.20

Power Boost Couple

Determines whether or not all the PUSCH Slots will use the Common Power Boost value.

Key Path	Meas Setup, Chan Profile Setup, Edit User Mapping, PUSCH,Couple Power
Mode	LTE, LTETDD
Remote Command	[:SENSe] :EVM:ULINk:PROFile:USER<n>:PUSCh:PWRBoost:COUPle OFF ON 0 1 [:SENSe] :EVM:ULINk:PROFile:USER<n>:PUSCh:PWRBoost:COUPle
Example	EVM:ULIN:PROF:USER1:PUSC:PWRB:COUP ON EVM:ULIN:PROF:USER1:PUSC:PWRB:COUP?
Notes	Changes to this parameter will not be applied until Update Changes command is sent. See " RB Parameter Manager (Uplink) " on page 2178 section for more details.
Dependencies	The range of sub op code <n> values is determined by the number of Users the user has configured. Max value for n = 50. If the user attempts to remotely set or query a sub op code that is out of range, this will result in an error message. Enabled when Detection is Manual.
Preset	ON
State Saved	Saved in instrument state.
Initial S/W Revision	Prior to A.02.00
Modified at S/W Revision	A.03.00

Common DMRS Group

Specifies the DMRS Group for a slot.

Key Path	Meas Setup, Chan Profile Setup, Edit User Mapping, PUSCH
----------	--

DMRS Group

Sets the DMRS Group for all the PUSCH Slots when DMRS Group Couple is On and when Detection is Manual.

Key Path	Meas Setup, Chan Profile Setup, Edit User Mapping, PUSCH, DMRS Group
Mode	LTE, LTETDD
Remote Command	[:SENSe] :EVM:ULINk:PROFile:USER<n>:PUSCh:DMRS:GROup <integer> [:SENSe] :EVM:ULINk:PROFile:USER<n>:PUSCh:DMRS:GROup?
Example	EVM:ULIN:PROF:USER1:PUSC:DMRS:GRO 1 EVM:ULIN:PROF:USER1:PUSC:DMRS:GRO?
Notes	Changes to this parameter will not be applied until Update Changes command is sent. See " RB Parameter Manager (Uplink) " on page 2178 section for more details.
Dependencies	The range of sub op code <n> values is determined by the number of Users the user has configured. Max value for n = 50. If the user attempts to remotely set or query a sub op code that is out of range, this will result in an error message. Enabled when Detection is Manual, DMRS Params is Off, DMRS Group Couple is On, and PUSCH Active is ON.
Preset	0
State Saved	Saved in instrument state.
Min	0
Max	29
Initial S/W Revision	Prior to A.02.00
Modified at S/W Revision	A.03.00

Auto Detect DMRS Group

Sets the DMRS Group for all the PUSCH Slots when Detection is Auto.

Key Path	Meas Setup, Chan Profile Setup, Edit User Mapping, PUSCH, DMRS Group
Mode	LTE, LTETDD
Remote Command	[:SENSe] :EVM:ULINk:PROFile:AUTO:PUSCh:DMRS:GROup <integer> [:SENSe] :EVM:ULINk:PROFile:AUTO:PUSCh:DMRS:GROup?
Example	EVM:ULIN:PROF:AUTO:PUSC:DMRS:GRO 1 EVM:ULIN:PROF:AUTO:PUSC:DMRS:GRO?
Notes	Changes to this parameter will not be applied until Update Changes command is sent. See " RB Parameter Manager (Uplink) " on page 2178 section for more details.
Dependencies	Enabled when Detection is Auto, Auto Detect DMRS Params is Off, and Auto Detect PUSCH Active is ON.
Preset	0
State Saved	Saved in instrument state.
Min	0
Max	29
Initial S/W Revision	Prior to A.02.00
Modified at S/W Revision	A.03.00

DMRS Group Couple

Determines whether or not all the PUSCH Slots will use the Common DMRS Group value.

Key Path	Meas Setup, Chan Profile Setup, Edit User Mapping, PUSCH,DMRS Group
Mode	LTE, LTETDD
Remote Command	[:SENSe] :EVM:ULINk:PROFile:USER<n>:PUSCh:DMRS:GROup:COUPle OFF ON 0 1 [:SENSe] :EVM:ULINk:PROFile:USER<n>:PUSCh:DMRS:GROup:COUPle?
Example	EVM:ULIN:PROF:USER1:PUSC:DMRS:GRO:COUP ON EVM:ULIN:PROF:USER1:PUSC:DMRS:GRO:COUP?
Notes	Changes to this parameter will not be applied until Update Changes command is sent. See " RB Parameter Manager (Uplink) " on page 2178 section for more details.
Dependencies	The range of sub op code <n> values is determined by the number of Users the user has configured. Max value for n = 50. If the user attempts to remotely set or query a sub op code that is out of range, this will result in an error message. Enabled when Detection is Manual, DMRS Params is Off, PUSCH Active is ON, and PUSCH Active is ON.
Preset	ON
State Saved	Saved in instrument state.

Initial S/W Revision	Prior to A.02.00
Modified at S/W Revision	A.03.00

Common DMRS Sequence

Specifies the RMRS Sequence for a slot.

Key Path	Meas Setup, Chan Profile Setup, Edit User Mapping, PUSCH
----------	--

DMRS Sequence

Sets the DMRS Sequence (v) for all the PUSCH Slots when DMRS Sequence Couple is On and when Detection is Manual. DMRS Sequence or v, is the sequence number within the group and can take on values from 0 to floor(NZCRS/30)-1, where NZCRS is the largest prime number less than MSCRS

Key Path	Meas Setup, Chan Profile Setup, Edit User Mapping, PUSCH, DMRS Seq
Mode	LTE, LTETDD
Remote Command	[:SENSe] :EVM:ULINK:PROFile:USER<n>:PUSCh:DMRS:SEQuence <integer> [:SENSe] :EVM:ULINK:PROFile:USER<n>:PUSCh:DMRS:SEQuence?
Example	EVM:ULIN:PROF:USER1:PUSC:DMRS:SEQ 1 EVM:ULIN:PROF:USER1:PUSC:DMRS:SEQ?
Notes	Changes to this parameter will not be applied until Update Changes command is sent. See " RB Parameter Manager (Uplink) " on page 2178 section for more details.
Dependencies	The range of sub op code <n> values is determined by the number of Users the user has configured. Max value for n = 50. If the user attempts to remotely set or query a sub op code that is out of range, this will result in an error message. Enabled when Detection is Manual, DMRS Params is Off, DMRS Sequence Couple is On, and PUSCH Active is ON.
Preset	0
State Saved	Saved in instrument state.
Min	0
Max	1
Initial S/W Revision	Prior to A.02.00
Modified at S/W Revision	A.03.00

Auto Detect DMRS Sequence

Sets the DMRS Sequence (v) for all the PUSCH Slots when Detection is Auto. DMRS Sequence or v, is the sequence number within the group and can take on values from 0 to $\text{floor}(\text{NZCRS}/30)-1$, where NZCRS is the largest prime number less than MSCRS

Key Path	Meas Setup, Chan Profile Setup, Edit User Mapping, PUSCH,DMRS Seq
Mode	LTE, LTETDD
Remote Command	[:SENSe] :EVM:ULINk:PROFile:AUTO:PUSCh:DMRS:SEQuence <integer> [:SENSe] :EVM:ULINk:PROFile:AUTO:PUSCh:DMRS:SEQuence?
Example	EVM:ULIN:PROF:AUTO:PUSC:DMRS:SEQ 1 EVM:ULIN:PROF:AUTO:PUSC:DMRS:SEQ?
Notes	Changes to this parameter will not be applied until Update Changes command is sent. See " RB Parameter Manager (Uplink) " on page 2178 section for more details.
Dependencies	Enabled when Detection is Auto, Auto Detect DMRS Params is Off, and Auto Detect PUSCH Active is ON.
Preset	0
State Saved	Saved in instrument state.
Min	0
Max	$\text{floor}(\text{NZCRS}/30)-1$ (can be restricted based on bandwidth)
Initial S/W Revision	Prior to A.02.00
Modified at S/W Revision	A.03.00

DMRS Sequence Couple

Determines whether or not all the PUSCH Slots will use the Common DMRS Sequence value.

Key Path	Meas Setup, Chan Profile Setup, Edit User Mapping, PUSCH, DMRS Seq
Mode	LTE, LTETDD
Remote Command	[:SENSe] :EVM:ULINk:PROFile:USER<n>:PUSCh:DMRS:SEQuence:COUPle OFF ON 0 1 [:SENSe] :EVM:ULINk:PROFile:USER<n>:PUSCh:DMRS:SEQuence:COUPle?
Example	EVM:ULIN:PROF:USER1:PUSC:DMRS:SEQ:COUP ON EVM:ULIN:PROF:USER1:PUSC:DMRS:SEQ:COUP?
Notes	Changes to this parameter will not be applied until Update Changes command is sent. See " RB Parameter Manager (Uplink) " on page 2178 section for more details.
Dependencies	The range of sub op code <n> values is determined by the number of Users the user has configured. Max value for n = 50.If the user attempts to remotely set or query a sub op code that is out of range, this will result in an error message. Enabled when Detection is Manual, DMRS Params is OFF, and PUSCH Active is ON.
Preset	ON
State Saved	Saved in instrument state.

Initial S/W Revision	Prior to A.02.00
Modified at S/W Revision	A.03.00

Common DMRS Cyclic Shift

Specifies the DMRS Cyclic Shift for a slot.

Key Path	Meas Setup, Chan Profile Setup, Edit User Mapping, PUSCH
----------	--

DMRS Cyclic Shift

Sets the DMRS Cyclic Shift for all the PUSCH Slots when DMRS Cyclic Shift Couple is On and Detection is Manual.

Key Path	Meas Setup, Chan Profile Setup, Edit User Mapping, PUSCH, DMRS Cyclic Shift Couple
Mode	LTE, LTE-TDD
Remote Command	[:SENSe] :EVM:ULINk:PROFile:USER<n>:PUSCh:DMRS:CSHift <integer> [:SENSe] :EVM:ULINk:PROFile:USER<n>:PUSCh:DMRS:CSHift?
Example	EVM:ULIN:PROF:USER1:PUSC:DMRS:CSH 1 EVM:ULIN:PROF:USER1:PUSC:DMRS:CSH?
Notes	Changes to this parameter will not be applied until Update Changes command is sent. See " RB Parameter Manager (Uplink) " on page 2178 section for more details.
Dependencies	The range of sub op code <n> values is determined by the number of Users the user has configured. Max value for n = 50. If the user attempts to remotely set or query a sub op code that is out of range, this will result in an error message. Enabled when Detection is Manual, DMRS Params is Off, and DMRS Cyclic Shift Couple is On
Preset	0
State Saved	Saved in instrument state.
Min	0
Max	11
Initial S/W Revision	Prior to A.02.00
Modified at S/W Revision	A.03.00

Auto Detect DMRS Cyclic Shift

Sets the DMRS Cyclic Shift for all the PUSCH Slots when Detection is Auto.

Key Path	Meas Setup, Chan Profile Setup, Edit User Mapping, PUSCH,DMRS Cyclic Shift Couple
Mode	LTE, LTETDD
Remote Command	[:SENSe] :EVM:ULINk:PROFile:AUTO:PUSCh:DMRS:CSHift <integer> [:SENSe] :EVM:ULINk:PROFile:AUTO:PUSCh:DMRS:CSHift?
Example	EVM:ULIN:PROF:AUTO:PUSC:DMRS:CSH 1 EVM:ULIN:PROF:AUTO:PUSC:DMRS:CSH?
Notes	Changes to this parameter will not be applied until Update Changes command is sent. See " RB Parameter Manager (Uplink) " on page 2178 section for more details.
Dependencies	Enabled when Detection is Auto and Auto Detect DMRS Params is Off.
Preset	0
State Saved	Saved in instrument state.
Min	0
Max	11
Initial S/W Revision	Prior to A.02.00
Modified at S/W Revision	A.03.00

DMRS Cyclic Shift Couple

Determines whether or not all the PUSCH Slots will use the Common DMRS Cyclic Shift value.

Key Path	Meas Setup, Chan Profile Setup, Edit User Mapping, PUSCH,DMRS Cyclic Shift Couple
Mode	LTE, LTETDD
Remote Command	[:SENSe] :EVM:ULINk:PROFile:USER<n>:PUSCh:DMRS:CSHift:COUPle OFF ON 0 1 [:SENSe] :EVM:ULINk:PROFile:USER<n>:PUSCh:DMRS:CSHift:COUPle?
Example	EVM:ULIN:PROF:USER1:PUSC:DMRS:CSH:COUP ON EVM:ULIN:PROF:USER1:PUSC:DMRS:CSH:COUP?
Notes	Changes to this parameter will not be applied until Update Changes command is sent. See " RB Parameter Manager (Uplink) " on page 2178 section for more details.
Dependencies	The range of sub op code <n> values is determined by the number of Users the user has configured. Max value for n = 50.If the user attempts to remotely set or query a sub op code that is out of range, this will result in an error message. Enabled when Detection is Manual, DMRS Params is Off, and PUSCH Active is ON.
Preset	ON
State Saved	Saved in instrument state.
Initial S/W Revision	Prior to A.02.00
Modified at S/W Revision	A.03.00

Common DMRS Power Boost

Specifies the value to set DMRS power equal to for a slot.

Key Path	Meas Setup, Chan Profile Setup, Edit User Mapping, PUSCH
----------	--

DMRS Power Boost

Sets the DMRS Power Boost value for all the PUSCH Slots when DMRS Power Boost Couple is On and Detection is Manual.

NOTE

All channel and signal powers are relative to the power of the channel/signal chosen for synchronization. For example, when PUSCH DMRS is chosen for synchronization, setting PUSCH DMRS Power = 2 dB and PUSCH Power = 0.1 dB means that the demodulator will expect PUSCH average power level to be 1.9 dB below the average DMRS power level.

Key Path	Meas Setup, Chan Profile Setup, Edit User Mapping, PUSCH,Couple DMRS Power
Mode	LTE, LTETDD
Remote Command	[:SENSe] :EVM:ULINk:PROFile:USER<n>:PUSCh:DMRS:PWRBoost <rel_ampl> [:SENSe] :EVM:ULINk:PROFile:USER<n>:PUSCh:DMRS:PWRBoost?
Example	EVM:ULIN:PROF:USER1:PUSC:DMRS:PWRB 0 EVM:ULIN:PROF:USER1:PUSC:DMRS:PWRB?
Notes	Changes to this parameter will not be applied until Update Changes command is sent. See " RB Parameter Manager (Uplink) " on page 2178 section for more details.
Dependencies	The range of sub op code <n> values is determined by the number of Users the user has configured. Max value for n = 50. If the user attempts to remotely set or query a sub op code that is out of range, this will result in an error message. Enabled when Detection is Manual, DMRS Power Boost Couple is ON, and PUSCH Active is ON.
Preset	0 dB
State Saved	Saved in instrument state.
Min	-100 dB
Max	100 dB
Initial S/W Revision	Prior to A.02.00
Modified at S/W Revision	A.03.00
Modified at S/W Revision	A.04.20

Auto Detect DMRS Power Boost

Sets the DMRS Power Boost value for all the PUSCH Slots when Detection is Auto.

Key Path	Meas Setup, Chan Profile Setup, Edit User Mapping, PUSCH,Couple DMRS Power
Mode	LTE, LTE-TDD
Remote Command	<code>[:SENSe] :EVM:ULINK:PROFile:AUTO:PUSCh:DMRS:PWRBoost <rel_ampl></code> <code>[:SENSe] :EVM:ULINK:PROFile:AUTO:PUSCh:DMRS:PWRBoost?</code>
Example	<code>EVM:ULIN:PROF:AUTO:PUSC:DMRS:PWRB 0</code> <code>EVM:ULIN:PROF:AUTO:PUSC:DMRS:PWRB?</code>
Notes	Changes to this parameter will not be applied until Update Changes command is sent. See " RB Parameter Manager (Uplink) " on page 2178 section for more details.
Dependencies	Enabled when Detection is Auto and Auto Detect PUSCH Active is ON.
Preset	0 dB
State Saved	Saved in instrument state.
Min	-100 dB
Max	100 dB
Initial S/W Revision	Prior to A.02.00
Modified at S/W Revision	A.03.00
Modified at S/W Revision	A.04.20

DMRS Power Boost Couple

Determines whether or not all the PUSCH Slots will use the Common DMRS Power Boost value.

Key Path	Meas Setup, Chan Profile Setup, Edit User Mapping, PUSCH,Couple DMRS Power
Mode	LTE, LTE-TDD
Remote Command	<code>[:SENSe] :EVM:ULINK:PROFile:USER<n>:PUSCh:DMRS:PWRBoost:COUPle OFF ON</code> <code> 0 1</code> <code>[:SENSe] :EVM:ULINK:PROFile:USER<n>:PUSCh:DMRS:PWRBoost:COUPle</code>
Example	<code>EVM:ULIN:PROF:USER1:PUSC:DMRS:PWRB:COUP ON</code> <code>EVM:ULIN:PROF:USER1:PUSC:DMRS:PWRB:COUP?</code>
Notes	Changes to this parameter will not be applied until Update Changes command is sent. See " RB Parameter Manager (Uplink) " on page 2178 section for more details.
Dependencies	The range of sub op code <n> values is determined by the number of Users the user has configured. Max value for n = 50. If the user attempts to remotely set or query a sub op code that is out of range, this will result in an error message. Enabled when Detection is Manual and PUSCH Active is ON.
Preset	ON

State Saved	Saved in instrument state.
Initial S/W Revision	Prior to A.02.00
Modified at S/W Revision	A.03.00

Common CURRENT_TX_NB

Specifies whether or not allocation is mirrored.

Key Path	Meas Setup, Chan Profile Setup, Edit User Mapping, PUSCH
----------	--

Common CURRENT_TX_NB

Selects CURRENT_TX_NB when Detection is Manual.

CUURENT_TX_NB specifies whether or not allocation is mirrored.

Key Path	Meas Setup, Chan Profile Setup, Edit User Mapping
Mode	LTE, LTETDD
Remote Command	[:SENSe] :EVM:ULINK:PROFile:USER1 50:PUSCh:CTNB EVEN ODD [:SENSe] :EVM:ULINK:PROFile:USER1 50:PUSCh:CTNB?
Remote Command	[:SENSe] :EVM:ULINK:PROFile:USER<n> :PUSCh:CTNB EVEN ODD [:SENSe] :EVM:ULINK:PROFile:USER<n> :PUSCh:CTNB?
Example	EVM:ULIN:PROF:USER1:PUSC:CTNB EVEN EVM:ULIN:PROF:USER1:PUSC:CTNB?
Notes	Changes to this parameter will not be applied until Update Changes command is sent. See " RB Parameter Manager (Uplink) " on page 2178 section for more details.
Dependencies	Enabled when Detection is Manual, PUSCH Active is ON, and CURRENT_TX_NB Couple is ON. Disabled when Intra/Inter-SF hopping is selected for Frequency Hopping Mode.
Preset	EVEN
State Saved	Saved in instrument state.
Range	Even Odd
Initial S/W Revision	A.03.00

CURRENT_TX_NB Couple

Determines whether or not all the PUSCH Slots will use the Common CURRENT_TX_NB value.

Key Path	Meas Setup, Chan Profile Setup, Edit User Mapping
Mode	LTE, LTETDD
Remote Command	[:SENSe] :EVM:ULINK:PROFile:USER<n> :PUSCh:CTNB:COUPle OFF ON 0 1

	[:SENSe] :EVM:ULINk:PROFile:USER<n>:PUSCh:CTNB:COUPle?
Example	EVM:ULIN:PROF:USER1:PUSC:CTNB:COUP OFF EVM:ULIN:PROF:USER1:PUSC:CTNB:COUP?
Notes	Changes to this parameter is applied until Update Changes command is sent. See " RB Parameter Manager (Uplink) " on page 2178 section for more details.
Dependencies	Enabled when Detection is Manual and PUSCH Active is ON.
Preset	ON
State Saved	Saved in instrument state.
Initial S/W Revision	A.03.00

PUSCH Slots Parameters

Sets all RB allocation for each slot.

Key Path	Meas Setup, Chan Profile Setup, Edit User Mapping, PUSCH
----------	--

Slot RB Start

Sets the Start Resource Block for the selected PUSCH Slot.

Key Path	Meas Setup, Chan Profile Setup, Edit User Mapping, PUSCH, RB Start
Mode	LTE, LTE-TDD
Remote Command	[:SENSe] :EVM:ULINk:PROFile:USER<n>:PUSCh:SLOT<m>:RB:STARt <integer> [:SENSe] :EVM:ULINk:PROFile:USER<n>:PUSCh:SLOT<m>:RB:STARt?
Example	EVM:ULIN:PROF:USER1:PUSC:SLOT0:RB:STAR 0 EVM:ULIN:PROF:USER1:PUSC:SLOT0:RB:STAR?
Notes	The index <m> in the above SCPI command is the allocation index, not the slot position. See the " Add PUSCH Slot " on page 2087 command for an explanation of the difference. Changes to this parameter will not be applied until Update Changes command is sent. See " RB Parameter Manager (Uplink) " on page 2178 section for more details.
Dependencies	The range of sub op code <n> values is determined by the number of Users the user has configured. The range of sub op code <m> values is determined by the number of Slots the user has configured. . Max value for n=50. The range of sub op code <m> values is 0 – 19. If the user attempts to remotely set or query a sub op code that is out of range, this will result in an error message. Enabled when RB Start Couple is OFF and PUSCH Active is ON.
Couplings	If the user attempts to set a RB Start value greater than the RB End value, both values will be set to the RB Start value or clipped to the min or max value if the entered value is out of range. Max value is dependent on Bandwidth.
Preset	0

State Saved	Saved in instrument state.
Min	0
Max	5 – Bandwidth 1.4 MHz 14 – Bandwidth 3 MHz 24 – Bandwidth 5 MHz 49 – Bandwidth 10 MHz 74 – Bandwidth 15 MHz 99 – Bandwidth 20 MHz
Initial S/W Revision	Prior to A.02.00
Modified at S/W Revision	A.03.00

Slot RB End

Sets the Stop Resource Block for the selected PUSCH Slot.

Key Path	Meas Setup, Chan Profile Setup, Edit User Mapping, PUSCH, RB End
Mode	LTE, LTE-TDD
Remote Command	[:SENSe] :EVM:ULINK:PROFile:USER<n>:PUSCh:SLOT<m>:RB:END <integer> [:SENSe] :EVM:ULINK:PROFile:USER<n>:PUSCh:SLOT<m>:RB:END?
Example	EVM:ULIN:PROF:USER1:PUSC:SLOT0:RB:END 0 EVM:ULIN:PROF:USER1:PUSC:SLOT0:RB:END?
Notes	The index <m> in the above SCPI command is the allocation index, not the slot position. See the "Add PUSCH Slot" on page 2087 command for an explanation of the difference. Changes to this parameter will not be applied until Update Changes command is sent. See "RB Parameter Manager (Uplink)" on page 2178 section for more details.
Dependencies	The range of sub op code <n> values is determined by the number of Users the user has configured. The range of sub op code <m> values is determined by the number of Slots the user has configured. . Max value for n = 50. The range of sub op code <m> values is 0 – 19. If the user attempts to remotely set or query a sub op code that is out of range, this will result in an error message. Enabled when RB End Couple is OFF and PUSCH Active is ON.
Couplings	If the user attempts to set a RB End value less than the RB Start value, both values will be set to the RB End value or clipped to the min or max value if the entered value is out of range. Max value is dependent on Bandwidth.
Preset	0
State Saved	Saved in instrument state.
Min	0
Max	5 – Bandwidth 1.4 MHz 14 – Bandwidth 3 MHz 24 – Bandwidth 5 MHz 49 – Bandwidth 10 MHz

	74 – Bandwidth 15 MHz
	99 – Bandwidth 20 MHz
Initial S/W Revision	Prior to A.02.00
Modified at S/W Revision	A.03.00

Slot Mod Type

Selects the Modulation Type for the selected PUSCH Slot.

Key Path	Meas Setup, Chan Profile Setup, Edit User Mapping, PUSCH, Mod Type
Mode	LTE, LTETDD
Remote Command	[:SENSe] :EVM:ULINK:PROFile:USER<n>:PUSCh:SLOT<m>:MODulation:TYPE QPSK QAM16 QAM64 [:SENSe] :EVM:ULINK:PROFile:USER<n>:PUSCh:SLOT<m>:MODulation:TYPE?
Example	EVM:ULIN:PROF:USER1:PUSC:SLOT0:MOD:TYPE QPSK EVM:ULIN:PROF:USER1:PUSC:SLOT0:MOD:TYPE?
Notes	The index <m> in the above SCPI command is the allocation index, not the slot position. See the "Add PUSCH Slot" on page 2087 command for an explanation of the difference. Changes to this parameter will not be applied until Update Changes command is sent. See "RB Parameter Manager (Uplink)" on page 2178 section for more details.
Dependencies	The range of sub op code <n> values is determined by the number of Users the user has configured. The range of sub op code <m> values is determined by the number of Slots the user has configured. . Max value for n = 50. The range of sub op code <m> values is 0 – 19. If the user attempts to remotely set or query a sub op code that is out of range, this will result in an error message. Enabled when Mod Type Couple is OFF and PUSCH Active is ON.
Preset	QPSK
State Saved	Saved in instrument state.
Range	QPSK 16QAM 64QAM
Initial S/W Revision	Prior to A.02.00
Modified at S/W Revision	A.03.00

64QAM

Selects 64QAM for the Modulation Type of the selected PUSCH Slot.

Key Path	Meas Setup, Chan Profile Setup, Edit User Mapping, PUSCH, Mod Type
Mode	LTE, LTETDD
Initial S/W Revision	Prior to A.02.00
Modified at S/W Revision	A.03.00

Slot Power Boost

Sets the Power Boost value for the selected PUSCH Slot.

Key Path	Meas Setup, Chan Profile Setup, Edit User Mapping, PUSCH, Power Boost
Mode	LTE, LTETDD
Remote Command	[:SENSe] :EVM:ULINK:PROFile:USER<n>:PUSCh:SLOT<m>:PWRBoost <rel_ampl> [:SENSe] :EVM:ULINK:PROFile:USER<n>:PUSCh:SLOT<m>:PWRBoost?
Example	EVM:ULIN:PROF:USER1:PUSC:SLOT0:PWRB 0 EVM:ULIN:PROF:USER1:PUSC:SLOT0:PWRB?
Notes	The index <m> in the above SCPI command is the allocation index, not the slot position. See the "Add PUCCH Slot" on page 2132 command for an explanation of the difference. Changes to this parameter will not be applied until Update Changes command is sent. See "RB Parameter Manager (Uplink)" on page 2178 section for more details.
Dependencies	The range of sub op code <n> values is determined by the number of Users the user has configured. The range of sub op code <m> values is determined by the number of Slots the user has configured. . Max value for n = 50. The range of sub op code <m> values is 0 – 19. If the user attempts to remotely set or query a sub op code that is out of range, this will result in an error message. Enabled when Power Boost Couple is OFF and PUSCH Active is ON.
Preset	0 dB
State Saved	Saved in instrument state.
Min	-100 dB
Max	100 dB
Initial S/W Revision	Prior to A.02.00
Modified at S/W Revision	A.03.00
Modified at S/W Revision	A.04.20

Slot DMRS Group

Specifies the DMRS Group for the selected PUSCH Slot.

Key Path	Meas Setup, Chan Profile Setup, Edit User Mapping, PUSCH,DMRS Group
Mode	LTE, LTETDD
Remote Command	[:SENSe] :EVM:ULINK:PROFile:USER<n>:PUSCh:SLOT<m>:DMRS:GROup <integer> [:SENSe] :EVM:ULINK:PROFile:USER<n>:PUSCh:SLOT<m>:DMRS:GROup?
Example	EVM:ULIN:PROF:USER1:PUSC:SLOT0:DMRS:GRO 1 EVM:ULIN:PROF:USER1:PUSC:SLOT0:DMRS:GRO?
Notes	The index <m> in the above SCPI command is the allocation index, not the slot position. See the "Add PUSCH Slot" on page 2087 command for an explanation of the difference. Changes to this parameter will not be applied until Update Changes command is sent. See "RB Parameter Manager (Uplink)" on page 2178 section for more details.

Dependencies	The range of sub op code <n> values is determined by the number of Users the user has configured. The range of sub op code <m> values is determined by the number of Slots the user has configured. . Max value for n = 50. The range of sub op code <m> values is 0 - 19.If the user attempts to remotely set or query a sub op code that is out of range, this will result in an error message. Enabled when DMRS Params is OFF, DMRS Group Couple is OFF, and PUSCH Active is ON.
Preset	0
State Saved	Saved in instrument state.
Min	0
Max	29
Initial S/W Revision	Prior to A.02.00
Modified at S/W Revision	A.03.00

Slot DMRS Sequence

Specifies the DMRS Sequence (v) for the selected PUSCH. DMRS Sequence or v, is the sequence number within the group and can take on values from 0 to floor(NZCRS/30)-1, where NZCRS is the largest prime number less than MSCRS

Key Path	Meas Setup, Chan Profile Setup, Edit User Mapping, PUSCH,DMRS Seq
Mode	LTE, LTETDD
Remote Command	[:SENSe] :EVM:ULINk:PROFile:USER<n>:PUSCh:SLOT<m>:DMRS:SEQuence <integer> [:SENSe] :EVM:ULINk:PROFile:USER<n>:PUSCh:SLOT<m>:DMRS:SEQuence?
Example	EVM:ULIN:PROF:USER1:PUSC:SLOT0:DMRS:SEQ 1 EVM:ULIN:PROF:USER1:PUSC:SLOT0:DMRS:SEQ?
Notes	The index <m> in the above SCPI command is the allocation index, not the slot position. See the "Add PUSCH Slot" on page 2087 command for an explanation of the difference. Changes to this parameter will not be applied until Update Changes command is sent. See "RB Parameter Manager (Uplink)" on page 2178 section for more details.
Dependencies	The range of sub op code <n> values is determined by the number of Users the user has configured. The range of sub op code <m> values is determined by the number of Slots the user has configured. . Max value for n = 50. The range of sub op code <m> values is 0 - 19. If the user attempts to remotely set or query a sub op code that is out of range, this will result in an error message. Enabled when DMRS Params is OFF, DMRS Sequence Couple is OFF and PUSCH Active is ON.
Preset	0
State Saved	Saved in instrument state.
Min	0
Max	floor(NZCRS/30)-1 (can be restricted based on bandwidth)
Initial S/W Revision	Prior to A.02.00
Modified at S/W Revision	A.03.00

Slot DMRS Cyclic Shift

Specifies the DMRS Cyclic Shift for the selected PUSCH Slot.

Key Path	Meas Setup, Chan Profile Setup, Edit User Mapping, PUSCH,DMRS Cyclic Shift
Mode	LTE, LTETDD
Remote Command	[:SENSe] :EVM:ULINk:PROFile:USER<n>:PUSCh:SLOT<m>:DMRS:CShift <integer> [:SENSe] :EVM:ULINk:PROFile:USER<n>:PUSCh:SLOT<m>:DMRS:CShift?
Example	EVM:ULIN:PROF:USER1:PUSC:SLOT0:DMRS:CSH 1 EVM:ULIN:PROF:USER1:PUSC:SLOT0:DMRS:CSH?
Notes	The index <m> in the above SCPI command is the allocation index, not the slot position. See the "Add PUSCH Slot" on page 2087 command for an explanation of the difference. Changes to this parameter will not be applied until Update Changes command is sent. See "RB Parameter Manager (Uplink)" on page 2178 section for more details.
Dependencies	The range of sub op code <n> values is determined by the number of Users the user has configured. The range of sub op code <m> values is determined by the number of Slots the user has configured. . Max value for n = 50. The range of sub op code <m> values is 0 – 19. If the user attempts to remotely set or query a sub op code that is out of range, this will result in an error message. Enabled when DMRS Params is OFF, DMRS Cyclic Shift Couple is OFF, and PUSCH Active is ON.
Preset	0
State Saved	Saved in instrument state.
Min	0
Max	11
Initial S/W Revision	Prior to A.02.00
Modified at S/W Revision	A.03.00

Slot DMRS Power Boost

Sets the DMRS Power Boost value for the selected PUSCH Slot.

Key Path	Meas Setup, Chan Profile Setup, Edit User Mapping, PUSCH, DMRS Power Boost
Mode	LTE, LTETDD
Remote Command	[:SENSe] :EVM:ULINk:PROFile:USER<n>:PUSCh:SLOT<m>:DMRS:PWRBoost <rel_ ampl> [:SENSe] :EVM:ULINk:PROFile:USER<n>:PUSCh:SLOT<m>:DMRS:PWRBoost?
Example	EVM:ULIN:PROF:USER1:PUSC:SLOT0:DMRS:PWRB 0 EVM:ULIN:PROF:USER1:PUSC:SLOT0:DMRS:PWRB?
Notes	The index <m> in the above SCPI command is the allocation index, not the slot position. See the "Add PUSCH Slot" on page 2087 command for an explanation of the difference. Changes to this parameter will not be applied until Update Changes command is sent. See "RB Parameter Manager (Uplink)" on page 2178 section for more details.
Dependencies	The range of sub op code <n> values is determined by the number of Users the user has configured.

	<p>The range of sub op code <m> values is determined by the number of Slots the user has configured. . Max value for n = 50. The range of sub op code <m> values is 0 - 19.</p> <p>If the user attempts to remotely set or query a sub op code that is out of range, this will result in an error message.</p> <p>Enabled when DMRS Power Boost Couple is OFF and PUSCH Active is ON.</p>
Preset	0 dB
State Saved	Saved in instrument state.
Min	-100 dB
Max	100 dB
Initial S/W Revision	Prior to A.02.00
Modified at S/W Revision	A.03.00
Modified at S/W Revision	A.04.20

Slot CURRENT_TX_NB

Sets the CURRENT_TX_NB for the selected PUSCH Slot.

Key Path	Meas Setup, Chan Profile Setup, Edit User Mapping
Mode	LTE, LTETDD
Remote Command	[:SENSe]:EVM:ULINk:PROFile:USER<n>:PUSCh:SLOT<m>:CTNB OFF ON 0 1 [:SENSe]:EVM:ULINk:PROFile:USER<n>:PUSCh:SLOT<m>:CTNB?
Example	EVM:ULIN:PROF:USER1:PUSC:SLOT0:CTNB OFF EVM:ULIN:PROF:USER1:PUSC:SLOT0:CTNB?
Notes	<p>The range of sub op code <n> values is determined by the number of Users the user has configured. The range of sub op code <m> values is determined by the number of Slots the user has configured. . Max value for n = 50. The range of sub op code <m> values is 0 - 19.</p> <p>Changes to this parameter will not be applied until Update Changes command is sent. See "RB Parameter Manager (Uplink)" on page 2178 section for more details.</p>
Dependencies	<p>Enabled when Detection is Manual, Current TX NB Couple is OFF, and PUSCH Active is ON. Disabled when Intra/Inter-SF hopping is selected for Frequency Hopping Mode.</p>
Preset	EVEN
State Saved	Saved in instrument state.
Range	Even Odd
Initial S/W Revision	A.03.00

Add PUSCH Slot

Adds a new allocation in the slot position specified, if available. The new allocation will have its parameters set to the default values. It is put into a collection of allocations in ascending order of slot position. The SCPI commands that follow are used to set slot allocation parameters, such as RB start and

end. They all contain the mnemonic SLOT<m>, where <m> is an index into the collection of allocations. The index ranges from 0 to a maximum of 19. Do not confuse the allocation index with the slot position.

To avoid confusion, you should make PUSCH allocations in ascending order of slot position.

For example, if you wished to add 4 allocations for User1 at slot positions 2, 4, 7, and 10, use the following commands in order:

```
EVM:ULIN:PROF:USER1:PUSC:ADD:SLOT 2
```

```
EVM:ULIN:PROF:USER1:PUSC:ADD:SLOT 4
```

```
EVM:ULIN:PROF:USER1:PUSC:ADD:SLOT 7
```

```
EVM:ULIN:PROF:USER1:PUSC:ADD:SLOT 10
```

You now have four allocations. Allocation 0 is at slot position 2, allocation 1 at slot position 4, allocation 2 at slot position 7, and allocation 3 at slot position 10. The allocations are referenced as SLOT0, SLOT1, SLOT2, and SLOT3 in the commands that follow. For example, if you want to verify the slot position of the third allocation, send the query:

```
EVM:ULIN:PROF:USER1:PUSC:SLOT2:POS?
```

This will return 7 for the example above.

Note that if you delete an allocation, the indices of the allocations above it reduce by 1. To continue the previous example, if you send the command:

```
EVM:ULIN:PROF:USER1:PUSC:SLOT1:DEL
```

This removes the allocation at slot position 4. The allocations at slot positions 7 and 10 are now referenced as SLOT1 and SLOT2, whereas before they were referenced as SLOT2 and SLOT3.

Key Path	Meas Setup, Chan Profile Setup, Edit User Mapping, PUSCH, Slot
Mode	LTE, LTETDD
Remote Command	[:SENSe] :EVM:ULINK:PROFile:USER<n>:PUSCh:ADD:SLOT <integer>
Example	EVM:ULIN:PROF:USER1:PUSC:ADD:SLOT 0
Notes	The softkey for this parameter is an Immediate Action key. The value that is passed in by the SCPI command enables the user to position the allocation at a particular slot. Changes to this parameter will not be applied until Update Changes command is sent. See " RB Parameter Manager (Uplink) " on page 2178 section for more details.
Dependencies	The range of sub op code <n> values is determined by the number of Users the user has configured. If the user attempts to add a Slot to a User and the slot is already allocated, an error message will be generated. Disabled once the number of Slots reaches to 20, the max number.
Preset	0
State Saved	Saved in instrument state.
Min	0
Max	19
Initial S/W Revision	Prior to A.02.00
Modified at S/W Revision	A.03.00

Delete PUSCH Slot

Deletes the currently selected slot allocation.

Key Path	Meas Setup, Chan Profile Setup, Edit User Mapping, PUSCH, Slot
Mode	LTE, LTETDD
Remote Command	[:SENSe] :EVM:ULINK:PROF:USER<n>:PUSCh:SLOT<m>:DELeTe
Example	EVM:ULIN:PROF:USER1:PUSC:SLOT1:DEL
Notes	The index <m> in the above SCPI command is the allocation index, not the slot position. See the "Add PUSCH Slot" on page 2087 command for an explanation of the difference. Changes to this parameter will not be applied until Update Changes command is sent. See "RB Parameter Manager (Uplink)" on page 2178 section for more details.
Dependencies	Disabled when there is only one Slot. The range of sub op code <n> values is determined by the number of Users the user has configured. The range of sub op code <m> values is determined by the number of Slots the user has configured. . Max value for n=50. The range of sub op code <m> values is 0 - 19. If the user attempts to delete a Slot that does not exist, an error message will be generated.
Initial S/W Revision	Prior to A.02.00
Modified at S/W Revision	A.03.00

Move Up

Moves the currently selected Slot up.

See also ["Slot Position" on page 2090](#) query

Key Path	Meas Setup, Chan Profile Setup, Edit User Mapping, PUSCH, Slot
Mode	LTE, LTETDD
Dependencies	Disabled when there are no Slots defined or if the slot is at Slot19.
Initial S/W Revision	Prior to A.02.00
Modified at S/W Revision	A.03.00

Move Down

Moves the currently selected Slot down .

See also ["Slot Position" on page 2090](#) query

Key Path	Meas Setup, Chan Profile Setup, Edit User Mapping, PUSCH, Slot
Mode	LTE, LTETDD
Dependencies	Disabled when there are no Slots defined or if the slot is at Slot0.
Initial S/W Revision	Prior to A.02.00
Modified at S/W Revision	A.03.00

Slot Position

Queries the PUSCH slot start position.

Key Path	SCPI Only
Mode	LTE, LTETDD
Remote Command	[:SENSe] :EVM:ULINk:PROFile:USER<n>:PUSCh:SLOT<m>:POSition?
Example	EVM:ULIN:PROF:USER1:PUSC:SLOT0:POS?
Notes	The index <m> in the above SCPI command is the allocation index, not the slot position. See the "Add PUSCH Slot" on page 2087 command for an explanation of the difference.
Dependencies	The range of sub op code <n> values is determined by the number of Users the user has configured. The range of sub op code <m> values is determined by the number of Slots the user has configured. Max value for n = 50. The range of sub op code <m> values is 0 - 19.
Preset	0
State Saved	Saved in instrument state.
Min	0
Max	19
Initial S/W Revision	Prior to A.02.00
Modified at S/W Revision	A.03.00

PUCCH Active

Selects whether or not PUCCH exists in the input signal when Detection is Manual.

Key Path	Meas Setup, Chan Profile Setup, Edit User Mapping
Mode	LTE, LTETDD
Remote Command	[:SENSe] :EVM:ULINk:PROFile:USER1 50:PUCCh:ACTive OFF ON 0 1 [:SENSe] :EVM:ULINk:PROFile:USER1 50:PUCCh:ACTive?
Example	EVM:ULIN:PROF:USER1:PUCCh:ACT OFF EVM:ULIN:PROF:USER1:PUCCh:ACT?
Notes	Changes to this parameter will not be applied until Update Changes command is sent. See "RB Parameter Manager (Uplink)" on page 2178 section for more details.
Dependencies	Enabled when Detection is Manual. All soft keys for PUCCH parameter are grayed out when this parameter is OFF.
Preset	OFF
State Saved	Saved in instrument state.
Initial S/W Revision	A.03.00

Auto Detect PUCCH Active

Selects whether or not PUCCH exists in the input signal when Detection is Auto.

Key Path	Meas Setup, Chan Profile Setup, Edit User Mapping
Mode	LTE, LTETDD
Remote Command	[:SENSe] :EVM:ULINk:PROFile:AUTO:PUCCh:ACTive OFF ON 0 1 [:SENSe] :EVM:ULINk:PROFile:AUTO:PUCCh:ACTive?
Example	EVM:ULIN:PROF:AUTO:PUCCh:ACT OFF EVM:ULIN:PROF:AUTO:PUCCh:ACT?
Notes	Changes to this parameter will not be applied until Update Changes command is sent. See " RB Parameter Manager (Uplink) " on page 2178 section for more details.
Dependencies	Enabled when Detection is Auto.
Preset	OFF
State Saved	Saved in instrument state.
Initial S/W Revision	A.03.00

DMRS Params

Determines if all DMRS parameters to be used are common to all Slots or if they are to be defined on a per Slot basis when Detection is Manual.

Enabling this parameter sets PUCCH Per-slot Parameters First RB, Cyclic Shift, OS, and DMRS Group (u) to be automatically calculated given the parameters NRB(2), NCS(1), nPUCCH(1), nPUCCH(2), DshiftPUCCH parameters that are defined in 3GPP TS 36.211.

Key Path	Meas Setup, Chan Profile Setup, Edit User Mapping, PUCCH, DMRS Params
Mode	LTE, LTETDD
Remote Command	[:SENSe] :EVM:ULINk:PROFile:USER<n>:PUCCh:DMRS:PARams OFF ON 0 1 [:SENSe] :EVM:ULINk:PROFile:USER<n>:PUCCh:DMRS:PARams?
Example	EVM:ULIN:PROF:USER1:PUCCh:DMRS:PAR OFF EVM:ULIN:PROF:USER1:PUCCh:DMRS:PAR?
Notes	Changes to this parameter will not be applied until Update Changes command is sent. See " RB Parameter Manager (Uplink) " on page 2178 section for more details.
Dependencies	The range of sub op code <n> values is determined by the number of Users the user has configured. If the user attempts to remotely set or query a sub op code that is out of range, this will result in an error message. When this parameter is on, NRB(2), NCS (1), nPUCCH(1), nPUCCH(2), and PUCCH Shift are enabled and First RB, Cyclic Shift, OS and DMRS Group (u) are disabled. Enabled when Detection is Manual and PUCCH Active is ON.
Preset	ON
State Saved	Saved in instrument state.
Initial S/W Revision	A.03.00

Auto Detect DMRS Params

Determines if all DMRS parameters are common to all Slots for PUCCH or if they are to be defined on a per Slot basis when Detection is Auto.

Key Path	Meas Setup, Chan Profile Setup, Edit User Mapping, PUCCH, DMRS Params
Mode	LTE, LTETDD
Remote Command	[:SENSe] :EVM:ULINk:PROFile:AUTO:PUCCh:DMRS:PARams OFF ON 0 1 [:SENSe] :EVM:ULINk:PROFile:AUTO:PUCCh:DMRS:PARams?
Example	EVM:ULIN:PROF:AUTO:PUCCh:DMRS:PAR OFF EVM:ULIN:PROF:AUTO:PUCCh:DMRS:PAR?
Notes	Changes to this parameter will not be applied until Update Changes command is sent. See " RB Parameter Manager (Uplink) " on page 2178 section for more details.
Dependencies	When this parameter is on, NRB(2), NCS (1), nPUCCH(1), nPUCCH(2), and PUCCH Shift are enabled and First RB, Cyclic Shift, OS and DMRS Group (u) are disabled. Enabled when Detection is AUTO and Auto Detect PUCCH Active is ON.
Preset	ON
State Saved	Saved in instrument state.
Initial S/W Revision	A.03.00

N RB (2)

Sets the NRB(2) for all PUCCH Slots when Detection is Manual.

NRB(2) specifies the number of resource blocks per slot that are available for PUCCH type 2/2a/2b transmissions.

Key Path	Meas Setup, Chan Profile Setup, Edit User Mapping, PUCCH, N RB (2)
Mode	LTE, LTETDD
Remote Command	[:SENSe] :EVM:ULINk:PROFile:USER<n>:PUCCh:NRB:TWO <integer> [:SENSe] :EVM:ULINk:PROFile:USER<n>:PUCCh:NRB:TWO?
Example	EVM:ULIN:PROF:USER1:PUCCh:NRB:TWO 1 EVM:ULIN:PROF:USER1:PUCCh:NRB:TWO?
Notes	Changes to this parameter will not be applied until Update Changes command is sent. See " RB Parameter Manager (Uplink) " on page 2178 section for more details.
Dependencies	The range of sub op code <n> values is determined by the number of Users the user has configured. If the user attempts to remotely set or query a sub op code that is out of range, this will result in an error message. Enabled when Detection is Manual, DMRS Params is On, and PUCCH Active is ON.
Couplings	NRB(2) should always be less than the total RB number of selected Bandwidth Selection.
Preset	0

15 LTE Modulation Analysis Measurement
Meas Setup

State Saved	Saved in instrument state.
Min	0
Max	5 - Bandwidth 1.4 MHz 14 - Bandwidth 3 MHz 24 - Bandwidth 5 MHz 49 - Bandwidth 10 MHz 74 - Bandwidth 15 MHz 99 - Bandwidth 20 MHz
Initial S/W Revision	A.03.00

Auto Detect N RB (2)

Sets the NRB(2) for all PUCCH Slots when Detection is Auto.

Key Path	Meas Setup, Chan Profile Setup, Edit User Mapping, PUCCH, N RB (2)
Mode	LTE, LTETDD
Remote Command	[:SENSe] :EVM:ULINk:PROFile:AUTO:PUCCh:NRB:TWO <integer> [:SENSe] :EVM:ULINk:PROFile:AUTO:PUCCh:NRB:TWO?
Example	EVM:ULIN:PROF:AUTO:PUCCh:NRB:TWO 1 EVM:ULIN:PROF:AUTO:PUCCh:NRB:TWO?
Notes	Changes to this parameter will not be applied until Update Changes command is sent. See " RB Parameter Manager (Uplink) " on page 2178 section for more details.
Dependencies	If the user attempts to remotely set or query a sub op code that is out of range, this will result in an error message. Enabled when Detection is Auto, Auto Detect PUCCH DMRS Params is On, and Auto Detect PUCCH Active is ON.
Couplings	NRB(2) should always be less than the total RB number of selected Bandwidth Selection.
Preset	0
State Saved	Saved in instrument state.
Min	0
Max	5 – Bandwidth 1.4 MHz 14 – Bandwidth 3 MHz 24 – Bandwidth 5 MHz 49 – Bandwidth 10 MHz 74 – Bandwidth 15 MHz 99 – Bandwidth 20 MHz
Initial S/W Revision	A.03.00

N CS (1)

Sets the NCS(1) for all PUCCH Slots when Detection is Manual.

NCS(1) specifies the number of cyclic shifts used for PUCCH formats 1/1a/1b in a resource block with a mix of formats 1/1a/1b and 2/2a/2b.

Key Path	Meas Setup, Chan Profile Setup, Edit User Mapping, PUCCH, N CS (1)
Mode	LTE, LTETDD
Remote Command	[:SENSe] :EVM:ULINk:PROFile:USER<n>:PUCCh:NCS:ONE <integer> [:SENSe] :EVM:ULINk:PROFile:USER<n>:PUCCh:NCS:ONE?
Example	EVM:ULIN:PROF:USER1:PUCCh:NCS:ONE 1 EVM:ULIN:PROF:USER1:PUCCh:NCS:ONE?
Notes	Changes to this parameter will not be applied until Update Changes command is sent. See " RB "

	Parameter Manager (Uplink)" on page 2178 section for more details.
Dependencies	The range of sub op code <n> values is determined by the number of Users the user has configured. If the user attempts to remotely set or query a sub op code that is out of range, this will result in an error message. Enabled when Detection is Manual, DMRS Params is On, and PUCCH Active is ON.
Preset	0
State Saved	Saved in instrument state.
Min	0
Max	7
Initial S/W Revision	A.03.00

Auto Detect N CS (1)

Sets the NCS(1) for all PUCCH Slots when Detection is Auto.

Key Path	Meas Setup, Chan Profile Setup, Edit User Mapping, PUCCH, N CS (1)
Mode	LTE, LTETDD
Remote Command	[:SENSe] :EVM:ULINk:PROFile:AUTO:PUCCh:NCS:ONE <integer> [:SENSe] :EVM:ULINk:PROFile:AUTO:PUCCh:NCS:ONE?
Example	EVM:ULIN:PROF:AUTO:PUCCh:NCS:ONE 1 EVM:ULIN:PROF:AUTO:PUCCh:NCS:ONE?
Notes	Changes to this parameter will not be applied until Update Changes command is sent. See " RB Parameter Manager (Uplink) " on page 2178 section for more details.
Dependencies	If the user attempts to remotely set or query a sub op code that is out of range, this will result in an error message. Enabled when Detection is Auto, Auto Detect PUCCH DMRS Params is On, and Auto Detect PUCCH Active is ON.
Preset	0
State Saved	Saved in instrument state.
Min	0
Max	7
Initial S/W Revision	A.03.00

N PUCCH (2)

Sets the NPUCCH(2) for all PUCCH Slots when Detection is Manual.

Key Path	Meas Setup, Chan Profile Setup, Edit User Mapping, PUCCH, N PUCCH (2)
Mode	LTE, LTETDD
Remote Command	[:SENSe] :EVM:ULINk:PROFile:USER<n>:PUCCh:N:TWO <integer> [:SENSe] :EVM:ULINk:PROFile:USER<n>:PUCCh:N:TWO?
Example	EVM:ULIN:PROF:USER1:PUCCh:N:TWO 1 EVM:ULIN:PROF:USER1:PUCCh:N:TWO?
Notes	Changes to this parameter will not be applied until Update Changes command is sent. See " RB Parameter Manager (Uplink) " on page 2178 section for more details.
Dependencies	The range of sub op code <n> values is determined by the number of Users the user has configured. If the user attempts to remotely set or query a sub op code that is out of range, this will result in an error message. Enabled when Detection is Manual, DMRS Params is On, and PUCCH Active is ON.
Couplings	NPUCCH(2) should always be less than the total available subcarrier number of current bandwidth selection.

15 LTE Modulation Analysis Measurement
Meas Setup

Preset	0
State Saved	Saved in instrument state.
Min	0
Max	$N_{\text{PUCCH}}^{(2)} < N_{\text{RB}}^{(2)} N_{\text{sc}}^{\text{RB}} + \left\lceil \frac{N_{\text{cs}}^{(1)}}{8} \right\rceil \cdot (N_{\text{sc}}^{\text{RB}} - N_{\text{cs}}^{(1)} - 2)$
Initial S/W Revision	A.03.00

Auto Detect N PUCCH (2)

Sets the NPUCCH(2) for all PUCCH Slots when Detection is Auto.

Key Path	Meas Setup, Chan Profile Setup, Edit User Mapping, PUCCH, N PUCCH (2)
Mode	LTE, LTETDD
Remote Command	[:SENSe] :EVM:ULINK:PROFile:AUTO:PUCCh:N:TWO <integer> [:SENSe] :EVM:ULINK:PROFile:AUTO:PUCCh:N:TWO?
Example	EVM:ULIN:PROF:AUTO:PUCCh:N:TWO 1 EVM:ULIN:PROF:AUTO:PUCCh:N:TWO?
Notes	Changes to this parameter will not be applied until Update Changes command is sent. See " RB Parameter Manager (Uplink) " on page 2178 section for more details.
Dependencies	If the user attempts to remotely set or query a sub op code that is out of range, this will result in an error message. Enabled when Detection is Auto, Auto Detect PUCCH DMRS Params is On, and Auto Detect PUCCH Active is ON.
Couplings	NPUCCH(2) should always be less than the total available subcarrier number of current bandwidth selection.
Preset	0
State Saved	Saved in instrument state.
Min	0
Max	$N_{\text{PUCCH}}^{(2)} < N_{\text{RB}}^{(2)} N_{\text{sc}}^{\text{RB}} + \left\lceil \frac{N_{\text{cs}}^{(1)}}{8} \right\rceil \cdot (N_{\text{sc}}^{\text{RB}} - N_{\text{cs}}^{(1)} - 2)$
Initial S/W Revision	A.03.00

PUCCH Shift

Sets the PUCCH Shift for all PUCCH Slots when Detection is Manual.

Key Path	Meas Setup, Chan Profile Setup, Edit User Mapping, PUCCH, PUCCH Shift
Mode	LTE, LTETDD
Remote Command	[:SENSe] :EVM:ULINK:PROFile:USER<n>:PUCCh:SHIFt <integer> [:SENSe] :EVM:ULINK:PROFile:USER<n>:PUCCh:SHIFt?
Example	EVM:ULIN:PROF:USER1:PUCCh:SHIF 1 EVM:ULIN:PROF:USER1:PUCCh:SHIF?
Notes	Changes to this parameter will not be applied until Update Changes command is sent. See " RB Parameter Manager (Uplink) " on page 2178 section for more details.
Dependencies	The range of sub op code <n> values is determined by the number of Users the user has configured. If the user attempts to remotely set or query a sub op code that is out of range, this will result in an

	error message. Enabled when Detection is Manual and PUCCH DMRS Params is On.
Preset	1
State Saved	Saved in instrument state.
Min	1
Max	3
Initial S/W Revision	A.03.00

Auto Detect PUCCH Shift

Sets the PUCCH Shift for all PUCCH Slots when Detection is Auto.

Key Path	Meas Setup, Chan Profile Setup, Edit User Mapping, PUCCH, PUCCH Shift
Mode	LTE, LTETDD
Remote Command	[:SENSe] :EVM:ULINk:PROFile:AUTO:PUCCh:SHIFt <integer> [:SENSe] :EVM:ULINk:PROFile:AUTO:PUCCh:SHIFt?
Example	EVM:ULIN:PROF:AUTO:PUCCh:SHIF 1 EVM:ULIN:PROF:AUTO:PUCCh:SHIF?
Notes	Changes to this parameter will not be applied until Update Changes command is sent. See " RB Parameter Manager (Uplink) " on page 2178 section for more details.
Dependencies	Enabled when Detection is Auto and Auto Detect PUCCH DMRS Params is On.
Preset	1
State Saved	Saved in instrument state.
Min	1
Max	3
Initial S/W Revision	A.03.00

PUCCH Sync Slot

Sets the Sync Slot for all PUCCH Slots when Detection is Manual.

Sync Slot specifies the index of the slot to use for initial synchronization. The demodulator searches for the slot with the characteristics specified in Per-slot Parameters and the slot that matches the Per-slot Parameters with the highest correlation will be assigned the slot number given in the Sync Slot parameter.

When Sync Slot is set to Auto, the demod algorithm may automatically determine the best time slot to synchronise to. This approach simplifies parameter entry and provides easier setup. However, the complexity of the algorithm makes it rather slow and prone to errors in the presence of noise.

Key Path	Meas Setup, Chan Profile Setup, Edit User Mapping
Mode	LTE, LTETDD
Remote Command	[:SENSe] :EVM:ULINk:PROFile:USER<n>:PUCCh:SSLot <integer> [:SENSe] :EVM:ULINk:PROFile:USER<n>:PUCCh:SSLot? [:SENSe] :EVM:ULINk:PROFile:USER<n>:PUCCh:SSLot:AUTO OFF ON 0 1 [:SENSe] :EVM:ULINk:PROFile:USER<n>:PUCCh:SSLot:AUTO?
Example	EVM:ULIN:PROF:USER1:PUCCh:SSL 1 EVM:ULIN:PROF:USER1:PUCCh:SSL? EVM:ULIN:PROF:USER1:PUCCh:SSL:AUTO 1 EVM:ULIN:PROF:USER1:PUCCh:SSL:AUTO?
Notes	Changes to this parameter will not be applied until Update Changes command is sent. See " RB "

	Parameter Manager (Uplink)" on page 2178 section for more details.
Dependencies	The range of sub op code <n> values is determined by the number of Users the user has configured. Max value for n=50. If the user attempts to remotely set or query a sub op code that is out of range, this will result in an error message. PUCCH Sync Slot is enabled when Detection is Manual, PUCCH Active is ON, and PUCCH Sync Slot Auto is OFF. PUCCH Sync Slot Auto is enabled when Detection is Manual and PUCCH Active is ON.
Preset	0 ON
State Saved	Saved in instrument state.
Min	0
Max	19
Initial S/W Revision	Prior to A.02.00
Modified at S/W Revision	A.03.00

Auto Detect PUCCH Sync Slot

Sets the Sync Slot for all PUCCH Slots when Detection is Auto.

Key Path	Meas Setup, Chan Profile Setup, Edit User Mapping
Mode	LTE, LTETDD
Remote Command	[:SENSe] :EVM:ULINK:PROFile:AUTO:PUCCh:SSLot <integer> [:SENSe] :EVM:ULINK:PROFile:AUTO:PUCCh:SSLot? [:SENSe] :EVM:ULINK:PROFile:AUTO:PUCCh:SSLot:AUTO OFF ON 0 1 [:SENSe] :EVM:ULINK:PROFile:AUTO:PUCCh:SSLot:AUTO?
Example	EVM:ULIN:PROF:AUTO:PUCCh:SSL 1 EVM:ULIN:PROF:AUTO:PUCCh:SSL? EVM:ULIN:PROF:AUTO:PUCCh:SSL:AUTO 1 EVM:ULIN:PROF:AUTO:PUCCh:SSL:AUTO?
Notes	Changes to this parameter will not be applied until Update Changes command is sent. See section 3.11.8.5.22 RB Parameter Manager (Uplink) for more details.
Dependencies	Auto Detect PUCCH Sync Slot is enabled when Detection is Auto, Auto Detect PUCCH Active is ON, and Auto Detect PUCCH Sync Slot Auto is OFF. Auto Detect PUCCH Sync Slot Auto is enabled when Detection is Auto and Auto Detect PUCCH Active is ON, and "Auto-detect Format/nPUCCH(1)" on page 2103 is Man.
Preset	0 OFF
State Saved	Saved in instrument state.
Min	0
Max	19
Initial S/W Revision	Prior to A.02.00
Modified at S/W Revision	A.03.00, A.10.00

Auto-detect Format/n_{PUCCH}⁽¹⁾

Enables auto detection of PUCCH Format and nPUCCH(1) for all subframes. This is useful when the format and/or nPUCCH(1) value is different for each subframe. When this parameter is set to Manual, if Detection is Auto, PUCCH parameters are auto detected, but PUCCH Format and nPUCCH(1) are expected to be constant for the entire frame. When this parameter is set to AutoDet, the Auto Detect PUCCH Auto Sync setting will be ignored. When Sync Type is set to PUCCH DMRS, you must define a sync slot by setting the Per-Slot Parameters for the sync slot as well as setting the index using the Sync Slot parameter.

Key Path	Meas Setup, Chan Profile Setup, Edit User Mapping
Mode	LTE, LTETDD
Remote Command	[:SENSe] :EVM:ULINK:PROFile:AUTO:PUCCh:FNPucch:AUTO OFF ON 0 1 [:SENSe] :EVM:ULINK:PROFile:AUTO:PUCCh:FNPucch:AUTO?

Example	EVM:ULIN:PROF:AUTO:PUC: FNP:AUTO 1 EVM:ULIN:PROF:AUTO:PUC: FNP:AUTO?
Notes	Changes to this parameter will not be applied until Update Changes command is sent. See section 3.11.8.5.22 RB Parameter Manager (Uplink) for more details.
Dependencies	Enabled when Detection is Auto and Auto Detect PUCCH Active is ON.
Preset	ON
State Saved	Saved in instrument state.
Range	AutoDet Man
Initial S/W Revision	A.10.00

PUCCH Couple

Selecting the checkbox next to a parameter in the PUCCH Per-slot Parameters area will couple that parameter across all RB allocation.

Key Path	Meas Setup, Chan Profile Setup, Edit User Mapping, PUCCH
-----------------	--

Common First RB

Sets the RB index of the selected user's PUCCH allocation for this slot.

Key Path	Meas Setup, Chan Profile Setup, Edit User Mapping, PUCCH
-----------------	--

First RB

Sets the First Resource Block for all the PUCCH Slots when First RB Couple is On and when Detection is Manual.

This value sets the RB index of the selected user's PUCCH allocation for this slot. The next or previous (see Notes below) slot's PUCCH allocation will automatically be set according to the LTE standard (mirrored in frequency).

For example, in a 5 MHz LTE signal (25 RBs), when Slot 0 contains a PUCCH allocation at RB 0, Slot 1 will be set to have a PUCCH allocation at RB 24.

NOTE

A user can only have one RB allocated to PUCCH per slot.

When Detection is Auto and Sync Slot is odd, this parameter sets the RB index for the second slot in a PUCCH subframe, causing the previous (instead of the next) slot to contain a mirrored PUCCH allocation for the current user.

See also: ["Auto Detect First RB" on page 2106](#)

Key Path	Meas Setup, Chan Profile Setup, Edit User Mapping, PUCCH, First RB
-----------------	--

Mode	LTE, LTETDD
Remote Command	[:SENSe] :EVM:ULINk:PROFile:USER<n>:PUCCh:RB <integer> [:SENSe] :EVM:ULINk:PROFile:USER<n>:PUCCh:RB?
Example	EVM:ULIN:PROF:USER1:PUCCh:RB 0 EVM:ULIN:PROF:USER1:PUCCh:RB?
Notes	Changes to this parameter will not be applied until Update Changes command is sent. See " RB Parameter Manager (Uplink) " on page 2178 section for more details.
Dependencies	The range of sub op code <n> values is determined by the number of Users the user has configured. Max value for n = 50. If the user attempts to remotely set or query a sub op code that is out of range, this will result in an error message. Enabled when Detection is Manual, First RB Couple is ON, DMRS Params is OFF, and PUCCH Active is ON.
Couplings	Max value dependent on Bandwidth.
Preset	0
State Saved	Saved in instrument state.
Min	0
Max	5 – Bandwidth 1.4 MHz 14 – Bandwidth 3 MHz 24 – Bandwidth 5 MHz 49 – Bandwidth 10 MHz 74 – Bandwidth 15 MHz 99 – Bandwidth 20 MHz
Initial S/W Revision	Prior to A.02.00
Modified at S/W Revision	A.03.00

Auto Detect First RB

Sets the First Resource Block for all the PUCCH Slots when Detection is Auto.

Key Path	Meas Setup, Chan Profile Setup, Edit User Mapping, PUCCH, First RB
Mode	LTE, LTETDD
Remote Command	[:SENSe] :EVM:ULINK:PROFile:AUTO:PUCCh:RB <integer> [:SENSe] :EVM:ULINK:PROFile:AUTO:PUCCh:RB?
Example	EVM:ULIN:PROF:AUTO:PUCC:RB 0 EVM:ULIN:PROF:AUTO:PUCC:RB?
Notes	Changes to this parameter will not be applied until Update Changes command is sent. See " RB Parameter Manager (Uplink) " on page 2178 section for more details.
Dependencies	Enabled when Detection is Auto, First RB Couple is ON, Auto Detect DMRS Params is OFF, and Auto Detect PUCCH Active is ON.
Preset	0
State Saved	Saved in instrument state.
Min	0
Max	5 – Bandwidth 1.4 MHz 14 – Bandwidth 3 MHz 24 – Bandwidth 5 MHz 49 – Bandwidth 10 MHz 74 – Bandwidth 15 MHz 99 – Bandwidth 20 MHz
Initial S/W Revision	Prior to A.02.00
Modified at S/W Revision	A.03.00

First RB Couple

Determines whether or not all the PUCCH Slots will use the Common First RB value.

Key Path	Meas Setup, Chan Profile Setup, Edit User Mapping, PUCCH, Couple First RB
Mode	LTE, LTETDD
Remote Command	[:SENSe] :EVM:ULINK:PROFile:USER<n>:PUCCh:RB:COUPle OFF ON 0 1 [:SENSe] :EVM:ULINK:PROFile:USER<n>:PUCCh:RB:COUPle?
Example	EVM:ULIN:PROF:USER1:PUCC:RB:COUP ON EVM:ULIN:PROF:USER1:PUCC:RB:COUP?
Notes	Changes to this parameter will not be applied until Update Changes command is sent. See " RB Parameter Manager (Uplink) " on page 2178 section for more details.
Dependencies	The range of sub op code <n> values is determined by the number of Users the user has configured. Max value for n = 50. If the user attempts to remotely set or query a sub op code that is out of range, this will result in an

	error message. Enabled when Detection is Manual, DMRS Params is OFF, and PUCCH Active is ON.
Preset	ON
State Saved	Saved in instrument state.
Initial S/W Revision	Prior to A.02.00
Modified at S/W Revision	A.03.00

Common Format

Selects the PUCCH Format type for all the PUCCH Slots when Format Couple is On.

Key Path	Meas Setup, Chan Profile Setup, Edit User Mapping, PUCCH, Format
Mode	LTE, LTE-TDD
Remote Command	<code>[:SENSe] :EVM:ULINk:PROFile:USER<n>:PUCCh:FORMat T1 T1A T1B T2 T2A T2B T1S T1AS T1BS</code> <code>[:SENSe] :EVM:ULINk:PROFile:USER<n>:PUCCh:FORMat?</code>
Example	EVM:ULIN:PROF:USER1:PUCC:FORM T1 EVM:ULIN:PROF:USER1:PUCC:FORM?
Notes	Changes to this parameter will not be applied until Update Changes command is sent. See " RB Parameter Manager (Uplink) " on page 2178 section for more details.
Dependencies	The range of sub op code <n> values is determined by the number of Users the user has configured. Max value for n = 50. If the user attempts to remotely set or query a sub op code that is out of range, this will result in an error message. Enabled when Detection is Manual and Format Couple is ON, and PUCCH Active is ON.
Preset	T1
State Saved	Saved in instrument state.
Range	Type 1 Type 1a Type 1b Type 2 Type 2a Type 2b Type 1 Short Type 1a Short Type 1b Short
Initial S/W Revision	Prior to A.02.00
Modified at S/W Revision	A.03.00

Auto Detect Format

Selects the PUCCH Format type for all the PUCCH Slots when Detection is Auto.

Key Path	Meas Setup, Chan Profile Setup, Edit User Mapping, PUCCH, Format
Mode	LTE, LTETDD
Remote Command	[:SENSe] :EVM:ULINK:PROFile:AUTO:PUCCh:FORMat T1 T1A T1B T2 T2A T2B T1S T1AS T1BS [:SENSe] :EVM:ULINK:PROFile:AUTO:PUCCh:FORMat?
Example	EVM:ULIN:PROF:AUTO:PUCC:FORM T1 EVM:ULIN:PROF:AUTO:PUCC:FORM?
Notes	Changes to this parameter will not be applied until Update Changes command is sent. See " RB Parameter Manager (Uplink) " on page 2178 section for more details.
Dependencies	Enabled when Detection is Auto and Auto Detect PUCCH Active is ON.
Preset	T1
State Saved	Saved in instrument state.
Range	Type 1 Type 1a Type 1b Type 2 Type 2a Type 2b Type 1 Short Type 1a Short Type 1b Short
Initial S/W Revision	Prior to A.02.00
Modified at S/W Revision	A.03.00

Type 1

Selects Type 1 for the Format type for all the PUCCH Slots when Format Couple is On.

Key Path	Meas Setup, Chan Profile Setup, Edit User Mapping, PUCCH, Format
Mode	LTE, LTETDD
Initial S/W Revision	Prior to A.02.00
Modified at S/W Revision	A.03.00

Type 1a

Selects Type 1a for the Format type for all the PUCCH Slots when Format Couple is On.

Key Path	Meas Setup, Chan Profile Setup, Edit User Mapping, PUCCH, Format
Mode	LTE, LTETDD
Initial S/W Revision	Prior to A.02.00
Modified at S/W Revision	A.03.00

Type 1b

Selects Type 1b for the Format type for all the PUCCH Slots when Format Couple is On and when Detection is Manual.

Key Path	Meas Setup, Chan Profile Setup, Edit User Mapping, PUCCH, Format
Mode	LTE, LTETDD
Initial S/W Revision	Prior to A.02.00
Modified at S/W Revision	A.03.00

Type 2

Selects Type 2 for the Format type for all the PUCCH Slots when Format Couple is On.

Key Path	Meas Setup, Chan Profile Setup, Edit User Mapping, PUCCH, Format
Mode	LTE, LTETDD
Initial S/W Revision	Prior to A.02.00
Modified at S/W Revision	A.03.00

Type 2a

Selects Type 2a for the Format type for all the PUCCH Slots when Format Couple is On.

Key Path	Meas Setup, Chan Profile Setup, Edit User Mapping, PUCCH, Format
Mode	LTE, LTETDD
Initial S/W Revision	Prior to A.02.00
Modified at S/W Revision	A.03.00

Type 2b

Selects Type 2b for the Format type for all the PUCCH Slots when Format Couple is On.

Key Path	Meas Setup, Chan Profile Setup, Edit User Mapping, PUCCH, Format
Mode	LTE, LTETDD
Initial S/W Revision	Prior to A.02.00
Modified at S/W Revision	A.03.00

Type 1 Short

Selects Type 1 Short for the Format type for all the PUCCH Slots when Format Couple is On.

Key Path	Meas Setup, Chan Profile Setup, Edit User Mapping, PUCCH, Format
Mode	LTETDD
Initial S/W Revision	A.03.00

Type 1a Short

Selects Type 1a Short for the Format type for all the PUCCH Slots when Format Couple is On.

Key Path	Meas Setup, Chan Profile Setup, Edit User Mapping, PUCCH, Format
Mode	LTETDD
Initial S/W Revision	A.03.00

Type 1b Short

Selects Type 1b Short for the Format type for all the PUCCH Slots when Format Couple is On.

Key Path	Meas Setup, Chan Profile Setup, Edit User Mapping, PUCCH, Format
Mode	LTETDD
Initial S/W Revision	A.03.00

Common Format Couple

Determines whether or not all the PUCCH Slots will use the Common Format value.

Key Path	Meas Setup, Chan Profile Setup, Edit User Mapping, PUCCH, Format
Mode	LTE, LTETDD
Remote Command	[:SENSE] :EVM:ULINK:PROFile:USER<n>:PUCCh:FORMat:COUPle OFF ON 0 1 [:SENSE] :EVM:ULINK:PROFile:USER<n>:PUCCh:FORMat:COUPle?
Example	EVM:ULIN:PROF:USER1:PUCc:FORM:COUP ON EVM:ULIN:PROF:USER1:PUCc:FORM:COUP?
Notes	Changes to this parameter will not be applied until Update Changes command is sent. See " RB Parameter Manager (Uplink) " on page 2178 section for more details.
Dependencies	The range of sub op code <n> values is determined by the number of Users the user has configured. Max value for n = 50. If the user attempts to remotely set or query a sub op code that is out of range, this will result in an error message. Enabled when Detection is Manual and PUCCH Active is ON.
Preset	ON
State Saved	Saved in instrument state.
Initial S/W Revision	Prior to A.02.00
Modified at S/W Revision	A.03.00

Common Cyclic Shift

Sets PUCCH cyclic shift.

Key Path	Meas Setup, Chan Profile Setup, Edit User Mapping, PUCCH
----------	--

Common Cyclic Shift

Sets the Cyclic Shift for all the PUCCH Slots when Cyclic Shift Couple is On and Auto Detect is Off.

Key Path	Meas Setup, Chan Profile Setup, Edit User Mapping, PUCCH, Cyclic Shift
Mode	LTE, LTETDD
Remote Command	[:SENSe] :EVM:ULINk:PROFile:USER<n>:PUCCh:CSHift <integer> [:SENSe] :EVM:ULINk:PROFile:USER<n>:PUCCh:CSHift?
Example	EVM:ULIN:PROF:USER1:PUCc:CSH 1 EVM:ULIN:PROF:USER1:PUCc:CSH
Notes	Changes to this parameter will not be applied until Update Changes command is sent. See " RB Parameter Manager (Uplink) " on page 2178 section for more details.
Dependencies	The range of sub op code <n> values is determined by the number of Users the user has configured. Max value for n = 50. If the user attempts to remotely set or query a sub op code that is out of range, this will result in an error message. Enabled when Detection is Manual, Cyclic Shift Couple is ON, DMRS Params is OFF, and PUCCH Active is ON.
Preset	0
State Saved	Saved in instrument state.
Min	0
Max	11
Initial S/W Revision	Prior to A.02.00
Modified at S/W Revision	A.03.00

Auto Detect Cyclic Shift

Sets the Cyclic Shift for all the PUCCH Slots when Detection is Auto.

Key Path	Meas Setup, Chan Profile Setup, Edit User Mapping, PUCCH, Cyclic Shift
Mode	LTE, LTETDD
Remote Command	[:SENSe] :EVM:ULINk:PROFile:AUTO:PUCCh:CSHift <integer> [:SENSe] :EVM:ULINk:PROFile:AUTO:PUCCh:CSHift?
Example	EVM:ULIN:PROF:AUTO:PUCC:CSH 1 EVM:ULIN:PROF:AUTO:PUCC:CSH?
Notes	Changes to this parameter will not be applied until Update Changes command is sent. See " RB Parameter Manager (Uplink) " on page 2178 section for more details. Enabled when Detection is Auto, Auto Detect DMRS Params is OFF and Auto Detect PUCCH Active is ON.
Preset	0
State Saved	Saved in instrument state.
Min	0
Max	11
Initial S/W Revision	Prior to A.02.00
Modified at S/W Revision	A.03.00

Cyclic Shift Couple

Determines whether or not all the PUCCH Slots will use the Common Cyclic Shift value.

Key Path	Meas Setup, Chan Profile Setup, Edit User Mapping, PUCCH, Cyclic Shift
Mode	LTE, LTETDD
Remote Command	[:SENSe] :EVM:ULINk:PROFile:USER<n>:PUCCh:CSHift:COUPle OFF ON 0 1 [:SENSe] :EVM:ULINk:PROFile:USER<n>:PUCCh:CSHift:COUPle?
Example	EVM:ULIN:PROF:USER1:PUCC:CSH:COUP ON EVM:ULIN:PROF:USER1:PUCC:CSH:COUP?
Notes	Changes to this parameter will not be applied until Update Changes command is sent. See " RB Parameter Manager (Uplink) " on page 2178 section for more details.
Dependencies	The range of sub op code <n> values is determined by the number of Users the user has configured. Max value for n = 50. If the user attempts to remotely set or query a sub op code that is out of range, this will result in an error message. Enabled when Detection is Manual, DMRS Params is OFF, and PUCCH Active is ON.
Preset	ON
State Saved	Saved in instrument state.
Initial S/W Revision	Prior to A.02.00
Modified at S/W Revision	A.03.00

Common OS

Sets the Orthogonal Sequence index for all the PUCCH Slots when OS Couple is On and Detection is Auto.

Key Path	Meas Setup, Chan Profile Setup, Edit User Mapping, PUCCH, OS
Mode	LTE, LTETDD
Remote Command	[:SENSe] :EVM:ULINk:PROFile:USER<n>:PUCCh:OS INDeX0 INDeX1 INDeX2 [:SENSe] :EVM:ULINk:PROFile:USER<n>:PUCCh:OS?
Example	EVM:ULIN:PROF:USER1:PUCc:OS INDO EVM:ULIN:PROF:USER1:PUCc:OS?
Notes	Changes to this parameter will not be applied until Update Changes command is sent. See " RB Parameter Manager (Uplink) " on page 2178 section for more details.
Dependencies	The range of sub op code <n> values is determined by the number of Users the user has configured. Max value for n = 50. If the user attempts to remotely set or query a sub op code that is out of range, this will result in an error message. Enabled when all the following conditions are met. Detection is Manual, DMRS Params is OFF, OS Couple is ON, PUCCH Active is ON, and Format is not Type2, Type 2a, Type 2b.
Preset	IND0
State Saved	Saved in instrument state.
Range	Index 0 Index1 Index2
Initial S/W Revision	Prior to A.02.00
Modified at S/W Revision	A.03.00

Auto Detect OS

Sets the Orthogonal Sequence index for all the PUCCH Slots when Detection is Auto.

Key Path	Meas Setup, Chan Profile Setup, Edit User Mapping, PUCCH, OS
Mode	LTE, LTETDD
Remote Command	[:SENSe] :EVM:ULINK:PROFile:AUTO:PUCCh:OS INDeX0 INDeX1 INDeX2 [:SENSe] :EVM:ULINK:PROFile:AUTO:PUCCh:OS?
Example	EVM:ULIN:PROF:AUTO:PUCC:OS INDO EVM:ULIN:PROF:AUTO:PUCC:OS?
Notes	Changes to this parameter will not be applied until Update Changes command is sent. See " RB Parameter Manager (Uplink) " on page 2178 section for more details.
Dependencies	Enabled when all the following conditions are met. Detection is Auto, Auto Detect DMRS Params is OFF, Auto Detect PUCCH Active is ON, and Auto Detect Format is not Type2, Type 2a, Type 2b.
Preset	INDO
State Saved	Saved in instrument state.
Range	Index 0 Index1 Index2
Initial S/W Revision	Prior to A.02.00
Modified at S/W Revision	A.03.00

Index0

Selects Index0 for the OS for all the PUCCH Slots when OS Couple is On.

Key Path	Meas Setup, Chan Profile Setup, Edit User Mapping, PUCCH, OS
Mode	LTE, LTETDD
Initial S/W Revision	Prior to A.02.00
Modified at S/W Revision	A.03.00

Index1

Selects Index1 for the OS for all the PUCCH Slots when OS Couple is On.

Key Path	Meas Setup, Chan Profile Setup, Edit User Mapping, PUCCH, OS
Mode	LTE, LTETDD
Initial S/W Revision	Prior to A.02.00
Modified at S/W Revision	A.03.00

Index2

Selects Index2 for the OS for all the PUCCH Slots when OS Couple is On.

Key Path	Meas Setup, Chan Profile Setup, Edit User Mapping, PUCCH, OS
Mode	LTE, LTETDD
Initial S/W Revision	Prior to A.02.00
Modified at S/W Revision	A.03.00

OS Couple

Determines whether or not all the PUCCH Slots will use the Common OS value.

Key Path	Meas Setup, Chan Profile Setup, Edit User Mapping, PUCCH,OS
Mode	LTE, LTETDD
Remote Command	[:SENSe] :EVM:ULINk:PROFile:USER<n>:PUCCh:OS:COUPle OFF ON 0 1 [:SENSe] :EVM:ULINk:PROFile:USER<n>:PUCCh:OS:COUPle?
Example	EVM:ULIN:PROF:USER1:PUCC:OS:COUP ON EVM:ULIN:PROF:USER1:PUCC:OS:COUP?
Notes	Changes to this parameter will not be applied until Update Changes command is sent. See " RB Parameter Manager (Uplink) " on page 2178 section for more details.
Dependencies	The range of sub op code <n> values is determined by the number of Users the user has configured. Max value for n = 50. If the user attempts to remotely set or query a sub op code that is out of range, this will result in an error message. Enabled when Detection is Manual, DMRS Params is OFF, and PUCCH Active is ON. .
Preset	ON
State Saved	Saved in instrument state.
Initial S/W Revision	Prior to A.02.00
Modified at S/W Revision	A.03.00

Common Power

Sets the PUCCH average power level relative to the 0 dB point set by the PUCCH DMRS Power.

Key Path	Meas Setup, Chan Profile Setup, Edit User Mapping, PUCCH
----------	--

Common Power Boost

Sets the Power Boost value for all the PUCCH Slots when Power Boost Couple is On and Auto Detect is Off.

Power Boost specifies the average PUCCH DMRS power for a slot.

NOTE

All channel and signal powers are relative to the 0 dB level determined by the power of the channel/signal chosen for synchronization.

Key Path	Meas Setup, Chan Profile Setup, Edit User Mapping, PUCCH, Couple Power Boost
Mode	LTE, LTETDD
Remote Command	[:SENSe] :EVM:ULINK:PROFile:USER<n>:PUCCh:PWRBoost <rel_ampl> [:SENSe] :EVM:ULINK:PROFile:USER<n>:PUCCh:PWRBoost?
Example	EVM:ULIN:PROF:USER1:PUCCh:PWRB 0 EVM:ULIN:PROF:USER1:PUCCh:PWRB?
Notes	Changes to this parameter will not be applied until Update Changes command is sent. See " RB Parameter Manager (Uplink) " on page 2178 section for more details.
Dependencies	The range of sub op code <n> values is determined by the number of Users the user has configured. Max value for n = 50. If the user attempts to remotely set or query a sub op code that is out of range, this will result in an error message. Enabled when Power Boost Couple is On, Detection is Manual, and PUCCH Active is ON.
Preset	0 dB
State Saved	Saved in instrument state.
Min	-100 dB
Max	100 dB
Initial S/W Revision	Prior to A.02.00
Modified at S/W Revision	A.03.00, A.04.20

Auto Detect Power Boost

Sets the Power Boost value for all the PUCCH Slots when Detection is Auto.

Key Path	Meas Setup, Chan Profile Setup, Edit User Mapping, PUCCH, Couple Power Boost
Mode	LTE, LTETDD
Remote Command	[:SENSe] :EVM:ULINk:PROFile:AUTO:PUCCh:PWRBoost <rel_amp1> [:SENSe] :EVM:ULINk:PROFile:AUTO:PUCCh:PWRBoost?
Example	EVM:ULIN:PROF:AUTO:PUCCh:PWRB 0 EVM:ULIN:PROF:AUTO:PUCCh:PWRB?
Notes	Changes to this parameter will not be applied until Update Changes command is sent. See " RB Parameter Manager (Uplink) " on page 2178 section for more details.
Dependencies	Enabled when Detection is Auto and Auto Detect PUCCH Active is ON.
Preset	0 dB
State Saved	Saved in instrument state.
Min	-100 dB
Max	100 dB
Initial S/W Revision	Prior to A.02.00
Modified at S/W Revision	A.03.00, A.04.20

Power Boost Couple

Determines whether or not all the PUCCH Slots will use the Common Power Boost value.

Key Path	Meas Setup, Chan Profile Setup, Edit User Mapping, PUCCH, Power Boost
Mode	LTE, LTETDD
Remote Command	[:SENSe] :EVM:ULINk:PROFile:USER<n>:PUCCh:PWRBoost:COUPle OFF ON 0 1 [:SENSe] :EVM:ULINk:PROFile:USER<n>:PUCCh:PWRBoost:COUPle?
Example	EVM:ULIN:PROF:USER1:PUCCh:PWRB:COUP ON EVM:ULIN:PROF:USER1:PUCCh:PWRB:COUP?
Notes	Changes to this parameter will not be applied until Update Changes command is sent. See " RB Parameter Manager (Uplink) " on page 2178 section for more details.
Dependencies	The range of sub op code <n> values is determined by the number of Users the user has configured. Max value for n = 50. If the user attempts to remotely set or query a sub op code that is out of range, this will result in an error message. Enabled when Detection is Manual, and PUCCH Active is ON.
Preset	ON
State Saved	Saved in instrument state.
Initial S/W Revision	Prior to A.02.00
Modified at S/W Revision	A.03.00

Common DMRS Group

Sets the group number for the PUCCH demodulation reference signal (DMRS) when DMRS Group Couple is On and Detection is Manual.

Key Path	Meas Setup, Chan Profile Setup, Edit User Mapping, PUCCH, DMRS Group
Mode	LTE, LTETDD
Remote Command	[:SENSe] :EVM:ULINk:PROFile:USER<n>:PUCCh:DMRS:GROup <integer> [:SENSe] :EVM:ULINk:PROFile:USER<n>:PUCCh:DMRS:GROup?
Example	EVM:ULIN:PROF:USER1:PUCCh:DMRS:GRO 1 EVM:ULIN:PROF:USER1:PUCCh:DMRS:GRO?
Notes	Changes to this parameter will not be applied until Update Changes command is sent. See " RB Parameter Manager (Uplink) " on page 2178 section for more details.
Dependencies	The range of sub op code <n> values is determined by the number of Users the user has configured. Max value for n = 50. If the user attempts to remotely set or query a sub op code that is out of range, this will result in an error message. Enabled when Detection is Manual, DMRS Group Couple is ON, DMRS Params is OFF, and PUCCH Active is ON.
Preset	0
State Saved	Saved in instrument state.
Min	0
Max	29
Initial S/W Revision	Prior to A.02.00
Modified at S/W Revision	A.03.00

Auto Detect DMRS Group

Sets the group number for the PUCCH demodulation reference signal (DMRS) when Detection is Auto.

Key Path	Meas Setup, Chan Profile Setup, Edit User Mapping, PUCCH, DMRS Group
Mode	LTE, LTETDD
Remote Command	[:SENSe] :EVM:ULINk:PROFile:AUTO:PUCCh:DMRS:GROup <integer> [:SENSe] :EVM:ULINk:PROFile:AUTO:PUCCh:DMRS:GROup?
Example	EVM:ULIN:PROF:AUTO:PUCCh:DMRS:GRO 1 EVM:ULIN:PROF:AUTO:PUCCh:DMRS:GRO?
Notes	Changes to this parameter will not be applied until Update Changes command is sent. See " RB Parameter Manager (Uplink) " on page 2178 section for more details.
Dependencies	Enabled when Detection is Auto, Auto Detect DMRS Params is OFF, and Auto Detect PUCCH Active is ON.
Preset	0
State Saved	Saved in instrument state.
Min	0
Max	29
Initial S/W Revision	Prior to A.02.00
Modified at S/W Revision	A.03.00

DMRS Group Couple

Determines whether or not all the PUCCH Slots will use the DMRS Group All value.

Key Path	Meas Setup, Chan Profile Setup, Edit User Mapping, PUCCH,DMRS Group
Mode	LTE, LTETDD
Remote Command	[:SENSe] :EVM:ULINk:PROFile:USER<n>:PUCCh:DMRS:GROup:COUPle OFF ON 0 1 [:SENSe] :EVM:ULINk:PROFile:USER<n>:PUCCh:DMRS:GROup:COUPle?
Example	EVM:ULIN:PROF:USER1:PUCCh:DMRS:GRO:COUP ON EVM:ULIN:PROF:USER1:PUCCh:DMRS:GRO:COUP?
Notes	Changes to this parameter will not be applied until Update Changes command is sent. See " RB Parameter Manager (Uplink) " on page 2178 section for more details.
Dependencies	The range of sub op code <n> values is determined by the number of Users the user has configured. Max value for n = 50. If the user attempts to remotely set or query a sub op code that is out of range, this will result in an error message. Enabled when Detection is Manual, DMRS Params is OFF and PUCCH Active is ON.
Preset	ON
State Saved	Saved in instrument state.

Initial S/W Revision	Prior to A.02.00
Modified at S/W Revision	A.03.00

Common DMRS Power

Sets the power level for the PUCCH demodulation reference signal (DMRS) during the selected subframe.

Key Path	Meas Setup, Chan Profile Setup, Edit User Mapping, PUCCH
----------	--

Common DMRS Power Boost

Sets the DMRS Power Boost value for all the PUCCH Slots when DMRS Power Boost Couple is On and Detection is Manual.

This value sets the power level for the PUCCH demodulation reference signal (DMRS) of the selected subframe. PUCCH Power is set relative to the 0 dB point determined by this parameter.

For example, setting DMRS Power = 2 dB and PUCCH Power = 0.1 dB means that the demodulator will expect PUCCH average power level to be 1.9 dB below the average DMRS power level.

Key Path	Meas Setup, Chan Profile Setup, Edit User Mapping, PUCCH, Couple DMRS Power Boost
Mode	LTE, LTETDD
Remote Command	[:SENSe] :EVM:ULINk:PROFile:USER<n>:PUCCh:DMRS:PWRBoost <rel_ampl> [:SENSe] :EVM:ULINk:PROFile:USER<n>:PUCCh:DMRS:PWRBoost?
Example	EVM:ULIN:PROF:USER1:PUC:PW RB 0 EVM:ULIN:PROF:USER1:PUC:PW RB?
Notes	Changes to this parameter will not be applied until Update Changes command is sent. See " RB Parameter Manager (Uplink) " on page 2178 section for more details.
Dependencies	The range of sub op code <n> values is determined by the number of Users the user has configured. Max value for n = 50. If the user attempts to remotely set or query a sub op code that is out of range, this will result in an error message. Enabled when DMRS Power Boost Couple is On, Detection is Manual, and PUCCH Active is ON.
Preset	0 dB
State Saved	Saved in instrument state.
Min	-100 dB
Max	100 dB
Initial S/W Revision	Prior to A.02.00
Modified at S/W Revision	A.03.00
Modified at S/W Revision	A.04.20

Auto Detect DMRS Power Boost

Sets the DMRS Power Boost value for all the PUCCH Slots when Detection is Auto.

Key Path	Meas Setup, Chan Profile Setup, Edit User Mapping, PUCCH, Couple DMRS Power Boost
Mode	LTE, LTETDD
Remote Command	[:SENSe] :EVM:ULINk:PROFile:AUTO:PUCCh:DMRS:PWRBoost <rel_ampl> [:SENSe] :EVM:ULINk:PROFile:AUTO:PUCCh:DMRS:PWRBoost?
Example	EVM:ULIN:PROF:AUTO:PUCCh:PWRB 0 EVM:ULIN:PROF:AUTO:PUCCh:PWRB?
Notes	Changes to this parameter will not be applied until Update Changes command is sent. See " RB Parameter Manager (Uplink) " on page 2178 section for more details.
Dependencies	Enabled when Detection is Auto and Auto Detect PUCCH Active is ON.
Preset	0 dB
State Saved	Saved in instrument state.
Min	-100 dB
Max	100 dB
Initial S/W Revision	Prior to A.02.00
Modified at S/W Revision	A.03.00, A.04.20

DMRS Power Boost Couple

Determines whether or not all the PUCCH Slots will use the Common DMRS Power Boost value.

Key Path	Meas Setup, Chan Profile Setup, Edit User Mapping, PUCCH, DMRS Power Boost
Mode	LTE, LTETDD
Remote Command	[:SENSe] :EVM:ULINk:PROFile:USER<n>:PUCCh:DMRS:PWRBoost:COUple OFF ON 0 1 [:SENSe] :EVM:ULINk:PROFile:USER<n>:PUCCh:DMRS:PWRBoost:COUple?
Example	EVM:ULIN:PROF:USER1:PUCCh:DMRS:PWRB:COUP ON EVM:ULIN:PROF:USER1:PUCCh:DMRS:PWRB:COUP?
Notes	Changes to this parameter will not be applied until Update Changes command is sent. See " RB Parameter Manager (Uplink) " on page 2178 section for more details.
Dependencies	The range of sub op code <n> values is determined by the number of Users the user has configured. Max value for n = 50. If the user attempts to remotely set or query a sub op code that is out of range, this will result in an error message. Enabled when Detection is Manual and PUCCH Active is ON.
Preset	ON
State Saved	Saved in instrument state.
Initial S/W Revision	Prior to A.02.00
Modified at S/W Revision	A.03.00

Common N PUCCH (1)

Key Path	Meas Setup, Chan Profile Setup, Edit User Mapping, PUCCH
----------	--

Common N PUCCH (1)

Sets the nPUCCH(1) for all PUCCH Slots when Detection is Manual.

Key Path	Meas Setup, Chan Profile Setup, Edit User Mapping, PUCCH, N PUCCH (1)
Mode	LTE, LTETDD
Remote Command	[:SENSe] :EVM:ULINK:PROFile:USER<n>:PUCCh:N:ONE <integer> [:SENSe] :EVM:ULINK:PROFile:USER<n>:PUCCh:N:ONE?
Example	EVM:ULIN:PROF:USER1:PUCCh:N:ONE 1 EVM:ULIN:PROF:USER1:PUCCh:N:ONE?
Notes	Changes to this parameter will not be applied until Update Changes command is sent. See " RB Parameter Manager (Uplink) " on page 2178 section for more details.
Dependencies	The range of sub op code <n> values is determined by the number of Users the user has configured. If the user attempts to remotely set or query a sub op code that is out of range, this will result in an error message. Enabled when Detection is Manual, DMRS Params is On, and PUCCH Active is ON.
Couplings	nPUCCH(1) should always be less than the total available subcarrier number of current bandwidth selection.
Preset	0
State Saved	Saved in instrument state.
Min	0
Max	215 - Bandwidth 1.4 MHz 539 - Bandwidth 3 MHz 899 - Bandwidth 5 MHz 1799 - Bandwidth 10 MHz 2699 - Bandwidth 15 MHz 3599 - Bandwidth 20 MHz
Initial S/W Revision	A.03.00
Modified at S/W Revision	A.06.00, A.13.00

Auto Detect N PUCCH (1)

Sets the nPUCCH(1) for all PUCCH Slots when Detection is Auto.

Key Path	Meas Setup, Chan Profile Setup, Edit User Mapping, PUCCH, N PUCCH (1)
Mode	LTE, LTETDD
Remote Command	[:SENSe] :EVM:ULINk:PROFile:AUTO:PUCCh:N:ONE <integer> [:SENSe] :EVM:ULINk:PROFile:AUTO:PUCCh:N:ONE?
Example	EVM:ULIN:PROF:AUTO:PUCCh:N:ONE 1 EVM:ULIN:PROF:AUTO:PUCCh:N:ONE?
Notes	Changes to this parameter will not be applied until Update Changes command is sent. See " RB Parameter Manager (Uplink) " on page 2178 section for more details.
Dependencies	If the user attempts to remotely set or query a sub op code that is out of range, this will result in an error message. Enabled when Detection is Auto, Auto Detect PUCCH DMRS Params is On, and Auto Detect PUCCH Active is ON.
Couplings	nPUCCH(1) should always be less than the total available subcarrier number of current bandwidth selection.
Preset	0
State Saved	Saved in instrument state.
Min	0
Max	215 – Bandwidth 1.4 MHz 539 – Bandwidth 3 MHz 899 – Bandwidth 5 MHz 1799 – Bandwidth 10 MHz 2699 – Bandwidth 15 MHz 3599 – Bandwidth 20 MHz
Initial S/W Revision	A.03.00
Modified at S/W Revision	A.06.00, A.13.00

N PUCCH (1) Couple

Determines whether or not all the PUCCH Slots will use the Common N PUCCH (1) value.

Key Path	Meas Setup, Chan Profile Setup, Edit User Mapping, PUCCH
Mode	LTE, LTETDD
Remote Command	[:SENSe] :EVM:ULINk:PROFile:USER<n>:PUCCh:N:ONE:COUple OFF ON 0 1 [:SENSe] :EVM:ULINk:PROFile:USER<n>:PUCCh:N:ONE:COUple?
Example	EVM:ULIN:PROF:USER1:PUCC:N:ONE:COUP ON EVM:ULIN:PROF:USER1:PUCC:N:ONE:COUP?
Notes	Changes to this parameter will not be applied until Update Changes command is sent. See RB

	Parameter Manager (Uplink) section for more details.
Dependencies	The range of sub op code <n> values is determined by the number of Users the user has configured. Max value for n = 50. If the user attempts to remotely set or query a sub op code that is out of range, this will result in an error message. Enabled when Detection is Manual, PUCCH Active is ON and PUCCH DMRS Params is ON.
Preset	ON
State Saved	Saved in instrument state.
Initial S/W Revision	A.06.00

PUCCH Slot Parameters

Sets all RB allocation for each slot.

Key Path	Meas Setup, Chan Profile Setup, Edit User Mapping, PUCCH
----------	--

Slot First RB

Sets the First Resource Block for the selected PUCCH slot allocation. Note that you can only set the first RB on even numbered slot allocations. The RB for the paired odd allocations are automatically set according to the constraints set by the LTE standard.

Key Path	Meas Setup, Chan Profile Setup, Edit User Mapping, PUCCH, RB
Mode	LTE, LTETDD
Remote Command	[:SENSe] :EVM:ULINK:PROFile:USER<n>:PUCCh:SLOT<m>:RB <integer> [:SENSe] :EVM:ULINK:PROFile:USER<n>:PUCCh:SLOT<m>:RB?
Example	EVM:ULIN:PROF:USER1:PUCC:SLOT0:RB 0 EVM:ULIN:PROF:USER1:PUCC:SLOT0:RB?
Notes	The index <m> in the above SCPI command is the allocation index, not the slot position. See the "Add PUCCH Slot" on page 2132 command for an explanation of the difference. Changes to this parameter will not be applied until Update Changes command is sent. See "RB Parameter Manager (Uplink)" on page 2178 section for more details.
Dependencies	The range of sub op code <n> values is determined by the number of Users the user has configured. The range of sub op code <m> values is determined by the number of Slots the user has configured. Max value for n= 50. The range of sub op code <m> values is 0 – 19. If the user attempts to set the RB for an odd numbered slot, the command returns an error. However, odd slots may be queried. If the user attempts to remotely set or query a sub op code that is out of range, this will result in an error message. Disabled when the slot is odd indexed. Enabled when First RB Couple is OFF, PUCCH DMRS Params is Off, and PUCCH Active is ON.

Couplings	Max value dependent on Bandwidth.
Preset	0
State Saved	Saved in instrument state.
Min	0
Max	5 – Bandwidth 1.4 MHz 14 – Bandwidth 3 MHz 24 – Bandwidth 5 MHz 49 – Bandwidth 10 MHz 74 – Bandwidth 15 MHz 99 – Bandwidth 20 MHz
Initial S/W Revision	Prior to A.02.00
Modified at S/W Revision	A.03.00

Slot Format

Selects the PUCCH Format type to be used for the selected PUCCH Slot.

Key Path	Meas Setup, Chan Profile Setup, Edit User Mapping, PUCCH, Format
Mode	LTE, LTETDD
Remote Command	[:SENSe] :EVM:ULINk:PROFile:USER<n>:PUCCh:SLOT<m>:FORMat T1 T1A T1B T2 T2A T2B T1S T1AS T1BS [:SENSe] :EVM:ULINk:PROFile:USER<n>:PUCCh:SLOT<m>:FORMat?
Example	EVM:ULIN:PROF:USER1:PUCC:SLOT0:FORMAT T1 EVM:ULIN:PROF:USER1:PUCC:SLOT0:FORMAT?
Notes	The index <m> in the above SCPI command is the allocation index, not the slot position. See the "Add PUCCH Slot" on page 2132 command for an explanation of the difference. Changes to this parameter will not be applied until Update Changes command is sent. See "RB Parameter Manager (Uplink)" on page 2178 section for more details.
Dependencies	The range of sub op code <n> values is determined by the number of Users the user has configured. The range of sub op code <m> values is determined by the number of Slots the user has configured. . Max value for n=50. The range of sub op code <m> values is 0 – 19. If the user attempts to remotely set or query a sub op code that is out of range, this will result in an error message. Enabled when Format Couple is OFF.
Preset	T1
State Saved	Saved in instrument state.
Range	Type 1 Type 1a Type 1b Type 2 Type 2a Type 2b Type 1 Short Type 1a Short Type 1b Short
Initial S/W Revision	Prior to A.02.00
Modified at S/W Revision	A.03.00

Type 1

Selects Type 1 for the Format type for the selected PUCCH Slot.

Key Path	Meas Setup, Chan Profile Setup, Edit User Mapping, PUCCH, Format
Mode	LTE, LTETDD
Initial S/W Revision	Prior to A.02.00
Modified at S/W Revision	A.03.00

Type 1a

Selects Type 1a for the Format type for the selected PUCCH Slot.

Key Path	Meas Setup, Chan Profile Setup, Edit User Mapping, PUCCH, Format
Mode	LTE, LTETDD
Initial S/W Revision	Prior to A.02.00
Modified at S/W Revision	A.03.00

Type 1b

Selects Type 1b for the Format type for the selected PUCCH Slot.

Key Path	Meas Setup, Chan Profile Setup, Edit User Mapping, PUCCH, Format
Mode	LTE, LTETDD
Initial S/W Revision	Prior to A.02.00
Modified at S/W Revision	A.03.00

Type 2

Selects Type 2 for the Format type for the selected PUCCH Slot.

Key Path	Meas Setup, Chan Profile Setup, Edit User Mapping, PUCCH, Format
Mode	LTE, LTETDD
Initial S/W Revision	Prior to A.02.00
Modified at S/W Revision	A.03.00

Type 2a

Selects Type 2a for the Format type for the selected PUCCH Slot.

Key Path	Meas Setup, Chan Profile Setup, Edit User Mapping, PUCCH, Format
Mode	LTE, LTETDD

Initial S/W Revision	Prior to A.02.00
Modified at S/W Revision	A.03.00

Type 2b

Selects Type 2b for the Format type for the selected PUCCH Slot.

Key Path	Meas Setup, Chan Profile Setup, Edit User Mapping, PUCCH, Format
Mode	LTE, LTETDD
Initial S/W Revision	Prior to A.02.00
Modified at S/W Revision	A.03.00

Type 1 Short

Selects Type 1 Short for the Format type for the selected PUCCH Slot.

Key Path	Meas Setup, Chan Profile Setup, Edit User Mapping, PUCCH, Format
Mode	LTE, LTETDD
Initial S/W Revision	A.03.00

Type 1a Short

Selects Type 1a Short for the Format type for the selected PUCCH Slot.

Key Path	Meas Setup, Chan Profile Setup, Edit User Mapping, PUCCH, Format
Mode	LTE, LTETDD
Initial S/W Revision	A.03.00

Type 1b Short

Selects Type 1b Short for the Format type for the selected PUCCH Slot.

Key Path	Meas Setup, Chan Profile Setup, Edit User Mapping, PUCCH, Format
Mode	LTE, LTETDD
Initial S/W Revision	A.03.00

Slot Cyclic Shift

Sets the Cyclic Shift for the selected PUCCH Slot.

Key Path	Meas Setup, Chan Profile Setup, Edit User Mapping, PUCCH, Cyclic Shift
Mode	LTE, LTETDD
Remote Command	[:SENSe] :EVM:ULINK:PROFile:USER<n>:PUCCh:SLOT<m>:CSHift <integer> [:SENSe] :EVM:ULINK:PROFile:USER<n>:PUCCh:SLOT<m>:CSHift?
Example	EVM:ULIN:PROF:USER1:PUCCh:SLOT0:CSH 1 EVM:ULIN:PROF:USER1:PUCCh:SLOT0:CSH?
Notes	The index <m> in the above SCPI command is the allocation index, not the slot position. See the "Add PUCCH Slot" on page 2132 command for an explanation of the difference. Changes to this parameter will not be applied until Update Changes command is sent. See "RB Parameter Manager (Uplink)" on page 2178 section for more details.
Dependencies	The range of sub op code <n> values is determined by the number of Users the user has configured. The range of sub op code <m> values is determined by the number of Slots the user has configured. . Max value for n=50. The range of sub op code <m> values is 0 - 19. If the user attempts to remotely set or query a sub op code that is out of range, this will result in an error message. Enabled when Cyclic Shift Couple is OFF, PUCCh DMRS Params is OFF and PUCCH Active is ON
Preset	0
State Saved	Saved in instrument state.
Min	0
Max	11
Initial S/W Revision	Prior to A.02.00
Modified at S/W Revision	A.03.00

Slot OS

Sets the Orthogonal Sequence index for the selected PUCCH Slot.

Key Path	Meas Setup, Chan Profile Setup, Edit User Mapping, PUCCH, OS
Mode	LTE, LTETDD
Remote Command	[:SENSe] :EVM:ULINK:PROFile:USER<n>:PUCCh:SLOT<m>:OS INDeX0 INDeX1 INDeX2 [:SENSe] :EVM:ULINK:PROFile:USER<n>:PUCCh:SLOT<m>:OS?
Example	EVM:ULIN:PROF:USER1:PUCCh:SLOT0:OS INDO EVM:ULIN:PROF:USER1:PUCCh:SLOT0:OS?
Notes	The index <m> in the above SCPI command is the allocation index, not the slot position. See the "Add PUCCH Slot" on page 2132 command for an explanation of the difference. Changes to this parameter will not be applied until Update Changes command is sent. See "RB Parameter Manager (Uplink)" on page 2178 section for more details.
Dependencies	The range of sub op code <n> values is determined by the number of Users the user has configured. Max value for n=50. The range of sub op code <m> values is 0 - 19. If the user attempts to remotely set or query a sub op code that is out of range, this will result in an

error message.
 Enabled when all the following conditions are met.
 Either Format Couple is ON and Common Format is not Type 2, Type 2a, Type 2b or Format Couple is OFF and Slot Format of the same slot is not Type 2, Type 2a, Type 2b.
 OS Couple is OFF.
 and PUCCH Active is ON

Preset	INDO
State Saved	Saved in instrument state.
Range	Index 0 Index1 Index2
Initial S/W Revision	Prior to A.02.00
Modified at S/W Revision	A.03.00

Index0

Selects Index0 for the OS for the selected PUCCH Slot.

Key Path	Meas Setup, Chan Profile Setup, Edit User Mapping, PUCCH, OS
Mode	LTE, LTETDD
Initial S/W Revision	Prior to A.02.00
Modified at S/W Revision	A.03.00

Index1

Selects Index1 for the OS for the selected PUCCH Slot.

Key Path	Meas Setup, Chan Profile Setup, Edit User Mapping, PUCCH, OS
Mode	LTE, LTETDD
Initial S/W Revision	Prior to A.02.00
Modified at S/W Revision	A.03.00

Index2

Selects Index2 for the OS for the selected PUCCH Slot.

Key Path	Meas Setup, Chan Profile Setup, Edit User Mapping, PUCCH, OS
Mode	LTE, LTETDD
Initial S/W Revision	Prior to A.02.00
Modified at S/W Revision	A.03.00

Slot Power Boost

Sets the Power Boost value for the selected PUCCH Slot.

Key Path	Meas Setup, Chan Profile Setup, Edit User Mapping, PUCCH, Power Boost
Mode	LTE, LTETDD
Remote Command	[:SENSe] :EVM:ULINK:PROFile:USER<n>:PUCCh:SLOT<m>:PWRBoost <rel_ampl> [:SENSe] :EVM:ULINK:PROFile:USER<n>:PUCCh:SLOT<m>:PWRBoost?
Example	EVM:ULIN:PROF:USER1:PUCCh:SLOT0:PWRB 0 EVM:ULIN:PROF:USER1:PUCCh:SLOT0:PWRB?
Notes	The index <m> in the above SCPI command is the allocation index, not the slot position. See the "Add PUCCH Slot" on page 2132 command for an explanation of the difference. Changes to this parameter will not be applied until Update Changes command is sent. See "RB Parameter Manager (Uplink)" on page 2178 section for more details.
Dependencies	The range of sub op code <n> values is determined by the number of Users the user has configured. The range of sub op code <m> values is determined by the number of Slots the user has configured. . Max value for n=50. The range of sub op code <m> values is 0 - 19. If the user attempts to remotely set or query a sub op code that is out of range, this will result in an error message. Enabled when Power Boost Couple is OFF and PUCCH Active is ON.
Preset	0 dB
State Saved	Saved in instrument state.
Min	-100 dB
Max	100 dB
Initial S/W Revision	Prior to A.02.00
Modified at S/W Revision	A.03.00, A.04.20

Slot DMRS Group

Selects the DMRS Group for the selected PUCCH Slot.

Key Path	Meas Setup, Chan Profile Setup, Edit User Mapping, PUSCH,DMRS Group
Mode	LTE, LTETDD
Remote Command	[:SENSe] :EVM:ULINK:PROFile:USER<n>:PUCCh:SLOT<m>:DMRS:GROup <integer> [:SENSe] :EVM:ULINK:PROFile:USER<n>:PUCCh:SLOT<m>:DMRS:GROup?
Example	EVM:ULIN:PROF:USER1:PUCCh:SLOT0:DMRS:GRO 1 EVM:ULIN:PROF:USER1:PUCCh:SLOT0:DMRS:GRO?
Notes	The index <m> in the above SCPI command is the allocation index, not the slot position. See the "Add PUCCH Slot" on page 2132 command for an explanation of the difference. Changes to this parameter will not be applied until Update Changes command is sent. See "RB Parameter Manager (Uplink)" on page 2178 section for more details.
Dependencies	The range of sub op code <n> values is determined by the number of Users the user has configured.

	<p>The range of sub op code <m> values is determined by the number of Slots the user has configured. Max value for n=50. The range of sub op code <m> values is 0 – 19.</p> <p>If the user attempts to remotely set or query a sub op code that is out of range, this will result in an error message.</p> <p>Enabled when DMRS Params is OFF, DMRS Group Couple is OFF and PUCCH Active is ON.</p>
Preset	0
State Saved	Saved in instrument state.
Min	0
Max	29
Initial S/W Revision	Prior to A.02.00
Modified at S/W Revision	A.03.00

Slot DMRS Power Boost

Sets the DMRS Power Boost value for the selected PUCCH Slot.

Key Path	Meas Setup, Chan Profile Setup, Edit User Mapping, PUCCH, DMRS Power Boost
Mode	LTE, LTE-TDD
Remote Command	<pre>[:SENSe] :EVM:ULINk:PROFile:USER<n>:PUCCh:SLOT<m>:DMRS:PWRBoost <rel_ ampl></pre> <pre>[:SENSe] :EVM:ULINk:PROFile:USER<n>:PUCCh:SLOT<m>:DMRS:PWRBoost?</pre>
Example	<pre>EVM:ULIN:PROF:USER1:PUCCh:SLOT0:DMRS:PWRB 0</pre> <pre>EVM:ULIN:PROF:USER1:PUCCh:SLOT0:DMRS:PWRB?</pre>
Notes	<p>The index <m> in the above SCPI command is the allocation index, not the slot position. See the "Add PUCCH Slot" on page 2132 command for an explanation of the difference.</p> <p>Changes to this parameter will not be applied until Update Changes command is sent. See "RB Parameter Manager (Uplink)" on page 2178 section for more details.</p>
Dependencies	<p>The range of sub op code <n> values is determined by the number of Users the user has configured. The range of sub op code <m> values is determined by the number of Slots the user has configured. . Max value for n=50. The range of sub op code <m> values is 0 – 19.</p> <p>If the user attempts to remotely set or query a sub op code that is out of range, this will result in an error message.</p> <p>Enabled when Power Boost Couple is OFF and PUCCH Active is ON.</p>
Preset	0 dB
State Saved	Saved in instrument state.
Min	-100 dB
Max	100 dB
Initial S/W Revision	Prior to A.02.00
Modified at S/W Revision	A.03.00, A.04.20

Slot N PUCCH (1)

Sets the N PUCCH (1) value for the selected PUCCH Slot.

Key Path	Meas Setup, Chan Profile Setup, Edit User Mapping, PUCCH
Mode	LTE, LTETDD
Remote Command	[:SENSe] :EVM:ULINk:PROFile:USER<n>:PUCCh:SLOT<m>:N:ONE <integer> [:SENSe] :EVM:ULINk:PROFile:USER<n>:PUCCh:SLOT<m>:N:ONE?
Example	EVM:ULIN:PROF:USER1:PUCCh:SLOT1:N:ONE 1 EVM:ULIN:PROF:USER1:PUCCh:SLOT1:N:ONE?
Notes	Changes to this parameter will not be applied until Update Changes command is sent. See RB Parameter Manager (Uplink) section for more details.
Dependencies	The range of sub op code <n> values is determined by the number of Users the user has configured. The range of sub op code <m> values is determined by the number of Slots the user has configured. . Max value for n=50. The range of sub op code <m> values is 0 - 19. If the user attempts to remotely set or query a sub op code that is out of range, this will result in an error message. Enabled when Detection is Manual, PUCCH Active is ON, PUCCH DMRS Params is ON and N PUCCH (1) Couple is OFF.
Couplings	nPUCCH(1) should be less than the total available subcarrier number of the current bandwidth selection.
Preset	0
State Saved	Saved in instrument state.
Min	0
Max	1199
Initial S/W Revision	A.06.00

Add PUCCH Slot

Adds a new PUCCH allocation pair. One of the allocations will be in the slot position specified, if available. The other will be in the slot immediately following if the parameter is even, or the slot immediately preceding if the parameter is odd. The new allocations will have their parameters set to default values. They are put into a collection of allocations in ascending order of slot position. The allocation at the even numbered slot gets the lower index. The SCPI commands that follow are used to set slot allocation parameters, such as RB. They all contain the mnemonic SLOT<m>, where <m> is an index into the collection of allocations. The index ranges from 0 to a maximum of 19. Do not confuse the allocation index with the slot position.

To avoid confusion, you should make PUCCH allocations in ascending order of even slot positions.

For example, suppose you sent the following commands in order (and no previous allocations were made):

```
EVM:ULIN:PROF:USER1:PUCCh:ADD:SLOT 0
```

```
EVM:ULIN:PROF:USER1:PUCCh:ADD:SLOT 8
```

```
EVM:ULIN:PROF:USER1:PUCCh:ADD:SLOT 10
```

You now have six allocations. Allocation 0 is at slot position 0, allocation 1 is made automatically at slot position 1, allocations 2 and 3 are at slot positions 8 and 9, and allocations 4 and 5 at slot positions 10 and 11. The allocations are referenced as SLOT0, SLOT1, SLOT2, etc. in the commands that follow. For example, if you want to verify the slot position of the third allocation, send the following query:

```
EVM:ULIN:PROF:USER1:PUCCH:SLOT2:POS?
```

This will return 8 for this example, and the following query will return "9"s:

```
EVM:ULIN:PROF:USER1:PUCCH:SLOT3:POS?
```

Note that if you delete an allocation, its paired companion is deleted also. It is recommended that you only delete even indices. To continue the previous example, send the following command:

```
EVM:ULIN:PROF:USER1:PUCCH:SLOT2:DEL
```

This removes the allocations at slot positions 8 and 9. The allocations at slot positions 10 and 11 are now referenced as SLOT2 and SLOT3, where before they were referenced as SLOT4 and SLOT5.

Key Path	Meas Setup, Chan Profile Setup, Edit User Mapping, PUCCH, Slot
Mode	LTE, LTETDD
Remote Command	[:SENSe] :EVM:ULInk:PROFile:USER<n>:PUCCh:ADD:SLOT<integer>
Example	EVM:ULIN:PROF:USER1:PUCCH:ADD:SLOT 0
Notes	The softkey for this parameter is an Immediate Action key. The value that is passed in by the SCPI command enables you to specify the slot position. As PUCCH has subframes, adding a slot will add the slot specified, if available, and the second slot in the subframe.
Notes	Changes to this parameter will not be applied until Update Changes command is sent. See " RB Parameter Manager (Uplink) " on page 2178 section for more details.
Dependencies	The range of sub op code <n> values is determined by the number of Users the user has configured. If the user attempts to add a Slot to a User and the slot is already allocated an error message will be generated. Disabled once the number of Slots reaches to 20 (max).
Preset	0
State Saved	Saved in instrument state.
Min	0
Max	19
Initial S/W Revision	Prior to A.02.00
Modified at S/W Revision	A.03.00

Delete PUCCH Slot

Deletes the currently selected slot allocation and its paired slot allocation.

Key Path	Meas Setup, Chan Profile Setup, Edit User Mapping, PUCCH, Slot
Mode	LTE, LTETDD

Remote Command	[:SENSe] :EVM:ULINK:PROFile:USER<n>:PUCCh:SLOT<m>:DELeTe
Example	EVM:ULIN:PROF:USER1:PUCC:SLOT0:DEL
Notes	The index <m> in the above SCPI command is the allocation index, not the slot position. See the "Add PUCCH Slot" on page 2132 command for an explanation of the difference. Changes to this parameter will not be applied until Update Changes command is sent. See "RB Parameter Manager (Uplink)" on page 2178 section for more details.
Dependencies	Disabled when there is only one Slot. The range of sub op code <n> values is determined by the number of Users the user has configured. The range of sub op code <m> values is determined by the number of Slots the user has configured. . Max value for n=50. The range of sub op code <m> values is 0 - 19. If the user attempts to delete a Slot that does not exist, an error message will be generated.
Initial S/W Revision	Prior to A.02.00
Modified at S/W Revision	A.03.00

Move Up

Moves the currently selected Slot up.

See also ["Slot Position " on page 2134](#) query

Key Path	Meas Setup, Chan Profile Setup, Edit User Mapping, PUCCH, Slot
Mode	LTE, LTETDD
Dependencies	Disabled when there are no Slots defined or if the slot is at Slot19.
Initial S/W Revision	Prior to A.02.00
Modified at S/W Revision	A.03.00

Move Down

Moves the currently selected Slot down.

See also ["Slot Position " on page 2134](#) query.

Key Path	Meas Setup, Chan Profile Setup, Edit User Mapping, PUCCH, Slot
Mode	LTE, LTETDD
Dependencies	Disabled when there are no Slots defined or if the slot is at Slot0.
Initial S/W Revision	Prior to A.02.00
Modified at S/W Revision	A.03.00

Slot Position

Queries the PUCCH slot start position.

Key Path	SCPI Only
Mode	LTE, LTETDD
Remote Command	[:SENSe] :EVM:ULINk:PROFile:USER<n>:PUCCh:SLOT<m>:POSition?
Example	EVM:ULIN:PROF:USER1:PUCc:SLOT0:POS?
Dependencies	The range of sub op code <n> values is determined by the number of Users the user has configured. The range of sub op code <m> values is determined by the number of Slots the user has configured. . Max value for n=50. The range of sub op code <m> values is 0 – 19.
Preset	0
State Saved	Saved in instrument state.
Min	0
Max	19
Initial S/W Revision	Prior to A.02.00
Modified at S/W Revision	A.03.00

PRACH Active

Selects whether or not PRACH exists in the input signal when Detection is Manual.

Key Path	Meas Setup, Chan Profile Setup, Edit User Mapping
Mode	LTE, LTETDD
Remote Command	[:SENSe] :EVM:ULINk:PROFile:USER1 50:PRACH:ACTive OFF ON 0 1 [:SENSe] :EVM:ULINk:PROFile:USER1 50:PRACH:ACTive?
Example	EVM:ULIN:PROF:USER1:PRAC:ACT OFF EVM:ULIN:PROF:USER1:PRAC:ACT?
Notes	Changes to this parameter will not be applied until Update Changes command is sent. See " RB Parameter Manager (Uplink) " on page 2178 section for more details.
Dependencies	Enabled when Detection is Manual. When this parameter is set to OFF, all of soft keys for PRACH parameter are grayed out.
Preset	OFF
State Saved	Saved in instrument state.
Initial S/W Revision	A.03.00

Auto Detect PRACH Active

Selects whether or not PRACH exists in the input signal when Detection is Auto.

Key Path	Meas Setup, Chan Profile Setup, Edit User Mapping
Mode	LTE, LTETDD
Remote Command	[:SENSe] :EVM:ULINK:PROFile:AUTO:PRACH:ACTive OFF ON 0 1 [:SENSe] :EVM:ULINK:PROFile:AUTO:PRACH:ACTive?
Example	EVM:ULIN:PROF:AUTO:PRAC:ACT OFF EVM:ULIN:PROF:AUTO:PRAC:ACT?
Notes	Changes to this parameter will not be applied until Update Changes command is sent. See " RB Parameter Manager (Uplink) " on page 2178 section for more details.
Dependencies	Enabled when Detection is Auto.
Preset	OFF
State Saved	Saved in instrument state.
Initial S/W Revision	A.03.00

Resource Block Offset (n_{PRB}^{RA})

Sets the number of Resource Block that PRACH is offset from 0 in the frequency domain (n_{RAPRB}) when Detection is Manual. (3GPP TS 36.211 V8.5.0 5.7)

For PRACH preamble formats 0–3, this parameter is used to calculate the start location in frequency for the PRACH preamble. This parameter does not affect the start location of format 4 preamble.

Key Path	Meas Setup, Chan Profile Setup, Edit User Mapping, PRACH Setup
Mode	LTE, LTETDD
Remote Command	[:SENSe] :EVM:ULINK:PROFile:USER<n>:PRACH:NRAPrb <integer> [:SENSe] :EVM:ULINK:PROFile:USER<n>:PRACH:NRAPrb?
Example	EVM:ULIN:PROF:USER1:PRACH:NRAP 1 EVM:ULIN:PROF:USER1:PRACH:NRAP?
Notes	Changes to this parameter will not be applied until Update Changes command is sent. See " RB Parameter Manager (Uplink) " on page 2178 section for more details.
Dependencies	The range of sub op code <n> values is determined by the number of Users the user has configured. If the user attempts to remotely set or query a sub op code that is out of range, this will result in an error message. The maximum value is [number of resource blocks in a slot] – 6. Enabled when Detection is Manual and PRACH Active is ON.
Preset	0
State Saved	Saved in instrument state.
Min	0
Max	94 - The maximum value is [number of resource blocks in a slot] – 6.

[number of resource blocks in a slot] is determined by Bandwidth setting.

- 0 - Bandwidth 1.4 MHz
- 9 - Bandwidth 3 MHz
- 19 - Bandwidth 5 MHz
- 44 - Bandwidth 10 MHz
- 69 - Bandwidth 15 MHz
- 94 - Bandwidth 20 MHz

Initial S/W Revision A.03.00

Auto Detect Resource Block Offset (n_{PRB}^{RA})

Sets the number of Resource Block that PRACH is offset from 0 in the frequency domain (n_{PRB}) when Detection is Auto. (3GPP TS 36.211 V8.5.0 5.7)

Key Path	Meas Setup, Chan Profile Setup, Edit User Mapping, PRACH Setup
Mode	LTE, LTETDD
Remote Command	[:SENSe] :EVM:ULINK:PROFile:AUTO:PRACH:NRAPrb <integer> [:SENSe] :EVM:ULINK:PROFile:AUTO:PRACH:NRAPrb?
Example	EVM:ULIN:PROF:AUTO:PRACH:NRAP 1 EVM:ULIN:PROF:AUTO:PRACH:NRAP?
Notes	Changes to this parameter will not be applied until Update Changes command is sent. See " RB Parameter Manager (Uplink) " on page 2178 section for more details.
Dependencies	Enabled when Detection is Auto and Auto Detect PRACH Active is ON.
Preset	0
State Saved	Saved in instrument state.
Min	0
Max	94 - The maximum value is [number of resource blocks in a slot] - 6. [number of resource blocks in a slot] is determined by Bandwidth setting. 0 - Bandwidth 1.4 MHz 9 - Bandwidth 3 MHz 19 - Bandwidth 5 MHz 44 - Bandwidth 10 MHz 69 - Bandwidth 15 MHz 94 - Bandwidth 20 MHz
Initial S/W Revision	A.03.00

Configuration Index

Sets PRACH Configuration Index to give frame structure when Detection is Manual. (3GPP TS 36.211 V8.5.0 5.7)

This parameter determines the PRACH preamble format and the locations where PRACH can be transmitted in the frame.

This information is given in table 5.7.1–2 for frame type 1 FDD signals and in table 5.7.1–3 for frame type 2 TDD signals in 3GPP TS 36.211.

Key Path	Meas Setup, Chan Profile Setup, Edit User Mapping, PRACH Setup
Mode	LTE, LTETDD
Remote Command	[:SENSe] :EVM:ULINK:PROFile:USER<n>:PRACH:CINDEX <integer> [:SENSe] :EVM:ULINK:PROFile:USER<n>:PRACH:CINDEX?
Example	EVM:ULIN:PROF:USER1:PRACH:CIND 1

	EVM:ULIN:PROF:USER1:PRACH:CIND?
Notes	Changes to this parameter will not be applied until Update Changes command is sent. See " RB Parameter Manager (Uplink) " on page 2178 section for more details.
Dependencies	The range of sub op code <n> values is determined by the number of Users the user has configured. If the user attempts to remotely set or query a sub op code that is out of range, this will result in an error message. Enabled when Detection is Manual and PRACH Active is ON.
Preset	0
State Saved	Saved in instrument state.
Min	0
Max	LTE: 63 LTETDD: 57
Initial S/W Revision	A.03.00

Auto Detect Configuration Index

Sets the PRACH Configuration Index to give frame structure when Detection is Auto. (3GPP TS 36.211 V8.5.0 5.7)

Key Path	Meas Setup, Chan Profile Setup, Edit User Mapping, PRACH Setup
Mode	LTE, LTETDD
Remote Command	[:SENSe] :EVM:ULINk:PROFile:AUTO:PRACH:CINDeX <integer> [:SENSe] :EVM:ULINk:PROFile:AUTO:PRACH:CINDeX?
Example	EVM:ULIN:PROF:AUTO:PRACH:CIND 1 EVM:ULIN:PROF:AUTO:PRACH:CIND?
Notes	Changes to this parameter will not be applied until Update Changes command is sent. See " RB Parameter Manager (Uplink) " on page 2178 section for more details.
Dependencies	Enabled when Detection is Auto and Auto Detect PRACH Active is ON.
Preset	0
State Saved	Saved in instrument state.
Min	0
Max	LTE: 63 LTETDD: 57
Initial S/W Revision	A.03.00

Logical Root Seq Index

Sets the Logical Root Seq Index to give root Zadoff-Chu sequence order when Detection is Manual. (3GPP TS 36.211 V8.5.0 5.7)

For preamble formats 0–3, there are 838 total logical indexes. For preamble format 4, there are 138 logical indexes.

The mapping between logical and physical Zadoff-Chu indexes is given in Table 5.7.2–4 for preamble formats 0–3 and in Table 5.7.2–5 for preamble format 4 in TS 36.211.

Key Path	Meas Setup, Chan Profile Setup, Edit User Mapping, PRACH Setup
Mode	LTE, LTETDD
Remote Command	[:SENSe] :EVM:ULINk:PROFile:USER<n>:PRACH:LRSindex <integer> [:SENSe] :EVM:ULINk:PROFile:USER<n>:PRACH:LRSindex?
Example	EVM:ULIN:PROF:USER1:PRACH:LRS 1 EVM:ULIN:PROF:USER1:PRACH:LRS?
Notes	Changes to this parameter will not be applied until Update Changes command is sent. See " RB Parameter Manager (Uplink) " on page 2178 section for more details.
Dependencies	The range of sub op code <n> values is determined by the number of Users the user has configured. If the user attempts to remotely set or query a sub op code that is out of range, this will result in an error message.

	Enabled when Detection is Manual and PRACH Active is ON.
Preset	0
State Saved	Saved in instrument state.
Min	0
Max	837
Initial S/W Revision	A.03.00

Auto Detect Logical Root Seq Index

Sets Logical Root Seq Index to give root Zadoff-Chu sequence order when Detection is Auto. (3GPP TS 36.211 V8.5.0 5.7)

Key Path	Meas Setup, Chan Profile Setup, Edit User Mapping, PRACH Setup
Mode	LTE, LTETDD
Remote Command	[:SENSe] :EVM:ULINk:PROFile:AUTO:PRACH:LRSindex <integer> [:SENSe] :EVM:ULINk:PROFile:AUTO:PRACH:LRSindex?
Example	EVM:ULIN:PROF:AUTO:PRACH:LRS 1 EVM:ULIN:PROF:AUTO:PRACH:LRS?
Notes	Changes to this parameter will not be applied until Update Changes command is sent. See " RB Parameter Manager (Uplink) " on page 2178 section for more details.
Dependencies	Enabled when Detection is Auto and Auto Detect PRACH Active is ON.
Preset	0
State Saved	Saved in instrument state.
Min	0
Max	837
Initial S/W Revision	A.03.00

Cyclic Shift Set

Sets Cyclic Shift Set to give NCS (Number of Cyclic Shifts) for PRACH preamble sequence generation when Detection is Manual. Value of NCS will be determined by this selection and value of NCS Configuration. (3GPP TS 36.211 V8.5.0 Table 5.7.2-2)

Key Path	Meas Setup, Chan Profile Setup, Edit User Mapping, PRACH Setup
Mode	LTE, LTETDD
Remote Command	[:SENSe] :EVM:ULINk:PROFile:USER<n>:PRACH:CSSet UNRestricted RESTRicted [:SENSe] :EVM:ULINk:PROFile:USER<n>:PRACH:CSSet?
Example	EVM:ULIN:PROF:USER1:PRAC:CSS UNR EVM:ULIN:PROF:USER1:PRAC:CSS?
Notes	Changes to this parameter will not be applied until Update Changes command is sent. See " RB Parameter Manager (Uplink) " on page 2178 section for more details.
Dependencies	The range of sub op code <n> values is determined by the number of Users the user has configured. Enabled when Detection is Manual and PRACH Active is ON.
Preset	UNRestricted
State Saved	Saved in instrument state.
Range	Unrestricted Restricted
Initial S/W Revision	A.03.00

Auto Detect Cyclic Shift Set

Sets Cyclic Shift Set to give NCS (Number of Cyclic Shifts) for PRACH preamble sequence generation when Detection is Auto. Value of NCS will be determined by this selection and value of NCS Configuration. (3GPP TS 36.211 V8.5.0 Table 5.7.2–3)

Key Path	Meas Setup, Chan Profile Setup, Edit User Mapping, PRACH Setup
Mode	LTE, LTETDD
Remote Command	[:SENSe] :EVM:ULINK:PROFile:AUTO:PRACH:CSSet UNRestricted REStRicted [:SENSe] :EVM:ULINK:PROFile:AUTO:PRACH:CSSet?
Example	EVM:ULIN:PROF:AUTO:PRAC:CSS UNR EVM:ULIN:PROF:AUTO:PRAC:CSS?
Notes	Changes to this parameter will not be applied until Update Changes command is sent. See " RB Parameter Manager (Uplink) " on page 2178 section for more details.
Dependencies	Enabled when Detection is Auto and Auto Detect PRACH Active is ON.
Preset	UNRestricted
State Saved	Saved in instrument state.
Range	Unrestricted Restricted
Initial S/W Revision	A.03.00

N_{CS} Configuration

Sets the Cyclic Shift Configuration Number to give NCS (Number of Cyclic Shifts) PRACH preamble sequence generation when Detection is Manual. Value of NCS will be determined by this value and selection of Cyclic Shift Set. (3GPP TS 36.211 V8.5.0 Table 5.7.2–2,3)

Key Path	Meas Setup, Chan Profile Setup, Edit User Mapping, PRACH Setup
Mode	LTE, LTETDD
Remote Command	[:SENSe] :EVM:ULINK:PROFile:USER<n>:PRACH:NCSConfig <integer> [:SENSe] :EVM:ULINK:PROFile:USER<n>:PRACH:NCSConfig?
Example	EVM:ULIN:PROF:USER1:PRACH:NCSC 1 EVM:ULIN:PROF:USER1:PRACH:NCSC?
Notes	Changes to this parameter will not be applied until Update Changes command is sent. See " RB Parameter Manager (Uplink) " on page 2178 section for more details.
Dependencies	The range of sub op code <n> values is determined by the number of Users the user has configured. If the user attempts to remotely set or query a sub op code that is out of range, this will result in an error message. Enabled when Detection is Manual and PRACH Active is ON.
Preset	0
State Saved	Saved in instrument state.
Min	0

Max	15
Initial S/W Revision	A.03.00

Auto Detect N_{CS} Configuration

Sets the Cyclic Shift Configuration Number to give NCS (Number of Cyclic Shifts) PRACH preamble sequence generation when Detection is Auto. Value of NCS will be determined by this value and selection of Cyclic Shift Set. (3GPP TS 36.211 V8.5.0 Table 5.7.2–3)

Key Path	Meas Setup, Chan Profile Setup, Edit User Mapping, PRACH Setup
Mode	LTE, LTETDD
Remote Command	[:SENSe] :EVM:ULINK:PROFile:AUTO:PRACH:NCSConfig <integer> [:SENSe] :EVM:ULINK:PROFile:AUTO:PRACH:NCSConfig?
Example	EVM:ULIN:PROF:AUTO:PRAC:NCSC 1 EVM:ULIN:PROF:AUTO:PRAC:NCSC?
Notes	Changes to this parameter will not be applied until Update Changes command is sent. See " RB Parameter Manager (Uplink) " on page 2178 section for more details.
Dependencies	Enabled when Detection is Auto and Auto Detect PRACH Active is ON.
Preset	0
State Saved	Saved in instrument state.
Min	0
Max	15
Initial S/W Revision	A.03.00

Preamble Index

Sets the Preamble Index when Detection is Manual. Preamble sequence generation is presented on 3GPP TS 36.211 V8.5.0 – 5.7.2.

Key Path	Meas Setup, Chan Profile Setup, Edit User Mapping, PRACH Setup
Mode	LTE, LTETDD
Remote Command	[:SENSe] :EVM:ULINK:PROFile:USER<n>:PRACH:PINDEX <integer> [:SENSe] :EVM:ULINK:PROFile:USER<n>:PRACH:PINDEX?
Example	EVM:ULIN:PROF:USER1:PRACH:PIND 1 EVM:ULIN:PROF:USER1:PRACH:PIND?
Notes	Changes to this parameter will not be applied until Update Changes command is sent. See " RB Parameter Manager (Uplink) " on page 2178 section for more details.
Dependencies	The range of sub op code <n> values is determined by the number of Users the user has configured. If the user attempts to remotely set or query a sub op code that is out of range, this will result in an error message. Enabled when Detection is Manual and PRACH Active is ON.
Preset	0
State Saved	Saved in instrument state.

Min	0
Max	63
Initial S/W Revision	A.03.00

Auto Detect Preamble Index

Sets the Preamble Index when Detection is Auto. Preamble sequence generation is presented on 3GPP TS 36.211 V8.5.0 – 5.7.2.

Key Path	Meas Setup, Chan Profile Setup, Edit User Mapping, PRACH Setup
Mode	LTE, LTETDD
Remote Command	[:SENSe] :EVM:ULINk:PROFile:AUTO:PRACH:PINDeX <integer> [:SENSe] :EVM:ULINk:PROFile:AUTO:PRACH:PINDeX?
Example	EVM:ULIN:PROF:AUTO:PRAC:PIND 1 EVM:ULIN:PROF:AUTO:PRAC:PIND?
Notes	Changes to this parameter will not be applied until Update Changes command is sent. See " RB Parameter Manager (Uplink) " on page 2178 section for more details.
Dependencies	Enabled when Detection is Auto and Auto Detect PRACH Active is ON.
Preset	0
State Saved	Saved in instrument state.
Min	0
Max	63
Initial S/W Revision	A.03.00

PRACH Power Boost

Sets the PRACH Power Boost value when Detection is Manual.

This parameter specifies the average power of PRACH subcarriers.

Key Path	Meas Setup, Chan Profile Setup, Edit User Mapping, PRACH Setup
Mode	LTE, LTETDD
Remote Command	[:SENSe] :EVM:ULINk:PROFile:USER<n>:PRACH:PWRBoost <rel_ampl> [:SENSe] :EVM:ULINk:PROFile:USER<n>:PRACH:PWRBoost?
Example	EVM:ULIN:PROF:USER1:PRAC:PWRB 1 EVM:ULIN:PROF:USER1:PRAC:PWRB?
Notes	Changes to this parameter will not be applied until Update Changes command is sent. See " RB Parameter Manager (Uplink) " on page 2178 section for more details.
Dependencies	The range of sub op code <n> values is determined by the number of Users the user has configured. If the user attempts to remotely set or query a sub op code that is out of range, this will result in an error message. Enabled when Detection is Manual and PRACH Active is ON.
Preset	0
State Saved	Saved in instrument state.
Min	-100

Max	100
Initial S/W Revision	A.03.00
Modified at S/W Revision	A.04.20

Auto Detect PRACH Power Boost

Sets the PRACH Power Boost value when Detection is Auto.

Key Path	Meas Setup, Chan Profile Setup, Edit User Mapping, PRACH Setup
Mode	LTE, LTETDD
Remote Command	[:SENSe] :EVM:ULINK:PROFile:AUTO:PRACH:PWRBoost <rel_ampl> [:SENSe] :EVM:ULINK:PROFile:AUTO:PRACH:PWRBoost?
Example	EVM:ULIN:PROF:AUTO:PRACH:PWRB 1 EVM:ULIN:PROF:AUTO:PRACH:PWRB?
Notes	Changes to this parameter will not be applied until Update Changes command is sent. See " RB Parameter Manager (Uplink) " on page 2178 section for more details.
Dependencies	Enabled when Detection is Auto and Auto Detect PRACH Active is ON.
Preset	0
State Saved	Saved in instrument state.
Min	-100
Max	100
Initial S/W Revision	A.03.00
Modified at S/W Revision	A.04.20

Sync Resource

Sets the index value for random access resource, which is used as a synchronization reference when Detection is Manual. Random access preamble mapping is presented on 3GPP TS 36.211 V8.5.0 5.7 Table 5.7.1–4.

Key Path	Meas Setup, Chan Profile Setup, Edit User Mapping, PRACH Setup
Mode	LTETDD
Remote Command	[:SENSe] :EVM:ULINK:PROFile:USER<n>:PRACH:SRESouce <integer> [:SENSe] :EVM:ULINK:PROFile:USER<n>:PRACH:SRESouce?
Example	EVM:ULIN:PROF:USER1:PRAC:SRES 0 EVM:ULIN:PROF:USER1:PRAC:SRES?
Notes	Max value of this parameter depends on Configuration Index and UL/DL Configuration. Disabled when the combination of Configuration Index and UL/DL Configuration results in the N/A in 3GPP TS 36.211 V8.5.0 5.7 Table5.7.1–4.
Notes	Changes to this parameter will not be applied until Update Changes command is sent. See " RB Parameter Manager (Uplink) " on page 2178 section for more details.
Dependencies	The range of sub op code <n> values is determined by the number of Users the user has configured. If the user attempts to remotely set or query a sub op code that is out of range, this will result in an error message. Enabled when the mode is LTE TDD, Detection is Manual, and PRACH Active is ON.

Preset	0
State Saved	Saved in instrument state.
Min	0
Max	5
Initial S/W Revision	A.03.00

Auto Detect Sync Resource

Sets the index value for random access resource, which is used as synchronization reference when Detection is Auto. Random access preamble mapping is presented on 3GPP TS 36.211 V8.5.0 5.7 Table 5.7.1–4.

Key Path	Meas Setup, Chan Profile Setup, Edit User Mapping, PRACH Setup
Mode	LTETDD
Remote Command	[:SENSe] :EVM:ULINK:PROFile:AUTO:PRACH:SRESorce <integer> [:SENSe] :EVM:ULINK:PROFile:AUTO:PRACH:SRESorce?
Example	EVM:ULIN:PROF:AUTO:PRACH:SRES 0 EVM:ULIN:PROF:AUTO:PRACH:SRES?
Notes	Max value of this parameter depends on Configuration Index and UL/DL Configuration. This parameter is disabled when the combination of Configuration Index and UL/DL Configuration results in the N/A in 3GPP TS 36.211 V8.5.0 5.7 Table5.7.1–4. Changes to this parameter will not be applied until Update Changes command is sent. See " RB Parameter Manager (Uplink) " on page 2178 section for more details.
Dependencies	Enabled when the mode is LTE TDD, Detection is Auto and Auto Detect PRACH Active is ON.
Preset	0
State Saved	Saved in instrument state.
Min	0
Max	5
Initial S/W Revision	A.03.00

S-RS Active

Selects whether or not S-RS exists in the input signal when Detection is Manual.

Key Path	Meas Setup, Chan Profile Setup, Edit User Mapping
Mode	LTE, LTETDD
Remote Command	[:SENSe] :EVM:ULINK:PROFile:USER1 50:SRS:ACTive OFF ON 0 1 [:SENSe] :EVM:ULINK:PROFile:USER1 50:SRS:ACTive?
Example	EVM:ULIN:PROF:USER1:SRS:ACT OFF EVM:ULIN:PROF:USER1:SRS:ACT?
Notes	Changes to this parameter will not be applied until Update Changes command is sent. See " RB Parameter Manager (Uplink) " on page 2178 section for more details.
Dependencies	Enabled when Detection is Manual. When this parameter is set to OFF, all of soft keys for S-RS parameter are grayed out.
Preset	OFF
State Saved	Saved in instrument state.
Initial S/W Revision	A.03.00

Auto Detect S-RS Active

Selects whether or not S-RS exists in the input signal when Detection is Auto.

Key Path	Meas Setup, Chan Profile Setup, Edit User Mapping
Mode	LTE, LTETDD
Remote Command	[:SENSe] :EVM:ULINK:PROFile:AUTO:SRS:ACTive OFF ON 0 1 [:SENSe] :EVM:ULINK:PROFile:AUTO:SRS:ACTive?
Example	EVM:ULIN:PROF:AUTO:SRS:ACT OFF EVM:ULIN:PROF:AUTO:SRS:ACT?
Notes	Changes to this parameter will not be applied until Update Changes command is sent. See " RB Parameter Manager (Uplink) " on page 2178 section for more details.
Dependencies	Enabled when Detection is Auto.
Preset	OFF
State Saved	Saved in instrument state.
Initial S/W Revision	A.03.00

Cyclic Shift (n_{SRS}^{CS})

Sets S-RS Cyclic Shift when Detection is Manual. This value determines the cyclic shift of R-RS.

Key Path	Meas Setup, Chan Profile Setup, Edit User Mapping, SRS Setup
Mode	LTE, LTETDD
Remote Command	[:SENSe] :EVM:ULINK:PROFile:USER<n>:SRS:CSHift <integer> [:SENSe] :EVM:ULINK:PROFile:USER<n>:SRS:CSHift?
Example	EVM:ULIN:PROF:USER1:SRS:CSH 1 EVM:ULIN:PROF:USER1:SRS:CSH?
Notes	Changes to this parameter will not be applied until Update Changes command is sent. See " RB Parameter Manager (Uplink) " on page 2178 section for more details.
Dependencies	The range of sub op code <n> values is determined by the number of Users the user has configured. If the user attempts to remotely set or query a sub op code that is out of range, this will result in an error message. Enabled when Detection is Manual and S-RS Active is ON.
Preset	0
State Saved	Saved in instrument state.
Min	0
Max	7
Initial S/W Revision	A.03.00

Auto Detect Cyclic Shift

Sets S-RS Cyclic Shift when Detection is Auto.

Key Path	Meas Setup, Chan Profile Setup, Edit User Mapping, SRS Setup
Mode	LTE, LTE-TDD
Remote Command	[:SENSe] :EVM:ULINK:PROFile:AUTO:SRS:CSHift <integer> [:SENSe] :EVM:ULINK:PROFile:AUTO:SRS:CSHift?
Example	EVM:ULIN:PROF:AUTO:SRS:CSH 1 EVM:ULIN:PROF:AUTO:SRS:CSH?
Notes	Changes to this parameter will not be applied until Update Changes command is sent. See " RB Parameter Manager (Uplink) " on page 2178 section for more details.
Dependencies	Enabled when Detection is Auto and Auto Detect S-RS Active is ON
Preset	0
State Saved	Saved in instrument state.
Min	0
Max	7
Initial S/W Revision	A.03.00

Bandwidth Configuration (C_{SRS})

Sets S-RS Bandwidth Configuration (CSRS) when Detection is Manual.

This parameter, along with BSRS, determines the values of mSRS,b and Nb from tables 5.5.3.2-1 through 5.5.3.2-4 in TS 36.211.

Key Path	Meas Setup, Chan Profile Setup, Edit User Mapping, SRS Setup
Mode	LTE, LTE-TDD
Remote Command	[:SENSe] :EVM:ULINK:PROFile:USER<n>:SRS:BCONfig <integer> [:SENSe] :EVM:ULINK:PROFile:USER<n>:SRS:BCONfig?
Example	EVM:ULIN:PROF:USER1:SRS:BCON 1 EVM:ULIN:PROF:USER1:SRS:BCON?
Notes	Changes to this parameter will not be applied until Update Changes command is sent. See " RB Parameter Manager (Uplink) " on page 2178 section for more details.
Dependencies	The range of sub op code <n> values is determined by the number of Users the user has configured. If the user attempts to remotely set or query a sub op code that is out of range, this will result in an error message. Enabled when Detection is Manual and S-RS Active is ON.
Preset	7
State Saved	Saved in instrument state.
Min	0

15 LTE Modulation Analysis Measurement
Meas Setup

Max	7
Initial S/W Revision	A.03.00

Auto Detect Bandwidth Configuration (C_{SRS})

Sets S-RS Bandwidth Configuration (CSRS) when Detection is Auto.

Key Path	Meas Setup, Chan Profile Setup, Edit User Mapping, SRS Setup
Mode	LTE, LTETDD
Remote Command	[:SENSe] :EVM:ULINk:PROFile:AUTO:SRS:BConfig <integer> [:SENSe] :EVM:ULINk:PROFile:AUTO:SRS:BConfig?
Example	EVM:ULIN:PROF:AUTO:SRS:BCON 1 EVM:ULIN:PROF:AUTO:SRS:BCON?
Notes	Changes to this parameter will not be applied until Update Changes command is sent. See " RB Parameter Manager (Uplink) " on page 2178 section for more details.
Dependencies	Enabled when Detection is Auto and Auto Detect S-RS Active is ON
Preset	7
State Saved	Saved in instrument state.
Min	0
Max	7
Initial S/W Revision	A.03.00

Bandwidth (B_{SRS})

Sets S-RS Bandwidth (BSRS) when Detection is Manual. This parameter, along with CSRS, determines the values of mSRS,b and Nb from tables 5.5.3.2-1 through 5.5.3.2-4 in TS 36.211.

Key Path	Meas Setup, Chan Profile Setup, Edit User Mapping, SRS Setup
Mode	LTE, LTETDD
Remote Command	[:SENSe] :EVM:ULINk:PROFile:USER<n>:SRS:BWIDth <integer> [:SENSe] :EVM:ULINk:PROFile:USER<n>:SRS:BWIDth?
Example	EVM:ULIN:PROF:USER1:SRS:BWID 1 EVM:ULIN:PROF:USER1:SRS:BWID?
Notes	Changes to this parameter will not be applied until Update Changes command is sent. See " RB Parameter Manager (Uplink) " on page 2178 section for more details.
Dependencies	The range of sub op code <n> values is determined by the number of Users the user has configured. If the user attempts to remotely set or query a sub op code that is out of range, this will result in an error message. Enabled when Detection is Manual, and S-RS Active is ON.
Preset	0
State Saved	Saved in instrument state.
Min	0
Max	3
Initial S/W Revision	A.03.00

Auto Detect Bandwidth (B_{SRS})

Sets S-RS Bandwidth (BSRS) when Detection is Auto.

Key Path	Meas Setup, Chan Profile Setup, Edit User Mapping, SRS Setup
Mode	LTE, LTE-TDD
Remote Command	[:SENSe] :EVM:ULINK:PROFile:AUTO:SRS:BWIDth <integer> [:SENSe] :EVM:ULINK:PROFile:AUTO:SRS:BWIDth?
Example	EVM:ULIN:PROF:AUTO:SRS:BWID 1 EVM:ULIN:PROF:AUTO:SRS:BWID?
Notes	Changes to this parameter will not be applied until Update Changes command is sent. See " RB Parameter Manager (Uplink) " on page 2178 section for more details.
Dependencies	Enabled when Detection is Auto and Auto Detect S-RS Active is ON
Preset	0
State Saved	Saved in instrument state.
Min	0
Max	3
Initial S/W Revision	A.03.00

Transmission Comb (k_{TC})

Sets Transmission Comb (kTC) of S-RS when Detection is Manual.

This parameter influences the starting frequency location of S-RS.

Key Path	Meas Setup, Chan Profile Setup, Edit User Mapping, SRS Setup
Mode	LTE, LTE-TDD
Remote Command	[:SENSe] :EVM:ULINK:PROFile:USER<n>:SRS:TCoMb <integer> [:SENSe] :EVM:ULINK:PROFile:USER<n>:SRS:TCoMb?
Example	EVM:ULIN:PROF:USER1:SRS:TCoM 1 EVM:ULIN:PROF:USER1:SRS:TCoM?
Notes	Changes to this parameter will not be applied until Update Changes command is sent. See " RB Parameter Manager (Uplink) " on page 2178 section for more details.
Dependencies	The range of sub op code <n> values is determined by the number of Users the user has configured. If the user attempts to remotely set or query a sub op code that is out of range, this will result in an error message. Enabled when Detection is Manual and S-RS Active is ON.
Preset	0
State Saved	Saved in instrument state.
Min	0
Max	1
Initial S/W Revision	A.03.00

Auto Detect Transmission Comb (k_{TC})

Sets Transmission Comb (kTC) of S-RS when Detection is Auto.

Key Path	Meas Setup, Chan Profile Setup, Edit User Mapping, SRS Setup
Mode	LTE, LTETDD
Remote Command	[:SENSE] :EVM:ULINK:PROF:FILE:AUTO:SRS:TCOMB <integer> [:SENSE] :EVM:ULINK:PROF:FILE:AUTO:SRS:TCOMB?
Example	EVM:ULIN:PROF:AUTO:SRS:TCOM 1 EVM:ULIN:PROF:AUTO:SRS:TCOM?
Notes	Changes to this parameter will not be applied until Update Changes command is sent. See " RB Parameter Manager (Uplink) " on page 2178 section for more details.
Dependencies	Enabled when Detection is Auto and Auto Detect S-RS Active is ON.
Preset	0
State Saved	Saved in instrument state.
Min	0
Max	1
Initial S/W Revision	A.03.00

Hopping Bandwidth (b_{hop})

Sets S-RS Hopping Bandwidth (bhop) when Detection is Manual.

Key Path	Meas Setup, Chan Profile Setup, Edit User Mapping, SRS Setup
Mode	LTE, LTETDD
Remote Command	[:SENSE] :EVM:ULINK:PROF:FILE:USER<n>:SRS:HBWidth <integer> [:SENSE] :EVM:ULINK:PROF:FILE:USER<n>:SRS:HBWidth?
Example	EVM:ULIN:PROF:USER1:SRS:HBW 1 EVM:ULIN:PROF:USER1:SRS:HBW?
Notes	Changes to this parameter will not be applied until Update Changes command is sent. See " RB Parameter Manager (Uplink) " on page 2178 section for more details.
Dependencies	The range of sub op code <n> values is determined by the number of Users the user has configured. If the user attempts to remotely set or query a sub op code that is out of range, this will result in an error message. Enabled when Detection is Manual and S-RS Active is ON
Preset	3
State Saved	Saved in instrument state.
Min	0
Max	3
Initial S/W Revision	A.03.00
Modified at S/W Revision	A.06.00

Auto Detect Hopping Bandwidth (b_{hop})

Sets S-RS Hopping Bandwidth (bhop) when Detection is Auto.

Key Path	Meas Setup, Chan Profile Setup, Edit User Mapping, SRS Setup
Mode	LTE, LTETDD
Remote Command	[:SENSe] :EVM:ULINk:PROFile:AUTO:SRS:HBWidth <integer> [:SENSe] :EVM:ULINk:PROFile:AUTO:SRS:HBWidth?
Example	EVM:ULIN:PROF:AUTO:SRS:HBW 1 EVM:ULIN:PROF:AUTO:SRS:HBW?
Notes	Changes to this parameter will not be applied until Update Changes command is sent. See " RB Parameter Manager (Uplink) " on page 2178 section for more details.
Dependencies	Enabled when Detection is Auto and Auto Detect S-RS Active is ON
Preset	3
State Saved	Saved in instrument state.
Min	0
Max	3
Initial S/W Revision	A.03.00
Modified at S/W Revision	A.06.00

Frequency Domain Position (n_{RRC})

Sets the S-RS Frequency Domain Position (nRRC) when Detection is Manual.

Key Path	Meas Setup, Chan Profile Setup, Edit User Mapping, SRS Setup
Mode	LTE, LTETDD
Remote Command	[:SENSe] :EVM:ULINk:PROFile:USER<n>:SRS:FDPosition <integer> [:SENSe] :EVM:ULINk:PROFile:USER<n>:SRS:FDPosition?
Example	EVM:ULIN:PROF:USER1:SRS:FDP 1 EVM:ULIN:PROF:USER1:SRS:FDP?
Notes	Changes to this parameter will not be applied until Update Changes command is sent. See " RB Parameter Manager (Uplink) " on page 2178 section for more details.
Dependencies	The range of sub op code <n> values is determined by the number of Users the user has configured. If the user attempts to remotely set or query a sub op code that is out of range, this will result in an error message. Enabled when Detection is Manual and S-RS Active is ON.
Preset	0
State Saved	Saved in instrument state.
Min	0
Max	23

Initial S/W Revision	A.03.00
Modified at S/W Revision	A.06.00

Auto Detect Frequency Domain Position (n_{RRC})

Sets the S-RS Frequency Domain Position (n_{RRC}) when Detection is Auto.

Key Path	Meas Setup, Chan Profile Setup, Edit User Mapping, SRS Setup
Mode	LTE, LTETDD
Remote Command	[:SENSe] :EVM:ULINK:PROFile:AUTO:SRS:FDPosition <integer> [:SENSe] :EVM:ULINK:PROFile:AUTO:SRS:FDPosition?
Example	EVM:ULIN:PROF:AUTO:SRS:FDP 1 EVM:ULIN:PROF:AUTO:SRS:FDP?
Notes	Changes to this parameter will not be applied until Update Changes command is sent. See "RB Parameter Manager (Uplink)" on page 2178 section for more details.
Dependencies	Enabled when Detection is Auto and Auto Detect S-RS Active is ON
Preset	0
State Saved	Saved in instrument state.
Min	0
Max	23
Initial S/W Revision	A.03.00
Modified at S/W Revision	A.06.00

Subframe Configuration

Sets the value for srsSubframeConfiguration in Table 5.5.3.3–1 (FDD) or Table 5.5.3.3–2 (TDD) in TS 36.211 when Detection is Manual.

srsSubframeConfiguration determines TSFC and DSFC.

Key Path	Meas Setup, Chan Profile Setup, Edit User Mapping, SRS Setup
Mode	LTE, LTETDD
Remote Command	[:SENSe] :EVM:ULINK:PROFile:USER<n>:SRS:SFConfig <integer> [:SENSe] :EVM:ULINK:PROFile:USER<n>:SRS:SFConfig?
Example	EVM:ULIN:PROF:USER1:SRS:SFC 1 EVM:ULIN:PROF:USER1:SRS:SFC?
Notes	Changes to this parameter will not be applied until Update Changes command is sent. See "RB Parameter Manager (Uplink)" on page 2178 section for more details.
Dependencies	The range of sub op code <n> values is determined by the number of Users the user has configured. If the user attempts to remotely set or query a sub op code that is out of range, this will result in an error message. Enabled when Detection is Manual and S-RS Active is ON.
Preset	0
State Saved	Saved in instrument state.

15 LTE Modulation Analysis Measurement
Meas Setup

Min	0
Max	15
Initial S/W Revision	A.03.00

Auto Detect Subframe Configuration

Sets the value for srsSubframeConfiguration in Table 5.5.3.3–1 (FDD) or Table 5.5.3.3–2 (TDD) in TS 36.211 when Detection is Auto.

Key Path	Meas Setup, Chan Profile Setup, Edit User Mapping, SRS Setup
Mode	LTE, LTETDD
Remote Command	[:SENSe] :EVM:ULINk:PROFile:AUTO:SRS:SFConfig <integer> [:SENSe] :EVM:ULINk:PROFile:AUTO:SRS:SFConfig?
Example	EVM:ULIN:PROF:AUTO:SRS:SFC 1 EVM:ULIN:PROF:AUTO:SRS:SFC?
Notes	Changes to this parameter will not be applied until Update Changes command is sent. See " RB Parameter Manager (Uplink) " on page 2178 section for more details.
Dependencies	Enabled when Detection is Auto and Auto Detect S-RS Active is ON
Preset	0
State Saved	Saved in instrument state.
Min	0
Max	15
Initial S/W Revision	A.03.00

S-RS Power Boost

Sets S-RS Power Boost value when Detection is Manual.

This value specifies the average power for SRS.

NOTE

All channel and signal powers are relative to the 0 dB level determined by the power of the channel/signal chosen for synchronization.

Key Path	Meas Setup, Chan Profile Setup, Edit User Mapping, SRS Setup
Mode	LTE, LTETDD
Remote Command	[:SENSe] :EVM:ULINk:PROFile:USER<n>:SRS:PWRBoost <rel_ampl> [:SENSe] :EVM:ULINk:PROFile:USER<n>:SRS:PWRBoost?
Example	EVM:ULIN:PROF:USER1:SRS:PWRB 1 EVM:ULIN:PROF:USER1:SRS:PWRB?
Notes	Changes to this parameter will not be applied until Update Changes command is sent. See " RB Parameter Manager (Uplink) " on page 2178 section for more details.
Dependencies	The range of sub op code <n> values is determined by the number of Users the user has configured. If the user attempts to remotely set or query a sub op code that is out of range, this will result in an error message. Enabled when Detection is Manual and S-RS Active is ON.
Preset	0

15 LTE Modulation Analysis Measurement
Meas Setup

State Saved	Saved in instrument state.
Min	-100
Max	100
Initial S/W Revision	A.03.00
Modified at S/W Revision	A.04.20

Auto Detect S-RS Power Boost

Sets the S-RS Power Boost value when Detection is Auto.

Key Path	Meas Setup, Chan Profile Setup, Edit User Mapping, SRS Setup
Mode	LTE, LTE-TDD
Remote Command	[:SENSe] :EVM:ULINK:PROFile:AUTO:SRS:PWRBoost <rel_ampl> [:SENSe] :EVM:ULINK:PROFile:AUTO:SRS:PWRBoost?
Example	EVM:ULIN:PROF:AUTO:SRS:PWRB 1 EVM:ULIN:PROF:AUTO:SRS:PWRB?
Notes	Changes to this parameter will not be applied until Update Changes command is sent. See " RB Parameter Manager (Uplink) " on page 2178 section for more details.
Dependencies	Enabled when Detection is Auto and Auto Detect S-RS Active is ON.
Preset	0
State Saved	Saved in instrument state.
Min	-100
Max	100
Initial S/W Revision	A.03.00
Modified at S/W Revision	A.04.20

Configuration Index (I_{SRS})

Sets the S-RS Configuration Index (ISRS) when Detection is Manual. (3GPP TS 36.213 V8.5.0 8.2 Table 8.2-1~2)

The S-RS Configuration Index value determines S-RS periodicity and subframe offset configuration from Table 8.2-1 for FDD and Table 8.2-2 for TDD in 3GPP TS 36.213.

Key Path	Meas Setup, Chan Profile Setup, Edit User Mapping, SRS Setup
Mode	LTE, LTE-TDD
Remote Command	[:SENSe] :EVM:ULINK:PROFile:USER<n>:SRS:CINdex <integer> [:SENSe] :EVM:ULINK:PROFile:USER<n>:SRS:CINdex?
Example	EVM:ULIN:PROF:USER1:SRS:CIND 1 EVM:ULIN:PROF:USER1:SRS:CIND?
Notes	Changes to this parameter will not be applied until Update Changes command is sent. See " RB Parameter Manager (Uplink) " on page 2178 section for more details.
Dependencies	The range of sub op code <n> values is determined by the number of Users the user has configured. If the user attempts to remotely set or query a sub op code that is out of range, this will result in an error message. Enabled when Detection is Manual and S-RS Active is ON
Preset	0

15 LTE Modulation Analysis Measurement
Meas Setup

State Saved	Saved in instrument state.
Min	0
Max	1023
Initial S/W Revision	A.03.00

Auto Detect Configuration Index (I_{SRS})

Sets the S-RS Configuration Index (ISRS) when Detection is Auto. (3GPP TS 36.213 V8.5.0 8.2 Table 8.2-1~2)

Key Path	Meas Setup, Chan Profile Setup, Edit User Mapping, SRS Setup
Mode	LTE, LTETDD
Remote Command	[:SENSe] :EVM:ULINK:PROFile:AUTO:SRS:CINdex <integer> [:SENSe] :EVM:ULINK:PROFile:AUTO:SRS:CINdex?
Example	EVM:ULIN:PROF:AUTO:SRS:CIND 1 EVM:ULIN:PROF:AUTO:SRS:CIND?
Notes	Changes to this parameter will not be applied until Update Changes command is sent. See " RB Parameter Manager (Uplink) " on page 2178 section for more details.
Dependencies	Enabled when Detection is Auto and Auto Detect S-RS Active is ON
Preset	0
State Saved	Saved in instrument state.
Min	0
Max	1023
Initial S/W Revision	A.03.00

S-RS Sync Slot

Sets the S-RS Sync Slot when Detection is Manual.

This value specifies the index of the slot to use for initial synchronization. The demodulator searches for the slot with the characteristics specified in Channel Parameters and the slot that matches the Channel Parameters with the highest correlation will be assigned the slot number given in the Sync Slot parameter.

When Sync Slot is set to Auto, the demod algorithm may automatically determine the best time slot to synchronize to. This approach simplifies parameter entry and provides easier setup. However, the complexity of the algorithm makes it rather slow and prone to errors in the presence of noise.

Key Path	Meas Setup, Chan Profile Setup, Edit User Mapping
Mode	LTE, LTETDD
Remote Command	[:SENSe] :EVM:ULINK:PROFile:USER<n>:SRS:SSLot <integer> [:SENSe] :EVM:ULINK:PROFile:USER<n>:SRS:SSLot? [:SENSe] :EVM:ULINK:PROFile:USER<n>:SRS:SSLot:AUTO OFF ON 0 1 [:SENSe] :EVM:ULINK:PROFile:USER<n>:SRS:SSLot:AUTO?
Example	EVM:ULIN:PROF:USER1:SRS:SSL 1 EVM:ULIN:PROF:USER1:SRS:SSL? EVM:ULIN:PROF:USER1:SRS:SSL:AUTO 1 EVM:ULIN:PROF:USER1:SRS:SSL:AUTO?

Notes	Changes to this parameter will not be applied until Update Changes command is sent. See " RB Parameter Manager (Uplink) " on page 2178 section for more details.
Dependencies	<p>The range of sub op code <n> values is determined by the number of Users the user has configured. Max value for n=50</p> <p>If the user attempts to remotely set or query a sub op code that is out of range, this will result in an error message.</p> <p>S-RS Sync Slot is enabled when S-RS Active is ON, Detection is Manual and S-RS Sync Slot Auto is OFF.</p> <p>S-RS Sync Slot Auto is enabled when S-RS Active is ON and Detection is Manual</p>
Preset	1 ON
State Saved	Saved in instrument state.
Min	1
Max	19
Initial S/W Revision	A.03.00

Auto Detect S-RS Sync Slot

Sets the S-RS Sync Slot when Detection is Auto.

Key Path	Meas Setup, Chan Profile Setup, Edit User Mapping
Mode	LTE, LTETDD
Remote Command	[:SENSe] :EVM:ULINK:PROFile:AUTO:SRS:SSLot <integer> [:SENSe] :EVM:ULINK:PROFile:AUTO:SRS:SSLot? [:SENSe] :EVM:ULINK:PROFile:AUTO:SRS:SSLot:AUTO OFF ON 0 1 [:SENSe] :EVM:ULINK:PROFile:AUTO:SRS:SSLot:AUTO?
Example	EVM:ULIN:PROF:AUTO:SRS:SSL 1 EVM:ULIN:PROF:AUTO:SRS:SSL? EVM:ULIN:PROF:AUTO:SRS:SSL:AUTO 1 EVM:ULIN:PROF:AUTO:SRS:SSL:AUTO?
Notes	Changes to this parameter will not be applied until Update Changes command is sent. See " RB Parameter Manager (Uplink) " on page 2178 section for more details.
Dependencies	Enabled when Detection is Auto and Auto Detect S-RS Active is ON.
Preset	1 ON
State Saved	Saved in instrument state.
Min	1
Max	19
Initial S/W Revision	A.03.00

Max UpPTS

Sets the value of srsMaxUpPts to indicate whether or not *mSRS,0* reconfiguration is enabled for UpPTS when Detection is Manual, where *mSRS,0* is given by Table 5.5.3.2–1 through Table 5.5.3.2–4 for each uplink bandwidth in 3GPP TS36.211 v8.5.0.

Key Path	Meas Setup, Chan Profile Setup, Edit User Mapping, SRS Setup
Mode	LTETDD
Remote Command	[:SENSe] :EVM:ULINK:PROFile:USER<n>:SRS:MUPTs OFF ON 0 1 [:SENSe] :EVM:ULINK:PROFile:USER<n>:SRS:MUPTs?
Example	EVM:ULIN:PROF:USER1:SRS:MUPT 0 EVM:ULIN:PROF:USER1:SRS:MUPT?
Notes	Changes to this parameter will not be applied until Update Changes command is sent. See " RB Parameter Manager (Uplink) " on page 2178 section for more details.
Dependencies	The range of sub op code <n> values is determined by the number of Users the user has configured. Enabled when the mode is LTE TDD, Detection is Manual, and S-RS Active is ON.
Preset	OFF

State Saved	Saved in instrument state.
Initial S/W Revision	A.03.00
<hr/>	
Key Path	Meas Setup, Chan Profile Setup, Edit User Mapping, SRS Setup
Mode	LTETDD
Remote Command	[:SENSe] :EVM:ULINK:PROFile:AUTO:SRS:MUPTs OFF ON 0 1 [:SENSe] :EVM:ULINK:PROFile:AUTO:SRS:MUPTs?
Example	EVM:ULIN:PROF:AUTO:SRS:MUPT 0 EVM:ULIN:PROF:AUTO:SRS:MUPT?
Notes	Changes to this parameter will not be applied until Update Changes command is sent. See " RB Parameter Manager (Uplink) " on page 2178 section for more details.
Dependencies	Enabled when the mode is LTE TDD, Detection is Auto, and Auto Detect S-RS Active is ON.
Preset	OFF
State Saved	Saved in instrument state.
Initial S/W Revision	A.03.00

S-RS NraS1

Sets the format number for PRACH in subframe1's UpPTS, which is derived from 3GPP TS 36.211 V8.5.0 5.7 Table5.7.1-4.

Key Path	Meas Setup, Chan Profile Setup, Edit User Mapping, SRS Setup
Mode	LTETDD
Remote Command	[:SENSe] :EVM:ULINK:PROFile:USER<n>:SRS:NRA:SONe <integer> [:SENSe] :EVM:ULINK:PROFile:USER<n>:SRS:NRA:SONe?
Example	EVM:ULIN:PROF:USER1:SRS:NRA:SON 1 EVM:ULIN:PROF:USER1:SRS:NRA:SON?
Notes	Changes to this parameter will not be applied until Update Changes command is sent. See " RB Parameter Manager (Uplink) " on page 2178 section for more detail.
Dependencies	The range of sub op code <n> values is determined by the number of Users the user has configured. Max value for n=50 If the user attempts to remotely set or query a sub op code that is out of range, this will result in an error message. Enabled when the mode is LTE TDD, Detection is Manual and S-RS Active is ON.
Preset	0
State Saved	Saved in instrument state.
Min	0
Max	6
Initial S/W Revision	A.03.00

Auto Detect S-RS NraS1

Sets S-RS NraS1 when Auto Detection is On.

Key Path	Meas Setup, Chan Profile Setup, Edit User Mapping, SRS Setup
Mode	LTETDD
Remote Command	[:SENSe] :EVM:ULINk:PROFile:AUTO:SRS:NRA:SONe <integer> [:SENSe] :EVM:ULINk:PROFile:AUTO:SRS:NRA:SONe?
Example	EVM:ULIN:PROF:AUTO:SRS:NRA:SON 1 EVM:ULIN:PROF:AUTO:SRS:NRA:SON?
Notes	Changes to this parameter will not be applied until Update Changes command is sent. See " RB Parameter Manager (Uplink) " on page 2178 section for more detail.
Dependencies	Enabled when the mode is LTE TDD, Detection is Auto and Auto Detect S-RS Active is ON.
Preset	0
State Saved	Saved in instrument state.
Min	0
Max	6
Initial S/W Revision	A.03.00

S-RS NraS6

Sets the format number for PRACH in subframe6's UpPTS, which is derived from 3GPP TS 36.211 V8.5.0 5.7 Table 5.7.1-4.

Key Path	Meas Setup, Chan Profile Setup, Edit User Mapping, SRS Setup
Mode	LTETDD
Remote Command	[:SENSe] :EVM:ULINk:PROFile:USER<n>:SRS:NRA:SSIX <integer> [:SENSe] :EVM:ULINk:PROFile:USER<n>:SRS:NRA:SSIX?
Example	EVM:ULIN:PROF:USER1:SRS:NRA:SSIX 1 EVM:ULIN:PROF:USER1:SRS:NRA:SSIX?
Notes	Changes to this parameter will not be applied until Update Changes command is sent. See " RB Parameter Manager (Uplink) " on page 2178 section for more detail.
Dependencies	The range of sub op code <n> values is determined by the number of Users the user has configured. Max value for n=50 If the user attempts to remotely set or query a sub op code that is out of range, this will result in an error message. Enabled when the mode is LTE TDD, Detection is Manual and S-RS Active is ON.
Preset	0
State Saved	Saved in instrument state.
Min	0
Max	6
Initial S/W Revision	A.03.00

Auto Detect S-RS NraS6

Sets S-RS NraS6 when Auto Detection is On.

Key Path	Meas Setup, Chan Profile Setup, Edit User Mapping, SRS Setup
Mode	LTETDD
Remote Command	[:SENSe] :EVM:ULINK:PROFile:AUTO:SRS:NRA:SSIX <integer> [:SENSe] :EVM:ULINK:PROFile:AUTO:SRS:NRA:SSIX?
Example	EVM:ULIN:PROF:AUTO:SRS:NRA:SSIX 1 EVM:ULIN:PROF:AUTO:SRS:NRA:SSIX?
Notes	Changes to this parameter will not be applied until Update Changes command is sent. See " RB Parameter Manager (Uplink) " on page 2178 section for more detail.
Dependencies	Enabled when the mode is LTE TDD, Detection is Auto and Auto Detect S-RS Active is ON.
Preset	0
State Saved	Saved in instrument state.
Min	0
Max	6
Initial S/W Revision	A.03.00

OK/Cancel

Displays a menu that enables the changes to the parameters on the dialog to be applied or cancelled.

Mode	LTE, LTETDD
Initial S/W Revision	Prior to A.02.00
Modified at S/W Revision	A.03.00

RB Parameter Manager (Uplink)

Reduces the time it takes to configure channel profile related parameters with SCPI commands.

The SCPI command parameters shown below are managed in this scheme.

Note that changes to the parameters are not applied until the Update Changes command is sent. See "[Update Changes \(Uplink\)](#)" on page 2183 section for more details.

[:SENSe] :EVM:ULINK:PROFile:ADD:USER
[:SENSe] :EVM:ULINK:PROFile:AUTO:CID
[:SENSe] :EVM:ULINK:PROFile:AUTO:HOPPIng:GROup
[:SENSe] :EVM:ULINK:PROFile:AUTO:HOPPIng:SEQuence
[:SENSe] :EVM:ULINK:PROFile:AUTO:RNTI

```
[SENSe]:EVM:ULINK:PROFile:AUTO:SFNumber
```

```
[SENSe]:EVM:ULINK:PROFile:AUTO:PRACH:ACTive
```

```
[SENSe]:EVM:ULINK:PROFile:AUTO:PRACH:CINdex
```

```
[SENSe]:EVM:ULINK:PROFile:AUTO:PRACH:CSset
```

```
[SENSe]:EVM:ULINK:PROFile:AUTO:PRACH:PINdex
```

```
[SENSe]:EVM:ULINK:PROFile:AUTO:PRACH:LRsindex
```

```
[SENSe]:EVM:ULINK:PROFile:AUTO:PRACH:NCsConfig
```

```
[SENSe]:EVM:ULINK:PROFile:AUTO:PRACH:NRAPrb
```

```
[SENSe]:EVM:ULINK:PROFile:AUTO:PRACH:PWRBoost
```

```
[SENSe]:EVM:ULINK:PROFile:AUTO:PRACH:SRESource
```

```
[SENSe]:EVM:ULINK:PROFile:AUTO:PUCCh:ACTive
```

```
[SENSe]:EVM:ULINK:PROFile:AUTO:PUCCh:CSHift
```

```
[SENSe]:EVM:ULINK:PROFile:AUTO:PUCCh:DMRS:GROup
```

```
[SENSe]:EVM:ULINK:PROFile:AUTO:PUCCh:DMRS:PARams
```

```
[SENSe]:EVM:ULINK:PROFile:AUTO:PUCCh:DMRS:PWRBoost
```

```
[SENSe]:EVM:ULINK:PROFile:AUTO:PUCCh:FORMat
```

```
[SENSe]:EVM:ULINK:PROFile:AUTO:PUCCh:N:ONE
```

```
[SENSe]:EVM:ULINK:PROFile:AUTO:PUCCh:N:TWO
```

```
[SENSe]:EVM:ULINK:PROFile:AUTO:PUCCh:NCS:ONE
```

```
[SENSe]:EVM:ULINK:PROFile:AUTO:PUCCh:NRB:TWO
```

```
[SENSe]:EVM:ULINK:PROFile:AUTO:PUCCh:OS
```

```
[SENSe]:EVM:ULINK:PROFile:AUTO:PUCCh:PWRBoost
```

```
[SENSe]:EVM:ULINK:PROFile:AUTO:PUCCh:RB
```

```
[SENSe]:EVM:ULINK:PROFile:AUTO:PUCCh:SHIFt
```

```
[SENSe]:EVM:ULINK:PROFile:AUTO:PUCCh:SSLot
```

```
[SENSe]:EVM:ULINK:PROFile:AUTO:PUCCh:SSLot:AUTO
```

```
[SENSe]:EVM:ULINK:PROFile:AUTO:PUSCh:ACTive
```

```
[SENSe]:EVM:ULINK:PROFile:AUTO:PUSCh:DMRS:CSHift
```

```
[SENSe]:EVM:ULINK:PROFile:AUTO:PUSCh:DMRS:GROup
```

```
[SENSe]:EVM:ULINK:PROFile:AUTO:PUSCh:DMRS:ONE
```

```
[SENSe]:EVM:ULINK:PROFile:AUTO:PUSCh:DMRS:PARams
```

```
[SENSe]:EVM:ULINK:PROFile:AUTO:PUSCh:DMRS:PWRBoost
```

```
[SENSe]:EVM:ULINK:PROFile:AUTO:PUSCh:DMRS:SEQuence
```

```
[SENSe]:EVM:ULINK:PROFile:AUTO:PUSCh:DMRS:TWO
```

[.SENSe]:EVM:ULINK:PROFile:AUTO:PUSCh:DSS

[.SENSe]:EVM:ULINK:PROFile:AUTO:PUSCh:FHOPping

[.SENSe]:EVM:ULINK:PROFile:AUTO:PUSCh:MODulation:TYPE

[.SENSe]:EVM:ULINK:PROFile:AUTO:PUSCh:NRBHo

[.SENSe]:EVM:ULINK:PROFile:AUTO:PUSCh:NSB

[.SENSe]:EVM:ULINK:PROFile:AUTO:PUSCh:PWRBoost

[.SENSe]:EVM:ULINK:PROFile:AUTO:PUSCh:RB:END

[.SENSe]:EVM:ULINK:PROFile:AUTO:PUSCh:RB:STARt

[.SENSe]:EVM:ULINK:PROFile:AUTO:PUSCh:SSLot

[.SENSe]:EVM:ULINK:PROFile:AUTO:PUSCh:SSLot:AUTO

[.SENSe]:EVM:ULINK:PROFile:AUTO:SRS:ACTive

[.SENSe]:EVM:ULINK:PROFile:AUTO:SRS:BCONfig

[.SENSe]:EVM:ULINK:PROFile:AUTO:SRS:BWIDth

[.SENSe]:EVM:ULINK:PROFile:AUTO:SRS:CINDex

[.SENSe]:EVM:ULINK:PROFile:AUTO:SRS:CSHift

[.SENSe]:EVM:ULINK:PROFile:AUTO:SRS:FDPosition

[.SENSe]:EVM:ULINK:PROFile:AUTO:SRS:HBWIDth

[.SENSe]:EVM:ULINK:PROFile:AUTO:SRS:MUPTs

[.SENSe]:EVM:ULINK:PROFile:AUTO:SRS:PWRBoost

[.SENSe]:EVM:ULINK:PROFile:AUTO:SRS:SFConfig

[.SENSe]:EVM:ULINK:PROFile:AUTO:SRS:SSLot

[.SENSe]:EVM:ULINK:PROFile:AUTO:SRS:SSLot:AUTO

[.SENSe]:EVM:ULINK:PROFile:AUTO:SRS:TComB

[.SENSe]:EVM:ULINK:PROFile:USER(1:50):CID

[.SENSe]:EVM:ULINK:PROFile:USER(1:50):DElete

[.SENSe]:EVM:ULINK:PROFile:USER(1:50):HOPping:GROup

[.SENSe]:EVM:ULINK:PROFile:USER(1:50):HOPping:SEquence

[.SENSe]:EVM:ULINK:PROFile:USER(1:50):RNTI

[.SENSe]:EVM:ULINK:PROFile:USER(1:50):SFNumber

[.SENSe]:EVM:ULINK:PROFile:USER(1:50):PRACH:ACTive

[.SENSe]:EVM:ULINK:PROFile:USER(1:50):PRACH:CINDex

[.SENSe]:EVM:ULINK:PROFile:USER(1:50):PRACH:CSSet

[.SENSe]:EVM:ULINK:PROFile:USER(1:50):PRACH:PINdex

[.SENSe]:EVM:ULINK:PROFile:USER(1:50):PRACH:LRSindex

```
[SENSe]:EVM:ULINK:PROFile:USER(1:50):PRACH:NCSConfig
[SENSe]:EVM:ULINK:PROFile:USER(1:50):PRACH:NRAPrb
[SENSe]:EVM:ULINK:PROFile:USER(1:50):PRACH:PWRBoost
[SENSe]:EVM:ULINK:PROFile:USER(1:50):PRACH:SRESource

[SENSe]:EVM:ULINK:PROFile:USER(1:50):PUCCh:ACTive
[SENSe]:EVM:ULINK:PROFile:USER(1:50):PUCCh:ADD:SLOT
[SENSe]:EVM:ULINK:PROFile:USER(1:50):PUCCh:CSHift
[SENSe]:EVM:ULINK:PROFile:USER(1:50):PUCCh:CSHift:COUPle
[SENSe]:EVM:ULINK:PROFile:USER(1:50):PUCCh:DMRS:GROup
[SENSe]:EVM:ULINK:PROFile:USER(1:50):PUCCh:DMRS:GROup:COUPle
[SENSe]:EVM:ULINK:PROFile:USER(1:50):PUCCh:DMRS:PARams
[SENSe]:EVM:ULINK:PROFile:USER(1:50):PUCCh:DMRS:PWRBoost
[SENSe]:EVM:ULINK:PROFile:USER(1:50):PUCCh:DMRS:PWRBoost:COUPle
[SENSe]:EVM:ULINK:PROFile:USER(1:50):PUCCh:FORMat
[SENSe]:EVM:ULINK:PROFile:USER(1:50):PUCCh:FORMat:COUPle
[SENSe]:EVM:ULINK:PROFile:USER(1:50):PUCCh:N:ONE
[SENSe]:EVM:ULINK:PROFile:USER(1:50):PUCCh:N:TWO
[SENSe]:EVM:ULINK:PROFile:USER(1:50):PUCCh:NCS:ONE
[SENSe]:EVM:ULINK:PROFile:USER(1:50):PUCCh:NRB:TWO
[SENSe]:EVM:ULINK:PROFile:USER(1:50):PUCCh:OS
[SENSe]:EVM:ULINK:PROFile:USER(1:50):PUCCh:OS:COUPle
[SENSe]:EVM:ULINK:PROFile:USER(1:50):PUCCh:PWRBoost
[SENSe]:EVM:ULINK:PROFile:USER(1:50):PUCCh:PWRBoost:COUPle
[SENSe]:EVM:ULINK:PROFile:USER(1:50):PUCCh:RB
[SENSe]:EVM:ULINK:PROFile:USER(1:50):PUCCh:RB:COUPle
[SENSe]:EVM:ULINK:PROFile:USER(1:50):PUCCh:SHIFt
[SENSe]:EVM:ULINK:PROFile:USER(1:50):PUCCh:SLOT(0:19):CSHift
[SENSe]:EVM:ULINK:PROFile:USER(1:50):PUCCh:SLOT(0:19):DELete
[SENSe]:EVM:ULINK:PROFile:USER(1:50):PUCCh:SLOT(0:19):DMRS:GROup
[SENSe]:EVM:ULINK:PROFile:USER(1:50):PUCCh:SLOT(0:19):DMRS:PWRBoost
[SENSe]:EVM:ULINK:PROFile:USER(1:50):PUCCh:SLOT(0:19):FORMat
[SENSe]:EVM:ULINK:PROFile:USER(1:50):PUCCh:SLOT(0:19):OS
[SENSe]:EVM:ULINK:PROFile:USER(1:50):PUCCh:SLOT(0:19):PWRBoost
[SENSe]:EVM:ULINK:PROFile:USER(1:50):PUCCh:SLOT(0:19):RB
[SENSe]:EVM:ULINK:PROFile:USER(1:50):PUCCh:SSLot
[SENSe]:EVM:ULINK:PROFile:USER(1:50):PUCCh:SSLot:AUTO
```

[.SENSe];EVM:ULINK:PROFile:USER(1:50):PUSCh:ACTive

[.SENSe];EVM:ULINK:PROFile:USER(1:50):PUSCh:ADD:SLOT

[.SENSe];EVM:ULINK:PROFile:USER(1:50):PUSCh:CTNB

[.SENSe];EVM:ULINK:PROFile:USER(1:50):PUSCh:CTNB:COUPle

[.SENSe];EVM:ULINK:PROFile:USER(1:50):PUSCh:DMRS:CSHift

[.SENSe];EVM:ULINK:PROFile:USER(1:50):PUSCh:DMRS:CSHift:COUPle

[.SENSe];EVM:ULINK:PROFile:USER(1:50):PUSCh:DMRS:GROup

[.SENSe];EVM:ULINK:PROFile:USER(1:50):PUSCh:DMRS:GROup:COUPle

[.SENSe];EVM:ULINK:PROFile:USER(1:50):PUSCh:DMRS:ONE

[.SENSe];EVM:ULINK:PROFile:USER(1:50):PUSCh:DMRS:PARAmS

[.SENSe];EVM:ULINK:PROFile:USER(1:50):PUSCh:DMRS:PWRBoost

[.SENSe];EVM:ULINK:PROFile:USER(1:50):PUSCh:DMRS:PWRBoost:COUPle

[.SENSe];EVM:ULINK:PROFile:USER(1:50):PUSCh:DMRS:SEQuence

[.SENSe];EVM:ULINK:PROFile:USER(1:50):PUSCh:DMRS:SEQuence:COUPle

[.SENSe];EVM:ULINK:PROFile:USER(1:50):PUSCh:DMRS:TWO

[.SENSe];EVM:ULINK:PROFile:USER(1:50):PUSCh:DSS

[.SENSe];EVM:ULINK:PROFile:USER(1:50):PUSCh:FHOPping

[.SENSe];EVM:ULINK:PROFile:USER(1:50):PUSCh:MODulation:TYPE

[.SENSe];EVM:ULINK:PROFile:USER(1:50):PUSCh:MODulation:TYPE:COUPle

[.SENSe];EVM:ULINK:PROFile:USER(1:50):PUSCh:NRBHo

[.SENSe];EVM:ULINK:PROFile:USER(1:50):PUSCh:NSB

[.SENSe];EVM:ULINK:PROFile:USER(1:50):PUSCh:PWRBoost

[.SENSe];EVM:ULINK:PROFile:USER(1:50):PUSCh:PWRBoost:COUPle

[.SENSe];EVM:ULINK:PROFile:USER(1:50):PUSCh:RB:END

[.SENSe];EVM:ULINK:PROFile:USER(1:50):PUSCh:RB:END:COUPle

[.SENSe];EVM:ULINK:PROFile:USER(1:50):PUSCh:RB:START

[.SENSe];EVM:ULINK:PROFile:USER(1:50):PUSCh:RB:START:COUPle

[.SENSe];EVM:ULINK:PROFile:USER(1:50):PUSCh:SLOT(0:19):CTNB

[.SENSe];EVM:ULINK:PROFile:USER(1:50):PUSCh:SLOT(0:19):DELete

[.SENSe];EVM:ULINK:PROFile:USER(1:50):PUSCh:SLOT(0:19):DMRS:CSHift

[.SENSe];EVM:ULINK:PROFile:USER(1:50):PUSCh:SLOT(0:19):DMRS:GROup

[.SENSe];EVM:ULINK:PROFile:USER(1:50):PUSCh:SLOT(0:19):DMRS:PWRBoost

[.SENSe];EVM:ULINK:PROFile:USER(1:50):PUSCh:SLOT(0:19):DMRS:SEQuence

[.SENSe];EVM:ULINK:PROFile:USER(1:50):PUSCh:SLOT(0:19):MODulation:TYPE

[.SENSe];EVM:ULINK:PROFile:USER(1:50):PUSCh:SLOT(0:19):PWRBoost

```
[SENSe]:EVM:ULINK:PROFile:USER(1:50):PUSCh:SLOT(0:19):RB:END
[SENSe]:EVM:ULINK:PROFile:USER(1:50):PUSCh:SLOT(0:19):RB:START
[SENSe]:EVM:ULINK:PROFile:USER(1:50):PUSCh:SSLot
[SENSe]:EVM:ULINK:PROFile:USER(1:50):PUSCh:SSLot:AUTO
```

```
[SENSe]:EVM:ULINK:PROFile:USER(1:50):SRS:ACTive
[SENSe]:EVM:ULINK:PROFile:USER(1:50):SRS:BCONfig
[SENSe]:EVM:ULINK:PROFile:USER(1:50):SRS:BWIDth
[SENSe]:EVM:ULINK:PROFile:USER(1:50):SRS:CINdex
[SENSe]:EVM:ULINK:PROFile:USER(1:50):SRS:CSHift
[SENSe]:EVM:ULINK:PROFile:USER(1:50):SRS:FDPosition
[SENSe]:EVM:ULINK:PROFile:USER(1:50):SRS:HBWIDth
[SENSe]:EVM:ULINK:PROFile:USER(1:50):SRS:MUPTs
[SENSe]:EVM:ULINK:PROFile:USER(1:50):SRS:PWRBoost
[SENSe]:EVM:ULINK:PROFile:USER(1:50):SRS:SFCOnfig
[SENSe]:EVM:ULINK:PROFile:USER(1:50):SRS:SSLot
[SENSe]:EVM:ULINK:PROFile:USER(1:50):SRS:SSLot:AUTO
[SENSe]:EVM:ULINK:PROFile:USER(1:50):SRS:TCOMb
```

This feature supports the following operations:

- **"Update Changes (Uplink)" on page 2183** command, which applies pending changes to parameters.
- **"Ignore Changes (Uplink)" on page 2184** Ignore Changes command, which discards pending changes to parameters.
- **"Clear Changes (Uplink)" on page 2184** command, which clears all existing RB mapping information for uplink.

The Update Changes and Ignore Changes commands behave similarly to the OK and Cancel buttons on user interface dialogs, respectively.

For example, to clear existing RB mapping information and configure one user with one PUSCH slot with RB End set to 49, send the following sequence in order. Note that the Clear Changes command is not required just after mode preset since there is no RB mapping information by default.

```
[SENSe]:EVM:ULINK:PROFile:ADD:USER
[SENSe]:EVM:ULINK:PROFile:USER1:PUSCh:ADD:SLOT
[SENSe]:EVM:ULINK:PROFile:USER1:PUSCh:RB:END 49
[SENSe]:EVM:ULINK:PROFile:UPDate
```

Update Changes (Uplink)

SCPI Only. This command updates changes sent after last UPDate or preset.

Mode	LTE, LTETDD
Remote Command	[:SENSe] :EVM:ULINk:PROFile:UPDate
Example	EVM:ULIN:PROF:UPD
Initial S/W Revision	A.03.00

Clear Changes (Uplink)

SCPI Only. This command clears allocated resource blocks and delete all Users

Mode	LTE, LTETDD
Remote Command	[:SENSe] :EVM:ULINk:PROFile:CLEAr
Example	EVM:ULIN:PROF:CLE
Initial S/W Revision	A.03.00

Ignore Changes (Uplink)

SCPI Only. This command ignores (clears) changes that are not updated.

Mode	LTE, LTETDD
Remote Command	[:SENSe] :EVM:ULINk:PROFile:IGNore
Example	EVM:ULIN:PROF:IGN
Initial S/W Revision	A.03.00

Count Number of Users (Uplink)

SCPI Only. This command returns the number of added users.

Mode	LTE, LTETDD
Remote Command	[:SENSe] :EVM:ULINk:PROFile:COUNT?
Example	EVM:ULIN:PROF:COUN?
Initial S/W Revision	A.03.00

Count Number of PUCCH Slots (Uplink)

SCPI Only. This command returns the number of added PUCCH slots.

Mode	LTE, LTETDD
Remote Command	[:SENSe] :EVM:ULINk:PROFile:USER<n>:PUCCh:COUNT?
Example	EVM:ULIN:PROF:USER2:PUCC:COUN?
Dependencies	The range of sub op code <n> values is determined by the number of Users the user has configured.

If the user attempts to remotely set or query a sub op code that is out of range, this will result in an error message.

Initial S/W Revision	A.03.00
----------------------	---------

Count Number of PUSCH Slots (Uplink)

SCPI Only. This command returns the number of added PUSCH slots.

Mode	LTE, LTETDD
Remote Command	[:SENSe] :EVM:ULINk:PROFile:USER<n>:PUSCh:COUNT?
Example	EVM:ULIN:PROF:USER2:PUSC:COUN?
Dependencies	The range of sub op code <n> values is determined by the number of Users the user has configured. If the user attempts to remotely set or query a sub op code that is out of range, this will result in an error message.
Initial S/W Revision	A.03.00

Copy Auto -> Manual

Copies all autodetected allocations into the Resource Block Editor.

For downlink, when Copy Auto -> Manual is pressed, each autodetected modulation group will be assigned to a user. When RB Auto Detect Mode is set to Power Based, User_01 will contain resource blocks with QPSK; User_02 will contain resource blocks with 16QAM; and User_03 will contain resource blocks with 64QAM.

When RB Auto Detect Mode is set to Decode PDCCH, the user allocations will be copied into the LTE Allocation Editor as manual allocations.

For uplink, when Copy Auto -> Manual is pressed, User_01, which contains all autodetected channels, will be copied into the LTE Allocation Editor.

This key is useful when you have two signals with identical allocations, where one has a fairly good SNR, but the other has a low SNR. In this case, RB Auto Detect may detect the allocations for the noisy signal incorrectly. To work around this, you can recall the clean signal, autodetect allocations, and press Copy Auto -> Manual. Then you can recall the noisy signal and don't need to rely on auto detection.

Note that existing manual user mappings will be overwritten when you press this button.

Key Path	Meas Setup, Chan Profile Setup
Mode	LTE, LTETDD
Remote Command	[:SENSe] :EVM:PROFile:COPY [:IMMediate]
Example	EVM:PROF:COPY
Notes	Available when Detection is Auto.
Initial S/W Revision	A.06.00

Decode

Displays a menu that enables you to configure RA-RNTI and TPC-RNTI search ranges and what level of decoding to perform on PBCH, PCFICH, PDCCH, PDSCH, and PUSCH.

Key Path	Meas Setup
Initial S/W Revision	A.06.00

Decode Type

Displays a menu that enables you to select the decoding type of each channel. The decoded symbols will be displayed in the Decoded Symbol Table.

Key Path	Meas Setup, Decode
Initial S/W Revision	A.06.00

PBCH Decoding

Selects the decoding type of the PBCH. It specifies how much coding to undo before showing the Master Information Block (MIB) bits from PBCH on the Decoded Symbol Table. See 3GPP TS 36.212, Section 5.3.1 for a diagram of the coding operations performed on PBCH.

The following is a list of the available PBCH decoding type selections and the resulting bits:

- NONE – None, no bits for this channel will be shown on the Decoded Symbol Table.
- DESCrambled – Descrambled, 480 (Normal CP) or 432 (Extended CP) descrambled (rate-matched) bits for each subframe 0 in a frame
- DRMatched – DeRateMatched, 120 deratematched (channel coded) bits for each subframe 0 in a frame
- DECoded – 40 (information bits + CRC) bits for each subframe 0 in a frame

NOTE

The PBCH decoder is On when PBCH Decoding is not set to None or when PHICH Duration or PHICH Allocation (Ng) are set to Auto Detect.

Key Path	Meas Setup, Decode, Decode Type
Mode	LTE, LTETDD
Remote Command	[:SENSe] :EVM:DLINk:DECode:PBCH NONE DESCrambled DRMatched DECoded [:SENSe] :EVM:DLINk:DECode:PBCH?
Example	EVM:DLIN:DEC:PBCH NONE EVM:DLIN:DEC:PBCH?
Notes	Available when Direction is Downlink.
State Saved	Saved in instrument state.
Range	None Descrambled DeRateMatched Decoded
Initial S/W Revision	A.06.00

PCFICH Decoding

Selects the decoding type of the PCFICH. It specifies how much coding to undo before showing the bits from PCFICH on the Decoded Symbol Table. See 3GPP TS 36.212, Section 5.3.4 for a diagram of the coding operations performed to PCFICH.

The following is a list of the available PCFICH decoding type selections and the resulting bits:

- NONE – None, no bits for this channel will be shown on the Decoded Symbol Table.
- DESCrambled – Descrambled, 32 descrambled (channel coded) bits per subframe
- DECoded – Decoded, 2 decoded bits (CFI) per subframe

NOTE

The PCFICH decoder is On when PCFICH Decoding is not set to None or when PDCCH Allocation Auto Detect is set to On.

Key Path	Meas Setup, Decode, Decode Type
Mode	LTE, LTE-TDD
Remote Command	[:SENSe] :EVM:DLInk:DECode:PCFich NONE DESCrambled DECoded [:SENSe] :EVM:DLInk:DECode:PCFich?
Example	EVM:DLIN:DEC:PCF NONE EVM:DLIN:DEC:PCF?
Notes	Available when Direction is Downlink.
State Saved	Saved in instrument state.
Range	None Descrambled Decoded
Initial S/W Revision	A.06.00

PDCCH Decoding

Selects the decoding type of the PDCCH. It specifies how much coding to undo before showing the bits from PDCCH on the Decoded Symbol Table. See 3GPP TS 36.212, Section 5.3.1 for a diagram of the coding operations performed on PDCCH.

The following is a list of the available PDCCH decoding type selections and the resulting bits. NREG is the number of resource element groups not allocated for PHICH or PCFICH in a subframe.

- NONE – None, no PDCCH bits will be shown in the Decoded Symbol Table.
- DEMapped – Demapped, NREG*8 demapped (interleaved) DCI format bits for each subframe
- DINTERleaved – Deinterleaved, NREG*8 deinterleaved (scrambled) DCI format bits for each subframe
- DESCrambled – Descrambled, NREG*8 descrambled (rate-matched) bits for each subframe
- DRMatched – DeRateMatched, $\sum (8 + LEN_i)$ bits for each subframe
- Each set of bits for an active PDCCH transmission consists of an 8-bit length field (LEN_i) followed by the deratematched (channel coded) bits.

- LEN_i indicates the number of deratematched bits for the ith PDCCH transmission in a subframe and can be used to determine where a PDCCH ends and the next PDCCH begins in the Decoded Symbol Table.
- LEN_i = 3 * (DCI Payload Length + CRC Length)
- DECODED – Decoded, Σ (8 + LEN_i) bits for each subframe
- Each set of bits for an active PDCCH transmission consists of an 8-bit length field (LEN_i), the decoded (DCI payload + CRC) bits, and the 16-bit CRC.
- LEN_i indicates the number of decoded bits (including CRC) for the ith PDCCH transmission in a subframe and can be used to determine where a PDCCH ends and the next PDCCH begins in the Decoded Symbol Table.
- LEN_i = DCI Payload Length + CRC Length

NOTE

For both Deratematched and Decoded PDCCH bits, the analyzer auto-detects the number of active PDCCH transmitted within each subframe, nPDCCH.

The PDCCH decoder is On when RB Auto Detect Mode is set to Decode PDCCH or when PDCCH Decoding is not set to None.

Key Path	Meas Setup, Decode, Decode Type
Mode	LTE, LTETDD
Remote Command	[:SENSe] :EVM:DLINK:DECode:PDCC NONE DEMapped DINTerleaved DESCrambled DRMatched DECODED [:SENSe] :EVM:DLINK:DECode:PDCC?
Example	EVM:DLIN:DEC:PDCC NONE EVM:DLIN:DEC:PDCC?
Notes	Available when Direction is Downlink.
State Saved	Saved in instrument state.
Range	None Demapped Deinterleaved Descrambled DeRateMatched Decoded
Initial S/W Revision	A.06.00

PDSCH Decoding

Selects the decoding type of the PDSCH. It specifies how much coding to undo before showing the bits from PDSCH on the Decoded Symbol Table. See 3GPP TS 36.212, Section 5.3.2 for a diagram of the coding operations performed on PDSCH. The following is a list of the available PDSCH decoding type selections and the resulting bits:

- NONE - None, no bits for this channel will be shown on the Decoded Symbol Table.
- DESCrambled - Descrambled, descrambled (rate-matched) bits for each subframe
- DRMatched – DeRateMatched, Σ (16 + LEN_i) bits per subframe
- Each set of bits for a PDSCH transmission consists of an 16-bit length field (LEN_i) followed by the deratematched (channel coded) bits.

- LENi indicates the number of deratematched bits for the ith PDSCH allocation in a subframe and can be used to determine where one set of deratematched bits ends and the next set begins in the Decoded Symbol Table.
- $LEN_i = 3 * (\text{Codeblock Length} + \text{CRC Length} + \text{Trellis Termination Bit Length})$ where Trellis Termination Bit Length = 4.
- DCBLoCk – Decoded CB, $\Sigma (16 + LEN_i)$ bits per subframe
- Each set of bits for a PDSCH codeblock consists of a 16-bit length field (LENi), the decoded codeblock bits, and a 24-bit CRC. When codeblock segmentation is not performed (Transport Block Size (TBS(n)) is less than 6144), the codeblock + CRC bits shown are the same as the transport block + CRC bits.
- LENi indicates the number of decoded bits (including CRC) for the ith PDSCH codeblock in a subframe and can be used to determine where a set of codeblock bits ends and the next set begins in the Decoded Symbol Table.
- DTBLoCk – Decoded TB, $\Sigma (\text{Transport Block Sizes} + 24)$ decoded transport block bits (including CRCs) per subframe
- Each set of bits consists of the decoded transport block bits followed by a 24-bit CRC. There is no LEN field for decoded transport block bits since the Transport Block Size for each PDSCH allocation is shown on the DL Decode Info table in the TBS(n) data result.

NOTE

The PDSCH decoder is On when PDSCH Decoding is not set to None.

Key Path	Meas Setup, Decode, Decode Type
Mode	LTE, LTETDD
Remote Command	[:SENSe] :EVM:DLINk:DECode:PDSCh NONE DESCrambled DRMatched DCBLoCk DTBLoCk [:SENSe] :EVM:DLINk:DECode:PDSCh?
Example	EVM:DLIN:DEC:PDSC NONE EVM:DLIN:DEC:PDSC?
Dependencies	Available when Direction is Downlink. Available when Detection is Auto and RB Auto Detect Mode is Decoded PDCCH.
State Saved	Saved in instrument state.
Range	None DESCrambled DeRateMatched Decoded Code Block Decoded Tx Port Block
Initial S/W Revision	A.06.00

PUSCH Decoding

Selects the decoding type of the PUSCH. It determines the level of decoding for PUSCH bits shown in the Decoded Symbol Table.

- NONE - None, no decoding is performed on PUCCH bits. Mapped bits are shown in the Symbol Table.
- DESCrambled – Descrambled, descrambled (rate-matched) bits for each subframe are shown in the Decoded Symbol Table.
- DRMatched – DeRateMatched, $\Sigma (16 + LEN_i)$ bits per subframe.

- Each set of bits for a PUSCH transmission consists of a 16-bit length field (LEN_i) followed by the deratematched (channel coded) bits for each codeblock.
- LEN_i indicates the number of deratematched bits for the ith codeblock in a subframe and can be used to determine where one set of deratematched codeblock bits ends and the next set begins in the Decoded Symbol Table.
- $LEN = 3 * (\text{Codeblock Length} + \text{CRC Length} + \text{Trellis Termination Bit Length})$ bits, where Codeblock Length is transmission dependent, CRC Length = 24 bits, and Trellis Termination Bit Length = 4 bits.
- DCBLoCk – Decoded CB, $\Sigma (16 + LEN_i)$ bits per subframe.
- Each set of bits for a PUSCH codeblock consists of a 16-bit length field (LEN), the decoded codeblock bits, and a 24-bit CRC. When codeblock segmentation is not performed (Transport Block Size (TBS(n)) is less than 6144), the codeblock + CRC bits shown are the same as the transport block + CRC bits.
- LEN_i indicates the number of decoded bits (including CRC) for the ith codeblock in a subframe and can be used to determine where a set of codeblock bits ends and the next set begins in the Decoded Symbol Table. $LEN_i = \text{Codeblock Length} + \text{CRC Length}$, where Codeblock Length is transmission dependent, and CRC Length = 24 bits.
- DTBLoCk – Decoded TB, (Transport Block Size + 24) decoded transport block bits (including CRCs) per subframe.
- The number of bits shown on the Decoded Symbol Table for a PUSCH channel allocation when PUSCH Bits is set to Decoded is equal to the sum of the Size metrics (HARQ Size, CQI/PMI Size, SR Size, etc.) plus the Transport Block Size (TBS) for the corresponding decoded PUSCH allocation listed in the UL Decode Info trace.

NOTE

RNTI needs to be specified for a user allocation for PUSCH descrambling to be performed.

Key Path	Meas Setup, Decode, Decode Type
Mode	LTE, LTETDD
Remote Command	[:SENSe] :EVM:ULINk:DECode:PUSCh NONE DESCrambled DRMatched DCBLoCk DTBLoCk [:SENSe] :EVM:ULINk:DECode:PUSCh?
Example	EVM:ULIN:DEC:PUSC NONE EVM:ULIN:DEC:PUSC?
Notes	Available when Direction is Uplink. RNTI needs to be specified for a user allocation in the LTE Allocation Editor for PUSCH descrambling to be performed.
State Saved	Saved in instrument state.
Range	None Descrambled DeRatematched Decoded Code Block Decoded Tx Port Block
Initial S/W Revision	A.06.00
Modified at S/W Revision	A.10.00

PUCCH Decoding

Selects the decoding type of the PUCCH. It determines how much coding to undo before showing the bits from PUCCH on the Decoded Symbol Table. See 3GPP TS 36.212, Section 5.2.3 for a diagram of the coding operations performed on PUCCH.

- NONE - None, raw PUCCH bits are mapped to resource element locations and shown in the Symbol Table. No PUCCH bits are shown in the Decoded Symbol Table.
- DESCrambled –Descrambled, descrambled (channel coded) bits for each subframe are shown on the Decoded Symbol Table.
- DECodeD – Decoded, decoded bits for each subframe are shown in the Decoded Symbol Table.

NOTE

For PUCCH Format 2/2a/2b, where both CQI/PMI and HARQ-ACK bits are jointly encoded, CQI/PMI information bits are listed first in a set of PUCCH bits, followed by HARQ-ACK information bits.

Key Path	Meas Setup, Decode, Decode Type
Mode	LTE, LTETDD
Remote Command	[:SENSe] :EVM:ULINk:DECode:PUCCh NONE DESCrambled DECodeD [:SENSe] :EVM:ULINk:DECode:PUCCh?
Example	EVM:ULIN:DEC:PUC NONE EVM:ULIN:DEC:PUC?
Notes	Available when Direction is Uplink.
State Saved	Saved in instrument state.
Range	None DESCrambled DECodeD
Initial S/W Revision	A.10.00

DCI Format Detection Include

Configures how the demodulator detects DCI formats 1, 1B, and 1D.

The analyzer uses the number of the PDCCH message payload bits to determine the DCI format used in a PDCCH. DCI formats 1B and 1D always have equal lengths. In some cases, message payload length for DCI format 1 can be the same length as 1B and 1D. To specify which DCI formats to look for, the analyzer provides the following settings for the DCI Formats 1, 1B, 1D Detection Include parameter.

- F1F1B - Formats 1 and 1B, the analyzer assumes format 1D is not present. When frame configuration enables format 1 to have the same length as format 1B, all DCI message payloads of this length are decoded as format 1. Otherwise, formats 1 and 1B are decoded separately.
- F1FD - Formats 1 and 1D, the analyzer assumes format 1B is not present. When frame configuration enables format 1 to have the same length as format 1D, all DCI message payloads of this length are decoded as format 1. Otherwise, formats 1 and 1D are decoded separately.
- F1 - Format 1 only, the analyzer assumes that formats 1B and 1D are not present. Format 1B or 1D message payloads are decoded as format 1 when possible format 1 message payload lengths include the format 1B/1D payload length. Otherwise, format 1B or 1D message payloads are ignored.

- F1B - Format 1B only, the analyzer assumes that formats 1 and 1D are not present. Any message payloads with the length of a format 1B payload are decoded as format 1B.
- F1D - Format 1D only, the analyzer assumes that formats 1 and 1B are not present. Any message payloads with the length of a format 1D payload are decoded as format 1D.

Key Path	Meas Setup, Decode
Mode	LTE, LTETDD
Remote Command	[:SENSe] :EVM:DLINK:DECode:DFINclude F1F1B F1F1D F1 F1B F1D [:SENSe] :EVM:DLINK:DECode:DFINclude?
Example	EVM:DLIN:DEC:DFIN F1F1B EVM:DLIN:DEC:DFIN?
Dependencies	Available when Direction is Downlink.
Preset	F1F1B
State Saved	Saved in instrument state.
Range	Formats1 and 1B Formats1 and 1D Format1 only Format1B only Format1D only
Initial S/W Revision	A.06.00

RNTI Range

Specifies the range of RNTI values for PDCCH transmissions that will be used as Random Access RNTIs (=RA-RNTI) or Transmit Power Control RNTIs (=TPC-RNTI) for decoding purposes. This parameter is available when Direction is Downlink.

Key Path	Meas Setup, Decode
Initial S/W Revision	A.06.00

RA-RNTI Range Min Value

Sets the minimum value of the RA-RNTI range.

RA-RNTI Range specifies the range of RNTI values that are assumed to be RA-RNTIs when decoding PDCCH transmissions. This parameter is needed to unambiguously decode the contents of DCI Format 1A.

NOTE

Zero is not a valid RA-RNTI value, but is used to indicate that there are no RA-RNTI contained in the LTE signal when both the Min and Max values are set to 0.

Any PDCCH whose CRC is scrambled with an RNTI that is not contained in either the RA-RNTI or TPC-RNTI ranges and cannot be determined to be a SI-RNTI or P-RNTI will be demodulated as a C-RNTI PDCCH.

Key Path	Meas Setup, Decode, RNTI Range
Mode	LTE, LTETDD
Remote Command	[:SENSe] :EVM:DLINK:DECode:RNTI:MINimum:RA <integer>

	<code>[:SENSe] :EVM:DLINk:DECode:RNTI:MINimum:RA?</code>
Example	<code>EVM:DLIN:DEC:RNTI:MIN:RA 0</code> <code>EVM:DLIN:DEC:RNTI:MIN:RA?</code>
Notes	The value should be less than or equal to RA-RNTI Range Max Value.
Dependencies	Available when Direction is Downlink.
Preset	0
State Saved	Saved in instrument state.
Min	0
Max	60
Initial S/W Revision	A.06.00

RA-RNTI Range Max Value

Sets the maximum value of the RA-RNTI range.

RA-RNTI Range specifies the range of RNTI values that are assumed to be RA-RNTIs when decoding PDCCH transmissions. This parameter is needed to unambiguously decode the contents of DCI Format 1A.

NOTE

Zero is not a valid RA-RNTI value, but is used to indicate that there are no RA-RNTI contained in the LTE signal when both the Min and Max values are set to 0.

Any PDCCH whose CRC is scrambled with an RNTI that is not contained in either the RA-RNTI or TPC-RNTI ranges and cannot be determined to be a SI-RNTI or P-RNTI will be demodulated as a C-RNTI PDCCH.

Key Path	Meas Setup, Decode, RNTI Range
Mode	LTE, LTETDD
Remote Command	<code>[:SENSe] :EVM:DLINk:DECode:RNTI:MAXimum:RA <integer></code> <code>[:SENSe] :EVM:DLINk:DECode:RNTI:MAXimum:RA?</code>
Example	<code>EVM:DLIN:DEC:RNTI:MAX:RA 0</code> <code>EVM:DLIN:DEC:RNTI:MAX:RA?</code>
Notes	The value should be greater than or equal to the RA-RNTI Range Min Value.
Dependencies	Available only when Direction is Downlink.
Preset	0
State Saved	Saved in instrument state.
Min	0
Max	60
Initial S/W Revision	A.06.00

TPC-RNTI Range Min Value

Sets the minimum value of the TPC-RNTI range.

TPC-RNTI Range specifies the range of RNTI values that are assumed to be TPC-RNTIs when decoding PDCCH transmissions.

DCI Formats 3 and 3A have the same message payload size as DCI Formats 0 and 1A. Any PDCCHs with a RNTI falling within the specified TPC-RNTI Range will be decoded as DCI Format 3/3A transmit power control commands.

NOTE Any PDCCH whose CRC is scrambled with an RNTI that is not contained in either the RA-RNTI or TPC-RNTI ranges and cannot be determined to be a SI-RNTI or P-RNTI will be demodulated as a C-RNTI PDCCH.

Key Path	Meas Setup, Decode, RNTI Range
Mode	LTE, LTETDD
Remote Command	[:SENSe] :EVM:DLINk:DECode:RNTI:MINimum:TPC <integer> [:SENSe] :EVM:DLINk:DECode:RNTI:MINimum:TPC?
Example	EVM:DLIN:DEC:RNTI:MIN:TPC 0 EVM:DLIN:DEC:RNTI:MIN:TPC?
Notes	The value should be less than or equal to TPC-RNTI Range Max Value.
Dependencies	Available only when Direction is Downlink.
Preset	0
State Saved	Saved in instrument state.
Min	0
Max	65523
Initial S/W Revision	A.06.00

TPC-RNTI Range Max Value

Sets the maximum value of the TPC-RNTI range.

TPC-RNTI Range specifies the range of RNTI values that are assumed to be TPC-RNTIs when decoding PDCCH transmissions.

DCI Formats 3 and 3A have the same message payload size as DCI Formats 0 and 1A. Any PDCCHs with a RNTI falling within the specified TPC-RNTI Range will be decoded as DCI Format 3/3A transmit power control commands.

NOTE Any PDCCH whose CRC is scrambled with an RNTI that is not contained in either the RA-RNTI or TPC-RNTI ranges and cannot be determined to be a SI-RNTI or P-RNTI will be demodulated as a C-RNTI PDCCH.

Key Path	Meas Setup, Decode, RNTI Range
Mode	LTE, LTETDD
Remote Command	[:SENSe] :EVM:DLINk:DECode:RNTI:MAXimum:TPC <integer> [:SENSe] :EVM:DLINk:DECode:RNTI:MAXimum:TPC?
Example	EVM:DLIN:DEC:RNTI:MAX:TPC 0

	EVM:DLIN:DEC:RNTI:MAX:TPC?
Notes	The value should be greater than or equal to the TPC-RNTI Range Min Value.
Dependencies	Available only when Direction is Downlink.
Preset	0
State Saved	Saved in instrument state.
Min	0
Max	65523
Initial S/W Revision	A.06.00

DCI Format 2 PMI Config

Displays a menu that enables you to specify the latest Precoding Matrix Indicator(s) (PMI) reported by the UE. The latest PMI report can be specified for PDSCH allocations using 1, 2, 3, or 4 layers. Valid PMI reports are shown in the table below:

Num. of Layers	2 Tx Antenna Ports	4 Tx Antenna Ports
1	0-3	0-15
2	0-1	0-15
3	n/a	0-15
4	n/a	0-15

When Format 2 DCI is used to specify PDSCH RB allocations for a user, the eNodeB can explicitly specify the precoding that was applied to the PDSCH allocations, or can indicate that the last PMI report from the UE was used. In the latter case, the LTE demodulator needs to know what PMI that the UE reported to be able to completely decode the contents of the DCI payload as well as decode the corresponding PDSCH user allocation.

More information about DCI Format 2 can be found in 3GPP TS 36.211, Section 5.3.3.1.5.

Key Path	Meas Setup, Decode,
Mode	LTE, LTETDD
Initial S/W Revision	A.10.00

Latest PMI Report on PUSCH using 1 Layer

Specifies the latest Precoding Matrix Indicator(s) (PMI) reported by the UE.

Key Path	Meas Setup, Decode, DCI Format 2 PMI Config
Mode	LTE, LTETDD

Remote Command	<code>[:SENSe] :EVM:DLINK:DECode:DFTWo:PRONe <integer></code> <code>[:SENSe] :EVM:DLINK:DECode:DFTWo:PRONe?</code>
Example	<code>EVM:DLIN:DEC:DFTW:PRON 1</code> <code>EVM:DLIN:DEC:DFTW:PRON?</code>
Dependencies	Available when Direction is Downlink and Number of C-RS Ports is set to 2 or 4 Antennas. The number of valid PMI reports differs depending on the number of C-RS Ports. 2 Antennas: 0-3 4 Antennas: 0-15
Preset	0
State Saved	Saved in instrument state.
Min	0
Max	Depends on the number of C-RS Ports. 2 Antennas: 3 4 Antennas: 15
Initial S/W Revision	A.10.00

Latest PMI Report on PUSCH using 2 Layers

Specifies the latest Precoding Matrix Indicator(s) (PMI) reported by the UE.

Key Path	Meas Setup, Decode, DCI Format 2 PMI Config
Mode	LTE, LTETDD
Remote Command	<code>[:SENSe] :EVM:DLINK:DECode:DFTWo:PRTWo <integer></code> <code>[:SENSe] :EVM:DLINK:DECode:DFTWo:PRTWo?</code>
Example	<code>EVM:DLIN:DEC:DFTW:PRTW 1</code> <code>EVM:DLIN:DEC:DFTW:PRTW?</code>
Dependencies	Available when Direction is Downlink and Number of C-RS Ports is set to 2 or 4 Antennas. The number of valid PMI reports differs depending on Number of C-RS Ports. 2 Antennas: 0-1 4 Antennas: 0-15
Preset	0
State Saved	Saved in instrument state.
Min	0
Max	Depends on the number of C-RS Ports. 2 Antennas: 1 4 Antennas: 15
Initial S/W Revision	A.10.00

Latest PMI Report on PUSCH using 3 Layers

Specifies the latest Precoding Matrix Indicator(s) (PMI) reported by the UE.

Key Path	Meas Setup, Decode, DCI Format 2 PMI Config
Mode	LTE, LTE-TDD
Remote Command	[:SENSe] :EVM:DLINK:DECode:DFTWo:PRTHree <integer> [:SENSe] :EVM:DLINK:DECode:DFTWo:PRTHree?
Example	EVM:DLIN:DEC:DFTW:PRTH 1 EVM:DLIN:DEC:DFTW:PRTH?
Dependencies	Available when Direction is Downlink and Number of C-RS Ports is set to 4 Antennas. The number of valid PMI reports differs depending on Number of C-RS Ports.
Preset	0
State Saved	Saved in instrument state.
Min	0
Max	15
Initial S/W Revision	A.10.00

Latest PMI Report on PUSCH using 4 Layers

Specifies the latest Precoding Matrix Indicator(s) (PMI) reported by the UE.

Key Path	Meas Setup, Decode, DCI Format 2 PMI Config
Mode	LTE, LTE-TDD
Remote Command	[:SENSe] :EVM:DLINK:DECode:DFTWo:PRFour <integer> [:SENSe] :EVM:DLINK:DECode:DFTWo:PRFour?
Example	EVM:DLIN:DEC:DFTW:PRF 1 EVM:DLIN:DEC:DFTW:PRF?
Dependencies	Available when Direction is Downlink and Number of C-RS Ports is set to 4 Antennas.
Preset	0
State Saved	Saved in instrument state.
Min	0
Max	15
Initial S/W Revision	A.10.00

PUSCH Decode Parameters

Displays a menu that enables you to configure decoding of HARQ-ACK, RI, and CQI/PMI information bits.

Available when Direction is Uplink.

Info Size parameter

Specifies the number of bits for all PUSCH transmissions for the selected uplink user allocation.

When AutoDet is selected for HARQ-ACK, RI, or CQI/PMI, the corresponding information bit size will be auto detected as far as possible.

The possible range of information bits is listed as follows:

- HARQ-ACK bits range: 0–11 bits
- RI bits range: 0–2 bits
- CQI-PMI bits range: 0–128 bits

TIP: For best demodulation performance, specify Info Size manually.

Offset Index parameter

Specifies the value of loffset for HARQ-ACK, RI, and CQI in the tables listed in 3GPP TS 36.213, Section 8.6.3.

The possible range of Offset Index values are as follows:

- HARQ-ACK bits range: 0–14 bits
- RI bits range: 0–12 bits
- CQI-PMI bits range: 2–15 bits

Key Path	Meas Setup, Decode
Mode	LTE, LTETDD
Initial S/W Revision	A.10.00

PUSCH HARQ-ACK

Displays a menu that enables you to set the information size and offset index of PUSCH HARQ ACK/NACK.

Key Path	Meas Setup, Decode, PUSCH Decode Parameters
Mode	LTE, LTETDD
Initial S/W Revision	A.10.00

PUSCH HARQ-ACK Info Size

Specifies the HARQ-ACK informatin size in bits.

When AutoDet is selected, information size will be auto detected as far as possible.

TIP: For the best demodulation performance, specify Info Size manually.

Key Path	Meas Setup, Decode, PUSCH Decode Parameters, HARQ-ACK
----------	---

Mode	LTE, LTETDD
Remote Command	[:SENSe] :EVM:ULINk:DECode:PUSCh:HARQ:ISIZe <integer> [:SENSe] :EVM:ULINk:DECode:PUSCh:HARQ:ISIZe? [:SENSe] :EVM:ULINk:DECode:PUSCh:HARQ:ISIZe:AUTO OFF ON 0 1 [:SENSe] :EVM:ULINk:DECode:PUSCh:HARQ:ISIZe:AUTO?
Example	EVM:ULIN:DEC:PUSC:HARQ:ISIZ 0 EVM:ULIN:DEC:PUSC:HARQ:ISIZ? EVM:ULIN:DEC:PUSC:HARQ:ISIZ:AUTO 0 EVM:ULIN:DEC:PUSC:HARQ:ISIZ:AUTO?
Dependencies	Available when Direction is Uplink and PUSCH HARQ-ACK Info Size Auto Detect is OFF.
Preset	0 ON
State Saved	Saved in instrument state.
Min	0
Max	11
Initial S/W Revision	A.10.00

PUSCH HARQ-ACK Offset Index

Specifies the value of loffset for HARQ-ACK in the tables listed in 3GPP TS 36.213, Section 8.6.3.

Key Path	Meas Setup, Decode, PUSCH Decode Parameters, HARQ-ACK
Mode	LTE, LTETDD
Remote Command	[:SENSe] :EVM:ULINk:DECode:PUSCh:HARQ:OFFSet <integer> [:SENSe] :EVM:ULINk:DECode:PUSCh:HARQ:OFFSet?
Example	EVM:ULIN:DEC:PUSC:HARQ:OFFS 0 EVM:ULIN:DEC:PUSC:HARQ:OFFS?
Dependencies	Available when Direction is Uplink.
Preset	0
State Saved	Saved in instrument state.
Min	0
Max	14
Initial S/W Revision	A.10.00

PUSCH RI

Displays a menu that enables you to set the information size and offset index of PUSCH Rank Indicator.

Key Path	Meas Setup, Decode, PUSCH Decode Parameters
Mode	LTE, LTETDD
Initial S/W Revision	A.10.00

PUSCH RI Info Size

Specifies the RI informatin size in bits.

When AutoDet is selected, information size will be auto detected as far as possible.

TIP: For the best demodulation performance, specify Info Size manually.

Key Path	Meas Setup, Decode, PUSCH Decode Parameters, RI
Mode	LTE, LTETDD
Remote Command	[:SENSe]:EVM:ULINk:DECode:PUSCh:RI:ISIZe <integer> [:SENSe]:EVM:ULINk:DECode:PUSCh:RI:ISIZe? [:SENSe]:EVM:ULINk:DECode:PUSCh:RI:ISIZe:AUTO OFF ON 0 1 [:SENSe]:EVM:ULINk:DECode:PUSCh:RI:ISIZe:AUTO?
Example	EVM:ULIN:DEC:PUSC:RI:ISIZ 0 EVM:ULIN:DEC:PUSC:RI:ISIZ? EVM:ULIN:DEC:PUSC:RI:ISIZ:AUTO 1 EVM:ULIN:DEC:PUSC:RI:ISIZ:AUTO?
Dependencies	Available when Direction is Uplink and PUSCH RI Info Size Auto Detect is Off.
Preset	0 ON
State Saved	Saved in instrument state.
Min	0
Max	2
Initial S/W Revision	A.10.00

PUSCH RI Offset Index

Specifies the value of loffset for RI in the tables listed in 3GPP TS 36.213, Section 8.6.3.

Key Path	Meas Setup, Decode, PUSCH Decode Parameters, RI
Mode	LTE, LTETDD
Remote Command	[:SENSe]:EVM:ULINk:DECode:PUSCh:RI:OFFSet <integer> [:SENSe]:EVM:ULINk:DECode:PUSCh:RI:OFFSet?
Example	EVM:ULIN:DEC:PUSC:RI:OFFS 1 EVM:ULIN:DEC:PUSC:RI:OFFS?

Dependencies	Available when Direction is Uplink.
Preset	0
State Saved	Saved in instrument state.
Min	0
Max	12
Initial S/W Revision	A.10.00

PUSCH CQI/PMI

Displays a menu that enables you to set the information size and offset index of PUSCH Channel Quality & Precoding Matrix Indicator.

Key Path	Meas Setup, Decode, PUSCH Decode Parameters
Mode	LTE, LTETDD
Initial S/W Revision	A.10.00

PUSCH CQI/PMI Info Size

Specifies the CQI/PMI information size in bits.

When AutoDet is selected, information size will be auto detected as far as possible.

TIP: For the best demodulation performance, specify Info Size manually.

Key Path	Meas Setup, Decode, PUSCH Decode Parameters, CQI/PMI
Mode	LTE, LTETDD
Remote Command	<pre>[:SENSe] :EVM:ULINk:DECode:PUSCh:CQI:ISIZe <integer> [:SENSe] :EVM:ULINk:DECode:PUSCh:CQI:ISIZe? [:SENSe] :EVM:ULINk:DECode:PUSCh:CQI:ISIZe:AUTO OFF ON 0 1 [:SENSe] :EVM:ULINk:DECode:PUSCh:CQI:ISIZe:AUTO?</pre>
Example	<pre>EVM:ULIN:DEC:PUSC:CQI:ISIZ 1 EVM:ULIN:DEC:PUSC:CQI:ISIZ? EVM:ULIN:DEC:PUSC:CQI:ISIZ:AUTO OFF EVM:ULIN:DEC:PUSC:CQI:ISIZ:AUTO?</pre>
Dependencies	Available when Direction is Uplink and PUSCH CQI/RI Info Size Auto Detect is Off.
Preset	0 ON
State Saved	Saved in instrument state.
Min	0
Max	128
Initial S/W Revision	A.10.00

PUSCH CQI/PMI Offset Index

Specifies the value of loffset for CQI/PMI in the tables listed in 3GPP TS 36.213, Section 8.6.3.

Key Path	Meas Setup, Decode, PUSCH Decode Parameters, CQI/PMI
Mode	LTE, LTETDD
Remote Command	[:SENSe] :EVM:ULINk:DECode:PUSCh:CQI:OFFSet <integer> [:SENSe] :EVM:ULINk:DECode:PUSCh:CQI:OFFSet?
Example	EVM:ULIN:DEC:PUSC:CQI:OFFS 2 EVM:ULIN:DEC:PUSC:CQI:OFFS?
Preset	2
State Saved	Saved in instrument state.
Min	2
Max	15
Initial S/W Revision	A.10.00

PUCCH Decode Parameters

Displays a menu that enables you to configure decoding of HARQ-ACK and CQI/PMI information bits. The Info Size parameter specifies the number of bits for all PUCCH transmissions for the selected uplink user allocation.

Available when Direction is Uplink.

Info Size parameter

Specifies the number of bits for all PUCCH transmissions for the selected uplink user allocation.

When AutoDet is selected for HARQ-ACK or CQI/PMI, the corresponding information bit size will be auto detected as far as possible.

The possible range of information bits is listed as follows:

- HARQ-ACK bits range: 0–2 bits
- CQI-PMI bits range: 0–11 bits

TIP: For best demodulation performance, specify Info Size manually.

Key Path	Meas Setup, Decode
Mode	LTE, LTETDD
Initial S/W Revision	A.10.00

PUCCH HARQ-ACK

Displays a menu that enables you to set the of PUCCH HARQ ACK/NACK information size in bits.

Key Path	Meas Setup, Decode, PUCCH Decode Parameters
Mode	LTE, LTETDD
Initial S/W Revision	A.10.00

PUCCH HARQ-ACK Info Size

Specifies the HARQ-ACK information size in bits.

When AutoDet is selected, information size will be auto detected as far as possible.

TIP: For the best demodulation performance, specify Info Size manually.

Key Path	Meas Setup, Decode, PUCCH Decode Parameters, HARQ-ACK
Mode	LTE, LTETDD
Remote Command	<pre>[:SENSe] :EVM:ULINk:DECode:PUCCh:HARQ:ISIZe <integer> [:SENSe] :EVM:ULINk:DECode:PUCCh:HARQ:ISIZe? [:SENSe] :EVM:ULINk:DECode:PUCCh:HARQ:ISIZe:AUTO OFF ON 0 1 [:SENSe] :EVM:ULINk:DECode:PUCCh:HARQ:ISIZe:AUTO?</pre>
Example	<pre>EVM:ULIN:DEC:PUCCh:HARQ:ISIZ 0 EVM:ULIN:DEC:PUCCh:HARQ:ISIZ? EVM:ULIN:DEC:PUCCh:HARQ:ISIZ:AUTO 0 EVM:ULIN:DEC:PUCCh:HARQ:ISIZ:AUTO?</pre>
Dependencies	Available when Direction is Uplink and PUCCH HARQ-ACK Info Size Auto Detect is Off.
Preset	0 ON
State Saved	Saved in instrument state.
Min	0
Max	2
Initial S/W Revision	A.10.00

PUCCH CQI/PMI

Displays a menu that enables you to set the Channel Quality & Precoding Matrix Indicator information size in bits.

Key Path	Meas Setup, Decode, PUCCH Decode Parameters
Mode	LTE, LTETDD
Initial S/W Revision	A.10.00

PUCCH CQI/PMI Info Size

Specifies the CQI/PMI information size in bits.

When AutoDet is selected, information size will be auto detected as far as possible.

TIP: For the best demodulation performance, specify Info Size manually.

Key Path	Meas Setup, Decode, PUCCH Decode Parameters, CQI/PMI
Mode	LTE, LTETDD
Remote Command	[:SENSe] :EVM:ULINk:DECode:PUCCh:CQI:ISIZe <integer> [:SENSe] :EVM:ULINk:DECode:PUCCh:CQI:ISIZe? [:SENSe] :EVM:ULINk:DECode:PUCCh:CQI:ISIZe:AUTO OFF ON 0 1 [:SENSe] :EVM:ULINk:DECode:PUCCh:CQI:ISIZe:AUTO?
Example	EVM:ULIN:DEC:PUCC:CQI:ISIZ 0 EVM:ULIN:DEC:PUCC:CQI:ISIZ? EVM:ULIN:DEC:PUCC:CQI:ISIZ:AUTO 0 EVM:ULIN:DEC:PUCC:CQI:ISIZ:AUTO?
Dependencies	Available when Direction is Uplink and PUCCH HARQ-ACK Info Size Auto Detect is Off.
Preset	0 ON
State Saved	Saved in instrument state.
Min	0
Max	11
Initial S/W Revision	A.10.00

ACK/NACK Feedback Mode

Specifies whether the current HARQ ACK/NACK feedback mode is ACK/NACK multiplexing or ACK/NACK bundling. See 3GPP TS 36.212, Section 5.2.2.6 and 3GPP TS 36.213, Section 7.3 for more information.

Key Path	Meas Setup, Decode
Mode	LTETDD
Remote Command	[:SENSe] :EVM:ULINk:DECode:ANFMode MULTiplexing BUNDling [:SENSe] :EVM:ULINk:DECode:ANFMode?
Example	EVM:ULIN:DEC:ANFM MULT EVM:ULIN:DEC:ANFM?
Dependencies	Available when Direction is Uplink.
Preset	MULTiplexing
State Saved	Saved in instrument state.
Range	BUNDling MULTiplexing
Initial S/W Revision	A.10.00

Advanced

Displays a menu that enables you to select lesser used demodulation parameters for the current measurement. These settings are for advanced users and do not normally require adjustment for most common measurements.

Key Path	Meas Setup, More
Mode	LTE, LTETDD
Initial S/W Revision	Prior to A.02.00
Modified at S/W Revision	A.03.00

Cyclic Prefix Length (Downlink)

Selects whether to automatically detect the Cyclic Prefix Length or specify the cyclic prefix length for Downlink.

- AUTO – Auto detect the Cyclic Prefix Length
- NORMAl – Specify Cyclic Prefix Length as Normal (7.03125% the length of the symbol)
- EXTended – Specify Cyclic Prefix Length as Extended (25% the length of the symbol)

Cyclic Prefix Length specifies the cyclic prefix mode. The current Cyclic Prefix Length mode is displayed in the "Error Summary" on page 2309 trace.

The Cyclic Prefix is added by the transmitter to each OFDM symbol by taking the last 7% (or 25% for extended Cyclic Prefix) of the OFDM symbol and appending it to the front. The addition of the Cyclic Prefix enables time for all the paths in a multipath environment to arrive at the receiver before the symbol is demodulated.

See "Symbol Timing Adjust" on page 2212 for information about setting the location of the symbol FFT.

Key Path	Meas Setup, Advanced
Mode	LTE, LTETDD
Remote Command	[:SENSe] :EVM:DLINK:SYNC:CPLength AUTO NORMAl EXTended [:SENSe] :EVM:DLINK:SYNC:CPLength? [:SENSe] :EVM:DLINK:SYNC:CPLength:AUTO OFF ON 0 1 [:SENSe] :EVM:DLINK:SYNC:CPLength:AUTO?
Example	EVM:DLIN:SYNC:CPL NORM EVM:DLIN:SYNC:CPL? EVM:DLIN:SYNC:CPL:AUTO 1 EVM:DLIN:SYNC:CPL:AUTO?
Couplings	Coupled with Cyclic Prefix Length (Uplink).
Preset	AUTO ON

State Saved	Saved in instrument state.
Range	Normal Extended
Initial S/W Revision	Prior to A.02.00
Modified at S/W Revision	A.03.00

Auto

Selects Cyclic Prefix Length automatically.

Key Path	Meas Setup, Advanced, Cyclic Prefix Length
Mode	LTE, LTETDD
Initial S/W Revision	Prior to A.02.00
Modified at S/W Revision	A.03.00

Normal

Selects Normal Cyclic Prefix Length.

Key Path	Meas Setup, Advanced, Cyclic Prefix Length
Mode	LTE, LTETDD
Initial S/W Revision	Prior to A.02.00
Modified at S/W Revision	A.03.00

Extended

Selects Extended Cyclic Prefix Length.

Key Path	Meas Setup, Advanced, Cyclic Prefix Length
Mode	LTE, LTETDD
Initial S/W Revision	Prior to A.02.00
Modified at S/W Revision	A.03.00

Cyclic Prefix Length (Uplink)

Selects whether to automatically detect the Cyclic Prefix Length or specify the cyclic prefix length for Uplink.

- AUTO – Auto detect the Cyclic Prefix Length
- NORMal – Specify Cyclic Prefix Length as Normal (7.03125% the length of the symbol)
- EXTended – Specify Cyclic Prefix Length as Extended (25% the length of the symbol)

Cyclic Prefix Length specifies the cyclic prefix mode. The current Cyclic Prefix Length mode is displayed in the ["Error Summary" on page 2309](#) trace.

The Cyclic Prefix is added by the transmitter to each OFDM symbol by taking the last 7% (or 25% for extended Cyclic Prefix) of the OFDM symbol and appending it to the front. The addition of the Cyclic Prefix enables time for all the paths in a multipath environment to arrive at the receiver before the symbol is demodulated.

See ["Symbol Timing Adjust" on page 2212](#) for information about setting the location of the symbol FFT.

Key Path	Meas Setup, Advanced
Mode	LTE, LTETDD
Remote Command	[:SENSe] :EVM:ULINk:SYNC:CPLength AUTO NORMal EXTended [:SENSe] :EVM:ULINk:SYNC:CPLength? [:SENSe] :EVM:ULINk:SYNC:CPLength:AUTO OFF ON 0 1 [:SENSe] :EVM:ULINk:SYNC:CPLength:AUTO?
Example	EVM:ULIN:SYNC:CPL AUTO EVM:ULIN:SYNC:CPL? EVM:ULIN:SYNC:CPL:AUTO 1 EVM:ULIN:SYNC:CPL:AUTO?
Dependencies	When Sync Type is set to PRACH, Auto softkey is grayed out.
Couplings	Coupled with Cyclic Prefix Length (Downlink).
Preset	AUTO ON
State Saved	Saved in instrument state.
Range	Normal Extended
Initial S/W Revision	Prior to A.02.00
Modified at S/W Revision	A.03.00

Extended Freq Lock Range

Provides the ability to reduce the frequency lock range. When this parameter is on, the frequency lock range is two and a half times the subcarrier spacing or 37.5 kHz. When this parameter is off, it is reduced to one half the subcarrier spacing, or 7.5kHz, which enables faster processing time.

Key Path	Meas Setup, Advanced
Mode	LTE, LTETDD
Remote Command	[:SENSe] :EVM:EXTended:FREQuency:LOCK:RANGe OFF ON 0 1 [:SENSe] :EVM:EXTended:FREQuency:LOCK:RANGe?
Example	EVM:EXT:FREQ:LOCK:RANG OFF EVM:EXT:FREQ:LOCK:RANG?
Preset	OFF

State Saved	Saved in instrument state.
Initial S/W Revision	Prior to A.02.00
Modified at S/W Revision	A.03.00

Equalizer Training

Displays a menu that enables you to set whether or not to equalize the signal.

Channel equalization only applies to phase and amplitude. For information about signal-level timing correction, see ["Sync Type" on page 1862](#).

NOTE

Small-scale deviations (slot-by-slot or symbol-by-symbol) from the equalization channel frequency response are compensated by EVM Minimization.

Downlink:

The channel frequency response is computed over the entire Result Length, and the resulting coefficients are shown in the Eq Chan Freq Resp trace.

- OFF - When Off is selected, no equalization will be applied to the signal.
- RS - When RS is selected, equalization will be performed using the frequency response calculated from the reference signal for the reference antenna path. The channel frequency response for subcarriers between reference signals will be linearly interpolated.
- For downlink, the standard only specifies using the reference signal for equalization. However, the LTE demodulator can apply a RS+Data equalization for single-channel downlink signals.
- RSD - When RS+Data is selected, equalization will be performed using the frequency response calculated using the reference signal and the data subcarriers. RS+Data equalization is not supported for multi-antenna downlink signals (when number of input channels is greater than 1).

When including data (PDSCH) subcarriers in equalizer calculations:

1. The demodulator equalizes the signal using the reference signal and demodulates the data subcarrier values.
2. Using the demodulated signal, the demodulator calculates a reference LTE signal (shown in IQ Ref)
3. Then the demodulator calculates another equalizer channel frequency response by comparing all the measured PDSCH and RS subcarrier values with the corresponding reference subcarrier values
4. Finally, the channel frequency response including PDSCH is applied to the signal, the signal is demodulated, and the results of the demodulation are shown on the traces

A moving average can be applied to the RS subcarriers in frequency. For more information, see ["Moving Average Filter" on page 2210](#).

NOTE

To see the measured channel frequency response for the current Tx/Rx path, use the Eq Chan Freq Resp trace.

To see the measured channel frequency responses for all Tx/Rx paths, use the MIMO Eq Chan Freq Resp trace.

The **Equalizer Training** setting determines what subcarriers are used when the Tracking method of EVM Minimization is selected. See the **"EVM Minimization" on page 2223** for more information.

Uplink:

Channel frequency responses are computed and equalization is applied on a slot-by-slot basis. These per-slot channel frequency responses are shown in the **"Eq Ch Freq Resp Per Slot" on page 2320** trace. The **"Eq Ch Frequency Response" on page 2319** trace however shows a single set of channel frequency response coefficients computed from the time data in the **"Search Time" on page 2299** trace (capture length defined by **"Result Length" on page 1879**).

- OFF - When Off is selected, the channel frequency response will still be calculated from the DM-RS subcarriers but will not be applied to the signal.
- RS - When RS is selected, the signal will be equalized using the channel frequency response calculated using the DM-RS subcarriers in the signal.
- RSD - When RS+Data is selected, the LTE demodulator calculates the equalizer channel frequency response according to the standard using the DM-RS subcarriers and the DFT-spread (SC-FDMA) subcarriers (PUSCH). The LTE standard specifies that an RS+Data equalization should be performed for uplink signals.

NOTE

PRACH equalization is done differently from the other uplink channels' equalization. First, the channel frequency response is calculated for a PRACH transmission by comparing the received preamble sequence to the reference preamble sequence. Then, the channel frequency response is averaged to a single correction value and this correction is applied to all subcarriers in the PRACH preamble. Each PRACH transmission is equalized separately from the other PRACH transmissions.

PRACH equalization is done this way because if each PRACH subcarrier were corrected individually, the equalization will simply remove the error from the PRACH transmission (resulting in near zero EVM) since the channel frequency response will be calculated from the same subcarriers that were being equalized.

Key Path	Meas Setup, Advanced
Mode	LTE, LTETDD
Remote Command	[:SENSe] :EVM:EQUalizer:TRaining OFF RS RSD [:SENSe] :EVM:EQUalizer:TRaining?
Example	EVM:EQU:TRA RS EVM:EQU:TRA?
Preset	RS
State Saved	Saved in instrument state.
Range	None RS RS + Data
Initial S/W Revision	Prior to A.02.00
Modified at S/W Revision	A.03.00

Off

Selects no Equalizer Training.

Key Path	Meas Setup, Advanced, Equalizer Training
Mode	LTE, LTETDD
Initial S/W Revision	Prior to A.02.00
Modified at S/W Revision	A.03.00

RS

Selects RS Equalizer Training.

Key Path	Meas Setup, Advanced, Equalizer Training
Mode	LTE, LTETDD
Initial S/W Revision	Prior to A.02.00
Modified at S/W Revision	A.03.00

RS + Data

Selects RS + Data Equalizer Training.

Key Path	Meas Setup, Advanced, Equalizer Training
Mode	LTE, LTETDD
Initial S/W Revision	A.03.00

Moving Average Filter

Sets the value and state of the Moving Avg Filter.

Moving Avg Filter specifies whether or not to perform a moving average (frequency smoothing) on the reference signals during equalization, as well as the number of RS subcarriers to use in each average.

When Equalizer Training is set to **RS**, a value of 5 RS means the value of an RS subcarrier is calculated as the average of the value of that subcarrier and the values of the next two and previous two RS subcarriers in frequency.

When Equalizer Training is set to **RS+Data**, data subcarriers (PDSCH) in between the RS subcarriers are included in the average. For example, a setting of 3 RS means that the value of an RS subcarrier will be taken as the average of the next and previous RS subcarrier in frequency and all data subcarriers that are in between the next and previous RS subcarriers.

For RS subcarrier locations that do not have enough RS subcarriers to one side or the other (those near the edge of the frequency spectrum), the average is taken over available reference signal subcarriers.

Key Path	Meas Setup, Sync/Format Setup
Mode	LTE, LTETDD
Remote Command	[:SENSe]:EVM:EQUalizer:TRaining:MAFilter:LENGth <integer> [:SENSe]:EVM:EQUalizer:TRaining:MAFilter:LENGth? [:SENSe]:EVM:EQUalizer:TRaining:MAFilter OFF ON 0 1 [:SENSe]:EVM:EQUalizer:TRaining:MAFilter?
Example	EVM:EQU:TRA:MAF:LENG 19 EVM:EQU:TRA:MAF:LENG? EVM:EQU:TRA:MAF ON EVM:EQU:TRA:MAF?
Notes	This parameter will always clip to an odd number. Available when Direction is Downlink.
Preset	19 ON
State Saved	Saved in instrument state.
Min	1
Max	399
Initial S/W Revision	Prior to A.02.00
Modified at S/W Revision	A.03.00

MIMO Channel Frequency Normalize

Selects normalized or non-normalized MIMO Ch Frequency Response trace data. Normalized trace data is scaled to show each MIMO channel antenna path frequency response trace centered around 0 db. For normalized traces, all MIMO Channel paths are individually normalized for magnitude, phase, and time offset. For non-normalized trace data, the trace data is not scaled or modified.

Key Path	Meas Setup, Advanced, Equalizer Training
Mode	LTE, LTETDD
Remote Command	[:SENSe]:EVM:EQUalizer:TRaining:MCFNnormalize OFF ON 0 1 [:SENSe]:EVM:EQUalizer:TRaining:MCFNnormalize?
Example	EVM:EQU:TRA:MCFN OFF EVM:EQU:TRA:MCFN?
Dependencies	Available only when Direction is Downlink.
Preset	ON
State Saved	Saved in instrument state.
Range	On Off
Initial S/W Revision	A.06.00

Equalizer Training Mode

Selects the equalization method. This key is available only when Direction is set to Uplink.

- ZFORcing – Use Zero-Forcing equalizer
- LSQuares – Use Least Squares equalizer

Key Path	Meas Setup, Advanced
Mode	LTE, LTETDD
Remote Command	[:SENSe] :EVM:EQUalizer:TRaining:MODE ZFORcing LSQuares [:SENSe] :EVM:EQUalizer:TRaining:MODE?
Example	EVM:EQU:TRA:MODE ZFOR EVM:EQU:TRA:MODE?
Dependencies	Available only when Direction is Uplink. Disabled when Sync Type is PRACH.
Preset	ZFORcing
State Saved	Saved in instrument state.
Range	Zero Forcing Least Squares
Initial S/W Revision	A.06.00

Symbol Timing Adjust

Sets the demodulator to equalize the signal (i.e., whether or not to compensate for measured channel frequency response).

Key Path	Meas Setup, Advanced
Mode	LTE, LTETDD
Remote Command	[:SENSe] :EVM:SYMBol:TIMing:ADJust MAX MIN START END CENTer FFTSize [:SENSe] :EVM:SYMBol:TIMing:ADJust?
Example	EVM:SYMB:TIM:ADJ MAX EVM:SYMB:TIM:ADJ?
Preset	MAX
State Saved	Saved in instrument state.
Range	Max of EVM Win Start/End Min of EVM Win Start/End EVM Window Start EVM Window End EVM Window Center %FFT Size
Initial S/W Revision	Prior to A.02.00
Modified at S/W Revision	A.03.00

Max of EVM Window Start/End

Selects Max of EVM Window Start/End for Symbol Timing Adjust . When Max of EVM Window Start / End selected, the EVM for each subcarrier comes from the data set determined in the following manner: For each OFDM symbol, two FFTs are taken to determine the values of the subcarriers. The first FFT is taken starting at the beginning of the EVM Window. The second is taken starting at the end of the EVM Window. Two sets of EVMs are calculated for the subcarriers, one from each FFT. Then an RMS average is taken over each set. The set with the highest RMS average EVM is then chosen as the set to use in EVM and demodulation results.

Key Path	Meas Setup, Advanced, Symbol Timing Adjust
Mode	LTE, LTETDD
Initial S/W Revision	Prior to A.02.00
Modified at S/W Revision	A.03.00

Min of EVM in Start/End

Selects Min of EVM Window Start/End for Symbol Timing Adjust. When Min of EVM Window Start / End is selected, the EVM for each subcarrier comes from the data set determined in the following manner: For each OFDM symbol, two FFTs are taken to determine the values of the subcarriers. The first FFT is taken starting at the beginning of the EVM Window. The second is taken starting at the end of the EVM Window. Two sets of EVMs are calculated for the subcarriers, one from each FFT. Then an RMS average is taken over each set. The set with the highest RMS average EVM is then chosen as the set to use in EVM and demodulation results.

Key Path	Meas Setup, Advanced, Symbol Timing Adjust
Mode	LTE, LTETDD
Initial S/W Revision	Prior to A.02.00
Modified at S/W Revision	A.03.00

EVM Window Start

Selects EVM Window Start for Symbol Timing Adjust .

Key Path	Meas Setup, Advanced, Symbol Timing Adjust
Mode	LTE, LTETDD
Initial S/W Revision	Prior to A.02.00
Modified at S/W Revision	A.03.00

EVM Window End

Selects EVM Window Stop for Symbol Timing Adjust.

Key Path	Meas Setup, Advanced, Symbol Timing Adjust
Mode	LTE, LTETDD
Initial S/W Revision	Prior to A.02.00
Modified at S/W Revision	A.03.00

EVM Window Center

Selects EVM Window Center for Symbol Timing Adjust.

Key Path	Meas Setup, Advanced, Symbol Timing Adjust
Mode	LTE, LTETDD
Initial S/W Revision	Prior to A.02.00
Modified at S/W Revision	A.03.00

% FFT Size

Selects %FFT Size for Symbol Timing Adjust which enables you to enter the value. When % of FFT Size is selected, the symbol FFT used for EVM and demodulation results begins at the specified location. A maximum value of 0% begins the FFT at the end of the CP (beginning of the Symbol). The minimum value of -7.125% (or -25% for extended CP Length) begins the FFT at the beginning of the cyclic prefix. Setting the value to 0% will provide the maximum amount of time for all the paths in a multipath environment to arrive at the receiver before the symbol FFT is taken.

Key Path	Meas Setup, Advanced, Symbol Timing Adjust
Mode	LTE, LTETDD
Remote Command	[:SENSe] :EVM:SYMBol:TIMing:ADJust:USER <percent> [:SENSe] :EVM:SYMBol:TIMing:ADJust:USER?
Example	EVM:SYMB:TIM:ADJ:USER -3.125 EVM:SYMB:TIM:ADJ:USER?
Preset	-3.125 %
State Saved	Saved in instrument state.
Min	-25 %
Max	0 %
Initial S/W Revision	Prior to A.02.00
Modified at S/W Revision	A.03.00

EVM Window Length

Selects the EVM Window Length.

EVM Window Length specifies the length of the window used for EVM calculations. The EVM window is centered in the cyclic prefix.

A value of 3GPP will set EVM Window Length according to the LTE standard for EVM measurements. A Custom EVM window length can also be specified in the range of 1–512 samples. A value of 512 samples corresponds to the entire CP length for Extended CP on a 20 MHz signal.

The standard states that the EVM for an LTE signal's subcarriers should be taken from the higher of the two EVM RMS averages calculated from the FFTs taken from the start and from the end of the EVM window. For example, an EVM Window Length of 3 samples means that two FFTs will be taken, one on either sample adjacent to the center sample of the CP. The EVMs for the subcarriers will come from the FFT with the higher EVM RMS average. However, the location of the symbol FFT used for EVM calculations can be set specifically using the Symbol Timing Adjust parameter.

NOTE

A value of 1 sample will cause the EVM to be measured from an FFT taken from the center of the cyclic prefix, since any other FFTs will just be taken over the same sample points.

EVM Window Length does not apply when Symbol Timing Adjust is set to % of FFT Size or EVM Window Center since these settings cause only one FFT to be taken starting from the specified location within the cyclic prefix regardless of the EVM Window Length setting.

Key Path	Meas Setup, Advanced
Mode	LTE, LTETDD
Remote Command	[:SENSe] :EVM:WINDow:LENGth GPP CUSTom [:SENSe] :EVM:WINDow:LENGth?
Example	EVM:WIND:LENG GPP EVM:WIND:LENG?
Preset	GPP
State Saved	Saved in instrument state.
Range	RS None
Initial S/W Revision	Prior to A.02.00
Modified at S/W Revision	A.03.00

3GPP

Selects 3GPP for EVM Window Length.

Key Path	Meas Setup, Advanced, EVM Window Length
Mode	LTE, LTETDD
Initial S/W Revision	Prior to A.02.00
Modified at S/W Revision	A.03.00

EVM Window Length Custom

Sets the EVM Window Length. This key is available only when EVM Window Length is set to Custom

Key Path	Meas Setup, Advanced, EVM Window Length, Custom
Mode	LTE, LTETDD
Remote Command	[:SENSe] :EVM:WINDow:LENGth:CUSTom <int> [:SENSe] :EVM:WINDow:LENGth:CUSTom?
Example	EVM:WIND:LENG:CUST 1 EVM:WIND:LENG:CUST?
Preset	32
State Saved	Saved in instrument state.
Min	1
Max	The max value differs depending on the Sync Type (Uplink) and BW the user selected. When Sync Type (Uplink) is set to PRACH; 1.4 MHz -> 1314 3 MHz -> 2628 5 MHz -> 5256 10 MHz -> 10512 15 MHz -> 15768 20 MHz -> 21024 When Sync Type (Uplink) is set to other than PRACH; 1.4 MHz -> 32 3 MHz -> 64 5 MHz -> 128 10 MHz -> 256 15 MHz -> 384 20 MHz -> 512
Initial S/W Revision	Prior to A.02.00
Modified at S/W Revision	A.03.00, A.06.00

Result Format

Displays a menu of keys that enables you to set the result format.

Key Path	Meas Setup, Advanced
Mode	LTE, LTETDD
Initial S/W Revision	A.06.00

Report EVM in dB

Switches the unit of EVM reporting between percentage and dB.

When set to ON, EVM is reported in dB on all traces.

When set to Off, EVM is reported in %rms according to the LTE standard.

The reference for EVM calculation in both cases is the ideal IQ points that are displayed on the IQ Ref and IQ Ref Time traces.

Key Path	Meas Setup, Advanced, Result Format
Mode	LTE, LTETDD
Remote Command	[:SENSe] :EVM:REPort:DB OFF ON 0 1 [:SENSe] :EVM:REPort:DB?
Example	EVM:REP:DB OFF EVM:REP:DB?
Preset	OFF
State Saved	Saved in instrument state.
Initial S/W Revision	Prior to A.02.00
Modified at S/W Revision	A.03.00

Report Relative Power Levels

Switches the unit of Power reporting between in Absolute (dBm) and relative (dB).

The following traces are affected by this parameter:

- Error Vector Spectrum
- Error Vector Time
- IQ Freq Meas
- IQ Freq Ref
- IQ Meas
- IQ Meas Time
- IQ Ref
- IQ Ref Time
- RB Error Mag Spectrum
- RB Error Mag Time
- RB Power Spectrum
- RB Power Time
- RMS Error Vector Spectrum
- RMS Error Vector Time

The only summary table affected by this parameter is the Frame Summary table. The channel power will be reported in dB when this parameter is selected and in dBm when this parameter is cleared. The power values reported on Error Summary and MIMO Info Table are not affected by this parameter.

Key Path	Meas Setup, Advanced, Result Format
Mode	LTE, LTETDD
Remote Command	[:SENSe]:EVM:REPort:POWer:RELative OFF ON 0 1 [:SENSe]:EVM:REPort:POWer:RELative?
Example	EVM:REP:POW:REL OFF EVM:REP:POW:REL?
Preset	ON
State Saved	Saved in instrument state.
Initial S/W Revision	A.03.00

Power Boost Normalize

Determines if Power Boost Normalize is used.

When Power Boost Normalize is enabled, results displayed on IQ traces will be normalized by the power level (set for each channel in the LTE Allocation Editor) or power boost (in Downlink Control Channel Properties) settings of the corresponding channels so that each channel's average power is 0 dB.

Key Path	Meas Setup, Advanced, Result Format
Mode	LTE, LTETDD
Remote Command	[:SENSe]:EVM:POWer:BOOSt:NORMAlize OFF ON 0 1 [:SENSe]:EVM:POWer:BOOSt:NORMAlize?
Example	EVM:POW:BOOS:NORM OFF EVM:POW:BOOS:NORM?
Preset	ON
State Saved	Saved in instrument state.
Initial S/W Revision	Prior to A.02.00
Modified at S/W Revision	A.03.00

UE-RS Weights

Displays a menu that enables you to set UE-RS Weights parameters.

Key Path	Meas Setup, Advanced, Result Format
Mode	LTE, LTETDD
Initial S/W Revision	A.10.00
Modified at S/W Revision	A.13.00

Compensate Chan Freq Resp

Determines whether the UE-RS weights are compensated for the channel calculated from the Reference Signal.

- On: the UE-RS weights are compensated for the channel frequency response which is shown in the Eq Chan Freq trace.
- Off: the UE-RS weights are not compensated for the channel frequency response.

Key Path	Meas Setup, Advanced, Result Format, UE-RS Weights
Mode	LTE, LTETDD
Remote Command	[:SENSe] :EVM:DLINK:UERS:CFRCompen OFF ON 0 1 [:SENSe] :EVM:DLINK:UERS:CFRCompen?
Example	EVM:DLIN:UERS:CFRC ON EVM:DLIN:UERS:CFRC?
Notes	Available when Direction is Downlink.
Preset	ON
State Saved	Saved in instrument state.
Range	On Off
Initial S/W Revision	A.10.00
Modified at S/W Revision	A.13.00

Display Weights in Real/Imaginary Format

Determines whether the values of complex UE-RS weights are shown as real/imaginary pairs or as magnitude/phase pairs on the UE-Specific RS Weights summary table.

Key Path	Meas Setup, Advanced, Result Format, UE-RS Weights
Mode	LTE, LTETDD
Remote Command	[:SENSe] :EVM:DLINK:UERS:WEIGhts:RIFormat OFF ON 0 1 [:SENSe] :EVM:DLINK:UERS:WEIGhts:RIFormat?
Example	EVM:DLIN:UERS:WEIG:RIF ON EVM:DLIN:UERS:WEIG:RIF?
Notes	Available when Direction is Downlink.
Preset	OFF
State Saved	Saved in instrument state.
Range	On Off
Initial S/W Revision	A.10.00
Modified at S/W Revision	A.13.00

Weights Display Mode

Determines how the UE-RS weights are shown in the UE-specific Weights summary table.

- PSUBcarrier - Per Subcarrier: the UE-RS weights are shown for each UE-RS subcarrier. UE-RS subcarrier weights are averaged over all subframes in the Measurement Interval. Weights Display Mode can be set to Per Subcarrier only by SCPI command, it is not accessible from front panel.
- PRB - Per RB: the UE-RS weights are shown for each resource block in frequency. A UE-RS weight for a resource block is averaged over the subcarriers in the resource block as well as all subframes in the Measure Interval.
- PUSer - Per User: UE-RS subcarrier weights are averaged over all UE-RS resource elements in the Measurement Interval for a user allocation and the averaged UE-RS is shown for each user.

Key Path	Meas Setup, Advanced, Result Format, UE-RS Weights
Mode	LTE, LTETDD
Remote Command	<code>[:SENSe] :EVM:DLINK:UERS:WEIGhts:DISPlay PSUBcarrier PRB PUSer</code> <code>[:SENSe] :EVM:DLINK:UERS:WEIGhts:DISPlay?</code>
Example	<code>EVM:DLIN:UERS:WEIG:DISP PUSer</code> <code>EVM:DLIN:UERS:WEIG:DISP?</code>
Notes	Available when Direction is Downlink.
Preset	PUSer
State Saved	Saved in instrument state.
Range	PRB PUSer
Initial S/W Revision	A.10.00
Modified at S/W Revision	A.12.00, , A.13.00

Time Scale Factor

Sets Time Scale Factor.

Time Scale Factor sets the value by which to scale the bandwidth and time lengths of the measured signal. This setting can be used to compensate for mistuned crystals or to enable demodulation of signals at a lower rate, such as half rate or 1/10 rate.

Key Path	Meas Setup, Advanced, More
Mode	LTE, LTETDD
Remote Command	<code>[:SENSe] :EVM:TIME:SCALE:FACTor <value></code> <code>[:SENSe] :EVM:TIME:SCALE:FACTor?</code>
Example	<code>EVM:TIME:SCAL:FACT 1</code> <code>EVM:TIME:SCAL:FACT?</code>
Preset	1
State Saved	Saved in instrument state.
Min	0.0625

Max	16
Initial S/W Revision	Prior to A.02.00
Modified at S/W Revision	A.03.00

Multi Carrier Filter

Specifies whether or not to apply a filter to the received LTE signal to filter out adjacent carriers.

When other carriers are expected to be adjacent to the LTE carrier of interest, this multi-carrier filter can be used to filter out the unwanted carrier and minimize leakage into the LTE carrier of interest.

Key Path	Meas Setup, Advanced
Mode	LTE, LTETDD
Remote Command	<code>[:SENSe] :EVM:MCFilter:STATe OFF ON 0 1</code> <code>[:SENSe] :EVM:MCFilter:STATe?</code>
Example	<code>EVM:MCF:STAT ON</code> <code>EVM:MCF:STAT?</code>
Preset	OFF
State Saved	Saved in instrument state.
Range	On Off
Initial S/W Revision	A.06.00

Phase Noise Optimization

The Phase Noise Optimization setting affects the phase noise distribution on the analyzer's LO.

Key Path	Meas Setup, Advanced
Mode	LTE, LTETDD
Remote Command	<code>[:SENSe] :EVM:FREQuency:SYNThesis [:STATe] 1 2 3</code> <code>[:SENSe] :EVM:FREQuency:SYNThesis [:STATe] ?</code>
Example	<code>EVM:FREQ:SYNT 1</code> <code>EVM:FREQ:SYNT?</code>
Notes	Parameter key: 1 - Best Close-in 2 - Best Wide-offset 3 - Fast Tuning
Preset	Models with option EP2: 3 Other: 1 The preset value of PXA is determined by considering balance of speed and phase noise. Compared

	with Best Wide-offset, Best Close-in is faster, however, it has phase noise disadvantage.
State Saved	Saved in instrument state.
Initial S/W Revision	A.03.00
Modified at S/W Revision	A.13.00, A.14.00

Best Close-in Φ Noise

Selects Best Close-in Φ Noise for the Phase Noise Optimization.

Key Path	Meas Setup, Advanced, PhNoise Opt
Mode	LTE, LTETDD
Couplings	The frequency below which the phase noise is optimized is model dependent: <ul style="list-style-type: none"> • PXA with option EP1: [offset <140 kHz] • Models with option EP2: [offset <70 kHz] • CXA with option EP4: [offset <90 kHz] • CXA without option EP4: n/a • All other models: [offset <20 kHz]
Initial S/W Revision	A.03.00

Best Wide-offset Φ Noise

Selects Best Wide-offset Φ Noise for the Phase Noise Optimization.

Key Path	Meas Setup, Advanced, PhNoise Opt
Mode	LTE, LTETDD
Couplings	The frequency below which the phase noise is optimized is model dependent: <ul style="list-style-type: none"> • PXA with option EP1: [offset >160 kHz] • Models with option EP2: [offset >100 kHz] • CXA with option EP4: [offset >130 kHz] • CXA without option EP4: n/a • All other models: [offset >30 kHz]
Initial S/W Revision	A.03.00

Fast Tuning

Selects Fast Tuning for the Phase Noise Optimization.

Key Path	Meas Setup, Advanced, PhNoise Opt
Mode	LTE, LTETDD

Couplings	The Fast Tuning details are model dependent: <ul style="list-style-type: none"> • CXA without option EP4: n/a • PXA with option EP1: [single loop] • Models with option EP2: [medium loop bandwidth] • All other models: [same as Close-in]
Initial S/W Revision	A.13.00

EVM Minimization

Selects whether or not EVM Minimization algorithm will be applied. EVM Minimization uses the reference signal to correct the signal.

- OFF - Disable EVM Minimization
- GPP – 3GPP EVM minimization, the demodulator calculates timing, frequency/phase and IQ offset corrections using the reference signal and the data subcarriers as defined in Section F.3.1 of 36.141 for DL and Section E.3.1 of 36.521 for UL. For downlink, the data subcarriers are from PDSCH, and for uplink the data subcarriers are from PUSCH and PUCCH.
- The demodulator applies the corrections on a slot-by-slot basis for uplink, or on a subframe-by-subframe basis for downlink, as defined by the LTE standard.
- TRACKing - Tracking, the demodulator applies corrections on a symbol-by-symbol basis and the Equalizer Training parameter determines whether or not data subcarriers are included in calculating corrections. When Equalizer Training is set to RS+Data, EVM Minimization Tracking is performed using the reference signal and the PDSCH data subcarriers. When Equalizer Training is set to RS or Off, EVM Minimization Tracking is performed using only the reference signal.

Reference signal subcarriers are transmitted periodically in time and frequency. The demodulator compares the reference signals with the expected data sequence and computes an error, or correction value, that can be used to track phase, amplitude, and timing at the symbol level when Tracking is selected and at the slot or subframe level when 3GPP is selected. For subcarriers that do not have a corresponding reference subcarrier to compare to, the correction value is calculated by linearly interpolating between RS (and PDSCH, when Equalizer Training is set to RS+Data) subcarrier corrections.

When corrections are averaged and applied to a slot or subframe, the same correction is applied to each symbol in the slot or subframe.

There are four corrections that can be applied to the signal to minimize the EVM: Amplitude, Frequency/Phase, Timing, and IQ Offset (IQ Offset is only for Uplink). See ["EVM Minimization Items" on page 2224](#) for more details.

Key Path	Meas Setup, Advanced
Mode	LTE, LTETDD
Remote Command	[:SENSE] :EVM:EVMMinimize OFF GPP TRACKing [:SENSE] :EVM:EVMMinimize?
Example	EVM:EVMM OFF

	EVM:EVMM?
Dependencies	3GPP is available only when Number of C-RS Ports is set to 1 Port.
Preset	3GPP
State Saved	Saved in instrument state.
Range	Off 3GPP Tracking
Initial S/W Revision	A.03.00

EVM Minimization Items

Four types of corrections are available. They are calculated by comparing the measured reference signal to the ideal reference signal:

- Amplitude - When selected, the average reference signal amplitude error will be used to correct the amplitudes of the subcarriers.
- Frequency/Phase - When selected, the average reference signal phase difference will be used to adjust subcarrier phase.
- Timing - When selected, the average slope (average rate of change) of the RS phase in the frequency domain is used to correct the timing.
- IQ Offset (uplink, 3GPP only) - When selected, any IQ offset is compensated for on a slot-by-slot basis. This type of EVM minimization is only available when 3GPP is selected and the direction is uplink.

For uplink, both equalization and 3GPP EVM Minimization occur on a slot-by-slot basis, while for downlink, equalization occurs over the entire Measurement Interval and 3GPP EVM Minimization occurs on a subframe-by-subframe basis.

Key Path	Meas Setup, Advanced
Mode	LTE, LTETDD
Initial S/W Revision	A.03.00
Modified at S/W Revision	A.11.00

EVM Minimization by Timing

Selects whether or not Timing will be used for EVM minimization algorithm.

Key Path	Meas Setup, Advanced, EVM Minimization Items
Mode	LTE, LTETDD
Remote Command	[[:SENSE]:EVM:EVMMinimize:TIMing OFF ON 0 1 [:SENSE]:EVM:EVMMinimize:TIMing?
Example	EVM:EVMM:TIM OFF EVM:EVMM:TIM?

Dependencies	Enabled when EVM minimization is set to ON.
Preset	ON
State Saved	Saved in instrument state.
Backwards Compatibility SCPI	[:SENSe] :EVM:PILot:TRACk:TIMing
Initial S/W Revision	A.03.00
Modified at S/W Revision	A.06.00

EVM Minimization by Frequency/Phase

Selects whether or not Frequency/Phase will be used for EVM minimization algorithm.

Key Path	Meas Setup, Advanced, EVM Minimization Items
Mode	LTE, LTETDD
Remote Command	[:SENSe] :EVM:EVMMinimize:FREQuency OFF ON 0 1 [:SENSe] :EVM:EVMMinimize:FREQuency?
Example	EVM:EVMM:FREQ OFF EVM:EVMM:FREQ?
Dependencies	Enabled when EVM minimization is set to ON
Preset	ON
State Saved	Saved in instrument state.
Backwards Compatibility SCPI	[:SENSe] :EVM:PILot:TRACk:PHASe
Initial S/W Revision	A.03.00
Modified at S/W Revision	A.06.00

EVM Minimization by Amplitude

Selects whether or not Amplitude will be used for EVM minimization algorithm.

Key Path	Meas Setup, Advanced, EVM Minimization Items
Mode	LTE, LTETDD
Remote Command	[:SENSe] :EVM:EVMMinimize:AMPLitude OFF ON 0 1 [:SENSe] :EVM:EVMMinimize:AMPLitude?
Example	EVM:EVMM:AMPL OFF EVM:EVMM:AMPL?
Dependencies	Enabled when EVM minimization is set to ON
Preset	ON

State Saved	Saved in instrument state.
Backwards Compatibility SCPI	[:SENSe] :EVM:PILot:TRACk:AMPLitude
Initial S/W Revision	A.03.00
Modified at S/W Revision	A.06.00

EVM Minimization by IQ Offset

Selects whether or not IQ Offset will be used for EVM minimization algorithm.

Key Path	Meas Setup, Advanced, EVM Minimization Items
Mode	LTE, LTETDD
Remote Command	[:SENSe] :EVM:EVMMinimize:IQOffset OFF ON 0 1 [:SENSe] :EVM:EVMMinimize:IQOffset?
Example	EVM:EVMM:IQOF OFF EVM:EVMM:IQOF?
Dependencies	Enabled when EVM minimization is set to ON and Direction is Uplink.
Preset	ON
State Saved	Saved in instrument state.
Backwards Compatibility SCPI	[:SENSe] :EVM:ULINK:SYNC:IQOComp
Initial S/W Revision	A.03.00

Exclude EVM Transient Time

Excludes the EVM results calculated from part of OFDM symbols during a PUSCH allocation change as specified by the standard.

Key Path	Meas Setup, Advanced
Mode	LTE, LTETDD
Remote Command	[:SENSe] :EVM:EETTime OFF ON 0 1 [:SENSe] :EVM:EETTime?
Example	EVM:EETT ON EVM:EETT?
Notes	Available when Direction is Uplink.
Preset	OFF
State Saved	Saved in instrument state.
Range	On Off
Initial S/W Revision	A.10.00

Opposite Direction Active

Specifies whether or not the signal for opposite direction is present in the signal under test. For example, when downlink signal is under test, if there is also uplink signal present in uplink subframe, set the Opposite Direction Active to On will make the measurement more accurate with the knowledge of possible interference from uplink subframes.

Key Path	Meas Setup, Advanced
Mode	LTETDD
Remote Command	[[:SENSe]:EVM:ODActive OFF ON 0 1 [:SENSe]:EVM:ODActive?
Example	EVM:ODAC ON EVM:ODAC?
Preset	OFF
State Saved	Saved in instrument state.
Range	On Off
Initial S/W Revision	A.10.00

Antenna Element Spacing

Specifies the distance between the antennas in a linear antenna array. This parameter is specified in units of wavelengths of the Center Frequency.

NOTE

NOTE The LTE demodulator only supports vertical linear antenna arrays with uniform spacing.

Key Path	Meas Setup, Advanced
Mode	LTE, LTETDD
Remote Command	[[:SENSe]:EVM:DLINk:AESpacing <double> [:SENSe]:EVM:DLINk:AESpacing?
Example	EVM:DLIN:AESP 0 EVM:DLIN:AESP?
Dependencies	Available when Direction is Downlink.
Preset	0.5
State Saved	Saved in instrument state.
Min	0
Max	100
Initial S/W Revision	A.10.00
Modified at S/W Revision	A.11.00, , A.13.00

Number of Antenna Elements

Sets the number of antenna elements per antenna group.

Key Path	Meas Setup, Advanced
Mode	LTE, LTETDD
Remote Command	[:SENSe] :EVM:DLINk:AENumber <integer> [:SENSe] :EVM:DLINk:AENumber?
Example	EVM:DLIN:AEN 3 EVM:DLIN:AEN?
Dependencies	Available when Direction is Downlink.
Preset	2
State Saved	Saved in instrument state.
Min	2
Max	8
Initial S/W Revision	A.11.00
Modified at S/W Revision	A.13.00

Spectrum Flatness Mask

Four parameters are required to calculate the limit for Per Slot Freq Resp trace, which can be used to perform the EVM equalizer spectrum flatness test defined in TS36-521 6.5.2.4

- Channel Condition – Specify under what environmental condition the test is performed. There two temperature conditions defined in TS36.101 Annex E, which are normal condition(+15°C to +35°C) and extreme condition(-10°C to +55°C).
- F_UL_Center – Specify the carrier frequency of the signal under test.
- F_UL_Low – Specify the lower frequency of the E-UTRA operating band defined in TS36-521-1 Table 5.2.1
- F_UL_High – Specify the upper frequency of the E-UTRA operating band defined in TS36-521-1 Table 5.2.1

This key is available only when Direction is Uplink.

Key Path	Meas Setup, Advanced, Limit
Mode	LTE, LTETDD
Initial S/W Revision	A.11.00

Spectrum Flatness Mask

Four parameters are required to calculate the limit for Per Slot Freq Resp trace, which can be used to perform the EVM equalizer spectrum flatness test defined in TS36-521 6.5.2.4

- Channel Condition – Specify under what environmental condition the test is performed. There two temperature conditions defined in TS36.101 Annex E, which are normal condition(+15°C to +35°C) and extreme condition(–10°C to +55°C).
- F_UL_Center – Specify the carrier frequency of the signal under test.
- F_UL_Low – Specify the lower frequency of the E-UTRA operating band defined in TS36–521–1 Table 5.2.1
- F_UL_High – Specify the upper frequency of the E-UTRA operating band defined in TS36–521–1 Table 5.2.1

This key is available only when Direction is Uplink.

Key Path	Meas Setup, Advanced, Limit
Mode	LTE, LTETDD
Initial S/W Revision	A.11.00

Channel Condition

Specifies under what condition the test is performed. This parameter will determine the minimum requirements for EVM equalizer spectrum flatness test.

Key Path	Meas Setup, Advanced, Limit, Spectrum Flatness Mask
Mode	LTE, LTETDD
Remote Command	[:SENSe] :EVM:ULINk:FLATness:CHANnel:CONDition NORMal EXTReme [:SENSe] :EVM:ULINk:FLATness:CHANnel:CONDition?
Example	EVM:ULIN:FLAT:CHAN:COND NORM EVM:ULIN:FLAT:CHAN:COND?
Dependencies	Available when Direction is uplink.
Preset	NORMal
State Saved	Saved in instrument state.
Range	NORMal EXTReme
Initial S/W Revision	A.11.00

F_UL_Center

Specifies the carrier frequency of signal under test.

Key Path	Meas Setup, Advanced, Limit, Spectrum Flatness Mask
Remote Command	[:SENSe] :EVM:ULINk:FREQuency:CENTer <freq> [:SENSe] :EVM:ULINk:FREQuency:CENTer?
Example	EVM:ULIN:FREQ:CENT 1.95 GHz EVM:ULIN:FREQ:CENT?

Couplings	The value is clipped to F_UL_Low or F_UL_High. If the value entered is greater than F_UL_High, it is set to the value of F_UL_High. If the value entered is lower than F_UL_Low, it is set to the value of F_UL_Low.
Preset	1.95GHz
State Saved	Saved in instrument state
Min	Depends on F_UL_Low
Max	Depends on F_UL_High
Default Unit	Hz
Initial S/W Revision	A.11.00

F_UL_Low

Specifies the lower frequency of the E-UTRA operating band defined in TS36-521-1 Table 5.2.1.

Key Path	Meas Setup, Advanced, Limit, Spectrum Flatness Mask
Remote Command	[:SENSe] :EVM:ULINk:FREQuency:LOW <freq> [:SENSe] :EVM:ULINk:FREQuency:LOW?
Example	EVM:ULIN:FREQ:LOW 1.92 GHz EVM:ULIN:FREQ:LOW?
Couplings	If the value entered is greater than F_UL_High, F_UL_High is set to the value of F_UL_Low.
Preset	1.92GHz
State Saved	Saved in instrument state
Min	0Hz
Max	Depends on F_UL_High
Default Unit	Hz
Initial S/W Revision	A.11.00

F_UL_High

Specifies the upper frequency of the E-UTRA operating band defined in TS36-521-1 Table 5.2.1

Key Path	Meas Setup, Advanced, Limit, Spectrum Flatness Mask
Remote Command	[:SENSe] :EVM:ULINk:FREQuency:HIGH <freq> [:SENSe] :EVM:ULINk:FREQuency:HIGH?
Example	EVM:ULIN:FREQ:HIGH 1.98 GHz EVM:ULIN:FREQ:HIGH?
Couplings	The value entered is lower than F_UL_Low, it is set to the F_UL_Low.
Preset	1.98GHz

State Saved	Saved in instrument state
Min	Depends on F_UL_Low
Max	5GHz
Default Unit	Hz
Initial S/W Revision	A.11.00

Store Equalizer Channel Frequency Response

This parameter performs the immediate action to store the following items in the LTE EVM measurement.

- Equalizer Channel Frequency Response
- Number of Points in Equalizer Channel Frequency Response
- Link Direction (Downlink or Uplink)

Key Path	Meas Setup, Advanced
Mode	LTE, LTE-TDD
Remote Command	:MEMory:EVM:STOR:ECFResponse
Example	MEM:EVM:STOR:ECFR
Notes	To use this parameter, Eq Ch Freq Resp under Trace/Detector > Data > Response needs to be assigned. Otherwise, an advisory message “'Eq Chan Freq Resp' needs to be assigned. Trace/Det - Data - Response” will appear.
Dependencies	Available when Option BBA or N9080A-DP2 is installed.
Initial S/W Revision	A.14.00

Meas Preset

Immediately sets all measurement parameters to their Preset values.

Key Path	Meas Setup
Mode	VSA
Remote Command	:CONFigure:VECTor
Example	CONF:VECT

Mode

See "[Mode](#)" on page 316

Mode Preset

Returns the active mode to a known state.

Mode Preset does the following for the currently active mode:

- Aborts the currently running measurement.
- Brings up the default menu for the mode, with no active function.
- Sets measurement Global settings to their preset values for the active mode only.
- Activates the default measurement.
- Brings up the default menu for the mode.
- Clears the input and output buffers.
- Sets Status Byte to 0.

Mode Preset does not:

- Cause a mode switch
- Affect mode persistent settings
- Affect system settings

See "[How-To Preset](#)" on page 2234 for more information.

Key Path	Front-panel key
Remote Command	:SYSTem:PRESet
Example	:SYST:PRES
Notes	*RST is preferred over :SYST:PRES for remote operation. *RST does a Mode Preset, as done by the :SYST:PRES command, and it sets the measurement mode to Single measurement rather than Continuous for optimal remote control throughput. Clears all pending OPC bits. The Status Byte is set to 0.
Couplings	A Mode Preset aborts the currently running measurement, activates the default measurement, and gets the mode to a consistent state with all of the default couplings set.
Backwards Compatibility Notes	In the X-Series, the legacy "Factory Preset" has been replaced with Mode Preset, which only presets the currently active mode, not the entire instrument. In the X-Series, the way to preset the entire instrument is by using System, Restore System Defaults All, which behaves essentially the same way as restore System Defaults does on ESA and PSA. There is also no "Preset Type" as there is on the PSA. There is a green Mode Preset front-panel key that does a Mode Preset and a white-with-green-letters User Preset front-panel key that does a User Preset. The old PRESet:TYPE command is ignored (without generating an error), and SYST:PRES without a parameter does a Mode Preset, which should cover most backward code compatibility issues. The settings and correction data under the Input/Output front-panel key (examples: Input Z Corr, Ext Amp Gain, etc.) are no longer part of any Mode, so they will not be preset by a Mode Preset. They are preset using Restore Input/Output Defaults, Restore System Defaults All. Note that because User Preset does a Recall State, and all of these settings are saved in State, they ARE recalled when using

	User Preset.
Initial S/W Revision	Prior to A.02.00

How-To Preset

The table below shows all possible presets, their corresponding SCPI commands and front-panel access (key paths). Instrument settings depend on the current measurement context. Some settings are local to the current measurement, some are global (common) across all the measurements in the current mode, and some are global to all the available modes. In a similar way, restoring the settings to their preset state can be done within the different contexts.

Auto Couple - is a measurement local key. It sets all Auto/Man parameter couplings in the measurement to Auto. Any Auto/Man selection that is local to other measurements in the mode will not be affected.

Meas Preset - is a measurement local key. Meas Preset resets all the variables local to the current measurement except the persistent ones.

Mode Preset - resets all the current mode's measurement local and measurement global variables except the persistent ones.

Restore Mode Defaults - resets ALL the Mode variables (and all the Meas global and Meas local variables), including the persistent ones.

Type Of Preset	SCPI Command	Front Panel Access
Auto Couple	:COUPle ALL	Auto Couple front-panel key
Meas Preset	:CONFigure:<Measurement>	Meas Setup Menu
Mode Preset	:SYSTem:PRESet	Mode Preset (green key)
Restore Mode Defaults	:INSTrument:DEFault	Mode Setup Menu
Restore All Mode Defaults	:SYSTem:DEFault MODes	System Menu; Restore System Default Menu
*RST	*RST	not possible (Mode Preset with Single)
Restore Input/Output Defaults	:SYSTem:DEFault INPUt	System Menu; Restore System Default Menu
Restore Power On Defaults	:SYSTem:DEFault PON	System Menu; Restore System Default Menu
Restore Alignment Defaults	:SYSTem:DEFault ALIGN	System Menu; Restore System Default Menu
Restore Miscellaneous Defaults	:SYSTem:DEFault MISC	System Menu; Restore System Default Menu
Restore All System Defaults	:SYSTem:DEFault [ALL] :SYSTem:PRESet:PERsistent	System Menu; Restore System Default Menu
User Preset	:SYSTem:PRESet:USER	User Preset Menu
User Preset All Modes	:SYSTem:PRESet:USER:ALL	User Preset Menu

Power On Mode Preset	:SYSTem:PON:TYPE MODE	System Menu
Power On User Preset	:SYSTem:PON:TYPE USER	System Menu
Power On Last State	:SYSTem:PON:TYPE LAST	System Menu

Preset Type (Remote Command Only)

As stated in the Backward Compatibility section, to be compatible with ESA/PSA the PRESet:TYPE command will be implemented as a no-op.

Mode	All
Remote Command	:SYSTem:PRESet:TYPE FACTory MODE USER :SYSTem:PRESet:TYPE?
Example	:SYST:PRE:TYPE FACT
Notes	This command is supported for backward compatibility only. It is a no-op which does not change the behavior of any preset operation.
Preset	This is unaffected by Preset but is set to Mode on a “Restore System Defaults->All”
State Saved	No
Initial S/W Revision	Prior to A.02.00

Mode Setup

See "[Mode Setup](#)" on page 347

Peak Search

Displays a menu that enables markers to be easily moved among peaks on a trace and also performs the peak search function. Pressing Peak Search also makes the selected marker's X position the active function.

The peak search function causes the marker to move to the highest point in the trace. The highest point is the point with the largest y-axis value in the current trace format. If the format is complex (vector or constellation) then the point with the highest magnitude is chosen.

Pressing the Peak Search hard key always performs a Peak Search, with one exception: if the Peak Search menu is not showing but the selected marker is on (Normal, Delta, or Fixed), then pressing the Peak Search hardkey only displays the Peak Search menu. This enables you to select one of the other peak search functions without disturbing the selected marker's position. If you want to perform a peak search in this case, press the Peak Search hardkey again.

If the selected marker is Off, then pressing the Peak Search hardkey once not only shows the menu, but it turns on the selected marker in Normal mode, assigns it to the selected trace, and performs a peak search.

If any peak search SCPI command is invoked on a marker that is Off, the marker is first turned on in Normal mode and assigned to the selected trace. Then the peak search is performed.

Key Path	Front Panel
Mode	VSA, LTE, LTETDD, IDEN
Measurement	<meas>:=VECTor ADEMod DDEMod W11A W11B EVM IPOWER IDEMod MOTotalk
Remote Command	:CALCulate:<meas>:MARKer[1] 2 ...12:MAXimum
Example	CALC:VECT:MARK2:MAX
Notes	There is no softkey for this function. Instead, you press the Peak Search hardkey twice. (Pressing it once is sufficient if the Peak Search menu is showing, but twice guarantees that the function is invoked) If peak search function is not invoked (because the response to pressing the hardkey was only to show the menu) then the following message is shown: "Press Peak Search again to perform a Peak Search."
Initial S/W Revision	Prior to A.02.00
Modified at S/W Revision	A.02.00

Select Marker

Specifies the selected marker. The selected marker is the one that is affected by the marker position and properties settings, peak search, and other marker functions. Several menus have a Select Marker key for convenience. Marker selection using any one of these is reflected in all others, in other words, there is only one selected marker for the whole measurement. If all markers are off, then marker 1 becomes the selected marker.

As a convenience, if no markers are displayed on the selected trace, selecting a marker that is off automatically turns it on in normal mode on the selected trace.

There is no SCPI function for selecting a marker. Instead, SCPI functions can explicitly include the index of the marker for which they are to apply. (Most SCPI marker functions that affect the state of a marker also make it the selected marker for front panel commands.)

Key Path	Marker or Marker> or Marker Function or Peak Search
Mode	VSA, LTE, LTETDD, IDEN, LTEAFDD, LTEATDD
State Saved	No
Range	1 2 3 4 5 6 7 8 9 10 11 12
Initial S/W Revision	Prior to A.02.00
Modified at S/W Revision	A.02.00

Next Peak (Next Lower Amptd)

Moves the marker to the peak next lower in Y value than the peak it is currently on. If the format is complex (vector or constellation) then the marker moves to the closest point that has a lower magnitude than the marker's current position. If this function is invoked via SCPI on a marker that is off, the result is the same as if you sent a Peak Search command.

Key Path	Peak Search
Mode	VSA, LTE, LTETDD, IDEN
Measurement	<meas>:=VECTor ADEMod DDEMod W11A W11B EVM IPOWER IDEMod MOTotalk
Remote Command	:CALCulate:<meas>:MARKer [1] 2 . . . 12 :MAXimum:NEXT
Example	CALC:VECT:MARK2:MAX:NEXT
Initial S/W Revision	Prior to A.02.00
Modified at S/W Revision	A.02.00

Next Higher Amptd

Moves the marker to the peak next higher in Y value than the peak it is currently on. If the format is complex (vector or constellation) then the marker moves to the closest point that has a higher magnitude than the marker's current position. If this function is invoked via SCPI on a marker that is off, the result is the same as if you sent a Peak Search command.

Key Path	Peak Search
Mode	VSA, LTE, LTETDD, IDEN
Measurement	<meas>:=VECTor ADEMod DDEMod W11A W11B EVM IPOWER IDEMod MOTotalk
Remote Command	:CALCulate:<meas>:MARKer [1] 2 . . . 12 :MAXimum:PREVIOUS
Example	CALC:VECT:MARK2:MAX:PREV
Initial S/W Revision	Prior to A.02.00
Modified at S/W Revision	A.02.00

Next Right

Moves the marker to the next peak to the right of its current position. If the format is complex (vector or constellation) then the marker moves forward in time to the next peak. If this function is invoked via SCPI on a marker that is off, the result is the same as if you sent a Peak Search command.

A valid peak is one for which the displayed Y-axis values drop monotonically on both sides of the local maximum at least 4% of the distance between the top and bottom of the display grid before the values begin to rise again.

Key Path	Peak Search
Mode	VSA, LTE, LTETDD, IDEN
Measurement	<meas>:=VECTor ADEMod DDEMod W11A W11B EVM IPOWER IDEMod MOTotalk
Remote Command	:CALCulate:<meas>:MARKer[1] 2 ...12:MAXimum:RIGHT
Example	CALC:VECT:MARK2:MAX:RIGH
Initial S/W Revision	Prior to A.02.00
Modified at S/W Revision	A.02.00

Next Left

Moves the marker to the next peak to the left of its current position. If the format is complex (vector or constellation) then the marker moves back in time to the next peak. If this function is invoked via SCPI on a marker that is off, the result is the same as if you sent a Peak Search command.

A valid peak is one for which the displayed Y-axis values drop monotonically on both sides of the local maximum at least 4% of the distance between the top and bottom of the display grid before the values begin to rise again.

Key Path	Peak Search
Mode	VSA, LTE, LTETDD, IDEN
Measurement	<meas>:=VECTor ADEMod DDEMod W11A W11B EVM IPOWER IDEMod MOTotalk
Remote Command	:CALCulate:<meas>:MARKer[1] 2 ...12:MAXimum:LEFT
Example	CALC:VECT:MARK2:MAX:LEFT
Initial S/W Revision	Prior to A.02.00
Modified at S/W Revision	A.02.00

Mkr -> CF (Center Frequency)

Sets the center frequency equal to the selected marker's absolute frequency. The marker must be on a frequency-domain trace. The absolute marker frequency is used regardless of whether its control mode is Normal, Delta, or Fixed.

If the currently selected marker is not on when this key is pressed, it is turned on at the center of the screen as a normal type marker.

Key Path	Marker To
Mode	VSA, LTE, LTETDD, IDEN, LTEAFDD, LTEATDD
Initial S/W Revision	Prior to A.02.00
Modified at S/W Revision	A.02.00

Continuous Peak Search

Turns on Continuous Peak Search for the selected marker. This function can be turned on for any marker independently of any other marker. This function moves the marker to the highest point on the trace each time the trace is updated. If the SCPI command refers to a marker that is off, it is turned on in Normal mode.

It is possible to have Couple Markers and Continuous Peak Search both on. If this is the case, it is recommended that Continuous Peak search be turned on for only one marker in any tracking set (that is, any set of markers with the same or equivalent domain). Otherwise, conflicts over marker position can arise that cause erratic marker movement.

Key Path	Peak Search
Mode	VSA, LTE, LTETDD, IDEN
Measurement	<meas>:=VECTor ADEMod DDEMod W11A W11B EVM IPOWER IDEMod MOTotalk
Remote Command	:CALCulate:<meas>:MARKer[1] 2 ...12:CPSearch[:STATE] ON OFF 1 0 :CALCulate:<meas>:MARKer[1] 2 ...12:CPSearch[:STATE]?
Example	CALC:VECT:MARK1:CPS ON
Couplings	The Continuous Peak Search key is grayed out when the selected marker is a Fixed marker. Also, if Continuous Peak Search is on and the selected marker becomes a fixed marker, then Continuous Peak Search is turned off and the key grayed out. Continuous Peak Search is turned off when the selected marker is turned off.
Preset	OFF
State Saved	Saved in instrument state.
Range	Off On
Initial S/W Revision	Prior to A.02.00
Modified at S/W Revision	A.02.00

Min Search

Moves the marker to the lowest Y value on the trace. If the format is complex (vector or constellation) then the marker moves to the lowest value in magnitude. If the SCPI command refers to a marker that is off, it is first turned on in Normal mode and then set on the minimum point.

Key Path	Peak Search
Mode	VSA, LTE, LTETDD, IDEN

Measurement	<meas>:=VECTor ADEMod DDEMod W11A W11B EVM IPOWER IDEMod MOTotalk
Remote Command	:CALCulate:<meas>:MARKer [1] 2 . . . 12:MINimum
Example	CALC:VECT:MARK2:MIN
Initial S/W Revision	Prior to A.02.00
Modified at S/W Revision	A.02.00

Mkr -> Ref Lvl (Reference Level)

Sets the Y axis reference value equal to the selected marker's Y value. For example, if the reference position is at the top of the screen, the whole trace is moved up so that the marker appears at the top of the screen. Note that this is a display scaling function only. The input range remains the same.

Key Path	Peak Search
Mode	VSA, LTE, LTETDD, IDEN
Initial S/W Revision	Prior to A.02.00
Modified at S/W Revision	A.02.00

15 LTE Modulation Analysis Measurement
Print

Print

See ["Print" on page 365](#)

Quick Save

The Quick Save front-panel key repeats the most recent save that was performed from the Save menu, with the following exceptions:

- Register saves are not remembered as Saves for the purpose of the Quick Save function
- If the current measurement does not support the last non-register save that was performed, an informational message is generated, “File type not supported for this measurement”

Quick Save repeats the last type of qualified save (that is, a save qualified by the above criteria) in the last save directory by creating a unique filename using the Auto File Naming algorithm described below.

If Quick Save is pressed after startup and before any qualified Save has been performed, the Quick Save function performs a Screen Image save using the current settings for Screen Image saves (current theme, current directory), which then becomes the “last save” for the purpose of subsequent Quick Saves.

The Auto File Naming feature automatically generates a file name for use when saving a file. The filename consists of a prefix and suffix separated by a dot, as is standard for the Windows® file system. A default prefix exists for each of the available file types:

Type	Default Prefix	Menu
State	State_	(Save/Recall)
Trace + State	State_	(Save/Recall)
Screen	Screen_	(Save/Recall)
Amplitude Corrections	Ampcor_	(Import/Export)
Traces	Trace_	(Import/Export)
Limit Lines	LLine_	(Import/Export)
Measurement Result	MeasR_	(Import/Export)
Capture Buffer	CapBuf_	(Import/Export)

A four digit number is appended to the prefix to create a unique file name. The numbering sequence starts at 0000 within each Mode for each file type and updates incrementally to 9999, then wraps to 0000 again. It remembers where it was through a Mode Preset and when leaving and returning to the Mode. It is reset by Restore Misc Defaults and Restore System Defaults and subsequent running of the instrument application. So, for example, the first auto file name generated for State files is State_0000.state. The next is State_0001, and so forth.

One of the key features of Auto File Name is that we guarantee that the Auto File Name will never conflict with an existing file. The algorithm looks for the next available number. If it gets to 9999, then it looks for holes. If it find no holes, that is no more numbers are available, it gives an error.

For example, if when we get to State_0010.state there is already a State_0010.state file in the current directory, it advances the counter to State_0011.state to ensure that no conflict will exist (and then it verifies that State_0011.state also does not exist in the current directory and advances again if it does, and so forth).

If you enter a file name for a given file type, then the prefix becomes the filename you entered instead of the default prefix, followed by an underscore. The last four letters (the suffix) are the 4-digit number.

For example, if you save a measurement results file as “fred.csv”, then the next auto file name chosen for a measurement results save will be fred_0000.csv.

NOTE

Although 0000 is used in the example above, the number that is used is actually the current number in the Meas Results sequence, that is, the number that would have been used if you had not entered your own file name.

NOTE

If the filename you entered ends with _dddd, where d=any number, making it look just like an auto file name, then the next auto file name picks up where you left off with the suffix being dddd + 1.

Key Path	Front-panel key
Notes	No remote command for this key specifically.
Initial S/W Revision	Prior to A.02.00

Recall

In the LTE TDD mode, four types of recall functions are available under the Data menu: “Limit Mask”, “E-UTRA Test Model”, “Signal Studio Setup” and “Vector Signal Analyzer”. “Limit Mask” enables setting of a preset limit mask for Power Suite-based measurements, and currently it is available for the SEM/ACP measurements with the LTE TDD mode. Recalling “E-UTRA Test Model” sets complicated RB settings for each Test Model for the Modulation Analysis and Conformance EVM measurements. Recalling “Signal Studio Setup” or “89600 Vector Signal Analyzer” enables you to recall parameters which have been set and saved on the external platform.

Key Path	Front Panel
Mode	LTETDD
Initial S/W Revision	Prior to A.02.00
Modified at S/W Revision	A.06.00

State

The Recall State menu lets you choose a register or file from which to recall the state.

The content of a state file includes all of the settings and data required to return the analyzer as closely as possible to the Mode it was in, with the exact settings that were in place, when the save occurred. The Mode settings in each state file include the settings that are affected by Mode Preset, as well as the additional settings affected by Restore Mode Defaults; all of the Mode’s settings. In addition, all of the settings of the Input/Output system are included, even though they are outside of the Mode’s state, because they are needed to restore the complete setup. Persistent System settings (for example, GPIB address) are not affected by either a Mode Preset or Restore Mode Defaults, nor are they included in a saved State file.

Since each state file is only for one Mode, the settings for other Modes are unaffected when it is loaded. Recall State will cause a mode switch if the state being recalled is not from the current active mode.

After the recall completes, the message "File <filename> recalled" or “Recalled State Register <register number>” is displayed.

For rapid recalls, the State menu lists 16 registers that you can choose from to recall. Pressing a Register key initiates the recall. You can also select a file from which to recall.

The default path for all State Files is:

My Documents\<<mode name>\state

where <mode name> is the parameter used to select the mode with the INST:SEL command (for example, SA for the Spectrum Analyzer).

See ["More Information" on page 2246](#).

Key Path	Recall
Mode	All

Remote Command	:MMEMory:LOAD:STATe <filename>
Example	:MMEM:LOAD:STAT "myState.state" This recalls the file myState.state on the default path
Example	MMEM:LOAD:STAT "MyStateFile.state" This loads the state file data (on the default file directory path) into the instrument state.
Notes	<p>When you pick a file to recall, the analyzer first verifies that the file is recallable in the current instrument by checking the software version and model number of the instrument. If everything matches, a full recall proceeds by aborting the currently running measurement, clearing any pending operations, and then loading the State from the saved state file. You can open state files from any mode, so recalling a State file switches to the mode that was active when the save occurred. After switching to the mode of the saved state file, mode settings and data (if any for the mode) are loaded with values from the saved file. The saved measurement of the mode becomes the newly active measurement and the data relevant to the measurement (if there is any) is recalled.</p> <p>If there is a mismatch between file version or model number or instrument version or model number, the recall function tries to recall as much as possible and returns a warning message. It may limit settings that differ based on model number, licensing or version number.</p> <p>After recalling the state, the Recall State function does the following:</p> <ul style="list-style-type: none"> • Makes the saved measurement for the mode the active measurement. • Clears the input and output buffers. • Status Byte is set to 0. • Executes a *CLS <p>If the file specified is empty an error is generated. If the specified file does not exist, another error is generated. If there is a mismatch between the file and the proper file type, an error is generated. If there is a mismatch between file version or model number or instrument version or model number, a warning is displayed. Then it returns to the State menu and File Open dialog goes away.</p> <p>After the Recall, the analyzer exits the Recall menu and returns to the previous menu.</p>
Backwards Compatibility SCPI	:MMEMory:LOAD:STATe 1,<filename> For backwards compatibility, the above syntax is supported. The "1" is simply ignored.
Initial S/W Revision	Prior to A.02.00

More Information

In measurements that support saving Traces, for example, Swept SA, the Trace data is saved along with the State in the State file. When recalling the State, the Trace data is recalled as well. Traces are recalled exactly as they were stored, including the writing mode and update and display modes. If a Trace was updating and visible when the State was saved, it will come back updating and visible, and its data will be rewritten right away. When you use State to save and recall traces, any trace whose data must be preserved should be placed in View or Blank mode before saving.

The following table describes the Trace Save and Recall possibilities:

You want to recall state and one trace's data, leaving other traces unaffected.	Save Trace+State from 1 trace. Make sure that no other traces are updating (they should all be in View	On Recall, specify the trace you want to load the one trace's data into. This trace will load in View.
---	---	--

	or Blank mode) when the save is performed.	All other traces' data will be unaffected, although their trace mode will be as it was when the state save was performed.
You want to recall all traces	Save Trace+State from ALL traces.	On Recall, all traces will come back in View (or Blank if they were in Blank or Background when saved)
You want all traces to load exactly as they were when saved.	Save State	On recall, all traces' mode and data will be exactly as they were when saved. Any traces that were updating will have their data immediately overwritten.

From File...

When you press “From File”, the analyzer brings up a Windows dialog and a menu entitled “File Open.” This menu allows you to navigate to the various fields in the Windows dialog without using a keyboard or mouse. The Tab and Arrow keys can also be used for dialog navigation.

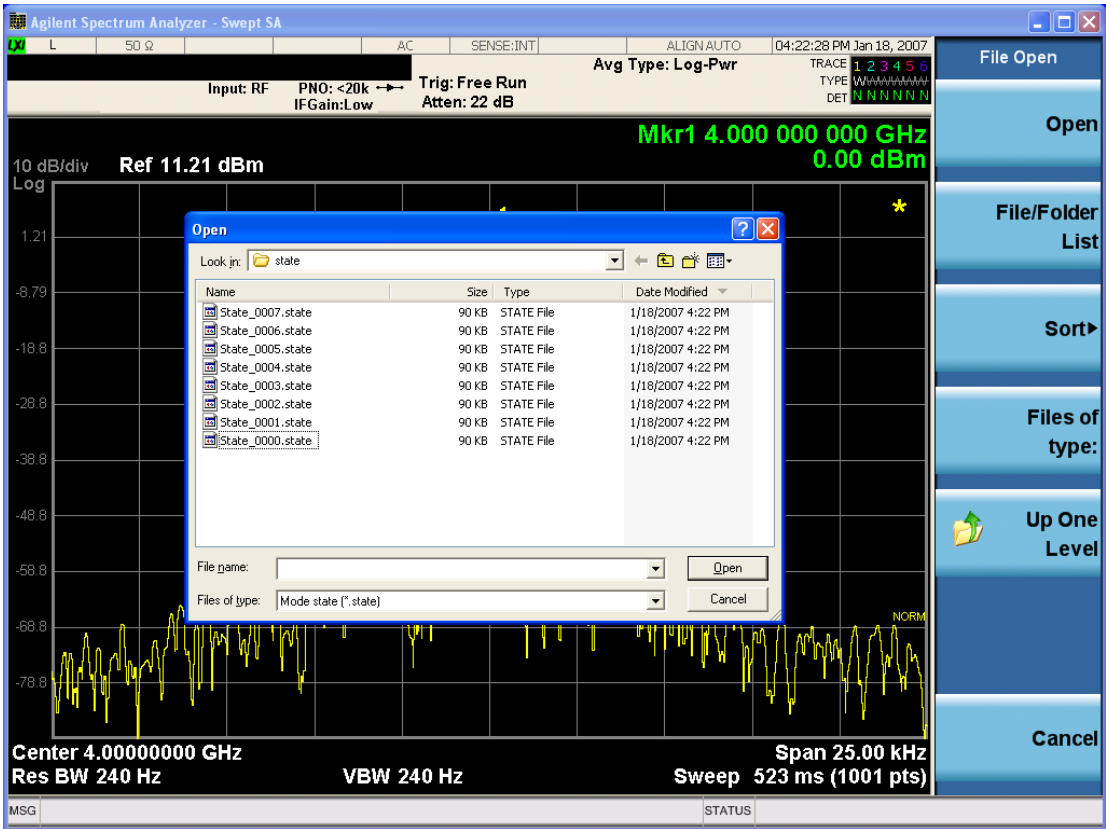

Listed below are the functions of the various fields in the dialog, and the corresponding softkeys:

Open

Performs the recall of the specified file. While the recall is being performed, the floppy icon appears briefly in the Meas bar.

File/Folder List

Enables you to navigate to the center of the dialog that contains the list of files and folders. Once here you can get information about the file and use the tab keys to navigate to the other fields in the dialog, such as Look In.

Look In

The Look In field shows the path from which the file will be recalled and allows you to change the path using the up and down arrow keys to navigate to other paths; the Enter key to open a directory; and the Backspace key to go back one directory. The **Look In field** first uses the last path from the Save As dialog **Save In:** path for that same file type. There is no softkey for directly navigating to the Look In field, but you can use the left tab to get here from the File/Folder List.

User specified paths are remembered when you leave and return to a Mode and are reset back to the default using Restore Mode Defaults.

Sort

Accesses a menu that enables you to sort the files within the File Open dialog. Only one sorting type can be selected at a time and the sorting happens immediately. The sorting types are By Date, By Name, By extension, and By Size.

Files of Type

This field shows the file suffix for the type of file you have selected to recall. For example, if you navigated here while recalling State, "Mode state (*.state)" is in the field. If you navigated here while recalling Trace, ""Mode state (*.trace)" is in the field. If you navigated here while importing a trace data file, "Trace Data (*.csv)" is in the field. For some file types, there is more than one choice in the dropdown menu, which you can select by using the up and down arrow keys and Enter.

Up One Level

This key corresponds to the icon of a folder with the up arrow that is in the tool bar of the dialog. When pressed, it causes the file and folder list to navigate up one level in the directory structure. The Backspace key does the same thing.

Cancel

This key corresponds to the Cancel selection in the dialog. It causes the current **Open** request to be cancelled. The ESC key does the same thing.

Key Path	Recall, State
Notes	Brings up the Open dialog for recalling a State Save Type
Initial S/W Revision	Prior to A.02.00

Edit Register Names

You may enter a custom name on any of the Register keys, to help you remember what you are using that state to save. To do this, press the Edit Register Names key, choose the register whose name you wish to edit, and then enter the desired label using the Alpha Editor or an external PC keyboard.

The maximum number of characters that can be added is 30. In most cases, 30 characters will fit on two lines of the key.

For more information and the SCPI command, see Edit Register Names under the Save, State function.

Key Path	Recall, State
Mode	All
Dependencies	N9060A-7FP or N9060B-2FP license required to edit the register names. When the feature is not licensed, sending the SCPI command generates an error, -221, "Settings conflict;Option not available"
Initial S/W Revision	A.11.00

Register 1 thru Register 16

Selecting any one of these register keys causes the State of the mode from the specified Register to be recalled. Each of the register keys annotates whether it is empty or at what date and time it was last modified. In addition, you can use the Edit Register Names key under Save, State to enter custom names for each register.

Registers are shared by all modes, so recalling from any one of the registers will cause a mode switch to the mode that was active when the save to the Register occurred.

Although these 16 registers are the only registers available from the front panel, there are 128 state registers available in the instrument. Registers 17-128 are only available from the SCPI interface, using the *RCL command.

After the recall completes, the message "Register <register number> recalled" appears in the message bar. If you are in the Spectrum Analyzer Mode, and you are recalling a register that was saved in the Spectrum Analyzer Mode, then after the recall, you will still be in the Recall Register menu. If the Recall causes you to switch modes, then after the Recall, you will be in the Frequency menu.

If a requested register is empty an error is generated.

Key Path	Recall, State
Example	*RCL 1
Range	1-16 from front panel, 1-128 from SCPI
Readback	Date and time with seconds resolution are displayed on the key OR A custom name of up to 30 characters entered using the Save, State,Edit Register Names key OR “(empty)” if no prior save operation has been performed to this register.
Initial S/W Revision	Prior to A.02.00
Modified at S/W Revision	Prior to A.11.00

Register 1 thru Register 16

Selecting any one of these register keys causes the State of the mode from the specified Register to be recalled. Each of the register keys annotates whether it is empty or at what date and time it was last modified. In addition, you can use the Edit Register Names key under Save, State to enter custom names for each register.

Registers are shared by all modes, so recalling from any one of the registers will cause a mode switch to the mode that was active when the save to the Register occurred.

Although these 16 registers are the only registers available from the front panel, there are 128 state registers available in the instrument. Registers 17–128 are only available from the SCPI interface, using the *RCL command.

After the recall completes, the message "Register <register number> recalled" appears in the message bar. If you are in the Spectrum Analyzer Mode, and you are recalling a register that was saved in the Spectrum Analyzer Mode, then after the recall, you will still be in the Recall Register menu. If the Recall causes you to switch modes, then after the Recall, you will be in the Frequency menu.

If a requested register is empty an error is generated.

Key Path	Recall, State
Example	*RCL 1
Range	1–16 from front panel, 1–128 from SCPI
Readback	Date and time with seconds resolution are displayed on the key OR A custom name of up to 30 characters entered using the Save, State, Edit Register Names key OR “(empty)” if no prior save operation has been performed to this register.
Initial S/W Revision	Prior to A.02.00
Modified at S/W Revision	Prior to A.11.00

Recall

In the LTE TDD mode, four types of recall functions are available under the Data menu: “Limit Mask”, “E-UTRA Test Model”, “Signal Studio Setup” and “Vector Signal Analyzer”. “Limit Mask” enables setting of a preset limit mask for Power Suite-based measurements, and currently it is available for the SEM/ACP measurements with the LTE TDD mode. Recalling “E-UTRA Test Model” sets complicated RB settings for each Test Model for the Modulation Analysis and Conformance EVM measurements. Recalling “Signal Studio Setup” or “89600 Vector Signal Analyzer” enables you to recall parameters which have been set and saved on the external platform.

Key Path	Front Panel
Mode	LTETDD
Initial S/W Revision	Prior to A.02.00
Modified at S/W Revision	A.06.00

Import Trace Data

Enables you to import previously saved trace data into a Data Register and optionally display it. Selecting this key displays a menu that enables you to select the destination data register, and also enables you to choose whether or not to display the recalled data in the currently selected trace. After making these selections, select Open... and use the file dialog to select the file you want to recall.

Recalling trace data into an already used Data Register overwrites the previous data. If the data register is displayed on any trace, the display is updated to reflect the new data.

The SCPI command

```
:MMEM:LOAD:TRAC:DATA D1|D2|D3|D4|D5|D6,<filename>
```

recalls data into a specified register, but does not display it in the selected trace. Use the command

```
:DISP:<meas>:TRAC<n>:FEED D1|D2|D3|D4|D5|D6
```

to display the register in the desired trace.

It is possible to recall trace data saved by other VXA measurements, or measurements made using the LTE, LTETDD, iDEN, or 89601 applications.

Key Path	Recall, Data (Import)
Mode	VSA, LTE, LTETDD, IDEN
Remote Command	:MMEMory:LOAD:TRACe:DATA D1 D2 D3 D4 D5 D6,<filename>[,CSV TXT SDF MAT4 MAT HDF5 BIN]
Example	:MMEM:LOAD:TRAC:DATA D1,"Trc1.txt",TXT
Notes	<p>The Open: dialog box has the following filter options when you are recalling trace data::</p> <ul style="list-style-type: none"> • CSV (Comma delimited) (*.csv) • SDF (Fast) (*.sdf;*.dat) • Text (Tab delimited) (*.txt) <p>The file must have the same format as that created by the Export Recorded Data command.</p> <p>The SCPI command has an optional file format parameter. If you do not include this parameter in the SCPI command, the file format is determined by the file name extension. If no file extension is recognized, the file is scanned to determine the format.</p> <p>If you are not licensed to recall a particular file type, then error -203.9010 is returned. If the file format cannot be determined or the file cannot be recalled successfully, then error -250.5290 is returned. If the recall is successful, then advisory 0.1600 is shown.</p>
State Saved	No
Readback	Data 1 Data 2 Data 3 Data 4 Data 5 Data 6

Data 1

Selects the Data 1 register as the destination for the imported data.

Key Path	Recall, Data (Import), Trace (to)
Mode	VSA, LTE, LTETDD, IDEN

Data 2

Selects the Data 2 register as the destination for the imported data.

Key Path	Recall, Data (Import), Trace (to)
Mode	VSA, LTE, LTETDD, IDEN

Data 3

Selects the Data 3 register as the destination for the imported data.

Key Path	Recall, Data (Import), Trace (to)
Mode	VSA, LTE, LTETDD, IDEN

Data 4

Selects the Data 4 register as the destination for the imported data.

Key Path	Recall, Data (Import), Trace (to)
Mode	VSA, LTE, LTETDD, IDEN

Data 5

Selects the Data 5 register as the destination for the imported data..

Key Path	Recall, Data (Import), Trace (to)
Mode	VSA, LTE, LTETDD, IDEN

Data 6

Selects the Data 6 register as the destination for the imported data.

Key Path	Recall, Data (Import), Trace (to)
Mode	VSA, LTE, LTETDD, IDEN

Display in Selected Trace

Enables you to select whether the recalled trace data is displayed in the current Trace.

Key Path	Recall, Data (Import), Trace (to)
----------	-----------------------------------

Mode	VSA, LTE, LTETDD, IDEN
State Saved	No

Signal Studio Setup

This key allows you to recall the Agilent Signal Studio setup file created on the Signal Studio (N7625B). This key is valid only for the Mod Analysis measurement. For E-TM test model signal, please use corresponding EVM setup file under My Documents\LTETDD\data\evmsetup.

For the supported carrier types, see the table below.

Signal Studio	Carrier Type
N7625B Signal Studio for 3GPP LTE TDD	Advanced LTE TDD(2009-03)
	Advanced LTE TDD(2009-12)
	Basic LTE TDD(2009-03)
	Basic LTE TDD(2009-12)

File Location and Extension

File location: "My Documents\LTETDD\data"

File type: xml

File extension: .scp

You need to place the Signal Studio Setup file created on N7625B in the above directory in advance. Pressing OPEN under the Import Data menu will open this directory from which you can select the setup file.

Example:

File Location: My Documents\LTETDD\data

File Name: Uplink PUSCH.scp

Key Path	Recall, Data
Mode	LTETDD
Remote Command	MMEMory:LOAD:SSSetup <string>
Example	MMEM:LOAD:SSS "Uplink PUSCH.scp"
Notes	Sets of parameters related to Signal Studio Setup are overwritten by the contents of the setup file.
Initial S/W Revision	A.06.00

89601 VSA Setup

Enables you to import the 89600 Vector Signal Analyzer Setup file created using the 89600 Vector Signal Analyzer Option BHE (LTE TDD). This key is valid only for the Mod Analysis measurement.

File Location and Extension

File location: "My Documents\LTETDD\data"

File type: text file

File extension: .set, .setx

Place the 89600 Vector Signal Analyzer Setup file that you saved on 89600 in the above directory. When you select OPEN under the Import Data menu, the directory opens enabling you to select your setup file.

Example:

File Location: My Documents\LTETDD\data

File Name: Uplink PRACH.set

Key Path	Recall, Data
Mode	LTETDD
Remote Command	MME ^M o ^R y:LOAD:VSAS ^E tup <string>
Example	MMEM:LOAD:VSAS "Uplink PRACH.set"
Notes	Sets of parameters related to Vector Signal Analyzer Setup are overwritten by the contents of the setup file.
Initial S/W Revision	A.06.00
Modified at S/W Revision	A.10.00

Masks

This key allows you to recall a preset mask file from the list. The preset mask file contains configuration for only Carrier, Offset, Limit settings and the preset profile BW. Any set of values not specified by the preset mask file will not be overwritten.

You cannot change or create the preset mask file since it is a binary file. This key is valid for the Spectrum Emission Mask and ACP measurements.

File location: "My Documents\LTETDD\data.masks"

Note that "My Documents" is an alias to a directory and its place differs depending on which user is logged in. At XSA start up, XSA will overwrite all of the limit mask files to the current user's "My Documents\LTETDD\data.masks" each time.

File type: Binary

Filename: The filename follows the rule below, in which the word is connected with underscores.

<Measurement>_<Direction>_<Bandwidth>_<Condition>.mask

Where

<Measurement> Measurement the limit mask file is applied to: SEM or ACP

<Direction> Direction: BS (Downlink) or MS (Uplink).

<Bandwidth> Bandwidth

<Condition> Condition. It depends on the measurement.

File extension: .mask

Pressing OPEN under the Import Data menu will open the above directory from which you can select a mask file. When you change the Bandwidth or Direction, all Power Suite measurement parameters are reset to the hard coded preset parameters. Thus you must recall the appropriate preset mask file again after the change.

You cannot read the contents of the provided preset mask file since it is a binary file. Detailed contents of the file are provided by a PDF format file located in the same directory as the preset mask file.

Example:

File Location: My Documents/LTETDD/data/masks/SEM_MS

File Name: SEM_MS_15MHz_Add_NS04.mask

The following table shows the sets of variables imported to the ACP measurement.

Offset	Start Freq (MHz)	Stop Freq (MHz)	Res BW (Hz)	Meas BW	Rel Start	Rel Stop	Fail Mask
A	5	7.14	30k	1	-8	-25	Rel
B	7.14	10.57	30k	1	-25	-27	Rel
C	10.57	20	30k	1	-27	-50	Rel
D	20	25	30k	1	-50	-50	Rel
E	25	30	30k	1	-50	-50	Rel

Key Path	Recall, Data
Mode	LTETDD
Remote Command	MMEMOry:LOAD:MASK <string>
Example	MMEMOry:LOAD:MASK "ACP_BS\ACP_BS_3MHz_pairE-UTRA_CatA.mask"
Notes	Sets of parameters related to Limit, Carrier and Offset are overwritten by the contents of the preset mask file.
Initial S/W Revision	A.03.00

EVM Setup

This key allows you to recall EVM parameter setting to measure E-UTRA Test Model in 3GPP standard (36.141-810 6.1.1).

- E-UTRA Test Model 1.1 (E-TM1.1)
- E-UTRA Test Model 1.2 (E-TM1.2)
- E-UTRA Test Model 2 (E-TM2)
- E-UTRA Test Model 3.1 (E-TM3.1)

- E-UTRA Test Model 3.2 (E-TM3.2)
- E-UTRA Test Model 3.3 (E-TM3.3)

This key is valid for the Modulation Analysis and Conformance EVM measurements only.

File Location and Extension

File location: My Documents\LTETDD\data\evmsetup

Note that “My Documents” is an alias to a directory and its place differs depending on which user is logged in. At XSA start up, XSA will overwrite all of the EVM Setup files to the current user’s “My Documents\LTETDD\data\evmsetup” each time.

File type: binary

File extension: .evms

Pressing OPEN under the Import Data menu will open the above directory from which you can select an EVM Setup file. When you change the Bandwidth, parameters are reset to the hard coded preset parameters. Thus you must recall the appropriate EVM Setup file again after the change.

You cannot read the contents of the provided EVM Setup file since it is a binary file.

Example:

File Location: My Documents\LTETDD\data\evmsetup

Filename: TM3.1-BW1.4MHz.evms

Key Path	Recall, Data
Mode	LTETDD
Remote Command	MME ^M MoRY:LOAD:EVMS ^E tup <string>
Example	MME ^M :LOAD:EVMS "TM2-BW15MHz.evms"
Notes	Sets of parameters related to EVM Setup are overwritten by the contents of the EVM Setup file.
Initial S/W Revision	A.03.00, A.08.00

Open...

When you press “Open”, the analyzer brings up a Windows dialog and a menu entitled “File Open.” This menu allows you to navigate to the various fields in the Windows dialog without using a keyboard or mouse. The Tab and Arrow keys can also be used for dialog navigation.

See "[From File...](#)" on page 2797 in Recall, State, for a full description of this dialog and menu.

Key Path	Recall, Data
Notes	The key location is mode-dependent and will vary. Brings up Open dialog for recalling a <mode specific> Save Type
Initial S/W Revision	Prior to A.02.00

Restart

The Restart function restarts the current sweep, or measurement, or set of averaged/held sweeps or measurements. If you are Paused, pressing Restart does a Resume.

The Restart function is accessed in several ways:

- Pressing the Restart key
- Sending the remote command INIT:IMMEDIATE
- Sending the remote command INIT:RESTART

See "[More Information](#)" on page 2257

Key Path	Front-panel key
Remote Command	:INITiate[:IMMEDIATE] :INITiate:RESTART
Example	:INIT:IMM :INIT:REST
Notes	:INITiate:RESTART and :INITiate:IMMEDIATE perform exactly the same function.
Couplings	Resets average/hold count k. For the first sweep overwrites all active (update=on) traces with new current data. For application modes, it resets other parameters as required by the measurement.
Status Bits/OPC dependencies	This is an Overlapped command. The STATUS:OPERation register bits 0 through 8 are cleared. The STATUS:QUESTIONable register bit 9 (INTEgrity sum) is cleared. The SWEEPING bit is set. The MEASURING bit is set.
Backwards Compatibility Notes	For Spectrum Analysis mode in ESA and PSA, the Restart hardkey and the INITiate:RESTART command restart trace averages (displayed average count reset to 1) for a trace in Clear Write, but did not restart Max Hold and Min Hold. In the X-Series, the Restart hardkey and the INITiate:RESTART command restart not only Trace Average, but MaxHold and MinHold traces as well. For wireless comms modes in ESA and PSA, the Restart hardkey and the INITiate:RESTART command restart every measurement, which includes all traces and numeric results. There is no change to this operation.
Initial S/W Revision	Prior to A.02.00

More Information

The **Restart** function first aborts the current sweep/measurement as quickly as possible. It then resets the sweep and trigger systems, sets up the measurement and initiates a new data measurement sequence with a new data acquisition (sweep) taken once the trigger condition is met.

If the analyzer is in the process of aligning when **Restart** is executed, the alignment finishes before the restart function is performed.

Even when set for Single operation, multiple sweeps may be taken when Restart is pressed (for example, when averaging/holding is on). Thus when we say that **Restart** "restarts a measurement," we may mean:

- It restarts the current sweep
- It restarts the current measurement
- It restarts the current set of sweeps if any trace is in Trace Average, Max Hold or Min Hold
- It restarts the current set of measurements if Averaging, or Max Hold, or Min Hold is on for the measurement
- depending on the current settings.

With **Average/Hold Number** (in **Meas Setup** menu) set to 1, or Averaging off, or no trace in Trace Average or Hold, a single sweep is equivalent to a single measurement. A single sweep is taken after the trigger condition is met; and the analyzer stops sweeping once that sweep has completed. However, with **Average/Hold Number** >1 and at least one trace set to **Trace Average, Max Hold, or Min Hold (SA Measurement)** or **Averaging on (most other measurements)**, multiple sweeps/data acquisitions are taken for a single measurement. The trigger condition must be met prior to each sweep. The sweep is stopped when the average count k equals the number N set for **Average/Hold Number**. A measurement average usually applies to all traces, marker results, and numeric results; but sometimes it only applies to the numeric results.

Once the full set of sweeps has been taken, the analyzer will go to idle state. To take one more sweep without resetting the average count, increment the average count by 1, by pressing the step up key while **Average/Hold Number** is the active function, or sending the remote command `CALC:AVER:TCON UP`.

Save

The Save menu lets you choose what you want to save and where you want to save it. Among the types of files you can save are **States**, **Traces**, and **Screen Images**. In addition, an Export (Data) option lets you save a number of data types as CSV files for easy import into Excel and other spreadsheet programs.

Key Path	Front-panel key
Mode	All
Notes	No remote command for this key specifically, but the :MMEM:STORe command is available for specific file types. An example is :MMEM:STOR:STATe <filename>.
Initial S/W Revision	Prior to A.02.00

State

The Save State menu lets you choose a register or file for saving the state.

The content of a state file includes all of the settings and data required to return the analyzer as closely as possible to the Mode it was in, with the exact settings which were in place, when the save occurred. The Mode settings in each state file include the settings that are affected by Mode Preset, as well as the additional settings affected by Restore Mode Defaults; all of the Mode's settings. In addition, all of the settings of the Input/Output system are included, even though they are outside of the Mode's state, because they are needed to restore the complete setup. Persistent System settings (for example, Verbose SCPI) are not affected by either Mode Preset or Restore Mode Defaults, nor are they included in a saved State file.

After the save completes, the message "File <filename> saved" or "State Register <register number> saved" is displayed.

For rapid saving, the State menu lists 16 registers to save to. Pressing a Register key initiates the save. You can also select a file to save to.

The default path for all State Files is:

My Documents\<<mode name>\state

where <mode name> is the parameter used to select the mode with the INST:SEL command (for example, SA for the Spectrum Analyzer).

Key Path	Save
Mode	All
Remote Command	:MMEMory:STORe:STATe <filename>
Example	MMEM:STOR:STATe "MyStateFile.state" This stores the current instrument state data in the file MyStateFile.state in the default directory.
Notes	Both single and double quotes are supported for any filename parameter over remote. After saving to a register, that register's menu key is updated with the date the time, unless a custom label has been entered for that key. After saving to a register, you remain in the Save State menu, so that you can see the Register key

update. After saving to a file, the analyzer automatically returns to the previous menu and any Save As dialog goes away.

Backwards Compatibility SCPI :MMEMory:STORe:STATe 1,<filename>

For backwards compatibility, the above syntax is supported. The "1" is simply ignored. The command is sequential.

Initial S/W Revision Prior to A.02.00

To File . . .

When you press “To File”, the analyzer brings up a Windows dialog and a menu entitled “Save As.” This menu allows you to navigate to the various fields in the Windows dialog without using a keyboard or mouse. The Tab and Arrow keys can also be used for dialog navigation.

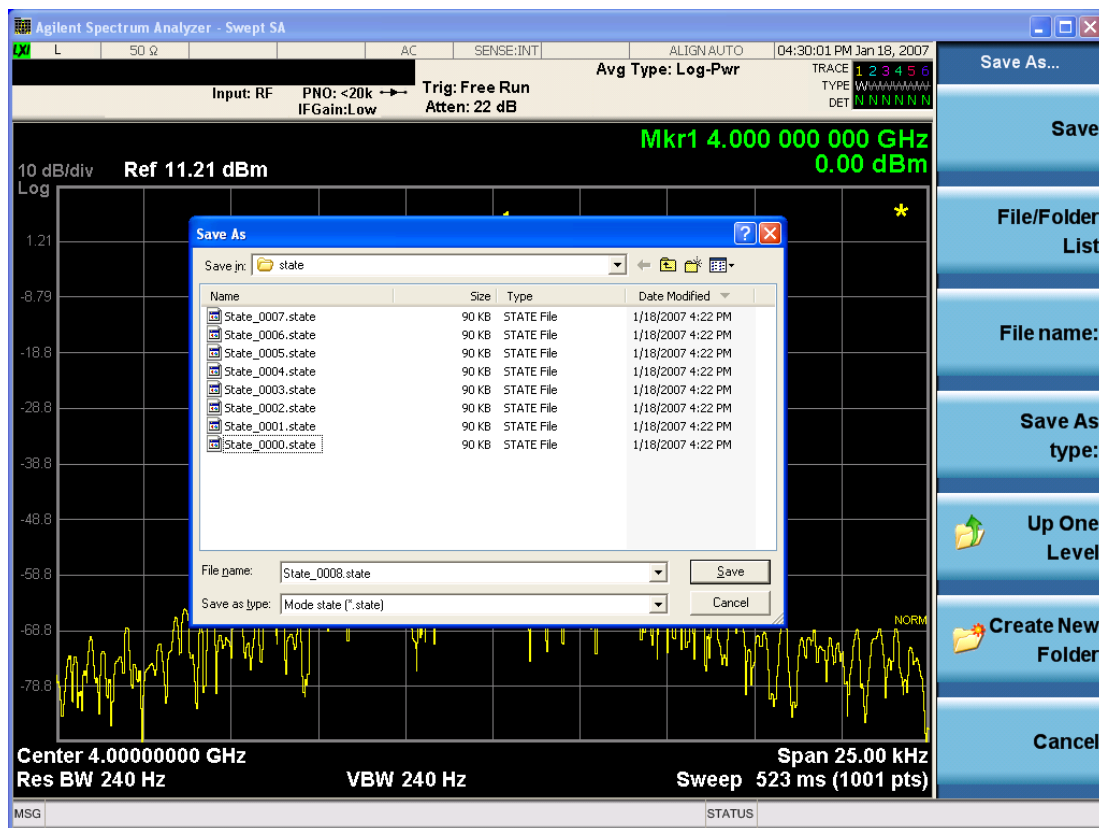

The Listed below

are the functions of the various fields in the dialog, and the corresponding softkeys:

Save

Performs the save to the specified file of the selected type. If the file already exists, a dialog will appear that allows you to replace the existing file by selecting OK, or you can Cancel the request. If you select OK, the file will be overwritten. Using the C: drive is strongly discouraged, since it runs the risk of being overwritten during an instrument software upgrade.

While the save is being performed, the floppy icon appears briefly in the Meas bar.

File/Folder List

Enables you to navigate to the center of the dialog that contains the list of files and folders. Once here you can get information about the file and use the tab keys to navigate to the other fields in the dialog, such as Save In.

Save In

The Save In field shows the path to which the file will be saved and allows you to change the path using the up and down arrow keys to navigate to other paths; the Enter key to open a directory; and the Backspace key to go back one directory. The **Save In field** defaults to the default path for this type of file and remembers the last path you used to save this type of file. There is no softkey for directly navigating to the Save In field but you can use left tab to get here from the File/Folder List.

User specified paths are remembered when you leave and return to a Mode and are reset back to the default using Restore Mode Defaults.

File Name

The File Name field is initially loaded with an automatically generated filename specific to the appropriate Save Type. The automatically generated filename is guaranteed not to conflict with any filename currently in the directory. You may replace or modify this filename using the File Name key. See the ["Quick Save " on page 2793](#) documentation for more on the automatic file naming algorithm.

When you press the File Name key the analyzer displays the Alpha Editor. Use the knob to choose the letter to add and the front-panel Enter key to add the letter to the file name. The BK character moves you back and the FW character moves you forward in the filename. The Select key on the front panel generates a space character. When you are done entering the filename press the Done softkey. This returns back to the **File Open** dialog and menu, but does not cause the save to occur.

Save As Type

This field shows the file suffix for the type of file you have selected to save. For example, if you navigated here while saving State, "Mode state (*.state)" is in the field. If you navigated here from saving Trace, ""Mode state (*.trace)" is in the field. If you navigated here while exporting a trace data file, "Trace Data (*.csv)" is in the field. For some file types, there is more than one choice in the dropdown, which you can select by using the up and down arrow keys and Enter.

Up One Level

This key corresponds to the icon of a folder with the up arrow that is in the tool bar of the dialog. When pressed, it causes the file and folder list to navigate up one level in the directory structure. The Backspace key does the same thing.

Create New Folder

This key corresponds to the icon of a folder with the "*" that is in the tool bar of the dialog. When pressed, a new folder is created in the current directory with the name **New Folder** and you can enter a new folder name using the Alpha Editor.

Cancel

This key corresponds to the Cancel selection in the dialog. It causes the current **Save As** request to be cancelled. The ESC key does the same thing.

Key Path	Save, State
Mode	All
Notes	Brings up Save As dialog for saving a State Save Type
Initial S/W Revision	Prior to A.02.00

Edit Register Names

You may enter a custom name on any of the Register keys, to help you remember what you are using that state to save. To do this, press the Edit Register Names key, choose the register whose name you wish to edit, and then enter the desired label using the Alpha Editor or an external PC keyboard.

The maximum number of characters that can be added is 30. In most cases, 30 characters will fit on two lines of the key.

See ["More Information" on page 2262](#)

Key Path	Save, State
Mode	All
Remote Command	:MMEMory:REGister:STATe:LABel <reg number>,"label" :MMEMory:REGister:STATe:LABel? <reg number>
Example	:MMEM:REG:STAT:LAB 1,"my label"
Notes	<reg number> is an integer from 1 to 16. If the SCPI specifies an invalid register number an error message is generated, -222,"Data out of range;Invalid register label number" "label" is a string from 0 to 30 characters in length. If a label exceeds 30 characters, an error message is generated, -150,"String data error;Label clipped to 30 characters" "label" of length 0 erases the custom label and restores the default (time and date) label. E.g.: :MMEM:REG:STAT:LAB 1,""
Dependencies	N9060A-7FP or N9060B-2FP license required to edit the register names. When the feature is not licensed, sending this command generates an error, -221,"Settings conflict;Option not available"
Preset	The names are unaffected by Preset or power cycle but are set to the default label (time and date) on a "Restore System Defaults->Misc"
Initial S/W Revision	A.11.00

More Information

When you edit one of the register names, the time and date field will be replaced by the custom name.

If you delete all the characters in the custom name, it restores the default (time and date).

The register names are stored within the state files, but they are not part of the instrument state; that is, once you have edited a register name, loading a new state will not change that register name. Another consequence of this is that the names will be persistent through a power cycle. Also, if a named state file is transferred to another analyzer, it will bring its custom name along with it.

If you try to edit the name of an empty register, the analyzer will first save the state to have a file to put the name in. If you load a named state file into an analyzer with older firmware it will ignore the metadata.

The *SAV and *RCL commands will not be affected by the custom register names, nor will the MMEM commands.

Register 1 thru Register 16

Selecting any one of these register menu keys causes the State of the currently active mode to be saved to the specified Register. The registers are provided for rapid saving and recalling, since you do not need to specify a filename or navigate to a file. Each of the register menu keys annotates whether it is empty or at what date and time it was last modified. In addition, you can use the Edit Register Names key to enter custom names for each register.

Although these 16 registers are the only registers available from the front panel, there are 128 state registers available in the instrument. Registers 17–128 are only available from the SCPI interface, using the *SAV command.

There is one set of 128 state registers in the instrument, not one set for each Mode. When a state is saved, the Mode it was saved from is saved with it; then when it is recalled, the instrument switches to that Mode.

After the save completes, the corresponding register menu key annotation is updated with the date and time and the message "Register <register number> saved" is displayed.

Key Path	Save, State
Mode	All
Example	*SAV 1
Range	1–16 from front panel, 1–128 from SCPI
Readback	Date and time with seconds resolution are displayed on the key OR A custom name of up to 30 characters entered using the Edit Register Names key OR “(empty)” if no prior save operation has been performed to this register.
Initial S/W Revision	Prior to A.02.00
Modified at S/W Revision	A.11.00

Register 1 thru Register 16

Selecting any one of these register menu keys causes the State of the currently active mode to be saved to the specified Register. The registers are provided for rapid saving and recalling, since you do not need to specify a filename or navigate to a file. Each of the register menu keys annotates whether it is empty or at what date and time it was last modified. In addition, you can use the Edit Register Names key to enter custom names for each register.

Although these 16 registers are the only registers available from the front panel, there are 128 state registers available in the instrument. Registers 17–128 are only available from the SCPI interface, using the *SAV command.

There is one set of 128 state registers in the instrument, not one set for each Mode. When a state is saved, the Mode it was saved from is saved with it; then when it is recalled, the instrument switches to that Mode.

After the save completes, the corresponding register menu key annotation is updated with the date and time and the message "Register <register number> saved" is displayed.

Key Path	Save, State
Mode	All
Example	*SAV 1
Range	1-16 from front panel, 1-128 from SCPI
Readback	Date and time with seconds resolution are displayed on the key OR A custom name of up to 30 characters entered using the Edit Register Names key OR “(empty)” if no prior save operation has been performed to this register.
Initial S/W Revision	Prior to A.02.00
Modified at S/W Revision	A.11.00

Data (Export)

Exporting a data file stores data from the current measurement to mass storage files. The Export Menu only contains data types that are supported by the current measurement.

Since the commonly exported data files are in .csv format, the data can be edited by you prior to importing. This allows you to export a data file, manipulate the data in Excel (the most common PC Application for manipulating .csv files) and then import it.

Selecting an Export Data menu key will not actually cause the exporting to occur, since the analyzer still needs to know where you wish to save the data. Pressing the Save As key in this menu brings up the Save As dialog and Save As menu that allows you to specify the destination file and directory. Once a filename has been selected or entered in the Open menu, the export will occur as soon as the Save key is pressed.

Key Path	Save
Mode	All
Notes	The menu is built from whatever data types are available for the mode. So the key locations in the sub menu will vary. No SCPI command directly controls the Data Type that this key controls. The Data Type is included in the MMEM:STORe commands.
Dependencies	If a file type is not used by a certain measurement, that type is grayed out for that measurement. The key for a file type will not show at all if there are no measurements in the Mode that support it.
Preset	Is not affected by a Preset or shutdown, but is reset during Restore Mode Defaults
Readback	The data type that is currently selected
Initial S/W Revision	Prior to A.02.00

Export Trace Data

Enables you to export trace data with (optional) associated headers. Selecting this key displays a menu that enables you to choose which Trace to save (default is the selected Trace) and whether or not to save headers with the data. The header information is used by the VXA application when saved trace data is recalled, and enables it to be displayed with the same formatting and scaling that it had when saved. If headers are not saved, the scaling and format are set to default values when the trace is recalled. After making these selections, press Save As... and use the file dialog to choose a file name and format for the saved data.

Trace data can be exported in several different formats. Text and comma-separated variable (CSV) formats are useful for viewing the data or importing it to a spreadsheet program. The other formats are binary and thus more compact. Trace data files can be recalled for viewing into other VXA, LTE, LTETDD, iDEN, or 89601 measurements.

Key Path	Save, Data (Export)
Mode	VSA, LTE, LTETDD, IDEN
Remote Command	:MMEMory:STORe:TRACe:DATA TRACE1 TRACE2 TRACE3 TRACE4 TRACE5 TRACE6, "<filename>"[,CSV TXT SDF MAT4 MAT HDF5 BIN[,OFF ON 0 1]]
Example	:MMEM:STOR:TRAC:DATA TRACE1, "TRC1.TXT", TXT, ON
Notes	<p>The Save As... dialog box has the following format options when you are saving trace data:</p> <ul style="list-style-type: none"> • CSV (Comma delimited) (*.csv) • SDF (Fast) (*.sdf;*.dat) • Text (Tab delimited) (*.txt) <p>File format saved depends on selection. The appropriate file extension is appended to the filename if it is not supplied by the user.</p> <p>If the SCPI command includes just a file name, the file format is determined by the filename extension, which must be one of the choices above. *.sdf or an unrecognized extension chooses the SDF fast format. If the optional file format enumerator is included in the command, then this determines the file format and the file extension is ignored. The optional binary parameter determines if file headers are saved. The default is ON. If file headers are not wanted, use the optional "OFF" parameter.</p> <p>The optional Boolean parameter determines whether headers are saved in the file. By default the headers are saved.</p> <p>If you are not licensed to save a particular file type, then error -203.9010 is returned. If an invalid file format is specified or the file cannot be saved successfully, then error -25x is returned. If the save is successful, then advisory 0.1500 is shown.</p>
State Saved	No
Readback	(Trace 1 Trace 2 Trace 3 Trace 4 Trace 5 Trace 6)(with without) headers

Trace 1

Selects the Trace 1 register as the destination for the imported data.

Key Path	Save, Data (Export), Trace
Mode	VSA, LTE, LTETDD, IDEN

Trace 2

Selects the Trace 2 register as the destination for the imported data.

Key Path	Save, Data (Export), Trace
Mode	VSA, LTE, LTETDD, IDEN

Trace 3

Selects the Trace 3 register as the destination for the imported data.

Key Path	Save, Data (Export), Trace
Mode	VSA, LTE, LTETDD, IDEN

Trace 4

Selects the Trace 4 register as the destination for the imported data.

Key Path	Save, Data (Export), Trace
Mode	VSA, LTE, LTETDD, IDEN

Include Header

Enables you to select whether or not the saved trace data includes header information describing scaling, formatting, etc.

Key Path	Save, Data (Export), Trace
Mode	VSA, LTE, LTETDD, IDEN
State Saved	No

Measurement Results

Pressing this key selects Meas Results as the data type to be exported. Pressing the key a second time brings up the Meas Results menu, which allows you to select which **Meas Result** to save. In the Swept SA measurement, there are three types of Measurement Results files: Peak Table, Marker Table and Spectrogram.

See "[Meas Results File Contents](#)" on page 2267.

See "[Marker Table](#)" on page 2267.

See "[Peak Table](#)" on page 2270.

See "[Spectrogram](#)" on page 2273

Remote Command	:MMEMory:STORe:RESults:MTABle PTABle SPEctrogram <filename>
Example	:MMEM:STOR:RES:MTAB "myResults.csv" Saves the results from the current marker table to the file myResults.csv in the current path. :MMEM:STOR:RES:PTAB "myResults.csv" Saves the results from the current peak table to the file myResults.csv in the current path. :MMEM:STOR:RES:SPEC "myResults.csv" Saves the results from the current Spectrogram display to the file myResults.csv in the current path. The default path is My Documents\SA\data\SAN\results
Notes	If the save is initiated via SCPI, and the file already exists, the file will be overwritten. Using the C: drive is strongly discouraged, since it runs the risk of being overwritten during an instrument software upgrade. Both single and double quotes are supported for any filename parameter over SCPI.
Dependencies	If a save of Marker Table results is requested and the Marker Table is not on, no file is saved and a message is generated If a save of Peak Table results is requested and the Peak Table is not on, no file is saved and a message is generated If a save of Spectrogram results is requested and the Spectrogram is not on, no file is saved and a message is generated. The Spectrogram choice only appears if option EDP is licensed.
Preset	Not part of Preset, but is reset to Peak Table by Restore Mode Defaults. Survives a shutdown.
Initial S/W Revision	Prior to A.02.00

Meas Results File Contents

All files are .csv files. The following section details the data in each file type.

Marker Table

This section discusses the Marker Table Meas Results file format.

Imagine that, at the point where a Marker Table Meas Result is requested, the following screen is showing:

15 LTE Modulation Analysis Measurement
Save

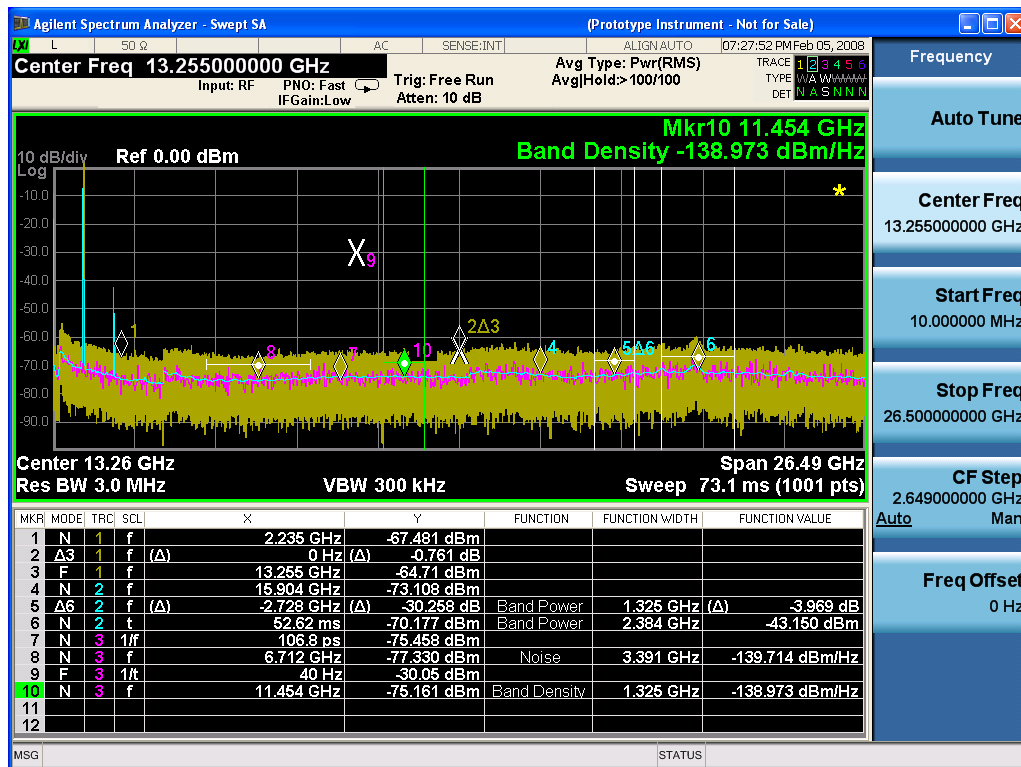

Then the Meas Results file, when opened, would show the following data:

MeasurementResult	
Swept SA	
A.01.40_R0017	N9020A
526 B25 PFR	1
P26 EA3	
Result Type	Marker Table
Ref Level	0
Number of Points	1001
Sweep Time	0.0662666 67
Start Frequency	10000000
Stop Frequency	26500000 000
Average Count	0
Average Type	LogPower (Video)
RBW	3000000

RBW Filter	Gaussian
RBW Filter BW	3dB
VBW	3000000
Sweep Type	Swept
X Axis Scale	Lin
PreAmp State	Off
PreAmp Band	Low
Trigger Source	Free
Trigger Level	1.2
Trigger Slope	Positive
Trigger Delay	1.00E-06
Phase Noise Optimization	Fast
Swept If Gain	Low
FFT If Gain	Autorange
RF Coupling	AC
FFT Width	411900
Ext Ref	10000000
Input	RF
RF Calibrator	Off
Attenuation	10
Ref Level Offset	0
External Gain	0
X Axis Units	Hz
Y Axis Units	dBm

DATA									
MKR	MODE	TR C	SCL	X	Y	FUNCTI ON	FUNCTIO N WIDTH	FUNCTI ON VALUE	FUNCTI ON UNIT
1	Normal	1	Freque ncy	2.2350E+09	- 67.481	Off	0.0000E+00	0	None
2	Delta3	1	Freque ncy	0.0000E+00	- 0.761	Off	0.0000E+00	0	None
3	Fixed	1	Freque ncy	1.3255E+10	- 64.71	Off	0.0000E+00	0	None
4	Normal	2	Freque ncy	1.5904E+10	- 73.1	Off	0.0000E+00	0	None

08									
5	Delta7	2	Frequency	-2.7280E+09	-30.258	Band Power	1.3250E+06	-3.969	dB
6	Normal	2	Time	5.2620E-02	-70.177	Band Power	2.3840E+06	-43.15	dBm
7	Normal	3	Period	1.0680E-10	-75.458	Off	0.0000E+00	0	None
8	Normal	3	Frequency	6.7120E+09	-77.33	Noise	3.3910E+06	-139.714	dBm/Hz
9	Fixed	3	Inverse Time	4.0000E+01	-30.05	Off	0.0000E+00	0	None
10	Normal	3	Frequency	1.1454E+10	-75.161	Band Density	1.3250E+06	-138.973	dBm/Hz
11	Off	1	Frequency	0.0000E+00	0	Off	0.0000E+00	0	None
12	Off	1	Frequency	0.0000E+00	0	Off	0.0000E+00	0	None

The numbers appear in the file exactly as they appear onscreen. If it says 11.454 GHz onscreen, then in the file it is 11.454E+09.

The metadata header is very similar to the metadata used in the trace data .csv files. See Trace File Contents. The only new information concerns the 1-of-N fields in the marker table itself.

Peak Table

This section discusses the Peak Table Meas Results file format.

Imagine that, at the point where a Marker Table Meas Result is requested, the following screen is showing:

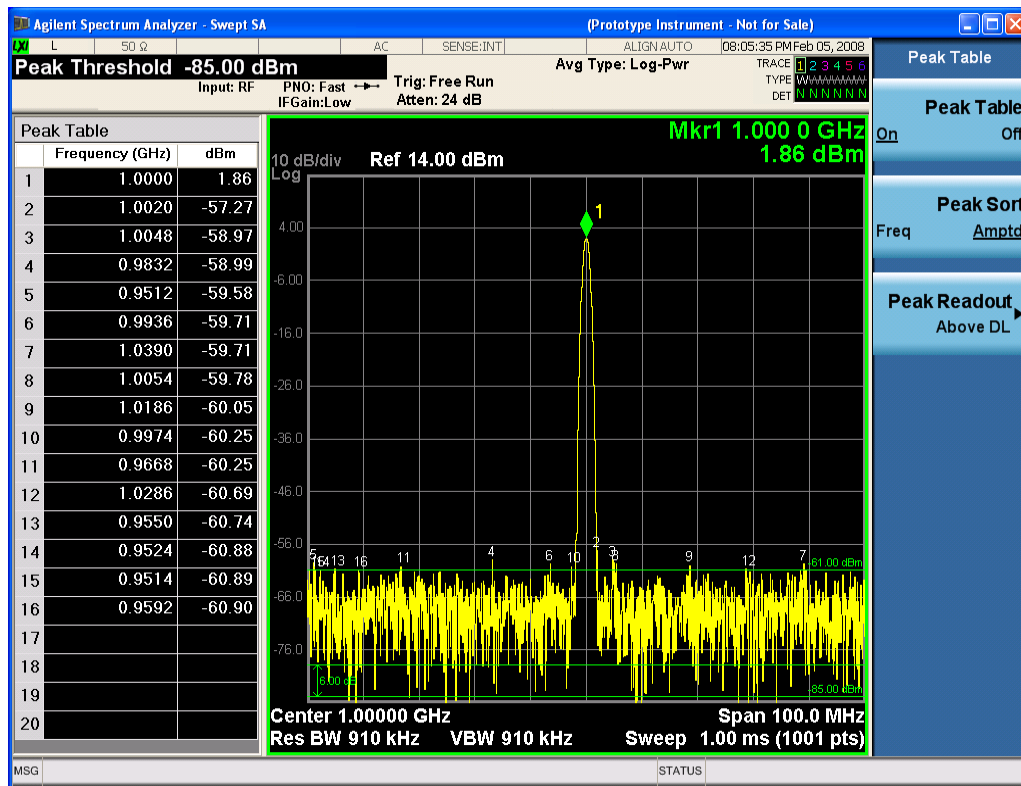

Then the Meas Results file, when opened, would show the header data (the same as for the Marker Table except that the Result Type is Peak Table) ending with a few fields of specific interest to Peak Table users:

- Peak Threshold
- Peak Threshold State (On|Off)
- Peak Excursion
- Peak Excursion State (On|Off)
- Display Line
- Peak Readout (All|AboveDL|BelowDL)
- Peak Sort (Freq|Amptd)

These fields are then followed by the data for the Peak Table itself.

Note that the label for the Frequency column changes to Time in 0 span.

Here is what the table for the above display looks like:

MeasurementResult	
Swept SA	
A.01.40_R0017	N9020A
526 B25 PFR P26 EA3	1

Result Type	Peak Table
Ref Level	0
Number of Points	1001
Sweep Time	0.066266667
Start Frequency	10000000
Stop Frequency	26500000000
Average Count	0
Average Type	LogPower(Video)
RBW	3000000
RBW Filter	Gaussian
RBW Filter BW	3dB
VBW	3000000
Sweep Type	Swept
X Axis Scale	Lin
PreAmp State	Off
PreAmp Band	Low
Trigger Source	Free
Trigger Level	1.2
Trigger Slope	Positive
Trigger Delay	1.00E-06
Phase Noise Optimization	Fast
Swept If Gain	Low
FFT If Gain	Autorange
RF Coupling	AC
FFT Width	411900
Ext Ref	10000000
Input	RF
RF Calibrator	Off
Attenuation	10
Ref Level Offset	0
External Gain	0
X Axis Units	Hz
Y Axis Units	dBm
Peak Threshold	-85
Peak Threshold State	On
Peak Excursion	6
Peak Excursion State	On

Display Line	-61	
Peak Readout	AboveDL	
Peak Sort	Amptd	
DATA		
Peak	Frequency	Amplitude
1	1.0000E+06	1.86
2	1.0020E+06	-57.27
3	1.0048E+06	-58.97
4	9.8320E+05	-58.99
5	9.5120E+05	-59.58
6	9.9360E+05	-59.71
7	1.0390E+06	-59.71
8	1.0054E+06	-59.78
9	1.1086E+06	-60.05
10	9.9740E+05	-60.25
11	9.6680E+05	-60.25
12	1.0286E+06	-60.69
13	9.5500E+05	-60.74
14	9.5240E+05	-60.88
15	9.5140E+05	-60.89
16	9.5920E+05	-60.90
17		
18		
19		
20		

Spectrogram

This section discusses the Spectrogram Results file format. The Spectrogram choice only appears if option EDP is licensed.

The Spectrogram results are the same as a Trace data export, except that instead of having just one trace's data, all 300 traces appear one after the other.

.

Each trace has its own data mark; the data for Spectrogram Trace 0 follows the row marked DATA, the data for Spectrogram Trace 1 follows the row marked DATA1, for Spectrogram Trace 2 follows the row marked DATA2, and so on.

Each DATA row has a timestamp in the second column (as of firmware revision A.11.01). So, for example, if Trace 0 had a relative start time of 1729.523 sec, then the first DATA row would look like this:

DATA,1729.523

And if Trace 13 had a relative start time of 100.45 sec, then the fourteenth data row would look like:

DATA13,100.453

To find the absolute time for the relative timestamps of each trace, the last row before the first DATA row gives the absolute start time of the Spectrogram, in the form YYYYMMDDHHMMSS

So, for example, if the absolute start time is 13:23:45:678 on January 30, 2012, this row would look like:

Start Time,20120130132345678

NOTE

The resolution of the absolute time stored is 1 ms, which matches up with the fact that the fastest sweep time is also 1 ms. However, there is no specification for the absolute accuracy of the clock in the analyzer, nor is there any facility provided to allow the user to set this time to any particular degree of accuracy.

Traces that have not yet been filled in the Spectrogram display are empty; there is no DATA header for them. The file ends after the last non-empty trace.

Imagine that, at the point where a Spectrogram Meas Result is requested, the following screen is showing:

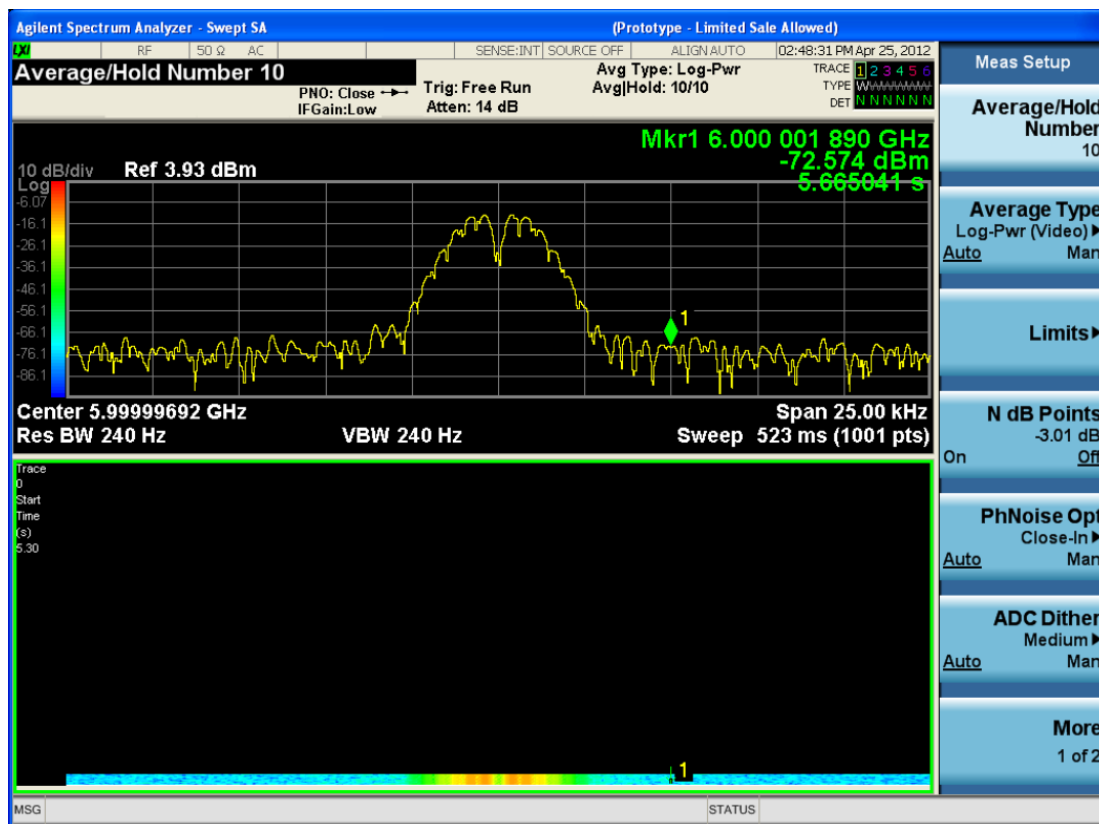

For the purpose of this example, we have set the Average/Hold Number to 10, thus we have only traces 0 thru 10. The Spectrogram was started at 02:28:08:700 pm on April 25, 2012 (that is, 700 ms after 2:28:08 pm), although the screen dump itself shows a different time, as it was taken ten minutes after the

Spectrogram data. Trace 0 is showing a start time of 5.30 seconds, meaning 5.3 seconds after the Spectrogram started (trace 10 has a start time of 0, as it was the first trace taken but has now rolled up into the tenth trace slot).

The Meas Results file, when opened, shows the header data and ten traces of trace data. Below is an extract from the result file for the above display. Note the start time of 20120425142808700 showing in the last row before the first DATA row, and the relative time of 5.299231048 showing in the first DATA row:

Result Type	Spectrogram
MeasResult	
Swept SA	
A.11.00.01	N9020A
503 508 513 526 ALL ALV B1C B1X B25 B2X B40 BAB BBA CR3 CRP DP2 DRD EA3 EDP EMC EP1 ERC ESC ESP EXM FSA HBA K03 LFE MPB P03 P08 P13 P26 PFR RTL RTS S40 SB1 SEC SM1 UK6 YAS YAV	1
Segment	0
Number of Points	1001
Sweep Time	0.523333333
Start Frequency	5999984415
Stop Frequency	6000009415
Average Count	0
Average Type	LogPower(Video)
RBW	240
RBW Filter	Gaussian
RBW Filter BW	3dB
VBW	240
Sweep Type	Swept
X Axis Scale	Lin
PreAmp State	Off
PreAmp Band	Low
Trigger Source	Free
Trigger Level	1.2
Trigger Slope	Positive
Trigger Delay	0
Phase Noise Optimization	Wide
Swept If Gain	Low
FFT If Gain	Autorange
RF Coupling	AC

Result Type	Spectrogram
FFT Width	411900
Ext Ref	10000000
Input	RF
RF Calibrator	Off
Attenuation	14
Ref Level Offset	0
External Gain	0
Trace Type	Clearwrite
Detector	Normal
Trace Math	Off
Trace Math Oper1	Trace5
Trace Math Oper2	Trace6
Trace Math Offset	0
Trace Name	Trace1
X Axis Units	Hz
Y Axis Units	dBm
Start Time	20120425142808700
DATA	5.299231048
5999984415	-76.34749519
5999984440	-77.28097006
5999984465	-75.32317869
5999984490	-73.64417681
5999984515	-72.67154604

- o
- o
- o

6000009315	-77.94423277
6000009340	-79.51829697
6000009365	-78.46108961
6000009390	-78.46108957
6000009415	-76.59570596
DATA2	4.708697055
5999984415	-80.98197882
5999984440	-80.98197879

5999984465	-75.83142132
5999984490	-74.02712079
5999984515	-73.57213005

-
-
-

6000009315	-75.9183103
6000009340	-79.53787488
6000009365	-78.82602191
6000009390	-78.82602188
6000009415	-76.37486709
DATA10	0
5999984415	-75.56751112
5999984440	-75.76485645
5999984465	-76.67718717
5999984490	-78.79238489
5999984515	-83.72680212

-
-
-

6000009315	-71.3942461
6000009340	-72.28308332
6000009365	-73.92684489
6000009390	-75.45548832
6000009415	-75.17904815

Save As . . .

When you press “Save As”, the analyzer brings up a Windows dialog and a menu entitled “**Save As.**” This menu allows you to navigate to the various fields in the Windows dialog without using a keyboard or mouse. The Tab and Arrow keys can also be used for dialog navigation.

See "[To File . . .](#)" on page 2810 in Save, State for a full description of this dialog and menu.

The default path for saving files is:

For all of the Trace Data Files:

My Documents\<<mode name>\data\traces

For all of the Limit Data Files:

My Documents\<<mode name>\data\limits

For all of the Measurement Results Data Files:

My Documents\<<mode name>\data\<<measurement name>\results

For all of the Capture Buffer Data Files:

My Documents\<<mode name>\data\captureBuffer

Key Path	Save, Data
Mode	All
Notes	The key location is mode-dependent and will vary. Brings up the Save As dialog for saving a <mode specific> Save Type. The save is performed immediately and does not wait until the measurement is complete.
Initial S/W Revision	Prior to A.02.00

Screen Image

Pressing Screen Image accesses a menu of functions that enable you to specify a format and location for the saved screen image. It brings up a menu that allows you to specify the color scheme of the Screen Image (Themes) or navigate to the Save As dialog to perform the actual save.

Screen Image files contain an exact representation of the analyzer display. They cannot be loaded back onto the analyzer, but they can be loaded into your PC for use in many popular applications.

The image to be saved is actually captured when the Save front panel key is pressed, and kept in temporary storage to be used if you ask for a Screen Image save. When the Screen Image key is pressed, a "thumbnail" of the captured image is displayed, as shown below:

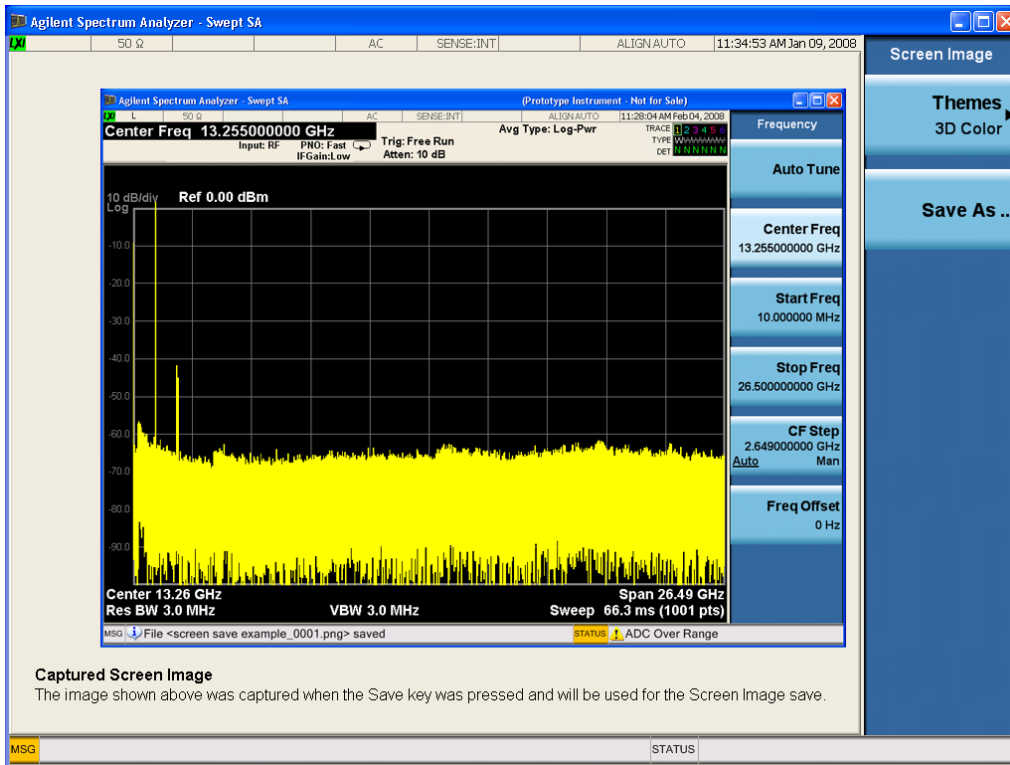

When you continue on into the Save As menu and complete the Screen Image save, the image depicted in the thumbnail is the one that gets saved, showing the menus that were on the screen before going into the Save menus. The save is performed immediately and does not wait until the measurement is complete.

After you have completed the save, the Quick Save front-panel key lets you quickly repeat the last save performed, using an auto-named file, with the current screen data.

NOTE

For versions previous to A.01.55, if you initiate a screen image save by navigating through the Save menus, the image that is saved will contain the Save menu softkeys, not the menus and the active function that were on the screen when you first pressed the Save front panel key.

Key Path	Save
Mode	All
Remote Command	:MMEMory:STORe:SCReem <filename>
Example	:MMEM:STOR:SCR "myScreen.png" This stores the current screen image in the file MyScreenFile.png in the default directory.
Initial S/W Revision	Prior to A.02.00

Themes

Accesses a menu of functions that enable you to choose the theme to be used when saving the screen image.

The **Themes** option is the same as the **Themes** option under the **Display** and **Page Setup** dialogs. It allows you to choose between themes to be used when saving the screen image.

Key Path	Save, Screen Image
Remote Command	:MMEMory:STORe:SCReem:THEMe TDColor TDMonochrome FCOLor FMONochrome :MMEMory:STORe:SCReem:THEMe?
Example	:MMEM:STOR:SCR:THEM TDM
Preset	3D Color; Is not part of Preset, but is reset by Restore Misc Defaults or Restore System Defaults All and survives subsequent running of the modes.
Readback	3D Color 3D Mono Flat Color Flat Mono
Backwards Compatibility Notes	In ESA and PSA we offer the choice of "Reverse Bitmap" or "Reverse Metafile" when saving screen images. This is much like the "Flat Color" theme available in X-Series. Also, if you selected Reverse Bitmap AND a black & white screen image, that would be much like "Flat Monochrome". In other words, each of the X-Series themes has a similar screen image type in ESA/PSA. But they are not identical.
Initial S/W Revision	Prior to A.02.00

3D Color

Selects a standard color theme with each object filled, shaded and colored as designed.

Key Path	Save, Screen Image, Themes
Example	MMEM:STOR:SCR:THEM TDC
Readback	3D Color
Initial S/W Revision	Prior to A.02.00

3D Monochrome

Selects a format that is like 3D color but shades of gray are used instead of colors.

Key Path	Save, Screen Image, Themes
Example	MMEM:STOR:SCR:THEM TDM
Readback	3D Mono
Initial S/W Revision	Prior to A.02.00

Flat Color

Selects a format that is best when the screen is to be printed on an ink printer.

Key Path	Save, Screen Image, Themes
-----------------	----------------------------

Example	MMEM:STOR:SCR:THEM FCOL
Readback	Flat Color
Initial S/W Revision	Prior to A.02.00

Flat Monochrome

Selects a format that is like Flat Color. But only black is used (no colors, not even gray), and no fill.

Key Path	Save, Screen Image, Themes
Example	MMEM:STOR:SCR:THEM FMON
Readback	Flat Mono
Initial S/W Revision	Prior to A.02.00

Save As...

When you press "Save As", the analyzer brings up a Windows dialog and a menu entitled "**Save As.**" This menu allows you to navigate to the various fields in the Windows dialog without using a keyboard or mouse. The Tab and Arrow keys can also be used for dialog navigation.

See "[To File . . .](#)" on page 2810 in Save, State for a full description of this dialog and menu.

The default path for Screen Images is

My Documents\`<mode name>`\screen.

where `<mode name>` is the parameter used to select the mode with the INST:SEL command (for example, SA for the Spectrum Analyzer).

Key Path	Save, Screen Image
Notes	Brings up Save As dialog for saving a Screen Image Save Type
Initial S/W Revision	Prior to A.02.00

Mass Storage Catalog (Remote Command Only)

Key path	SCPI Only
Remote Command	:MMEMory:CATalog? [<code><directory_name></code>]
Notes	<p>The string must be a valid logical path.</p> <p>Queries disk usage information (drive capacity, free space available) and obtains a list of files and directories in a specified directory in the following format:</p> <p><code><numeric_value>,<numeric_value>,{<file_entry>}</code></p> <p>It returns two numeric parameters and as many strings as there are files and directories. The first parameter indicates the total amount of storage currently used in bytes. The second parameter</p>

indicates the total amount of storage available, also in bytes. The <file_entry> is a string. Each <file_entry> indicates the name, type, and size of one file in the directory list:

<file_name>,<file_type>,<file_size>

As the windows file system has an extension that indicates file type, <file_type> is always empty. <file_size> provides the size of the file in bytes. For directories, <file_entry> is surrounded by square brackets and both <file_type> and <file_size> are empty

Initial S/W Revision Prior to A.02.00

Mass Storage Change Directory (Remote Command Only)

Key path SCPI Only

Remote Command :MMEMory:CDIRectory [<directory_name>]
 :MMEMory:CDIRectory?

Notes The string must be a valid logical path.

Changes the default directory for a mass memory file system. The <directory_name> parameter is a string. If no parameter is specified, the directory is set to the *RST value.

At *RST, this value is set to the default user data storage area, that is defined as System.Environment.SpecialFolder.Personal.

Query returns full path of the default directory.

Initial S/W Revision Prior to A.02.00

Mass Storage Copy (Remote Command Only)

Key path SCPI Only

Remote Command :MMEMory:COPY <string>,<string>[,<string>,<string>]

Notes The string must be a valid logical path.

Copies an existing file to a new file or an existing directory to a new directory.

Two forms of parameters are allowed. The first form has two parameters. In this form, the first parameter specifies the source, and the second parameter specifies the destination.

The second form has four parameters. In this form, the first and third parameters specify the source. The second and fourth parameters specify the directories. The first pair of parameters specifies the source. The second pair specifies the destination. An error is generated if the source doesn't exist or the destination file already exists.

This command will generate an "access denied" error if the destination is a restricted folder (e.g., C:\Windows) and the current user does not have Power User or Administrator privileges.

Mass Storage Device Copy (Remote Command Only)

This command transfers data to/from a file and a peripheral device.

Key path	SCPI Only
Remote Command	:MMEMory:COpy:DEvice <source_string>,<dest_string>
Notes	The strings must be a valid logical path or a valid device keyword. If the dest_string is a device keyword, the data is copied from the source file to the device. If the source_string is a device keyword, the data is copied to the source file from the device. Valid device keywords are: SNS (smart noise source) An error is generated if the file or device is not found.

Mass Storage Delete (Remote Command Only)

Key path	SCPI Only
Remote Command	:MMEMory:DElete <file_name>[,<directory_name>]
Notes	The string must be a valid logical path. Removes a file from the specified directory. The <file_name> parameter specifies the file name to be removed. This command will generate an “access denied” error if the file is in a restricted folder (e.g., C:\Windows) and the current user does not have Power User or Administrator privileges.
Initial S/W Revision	Prior to A.02.00

Mass Storage Data (Remote Command Only)

Creates a file containing the specified data OR queries the data from an existing file.

Key path	SCPI Only
Remote Command	:MMEMory:DATA <file_name>, <data> :MMEMory:DATA? <file_name>
Notes	The string must be a valid logical path. The command form is MMEMory:DATA <file_name>,<data>. It loads <data> into the file <file_name>. <data> is in 488.2 block format. <file_name> is string data. The query form is MMEMory:DATA? <file_name> with the response being the associated <data> in block format.
Initial S/W Revision	Prior to A.02.00

Mass Storage Make Directory (Remote Command Only)

Key path	SCPI Only
Remote Command	:MMEMory:MDIRectory <directory_name>
Notes	The string must be a valid logical path. Creates a new directory. The <directory_name> parameter specifies the name to be created.

	This command will generate an “access denied” error if the new directory would be in a restricted folder (e.g., C:\Windows) and the current user does not have Power User or Administrator privileges.
Initial S/W Revision	Prior to A.02.00

Mass Storage Move (Remote Command Only)

Key path	SCPI Only
Remote Command	:MMEMory:MOVE <string>,<string>[,<string>,<string>]
Notes	<p>The string must be a valid logical path.</p> <p>Moves an existing file to a new file or an existing directory to a new directory.</p> <p>Two forms of parameters are allowed. The first form has two parameters. In this form, the first parameter specifies the source, and the second parameter specifies the destination.</p> <p>The second form has four parameters. In this form, the first and third parameters specify the source. The second and fourth parameters specify the directories. The first pair of parameters specifies the source. The second pair specifies the destination. An error is generated if the source doesn't exist or the destination file already exists.</p> <p>This command will generate an “access denied” error if the destination is a restricted folder (e.g., C:\Windows) and the current user does not have Power User or Administrator privileges.</p>
Initial S/W Revision	Prior to A.02.00

Mass Storage Remove Directory (Remote Command Only)

Key path	SCPI Only
Remote Command	:MMEMory:RDIRECTory <directory_name>
Notes	<p>The string must be a valid logical path.</p> <p>Removes a directory. The <directory_name> parameter specifies the directory name to be removed. All files and directories under the specified directory shall also be removed.</p> <p>This command will generate an “access denied” error if the folder is a restricted folder (e.g., C:\Windows) or is in a restricted folder and the current user does not have Power User or Administrator privileges.</p>
Initial S/W Revision	Prior to A.02.00

Single (Single Measurement/Sweep)

Sets the analyzer for Single measurement operation. The single/continuous state is Meas Global, so the setting will affect all the measurements. If you are Paused, pressing Single does a Resume.

See "[More Information](#)" on page 2285

Key Path	Front-panel key
Example	:INIT:CONT OFF
Notes	See Cont key description.
Backwards Compatibility Notes	<p>For Spectrum Analysis mode in ESA and PSA, the Single hardkey and the INITiate:IMM switched from continuous measurement to single measurement and restarted sweeps and averages (displayed average count reset to 1), but did not restart Max Hold and Min Hold. In the X-Series, the Single hardkey and the INITiate:IMM command initiate a sweep/ measurement/ average sequence/hold sequence including MaxHold and MinHold.</p> <p>For Spectrum Analysis mode in ESA and PSA, the Single hardkey restarted the sweep regardless of whether or not you were in an active sweep or sweep sequence. In the X-Series, Restart does this but Single only restarts the sweep or sweep sequence if you are in the idle state.</p> <p>INIT[:IMM] in ESA & PSA Spectrum Analysis Mode does an implied ABORT. In some other PSA Modes, INIT[:IMM] is ignored if not in the idle state. . The X-Series follows the ESA/PSA SA Mode model, which may cause some Modes to have compatibility problems.</p>
Initial S/W Revision	Prior to A.02.00

More Information

See "[Restart](#)" on page 2807 for details on the INIT:IMMEDIATE (Restart) function.

If you are already in single sweep, the INIT:CONT OFF command has no effect.

If you are already in Single Sweep, then pressing the Single key in the middle of a sweep does not restart the sweep or sequence. Similarly, pressing the Single key does not restart the sweep or sequence if the sweep is not in the idle state (for example, if you are taking a very slow sweep, or the analyzer is waiting for a trigger). Instead, it results in a message. "Already in Single, press Restart to initiate a new sweep or sequence". Even though pressing the Single key in the middle of a sweep does not restart the sweep, sending INIT:IMMEDIATE does reset it.

To take one more sweep without resetting the average count, increment the average count by 1, by pressing the step up key while **Average/Hold Number** is the active function, or sending the remote command CALC:AVER:TCON UP.

Source

There is no Source control functionality for this measurement. When this key is pressed, the screen either displays a blank menu, or the previously-selected menu remains unchanged.

Key Path	Front-panel key
----------	-----------------

SPAN X Scale

Displays a menu for selecting measurement span and also for scaling of the X axis.

Key Path	Front Panel
Mode	VSA, LTE, LTETDD, IDEN, LTEAFDD, LTEATDD
Initial S/W Revision	Prior to A.02.00
Modified at S/W Revision	A.02.00

Span

Controls the frequency span of the measurement. This is the full span that is displayed on a spectrum display. The actual IF bandwidth that the time record detects is 1.28 times the span. See "[FREQ Channel](#)" on page 1816 for details on how this interacts with start, stop, and center frequencies.

Key Path	SPAN X Scale
Mode	VSA, IDEN
Remote Command	[:SENSe] :FREQuency:SPAN <freq> [:SENSe] :FREQuency:SPAN?
Example	FREQ:SPAN 10 MHZ FREQ:SPAN?
Couplings	Start Freq and Stop Freq. See " FREQ Channel " on page 1816 for details.
Preset	depends on span option
State Saved	Saved in instrument state.
Min	2 Hz
Max	depends on span option
Initial S/W Revision	Prior to A.02.00
Modified at S/W Revision	A.02.00

Full Span

Changes the span to the maximum available. The center frequency remains unchanged, regardless of whether the Frequency Annotation property is Start/Stop or Center/Span.

Key Path	SPAN X Scale
Mode	VSA, IDEN
Remote Command	[:SENSe] :FREQuency:SPAN:FULL
Example	FREQ:SPAN:FULL
Notes	The label on the softkey gives the full span available, which depends on span option.
Couplings	Changes span to maximum while keeping the center frequency constant. Start and Stop frequency

	are affected
Readback Text	[25 MHz] If playing back a recording, list the recorded bandwidth here
Initial S/W Revision	Prior to A.02.00
Modified at S/W Revision	A.02.00

Select Trace

Displays a menu that enables you to select the trace that is to receive the action of all successive trace-specific commands like scaling, assignment of trace data, and so on. The selected trace is outlined in green and is always visible. While the Select Trace menu is showing, each visible trace is annotated in the middle with its own trace number, as shown in the following figure. The trace number annotations disappear when any other menu is showing.

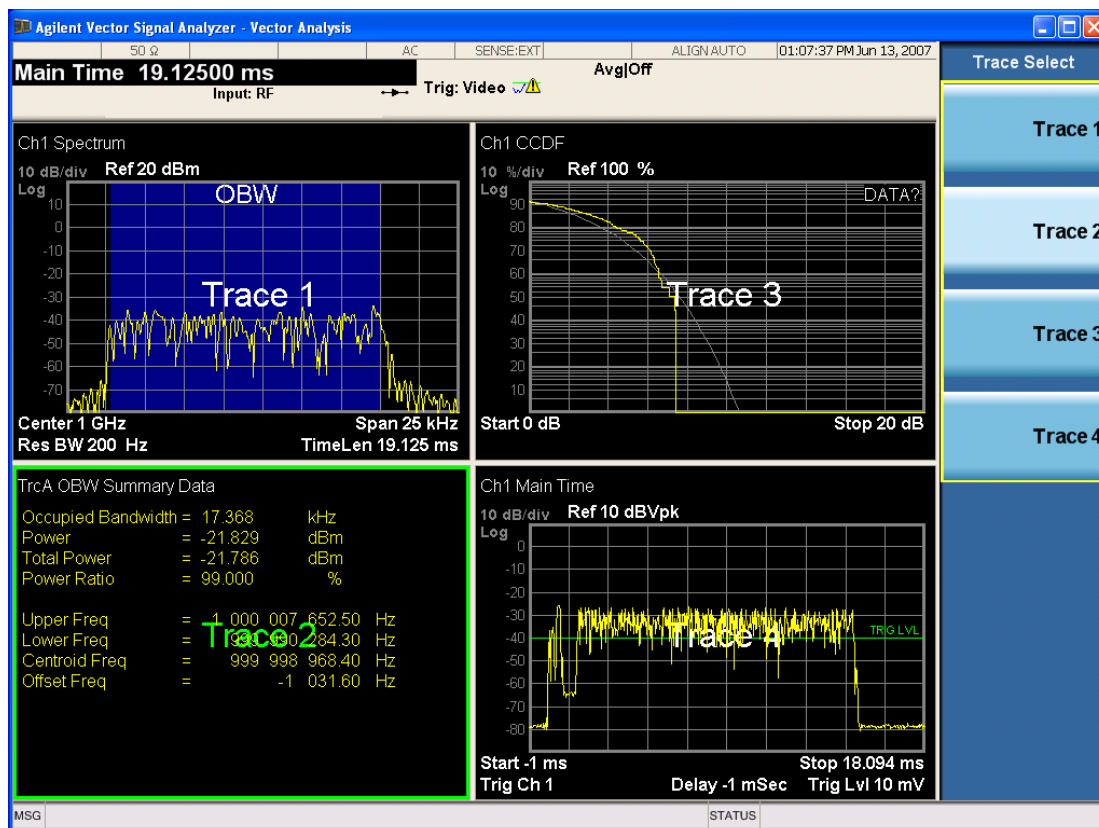

Grid 2x2 layout showing trace annotations when Trace Select dialog is active

This softkey also appears in the X and Y scaling menus. There is only one selected trace at any time. If you change which trace is selected, that change is reflected in this softkey/menu wherever it appears. Other ways to select a trace include use of the Next Window key, clicking within a trace window with a mouse cursor, and issuing a trace-specific SCPI command.

There is no SCPI command associated with this function. Instead, SCPI commands that are trace-specific have an index on the TRACe node that determines the selected trace. Using such a command has the side

effect that the trace addressed by the SCPI command becomes the selected trace for any front panel interaction.

Key Path	Trace/Detector or Span X Scale or AMPTD Y Scale
Mode	VSA, LTE, LTETDD, IDEN, LTEAFDD, LTEATDD
Notes	No SCPI. Front panel only.
Couplings	Affects any trace-specific commands
Range	Trace 1 Trace 2 Trace 3 Trace 4 Trace 5 Trace 6
Readback Text	Trace <n>
Initial S/W Revision	Prior to A.02.00
Modified at S/W Revision	A.02.00

X Scale

Causes the trace to display all available trace data when set to Auto. (Exception: the display of the outer edges of a spectrum that can contain aliases is governed by the All Frequency Points function setting – see below.) The annotation is updated as needed, but the X Reference Value and X Width keys are grayed out and not updated. When this function is set to Man, the X Reference Value and X Width softkey readbacks are updated with the current values.

Key Path	SPAN X Scale
Mode	VSA, LTE, LTETDD, IDEN, LTEAFDD, LTEATDD
Measurement	<meas>:=VECTor ADEMod DDEMod W11A W11B EVM IPOWER IDEMod MOTotalk
Remote Command	:DISPlay:<meas>:TRACe[1] 2 ...4:X[:SCALE]:COUPle OFF ON 0 1 :DISPlay:<meas>:TRACe[1] 2 ...4:X[:SCALE]:COUPle?
Example	:DISP:VECT:TRAC1:X:COUP ON DISP:VECT:TRAC1:X:COUP?
Couplings	Forced to Man if X Reference Value or X Width is set by user.
Preset	1
State Saved	Saved in instrument state.
Range	Auto Man
Initial S/W Revision	Prior to A.02.00
Modified at S/W Revision	A.02.00

X Reference Value

Controls the X value of the selected trace at the chosen X Reference Position (see below). It has no effect on hardware input settings.

Key Path	SPAN X Scale
----------	--------------

Mode	VSA, LTE, LTETDD, IDEN, LTEAFDD,LTEATDD
Measurement	<meas>:=VECTor ADEMod DDEMod W11A W11B EVM IPOWER IDEMod MOTotalk
Remote Command	:DISPlay:<meas>:TRACe [1] 2 ...4:X[:SCALE]:RLEVel <real> :DISPlay:<meas>:TRACe [1] 2 ...4:X[:SCALE]:RLEVel?
Example	DISP:VECT:TRAC:X:RLEV 1e9 DISP:VECT:TRAC:X:RLEV?
Couplings	If X Scale is set to Auto, the X Reference Value is determined by the trace data and this key is grayed out.
Preset	Depends on trace
State Saved	Saved in instrument state.
Min	-9.9E+37
Max	9.9E+37
Initial S/W Revision	Prior to A.02.00
Modified at S/W Revision	A.02.00

X Width

Sets the width of the X axis that is displayed for the selected trace. The X width can be set less than the Span for frequency-domain traces, enabling you to zoom in on just a portion of the measured values. Likewise, it can be less than time span covered by time-domain data. This plus the X Reference Value and X Reference Position control the range of X values that can be displayed on a trace. For example, if the X Reference position is Center, the X Reference value is 1 GHz and the X Width is 20 MHz.

Key Path	SPAN X Scale
Mode	VSA, LTE, LTETDD, IDEN, LTEAFDD,LTEATDD
Measurement	<meas>:=VECTor ADEMod DDEMod W11A W11B EVM IPOWER IDEMod MOTotalk
Remote Command	:DISPlay:<meas>:TRACe [1] 2 ...4:X[:SCALE]:SPAN <real> :DISPlay:<meas>:TRACe [1] 2 ...4:X[:SCALE]:SPAN?
Example	DISP:VECT:TRAC:X:SPAN 10e6 DISP:VECT:TRAC:X:SPAN?
Couplings	If X Scale is set to Auto, the X Width is determined by the trace data and this key is grayed out.
Preset	Depends on trace
State Saved	Saved in instrument state.
Min	-9.9E+37
Max	9.9E+37
Initial S/W Revision	Prior to A.02.00
Modified at S/W Revision	A.02.00

X Reference Position

Determines the position from which the X scaling is calculated for the selected trace. It can be set to the left side, center, or right side of the grid.

Key Path	SPAN X Scale
Mode	VSA, LTE, LTETDD, IDEN, LTEAFDD, LTEATDD
Measurement	<meas>:=VECTor ADEMod DDEMod W11A W11B EVM IPOWER IDEMod MOTotalk
Remote Command	:DISPlay:<meas>:TRACe [1] 2 ... 4 : X [: SCALe] : RPOSition LEFT CENTer RIGHT :DISPlay:<meas>:TRACe [1] 2 ... 4 : X [: SCALe] : RPOSition?
Example	DISP:VECT:TRAC1:X:RPOS LEFT DISP:VECT:TRAC1:X:RPOS?
Couplings	If X Scale is set to Auto, the X Reference Position is determined by the trace data and this key is grayed out.
Preset	CENT
State Saved	Saved in instrument state.
Range	Left Ctr Right
Initial S/W Revision	Prior to A.02.00
Modified at S/W Revision	A.02.00

Freq Annotation

Controls how Spectrum and PSD traces are annotated when their X Scale is set to Auto. If Freq Annotation is set to Center/Span, the X-axes on windows containing frequency domain traces are labeled with the center frequency on the left and the span on the right. If the Freq Annotation is set to Start/Stop, then the start and stop frequencies appear in place of center and span. If the X Scale is manual, then this annotation style does not apply.

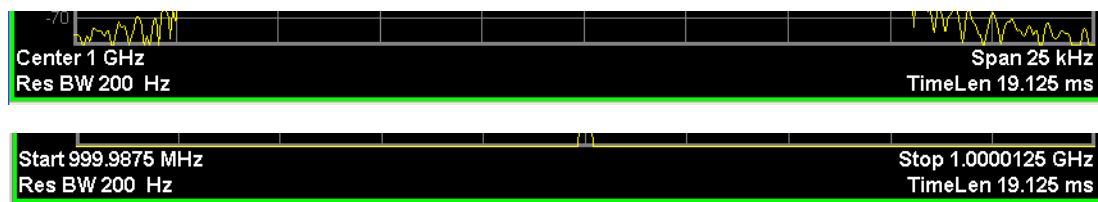

Key Path	SPAN X Scale
Mode	VSA, LTE, LTETDD, IDEN, LTEAFDD, LTEATDD
Measurement	<meas>:=VECTor ADEMod DDEMod W11A W11B EVM IPOWER IDEMod MOTotalk
Remote Command	:DISPlay:<meas>:FANNotation CSPan SSTop :DISPlay:<meas>:FANNotation?
Example	DISP:VECT:FANN CSP DISP:VECT:FANN?

Preset	CSP
State Saved	Saved in instrument state.
Range	Center/Span Start/Stop
Initial S/W Revision	Prior to A.02.00
Modified at S/W Revision	A.02.00

All Frequency Points

Spectrum trace data (and PSD) are based on the FFT algorithm. By default, the outer edges of the spectrum are not displayed because they can show spurious results that are aliases of real signals that are not completely filtered out by the IF filter. For example, in the case of a 1024 point FFT only 801 points are displayed. If you want to view the additional FFT points at the edges of spectral displays, turn this function on. It is global to all traces, not specific to a single trace.

Key Path	SPAN X Scale
Mode	VSA, LTE, LTETDD, IDEN, LTEAFDD, LTEATDD
Measurement	<meas>:=VECTor ADEMod DDEMod W11A W11B EVM IPOWER IDEMod MOTotalk
Remote Command	:DISPlay:<meas>:AFPpoints OFF ON 0 1 :DISPlay:<meas>:AFPpoints?
Example	DISP:VECT:AFP ON DISP:VECT:AFP?
Notes	ac
Couplings	Only applies if trace is showing Spectrum or PSD results.
Preset	OFF
State Saved	Saved in instrument state.
Range	On Off
Initial S/W Revision	Prior to A.02.00
Modified at S/W Revision	A.02.00

Copy X Scale

Copies the following X scaling information from the selected trace to another:

- X reference Position
- X Reference Value
- X Width
- X Scale (Auto/Man)

This is a front-panel only function.

Key Path	SPAN X Scale, X Axis Scaling
Mode	VSA, LTE, LTETDD, IDEN, LTEAFDD,LTEATDD
Initial S/W Revision	Prior to A.02.00
Modified at S/W Revision	A.02.00

Sweep/Control

Displays a menu that enables you to control time-related measurement parameters and to pause or resume the measurement.

Key Path	Front Panel
Mode	VSA
Initial S/W Revision	A.01060 or later

Pause / Resume

Pauses or resumes acquisition at the end of the current time record acquisition.

Key Path	Sweep Control
Mode	VSA
Initial S/W Revision	A.01060 or later

System

See "System" on page 366

Trace/Detector

Accesses a menu enabling you to select various trace parameters for all VSA based measurements.

Key Path	Front Panel
Mode	VSA, LTE, LTETDD, IDEN, LTEAFDD, LTEATDD
Initial S/W Revision	Prior to A.02.00
Modified at S/W Revision	A.02.00

Select Trace

Displays a menu that enables you to select the trace that is to receive the action of all successive trace-specific commands like scaling, assignment of trace data, and so on. The selected trace is outlined in green and is always visible. While the Select Trace menu is showing, each visible trace is annotated in the middle with its own trace number, as shown in the following figure. The trace number annotations disappear when any other menu is showing.

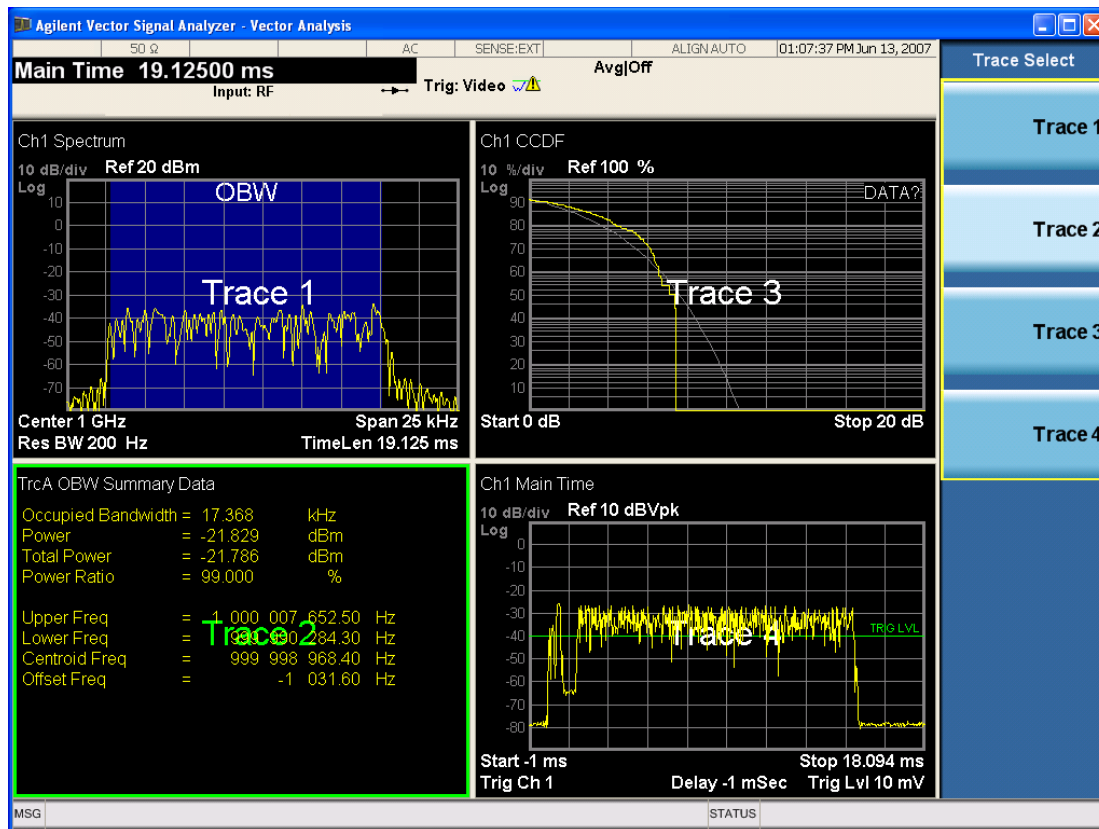

Grid 2x2 layout showing trace annotations when Trace Select dialog is active

This softkey also appears in the X and Y scaling menus. There is only one selected trace at any time. If you change which trace is selected, that change is reflected in this softkey/menu wherever it appears. Other

ways to select a trace include use of the Next Window key, clicking within a trace window with a mouse cursor, and issuing a trace-specific SCPI command.

There is no SCPI command associated with this function. Instead, SCPI commands that are trace-specific have an index on the TRACe node that determines the selected trace. Using such a command has the side effect that the trace addressed by the SCPI command becomes the selected trace for any front panel interaction.

Key Path	Trace/Detector or Span X Scale or AMPTD Y Scale
Mode	VSA, LTE, LTETDD, IDEN,LTEAFDD,LTEATDD
Notes	No SCPI. Front panel only.
Couplings	Affects any trace-specific commands
Range	Trace 1 Trace 2 Trace 3 Trace 4 Trace 5 Trace 6
Readback Text	Trace <n>
Initial S/W Revision	Prior to A.02.00
Modified at S/W Revision	A.02.00

Data

Accesses a menu of Trace data choices for the selected trace. A VSA Measurement can produce many different results from a single scan; either a graph or a table. In addition, the ACP and OBW functions can be enabled on any trace, showing a frequency-domain result, and produce Summary table results. Any of these results can be assigned to a trace and displayed.

The following Trace Data types are available in all measurements:

Soft Key Name	SCPI string form
No Data	"No Data"
Spectrum	"Spectrum1"
Inst Spectrum	"Inst Spectrum1"
Raw Main Time	"Raw Main Time1"
OBW Summary for Trace 1	"Obw Summary Trc1"
OBW Summary for Trace 2	"Obw Summary Trc2"
OBW Summary for Trace 3	"Obw Summary Trc3"
OBW Summary for Trace 4	"Obw Summary Trc4"
ACP Summary for Trace 1	"Acp Summary Trc1"
ACP Summary for Trace 2	" Acp Summary Trc2"
ACP Summary for Trace 3	" Acp Summary Trc3"
ACP Summary for Trace 4	" Acp Summary Trc4"

The following Data Registers are also available for display if there are traces stored in them (see ["Copy to Data Register" on page 2333](#) and ["Import Trace Data" on page 2801](#): "D1", "D2", "D3", "D4", "D5", and "D6")

Key Path	Trace/Detector, Data
Mode	VSA, LTE, LTETDD, IDEN
Measurement	<meas>:=VECTor ADEMod DDEMod W11A W11B EVM IPOWER IDEMod MOTotalk
Remote Command	:DISPlay:<meas>:TRACe[1] 2 ...4:FEED <string> :DISPlay:<meas>:TRACe[1] 2 ...4:FEED?
Example	DISP:VECT:TRAC1:FEED "Spectrum1" DISP:VECT:TRAC1:FEED?
Preset	Depends on trace number and measurement
State Saved	Saved in instrument state.
Initial S/W Revision	Prior to A.02.00
Modified at S/W Revision	A.02.00

The complete list of Trace Data names that can be assigned using the above SCPI can be obtained by using the following SCPI query:

Mode	VSA, LTE, LTETDD, IDEN
Measurement	<meas>:=VECTor ADEMod DDEMod W11A W11B EVM IPOWER IDEMod MOTotalk
Remote Command	:CALCulate:<meas>:DATA[1] 2 ...4:NAMes?
Example	CALC:VECT:DATA:NAM?
Notes	Query only. Returns a comma-separated list of trace data names that can be used in DISPlay:<meas>:TRACe[1] 2 3 4:FEED "<string>". The list is the same regardless of trace index.
Initial S/W Revision	Prior to A.02.00
Modified at S/W Revision	A.02.00

Pre Demod

Displays the Trace Data choices that show pre-demodulation results. See [Data](#) for the corresponding SCPI command.

Key Path	Trace/Detector, Data
Mode	LTE, LTETDD
Initial S/W Revision	Prior to A.02.00
Modified at S/W Revision	A.03.00

Spectrum

Averaged FFT of the Time waveform. See [Data](#) for the corresponding SCPI command.

Key Path	Trace/Detector, Data, Pre Demod
Mode	LTE, LTETDD
Initial S/W Revision	Prior to A.02.00
Modified at S/W Revision	A.03.00

Inst Spectrum

FFT of the time waveform for the current measurement. “Inst” or Instantaneous refers to this result not being averaged like the Trace Data result. See [Data](#) for the corresponding SCPI command.

Key Path	Trace/Detector, Data, Pre Demod
Mode	LTE, LTETDD
Initial S/W Revision	Prior to A.02.00
Modified at S/W Revision	A.03.00

Search Time

Search Length long time record acquired for the current measurement. See [Data](#) for the corresponding SCPI command.

Key Path	Trace/Detector, Data, Pre Demod
Mode	LTE, LTETDD
Initial S/W Revision	Prior to A.02.00
Modified at S/W Revision	A.03.00

Time

Time data corresponding to the measurement interval used to compute demod results. See [Data](#) for the corresponding SCPI command.

Key Path	Trace/Detector, Data, Pre Demod
Mode	LTE, LTETDD
Initial S/W Revision	Prior to A.02.00
Modified at S/W Revision	A.03.00

Raw Main Time

Raw time record acquired for the current measurement. This data is unprocessed and includes additional points acquired for settling of the filters involved in subsequent processing, such as the demodulation filtering. See [Data](#) for the corresponding SCPI command.

Key Path	Trace/Detector, Data, Pre Demod
Mode	LTE, LTETDD
Initial S/W Revision	Prior to A.02.00
Modified at S/W Revision	A.03.00

Statistical

Displays the Trace Data choices that show statistical results.

Key Path	Trace/Detector, Data
Mode	LTE, LTETDD
Initial S/W Revision	Prior to A.02.00
Modified at S/W Revision	A.03.00

CCDF (Complementary, Cumulative Density Function)

Displays the CCDF data result in the selected trace. CCDF trace data displays the complementary, cumulative density function (CCDF) for the selected input channel. The complementary, cumulative density function (CCDF) is a statistical-power calculation and can be performed only on time-domain data. As its name suggests, CCDF is the complement of CDF, and is defined as follows:

$$\text{CDF}(K) = \text{Probability}(x \leq K)$$

$$\text{CCDF}(K) = \text{Probability}(x \geq K)$$

CCDF provides better resolution than CDF for low probability signals, especially when log format is used for the y-axis.

The analyzer plots CCDF using units of percent (%) for the y-axis and power (dB) for the x-axis. Power on the x-axis is relative to the signal average power, so 0 dB is the average power of the signal. Therefore, a marker readout of

Trace A Marker 2 dB 12 %

means there is a 12% probability that the signal power is 2 dB or more above the average power.

CCDF Calculation:

1. Calculate the RMS value for all measured samples; this becomes the 0 dB point at the left end of the x-axis.
2. Normalize all samples to the RMS value in units of dB.
3. Determine which x-axis bin each sample belongs in between 0 and 20 dB.

4. Calculate the total number of samples that are greater than or equal to each x-axis bin and plot as a percent of the number of samples measured.

Samples Used in the Power Measurement

For the Demod Off and Analog demod modes, the analyzer computes CCDF using all samples in the current time record (all points in the active trace). Each successive time record adds additional samples to the CCDF measurement.

Restarting the Power Measurement

Selecting CCDF, restarting the measurement, or changing most measurement parameters restarts the CCDF measurement. For example, changing the range or center frequency resets the number of samples used in the CCDF measurement to zero and restarts the CCDF measurement.

Tips

Note the following when making CCDF measurements:

- For best results, set the analyzer's displayed frequency span to include all the energy of your signal. In other words, make sure the displayed frequency span includes the entire bandwidth of the measured signal.
- The CCDF measurement does not restart:
 - After a calibration
 - After you continue a paused measurement
- Many channel specific changes restart the CCDF measurement on both channels, such as changing the gate delay, or input coupling.
- The analyzer displays DATA? if the average power drifts 8 to 10 dB from the average power measured in the first time record. For example, the analyzer would display DATA? if you measured a transmitter signal that was off when the CCDF measurement started but then turned on later in the measurement.
- CCDF measurements are disabled during time averaging.

See also: ["Data" on page 2297](#)

Key Path	Trace/Detector, Data
Mode	VSA, LTE, LTETDD, IDEN
Initial S/W Revision	Prior to A.02.00
Modified at S/W Revision	A.02.00

CDF (Cumulative Density Function)

Displays the CDF data result in the selected trace. CDF trace data displays the Cumulative Density Function (CDF) for the selected input channel. CDF is computed by integrating the PDF (Probability Density Function).

See also: ["CCDF \(Complementary, Cumulative Density Function\)" on page 2300](#) and ["Data" on page 2297](#)

Key Path	Trace/Detector, Data
Mode	VSA, LTE, LTETDD, IDEN
Initial S/W Revision	Prior to A.02.00
Modified at S/W Revision	A.02.00

PDF (Probability Density Function)

Display the PDF data result in the selected trace. PDF trace data displays the Probability Density Function of the selected channel. PDF indicates the probability that a given level has occurred.

PDF is equivalent to a normalized histogram. A histogram shows how the amplitude of a signal is distributed between its maximum and minimum values. Amplitude is displayed on the X-axis, and number of counts on the Y-axis.

The number of averages for a histogram determines the number of counts in the histogram; in other words, how many records are measured – the records are not "averaged". If averaging is off or if exponential averaging is selected, the measurement continues indefinitely. Keep in mind that the accuracy of the histogram is dependent on the frequency span, time-record length, and number of averages (if averaging is on).

Histograms are used for such things as determining the statistical properties of noise and monitoring the performance of electromechanical positioning systems.

PDF trace data is normalized by multiplying the number of averages by the number of points in the time record, then dividing this value by the DV spacing on the X-axis. The probability of a signal falling between two points is equal to the integral of the curve between those points.

PDF trace data displays the number of points used in its computation above the trace (Pts:). It also displays the average level (Avg:) above the trace.

See also: ["Data" on page 2297](#)

Key Path	Trace/Detector, Data
Mode	VSA, LTE, LTETDD, IDEN
Initial S/W Revision	Prior to A.02.00
Modified at S/W Revision	A.02.00

Demod

Displays the Trace Data choices which show general demodulation results.

Key Path	Trace/Detector, Data
Mode	LTE, LTETDD
Initial S/W Revision	Prior to A.02.00
Modified at S/W Revision	A.03.00

IQ Meas

IQ Meas is the measured IQ symbol values of the subcarriers. There is one complex value for each subcarrier for each symbol in the burst.

Normally this trace data is displayed as a constellation. The constellation display shows both data and pilot subcarriers, the pilots and data values are shown in different colors.

See [Data](#) for the corresponding SCPI command.

Key Path	Trace/Detector, Data, Demod
Mode	LTE, LTETDD
Initial S/W Revision	Prior to A.02.00
Modified at S/W Revision	A.03.00

IQ Ref

IQ Ref is the reference (ideal) IQ values of the subcarriers. There is one complex value for each subcarrier for each symbol in the burst.

Normally this trace data is displayed as a constellation. The constellation shows both data and pilot subcarrier symbols, the pilots and data values are shown in different colors.

See [Data](#) for the corresponding SCPI command.

Key Path	Trace/Detector, Data, Demod
Mode	LTE, LTETDD
Initial S/W Revision	Prior to A.02.00
Modified at S/W Revision	A.03.00

IQ Meas Time

IQ Meas and IQ Ref traces show signal levels as a function of subcarriers or samples/subcarriers. Signals levels on different OFDM symbols are shown as different points on the same vertical line corresponding to a subcarrier or subcarrier/sample. There is also value in showing these traces as a function of symbols on the X-axis. For each symbol, different subcarriers or samples will be shown as different points on the same vertical line.

See [Data](#) for the corresponding SCPI command.

Key Path	Trace/Detector, Data, Demod
Mode	LTE, LTETDD
Initial S/W Revision	Prior to A.02.00
Modified at S/W Revision	A.03.00

IQ Ref Time

IQ Ref Time is similar to IQ Meas Time, except that the points plotted are the expected signal levels instead of the measured ones. See [Data](#) for the corresponding SCPI command.

Key Path	Trace/Detector, Data, Demod
Mode	LTE, LTETDD
Initial S/W Revision	Prior to A.02.00
Modified at S/W Revision	A.03.00

IQ Freq Meas

IQ Freq Meas displays the measured IQ values (measured at the output of the FFT) of the subcarriers for each OFDM symbol point. This trace is identical to IQ Meas in downlink mode since IQ Meas also displays measured IQ values at the output of FFT. In uplink mode, while IQ Meas displays PUSCH values after despreading (IFFT), IQ Freq Meas continues to display PUSCH IQ values at the output of the FFT, which resembles a collection of random points concentrated around the origin. See [Data](#) for the corresponding SCPI command.

NOTE To view SC-FDMA (uplink PUSCH) signals in the time domain, use IQ Meas.

The data in IQ Freq Meas, which comes from the Time trace data as that data is passed through the demodulator, is a 2x2 matrix with frequency along one dimension and time along the other. In addition, each one of the points in the matrix is a complex value; therefore there are 4 total dimensions. The choice of trace format determines which two dimensions will be on the x-y plane, and which dimensions will be overlapped, averaged, or ignored. The relevant trace formats and their corresponding view of the data are described below.

Constellation, IQ - The I-Q plane is mapped to the x-y plane and each point contains both a subcarrier and a symbol-time reference. In other words, each point plotted on the complex plane came from a symbol transmitted on a specific subcarrier at a certain time.

LogMag, LinMag, Real, Imag, Wrapped Phase, Unwrapped Phase - Subcarriers are plotted along the x-axis. All the symbols that a subcarrier transmits have been plotted above the corresponding subcarrier tick on the x-axis, in the specified format (whether it be dB magnitude or the real value of the symbol point, etc.).

Key Path	Trace/Detector, Data, Demod
Mode	LTE, LTETDD
Initial S/W Revision	A.02.00
Modified at S/W Revision	A.03.00

IQ Freq Ref

IQ Freq Ref displays the reference (demodulated) IQ values of the subcarriers for each OFDM symbol point at the output of the FFT. This trace is identical to IQ Ref in downlink mode. In uplink mode, this trace always

displays OFDM reference IQ points (unlike IQ Ref, which displays reference PUSCH SC-FDMA IQ points after despreading (IFFT)). See [Data](#) for the corresponding SCPI command.

NOTE

To view SC-FDMA (uplink PUSCH) signals in the time domain, use IQ Meas.

Key Path	Trace/Detector, Data, Demod
Mode	LTE, LTETDD
Initial S/W Revision	A.02.00
Modified at S/W Revision	A.03.00

Detected Allocations

Detected Allocations displays the RB allocations detected by the measurement if “Auto Detect” is on, or the user-configured RB allocations if “Auto Detect” is off.

See [Data](#) for the corresponding SCPI command.

Key Path	Trace/Detector, Data, Demod
Mode	LTE, LTETDD
Initial S/W Revision	A.02.00
Modified at S/W Revision	A.03.00

Demod Err (Error)

Displays the Trace Data Demod Error choices that show general demodulation results.

Key Path	Trace/Detector, Data
Mode	LTE, LTETDD
Initial S/W Revision	Prior to A.02.00
Modified at S/W Revision	A.03.00

Error Vector Time

This trace shows each of the individual signal error vectors for each subcarrier and symbol vs. Time (symbol) and frequency (subcarrier). Each error vector is the vector difference, for that subcarrier at that symbol-time, between the corresponding IQ Meas value and the IQ Ref value.

On this trace, the individual error vectors are plotted vs Time (symbol). So at each valid symbol, there is a point plotted for each valid subcarrier (52 total, since subcarrier 0 is not used.) In addition, a white trace is drawn, where each point is the RMS average over the valid subcarriers, which is the same result as is plotted separately as RMS Error Vector Time.

See [Data](#) for the corresponding SCPI command.

Key Path	Trace/Detector, Data, Demod Error
Mode	LTE, LTETDD
Initial S/W Revision	Prior to A.02.00
Modified at S/W Revision	A.03.00

RMS Error Vector Time

The difference between IQ Meas and IQ Ref is the error vector (which will have a complex value) at each subcarrier at each symbol-time. This trace is the RMS average of the error vector for each valid subcarrier at the plotted symbol, the same data shown as a white trace shown in Error Vector Time.

See [Data](#) for the corresponding SCPI command.

Key Path	Trace/Detector, Data, Demod Error
Mode	LTE, LTETDD
Initial S/W Revision	Prior to A.02.00
Modified at S/W Revision	A.03.00

Error Vector Spectrum

This trace, like Error Vector Time shows each of the individual signal error vectors for each subcarrier and symbol vs. Time (symbol) and frequency (subcarrier). Each error vector is the vector difference, for that subcarrier at that symbol-time, between the corresponding IQ Meas value and the IQ Ref value.

On this trace, the individual error vectors are plotted vs frequency (subcarrier). So at each valid subcarrier, there is a point plotted for each valid symbol. Note that subcarrier 0 is not plotted since it is not used. In addition, a white trace is drawn, where each point is the RMS average over the valid symbols, which is the same result as is plotted separately as RMS Error Vector Spectrum.

See [Data](#) for the corresponding SCPI command.

Key Path	Trace/Detector, Data, Demod Error
Mode	LTE, LTETDD
Initial S/W Revision	Prior to A.02.00
Modified at S/W Revision	A.03.00

RMS Error Vector Spectrum

This trace is the RMS average of the error vector for each valid symbol at the plotted subcarrier, the same data shown as a white trace shown in Error Vector Time. Note that subcarrier 0 is not plotted since it is not used.

See [Data](#) for the corresponding SCPI command.

Key Path	Trace/Detector, Data, Demod Error
Mode	LTE, LTETDD
Initial S/W Revision	Prior to A.02.00
Modified at S/W Revision	A.03.00

Common Tracking Error

This trace shows the small scale deviations from the averaged channel response occurring from one symbol to another.

See [Data](#) for the corresponding SCPI command.

Key Path	Trace/Detector, Data, Demod Error
Mode	LTE, LTETDD
Initial S/W Revision	Prior to A.02.00
Modified at S/W Revision	A.03.00

RB Error Mag Spectrum

This trace shows EVM (calculated as RMS average over one RB and one slot) and as functions of RBs on the X-axis and multiple slots for each RB. This is a frequency-domain trace coupled only to other frequency-domain traces (and not mixed-domain traces).

See [Data](#) for the corresponding SCPI command.

Key Path	Trace/Detector, Data, Demod Error
Mode	LTE, LTETDD
Initial S/W Revision	Prior to A.02.00
Modified at S/W Revision	A.03.00

RB Error Mag Time

This trace shows EVM (calculated as RMS average over one RB and one slot) and as functions of RBs on the X-axis and multiple slots for each RB. This is a frequency-domain trace coupled only to other frequency-domain traces (and not mixed-domain traces).

See [Data](#) for the corresponding SCPI command.

Key Path	Trace/Detector, Data, Demod Error, More
Mode	LTE, LTETDD
Initial S/W Revision	Prior to A.02.00
Modified at S/W Revision	A.03.00

RB Power Spectrum

This trace shows power levels (calculated as RMS average over one RB and one slot) as functions of RBs on the X-axis and multiple slots for each RB. This is a frequency-domain trace coupled only to other frequency-domain traces (and not mixed-domain traces).

See [Data](#) for the corresponding SCPI command.

Key Path	Trace/Detector, Data, Demod Error, More
Mode	LTE, LTETDD
Initial S/W Revision	Prior to A.02.00
Modified at S/W Revision	A.03.00

RB Power vs Time

This trace shows power levels (calculated as RMS average over one RB and one slot) as functions of slots on the X-axis and multiple RBs for each slot. This is a frequency-domain trace coupled only to other frequency-domain traces (and not mixed-domain traces).

See [Data](#) for the corresponding SCPI command.

Key Path	Trace/Detector, Data, Demod Error, More
Mode	LTE, LTETDD
Initial S/W Revision	Prior to A.02.00
Modified at S/W Revision	A.03.00

Freq Err Per Slot

This trace displays the average frequency error for each slot. The frequency error is expressed as an offset in Hz from the current center frequency setting.

See [Data](#) for the corresponding SCPI command.

Key Path	Trace/Detector, Data, Demod Error, More
Mode	LTE, LTETDD
Initial S/W Revision	A.03.00

IQ Offset Per Slot

IQ Offset Per Slot displays the average IQ Offset for each slot in the Measurement Interval. This trace is only available for uplink signals.

See [Data](#) for the corresponding SCPI command.

Key Path	Trace/Detector, Data, Demod Error, More
Mode	LTE, LTETDD
Initial S/W Revision	A.03.00

In-band Emissions

Shows the resource block power spectrum for the data specified by Measurement Interval and Measurement Offset.

This trace is identical to RB Power Spectrum except for two differences. The first difference is that In-band Emissions always includes Non-alloc signals, regardless of the Non-Alloc parameter selection. The second difference is that the RB Power levels are normalized such that the average active RB power is 0 dB.

See [Data](#) for the corresponding SCPI command.

See Section 6.5.2.3 of 3GPP TS 36.521–1 for more information about in-band emissions measurements.

This trace is available only when Direction is Uplink.

Key Path	Trace/Detector, Data, Demod Error,
Mode	LTE, LTETDD
Initial S/W Revision	A.06.00

Tables

Displays the Trace Data choices that are in tabular form, including demodulated symbols tables.

Key Path	Trace/Detector, Data
Mode	LTE, LTETDD
Initial S/W Revision	Prior to A.02.00
Modified at S/W Revision	A.03.00

Error Summary

The Error Summary table shows some metrics calculated from signal demod. The metrics are subject to averaging, unless indicated otherwise. See [Data](#) for the corresponding SCPI command.

A scrollbar will appear when the contents are too long to be displayed in the window. You can scroll the window without a mouse with the following steps.

1. Press NextWindow key to select the window you want to scroll.
2. Press Esc key to turn off the active function
3. Then, press one of Arrow keys.

The following metrics are shown:

- EVM
- EVM Symbol TimeAdjust
- Peak EVM
- Peak EVM location symbol number
- Peak EVM subcarrier number
- Data EVM
- 3GPP-defined QPSK EVM (%rms)
- 3GPP-defined 16QAM EVM (%rms)
- 3GPP-defined 64QAM EVM (%rms)
- RS EVM
- RS Tx. Power (avg)
- OFDM Sym. Tx. Power
- Reference Signal Rx Power (Avg). Downlink only.
- Received Signal Strength Indicator
- Reference Signal Rx Quality. Downlink only.
- Freq Err
- Sync Corr
- Sync Type
- Common Tracking Error
- Sym Clk Err
- Time Offset (not averaged)
- IQ Offset
- IQ Gain Imb
- IQ Quad Err
- IQ Time Skew
- CP Length (not averaged)
- RS-OS/PRS (not averaged) (downlink only)
- Cell ID (not averaged) (downlink only)
- Cell ID Group/Sector (not averaged) (downlink only)
- Channel Power

- In-band Emissions Result (uplink only)
- In-band Emissions Worst Margin (uplink only)
- In-band Emissions Worst Slot (uplink only)
- In-band Emissions Worst RB (uplink only)
- Spectral Flatness Result (uplink only)
- Spectral Flatness Worst Margin (uplink only)
- Spectral Flatness Worst Slot (uplink only)
- Spectral Flatness Worst Subcarrier (uplink only)

Result name	Displayed Unit	Remote Name	Remote Unit
EVM	%rms*	EVM	%rms
EVM Symbol Timing Adjust	none	EVMSymTimeAdj	none
EVM Pk	%	EVMPeak	%
Peak EVM location symbol number	sym	EVMPeakIdx	sym
Peak EVM subcarrier number	subcar	EVMPeakSubcarIdx	subcar
Data EVM	%rms*	DataEVM	%rms
3GPP-defined QPSK EVM	%rms*	3GPPEVMQPSK	%rms
3GPP-defined 16QAM EVM	%rms*	3GPPEVM16QAM	%rms
3GPP-defined 64QAM EVM	%rms*	3GPPEVM64QAM	%rms
RS EVM	%rms*	RSEVM	%rms
RS Tx. Power (avg)	dBm/subcar	RSTP	dBm
OFDM Sym. Tx. Power	dBm	OSTP	dBm
Reference Signal Rx Power (Avg)	dBm	RSRP	dBm
Received Signal Strength Indicator	dBm	RSSI	dBm
Reference Signal Rx Quality	dB	RSRQ	dB
Frequency Error	Hz	FreqErr	Hz
Sync Corr	%	SyncCorr	%
Sync Type	None	SyncType	none
Common Tracking Error	%rms	CTE	%rms
Symbol Clock Err	ppm	SymClkErr	ppm
Time Offset	s	TimeOffset	sec
IQ Offset	dB	IQOffset	dB
IQ Gain Imbalance	dB	IQGainImb	dB
IQ Quadrature Error	deg	IQQuadErr	deg
IQ Timing Skew	s	IQTimingSkew	sec
CP Length Mode	None	CpLengthMode	None

Cell ID	None	CellId	None
Cell ID Group/Sector	None	CellIdGroupSector	None
RS PRS	None	RSPRS	None
Channel Power	dBm	ChannelPower	dBm
In-band Emissions Result	None	InbandEmissionsResult	None
In-band Emissions worst Margin	dB	InbandEmissionsMargin	dB
In-band Emissions worst Slot	None	InbandEmissionsMarginLocationSlot	None
In-band Emissions worst RB	None	InbandEmissionsMarginLocationWorstRB	None
Spectral Flatness Result	None	SpectralFlatnessResult	None
Spectral Flatness worst Margin	dB	SpectralFlatnessMargin	dB
Spectral Flatness worst Slot	None	SpectralFlatnessMarginLocationSlot	None
Spectral Flatness worst Subcarrier	None	SpectralFlatnessMarginLocationSC	None

* displayed in dB when Report EVM in dB parameter is On.

The error summary values can be obtained using the CALC:EVM:DATA:TABL commands.

See also [":CALCulate:DATA" on page 2865](#) for more details.

Key Path	Trace/Detector, Data, Tables
Mode	LTE, LTETDD
Initial S/W Revision	Prior to A.02.00
Modified at S/W Revision	A.03.00, A.06.00, A.11.00, A13.00

Frame Summary

This table shows certain characteristics of each of the logical channels. The list of channels shown is different for Downlink and Uplink. If auto-detection is selected, the list contains only PDSCH1–3, corresponding to the three modulation formats. If a channel is not found in the measurement interval under consideration, it is marked with a ‘...’. Each of the channels shown have the same color coding as used in the IQ demod traces.

See [Data](#) for the corresponding SCPI command.

A scrollbar will appear when the contents are too long to be displayed in the window. You can scroll the window without a mouse with the following steps.

1. Press NextWindow key to select the window you want to scroll.
2. Press Esc key to turn off the active function
3. Then, press one of Arrow keys.

The following are the characteristics that are shown in the Frame Summary Table:

- Channel Name

- Error Vector Magnitude
- Relative Power Level
- Modulation Format
- Number of RBs occupied

When the link direction is downlink, the following channels are shown in the Frame Summary:

- P-SS
- S-SS
- PBCH
- PCFICH
- PHICH
- PDCCH
- RS
- P-RS
- MBSFN-RS
- PMCH
- PDSCH1 to PDSCHn
- Non-Alloc

Result name	Displayed Unit	Remote Name	Remote Unit
PSS EVM	%rms	PSSEVM	%rms
PSS Power	dB	PSSPower	dB
PSS Mod Format	none	PSSModFmt	none
PSS Num Rb	none	PSSNumRb	none
SSS EVM	%rms	SSSEVM	%rms
SSS Power	dB	SSSPower	dB
SSS Mod Format	none	SSSModFmt	none
SSS Num Rb	none	SSSNumRb	none
PBCH EVM	%rms	PBCH EVM	%rms
PBCH Power	dB	PBCHPower	dB
PBCH Mod Format	none	PBCHModFmt	none
PBCH Num Rb	none	PBCHNumRb	none
PCFICH EVM	%rms	PCFICHEVM	%rms
PCFICH Power	dB	PCFICHPower	dB
PCFICH Mod Format	none	PCFICHModFmt	none

PCFICH Num Rb	none	PCFICHNumRb	none
PHICH EVM	%rms	PHICHEVM	%rms
PHICH Power	dB	PHICHPower	dB
PHICH Mod Format	none	PHICHModFmt	none
PHICH Num Rb	none	PHICHNumRb	none
PDCCH EVM	%rms	PDCCHEVM	%rms
PDCCH Power	dB	PDCCHPower	dB
PDCCH Mod Format	none	PDCCHModFmt	none
PDCCH Num Rb	none	PDCCHNumRb	none
RS EVM	%rms	RSEVM	%rms
RS Power	dB	RSPower	dB
RS Mod Format	none	RSMoFmt	none
RS Num Rb	none	RSNumRb	none
P-RS EVM	%rms	PRSEVM	%rms
P-RS Power	dB	PRSPower	dB
P-RS Mod Format	none	PRSMoFmt	none
P-RS Num Rb	none	PRSNuRb	none
MBSFN-RS EVM	%rms	MBSFNRSEVM	%rms
MBSFN -RS Power	dB	MBSFNRSPower	dB
MBSFN -RS Mod Format	none	MBSFNRSModFmt	none
MBSFN -RS Num Rb	none	MBSFNRSNumRb	none
PMCH EVM	%rms	PMCHEVM	%rms
PMCH Power	dB	PMCHPower	dB
PMCH Mod Format	none	PMCHModFmt	none
PMCH Num Rb	none	PMCHNumRb	none
PDSCHn EVM	%rms	PDSCHnEVM	%rms
PDSCHn Power	dB	PDSCHnPower	dB
PDSCHn Mod Format	none	PDSCHnModFmt	none
PDSCHn Num Rb	none	PDSCHnNumRb	none
Inactive EVM	%rms	InactiveEVM	%rms
Inactive Power	dB	InactivePower	dB
Inactive Mod Format	none	InactiveModFmt	none
Inactive Num Rb	none	InactiveNumRb	none

When the link direction is uplink, the following are the channels that are shown in the Frame Summary:

- PUSCH DM-RS
- PUCCH

- PUSCH1 to PUSCHn
- PRACH
- S-RS
- Non-Alloc

Result name	Displayed Unit	Remote Name	Remote Unit
DMRS EVM	%rms	DMRSEVM	%rms
DMRS Power	dB	DMRSPower	dB
DMRS Mod Format	none	DMRSModFmt	none
DMRS Num Rb	none	DMRSNumRb	none
PUCCH EVM	%rms	PUCCH EVM	%rms
PUCCH Power	dB	PUCCH Power	dB
PUCCH Mod Format	none	PUCCH ModFmt	none
PUCCH Num Rb	none	PUCCH NumRb	none
PUSCHn EVM	%rms	PUSCHn EVM	%rms
PUSCHn Power	dB	PUSCHn Power	dB
PUSCHn Mod Format	none	PUSCHn ModFmt	none
PUSCHn Num Rb	none	PUSCHn NumRb	none
PRACH EVM	%rms	PRACHEVM	%rms
PRACH Power	dB	PRACHPower	dB
PRACH Mod Format	none	PRACHModFmt	none
PRACH Num Rb	none	PRACHNumRb	none
SRS EVM	%rms	SRSEVM	%rms
SRS Power	dB	SRSPower	dB
SRS Mod Format	none	SRSModFmt	none
SRS Num Rb	none	SRSNumRb	none
Inactive EVM	%rms	InactiveEVM	%rms
Inactive Power	dB	InactivePower	dB
Inactive Mod Format	none	InactiveModFmt	none
Inactive Num Rb	none	InactiveNumRb	none

These values are never averaged; they always show the results of the current measurement. These results are valid only for the current measurement interval.

Non-Alloc signals consist of unused subcarriers in all shared and control channels. This includes unallocated user data subcarriers, the DC subcarrier, certain RS subcarriers in multi-antenna mode, and unused P-SS and S-SS subcarriers.

Non-Alloc signals include the following:

- Unallocated user data subcarriers

- The unused DC subcarrier
- Unused P-SS and S-SS subcarriers: these signals are 6 RBs (72 subcarriers) wide in the frequency domain, but only the center 62 subcarriers are actually used, and the remaining 10 are set to zero.
- Subcarriers reserved for RS in a multiple antenna port signal. For example, in a four Tx Antenna signal, the transmission from antenna port 0 will not transmit anything on the subcarriers that will be used for RS in the other three antenna port transmissions.

Manually defined and autodetected user allocations are always considered allocated whether or not they are enabled for display in Composite Include and are not included in Non-Alloc.

Non-alloc means only unallocated shared channel subcarriers (those that could be allocated for users but are not). The rest of the traces consider Non-alloc to be any unused subcarrier (whether in control or shared channels).

Any resource elements (subcarriers) contained by a user channel that is present in the Composite Include list are considered allocated, regardless of whether or not the user channel has been selected for analysis and display.

Non-Alloc signal's EVMs are normalized with respect to the signal's average power per subcarrier, since dividing by the reference vector's magnitude (0 in this case) will cause the result to be undefined.

Key Path	Trace/Detector, Data, Tables
Mode	LTE, LTETDD
Initial S/W Revision	Prior to A.02.00
Modified at S/W Revision	A.03.00

Symbols

This table shows the demodulated symbols over the measurement interval. It displays one value per subcarrier for downlink and one value per sample/subcarrier for uplink. In uplink, this is a mixed-domain trace and coupled only to other mixed-domain traces (and not frequency domain traces).

See [Data](#) for the corresponding SCPI command.

A scrollbar will appear when the contents are too long to be displayed in the window. You can scroll the window without a mouse with the following steps.

1. Press NextWindow key to select the window you want to scroll.
2. Press Esc key to turn off the active function
3. Then, press one of Arrow keys.

Key Path	Trace/Detector, Data, Tables
Mode	LTE, LTETDD
Initial S/W Revision	Prior to A.02.00
Modified at S/W Revision	A.03.00

Decoded Symbol Table

When Direction is Downlink, this table shows the decoded values of the physical layer channels: PBCH, PDCCH, PCFICH, and PDSCH. The level of decoding is determined by each channel decoding selection (See "[Decode Type](#)" on page 2186 for details.)

When Direction is Uplink, this table shows descrambled PUSCH data when PUSCH Decoding is set to Descrambled. The default bit order for this trace is MSB-first.

See [Data](#) for the corresponding SCPI command.

A scrollbar will appear when the contents are too long to be displayed in the window. You can scroll the window without a mouse with the following steps.

1. Press NextWindow key to select the window you want to scroll.
2. Press Esc key to turn off the active function
3. Then, press one of Arrow keys.

Key Path	Trace/Detector, Data, Tables
Mode	LTE, LTETDD
Initial S/W Revision	A.06.00

DL Decode Info

DL Decode Info contains the decoded information from PBCH, PDCCH, PCFICH and PDSCH.

The upper section shows the status of the PBCH, PDCCH, PCFICH, and PDSCH decoders (On or Off).

The lower part of the table shows the decoded information for each frame. The data is color coded to match the color of the corresponding channel in the Frame Summary trace.

See [Data](#) for the corresponding SCPI command.

A scrollbar will appear when the contents are too long to be displayed in the window. You can scroll the window without a mouse with the following steps.

1. Press NextWindow key to select the window you want to scroll.
2. Press Esc key to turn off the active function
3. Then, press one of Arrow keys.

Key Path	Trace/Detector, Data, Tables
Mode	LTE, LTETDD
Initial S/W Revision	A.06.00

UL Decode Info

UL Decode Info contains the decoded information from PUCCH and PUSCH.

The upper section shows the status of the PUCCH and PUSCH decoders (On or Off).

The lower part of the table shows the decoded information for each frame.

See Data section for the corresponding SCPI command.

A scrollbar will appear when the contents are too long to be displayed in the window. You can scroll the window without a mouse with the following steps.

1. Press Next Window key to select the window you want to scroll.
2. Press Esc key to turn off the active function
3. Then, press one of Arrow keys.

Key Path	Trace/Detector, Data, Tables
Mode	LTE, LTETDD
Initial S/W Revision	A.10.00

UE-RS Weights

This table shows the channel response for each subcarrier that is assigned to carry UE-specific reference signal.

See [Data](#) for the corresponding SCPI command.

A scrollbar will appear when the contents are too long to be displayed in the window. You can scroll the window without a mouse with the following steps.

1. Press Next Window key to select the window you want to scroll.
2. Press Esc key to turn off the active function
3. Then, press one of Arrow keys.

Key Path	Trace/Detector, Data, Tables
Mode	LTETDD
Initial S/W Revision	A.06.00

Response

Displays the Trace Data choices that show equalizer response results.

Key Path	Trace/Detector, Data
Mode	LTE, LTETDD
Initial S/W Revision	Prior to A.02.00
Modified at S/W Revision	A.03.00

Eq Ch Frequency Response

This trace will show the frequency response of the channel derived from the equalizer coefficients, as a function of subcarriers. How the results are computed depends on the choice of Equalizer Training on the Advanced tab. Equalizer training off and that based on RS alone should yield the same trace, while that based on RS+Data should yield a different trace. This is a frequency domain trace coupled only to other frequency domain traces (and not mixed-domain traces).

See [Data](#) for the corresponding SCPI command.

Key Path	Trace/Detector, Data, Response
Mode	LTE, LTETDD
Initial S/W Revision	Prior to A.02.00
Modified at S/W Revision	A.03.00

Inst Eq Ch Freq Resp

As Eq Ch Frequency Response, but this trace is not averaged.

See [Data](#) for the corresponding SCPI command.

Key Path	Trace/Detector, Data, Response
Mode	LTE, LTETDD
Initial S/W Revision	Prior to A.02.00
Modified at S/W Revision	A.03.00

Eq Ch Freq Resp Diff

This is the adjacent difference of the channel frequency response. It shows the ratio of the magnitude of the channel response at adjacent subcarriers, expressed in dB so that an ideal response is flat at 0 dB. This trace is real valued. Because this is adjacent differences, the total number of points in the trace is one less than the number of subcarriers. This trace is averaged if averaging is turned on. This is a frequency domain trace coupled only to other frequency domain traces (and not mixed-domain traces).

See [Data](#) for the corresponding SCPI command.

Key Path	Trace/Detector, Data, Response
Mode	LTE, LTETDD
Initial S/W Revision	Prior to A.02.00
Modified at S/W Revision	A.03.00

Inst Eq Ch Freq Resp Diff

As Eq Ch Resp Diff, but this trace is not averaged. See [Data](#) for the corresponding SCPI command.

Key Path	Trace/Detector, Data, Response
Mode	LTE, LTETDD
Initial S/W Revision	Prior to A.02.00
Modified at S/W Revision	A.03.00

Eq Impulse Response

This shows the impulse response of the equalization filter. The equalizer impulse response is computed by taking the reciprocal of the channel equalizer frequency response, performing data filtering and computations that produce a result length of 4x the FFT length, and then converting to the time domain. The Eq Impulse Response is the computed channel impulse response used to compensate for signal channel response degradation.

See [Data](#) for the corresponding SCPI command.

Key Path	Trace/Detector, Data, Response
Mode	LTE, LTETDD
Initial S/W Revision	Prior to A.02.00
Modified at S/W Revision	A.03.00

Eq Ch Freq Resp Per Slot

This shows the frequency response of the channel for each slot in the Measurement Interval.

Each slot's channel frequency response is plotted as a separate line with a different color. The colors have no correspondence to other traces or channels. The colors are only used to visually separate each slot's channel frequency response.

See [Data](#) for the corresponding SCPI command.

NOTE This trace can be used to measure Spectral Flatness as defined in Section 6.5.2.4 of 3GPP TS 36.521-1.

Key Path	Trace/Detector, Data, Response
Mode	LTE, LTETDD
Initial S/W Revision	Prior to A.02.00
Modified at S/W Revision	A.03.00

MIMO

Displays the Trace Data choices that show MIMO results.

Key Path	Trace/Detector, Data, More
Mode	LTE, LTETDD

Initial S/W Revision	Prior to A.02.00
Modified at S/W Revision	A.03.00

Info Table

The measurement automatically detects the presence of signals from all the antenna ports and measures certain metrics related to them only if the antenna port parameter "[Reference C-RS Port](#)" on page 1867 is set to "auto". The results are reported in the form of the following table. The number of columns depends on the number of transmit antennas selected. Antenna ports that have not contributed to the composite signal have their corresponding columns displayed simply as "---".

See [Data](#) for the corresponding SCPI command.

	Tx0/Rx0	Tx1/Rx0	Tx2/Rx0	Tx3/Rx0
RS Power				
RS EVM				
CPE				
Timing				
Phase				
Freq. Error				
Sym Clock Error				

Key Path	Trace/Detector, Data, MIMO
Mode	LTE, LTETDD
Initial S/W Revision	Prior to A.02.00
Modified at S/W Revision	A.03.00

Ch Freq Resp

This trace shows the channel responses of the paths from all transmitter antenna ports that are auto-detected to exist in the signal. It comprises of up to 4 traces overlaid on top of each other, possibly with some color coding.

See [Data](#) for the corresponding SCPI command.

Key Path	Trace/Detector, Data, MIMO
Mode	LTE, LTETDD
Initial S/W Revision	Prior to A.02.00
Modified at S/W Revision	A.03.00

Ch Freq Resp Diff

This trace shows the channel response differences of the paths from all transmitter antenna ports that are auto-detected to exist in the signal. It comprises of up to 4 traces overlaid on top of each other, possibly with some color coding.

See [Data](#) for the corresponding SCPI command.

Key Path	Trace/Detector, Data, MIMO
Mode	LTE, LTETDD
Initial S/W Revision	Prior to A.02.00
Modified at S/W Revision	A.03.00

Eq Impulse Resp

This trace shows the Eq. impulse responses of the paths from all transmitter antenna ports that are auto-detected to exist in the signal. It comprises of up to 4 traces overlaid on top of each other, possibly with some color coding.

See [Data](#) for the corresponding SCPI command.

Key Path	Trace/Detector, Data, MIMO
Mode	LTE, LTETDD
Initial S/W Revision	Prior to A.02.00
Modified at S/W Revision	A.03.00

MIMO Common Tracking Error

This trace shows the common pilot errors of the paths from all transmitter antenna ports that are auto-detected to exist in the signal. It comprises of up to 4 traces overlaid on top of each other, possibly with some color coding.

See [Data](#) for the corresponding SCPI command.

Key Path	Trace/Detector, Data, MIMO
Mode	LTE, LTETDD
Initial S/W Revision	Prior to A.02.00
Modified at S/W Revision	A.03.00

ACP

This displays a selection of the ACP result traces. For more information, see Trace/Detector, Data, ACP.

Key Path	Trace/Detector, Data, ACP
Mode	LTE, LTETDD
Initial S/W Revision	Prior to A.02.00
Modified at S/W Revision	A.03.00

ACP Summary for Trace 1

Displays results for the ACP function on Trace 1 in the selected trace.

See also: ["ACP Setup" on page 2336](#)

Key Path	Trace/Detector, Data, ACP
Mode	VSA, LTE, LTETDD, IDEN
Initial S/W Revision	Prior to A.02.00
Modified at S/W Revision	A.02.00

ACP Summary for Trace 2

Displays results for the ACP function on Trace 2 in the selected trace.

See also: ["ACP Setup" on page 2336](#)

Key Path	Trace/Detector, Data, ACP
Mode	VSA, LTE, LTETDD, IDEN
Initial S/W Revision	Prior to A.02.00
Modified at S/W Revision	A.02.00

ACP Summary for Trace 3

Displays results for the ACP function on Trace 3 in the selected trace.

See also: ["ACP Setup" on page 2336](#)

Key Path	Trace/Detector, Data, ACP
Mode	VSA, LTE, LTETDD, IDEN
Initial S/W Revision	Prior to A.02.00
Modified at S/W Revision	A.02.00

ACP Summary for Trace 4

Displays results for the ACP function on Trace 4 in the selected trace.

See also: ["ACP Setup" on page 2336](#)

Key Path	Trace/Detector, Data, ACP
Mode	VSA, LTE, LTETDD, IDEN
Initial S/W Revision	Prior to A.02.00
Modified at S/W Revision	A.02.00

OBW

This displays a selection of the OBW result traces. For more information, see Analyzer Setup Functions, Trace/Detector, Data, OBW.

Key Path	Trace/Detector, Data, OBW
Mode	LTE, LTETDD
Initial S/W Revision	Prior to A.02.00
Modified at S/W Revision	A.03.00

OBW Summary for Trace 1

Displays results for the OBW function on Trace 1 in the selected trace.

See also: ["OBW Setup \(Occupied Bandwidth\)" on page 2344](#)

Key Path	Trace/Detector, Data, OBW
Mode	VSA, LTE, LTETDD, IDEN
Initial S/W Revision	Prior to A.02.00
Modified at S/W Revision	A.02.00

OBW Summary for Trace 2

Displays results for the OBW function on Trace 2 in the selected trace.

See also: ["OBW Setup \(Occupied Bandwidth\)" on page 2344](#)

Key Path	Trace/Detector, Data, OBW
Mode	VSA, LTE, LTETDD, IDEN
Initial S/W Revision	Prior to A.02.00
Modified at S/W Revision	A.02.00

OBW Summary for Trace 3

Displays results for the OBW function on Trace 3 in the selected trace.

See also: "[OBW Setup \(Occupied Bandwidth\)](#)" on page 2344

Key Path	Trace/Detector, Data, OBW
Mode	VSA, LTE, LTETDD, IDEN
Initial S/W Revision	Prior to A.02.00
Modified at S/W Revision	A.02.00

OBW Summary for Trace 4

Displays results for the OBW function on Trace 4 in the selected trace.

See also: "[OBW Setup \(Occupied Bandwidth\)](#)" on page 2344

Key Path	Trace/Detector, Data, OBW
Mode	VSA, LTE, LTETDD, IDEN
Initial S/W Revision	Prior to A.02.00
Modified at S/W Revision	A.02.00

Register

This displays a selection of the Data Registers. For more information, see Analyzer Setup Functions, Trace/Detector, Data, Register.

Key Path	Trace/Detector, Data, Register
Mode	LTE, LTETDD
Initial S/W Revision	Prior to A.02.00
Modified at S/W Revision	A.03.00

Data 1

Select register 1 for assignment of trace data.

Key Path	Trace/Detector, Data, Register
Mode	VSA, LTE, LTETDD, IDEN
Initial S/W Revision	Prior to A.02.00
Modified at S/W Revision	A.02.00

Data 2

Selects register 2 for assignment of trace data.

Key Path	Trace/Detector, Data, Register
Mode	VSA, LTE, LTETDD, IDEN
Initial S/W Revision	Prior to A.02.00
Modified at S/W Revision	A.02.00

Data 3

Selects register 3 for assignment of trace data.

Key Path	Trace/Detector, Data, Register
Mode	VSA, LTE, LTETDD, IDEN
Initial S/W Revision	Prior to A.02.00
Modified at S/W Revision	A.02.00

Data 4

Selects register 4 for assignment of trace data.

Key Path	Trace/Detector, Data, Register
Mode	VSA, LTE, LTETDD, IDEN
Initial S/W Revision	Prior to A.02.00
Modified at S/W Revision	A.02.00

Data 5

Selects register 5 for assignment of trace data.

Key Path	Trace/Detector, Data, Register
Mode	VSA
Initial S/W Revision	Prior to A.02.00
Modified at S/W Revision	A.02.00

Data 6

Selects register 6 for assignment of trace data.

Key Path	Trace/Detector, Data, Register
Mode	VSA
Initial S/W Revision	Prior to A.02.00
Modified at S/W Revision	A.02.00

No Data

A blank display is shown. For more information, see Analyzer Setup Functions, Trace/Detector, Data, No Data

Key Path	Trace/Detector, Data, No Data
Mode	LTE, LTETDD
Initial S/W Revision	Prior to A.02.00
Modified at S/W Revision	A.03.00

Format

Accesses a menu that enables you to choose the format of the selected trace. Any format can be assigned to any trace. For symbol tables and tabular data the format choice is ignored. If the data doesn't have defined symbol times, Constellation format is the same as I-Q, Eye formats are the same as Real or Imaginary, and Trellis format is the same as Unwrapped Phase.

The formats are:

Format name	Description
Log Mag (dB)	Data is converted to decibel units and shown on a linear Y axis
Linear Mag (Abs Value)	Magnitude of the data is shown on a linear Y axis
Real (I)	Real part of data is shown on a linear Y axis
Imaginary (Q)	Imaginary part of data is shown on linear Y axis
I-Q	Real part of data is shown on horizontal axis, imaginary part is shown on vertical axis, Independent variable (X axis) is normal to display
Constellation	Same as I-Q, but for data with symbols defined, only the symbol points are shown as dots with no connecting lines.
Wrap Phase	Phase of complex data, limited to ± 180 deg, is shown on Y axis
Unwrap Phase	Phase of complex data is shown "unwrapped", that is, without discontinuities. Not limited to ± 180 degrees.
I-Eye	Real part of data is shown with X axis segmented (generally into 2 symbol segments) and each segment is overlaid to show signal crossings at symbol boundaries
Q-Eye	Same as I-eye but imaginary part of data is shown
Trellis	Same as I-eye but uses unwrapped phase of data
Group Delay	Useful for frequency response displays. Shows the derivative of phase response with respect to frequency.
Log Mag (Linear Unit)	Displays data with a logarithmic Y axis, but marker read outs are in linear magnitude units.

Key Path	Trace/Detector, Format
Mode	VSA, LTE, LTETDD, IDEN
Measurement	<meas>:=VECTor ADEMod DDEMod W11A W11B EVM IPOWER IDEMod MOTotalk
Remote Command	:DISPlay:<meas>:TRACe[1] 2 ...4:FORMat MLOG MLINear REAL IMAGinary VECTor CONS PHASe UPHase IEYE QEYE TRELLis GDELay MLGLinear :DISPlay:<meas>:TRACe[1] 2 ...4:FORMat?
Example	DISP:DDEM:TRAC2:FORM MLIN DISP:DDEM:TRAC2:FORM?
Preset	Depends on trace and measurement
State Saved	Saved in instrument state.
Range	Log Mag (dB) Linear Mag (Abs Value) Real (I) (Lin) Imaginary (Q) (Lin) -Q Constellation Wrap Phase Unwrap Phase I-Eye Q-Eye Trellis-Eye Group Delay Log Mag (Linear Unit)
Readback Text	Log Mag (dB) Linear Mag Real (I) Imaginary (Q) I-Q Constellation Wrap Phase Unwrap Phase I-Eye Q- Eye Trellis-Eye Group Delay Log Mag
Initial S/W Revision	Prior to A.02.00
Modified at S/W Revision	A.02.00

Digital Demod Trace Setup

Accesses a menu of settings that control certain elements of displays of digitally demodulated trace data.

Key Path	Trace/Detector
Mode	VSA, LTE, LTETDD, IDEN
Initial S/W Revision	Prior to A.02.00
Modified at S/W Revision	A.02.00

Symbol Shape

Enables you to display dots, bars, or nothing (none) at symbol locations (if the trace contains demodulated time-domain data) for all time-domain displays except IQ diagrams. This key enables you to select the symbol shape for the selected trace.

If you select bars, vertical lines (bars) are drawn from the baseline to the symbol location on the trace. The baseline is 0 for all traces that have coordinates other than log (dB). The baseline is the bottom of the trace box for traces that have log (dB) coordinates.

With IQ diagrams, displaying vertical bars is meaningless. Therefore, selecting bars displays dots in IQ diagrams.

With constellation diagrams, selecting none is the same as selecting bars – you cannot turn off the dots in a constellation diagram.

Key Path	Trace/Detector, Digital Demod Trace Setup
Mode	VSA, LTE, LTETDD, IDEN
Measurement	<meas>:=VECTor ADEMod DDEMod W11A W11B EVM IPOWER IDEMod MOTotalk
Remote Command	:DISPlay:<meas>:TRACe [1] 2 . . . 4 :DDEMod:SYMBol BARS DOTS OFF :DISPlay:<meas>:TRACe [1] 2 . . . 4 :DDEMod:SYMBol?
Example	DISP:DDEM:TRAC2:DDEM:SYMB DOTS DISP:DDEM:TRAC2:DDEM:SYMB?
Preset	BARS
State Saved	Saved in instrument state.
Range	Bars Dots None
Initial S/W Revision	Prior to A.02.00
Modified at S/W Revision	A.02.00

Ideal State Shape

Enables you to choose between a cross, circle, or none to represent the ideal state on the selected trace. Digital Demodulation shows you the location of all ideal symbol states in an I-Q or constellation diagram.

Key Path	Trace/Detector, Digital Demod Trace Setup
Mode	VSA, LTE, LTETDD, IDEN
Measurement	<meas>:=VECTor ADEMod DDEMod W11A W11B EVM IPOWER IDEMod MOTotalk
Remote Command	:DISPlay:<meas>:TRACe [1] 2 . . . 4 :DDEMod:SYMBol:SHAPE CIRCle CROSS OFF :DISPlay:<meas>:TRACe [1] 2 . . . 4 :DDEMod:SYMBol:SHAPE?
Example	DISP:DDEM:TRAC2:DDEM:SYMB:SHAP CIRC DISP:DDEM:TRAC2:DDEM:SYMB:SHAP?
Preset	CIRC
State Saved	Saved in instrument state.
Range	Circle Cross None
Initial S/W Revision	Prior to A.02.00
Modified at S/W Revision	A.02.00

Ideal State Size

Determines the ideal state size, as a percentage of the maximum ideal state distance from the origin (the same way Error Vector Magnitude is defined). Ideal states are shown as circles or crosses in Vector and constellation diagrams, as determined by the Ideal State Shape setting.

The ideal state is where symbols occur if your signal is without error. Showing the ideal states gives a visual indication of the quality of your signal.

You can use this feature to determine if symbols have an EVM above a specified Value. For example, to see if any symbols have an EVM greater than 10%, set the state size to 10% and select Circle as the shape. Any symbols that fall outside of the circle (other than SYNC or PILOT symbols) have an EVM greater than 10%.

Key Path	Trace/Detector, Digital Demod Trace Setup
Mode	VSA, LTE, LTETDD, IDEN
Measurement	<meas>:=VECTor ADEMod DDEMod W11A W11B EVM IPOWER IDEMod MOTotalk
Remote Command	:DISPlay:<meas>:TRACe [1] 2 . . . 4 : DDEMod : SYMBol : SIZE <real> :DISPlay:<meas>:TRACe [1] 2 . . . 4 : DDEMod : SYMBol : SIZE?
Example	DISP:DDEM:TRAC2:DDEM:SYMB:SIZE 10 DISP:DDEM:TRAC2:DDEM:SYMB:SIZE?
Notes	Parameter is interpreted as a percent, e.g., if you want the ideal size to be 10% send 10, not 0.1
Preset	5
State Saved	Saved in instrument state.
Min	0.1
Max	50
Initial S/W Revision	Prior to A.02.00
Modified at S/W Revision	A.02.00

Symbol Table Format

Enables you to choose the format in which symbol table data is displayed, when the modulation format encodes 4 or more bits per symbol. You can choose binary or hexadecimal. Binary symbol data is padded with leading zeros to make a multiple of 4 bits before conversion to hexadecimal. For example, for 16 QAM format, each 4-bit symbol is displayed as 2 hex digits.

Binary Format: The symbol data bit format is binary and each character represents a binary digit. The number to the left of each row indicates the bit offset of the first bit in the row.

Hexadecimal Format: The symbol data bit format is hexadecimal and each character represents a hexadecimal digit. The number to the left of each row indicate the symbol offset of the first symbol in the row.

NOTE There must be at least 4 bits/symbol to use the hexadecimal format, that is, symbols that have less than 4 bits/symbol are only displayed in binary format regardless of the Symbol Table Format setting.

This parameter is valid only when:

- The active trace is a symbol table, and
- The current demodulation format supports hexadecimal, the demodulation format's bits/symbol is equal to or greater than four.

Key Path	Trace/Detector, Digital Demod Trace Setup
----------	---

Mode	VSA, LTE, LTETDD, IDEN
Measurement	<meas>:=VECTor ADEMod DDEMod W11A W11B EVM IPOWER IDEMod MOTotalk
Remote Command	:DISPlay:<meas>:TRACe[1] 2 ...4:DDEMod:SYMBol:FORMat HEXadecimal BINary :DISPlay:<meas>:TRACe[1] 2 ...4:DDEMod:SYMBol:FORMat?
Example	DISP:DDEM:TRAC2:DDEM:SYMB:FORM BIN DISP:DDEM:TRAC2:DDEM:SYMB:FORM?
Preset	HEX
Range	Hex Binary
Initial S/W Revision	Prior to A.02.00
Modified at S/W Revision	A.02.00

Time Unit

Enables you to select the time units that are applied to x-axis annotations and marker readouts for the selected trace, whenever it is assigned data with (demodulation) symbol information. The available measurement units are sym (symbols) or sec (seconds).

Key Path	Trace/Detector, Digital Demod Trace Setup
Mode	VSA, LTE, LTETDD, IDEN
Measurement	<meas>:=VECTor ADEMod DDEMod W11A W11B EVM IPOWER IDEMod MOTotalk
Remote Command	:DISPlay:<meas>:TRACe[1] 2 ...4:DDEMod:UNIT:TIME SEC SYMBol :DISPlay:<meas>:TRACe[1] 2 ...4:DDEMod:UNIT:TIME?
Example	DISP:VECT:TRAC2:DDEM:UNIT:TIME SYMB DISP:VECT:TRAC2:DDEM:UNIT:TIME?
Preset	SYMB
State Saved	Saved in instrument state.
Range	sym sec
Initial S/W Revision	Prior to A.02.00
Modified at S/W Revision	A.02.00

Freq Unit

Enables you to select the frequency units that are applied to x-axis annotations and marker readouts for the selected trace, whenever it is assigned data with (demodulation) carrier information. The available measurement units are carrier or Hz.

Key Path	Trace/Detector, Digital Demod Trace Setup
Mode	VSA, LTE, LTETDD, IDEN

Measurement	<meas>:=VECTor ADEMod DDEMod W11A W11B EVM IPOWER IDEMod MOTotalk
Remote Command	:DISPlay:<meas>:TRACe [1] 2 . . . 4 :DDEMod:UNIT:FREQuency CARRier HZ :DISPlay:<meas>:TRACe [1] 2 . . . 4 :DDEMod:UNIT:FREQuency?
Example	DISP:VECT:TRAC2:DDEM:UNIT:FREQ CARR DISP:VECT:TRAC2:DDEM:UNIT:FREQ?
Preset	CARR
State Saved	Saved in instrument state.
Range	carrier Hz
Initial S/W Revision	Prior to A.02.00
Modified at S/W Revision	A.02.00

Eye Length

Controls how wide (in symbol periods) the eye and trellis diagrams are, for the selected trace.

Key Path	Trace/Detector, Digital Demod Trace Setup
Mode	VSA, LTE, LTETDD, IDEN
Measurement	<meas>:=VECTor ADEMod DDEMod W11A W11B EVM IPOWER IDEMod MOTotalk
Remote Command	:DISPlay:<meas>:TRACe [1] 2 . . . 4 :DDEMod:EYE:COUNT <real> :DISPlay:<meas>:TRACe [1] 2 . . . 4 :DDEMod:EYE:COUNT?
Example	DISP:DDEM:TRAC2:DDEM:EYE:COUN 3 DISP:DDEM:TRAC2:DDEM:EYE:COUN?
Preset	2
State Saved	Saved in instrument state.
Min	0.1
Max	40
Initial S/W Revision	Prior to A.02.00
Modified at S/W Revision	A.02.00

Avg Line

Controls whether or not the average line is visible on certain demodulation analysis traces such as Error Vector Time and Error Vector Spectrum in Digital Demod measurements. These traces have 2-dimensional domains; typically subcarriers (frequency) and symbol times. Since the result can only be shown with one of these dimensions on the x-axis, the other dimension is placed on the z-axis. Since all the z-axis values are overlapped, an average is calculated for all z values at each x value and the average is normally displayed as a line in front of trace. The average line display can be turned on or off using this control.

Key Path	Trace/Detector, Digital Demod Trace Setup
----------	---

Mode	VSA, LTE, LTETDD, IDEN
Measurement	<meas>:=VECTor ADEMod DDEMod W11A W11B EVM IPOWER IDEMod MOTotalk
Remote Command	:DISPlay:<meas>:TRACe [1] 2 . . . 4 :DDEMod:ALINe OFF ON 0 1 :DISPlay:<meas>:TRACe [1] 2 . . . 4 :DDEMod:ALIN?
Example	DISP:W11A:TRAC:DDEM:ALIN OFF
Preset	1
State Saved	Saved in instrument state.
Initial S/W Revision	A.03.00 or later

Copy to Data Register

Accesses a menu of immediate execute keys, each of which copies the selected trace to a particular data register. Data registers can be displayed in any trace. They are measurement global, so you can copy data to a register while in the Digital Demod measurement and view it later while in the Vector measurement. Data registers are cleared when the VSA Application is exited and reentered, but not when you change Modes and return.

Key Path	Trace/Detector
Mode	VSA, LTE, LTETDD, IDEN
Measurement	<meas>:=VECTor ADEMod DDEMod W11A W11B EVM IPOWER IDEMod MOTotalk
Remote Command	:DISPlay:<meas>:TRACe [1] 2 . . . 4 :COPY D1 D2 D3 D4 D5 D6
Example	DISP:VECT:TRAC:COPY D1
Readback Text	Last: <date_time> Empty
Initial S/W Revision	Prior to A.02.00
Modified at S/W Revision	A.02.00

The following SCPI provides means to determine if a Data Register is empty, and to erase the data from any or all Data Registers.

Mode	VSA, LTE, LTETDD, IDEN
Remote Command	:CALCulate:DATA:REGister [1] 2 . . . 6 :EMPTy?
Example	:CALC:DATA:REG2:EMPT?
Notes	Query only: returns 1 if a Data Register has no trace data assigned to it.
Initial S/W Revision	Prior to A.02.00
Modified at S/W Revision	A.02.00

Mode	VSA, LTE, LTETDD, IDEN
------	------------------------

Remote Command	:CALCulate:DATA:REGister[1] 2 ...6:REMove
Example	:CALC:DATA:REG2:REM
Notes	Removes trace data assigned to specified Data Register.
Couplings	If Data Register is assigned to a trace, the trace data is changed to No Data
Initial S/W Revision	Prior to A.02.00
Modified at S/W Revision	A.02.00

Mode	VSA, LTE, LTETDD, IDEN
Remote Command	:CALCulate:DATA:REGister:ALL:REMove
Example	:CALC:DATA:REG:ALL:REM
Notes	Removes trace data assigned to all Data Registers.
Couplings	If Data Register is assigned to a trace, the trace data is changed to No Data
Initial S/W Revision	Prior to A.02.00
Modified at S/W Revision	A.02.00

Phase/Delay Properties

Accesses a menu of properties that affect the selected trace when displayed using phase or delay formats.

Key Path	Trace/Detector
Mode	VSA, LTE, LTETDD, IDEN
Initial S/W Revision	Prior to A.02.00
Modified at S/W Revision	A.02.00

Phase/Trellis Offset

Only used if the trace format is Wrap Phase, Unwrap Phase, or Trellis. For Unwrap Phase or Trellis traces, the phase offset value is added to the existing phase at each point. For example, if you are viewing an Unwrapped Phase trace, setting the Phase/Trellis Offset to 5 degrees moves the entire trace up 5 degrees (and changes the value displayed by a marker by the same amount). For Wrap Phase traces the phase offset only affects the phase wrap point, not the underlying data. The point at which the phase wraps is 180 degrees plus the phase offset. For example, suppose you have a marker on a Wrap Phase trace whose phase offset is 0 and the marker is showing -3 degrees. The trace data is all confined within (-180, 180] degrees. If you then change the phase offset to 180 degrees, then the Wrap Phase trace shows values within the interval (0, 360] degrees and the marker value is displayed as 357 degrees, which is the wrapped equivalent of -3 degrees.

Key Path	Trace/Detector, Phase Delay Properties
Mode	VSA, LTE, LTETDD, IDEN

Measurement	<meas>:=VECTor ADEMod DDEMod W11A W11B EVM IPOWER IDEMod MOTotalk
Remote Command	:DISPlay:<meas>:TRACe[1] 2 ...4:FORMat:PHASe:OFFSet <real> :DISPlay:<meas>:TRACe[1] 2 ...4:FORMat:PHASe:OFFSet?
Example	DISP:DDEM:TRAC3:FORM:PHAS:OFFS 31 DISP:DDEM:TRAC3:FORM:PHAS:OFFS?
Preset	0
State Saved	Saved in instrument state.
Min	-1E+8
Max	1E+8
Initial S/W Revision	Prior to A.02.00
Modified at S/W Revision	A.02.00

Unwrap Phase Ref

Enables you to designate the point (x-axis) value about which phase values are to be unwrapped. That is, the phase at the designated reference is within -180 to 180 degrees, and phase varies smoothly without jumps around that point.

Key Path	Trace/Detector, Phase Delay Properties
Mode	VSA, LTE, LTETDD, IDEN
Measurement	<meas>:=VECTor ADEMod DDEMod W11A W11B EVM IPOWER IDEMod MOTotalk
Remote Command	:DISPlay:<meas>:TRACe[1] 2 ...4:FORMat:PHASe:UNWRap:REFerence <real> :DISPlay:<meas>:TRACe[1] 2 ...4:FORMat:PHASe:UNWRap:REFerence?
Example	DISP:DDEM:TRAC3:FORM:PHAS:UNWR:REF 24.5E6 DISP:DDEM:TRAC3:FORM:PHAS:UNWR:REF?
Preset	0
State Saved	Saved in instrument state.
Min	-9.9e37
Max	9.9e37
Initial S/W Revision	Prior to A.02.00
Modified at S/W Revision	A.02.00

Group Delay Aperture

Used when the trace format is Group Delay. The aperture is specified as a percentage of the current frequency span for frequency-domain data. It is specified as a percentage of the time-record length for time-domain data.

When group delay is calculated for a given point (which can be a time- or frequency-domain point), the aperture is centered at that point. Larger apertures decrease resolution, but they increase the smoothing of the group-delay trace.

The point plotted for group delay is located between the data points used to calculate it. For example, in the frequency domain, the group delay for 100 Hz can be calculated by measuring the change in phase between 90 and 110 Hz. If you had specified a start frequency of 90 Hz, 100 Hz would be the first point with group delay data. This results in a trace that does not extend to the edges of the screen (more noticeable as the delay aperture increases).

Note that the smallest aperture that you can select depends on the number of frequency points. If you select an invalid aperture, the analyzer automatically selects the smallest valid aperture.

Key Path	Trace/Detector, Phase Delay Properties
Mode	VSA, LTE, LTETDD, IDEN
Measurement	<meas>:=VECTor ADEMod DDEMod W11A W11B EVM IPOWER IDEMod MOTotalk
Remote Command	:DISPlay:<meas>:TRACe[1] 2 ...4:FORMat:DELaY:APERture <real> :DISPlay:<meas>:TRACe[1] 2 ...4:FORMat:DELaY:APERture?
Example	DISP:DDEM:TRAC3:FORM:DEL:APER 1 DISP:DDEM:TRAC3:FORM:DEL:APER?
Notes	Parameter is interpreted as a percent, e.g., if you want the group delay aperture to be 1% send 1, not 0.01
Preset	0.5
State Saved	Saved in instrument state.
Min	0.00390625
Max	16
Initial S/W Revision	Prior to A.02.00
Modified at S/W Revision	A.02.00

ACP Setup

Accesses a menu of functions that enable you to define and turn on the ACP function on the selected trace. One reference channel and up to 5 offset frequencies can be defined, and ACP is calculated for bands both above and below the reference frequency for each offset.

The adjacent channel power (ACP) function calculates the power in a reference band of frequencies as well as bands of frequencies offset from the reference, and calculates the ratio of each offset band to the reference band power.

An ACP measurement can be defined for each trace, although it is only active on frequency-domain trace data. The reference and offset frequency bands defined by the ACP measurement are shown as gold bars overlaying the trace display. To see tabular data showing power and power ratio results, you can assign the ACP Summary (Trace n) to a different trace. For example, you can assign Spectrum data to trace 1, turn on and define an ACP measurement on trace 1, assign the ACP Summary (Trace 1) to trace 2, and use a 2x2 display to view both at the same time, as shown below.

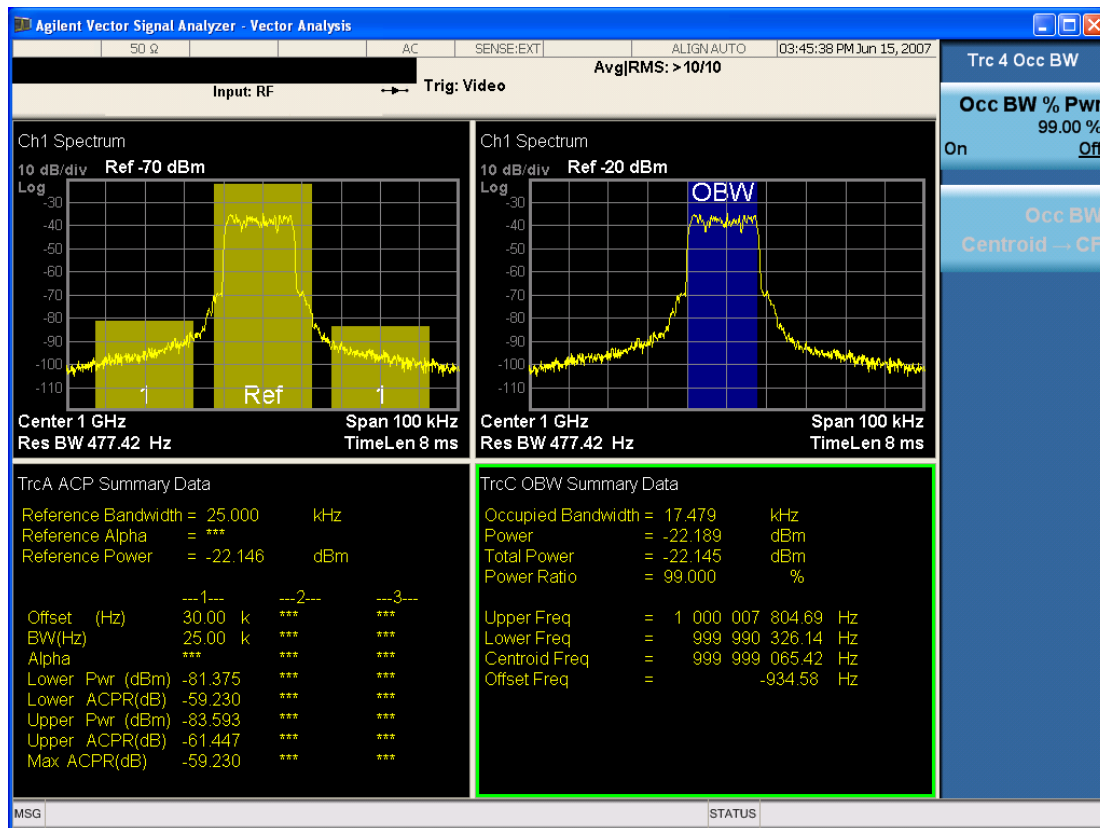

The summary data can be retrieved programmatically using FETCH? or the CALCulate:<meas>:DATA:TABLE commands. See [":CALCulate:DATA:TABLE commands"](#) on page 2870 for more details.

Key Path	Trace/Detector
Mode	VSA, LTE, LTETDD, IDEN
Readback Text	[On Off,]
Initial S/W Revision	Prior to A.02.00
Modified at S/W Revision	A.02.00

ACP On/Off

Turns the ACP function on or off for the selected trace.

Key Path	Trace/Detector, ACP
Mode	VSA, LTE, LTETDD, IDEN
Measurement	<meas>:=VECTor ADEMod DDEMod W11A W11B EVM IPOWER IDEMod MOTotalk
Remote Command	:CALCulate:<meas>:TRACe[1] 2 ...4:ACPpower:STATE OFF ON 0 1 :CALCulate:<meas>:TRACe[1] 2 ...4:ACPpower:STATE?
Example	CALC:VECT:TRAC1:ACP:STATE ON

	CALC:VECT:TRAC1:ACP:STATE?
Preset	0
State Saved	Saved in instrument state.
Initial S/W Revision	Prior to A.02.00
Modified at S/W Revision	A.02.00

Carrier Freq

Enables you to enter the carrier frequency of the reference channel for the ACP measurement. The carrier frequency is relative to the center frequency of the measurement. There is only one available reference carrier.

Key Path	Trace/Detector, ACP
Mode	VSA, LTE, LTETDD, IDEN
Measurement	<meas>:=VECTor ADEMod DDEMod W11A W11B EVM IPOWER IDEMod MOTotalk
Remote Command	:CALCulate:<meas>:TRACe[1] 2 ...4:ACPpower:CARRier:FREQuency <freq> :CALCulate:<meas>:TRACe[1] 2 ...4:ACPpower:CARRier:FREQuency?
Example	CALC:VECT:TRAC1:ACP:CARR:FREQ 100 KHZ CALC:VECT:TRAC1:ACP:CARR:FREQ?
Preset	0
State Saved	Saved in instrument state.
Min	-9.9e37
Max	9.9e37
Initial S/W Revision	Prior to A.02.00
Modified at S/W Revision	A.02.00

Carrier Meas Noise BW

Enables you to define the measurement noise bandwidth of the reference channel.

Key Path	Trace/Detector, ACP
Mode	VSA, LTE, LTETDD, IDEN
Measurement	<meas>:=VECTor ADEMod DDEMod W11A W11B EVM IPOWER IDEMod MOTotalk
Remote Command	:CALCulate:<meas>:TRACe[1] 2 ...4:ACPpower:CARRier:BANDwidth BWIth:INTegration <bandwidth> :CALCulate:<meas>:TRACe[1] 2 ...4:ACPpower:CARRier:BANDwidth BWIth:INTegration?
Example	CALC:VECT:TRAC1:ACP:CARR:BAND:INT 1 MHZ CALC:VECT:TRAC1:ACP:CARR:BAND:INT?

Preset	1000000
State Saved	Saved in instrument state.
Min	-9.9e37
Max	9.9e37
Initial S/W Revision	Prior to A.02.00
Modified at S/W Revision	A.02.00

Carrier RRC Weighting

Turns on or off RRC weighting for the reference (carrier) power measurement.

Key Path	Trace/Detector, ACP
Mode	VSA, LTE, LTETDD, IDEN
Measurement	<meas>:=VECTor ADEMod DDEMod W11A W11B EVM IPOWER IDEMod MOTotalk
Remote Command	:CALCulate:<meas>:TRACe[1] 2 ...4:ACPowEr:CARRier:FILTer:RRC:STATe OFF ON 0 1 :CALCulate:<meas>:TRACe[1] 2 ...4:ACPowEr:CARRier:FILTer:RRC:STATe?
Example	CALC:VECT:TRAC1:ACP:CARR:FILT:RRC:STAT ON CALC:VECT:TRAC1:ACP:CARR:FILT:RRC:STAT?
Preset	0
State Saved	Saved in instrument state.
Initial S/W Revision	Prior to A.02.00
Modified at S/W Revision	A.02.00

Carrier Filter Alpha

Enables you to adjust the alpha of the RRC filter for the reference (carrier) power measurement.

Key Path	Trace/Detector, ACP
Mode	VSA, LTE, LTETDD, IDEN
Measurement	<meas>:=VECTor ADEMod DDEMod W11A W11B EVM IPOWER IDEMod MOTotalk
Remote Command	:CALCulate:<meas>:TRACe[1] 2 ...4:ACPowEr:CARRier:FILTer:RRC:ALPHa <real> :CALCulate:<meas>:TRACe[1] 2 ...4:ACPowEr:CARRier:FILTer:RRC:ALPHa?
Example	CALC:VECT:TRAC1:ACP:CARR:FILT:RRC:ALPH 0.22 CALC:VECT:TRAC1:ACP:CARR:FILT:RRC:ALPH?
Preset	0.35
State Saved	Saved in instrument state.

Min	0
Max	1
Initial S/W Revision	Prior to A.02.00
Modified at S/W Revision	A.02.00

Offsets

Accesses a menu that has a key for each offset, and also an Offset RRC weighting on/off key. Each offset key shows a summary of its current parameters. Pressing one of the Offset A|B|C|D|E keys accesses a menu for adjusting its parameters.

The ACP measurement compares power in frequency bands offset from the carrier to power in the reference channel (centered on the carrier). Up to 5 offsets can be defined. The offsets are designated by letters A through E. Each offset is defined by an offset frequency, bandwidth, and optional RRC weighting. An offset actually defines two bands, one above the reference frequency and one below. Each band is used individually in the ACP calculation. RRC weighting can only be turned on or off for all offsets, but each offset can have its own RRC filter alpha. A filter alpha of 0 is the same as no RRC weighting.

Key Path	Trace/Detector,ACP,Offsets
Mode	VSA, LTE, LTETDD, IDEN
Initial S/W Revision	Prior to A.02.00
Modified at S/W Revision	A.02.00

Offsets

Accesses a menu that has a key for each offset, and also an Offset RRC weighting on/off key. Each offset key shows a summary of its current parameters. Pressing one of the Offset A|B|C|D|E keys accesses a menu for adjusting its parameters.

The ACP measurement compares power in frequency bands offset from the carrier to power in the reference channel (centered on the carrier). Up to 5 offsets can be defined. The offsets are designated by letters A through E. Each offset is defined by an offset frequency, bandwidth, and optional RRC weighting. An offset actually defines two bands, one above the reference frequency and one below. Each band is used individually in the ACP calculation. RRC weighting can only be turned on or off for all offsets, but each offset can have its own RRC filter alpha. A filter alpha of 0 is the same as no RRC weighting.

Key Path	Trace/Detector,ACP,Offsets
Mode	VSA, LTE, LTETDD, IDEN
Initial S/W Revision	Prior to A.02.00
Modified at S/W Revision	A.02.00

Offset Freq

Turns ACP analysis on or off for a selected offset and sets the offset frequency, which is relative to the carrier frequency.

Key Path	Trace/Detector, ACP, Offsets, Offset A B C D E
Mode	VSA, LTE, LTETDD, IDEN
Measurement	<meas>:=VECTor ADEMod DDEMod W11A W11B EVM IPOWER IDEMod MOTotalk
Remote Command	:CALCulate:<meas>:TRACe[1] 2 ...4:ACPpower:OFFSet:LIST:FREQuency <freq>, ... :CALCulate:<meas>:TRACe[1] 2 ...4:ACPpower:OFFSet:LIST:FREQuency? :CALCulate:<meas>:TRACe[1] 2 ...4:ACPpower:OFFSet:LIST:STATe OFF ON 0 1, ... :CALCulate:<meas>:TRACe[1] 2 ...4:ACPpower:OFFSet:LIST:STATe?
Example	CALC:VECT:TRAC1:ACP:OFFS:LIST:FREQ 1 MHZ, 1 MHZ, 500 KHZ, 500 KHZ, 1 MHZ CALC:VECT:TRAC1:ACP:OFFS:LIST:FREQ? :CALC:VECT:TRAC1:ACP:OFFS:LIST:STAT ON, OFF, OFF, ON, OFF
Notes	If you send fewer than 5 frequencies in the parameter list, then the remaining offsets frequencies are set to 0. You can send a single on/off parameter or a comma-separated list of up to 5 parameters. These enable/disable each of the Offsets in sequence. Any remaining Offsets are disabled
Preset	3000000,0,0,0,0 1,0,0,0,0
State Saved	Saved in instrument state.
Min	-9.9E+37
Max	9.9E+37
Initial S/W Revision	Prior to A.02.00
Modified at S/W Revision	A.02.00

Offset Meas Noise BW

Enables you to set the measurement noise bandwidth for the power measurement of a selected offset band.

Key Path	Trace/Detector, ACP, Offsets, Offset A B C D E
Mode	VSA, LTE, LTETDD, IDEN
Measurement	<meas>:=VECTor ADEMod DDEMod W11A W11B EVM IPOWER IDEMod MOTotalk
Remote Command	:CALCulate:<meas>:TRACe[1] 2 ...4:ACPpower:OFFSet:LIST:BANDwidth BWIDTH:INTEgration <bandwidth>, ... :CALCulate:<meas>:TRACe[1] 2 ...4:ACPpower:OFFSet:LIST:BANDwidth BWIDTH:INTEgration?
Example	CALC:VECT:TRAC1:ACP:OFFS:LIST:BAND:INT 1 MHZ, 2 MHZ, 3 MHZ, 4 MHZ, 5 MHZ CALC:VECT:TRAC1:ACP:OFFS:LIST:BAND:INT?

Notes	If you send fewer than 5 bandwidth parameters in the list, then Measurement Noise Bandwidths for the remaining Offsets are set to 0.
Preset	1000000,0,0,0,0
State Saved	Saved in instrument state.
Min	-9.9e37
Max	9.9e37
Initial S/W Revision	Prior to A.02.00
Modified at S/W Revision	A.02.00

Offset Filter Alpha

Enables you to adjust the alpha of the RRC filter for the power measurement of the selected offset band.

Key Path	Trace/Detector, ACP, Offsets, Offset A B C D E
Mode	VSA, LTE, LTETDD, IDEN
Measurement	<meas>:=VECTor ADEMod DDEMod W11A W11B EVM IPOWER IDEMod MOTotalk
Remote Command	:CALCulate:<meas>:TRACe[1] 2 ...4:ACP:OFFSet:LIST:FILTer:RRC:ALPHA <real>, ... :CALCulate:<meas>:TRACe[1] 2 ...4:ACP:OFFSet:LIST:FILTer:RRC:ALPHA?
Example	CALC:VECT:TRAC1:ACP:OFFS:LIST:FILT:RRC:ALPH 0.22, 0.22, 0.22, 0.22, 0.22 CALC:VECT:TRAC1:ACP:OFFS:LIST:FILT:RRC:ALPH?
Notes	You can send a single Filter Alpha for Offset A or a comma-separated list of up to 5 Filter Alpha parameters. These are assigned in sequence to the Offsets. Alpha for any remaining Offsets are set to 0.
Preset	0.35,0.35,0.35,0.35,0.35
State Saved	Saved in instrument state.
Min	0
Max	1.0
Initial S/W Revision	Prior to A.02.00
Modified at S/W Revision	A.02.00

Offset Relative Limit

Enables you to turn on/off a relative limit test and set the limit for the selected offset. The test shows a failure if the power in either the upper or lower band at the selected offset exceeds the reference power plus the relative test limit. For example, if the test limit is -60, the reference power is -4.5 dBm, a test failure would be shown if the power in the lower or upper band exceeds -64.5 dBm.

Key Path	Trace/Detector, ACP, Offsets
Mode	VSA, LTE, LTETDD, IDEN

Measurement	<meas>:=VECTor ADEMod DDEMod W11A W11B EVM IPOWER IDEMod MOTotalk
Remote Command	:CALCulate:<meas>:TRACe[1] 2 ...4:ACPpower:OFFSet:LIST:RCARrier <reall>, ... :CALCulate:<meas>:TRACe[1] 2 ...4:ACPpower:OFFSet:LIST:RCARrier? :CALCulate:<meas>:TRACe[1] 2 ...4:ACPpower:OFFSet:LIST:RCARrier:TEST OFF ON 0 1, ... :CALCulate:<meas>:TRACe[1] 2 ...4:ACPpower:OFFSet:LIST:RCARrier:TEST?
Example	CALC:VECT:TRAC1:ACP:OFFS:LIST:RCAR -50, -55, -60, -65, -80 CALC:VECT:TRAC1:ACP:OFFS:LIST:RCAR? CALC:VECT:TRAC1:ACP:OFFS:LIST:RCAR:TEST 1, 1, 1, 1, 1 CALC:VECT:TRAC1:ACP:OFFS:LIST:RCAR:TEST?
Notes	You can send a single Limit for Offset A or a comma-separated list of up to 5 limit parameters. These are assigned in sequence to the Offset frequencies with the remaining limits being set to 0. You can send a single on/off parameter or a comma-separated list of up to 5 parameters. These turn the Limit Test on or off for each of the Offsets in sequence. For any remaining Offsets, the Limit test is turned off.
Preset	-120,-120,-120,-120,-120 0,0,0,0,0
State Saved	Saved in instrument state.
Min	50
Max	-200
Initial S/W Revision	Prior to A.02.00
Modified at S/W Revision	A.02.00

RRC Weighting (All Offsets)

Turns on or off RRC weighting for the power measurement for all offsets. If RRC weighting is turned on, but you want to exclude RRC weighting for a particular offset, set its filter alpha to 0.

Key Path	Trace/Detector,ACP,Offsets
Mode	VSA, LTE, LTETDD, IDEN
Measurement	<meas>:=VECTor ADEMod DDEMod W11A W11B EVM IPOWER IDEMod MOTotalk
Remote Command	:CALCulate:<meas>:TRACe[1] 2 ...4:ACPpower:OFFSet:FILTer:RRC:STATe OFF ON 0 1 :CALCulate:<meas>:TRACe[1] 2 ...4:ACPpower:OFFSet:FILTer:RRC:STATe?
Example	CALC:VECT:TRAC1:ACP:OFFS:FILT:RRC:STAT ON CALC:VECT:TRAC1:ACP:OFFS:FILT:RRC:STAT?
Preset	0
State Saved	Saved in instrument state.
Initial S/W Revision	Prior to A.02.00
Modified at S/W Revision	A.02.00

OBW Setup (Occupied Bandwidth)

Accesses a menu of functions that enable you to define and turn on the OBW function on the selected trace.

The occupied bandwidth (OBW) function finds and displays the band of frequencies that contain a specified percentage of the total power within the measurement span.

An OBW measurement can be defined for each trace, although it is only active on frequency-domain trace data. The band defined by the OBW measurement is shown as a blue bar overlaying the trace display. To see tabular data showing the frequencies of the band limits, the total power, and so on, you can assign the OBW Summary (Trace n) to a different trace. For example, you can assign Spectrum data to trace 3, turn on OBW on trace 3, and assign the OBW Summary (Trace 3) to trace 4, as shown below.

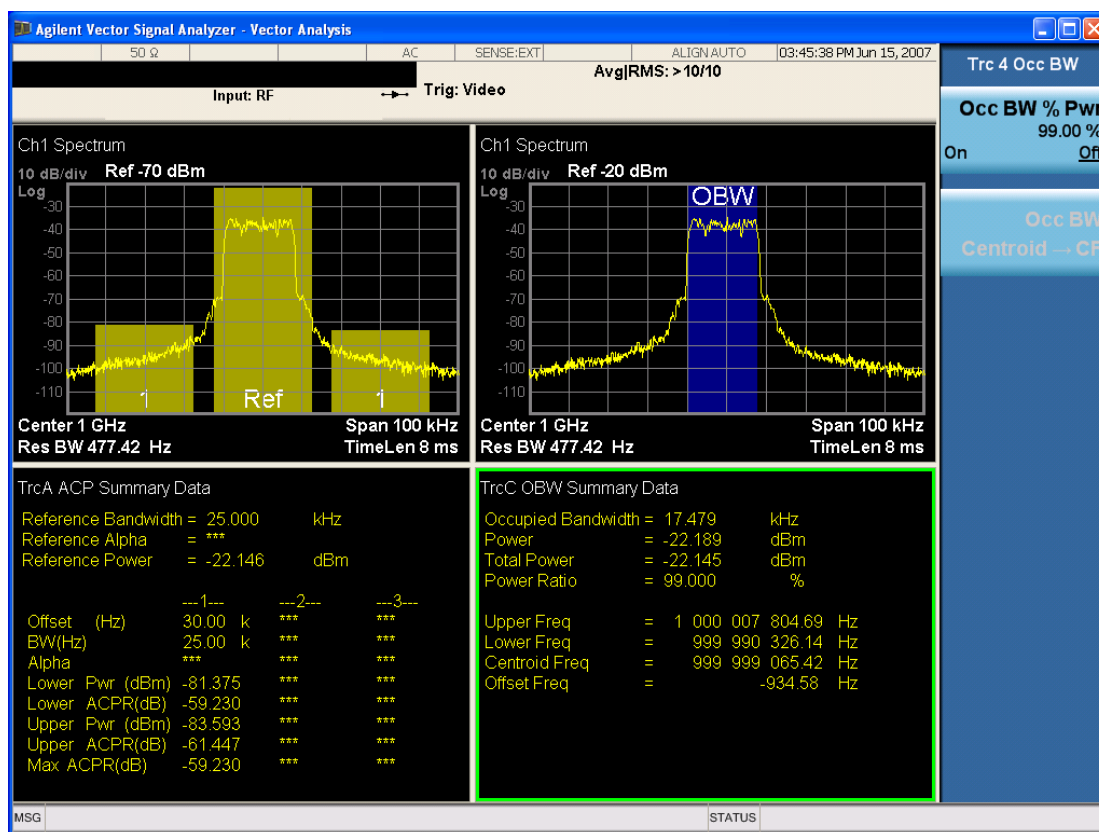

The summary data can be retrieved programmatically using FETCH? or the CALCulate:<meas>:DATA:TABLE commands. See "[CALCulate:DATA:TABLE commands](#)" on page 2870 for more details.

Key Path	Trace/Detector
Mode	VSA, LTE, LTETDD, IDEN
Readback Text	[On Off, <num>%]
Initial S/W Revision	Prior to A.02.00
Modified at S/W Revision	A.02.00

OBW Power

Specifies the percentage of power for determining the occupied BW, and turns the OBW function on or off for the selected trace.

Key Path	Trace/Detector, OBW
Mode	VSA, LTE, LTETDD, IDEN
Measurement	<meas>:=VECTor ADEMod DDEMod W11A W11B EVM IPOWER IDEMod MOTotalk
Remote Command	:CALCulate:<meas>:TRACe[1] 2 ...4:OBWidth:PERCent <real> :CALCulate:<meas>:TRACe[1] 2 ...4:OBWidth:PERCent? :CALCulate:<meas>:TRACe[1] 2 ...4:OBWidth:STATE OFF ON 0 1 :CALCulate:<meas>:TRACe[1] 2 ...4:OBWidth:STATE?
Example	CALC:VECT:TRAC1:OBW:PERC 99 CALC:VECT:TRAC1:OBW:PERC? CALC:VECT:TRAC1:OBW:STAT ON CALC:VECT:TRAC1:OBW:STAT?
Notes	Parameter is interpreted as a percent, e.g., if you want the OBW to be 95% send 95, not 0.95
Preset	99.0 0
State Saved	Saved in instrument state.
Min	0
Max	100
Initial S/W Revision	Prior to A.02.00
Modified at S/W Revision	A.02.00

OBW Centroid > CF

Copies the centroid of the occupied bandwidth to the Center Frequency. It only works if the currently selected trace has data compatible with the OBW function and OBW is turned on.

This is a front-panel function only.

You can read the OBW centroid using the following SCPI-only query and use the result to set the center frequency.

Mode	VSA, LTE, LTETDD, IDEN
Measurement	<meas>:=VECTor ADEMod DDEMod W11A W11B EVM IPOWER IDEMod MOTotalk
Remote Command	:CALCulate:<meas>:TRACe[1] 2 ...4:OBWidth:CENTroid?
Example	CALC:VECT:TRAC1:OBW:CENT?
Notes	Query only. Returns NaN (9.91E+37) if the OBW function is not active for the selected trace or is not supported for the trace data assigned to the selected trace.

Initial S/W Revision	Prior to A.02.00
Modified at S/W Revision	A.02.00

BW Limit

Turns on or off limit testing for the Occupied BW test for the selected trace, and enables you to define the limit. Test pass or fail status appears in the OBW Summary table associated with the trace.

Key Path	Trace/Detector, OBW
Mode	VSA, LTE, LTETDD, IDEN
Measurement	<meas>:=VECTor ADEMod DDEMod W11A W11B EVM IPOWER IDEMod MOTotalk
Remote Command	:CALCulate:<meas>:TRACe[1] 2 ...4:OBWidth:LIMit:FBLimit <freq> :CALCulate:<meas>:TRACe[1] 2 ...4:OBWidth:LIMit:FBLimit? :CALCulate:<meas>:TRACe[1] 2 ...4:OBWidth:LIMit[:TEST] OFF ON 0 1 :CALCulate:<meas>:TRACe[1] 2 ...4:OBWidth:LIMit[:TEST]?
Example	CALC:VECT:TRAC1:OBW:LIMIT:FBL 10 MHZ CALC:VECT:TRAC1:OBW:LIMIT:FBL? CALC:VECT:TRAC1:OBW:LIMIT:TEST ON CALC:VECT:TRAC1:OBW:LIMIT:TEST?
Preset	1000000 0
State Saved	Saved in instrument state.
Min	1 Hz
Max	9.9e37 (Infinity) Hz
Initial S/W Revision	Prior to A.02.00
Modified at S/W Revision	A.02.00

Trace Indicator Info

Enables you to get more information about why a trace indicator is showing. A trace indicator appears in the upper right corner of a trace display to announce exceptional conditions. When such an indicator is showing on the selected trace, pressing this key causes more information about the condition to appear in the message area. This is a front-panel only function. The SCPI commands for querying the Trace Indicator and the Trace Indicator Info for a particular trace are:

CALC:<meas>:DATA[1]]2|3|4:HEAD:STR? "TrcLedStr"

CALC:<meas>:DATA[1]]2|3|4:HEAD:STR? "TrcLedReason"

Key Path	Trace/Detector
Mode	VSA, LTE, LTETDD, IDEN

Initial S/W Revision	Prior to A.02.00
Modified at S/W Revision	A.02.00

Limit Test (SCPI Only)

Enables you to enable or disable the Limit Test function for each Trace when the Trace supports the Limit Test function.

When enabled, if the limit test fails on the trace, “FAIL” is shown on the Meas Bar. Otherwise, “PASS” is shown.

Available only for the EVM measurement.

Mode	VSA, LTE, LTETDD
Measurement	<meas>:=EVM
Remote Command	:CALCulate:<meas>:TRACe[1] 2 ...4:LIMit:VISible OFF ON 0 1 :CALCulate:<meas>:TRACe[1] 2 ...4:LIMit:VISible?
Example	CALC:EVM:TRAC1:LIM:VIS ON CALC:EVM:TRAC1:LIM:VIS?
Notes	On the LTE/LTETDD EVM measurement, the following trace data is supported: In-band Emissions Eq Ch Freq Resp Per Slot Limit data can be queried by :CALC:EVM:DATA[1]]2 3 4? LL UL command.
Preset	0
State Saved	Saved in instrument state.
Initial S/W Revision	A.08.00

Trigger

See ["Trigger" on page 438](#)

Free Run

See ["Free Run " on page 445](#)

Video

See ["Video \(IF Envelope\) " on page 446](#)

Trigger Level

See ["Trigger Level " on page 446](#)

Trig Slope

See ["Trig Slope " on page 447](#)

Trig Delay

See ["Trig Delay " on page 448](#)

Line

See ["Line " on page 2503](#)

Trig Slope

See ["Trig Slope " on page 2503](#)

Trig Delay

See ["Trig Delay " on page 450](#)

External 1

See ["External 1 " on page 2516](#)

Trigger Level

See ["Trigger Level " on page 2516](#)

Trig Slope

See ["Trig Slope " on page 2517](#)

Trig Delay

See ["Trig Delay " on page 453](#)

External 2

See ["External 2 " on page 2518](#)

Trigger Level

See ["Trigger Level "](#) on page 2518

Trig Slope

See ["Trig Slope "](#) on page 2519

Trig Delay

See ["Trig Delay "](#) on page 455

RF Burst

See ["RF Burst "](#) on page 2519

Absolute Trigger

See ["Absolute Trigger Level"](#) on page 2520

Trig Slope

See ["Trigger Slope "](#) on page 2521

Trig Delay

See ["Trig Delay "](#) on page 460

Periodic Timer

See ["Periodic Timer \(Frame Trigger\) "](#) on page 2511

Period

See ["Period "](#) on page 2512

Offset

See ["Offset "](#) on page 2513

Offset Adjust (Remote Command Only)

See ["Offset Adjust \(Remote Command Only\)"](#) on page 2514

Reset Offset Display

See ["Reset Offset Display "](#) on page 2515

Sync Source

See ["Sync Source "](#) on page 2515

Off

See ["Off "](#) on page 2516

External 1

See "[External 1](#)" on page 2516

Trigger Level

See "[Trigger Level](#)" on page 2516

Trig Slope

See "[Trig Slope](#)" on page 2517

External 2

See "[External 2](#)" on page 2518

Trigger Level

See "[Trigger Level](#)" on page 2518

Trig Slope

See "[Trig Slope](#)" on page 2519

RF Burst

See "[RF Burst](#)" on page 2519

Absolute Trigger

See "[Absolute Trigger Level](#)" on page 2520

Trig Slope

See "[Trigger Slope](#)" on page 2521

Trig Delay

See "[Trig Delay](#)" on page 470

Trig Reference Line

See [___](#) on page X

Auto/Holdoff

See "[Auto/Holdoff](#)" on page 471

Auto Trig

See "[Auto Trig](#)" on page 471

Trig Holdoff

See "[Trig Holdoff](#)" on page 472

Holdoff Type

See "[Holdoff Type](#)" on page 472

User Preset

Accesses a menu that gives you the following three choices:

- User Preset – recalls a state previously saved using the Save User Preset function.
- User Preset All Modes – presets all of the modes in the analyzer
- Save User Preset– saves the current state for the current mode

Key Path	Front-panel key
Backwards Compatibility Notes	<p>User Preset is actually loading a state, and in legacy analyzers, it was possible to load a state without affecting the trace data, limit lines or correction data. Similarly it was possible to do a User Preset without affecting the trace data, limit lines or correction data.</p> <p>In the X-Series, “state” always includes all of this data; so whenever state is loaded, or User Preset is executed, all of the traces, limit lines and corrections are affected. Although this differs from previous behavior, it is desirable behavior, and should not cause adverse issues for users.</p> <p>On ESA and PSA, User Preset affected the entire instrument’s state. In the X-Series, User Preset only recalls the state for the active mode. There is a User Preset file for each mode. User Preset can never cause a mode switch as it can in legacy analyzers. If you want to recall all modes to their user preset file state, you will need to do a User Preset after mode switching into each mode.</p> <p>User Preset recalls mode state which can now include data like traces; whereas on ESA and PSA, User Preset did not affect data.</p>
Initial S/W Revision	Prior to A.02.00

User Preset

User Preset sets the state of the currently active mode back to the state that was previously saved for this mode using the Save User Preset menu key or the SCPI command, SYST:PRES:USER:SAV. It not only recalls the Mode Preset settings, but it also recalls all of the mode persistent settings, and the Input/Output system setting that existed at the time Save User Preset was executed.

If a Save User Preset has not been done at any time, User Preset recalls the default user preset file for the currently active mode. The default user preset files are created if, at power-on, a mode detects there is no user preset file. There will never be a scenario when there is no user preset file to restore. For each mode, the default user preset state is the same state that would be saved if a Save User Preset is performed in each mode right after doing a Restore Mode Default and after a Restore Input/Output Defaults.

The User Preset function does the following:

- Aborts the currently running measurement.
- Sets the mode State to the values defined by Save User Preset.
- Makes the saved measurement for the currently running mode the active measurement.
- Brings up the saved menu for the power-on mode.
- Clears the input and output buffers.
- Sets the Status Byte to 0.

Key Path	User Preset
Remote Command	:SYSTem:PRESet:USER
Example	:SYST:PRES:USER:SAVE:SYST:PRES:USER
Notes	:SYST:PRES:USER:SAVE is used to save the current state as the user preset state. Clears all pending OPC bits. The Status Byte is set to 0. Pressing the User Preset front-panel key while already in the User Preset menu will cause the User Preset to get executed
Couplings	A user preset will cause the currently running measurement to be aborted and cause the saved measurement to be active. Recalling a User Preset file has the same issues that recalling a Save State file has. Some settings may need to be limited and therefore re-coupled, since the capabilities of the mode may have changes when the User Preset file was last saved.
Initial S/W Revision	Prior to A.02.00

User Preset All Modes

Recalls all of the User Preset files for each mode, switches to the power-on mode, and activates the saved measurement from the power-on mode User Preset file.

NOTE

When the instrument is secured, all of the user preset files are converted back to their default user preset files.

The User Preset function does the following:

- Aborts the currently running measurement.
- Switches the Mode to the power-on mode.
- Restores the User Preset files for each mode.
- Makes the saved measurement for the power-on mode the active measurement.
- Brings up the saved menu for the power-on mode.
- Clears the input and output buffers.
- Sets the Status Byte to 0.

Key Path	User Preset
Remote Command	:SYSTem:PRESet:USER:ALL
Example	:SYST:PRES:USER:SAVE:SYST:PRES:USER:ALL
Notes	Clears all pending OPC bits. The Status Byte is set to 0. :SYST:PRES:USER:SAVE is used to save the current state as the user preset state.
Couplings	A user preset will cause the currently running measurement to be aborted, cause a mode switch to the power-on mode, and cause the saved measurement to be active in the power-on mode. Recalling a User Preset file has the same issues that recalling a Save State file has. Some settings may need to be limited and therefore re-coupled, since the capabilities of the mode may have changes when the User Preset file was last saved.
Initial S/W Revision	Prior to A.02.00

Save User Preset

Saves the currently active mode and its State. You can recall this User Preset file by pressing the User Preset menu key or sending the SYST:PRES:USER remote command. This same state is also saved by the Save State function.

Key Path	User Preset
Remote Command	:SYSTem:PRESet:USER:SAVE
Example	:SYST:PRES:USER:SAVE
Notes	:SYST:PRES:SAVE creates the same file as if the user requested a *SAV or a MMEM:STOR:STAT, except User Preset Save does not allow the user to specify the filename or the location of the file.
Initial S/W Revision	Prior to A.02.00

View/Display

Enables you to set many display properties. Many View Preset softkeys appear under this menu. These set up measurement-specific views, which are described in individual measurements. A view in this application is simply a preset; that is, a choice of layout, trace data assignment, and trace formatting and scaling. After a view preset is performed, the resulting arrangement can then be changed by any available trace manipulation functions or by changing the layout. All measurements have a default view that is used when they are first started, and the first listed preset view restores that arrangement without otherwise affecting the measurement.

This menu contains keys that enable control over the way data is displayed. The Layout key is described here. Other keys specific to measurements are described in their own descriptions.

Key Path	Front Panel
Mode	VSA, LTE, LTETDD, IDEN, LTEAFDD, LTEATDD
Initial S/W Revision	Prior to A.02.00
Modified at S/W Revision	A.02.00

Display

The Display menu is common to most measurements, and is used for configuring items on the display. Some Display menu settings apply to all the measurements in a mode, and some only to the current measurement. Those under the System Display Settings key apply to all measurements in all modes.

Key Path	Display
Key Path	View/Display
Initial S/W Revision	Prior to A.02.00

Annotation

Turns on and off various parts of the display annotation. The annotation is divided up into four categories:

1. Meas Bar: This is the measurement bar at the top of the screen. It does not include the settings panel or the Active Function. Turning off the Meas Bar turns off the settings panel and the Active Function. When the Meas Bar is off, the graticule area expands to fill the area formerly occupied by the Meas Bar.
2. Screen Annotation: this is the annotation and annunciation around the graticule, including any annotation on lines (such as the display line, the threshold line, etc.) This does NOT include the marker number or the N dB result. When off, the graticule expands to fill the entire graticule area.
3. Trace annotation: these are the labels on the traces, showing their detector (or their math mode).
4. Active Function annotation: this is the active function display in the meas bar, and all of the active function values displayed on softkeys.

See the figure below. Each type of annotation can be turned on and off individually.

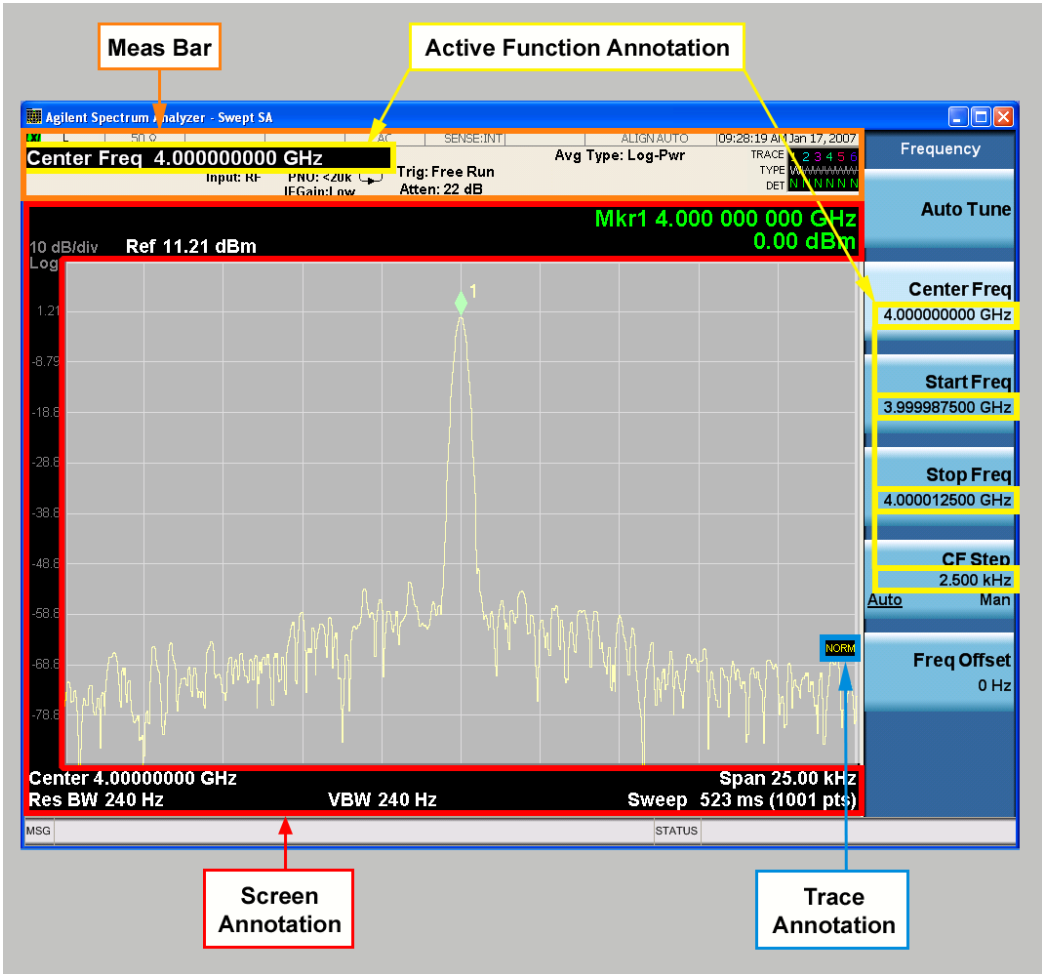

Key Path	View/Display, Display
Initial S/W Revision	Prior to A.02.00

Meas Bar On/Off

This function turns the Measurement Bar on and off, including the settings panel. When off, the graticule area expands to fill the area formerly occupied by the Measurement Bar.

Key Path	View/Display, Display, Annotation
Remote Command	:DISPlay:ANNotation:MBAR[:STATE] OFF ON 0 1 :DISPlay:ANNotation:MBAR[:STATE]?
Example	DISP:ANN:MBAR OFF
Dependencies	Grayed out and forced to OFF when System Display Settings, Annotation is set to Off.
Preset	On This should remain Off through a Preset when System DisplaySettings, Annotation is set to Off.
State Saved	Saved in instrument state.
Initial S/W Revision	Prior to A.02.00

Screen

This controls the display of the annunciation and annotation around the graticule, including any annotation on lines (such as the display line, the threshold line, etc.) and the y-axis annotation. This does NOT include marker annotation (or the N dB result). When off, the graticule expands to fill the entire graticule area, leaving only the 1.5% gap above the graticule as described in the Trace/Detector chapter.

Key Path	View/Display, Display, Annotation
Remote Command	:DISPlay:ANNotation:SCReen[:STATe] OFF ON 0 1 :DISPlay:ANNotation:SCReen[:STATe]?
Example	DISP:ANN:SCR OFF
Dependencies	Grayed-out and forced to OFF when System Display Settings, Annotation is set to Off.
Preset	On This should remain Off through a Preset when System DisplaySettings, Annotation is set to Off
State Saved	Saved in instrument state.
Initial S/W Revision	Prior to A.02.00

Active Function Values On/Off

Turns on and off the active function display in the Meas Bar, and all of the active function values displayed on the softkeys.

Note that all of the softkeys that have active functions have these numeric values blanked when this function is on. This is a security feature..

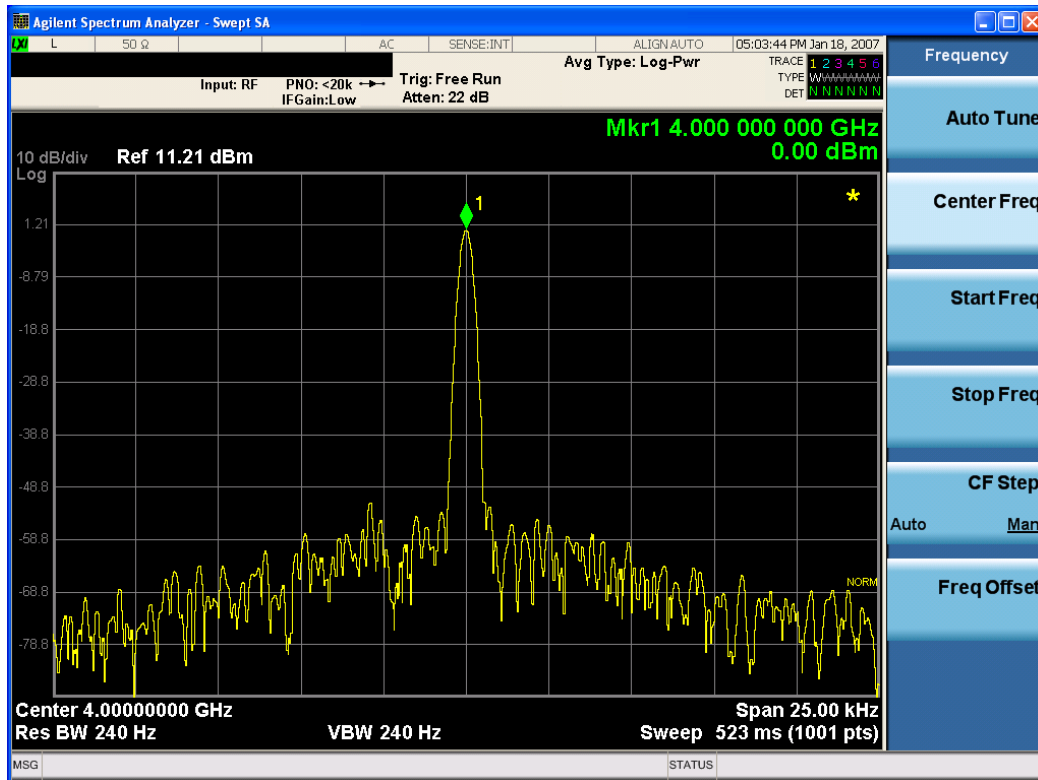

Key Path	View/Display, Display, Annotation
Remote Command	:DISPlay:ACTivefunc[:STATE] ON OFF 1 0 :DISPlay:ACTivefunc[:STATE]?
Example	DISP:ACT OFF
Dependencies	Grayed out and forced to OFF when System Display Settings, Annotation is set to Off.
Preset	On This should remain Off through a Preset when System DisplaySettings, Annotation is set to Off
State Saved	Saved in instrument state.
Initial S/W Revision	Prior to A.02.00

Title

Displays menu keys that enable you to change or clear a title on your display.

Key Path	View/Display, Display
Initial S/W Revision	Prior to A.02.00

Change Title

Writes a title into the "measurement name" field in the banner, for example, "Swept SA".

Press Change Title to enter a new title through the alpha editor. Press Enter or Return to complete the entry. Press ESC to cancel the entry and preserve your existing title.

The display title will replace the measurement name. It remains for this measurement until you press Change Title again, or you recall a state, or a Preset is performed. A title can also be cleared by pressing Title, Clear Title.

NOTE

Notice the inclusion of the <measurement> parameter in the command below. Because each measurement remembers the Display Title, the command must be qualified with the measurement name. For the Swept SA measurement this is not the case; no <measurement> parameter is used when changing the Display Title for the Swept SA measurement.

Key Path	View/Display, Display, Title
Mode	All
Remote Command	:DISPlay:<measurement>:ANNotation:TITLe:DATA <string> :DISPlay:<measurement>:ANNotation:TITLe:DATA?
Example	DISP:ANN:TITL:DATA "This Is My Title" This example is for the Swept SA measurement in the Spectrum Analyzer mode. The SANalyzer <measurement> name is not used. DISP:ACP:ANN:TITL:DATA "This Is My Title" This example is for Measurements other than Swept SA. Both set the title to: This Is My Title
Notes	Pressing this key cancels any active function. When a title is edited the previous title remains intact (it is not cleared) and the cursor goes at the end so that characters can be added or BKSP can be used to go back over previous characters.
Preset	No title (measurement name instead)
State Saved	Saved in instrument state.
Initial S/W Revision	Prior to A.02.00

Clear Title

Clears a title from the front-panel display. Once cleared, the title cannot be retrieved. After the title is cleared, the current Measurement Name replaces it in the title bar.

Key Path	View/Display, Display, Title
Example	The following commands clear the title and restore the measurement's original title: DISP:ANN:TITL:DATA "" This example is for the Swept SA measurement in the Spectrum Analyzer mode. The SANalyzer <measurement> name is not used. DISP:ACP:ANN:TITL:DATA "" This example is for ACP; in measurements other than Swept SA the measurement name is required.
Notes	Uses the :DISPlay:<measurement>:ANNotation:TITLe:DATA <string> command with an empty string (in the Swept SA, the <measurement> is omitted).
Preset	Performed on Preset.
Initial S/W Revision	Prior to A.02.00

Graticule

Pressing Graticule turns the display graticule On or Off. It also turns the graticule y-axis annotation on and off.

Key Path	View/Display, Display
Remote Command	:DISPlay:WINDow[1]:TRACe:GRATicule:GRID[:STATe] OFF ON 0 1 :DISPlay:WINDow[1]:TRACe:GRATicule:GRID[:STATe]?
Example	DISP:WIND:TRAC:GRAT:GRID OFF
Notes	The graticule is the set of horizontal and vertical lines that make up the grid/divisions for the x-axis and y-axis.
Preset	On
State Saved	Saved in instrument state
Initial S/W Revision	Prior to A.02.00

System Display Settings

These settings are "Mode Global" – they affect all modes and measurements and are reset only by Restore Misc Defaults or Restore System Defaults under System.

Key Path	View/Display, Display
Initial S/W Revision	Prior to A.02.00

Annotation Local Settings

This is a Mode Global override of the meas local annotation settings. When it is All Off, it forces ScreenAnnotation, Meas Bar, Trace, and Active Function Values settings to be OFF for all measurements in all modes. This provides the security based "annotation off" function of previous analyzers; hence it uses the legacy SCPI command.

When it is All Off, the Screen, Meas Bar, Trace, and Active Function Values keys under the Display, Annotation menu are grayed out and forced to Off. When Local Settings is selected, you are able to set the local annotation settings on a measurement by measurement basis.

Key Path	View/Display, Display, System Display Settings
Remote Command	:DISPlay:WINDow[1]:ANNotation[:ALL] OFF ON 0 1 :DISPlay:WINDow[1]:ANNotation[:ALL]?
Example	:DISP:WIND:ANN OFF
Preset	On (Set by Restore Misc Defaults)
State Saved	Not saved in instrument state.
Backwards Compatibility Notes	The WINDow parameter and optional subopcode is included for backwards compatibility but ignored – all windows are equally affected.
Initial S/W Revision	Prior to A.02.00

Themes

Accesses a menu of functions that enable you to choose the theme to be used when saving the screen image.

The **Themes** option is the same as the **Themes** option under the **Display** and **Page Setup** dialogs. It allows you to choose between themes to be used when saving the screen image.

Key Path	Save, Screen Image
Remote Command	:MMEMory:STORe:SCReem:THEMe TDColor TDMonochrome FCOLor FMONochrome :MMEMory:STORe:SCReem:THEMe?
Example	:MMEM:STOR:SCR:THEM TDM
Preset	3D Color; Is not part of Preset, but is reset by Restore Misc Defaults or Restore System Defaults All and survives subsequent running of the modes.
Readback	3D Color 3D Mono Flat Color Flat Mono
Backwards Compatibility Notes	In ESA and PSA we offer the choice of "Reverse Bitmap" or "Reverse Metafile" when saving screen images. This is much like the "Flat Color" theme available in X-Series. Also, if you selected Reverse Bitmap AND a black & white screen image, that would be much like "Flat Monochrome". In other words, each of the X-Series themes has a similar screen image type in ESA/PSA. But they are not identical.
Initial S/W Revision	Prior to A.02.00

3D Color

Selects a standard color theme with each object filled, shaded and colored as designed.

Key Path	Save, Screen Image, Themes
Example	MMEM:STOR:SCR:THEM TDC
Readback	3D Color
Initial S/W Revision	Prior to A.02.00

3D Monochrome

Selects a format that is like 3D color but shades of gray are used instead of colors.

Key Path	Save, Screen Image, Themes
Example	MMEM:STOR:SCR:THEM TDM
Readback	3D Mono
Initial S/W Revision	Prior to A.02.00

Flat Color

Selects a format that is best when the screen is to be printed on an ink printer.

Key Path	Save, Screen Image, Themes
Example	MMEM:STOR:SCR:THEM FCOL
Readback	Flat Color
Initial S/W Revision	Prior to A.02.00

Flat Monochrome

Selects a format that is like Flat Color. But only black is used (no colors, not even gray), and no fill.

Key Path	Save, Screen Image, Themes
Example	MMEM:STOR:SCR:THEM FMON
Readback	Flat Mono
Initial S/W Revision	Prior to A.02.00

Backlight

Accesses the display backlight on/off keys. This setting may interact with settings under the Windows "Power" menu.

When the backlight is off, pressing ESC, TAB, SPACE, ENTER, UP, DOWN, LEFT, RIGHT, DEL, BKSP, CTRL, or ALT turns the backlight on without affecting the application. Pressing any other key will turn backlight on and could potentially perform the action as well.

Key Path	View/Display, Display, System Display Settings
Remote Command	:DISPlay:BACKlight ON OFF :DISPlay:BACKlight?
Preset	ON (Set by Restore Misc Defaults)
Initial S/W Revision	Prior to A.02.00

Backlight Intensity

An active function used to set the backlight intensity. It goes from 0 to 100 where 100 is full on and 0 is off. This value is independent of the values set under the Backlight on/off key.

Key Path	View/Display, Display, System Display Settings
Remote Command	:DISPlay:BACKlight:INTensity <integer> :DISPlay:BACKlight:INTensity?
Example	DISP:BACK:INT 50

Preset	100 (Set by Restore Misc Defaults)
Min	0
Max	100
Initial S/W Revision	Prior to A.02.00

Layout

Enables you to choose the number and position of windows on the screen. Each window contains one trace. The selected trace is always visible and its window outlined in green. The Window zoom key toggles between multiple windows and a single window mode without changing the setting for Layout.

Single layout has one window.

Stack 2 layout has two windows, one on top of the other, that display either traces 1 (top) and 2 (bottom) or traces 3 and 4. The pair that is showing always includes the selected trace.

Stack 3 layout has three windows that display, top to bottom, traces 1, 2, 3 or traces 2, 3, 4.

Grid 2x2 layout has 4 windows, arranged 2x2. They display (in order top to bottom, left to right) traces 1, 2, 3, and 4.

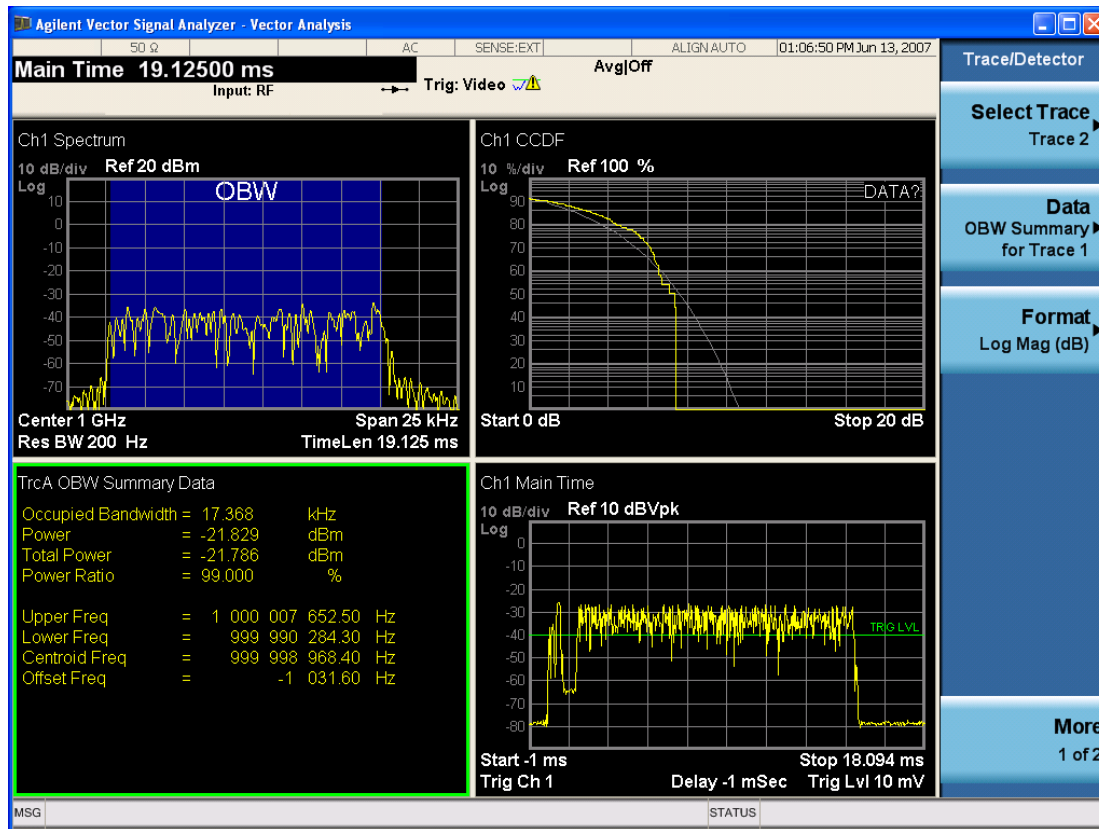

Grid 2x2 layout with Trace 2 selected

There are two other layouts that are available for iDEN Power, iDEN Demod, and MOTOTalk measurements since these enable 6 traces.

Grid 2x3 layout has 2 rows of 3 windows that display all 6 traces in order, top to bottom, then left to right.

Grid 3x2 layout has 3 rows of 2 windows that display all 6 traces in order, top to bottom, then left to right.

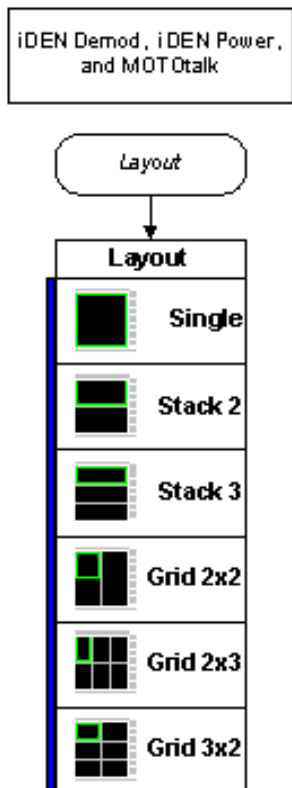

Key Path	View/Display
Mode	VSA, LTE, LTETDD, IDEN, LTEAFDD, LTEATDD
Measurement	<meas>:=VECTor ADEMod DDEMod W11A W11B EVM IPOWER IDEMod MOTotalk
Remote Command	:DISPlay:<meas>:WINDow:FORMat SINGLE TWO TRI QUAD :DISPlay:<meas>:WINDow:FORMat? For iDEN Power, iDEN Demod and MotoTalk measurements: :DISPlay:<meas>:WINDow:FORMat SINGLE TWO TRI QUAD GR2X3 GR3X2 :DISPlay:<meas>:WINDow:FORMat?
Example	DISP:VECT:WIND:FORM TWO DISP:IPOW:WIND:FORM GR2X3 DISP:VECT:WIND:FORM?
Couplings	If the window is currently zoomed, selecting a layout (even the current one) switches it to tiled mode.
Preset	TWO QUAD QUAD QUAD QUAD QUAD QUAD QUAD GR2X3 TRI

State Saved	Saved in instrument state.
Range	Single Stack 2 Stack 3 Grid 2x2 Grid 2x2 Grid 2x3 Stack 3
Initial S/W Revision	Prior to A.02.00
Modified at S/W Revision	A.02.00

Preset View: Basic

This preset view consists of the following traces in a Grid 2x2 layout:

- IQ Meas
- Spectrum
- Error Vector Spectrum
- Error Summary

This layout is set by Meas Preset and is good for insuring that the signal is being demodulated correctly, as well as showing many basic demodulation setup problems.

The Preset View: Basic softkey performs the immediate action of changing the layout and view to this configuration. Preset View is an action, not a state.

Key Path	View/Display
Mode	LTE, LTETDD
Remote Command	:DISPlay:EVM:VIEW:PRESet BASic
Example	DISP:EVM:VIEW:PRES BAS
Initial S/W Revision	Prior to A.02.00
Modified at S/W Revision	A.03.00

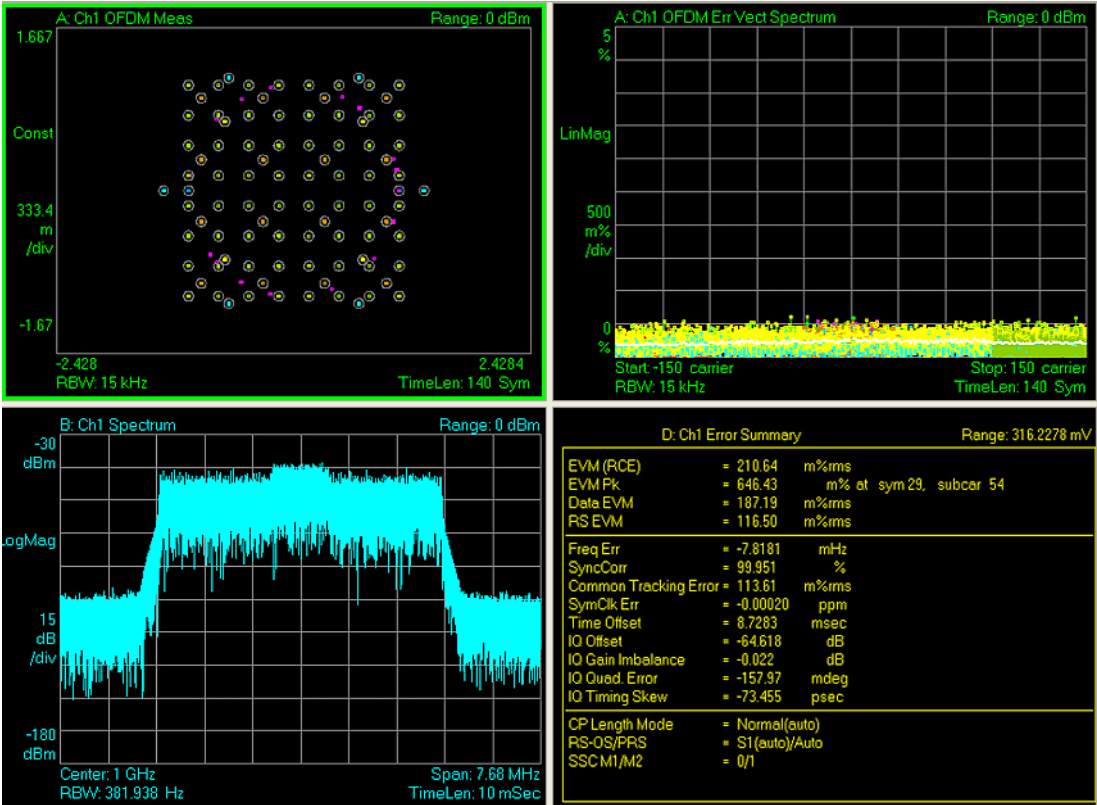

Preset View: Meas Summary

This preset view consists of the following traces in a Stacked layout:

- Error Summary
- Frame Summary

This layout provides the full list of the composite result metrics and characteristics of each of the logical channels.

The Preset View: Meas Summary softkey performs the immediate action of changing the layout and view to this configuration. Preset View is an action, not a state.

Key Path	View/Display
Mode	LTE, LTETDD
Remote Command	:DISPlay:EVM:VIEW:PRESet SUMMary
Example	DISP:EVM:VIEW:PRES SUMM
Initial S/W Revision	Prior to A.02.00
Modified at S/W Revision	A.03.00

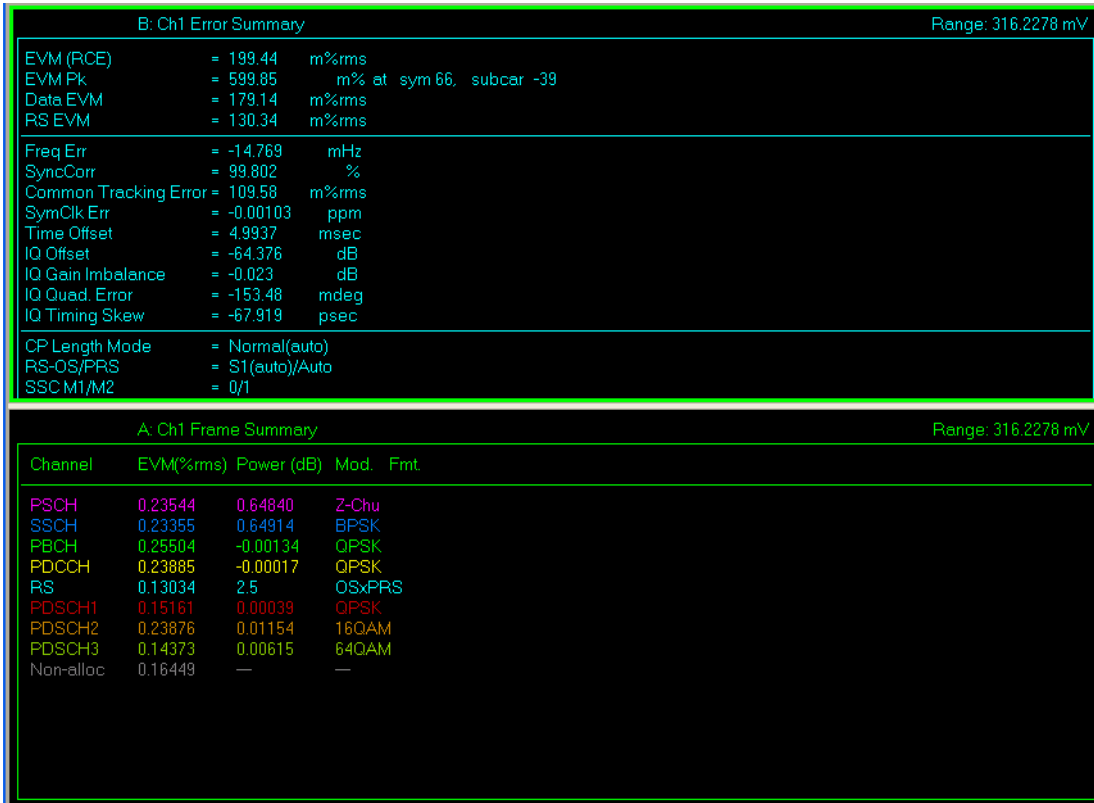

Preset View: RB Slot Meas

This preset view consists of the following traces in a Grid 2x2 layout:

- RB Power vs Spectrum
- RB Error Mag Spectrum
- RB Power vs Time
- RB Error Mag Time

This layout provides the details on the Resource Block.

The Preset View: RB Slot Meas softkey performs the immediate action of changing the layout and view to this configuration. Preset View is an action, not a state.

Key Path	View/Display
Mode	LTE, LTETDD
Remote Command	:DISPlay:EVM:VIEW:PRESet RBSlot
Example	DISP:EVM:VIEW:PRESet RBSlot
Initial S/W Revision	Prior to A.02.00
Modified at S/W Revision	A.03.00

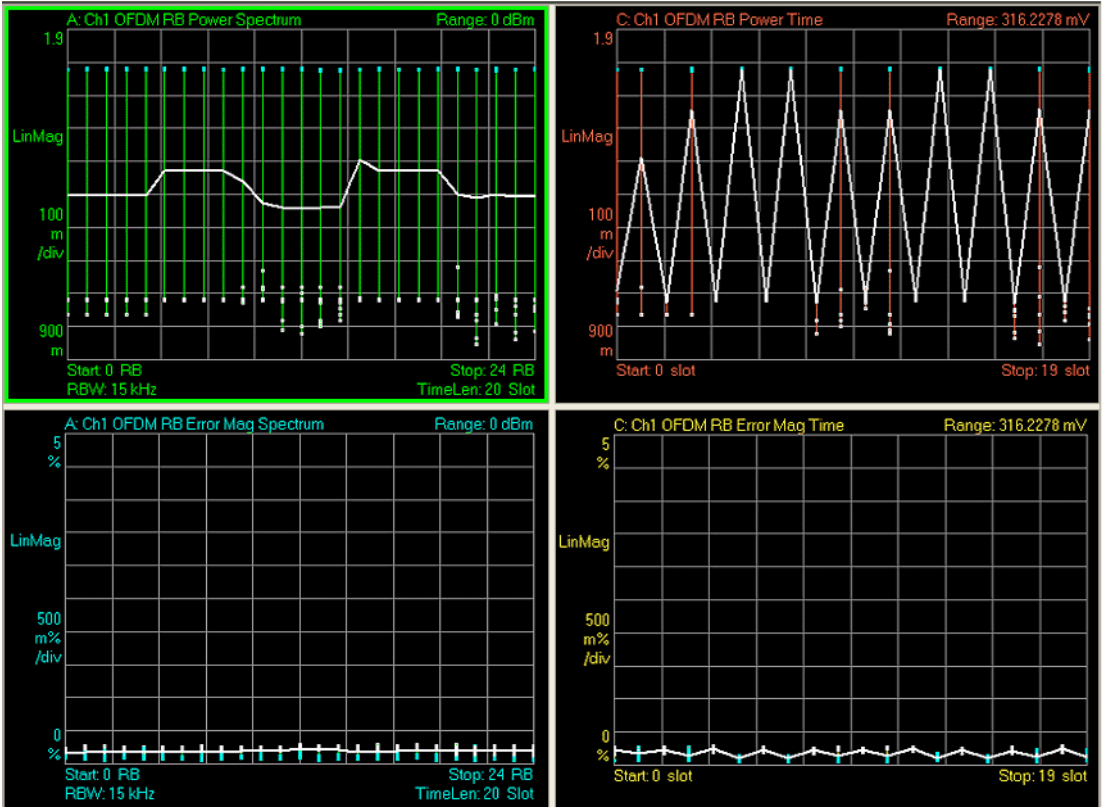

Preset View: Subcarrier Meas

This preset view consists of the following traces in a Grid 2x2 layout:

- Error Vector Spectrum
- IQ Meas (Log Mag)
- Error Vector Time
- IQ Meas Time (Log Mag)

This layout provides the details on the Power and EVM results.

The Preset View: Subcarrier Meas softkey performs the immediate action of changing the layout and view to this configuration. Preset View is an action, not a state.

Key Path	View/Display, More
Mode	LTE, LTETDD
Remote Command	:DISPlay:EVM:VIEW:PRESet SUBCarrier
Example	DISP:EVM:VIEW:PRE SUBC
Initial S/W Revision	Prior to A.02.00
Modified at S/W Revision	A.03.00

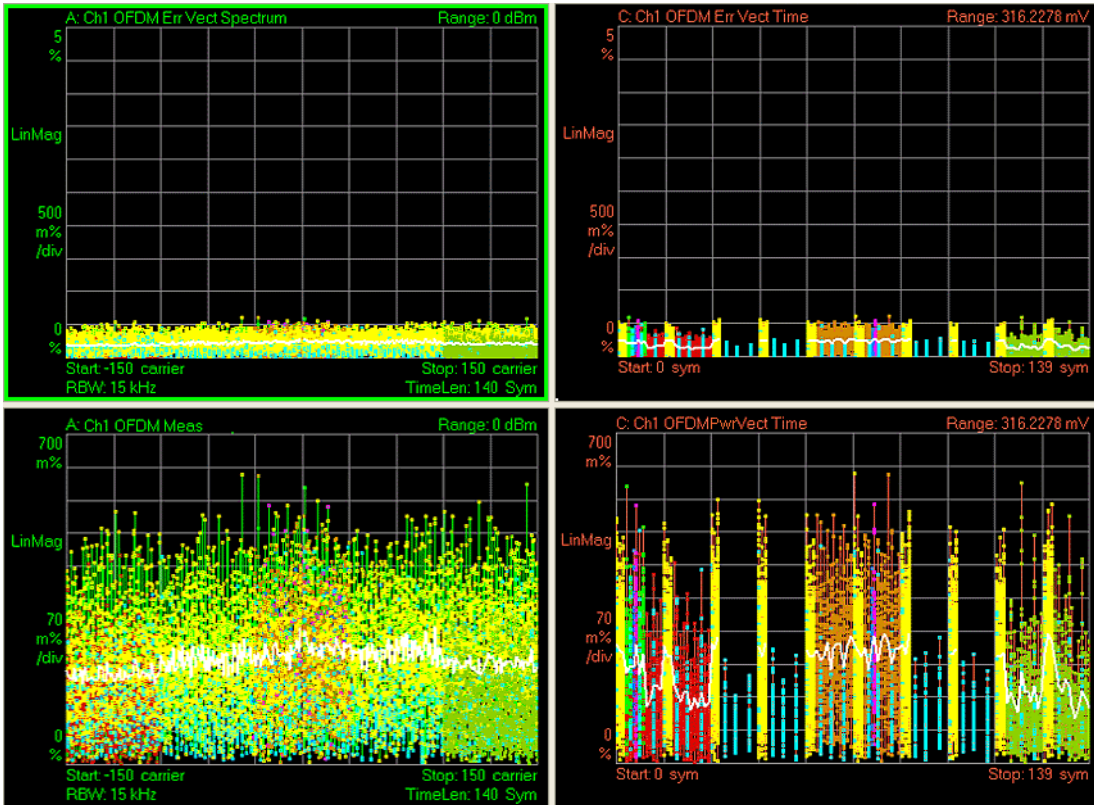

Preset View: MIMO Summary

This preset view consists of the following traces in a Stacked layout:

- MIMO Info Table
- Chan Freq Resp

This layout provides the details on the MIMO results.

The Preset View: MIMO Summary softkey performs the immediate action of changing the layout and view to this configuration. Preset View is an action, not a state.

Key Path	View/Display, More
Mode	LTE, LTETDD
Remote Command	:DISPlay:EVM:VIEW:PRESet MIMO
Example	DISP:EVM:VIEW:PRE MIMO
Dependencies	Available only when Direction is Downlink.
Initial S/W Revision	Prior to A.02.00
Modified at S/W Revision	A.03.00

Preset View

This command displays Preset Views that provide a set of trace data displays designed to help accomplish a specific measurement objective. The details of each Preset View are provided in the Help for the individual views.

Key Path	(SCPI only)
Mode	LTE, LTETDD
Remote Command	:DISPlay:EVM:VIEW:PRESet BASic SUMMary RBSLot SUBCarrier MIMO
Example	DISP:EVM:VIEW:PRES BAS
Preset	BASic
Initial S/W Revision	Prior to A.02.00
Modified at S/W Revision	A.03.00

Preset View: Basic

This preset view consists of the following traces in a Grid 2x2 layout:

- IQ Meas
- Spectrum
- Error Vector Spectrum
- Error Summary

This layout is set by Meas Preset and is good for insuring that the signal is being demodulated correctly, as well as showing many basic demodulation setup problems.

The Preset View: Basic softkey performs the immediate action of changing the layout and view to this configuration. Preset View is an action, not a state.

Key Path	View/Display
Mode	LTE, LTETDD
Remote Command	:DISPlay:EVM:VIEW:PRESet BASic
Example	DISP:EVM:VIEW:PRES BAS
Initial S/W Revision	Prior to A.02.00
Modified at S/W Revision	A.03.00

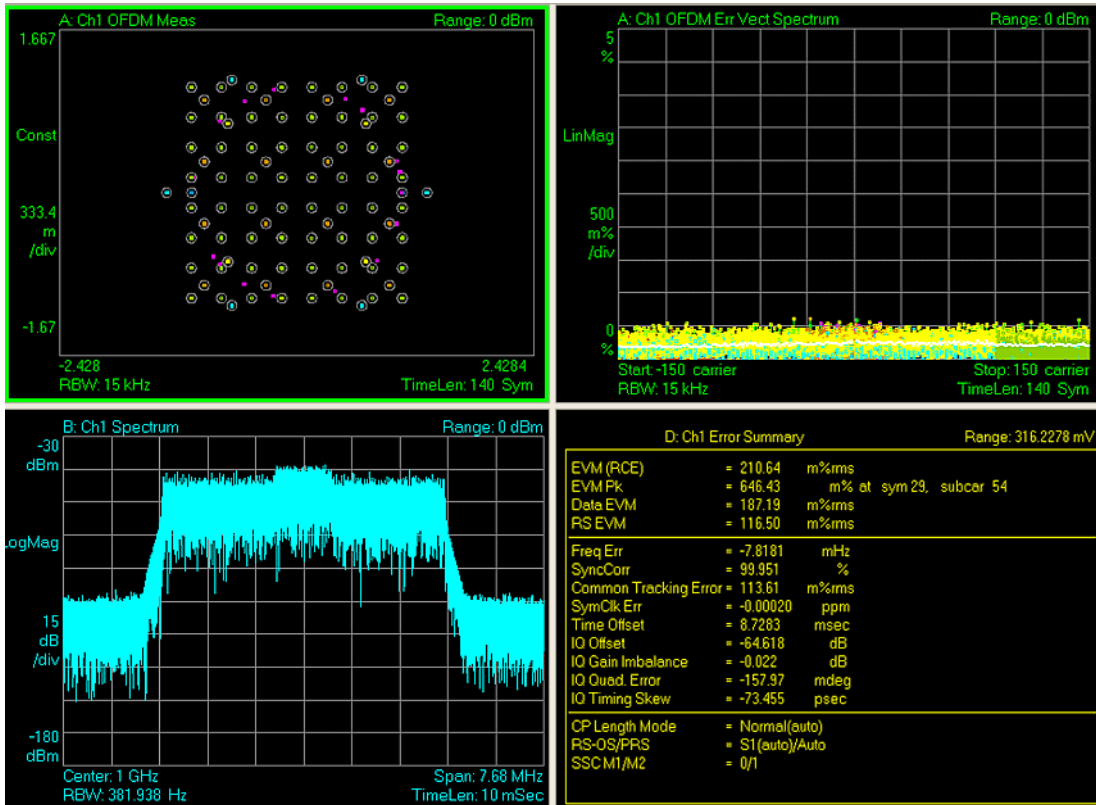

Preset View: Meas Summary

This preset view consists of the following traces in a Stacked layout:

- Error Summary
- Frame Summary

This layout provides the full list of the composite result metrics and characteristics of each of the logical channels.

The Preset View: Meas Summary softkey performs the immediate action of changing the layout and view to this configuration. Preset View is an action, not a state.

Key Path	View/Display
Mode	LTE, LTETDD
Remote Command	:DISPlay:EVM:VIEW:PRESet SUMMARY
Example	DISP:EVM:VIEW:PRES SUMM
Initial S/W Revision	Prior to A.02.00
Modified at S/W Revision	A.03.00

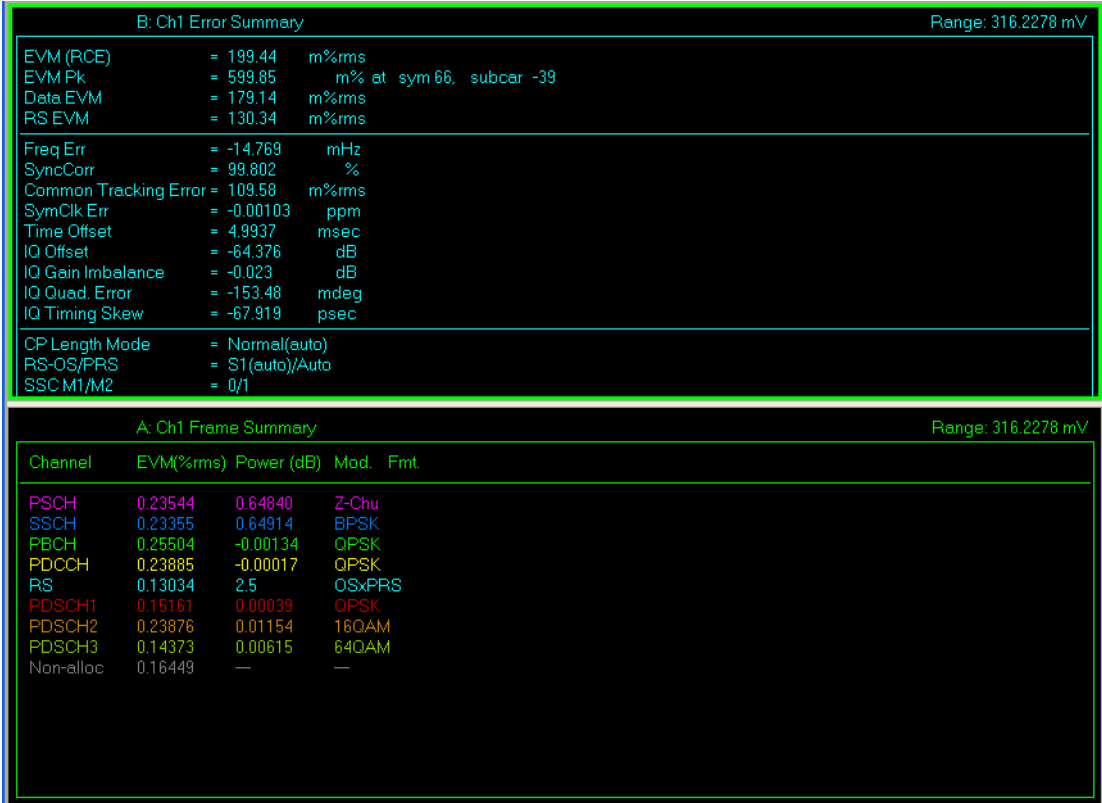

Preset View: RB Slot Meas

This preset view consists of the following traces in a Grid 2x2 layout:

- RB Power vs Spectrum
- RB Error Mag Spectrum
- RB Power vs Time
- RB Error Mag Time

This layout provides the details on the Resource Block.

The Preset View: RB Slot Meas softkey performs the immediate action of changing the layout and view to this configuration. Preset View is an action, not a state.

Key Path	View/Display
Mode	LTE, LTE-TDD
Remote Command	:DISPlay:EVM:VIEW:PRESet RBSlot
Example	DISP:EVM:VIEW:PRESet RBSlot
Initial S/W Revision	Prior to A.02.00
Modified at S/W Revision	A.03.00

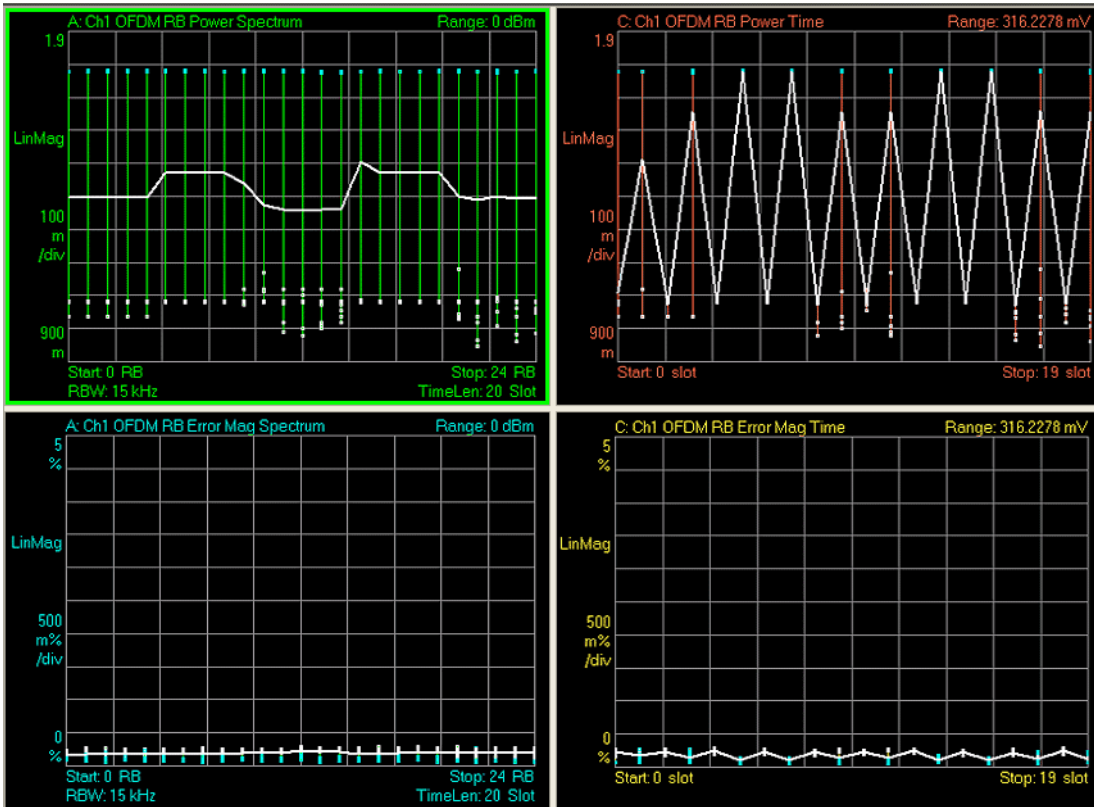

Preset View: Subcarrier Meas

This preset view consists of the following traces in a Grid 2x2 layout:

- Error Vector Spectrum
- IQ Meas (Log Mag)
- Error Vector Time
- IQ Meas Time (Log Mag)

This layout provides the details on the Power and EVM results.

The Preset View: Subcarrier Meas softkey performs the immediate action of changing the layout and view to this configuration. Preset View is an action, not a state.

Key Path	View/Display, More
Mode	LTE, LTETDD
Remote Command	:DISPlay:EVM:VIEW:PRESet SUBCarrier
Example	DISP:EVM:VIEW:PRES SUBC
Initial S/W Revision	Prior to A.02.00
Modified at S/W Revision	A.03.00

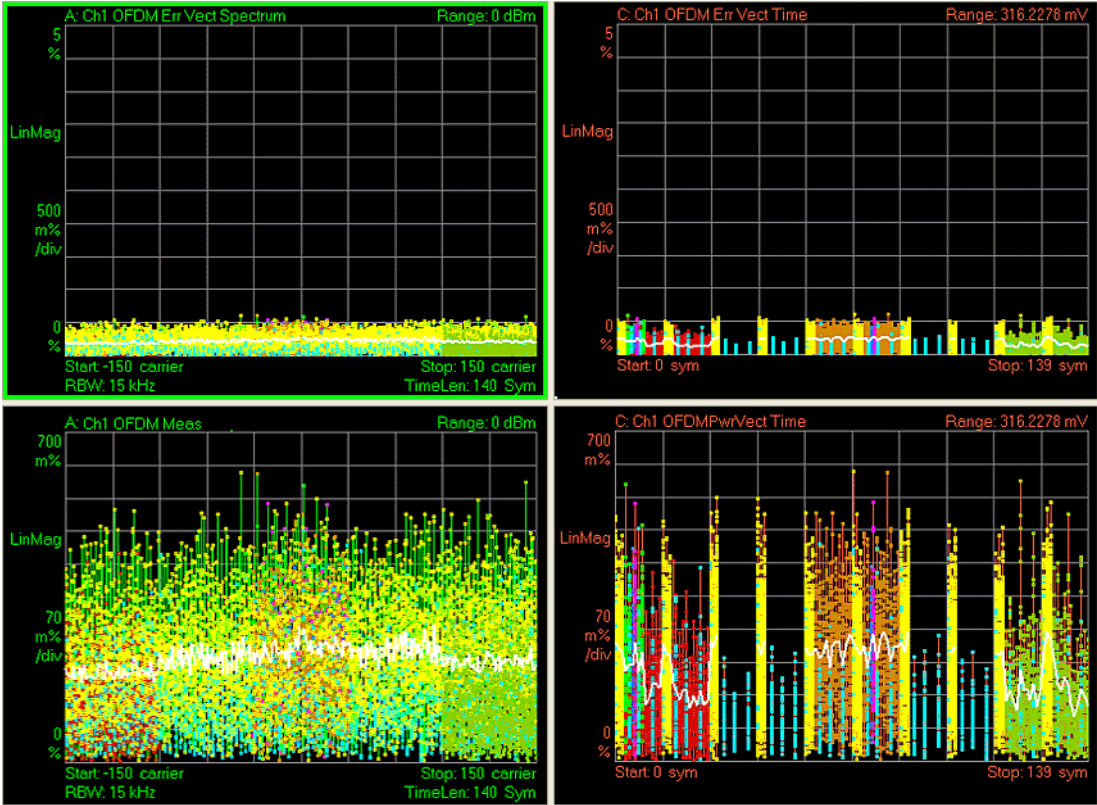

Preset View: MIMO Summary

This preset view consists of the following traces in a Stacked layout:

- MIMO Info Table
- Chan Freq Resp

This layout provides the details on the MIMO results.

The Preset View: MIMO Summary softkey performs the immediate action of changing the layout and view to this configuration. Preset View is an action, not a state.

Key Path	View/Display, More
Mode	LTE, LTETDD
Remote Command	:DISPlay:EVM:VIEW:PRESet MIMO
Example	DISP:EVM:VIEW:PRES MIMO
Dependencies	Available only when Direction is Downlink.
Initial S/W Revision	Prior to A.02.00
Modified at S/W Revision	A.03.00

16 Monitor Spectrum Measurement

The monitor spectrum measurement is used as a quick, convenient means of looking at the entire spectrum. While the look and feel are similar to the Spectrum Analyzer mode, the functionality is greatly reduced for easy operation. The main purpose of the measurement is to show the spectrum. The default span should cover an appropriate frequency range of the application.

For measurement results and views, see ["View/Display" on page 2541](#).

This topic contains the following sections:

["Measurement Commands for Monitor Spectrum" on page 2376](#)

["Remote Command Results for Monitor Spectrum Measurement" on page 2377](#)

Measurement Commands for Monitor Spectrum

The following commands can be used to retrieve the measurement results:

`:CONFigure:MONitor`

`:CONFigure:MONitor:NDEFault`

`:INITiate:MONitor`

`:FETCh:MONitor[n]?`

`:READ:MONitor[n]?`

`:MEASure:MONitor[n]?`

For more measurement related commands, see the SENSE subsystem, and the section "[Remote Measurement Functions](#)" on page 2770.

Remote Command Results for Monitor Spectrum Measurement

The following table describes the results returned by the queries listed above, according to the index value n .

n	Results Returned
1 (or not specified)	Returns trace1 data with comma separated floating numbers
2	Returns trace2 data with comma separated floating numbers
3	Returns trace3 data with comma separated floating numbers

Key Path	Meas
Initial S/W Revision	Prior to A.02.00

AMPTD Y Scale

Accesses a menu of functions that enable you to set the vertical scale parameters. These functions control how data on the vertical (Y) axis is displayed and control instrument settings that affect the vertical axis.

Key Path	Front-panel key
Initial S/W Revision	Prior to A.02.00

Ref Value

Sets the absolute power reference value. However, since Auto Scaling defaults to On, this value is automatically determined by the measurement result. When you set a value manually, Auto Scaling automatically changes to Off.

Key Path	AMPTD Y Scale
Mode	All except SA and BASIC
Remote Command	:DISPlay:MONitor:VIEW[1]:WINDow[1]:TRACe:Y[:SCALe]:RLEVel <real> :DISPlay:MONitor:VIEW[1]:WINDow[1]:TRACe:Y[:SCALe]:RLEVel?
Example	DISP:MON:VIEW:WIND:TRAC:Y:RLEV 2.0 DISP:MON:VIEW:WIND:TRAC:Y:RLEV?
Couplings	When the Auto Scaling is On, this value is automatically determined by the measurement result. When you set a value manually, Auto Scaling automatically changes to Off.
Preset	10.00 dBm
State Saved	Saved in instrument state.
Min	-250.00 dBm
Max	250.00 dBm
Initial S/W Revision	Prior to A.02.00

Attenuation

This menu controls the attenuator functions and interactions between the attenuation system components.

There are two attenuator configurations in the X-Series. One is a dual attenuator configuration consisting of a mechanical attenuator and an optional electronic attenuator. The other configuration uses a single attenuator with combined mechanical and electronic sections that controls all the attenuation functions. Different models in the X-Series come with different configurations.

See ["Dual Attenuator Configurations:" on page 2379](#)

See ["Single Attenuator Configuration:" on page 2379](#)

Most Attenuation settings are the same for all measurements – they do not change as you change measurements. Settings like these are called “Meas Global” and are unaffected by Meas Preset.

Key Path	AMPTD Y Scale
Scope	Meas Global
Dependencies	In measurements that support the I/Q inputs, this key is unavailable when I/Q is the selected input, and is replaced by the Range key in that case.
Readback Line	Contains a summary in [] brackets of the current total attenuation. See the descriptions of the , " (Mech) Atten " on page 2736, and " Enable Elec Atten " on page 2737 keys for more detail on the contributors to the total attenuation. Note that when "Pre-Adjust for Min Clip" is on, this value can change at the start of every measurement.
Initial S/W Revision	Prior to A.02.00
Modified at S/W Revision	A.03.00

Dual Attenuator Configurations:

Configuration 1: Mechanical attenuator + optional electronic attenuator

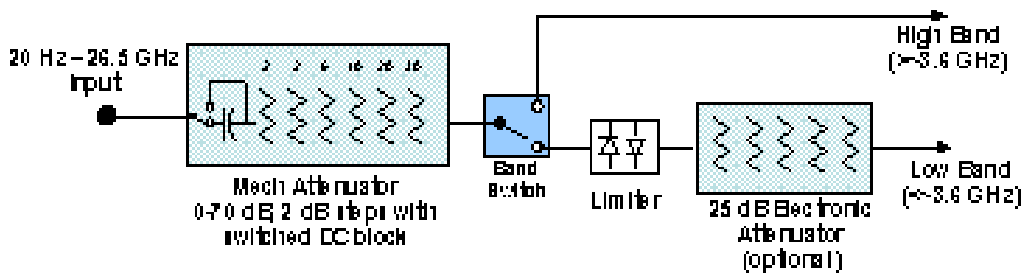

Configuration 2: Mechanical attenuator, no optional electronic attenuator

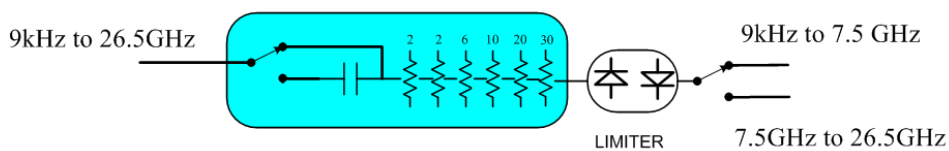

(note that Configuration 2 is not strictly speaking a dual-section attenuator, since there is no electronic section available. However, it behaves exactly like Configuration 1 without the Electronic Attenuator option EA3, therefore for the sake of this document it is grouped into the "Dual Attenuator" configuration)

Single Attenuator Configuration:

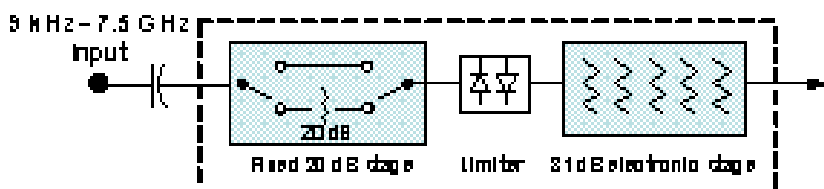

You can tell which attenuator configuration you have by pressing the Attenuation key, which (in most Modes) opens the Attenuation menu. If the first key in the Attenuation menu says Mech Atten you have the dual attenuator configuration. If the first key says Atten you have the single attenuator configuration.

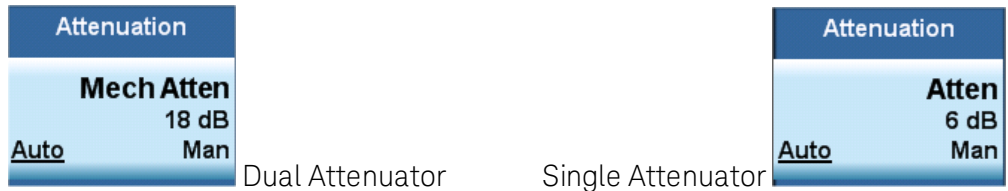

In the single attenuator configuration, you control the attenuation with a single control, as the fixed stage has only two states. In the dual attenuator configuration, both stages have significant range so you are given separate control of the mechanical and electronic attenuator stages.

When you have the dual attenuator configuration, you may still have only a single attenuator, because unless option EA3 (the Electronic Attenuator option) is available, and you purchase it, you will have only the mechanical attenuator.

(Mech) Atten

This key is labeled Mech Atten in dual attenuator models and Atten in single attenuator models. In the dual attenuator configuration, this key only affects the mechanical attenuator.

This key lets you modify the attenuation applied to the RF input signal path. This value is normally auto coupled to the Ref Level, the Internal Preamp Gain, any External Gain that is entered, and the Max Mixer Level, as described in the table below.

See "[Attenuator Configurations and Auto/Man](#)" on page 2381

Key Path	AMPTD Y Scale, Attenuation
Remote Command	[:SENSe]:POWer[:RF]:ATTenuation <rel_ampl> [:SENSe]:POWer[:RF]:ATTenuation? [:SENSe]:POWer[:RF]:ATTenuation:AUTO OFF ON 0 1 [:SENSe]:POWer[:RF]:ATTenuation:AUTO?
Example	POW:ATT 20 Dual attenuator configuration: sets the mechanical attenuator to 20 dB Single attenuator mode: sets the main attenuation to 20 dB (see below for definition of "main" attenuation). If the attenuator was in Auto, it sets it to Manual.
Dependencies	Some measurements do not support the Auto setting of (Mech) Atten. In these measurements, the Auto/Man selection is not available, and the Auto/Man line on the key disappears. In dual attenuator configurations, when the electronic attenuator is enabled, the mechanical attenuator has no auto setting and the Auto/Man line on the key disappears. The state of Auto/Man is remembered and restored when the electronic attenuator is once again disabled. This is described in more detail in the " Enable Elec Atten " on page 2737 key description. See " Attenuator Configurations and Auto/Man " on page 2381 for more information on the Auto/Man functionality of Attenuation.
Couplings	

	<p>When (Mech) Atten is in Auto, it uses the following algorithm to determine a value: If the USB Preamp is connected to USB, use 0 dB. Otherwise, Atten = ReferenceLevel + PreAmpGain + ExternalGain – RefLevelOffset - MaxMixerLevel + IF Gain. Limit this value to be between 6 dB and the Max value. No value below 6 dB can ever be chosen by Auto. The resulting value is rounded up to the largest value possible given the attenuation step setting. That is, 50.01 dB would change to 60 dB (for a 10 dB attenuation step). The “IF Gain” term in the equation above is either 0 dB or +10 dB, depending on the settings of FFT IF Gain, Swept IF Gain, max Ref Level and the Auto/Man setting of Mech Atten. In External Mixing and BBIQ, where the Attenuator is not in the signal path, the Attenuator setting changes as described above when (Mech) Atten is in Auto, but no changes are made to the actual attenuator hardware setting until the input is changed back to the RF Input.</p>
Preset	<p>The preset for Mech Attenuation is “Auto.” The Auto value of attenuation is: CXA, EXA, MXA and PXA: 10 dB</p>
State Saved	<p>Saved in instrument state</p>
Min	<p>0 dB The attenuation set by this key cannot be decreased below 6 dB with the knob or step keys. To get to a value below 6 dB it has to be directly entered from the keypad or via SCPI. This protects from adjusting the attenuation to a dangerously small value which can put the instrument at risk of damage to input circuitry. However, if the current mechanical attenuation is below 6 dB it can be increased with the knob and step keys, but not decreased.</p>
Max	<p>CXA N9000A–503/507: 50 dB CXA N9000A–513/526: 70dB EXA: 60 dB MXA and PXA: 70 dB In the single attenuator configuration, the total of ATT and EATT cannot exceed 50 dB, so if the EATT is set to 24 dB first, the main attenuation cannot be greater than 26 dB and will be reduced accordingly; if the main attenuator is set to 40 dB first, EATT cannot be greater than 10 dB.</p>
Initial S/W Revision	<p>Prior to A.02.00</p>
Modified at S/W Revision	<p>A.03.00</p>

Attenuator Configurations and Auto/Man

As described in the Attenuation key description, there are two distinct attenuator configurations available in the X-Series, the single attenuator and dual attenuator configurations. In dual attenuator configurations, we have the mechanical attenuation and the electronic attenuation, and the current total attenuation is the sum of the electronic + mechanical attenuation. In single attenuator configurations, we refer to the attenuation set using the (Mech) Atten key (or POW:ATT SCPI) as the “main” attenuation; and the attenuation that is set by the SCPI command POW:EATT as the “soft” attenuation (the POW:EATT command is honored even in the single attenuator configuration, for compatibility purposes). Then the

current total attenuation is the sum of the main + soft attenuation. See the Elec Atten key description for more on “soft” attenuation.

In the dual attenuator configuration, when the electronic attenuator is enabled, there is no Auto/Man functionality for the mechanical attenuator, and the third line of the key label (the Auto/Man line) disappears:

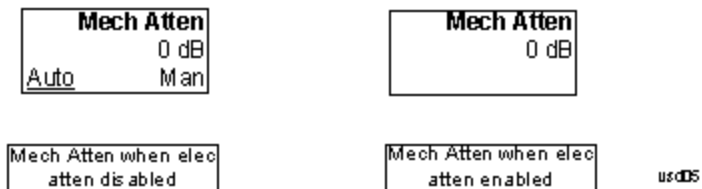

Enable Elec Atten

Enables the Electronic Attenuator.

The electronic attenuator offers finer steps than the mechanical attenuator, has no acoustical noise, is faster, and is less subject to wear. These advantages primarily aid in remote operation and are negligible for front panel use. See ["Using the Electronic Attenuator: Pros and Cons" on page 2384](#) for a detailed discussion of the pros and cons of using the electronic attenuator.

For the single attenuator configuration, for SCPI backwards compatibility, the “soft” attenuation feature replaces the dual attenuator configuration’s electronic attenuator. All the same couplings and limitations apply. See ["Attenuator Configurations and Auto/Man" on page 2737](#)

See ["More Information" on page 2383](#)

Key Path	AMPTD Y Scale, Attenuation
Remote Command	[:SENSE] :POWER [:RF] :EATTenuation :STATe OFF ON 0 1 [:SENSE] :POWER [:RF] :EATTenuation :STATe ?
Example	POW:EATT:STAT ON
Dependencies	<p>This key only appears in Dual Attenuator models with an Electronic Attenuator installed. It does not appear in models with the Single Attenuator configuration, as in the single attenuator configuration there is no “electronic attenuator” there is only a single integrated attenuator (which has both a mechanical and electronic stage). However, in the single attenuator configuration, EATT SCPI commands are accepted for compatibility with other X-series instruments and set a “soft” attenuation as described in "Attenuator Configurations and Auto/Man" on page 2737.</p> <p>The electronic attenuator (and the “soft” attenuation function provided in single attenuator configurations) is unavailable above 3.6 GHz. Therefore, if the Stop Frequency of the analyzer is > 3.6 GHz then the Enable Elec Atten key will be OFF and grayed out.</p> <p>If the Internal Preamp is on, meaning it is set to Low Band or Full, the electronic attenuator (and the “soft” attenuation function provided in single attenuator configurations) is unavailable. In this case the Enable Elec Atten key will be OFF and grayed out.</p> <p>If either of the above is true, if the SCPI command is sent, an error indicating that the electronic attenuator is unavailable will be sent.</p> <p>If the electronic/soft Attenuator is enabled, then the Stop Freq of the analyzer is limited to 3.6 GHz and the Internal Preamp is unavailable.</p> <p>The SCPI-only “soft” electronic attenuation for the single-attenuator configuration is not available in</p>

	all measurements; in particular, it is not available in the Swept SA measurement.
Couplings	Enabling and disabling the Electronic Attenuator affects the setting of the Mechanical Attenuator (in dual attenuator configurations). This is described in more detail below this table.
Preset	OFF for Swept SA measurement; ON for all other measurements that support the electronic attenuator
State Saved	Saved in instrument state
Initial S/W Revision	Prior to A.02.00
Modified at S/W Revision	A.03.00

More Information

Mechanical Attenuator Transition Rules

When the Electronic Attenuator is enabled, the Mechanical Attenuator transitions to a state that has no Auto function. Below are the rules for transitioning the Mechanical Attenuator. NOTE that the information below ONLY applies to the dual attenuator configurations, and ONLY when the Electronic Attenuator is installed:

When the Electronic Attenuation is enabled from a disabled state:

- The Mechanical Attenuator is initialized to 10 dB (this is its optimal performance setting). You can then set it as desired with SCPI, numeric keypad, step keys, or knob, and it behaves as it normally would in manual mode
- The Auto/Man state of (Mech) Atten is saved
- The Auto/Man line on the (Mech) Atten key disappears and the auto rules are disabled
- The Electronic Attenuator is set to 10 dB less than the previous value of the Mechanical Attenuator, within the limitation that it must stay within the range of 0 to 24 dB of attenuation.

Examples in the dual attenuator configuration:

- Mech Atten at 20 dB. Elec Atten enabled, Mech Atten set to 10 dB, and Elec Atten set to 10 dB. New total attenuation equals the value before Elec Atten enabled.
- Mech Atten at 0 dB. Elec Atten enabled, Mech Atten set to 10 dB, and Elec Atten set to 0 dB. New total attenuation does not equal the value before Elec Atten enabled.
- Mech Atten at 40 dB. Elec Atten enabled, Mech Atten set to 10 dB, and Elec Atten set to 24 dB. New total attenuation does not equal the value before Elec Atten enabled.

When the Electronic Attenuation is disabled from an enabled state:

- The Elec Atten key is grayed out
- The Auto/Man state of (Mech) Atten is restored
- If now in Auto, (Mech) Atten recouples

- If now in Man, (Mech) Atten is set to the value of total attenuation that existed before the Elec Atten was disabled. The resulting value is rounded up to the smallest value possible given the (Mech) Atten Step setting - (That is, 57 dB changes to 58 dB when (Mech) Atten Step is 2 dB.)

Using the Electronic Attenuator: Pros and Cons

The electronic attenuator offers finer steps than the mechanical attenuator, has no acoustical noise, is faster, and is less subject to wear.

The “finer steps” advantage of the electronic attenuator is beneficial in optimizing the alignment of the analyzer dynamic range to the signal power in the front panel as well as remote use. Thus, you can achieve improved relative signal measurement accuracy. Compared to a mechanical attenuator with 2 dB steps, the 1 dB resolution of the electronic attenuator only gives better resolution when the odd-decibel steps are used. Those odd-decibel steps are less accurately calibrated than the even-decibel steps, so one tradeoff for this superior relative accuracy is reduced absolute amplitude accuracy.

Another disadvantage of the electronic attenuator is that the spectrum analyzer loses its “Auto” setting, making operation less convenient.

Also, the relationship between the dynamic range specifications (TOI, SHI, compression and noise) and instrument performance are less well-known with the electrical attenuator. With the mechanical attenuator, TOI, SHI and compression threshold levels increase dB-for-dB with increasing attenuation, and the noise floor does as well. With the electronic attenuator, there is an excess attenuation of about 1 to 3 dB between 0 and 3.6 GHz, making the effective TOI, SHI, and so forth, less well known. Excess attenuation is the actual attenuation relative to stated attenuation. Excess attenuation is accounted for in the analyzer calibration

Elec Atten

Controls the Electronic Attenuator in dual attenuator configurations. This key does not appear in single attenuator configurations, as the control of both the mechanical and electronic stages of the single attenuator is integrated into the single Atten key.

Key Path	AMPTD Y Scale, Attenuation
Remote Command	<code>[:SENSe] :POWer [:RF] :EATTenuation <rel_amp1></code> <code>[:SENSe] :POWer [:RF] :EATTenuation?</code>
Notes	Electronic Attenuation's specification is defined only when Mechanical Attenuation is 6 dB.
Dependencies	This key only appears in Dual Attenuator models with an Electronic Attenuator installed. It does not appear in models with the Single Attenuator configuration, as in the single attenuator configuration there is no “electronic attenuator” there is only a single integrated attenuator (which has both a mechanical and electronic stage). However, in the single attenuator configuration, EATT SCPI commands are accepted for compatibility with other X-series instruments and set a “soft” attenuation as described in "Attenuator Configurations and Auto/Man" on page 2737 . The “soft” attenuation is treated as an addition to the “main” attenuation value set by the Atten softkey or the POW:ATT SCPI command and affects the total attenuation displayed on the Attenuation key and the Meas Bar. When Enable Elec Atten is off or grayed out, the Elec Atten key is grayed out.
Preset	0 dB
State Saved	Saved in instrument state

Min	0 dB
Max	Dual attenuator configuration: 24 dB Single attenuator configuration: the total of ATT and EATT cannot exceed 50 dB, so if the EATT is set to 24 dB first, the main attenuation cannot be greater than 26 dB and will be reduced accordingly; if the main attenuator is set to 40 dB first, EATT cannot be greater than 10 dB
Initial S/W Revision	Prior to A.02.00
Modified at S/W Revision	A.03.00

Adjust Atten for Min Clip

Sets the combination of mechanical and electronic attenuation and gain based on the current measured signal level so that clipping will be at a minimum.

This is an "immediate action" function, that is, it executes once, when the key is pressed.

This key is grayed out in measurements that do not support this functionality. The spectrum analyzer measurement, Swept SA, does not support this functionality.

Key Path	AMPTD Y Scale, Attenuation
Remote Command	<code>[:SENSe] :POWer [:RF] :RANGe:OPTimize IMMEDIATE</code>
Initial S/W Revision	Prior to A.02.00
Modified at S/W Revision	A.03.00

Pre-Adjust for Min Clip

If this function is on, it does the adjustment described under "[Adjust Atten for Min Clip](#)" on page 2740 each time a measurement restarts. Therefore, in Continuous measurement mode, it only executes before the first measurement.

In dual attenuator models, you can set Elec+Mech Atten, in which case both attenuators participate in the autoranging, or Elec Atten Only, in which case the mechanical attenuator does not participate in the autoranging. This latter case results in less wear on the mechanical attenuator and is usually faster.

This key is grayed out in measurements that do not support this functionality. The spectrum analyzer measurement, Swept SA, does not support this functionality.

Key Path	AMPTD Y Scale, Attenuation
Remote Command	<code>[:SENSe] :POWer [:RF] :RANGe:OPTimize:ATTenuation OFF ELECTrical COMBined</code> <code>[:SENSe] :POWer [:RF] :RANGe:OPTimize:ATTenuation?</code>
Notes	The SCPI parameter ELECTrical sets this function to On in single attenuator models. The SCPI parameter COMBined is mapped to ELECTrical in single attenuator models; if you send COMBined, it sets the function to On and returns ELEC to a query.
Dependencies	This key only appears in Dual Attenuator models with an Electronic Attenuator installed.

	In instruments with Dual Attenuator model, when Enable Elec Atten is off or grayed out, the Pre-Adjust for Min Clip key is grayed out.
Preset	OFF for Swept SA measurement; ON for all other measurements that support Pre-Adjust for Min Clip
State Saved	Saved in instrument state
Range	Dual attenuator models: Off Elec Atten Only Mech + Elec Atten Single attenuator models: Off On
Initial S/W Revision	Prior to A.02.00
Modified at S/W Revision	A.03.00

Remote Command	<code>[:SENSe] :POWer [:RF] :RANGe :AUTO ON OFF 1 0</code> <code>[:SENSe] :POWer [:RF] :RANGe :AUTO?</code>
Notes	ON aliases to "Elec Atten Only" (:POW:RANG:OPT:ATT ELEC) OFF aliases to "Off" (:POW:RANG:OPT:ATT OFF) The query :POW:RANG:AUTO? returns true if :POW:RANG:OPT:ATT is not "Off"
Initial S/W Revision	Prior to A.02.00

Off

Turns Pre-Adjust for Min Clip off. This is the default setting.

This key is grayed out in measurements that do not support this functionality. The spectrum analyzer measurement, Swept SA, does not support this functionality.

Key Path	AMPTD Y Scale, Attenuation, Pre-Adjust for Min Clip
Example	:POW:RANGe:OPT:ATT OFF
Initial S/W Revision	Prior to A.02.00

Elec Atten Only

Selects only the electric attenuator to participate in auto ranging. This offers less wear on the mechanical attenuator and is usually faster.

This key is grayed out in measurements that do not support this functionality. The spectrum analyzer measurement, Swept SA, does not support this functionality.

Key Path	AMPTD Y Scale, Attenuation, Pre-Adjust for Min Clip
Example	:POW:RANGe:OPT:ATT ELEC
Initial S/W Revision	Prior to A.02.00

Mech + Elec Atten

In dual attenuator models, this selects both attenuators participate in the autoranging.

This key is grayed out in measurements that do not support this functionality. The spectrum analyzer measurement, Swept SA, does not support this functionality.

Key Path	AMPTD Y Scale, Attenuation, Pre-Adjust for Min Clip
Example	:POW:RANGe:OPT:ATT COMB
Initial S/W Revision	Prior to A.02.00

(Mech) Atten Step

This controls the step size used when making adjustments to the input attenuation.

This key is labeled Mech Atten Step in dual attenuator models and Atten Step in single attenuator models. In the dual attenuator configuration, this key only affects the step size of the mechanical attenuator.

Key Path	AMPTD Y Scale, Attenuation
Remote Command	<code>[:SENSe] :POWer [:RF] :ATTenuation :STEP [:INCRement] 10 dB 2 dB</code> <code>[:SENSe] :POWer [:RF] :ATTenuation :STEP [:INCRement] ?</code>
Example	POW:ATT:STEP 2
Notes	Note this feature works like a 1-N choice from the front panel, but it takes a specific value (in dB) when used remotely. The only valid values are 2 and 10.
Dependencies	Blanked in CXA and EXA if option FSA (2 dB steps) is not present. If blanked, attempts to set it via SCPI will yield an error.
Couplings	When the attenuation step size changes, the current mechanical attenuation value is adjusted (if necessary) to be quantized to the new step size. That is, if step is set to 10 dB, mech atten is increased if necessary so it is a multiple of 10 dB
Preset	PXA and MXA: 2 dB EXA and CXA: 10 dB (2 dB with option FSA)
State Saved	Saved in instrument state
Initial S/W Revision	Prior to A.02.00
Modified at S/W Revision	A.03.00

Scale/Div

Sets the logarithmic units per vertical graticule division on the display. However, since the Auto Scaling defaults to On, this value is automatically determined by the measurement result. When you set a value manually, Auto Scaling automatically changes to Off.

Key Path	AMPTD Y Scale
Mode	All except SA and BASIC
Remote Command	:DISPlay:MONitor:VIEW[1]:WINDow[1]:TRACe:Y[:SCALe]:PDIVision <rel_ampl> :DISPlay:MONitor:VIEW[1]:WINDow[1]:TRACe:Y[:SCALe]:PDIVision?
Example	DISP:MON:VIEW:WIND:TRAC:Y:PDIV 5.0 dB DISP:MON:VIEW:WIND:TRAC:Y:PDIV?
Couplings	When the Auto Scaling is On, this value is automatically determined by the measurement result. When you set a value manually, Auto Scaling automatically changes to Off.
Preset	10.00 dB
State Saved	Saved in instrument state.
Min	0.10 dB
Max	20.00 dB
Initial S/W Revision	Prior to A.02.00

Presel Center

When this key is pressed, the centering of the preselector filter is adjusted to optimize the amplitude accuracy at the frequency of the selected marker. If the selected marker is not on when Presel Center is pressed, the analyzer will turn on the selected marker, perform a peak search, and then perform centering on the marker's center frequency. If the selected marker is already on and between the start and stop frequencies of the analyzer, the analyzer performs the preselector calibration on that marker's frequency. If the selected marker is already on, but outside the frequency range between Start Freq and Stop Freq, the analyzer will first perform a peak search, and then perform centering on the marker's center frequency.

The value displayed on the Presel Adjust key will change to reflect the new preselector tuning (see Presel Adjust).

A number of considerations should be observed to ensure proper operation. See ["Proper Preselector Operation" on page 2389](#).

Key Path	AMPTD Y Scale
Remote Command	[:SENSe]:POWer[:RF]:PCENter
Example	POW:PCEN
Notes	Note that the rules outlined above under the key description apply for the remote command as well as the key. The result of the command is dependent on marker position, and so forth. Any message shown by the key press is also shown in response to the remote command.
Dependencies	<ul style="list-style-type: none"> • Grayed out if the microwave preselector is off.) • If the selected marker's frequency is below Band 1, advisory message 0.5001 is generated and no action is taken. • Grayed out if entirely in Band 0. • Blank in models that do not include a preselector, such as option 503. If the SCPI is sent in these instruments, it is accepted without error, and the query always returns 0.

- Grayed out in the Spectrogram View.

Couplings	The active marker position determines where the centering will be attempted. If the analyzer is in a measurement such as averaging when centering is initiated, the act of centering the preselector will restart averaging but the first average trace will not be taken until the centering is completed.
Status Bits/OPC dependencies	When centering the preselector, *OPC will not return true until the process is complete and a subsequent measurement has completed, nor will results be returned to a READ or MEASURE command. The Measuring bit should remain set while this command is operating and should not go false until the subsequent sweep/measurement has completed.
Initial S/W Revision	Prior to A.02.00
Modified at S/W Revision	A.03.00

Proper Preselector Operation

A number of considerations should be observed to ensure proper operation:

1. If the selected marker is off, the analyzer will turn on a marker, perform a peak search, and adjust the preselector using the selected marker's frequency. It uses the "highest peak" peak search method unqualified by threshold or excursion, so that there is no chance of a 'no peak found' error. It continues with that peak, even if it is the peak of just noise. Therefore, for this operation to work properly, there should be a signal on screen in a preselected range for the peak search to find.
2. If the selected marker is already on, the analyzer will attempt the centering at that marker's frequency. There is no preselector for signals below about 3.6 GHz, therefore if the marker is on a signal below 3.6 GHz, no centering will be attempted and an advisory message generated
3. In some models, the preselector can be bypassed. If it is bypassed, no centering will be attempted in that range and a message will be generated.

Preselector Adjust

Allows you to manually adjust the preselector filter frequency to optimize its response to the signal of interest. This function is only available when "Presel Center" on page 2743 is available.

For general purpose signal analysis, using Presel Center is recommended. Centering the filter minimizes the impact of long-term preselector drift. Presel Adjust can be used instead to manually optimize the preselector. One application of manual optimization would be to peak the preselector response, which both optimizes the signal-to-noise ratio and minimizes amplitude variations due to small (short-term) preselector drifting.

Key Path	AMPTD Y Scale
Scope	Meas Global
Remote Command	<code>[:SENSe] :POWer [:RF] :PADJust <freq></code>

	<code>[:SENSe] :POWer [:RF] :PADJust ?</code>
Example	POW:PADJ 100KHz POW:PADJ?
Notes	The value on the key reads out to 0.1 MHz resolution.
Dependencies	<ul style="list-style-type: none"> • Grayed out if microwave preselector is off.) • Grayed out if entirely in Band 0. • Blank in models that do not include a preselector, such as option 503. If the SCPI is sent in these instruments, it is accepted without error, and the query always returns 0. • Grayed out in the Spectrogram View.
Preset	0 MHz
State Saved	The Presel Adjust value set by Presel Center, or by manually adjusting Presel Adjust, is not saved in instrument state, and does not survive a Preset or power cycle.
Min	-500 MHz
Max	500 MHz
Default Unit	Hz
Backwards Compatibility SCPI	<code>[:SENSe] :POWer [:RF] :MW :PADJust</code> <code>[:SENSe] :POWer [:RF] :MMW :PADJust</code> PSA had multiple preselectors, but the X-Series has only one. These commands simply alias to <code>[:SENSe] :POWer [:RF] :PADJust</code>
Initial S/W Revision	Prior to A.02.00
Modified at S/W Revision	A.03.00

Remote Command	<code>[:SENSe] :POWer [:RF] :PADJust :PRESelector MWAVE MMWave EXTernal</code> <code>[:SENSe] :POWer [:RF] :PADJust :PRESelector ?</code>
Notes	PSA had multiple preselectors, and you could select which preselector to adjust. Since the X-Series has only one mm/uW preselector, the preselector selection softkey is no longer available. However, to provide backward compatibility, we accept the legacy remote commands. The command form has no effect, the query always returns MWAVE
Initial S/W Revision	Prior to A.02.00

μW Path Control

The μW Path Control functions include the μW Preselector Bypass (Option MPB) and Low Noise Path (Option LNP) controls in the High Band path circuits.

When the μW Preselector is bypassed, the user has better flatness, but will be subject to spurs from out of band interfering signals. When the Low Noise Path is enabled, the analyzer automatically switches around

certain circuitry in the high frequency bands which can contribute to noise, when it is appropriate based on other analyzer settings.

For most applications, the preset state is Standard Path, which gives the best remote-control throughput, minimizes acoustic noise from switching and minimizes the risk of wear out in the hardware switches. For applications that utilize the wideband IF paths, the preset state is the μ W Preselector Bypass path, if option MPB is present. This is because, when using a wideband IF such as the 140 MHz IF, the μ W Preselector's bandwidth can be narrower than the available IF bandwidth, causing degraded amplitude flatness and phase linearity, so it is desirable to bypass the preselector in the default case.

Users may choose Low Noise Path Enable. It gives a lower noise floor, especially in the 21–26.5 GHz region, though without improving many measures of dynamic range, and without giving the best possible noise floor. The preamp, if purchased and used, gives better noise floor than does the Low Noise Path, however its compression threshold and third-order intercept are much poorer than that of the non-preamp Low Noise Path. There are some applications, typically for signals around –30 dBm, for which the third-order dynamic range of the standard path is good enough, but the noise floor is not low enough even with 0 dB input attenuation. When the third-order dynamic range of the preamp path is too little and the noise floor of the standard path is too high, the Low Noise Path can provide the best dynamic range.

Key Path	AMPTD Y Scale
Mode	SA, BASIC, PNOISE, VSA , LTE, LTETDD
Scope	Meas Global
Remote Command	[:SENSe] :POWer [:RF] :MW:PATH STD LNPath MPBypass FULL [:SENSe] :POWer [:RF] :MW:PATH?
Example	:POW:MW:PATH LNP Enables the Low Noise path
Notes	If a Presel Center is performed, the analyzer will momentarily switch to the Standard Path, regardless of the setting of μ W Path Control The DC Block will always be switched in when the low noise path is switched in, to protect succeeding circuitry from DC. Note that this does not mean “when the low noise path is enabled” but when, based on the Low Noise Path rules, the path is actually switched in. This can happen when the selection is Low Noise Path Enable . In the case where the DC Block is switched in the analyzer is now AC coupled. However, if the user has selected DC coupling, the UI will still behave as though it were DC coupled, including all annunciation, warnings, status bits, and responses to SCPI queries. This is because, based on other settings, the analyzer could switch out the low noise path at any time and hence go back to being DC coupled. Alignment switching ignores the settings in this menu, and restores them when finished.
Dependencies	Unavailable in BBIQ and External Mixing
Preset	All modes other than IQ Analyzer mode and VXA: STD IQ Analyzer, VXA and WLAN mode: MPB option present and licensed: MPB MPB option not present and licensed: STD
State Saved	Save in instrument state
Readback	Value selected in the submenu
Initial S/W Revision	A.04.00
Modified at S/W Revision	A.10.00

Standard Path

This path gives the best remote-control throughput, minimizes acoustic noise from switching and minimizes the risk of wear in the hardware switches, particularly in remote test scenarios where both low band and high band setups will follow in rapid succession.

In this path, the bypass of the low band/high band switch and microwave preamp is never activated, which can cause some noise degradation but preserves the life of the bypass switch.

Key Path	AMPTD Y Scale, μ W Path Control
Example	:POW:MW:PATH STD
Readback Text	Standard Path
Initial S/W Revision	A.04.00

Low Noise Path Enable

You may choose Low Noise Path Enable, which gives a lower noise floor under some circumstances, particularly when operating in the 21–26.5 GHz region. With the Low Noise Path enabled, the low band/high band switch and microwave preamp are bypassed whenever all of the following are true:

- The analyzer is not in the Low Band, meaning:
- the start frequency is above 3.5 GHz and
- the stop frequency is above 3.6 GHz.
- the internal preamp is not installed or (if installed) is set to Off or Low Band

Note that this means that, when any part of a sweep is done in Low Band, the Low Noise Path is not used, whether or not the Low Noise Path Enable is selected in the user interface. Also, if the preamp is turned on, the Low Noise Path is not used, whether or not the Low Noise Path Enable is selected in the user interface. The only time the Low Noise Path is used is when Low Noise Path Enable is selected, the sweep is completely in High Band (> 3.6 GHz) and no preamp is in use.

See "[More Information](#)" on page 2393

Key Path	AMPTD Y Scale, μ W Path Control
Measurement	Swept SA
Example	:POW:MW:PATH LNP
Notes	For measurements that use IQ acquisition, the low noise path is used when the Center Frequency is in High Band (> 3.6 GHz) and no preamp is in use. In other words, the rules above are modified to use only the center frequency to qualify which path to switch in. This is not the case for FFT's in the Swept SA measurement; they use the same rules as swept measurements.
Dependencies	Key is blanked if current mode does not support it. Key is grayed out if mode supports it but current measurement does not support it. Unless Option LNP is present and licensed, key is blank and if SCPI command sent, error -241,

"Hardware missing; Option not installed" is generated.

Readback Text Low Noise Path Enable

Initial S/W Revision A.04.00

More Information

The user should understand that the Low Noise Path, while giving improved DANL, has the disadvantage of decreased TOI performance and decreased gain compression performance relative to the standard path.

The user should also understand that the bypass switch is a mechanical switch and has finite life, so if the Low Noise Path is enabled, it is possible to cause frequent cycling of this switch by frequently changing analyzer settings such that the above conditions hold true only some of the time. A user making tests of this nature should consider opting for the Standard Path, which will never throw the bypass switch, at the expense of some degraded noise performance.

The low noise path is useful for situations where the signal level is so low that the analyzer performance is dominated by noise even with 0 dB attenuation, but still high enough that the preamp option would have excessive third-order intermodulation or compression. The preamp, if purchased and used, gives better noise floor than does the "Low Noise Path." However, its compression threshold and third-order intercept are much poorer than that of the non-preamp path. There are some applications, typically for signals around -30 dBm, for which the third-order dynamic range of the standard path is good enough, but the noise floor is not low enough even with 0 dB input attenuation. When the third-order dynamic range of the preamp path is too little and the noise floor of the standard path is too high, the Low Noise Path can provide the best dynamic range

The graph below illustrates the concept. It shows, in red, the performance of an analyzer at different attenuation settings, both with the preamp on and off, in a measurement that is affected by both analyzer noise and analyzer TOI. The green shows the best available dynamic range, offset by 0.5 dB for clarity. The blue shows how the best available dynamic range improves for moderate signal levels with the low noise path switched in. In this illustration, the preamp improves the noise floor by 15 dB while degrading the third-order intercept by 30 dB, and the low noise path reduces loss by 8 dB. The attenuator step size is 2 dB.

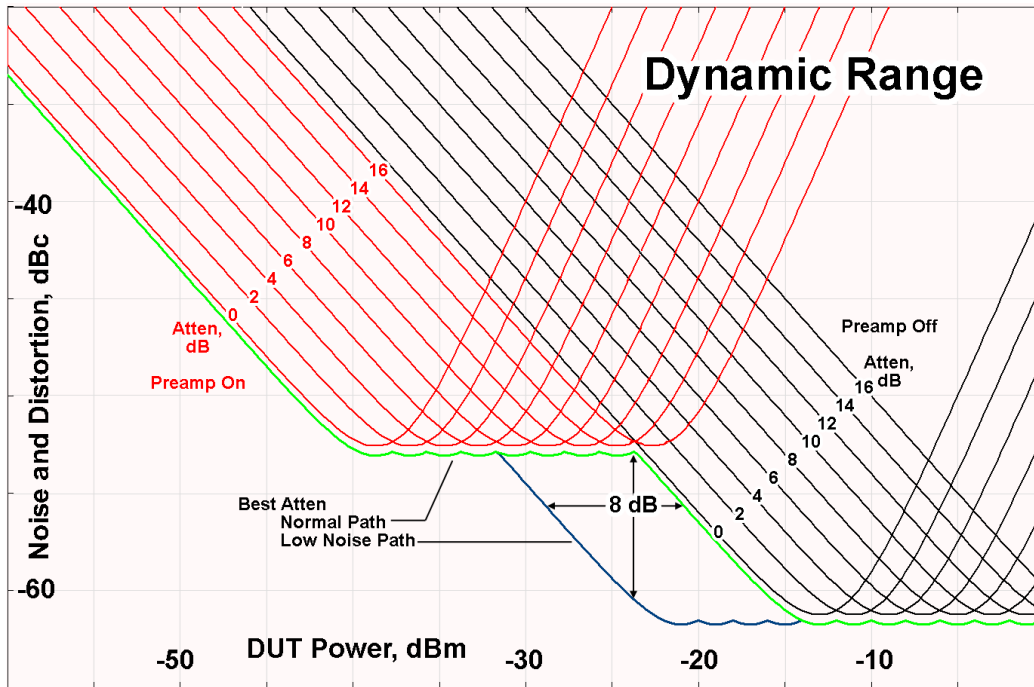

There are other times where selecting the low noise path improves performance, too. Compression-limited measurements such as finding the nulls in a pulsed-RF spectrum can profit from the low noise path in a way similar to the TOI-limited measurement illustrated. Accuracy can be improved when the low noise path allows the optimum attenuation to increase from a small amount like 0, 2 or 4 dB to a larger amount, giving better return loss at the analyzer input. Harmonic measurements, such as second and third harmonic levels, are much improved using the low noise path because of the superiority of that path for harmonic (though not intermodulation) distortion performance.

µW Preselector Bypass

This key toggles the preselector bypass switch for band 1 and higher. When the microwave preselector is on, the signal path is preselected. When the microwave preselector is off, the signal path is not preselected. The preselected path is the normal path for the analyzer.

The preselector is a tunable bandpass filter which prevents signals away from the frequency of interest from combining in the mixer to generate in-band spurious signals (images). The consequences of using a preselector filter are its limited bandwidth, the amplitude and phase ripple in its passband, and any amplitude and phase instability due to center frequency drift.

Option MPB or pre-selector bypass provides an unpreselected input mixer path for certain X-Series signal analyzers with frequency ranges above 3.6 GHz. This signal path allows a wider bandwidth and less amplitude variability, which is an advantage when doing modulation analysis and broadband signal analysis. The disadvantage is that, without the preselector, image signals will be displayed. Another disadvantage of bypassing the preselector is increased LO emission levels at the front panel input port.

Image responses are separated from the real signal by twice the 1st IF. For IF Paths of 10 MHz and 25 MHz, the 1st IF is 322.5 MHz, so the image response and the real signal will be separated by 645 MHz. The 1st IF will be different for other IF Path settings. When viewing a real signal and its corresponding image response in internal mixing, the image response will be to the left of the real signal.

Also, the image response and the real signal typically have the same amplitude and exhibit the same shape factor.

However, if Option FS1, Fast Sweep Capability, is enabled, the image response in the Swept SA measurement will appear lower in amplitude and have a much wider shape factor compared to the real signal.

Key Path	AMPTD Y Scale, μ W Path Control
Example	:POW:MW:PATH MPB
Dependencies	Key is blanked if current mode does not support it. Key is grayed out if mode supports it but current measurement does not support it. Key is blank unless Option MPB is present and licensed. If SCPI command sent when MPB not present, error -241, "Hardware missing; Option not installed" is generated.
Readback Text	μ W Preselector Bypass
Initial S/W Revision	A.04.00

Remote Command	[:SENSe] :POWer [:RF] :MW:PRESelector [:STATe] ON OFF 0 1 [:SENSe] :POWer [:RF] :MW:PRESelector [:STATe] ?
Example	:POW:MW:PRES OFF Bypasses the microwave preselector
Notes	The ON parameter sets the STD path (:POW:MW:PATH STD) The OFF parameter sets path MPB (:POW:MW:PATH MPB)
Preset	ON

Internal Preamp

Accesses a menu of keys that control the internal preamps. Turning on the preamp gives a better noise figure, but a poorer TOI to noise floor dynamic range. You can optimize this setting for your particular measurement.

The instrument takes the preamp gain into account as it sweeps. If you sweep outside of the range of the preamp the instrument will also account for that. The displayed result will always reflect the correct gain.

For some measurements, when the preamp is on and any part of the displayed frequency range is below the lowest frequency for which the preamp has specifications, a warning condition message appears in the status line. For example ,for a preamp with a 9 kHz lowest specified frequency: "Preamp: Accy unspec'd below 9 kHz".

Key Path	AMPTD Y Scale
Scope	Meas Global
Remote Command	[:SENSe] :POWer [:RF] :GAIN [:STATe] OFF ON 0 1 [:SENSe] :POWer [:RF] :GAIN [:STATe] ?
Dependencies	Preamp is not available on all hardware platforms. If the preamp is not present or is unlicensed, the

	key is not shown. The preamp is not available when the electronic/soft attenuator is enabled.
--	--

Couplings	<p>The act of connecting the U7227A USB Preamplifier to one of the analyzer's USB ports will cause the Internal Preamp to be switched on. When this happens an informational message will be generated: "Internal Preamp turned on for optimal operation with USB Preamp." Note that if the Internal Preamp was already on, there will be no change to the setting, but if it was Off it will be switched On, to Full Range.</p> <p>Note that this same action occurs when the SA mode is selected while the USB Preamp is connected to one of the analyzer's USB ports, if it is the first time that the SA mode has run since powerup, or if the last time the SA mode was running the USB Preamp was NOT connected.</p> <p>Subsequently disconnecting the USB Preamp from USB does not change the Internal Preamp setting nor restore the previous setting.</p>
Preset	OFF
State Saved	Saved in instrument state
Initial S/W Revision	Prior to A.02.00
Modified at S/W Revision	A.14.00

Key Path	AMPTD Y Scale, Internal Preamp
Scope	Meas Global
Remote Command	[:SENSe]:POWer[:RF]:GAIN:BAND LOW FULL [:SENSe]:POWer[:RF]:GAIN:BAND?
Dependencies	<p>Preamp is not available on all hardware platforms. If the preamp is not present or is unlicensed, the key is not shown.</p> <p>If a POW:GAIN:BAND FULL command is sent when a low band preamp is available, the preamp band parameter is to LOW instead of FULL, and an "Option not installed" message is generated.</p>
Preset	LOW
State Saved	Saved in instrument state
Initial S/W Revision	Prior to A.02.00

Off

Turns the internal preamp off

Key Path	AMPTD Y Scale, Internal Preamp
Example	:POW:GAIN OFF
Readback	Off
Initial S/W Revision	Prior to A.02.00

Low Band

Sets the internal preamp to use only the low band.

The frequency range of the installed (optional) low-band preamp is displayed in square brackets on the Low Band key label.

Key Path	AMPTD Y Scale, Internal Preamp
Example	:POW:GAIN ON :POW:GAIN:BAND LOW
Readback	Low Band
Initial S/W Revision	Prior to A.02.00

Full Range

Sets the internal preamp to use its full range. The low band (0–3.6 GHz or 0–3GHz, depending on the model) is supplied by the low band preamp and the frequencies above low band are supplied by the high band preamp.

The frequency range of the installed (optional) preamp is displayed in square brackets on the Full Range key label. If the high band option is not installed the Full Range key does not appear.

Key Path	AMPTD Y Scale, Internal Preamp
Example	:POW:GAIN ON :POW:GAIN:BAND FULL
Readback	Full Range
Initial S/W Revision	Prior to A.02.00

Ref Position

Positions the reference level at the top, center or bottom of the Y Scale display. Changing the reference position does not change the reference level value.

Key Path	AMPTD Y Scale
Mode	All except SA and BASIC
Remote Command	:DISPlay:MONitor:VIEW[1]:WINDow[1]:TRACe:Y[:SCALe]:RPOSition TOP CENTer BOTTom :DISPlay:MONitor:VIEW[1]:WINDow[1]:TRACe:Y[:SCALe]:RPOSition?
Example	DISP:MON:VIEW:WIND:TRAC:Y:RPOS CENT DISP:MON:VIEW:WIND:TRAC:Y:RPOS?
Preset	TOP
State Saved	Saved in instrument state.
Range	Top Ctr Bot
Initial S/W Revision	Prior to A.02.00

Auto Scaling

Toggles the Auto Scaling function between On and Off.

Key Path	AMPTD Y Scale
Mode	All except SA and BASIC
Remote Command	:DISPlay:MONitor:VIEW[1]:WINDow[1]:TRACe:Y[:SCALe]:COUPle 0 1 OFF ON :DISPlay:MONitor:VIEW[1]:WINDow[1]:TRACe:Y[:SCALe]:COUPle?
Example	DISP:MON:VIEW:WIND:TRAC:Y:COUP ON DISP:MON:VIEW:WIND:TRAC:Y:COUP?
Couplings	When Auto Scaling is On, and the Restart front-panel key is pressed, this function automatically determines the scale per division and reference values based on the measurement results. When you set a value to either Scale/Div or Ref Value manually, Auto Scaling automatically changes to Off.
Preset	ON
State Saved	Saved in instrument state.
Range	On Off
Initial S/W Revision	Prior to A.02.00

Auto Couple

The Auto Couple feature provides a quick and convenient way to automatically couple multiple instrument settings. This helps ensure accurate measurements and optimum dynamic range. When the Auto Couple feature is activated, either from the front panel or remotely, all parameters of the current measurement that have an Auto/Manual mode are set to Auto mode and all measurement settings dependent on (or coupled to) the Auto/Man parameters are automatically adjusted for optimal performance.

However, the Auto Couple key actions are confined to the current measurement only. It does not affect other measurements in the mode, and it does not affect markers, marker functions, or trace or display attributes.

See "[More Information](#)" on page 2399

Key Path	Front-panel key
Remote Command	:COUPle ALL NONE
Example	:COUP ALL
Notes	:COUPle ALL puts all Auto/Man parameters in Auto mode (equivalent to pressing the Auto Couple key). :COUPLE NONE puts all Auto/Man parameters in manual mode. It decouples all the coupled instrument parameters and is not recommended for making measurements.
Initial S/W Revision	Prior to A.02.00

More Information

There are two types of functions that have Auto/Manual modes.

Auto/Man Active Function keys

An Auto/Man toggle key controls the binary state associated with an instrument parameter by toggling between Auto (where the parameter is automatically coupled to the other parameters it is dependent upon) and Man (where the parameter is controlled independent of the other parameters), as well as making the parameter the active function. The current mode is indicated on the softkey with either Auto or Man underlined as illustrated below.



Auto/Man 1-of-N keys

An Auto/Man 1-of-N key allows you to manually pick from a list of parameter values, or place the function in Auto, in which case the value is automatically selected (and indicated) as shown below. If in Auto, Auto is underlined on the calling key. If in manual operation, manual is indicated on the calling key. But the calling key does not actually toggle the function, it simply opens the menu.

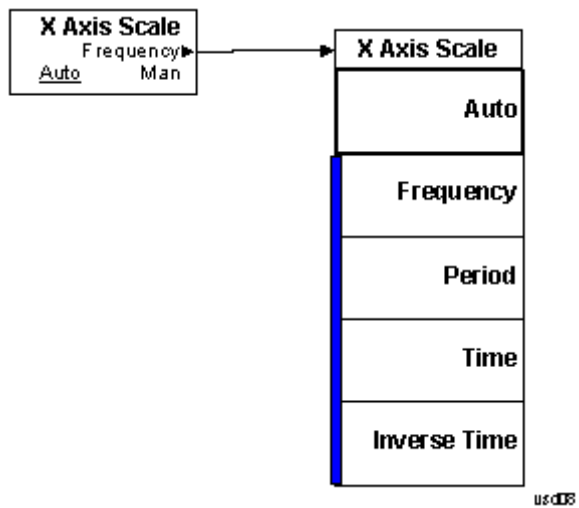

BW

Accesses a menu that enables you to specify the resolution bandwidth functions that control the bandwidth and filter selection.

Key Path	Front-panel key
Initial S/W Revision	Prior to A.02.00

Res BW

Sets the resolution bandwidth for the current measurement. If an unavailable bandwidth is entered with the numeric keypad, the closest available bandwidth is selected.

Key Path	BW
Mode	All except SA and BASIC
Remote Command	<pre>[:SENSe]:MONitor:BANDwidth[:RESolution] <freq> [:SENSe]:MONitor:BANDwidth[:RESolution]? [:SENSe]:MONitor:BANDwidth[:RESolution]:AUTO OFF ON 0 1 [:SENSe]:MONitor:BANDwidth[:RESolution]:AUTO?</pre>
Example	<pre>MON:BAND 2.4 MHz MON:BAND? MON:BAND:AUTO ON MON:BAND:AUTO?</pre>
Preset	<pre>WCDMA: Automatically calculated WIMAX OFDMA: 100kHz C2K: Automatically calculated BLUETOOTH: Automatically calculated PN: Automatically calculated GSM/EDGE: Automatically calculated TD-SCDMA: Automatically calculated 1xEVDO: 30kHz DVB-T/H: 3.9kHz DTMB (CTTB): 3.9kHz ISDB-T: 3.9kHz CMMB: 3.9kHz LTE: 100 kHz LTETDD: 100 kHz Digital Cable TV: 3.9kHz WLAN: 100 kHz MSR: Automatically calculated LTEAFDD, LTEATDD: 100kHz</pre>

	WCDMA: ON WIMAX: OFF C2K: ON BLUETOOTH: ON PN: ON GSM/EDGE: ON TD-SCDMA: ON 1xEVDO: ON DVB-T/H: OFF DTMB (CTTB): OFF ISDB-T: OFF CMMB: OFF LTE:OFF LTETDD: OFF Digital Cable TV: OFF WLAN: OFF MSR: ON LTEAFDD, LTEATDD: OFF
State Saved	Saved in instrument state.
Min	1.0 Hz
Max	8.0 MHz
Backwards Compatibility SCPI	<code>[:SENSe] :MONitor :BWIDth [:RESolution]</code>
Initial S/W Revision	Prior to A.02.00
Modified at S/W Revision	A.02.00
Modified at S/W Revision	A.03.00

Video BW

Changes the analyzer post-detection filter.

Key Path	BW
Mode	All except SA and BASIC
Remote Command	<code>[:SENSe] :MONitor :BANDwidth :VIDeo <bandwidth></code> <code>[:SENSe] :MONitor :BANDwidth :VIDeo?</code> <code>[:SENSe] :MONitor :BANDwidth :VIDeo :AUTO ON OFF 1 0</code> <code>[:SENSe] :MONitor :BANDwidth :VIDeo :AUTO?</code>
Example	MON:BAND:VID 10 MHz MON:BAND:VID? MON:BAND:VID:AUTO OFF

	MON:BAND:VID:AUTO?
Preset	WCDMA: Automatically calculated WIMAX OFDMA: 1 MHz C2K: Automatically calculated BLUETOOTH: Automatically calculated PN: Automatically calculated GSM/EDGE: Automatically calculated TD-SCDMA: Automatically calculated 1xEVDO: 300kHz DVB-T/H: 39kHz DTMB (CTTB): 39kHz ISDB-T: 39kHz CMMB: 39kHz LTE: 1 MHz LTETDD: 1 MHz Digital Cable TV: 39kHz WLAN: 1 MHz MSR: Automatically calculated LTEAFDD, LTEATDD: 1 MHz WCDMA: ON WIMAX: OFF C2K: ON BLUETOOTH: ON PN: ON GSM/EDGE: ON TD-SCDMA: ON 1xEVDO: ON DVB-T/H: OFF DTMB (CTTB): OFF ISDB-T: OFF CMMB: OFF LTE: OFF LTETDD: OFF Digital Cable TV: OFF WLAN: OFF MSR: ON LTEAFDD, LTEATDD: OFF
State Saved	Saved in instrument state.
Min	1 Hz
Max	50 MHz

Backwards Compatibility SCPI	<code>[:SENSe] :MONitor :BWIDth :VIDeo</code>
Initial S/W Revision	Prior to A.02.00
Modified at S/W Revision	A.02.00
Modified at S/W Revision	A.03.00

VBW:3dB RBW

Selects the ratio between the video bandwidth and the equivalent 3 dB resolution bandwidth to be used for setting the VBW when VBW is in Auto.

Key Path	BW
Mode	All except SA and BASIC
Remote Command	<code>[:SENSe] :MONitor :BANDwidth :VIDeo :RATio <real></code> <code>[:SENSe] :MONitor :BANDwidth :VIDeo :RATio?</code> <code>[:SENSe] :MONitor :BANDwidth :VIDeo :RATio :AUTO OFF ON 0 1</code> <code>[:SENSe] :MONitor :BANDwidth :VIDeo :RATio :AUTO?</code>
Example	MON:BAND:VID:RAT 2 MON:BAND:VID:RAT? MON:BAND:VID:RAT:AUTO 0 MON:BAND:VID:RAT:AUTO?
Preset	1 ON
State Saved	Saved in instrument state.
Min	0.00001
Max	3000000
Backwards Compatibility SCPI	<code>[:SENSe] :MONitor :BWIDth :VIDeo :RATio</code>
Initial S/W Revision	Prior to A.02.00

Span:3dB RBW

Selects the ratio between span and resolution bandwidth.

The default setting is Auto with a Span:3 dB RBW ratio of 106:1. You can manually change this ratio by pressing the key, entering a new value, and pressing Enter.

Key Path	BW
Mode	All except SA and BASIC
Remote Command	<code>[:SENSe] :MONitor :FREQuency :SPAN :BANDwidth [:RESolution] :RATio <integer></code>

```
[ :SENSe ] :MONitor :FREQuency :SPAN :BANDwidth [ :RESolution ] :RATio?
[ :SENSe ] :MONitor :FREQuency :SPAN :BANDwidth [ :RESolution ] :RATio :AUTO OFF |
ON | 0 | 1
[ :SENSe ] :MONitor :FREQuency :SPAN :BANDwidth [ :RESolution ] :RATio :AUTO?
```

Example

```
MON:FREQ:SPAN:BAND:RAT 200
MON:FREQ:SPAN:BAND:RAT?
MON:FREQ:SPAN:BAND:RAT:AUTO ON
MON:FREQ:SPAN:BAND:RAT:AUTO?
```

Preset 106
ON

State Saved Saved in instrument state.

Min 2

Max 10000

Backwards Compatibility SCPI [:SENSe] :MONitor :FREQuency :SPAN :BWIDth [:RESolution] :RATio

Initial S/W Revision Prior to A.02.00

Modified at S/W Revision A.04.00

Cont (Continuous Measurement/Sweep)

Sets the analyzer for Continuous measurement operation. The single/continuous state is Meas Global so the setting will affect all measurements. If you are Paused, pressing Cont does a Resume.

Key Path	Front-panel key
Remote Command	:INITiate:CONTinuous OFF ON 0 1 :INITiate:CONTinuous?
Example	:INIT:CONT 0 puts analyzer in Single measurement operation. :INIT:CONT 1 puts analyzer in Continuous measurement operation
Preset	ON (Note that SYST:PRESet sets INIT:CONT to ON but *RST sets INIT:CONT to OFF)
State Saved	Saved in instrument state
Backwards Compatibility Notes	For Spectrum Analysis mode in ESA and PSA, there is no Cont hardkey, instead there is a Sweep Single/Cont key. In these analyzers, switching the Sweep Single/Cont key from Single to Cont restarts averages (displayed average count reset to 1), but does not restart Max Hold and Min Hold. The X-Series has Single and Cont keys in place of the SweepSingleCont key. In the X-Series, if in single measurement, the Cont key (and INIT:CONT ON) switches to continuous measurement, but never restarts a measurement and never resets a sweep.
Initial S/W Revision	Prior to A.02.00

In Swept SA Measurement (Spectrum Analysis Mode):

The analyzer takes repetitive sweeps, averages, measurements, etc., when in Continuous mode. When the average count reaches the Average/Hold Number the count stops incrementing, but the analyzer keeps sweeping. See the Trace/Detector section for the averaging formula used both before and after the Average/Hold Number is reached. The trigger condition must be met prior to each sweep. The type of trace processing for multiple sweeps, is set under the Trace/Detector key, with choices of Trace Average, Max Hold, or Min Hold.

In Other Measurements/Modes:

With Avg/Hold Num (in the Meas Setup menu) set to Off or set to On with a value of 1, a sweep is taken after the trigger condition is met; and the analyzer continues to take new sweeps after the current sweep has completed and the trigger condition is again met. However, with Avg/Hold Num set to On with a value >1, multiple sweeps (data acquisitions) are taken for the measurement. The trigger condition must be met prior to each sweep. The sweep is not stopped when the average count k equals the number N set for Avg/Hold Num is reached, but the number k stops incrementing. A measurement average usually applies to all traces, marker results, and numeric results. But sometimes it only applies to the numeric results.

If the analyzer is in Single measurement, pressing the Cont key does not change k and does not cause the sweep to be reset; the only action is to put the analyzer into Continuous measurement operation.

If it is already in continuous sweep:

the INIT:CONT 1 command has no effect

the INIT:CONT 0 command will place the analyzer in Single Sweep but will have no effect on the current sequence until $k = N$, at which point the current sequence will stop and the instrument will go to the idle state.

16 Monitor Spectrum Measurement
File

File

See "File" on page 360

FREQ Channel

Accesses a menu of keys that allow you to control the Frequency and Channel parameters of the instrument.

Some features in the Frequency menu are the same for all measurements – they do not change as you change measurements. Settings like these are called “Meas Global” and are unaffected by Meas Preset. For example, the Center Freq setting is the same for all measurements – it does not change as you change measurements.

Key Path	Front-panel key
Initial S/W Revision	Prior to A.02.00

Center Freq

Sets the frequency that corresponds to the horizontal center of the graticule (when frequency Scale Type is set to linear). While adjusting the Center Frequency the Span is held constant, which means that both Start Frequency and Stop Frequency will change.

Pressing Center Freq also sets the frequency entry mode to Center/Span. In Center/Span mode, the center frequency and span values are displayed below the graticule, and the default active function in the Frequency menu is Center Freq.

The center frequency setting is the same for all measurements within a mode, that is, it is Meas Global. Some modes are also able to share a Mode Global center frequency value. If this is the case, the Mode will have a Global Settings key in its Mode Setup menu.

The Center Freq function sets (and queries) the Center Frequency for the currently selected input. If your analyzer has multiple inputs, and you select another input, the Center Freq changes to the value for that input. SCPI commands are available to directly set the Center Freq for a specific input.

Center Freq is remembered as you go from input to input. Thus you can set a Center Freq of 10 GHz with the RF Input selected, change to BBIQ and set a Center Freq of 20 MHz, then switch to External Mixing and set a Center Freq of 60 GHz, and when you go back to the RF Input the Center Freq will go back to 10 GHz; back to BBIQ and it is 20 MHz; back to External Mixing and it is 60 GHz.

See ["RF Center Freq" on page 2412](#)

See [Ext Mix Center Freq](#)

See ["I/Q Center Freq" on page 2414](#)

See ["Center Frequency Presets" on page 2410](#)

Key Path	FREQ Channel
Scope	Meas Global
Remote Command	[:SENSe] :FREQuency:CENTer <freq> [:SENSe] :FREQuency:CENTer?

Example	FREQ:CENT 50 MHz FREQ:CENT UP changes the center frequency to 150 MHz if you use FREQ:CENT:STEP 100 MHz to set the center frequency step size to 100 MHz FREQ:CENT?
Notes	This command sets either the RF or I/Q Center Frequency depending on the selected input. For RF input it is equivalent to FREQ:RF:CENT For I/Q input it is equivalent to FREQ:IQ:CENT Preset and Max values are dependent on Hardware Options (5xx) If no terminator (e.g. MHz) is sent the terminator Hz is used. If a terminator with unit other than Frequency is used, an invalid suffix error message is generated.
Dependencies	The Center Frequency can be limited by Start or Stop Freq limits, if the Span is so large that Start or Stop reach their limit.
Couplings	When operating in “swept span”, any value of the Center Frequency or Span that is within the frequency range of the analyzer is allowed when the value is being set through the front panel numeric key pad or the SCPI command. The other parameter is forced to a different value if needed, to keep the Start and the Stop Frequencies within the analyzer’s frequency range
Preset	Depends on instrument maximum frequency, mode, measurement, and selected input. See "Center Frequency Presets" on page 2410 and "RF Center Freq" on page 2412 and Ext Mix Center Freq and "I/Q Center Freq" on page 2414 .
State Saved	Saved in instrument state
Min	Depends on instrument maximum frequency, mode, measurement, and selected input.. See "Center Frequency Presets" on page 2410 and "RF Center Freq" on page 2412 and "I/Q Center Freq" on page 2414 .
Max	Depends on instrument maximum frequency, mode, measurement, and selected input.. See "Center Frequency Presets" on page 2410 and "RF Center Freq" on page 2412 and "I/Q Center Freq" on page 2414 .
Default Unit	Hz
Status Bits/OPC	Non-overlapped
Dependencies	
Initial S/W Revision	Prior to A.02.00

Center Frequency Presets

The following table provides the Center Frequency Presets for the Spectrum Analyzer mode, and the Max Freq, for the various frequency options:

Freq Option	CF after Mode Preset	Stop Freq after Mode Preset	Max Freq (can't tune)

			above)
503 (all but N9000A)	1.805 GHz	3.6 GHz	3.7 GHz
503 (N9000A)	1.505 GHz	3.0 GHz	3.08 GHz
507 (all but N9000A)	3.505 GHz	7.0 GHz	7.1 GHz
507 (N9000A)	3.755 GHz	7.5 GHz	7.58 GHz
508 (all but N9038A)	1.805 GHz	3.6 GHz	8.5 GHz
508 (N9038A)	4.205 GHz	8.4 GHz	8.5 GHz
513	6.805 GHz	13.6 GHz	13.8 GHz
526 (all but N9000A and N9038A)	13.255 GHz	26.5 GHz	27.0 GHz
526 (N9000A)	13.255 GHz	26.5 GHz	26.55 GHz
526 (N9038A)	1.805 GHz	3.6 GHz	27.0 GHz
532	16.005 GHz	32.0 GHz	32.5 GHz
543	21.505 GHz	43.0 GHz	TBD
544	22.005 GHz	44.0 GHz	44.5 GHz
550	25.005 GHz	50.0 GHz	51 GHz

Input 2:

Model	CF after Mode Preset	Stop Freq after Mode Preset	Max Freq (can't tune above)
N9000A opt C75	0.7505GHz	1.5 GHz	1.58 GHz
N9038A	505 MHz	1 GHz	1.000025 GHz

Tracking Generator Frequency Limits (N9000A only):

Tracking Generator Option	Min Freq (clips to this freq when turn TG on and	If above this Freq, Stop Freq clipped to this Freq when	Max Freq (can't tune above) while TG

	can't tune below while TG on)	TG turned on	on
T03	9 kHz	3.0 GHz	3.08 GHz
T06	9 kHz	6.0 GHz	6.05 GHz

The following table shows the Center Frequency Presets for modes other than Spectrum Analyzer:

Mode	CF Preset for RF
WCDMA	1 GHz
WIMAXOFDMA,	1 GHz
BASIC	1 GHz
ADEMOD	1 GHz
VSA	1 GHz
TDSCDMA	1 GHz
PNOISE	1 GHz
LTE	1 GHz
LTETDD	1 GHz
MSR	1 GHz
GSM	935.2 MHz
NFIGURE	1.505 GHz

RF Center Freq

SCPI command for specifying the RF Center Frequency. This command will set the Center Frequency to be used when the RF input is selected, even if the RF input is not the input that is selected at the time the command is sent. Note that the Center Freq function in the Frequency menu on the front panel always applies to the currently selected input.

Scope	Meas Global
Remote Command	<code>[:SENSe] :FREQuency:RF:CENTer <freq></code> <code>[:SENSe] :FREQuency:RF:CENTer?</code>
Example	FREQ:RF:CENT 30 MHz
Notes	This command is the same in all modes, but the parameter is Measurement Global. So the value is independent in each mode and common across all the measurements in the mode.
Dependencies	If the electronic/soft attenuator is enabled, any attempt to set Center Frequency such that the Stop Frequency would be >3.6 GHz fails and results in an advisory message. If the equivalent SCPI command is sent, this same message is generated as part of a “-221, Settings conflict” warning. If Source Mode is set to Tracking, and the Max or Min Center Freq is therefore limited by the limits of the source, a warning message is generated, “Data out of range;clipped to source max/min” if these limits are exceeded. Note that for an external source, these limits can be affected by the settings of

	Source Numerator, Source Denominator and Power Sweep.
Preset	See table above
State Saved	Saved in instrument state.
Min	-79.999995 MHz, unless Source Mode is set to Tracking, in which case it is limited by the minimum frequency of the Source
Max	See table above. Basically instrument maximum frequency - 5 Hz. Note that, if the Source Mode is set to Tracking, the effective instrument maximum frequency may be limited by the source maximum frequency. If the knob or step keys are being used, also depends on the value of the other three interdependent parameters Span, Start Frequency and Stop Frequency
Initial S/W Revision	Prior to A.02.00
Modified at S/W Revision	A.03.00

Ext Mix Center Freq

SCPI command for specifying the External Mixer Center Frequency. This command will set the Center Frequency to be used when the External Mixer is selected, even if the External Mixer input is not the input which is selected at the time the command is sent. Note that the Center Freq function in the Frequency menu on the front panel always applies to the currently selected input.

Scope	Meas Global
Remote Command	<code>[:SENSe] :FREQuency:EMIXer:CENTer <freq></code> <code>[:SENSe] :FREQuency:EMIXer:CENTer?</code>
Example	<code>:FREQ:EMIX:CENT 60 GHz</code> <code>:FREQ:EMIX:CENT?</code>
Notes	This command is the same in all modes, but the parameter is Measurement Global. So the value is independent in each mode and common across all the measurements in the mode.
Couplings	When returning to External Mixing after having been switched to one of the other inputs (e.g., RF), you will come back into the settings that you had when you left External Mixing. So you will come back to the band you were in with the Center Frequency that you had. However, Span is not an input-dependent parameter, therefore you will bring the span over from the other input. Therefore, the analyzer comes back with the span from the previous input, limited as necessary by the current mixer setup.
Preset	When a Mode Preset is performed while in External Mixing, the Start frequency of the current Mode is set to the nominal Min Freq of the lowest harmonic range in the Harmonic Table for the current mixer setup. Similarly, the Stop frequency of the current Mode is set to the nominal Max Freq of the highest harmonic range in the Harmonic Table. The Center Freq thus presets to the point arithmetically equidistant from these two frequencies. If the current measurement has a limited Span available to it, and cannot achieve the Span shown in the table ($\text{Span} = \text{Stop Freq} - \text{Start Freq}$), the analyzer uses the maximum Span the measurement allows, and still sets the Center Freq to the midpoint of the Start and Stop Freq values in the Harmonic Table.

	<p>When Restore Input/Output Defaults is performed, the mixer presets to the 11970A, whose Start and Stop frequencies are 26.5 and 40 GHz respectively. The center of these two frequencies is 33.25 GHz.</p> <p>Therefore, after a Restore Input/Output Defaults, if you go into External Mixing and do a Mode Preset while in the Spectrum Analyzer Mode, the resulting Center Freq is 33.25 GHz.</p>
State Saved	Saved in instrument state.
Min	The minimum frequency in the currently selected mixer band + 5 Hz
Max	The maximum frequency in the currently selected mixer band – 5 Hz If the knob or step keys are being used, also depends on the value of the other three interdependent parameters Span, Start Frequency and Stop Frequency
Initial S/W Revision	A.08.01

I/Q Center Freq

SCPI command for specifying the I/Q Center Frequency. This command will set the Center Frequency to be used when the I/Q input is selected, even if the I/Q input is not the input which is selected at the time the command is sent. Note that the Center Freq function in the Frequency menu on the front panel always applies to the currently selected input.

Scope	Meas Global
Remote Command	<pre>[:SENSe] :FREQuency:IQ:CENTer <freq></pre> <pre>[:SENSe] :FREQuency:IQ:CENTer?</pre>
Example	FREQ:IQ:CEN: 30 MHz
Notes	This command is the same in all modes, but the parameter is Measurement Global. So the value is independent in each mode and common across all the measurements in the mode.
Preset	0 Hz
State Saved	Saved in instrument state.
Min	-40.049995 MHz
Max	40.049995 MHz
Initial S/W Revision	Prior to A.02.00

CF Step

Changes the step size for the center frequency and start and stop frequency functions. Once a step size has been selected and the center frequency function is active, the step keys (and the UP|DOWN parameters for Center Frequency from remote commands) change the center frequency by the step-size value. The step size function is useful for finding harmonics and sidebands beyond the current frequency span of the analyzer.

Note that the start and stop frequencies also step by the CF Step value.

Key Path	FREQ Channel
Remote Command	[:SENSe]:FREQuency:CENTer:STEP[:INCRement] <freq> [:SENSe]:FREQuency:CENTer:STEP[:INCRement]? [:SENSe]:FREQuency:CENTer:STEP:AUTO OFF ON 0 1 [:SENSe]:FREQuency:CENTer:STEP:AUTO?
Example	FREQ:CENT:STEP:AUTO ON FREQ:CENT:STEP 500 MHz FREQ:CENT UP increases the current center frequency value by 500 MHz FREQ:CENT:STEP? FREQ:CENT:STEP:AUTO?
Notes	Preset and Max values are depending on Hardware Options (503, 507, 508, 513, 526)
Notes	Preset and Max values are dependent on Hardware Options (5xx)
Dependencies	Freq Offset is not available in External Mixing. In this case the Freq Offset key is grayed out and shows a value of zero. It will once again be available, and show the previously set value, when you return to the RF Input.
Dependencies	Span, RBW, Center frequency If the electronic/soft attenuator is enabled, any attempt to change the value of the center frequency >3.6 GHz by pressing the Up-arrow key, fails and results in an advisory message. If the equivalent SCPI command is sent, this same message is generated as part of a “-221, Settings conflict” warning.
Couplings	When auto-coupled in a non-zero span, the center frequency step size is set to 10% of the span. When auto-coupled in zero span, the center frequency step size is set to the equivalent -3 dB RBW value.
Preset	Auto ADEMOD: 1 MHz ON
State Saved	Saved in instrument state
Min	– (the maximum frequency of the instrument). That is, 27 GHz max freq instrument has a CF step range of +/- 27 GHz. Note that this is the maximum frequency given the current settings of the instrument, so in External Mixing, for example, it is the maximum frequency of the current mixer band.
Max	The maximum frequency of the instrument. That is, 27 GHz max freq instrument has a CF step range of +/- 27 GHz. Note that this is the maximum frequency given the current settings of the instrument, so in External Mixing, for example, it is the maximum frequency of the current mixer band.
Default Unit	Hz
Status Bits/OPC dependencies	non-overlapped
Initial S/W Revision	Prior to A.02.00
Modified at S/W Revision	A.03.00

16 Monitor Spectrum Measurement
Input/Output

Input/Output

See ["Input/Output" on page 224](#)

Marker

Accesses a menu that enables you to select, set up and control the markers for the current measurement.

For remote-only commands associated with Marker functionality, see:

- "Marker X Axis Value (Remote Command only)" on page 2420
- "Marker X Axis Position (Remote Command only)" on page 2420
- "Marker Y Axis Value (Remote Command only)" on page 2421

Key Path	Front-panel key
Initial S/W Revision	Prior to A.02.00

Select Marker

Displays 12 markers available for selection.

Key Path	Marker
Initial S/W Revision	Prior to A.02.00

Marker Type

Sets the marker control mode to Normal, Delta or Off. If the selected marker is Off, pressing Marker sets it to Normal and places a single marker at the center of the display. At the same time, Marker X Axis Value appears on the Active Function area.

Key Path	Marker
Mode	All except SA and BASIC
Remote Command	:CALCulate:MONitor:MARKer[1] 2 ... 12:MODE POSition DELTa OFF :CALCulate:MONitor:MARKer[1] 2 ... 12:MODE?
Example	CALC:MON:MARK:MODE POS CALC:MON:MARK:MODE?
Notes	If the selected marker is Off, pressing Marker sets it to Normal and places it at the center of the screen on the trace determined by the Marker Trace rules. At the same time, Marker X Axis Value appears on the Active Function area. Default Active Function: the active function for the selected marker's current control mode. If the current control mode is Off, there is no active function and the active function is turned off. Active Function Display: the marker X axis value entered in the active function area displays the marker value to its full entered precision.
Preset	OFF
State Saved	Saved in instrument state.
Range	Normal Delta Off
Initial S/W Revision	Prior to A.02.00

Properties

Accesses a menu that enables you to select the active marker, the reference marker and the trace for the current measurement.

Key Path	Marker
Initial S/W Revision	Prior to A.02.00

Select Marker

Displays 12 markers available for selection.

Key Path	Marker
Initial S/W Revision	Prior to A.02.00

Relative To

Selects the desired marker. The selected marker is relative to its reference marker.

Key Path	Marker, Properties
Mode	All except SA and BASIC
Remote Command	:CALCulate:MONitor:MARKer[1] 2 ... 12:REference <integer> :CALCulate:MONitor:MARKer[1] 2 ... 12:REference?
Example	CALC:MON:MARK2:REF 1 CALC:MON:MARK2:REF?
Notes	A marker cannot be relative to itself so that choice is grayed out, and if sent from SCPI generates error -221: "Settings conflict; marker cannot be relative to itself." When queried a single value is returned (the specified marker number's relative marker).
Preset	2 3 4 5 6 7 8 9 10 11 12 1
State Saved	Saved in instrument state.
Min	1
Max	12
Initial S/W Revision	Prior to A.02.00

Marker Trace

Assigns the specified marker to the designated trace.

Key Path	Marker, Properties
Mode	All except SA and BASIC

Remote Command	:CALCulate:MONitor:MARKer[1] 2 ... 12:TRACe <integer> :CALCulate:MONitor:MARKer[1] 2 ... 12:TRACe?
Example	CALC:MON:MARK:TRAC 1 CALC:MON:MARK:TRAC?
Preset	1
State Saved	Saved in instrument state.
Min	1
Max	3
Initial S/W Revision	Prior to A.02.00

Couple Markers

When this function is true, moving any marker causes an equal X Axis movement of every other marker that is not Off. By “equal X Axis movement” we mean that we preserve the difference between each marker’s X Axis value (in the fundamental x-axis units of the trace that marker is on) and the X Axis value of the marker being moved (in the same fundamental x-axis units).

Key Path	Marker
Mode	All except SA and BASIC
Remote Command	:CALCulate:MONitor:MARKer:COUPle[:STATe] ON OFF 1 0 :CALCulate:MONitor:MARKer:COUPle[:STATe]?
Example	CALC:MON:MARK:COUP ON CALC:MON:MARK:COUP?
Preset	OFF
State Saved	Saved in instrument state.
Range	On Off
Initial S/W Revision	Prior to A.02.00

All Markers Off

Turns off all markers on the current measurement.

Key Path	Marker
Mode	All except SA and BASIC
Remote Command	:CALCulate:MONitor:MARKer:AOFF
Example	CALC:MON:MARK:AOFF
Initial S/W Revision	Prior to A.02.00

Marker X Axis Value (Remote Command only)

Sets the marker X Axis value in the current marker X Axis Scale unit. It has no effect if the control mode is Off, but is the SCPI equivalent of entering an X value if the control mode is Normal or Delta.

Mode	All except SA and BASIC
Remote Command	:CALCulate:MONitor:MARKer[1] 2 ... 12:X <freq> :CALCulate:MONitor:MARKer[1] 2 ... 12:X?
Example	CALC:MON:MARK3:X 0 CALC:MON:MARK3:X?
Notes	If no suffix is sent, uses the fundamental units for the current marker X Axis Scale. If a suffix is sent that does not match the current marker X Axis Scale unit, an error "Invalid suffix" is generated. The query returns the marker's absolute X Axis value if the control mode is Normal, or the offset from the marker's reference marker if the control mode is Delta. The query is returned in the fundamental units for the current marker X Axis scale: Hz for Frequency and Inverse Time, seconds for Period and Time. If the marker is Off the response is not a number.
Preset	After a preset, all markers are turned OFF, so Marker X Axis Value query returns a not a number (NAN).
State Saved	No
Min	-9.9E+37
Max	9.9E+37
Initial S/W Revision	Prior to A.02.00

Marker X Axis Position (Remote Command only)

Sets the marker X position in trace points. It has no effect if the control mode is Off, but is the SCPI equivalent of entering a value if the control mode is Normal or Delta – except in trace points rather than X Axis Scale units. The entered value is immediately translated into the current X Axis Scale units for setting the value of the marker.

Mode	All except SA and BASIC
Remote Command	:CALCulate:MONitor:MARKer[1] 2 ... 12:X:POSition <real> :CALCulate:MONitor:MARKer[1] 2 ... 12:X:POSition?
Example	CALC:MON:MARK:X:POS 0 CALC:MON:MARK:X:POS?
Notes	The query returns the marker's absolute X Axis value in trace points if the control mode is Normal, or the offset from the marker's reference marker in trace points if the control mode is Delta. The value is returned as a real number, not an integer, corresponding to the translation from X Axis Scale units to trace points. If the marker is Off the response is not a number.
Preset	After a preset, all markers are turned OFF, so Marker X Axis Value query returns a not a number (NAN).
State Saved	No
Min	-9.9E+37

Max	9.9E+37
Initial S/W Revision	Prior to A.02.00

Marker Y Axis Value (Remote Command only)

Returns the marker Y Axis value in the current marker.

Mode	All except SA and BASIC
Remote Command	:CALCulate:MONitor:MARKer[1] 2 ... 12:Y?
Example	CALC:MON:MARK11:Y?
Preset	Result dependent on markers setup and signal source
Backwards Compatibility SCPI	:CALCulate:MONitor:MARKer[1] 2 ... 12:FUNCTION:RESULT?
Initial S/W Revision	Prior to A.02.00

Marker Function

Accesses special marker functions such as marker noise, and power in a specified bandwidth or time interval.

Key Path	Front-panel key
Initial S/W Revision	Prior to A.02.00

Select Marker

Displays 12 markers available for selection.

Key Path	Marker
Initial S/W Revision	Prior to A.02.00

Marker Function Type

Sets the marker control function type to one of the following:

NOISe	Marker Noise
BPOWer	Band/Interval Power
BDENsity	Band Interval Density
OFF	Marker Function Off

Key Path	Marker Function
Mode	All except SA and BASIC
Remote Command	:CALCulate:MONitor:MARKer[1] 2 ... 12:FUNction NOISe BPOWer BDENsity OFF :CALCulate:MONitor:MARKer[1] 2 ... 12:FUNction?
Example	CALC:MON:MARK:FUNC NOISCALC:MON:MARK:FUNC?
Preset	OFF
State Saved	Saved in instrument state.
Range	Marker Noise Band/Interval Power Band Interval Density Marker Function Off
Initial S/W Revision	Prior to A.02.00

Band Adjust

Accesses a menu that enables you to set the frequency span width and the left and right edge, or time values, for the band or interval of the selected marker.

Key Path	Marker Function
Initial S/W Revision	Prior to A.02.00

Band/Interval Span for Frequency Domain

Sets the width of the frequency span for the selected marker.

Key Path	Marker Function
Mode	All except SA and BASIC
Remote Command	:CALCulate:MONitor:MARKer[1] 2 ... 12:FUNCtion:BAND:SPAN <freq> :CALCulate:MONitor:MARKer[1] 2 ... 12:FUNCtion:BAND:SPAN?
Example	CALC:MON:MARK12:FUNC:BAND:SPAN 20 MHz CALC:MON:MARK12:FUNC:BAND:SPAN?
Couplings	Changing the Band/Interval Span necessarily changes the Band/Interval Left and Band/Interval Right values.
Preset	Depends on X axis range of selected Trace.
State Saved	Saved in instrument state.
Min	-9.9E+37
Max	9.9E+37
Initial S/W Revision	Prior to A.02.00

Band/Interval Left for Frequency Domain

Sets the left edge frequency or time value for the band of the selected marker.

Key Path	Marker Function
Mode	All except SA and BASIC
Remote Command	:CALCulate:MONitor:MARKer[1] 2 ... 12:FUNCtion:BAND:LEFT <freq> :CALCulate:MONitor:MARKer[1] 2 ... 12:FUNCtion:BAND:LEFT?
Example	CALC:MON:MARK12:FUNC:BAND:LEFT 20 GHz CALC:MON:MARK12:FUNC:BAND:LEFT?
Couplings	Changing the Band/Interval Left necessarily changes the Band/Interval Span value.
Preset	Depends on X axis range of selected Trace.
State Saved	Saved in instrument state.
Min	-9.9E+37
Max	9.9E+37
Initial S/W Revision	Prior to A.02.00

Band/Interval Right for Frequency Domain

Sets the right edge frequency or time value for the band of the selected marker.

Key Path	Marker Function
Mode	All except SA and BASIC
Remote Command	:CALCulate:MONitor:MARKer[1] 2 ... 12:FUNCTion:BAND:RIGHT <freq> :CALCulate:MONitor:MARKer[1] 2 ... 12:FUNCTion:BAND:RIGHT?
Example	CALC:MON:MARK12:FUNC:BAND:RIGH 20 GHz CALC:MON:MARK12:FUNC:BAND:RIGH?
Couplings	Changing the Band/Interval Right necessarily changes the Band/Interval Span value.
Preset	Depends on X axis range of selected Trace.
State Saved	Saved in instrument state.
Min	-9.9E+37
Max	9.9E+37
Initial S/W Revision	Prior to A.02.00

Marker To

There is no 'Marker To' functionality supported in Monitor Spectrum. The front-panel key displays a blank menu when pressed.

Key Path	Front-panel key
Initial S/W Revision	Prior to A.02.00

Meas

The information in this section is common to all measurements. For key and remote command information for a specific measurement, refer to the section that describes the measurement of interest.

Measurements available under the Meas key are specific to the current Mode.

When viewing Help for measurements, note the following:

NOTE

Operation for some keys differs between measurements. The information displayed in Help pertains to the current measurement. To see how a key operates in a different measurement, exit Help (press the Cancel Esc key), select the measurement, then reenter Help (press the Help key) and press that key.

Key Path	Front-panel key
Initial S/W Revision	Prior to A.02.00

Remote Measurement Functions

This section contains the following topics:

["Measurement Group of Commands" on page 2771](#)

["Current Measurement Query \(Remote Command Only\)" on page 2773](#)

["Limit Test Current Results \(Remote Command Only\)" on page 2773](#)

["Data Query \(Remote Command Only\)" on page 2773](#)

["Calculate/Compress Trace Data Query \(Remote Command Only\)" on page 2774](#)

["Calculate Peaks of Trace Data \(Remote Command Only\)" on page 2779](#)

[Hardware-Accelerated Fast Power Measurement \(Remote Command Only\)](#)

["Format Data: Numeric Data \(Remote Command Only\)" on page 2780](#)

["Format Data: Byte Order \(Remote Command Only\)" on page 2781](#)

Initial S/W Revision	Prior to A.02.00
----------------------	------------------

Measurement Group of Commands

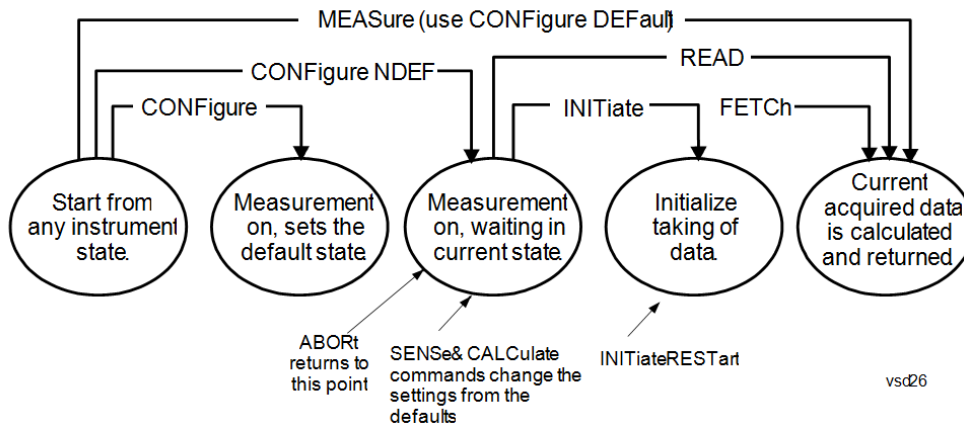

Measure Commands:

:MEASure:<measurement>[n]?

This is a fast single-command way to make a measurement using the factory default instrument settings. These are the settings and units that conform to the Mode Setup settings (e.g. radio standard) that you have currently selected.

- Stops the current measurement (if any) and sets up the instrument for the specified measurement using the factory defaults
- Initiates the data acquisition for the measurement
- Blocks other SCPI communication, waiting until the measurement is complete before returning results.
- If the function does averaging, it is turned on and the number of averages is set to 10.
- After the data is valid it returns the scalar results, or the trace data, for the specified measurement. The type of data returned may be defined by an [n] value that is sent with the command.
- The scalar measurement results will be returned if the optional [n] value is not included, or is set to 1. If the [n] value is set to a value other than 1, the selected trace data results will be returned. See each command for details of what types of scalar results or trace data results are available.
- ASCII is the default format for the data output. (Older versions of Spectrum Analysis and Phase Noise mode measurements only use ASCII.) The binary data formats should be used for handling large blocks of data since they are smaller and faster than the ASCII format. Refer to the FORMat:DATA command for more information.

If you need to change some of the measurement parameters from the factory default settings you can set up the measurement with the CONFIGure command. Use the commands in the SENSe:<measurement> and CALCulate:<measurement> subsystems to change the settings. Then you can use the READ? command to initiate the measurement and query the results.

If you need to repeatedly make a given measurement with settings other than the factory defaults, you can use the commands in the SENSe:<measurement> and CALCulate:<measurement> subsystems to set up the measurement. Then use the READ? command to initiate the measurement and query results.

Measurement settings persist if you initiate a different measurement and then return to a previous one. Use READ:<measurement>? if you want to use those persistent settings. If you want to go back to the default settings, use MEASure:<measurement>?.

Configure Commands:

:CONFigure:<measurement>

This command stops the current measurement (if any) and sets up the instrument for the specified measurement using

the factory default instrument settings. It does not initiate the taking of measurement data unless INIT:CONTinuous is ON. If you change any measurement settings after using the CONFigure command, the READ command can be used to initiate a measurement without changing the settings back to their defaults.

In the Swept SA measurement in Spectrum Analyzer mode the CONFigure command also turns the averaging function on and sets the number of averages to 10 for all measurements.

:CONFigure: <measurement>: NDEFault stops the current measurement and changes to the specified measurement. It does not change the settings to the defaults. It does not initiate the taking of measurement data unless INIT:CONTinuous is ON.

The CONFigure? query returns the current measurement name.

The CONFigure:CATalog? query returns a quoted string of all licensed measurement names in the current mode. For example, "SAN, CHP, OBW, ACP, PST, TXP, SPUR, SEM, LIST".

Fetch Commands:

:FETCh:<measurement>[n]?

This command puts selected data from the most recent measurement into the output buffer. Use FETCh if you have already made a good measurement and you want to return several types of data (different [n] values, for example, both scalars and trace data) from a single measurement. FETCh saves you the time of re-making the measurement. You can only FETCh results from the measurement that is currently active, it will not change to a different measurement. An error message is reported if a measurement other than the current one is specified.

If you need to get new measurement data, use the READ command, which is equivalent to an INITiate followed by a FETCh.

The scalar measurement results will be returned if the optional [n] value is not included, or is set to 1. If the [n] value is set to a value other than 1, the selected trace data results will be returned. See each command for details of what types of scalar results or trace data results are available. The binary data formats should be used for handling large blocks of data since they are smaller and transfer faster than the ASCII format. (FORMat:DATA)

FETCh may be used to return results other than those specified with the original READ or MEASure command that you sent.

INITiate Commands:

:INITiate:<measurement>

This command is not available for measurements in all the instrument modes:

- Initiates a trigger cycle for the specified measurement, but does not output any data. You must then use the FETCh<meas> command to return data. If a measurement other than the current one is specified, the instrument will switch to that measurement and then initiate it.
 - For example, suppose you have previously initiated the ACP measurement, but now you are running the channel power measurement. If you send INIT:ACP? it will change from channel power to ACP and will initiate an ACP measurement.
 - Does not change any of the measurement settings. For example, if you have previously started the ACP measurement and you send INIT:ACP? it will initiate a new ACP measurement using the same instrument settings as the last time ACP was run.
 - If your selected measurement is currently active (in the idle state) it triggers the measurement, assuming the trigger conditions are met. Then it completes one trigger cycle. Depending upon the measurement and the number of averages, there may be multiple data acquisitions, with multiple trigger events, for one full trigger cycle. It also holds off additional commands on GPIB until the acquisition is complete.
-

READ Commands:

:READ:<measurement>[n]?

- Does not preset the measurement to the factory default settings. For example, if you have previously initiated the ACP
-

measurement and you send READ:ACP? it will initiate a new measurement using the same instrument settings.

- Initiates the measurement and puts valid data into the output buffer. If a measurement other than the current one is specified, the instrument will switch to that measurement before it initiates the measurement and returns results.
 - For example, suppose you have previously initiated the ACP measurement, but now you are running the channel power measurement. Then you send READ:ACP? It will change from channel power back to ACP and, using the previous ACP settings, will initiate the measurement and return results.
 - Blocks other SCPI communication, waiting until the measurement is complete before returning the results
 - If the optional [n] value is not included, or is set to 1, the scalar measurement results will be returned. If the [n] value is set to a value other than 1, the selected trace data results will be returned. See each command for details of what types of scalar results or trace data results are available. The binary data formats should be used when handling large blocks of data since they are smaller and faster than the ASCII format. (FORMat:DATA)
-

Initial S/W Revision	Prior to A.02.00
----------------------	------------------

Current Measurement Query (Remote Command Only)

This command returns the name of the measurement that is currently running.

Remote Command	:CONFigure?
-----------------------	-------------

Example	CONF?
----------------	-------

Initial S/W Revision	Prior to A.02.00
----------------------	------------------

Limit Test Current Results (Remote Command Only)

Queries the status of the current measurement limit testing. It returns a 0 if the measured results pass when compared with the current limits. It returns a 1 if the measured results fail any limit tests.

Remote Command	:CALCulate:CLIMits:FAIL?
-----------------------	--------------------------

Example	CALC:CLIM:FAIL? queries the current measurement to see if it fails the defined limits. Returns a 0 or 1: 0 it passes, 1 it fails.
----------------	--

Initial S/W Revision	Prior to A.02.00
----------------------	------------------

Data Query (Remote Command Only)

Returns the designated measurement data for the currently selected measurement and subopcode.

n = any valid subopcode for the current measurement. See the measurement command results table for your current measurement, for information about what data is returned for the subopcodes.

This command uses the data setting specified by the FORMat:BORDER and FORMat:DATA commands and can return real or ASCII data. (See the format command descriptions under Input/Output in the Analyzer Setup section.)

Remote Command	:CALCulate:DATA[n]?
Notes	The return trace depends on the measurement. In CALCulate:<meas>:DATA[n], n is any valid subopcode for the current measurement. It returns the same data as the FETCH:<measurement>? query where <measurement> is the current measurement.
Initial S/W Revision	Prior to A.02.00

Calculate/Compress Trace Data Query (Remote Command Only)

Returns compressed data for the currently selected measurement and sub-opcode [n].

n = any valid sub-opcode for that measurement. See the MEASure:<measurement>? command description of your specific measurement for information on the data that can be returned.

The data is returned in the current Y Axis Unit of the analyzer. The command is used with a sub-opcode <n> (default=1) to specify the trace. With trace queries, it is best if the analyzer is not sweeping during the query. Therefore, it is generally advisable to be in Single Sweep, or Update=Off.

This command is used to compress or decimate a long trace to extract and return only the desired data. A typical example would be to acquire N frames of GSM data and return the mean power of the first burst in each frame. The command can also be used to identify the best curve fit for the data.

Remote Command	:CALCulate:DATA<n>:COMPRESS? BLOCK CFIT MAXimum MINimum MEAN DMEan RMS RMSCubed SAMPLE SDEVIation PPHase [,<soffset> [,<length>[,<roffset>[,<rlimit>]]]]
Example	To query the mean power of a set of GSM bursts: Supply a signal that is a set of GSM bursts. Select the IQ Waveform measurement (in IQ Analyzer Mode). Set the sweep time to acquire at least one burst. Set the triggers such that acquisition happens at a known position relative to a burst. Then query the mean burst levels using, CALC:DATA2:COMP? MEAN, 24e-6, 526e-6 (These parameter values correspond to GSM signals, where 526e-6 is the length of the burst in the slot and you just want 1 burst.)
Notes	The command supports 5 parameters. Note that the last 4 (<soffset>, <length>, <roffset>, <rlimit>) are optional. But these optional parameters must be entered in the specified order. For example, if you want to specify <length>, then you must also specify <soffset>. See details below for a definition of each of these parameters. This command uses the data in the format specified by FORMat:DATA, returning either binary or ASCII data.
Initial S/W Revision	Prior to A.02.00

- BLOCK or block data - returns all the data points from the region of the trace data that you specify. For example, it could be used to return the data points of an input signal over several timeslots, excluding the portions of the trace data that you do not want. (This is x,y pairs for trace data and I,Q pairs for complex data.)

- CFIT or curve fit - applies curve fitting routines to the data. <soffset> and <length> are required to define the data that you want. <roffset> is an optional parameter for the desired order of the curve equation. The query will return the following values: the x-offset (in seconds) and the curve coefficients ((order + 1) values).

MIN, MAX, MEAN, DME, RMS, RMSC, SAMP, SDEV and PPH return one data value for each specified region (or <length>) of trace data, for as many regions as possible until you run out of trace data (using <roffset> to specify regions). Or they return the number of regions you specify (using <rlimit>) ignoring any data beyond that.

- MINimum - returns the minimum data point (y value) for the specified region(s) of trace data. For I/Q trace data, the minimum magnitude of the I/Q pairs is returned.
- MAXimum - returns the maximum data point (y value) for the specified region(s) of trace data. For I/Q trace data, the maximum magnitude of the I/Q pairs is returned.
- MEAN - returns a single value that is the arithmetic mean of the data point values (in dB/ dBm) for the specified region(s) of trace data. For I/Q trace data, the mean of the magnitudes of the I/Q pairs is returned. See the following equations.

-

NOTE

If the original trace data is in dB, this function returns the arithmetic mean of those log values, not log of the mean power which is a more useful value. The mean of the log is the better measurement technique when measuring CW signals in the presence of noise. The mean of the power, expressed in dB, is useful in power measurements such as Channel Power. To achieve the mean of the power, use the RMS option.

Equation 1

Mean Value of Data Points for Specified Region(s)

$$\text{MEAN} = \frac{1}{n} \sum_{X_i \in \text{region}(s)} X_i$$

where X_i is a data point value, and n is the number of data points in the specified region(s).

Equation 2

Mean Value of I/Q Data Pairs for Specified Region(s)

$$\text{MEAN} = \frac{1}{n} \sum_{X_i \in \text{region}(s)} |X_i|$$

where $|X_i|$ is the magnitude of an I/Q pair, and n is the number of I/Q pairs in the specified region(s).

- DMEan - returns a single value that is the mean power (in dB/ dBm) of the data point values for the specified region(s) of trace data. See the following equation:

Equation 3

DMEan Value of Data Points for Specified Region(s)

$$\text{DME} = 10 \times \log_{10} \left(\frac{1}{n} \sum_{X_i \in \text{region}(s)} 10^{\frac{X_i}{10}} \right)$$

- RMS - returns a single value that is the average power on a root-mean-squared voltage scale (arithmetic rms) of the data point values for the specified region(s) of trace data. See the following equation.

NOTE For I/Q trace data, the rms of the magnitudes of the I/Q pairs is returned. See the following equation. This function is very useful for I/Q trace data. However, if the original trace data is in dB, this function returns the rms of the log values which is not usually needed.

Equation 4

RMS Value of Data Points for Specified Region(s)

$$\text{RMS} = \sqrt{\frac{1}{n} \sum_{X_i \in \text{region}(s)} X_i^2}$$

where X_i is a data point value, and n is the number of data points in the specified region(s).

Equation 5

RMS Value of I/Q Data Pairs for Specified Region(s)

$$\text{RMS} = \sqrt{\frac{1}{n} \sum_{X_i \in \text{region}(s)} X_i X_i^*}$$

where X_i is the complex value representation of an I/Q pair, X_i^* its conjugate complex number, and n is the number of I/Q pairs in the specified region(s).

Once you have the rms value for a region of trace data (linear or I/Q), you may want to calculate the mean power. You must convert this rms value (peak volts) to power in dBm:

$$10 \times \log[10 \times (\text{rms value})^2]$$

- SAMPlE - returns the first data value (x,y pair) for the specified region(s) of trace data. For I/Q trace data, the first I/Q pair is returned.
- SDEViation - returns a single value that is the arithmetic standard deviation for the data point values for the specified region(s) of trace data. See the following equation.
- For I/Q trace data, the standard deviation of the magnitudes of the I/Q pairs is returned. See the following equation.

Equation 6

Standard Deviation of Data Point Values for Specified Region(s)

$$\text{SDEV} = \sqrt{\frac{1}{n} \sum_{X_i \in \text{region}(s)} (X_i - \bar{X})^2}$$

where X_i is a data point value, \bar{X} is the arithmetic mean of the data point values for the specified region (s), and n is the number of data points in the specified region(s).

$$\text{SDEV} = \sqrt{\frac{1}{n} \sum_{X_i \in \text{region}(s)} (|X_i| - \bar{X})^2}$$

where $|X_i|$ is the magnitude of an I/Q pair, \bar{X} is the mean of the magnitudes for the specified region(s), and n is the number of data points in the specified region(s).

- PPHase - returns the x,y pairs of both rms power (dBm) and arithmetic mean phase (radian) for every specified region and frequency offset (Hz). The number of pairs is defined by the specified number of regions. This parameter can be used for I/Q vector ($n=0$) in Waveform (time domain) measurement and all parameters are specified by data point in PPHase.

The rms power of the specified region may be expressed as:

$$\text{Power} = 10 \times \log [10 \times (\text{RMS I/Q value})] + 10.$$

The RMS I/Q value (peak volts) is:

$$\sqrt{\frac{1}{n} \sum_{X_i \in \text{region}} X_i X_i^*}$$

where X_i is the complex value representation of an I/Q pair, X_i^* its conjugate complex number, and n is the number of I/Q pairs in the specified region.

The arithmetic mean phase of the specified region may be expressed as:

$$\frac{1}{n} \sum_{Y_i \in \text{region}} Y_i$$

where Y_i is the unwrapped phase of I/Q pair with applying frequency correction and n is the number of I/Q pairs in the specified region.

The frequency correction is made by the frequency offset calculated by the arithmetic mean of every specified region's frequency offset. Each frequency offset is calculated by the least square method against the unwrapped phase of I/Q pair.

Sample Trace Data - Constant Envelope

(See below for explanation of variables.)

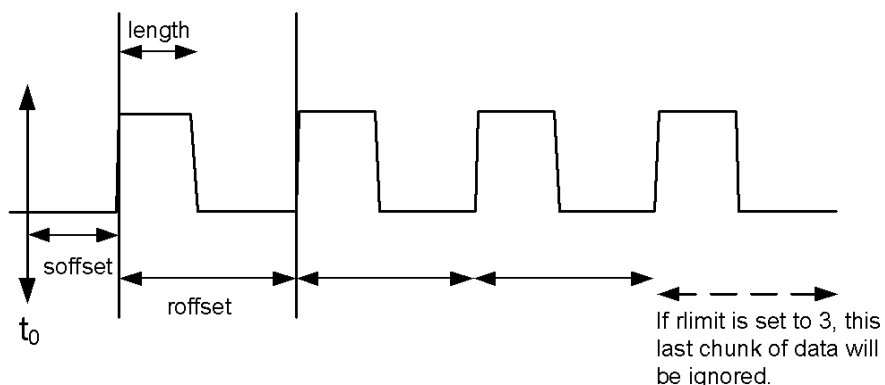

Sample Trace Data - Not Constant Envelope

(See below for explanation of variables.)

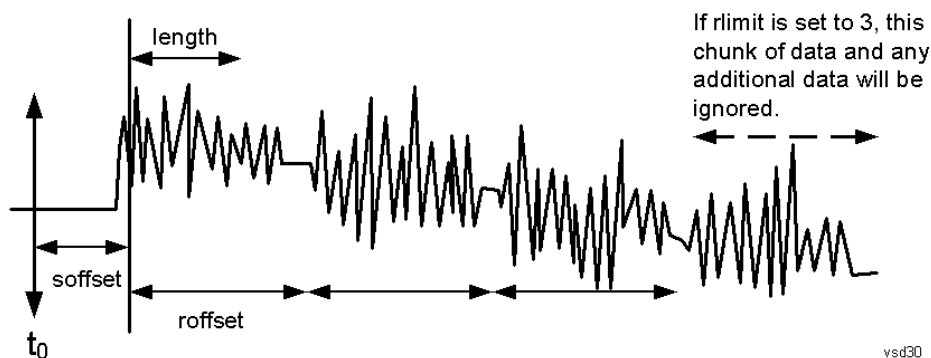

<soffset> - start offset is an optional real number. (It is in seconds for time-domain traces, and is a dimensionless index 0 to Npoints - 1, for frequency-domain traces). It specifies the amount of data at the beginning of the trace that will be ignored before the decimation process starts. It is the time or frequency change from the start of the trace to the point where you want to start using the data. The default value is zero.

<length> - is an optional real number. (It is in seconds for time-domain traces, and is a dimensionless index 0 to Npoints - 1, for frequency-domain traces). It defines how much data will be compressed into one value. This parameter has a default value equal to the current trace length.

<roffset> - repeat offset is an optional real number. (It is in seconds for time-domain traces, and is a dimensionless index 0 to Npoints - 1, for frequency-domain traces). It defines the beginning of the next field of trace elements to be compressed. This is relative to the beginning of the previous field. This parameter has a default value equal to the <length> variable. Note that this parameter is used for a completely different purpose when curve fitting (see CFIT above).

<rlimit> - repeat limit is an optional integer. It specifies the number of data items that you want returned. It will ignore any additional items beyond that number. You can use the Start offset and the Repeat limit to pick out exactly what part of the data you want to use. The default value is all the data.

Calculate Peaks of Trace Data (Remote Command Only)

Returns a list of all the peaks for the currently selected measurement and sub-opcode [n]. The peaks must meet the requirements of the peak threshold and excursion values.

n = any valid sub-opcode for the current measurement. See the MEASure:<measurement> command description of your specific measurement for information on the data that can be returned.

The command can only be used with specific sub-opcodes with measurement results that are trace data. Both real and complex traces can be searched, but complex traces are converted to magnitude in dBm. In many measurements the sub-opcode n=0, is the raw trace data which cannot be searched for peaks. And Sub-opcode n=1, is often calculated results values which also cannot be searched for peaks.

This command uses the data setting specified by the FORMat:BORDER and FORMat:DATA commands and can return real or ASCII data. If the format is set to INT,32, it returns REAL,32 data.

The command has four types of parameters:

- Threshold (in dBm)
- Excursion (in dB)
- Sorting order (amplitude, frequency, time)
- Optional in some measurements: Display line use (all, > display line, < display line)

Remote Command	<p>For Swept SA measurement:</p> <pre>:CALCulate:DATA[1] 2 ... 6:PEAKs? <threshold>,<excursion>[,AMPLitude FREQuency TIME[,ALL GTDLline LTDLine]]</pre> <p>For most other measurements:</p> <pre>:CALCulate:DATA[1] 2 ... 6:PEAKs? <threshold>,<excursion>[,AMPLitude FREQuency TIME]</pre>
-----------------------	---

Example	<p>Example for Swept SA measurement in Spectrum Analyzer Mode:</p> <p>CALC:DATA4:PEAK? -40, 10, FREQ, GTDL This will identify the peaks of trace 4 that are above -40 dBm, with excursions of at least 10 dB. The peaks are returned in order of increasing frequency, starting with the lowest frequency. Only the peaks that are above the display line are returned.</p> <p>Query Results 1:</p> <p>With FORMat:DATA REAL, 32 selected, it returns a list of floating-point numbers. The first value in the list is the number of peak points that are in the following list. A peak point consists of two values: a peak amplitude followed by its corresponding frequency (or time).</p> <p>If no peaks are found the peak list will consist of only the number of peaks, (0).</p>
----------------	---

Notes	<p><n> - is the trace that will be used</p> <p><threshold> - is the level below which trace data peaks are ignored. Note that the threshold value is required and is always used as a peak criterion. To effectively disable the threshold criterion for this command, provide a substantially low threshold value such as -200 dBm. Also note that the threshold value used in this command is independent of and has no effect on the threshold value stored under the Peak Criteria menu.</p> <p><excursion> - is the minimum amplitude variation (rise and fall) required for a signal to be identified as peak. Note that the excursion value is required and is always used as a peak criterion. To effectively disable the excursion criterion for this command, provide the minimum value of 0.0 dB. Also note that the excursion value used in this command is independent of and has no effect on the</p>
--------------	---

excursion value stored under the Peak Criteria menu.

Values must be provided for threshold and excursion. The sorting and display line parameters are optional (defaults are AMPLitude and ALL).

Note that there is always a Y-axis value for the display line, regardless of whether the display line state is on or off. It is the current Y-axis value of the display line which is used by this command to determine whether a peak should be reported

Sorting order:

AMPLitude - lists the peaks in order of descending amplitude, with the highest peak first (default if optional parameter not sent)

FREQuency - lists the peaks in order of occurrence, left to right across the x-axis.

TIME - lists the peaks in order of occurrence, left to right across the x-axis.

Peaks vs. Display Line:

ALL - lists all of the peaks found (default if optional parameter not sent).

GTDLine (greater than display line) - lists all of the peaks found above the display line.

LTDLine (less than display line) - lists all of the peaks found below the display line.

Initial S/W Revision Prior to A.02.00

Format Data: Numeric Data (Remote Command Only)

This command specifies the format of the trace data input and output. It specifies the formats used for trace data during data transfer across any remote port. It affects only the data format for setting and querying trace data for the :TRACe[:DATA], TRACe[:DATA]?, :CALCulate:DATA[n]? and FETCh:SANalyzer [n]? commands and queries.

Remote Command :FORMat [:TRACe] [:DATA] ASCii|INTeger,32|REAL,32 |REAL,64
:FORMat [:TRACe] [:DATA] ?

Notes The query response is:
ASCii: ASC,8
REAL,32: REAL,32
REAL,64: REAL,64
INTeger,32: INT,32

When the numeric data format is REAL or ASCii, data is output in the current Y Axis unit. When the data format is INTeger, data is output in units of m dBm (.001 dBm).

The INT,32 format returns binary 32-bit integer values in internal units (m dBm), in a definite length block.

Dependencies Sending a data format spec with an invalid number (for example, INT,48) generates no error. The analyzer simply uses the default (8 for ASCii, 32 for INTeger, 32 for REAL).

Sending data to the analyzer which does not conform to the current FORMat specified, results in an error. Sending ASCII data when a definite block is expected generates message -161 "Invalid Block Data" and sending a definite block when ASCII data is expected generates message -121 "Invalid Character in Number".

Preset ASCii

Backwards Compatibility Notes Note that the INT,32 format is only applicable to the command, TRACe:DATA. This preserves backwards compatibility for the Swept SA measurement. For all other commands/queries which honor FORMat:DATA, if INT,32 is sent the analyzer will behave as though it were set to REAL,32.

Initial S/W Revision Prior to A.02.00

The specs for each output type follow:

ASCIi - Amplitude values are in ASCII, in the current Y Axis Unit, one ASCII character per digit, values separated by commas, each value in the form:

SX.YYYYYEsZZ

Where:

S = sign (+ or -)

X = one digit to left of decimal point

Y = 5 digits to right of decimal point

E = E, exponent header

s = sign of exponent (+ or -)

ZZ = two digit exponent

REAL,32 - Binary 32-bit real values in the current Y Axis Unit, in a definite length block.

REAL,64 - Binary 64-bit real values in the current Y Axis Unit, in a definite length block.

Format Data: Byte Order (Remote Command Only)

This command selects the binary data byte order for data transfer and other queries. It controls whether binary data is transferred in normal or swapped mode. This command affects only the byte order for setting and querying trace data for the :TRACe[:DATA], TRACe[:DATA]? , :CALCulate:DATA[n]? and FETCh:SANalyzer[n]? commands and queries.

By definition any command that says it uses FORMat:DATA uses any format supported by FORMat:DATA.

The NORMal order is a byte sequence that begins with the most significant byte (MSB) first, and ends with the least significant byte (LSB) last in the sequence: 1|2|3|4. SWAPPed order is when the byte sequence begins with the LSB first, and ends with the MSB last in the sequence: 4|3|2|1.

Remote Command	:FORMat:BORDER NORMal SWAPPed :FORMat:BORDER?
Preset	NORMal
Initial S/W Revision	Prior to A.02.00

Meas Setup

Displays the setup menu for the current measurement. The measurement setup parameters include the number of measurement averages used to calculate the measurement result and the averaging mode. The setup menu also includes the option to reset the measurement settings to their factory defaults.

Key Path	Front-panel key
Initial S/W Revision	Prior to A.02.00

Avg/Hold Num

Specifies the number of measurement averages used when calculating the measurement result. The average is displayed at the end of each sweep.

After the specified number of average counts, the averaging mode (terminal control) setting determines the averaging action.

Key Path	Meas Setup
Mode	All except SA and BASIC
Remote Command	[:SENSe]:MONitor:AVERage:COUNT <integer> [:SENSe]:MONitor:AVERage:COUNT? [:SENSe]:MONitor:AVERage[:STATe] OFF ON 0 1 [:SENSe]:MONitor:AVERage[:STATe]?
Example	MON:AVER:COUN 25 MON:AVER:COUN? MON:AVER ON MON:AVER?
Preset	10 OFF
State Saved	Saved in instrument state.
Min	1
Max	1000
Initial S/W Revision	Prior to A.02.00

Avg Mode

Toggles the average mode between exponential (Exp) and Repeat.

- **Exp**– continues measurement averaging, using the specified number of averages to compute each averaged value. The average is displayed at the end of each sweep.
- **Repeat**– causes the measurement to reset the average counter each time the specified number of averages is reached.

Key Path	Meas Setup
Mode	All except SA and BASIC
Remote Command	[:SENSe]:MONitor:AVERage:TCONtrol EXPonential REPeat [:SENSe]:MONitor:AVERage:TCONtrol?
Example	MON:AVER:TCON EXP MON:AVER:TCON?
Preset	EXPonential
State Saved	Saved in instrument state.
Range	ExpRepeat
Initial S/W Revision	Prior to A.02.00

Meas Preset

Restores all the measurement parameters to their default values.

Key Path	Meas Setup
Mode	All except SA and BASIC
Remote Command	:CONFigure:MONitor
Example	CONF:MON
Initial S/W Revision	Prior to A.02.00

16 Monitor Spectrum Measurement
Mode

Mode

See "[Mode](#)" on page 316

Mode Preset

Returns the active mode to a known state.

Mode Preset does the following for the currently active mode:

- Aborts the currently running measurement.
- Brings up the default menu for the mode, with no active function.
- Sets measurement Global settings to their preset values for the active mode only.
- Activates the default measurement.
- Brings up the default menu for the mode.
- Clears the input and output buffers.
- Sets Status Byte to 0.

Mode Preset does not:

- Cause a mode switch
- Affect mode persistent settings
- Affect system settings

See "[How-To Preset](#)" on page 2442 for more information.

Key Path	Front-panel key
Remote Command	:SYSTem:PRESet
Example	:SYST:PRES
Notes	*RST is preferred over :SYST:PRES for remote operation. *RST does a Mode Preset, as done by the :SYST:PRES command, and it sets the measurement mode to Single measurement rather than Continuous for optimal remote control throughput. Clears all pending OPC bits. The Status Byte is set to 0.
Couplings	A Mode Preset aborts the currently running measurement, activates the default measurement, and gets the mode to a consistent state with all of the default couplings set.
Backwards Compatibility Notes	In the X-Series, the legacy "Factory Preset" has been replaced with Mode Preset, which only presets the currently active mode, not the entire instrument. In the X-Series, the way to preset the entire instrument is by using System, Restore System Defaults All, which behaves essentially the same way as restore System Defaults does on ESA and PSA. There is also no "Preset Type" as there is on the PSA. There is a green Mode Preset front-panel key that does a Mode Preset and a white-with-green-letters User Preset front-panel key that does a User Preset. The old PRESet:TYPE command is ignored (without generating an error), and SYST:PRES without a parameter does a Mode Preset, which should cover most backward code compatibility issues. The settings and correction data under the Input/Output front-panel key (examples: Input Z Corr, Ext Amp Gain, etc.) are no longer part of any Mode, so they will not be preset by a Mode Preset. They are preset using Restore Input/Output Defaults, Restore System Defaults All. Note that because User Preset does a Recall State, and all of these settings are saved in State, they ARE recalled when using

	User Preset.
Initial S/W Revision	Prior to A.02.00

How-To Preset

The table below shows all possible presets, their corresponding SCPI commands and front-panel access (key paths). Instrument settings depend on the current measurement context. Some settings are local to the current measurement, some are global (common) across all the measurements in the current mode, and some are global to all the available modes. In a similar way, restoring the settings to their preset state can be done within the different contexts.

Auto Couple - is a measurement local key. It sets all Auto/Man parameter couplings in the measurement to Auto. Any Auto/Man selection that is local to other measurements in the mode will not be affected.

Meas Preset - is a measurement local key. Meas Preset resets all the variables local to the current measurement except the persistent ones.

Mode Preset - resets all the current mode's measurement local and measurement global variables except the persistent ones.

Restore Mode Defaults - resets ALL the Mode variables (and all the Meas global and Meas local variables), including the persistent ones.

Type Of Preset	SCPI Command	Front Panel Access
Auto Couple	:COUPle ALL	Auto Couple front-panel key
Meas Preset	:CONFigure:<Measurement>	Meas Setup Menu
Mode Preset	:SYSTem:PRESet	Mode Preset (green key)
Restore Mode Defaults	:INSTrument:DEFault	Mode Setup Menu
Restore All Mode Defaults	:SYSTem:DEFault MODes	System Menu; Restore System Default Menu
*RST	*RST	not possible (Mode Preset with Single)
Restore Input/Output Defaults	:SYSTem:DEFault INPUt	System Menu; Restore System Default Menu
Restore Power On Defaults	:SYSTem:DEFault PON	System Menu; Restore System Default Menu
Restore Alignment Defaults	:SYSTem:DEFault ALIGN	System Menu; Restore System Default Menu
Restore Miscellaneous Defaults	:SYSTem:DEFault MISC	System Menu; Restore System Default Menu
Restore All System Defaults	:SYSTem:DEFault [ALL] :SYSTem:PRESet:PERsistent	System Menu; Restore System Default Menu
User Preset	:SYSTem:PRESet:USER	User Preset Menu
User Preset All Modes	:SYSTem:PRESet:USER:ALL	User Preset Menu

Power On Mode Preset	:SYSTem:PON:TYPE MODE	System Menu
Power On User Preset	:SYSTem:PON:TYPE USER	System Menu
Power On Last State	:SYSTem:PON:TYPE LAST	System Menu

Preset Type (Remote Command Only)

As stated in the Backward Compatibility section, to be compatible with ESA/PSA the PRESet:TYPE command will be implemented as a no-op.

Mode	All
Remote Command	:SYSTem:PRESet:TYPE FACTory MODE USER :SYSTem:PRESet:TYPE?
Example	:SYST:PRESet:TYPE FACT
Notes	This command is supported for backward compatibility only. It is a no-op which does not change the behavior of any preset operation.
Preset	This is unaffected by Preset but is set to Mode on a “Restore System Defaults->All”
State Saved	No
Initial S/W Revision	Prior to A.02.00

Mode Setup

See "[Mode Setup](#)" on page 347

Peak Search

Places the selected marker on the trace point with the maximum y-axis value for that marker's trace. Pressing Peak Search with the selected marker off causes the selected marker to be set to Normal, then a peak search is immediately performed.

Key Path	Front-panel key
Mode	All except SA and BASIC
Remote Command	:CALCulate:MONitor:MARKer[1] 2 ... 12:MAXimum
Example	CALC:MON:MARK2:MAX
Initial S/W Revision	Prior to A.02.00

16 Monitor Spectrum Measurement
Print

Print

See ["Print" on page 365](#)

Quick Save

The Quick Save front-panel key repeats the most recent save that was performed from the Save menu, with the following exceptions:

- Register saves are not remembered as Saves for the purpose of the Quick Save function
- If the current measurement does not support the last non-register save that was performed, an informational message is generated, “File type not supported for this measurement”

Quick Save repeats the last type of qualified save (that is, a save qualified by the above criteria) in the last save directory by creating a unique filename using the Auto File Naming algorithm described below.

If Quick Save is pressed after startup and before any qualified Save has been performed, the Quick Save function performs a Screen Image save using the current settings for Screen Image saves (current theme, current directory), which then becomes the “last save” for the purpose of subsequent Quick Saves.

The Auto File Naming feature automatically generates a file name for use when saving a file. The filename consists of a prefix and suffix separated by a dot, as is standard for the Windows® file system. A default prefix exists for each of the available file types:

Type	Default Prefix	Menu
State	State_	(Save/Recall)
Trace + State	State_	(Save/Recall)
Screen	Screen_	(Save/Recall)
Amplitude Corrections	Ampcor_	(Import/Export)
Traces	Trace_	(Import/Export)
Limit Lines	LLine_	(Import/Export)
Measurement Result	MeasR_	(Import/Export)
Capture Buffer	CapBuf_	(Import/Export)

A four digit number is appended to the prefix to create a unique file name. The numbering sequence starts at 0000 within each Mode for each file type and updates incrementally to 9999, then wraps to 0000 again. It remembers where it was through a Mode Preset and when leaving and returning to the Mode. It is reset by Restore Misc Defaults and Restore System Defaults and subsequent running of the instrument application. So, for example, the first auto file name generated for State files is State_0000.state. The next is State_0001, and so forth.

One of the key features of Auto File Name is that we guarantee that the Auto File Name will never conflict with an existing file. The algorithm looks for the next available number. If it gets to 9999, then it looks for holes. If it find no holes, that is no more numbers are available, it gives an error.

For example, if when we get to State_0010.state there is already a State_0010.state file in the current directory, it advances the counter to State_0011.state to ensure that no conflict will exist (and then it verifies that State_0011.state also does not exist in the current directory and advances again if it does, and so forth).

If you enter a file name for a given file type, then the prefix becomes the filename you entered instead of the default prefix, followed by an underscore. The last four letters (the suffix) are the 4-digit number.

For example, if you save a measurement results file as “fred.csv”, then the next auto file name chosen for a measurement results save will be fred_0000.csv.

NOTE

Although 0000 is used in the example above, the number that is used is actually the current number in the Meas Results sequence, that is, the number that would have been used if you had not entered your own file name.

NOTE

If the filename you entered ends with _dddd, where d=any number, making it look just like an auto file name, then the next auto file name picks up where you left off with the suffix being dddd + 1.

Key Path	Front-panel key
Notes	No remote command for this key specifically.
Initial S/W Revision	Prior to A.02.00

Recall

In the LTE TDD mode, four types of recall functions are available under the Data menu: “Limit Mask”, “E-UTRA Test Model”, “Signal Studio Setup” and “Vector Signal Analyzer”. “Limit Mask” enables setting of a preset limit mask for Power Suite-based measurements, and currently it is available for the SEM/ACP measurements with the LTE TDD mode. Recalling “E-UTRA Test Model” sets complicated RB settings for each Test Model for the Modulation Analysis and Conformance EVM measurements. Recalling “Signal Studio Setup” or “89600 Vector Signal Analyzer” enables you to recall parameters which have been set and saved on the external platform.

Key Path	Front Panel
Mode	LTETDD
Initial S/W Revision	Prior to A.02.00
Modified at S/W Revision	A.06.00

State

The Recall State menu lets you choose a register or file from which to recall the state.

The content of a state file includes all of the settings and data required to return the analyzer as closely as possible to the Mode it was in, with the exact settings that were in place, when the save occurred. The Mode settings in each state file include the settings that are affected by Mode Preset, as well as the additional settings affected by Restore Mode Defaults; all of the Mode’s settings. In addition, all of the settings of the Input/Output system are included, even though they are outside of the Mode’s state, because they are needed to restore the complete setup. Persistent System settings (for example, GPIB address) are not affected by either a Mode Preset or Restore Mode Defaults, nor are they included in a saved State file.

Since each state file is only for one Mode, the settings for other Modes are unaffected when it is loaded. Recall State will cause a mode switch if the state being recalled is not from the current active mode.

After the recall completes, the message "File <filename> recalled" or “Recalled State Register <register number>” is displayed.

For rapid recalls, the State menu lists 16 registers that you can choose from to recall. Pressing a Register key initiates the recall. You can also select a file from which to recall.

The default path for all State Files is:

My Documents\<<mode name>\state

where <mode name> is the parameter used to select the mode with the INST:SEL command (for example, SA for the Spectrum Analyzer).

See "[More Information](#)" on page 2450.

Key Path	Recall
Mode	All

Remote Command	:MMEMory:LOAD:STATe <filename>
Example	:MMEM:LOAD:STAT "myState.state" This recalls the file myState.state on the default path
Example	MMEM:LOAD:STAT "MyStateFile.state" This loads the state file data (on the default file directory path) into the instrument state.
Notes	<p>When you pick a file to recall, the analyzer first verifies that the file is recallable in the current instrument by checking the software version and model number of the instrument. If everything matches, a full recall proceeds by aborting the currently running measurement, clearing any pending operations, and then loading the State from the saved state file. You can open state files from any mode, so recalling a State file switches to the mode that was active when the save occurred. After switching to the mode of the saved state file, mode settings and data (if any for the mode) are loaded with values from the saved file. The saved measurement of the mode becomes the newly active measurement and the data relevant to the measurement (if there is any) is recalled.</p> <p>If there is a mismatch between file version or model number or instrument version or model number, the recall function tries to recall as much as possible and returns a warning message. It may limit settings that differ based on model number, licensing or version number.</p> <p>After recalling the state, the Recall State function does the following:</p> <ul style="list-style-type: none"> • Makes the saved measurement for the mode the active measurement. • Clears the input and output buffers. • Status Byte is set to 0. • Executes a *CLS <p>If the file specified is empty an error is generated. If the specified file does not exist, another error is generated. If there is a mismatch between the file and the proper file type, an error is generated. If there is a mismatch between file version or model number or instrument version or model number, a warning is displayed. Then it returns to the State menu and File Open dialog goes away.</p> <p>After the Recall, the analyzer exits the Recall menu and returns to the previous menu.</p>
Backwards Compatibility SCPI	:MMEMory:LOAD:STATe 1,<filename> For backwards compatibility, the above syntax is supported. The "1" is simply ignored.
Initial S/W Revision	Prior to A.02.00

More Information

In measurements that support saving Traces, for example, Swept SA, the Trace data is saved along with the State in the State file. When recalling the State, the Trace data is recalled as well. Traces are recalled exactly as they were stored, including the writing mode and update and display modes. If a Trace was updating and visible when the State was saved, it will come back updating and visible, and its data will be rewritten right away. When you use State to save and recall traces, any trace whose data must be preserved should be placed in View or Blank mode before saving.

The following table describes the Trace Save and Recall possibilities:

You want to recall state and one trace's data, leaving other traces unaffected.	Save Trace+State from 1 trace. Make sure that no other traces are updating (they should all be in View	On Recall, specify the trace you want to load the one trace's data into. This trace will load in View.
---	---	--

	or Blank mode) when the save is performed.	All other traces' data will be unaffected, although their trace mode will be as it was when the state save was performed.
You want to recall all traces	Save Trace+State from ALL traces.	On Recall, all traces will come back in View (or Blank if they were in Blank or Background when saved)
You want all traces to load exactly as they were when saved.	Save State	On recall, all traces' mode and data will be exactly as they were when saved. Any traces that were updating will have their data immediately overwritten.

From File...

When you press “From File”, the analyzer brings up a Windows dialog and a menu entitled “File Open.” This menu allows you to navigate to the various fields in the Windows dialog without using a keyboard or mouse. The Tab and Arrow keys can also be used for dialog navigation.

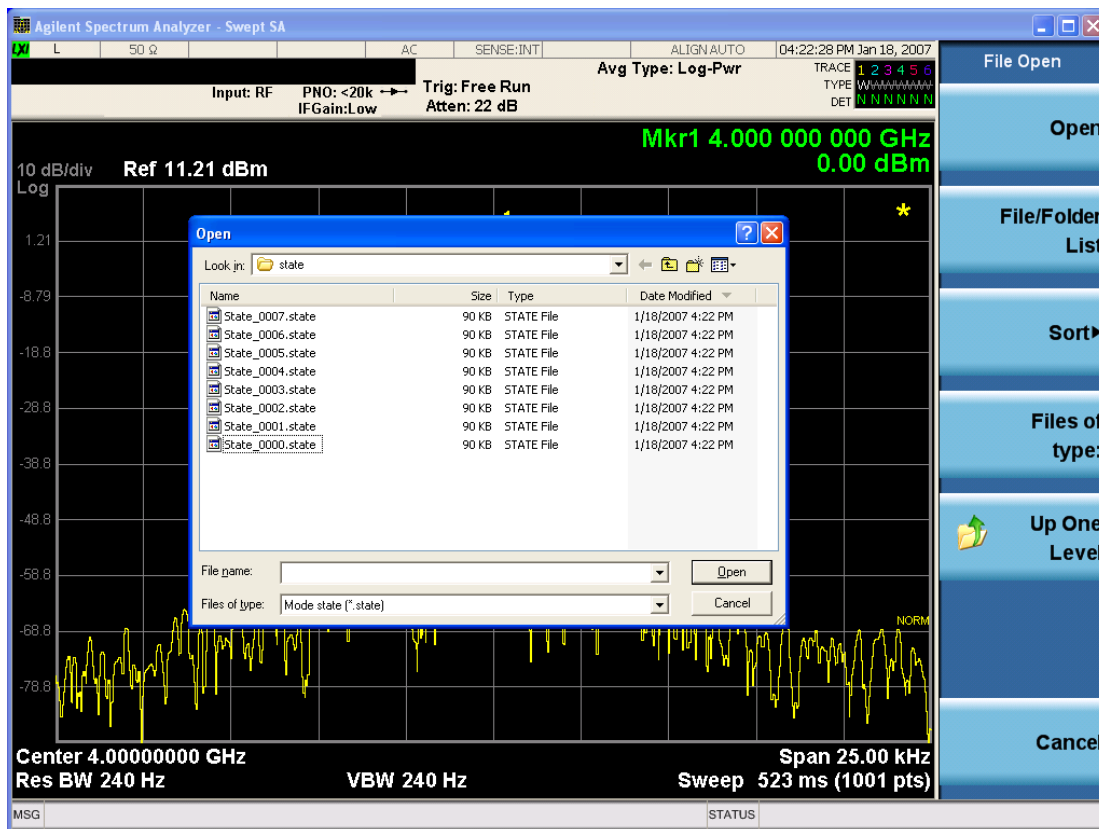

Listed below are the functions of the various fields in the dialog, and the corresponding softkeys:

Open

Performs the recall of the specified file. While the recall is being performed, the floppy icon appears briefly in the Meas bar.

File/Folder List

Enables you to navigate to the center of the dialog that contains the list of files and folders. Once here you can get information about the file and use the tab keys to navigate to the other fields in the dialog, such as Look In.

Look In

The Look In field shows the path from which the file will be recalled and allows you to change the path using the up and down arrow keys to navigate to other paths; the Enter key to open a directory; and the Backspace key to go back one directory. The **Look In field** first uses the last path from the Save As dialog **Save In:** path for that same file type. There is no softkey for directly navigating to the Look In field, but you can use the left tab to get here from the File/Folder List.

User specified paths are remembered when you leave and return to a Mode and are reset back to the default using Restore Mode Defaults.

Sort

Accesses a menu that enables you to sort the files within the File Open dialog. Only one sorting type can be selected at a time and the sorting happens immediately. The sorting types are By Date, By Name, By extension, and By Size.

Files of Type

This field shows the file suffix for the type of file you have selected to recall. For example, if you navigated here while recalling State, "Mode state (*.state)" is in the field. If you navigated here while recalling Trace, ""Mode state (*.trace)" is in the field. If you navigated here while importing a trace data file, "Trace Data (*.csv)" is in the field. For some file types, there is more than one choice in the dropdown menu, which you can select by using the up and down arrow keys and Enter.

Up One Level

This key corresponds to the icon of a folder with the up arrow that is in the tool bar of the dialog. When pressed, it causes the file and folder list to navigate up one level in the directory structure. The Backspace key does the same thing.

Cancel

This key corresponds to the Cancel selection in the dialog. It causes the current **Open** request to be cancelled. The ESC key does the same thing.

Key Path	Recall, State
Notes	Brings up the Open dialog for recalling a State Save Type
Initial S/W Revision	Prior to A.02.00

Edit Register Names

You may enter a custom name on any of the Register keys, to help you remember what you are using that state to save. To do this, press the Edit Register Names key, choose the register whose name you wish to edit, and then enter the desired label using the Alpha Editor or an external PC keyboard.

The maximum number of characters that can be added is 30. In most cases, 30 characters will fit on two lines of the key.

For more information and the SCPI command, see Edit Register Names under the Save, State function.

Key Path	Recall, State
Mode	All
Dependencies	N9060A-7FP or N9060B-2FP license required to edit the register names. When the feature is not licensed, sending the SCPI command generates an error, -221, "Settings conflict;Option not available"
Initial S/W Revision	A.11.00

Register 1 thru Register 16

Selecting any one of these register keys causes the State of the mode from the specified Register to be recalled. Each of the register keys annotates whether it is empty or at what date and time it was last modified. In addition, you can use the Edit Register Names key under Save, State to enter custom names for each register.

Registers are shared by all modes, so recalling from any one of the registers will cause a mode switch to the mode that was active when the save to the Register occurred.

Although these 16 registers are the only registers available from the front panel, there are 128 state registers available in the instrument. Registers 17-128 are only available from the SCPI interface, using the *RCL command.

After the recall completes, the message "Register <register number> recalled" appears in the message bar. If you are in the Spectrum Analyzer Mode, and you are recalling a register that was saved in the Spectrum Analyzer Mode, then after the recall, you will still be in the Recall Register menu. If the Recall causes you to switch modes, then after the Recall, you will be in the Frequency menu.

If a requested register is empty an error is generated.

Key Path	Recall, State
Example	*RCL 1
Range	1-16 from front panel, 1-128 from SCPI
Readback	Date and time with seconds resolution are displayed on the key OR A custom name of up to 30 characters entered using the Save, State,Edit Register Names key OR “(empty)” if no prior save operation has been performed to this register.
Initial S/W Revision	Prior to A.02.00
Modified at S/W Revision	Prior to A.11.00

Register 1 thru Register 16

Selecting any one of these register keys causes the State of the mode from the specified Register to be recalled. Each of the register keys annotates whether it is empty or at what date and time it was last modified. In addition, you can use the Edit Register Names key under Save, State to enter custom names for each register.

Registers are shared by all modes, so recalling from any one of the registers will cause a mode switch to the mode that was active when the save to the Register occurred.

Although these 16 registers are the only registers available from the front panel, there are 128 state registers available in the instrument. Registers 17–128 are only available from the SCPI interface, using the *RCL command.

After the recall completes, the message "Register <register number> recalled" appears in the message bar. If you are in the Spectrum Analyzer Mode, and you are recalling a register that was saved in the Spectrum Analyzer Mode, then after the recall, you will still be in the Recall Register menu. If the Recall causes you to switch modes, then after the Recall, you will be in the Frequency menu.

If a requested register is empty an error is generated.

Key Path	Recall, State
Example	*RCL 1
Range	1–16 from front panel, 1–128 from SCPI
Readback	Date and time with seconds resolution are displayed on the key OR A custom name of up to 30 characters entered using the Save, State, Edit Register Names key OR “(empty)” if no prior save operation has been performed to this register.
Initial S/W Revision	Prior to A.02.00
Modified at S/W Revision	Prior to A.11.00

Recall

In the LTE TDD mode, four types of recall functions are available under the Data menu: “Limit Mask”, “E-UTRA Test Model”, “Signal Studio Setup” and “Vector Signal Analyzer”. “Limit Mask” enables setting of a preset limit mask for Power Suite-based measurements, and currently it is available for the SEM/ACP measurements with the LTE TDD mode. Recalling “E-UTRA Test Model” sets complicated RB settings for each Test Model for the Modulation Analysis and Conformance EVM measurements. Recalling “Signal Studio Setup” or “89600 Vector Signal Analyzer” enables you to recall parameters which have been set and saved on the external platform.

Key Path	Front Panel
Mode	LTETDD
Initial S/W Revision	Prior to A.02.00
Modified at S/W Revision	A.06.00

Import Trace Data

Enables you to import previously saved trace data into a Data Register and optionally display it. Selecting this key displays a menu that enables you to select the destination data register, and also enables you to choose whether or not to display the recalled data in the currently selected trace. After making these selections, select Open... and use the file dialog to select the file you want to recall.

Recalling trace data into an already used Data Register overwrites the previous data. If the data register is displayed on any trace, the display is updated to reflect the new data.

The SCPI command

```
:MMEM:LOAD:TRAC:DATA D1|D2|D3|D4|D5|D6,<filename>
```

recalls data into a specified register, but does not display it in the selected trace. Use the command

```
:DISP:<meas>:TRAC<n>:FEED D1|D2|D3|D4|D5|D6
```

to display the register in the desired trace.

It is possible to recall trace data saved by other VXA measurements, or measurements made using the LTE, LTETDD, iDEN, or 89601 applications.

Key Path	Recall, Data (Import)
Mode	VSA, LTE, LTETDD, IDEN
Remote Command	:MMEMory:LOAD:TRACe:DATA D1 D2 D3 D4 D5 D6,<filename>[,CSV TXT SDF MAT4 MAT HDF5 BIN]
Example	:MMEM:LOAD:TRAC:DATA D1,"Trc1.txt",TXT
Notes	<p>The Open: dialog box has the following filter options when you are recalling trace data::</p> <ul style="list-style-type: none"> • CSV (Comma delimited) (*.csv) • SDF (Fast) (*.sdf;*.dat) • Text (Tab delimited) (*.txt) <p>The file must have the same format as that created by the Export Recorded Data command.</p> <p>The SCPI command has an optional file format parameter. If you do not include this parameter in the SCPI command, the file format is determined by the file name extension. If no file extension is recognized, the file is scanned to determine the format.</p> <p>If you are not licensed to recall a particular file type, then error -203.9010 is returned. If the file format cannot be determined or the file cannot be recalled successfully, then error -250.5290 is returned. If the recall is successful, then advisory 0.1600 is shown.</p>
State Saved	No
Readback	Data 1 Data 2 Data 3 Data 4 Data 5 Data 6

Data 1

Selects the Data 1 register as the destination for the imported data.

Key Path	Recall, Data (Import), Trace (to)
Mode	VSA, LTE, LTETDD, IDEN

Data 2

Selects the Data 2 register as the destination for the imported data.

Key Path	Recall, Data (Import), Trace (to)
Mode	VSA, LTE, LTETDD, IDEN

Data 3

Selects the Data 3 register as the destination for the imported data.

Key Path	Recall, Data (Import), Trace (to)
Mode	VSA, LTE, LTETDD, IDEN

Data 4

Selects the Data 4 register as the destination for the imported data.

Key Path	Recall, Data (Import), Trace (to)
Mode	VSA, LTE, LTETDD, IDEN

Data 5

Selects the Data 5 register as the destination for the imported data..

Key Path	Recall, Data (Import), Trace (to)
Mode	VSA, LTE, LTETDD, IDEN

Data 6

Selects the Data 6 register as the destination for the imported data.

Key Path	Recall, Data (Import), Trace (to)
Mode	VSA, LTE, LTETDD, IDEN

Display in Selected Trace

Enables you to select whether the recalled trace data is displayed in the current Trace.

Key Path	Recall, Data (Import), Trace (to)
----------	-----------------------------------

Mode	VSA, LTE, LTETDD, IDEN
State Saved	No

Signal Studio Setup

This key allows you to recall the Agilent Signal Studio setup file created on the Signal Studio (N7625B). This key is valid only for the Mod Analysis measurement. For E-TM test model signal, please use corresponding EVM setup file under My Documents\LTETDD\data\evmsetup.

For the supported carrier types, see the table below.

Signal Studio	Carrier Type
N7625B Signal Studio for 3GPP LTE TDD	Advanced LTE TDD(2009-03)
	Advanced LTE TDD(2009-12)
	Basic LTE TDD(2009-03)
	Basic LTE TDD(2009-12)

File Location and Extension

File location: "My Documents\LTETDD\data"

File type: xml

File extension: .scp

You need to place the Signal Studio Setup file created on N7625B in the above directory in advance. Pressing OPEN under the Import Data menu will open this directory from which you can select the setup file.

Example:

File Location: My Documents\LTETDD\data

File Name: Uplink PUSCH.scp

Key Path	Recall, Data
Mode	LTETDD
Remote Command	MMEMory:LOAD:SSSetup <string>
Example	MMEM:LOAD:SSS "Uplink PUSCH.scp"
Notes	Sets of parameters related to Signal Studio Setup are overwritten by the contents of the setup file.
Initial S/W Revision	A.06.00

89601 VSA Setup

Enables you to import the 89600 Vector Signal Analyzer Setup file created using the 89600 Vector Signal Analyzer Option BHE (LTE TDD). This key is valid only for the Mod Analysis measurement.

File Location and Extension

File location: "My Documents\LTETDD\data"

File type: text file

File extension: .set, .setx

Place the 89600 Vector Signal Analyzer Setup file that you saved on 89600 in the above directory. When you select OPEN under the Import Data menu, the directory opens enabling you to select your setup file.

Example:

File Location: My Documents\LTETDD\data

File Name: Uplink PRACH.set

Key Path	Recall, Data
Mode	LTETDD
Remote Command	MME ^M o ^R y:LOAD:VSAS ^E tup <string>
Example	MMEM:LOAD:VSAS "Uplink PRACH.set"
Notes	Sets of parameters related to Vector Signal Analyzer Setup are overwritten by the contents of the setup file.
Initial S/W Revision	A.06.00
Modified at S/W Revision	A.10.00

Masks

This key allows you to recall a preset mask file from the list. The preset mask file contains configuration for only Carrier, Offset, Limit settings and the preset profile BW. Any set of values not specified by the preset mask file will not be overwritten.

You cannot change or create the preset mask file since it is a binary file. This key is valid for the Spectrum Emission Mask and ACP measurements.

File location: "My Documents\LTETDD\data.masks"

Note that "My Documents" is an alias to a directory and its place differs depending on which user is logged in. At XSA start up, XSA will overwrite all of the limit mask files to the current user's "My Documents\LTETDD\data.masks" each time.

File type: Binary

Filename: The filename follows the rule below, in which the word is connected with underscores.

<Measurement>_<Direction>_<Bandwidth>_<Condition>.mask

Where

<Measurement> Measurement the limit mask file is applied to: SEM or ACP

<Direction> Direction: BS (Downlink) or MS (Uplink).

<Bandwidth> Bandwidth

<Condition> Condition. It depends on the measurement.

File extension: .mask

Pressing OPEN under the Import Data menu will open the above directory from which you can select a mask file. When you change the Bandwidth or Direction, all Power Suite measurement parameters are reset to the hard coded preset parameters. Thus you must recall the appropriate preset mask file again after the change.

You cannot read the contents of the provided preset mask file since it is a binary file. Detailed contents of the file are provided by a PDF format file located in the same directory as the preset mask file.

Example:

File Location: My Documents/LTETDD/data/masks/SEM_MS

File Name: SEM_MS_15MHz_Add_NS04.mask

The following table shows the sets of variables imported to the ACP measurement.

Offset	Start Freq (MHz)	Stop Freq (MHz)	Res BW (Hz)	Meas BW	Rel Start	Rel Stop	Fail Mask
A	5	7.14	30k	1	-8	-25	Rel
B	7.14	10.57	30k	1	-25	-27	Rel
C	10.57	20	30k	1	-27	-50	Rel
D	20	25	30k	1	-50	-50	Rel
E	25	30	30k	1	-50	-50	Rel

Key Path	Recall, Data
Mode	LTETDD
Remote Command	MMEemory:LOAD:MASK <string>
Example	MMEemory:LOAD:MASK "ACP_BS\ACP_BS_3MHz_pairE-UTRA_CatA.mask"
Notes	Sets of parameters related to Limit, Carrier and Offset are overwritten by the contents of the preset mask file.
Initial S/W Revision	A.03.00

EVM Setup

This key allows you to recall EVM parameter setting to measure E-UTRA Test Model in 3GPP standard (36.141–810 6.1.1).

- E-UTRA Test Model 1.1 (E-TM1.1)
- E-UTRA Test Model 1.2 (E-TM1.2)
- E-UTRA Test Model 2 (E-TM2)
- E-UTRA Test Model 3.1 (E-TM3.1)

- E-UTRA Test Model 3.2 (E-TM3.2)
- E-UTRA Test Model 3.3 (E-TM3.3)

This key is valid for the Modulation Analysis and Conformance EVM measurements only.

File Location and Extension

File location: My Documents\LTETDD\data\evmsetup

Note that “My Documents” is an alias to a directory and its place differs depending on which user is logged in. At XSA start up, XSA will overwrite all of the EVM Setup files to the current user’s “My Documents\LTETDD\data\evmsetup” each time.

File type: binary

File extension: .evms

Pressing OPEN under the Import Data menu will open the above directory from which you can select an EVM Setup file. When you change the Bandwidth, parameters are reset to the hard coded preset parameters. Thus you must recall the appropriate EVM Setup file again after the change.

You cannot read the contents of the provided EVM Setup file since it is a binary file.

Example:

File Location: My Documents\LTETDD\data\evmsetup

Filename: TM3.1-BW1.4MHz.evms

Key Path	Recall, Data
Mode	LTETDD
Remote Command	MME ^M o ^R y:LOAD:EVMS ^E tup <string>
Example	MME ^M :LOAD:EVMS "TM2-BW15MHz.evms"
Notes	Sets of parameters related to EVM Setup are overwritten by the contents of the EVM Setup file.
Initial S/W Revision	A.03.00, A.08.00

Open...

When you press “Open”, the analyzer brings up a Windows dialog and a menu entitled “File Open.” This menu allows you to navigate to the various fields in the Windows dialog without using a keyboard or mouse. The Tab and Arrow keys can also be used for dialog navigation.

See "[From File...](#)" on page 2797 in Recall, State, for a full description of this dialog and menu.

Key Path	Recall, Data
Notes	The key location is mode-dependent and will vary. Brings up Open dialog for recalling a <mode specific> Save Type
Initial S/W Revision	Prior to A.02.00

Restart

The Restart function restarts the current sweep, or measurement, or set of averaged/held sweeps or measurements. If you are Paused, pressing Restart does a Resume.

The Restart function is accessed in several ways:

- Pressing the Restart key
- Sending the remote command INIT:IMMEDIATE
- Sending the remote command INIT:RESTART

See "[More Information](#)" on page 2461

Key Path	Front-panel key
Remote Command	:INITiate[:IMMEDIATE] :INITiate:RESTART
Example	:INIT:IMM :INIT:REST
Notes	:INITiate:RESTART and :INITiate:IMMEDIATE perform exactly the same function.
Couplings	Resets average/hold count k. For the first sweep overwrites all active (update=on) traces with new current data. For application modes, it resets other parameters as required by the measurement.
Status Bits/OPC dependencies	This is an Overlapped command. The STATUS:OPERation register bits 0 through 8 are cleared. The STATUS:QUESTIONable register bit 9 (INTEgrity sum) is cleared. The SWEEPING bit is set. The MEASURING bit is set.
Backwards Compatibility Notes	For Spectrum Analysis mode in ESA and PSA, the Restart hardkey and the INITiate:RESTART command restart trace averages (displayed average count reset to 1) for a trace in Clear Write, but did not restart Max Hold and Min Hold. In the X-Series, the Restart hardkey and the INITiate:RESTART command restart not only Trace Average, but MaxHold and MinHold traces as well. For wireless comms modes in ESA and PSA, the Restart hardkey and the INITiate:RESTART command restart every measurement, which includes all traces and numeric results. There is no change to this operation.
Initial S/W Revision	Prior to A.02.00

More Information

The **Restart** function first aborts the current sweep/measurement as quickly as possible. It then resets the sweep and trigger systems, sets up the measurement and initiates a new data measurement sequence with a new data acquisition (sweep) taken once the trigger condition is met.

If the analyzer is in the process of aligning when **Restart** is executed, the alignment finishes before the restart function is performed.

Even when set for Single operation, multiple sweeps may be taken when Restart is pressed (for example, when averaging/holding is on). Thus when we say that **Restart** "restarts a measurement," we may mean:

- It restarts the current sweep
- It restarts the current measurement
- It restarts the current set of sweeps if any trace is in Trace Average, Max Hold or Min Hold
- It restarts the current set of measurements if Averaging, or Max Hold, or Min Hold is on for the measurement
- depending on the current settings.

With **Average/Hold Number** (in **Meas Setup** menu) set to 1, or Averaging off, or no trace in Trace Average or Hold, a single sweep is equivalent to a single measurement. A single sweep is taken after the trigger condition is met; and the analyzer stops sweeping once that sweep has completed. However, with **Average/Hold Number** >1 and at least one trace set to **Trace Average, Max Hold, or Min Hold (SA Measurement)** or **Averaging on (most other measurements)**, multiple sweeps/data acquisitions are taken for a single measurement. The trigger condition must be met prior to each sweep. The sweep is stopped when the average count k equals the number N set for **Average/Hold Number**. A measurement average usually applies to all traces, marker results, and numeric results; but sometimes it only applies to the numeric results.

Once the full set of sweeps has been taken, the analyzer will go to idle state. To take one more sweep without resetting the average count, increment the average count by 1, by pressing the step up key while **Average/Hold Number** is the active function, or sending the remote command `CALC:AVER:TCON UP`.

Save

The Save menu lets you choose what you want to save and where you want to save it. Among the types of files you can save are **States**, **Traces**, and **Screen Images**. In addition, an Export (Data) option lets you save a number of data types as CSV files for easy import into Excel and other spreadsheet programs.

Key Path	Front-panel key
Mode	All
Notes	No remote command for this key specifically, but the :MMEM:STORe command is available for specific file types. An example is :MMEM:STOR:STATe <filename>.
Initial S/W Revision	Prior to A.02.00

State

The Save State menu lets you choose a register or file for saving the state.

The content of a state file includes all of the settings and data required to return the analyzer as closely as possible to the Mode it was in, with the exact settings which were in place, when the save occurred. The Mode settings in each state file include the settings that are affected by Mode Preset, as well as the additional settings affected by Restore Mode Defaults; all of the Mode's settings. In addition, all of the settings of the Input/Output system are included, even though they are outside of the Mode's state, because they are needed to restore the complete setup. Persistent System settings (for example, Verbose SCPI) are not affected by either Mode Preset or Restore Mode Defaults, nor are they included in a saved State file.

After the save completes, the message "File <filename> saved" or "State Register <register number> saved" is displayed.

For rapid saving, the State menu lists 16 registers to save to. Pressing a Register key initiates the save. You can also select a file to save to.

The default path for all State Files is:

My Documents\<<mode name>\state

where <mode name> is the parameter used to select the mode with the INST:SEL command (for example, SA for the Spectrum Analyzer).

Key Path	Save
Mode	All
Remote Command	:MMEMory:STORe:STATe <filename>
Example	MMEM:STOR:STATe "MyStateFile.state" This stores the current instrument state data in the file MyStateFile.state in the default directory.
Notes	Both single and double quotes are supported for any filename parameter over remote. After saving to a register, that register's menu key is updated with the date the time, unless a custom label has been entered for that key. After saving to a register, you remain in the Save State menu, so that you can see the Register key

update. After saving to a file, the analyzer automatically returns to the previous menu and any Save As dialog goes away.

Backwards Compatibility SCPI :MMEMory:STORe:STATe 1,<filename>

For backwards compatibility, the above syntax is supported. The "1" is simply ignored. The command is sequential.

Initial S/W Revision Prior to A.02.00

To File . . .

When you press “To File”, the analyzer brings up a Windows dialog and a menu entitled “Save As.” This menu allows you to navigate to the various fields in the Windows dialog without using a keyboard or mouse. The Tab and Arrow keys can also be used for dialog navigation.

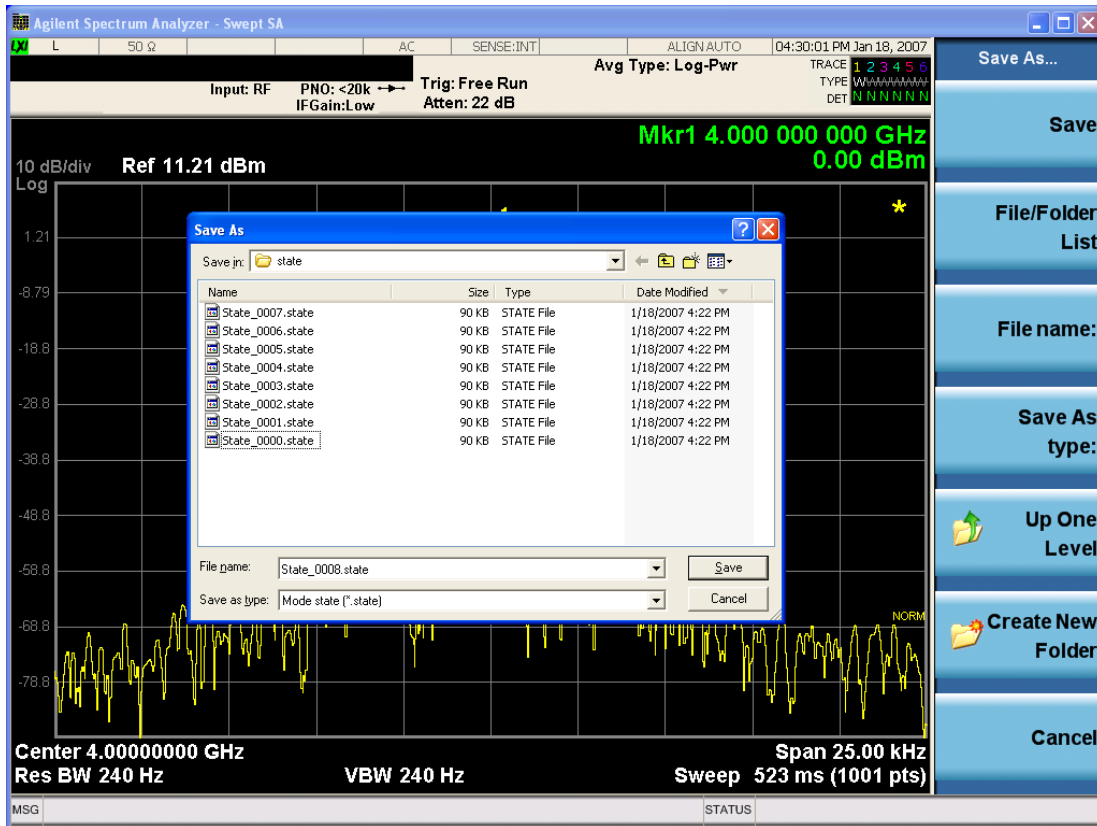

The Listed below are the functions of the various fields in the dialog, and the corresponding softkeys:

Save

Performs the save to the specified file of the selected type. If the file already exists, a dialog will appear that allows you to replace the existing file by selecting OK, or you can Cancel the request. If you select OK, the file will be overwritten. Using the C: drive is strongly discouraged, since it runs the risk of being overwritten during an instrument software upgrade.

While the save is being performed, the floppy icon appears briefly in the Meas bar.

File/Folder List

Enables you to navigate to the center of the dialog that contains the list of files and folders. Once here you can get information about the file and use the tab keys to navigate to the other fields in the dialog, such as Save In.

Save In

The Save In field shows the path to which the file will be saved and allows you to change the path using the up and down arrow keys to navigate to other paths; the Enter key to open a directory; and the Backspace key to go back one directory. The **Save In field** defaults to the default path for this type of file and remembers the last path you used to save this type of file. There is no softkey for directly navigating to the Save In field but you can use left tab to get here from the File/Folder List.

User specified paths are remembered when you leave and return to a Mode and are reset back to the default using Restore Mode Defaults.

File Name

The File Name field is initially loaded with an automatically generated filename specific to the appropriate Save Type. The automatically generated filename is guaranteed not to conflict with any filename currently in the directory. You may replace or modify this filename using the File Name key. See the ["Quick Save " on page 2793](#) documentation for more on the automatic file naming algorithm.

When you press the File Name key the analyzer displays the Alpha Editor. Use the knob to choose the letter to add and the front-panel Enter key to add the letter to the file name. The BK character moves you back and the FW character moves you forward in the filename. The Select key on the front panel generates a space character. When you are done entering the filename press the Done softkey. This returns back to the **File Open** dialog and menu, but does not cause the save to occur.

Save As Type

This field shows the file suffix for the type of file you have selected to save. For example, if you navigated here while saving State, "Mode state (*.state)" is in the field. If you navigated here from saving Trace, ""Mode state (*.trace)" is in the field. If you navigated here while exporting a trace data file, "Trace Data (*.csv)" is in the field. For some file types, there is more than one choice in the dropdown, which you can select by using the up and down arrow keys and Enter.

Up One Level

This key corresponds to the icon of a folder with the up arrow that is in the tool bar of the dialog. When pressed, it causes the file and folder list to navigate up one level in the directory structure. The Backspace key does the same thing.

Create New Folder

This key corresponds to the icon of a folder with the "*" that is in the tool bar of the dialog. When pressed, a new folder is created in the current directory with the name **New Folder** and you can enter a new folder name using the Alpha Editor.

Cancel

This key corresponds to the Cancel selection in the dialog. It causes the current **Save As** request to be cancelled. The ESC key does the same thing.

Key Path	Save, State
Mode	All
Notes	Brings up Save As dialog for saving a State Save Type
Initial S/W Revision	Prior to A.02.00

Edit Register Names

You may enter a custom name on any of the Register keys, to help you remember what you are using that state to save. To do this, press the Edit Register Names key, choose the register whose name you wish to edit, and then enter the desired label using the Alpha Editor or an external PC keyboard.

The maximum number of characters that can be added is 30. In most cases, 30 characters will fit on two lines of the key.

See ["More Information" on page 2466](#)

Key Path	Save, State
Mode	All
Remote Command	:MMEMory:REGister:STATe:LABel <reg number>,"label" :MMEMory:REGister:STATe:LABel? <reg number>
Example	:MMEM:REG:STAT:LAB 1,"my label"
Notes	<reg number> is an integer from 1 to 16. If the SCPI specifies an invalid register number an error message is generated, -222,"Data out of range;Invalid register label number" "label" is a string from 0 to 30 characters in length. If a label exceeds 30 characters, an error message is generated, -150,"String data error;Label clipped to 30 characters" "label" of length 0 erases the custom label and restores the default (time and date) label. E.g.: :MMEM:REG:STAT:LAB 1,""
Dependencies	N9060A-7FP or N9060B-2FP license required to edit the register names. When the feature is not licensed, sending this command generates an error, -221,"Settings conflict;Option not available"
Preset	The names are unaffected by Preset or power cycle but are set to the default label (time and date) on a "Restore System Defaults->Misc"
Initial S/W Revision	A.11.00

More Information

When you edit one of the register names, the time and date field will be replaced by the custom name.

If you delete all the characters in the custom name, it restores the default (time and date).

The register names are stored within the state files, but they are not part of the instrument state; that is, once you have edited a register name, loading a new state will not change that register name. Another consequence of this is that the names will be persistent through a power cycle. Also, if a named state file is transferred to another analyzer, it will bring its custom name along with it.

If you try to edit the name of an empty register, the analyzer will first save the state to have a file to put the name in. If you load a named state file into an analyzer with older firmware it will ignore the metadata.

The *SAV and *RCL commands will not be affected by the custom register names, nor will the MMEM commands.

Register 1 thru Register 16

Selecting any one of these register menu keys causes the State of the currently active mode to be saved to the specified Register. The registers are provided for rapid saving and recalling, since you do not need to specify a filename or navigate to a file. Each of the register menu keys annotates whether it is empty or at what date and time it was last modified. In addition, you can use the Edit Register Names key to enter custom names for each register.

Although these 16 registers are the only registers available from the front panel, there are 128 state registers available in the instrument. Registers 17–128 are only available from the SCPI interface, using the *SAV command.

There is one set of 128 state registers in the instrument, not one set for each Mode. When a state is saved, the Mode it was saved from is saved with it; then when it is recalled, the instrument switches to that Mode.

After the save completes, the corresponding register menu key annotation is updated with the date and time and the message "Register <register number> saved" is displayed.

Key Path	Save, State
Mode	All
Example	*SAV 1
Range	1–16 from front panel, 1–128 from SCPI
Readback	Date and time with seconds resolution are displayed on the key OR A custom name of up to 30 characters entered using the Edit Register Names key OR “(empty)” if no prior save operation has been performed to this register.
Initial S/W Revision	Prior to A.02.00
Modified at S/W Revision	A.11.00

Register 1 thru Register 16

Selecting any one of these register menu keys causes the State of the currently active mode to be saved to the specified Register. The registers are provided for rapid saving and recalling, since you do not need to specify a filename or navigate to a file. Each of the register menu keys annotates whether it is empty or at what date and time it was last modified. In addition, you can use the Edit Register Names key to enter custom names for each register.

Although these 16 registers are the only registers available from the front panel, there are 128 state registers available in the instrument. Registers 17–128 are only available from the SCPI interface, using the *SAV command.

There is one set of 128 state registers in the instrument, not one set for each Mode. When a state is saved, the Mode it was saved from is saved with it; then when it is recalled, the instrument switches to that Mode.

After the save completes, the corresponding register menu key annotation is updated with the date and time and the message "Register <register number> saved" is displayed.

Key Path	Save, State
Mode	All
Example	*SAV 1
Range	1-16 from front panel, 1-128 from SCPI
Readback	Date and time with seconds resolution are displayed on the key OR A custom name of up to 30 characters entered using the Edit Register Names key OR “(empty)” if no prior save operation has been performed to this register.
Initial S/W Revision	Prior to A.02.00
Modified at S/W Revision	A.11.00

Data (Export)

Exporting a data file stores data from the current measurement to mass storage files. The Export Menu only contains data types that are supported by the current measurement.

Since the commonly exported data files are in .csv format, the data can be edited by you prior to importing. This allows you to export a data file, manipulate the data in Excel (the most common PC Application for manipulating .csv files) and then import it.

Selecting an Export Data menu key will not actually cause the exporting to occur, since the analyzer still needs to know where you wish to save the data. Pressing the Save As key in this menu brings up the Save As dialog and Save As menu that allows you to specify the destination file and directory. Once a filename has been selected or entered in the Open menu, the export will occur as soon as the Save key is pressed.

Key Path	Save
Mode	All
Notes	The menu is built from whatever data types are available for the mode. So the key locations in the sub menu will vary. No SCPI command directly controls the Data Type that this key controls. The Data Type is included in the MMEM:STORe commands.
Dependencies	If a file type is not used by a certain measurement, that type is grayed out for that measurement. The key for a file type will not show at all if there are no measurements in the Mode that support it.
Preset	Is not affected by a Preset or shutdown, but is reset during Restore Mode Defaults
Readback	The data type that is currently selected
Initial S/W Revision	Prior to A.02.00

Export Trace Data

Enables you to export trace data with (optional) associated headers. Selecting this key displays a menu that enables you to choose which Trace to save (default is the selected Trace) and whether or not to save headers with the data. The header information is used by the VXA application when saved trace data is recalled, and enables it to be displayed with the same formatting and scaling that it had when saved. If headers are not saved, the scaling and format are set to default values when the trace is recalled. After making these selections, press Save As... and use the file dialog to choose a file name and format for the saved data.

Trace data can be exported in several different formats. Text and comma-separated variable (CSV) formats are useful for viewing the data or importing it to a spreadsheet program. The other formats are binary and thus more compact. Trace data files can be recalled for viewing into other VXA, LTE, LTETDD, iDEN, or 89601 measurements.

Key Path	Save, Data (Export)
Mode	VSA, LTE, LTETDD, IDEN
Remote Command	:MMEMory:STORe:TRACe:DATA TRACE1 TRACE2 TRACE3 TRACE4 TRACE5 TRACE6, "<filename>" [,CSV TXT SDF MAT4 MAT HDF5 BIN[,OFF ON 0 1]]
Example	:MMEM:STOR:TRAC:DATA TRACE1, "TRC1.TXT", TXT, ON
Notes	<p>The Save As... dialog box has the following format options when you are saving trace data:</p> <ul style="list-style-type: none"> • CSV (Comma delimited) (*.csv) • SDF (Fast) (*.sdf;*.dat) • Text (Tab delimited) (*.txt) <p>File format saved depends on selection. The appropriate file extension is appended to the filename if it is not supplied by the user.</p> <p>If the SCPI command includes just a file name, the file format is determined by the filename extension, which must be one of the choices above. *.sdf or an unrecognized extension chooses the SDF fast format. If the optional file format enumerator is included in the command, then this determines the file format and the file extension is ignored. The optional binary parameter determines if file headers are saved. The default is ON. If file headers are not wanted, use the optional "OFF" parameter.</p> <p>The optional Boolean parameter determines whether headers are saved in the file. By default the headers are saved.</p> <p>If you are not licensed to save a particular file type, then error -203.9010 is returned. If an invalid file format is specified or the file cannot be saved successfully, then error -25x is returned. If the save is successful, then advisory 0.1500 is shown.</p>
State Saved	No
Readback	(Trace 1 Trace 2 Trace 3 Trace 4 Trace 5 Trace 6)(with without) headers

Trace 1

Selects the Trace 1 register as the destination for the imported data.

Key Path	Save, Data (Export), Trace
Mode	VSA, LTE, LTETDD, IDEN

Trace 2

Selects the Trace 2 register as the destination for the imported data.

Key Path	Save, Data (Export), Trace
Mode	VSA, LTE, LTETDD, IDEN

Trace 3

Selects the Trace 3 register as the destination for the imported data.

Key Path	Save, Data (Export), Trace
Mode	VSA, LTE, LTETDD, IDEN

Trace 4

Selects the Trace 4 register as the destination for the imported data.

Key Path	Save, Data (Export), Trace
Mode	VSA, LTE, LTETDD, IDEN

Include Header

Enables you to select whether or not the saved trace data includes header information describing scaling, formatting, etc.

Key Path	Save, Data (Export), Trace
Mode	VSA, LTE, LTETDD, IDEN
State Saved	No

Measurement Results

Pressing this key selects Meas Results as the data type to be exported. Pressing the key a second time brings up the Meas Results menu, which allows you to select which **Meas Result** to save. In the Swept SA measurement, there are three types of Measurement Results files: Peak Table, Marker Table and Spectrogram.

See "[Meas Results File Contents](#)" on page 2471.

See "[Marker Table](#)" on page 2471.

See "[Peak Table](#)" on page 2474.

See "[Spectrogram](#)" on page 2477

Remote Command	:MMEMory:STORe:RESults:MTABle PTABle SPEctrogram <filename>
Example	:MMEM:STOR:RES:MTAB "myResults.csv" Saves the results from the current marker table to the file myResults.csv in the current path. :MMEM:STOR:RES:PTAB "myResults.csv" Saves the results from the current peak table to the file myResults.csv in the current path. :MMEM:STOR:RES:SPEC "myResults.csv" Saves the results from the current Spectrogram display to the file myResults.csv in the current path. The default path is My Documents\SA\data\SAN\results
Notes	If the save is initiated via SCPI, and the file already exists, the file will be overwritten. Using the C: drive is strongly discouraged, since it runs the risk of being overwritten during an instrument software upgrade. Both single and double quotes are supported for any filename parameter over SCPI.
Dependencies	If a save of Marker Table results is requested and the Marker Table is not on, no file is saved and a message is generated If a save of Peak Table results is requested and the Peak Table is not on, no file is saved and a message is generated If a save of Spectrogram results is requested and the Spectrogram is not on, no file is saved and a message is generated. The Spectrogram choice only appears if option EDP is licensed.
Preset	Not part of Preset, but is reset to Peak Table by Restore Mode Defaults. Survives a shutdown.
Initial S/W Revision	Prior to A.02.00

Meas Results File Contents

All files are .csv files. The following section details the data in each file type.

Marker Table

This section discusses the Marker Table Meas Results file format.

Imagine that, at the point where a Marker Table Meas Result is requested, the following screen is showing:

16 Monitor Spectrum Measurement
Save

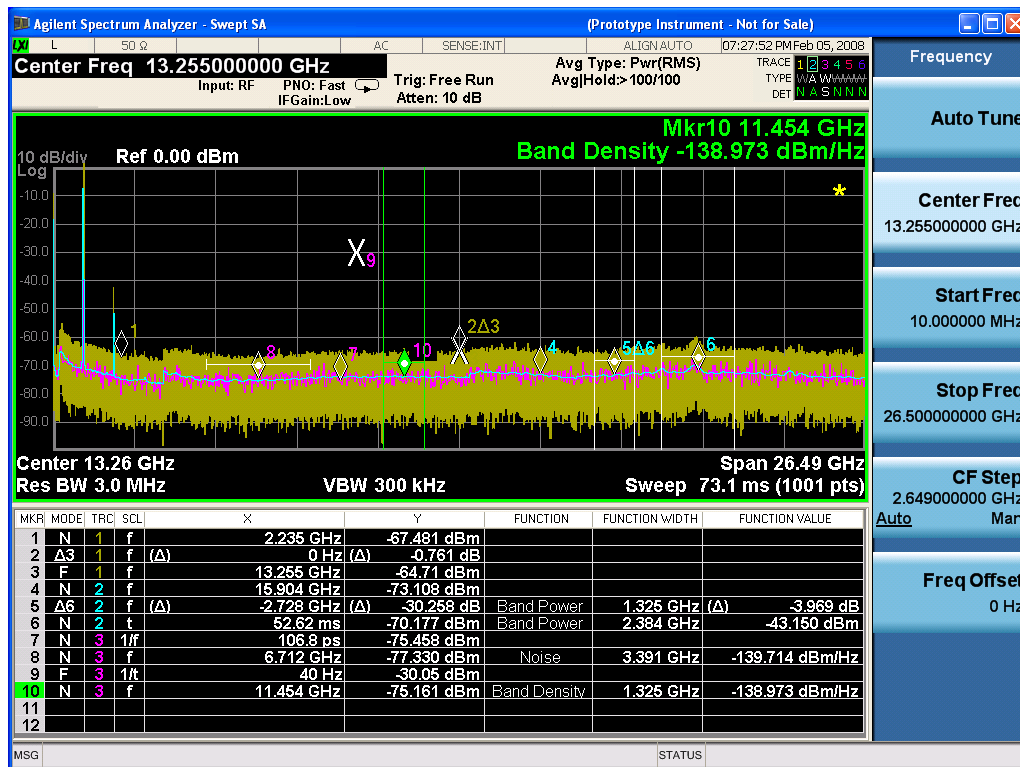

Then the Meas Results file, when opened, would show the following data:

MeasurementResult	
Swept SA	
A.01.40_R0017	N9020A
526 B25 PFR	1
P26 EA3	
Result Type	Marker Table
Ref Level	0
Number of Points	1001
Sweep Time	0.0662666 67
Start Frequency	10000000
Stop Frequency	26500000 000
Average Count	0
Average Type	LogPower (Video)
RBW	3000000

RBW Filter	Gaussian
RBW Filter BW	3dB
VBW	3000000
Sweep Type	Swept
X Axis Scale	Lin
PreAmp State	Off
PreAmp Band	Low
Trigger Source	Free
Trigger Level	1.2
Trigger Slope	Positive
Trigger Delay	1.00E-06
Phase Noise Optimization	Fast
Swept If Gain	Low
FFT If Gain	Autorange
RF Coupling	AC
FFT Width	411900
Ext Ref	10000000
Input	RF
RF Calibrator	Off
Attenuation	10
Ref Level Offset	0
External Gain	0
X Axis Units	Hz
Y Axis Units	dBm

DATA									
MKR	MODE	TR C	SCL	X	Y	FUNCTI ON	FUNCTIO N WIDTH	FUNCTI ON VALUE	FUNCTI ON UNIT
1	Normal	1	Freque ncy	2.2350E+09	- 67.481	Off	0.0000E+00	0	None
2	Delta3	1	Freque ncy	0.0000E+00	- 0.761	Off	0.0000E+00	0	None
3	Fixed	1	Freque ncy	1.3255E+10	- 64.71	Off	0.0000E+00	0	None
4	Normal	2	Freque ncy	1.5904E+10	- 73.1	Off	0.0000E+00	0	None

08									
5	Delta7	2	Frequ ncy	- 2.7280E+ 09	- 30.2 58	Band Power	1.3250E+ 06	-3.969	dB
6	Normal	2	Time	5.2620E- 02	- 70.1 77	Band Power	2.3840E+ 06	-43.15	dBm
7	Normal	3	Period	1.0680E- 10	- 75.4 58	Off	0.0000E+ 00	0	None
8	Normal	3	Frequ ncy	6.7120E+ 09	- 77.3 3	Noise	3.3910E+ 06	- 139.71 4	dBm/Hz
9	Fixed	3	Inverse Time	4.0000E+ 01	- 30.0 5	Off	0.0000E+ 00	0	None
10	Normal	3	Frequ ncy	1.1454E+ 10	- 75.1 61	Band Density	1.3250E+ 06	- 138.97 3	dBm/Hz
11	Off	1	Frequ ncy	0.0000E+ 00	0	Off	0.0000E+ 00	0	None
12	Off	1	Frequ ncy	0.0000E+ 00	0	Off	0.0000E+ 00	0	None

The numbers appear in the file exactly as they appear onscreen. If it says 11.454 GHz onscreen, then in the file it is 11.454E+09.

The metadata header is very similar to the metadata used in the trace data .csv files. See Trace File Contents. The only new information concerns the 1-of-N fields in the marker table itself.

Peak Table

This section discusses the Peak Table Meas Results file format.

Imagine that, at the point where a Marker Table Meas Result is requested, the following screen is showing:

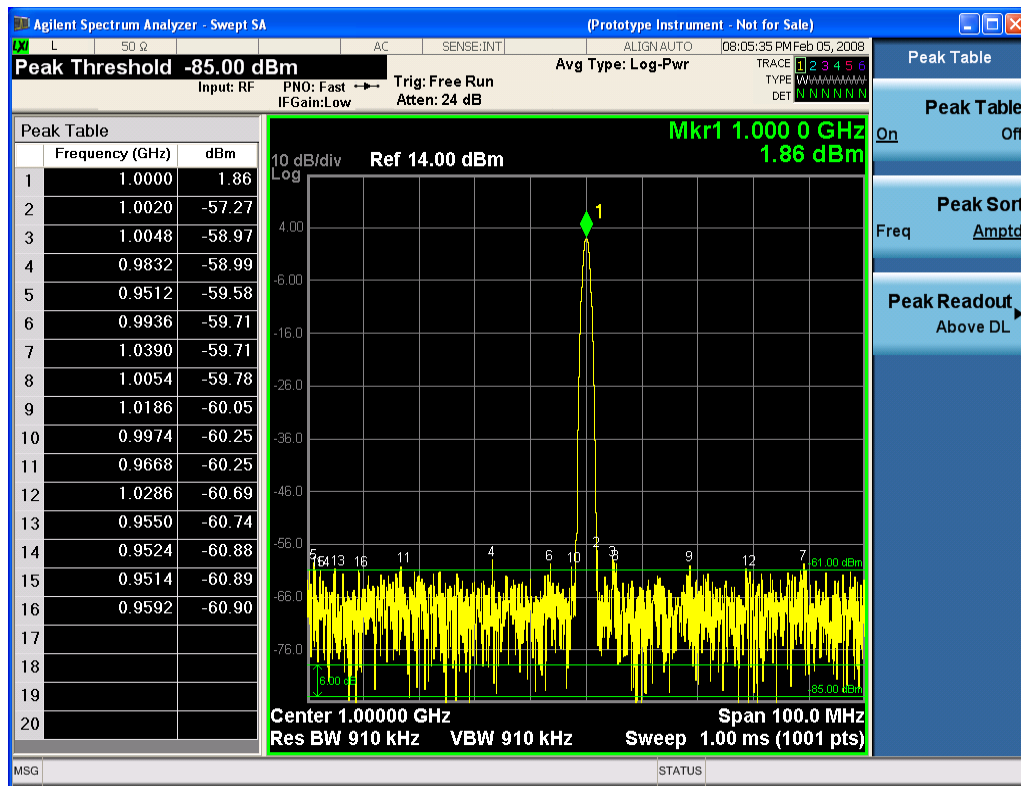

Then the Meas Results file, when opened, would show the header data (the same as for the Marker Table except that the Result Type is Peak Table) ending with a few fields of specific interest to Peak Table users:

- Peak Threshold
- Peak Threshold State (On|Off)
- Peak Excursion
- Peak Excursion State (On|Off)
- Display Line
- Peak Readout (All|AboveDL|BelowDL)
- Peak Sort (Freq|Amptd)

These fields are then followed by the data for the Peak Table itself.

Note that the label for the Frequency column changes to Time in 0 span.

Here is what the table for the above display looks like:

MeasurementResult	
Swept SA	
A.01.40_R0017	N9020A
526 B25 PFR P26 EA3	1

Result Type	Peak Table
Ref Level	0
Number of Points	1001
Sweep Time	0.066266667
Start Frequency	10000000
Stop Frequency	26500000000
Average Count	0
Average Type	LogPower(Video)
RBW	3000000
RBW Filter	Gaussian
RBW Filter BW	3dB
VBW	3000000
Sweep Type	Swept
X Axis Scale	Lin
PreAmp State	Off
PreAmp Band	Low
Trigger Source	Free
Trigger Level	1.2
Trigger Slope	Positive
Trigger Delay	1.00E-06
Phase Noise Optimization	Fast
Swept If Gain	Low
FFT If Gain	Autorange
RF Coupling	AC
FFT Width	411900
Ext Ref	10000000
Input	RF
RF Calibrator	Off
Attenuation	10
Ref Level Offset	0
External Gain	0
X Axis Units	Hz
Y Axis Units	dBm
Peak Threshold	-85
Peak Threshold State	On
Peak Excursion	6
Peak Excursion State	On

Display Line	-61	
Peak Readout	AboveDL	
Peak Sort	Amptd	
DATA		
Peak	Frequency	Amplitude
1	1.0000E+06	1.86
2	1.0020E+06	-57.27
3	1.0048E+06	-58.97
4	9.8320E+05	-58.99
5	9.5120E+05	-59.58
6	9.9360E+05	-59.71
7	1.0390E+06	-59.71
8	1.0054E+06	-59.78
9	1.1086E+06	-60.05
10	9.9740E+05	-60.25
11	9.6680E+05	-60.25
12	1.0286E+06	-60.69
13	9.5500E+05	-60.74
14	9.5240E+05	-60.88
15	9.5140E+05	-60.89
16	9.5920E+05	-60.90
17		
18		
19		
20		

Spectrogram

This section discusses the Spectrogram Results file format. The Spectrogram choice only appears if option EDP is licensed.

The Spectrogram results are the same as a Trace data export, except that instead of having just one trace's data, all 300 traces appear one after the other.

Each trace has its own data mark; the data for Spectrogram Trace 0 follows the row marked DATA, the data for Spectrogram Trace 1 follows the row marked DATA1, for Spectrogram Trace 2 follows the row marked DATA2, and so on.

Each DATA row has a timestamp in the second column (as of firmware revision A.11.01). So, for example, if Trace 0 had a relative start time of 1729.523 sec, then the first DATA row would look like this:

DATA,1729.523

And if Trace 13 had a relative start time of 100.45 sec, then the fourteenth data row would look like:

DATA13,100.453

To find the absolute time for the relative timestamps of each trace, the last row before the first DATA row gives the absolute start time of the Spectrogram, in the form YYYYMMDDHHMMSS

So, for example, if the absolute start time is 13:23:45:678 on January 30, 2012, this row would look like:

Start Time,20120130132345678

NOTE The resolution of the absolute time stored is 1 ms, which matches up with the fact that the fastest sweep time is also 1 ms. However, there is no specification for the absolute accuracy of the clock in the analyzer, nor is there any facility provided to allow the user to set this time to any particular degree of accuracy.

Traces that have not yet been filled in the Spectrogram display are empty; there is no DATA header for them. The file ends after the last non-empty trace.

Imagine that, at the point where a Spectrogram Meas Result is requested, the following screen is showing:



For the purpose of this example, we have set the Average/Hold Number to 10, thus we have only traces 0 thru 10. The Spectrogram was started at 02:28:08:700 pm on April 25, 2012 (that is, 700 ms after 2:28:08 pm), although the screen dump itself shows a different time, as it was taken ten minutes after the

Spectrogram data. Trace 0 is showing a start time of 5.30 seconds, meaning 5.3 seconds after the Spectrogram started (trace 10 has a start time of 0, as it was the first trace taken but has now rolled up into the tenth trace slot).

The Meas Results file, when opened, shows the header data and ten traces of trace data. Below is an extract from the result file for the above display. Note the start time of 20120425142808700 showing in the last row before the first DATA row, and the relative time of 5.299231048 showing in the first DATA row:

Result Type	Spectrogram
MeasResult	
Swept SA	
A.11.00.01	N9020A
503 508 513 526 ALL ALV B1C B1X B25 B2X B40 BAB BBA CR3 CRP DP2 DRD EA3 EDP EMC EP1 ERC ESC ESP EXM FSA HBA K03 LFE MPB P03 P08 P13 P26 PFR RTL RTS S40 SB1 SEC SM1 UK6 YAS YAV	1
Segment	0
Number of Points	1001
Sweep Time	0.523333333
Start Frequency	5999984415
Stop Frequency	6000009415
Average Count	0
Average Type	LogPower(Video)
RBW	240
RBW Filter	Gaussian
RBW Filter BW	3dB
VBW	240
Sweep Type	Swept
X Axis Scale	Lin
PreAmp State	Off
PreAmp Band	Low
Trigger Source	Free
Trigger Level	1.2
Trigger Slope	Positive
Trigger Delay	0
Phase Noise Optimization	Wide
Swept If Gain	Low
FFT If Gain	Autorange
RF Coupling	AC

Result Type	Spectrogram
FFT Width	411900
Ext Ref	10000000
Input	RF
RF Calibrator	Off
Attenuation	14
Ref Level Offset	0
External Gain	0
Trace Type	Clearwrite
Detector	Normal
Trace Math	Off
Trace Math Oper1	Trace5
Trace Math Oper2	Trace6
Trace Math Offset	0
Trace Name	Trace1
X Axis Units	Hz
Y Axis Units	dBm
Start Time	20120425142808700
DATA	5.299231048
5999984415	-76.34749519
5999984440	-77.28097006
5999984465	-75.32317869
5999984490	-73.64417681
5999984515	-72.67154604

o
o
o

6000009315	-77.94423277
6000009340	-79.51829697
6000009365	-78.46108961
6000009390	-78.46108957
6000009415	-76.59570596
DATA2	4.708697055
5999984415	-80.98197882
5999984440	-80.98197879

5999984465	-75.83142132
5999984490	-74.02712079
5999984515	-73.57213005

o
o
o

6000009315	-75.9183103
6000009340	-79.53787488
6000009365	-78.82602191
6000009390	-78.82602188
6000009415	-76.37486709
DATA10	0
5999984415	-75.56751112
5999984440	-75.76485645
5999984465	-76.67718717
5999984490	-78.79238489
5999984515	-83.72680212

o
o
o

6000009315	-71.3942461
6000009340	-72.28308332
6000009365	-73.92684489
6000009390	-75.45548832
6000009415	-75.17904815

Save As . . .

When you press “Save As”, the analyzer brings up a Windows dialog and a menu entitled “**Save As.**” This menu allows you to navigate to the various fields in the Windows dialog without using a keyboard or mouse. The Tab and Arrow keys can also be used for dialog navigation.

See "[To File . . .](#)" on page 2810 in Save, State for a full description of this dialog and menu.

The default path for saving files is:

For all of the Trace Data Files:

My Documents\<<mode name>\data\traces

For all of the Limit Data Files:

My Documents\<<mode name>\data\limits

For all of the Measurement Results Data Files:

My Documents\<<mode name>\data\<<measurement name>\results

For all of the Capture Buffer Data Files:

My Documents\<<mode name>\data\captureBuffer

Key Path	Save, Data
Mode	All
Notes	The key location is mode-dependent and will vary. Brings up the Save As dialog for saving a <mode specific> Save Type. The save is performed immediately and does not wait until the measurement is complete.
Initial S/W Revision	Prior to A.02.00

Screen Image

Pressing Screen Image accesses a menu of functions that enable you to specify a format and location for the saved screen image. It brings up a menu that allows you to specify the color scheme of the Screen Image (Themes) or navigate to the Save As dialog to perform the actual save.

Screen Image files contain an exact representation of the analyzer display. They cannot be loaded back onto the analyzer, but they can be loaded into your PC for use in many popular applications.

The image to be saved is actually captured when the Save front panel key is pressed, and kept in temporary storage to be used if you ask for a Screen Image save. When the Screen Image key is pressed, a "thumbnail" of the captured image is displayed, as shown below:

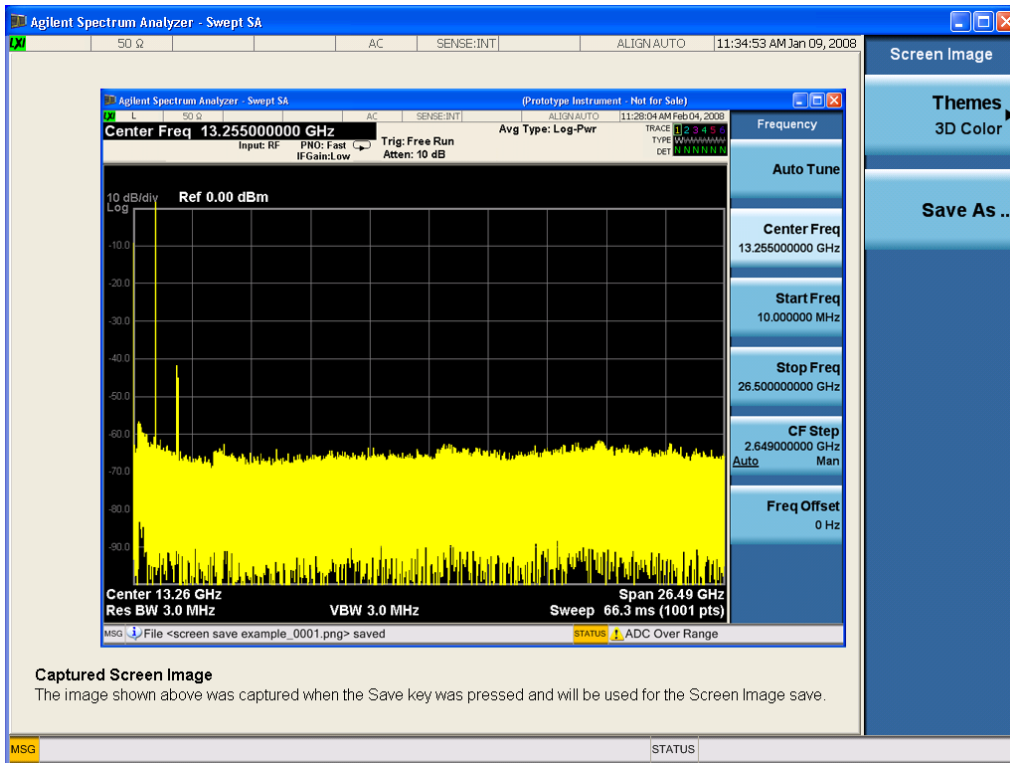

When you continue on into the Save As menu and complete the Screen Image save, the image depicted in the thumbnail is the one that gets saved, showing the menus that were on the screen before going into the Save menus. The save is performed immediately and does not wait until the measurement is complete.

After you have completed the save, the Quick Save front-panel key lets you quickly repeat the last save performed, using an auto-named file, with the current screen data.

NOTE

For versions previous to A.01.55, if you initiate a screen image save by navigating through the Save menus, the image that is saved will contain the Save menu softkeys, not the menus and the active function that were on the screen when you first pressed the Save front panel key.

Key Path	Save
Mode	All
Remote Command	:MMEMory:STORe:SCReem <filename>
Example	:MMEM:STOR:SCR "myScreen.png" This stores the current screen image in the file MyScreenFile.png in the default directory.
Initial S/W Revision	Prior to A.02.00

Themes

Accesses a menu of functions that enable you to choose the theme to be used when saving the screen image.

The **Themes** option is the same as the **Themes** option under the **Display** and **Page Setup** dialogs. It allows you to choose between themes to be used when saving the screen image.

Key Path	Save, Screen Image
Remote Command	:MMEMory:STORe:SCReem:THEMe TDColor TDMonochrome FCOLor FMONochrome :MMEMory:STORe:SCReem:THEMe?
Example	:MMEM:STOR:SCR:THEM TDM
Preset	3D Color; Is not part of Preset, but is reset by Restore Misc Defaults or Restore System Defaults All and survives subsequent running of the modes.
Readback	3D Color 3D Mono Flat Color Flat Mono
Backwards Compatibility Notes	In ESA and PSA we offer the choice of "Reverse Bitmap" or "Reverse Metafile" when saving screen images. This is much like the "Flat Color" theme available in X-Series. Also, if you selected Reverse Bitmap AND a black & white screen image, that would be much like "Flat Monochrome". In other words, each of the X-Series themes has a similar screen image type in ESA/PSA. But they are not identical.
Initial S/W Revision	Prior to A.02.00

3D Color

Selects a standard color theme with each object filled, shaded and colored as designed.

Key Path	Save, Screen Image, Themes
Example	MMEM:STOR:SCR:THEM TDC
Readback	3D Color
Initial S/W Revision	Prior to A.02.00

3D Monochrome

Selects a format that is like 3D color but shades of gray are used instead of colors.

Key Path	Save, Screen Image, Themes
Example	MMEM:STOR:SCR:THEM TDM
Readback	3D Mono
Initial S/W Revision	Prior to A.02.00

Flat Color

Selects a format that is best when the screen is to be printed on an ink printer.

Key Path	Save, Screen Image, Themes
-----------------	----------------------------

Example	MMEM:STOR:SCR:THEM FCOL
Readback	Flat Color
Initial S/W Revision	Prior to A.02.00

Flat Monochrome

Selects a format that is like Flat Color. But only black is used (no colors, not even gray), and no fill.

Key Path	Save, Screen Image, Themes
Example	MMEM:STOR:SCR:THEM FMON
Readback	Flat Mono
Initial S/W Revision	Prior to A.02.00

Save As...

When you press "Save As", the analyzer brings up a Windows dialog and a menu entitled "**Save As.**" This menu allows you to navigate to the various fields in the Windows dialog without using a keyboard or mouse. The Tab and Arrow keys can also be used for dialog navigation.

See "[To File . . .](#)" on page 2810 in Save, State for a full description of this dialog and menu.

The default path for Screen Images is

My Documents\`<mode name>`\screen.

where `<mode name>` is the parameter used to select the mode with the INST:SEL command (for example, SA for the Spectrum Analyzer).

Key Path	Save, Screen Image
Notes	Brings up Save As dialog for saving a Screen Image Save Type
Initial S/W Revision	Prior to A.02.00

Mass Storage Catalog (Remote Command Only)

Key path	SCPI Only
Remote Command	:MMEMory:CATalog? [<code><directory_name></code>]
Notes	<p>The string must be a valid logical path.</p> <p>Queries disk usage information (drive capacity, free space available) and obtains a list of files and directories in a specified directory in the following format:</p> <p><code><numeric_value>,<numeric_value>,{<file_entry>}</code></p> <p>It returns two numeric parameters and as many strings as there are files and directories. The first parameter indicates the total amount of storage currently used in bytes. The second parameter</p>

indicates the total amount of storage available, also in bytes. The <file_entry> is a string. Each <file_entry> indicates the name, type, and size of one file in the directory list:

<file_name>,<file_type>,<file_size>

As the windows file system has an extension that indicates file type, <file_type> is always empty. <file_size> provides the size of the file in bytes. For directories, <file_entry> is surrounded by square brackets and both <file_type> and <file_size> are empty

Initial S/W Revision Prior to A.02.00

Mass Storage Change Directory (Remote Command Only)

Key path SCPI Only

Remote Command :MMEMory:CDIRectory [<directory_name>]
 :MMEMory:CDIRectory?

Notes The string must be a valid logical path.

Changes the default directory for a mass memory file system. The <directory_name> parameter is a string. If no parameter is specified, the directory is set to the *RST value.

At *RST, this value is set to the default user data storage area, that is defined as System.Environment.SpecialFolder.Personal.

Query returns full path of the default directory.

Initial S/W Revision Prior to A.02.00

Mass Storage Copy (Remote Command Only)

Key path SCPI Only

Remote Command :MMEMory:COPY <string>,<string>[,<string>,<string>]

Notes The string must be a valid logical path.

Copies an existing file to a new file or an existing directory to a new directory.

Two forms of parameters are allowed. The first form has two parameters. In this form, the first parameter specifies the source, and the second parameter specifies the destination.

The second form has four parameters. In this form, the first and third parameters specify the source. The second and fourth parameters specify the directories. The first pair of parameters specifies the source. The second pair specifies the destination. An error is generated if the source doesn't exist or the destination file already exists.

This command will generate an "access denied" error if the destination is a restricted folder (e.g., C:\Windows) and the current user does not have Power User or Administrator privileges.

Mass Storage Device Copy (Remote Command Only)

This command transfers data to/from a file and a peripheral device.

Key path	SCPI Only
Remote Command	:MMEMory:COpy:DEvice <source_string>,<dest_string>
Notes	<p>The strings must be a valid logical path or a valid device keyword. If the dest_string is a device keyword, the data is copied from the source file to the device. If the source_string is a device keyword, the data is copied to the source file from the device.</p> <p>Valid device keywords are: SNS (smart noise source)</p> <p>An error is generated if the file or device is not found.</p>

Mass Storage Delete (Remote Command Only)

Key path	SCPI Only
Remote Command	:MMEMory:DElete <file_name>[,<directory_name>]
Notes	<p>The string must be a valid logical path.</p> <p>Removes a file from the specified directory. The <file_name> parameter specifies the file name to be removed. This command will generate an “access denied” error if the file is in a restricted folder (e.g., C:\Windows) and the current user does not have Power User or Administrator privileges.</p>
Initial S/W Revision	Prior to A.02.00

Mass Storage Data (Remote Command Only)

Creates a file containing the specified data OR queries the data from an existing file.

Key path	SCPI Only
Remote Command	:MMEMory:DATA <file_name>, <data> :MMEMory:DATA? <file_name>
Notes	<p>The string must be a valid logical path.</p> <p>The command form is MMEMory:DATA <file_name>,<data>. It loads <data> into the file <file_name>. <data> is in 488.2 block format. <file_name> is string data.</p> <p>The query form is MMEMory:DATA? <file_name> with the response being the associated <data> in block format.</p>
Initial S/W Revision	Prior to A.02.00

Mass Storage Make Directory (Remote Command Only)

Key path	SCPI Only
Remote Command	:MMEMory:MDIRectory <directory_name>
Notes	<p>The string must be a valid logical path.</p> <p>Creates a new directory. The <directory_name> parameter specifies the name to be created.</p>

	This command will generate an “access denied” error if the new directory would be in a restricted folder (e.g., C:\Windows) and the current user does not have Power User or Administrator privileges.
Initial S/W Revision	Prior to A.02.00

Mass Storage Move (Remote Command Only)

Key path	SCPI Only
Remote Command	:MMEMory:MOVE <string>,<string>[,<string>,<string>]
Notes	<p>The string must be a valid logical path.</p> <p>Moves an existing file to a new file or an existing directory to a new directory.</p> <p>Two forms of parameters are allowed. The first form has two parameters. In this form, the first parameter specifies the source, and the second parameter specifies the destination.</p> <p>The second form has four parameters. In this form, the first and third parameters specify the source. The second and fourth parameters specify the directories. The first pair of parameters specifies the source. The second pair specifies the destination. An error is generated if the source doesn't exist or the destination file already exists.</p> <p>This command will generate an “access denied” error if the destination is a restricted folder (e.g., C:\Windows) and the current user does not have Power User or Administrator privileges.</p>
Initial S/W Revision	Prior to A.02.00

Mass Storage Remove Directory (Remote Command Only)

Key path	SCPI Only
Remote Command	:MMEMory:RDIRECTory <directory_name>
Notes	<p>The string must be a valid logical path.</p> <p>Removes a directory. The <directory_name> parameter specifies the directory name to be removed. All files and directories under the specified directory shall also be removed.</p> <p>This command will generate an “access denied” error if the folder is a restricted folder (e.g., C:\Windows) or is in a restricted folder and the current user does not have Power User or Administrator privileges.</p>
Initial S/W Revision	Prior to A.02.00

Single (Single Measurement/Sweep)

Sets the analyzer for Single measurement operation. The single/continuous state is Meas Global, so the setting will affect all the measurements. If you are Paused, pressing Single does a Resume.

See "[More Information](#)" on page 2489

Key Path	Front-panel key
Example	:INIT:CONT OFF
Notes	See Cont key description.
Backwards Compatibility Notes	<p>For Spectrum Analysis mode in ESA and PSA, the Single hardkey and the INITiate:IMM switched from continuous measurement to single measurement and restarted sweeps and averages (displayed average count reset to 1), but did not restart Max Hold and Min Hold. In the X-Series, the Single hardkey and the INITiate:IMM command initiate a sweep/ measurement/ average sequence/hold sequence including MaxHold and MinHold.</p> <p>For Spectrum Analysis mode in ESA and PSA, the Single hardkey restarted the sweep regardless of whether or not you were in an active sweep or sweep sequence. In the X-Series, Restart does this but Single only restarts the sweep or sweep sequence if you are in the idle state.</p> <p>INIT[:IMM] in ESA & PSA Spectrum Analysis Mode does an implied ABORT. In some other PSA Modes, INIT[:IMM] is ignored if not in the idle state. . The X-Series follows the ESA/PSA SA Mode model, which may cause some Modes to have compatibility problems.</p>
Initial S/W Revision	Prior to A.02.00

More Information

See "[Restart](#)" on page 2807 for details on the INIT:IMMEDIATE (Restart) function.

If you are already in single sweep, the INIT:CONT OFF command has no effect.

If you are already in Single Sweep, then pressing the Single key in the middle of a sweep does not restart the sweep or sequence. Similarly, pressing the Single key does not restart the sweep or sequence if the sweep is not in the idle state (for example, if you are taking a very slow sweep, or the analyzer is waiting for a trigger). Instead, it results in a message. "Already in Single, press Restart to initiate a new sweep or sequence". Even though pressing the Single key in the middle of a sweep does not restart the sweep, sending INIT:IMMEDIATE does reset it.

To take one more sweep without resetting the average count, increment the average count by 1, by pressing the step up key while **Average/Hold Number** is the active function, or sending the remote command CALC:AVER:TCON UP.

Source

There is no Source control functionality for this measurement. When this key is pressed, the screen either displays a blank menu, or the previously-selected menu remains unchanged.

Key Path	Front-panel key
----------	-----------------

Span X Scale

Accesses a menu of functions that enable you to set the horizontal scale parameters.

Key Path	Front-panel key
Initial S/W Revision	Prior to A.02.00

Span

Changes the frequency range symmetrically about the center frequency.

For details of WiDEN preset values, see ["IDEN Mode Span Preset for Monitor Spectrum" on page 2492](#).

Key Path	Span X Scale
Mode	All except SA, BASIC
Remote Command	[:SENSe] :MONitor:FREQuency:SPAN <freq> [:SENSe] :MONitor:FREQuency:SPAN?
Example	MON:FREQ:SPAN 1 MHz MON:FREQ:SPAN?
Couplings	Changing the span causes the resolution bandwidth to change automatically, and affects data acquisition time.
Preset	WCDMA: 10.0 MHz WIMAX OFDMA: 50.0 MHz C2K: 2.5MHz PN: 1.0 MHz GSM/EDGE: 1.0 MHz TD-SCDMA: 3.2 MHz 1xEVDO: 2.0MHz DVB-T/H: 10.0MHz DTMB (CTTB): 10.0MHz ISDB-T: 10.0MHz CMMB: 10.0MHz LTE: 50 MHz LTETDD: 50 MHz IDEN: See the table below Digital Cable TV: 10.0MHz WLAN: If Radio Std is 802.11a/b/g 802.11n(20MHz) 802.11ac(20MHz): 25 MHz If Radio Std is 802.11n(40MHz), 802.11ac (40MHz): 50 MHz If Radio Std is 802.11ac(80MHz): 100MHz If Radio Std is 802.11ac(160MHz): 200MHz

	MSR: 20.0 MHz LTEAFDD, LTEATDD: 20.0MHz
State Saved	Saved in instrument state.
Min	10 Hz
Max	Hardware Dependent: Option 503 = 3.7 GHz Option 507 = 7.1GHz Option 508 = 8.5 GHz Option 513 = 13.8 GHz Option 526 = 27.0 GHz
Initial S/W Revision	Prior to A.02.00
Modified at S/W Revision	A.02.00
Modified at S/W Revision	A.03.00

IDEN Mode Span Preset for Monitor Spectrum

iDEN Slot Format	WiDEN Slot Format 25kHz	WiDEN Slot Format 50kHz	WiDEN Slot Format 75kHz	WiDEN Slot Format 100kHz	WiDEN Slot Format 50kHz Out
60kHz	60kHz	85kHz	110kHz	135kHz	135kHz

Full Span

Changes the Span to show the full frequency range of the analyzer.

Key Path	Span X Scale
Mode	All except SA and BASIC
Remote Command	[:SENSe] :MONitor:FREQuency:SPAN:FULL
Example	MON:FREQ:SPAN:FULL
Couplings	Sets the span to the full frequency range, and adjusts the center frequency accordingly.
Initial S/W Revision	Prior to A.02.00

Last Span

Changes the measurement span to the span setting of the previous measurement. If there is no existing previous span value, then the span remains unchanged.

Key Path	Span X Scale
----------	--------------

Mode	All except SA and BASIC
Remote Command	<code>[:SENSe] :MONitor :FREQuency :SPAN :PREVious</code>
Example	MON:FREQ:SPAN:PREV
Couplings	Selecting last span changes the measurement span value.
Initial S/W Revision	Prior to A.02.00

Sweep/Control

Access a menu of functions that enable you to set up and control the sweep time for the current measurement

Key Path	Front-panel key
Initial S/W Revision	Prior to A.02.00

Sweep Time

Selects the length of time in which the spectrum analyzer sweeps the displayed frequency span. Additional overhead time is required by the analyzer. It impacts the sweep rate, but is not calculated as part of the sweep time. Reducing the sweep time increases the rate of sweeps.

Key Path	Sweep/Control
Mode	All except SA and BASIC
Remote Command	[:SENSe]:MONitor:SWEep:TIME <time> [:SENSe]:MONitor:SWEep:TIME? [:SENSe]:MONitor:SWEep:TIME:AUTO OFF ON 0 1 [:SENSe]:MONitor:SWEep:TIME:AUTO?
Example	MON:SWE:TIME 100 ms MON:SWE:TIME? MON:SWE:TIME:AUTO ON MON:SWE:TIME:AUTO?
Preset	Automatically Calculated
State Saved	Saved in instrument state.
Min	1 ms
Max	4000 s
Initial S/W Revision	Prior to A.02.00
MIN/MAX/DEF Support	Yes

Pause

Pauses a measurement after the current data acquisition is complete.

When Paused, the label on the key changes to Resume. Pressing Resume continues the measurement at the point where it had been paused.

See "[Pause/Resume](#)" on page 2703 under Sweep/Control for more information.

Key Path	Sweep/Control
Initial S/W Revision	Prior to A.02.00

Gate

Accesses a menu that enables you to control the gating function. The Gate functionality is used to view signals best viewed by qualifying them with other events.

Gate setup parameters are the same for all measurements – they do not change as you change measurements. Settings like these are called “Meas Global” and are unaffected by Meas Preset.

Note that Sweep Time autocoupling rules and annotation are changed by Gate being on.

Key Path	Sweep/Control
Scope	Meas Global
Readback	The state and method of Gate, as [Off, LO] or [On, Video]. Note that for measurements that only support gated LO, the method is nonetheless read back, but always as LO.
Initial S/W Revision	Prior to A.02.00

Gate On/Off

Turns the gate function on and off.

When the Gate Function is on, the selected Gate Method is used along with the gate settings and the signal at the gate source to control the sweep and video system with the gate signal. Not all measurements allow every type of Gate Methods.

When Gate is on, the annunciation in the measurement bar reflects that it is on and what method is used, as seen in the following "Gate: LO" annunciator graphic.

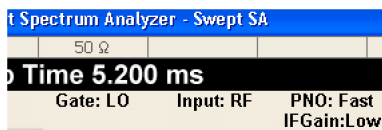

Key Path	Sweep/Control, Gate
Remote Command	[:SENSe] :SWEep:EGATe [:STATe] OFF ON 0 1 [:SENSe] :SWEep:EGATe [:STATe] ?
Example	SWE:EGAT ON SWE:EGAT?
Dependencies	The function is unavailable (grayed out) and Off when:

- Gate Method is LO or Video and FFT Sweep Type is manually selected.
- Gate Method is FFT and Swept Sweep Type is manually selected.
- Marker Count is ON.

The following are unavailable whenever Gate is on:

- FFT under Sweep Type when Method=LO or Video or Swept under Sweep Type when Method=FFT
- Marker Count

While Gate is on, the Auto Rules for Sweep Type are modified so that the choice agrees with the Gate Method: i.e., FFT for Method = FFT and Swept for Method = LO or Video.

The Gate softkey and all SCPI under the [:SENSe]:SWEep:EGATe SCPI node are grayed out when Source Mode is Tracking with an external source. This is because the Gate circuitry is used to sync the external source. If the Tracking Source is turned on, the Gate is turned off.

When in the ACP measurement:

- When Meas Method is RBW or FAST, this function is unavailable and the key is grayed out.
- Whenever Gate is on, Meas Method, RBW or FAST is unavailable and keys for those are grayed out.
- When Gate is on, Offset Res BW and Offset Video BW are ignored (if you set these values) and the measurement works as if all Offset Res BW and all Offset Video BW are coupled with the Res BW and the Video BW under the BW menu. When Gate is on, the Offset BW key in the Offset/Limit menu is grayed out.

Preset	Off LTETDD: On
State Saved	Saved in instrument state
Range	On Off
Backwards Compatibility SCPI	[:SENSe]:SWEep:TIME:GATE[:STATe] ESA compatibility
Backwards Compatibility Notes	In ESA, Trig Delay (On) and Gate (On) could not be active at the same time.. This dependency does not exist in PSA or in the X-Series.
Initial S/W Revision	Prior to A.02.00

Gate View On/Off

Turning on Gate View in the Swept SA measurement provides a single-window gate view display..

Turning on Gate View in other measurements shows the split-screen Gate View. In these measurements, when the Gate View is on, the regular view of the current measurement traces and results are reduced vertically to about 70% of the regular height. The Zero Span window, showing the positions of the Gate, is shown between the Measurement Bar and the reduced measurement window. By reducing the height of the measurement window, some of the annotation on the Data Display may not fit and is not shown.

Key Path	Sweep/Control, Gate
Remote Command	[:SENSe]:SWEep:EGATe:VIEW ON OFF 1 0 [:SENSe]:SWEep:EGATe:VIEW?

Example	SWE:EGAT:VIEW ON turns on the gate view.
Dependencies	<p>In the Swept SA measurement:</p> <p>In Gate View, the regular Sweep Time key is grayed out . When pressed, the grayed out key puts up the informational message "Use Gate View Sweep Time in the Gate menu."</p> <p>In the other measurements:</p> <p>When you turn Gate View on, the lower window takes on the current state of the instrument. Upon leaving Gate View, the instrument takes on the state of the lower window.</p> <p>When you turn Gate View on, the upper window Sweep Time is set to the gate view sweep time.</p>
Couplings	<p>These couplings apply to the Swept SA measurement:</p> <ul style="list-style-type: none"> • When Gate View is turned on, the instrument is set to Zero Span. • Gate View automatically turns off whenever a Span other than Zero is selected. • Gate View automatically turns off if you press the Last Span key while in Gate View, and the instrument returns to the Span it was in before entering Gate View (even if that is Zero Span). • When Gate View is turned on, the sweep time used is the gate view sweep time. This is set according to the rules in section "Gate View Setup" on page 2499 • When Gate View is turned off, Sweep Time is set to the normal Swept SA measurement sweep time. • If Gate View is on and Gate is off, then turning on Gate turns off Gate View.
Preset	OFF
State Saved	Saved in instrument state
Range	On Off
Initial S/W Revision	Prior to A.02.00

A sample of the Gate View screen in the Swept SA measurement is shown in the following graphic :

16 Monitor Spectrum Measurement Sweep/Control

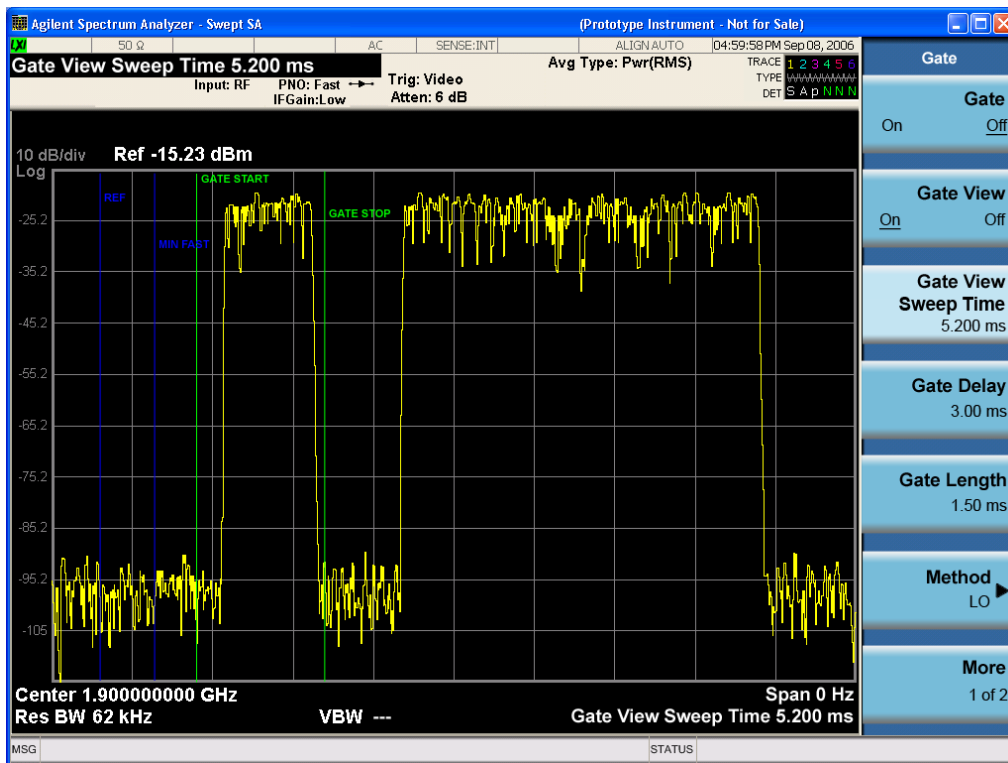

A sample of the Gate View screen in other measurements is shown in the following graphic. This example is for the ACP measurement:

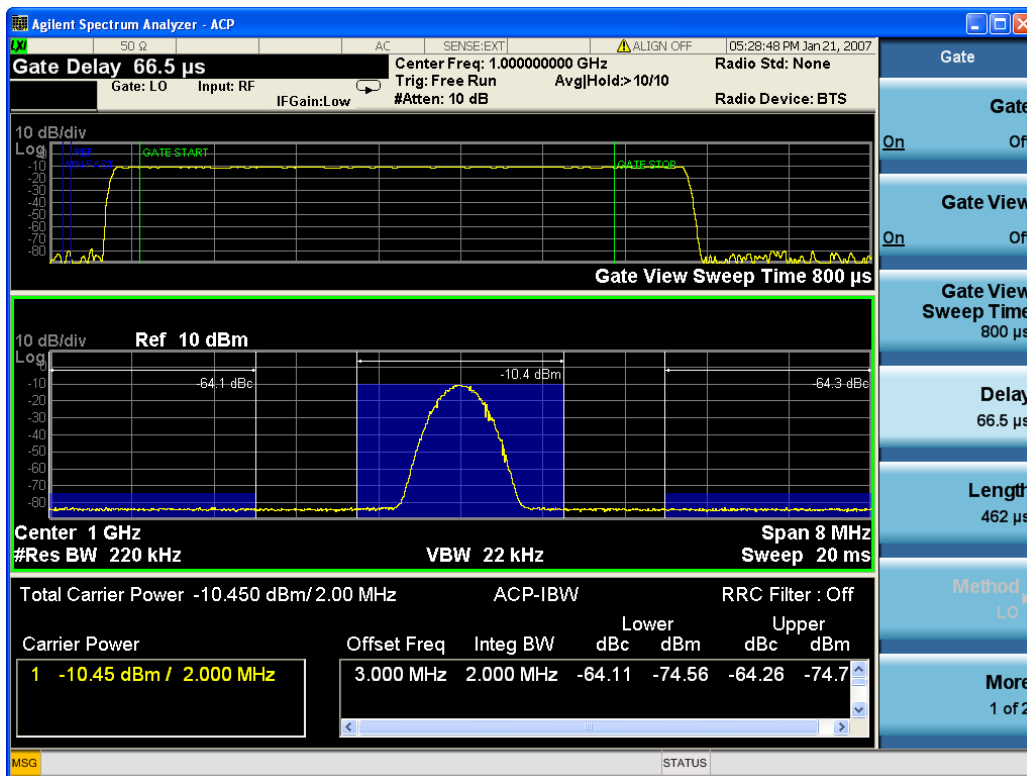

Turning Gate View off returns the analyzer to the Normal measurement view.

In the Swept SA, the normal measurement view is the single-window Swept SA view. When returning to this view, the Swept SA measurement returns to the Span it was in before entering **Gate View** (even if that is Zero Span).

The **Gate View** window is triggered from the Gate Source, with zero trigger delay. Also, when updating the **Gate View** window, the Gate itself must not operate. So it is internally shut off while the gate view window is being updated. For the Swept SA measurement, this means that the Gate is internally shut off whenever the gate view window is displayed. The measurement bar and softkeys continue to show the Trigger source for the main sweep window and give no indication that the Gate is shut off or that the Gate View window is triggered from the Gate Source.

When in **Gate View**, vertical lines are displayed in the Gate View window as follows:

- Green lines are displayed at the gate edges as follows: in Edge Gate, a line is shown for Delay and one for the end of the Gate period, defined by Length. In Level Gate a line is shown only for Delay. You can adjust the position of the green lines by adjusting the gate length and the gate delay. These lines update in the Gate View window as the active function changes, even if the window is not being updated. In Gated LO and Gated Video, these lines are positioned relative to the delay reference line (not relative to 0 time). In Gated FFT, their location is relative to the left edge of the screen.
- A blue line is displayed showing the delay reference, that is, the reference point for the Gate Delay within the Zero Span window. The blue line represents where (in time) the effective location of the gate start would be if the gate were programmed to zero delay.
-
- The second blue line is labeled "MIN FAST" as shown in the figure above because it represents the minimum Gate Delay for fast Gated LO operation. This line is only displayed in Gated LO. You cannot scroll (knob) or decrement (down key) the Gate Delay to less than that represented by the position of this line, it can only be set below this position manually, although once there it can be moved freely with the knob while below the line.
- A yellow line in the Gated Video case only, is displayed at Blength, where Blength is the display point (bucket) length for the swept trace, which is given by the sweep time for that trace divided by number of Points – 1. So it is referenced to 0 time, not to the delay reference. This line is labeled NEXT PT (it is not shown in the figure above because the figure above is for Gated LO).
- The yellow line represents the edge of a display point (bucket). Normally in Gated Video, the bucket length must be selected so that it exceeds the off time of the burst. There is another way to use the analyzer in Gated Video measurements, and that is to set the bucket width much shorter than the off time of the burst. Then use the Max Hold trace function to fill in "missing" buckets more slowly. This allows you to see some of the patterns of the Gated Video results earlier, though seeing a completely filled-in spectrum later.

Gate View Setup

Accesses a menu that enables you to setup parameters relevant to the Gate View

Key Path	Sweep/Control, Gate
Scope	Meas Global
Initial S/W Revision	A.10.00

Gate View Sweep Time

Controls the sweep time in the Gate View window. To provide an optimal view of the gate signal, the analyzer initializes Gate View Sweep Time based on the current settings of Gate Delay and Gate Length.

Key Path	Sweep/Control, Gate, Gate View Setup
Remote Command	[:SENSe] :SWEep:EGATe:TIME <time> [:SENSe] :SWEep:EGATe:TIME?
Example	SWE:EGAT:TIME 500 ms
Dependencies	Gate View Sweep Time is initialized: <ul style="list-style-type: none"> • On Preset (after initializing delay and length). • Every time the Gate Method is set/changed. <p>Additionally, in the Swept SA measurement, whenever you do a Preset, or leave Gate View, the analyzer remembers the Gate Delay and Gate Length settings. Then, when returning to Gate View, if the current Gate Delay and/or Gate Length do not match the remembered values Gate View Sweep Time is re-initialized.</p> <ol style="list-style-type: none"> 1. Compute the location of the "gate stop" line, which you know is at time $t = t_{min} + \text{GateDelay} + \text{GateLength}$.
Preset	519.3 μ s WiMAX OFDMA: 5 ms GSM/EDGE: 1 ms
State Saved	Saved in instrument state
Max	6000 s
Initial S/W Revision	Prior to A.02.00

Gate View Start Time

Controls the time at the left edge of the Gate View.

Key Path	Sweep/Control, Gate, Gate View Setup
Remote Command	[:SENSe] :SWEep:EGATe:VIEW:START <time> [:SENSe] :SWEep:EGATe:VIEW:START?
Example	SWE:EGAT:VIEW:STAR 10ms
Notes	Units of time are required or no units; otherwise an invalid suffix error message will be generated. See error -131.
Preset	0 ms
State Saved	Saved in instrument state
Min	0
Max	500 ms
Initial S/W Revision	A.10.00

Gate Delay

Controls the length of time from the time the gate condition goes True until the gate is turned on.

Key Path	Sweep/Control, Gate
Remote Command	[:SENSe] :SWEep:EGATe:DELay <time> [:SENSe] :SWEep:EGATe:DELay?
Example	SWE:EGAT:DELay 500ms SWE:EGAT:DELay?
Notes	Units of time are required or no units; otherwise an invalid suffix error message will be generated.
Preset	57.7 us WiMAX OFDMA: 71 us GSM/EDGE: 600 us WLAN: 500 us
State Saved	Saved in instrument state
Min	0.0 us
Max	100 s
Backwards Compatibility SCPI	[:SENSe] :SWEep:TIME:GATE:DELay ESA compatibility
Initial S/W Revision	Prior to A.02.00

Gate Length

Controls the length of time that the gate is on after it opens.

Key Path	Sweep/Control, Gate
Remote Command	[:SENSe] :SWEep:EGATe:LENGth <time> [:SENSe] :SWEep:EGATe:LENGth?
Example	SWE:EGAT:LENG 1 SWE:EGAT:LENG?
Notes	Units of time are required or no units; otherwise an invalid suffix error message will be generated.
Dependencies	<p>Grayed out when Gate Method is set to FFT in which case the label changes to that shown below.</p> <div style="border: 1px solid black; padding: 5px; display: inline-block;"> <p>Gate Length (=1.83/RBW) 2.8 ms</p> </div> <p style="margin-left: 20px;">vsd 39-1</p> <p>The key is also grayed out if Gate Control = Level.</p>
Preset	461.6 us

	WiMAX OFDMA: 50 us GSM/EDGE: 200 us WLAN: 1.54 ms
State Saved	Saved in instrument state
Min	100 ns
Max	5 s
Backwards Compatibility SCPI	[:SENSe] :SWEep:TIME:GATE:LENGth ESA compatibility
Initial S/W Revision	Prior to A.02.00

Gate Source

The menus under the Gate Source key are the same as those under the Trigger key, with the exception that neither Free Run nor Video are available as Gate Source selections. However, a different SCPI command is used to select the Gate Source (see table below) because you may independently set the Gate Source and the Trigger Source.

Any changes to the settings in the setup menus under each Gate Source selection key (for example: Trigger Level, Trigger Delay, etc.) also affect the corresponding settings under the Trigger menu keys. The SCPI commands used for these are the same for Trigger and Gate, since there is only one setting which affects both Gate and Trigger. Example: to set the Trigger Level for External 1 you use the command :TRIG:EXT1:LEV regardless of whether you are using External 1 as a Trigger Source or a Gate Source.

Key Path	Sweep/Control, Gate
Remote Command	[:SENSe] :SWEep:EGATE:SOURce EXTernal1 EXTernal2 LINE FRAME RFBurst [:SENSe] :SWEep:EGATE:SOURce?
Dependencies	In some models, there is no second External input. In these models, the External 2 key is blanked and the EXTernal2 parameter will generate a “Hardware missing; Not available for this model number” error.
Preset	EXTernal 1 GSM/EDGE, MSR: FRAME LTETDD: EXTernal 1When Direction is Downlink, FRAME when Direction is Uplink.
Backwards Compatibility Notes	In ESA, there is a single Gate input port. In PSA, the Gate Source may be taken from one of two specified input ports. In the X-Series, any Trigger Source can be a Gate Source.
Initial S/W Revision	Prior to A.02.00
Modified at S/W Revision	A.03.00, A.14.00

Line

Pressing this key, when it is not selected, selects the line signal as the trigger. A new sweep/measurement will start synchronized with the next cycle of the line voltage. Pressing this key, when it is already selected, access the line trigger setup menu.

Key Path	Trigger
Example	TRIG:SOUR LINE Swept SA measurement TRIG:<meas>:SOUR LINE Measurements other than Swept SA
Dependencies	Line trigger is not available when operating from a "dc power source", for example, when the instrument is powered from batteries.
State Saved	Saved in instrument state
Status Bits/OPC dependencies	The Status Operation Register bit 5 "Waiting for Trigger" is set at the same time as the Sweeping or Measuring bit is set. It is cleared when the trigger actually occurs (that is, after the trigger event occurs and all the applicable trigger criteria have been met). A corresponding pop-up message ("Waiting for trigger") is generated if no trigger signal appears after approximately 2 sec. This message goes away when a trigger signal appears.
Initial S/W Revision	Prior to A.02.00

Trig Slope

Controls the trigger polarity. It is set positive to trigger on a rising edge and negative to trigger on a falling edge.

Key Path	Trigger, Line
Remote Command	:TRIGger[:SEQuence]:LINE:SLOPe POSitive NEGative :TRIGger[:SEQuence]:LINE:SLOPe?
Example	TRIG:LINE:SLOP NEG
Preset	POSitive
State Saved	Saved in instrument state
Backwards Compatibility Notes	The legacy :TRIGger[:SEQuence]:SLOPe command affects the slopes for the VID, LINE, EXT1, EXT2, and RFB triggers.
Initial S/W Revision	Prior to A.02.00

External 1

Pressing this key, when it is not selected, selects an external input signal as the trigger. A new sweep/measurement will start when the external trigger condition is met using the external 1 input connector on the rear panel.

Pressing this key, when it is already selected, accesses the external 1 trigger setup menu.

Key Path	Trigger
Example	TRIG:SOUR EXT1 Swept SA measurement TRIG:<meas>:SOUR EXT1 Measurements other than Swept SA
Dependencies	Grayed out if in use by Point Trigger in the Source Setup menu. Forced to Free Run if already selected and Point Trigger is set to External 1.
State Saved	Saved in instrument state
Status Bits/OPC dependencies	The Status Operation Register bit 5 "Waiting for Trigger" is set at the same time as the Sweeping or Measuring bit is set. It is cleared when the trigger actually occurs (that is, after the trigger event occurs and all the applicable trigger criteria have been met). A corresponding pop-up message ("Waiting for trigger") is generated if no trigger signal appears after approximately 2 sec. This message goes away when a trigger signal appears.
Initial S/W Revision	Prior to A.02.00

Trigger Level

Sets the value where the external 1 trigger input will trigger a new sweep/measurement.

Key Path	Trigger, External 1
Remote Command	:TRIGger[:SEquence]:EXTernal1:LEVel <level> :TRIGger[:SEquence]:EXTernal1:LEVel?
Example	TRIG:EXT1:LEV 0.4 V
Couplings	This same level is used for the Ext1 trigger source in the Trigger menu, for the Ext1 selection in the Periodic Timer sync source (in the Trigger menu and in the Gate Source menu), and also for the Ext1 selection in the Gate Source menu.
Preset	1.2 V
State Saved	Saved in instrument state
Min	-5 V
Max	5 V
Default Unit	V
Backwards Compatibility SCPI	:TRIGger[:SEquence]:EXTernal:LEVel For backward compatibility, the parameter EXTernal is mapped to EXTernal1
Backwards Compatibility SCPI	:TRIGger[:SEquence]:FRAME:EXTernal1:LEVel
Initial S/W Revision	Prior to A.02.00

Trig Slope

Controls the trigger polarity. It is set positive to trigger on a rising edge and negative to trigger on a falling edge.

Key Path	Trigger, External 1
Remote Command	:TRIGger[:SEquence]:EXTernal1:SLOPe POSitive NEGative :TRIGger[:SEquence]:EXTernal1:SLOPe?
Example	TRIG:EXT1:SLOP NEG
Couplings	This same slope is used in the Ext1 selection for the trigger source in the Trigger menu and for the period timer sync source (in the Trigger menu and in the Gate Source menu).
Preset	POSitive
State Saved	Saved in instrument state
Backwards Compatibility SCPI	:TRIGger[:SEquence]:EXTernal:SLOPe For backward compatibility, the parameter EXTernal is mapped to EXTernal1
Backwards Compatibility SCPI	:TRIGger[:SEquence]:FRAMe:EXTernal1:SLOPe
Backwards Compatibility Notes	The legacy :TRIGger[:SEquence]:SLOPe command affects the slopes for the VID, LINE, EXT1, EXT2, and RFB triggers.
Initial S/W Revision	Prior to A.02.00

Zero Span Delay Comp On/Off

In zero span, there is a natural delay in the signal path, which comes from the RBW filter. This is usually desirable, as it allows you to trigger on events and also see those events, because the signal is delayed from the trigger event. However, in some cases it is desirable to eliminate this delay, so that trigger events line up exactly with the zero time point in zero span. You can use the Zero Span Delay Comp On/Off feature to enable or disable zero span delay compensation.

Key Path	Trigger, External 1
Remote Command	:TRIGger[:SEquence]:EXTernal1:DELay:COMPensation OFF ON 0 1 :TRIGger[:SEquence]:EXTernal1:DELay:COMPensation?
Example	TRIG:EXT1:DEL:COMP ON
Dependencies	No effect except in zero-span, but not locked out in nonzero spans. Blanked in modes that do not support zero-span measurements. If the SCPI command is sent when the key is blanked, an error is returned: -221, "Settings conflict; Feature not supported for this measurement" In analyzers shipping N9060A, this feature requires N9060A-7FP.
Preset	OFF
State Saved	Saved in instrument state
Initial S/W Revision	A.11.00

External 2

Pressing this key, when it is not selected, selects an external input signal as the trigger. A new sweep/measurement will start when the external trigger condition is met using the external 2 input

connector. The external trigger 2 input connector is on the rear panel.

Pressing this key, when it is already selected, accesses the external 2 trigger setup menu.

Key Path	Trigger
Example	TRIG:SOUR EXT2 Swept SA measurement TRIG:<meas>:SOUR EXT2 Measurements other than Swept SA
Dependencies	In some models, there is no second External input. In these models, the External 2 key is blanked and the EXTernal2 parameter will generate a "Hardware missing; Not available for this model number" message. Grayed out if in use by Point Trigger in the Source Setup menu. Forced to Free Run if already selected and Point Trigger is set to External 2.
State Saved	Saved in instrument state
Status Bits/OPC dependencies	The Status Operation Register bit 5 "Waiting for Trigger" is set at the same time as the Sweeping or Measuring bit is set. It is cleared when the trigger actually occurs (that is, after the trigger event occurs and all the applicable trigger criteria have been met). A corresponding pop-up message ("Waiting for trigger") is generated if no trigger signal appears after approximately 2 sec. This message goes away when a trigger signal appears.
Initial S/W Revision	Prior to A.02.00
Modified at S/W Revision	A.03.00

Trigger Level

Sets the value where the external 2 trigger input will trigger a new sweep/measurement.

Key Path	Trigger, External 2
Remote Command	:TRIGger[:SEquence]:EXTernal2:LEVel :TRIGger[:SEquence]:EXTernal2:LEVel?
Example	TRIG:EXT2:LEV 1.1 V
Couplings	This same level is used for the Ext2 trigger source in the Trigger menu, for the Ext2 selection in the Periodic Timer sync source (in the Trigger menu and in the Gate Source menu), and also for the Ext2 selection in the Gate Source menu.
Preset	1.2 V
State Saved	Saved in instrument state
Min	-5 V
Max	5 V
Default Unit	V
Backwards Compatibility SCPI	:TRIGger[:SEquence]:FRAMe:EXTernal2:LEVel
Initial S/W Revision	Prior to A.02.00

Trig Slope

Controls the trigger polarity. It is set positive to trigger on a rising edge and negative to trigger on a falling edge.

Key Path	Trigger, External 2
Remote Command	:TRIGger[:SEquence]:EXTernal2:SLOPe POSitive NEGative :TRIGger[:SEquence]:EXTernal2:SLOPe?
Example	TRIG:EXT2:SLOP NEG
Couplings	This same slope is used in the Ext2 selection for the trigger source in the Trigger menu and for the period timer sync source (in the Trigger menu and in the Gate Source menu).
Preset	POSitive
State Saved	Saved in instrument state
Backwards Compatibility SCPI	:TRIGger[:SEquence]:FRAMe:EXTernal2:SLOPe
Backwards Compatibility Notes	The legacy :TRIGger[:SEquence]:SLOPe command affects the slopes for the VID, LINE, EXT1, EXT2, and RFB triggers.
Initial S/W Revision	Prior to A.02.00

Zero Span Delay Comp On/Off

In zero span, there is a natural delay in the signal path, which comes from the RBW filter. This is usually desirable, as it allows you to trigger on events and also see those events, because the signal is delayed from the trigger event. However, in some cases it is desirable to eliminate this delay, so that trigger events line up exactly with the zero time point in zero span. You can use the Zero Span Delay Comp On/Off feature to enable or disable zero span delay compensation.

Key Path	Trigger, External 2
Remote Command	:TRIGger[:SEquence]:EXTernal2:DELAy:COMPensation OFF ON 0 1 :TRIGger[:SEquence]:EXTernal2:DELAy:COMPensation?
Example	TRIG:EXT2:DEL:COMP ON
Dependencies	No effect except in zero-span, but not locked out in nonzero spans. Blanked in modes that do not support zero-span measurements. If the SCPI command is sent when the key is blanked, an error is returned: -221, "Settings conflict; Feature not supported for this measurement" In analyzers shipping N9060A, this feature requires N9060A-7FP.
Preset	OFF
State Saved	Saved in instrument state
Initial S/W Revision	A.11.00

RF Burst

Pressing this key, when it is not selected, selects the RF Burst as the trigger. A new sweep/measurement will start when an RF burst envelope signal is identified from the signal at the RF Input connector. Pressing this key, when it is already selected, accesses the RF Burst trigger setup menu.

In some models, a variety of burst trigger circuitry is available, resulting in various available burst trigger bandwidths. The analyzer automatically chooses the appropriate trigger path based on the hardware configuration and other settings of the analyzer.

Key Path	Trigger
Example	TRIG:SOUR RFB Swept SA measurement TRIG:< meas>:SOUR RFB Measurements other than Swept SA
State Saved	Saved in instrument state
Status Bits/OPC dependencies	The Status Operation Register bit 5 "Waiting for Trigger" is set at the same time as the Sweeping or Measuring bit is set. It is cleared when the trigger actually occurs (that is, after the trigger event occurs and all the applicable trigger criteria have been met). A corresponding pop-up message ("Waiting for trigger") is generated if no trigger signal appears after approximately 2 sec. This message goes away when a trigger signal appears.
Backwards Compatibility Notes	The legacy command: :TRIGger[:SEQuence]:RFBurst:FSElectivity[:STATe] OFF ON 0 1 is not supported in the X-Series, as the hardware to do Frequency Selective burst triggers does not exist in X-Series.
Initial S/W Revision	Prior to A.02.00
Modified at S/W Revision	A.04.00

Absolute Trigger Level

Sets the absolute trigger level for the RF burst envelope.

When using the External Mixing path, the Absolute Trigger Level is uncalibrated because the factory default was set to accommodate the expected IF levels for the RF path.

Key Path	Trigger, RF Burst
Scope	Meas Global
Remote Command	:TRIGger[:SEQuence]:RFBurst:LEVel:ABSolute <ampl> :TRIGger[:SEQuence]:RFBurst:LEVel:ABSolute?
Example	TRIG:RFB:LEV:ABS 10 dBm sets the trigger level of the RF burst envelope signal to the absolute level of 10 dBm
Notes	Sending this command does not switch the setting from relative to absolute; to switch it you need to send the :TRIGger[:SEQuence]:RFBurst:LEVel:TYPE command, below. Amplitude Corrections are not taken into account by the Absolute Trigger Level. For example, if you have given yourself effective gain with an amplitude correction factor, the Absolute Trigger will not fire until you have set the trigger level that far below the displayed signal level, rather than simply to

	the displayed signal level. This is only true for Amplitude Corrections, not External Gain or Ref Level Offset functions. If mode is Bluetooth, the default value is -50 dBm.
Couplings	This same level is used for the RF Burst trigger source in the Trigger menu, for the RF Burst selection in the Periodic Timer sync source (in the Trigger menu and in the Gate Source menu), and also for the RF Burst selection in the Gate Source menu
Preset	-20 dBm
State Saved	Saved in instrument state
Min	-200 dBm
Max	100 dBm
Default Unit	depends on the current selected Y-Axis unit
Backwards Compatibility SCPI	:TRIGger[:SEquence]:FRAMe:RFBurst:LEVel:ABSolute
Initial S/W Revision	Prior to A.02.00
Modified at S/W Revision	A.04.00

Key Path	Trigger, RF Burst
Remote Command	:TRIGger[:SEquence]:RFBurst:LEVel:TYPE ABSolute RELative :TRIGger[:SEquence]:RFBurst:LEVel:TYPE?
Example	TRIG:RFB:LEV:TYPE REL sets the trigger level type of the RF burst trigger to Relative.
Preset	ABSolute
State Saved	Saved in instrument state
Initial S/W Revision	Prior to A.02.00
Modified at S/W Revision	A.04.00

Relative Trigger Level

Sets the relative trigger level for the RF burst envelope.

In some models, the relative burst trigger function is implemented in hardware. In other models, without the advanced triggering hardware required, the relative burst trigger function is implemented in software in some measurements, and is unavailable in other measurements.

When implemented in software, the relative RF Burst trigger function is implemented as follows:

1. The measurement starts with the absolute RF Burst trigger setting. If it cannot get a trigger with that level, auto trigger fires and the acquisition starts anyway. After the acquisition, the measurement searches for the peak in the acquired waveform and saves it.

2. Now, in the next cycle of the measurement, the measurement determines a new absolute RF Burst level based on the peak value from the first measurement and the Relative RF Burst Trigger Level (always 0 or negative dB) set by the user. The following formula is used:
 3. absolute RF Burst level = peak level of the previous acquisition + relative RF Burst level
 4. If the new absolute RF Burst level differs from the previous by more than 0.5 dB, the new level is sent to the hardware; otherwise it is not updated (to avoid slowing down the acquisition)
- Steps 2 and 3 repeat for subsequent measurements.

Key Path	Trigger, RF Burst
Scope	Meas Global
Remote Command	:TRIGger[:SEquence]:RFBurst:LEVel:RELative <rel_ampl> :TRIGger[:SEquence]:RFBurst:LEVel:RELative?
Example	TRIG:RFB:LEV:REL -10 dB sets the trigger level of the RF burst envelope signal to the relative level of -10 dB
Notes	Sending this command does not switch the setting from absolute to relative; to switch it you need to send the :TRIGger[:SEquence]:RFBurst:LEVel:TYPE command, above. The relative trigger level is not available in some measurements. In those measurements the RELative parameter, and the :TRIGger[:SEquence]:RFBurst:LEVel:TYPE command (above), will generate an error if sent.
Dependencies	This key is grayed out and Absolute Trigger Level selected if the required hardware is not present in your analyzer and the current measurement does not support Relative triggering.
Preset	-6 dB GSM: -25 dB
State Saved	Saved in instrument state
Min	-45 dB
Max	0 dB
Default Unit	dB or dBc
Backwards Compatibility SCPI	:TRIGger[:SEquence]:RFBurst:LEVel This legacy command is aliased to :TRIGger[:SEquence]:RFBurst:LEVel:RELative because the PSA had ONLY relative burst triggering
Initial S/W Revision	Prior to A.02.00
Modified at S/W Revision	A.04.00

Trigger Slope

It is set positive to trigger on a rising edge and negative to trigger on a falling edge.

Key Path	Trigger, RF Burst
Remote Command	:TRIGger[:SEquence]:RFBurst:SLOPe POSitive NEGative :TRIGger[:SEquence]:RFBurst:SLOPe?

Example	TRIG:RFB:SLOP NEG
Couplings	This same slope is used in the RF Burst selection for the trigger source in the Trigger menu and for the period timer sync source (in the Trigger menu and in the Gate Source menu).
Preset	POSitive
State Saved	Saved in instrument state
Backwards Compatibility SCPI	:TRIGger[:SEQuence]:FRAMe:RFBurst:SLOPe
Backwards Compatibility Notes	The legacy :TRIGger[:SEQuence]:SLOPe command affects the slopes for the VID, LINE, EXT1, EXT2, and RFB triggers.
Initial S/W Revision	Prior to A.02.00

Periodic Timer (Frame Trigger)

Pressing this key, when it is not selected, selects the internal periodic timer signal as the trigger. Triggering occurrences are set by the **Period** parameter, which is modified by the **Sync Source** and **Offset**. Pressing this key, when it is already selected, accesses the periodic timer trigger setup functions.

If you do not have a sync source selected (it is Off), then the internal timer will not be synchronized with any external timing events.

Key Path	Trigger
Example	TRIG:SOUR FRAM Swept SA measurement TRIG:<meas>:SOUR FRAM Measurements other than Swept SA
State Saved	Saved in instrument state
Readback	[Sync: <value of Sync Source>], for example, [Sync: External 1]
Status Bits/OPC dependencies	The Status Operation Register bit 5 "Waiting for Trigger" is set at the same time as the Sweeping or Measuring bit is set. It is cleared when the trigger actually occurs (that is, after the trigger event occurs and all the applicable trigger criteria have been met). A corresponding pop-up message ("Waiting for trigger") is generated if no trigger signal appears after approximately 2 sec. This message goes away when a trigger signal appears.
Initial S/W Revision	Prior to A.02.00

Periodic Timer Triggering:

This feature selects the internal periodic timer signal as the trigger. Trigger occurrences are set by the **Periodic Timer** parameter, which is modified by the **Sync Source** and **Offset**.

The figure below shows the action of the periodic timer trigger. Before reviewing the figure, we'll explain some uses for the periodic trigger.

A common application is measuring periodic burst RF signals for which a trigger signal is not easily available. For example, we might be measuring a TDMA radio which bursts every 20 ms. Let's assume that the 20 ms period is very consistent. Let's also assume that we do not have an external trigger source

available that is synchronized with the period, and that the signal-to-noise ratio of the signal is not high enough to provide a clean RF burst trigger at all of the analysis frequencies. For example, we might want to measure spurious transmissions at an offset from the carrier that is larger than the bandwidth of the RF burst trigger. In this application, we can set the Periodic Timer to a 20.00 ms period and adjust the offset from that timer to position our trigger just where we want it. If we find that the 20.00 ms is not exactly right, we can adjust the period slightly to minimize the drift between the period timer and the signal to be measured.

A second way to use this feature would be to use **Sync Source** temporarily, instead of **Offset**. In this case, we might tune to the signal in a narrow span and use the RF Burst trigger to synchronize the periodic timer. Then we would turn the sync source off so that it would not miss-trigger. Miss-triggering can occur when we are tuned so far away from the RF burst trigger that it is no longer reliable.

A third example would be to synchronize to a signal that has a reference time element of much longer period than the period of interest. In some CDMA applications, it is useful to look at signals with a short periodicity, by synchronizing that periodicity to the "even-second clock" edge that happens every two seconds. Thus, we could connect the even-second clock trigger to Ext1 and use then Ext1 as the sync source for the periodic timer.

The figure below illustrates this third example. The top trace represents the even-second clock. It causes the periodic timer to synchronize with the leading edge shown. The analyzer trigger occurs at a time delayed by the accumulated offset from the period trigger event. The periodic timer continues to run, and triggers continue to occur, with a periodicity determined by the analyzer time base. The timer output (labeled "late event") will drift away from its ideal time due to imperfect matching between the time base of the signal being measured and the time base of the analyzer, and also because of imperfect setting of the period parameter. But the synchronization is restored on the next even-second clock event. ("Accumulated offset" is described in the in the **Offset** function section.)

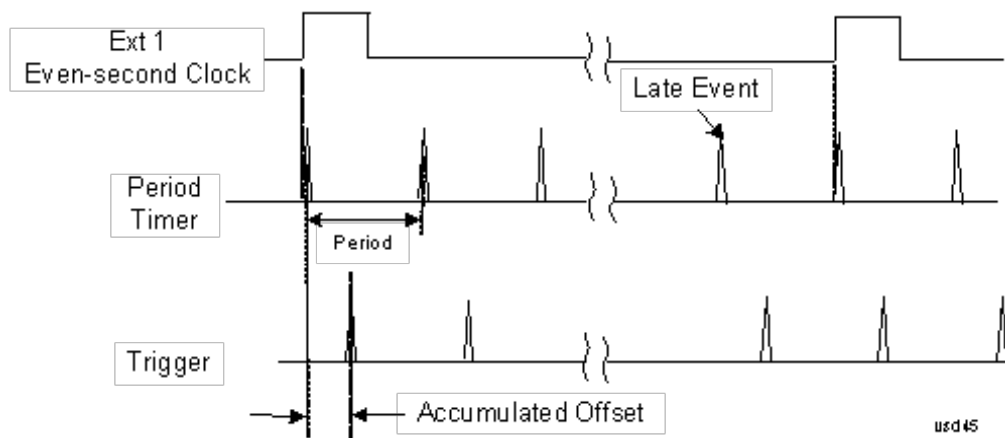

Period

Sets the period of the internal periodic timer clock. For digital communications signals, this is usually set to the frame period of your current input signal. In the case that sync source is not set to OFF, and the external sync source rate is changed for some reason, the periodic timer is synchronized at the every external synchronization pulse by resetting the internal state of the timer circuit.

Key Path	Trigger, Periodic Timer
Remote Command	:TRIGger[:SEquence]:FRAME:PERiod <time>

	:TRIGger[:SEquence]:FRAMe:PERiod?
Example	TRIG:FRAM:PER 100 ms
Dependencies	The invalid data indicator turns on when the period is changed, until the next sweep/measurement completes.
Couplings	The same period is used in the Gate Source selection of the period timer.
Preset	20 ms GSM: 4.615383
State Saved	Saved in instrument state
Min	100.000 ns
Max	559.0000 ms
Default Unit	S
Initial S/W Revision	Prior to A.02.00

Offset

Adjusts the accumulated offset between the periodic timer events and the trigger event. Adjusting the accumulated offset is different than setting an offset, and requires explanation.

The periodic timer is usually not synchronized with any external events, so the timing of its output events has no absolute meaning. Since the timing relative to external events (RF signals) is important, you need to be able to adjust (offset) it. However, you have no direct way to see when the periodic timer events occur. All that you can see is the trigger timing. When you want to adjust the trigger timing, you will be changing the internal offset between the periodic timer events and the trigger event. Because the absolute value of that internal offset is unknown, we will just call that the accumulated offset. Whenever the Offset parameter is changed, you are changing that accumulated offset. You can reset the displayed offset using Reset Offset Display. Changing the display does not change the value of the accumulated offset, and you can still make additional changes to accumulated offset.

To avoid ambiguity, we define that an increase in the "offset" parameter, either from the knob or the SCPI adjust command, serves to delay the timing of the trigger event.

Key Path	Trigger, Periodic Timer
Remote Command	:TRIGger[:SEquence]:FRAMe:OFFSet <time> :TRIGger[:SEquence]:FRAMe:OFFSet?
Example	TRIG:FRAM:OFFS 1.2 ms
Notes	The front panel interface (for example, the knob), and this command, adjust the accumulated offset, which is shown on the active function display. However, the actual amount sent to the hardware each time the offset is updated is the delta value, that is, the current accumulated offset value minus the previous accumulated offset value. Note that the accumulated offset value is essentially arbitrary; it represents the accumulated offset from the last time the offset was zeroed (with the Reset Offset Display key). Note that this command does not change the period of the trigger waveform. Note also that Offset is used only when the sync source is set to OFF, otherwise delay is used, see section "Trig Delay" on page 470.

	An increase in the "offset" parameter, either from the knob or the SCPI adjust command, serves to delay the timing of the trigger event.
Notes	When the SCPI command is sent the value shown on the key (and the Active Function, if this happens to be the active function) is updated with the new value. However, the actual amount sent to the hardware is the delta value, that is, the current accumulated offset value minus the previous accumulated offset value. The SCPI query simply returns the value currently showing on the key.
Dependencies	The invalid data indicator turns on when the offset is changed, until the next sweep/measurement completes.
Couplings	The same offset is used in the Gate Source selection of the period timer.
Preset	0 s
State Saved	Saved in instrument state
Min	-10.000 s
Max	10.000 s
Default Unit	S
Initial S/W Revision	Prior to A.02.00

Offset Adjust (Remote Command Only)

This remote command does not work at all like the related front panel keys. This command lets you advance the phase of the frame trigger by the amount you specify.

It does not change the period of the trigger waveform. If the command is sent multiple times, it advances the phase of the frame trigger an additional amount each time it is sent. Negative numbers are permitted.

Remote Command	:TRIGger[:SEquence]:FRAMe:ADJust <time>
Example	TRIG:FRAM:ADJ 1.2 ms
Notes	Note also that Offset is used only when the sync source is set to OFF, otherwise delay is used, see section "Trig Delay" on page 470 An increase in the "offset" parameter, either from the knob or the SCPI adjust command, serves to delay the timing of the trigger event.
Notes	The front panel interface (for example, the knob) and the :TRIG:FRAM:OFFS command adjust the accumulated offset, which is shown on the active function display. However, the actual amount sent to the hardware is the delta value, that is, the current offset value minus the previous offset value. When the SCPI command is sent the value shown on the key (and the Active Function, if this happens to be the active function) is updated by increasing it (or decreasing it if the value sent is negative) by the amount specified in the SCPI command. This is a "command only" SCPI command, with no query.
Dependencies	The invalid data indicator turns on when the offset is changed, until the next sweep/measurement completes.
Couplings	The same offset is used in the Gate Source selection of the period timer.
Preset	0 s

State Saved	Saved in instrument state
Min	-10.000 s
Max	10.000 s
Default Unit	S
Initial S/W Revision	Prior to A.02.00

Reset Offset Display

Resets the value of the periodic trigger offset display setting to 0.0 seconds. The current displayed trigger location may include an offset value defined with the Offset key. Pressing this key redefines the currently displayed trigger location as the new trigger point that is 0.0 s offset. The Offset key can then be used to add offset relative to this new timing.

Key Path	Trigger, Periodic Timer
Remote Command	:TRIGger[:SEquence]:FRAMe:OFFSet:DISPlay:RESet
Example	TRIG:FRAM:OFFS:DISP:RES
Initial S/W Revision	Prior to A.02.00

Sync Source

Selects a signal source for you to synchronize your periodic timer trigger to, otherwise you are triggering at some arbitrary location in the frame. Synchronization reduces the precision requirements on the setting of the period.

For convenience you may adjust the level and slope of the selected sync source in a conditional branch setup menu accessed from the Sync Source menu. Note that these settings match those in the **Trigger** and **Gate Source** menus; that is, each trigger source has only one value of level and slope, regardless of which menu it is accessed from.

Key Path	Trigger, Periodic Timer
Remote Command	:TRIGger[:SEquence]:FRAMe:SYNC EXTernal1 EXTernal2 RFBurst OFF :TRIGger[:SEquence]:FRAMe:SYNC?
Example	TRIG:FRAM:SYNC EXT2
Dependencies	In some models, there is no second External input. In these models, the External 2 key is blanked and the EXTernal2 parameter will generate a "Hardware missing; Not available for this model number" message.
Preset	Off GSM/EDGE, MSR,LTE,LTETDD: RFBurst
State Saved	Saved in instrument state
Readback	The current setting is read back to this key and it is also Readback to the previous Periodic Timer trigger key.

Backwards Compatibility SCPI	:TRIGger[:SEquence]:FRAMe:SYNC EXTernal
Initial S/W Revision	Prior to A.02.00
Modified at S/W Revision	A.03.00, A.14.00

Off

Turns off the sync source for your periodic trigger. With the sync source off, the timing will drift unless the signal source frequency is locked to the analyzer frequency reference.

Key Path	Trigger, Periodic Timer, Sync Source
Example	TRIG:FRAM:SYNC OFF
Readback	Off
Initial S/W Revision	Prior to A.02.00

External 1

Pressing this key, when it is not selected, selects an external input signal as the trigger. A new sweep/measurement will start when the external trigger condition is met using the external 1 input connector on the rear panel.

Pressing this key, when it is already selected, accesses the external 1 trigger setup menu.

Key Path	Trigger
Example	TRIG:SOUR EXT1 Swept SA measurement TRIG:<meas>:SOUR EXT1 Measurements other than Swept SA
Dependencies	Grayed out if in use by Point Trigger in the Source Setup menu. Forced to Free Run if already selected and Point Trigger is set to External 1.
State Saved	Saved in instrument state
Status Bits/OPC dependencies	The Status Operation Register bit 5 "Waiting for Trigger" is set at the same time as the Sweeping or Measuring bit is set. It is cleared when the trigger actually occurs (that is, after the trigger event occurs and all the applicable trigger criteria have been met). A corresponding pop-up message ("Waiting for trigger") is generated if no trigger signal appears after approximately 2 sec. This message goes away when a trigger signal appears.
Initial S/W Revision	Prior to A.02.00

Trigger Level

Sets the value where the external 1 trigger input will trigger a new sweep/measurement.

Key Path	Trigger, External 1
Remote Command	:TRIGger[:SEquence]:EXTernal1:LEVel <level> :TRIGger[:SEquence]:EXTernal1:LEVel?
Example	TRIG:EXT1:LEV 0.4 V
Couplings	This same level is used for the Ext1 trigger source in the Trigger menu, for the Ext1 selection in the Periodic Timer sync source (in the Trigger menu and in the Gate Source menu), and also for the Ext1 selection in the Gate Source menu.
Preset	1.2 V
State Saved	Saved in instrument state
Min	-5 V
Max	5 V
Default Unit	V
Backwards Compatibility SCPI	:TRIGger[:SEquence]:EXTernal:LEVel For backward compatibility, the parameter EXTernal is mapped to EXTernal1
Backwards Compatibility SCPI	:TRIGger[:SEquence]:FRAMe:EXTernal1:LEVel
Initial S/W Revision	Prior to A.02.00

Trig Slope

Controls the trigger polarity. It is set positive to trigger on a rising edge and negative to trigger on a falling edge.

Key Path	Trigger, External 1
Remote Command	:TRIGger[:SEquence]:EXTernal1:SLOPe POSitive NEGative :TRIGger[:SEquence]:EXTernal1:SLOPe?
Example	TRIG:EXT1:SLOP NEG
Couplings	This same slope is used in the Ext1 selection for the trigger source in the Trigger menu and for the period timer sync source (in the Trigger menu and in the Gate Source menu).
Preset	POSitive
State Saved	Saved in instrument state
Backwards Compatibility SCPI	:TRIGger[:SEquence]:EXTernal:SLOPe For backward compatibility, the parameter EXTernal is mapped to EXTernal1
Backwards Compatibility SCPI	:TRIGger[:SEquence]:FRAMe:EXTernal1:SLOPe
Backwards Compatibility Notes	The legacy :TRIGger[:SEquence]:SLOPe command affects the slopes for the VID, LINE, EXT1, EXT2, and RFB triggers.
Initial S/W Revision	Prior to A.02.00

External 2

Pressing this key, when it is not selected, selects an external input signal as the trigger. A new sweep/measurement will start when the external trigger condition is met using the external 2 input connector. The external trigger 2 input connector is on the rear panel.

Pressing this key, when it is already selected, accesses the external 2 trigger setup menu.

Key Path	Trigger
Example	TRIG:SOUR EXT2 Swept SA measurement TRIG:<meas>:SOUR EXT2 Measurements other than Swept SA
Dependencies	In some models, there is no second External input. In these models, the External 2 key is blanked and the EXTERNAL2 parameter will generate a "Hardware missing; Not available for this model number" message. Grayed out if in use by Point Trigger in the Source Setup menu. Forced to Free Run if already selected and Point Trigger is set to External 2.
State Saved	Saved in instrument state
Status Bits/OPC dependencies	The Status Operation Register bit 5 "Waiting for Trigger" is set at the same time as the Sweeping or Measuring bit is set. It is cleared when the trigger actually occurs (that is, after the trigger event occurs and all the applicable trigger criteria have been met). A corresponding pop-up message ("Waiting for trigger") is generated if no trigger signal appears after approximately 2 sec. This message goes away when a trigger signal appears.
Initial S/W Revision	Prior to A.02.00
Modified at S/W Revision	A.03.00

Trigger Level

Sets the value where the external 2 trigger input will trigger a new sweep/measurement.

Key Path	Trigger, External 2
Remote Command	:TRIGger[:SEquence]:EXTernal2:LEVel :TRIGger[:SEquence]:EXTernal2:LEVel?
Example	TRIG:EXT2:LEV 1.1 V
Couplings	This same level is used for the Ext2 trigger source in the Trigger menu, for the Ext2 selection in the Periodic Timer sync source (in the Trigger menu and in the Gate Source menu), and also for the Ext2 selection in the Gate Source menu.
Preset	1.2 V
State Saved	Saved in instrument state
Min	-5 V
Max	5 V
Default Unit	V
Backwards Compatibility SCPI	:TRIGger[:SEquence]:FRAMe:EXTernal2:LEVel
Initial S/W Revision	Prior to A.02.00

Trig Slope

Controls the trigger polarity. It is set positive to trigger on a rising edge and negative to trigger on a falling edge.

Key Path	Trigger, External 2
Remote Command	:TRIGger[:SEquence]:EXTernal2:SLOPe POSitive NEGative :TRIGger[:SEquence]:EXTernal2:SLOPe?
Example	TRIG:EXT2:SLOP NEG
Couplings	This same slope is used in the Ext2 selection for the trigger source in the Trigger menu and for the period timer sync source (in the Trigger menu and in the Gate Source menu).
Preset	POSitive
State Saved	Saved in instrument state
Backwards Compatibility SCPI	:TRIGger[:SEquence]:FRAMe:EXTernal2:SLOPe
Backwards Compatibility Notes	The legacy :TRIGger[:SEquence]:SLOPe command affects the slopes for the VID, LINE, EXT1, EXT2, and RFB triggers.
Initial S/W Revision	Prior to A.02.00

RF Burst

Pressing this key, when it is not selected, selects the RF Burst as the trigger. A new sweep/measurement will start when an RF burst envelope signal is identified from the signal at the RF Input connector. Pressing this key, when it is already selected, accesses the RF Burst trigger setup menu.

In some models, a variety of burst trigger circuitry is available, resulting in various available burst trigger bandwidths. The analyzer automatically chooses the appropriate trigger path based on the hardware configuration and other settings of the analyzer.

Key Path	Trigger
Example	TRIG:SOUR RFB Swept SA measurement TRIG:<meas>:SOUR RFB Measurements other than Swept SA
State Saved	Saved in instrument state
Status Bits/OPC dependencies	The Status Operation Register bit 5 "Waiting for Trigger" is set at the same time as the Sweeping or Measuring bit is set. It is cleared when the trigger actually occurs (that is, after the trigger event occurs and all the applicable trigger criteria have been met). A corresponding pop-up message ("Waiting for trigger") is generated if no trigger signal appears after approximately 2 sec. This message goes away when a trigger signal appears.
Backwards Compatibility Notes	The legacy command: :TRIGger[:SEquence]:RFBurst:FSElectivity[:STATe] OFF ON 0 1 is not supported in the X-Series, as the hardware to do Frequency Selective burst triggers does not exist in X-Series.

Initial S/W Revision	Prior to A.02.00
Modified at S/W Revision	A.04.00

Absolute Trigger Level

Sets the absolute trigger level for the RF burst envelope.

When using the External Mixing path, the Absolute Trigger Level is uncalibrated because the factory default was set to accommodate the expected IF levels for the RF path.

Key Path	Trigger, RF Burst
Scope	Meas Global
Remote Command	:TRIGger[:SEquence]:RFBurst:LEVel:ABSolute <ampl> :TRIGger[:SEquence]:RFBurst:LEVel:ABSolute?
Example	TRIG:RFB:LEV:ABS 10 dBm sets the trigger level of the RF burst envelope signal to the absolute level of 10 dBm
Notes	Sending this command does not switch the setting from relative to absolute; to switch it you need to send the :TRIGger[:SEquence]:RFBurst:LEVel:TYPE command, below. Amplitude Corrections are not taken into account by the Absolute Trigger Level. For example, if you have given yourself effective gain with an amplitude correction factor, the Absolute Trigger will not fire until you have set the trigger level that far below the displayed signal level, rather than simply to the displayed signal level. This is only true for Amplitude Corrections, not External Gain or Ref Level Offset functions. If mode is Bluetooth, the default value is -50 dBm.
Couplings	This same level is used for the RF Burst trigger source in the Trigger menu, for the RF Burst selection in the Periodic Timer sync source (in the Trigger menu and in the Gate Source menu), and also for the RF Burst selection in the Gate Source menu
Preset	-20 dBm
State Saved	Saved in instrument state
Min	-200 dBm
Max	100 dBm
Default Unit	depends on the current selected Y-Axis unit
Backwards Compatibility SCPI	:TRIGger[:SEquence]:FRAME:RFBurst:LEVel:ABSolute
Initial S/W Revision	Prior to A.02.00
Modified at S/W Revision	A.04.00

Key Path	Trigger, RF Burst
Remote Command	:TRIGger[:SEquence]:RFBurst:LEVel:TYPE ABSolute RELative :TRIGger[:SEquence]:RFBurst:LEVel:TYPE?

Example	TRIG:RFB:LEV:TYPE REL sets the trigger level type of the RF burst trigger to Relative.
Preset	ABSolute
State Saved	Saved in instrument state
Initial S/W Revision	Prior to A.02.00
Modified at S/W Revision	A.04.00

Trigger Slope

It is set positive to trigger on a rising edge and negative to trigger on a falling edge.

Key Path	Trigger, RF Burst
Remote Command	:TRIGger[:SEQuence]:RFBurst:SLOPe POSitive NEGative :TRIGger[:SEQuence]:RFBurst:SLOPe?
Example	TRIG:RFB:SLOP NEG
Couplings	This same slope is used in the RF Burst selection for the trigger source in the Trigger menu and for the period timer sync source (in the Trigger menu and in the Gate Source menu).
Preset	POSitive
State Saved	Saved in instrument state
Backwards Compatibility SCPI	:TRIGger[:SEQuence]:FRAME:RFBurst:SLOPe
Backwards Compatibility Notes	The legacy :TRIGger[:SEQuence]:SLOPe command affects the slopes for the VID, LINE, EXT1, EXT2, and RFB triggers.
Initial S/W Revision	Prior to A.02.00

Sync Holdoff

Sync Holdoff specifies the duration that the sync source signal must be kept false before the transition to true to be recognized as the sync timing. The periodic timer phase is aligned when the sync source signal becomes true, after the Holdoff time is satisfied.

A holdoff of 2 ms will work with most WiMAX signals, but there may be cases where the burst off duration is less than 1 ms and this value will need to be changed.

Key Path	Trigger, Periodic Timer
Remote Command	:TRIGger[:SEQuence]:FRAME:SYNC:HOLDoff <time> :TRIGger[:SEQuence]:FRAME:SYNC:HOLDoff? :TRIGger[:SEQuence]:FRAME:SYNC:HOLDoff:STATe OFF ON 0 1 :TRIGger[:SEQuence]:FRAME:SYNC:HOLDoff:STATe?
Preset	On, 1.000 ms

State Saved	Saved in instrument state
Min	0 ms
Max	+500 ms
Default Unit	s
Initial S/W Revision	Prior to A.02.00

Control Edge/Level

Sets the method of controlling the gating function from the gating signal.

Edge

In Edge triggering, the gate opens (after the Delay) on the selected edge (for example, positive) of the gate signal and closes on the alternate edge (for example, negative).

Level

In Level triggering, the gate opens (after the Delay) when the gate signal has achieved a certain level and stays open as long as that level is maintained.

Key Path	Sweep/Control, Gate
Remote Command	[:SENSe] :SWEep:EGATe:CONTRol EDGE LEVEl [:SENSe] :SWEep:EGATe:CONTRol?
Example	SWE:EGAT:CONT EDGE
Dependencies	If the Gate Method is FFT the Control key is grayed out and Edge is selected. If the Gate Source is TV, Frame or Line, the Control key is grayed out and Edge is selected.
Preset	EDGE
State Saved	Saved in instrument state
Backwards Compatibility SCPI	[:SENSe] :SWEep:TIME:GATE:TYPE ESA Compatibility
Initial S/W Revision	Prior to A.02.00

Gate Holdoff

Lets you increase or decrease the wait time after a gate event ends before the analyzer will respond to the next gate signal.

After any Gate event finishes, the analyzer must wait for the sweep system to settle before it can respond to another Gate signal. The analyzer calculates a "wait time," taking into account a number of factors, including RBW and Phase Noise Optimization settings. The goal is to achieve the same accuracy when gated as in ungated operation. The figure below illustrates this concept:

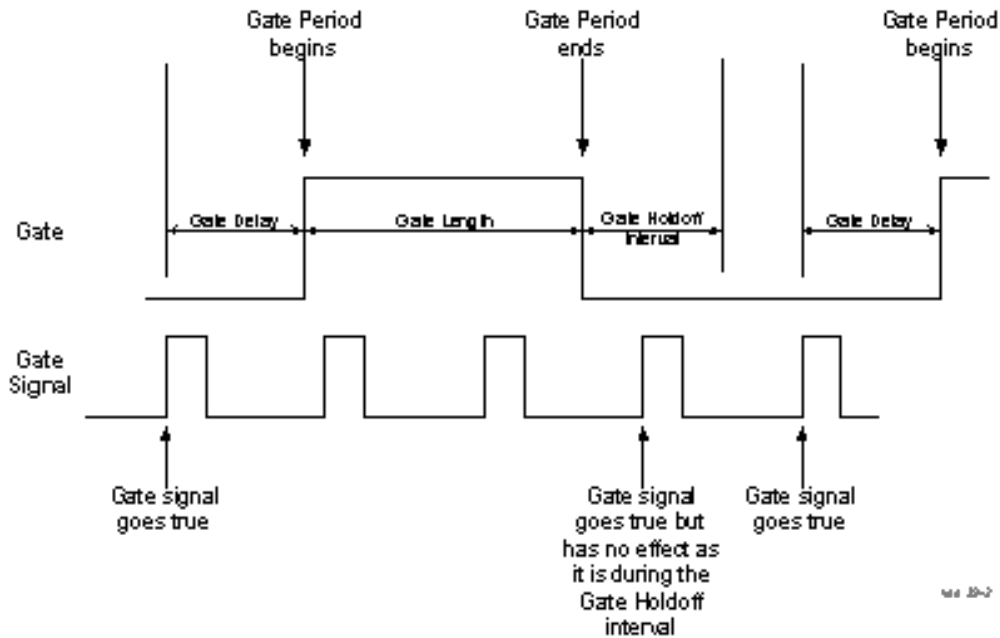

When Gate Holdoff is in Auto, the wait time calculated by the analyzer is used. When Gate Time is in Manual, the user may adjust the wait time, usually decreasing it in order to achieve greater speed, but at the risk of decreasing accuracy.

When the Method key is set to Video or FFT, the Gate Holdoff function has no effect.

In measurements that do not support Auto, the value shown when Auto is selected is “---” and the manually set holdoff is returned to a query.

Key Path	Sweep/Control, Gate
Remote Command	<pre>[:SENSe] :SWEep:EGATe:HOLDoff <time> [:SENSe] :SWEep:EGATe:HOLDoff? [:SENSe] :SWEep:EGATe:HOLDoff:AUTO OFF ON 0 1 [:SENSe] :SWEep:EGATe:HOLDoff:AUTO?</pre>
Example	<pre>SWE:EGAT:HOLD 0.0002 SWE:EGAT:HOLD? SWE:EGAT:HOLD:AUTO ON SWE:EGAT:HOLD:AUTO?</pre>
Couplings	<p>When Gate Holdoff is Auto, the Gate Holdoff key shows the value calculated by the analyzer for the wait time.</p> <p>Pressing the Gate Holdoff key while it is in Auto and not selected, causes the key to become selected and allows the user to adjust the value. If the value is adjusted, the setting changes to Man.</p> <p>Pressing the Gate Holdoff key, while it is in Auto and selected, does not change the value of Gate Holdoff, but causes the setting to change to Man. Now the user can adjust the value.</p> <p>Pressing the key while it is in Man and selected, cause the value to change back to Auto.</p> <p>Pressing the key while it is in Man and not selected, causes the key to become selected and allows the user to adjust the value.</p>

	When Method is set to Video or FFT, the Gate Holdoff function has no effect.
Preset	Auto Auto/On
State Saved	Saved in instrument state
Min	1 µsec
Max	1 sec
Initial S/W Revision	Prior to A.02.00

Gate Delay Compensation

This function allows you to select an RBW-dependent value by which to adjust the gate delay, to compensate for changes in the delay caused by RBW effects.

You can select between uncompensated operation and two types of compensation, Delay Until RBW Settled and Compensate for RBW Group Delay.

See "[More Information](#)" on page 2525

Key Path	Sweep/Control, Gate
Scope	Meas Global
Remote Command	[:SENSe] :SWEep:EGATe:DELay:COMPensation:TYPE OFF SETTled GDELay [:SENSe] :SWEep:EGATe:DELay:COMPensation:TYPE?
Example	SWE:EGAT:DEL:COMP:TYPE SETT SWE:EGAT:DEL:COMP:TYPE?
Notes	Although this function is Meas Global, there are some measurements that do not support this function. In those measurements the operation will be Uncompensated. Going into one of those measurements will not change the Meas Global selection; it will simply display the grayed-out menu key with “Uncompensated” showing as the selection. This is a non-forceful grayout, so the SCPI command is still accepted. If Gate Delay Compensation is not supported at all within a particular mode, the key is not displayed, and if the SCPI command is sent while in a measurement within that mode, an “Undefined Header” message is generated. Measurements that do not support this function include: Swept SA
Preset	TD-SCDMA mode: Compensate for RBW Group Delay All other modes: Delay Until RBW Settled
State Saved	Saved in instrument state
Range	Uncompensated Delay Until RBW Settled Compensate for RBW Group Delay
Readback text	Uncompensated Settled Group Delay
Initial S/W Revision	Prior to A.02.00
Modified at S/W Revision	A.11.0

More Information

Selecting Uncompensated means that the actual gate delay is as you sets it.

Selecting Delay Until RBW Settled causes the gate delay to be increased above the user setting by an amount equal to $3.06/\text{RBW}$. This compensated delay causes the GATE START and GATE STOP lines on the display to move by the compensation amount, and the actual hardware gate delay to be increased by the same amount. All the other gate lines (for example, MIN FAST) are unaffected. If the RBW subsequently changes, the compensation is readjusted for the new RBW. The value shown on the Gate Delay key does NOT change.

Delay Until RBW Settled allows excellent measurements of gated signals, by allowing the IF to settle following any transient that affects the burst. Excellent measurements also require that the analysis region not extend into the region affected by the falling edge of the burst. Thus, excellent measurements can only be made over a width that declines with narrowing RBWs, which is achieved by decreasing the gate length below the user setting by an amount equal to $2.53/\text{RBW}$. Therefore, for general purpose compensation, you will still want to change the gate length with changes in RBW even if the gate delay is compensated. The compensated Gate Length is limited by the analyzer so that it will never go below 10% of the value shown on the Gate Length key, as otherwise the sweep times could get very long. Anytime the Gate Length and RBW values combine in such a way that this limiting takes place, a warning is displayed. For measurements which contain multiple sweeps with different RBW like SEM and SPUR, the smallest RBW is used for this limiting.

Selecting Compensate for RBW Group Delay causes the gate delay to be increased above the user setting by an amount equal to $1.81/\text{RBW}$. This compensated delay causes the GATE START, GATE STOP lines on the display to move by the compensation amount, and the actual hardware gate delay to be increased by the same amount. All the other gate lines (for example, MIN FAST) are unaffected. If the RBW subsequently changes, the compensation is readjusted for the new RBW. The value shown on the Gate Delay key does NOT change. Compensate for RBW Group Delay also includes gate length compensation; the gate length itself is adjusted as necessary to attempt to compensate for delay effects imposed by the RBW.

Compensate for RBW Group Delay is similar to Delay Until RBW Settled, but compensates for the group delay of the RBW filter, rather than the filter settling time. As the RBW gets narrow, this can allow the settling tail of the RBW to affect the beginning part of the gated measurement, and allow the beginning of the RBW settling transient to affect the end of the gated measurement. These two effects are symmetric because the RBW response is symmetric. Because the gate length is not automatically compensated, some users might find this compensation to be more intuitive than compensation for RBW settling.

Min Fast Position Query (Remote Command Only)

This command queries the position of the MIN FAST line, relative to the delay reference (REF) line. See section "[Gate View On/Off](#)" on page 2496. If this query is sent while not in gate view, the MinFast calculation is performed based on the current values of the appropriate parameters and the result is returned. Knowing this value lets you set an optimal gate delay value for the current measurement setup.

Remote Command	[:SENSe] :SWEep:EGATe:MINFast?
Example	SWE:EGAT:MIN?
Initial S/W Revision	Prior to A.02.00

Gate Preset (Remote Command Only)

Presets the time-gated spectrum analysis capability.

This command sets gate parameter values to the ESA preset values, as follows:

Gate trigger type = edge

Gate polarity = positive

Gate delay = 1 us

Gate length = 1 us

Remote Command	<code>[:SENSe]:SWEep:TIME:GATE:PRESet</code> ESA Compatibility
Initial S/W Revision	Prior to A.02.00

Gate Level (Remote Command Only)

Sets the gate input transition point level for the external TRIGGER inputs on the front and rear panel. This is a legacy command for PSA compatibility. It is simply an alias to the equivalent trigger level command.

Remote Command	<code>[:SENSe]:SWEep:EGATE:EXTErnal[1] 2:LEVel <voltage></code> <code>[:SENSe]:SWEep:EGATE:EXTErnal[1] 2:LEVel?</code>
Notes	This command is simply an alias to <code>:TRIGger[:SEQuence]:EXTErnal[1] 2:LEVel</code> For details refer
Initial S/W Revision	Prior to A.02.00

Gate Polarity (Remote Command Only)

Sets the polarity for the gate signal. This setup is now done using the gate trigger's slope setting.

When Positive (Pos) is selected, a positive-going edge (Edge) or a high voltage (Level) will satisfy the gate condition, after the delay set with the Gate Delay key. When Negative (Neg) is selected, a negative-going edge (Edge) or a low voltage (Level) will satisfy the gate condition after the delay.

Remote Command	<code>[:SENSe]:SWEep:EGATE:POLarity</code> NEGative POSitive <code>[:SENSe]:SWEep:EGATE:POLarity?</code>
Example	<code>SWE:EGAT:POL</code> NEG <code>SWE:EGAT:POL?</code>
Preset	POSitive
State Saved	Saved in instrument state
Backwards Compatibility SCPI	<code>[:SENSe]:SWEep:TIME:GATE:POLarity</code> ESA compatibility
Initial S/W Revision	Prior to A.02.00

Remote Command	[:SENSe] :SWEep:TIME:GATE:LEVel HIGH LOW [:SENSe] :SWEep:TIME:GATE:LEVel? ESA compatibility
Preset	HIGH
Initial S/W Revision	Prior to A.02.00

Points

Sets the number of points per sweep. The resolution of setting the sweep time depends on the number of points selected. If Preset is selected, the number of points per sweep defaults to 1001. The current value of points is displayed parenthetically, next to the sweep time in the lower right corner of the display.

Key Path	Sweep/Control
Mode	All except SA and BASIC
Remote Command	[:SENSe] :MONitor:SWEep:POINts <integer> [:SENSe] :MONitor:SWEep:POINts?
Example	:MON:SWE:POIN 1000 :MON:SWE:POIN?
Couplings	Whenever the number of sweep points changes, the sweep time is re-quantized.
Preset	1001
State Saved	Saved in instrument state.
Range	1 to 20001
Min	1
Max	20001
Initial S/W Revision	Prior to A.02.00

16 Monitor Spectrum Measurement
System

System

See ["System" on page 366](#)

Trace/Detector

Accesses a menu that enables you to control the display, storage, detection and manipulation of trace data. Each trace is comprised of a series of data points in which X and Y axis information is stored. The analyzer updates the information for the active trace with each sweep of the current measurement.

Key Path	Front-panel key
Initial S/W Revision	Prior to A.02.00

Select Trace

Allows you to select which trace you want to use for the current measurement. You can select one of three traces. Monitor Spectrum supports 3 traces, numbered 1 through 3.

Key Path	Trace/Detector
Mode	All except SA and BASIC
Preset	Trace 1
State Saved	The number of the selected trace is saved in Instrument State
Initial S/W Revision	Prior to A.02.00

Trace Type

Allows you to select the type of trace you want to use for the current measurement. You can assign a trace type to one of the three available traces.

The first page of this menu contains a 1–of–N selection of the trace type for the selected trace:

WRITe	Clear Write
AVERage	Average
MAXHold	Max Hold
MINHold	Min Hold

Key Path	Trace/Detector
Mode	All except SA and BASIC
Remote Command	:TRACe[1] 2 3:MONitor:TYPE WRITe AVERage MAXHold MINHold :TRACe[1] 2 3:MONitor:TYPE?
Example	TRAC:MON:TYPE WRIT TRAC:MON:TYPE?
Preset	WRITe
State Saved	Saved in instrument state.

Range	WRITE AVERage MAXHold MINHold for traces 1 through 3
Backwards Compatibility SCPI	:DISPlay:MONitor:VIEW:WINDow:TRACe[1] 2 3:TYPE
Initial S/W Revision	Prior to A.02.00

Update

Toggles a trace state between Update and Off. The Off selection makes the trace inactive (or a *stored trace*). This does not affect whether the trace is visible or not. To change the trace visibility, see ["Display" on page 2530](#).

Key Path	Trace/Detector
Mode	All except SA and BASIC
Remote Command	:TRACe[1] 2 3:MONitor:UPDate[:STATe] ON OFF 0 1 :TRACe[1] 2 3:MONitor:UPDate[:STATe]?
Example	TRAC3:MON:UPD OFF TRAC3:MON:UPD?
Preset	ON
State Saved	Saved in instrument state.
Range	On Off(View)
Initial S/W Revision	Prior to A.02.00

Display

Controls the visibility of a trace. When set to Blank, traces do not display nor appear on printouts but are otherwise unaffected. They may be queried and markers may be placed on them.

Key Path	Trace/Detector
Mode	All except SA and BASIC
Remote Command	:TRACe[1] 2 3:MONitor:DISPlay[:STATe] ON OFF 0 1 :TRACe[1] 2 3:MONitor:DISPlay[:STATe]?
Example	TRAC:MON:DISP ON TRAC:MON:DISP?
Preset	ON OFF OFF
State Saved	Saved in instrument state.
Range	Show Blank
Initial S/W Revision	Prior to A.02.00

Detector

Accesses a menu of functions that enable you to control the detectors for the current measurement. The following choices are available:

- **Auto** – the detector selected depends on marker functions, trace functions, average type, and the trace averaging function. See ["Auto" on page 2532](#).
- **Normal** – the detector determines the peak of the CW-like signals, and it yields alternating maximums and minimums of noise-like signals. This is also referred to as Rosenfell detection.
- **Average** – the detector determines the average of the signal within the sweep points. The averaging method depends upon the Average Type selection (voltage, power or log scales).
- **Peak** – the detector determines the maximum of the signal within the sweep points.
- **Sample** – the detector indicates the instantaneous level of the signal at the center of the sweep points represented by each display point.
- **Negative Peak** – the detector determines the minimum of the signal within the sweep points.

In swept analysis, the time interval of the data collection for the display sweep points also represents a frequency interval. In FFT analysis, the sweep points represent just a frequency interval. The detector determines the relationship between the spectrum computed by the FFT and the single data point displayed for the sweep points.

Key Path	Trace/Detector
Mode	All except SA and BASIC
Remote Command	[:SENSe]:MONitor:DETEctor:TRACe AVERage NEGative NORMal POSitive SAMPlE [:SENSe]:MONitor:DETEctor:TRACe?
Example	MON:DET:TRAC NORM MON:DET:TRAC?
Notes	The query returns a name that corresponds to the detector type as shown below. String Returned - Definition <ul style="list-style-type: none"> • NORM - Normal • AVER - Average • POS - Peak • SAMP - Sample • NEG - Negative Peak
Couplings	When the Detector choice is Auto, the detector selected depends on average type.
Preset	NORMAL
State Saved	Saved in instrument state.
Range	Normal Average(RMS) Peak Sample Negative Peak
Backwards Compatibility SCPI	[:SENSe]:MONitor:DETEctor[:FUNction]
Initial S/W Revision	Prior to A.02.00

Auto

Sets the detector for the currently selected trace to Auto. When the detector choice is Auto, the analyzer selects the detector. The selected detector depends on marker functions, trace functions, and trace averaging functions for the current measurement.

Key Path	Trace/DetectorTrace/Detector, Detector
Mode	All except SA and BASIC
Remote Command	<code>[:SENSe] :MONitor:DETECTOR:AUTO ON OFF 1 0</code> <code>[:SENSe] :MONitor:DETECTOR:AUTO?</code>
Example	MON:DET:AUTO OFF MON:DET:AUTO?
Couplings	When the Detector choice is Auto, the detector selected depends on average state and trace type.
Preset	ON
State Saved	Saved in instrument state.
Range	Auto Man
Initial S/W Revision	Prior to A.02.00

Clear Trace

Clears the selected trace from the display.

Key Path	Trace/Detector
Mode	All except SA and BASIC
Remote Command	<code>:TRACe:MONitor:CLEAr [TRACE1] TRACE2 TRACE3</code>
Example	TRAC:MON:CLE
Initial S/W Revision	Prior to A.02.00

Mode	All except SA and BASIC
Remote Command	<code>:DISPlay:MONitor:VIEW:WINDow:TRACe [1] 2 3:CLEAr</code>
Example	DISP:MON:VIEW:WIND:TRAC:CLE
Initial S/W Revision	Prior to A.02.00

Clear All Traces

Clears all traces from the display.

Key Path	Trace/Detector
Mode	All except SA and BASIC

Remote Command	:TRACe:MONitor:CLEar:ALL
Example	TRAC:MON:CLE:ALL
Backwards Compatibility SCPI	:DISPlay:MONitor:VIEW:WINDow:TRACe:CLEar:ALL
Initial S/W Revision	Prior to A.02.00

Trigger

See ["Trigger" on page 438](#)

Free Run

See ["Free Run " on page 445](#)

Video

See ["Video \(IF Envelope\) " on page 446](#)

Trigger Level

See ["Trigger Level " on page 446](#)

Trig Slope

See ["Trig Slope " on page 447](#)

Trig Delay

See ["Trig Delay " on page 448](#)

Line

See ["Line " on page 2503](#)

Trig Slope

See ["Trig Slope " on page 2503](#)

Trig Delay

See ["Trig Delay " on page 450](#)

External 1

See ["External 1 " on page 2516](#)

Trigger Level

See ["Trigger Level " on page 2516](#)

Trig Slope

See ["Trig Slope " on page 2517](#)

Trig Delay

See ["Trig Delay " on page 453](#)

Zero Span Delay Comp

See ["Zero Span Delay Comp On/Off" on page 2505](#)

External 2

See ["External 2 "](#) on page 2518

Trigger Level

See ["Trigger Level "](#) on page 2518

Trig Slope

See ["Trig Slope "](#) on page 2519

Trig Delay

See ["Trig Delay "](#) on page 455

Zero Span Delay Comp

See ["Zero Span Delay Comp On/Off"](#) on page 2507

RF Burst

See ["RF Burst "](#) on page 2519

Absolute Trigger

See ["Absolute Trigger Level"](#) on page 2520

Relative Trigger

See ["Relative Trigger Level"](#) on page 2509

Trig Slope

See ["Trigger Slope "](#) on page 2521

Trig Delay

See ["Trig Delay "](#) on page 460

Periodic Timer

See ["Periodic Timer \(Frame Trigger\) "](#) on page 2511

Period

See ["Period "](#) on page 2512

Offset

See ["Offset "](#) on page 2513

Reset Offset Display

See ["Reset Offset Display "](#) on page 2515

Sync Source

See ["Sync Source "](#) on page 2515

Off

See ["Off "](#) on page 2516

External 1

See ["External 1 "](#) on page 2516

Trigger Level

See ["Trigger Level "](#) on page 2516

Trig Slope

See ["Trig Slope "](#) on page 2517

External 2

See ["External 2 "](#) on page 2518

Trigger Level

See ["Trigger Level "](#) on page 2518

Trig Slope

See ["Trig Slope "](#) on page 2519

RF Burst

See ["RF Burst "](#) on page 2519

Absolute Trigger

See ["Absolute Trigger Level"](#) on page 2520

Trig Slope

See ["Trigger Slope "](#) on page 2521

Trig Delay

See ["Trig Delay"](#) on page 470

Auto/Holdoff

See ["Auto/Holdoff "](#) on page 471

Auto Trig

See ["Auto Trig "](#) on page 471

Trig Holdoff

See ["Trig Holdoff "](#) on page 472

Holdoff Type

See "Holdoff Type" on page 472

User Preset

Accesses a menu that gives you the following three choices:

- User Preset – recalls a state previously saved using the Save User Preset function.
- User Preset All Modes – presets all of the modes in the analyzer
- Save User Preset– saves the current state for the current mode

Key Path	Front-panel key
Backwards Compatibility Notes	<p>User Preset is actually loading a state, and in legacy analyzers, it was possible to load a state without affecting the trace data, limit lines or correction data. Similarly it was possible to do a User Preset without affecting the trace data, limit lines or correction data.</p> <p>In the X-Series, “state” always includes all of this data; so whenever state is loaded, or User Preset is executed, all of the traces, limit lines and corrections are affected. Although this differs from previous behavior, it is desirable behavior, and should not cause adverse issues for users.</p> <p>On ESA and PSA, User Preset affected the entire instrument’s state. In the X-Series, User Preset only recalls the state for the active mode. There is a User Preset file for each mode. User Preset can never cause a mode switch as it can in legacy analyzers. If you want to recall all modes to their user preset file state, you will need to do a User Preset after mode switching into each mode.</p> <p>User Preset recalls mode state which can now include data like traces; whereas on ESA and PSA, User Preset did not affect data.</p>
Initial S/W Revision	Prior to A.02.00

User Preset

User Preset sets the state of the currently active mode back to the state that was previously saved for this mode using the Save User Preset menu key or the SCPI command, SYST:PRES:USER:SAV. It not only recalls the Mode Preset settings, but it also recalls all of the mode persistent settings, and the Input/Output system setting that existed at the time Save User Preset was executed.

If a Save User Preset has not been done at any time, User Preset recalls the default user preset file for the currently active mode. The default user preset files are created if, at power-on, a mode detects there is no user preset file. There will never be a scenario when there is no user preset file to restore. For each mode, the default user preset state is the same state that would be saved if a Save User Preset is performed in each mode right after doing a Restore Mode Default and after a Restore Input/Output Defaults.

The User Preset function does the following:

- Aborts the currently running measurement.
- Sets the mode State to the values defined by Save User Preset.
- Makes the saved measurement for the currently running mode the active measurement.
- Brings up the saved menu for the power-on mode.
- Clears the input and output buffers.
- Sets the Status Byte to 0.

Key Path	User Preset
Remote Command	:SYSTem:PRESet:USER
Example	:SYST:PRES:USER:SAVE:SYST:PRES:USER
Notes	:SYST:PRES:USER:SAVE is used to save the current state as the user preset state. Clears all pending OPC bits. The Status Byte is set to 0. Pressing the User Preset front-panel key while already in the User Preset menu will cause the User Preset to get executed
Couplings	A user preset will cause the currently running measurement to be aborted and cause the saved measurement to be active. Recalling a User Preset file has the same issues that recalling a Save State file has. Some settings may need to be limited and therefore re-coupled, since the capabilities of the mode may have changes when the User Preset file was last saved.
Initial S/W Revision	Prior to A.02.00

User Preset All Modes

Recalls all of the User Preset files for each mode, switches to the power-on mode, and activates the saved measurement from the power-on mode User Preset file.

NOTE

When the instrument is secured, all of the user preset files are converted back to their default user preset files.

The User Preset function does the following:

- Aborts the currently running measurement.
- Switches the Mode to the power-on mode.
- Restores the User Preset files for each mode.
- Makes the saved measurement for the power-on mode the active measurement.
- Brings up the saved menu for the power-on mode.
- Clears the input and output buffers.
- Sets the Status Byte to 0.

Key Path	User Preset
Remote Command	:SYSTem:PRESet:USER:ALL
Example	:SYST:PRES:USER:SAVE:SYST:PRES:USER:ALL
Notes	Clears all pending OPC bits. The Status Byte is set to 0. :SYST:PRES:USER:SAVE is used to save the current state as the user preset state.
Couplings	A user preset will cause the currently running measurement to be aborted, cause a mode switch to the power-on mode, and cause the saved measurement to be active in the power-on mode. Recalling a User Preset file has the same issues that recalling a Save State file has. Some settings may need to be limited and therefore re-coupled, since the capabilities of the mode may have changes when the User Preset file was last saved.
Initial S/W Revision	Prior to A.02.00

Save User Preset

Saves the currently active mode and its State. You can recall this User Preset file by pressing the User Preset menu key or sending the SYST:PRES:USER remote command. This same state is also saved by the Save State function.

Key Path	User Preset
Remote Command	:SYSTem:PRESet:USER:SAVE
Example	:SYST:PRES:USER:SAVE
Notes	:SYST:PRES:SAVE creates the same file as if the user requested a *SAV or a MMEM:STOR:STAT, except User Preset Save does not allow the user to specify the filename or the location of the file.
Initial S/W Revision	Prior to A.02.00

View/Display

Accesses a menu of functions that enable you to control certain functions related to the display of the analyzer.

The available views and related commands depend on the currently-selected mode. This section includes the following topics:

- ["View for all modes except MSR, 1xEV-DO, LTE-Advanced FDD/TDD" on page 2541](#), LTE-Advanced FDD/TDD
- ["1xEV-DO Mode View" on page 2542](#)
- ["MSR and LTE-Advanced FDD/TDD Mode Views" on page 2542](#)
- ["View Selection by Name \(MSR and LTE-Advanced FDD/TDD mode only\)" on page 2543](#)
- ["View Selection by Number \(MSR and LTE-Advanced FDD/TDD mode only\)" on page 2543](#)

View for all modes except MSR, 1xEV-DO, LTE-Advanced FDD/TDD

When the current mode is **not** MSR, LTE-Advanced FDD/TDD or 1xEV-DO, there is a single trace view for this measurement, as shown below:

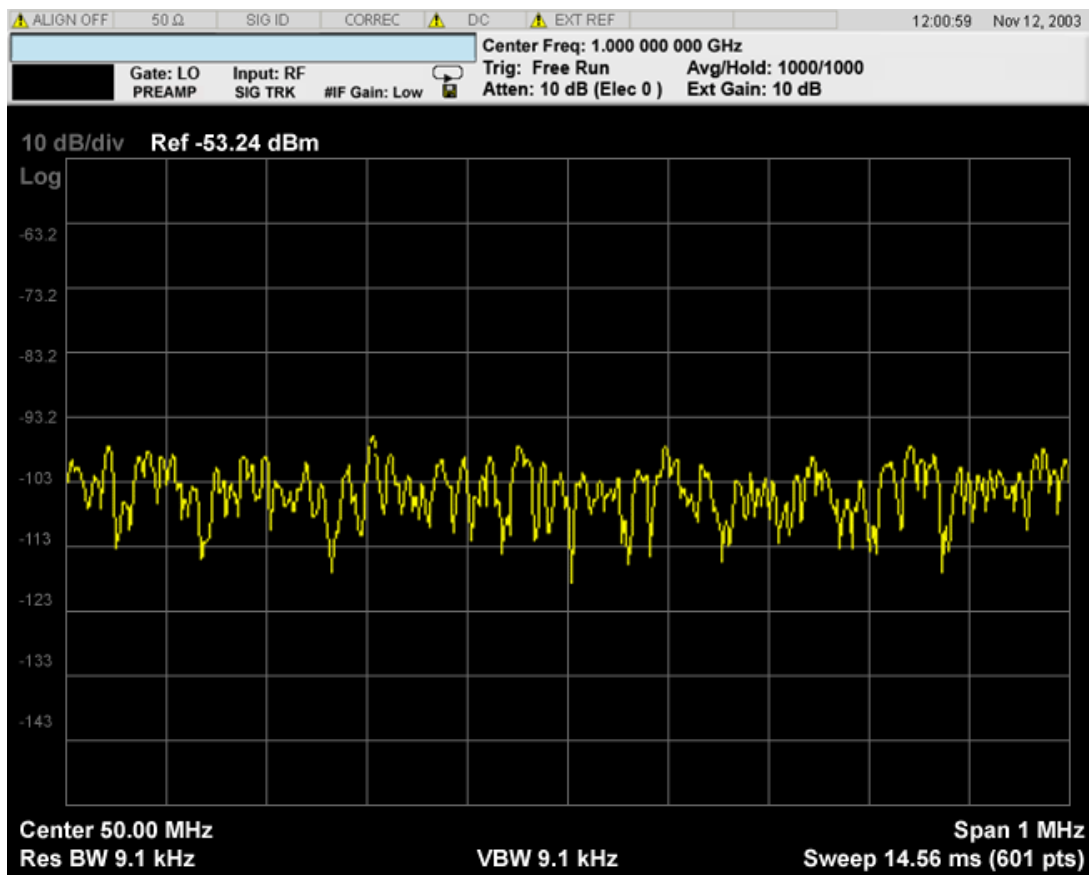

1xEV-DO Mode View

When the current mode is 1xEV-DO, a single view is available, as shown in the example below:

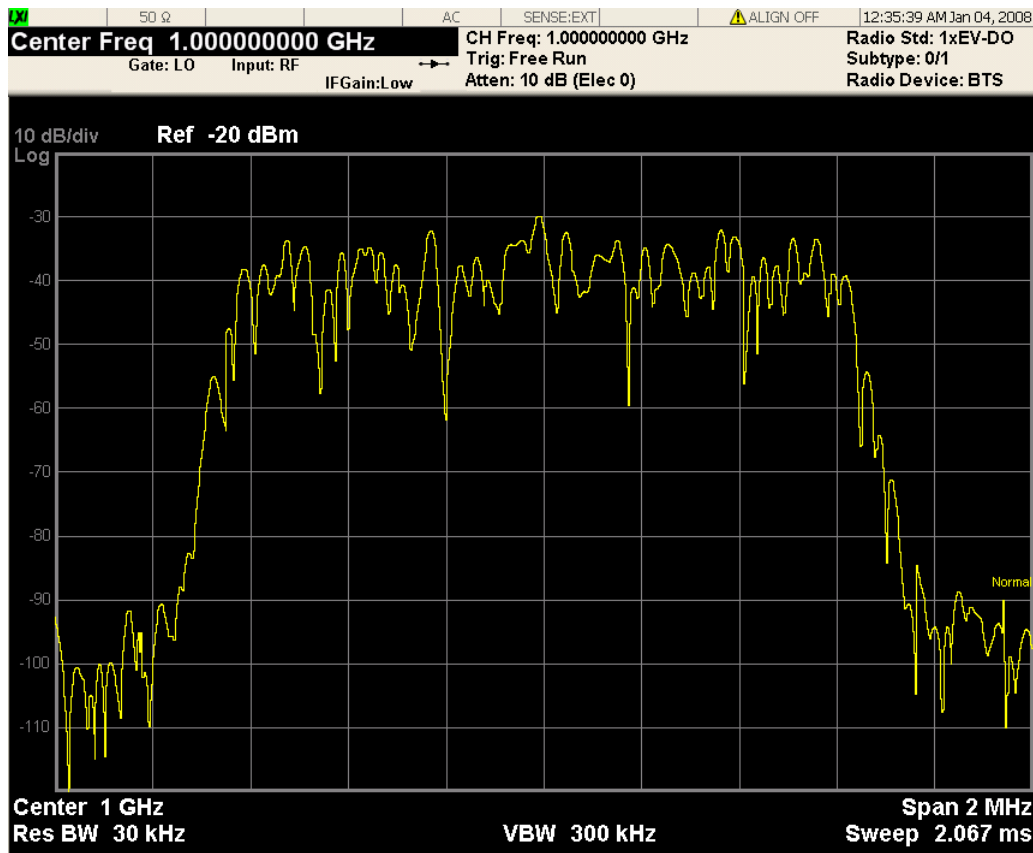

The measurement has no results, but has a number of features that make it flexible and simple to use.

MSR and LTE-Advanced FDD/TDD Mode Views

When the current mode is MSR and LTE-Advanced FDD/TDD, there are two views, Result Trace and Carrier Info, as described in the table below. The Result Trace view is the same as the common Monitor Spectrum view in other modes. Carrier Info is available on the spectrum trace.

Result Trace	<p>The spectrum trace and power bars are displayed in the upper window. Carrier and offset powers are summarized in the lower window.</p> <p>For more details, see Result Trace (MSR and LTE-Advanced FDD/TDD mode only).</p>
Carrier Info	<p>Carrier center frequency can be displayed in either offset or absolute frequency depending on Carrier Freq. The table can be scrolled by Select Carrier in the Config Carriers menu. The highlighted row changes as Select Carrier is changed. The highlighted row and Select Carrier are not coupled.</p> <p>For more details, see Carrier Info (MSR and LTE-Advanced FDD/TDD mode only).</p>

View Selection by Name (MSR and LTE-Advanced FDD/TDD mode only)

Key Path	Display
Mode	MSR, LTEAFDD, LTEATDD
Remote Command	:DISPlay:MONitor:VIEW[:SElect] RTRace CINformation :DISPlay:MONitor:VIEW[:SElect]?
Example	DISP:MON:VIEW RTR DISP:MON:VIEW?
Preset	RTRace
State Saved	Saved in instrument state
Range	Power Results Carrier Info
Initial S/W Revision	A.10.00

View Selection by Number (MSR and LTE-Advanced FDD/TDD mode only)

Key Path	DISP:MON:VIEW
Mode	MSR, LTEAFDD, LTEATDD
Remote Command	:DISPlay:MONitor:VIEW:NSElect <integer> :DISPlay:MONitor:VIEW:NSElect?
Example	DISP:MON:VIEW:NSEL 1 DISP:MON:VIEW:NSEL?
Preset	1
State Saved	Saved in instrument state
Min	1
Max	2
Initial S/W Revision	A.10.00

Key Path	Front-panel key
Initial S/W Revision	Prior to A.02.00

Display

The Display menu is common to most measurements, and is used for configuring items on the display. Some Display menu settings apply to all the measurements in a mode, and some only to the current measurement. Those under the System Display Settings key apply to all measurements in all modes.

Key Path	Display
Key Path	View/Display
Initial S/W Revision	Prior to A.02.00

Annotation

Turns on and off various parts of the display annotation. The annotation is divided up into four categories:

1. Meas Bar: This is the measurement bar at the top of the screen. It does not include the settings panel or the Active Function. Turning off the Meas Bar turns off the settings panel and the Active Function. When the Meas Bar is off, the graticule area expands to fill the area formerly occupied by the Meas Bar.
2. Screen Annotation: this is the annotation and annunciation around the graticule, including any annotation on lines (such as the display line, the threshold line, etc.) This does NOT include the marker number or the N dB result. When off, the graticule expands to fill the entire graticule area.
3. Trace annotation: these are the labels on the traces, showing their detector (or their math mode).
4. Active Function annotation: this is the active function display in the meas bar, and all of the active function values displayed on softkeys.

See the figure below. Each type of annotation can be turned on and off individually.

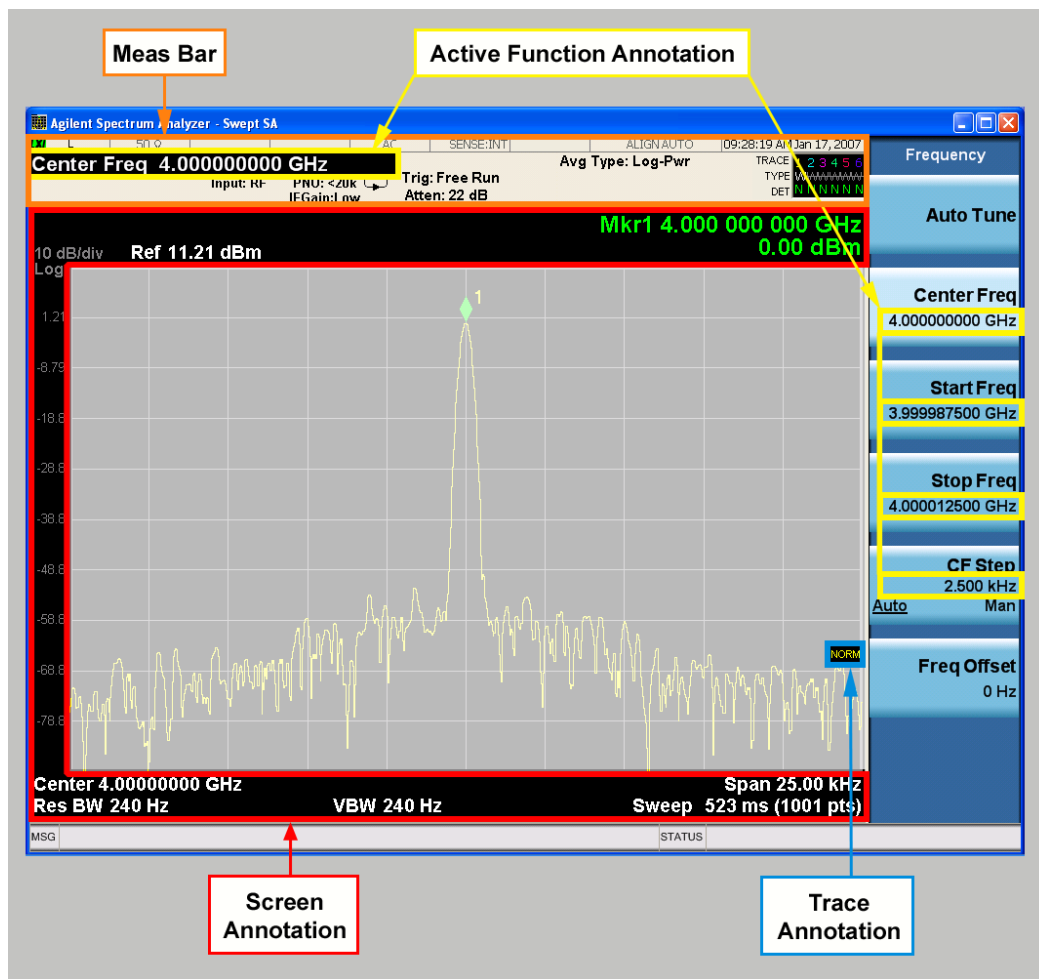

Key Path	View/Display, Display
Initial S/W Revision	Prior to A.02.00

Meas Bar On/Off

This function turns the Measurement Bar on and off, including the settings panel. When off, the graticule area expands to fill the area formerly occupied by the Measurement Bar.

Key Path	View/Display, Display, Annotation
Remote Command	:DISPlay:ANNotation:MBAR[:STATe] OFF ON 0 1 :DISPlay:ANNotation:MBAR[:STATe]?
Example	DISP:ANN:MBAR OFF
Dependencies	Grayed out and forced to OFF when System Display Settings, Annotation is set to Off.
Preset	On This should remain Off through a Preset when System DisplaySettings, Annotation is set to Off.
State Saved	Saved in instrument state.
Initial S/W Revision	Prior to A.02.00

Screen

This controls the display of the annunciation and annotation around the graticule, including any annotation on lines (such as the display line, the threshold line, etc.) and the y-axis annotation. This does NOT include marker annotation (or the N dB result). When off, the graticule expands to fill the entire graticule area, leaving only the 1.5% gap above the graticule as described in the Trace/Detector chapter.

Key Path	View/Display, Display, Annotation
Remote Command	:DISPlay:ANNotation:SCReen[:STATe] OFF ON 0 1 :DISPlay:ANNotation:SCReen[:STATe]?
Example	DISP:ANN:SCR OFF
Dependencies	Grayed-out and forced to OFF when System Display Settings, Annotation is set to Off.
Preset	On This should remain Off through a Preset when System DisplaySettings, Annotation is set to Off
State Saved	Saved in instrument state.
Initial S/W Revision	Prior to A.02.00

Active Function Values On/Off

Turns on and off the active function display in the Meas Bar, and all of the active function values displayed on the softkeys.

Note that all of the softkeys that have active functions have these numeric values blanked when this function is on. This is a security feature..

16 Monitor Spectrum Measurement
View/Display

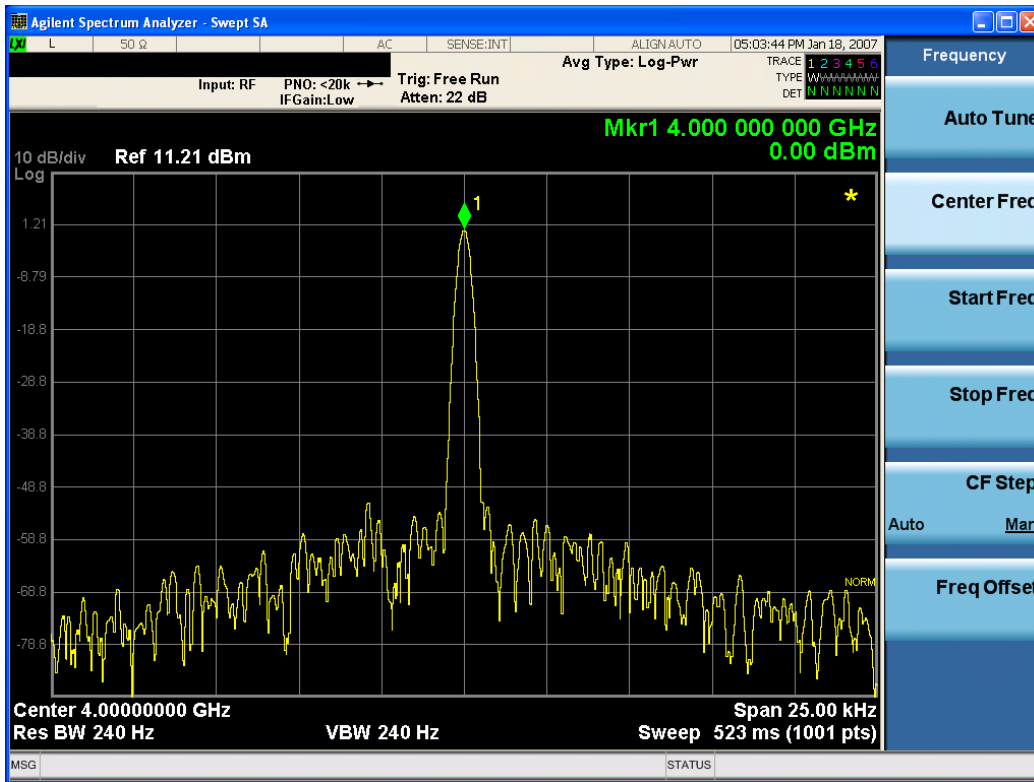

Key Path	View/Display, Display, Annotation
Remote Command	:DISPlay:ACTivefunc[:STATE] ON OFF 1 0 :DISPlay:ACTivefunc[:STATE] ?
Example	DISP:ACT OFF
Dependencies	Grayed out and forced to OFF when System Display Settings, Annotation is set to Off.
Preset	On This should remain Off through a Preset when System DisplaySettings, Annotation is set to Off
State Saved	Saved in instrument state.
Initial S/W Revision	Prior to A.02.00

Title

Displays menu keys that enable you to change or clear a title on your display.

Key Path	View/Display, Display
Initial S/W Revision	Prior to A.02.00

Change Title

Writes a title into the "measurement name" field in the banner, for example, "Swept SA".

Press Change Title to enter a new title through the alpha editor. Press Enter or Return to complete the entry. Press ESC to cancel the entry and preserve your existing title.

The display title will replace the measurement name. It remains for this measurement until you press Change Title again, or you recall a state, or a Preset is performed. A title can also be cleared by pressing Title, Clear Title.

NOTE

Notice the inclusion of the <measurement> parameter in the command below. Because each measurement remembers the Display Title, the command must be qualified with the measurement name. For the Swept SA measurement this is not the case; no <measurement> parameter is used when changing the Display Title for the Swept SA measurement.

Key Path	View/Display, Display, Title
Mode	All
Remote Command	:DISPlay:<measurement>:ANNotation:TITLe:DATA <string> :DISPlay:<measurement>:ANNotation:TITLe:DATA?
Example	DISP:ANN:TITL:DATA "This Is My Title" This example is for the Swept SA measurement in the Spectrum Analyzer mode. The SANalyzer <measurement> name is not used. DISP:ACP:ANN:TITL:DATA "This Is My Title" This example is for Measurements other than Swept SA. Both set the title to: This Is My Title
Notes	Pressing this key cancels any active function. When a title is edited the previous title remains intact (it is not cleared) and the cursor goes at the end so that characters can be added or BKSP can be used to go back over previous characters.
Preset	No title (measurement name instead)
State Saved	Saved in instrument state.
Initial S/W Revision	Prior to A.02.00

Clear Title

Clears a title from the front-panel display. Once cleared, the title cannot be retrieved. After the title is cleared, the current Measurement Name replaces it in the title bar.

Key Path	View/Display, Display, Title
Example	The following commands clear the title and restore the measurement's original title: DISP:ANN:TITL:DATA "" This example is for the Swept SA measurement in the Spectrum Analyzer mode. The SANalyzer <measurement> name is not used. DISP:ACP:ANN:TITL:DATA "" This example is for ACP; in measurements other than Swept SA the measurement name is required.
Notes	Uses the :DISPlay:<measurement>:ANNotation:TITLe:DATA <string> command with an empty string (in the Swept SA, the <measurement> is omitted).
Preset	Performed on Preset.
Initial S/W Revision	Prior to A.02.00

Graticule

Pressing Graticule turns the display graticule On or Off. It also turns the graticule y-axis annotation on and off.

Key Path	View/Display, Display
Remote Command	:DISPlay:WINDow[1]:TRACe:GRATicule:GRID[:STATe] OFF ON 0 1 :DISPlay:WINDow[1]:TRACe:GRATicule:GRID[:STATe]?
Example	DISP:WIND:TRAC:GRAT:GRID OFF
Notes	The graticule is the set of horizontal and vertical lines that make up the grid/divisions for the x-axis and y-axis.
Preset	On
State Saved	Saved in instrument state
Initial S/W Revision	Prior to A.02.00

System Display Settings

These settings are "Mode Global" – they affect all modes and measurements and are reset only by Restore Misc Defaults or Restore System Defaults under System.

Key Path	View/Display, Display
Initial S/W Revision	Prior to A.02.00

Annotation Local Settings

This is a Mode Global override of the meas local annotation settings. When it is All Off, it forces ScreenAnnotation, Meas Bar, Trace, and Active Function Values settings to be OFF for all measurements in all modes. This provides the security based "annotation off" function of previous analyzers; hence it uses the legacy SCPI command.

When it is All Off, the Screen, Meas Bar, Trace, and Active Function Values keys under the Display, Annotation menu are grayed out and forced to Off. When Local Settings is selected, you are able to set the local annotation settings on a measurement by measurement basis.

Key Path	View/Display, Display, System Display Settings
Remote Command	:DISPlay:WINDow[1]:ANNotation[:ALL] OFF ON 0 1 :DISPlay:WINDow[1]:ANNotation[:ALL]?
Example	:DISP:WIND:ANN OFF
Preset	On (Set by Restore Misc Defaults)
State Saved	Not saved in instrument state.
Backwards Compatibility Notes	The WINDow parameter and optional subopcode is included for backwards compatibility but ignored – all windows are equally affected.
Initial S/W Revision	Prior to A.02.00

Themes

Accesses a menu of functions that enable you to choose the theme to be used when saving the screen image.

The **Themes** option is the same as the **Themes** option under the **Display** and **Page Setup** dialogs. It allows you to choose between themes to be used when saving the screen image.

Key Path	Save, Screen Image
Remote Command	:MMEMory:STORe:SCReen:THEMe TDColor TDMonochrome FCOLOR FMONochrome :MMEMory:STORe:SCReen:THEMe?
Example	:MMEM:STOR:SCR:THEM TDM
Preset	3D Color; Is not part of Preset, but is reset by Restore Misc Defaults or Restore System Defaults All and survives subsequent running of the modes.
Readback	3D Color 3D Mono Flat Color Flat Mono
Backwards Compatibility Notes	In ESA and PSA we offer the choice of "Reverse Bitmap" or "Reverse Metafile" when saving screen images. This is much like the "Flat Color" theme available in X-Series. Also, if you selected Reverse Bitmap AND a black & white screen image, that would be much like "Flat Monochrome". In other words, each of the X-Series themes has a similar screen image type in ESA/PSA. But they are not identical.
Initial S/W Revision	Prior to A.02.00

3D Color

Selects a standard color theme with each object filled, shaded and colored as designed.

Key Path	Save, Screen Image, Themes
Example	MMEM:STOR:SCR:THEM TDC
Readback	3D Color
Initial S/W Revision	Prior to A.02.00

3D Monochrome

Selects a format that is like 3D color but shades of gray are used instead of colors.

Key Path	Save, Screen Image, Themes
Example	MMEM:STOR:SCR:THEM TDM
Readback	3D Mono
Initial S/W Revision	Prior to A.02.00

Flat Color

Selects a format that is best when the screen is to be printed on an ink printer.

Key Path	Save, Screen Image, Themes
Example	MMEM:STOR:SCR:THEM FCOL
Readback	Flat Color
Initial S/W Revision	Prior to A.02.00

Flat Monochrome

Selects a format that is like Flat Color. But only black is used (no colors, not even gray), and no fill.

Key Path	Save, Screen Image, Themes
Example	MMEM:STOR:SCR:THEM FMON
Readback	Flat Mono
Initial S/W Revision	Prior to A.02.00

Backlight

Accesses the display backlight on/off keys. This setting may interact with settings under the Windows "Power" menu.

When the backlight is off, pressing ESC, TAB, SPACE, ENTER, UP, DOWN, LEFT, RIGHT, DEL, BKSP, CTRL, or ALT turns the backlight on without affecting the application. Pressing any other key will turn backlight on and could potentially perform the action as well.

Key Path	View/Display, Display, System Display Settings
Remote Command	:DISPlay:BACKlight ON OFF :DISPlay:BACKlight?
Preset	ON (Set by Restore Misc Defaults)
Initial S/W Revision	Prior to A.02.00

Backlight Intensity

An active function used to set the backlight intensity. It goes from 0 to 100 where 100 is full on and 0 is off. This value is independent of the values set under the Backlight on/off key.

Key Path	View/Display, Display, System Display Settings
Remote Command	:DISPlay:BACKlight:INTensity <integer> :DISPlay:BACKlight:INTensity?
Example	DISP:BACK:INT 50

Preset	100 (Set by Restore Misc Defaults)
Min	0
Max	100
Initial S/W Revision	Prior to A.02.00

17 Waveform Measurement

The waveform measurement is a generic measurement for viewing the input signal waveforms in the time domain. This measurement represents how the instrument performs the zero span functionality found in traditional spectrum analyzers. For more details, see ["Waveform Measurement Description" on page 2556](#) below.

This topic contains the following sections:

["Measurement Commands for Waveform" on page 2554](#)

["Remote Command Results for the Waveform Measurement" on page 2555](#)

Measurement Commands for Waveform

The general functionality of CONFigure, INITiate, FETCh, MEASure, and READ are described at this section.

:CONFigure:WAVeform

:CONFigure:WAVeform:NDEFault

:INITiate:WAVeform

:FETCh:WAVeform[n]?

:MEASure:WAVeform[n]?

:READ:WAVeform[n]?

For more measurement related commands, see the SENSE subsystem, and the section "[Remote Measurement Functions](#)" on page 2770.

Remote Command Results for the Waveform Measurement

The following table denotes the returned results from the FETCh|MEASure|READ commands:

n	Results Returned
0	Returns unprocessed I/Q trace data, as a series of trace point values, in volts. The I values are listed first in each pair, using the 0 through even-indexed values. The Q values are the odd-indexed values.
1	<p>Returns the following scalar results:</p> <ol style="list-style-type: none"> 1. Sample Time is a floating point number representing the time between samples when using the trace queries (n=0, 2, and so forth). 2. Mean Power is the mean power (in dBm). This is the power across the entire trace. If averaging is on, the power is for the latest acquisition. 3. Mean Power Averaged is the power (in dBm) for N averages, if averaging is on. This is the power across the entire trace. If averaging is on, the power is for the latest acquisition. If averaging is off, the value of the mean power averaged is the same as the value of the mean power. 4. Number of samples is the number of data points in the captured signal. This number is useful when performing a query on the signal (i.e. when n=0, 2, etc.). 5. Peak-to-mean ratio has units of dB. This is the ratio of the maximum signal level to the mean power. Valid values are only obtained with averaging turned off. If averaging is on, the peak-to-mean ratio is calculated using the highest peak value, rather than the displayed average peak value. 6. Maximum value is the maximum of the most recently acquired data (in dBm). 7. Minimum value is the minimum of the most recently acquired data (in dBm).
2	Returns trace point values of the entire captured signal envelope trace data. These data points are floating point numbers representing the power of the signal (in dBm). There are N data points, where N is the number of samples. The period between the samples is defined by the sample time.

Waveform Measurement Description

Also available under the basic Waveform measurement is an I/Q window, which shows the I and Q signal waveforms in parameters of voltage versus time to disclose the voltages that comprise the complex modulated waveform of a digital signal.

The waveform measurement can also be used to perform general purpose power measurements to a high degree of accuracy.

Key Path	Front-panel key
Initial S/W Revision	Prior to A.02.00

AMPTD Y Scale

Accesses a menu of functions that enable you to set the vertical scale parameters.

Key Path	Front-panel key
Initial S/W Revision	Prior to A.02.00

Ref Value (RF Envelope View)

Sets the Y Scale reference value (in dBm) when the RF Envelope View is active. By default, the measurement determines the reference value with Auto Scaling. Entering a reference value manually turns Auto Scaling off.

Key Path	AMPTD Y Scale
Mode	BASIC, PNOISE, WCDMA, C2K, GSM, WIMAXOFDMA, TDSCDMA, 1XEVD0, DVB, DTMB, ISDBT, CMMB, LTE, LTETDD, DCATV, WLAN,LTEATDD, LTEAFDD
Remote Command	:DISPlay:WAVeform:VIEW[1]:WINDow[1]:TRACe:Y[:SCALE]:RLEVel <ampl> :DISPlay:WAVeform:VIEW[1]:WINDow[1]:TRACe:Y[:SCALE]:RLEVel?
Example	DISP:WAV:VIEW:WIND:TRAC:Y:RLEV -50 dBm DISP:WAV:VIEW:WIND:TRAC:Y:RLEV?
Notes	You must be in the mode that includes Waveform measurement to use this command. Use INSTRument:SElect to set the mode.
Couplings	When Auto Scaling is On, this value is automatically determined by the measurement result. When you set a value manually, Auto Scaling automatically changes to Off.
Preset	10.00 dBm
State Saved	Saved in instrument state.
Range	-250.00 dBm to 250.00 dBm
Min	-250.00 dBm
Max	250.00 dBm
Initial S/W Revision	Prior to A.02.00
Modified at S/W Revision	A.03.00

Attenuation

This menu controls the attenuator functions and interactions between the attenuation system components.

There are two attenuator configurations in the X-Series. One is a dual attenuator configuration consisting of a mechanical attenuator and an optional electronic attenuator. The other configuration uses a single attenuator with combined mechanical and electronic sections that controls all the attenuation functions. Different models in the X-Series come with different configurations.

See "[Dual Attenuator Configurations:](#)" on page 2558

See "Single Attenuator Configuration:" on page 2559

Most Attenuation settings are the same for all measurements – they do not change as you change measurements. Settings like these are called “Meas Global” and are unaffected by Meas Preset.

Key Path	AMPTD Y Scale
Scope	Meas Global
Dependencies	In measurements that support the I/Q inputs, this key is unavailable when I/Q is the selected input, and is replaced by the Range key in that case.
Readback Line	Contains a summary in [] brackets of the current total attenuation. See the descriptions of the , " (Mech) Atten " on page 2736, and "Enable Elec Atten" on page 2737 keys for more detail on the contributors to the total attenuation. Note that when "Pre-Adjust for Min Clip" is on, this value can change at the start of every measurement.
Initial S/W Revision	Prior to A.02.00
Modified at S/W Revision	A.03.00

Dual Attenuator Configurations:

Configuration 1: Mechanical attenuator + optional electronic attenuator

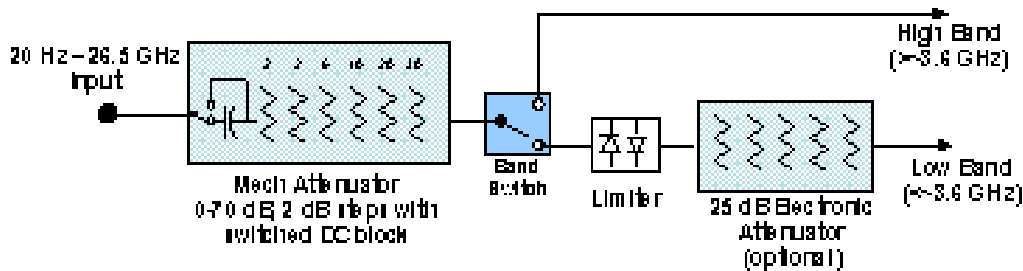

Configuration 2: Mechanical attenuator, no optional electronic attenuator

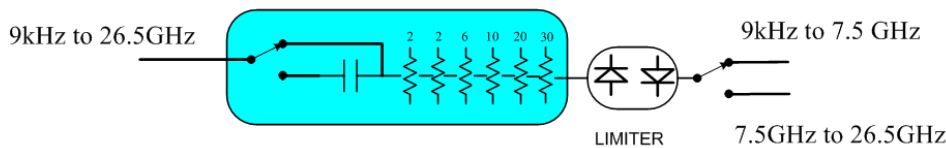

(note that Configuration 2 is not strictly speaking a dual-section attenuator, since there is no electronic section available. However, it behaves exactly like Configuration 1 without the Electronic Attenuator option EA3, therefore for the sake of this document it is grouped into the “Dual Attenuator” configuration)

Single Attenuator Configuration:

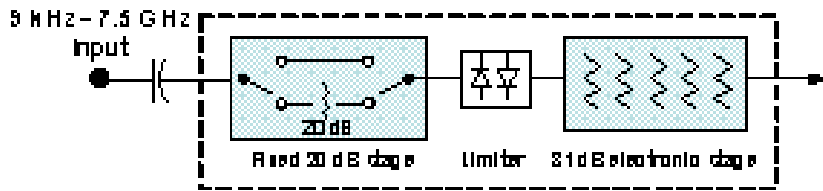

You can tell which attenuator configuration you have by pressing the Attenuation key, which (in most Modes) opens the Attenuation menu. If the first key in the Attenuation menu says Mech Atten you have the dual attenuator configuration. If the first key says Atten you have the single attenuator configuration.

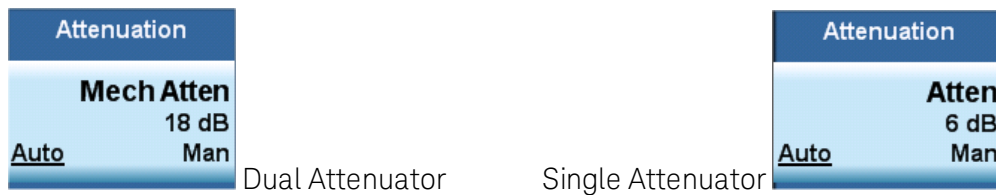

In the single attenuator configuration, you control the attenuation with a single control, as the fixed stage has only two states. In the dual attenuator configuration, both stages have significant range so you are given separate control of the mechanical and electronic attenuator stages.

When you have the dual attenuator configuration, you may still have only a single attenuator, because unless option EA3 (the Electronic Attenuator option) is available, and you purchase it, you will have only the mechanical attenuator.

(Mech) Atten

This key is labeled Mech Atten in dual attenuator models and Atten in single attenuator models. In the dual attenuator configuration, this key only affects the mechanical attenuator.

This key lets you modify the attenuation applied to the RF input signal path. This value is normally auto coupled to the Ref Level, the Internal Preamp Gain, any External Gain that is entered, and the Max Mixer Level, as described in the table below.

See "[Attenuator Configurations and Auto/Man](#)" on page 2561

Key Path	AMPTD Y Scale, Attenuation
Remote Command	<pre>[:SENSe]:POWer[:RF]:ATTenuation <rel_amp1></pre> <pre>[:SENSe]:POWer[:RF]:ATTenuation?</pre> <pre>[:SENSe]:POWer[:RF]:ATTenuation:AUTO OFF ON 0 1</pre> <pre>[:SENSe]:POWer[:RF]:ATTenuation:AUTO?</pre>
Example	<p>POW:ATT 20</p> <p>Dual attenuator configuration: sets the mechanical attenuator to 20 dB</p> <p>Single attenuator mode: sets the main attenuation to 20 dB (see below for definition of "main" attenuation).</p> <p>If the attenuator was in Auto, it sets it to Manual.</p>
Dependencies	Some measurements do not support the Auto setting of (Mech) Atten. In these measurements, the

Auto/Man selection is not available, and the Auto/Man line on the key disappears.

In dual attenuator configurations, when the electronic attenuator is enabled, the mechanical attenuator has no auto setting and the Auto/Man line on the key disappears. The state of Auto/Man is remembered and restored when the electronic attenuator is once again disabled. This is described in more detail in the ["Enable Elec Atten" on page 2737](#) key description.

See ["Attenuator Configurations and Auto/Man" on page 2561](#) for more information on the Auto/Man functionality of Attenuation.

Couplings

When (Mech) Atten is in Auto, it uses the following algorithm to determine a value:

If the USB Preamp is connected to USB, use 0 dB.

Otherwise, $Atten = ReferenceLevel + PreAmpGain + ExternalGain - RefLevelOffset - MaxMixerLevel + IF\ Gain$.

Limit this value to be between 6 dB and the Max value. No value below 6 dB can ever be chosen by Auto.

The resulting value is rounded up to the largest value possible given the attenuation step setting. That is, 50.01 dB would change to 60 dB (for a 10 dB attenuation step).

The "IF Gain" term in the equation above is either 0 dB or +10 dB, depending on the settings of FFT IF Gain, Swept IF Gain, max Ref Level and the Auto/Man setting of Mech Atten.

In External Mixing and BBIQ, where the Attenuator is not in the signal path, the Attenuator setting changes as described above when (Mech) Atten is in Auto, but no changes are made to the actual attenuator hardware setting until the input is changed back to the RF Input.

Preset The preset for Mech Attenuation is "Auto."
 The Auto value of attenuation is:
 CXA, EXA, MXA and PXA: 10 dB

State Saved Saved in instrument state

Min 0 dB

The attenuation set by this key cannot be decreased below 6 dB with the knob or step keys. To get to a value below 6 dB it has to be directly entered from the keypad or via SCPI. This protects from adjusting the attenuation to a dangerously small value which can put the instrument at risk of damage to input circuitry. However, if the current mechanical attenuation is below 6 dB it can be increased with the knob and step keys, but not decreased.

Max CXA N9000A-503/507: 50 dB
 CXA N9000A-513/526: 70dB
 EXA: 60 dB
 MXA and PXA: 70 dB

In the single attenuator configuration, the total of ATT and EATT cannot exceed 50 dB, so if the EATT is set to 24 dB first, the main attenuation cannot be greater than 26 dB and will be reduced accordingly; if the main attenuator is set to 40 dB first, EATT cannot be greater than 10 dB.

Initial S/W Revision Prior to A.02.00

Modified at S/W Revision A.03.00

Attenuator Configurations and Auto/Man

As described in the Attenuation key description, there are two distinct attenuator configurations available in the X-Series, the single attenuator and dual attenuator configurations. In dual attenuator configurations, we have the mechanical attenuation and the electronic attenuation, and the current total attenuation is the sum of the electronic + mechanical attenuation. In single attenuator configurations, we refer to the attenuation set using the (Mech) Atten key (or POW:ATT SCPI) as the “main” attenuation; and the attenuation that is set by the SCPI command POW:EATT as the “soft” attenuation (the POW:EATT command is honored even in the single attenuator configuration, for compatibility purposes). Then the current total attenuation is the sum of the main + soft attenuation. See the Elec Atten key description for more on “soft” attenuation.

In the dual attenuator configuration, when the electronic attenuator is enabled, there is no Auto/Man functionality for the mechanical attenuator, and the third line of the key label (the Auto/Man line) disappears:

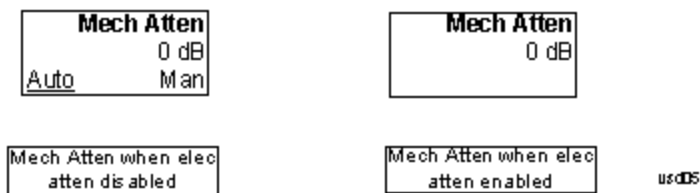

Enable Elec Atten

Enables the Electronic Attenuator.

The electronic attenuator offers finer steps than the mechanical attenuator, has no acoustical noise, is faster, and is less subject to wear. These advantages primarily aid in remote operation and are negligible for front panel use. See ["Using the Electronic Attenuator: Pros and Cons" on page 2563](#) for a detailed discussion of the pros and cons of using the electronic attenuator.

For the single attenuator configuration, for SCPI backwards compatibility, the “soft” attenuation feature replaces the dual attenuator configuration’s electronic attenuator. All the same couplings and limitations apply. See ["Attenuator Configurations and Auto/Man" on page 2737](#)

See ["More Information" on page 2562](#)

Key Path	AMPTD Y Scale, Attenuation
Remote Command	[:SENSE] :POWER [:RF] :EATTenuation:STATE OFF ON 0 1 [:SENSE] :POWER [:RF] :EATTenuation:STATE?
Example	POW:EATT:STAT ON
Dependencies	This key only appears in Dual Attenuator models with an Electronic Attenuator installed. It does not appear in models with the Single Attenuator configuration, as in the single attenuator configuration there is no “electronic attenuator” there is only a single integrated attenuator (which has both a mechanical and electronic stage). However, in the single attenuator configuration, EATT SCPI commands are accepted for compatibility with other X-series instruments and set a “soft” attenuation as described in "Attenuator Configurations and Auto/Man" on page 2737 . The electronic attenuator (and the “soft” attenuation function provided in single attenuator configurations) is unavailable above 3.6 GHz. Therefore, if the Stop Frequency of the analyzer is > 3.6 GHz then the Enable Elec Atten key will be OFF and grayed out.

	<p>If the Internal Preamp is on, meaning it is set to Low Band or Full, the electronic attenuator (and the “soft” attenuation function provided in single attenuator configurations) is unavailable. In this case the Enable Elec Atten key will be OFF and grayed out.</p> <p>If either of the above is true, if the SCPI command is sent, an error indicating that the electronic attenuator is unavailable will be sent.</p> <p>If the electronic/soft Attenuator is enabled, then the Stop Freq of the analyzer is limited to 3.6 GHz and the Internal Preamp is unavailable.</p> <p>The SCPI-only “soft” electronic attenuation for the single-attenuator configuration is not available in all measurements; in particular, it is not available in the Swept SA measurement.</p>
Couplings	Enabling and disabling the Electronic Attenuator affects the setting of the Mechanical Attenuator (in dual attenuator configurations). This is described in more detail below this table.
Preset	OFF for Swept SA measurement; ON for all other measurements that support the electronic attenuator
State Saved	Saved in instrument state
Initial S/W Revision	Prior to A.02.00
Modified at S/W Revision	A.03.00

More Information

Mechanical Attenuator Transition Rules

When the Electronic Attenuator is enabled, the Mechanical Attenuator transitions to a state that has no Auto function. Below are the rules for transitioning the Mechanical Attenuator. NOTE that the information below ONLY applies to the dual attenuator configurations, and ONLY when the Electronic Attenuator is installed:

When the Electronic Attenuation is enabled from a disabled state:

- The Mechanical Attenuator is initialized to 10 dB (this is its optimal performance setting). You can then set it as desired with SCPI, numeric keypad, step keys, or knob, and it behaves as it normally would in manual mode
- The Auto/Man state of (Mech) Atten is saved
- The Auto/Man line on the (Mech) Atten key disappears and the auto rules are disabled
- The Electronic Attenuator is set to 10 dB less than the previous value of the Mechanical Attenuator, within the limitation that it must stay within the range of 0 to 24 dB of attenuation.

Examples in the dual attenuator configuration:

- Mech Atten at 20 dB. Elec Atten enabled, Mech Atten set to 10 dB, and Elec Atten set to 10 dB. New total attenuation equals the value before Elec Atten enabled.
- Mech Atten at 0 dB. Elec Atten enabled, Mech Atten set to 10 dB, and Elec Atten set to 0 dB. New total attenuation does not equal the value before Elec Atten enabled.
- Mech Atten at 40 dB. Elec Atten enabled, Mech Atten set to 10 dB, and Elec Atten set to 24 dB. New total attenuation does not equal the value before Elec Atten enabled.

When the Electronic Attenuation is disabled from an enabled state:

- The Elec Atten key is grayed out
- The Auto/Man state of (Mech) Atten is restored
- If now in Auto, (Mech) Atten recouples
- If now in Man, (Mech) Atten is set to the value of total attenuation that existed before the Elec Atten was disabled. The resulting value is rounded up to the smallest value possible given the (Mech) Atten Step setting - (That is, 57 dB changes to 58 dB when (Mech) Atten Step is 2 dB.)

Using the Electronic Attenuator: Pros and Cons

The electronic attenuator offers finer steps than the mechanical attenuator, has no acoustical noise, is faster, and is less subject to wear.

The “finer steps” advantage of the electronic attenuator is beneficial in optimizing the alignment of the analyzer dynamic range to the signal power in the front panel as well as remote use. Thus, you can achieve improved relative signal measurement accuracy. Compared to a mechanical attenuator with 2 dB steps, the 1 dB resolution of the electronic attenuator only gives better resolution when the odd-decibel steps are used. Those odd-decibel steps are less accurately calibrated than the even-decibel steps, so one tradeoff for this superior relative accuracy is reduced absolute amplitude accuracy.

Another disadvantage of the electronic attenuator is that the spectrum analyzer loses its “Auto” setting, making operation less convenient.

Also, the relationship between the dynamic range specifications (TOI, SHI, compression and noise) and instrument performance are less well-known with the electrical attenuator. With the mechanical attenuator, TOI, SHI and compression threshold levels increase dB-for-dB with increasing attenuation, and the noise floor does as well. With the electronic attenuator, there is an excess attenuation of about 1 to 3 dB between 0 and 3.6 GHz, making the effective TOI, SHI, and so forth, less well known. Excess attenuation is the actual attenuation relative to stated attenuation. Excess attenuation is accounted for in the analyzer calibration

Elec Atten

Controls the Electronic Attenuator in dual attenuator configurations. This key does not appear in single attenuator configurations, as the control of both the mechanical and electronic stages of the single attenuator is integrated into the single Atten key.

Key Path	AMPTD Y Scale, Attenuation
Remote Command	<code>[:SENSe] :POWer [:RF] :EATTenuation <rel_ampl></code> <code>[:SENSe] :POWer [:RF] :EATTenuation?</code>
Notes	Electronic Attenuation's specification is defined only when Mechanical Attenuation is 6 dB.
Dependencies	This key only appears in Dual Attenuator models with an Electronic Attenuator installed. It does not appear in models with the Single Attenuator configuration, as in the single attenuator configuration there is no “electronic attenuator” there is only a single integrated attenuator (which has both a mechanical and electronic stage). However, in the single attenuator configuration, EATT SCPI commands are accepted for compatibility with other X-series instruments and set a “soft” attenuation as described in "Attenuator Configurations and Auto/Man" on page 2737 . The “soft” attenuation is treated as an addition to the “main” attenuation value set by the Atten softkey or the

	POW:ATT SCPI command and affects the total attenuation displayed on the Attenuation key and the Meas Bar. When Enable Elec Atten is off or grayed out, the Elec Atten key is grayed out.
Preset	0 dB
State Saved	Saved in instrument state
Min	0 dB
Max	Dual attenuator configuration: 24 dB Single attenuator configuration: the total of ATT and EATT cannot exceed 50 dB, so if the EATT is set to 24 dB first, the main attenuation cannot be greater than 26 dB and will be reduced accordingly; if the main attenuator is set to 40 dB first, EATT cannot be greater than 10 dB
Initial S/W Revision	Prior to A.02.00
Modified at S/W Revision	A.03.00

Adjust Atten for Min Clip

Sets the combination of mechanical and electronic attenuation and gain based on the current measured signal level so that clipping will be at a minimum.

This is an "immediate action" function, that is, it executes once, when the key is pressed.

This key is grayed out in measurements that do not support this functionality. The spectrum analyzer measurement, Swept SA, does not support this functionality.

Key Path	AMPTD Y Scale, Attenuation
Remote Command	<code>[:SENSe] :POWer [:RF] :RANGe :OPTimize IMMEDIATE</code>
Initial S/W Revision	Prior to A.02.00
Modified at S/W Revision	A.03.00

Pre-Adjust for Min Clip

If this function is on, it does the adjustment described under "[Adjust Atten for Min Clip](#)" on page 2740 each time a measurement restarts. Therefore, in Continuous measurement mode, it only executes before the first measurement.

In dual attenuator models, you can set Elec+Mech Atten, in which case both attenuators participate in the autoranging, or Elec Atten Only, in which case the mechanical attenuator does not participate in the autoranging. This latter case results in less wear on the mechanical attenuator and is usually faster.

This key is grayed out in measurements that do not support this functionality. The spectrum analyzer measurement, Swept SA, does not support this functionality.

Key Path	AMPTD Y Scale, Attenuation
Remote Command	<code>[:SENSe] :POWer [:RF] :RANGe :OPTimize :ATTenuation OFF ELECTRical COMBined</code>

	<code>[:SENSe] :POWer [:RF] :RANGe:OPTimize:ATTenuation?</code>
Notes	The SCPI parameter <code>ELECTrical</code> sets this function to On in single attenuator models. The SCPI parameter <code>COMBined</code> is mapped to <code>ELECTrical</code> in single attenuator models; if you send <code>COMBined</code> , it sets the function to On and returns <code>ELEC</code> to a query.
Dependencies	This key only appears in Dual Attenuator models with an Electronic Attenuator installed. In instruments with Dual Attenuator model, when Enable Elec Atten is off or grayed out, the Pre-Adjust for Min Clip key is grayed out.
Preset	OFF for Swept SA measurement; ON for all other measurements that support Pre-Adjust for Min Clip
State Saved	Saved in instrument state
Range	Dual attenuator models: Off Elec Atten Only Mech + Elec Atten Single attenuator models: Off On
Initial S/W Revision	Prior to A.02.00
Modified at S/W Revision	A.03.00

Remote Command	<code>[:SENSe] :POWer [:RF] :RANGe:AUTO ON OFF 1 0</code> <code>[:SENSe] :POWer [:RF] :RANGe:AUTO?</code>
Notes	ON aliases to "Elec Atten Only" (<code>:POW:RANG:OPT:ATT ELEC</code>) OFF aliases to "Off" (<code>:POW:RANG:OPT:ATT OFF</code>) The query <code>:POW:RANG:AUTO?</code> returns true if <code>:POW:RANG:OPT:ATT</code> is not "Off"
Initial S/W Revision	Prior to A.02.00

Off

Turns Pre-Adjust for Min Clip off. This is the default setting.

This key is grayed out in measurements that do not support this functionality. The spectrum analyzer measurement, Swept SA, does not support this functionality.

Key Path	AMPTD Y Scale, Attenuation, Pre-Adjust for Min Clip
Example	<code>:POW:RANGe:OPT:ATT OFF</code>
Initial S/W Revision	Prior to A.02.00

Elec Atten Only

Selects only the electric attenuator to participate in auto ranging. This offers less wear on the mechanical attenuator and is usually faster.

This key is grayed out in measurements that do not support this functionality. The spectrum analyzer measurement, Swept SA, does not support this functionality.

Key Path	AMPTD Y Scale, Attenuation, Pre-Adjust for Min Clip
Example	:POW:RANGe:OPT:ATT ELEC
Initial S/W Revision	Prior to A.02.00

Mech + Elec Atten

In dual attenuator models, this selects both attenuators participate in the autoranging.

This key is grayed out in measurements that do not support this functionality. The spectrum analyzer measurement, Swept SA, does not support this functionality.

Key Path	AMPTD Y Scale, Attenuation, Pre-Adjust for Min Clip
Example	:POW:RANGe:OPT:ATT COMB
Initial S/W Revision	Prior to A.02.00

(Mech) Atten Step

This controls the step size used when making adjustments to the input attenuation.

This key is labeled Mech Atten Step in dual attenuator models and Atten Step in single attenuator models. In the dual attenuator configuration, this key only affects the step size of the mechanical attenuator.

Key Path	AMPTD Y Scale, Attenuation
Remote Command	[:SENSe] :POWer [:RF] :ATTenuation :STEP [:INCRement] 10 dB 2 dB [:SENSe] :POWer [:RF] :ATTenuation :STEP [:INCRement] ?
Example	POW:ATT:STEP 2
Notes	Note this feature works like a 1-N choice from the front panel, but it takes a specific value (in dB) when used remotely. The only valid values are 2 and 10.
Dependencies	Blanked in CXA and EXA if option FSA (2 dB steps) is not present. If blanked, attempts to set it via SCPI will yield an error.
Couplings	When the attenuation step size changes, the current mechanical attenuation value is adjusted (if necessary) to be quantized to the new step size. That is, if step is set to 10 dB, mech atten is increased if necessary so it is a multiple of 10 dB
Preset	PXA and MXA: 2 dB EXA and CXA: 10 dB (2 dB with option FSA)
State Saved	Saved in instrument state
Initial S/W Revision	Prior to A.02.00
Modified at S/W Revision	A.03.00

Scale/Div (RF Envelope View)

Sets the scale per division for the RF Envelope result waveform (time domain) measurements in the graph window.

Key Path	AMPTD Y Scale
Mode	BASIC, PNOISE, WCDMA, C2K, GSM, WIMAXOFDMA, TDSCDMA, 1XEVD0, DVB, DTMB, ISDBT, CMMB, LTE, LTETDD, DCATV, WLAN,LTEATDD, LTEAFDD
Remote Command	:DISPlay:WAVeform:VIEW[1]:WINDow[1]:TRACe:Y[:SCALe]:PDIVision <rel_ ampl> :DISPlay:WAVeform:VIEW[1]:WINDow[1]:TRACe:Y[:SCALe]:PDIVision?
Example	DISP:WAV:VIEW:WIND:TRAC:Y:PDIV 5 DISP:WAV:VIEW:WIND:TRAC:Y:PDIV?
Notes	You must be in a mode that includes the Waveform measurement to use this command. Use INSTRument:SElect to set the mode.
Couplings	When Auto Scaling is On, this value is automatically determined by the measurement result. When you set a value manually, Auto Scaling automatically changes to Off.
Preset	10.00 dB
State Saved	Saved in instrument state.
Range	0.10 dB to 20.00 dB
Min	0.10 dB
Max	20.00 dB
Initial S/W Revision	Prior to A.02.00
Modified at S/W Revision	A.03.00

Presel Center

When this key is pressed, the centering of the preselector filter is adjusted to optimize the amplitude accuracy at the frequency of the selected marker. If the selected marker is not on when Presel Center is pressed, the analyzer will turn on the selected marker, perform a peak search, and then perform centering on the marker's center frequency. If the selected marker is already on and between the start and stop frequencies of the analyzer, the analyzer performs the preselector calibration on that marker's frequency. If the selected marker is already on, but outside the frequency range between Start Freq and Stop Freq, the analyzer will first perform a peak search, and then perform centering on the marker's center frequency.

The value displayed on the Presel Adjust key will change to reflect the new preselector tuning (see Presel Adjust).

A number of considerations should be observed to ensure proper operation. See ["Proper Preselector Operation" on page 2568](#).

Key Path	AMPTD Y Scale
Remote Command	[:SENSe]:POWer[:RF]:PCENter

Example	POW:PCEN
Notes	Note that the rules outlined above under the key description apply for the remote command as well as the key. The result of the command is dependent on marker position, and so forth. Any message shown by the key press is also shown in response to the remote command.
Dependencies	<ul style="list-style-type: none"> • Grayed out if the microwave preselector is off.) • If the selected marker's frequency is below Band 1, advisory message 0.5001 is generated and no action is taken. • Grayed out if entirely in Band 0. • Blank in models that do not include a preselector, such as option 503. If the SCPI is sent in these instruments, it is accepted without error, and the query always returns 0. • Grayed out in the Spectrogram View.
Couplings	<p>The active marker position determines where the centering will be attempted.</p> <p>If the analyzer is in a measurement such as averaging when centering is initiated, the act of centering the preselector will restart averaging but the first average trace will not be taken until the centering is completed.</p>
Status Bits/OPC dependencies	<p>When centering the preselector, *OPC will not return true until the process is complete and a subsequent measurement has completed, nor will results be returned to a READ or MEASure command.</p> <p>The Measuring bit should remain set while this command is operating and should not go false until the subsequent sweep/measurement has completed.</p>
Initial S/W Revision	Prior to A.02.00
Modified at S/W Revision	A.03.00

Proper Preselector Operation

A number of considerations should be observed to ensure proper operation:

1. If the selected marker is off, the analyzer will turn on a marker, perform a peak search, and adjust the preselector using the selected marker's frequency. It uses the "highest peak" peak search method unqualified by threshold or excursion, so that there is no chance of a 'no peak found' error. It continues with that peak, even if it is the peak of just noise. Therefore, for this operation to work properly, there should be a signal on screen in a preselected range for the peak search to find.
2. If the selected marker is already on, the analyzer will attempt the centering at that marker's frequency. There is no preselector for signals below about 3.6 GHz, therefore if the marker is on a signal below 3.6 GHz, no centering will be attempted and an advisory message generated
3. In some models, the preselector can be bypassed. If it is bypassed, no centering will be attempted in that range and a message will be generated.

Preselector Adjust

Allows you to manually adjust the preselector filter frequency to optimize its response to the signal of interest. This function is only available when **"Presel Center"** on page 2743 is available.

For general purpose signal analysis, using Presel Center is recommended. Centering the filter minimizes the impact of long-term preselector drift. Presel Adjust can be used instead to manually optimize the preselector. One application of manual optimization would be to peak the preselector response, which both optimizes the signal-to-noise ratio and minimizes amplitude variations due to small (short-term) preselector drifting.

Key Path	AMPTD Y Scale
Scope	Meas Global
Remote Command	<code>[:SENSe] :POWer [:RF] :PADJust <freq></code> <code>[:SENSe] :POWer [:RF] :PADJust?</code>
Example	POW:PADJ 100KHz POW:PADJ?
Notes	The value on the key reads out to 0.1 MHz resolution.
Dependencies	<ul style="list-style-type: none"> • Grayed out if microwave preselector is off.) • Grayed out if entirely in Band 0. • Blank in models that do not include a preselector, such as option 503. If the SCPI is sent in these instruments, it is accepted without error, and the query always returns 0. • Grayed out in the Spectrogram View.
Preset	0 MHz
State Saved	The Presel Adjust value set by Presel Center, or by manually adjusting Presel Adjust, is not saved in instrument state, and does not survive a Preset or power cycle.
Min	-500 MHz
Max	500 MHz
Default Unit	Hz
Backwards Compatibility SCPI	<code>[:SENSe] :POWer [:RF] :MW :PADJust</code> <code>[:SENSe] :POWer [:RF] :MMW :PADJust</code> PSA had multiple preselectors, but the X-Series has only one. These commands simply alias to <code>[:SENSe] :POWer [:RF] :PADJust</code>
Initial S/W Revision	Prior to A.02.00
Modified at S/W Revision	A.03.00

Remote Command	<code>[:SENSe] :POWer [:RF] :PADJust :PRESelector MWAVE MMWave EXTERNAL</code> <code>[:SENSe] :POWer [:RF] :PADJust :PRESelector?</code>
Notes	PSA had multiple preselectors, and you could select which preselector to adjust. Since the X-Series has only one mm/uW preselector, the preselector selection softkey is no longer available. However, to provide backward compatibility, we accept the legacy remote commands. The command form has no effect, the query always returns MWAVE
Initial S/W Revision	Prior to A.02.00

μW Path Control

The μW Path Control functions include the μW Preselector Bypass (Option MPB) and Low Noise Path (Option LNP) controls in the High Band path circuits.

When the μW Preselector is bypassed, the user has better flatness, but will be subject to spurs from out of band interfering signals. When the Low Noise Path is enabled, the analyzer automatically switches around certain circuitry in the high frequency bands which can contribute to noise, when it is appropriate based on other analyzer settings.

For most applications, the preset state is Standard Path, which gives the best remote-control throughput, minimizes acoustic noise from switching and minimizes the risk of wear out in the hardware switches. For applications that utilize the wideband IF paths, the preset state is the μW Preselector Bypass path, if option MPB is present. This is because, when using a wideband IF such as the 140 MHz IF, the μW Preselector's bandwidth can be narrower than the available IF bandwidth, causing degraded amplitude flatness and phase linearity, so it is desirable to bypass the preselector in the default case.

Users may choose Low Noise Path Enable. It gives a lower noise floor, especially in the 21–26.5 GHz region, though without improving many measures of dynamic range, and without giving the best possible noise floor. The preamp, if purchased and used, gives better noise floor than does the Low Noise Path, however its compression threshold and third-order intercept are much poorer than that of the non-preamp Low Noise Path. There are some applications, typically for signals around –30 dBm, for which the third-order dynamic range of the standard path is good enough, but the noise floor is not low enough even with 0 dB input attenuation. When the third-order dynamic range of the preamp path is too little and the noise floor of the standard path is too high, the Low Noise Path can provide the best dynamic range.

Key Path	AMPTD Y Scale
Mode	SA, BASIC, PNOISE, VSA , LTE, LTETDD
Scope	Meas Global
Remote Command	[:SENSe] :POWer [:RF] :MW:PATH STD LNPath MPBypass FULL [:SENSe] :POWer [:RF] :MW:PATH?
Example	:POW:MW:PATH LNP Enables the Low Noise path
Notes	If a Presel Center is performed, the analyzer will momentarily switch to the Standard Path, regardless of the setting of μW Path Control The DC Block will always be switched in when the low noise path is switched in, to protect succeeding circuitry from DC. Note that this does not mean “when the low noise path is enabled” but when, based on the Low Noise Path rules, the path is actually switched in. This can happen when the selection is Low Noise Path Enable . In the case where the DC Block is switched in the analyzer is now AC coupled. However, if the user has selected DC coupling, the UI will still behave as though it were DC coupled, including all annunciation, warnings, status bits, and responses to SCPI queries. This is because, based on other settings, the analyzer could switch out the low noise path at any time and hence go back to being DC coupled. Alignment switching ignores the settings in this menu, and restores them when finished.
Dependencies	Unavailable in BBIQ and External Mixing
Preset	All modes other than IQ Analyzer mode and VXA: STD IQ Analyzer, VXA and WLAN mode:

	MPB option present and licensed: MPB MPB option not present and licensed: STD
State Saved	Save in instrument state
Readback	Value selected in the submenu
Initial S/W Revision	A.04.00
Modified at S/W Revision	A.10.00

Standard Path

This path gives the best remote-control throughput, minimizes acoustic noise from switching and minimizes the risk of wear in the hardware switches, particularly in remote test scenarios where both low band and high band setups will follow in rapid succession.

In this path, the bypass of the low band/high band switch and microwave preamp is never activated, which can cause some noise degradation but preserves the life of the bypass switch.

Key Path	AMPTD Y Scale, μ W Path Control
Example	:POW:MW:PATH STD
Readback Text	Standard Path
Initial S/W Revision	A.04.00

Low Noise Path Enable

You may choose Low Noise Path Enable, which gives a lower noise floor under some circumstances, particularly when operating in the 21–26.5 GHz region. With the Low Noise Path enabled, the low band/high band switch and microwave preamp are bypassed whenever all of the following are true:

- The analyzer is not in the Low Band, meaning:
- the start frequency is above 3.5 GHz and
- the stop frequency is above 3.6 GHz.
- the internal preamp is not installed or (if installed) is set to Off or Low Band

Note that this means that, when any part of a sweep is done in Low Band, the Low Noise Path is not used, whether or not the Low Noise Path Enable is selected in the user interface. Also, if the preamp is turned on, the Low Noise Path is not used, whether or not the Low Noise Path Enable is selected in the user interface. The only time the Low Noise Path is used is when Low Noise Path Enable is selected, the sweep is completely in High Band (> 3.6 GHz) and no preamp is in use.

See "[More Information](#)" on page 2572

Key Path	AMPTD Y Scale, μ W Path Control
Measurement	Swept SA

Example	:POW:MW:PATH LNP
Notes	<p>For measurements that use IQ acquisition, the low noise path is used when the Center Frequency is in High Band (> 3.6 GHz) and no preamp is in use.</p> <p>In other words, the rules above are modified to use only the center frequency to qualify which path to switch in.</p> <p>This is not the case for FFT's in the Swept SA measurement; they use the same rules as swept measurements.</p>
Dependencies	<p>Key is blanked if current mode does not support it.</p> <p>Key is grayed out if mode supports it but current measurement does not support it.</p> <p>Unless Option LNP is present and licensed, key is blank and if SCPI command sent, error -241, "Hardware missing; Option not installed" is generated.</p>
Readback Text	Low Noise Path Enable
Initial S/W Revision	A.04.00

More Information

The user should understand that the Low Noise Path, while giving improved DANL, has the disadvantage of decreased TOI performance and decreased gain compression performance relative to the standard path.

The user should also understand that the bypass switch is a mechanical switch and has finite life, so if the Low Noise Path is enabled, it is possible to cause frequent cycling of this switch by frequently changing analyzer settings such that the above conditions hold true only some of the time. A user making tests of this nature should consider opting for the Standard Path, which will never throw the bypass switch, at the expense of some degraded noise performance.

The low noise path is useful for situations where the signal level is so low that the analyzer performance is dominated by noise even with 0 dB attenuation, but still high enough that the preamp option would have excessive third-order intermodulation or compression. The preamp, if purchased and used, gives better noise floor than does the "Low Noise Path." However, its compression threshold and third-order intercept are much poorer than that of the non-preamp path. There are some applications, typically for signals around -30 dBm, for which the third-order dynamic range of the standard path is good enough, but the noise floor is not low enough even with 0 dB input attenuation. When the third-order dynamic range of the preamp path is too little and the noise floor of the standard path is too high, the Low Noise Path can provide the best dynamic range

The graph below illustrates the concept. It shows, in red, the performance of an analyzer at different attenuation settings, both with the preamp on and off, in a measurement that is affected by both analyzer noise and analyzer TOI. The green shows the best available dynamic range, offset by 0.5 dB for clarity. The blue shows how the best available dynamic range improves for moderate signal levels with the low noise path switched in. In this illustration, the preamp improves the noise floor by 15 dB while degrading the third-order intercept by 30 dB, and the low noise path reduces loss by 8 dB. The attenuator step size is 2 dB.

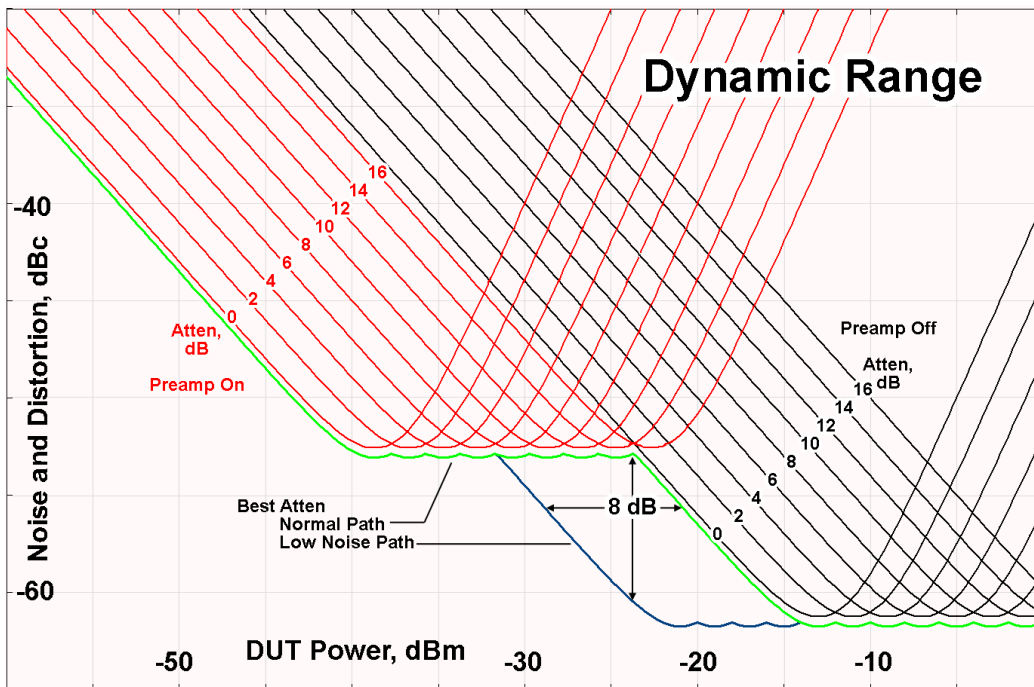

There are other times where selecting the low noise path improves performance, too. Compression-limited measurements such as finding the nulls in a pulsed-RF spectrum can profit from the low noise path in a way similar to the TOI-limited measurement illustrated. Accuracy can be improved when the low noise path allows the optimum attenuation to increase from a small amount like 0, 2 or 4 dB to a larger amount, giving better return loss at the analyzer input. Harmonic measurements, such as second and third harmonic levels, are much improved using the low noise path because of the superiority of that path for harmonic (though not intermodulation) distortion performance.

μW Preselector Bypass

This key toggles the preselector bypass switch for band 1 and higher. When the microwave preselector is on, the signal path is preselected. When the microwave preselector is off, the signal path is not preselected. The preselected path is the normal path for the analyzer.

The preselector is a tunable bandpass filter which prevents signals away from the frequency of interest from combining in the mixer to generate in-band spurious signals (images). The consequences of using a preselector filter are its limited bandwidth, the amplitude and phase ripple in its passband, and any amplitude and phase instability due to center frequency drift.

Option MPB or pre-selector bypass provides an unpreselected input mixer path for certain X-Series signal analyzers with frequency ranges above 3.6 GHz. This signal path allows a wider bandwidth and less amplitude variability, which is an advantage when doing modulation analysis and broadband signal analysis. The disadvantage is that, without the preselector, image signals will be displayed. Another disadvantage of bypassing the preselector is increased LO emission levels at the front panel input port.

Image responses are separated from the real signal by twice the 1st IF. For IF Paths of 10 MHz and 25 MHz, the 1st IF is 322.5 MHz, so the image response and the real signal will be separated by 645 MHz. The 1st IF will be different for other IF Path settings. When viewing a real signal and its corresponding image response in internal mixing, the image response will be to the left of the real signal.

Also, the image response and the real signal typically have the same amplitude and exhibit the same shape factor.

However, if Option FS1, Fast Sweep Capability, is enabled, the image response in the Swept SA measurement will appear lower in amplitude and have a much wider shape factor compared to the real signal.

Key Path	AMPTD Y Scale, μ W Path Control
Example	:POW:MW:PATH MPB
Dependencies	Key is blanked if current mode does not support it. Key is grayed out if mode supports it but current measurement does not support it. Key is blank unless Option MPB is present and licensed. If SCPI command sent when MPB not present, error -241, "Hardware missing; Option not installed" is generated.
Readback Text	μ W Preselector Bypass
Initial S/W Revision	A.04.00

Remote Command	[:SENSe] :POWeR [:RF] :MW :PRESelector [:STATe] ON OFF 0 1 [:SENSe] :POWeR [:RF] :MW :PRESelector [:STATe] ?
Example	:POW:MW:PRES OFF Bypasses the microwave preselector
Notes	The ON parameter sets the STD path (:POW:MW:PATH STD) The OFF parameter sets path MPB (:POW:MW:PATH MPB)
Preset	ON

Internal Preamp

Accesses a menu of keys that control the internal preamps. Turning on the preamp gives a better noise figure, but a poorer TOI to noise floor dynamic range. You can optimize this setting for your particular measurement.

The instrument takes the preamp gain into account as it sweeps. If you sweep outside of the range of the preamp the instrument will also account for that. The displayed result will always reflect the correct gain.

For some measurements, when the preamp is on and any part of the displayed frequency range is below the lowest frequency for which the preamp has specifications, a warning condition message appears in the status line. For example, for a preamp with a 9 kHz lowest specified frequency: "Preamp: Accy unspec'd below 9 kHz".

Key Path	AMPTD Y Scale
Scope	Meas Global
Remote Command	[:SENSe] :POWeR [:RF] :GAIN [:STATe] OFF ON 0 1 [:SENSe] :POWeR [:RF] :GAIN [:STATe] ?
Dependencies	Preamp is not available on all hardware platforms. If the preamp is not present or is unlicensed, the

key is not shown.
The preamp is not available when the electronic/soft attenuator is enabled.

Couplings	<p>The act of connecting the U7227A USB Preamplifier to one of the analyzer's USB ports will cause the Internal Preamp to be switched on. When this happens an informational message will be generated: "Internal Preamp turned on for optimal operation with USB Preamp." Note that if the Internal Preamp was already on, there will be no change to the setting, but if it was Off it will be switched On, to Full Range.</p> <p>Note that this same action occurs when the SA mode is selected while the USB Preamp is connected to one of the analyzer's USB ports, if it is the first time that the SA mode has run since powerup, or if the last time the SA mode was running the USB Preamp was NOT connected.</p> <p>Subsequently disconnecting the USB Preamp from USB does not change the Internal Preamp setting nor restore the previous setting.</p>
Preset	OFF
State Saved	Saved in instrument state
Initial S/W Revision	Prior to A.02.00
Modified at S/W Revision	A.14.00

Key Path	AMPTD Y Scale, Internal Preamp
Scope	Meas Global
Remote Command	<pre>[:SENSe] :POWer [:RF] :GAIN:BAND LOW FULL [:SENSe] :POWer [:RF] :GAIN:BAND?</pre>
Dependencies	<p>Preamp is not available on all hardware platforms. If the preamp is not present or is unlicensed, the key is not shown.</p> <p>If a POW:GAIN:BAND FULL command is sent when a low band preamp is available, the preamp band parameter is to LOW instead of FULL, and an "Option not installed" message is generated.</p>
Preset	LOW
State Saved	Saved in instrument state
Initial S/W Revision	Prior to A.02.00

Off

Turns the internal preamp off

Key Path	AMPTD Y Scale, Internal Preamp
Example	:POW:GAIN OFF
Readback	Off
Initial S/W Revision	Prior to A.02.00

Low Band

Sets the internal preamp to use only the low band.

The frequency range of the installed (optional) low-band preamp is displayed in square brackets on the Low Band key label.

Key Path	AMPTD Y Scale, Internal Preamp
Example	:POW:GAIN ON :POW:GAIN:BAND LOW
Readback	Low Band
Initial S/W Revision	Prior to A.02.00

Full Range

Sets the internal preamp to use its full range. The low band (0–3.6 GHz or 0–3GHz, depending on the model) is supplied by the low band preamp and the frequencies above low band are supplied by the high band preamp.

The frequency range of the installed (optional) preamp is displayed in square brackets on the Full Range key label. If the high band option is not installed the Full Range key does not appear.

Key Path	AMPTD Y Scale, Internal Preamp
Example	:POW:GAIN ON :POW:GAIN:BAND FULL
Readback	Full Range
Initial S/W Revision	Prior to A.02.00

Ref Position (RF Envelope View)

Positions the reference level at the top, center or bottom of the Y Scale display. Changing the reference position does not change the reference level value.

Key Path	AMPTD Y Scale
Mode	BASIC, PNOISE, WCDMA, C2K, GSM, WIMAXOFDMA, TDSCDMA, 1XEVD0, DVB, DTMB, ISDBT, CMMB, LTE, LTETDD, DCATV, WLAN, LTEATDD, LTEAFDD
Remote Command	:DISPlay:WAVeform:VIEW[1]:WINDow[1]:TRACe:Y[:SCALE]:RPOSition TOP CENTER BOTTom :DISPlay:WAVeform:VIEW[1]:WINDow[1]:TRACe:Y[:SCALE]:RPOSition?
Example	DISP:WAV:VIEW:WIND:TRAC:Y:RPOS CENT DISP:WAV:VIEW:WIND:TRAC:Y:RPOS?
Notes	You must be in a mode that includes the Waveform measurement to use this command. Use INSTRument:SElect to set the mode.
Preset	TOP

State Saved	Saved in instrument state.
Range	Top Ctr Bot
Initial S/W Revision	Prior to A.02.00
Modified at S/W Revision	A.03.00

Auto Scaling

Toggles the Auto Scaling function between On and Off. When the Restart front-panel key is pressed, this function automatically determines the scale per division and reference values based on the measurement results.

Key Path	AMPTD Y Scale
Mode	BASIC, PNOISE, WCDMA, C2K, GSM, WIMAXOFDMA, TDSCDMA, 1XEVD0, DVB, DTMB, ISDBT, CMMB, LTE, LTETDD, DCATV, WLAN,LTEATDD, LTEAFDD
Remote Command	:DISPlay:WAVeform:VIEW[1] 2:WINDow[1]:TRACe:Y[:SCALE]:COUPle 0 1 OFF ON :DISPlay:WAVeform:VIEW[1] 2:WINDow[1]:TRACe:Y[:SCALE]:COUPle?
Example	DISP:WAV:VIEW:WIND:TRAC:Y:COUP OFF DISP:WAV:VIEW:WIND:TRAC:Y:COUP?
Notes	You must be in a mode that includes the Waveform measurement to use this command. Use INSTRument:SElect to set the mode.
Couplings	When Auto Scaling is On, upon pressing the Restart front-panel key, this function automatically switches the scale per division and reference values into the defaults. When you set a value to either Scale/Div or Ref Value manually, Auto Scaling automatically changes to Off.
Preset	OFF
State Saved	Saved in instrument state.
Range	On Off
Initial S/W Revision	Prior to A.02.00
Modified at S/W Revision	A.03.00

Range

This key is only available when I/Q is the selected input. It replaces the Attenuation key in that case.

Each input channel (I and Q) has four internal gain ranges. The maximum allowed voltage in each gain range is slightly more than the nominal value, so the break point between ranges is a couple of millivolts higher than the nominal (setting a peak voltage of 0.502 mV will still map to the 0.5 V Peak range).

Gain Setting	Volts RMS	Volts Peak	Volts Peak - Peak	dBm (50Ω)	Break Point
0 dB	0.7071	1.0	2.0	10	n/a

6 dB	0.3536	0.5	1.0	4	0.502 V Peak
12 dB	0.1768	0.25	0.5	-2	0.252 V Peak
18 dB	0.0884	0.125	0.25	-8	0.127 V Peak

Key Path	AMPTD Y Scale
Notes	Visible only when the selected input is I/Q.
State Saved	No
Readback Text	When Range is Auto, "[Auto]" When Range is Man and I & Q are the same, "[<range value>]" When Range is Man and I & Q are different: "[: <I range value> Q: <Q range value>]" See I Range and Q Range for the <range value> enumeration definition.
Initial S/W Revision	Prior to A.02.00

Range Auto/Man

The Auto setting for Range causes the range to be set based on the Y Scale settings. When Range is "Auto", the I & Q Range are set based on the top of the Y Scale when the Y scale is in dB units (for example, power), or to the max(abs(top), abs(bottom)) when the Y scale reference is not at the top of the screen.

Not all measurements support Range Auto/Man. If Auto is not supported in the current measurement, this key is grayed out and shows "Man" and MAN is returned to a SCPI query, but this does NOT change the Auto/Man setting for Range. When you go to a measurement that supports Auto, it goes back to Auto if it was previously in Auto mode.

Key Path	AMPTD Y Scale, Range
Scope	Meas Global
Remote Command	<code>[:SENSe]:VOLTage:IQ:RANGe:AUTO OFF ON 0 1</code> <code>[:SENSe]:VOLTage:IQ:RANGe:AUTO?</code>
Example	Put the I Range and Q Range in manual. <code>VOLT:IQ:RANG:AUTO OFF</code>
Dependencies	If Auto is not supported, sending the SCPI command will generate an error.
Couplings	When in Auto, both I Range and Q Range are set to the same value, computed as follows: Maximum absolute value is computed for the Y Scale. The top and bottom of the graph are computed based on Ref Value, Scale/Div, and Ref Position. Formula: $Y_{Max} = \max(\text{abs}(\text{top}), \text{abs}(\text{bottom}))$. The I Range and Q Range are then set to YMax.
Preset	ON
State Saved	Saved in instrument state
Range	Auto Man
Initial S/W Revision	Prior to A.02.00

Remote Command	<code>[:SENSe] :POWeR :IQ :RANGe :AUTO OFF ON 0 1</code> <code>[:SENSe] :POWeR :IQ :RANGe :AUTO ?</code>
Example	Put the I Range and Q Range in manual. <code>POW:IQ:RANG:AUTO OFF</code>
Notes	The <code>POW:IQ:RANG:AUTO</code> is an alternate form of the <code>VOLT:IQ:RANG:AUTO</code> command. This is to maintain consistency with I Range and Q Range, which support both the <code>POWeR</code> and <code>VOLTage</code> forms of the command.
Preset	ON
Range	Auto Man
Initial S/W Revision	Prior to A.02.00

I Range

This is the internal gain range for the I channel when Input Path is I Only or I and I/Q, and it is used for both the I and Q channels when the Input Path is I+IQ. See "[I/Q Gain Ranges](#)" on page 2583.

Key Path	AMPTD Y Scale, Range
Remote Command	<code>[:SENSe] :VOLTagE :IQ [:I] :RANGe [:UPPer] <voltage></code> <code>[:SENSe] :VOLTagE :IQ [:I] :RANGe [:UPPer] ?</code>
Example	Set the I Range to 0.5 V Peak <code>VOLT:IQ:RANG 0.5 V</code>
Notes	The numeric entries are mapped to the smallest gain range whose break point is greater than or equal to the value, or 1 V Peak if the value is greater than 1 V.
Couplings	When Q Same as I is On, the I Range value will be copied to the Q Range. Changing the value will also set Range = Man.
Preset	1 V Peak
State Saved	Saved in instrument state
Range	1 V Peak 0.5 V Peak 0.25 V Peak 0.125 V Peak
Min	0.125 V
Max	1 V
Initial S/W Revision	Prior to A.02.00

Remote Command	<code>[:SENSe] :POWeR :IQ [:I] :RANGe [:UPPer] <amp;pl></code> <code>[:SENSe] :POWeR :IQ [:I] :RANGe [:UPPer] ?</code>
Example	Set the I Range to 0.5 V Peak when Reference Z is 50Ω, and to 1.0 V Peak when Reference Z is 75Ω. <code>POW:IQ:RANG 4 dBm</code>
Notes	The <code>POWeR</code> form of the command is provided for convenience. It maps to the same underlying gain

range parameter as the VOLTage form of the command.

The Reference Z (not the I channel Input Z) is used to convert the power to peak voltage, which is then used to set the I Range as with the VOLTage form of the command. The power values of the 4 range states (1V Peak, 0.5V Peak, 0.25V Peak, and 0.125V Peak) will vary with Reference Z. Here are some examples:

50Ω: 10, 4, -2, -8

75Ω: 8.2, 2.2, -3.8, -9.8

600Ω: -0.8, -6.8, -12.8, -18.9

Preset	10.0 dBm
Range	-20 dBm to 10 dBm
Min	-20 dBm
Max	10 dBm
Initial S/W Revision	Prior to A.02.00

1 V Peak

Set the channel gain state to 1 Volt Peak.

Key Path	AMPTD Y Scale, I Range Q Range
Initial S/W Revision	Prior to A.02.00

0.5 V Peak

Set the channel gain state to 0.5 Volt Peak.

Key Path	AMPTD Y Scale, I Range Q Range
Initial S/W Revision	Prior to A.02.00

0.25 V Peak

Set the channel gain state to 0.25 Volt Peak.

Key Path	AMPTD Y Scale, I Range Q Range
Initial S/W Revision	Prior to A.02.00

0.125 V Peak

Set the channel gain state to 0.125 Volt Peak.

Key Path	AMPTD Y Scale, I Range Q Range
Initial S/W Revision	Prior to A.02.00

Q Range Value

This is the internal gain range for the Q channel. See "[I/Q Gain Ranges](#)" on page 2583. The Q Range only applies to Input Path Q Only and Ind I/Q. For input I+jQ the I Range determines both I and Q channel range settings.

Key Path	AMPTD Y Scale, Range
Remote Command	[:SENSe] :VOLTage:IQ:Q:RANGe [:UPPer] <voltage> [:SENSe] :VOLTage:IQ:Q:RANGe [:UPPer] ?
Example	Set the Q Range to 0.5 V Peak VOLT:IQ:Q:RANG 0.5 V
Notes	The numeric entries are mapped to the smallest gain range whose break point is greater than or equal to the value, or 1 V Peak if the value is greater than 1 V. The Q Range is only used for Input Path Q Only and Ind I/Q. For input I+jQ the I Range determines both I and Q channel range settings.
Couplings	When Q Same as I is On, the I Range value will be copied to the Q Range and the range value keys are disabled. Changing the value will also set Range = Man.
Preset	1 V Peak
State Saved	Saved in instrument state
Range	1 V Peak 0.5 V Peak 0.25 V Peak 0.125 V Peak
Min	0.125 V
Max	1 V
Initial S/W Revision	Prior to A.02.00

Remote Command	[:SENSe] :POWer:IQ:Q:RANGe [:UPPer] <amp;#1> [:SENSe] :POWer:IQ:Q:RANGe [:UPPer] ?
Example	Will set the Q Range to 0.5 V Peak when Reference Z is 50 Ω , and to 1.0 V Peak when Reference Z is 75 Ω . POW:IQ:Q:RANG 4 dBm
Notes	The POWER form of the command is provided for convenience. It maps to the same underlying gain range parameter as the VOLTage form of the command. The Reference Z (not the Q channel Input Z) is used to convert the power to peak voltage, which is then used to set the Q Range as with the VOLTage form of the command. The power values of the 4 range states (1V Peak, 0.5V Peak, 0.25V Peak, and 0.125V Peak) will vary with Reference Z. Here are some examples: 50 Ω : 10, 4, -2, -8 75 Ω : 8.2, 2.2, -3.8, -9.8 600 Ω : -0.8, -6.8, -12.8, -18.9
Preset	10.0 dBm

Range	-20 dBm to 10 dBm
Min	-20 dBm
Max	10 dBm
Initial S/W Revision	Prior to A.02.00

Q Same as I

Many, but not all, usages require the I and Q channels to have an identical setup. To simplify channel setup, the Q Same as I will cause the Q channel range to be mirrored from the I channel. That way you only need to set up one channel (the I channel). The I channel values are copied to the Q channel, so at the time Q Same as I is Off, the I and Q channel setups will be identical.

Key Path	AMPTD Y Scale, Range, Q Range
Remote Command	[:SENSe] :VOLTage POWer : IQ : MIRRored OFF ON 0 1 [:SENSe] :VOLTage POWer : IQ : MIRRored ?
Example	Turn off the mirroring of I Range to Q Range. VOLT:IQ:MIRR OFF POW:IQ:MIRR OFF
Couplings	When On, the I Range value is mirrored (copied) to the Q Range.
Preset	On
State Saved	Saved in instrument state.
Range	On Off
Readback Text	"Q Same as I" when On, otherwise none.
Initial S/W Revision	Prior to A.02.00

1 V Peak

Set the channel gain state to 1 Volt Peak.

Key Path	AMPTD Y Scale, I Range Q Range
Initial S/W Revision	Prior to A.02.00

0.5 V Peak

Set the channel gain state to 0.5 Volt Peak.

Key Path	AMPTD Y Scale, I Range Q Range
Initial S/W Revision	Prior to A.02.00

0.25 V Peak

Set the channel gain state to 0.25 Volt Peak.

Key Path	AMPTD Y Scale, I Range Q Range
Initial S/W Revision	Prior to A.02.00

0.125 V Peak

Set the channel gain state to 0.125 Volt Peak.

Key Path	AMPTD Y Scale, I Range Q Range
Initial S/W Revision	Prior to A.02.00

I/Q Gain Ranges

See the following sections:

["1 V Peak" on page 2583](#)

["0.5 V Peak" on page 2583](#)

["0.25 V Peak" on page 2583](#)

["0.125 V Peak" on page 2584](#)

1 V Peak

Set the channel gain state to 1 Volt Peak.

Key Path	AMPTD Y Scale, I Range Q Range
Initial S/W Revision	Prior to A.02.00

0.5 V Peak

Set the channel gain state to 0.5 Volt Peak.

Key Path	AMPTD Y Scale, I Range Q Range
Initial S/W Revision	Prior to A.02.00

0.25 V Peak

Set the channel gain state to 0.25 Volt Peak.

Key Path	AMPTD Y Scale, I Range Q Range
Initial S/W Revision	Prior to A.02.00

0.125 V Peak

Set the channel gain state to 0.125 Volt Peak.

Key Path	AMPTD Y Scale, I Range Q Range
Initial S/W Revision	Prior to A.02.00

Ref Value

Sets the absolute power reference value. However, since Auto Scaling is defaulted to On, this value is automatically determined by the measurement result. When you set a value manually, Auto Scaling automatically changes to Off.

This functionality depends on the selected view:

- ["Ref Value \(RF Envelope View\)" on page 2584](#)
- ["Ref Value \(I/Q Waveform View\)" on page 2585](#)

Ref Value (RF Envelope View)

Sets the Y Scale reference value (in dBm) when the RF Envelope View is active. By default, the measurement determines the reference value with Auto Scaling. Entering a reference value manually turns Auto Scaling off.

Key Path	AMPTD Y Scale
Mode	BASIC, PNOISE, WCDMA, C2K, GSM, WIMAXOFDMA, TDSCDMA, 1XEVD0, DVB, DTMB, ISDBT, CMMB, LTE, LTETDD, DCATV, WLAN, LTEATDD, LTEAFDD
Remote Command	:DISPlay:WAVeform:VIEW[1]:WINDow[1]:TRACe:Y[:SCALe]:RLEVel <ampl> :DISPlay:WAVeform:VIEW[1]:WINDow[1]:TRACe:Y[:SCALe]:RLEVel?
Example	DISP:WAV:VIEW:WIND:TRAC:Y:RLEV -50 dBm DISP:WAV:VIEW:WIND:TRAC:Y:RLEV?
Notes	You must be in the mode that includes Waveform measurement to use this command. Use INSTRument:SElect to set the mode.
Couplings	When Auto Scaling is On, this value is automatically determined by the measurement result. When you set a value manually, Auto Scaling automatically changes to Off.
Preset	10.00 dBm
State Saved	Saved in instrument state.
Range	-250.00 dBm to 250.00 dBm
Min	-250.00 dBm
Max	250.00 dBm
Initial S/W Revision	Prior to A.02.00
Modified at S/W Revision	A.03.00

Ref Value (I/Q Waveform View)

Sets the Y Scale reference value (in volts) when the I/Q Waveform View is active. By default, the measurement determines the reference value with Auto Scaling. Entering a reference value manually turns Auto Scaling off.

Key Path	AMPTD Y Scale
Mode	BASIC, PNOISE, WCDMA, C2K, GSM, WIMAXOFDMA, TDSCDMA, 1XEVD0, DVB, DTMB, ISDB-T, CMMB, LTE, LTETDD, DCATV, WLAN, LTEATDD, LTEAFDD
Remote Command	:DISPlay:WAVeform:VIEW2:WINDow[1]:TRACe:Y[:SCALE]:RLEVel <voltage> :DISPlay:WAVeform:VIEW2:WINDow[1]:TRACe:Y[:SCALE]:RLEVel?
Example	DISP:WAV:VIEW2:WIND:TRAC:Y:RLEV 25 V DISP:WAV:VIEW2:WIND:TRAC:Y:RLEV?
Notes	You must be in a mode that includes the Waveform measurement to use this command. Use INSTRument:SElect to set the mode.
Couplings	When Auto Scaling is On, this value is automatically determined by the measurement result. When you set a value manually, Auto Scaling automatically changes to Off.
Preset	0 V
State Saved	Saved in instrument state.
Min	-250 V
Max	250 V
Initial S/W Revision	Prior to A.02.00
Modified at S/W Revision	A.03.00

Scale/Div

Sets the units per division of vertical scale in the logarithmic display. However, since Auto Scaling is defaulted to On, this value is automatically determined by the measurement result. When you set a value manually, Auto Scaling automatically changes to Off.

This functionality depends on the selected view:

- ["Scale/Div \(RF Envelope View\)" on page 2585](#)
- ["Scale/Div \(I/Q Waveform View\)" on page 2586](#)

Scale/Div (RF Envelope View)

Sets the scale per division for the RF Envelope result waveform (time domain) measurements in the graph window.

Key Path	AMPTD Y Scale
Mode	BASIC, PNOISE, WCDMA, C2K, GSM, WIMAXOFDMA, TDSCDMA, 1XEVD0, DVB, DTMB, ISDBT, CMMB, LTE, LTETDD, DCATV, WLAN, LTEATDD, LTEAFDD
Remote Command	:DISPlay:WAVeform:VIEW[1]:WINDow[1]:TRACe:Y[:SCALE]:PDIVision <rel_

	<pre> ampl> :DISPlay:WAVeform:VIEW[1]:WINDow[1]:TRACe:Y[:SCALe]:PDIVision? </pre>
Example	<pre> DISP:WAV:VIEW:WIND:TRAC:Y:PDIV 5 DISP:WAV:VIEW:WIND:TRAC:Y:PDIV? </pre>
Notes	You must be in a mode that includes the Waveform measurement to use this command. Use INSTRUMENT:SELEct to set the mode.
Couplings	When Auto Scaling is On, this value is automatically determined by the measurement result. When you set a value manually, Auto Scaling automatically changes to Off.
Preset	10.00 dB
State Saved	Saved in instrument state.
Range	0.10 dB to 20.00 dB
Min	0.10 dB
Max	20.00 dB
Initial S/W Revision	Prior to A.02.00
Modified at S/W Revision	A.03.00

Scale/Div (I/Q Waveform View)

Sets the scale per division for the I/Q signal waveform graph.

Key Path	AMPTD Y Scale
Mode	BASIC, PNOISE, WCDMA, C2K, GSM, WIMAXOFDMA, TDSCDMA, 1XEVD0, DVB, DTMB, ISDBT, CMMB, LTE, LTETDD, DCATV, WLAN,LTEATDD, LTEAFDD
Remote Command	<pre> :DISPlay:WAVeform:VIEW2:WINDow[1]:TRACe:Y[:SCALe]:PDIVision <voltage> :DISPlay:WAVeform:VIEW2:WINDow[1]:TRACe:Y[:SCALe]:PDIVision? </pre>
Example	<pre> DISP:WAV:VIEW2:WIND:TRAC:Y:PDIV 25mV DISP:WAV:VIEW2:WIND:TRAC:Y:PDIV? </pre>
Notes	You must be in a mode that includes the Waveform measurement to use this command. Use INSTRUMENT:SELEct to set the mode.
Couplings	When Auto Scaling is On, this value is automatically determined by the measurement result. When you set a value manually, Auto Scaling automatically changes to Off.
Preset	100.0 mV
State Saved	Saved in instrument state.
Min	1.0 nV
Max	20 V
Initial S/W Revision	Prior to A.02.00
Modified at S/W Revision	A.03.00

Ref Position

Positions the reference level at the top, center or bottom of the Y Scale display. Changing the reference position does not change the reference level value.

This functionality depends on the selected view:

- ["Ref Position \(RF Envelope View\)" on page 2587](#)
- ["Ref Position \(I/Q Waveform View\)" on page 2587](#)

Ref Position (RF Envelope View)

Positions the reference level at the top, center or bottom of the Y Scale display. Changing the reference position does not change the reference level value.

Key Path	AMPTD Y Scale
Mode	BASIC, PNOISE, WCDMA, C2K, GSM, WIMAXOFDMA, TDSCDMA, 1XEVD0, DVB, DTMB, ISDBT, CMMB, LTE, LTETDD, DCATV, WLAN,LTEATDD, LTEAFDD
Remote Command	:DISPlay:WAVeform:VIEW[1]:WINDow[1]:TRACe:Y[:SCALE]:RPOSition TOP CENTER BOTTom :DISPlay:WAVeform:VIEW[1]:WINDow[1]:TRACe:Y[:SCALE]:RPOSition?
Example	DISP:WAV:VIEW:WIND:TRAC:Y:RPOS CENT DISP:WAV:VIEW:WIND:TRAC:Y:RPOS?
Notes	You must be in a mode that includes the Waveform measurement to use this command. Use INSTRument:SElect to set the mode.
Preset	TOP
State Saved	Saved in instrument state.
Range	Top Ctr Bot
Initial S/W Revision	Prior to A.02.00
Modified at S/W Revision	A.03.00

Ref Position (I/Q Waveform View)

Positions the reference level at the top, center or bottom of the Y Scale display. Changing the reference position does not change the reference level value.

Key Path	AMPTD Y Scale
Mode	BASIC, PNOISE, WCDMA, C2K, GSM, WIMAXOFDMA, TDSCDMA, 1XEVD0, DVB, DTMB, ISDBT, CMMB, LTE, LTETDD, DCATV, WLAN,LTEATDD, LTEAFDD
Remote Command	:DISPlay:WAVeform:VIEW2:WINDow[1]:TRACe:Y[:SCALE]:RPOSition TOP CENTER BOTTom :DISPlay:WAVeform:VIEW2:WINDow[1]:TRACe:Y[:SCALE]:RPOSition?
Example	DISP:WAV:VIEW2:WIND:TRAC:Y:RPOS CENT DISP:WAV:VIEW2:WIND:TRAC:Y:RPOS?

Notes	You must be in a mode that includes the Waveform measurement to use this command. Use INSTRument:SElect to set the mode.
Preset	CENT
State Saved	Saved in instrument state.
Range	Top Ctr Bot
Initial S/W Revision	Prior to A.02.00
Modified at S/W Revision	A.03.00

Auto Couple

The Auto Couple feature provides a quick and convenient way to automatically couple multiple instrument settings. This helps ensure accurate measurements and optimum dynamic range. When the Auto Couple feature is activated, either from the front panel or remotely, all parameters of the current measurement that have an Auto/Manual mode are set to Auto mode and all measurement settings dependent on (or coupled to) the Auto/Man parameters are automatically adjusted for optimal performance.

However, the Auto Couple key actions are confined to the current measurement only. It does not affect other measurements in the mode, and it does not affect markers, marker functions, or trace or display attributes.

See ["More Information" on page 2589](#)

Key Path	Front-panel key
Remote Command	:COUPle ALL NONE
Example	:COUP ALL
Notes	:COUPle ALL puts all Auto/Man parameters in Auto mode (equivalent to pressing the Auto Couple key). :COUPLE NONE puts all Auto/Man parameters in manual mode. It decouples all the coupled instrument parameters and is not recommended for making measurements.
Initial S/W Revision	Prior to A.02.00

More Information

There are two types of functions that have Auto/Manual modes.

Auto/Man Active Function keys

An Auto/Man toggle key controls the binary state associated with an instrument parameter by toggling between Auto (where the parameter is automatically coupled to the other parameters it is dependent upon) and Man (where the parameter is controlled independent of the other parameters), as well as making the parameter the active function. The current mode is indicated on the softkey with either Auto or Man underlined as illustrated below.



Auto/Man 1-of-N keys

An Auto/Man 1-of-N key allows you to manually pick from a list of parameter values, or place the function in Auto, in which case the value is automatically selected (and indicated) as shown below. If in Auto, Auto is underlined on the calling key. If in manual operation, manual is indicated on the calling key. But the calling key does not actually toggle the function, it simply opens the menu.

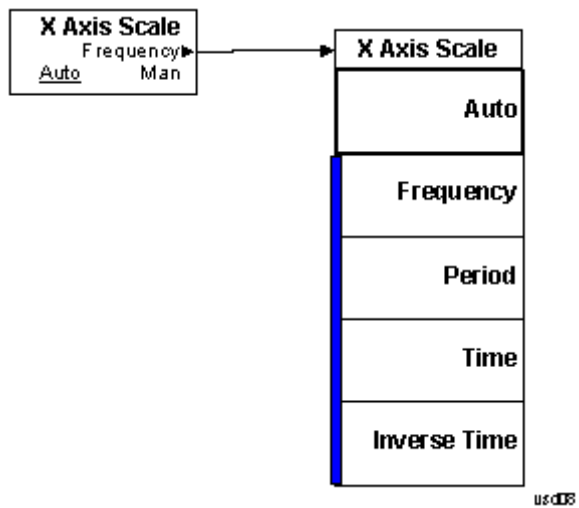

BW

Accesses a menu that enables you to control the information bandwidth functions of the instrument. You can also select the filter type for the measurement.

Key Path	Front-panel key
Initial S/W Revision	Prior to A.02.00

Digital IF BW

Enables you to set the Digital IF (formerly Info BW) bandwidth of the instrument.

Key Path	BW
Mode	BASIC, PNOISE, WCDMA, C2K, GSM, WIMAXOFDMA, TD-SCDMA, 1XEVD0, DVB, DTMB, ISDBT, CMMB, LTE, LTETDD, DCATV, WLAN, MSR,LTEATDD, LTEAFDD
Remote Command	<code>[:SENSe] :WAVeform :DIF :BANDwidth <freq></code> <code>[:SENSe] :WAVeform :DIF :BANDwidth?</code>
Example	WAV:DIF:BAND 1kHz WAV:DIF:BAND?
Notes	Max value depends on the IF Path Selection
Remote Command Notes	You must be in a mode that includes the Waveform measurements to use this command. Use INSTRument:SElect to set the mode.
Dependencies	For applications that have the IF Path Selection menu such as the BASIC mode, if IF Path Auto is OFF, the maximum value depends on which IF Path is currently selected. If 10 MHz, 25 MHz, 40 MHz, 85 MHz, 125 MHz, 140 MHz or 160 MHz paths are selected, the maximum value of this parameter will be 10, 25, 40, 85, 125, 140 or 160 MHz, respectively. If IF Path Auto is ON, the maximum value will be the maximum Digital IF BW available in the instrument regardless of the current IF Path Selection. For example, if the instrument has the options B25, B40, and B1X installed, the maximum available Digital IF BW of the instrument is 140 MHz. Thus, if IF Path Auto is ON and IF Path Selection is 25 MHz, the maximum Digital IF BW is not limited to 25 MHz but is 140 MHz.
Preset	All except the following list: 100 kHz GSM/EDGE: 510 kHz TDSCDMA: 1.3 MHz 1xEVD0: 1.3 MHz DVB-T/H: 8.0 MHz DTMB (CTTB): 8.0 MHz ISDB-T: 6.0 MHz CMMB: 8.0 MHz Digital Cable TV: 8 MHz LTEAFDD, LTEATDD: 6 MHz LTETDD: 6 MHz

	WLAN: Hardware Dependent No option = 10 MHz Option B25 = 25 MHz Option B40: if Radio Std is 802.11a/b/g/n(20MHz) = 25 MHz if Radio Std is 802.11n(40MHz) = 40 MHz if Radio Std is 802.11ac(20MHz) = 25 MHz if Radio Std is 802.11ac(40MHz) = 40 MHz Option B1X: if Radio Std is 802.11ac(80MHz) = 80 MHz Option B1Y: if Radio Std is 802.11ac(160MHz) = 160 MHz
State Saved	Saved in instrument state.
Min	10 Hz
Max	Hardware Dependent: RF Input: No Option = 10 MHz Option B25 = 25 MHz Option B40 = 40 MHz Option B85 = 85.0 MHz Option B1A = 125.0 MHz Option B1X = 140 MHz Option B1Y = 160 MHz I/Q Input: No Option = 10 MHz per channel (20 MHz for I+jQ) Option B25 = 25 MHz per channel (50 MHz for I+jQ) Option S40 = 40 MHz per channel (80 MHz for I+jQ)
Backwards Compatibility SCPI	[:SENSe]:WAVEform:BWIDth[:RESolution]
Initial S/W Revision	Prior to A.02.00
Modified at S/W Revision	A.03.00, A.13.00

Filter Type

Selects the type of bandwidth filter that is used.

Besides the Gaussian filter shape, a variety of other filter types are available with variable alpha settings for maximum control over the filter shape..

Key Path	BW
Mode	BASIC, PNOISE, WCDMA, C2K, GSM, WIMAXOFDMA, TDSCDMA, 1XEVD0, DVB, DTMB, ISDBT,

	CMMB, LTE, LTE40, DCATV, WLAN, MSR,,LTE40, LTEAFDD
Remote Command	[:SENSe]:WAVeform:DIF:FILTer:TYPE GAUSSian FLATtop [:SENSe]:WAVeform:DIF:FILTer:TYPE? (With DIF40 and/or WBDIF) [:SENSe]:WAVeform:DIF:FILTer:TYPE GAUSSian FLATtop SNYQuist RSNYquist RCOSine RRCosine [:SENSe]:WAVeform:DIF:FILTer:TYPE?
Example	WAV:DIF:FILT:TYPE GAUS WAV:DIF:FILT:TYPE?
Remote Command Notes	You must be in a mode that includes the Waveform measurements to use this command. Use INSTRument:SElect to set the mode.
Dependencies	Gaussian and Flattop are available in all DIF configurations. For the other filter types, the filters are only available when Option DP2, B40, or wider IF Bandwidth option is installed.
Preset	BASIC with DP2, B40, or wider IF Bandwidth option: FLATtop All other apps: GAUSSian
State Saved	Saved in instrument state.
Range	Gaussian FlatTop When Option DP2, B40, or wider IF Bandwidth option is installed, the range is as follows. Gaussian Flattop Short nyquist Root Short Nquist Raised Cosine Root RaisedCosine
Backwards Compatibility SCPI	[:SENSe]:WAVeform:BANDwidth:SHApe [:SENSe]:WAVeform:BWIDth:SHApe [:SENSe]:WAVeform:BANDwidth BWIDth[:RESolution]:TYPE
Initial S/W Revision	Prior to A.02.00
Modified at S/W Revision	A.03.00, A.13.00

Filter BW

This feature is only available when Option DP2, B40, or wider IF Bandwidth option is installed.

Key Path	BW
Mode	BASIC
Remote Command	[:SENSe]:WAVeform:DIF:FILTer:BANDwidth <freq> [:SENSe]:WAVeform:DIF:FILTer:BANDwidth? [:SENSe]:WAVeform:DIF:FILTer:BANDwidth:AUTO ON OFF 1 0 [:SENSe]:WAVeform:DIF:FILTer:BANDwidth:AUTO?
Example	WAV:DIF:FILT:BAND 1MHz WAV:DIF:FILT:BAND? WAV:DIF:FILT:BAND:AUTO 0

	WAV:DIF:FILT:BAND:AUTO?
Notes	You must be in the IQ Analyzer (Basic) mode to use this command. Use INSTRUMENT:SElect to set the mode.
Dependencies	This feature is only available when Option DP2, B40, or wider IF Bandwidth option is installed.
Couplings	Sets the same value as the current Digital IF BW value upon a preset or when Channel Filter Bandwidth Auto is ON.
Preset	Same value as Digital IF BW ON
State Saved	Saved in instrument state.
Min	10 Hz
Max	Clipped to the current Digital IF BW value.
Initial S/W Revision	A.04.00, A.13.00

Filter Alpha

Sets the filter alpha for the DIF filter. This feature is only available when Option DP2, B40, or wider IF Bandwidth option is installed.

Key Path	BW
Mode	BASIC
Remote Command	[:SENSE] :WAVeform:DIF:FILTer:ALPHa <real> [:SENSE] :WAVeform:DIF:FILTer:ALPHa?
Example	WAV:DIF:FILT:ALPH 0.5 WAV:DIF:FILT:ALPH?
Notes	You must be in the IQ Analyzer (Basic) mode to use this command. Use INSTRUMENT:SElect to set the mode.
Dependencies	This feature is only available when Option DP2, B40, or wider IF Bandwidth option is installed.
Preset	0.2
State Saved	Saved in instrument state.
Min	0.01
Max	1.00
Backwards Compatibility SCPI	[:SENSE] :WAVeform:WBIF:FILTer:ALPHa
Modified at S/W Revision	A.13.00

Filter Type Bwcc

This parameter is strictly for Bwcc purposes.

Remote Command	<code>[[:SENSe]:WAVeform:WBIF:FILTer[:TYPE] GAUSSian NONE NYQuist RNYQuist RCOSine RRCosine</code> <code>[[:SENSe]:WAVeform:WBIF:FILTer[:TYPE]?</code>
Preset	BASIC with Option DP2, B40, or wider IF Bandwidth option: FLATtop All other apps: GAUSSian

Gaussian

When Option DP2, B40, or wider IF Bandwidth option is installed, the capability for arbitrary Digital IF bandwidths is available. However, for instruments without DP2, B40, or wider IF Bandwidth option, the selectable Gaussian filter bandwidths are predetermined as shown in the following list. There are 160 Info BWs (RBWs) arranged in a 24-per-decade sequence from 1 Hz through 3 MHz, plus the 4, 5, 6 and 8 MHz settings.

The following table list all 160 Gaussian filter types

Gaussian filters

Normal (-3 dB)	-6 dB	Noise	Impulse
1.0 Hz	1.41 Hz	1.06 Hz	1.49 Hz
1.1 Hz	1.55 Hz	1.16 Hz	1.63 Hz
1.2 Hz	1.69 Hz	1.27 Hz	1.77 Hz
1.3 Hz	1.83 Hz	1.37 Hz	1.92 Hz
1.5 Hz	2.11 Hz	1.59 Hz	2.22 Hz
1.6 Hz	2.25 Hz	1.69 Hz	2.37 Hz
1.8 Hz	2.53 Hz	1.90 Hz	2.66 Hz
2.0 Hz	2.81 Hz	2.12 Hz	2.96 Hz
2.2 Hz	3.09 Hz	2.33 Hz	3.25 Hz
2.4 Hz	3.38 Hz	2.54 Hz	3.55 Hz
2.7 Hz	3.80 Hz	2.86 Hz	3.99 Hz
3.0 Hz	4.22 Hz	3.17 Hz	4.44 Hz
3.3 Hz	4.64 Hz	3.49 Hz	4.88 Hz
3.6 Hz	5.06 Hz	3.81 Hz	5.32 Hz
3.9 Hz	5.49 Hz	4.12 Hz	5.77 Hz
4.3 Hz	6.05 Hz	4.55 Hz	6.36 Hz
4.7 Hz	6.61 Hz	4.97 Hz	6.95 Hz
5.1 Hz	7.17 Hz	5.39 Hz	7.54 Hz
5.6 Hz	7.87 Hz	5.92 Hz	8.27 Hz
6.2 Hz	8.72 Hz	6.56 Hz	9.17 Hz

17 Waveform Measurement
 BW

6.8 Hz	9.55 Hz	7.18 Hz	10.0 Hz
7.5 Hz	10.5 Hz	7.93 Hz	11.1 Hz
8.2 Hz	11.5 Hz	8.66 Hz	12.1 Hz
9.1 Hz	12.8 Hz	9.64 Hz	13.5 Hz
10 Hz	14.0 Hz	10.6 Hz	14.8 Hz
11 Hz	15.4 Hz	11.6 Hz	16.2 Hz
12 Hz	16.9 Hz	12.7 Hz	17.7 Hz
13 Hz	18.3 Hz	13.7 Hz	19.2 Hz
15 Hz	21.1 Hz	15.9 Hz	22.2 Hz
16 Hz	22.5 Hz	16.9 Hz	23.7 Hz
18 Hz	25.3 Hz	19.1 Hz	26.6 Hz
20 Hz	28.1 Hz	21.1 Hz	29.5 Hz
22 Hz	30.9 Hz	23.2 Hz	32.5 Hz
24 Hz	33.8 Hz	25.4 Hz	35.5 Hz
27 Hz	38.0 Hz	28.6 Hz	40.0 Hz
30 Hz	42.3 Hz	31.8 Hz	44.5 Hz
33 Hz	46.3 Hz	34.8 Hz	48.7 Hz
36 Hz	50.7 Hz	38.1 Hz	53.3 Hz
39 Hz	54.9 Hz	41.3 Hz	57.7 Hz
43 Hz	60.5 Hz	45.5 Hz	63.6 Hz
47 Hz	66.1 Hz	49.7 Hz	69.5 Hz
51 Hz	71.7 Hz	53.9 Hz	75.3 Hz
56 Hz	78.9 Hz	59.3 Hz	83.0 Hz
62 Hz	87.3 Hz	65.6 Hz	91.7 Hz
68 Hz	95.5 Hz	71.8 Hz	100 Hz
75 Hz	106 Hz	79.4 Hz	111 Hz
82 Hz	115 Hz	86.8 Hz	121 Hz
91 Hz	128 Hz	96.4 Hz	135 Hz
100 Hz	141 Hz	106 Hz	148 Hz
110 Hz	154 Hz	116 Hz	162 Hz
120 Hz	169 Hz	127 Hz	178 Hz
130 Hz	183 Hz	137 Hz	192 Hz
150 Hz	211 Hz	159 Hz	222 Hz
160 Hz	225 Hz	169 Hz	237 Hz
180 Hz	253 Hz	190 Hz	266 Hz
200 Hz	281 Hz	211 Hz	295 Hz
220 Hz	309 Hz	232 Hz	325 Hz

240 Hz	337 Hz	254 Hz	355 Hz
270 Hz	380 Hz	286 Hz	400 Hz
300 Hz	422 Hz	317 Hz	444 Hz
330 Hz	463 Hz	348 Hz	487 Hz
360 Hz	507 Hz	381 Hz	533 Hz
390 Hz	550 Hz	413 Hz	578 Hz
430 Hz	605 Hz	455 Hz	636 Hz
470 Hz	662 Hz	498 Hz	696 Hz
510 Hz	718 Hz	540 Hz	755 Hz
560 Hz	789 Hz	593 Hz	829 Hz
620 Hz	872 Hz	655 Hz	916 Hz
680 Hz	958 Hz	720 Hz	1.01 kHz
750 Hz	1.06 kHz	794 Hz	1.11 kHz
820 Hz	1.15 kHz	866 Hz	1.21 kHz
910 Hz	1.28 kHz	964 Hz	1.35 kHz
1.0 kHz	1.41 kHz	1.06 kHz	1.48 kHz
1.1 kHz	1.55 kHz	1.17 kHz	1.63 kHz
1.2 kHz	1.69 kHz	1.27 kHz	1.78 kHz
1.3 kHz	1.83 kHz	1.38 kHz	1.93 kHz
1.5 kHz	2.11 kHz	1.59 kHz	2.22 kHz
1.6 kHz	2.26 kHz	1.70 kHz	2.37 kHz
1.8 kHz	2.54 kHz	1.91 kHz	2.67 kHz
2.0 kHz	2.82 kHz	2.12 kHz	2.96 kHz
2.2 kHz	3.10 kHz	2.33 kHz	3.26 kHz
2.4 kHz	3.38 kHz	2.54 kHz	3.56 kHz
2.7 kHz	3.80 kHz	2.86 kHz	4.00 kHz
3.0 kHz	4.23 kHz	3.18 kHz	4.44 kHz
3.3 kHz	4.65 kHz	3.49 kHz	4.89 kHz
3.6 kHz	5.06 kHz	3.81 kHz	5.32 kHz
3.9 kHz	5.48 kHz	4.12 kHz	5.76 kHz
4.3 kHz	6.07 kHz	4.56 kHz	6.38 kHz
4.7 kHz	6.62 kHz	4.98 kHz	6.96 kHz
5.1 kHz	7.16 kHz	5.38 kHz	7.53 kHz
5.6 kHz	7.87 kHz	5.92 kHz	8.27 kHz
6.2 kHz	8.74 kHz	6.57 kHz	9.18 kHz
6.8 kHz	9.58 kHz	7.20 kHz	10.1 kHz
7.5 kHz	10.5 kHz	7.92 kHz	11.1 kHz

8.2 kHz	11.5 kHz	8.66 kHz	12.1 kHz
9.1 kHz	12.8 kHz	9.64 kHz	13.5 kHz
10 kHz	14.1 kHz	10.6 kHz	14.8 kHz
11 kHz	15.4 kHz	11.6 kHz	16.2 kHz
12 kHz	16.9 kHz	12.7 kHz	17.8 kHz
13 kHz	18.3 kHz	13.7 kHz	19.2 kHz
15 kHz	21.2 kHz	15.9 kHz	22.3 kHz
16 kHz	22.4 kHz	16.8 kHz	23.5 kHz
18 kHz	25.2 kHz	19.0 kHz	26.5 kHz
20 kHz	28.4 kHz	21.3 kHz	29.8 kHz
22 kHz	31.2 kHz	23.4 kHz	32.8 kHz
24 kHz	33.8 kHz	25.4 kHz	35.6 kHz
27 kHz	38.1 kHz	28.7 kHz	40.1 kHz
30 kHz	42.1 kHz	31.7 kHz	44.3 kHz
33 kHz	46.8 kHz	35.2 kHz	49.2 kHz
36 kHz	50.1 kHz	37.7 kHz	52.7 kHz
39 kHz	54.8 kHz	41.2 kHz	57.6 kHz
43 kHz	61.1 kHz	46.0 kHz	64.3 kHz
47 kHz	66.2 kHz	49.8 kHz	69.6 kHz
51 kHz	72.3 kHz	54.3 kHz	76.0 kHz
56 kHz	79.5 kHz	59.8 kHz	83.6 kHz
62 kHz	86.3 kHz	64.9 kHz	90.8 kHz
68 kHz	96.5 kHz	72.6 kHz	101 kHz
75 kHz	106 kHz	79.7 kHz	111 kHz
82 kHz	114 kHz	86.0 kHz	120 kHz
91 kHz	129 kHz	97.3 kHz	136 kHz
100 kHz	140 kHz	105 kHz	147 kHz
110 kHz	154 kHz	116 kHz	162 kHz
120 kHz	169 kHz	127 kHz	178 kHz
130 kHz	182 kHz	137 kHz	192 kHz
150 kHz	210 kHz	158 kHz	221 kHz
160 kHz	223 kHz	168 kHz	235 kHz
180 kHz	253 kHz	190 kHz	266 kHz
200 kHz	280 kHz	211 kHz	295 kHz
220 kHz	308 kHz	232 kHz	324 kHz
240 kHz	336 kHz	253 kHz	353 kHz
270 kHz	380 kHz	286 kHz	400 kHz

300 kHz	420 kHz	316 kHz	441 kHz
330 kHz	467 kHz	352 kHz	491 kHz
360 kHz	506 kHz	380 kHz	532 kHz
390 kHz	550 kHz	414 kHz	578 kHz
430 kHz	599 kHz	451 kHz	629 kHz
470 kHz	660 kHz	497 kHz	693 kHz
510 kHz	715 kHz	538 kHz	750 kHz
560 kHz	786 kHz	592 kHz	826 kHz
620 kHz	867 kHz	653 kHz	912 kHz
680 kHz	952 kHz	717 kHz	1.00 MHz
750 kHz	1.05 MHz	791 kHz	1.10 MHz
820 kHz	1.14 MHz	859 kHz	1.19 MHz
910 kHz	1.27 MHz	960 kHz	1.34 MHz
1.0 MHz	1.40 MHz	1.06 MHz	1.47 MHz
1.1 MHz	1.53 MHz	1.15 MHz	1.61 MHz
1.2 MHz	1.66 MHz	1.26 MHz	1.75 MHz
1.3 MHz	1.80 MHz	1.36 MHz	1.89 MHz
1.5 MHz	2.06 MHz	1.56 MHz	2.17 MHz
1.6 MHz	2.19 MHz	1.66 MHz	2.29 MHz
1.8 MHz	2.51 MHz	1.91 MHz	2.63 MHz
2.0 MHz	2.75 MHz	2.10 MHz	2.88 MHz
2.2 MHz	3.00 MHz	2.30 MHz	3.14 MHz
2.4 MHz	3.30 MHz	2.54 MHz	3.45 MHz
2.7 MHz	3.63 MHz	2.81 MHz	3.78 MHz
3.0 MHz	4.09 MHz	3.18 MHz	4.22 MHz
4 MHz	5.30 MHz	4.23 MHz	5.30 MHz
5 MHz	5.78 MHz	4.81 MHz	5.41 MHz
6 MHz	6.31 MHz	5.50 MHz	5.82 MHz
8 MHz	8.07 MHz	7.21 MHz	6.90 MHz

Flattop

When Option DP2, B40, or wider IF Bandwidth option is installed, the capability for arbitrary Digital IF bandwidths is available. However, for instruments without Option DP2, B40 or wider IF Bandwidth option, the selectable Flattop filter bandwidths are predefined as shown in the following table. There are 134 Digital IF BWs (RBWs).

The table in the section ["Flattop Filters" on page 2600](#) lists all 134 Flattop filter types.

Flattop Filters

3.0 Hz	3.3 Hz	3.6 Hz	3.9 Hz
4.3 Hz	4.7 Hz	5.1 Hz	5.6 Hz
6.2 Hz	6.8 Hz	7.5 Hz	8.2 Hz
9.1 Hz	10 Hz	11 Hz	12 Hz
13 Hz	15 Hz	16 Hz	18 Hz
20 Hz	22 Hz	24 Hz	27 Hz
30 Hz	33 Hz	36 Hz	39 Hz
43 Hz	47 Hz	51 Hz	56 Hz
62 Hz	68 Hz	75 Hz	82 Hz
91 Hz	100 Hz	110 Hz	120 Hz
130 Hz	150 Hz	160 Hz	180 Hz
200 Hz	220 Hz	240 Hz	270 Hz
300 Hz	330 Hz	360 Hz	390 Hz
430 Hz	470 Hz	510 Hz	560 Hz
620 Hz	680 Hz	750 Hz	820 Hz
910 Hz	1.0 kHz	1.1 kHz	1.2 kHz
1.3 kHz	1.5 kHz	1.6 kHz	1.8 kHz
2.0 kHz	2.2 kHz	2.4 kHz	2.7 kHz
3.0 kHz	3.3 kHz	3.6 kHz	3.9 kHz
4.3 kHz	4.7 kHz	5.1 kHz	5.6 kHz
6.2 kHz	6.8 kHz	7.5 kHz	8.2 kHz
9.1 kHz	10 kHz	11 kHz	12 kHz
13 kHz	15 kHz	16 kHz	18 kHz
20 kHz	22 kHz	24 kHz	27 kHz
30 kHz	33 kHz	36 kHz	39 kHz
43 kHz	47 kHz	51 kHz	56 kHz
62 kHz	68 kHz	75 kHz	82 kHz
91 kHz	100 kHz	110 kHz	120 kHz
130 kHz	150 kHz	160 kHz	180 kHz
200 kHz	220 kHz	240 kHz	270 kHz
300 kHz	330 kHz	390 kHz	430 kHz
510 kHz	620 kHz	750 kHz	1.0 MHz
1.5 MHz	3.0 MHz	4 MHz	5 MHz
6 MHz	8 MHz		

Channel Filter Bandwidth Bwcc (Remote Command Only)

This is the backward compatibility command for Channel Filter Bandwidth.

Mode	BASIC
Remote Command	[:SENSe] :WAVeform:WBIF:FILTer:BA NDwidth <real> [:SENSe] :WAVeform:WBIF:FILTer:BA NDwidth?
Example	WAV:WBIF:FILT:BA ND 0.3 WAV:WBIF:FILT:BA ND?
Notes	You must be in the IQ Analyzer (Basic) mode to use this command. Use INSTRument:SElect to set the mode.
Dependencies	This feature is only available when Option DP2, B40, or wider IF Bandwidth option is installed.
Couplings	The value is determined by the following equation. $\text{ChannelFilterBwBwcc} = (\text{ChannelFilterBw} / (\text{DigitalIFBw} * \text{OverSampleRatio}))$
Preset	0.8
State Saved	Saved in instrument state.
Min	0.01
Max	1.0
Initial S/W Revision	A.04.00
Modified at S/W Revision	A.13.00

Cont (Continuous Measurement/Sweep)

Sets the analyzer for Continuous measurement operation. The single/continuous state is Meas Global so the setting will affect all measurements. If you are Paused, pressing Cont does a Resume.

Key Path	Front-panel key
Remote Command	:INITiate:CONTinuous OFF ON 0 1 :INITiate:CONTinuous?
Example	:INIT:CONT 0 puts analyzer in Single measurement operation. :INIT:CONT 1 puts analyzer in Continuous measurement operation
Preset	ON (Note that SYST:PRESet sets INIT:CONT to ON but *RST sets INIT:CONT to OFF)
State Saved	Saved in instrument state
Backwards Compatibility Notes	For Spectrum Analysis mode in ESA and PSA, there is no Cont hardkey, instead there is a Sweep Single/Cont key. In these analyzers, switching the Sweep Single/Cont key from Single to Cont restarts averages (displayed average count reset to 1), but does not restart Max Hold and Min Hold. The X-Series has Single and Cont keys in place of the SweepSingleCont key. In the X-Series, if in single measurement, the Cont key (and INIT:CONT ON) switches to continuous measurement, but never restarts a measurement and never resets a sweep.
Initial S/W Revision	Prior to A.02.00

In Swept SA Measurement (Spectrum Analysis Mode):

The analyzer takes repetitive sweeps, averages, measurements, etc., when in Continuous mode. When the average count reaches the Average/Hold Number the count stops incrementing, but the analyzer keeps sweeping. See the Trace/Detector section for the averaging formula used both before and after the Average/Hold Number is reached. The trigger condition must be met prior to each sweep. The type of trace processing for multiple sweeps, is set under the Trace/Detector key, with choices of Trace Average, Max Hold, or Min Hold.

In Other Measurements/Modes:

With Avg/Hold Num (in the Meas Setup menu) set to Off or set to On with a value of 1, a sweep is taken after the trigger condition is met; and the analyzer continues to take new sweeps after the current sweep has completed and the trigger condition is again met. However, with Avg/Hold Num set to On with a value >1, multiple sweeps (data acquisitions) are taken for the measurement. The trigger condition must be met prior to each sweep. The sweep is not stopped when the average count k equals the number N set for Avg/Hold Num is reached, but the number k stops incrementing. A measurement average usually applies to all traces, marker results, and numeric results. But sometimes it only applies to the numeric results.

If the analyzer is in Single measurement, pressing the Cont key does not change k and does not cause the sweep to be reset; the only action is to put the analyzer into Continuous measurement operation.

If it is already in continuous sweep:

the INIT:CONT 1 command has no effect

the INIT:CONT 0 command will place the analyzer in Single Sweep but will have no effect on the current sequence until $k = N$, at which point the current sequence will stop and the instrument will go to the idle state.

17 Waveform Measurement
File

File

See "File" on page 360

FREQ Channel

Accesses a menu of keys that allow you to control the Frequency and Channel parameters of the instrument.

Some features in the Frequency menu are the same for all measurements – they do not change as you change measurements. Settings like these are called “Meas Global” and are unaffected by Meas Preset. For example, the Center Freq setting is the same for all measurements – it does not change as you change measurements.

Key Path	Front-panel key
Initial S/W Revision	Prior to A.02.00

Center Freq

Sets the frequency that corresponds to the horizontal center of the graticule (when frequency Scale Type is set to linear). While adjusting the Center Frequency the Span is held constant, which means that both Start Frequency and Stop Frequency will change.

Pressing Center Freq also sets the frequency entry mode to Center/Span. In Center/Span mode, the center frequency and span values are displayed below the graticule, and the default active function in the Frequency menu is Center Freq.

The center frequency setting is the same for all measurements within a mode, that is, it is Meas Global. Some modes are also able to share a Mode Global center frequency value. If this is the case, the Mode will have a Global Settings key in its Mode Setup menu.

The Center Freq function sets (and queries) the Center Frequency for the currently selected input. If your analyzer has multiple inputs, and you select another input, the Center Freq changes to the value for that input. SCPI commands are available to directly set the Center Freq for a specific input.

Center Freq is remembered as you go from input to input. Thus you can set a Center Freq of 10 GHz with the RF Input selected, change to BBIQ and set a Center Freq of 20 MHz, then switch to External Mixing and set a Center Freq of 60 GHz, and when you go back to the RF Input the Center Freq will go back to 10 GHz; back to BBIQ and it is 20 MHz; back to External Mixing and it is 60 GHz.

See ["RF Center Freq" on page 2608](#)

See [Ext Mix Center Freq](#)

See ["I/Q Center Freq" on page 2610](#)

See ["Center Frequency Presets" on page 2606](#)

Key Path	FREQ Channel
Scope	Meas Global
Remote Command	[:SENSe] :FREQuency:CENTer <freq> [:SENSe] :FREQuency:CENTer?

Example	FREQ:CENT 50 MHz FREQ:CENT UP changes the center frequency to 150 MHz if you use FREQ:CENT:STEP 100 MHz to set the center frequency step size to 100 MHz FREQ:CENT?
Notes	This command sets either the RF or I/Q Center Frequency depending on the selected input. For RF input it is equivalent to FREQ:RF:CENT For I/Q input it is equivalent to FREQ:IQ:CENT Preset and Max values are dependent on Hardware Options (5xx) If no terminator (e.g. MHz) is sent the terminator Hz is used. If a terminator with unit other than Frequency is used, an invalid suffix error message is generated.
Dependencies	The Center Frequency can be limited by Start or Stop Freq limits, if the Span is so large that Start or Stop reach their limit.
Couplings	When operating in “swept span”, any value of the Center Frequency or Span that is within the frequency range of the analyzer is allowed when the value is being set through the front panel numeric key pad or the SCPI command. The other parameter is forced to a different value if needed, to keep the Start and the Stop Frequencies within the analyzer’s frequency range
Preset	Depends on instrument maximum frequency, mode, measurement, and selected input. See "Center Frequency Presets" on page 2606 and "RF Center Freq" on page 2608 and Ext Mix Center Freq and "I/Q Center Freq" on page 2610 .
State Saved	Saved in instrument state
Min	Depends on instrument maximum frequency, mode, measurement, and selected input.. See "Center Frequency Presets" on page 2606 and "RF Center Freq" on page 2608 and "I/Q Center Freq" on page 2610 .
Max	Depends on instrument maximum frequency, mode, measurement, and selected input.. See "Center Frequency Presets" on page 2606 and "RF Center Freq" on page 2608 and "I/Q Center Freq" on page 2610 .
Default Unit	Hz
Status Bits/OPC	Non-overlapped
Dependencies	
Initial S/W Revision	Prior to A.02.00

Center Frequency Presets

The following table provides the Center Frequency Presets for the Spectrum Analyzer mode, and the Max Freq, for the various frequency options:

Freq Option	CF after Mode Preset	Stop Freq after Mode Preset	Max Freq (can't tune)

			above)
503 (all but N9000A)	1.805 GHz	3.6 GHz	3.7 GHz
503 (N9000A)	1.505 GHz	3.0 GHz	3.08 GHz
507 (all but N9000A)	3.505 GHz	7.0 GHz	7.1 GHz
507 (N9000A)	3.755 GHz	7.5 GHz	7.58 GHz
508 (all but N9038A)	1.805 GHz	3.6 GHz	8.5 GHz
508 (N9038A)	4.205 GHz	8.4 GHz	8.5 GHz
513	6.805 GHz	13.6 GHz	13.8 GHz
526 (all but N9000A and N9038A)	13.255 GHz	26.5 GHz	27.0 GHz
526 (N9000A)	13.255 GHz	26.5 GHz	26.55 GHz
526 (N9038A)	1.805 GHz	3.6 GHz	27.0 GHz
532	16.005 GHz	32.0 GHz	32.5 GHz
543	21.505 GHz	43.0 GHz	TBD
544	22.005 GHz	44.0 GHz	44.5 GHz
550	25.005 GHz	50.0 GHz	51 GHz

Input 2:

Model	CF after Mode Preset	Stop Freq after Mode Preset	Max Freq (can't tune above)
N9000A opt C75	0.7505GHz	1.5 GHz	1.58 GHz
N9038A	505 MHz	1 GHz	1.000025 GHz

Tracking Generator Frequency Limits (N9000A only):

Tracking Generator Option	Min Freq (clips to this freq when turn TG on and	If above this Freq, Stop Freq clipped to this Freq when	Max Freq (can't tune above) while TG

	can't tune below while TG on)	TG turned on	on
T03	9 kHz	3.0 GHz	3.08 GHz
T06	9 kHz	6.0 GHz	6.05 GHz

The following table shows the Center Frequency Presets for modes other than Spectrum Analyzer:

Mode	CF Preset for RF
WCDMA	1 GHz
WIMAXOFDMA,	1 GHz
BASIC	1 GHz
ADEMOD	1 GHz
VSA	1 GHz
TDSCDMA	1 GHz
PNOISE	1 GHz
LTE	1 GHz
LTETDD	1 GHz
MSR	1 GHz
GSM	935.2 MHz
NFIGURE	1.505 GHz

RF Center Freq

SCPI command for specifying the RF Center Frequency. This command will set the Center Frequency to be used when the RF input is selected, even if the RF input is not the input that is selected at the time the command is sent. Note that the Center Freq function in the Frequency menu on the front panel always applies to the currently selected input.

Scope	Meas Global
Remote Command	<code>[:SENSe] :FREQuency:RF:CENTer <freq></code> <code>[:SENSe] :FREQuency:RF:CENTer?</code>
Example	FREQ:RF:CENT 30 MHz
Notes	This command is the same in all modes, but the parameter is Measurement Global. So the value is independent in each mode and common across all the measurements in the mode.
Dependencies	If the electronic/soft attenuator is enabled, any attempt to set Center Frequency such that the Stop Frequency would be >3.6 GHz fails and results in an advisory message. If the equivalent SCPI command is sent, this same message is generated as part of a “-221, Settings conflict” warning. If Source Mode is set to Tracking, and the Max or Min Center Freq is therefore limited by the limits of the source, a warning message is generated, “Data out of range;clipped to source max/min” if these limits are exceeded. Note that for an external source, these limits can be affected by the settings of

	Source Numerator, Source Denominator and Power Sweep.
Preset	See table above
State Saved	Saved in instrument state.
Min	-79.999995 MHz, unless Source Mode is set to Tracking, in which case it is limited by the minimum frequency of the Source
Max	See table above. Basically instrument maximum frequency - 5 Hz. Note that, if the Source Mode is set to Tracking, the effective instrument maximum frequency may be limited by the source maximum frequency. If the knob or step keys are being used, also depends on the value of the other three interdependent parameters Span, Start Frequency and Stop Frequency
Initial S/W Revision	Prior to A.02.00
Modified at S/W Revision	A.03.00

Ext Mix Center Freq

SCPI command for specifying the External Mixer Center Frequency. This command will set the Center Frequency to be used when the External Mixer is selected, even if the External Mixer input is not the input which is selected at the time the command is sent. Note that the Center Freq function in the Frequency menu on the front panel always applies to the currently selected input.

Scope	Meas Global
Remote Command	<code>[:SENSe] :FREQuency:EMIXer:CENTer <freq></code> <code>[:SENSe] :FREQuency:EMIXer:CENTer?</code>
Example	<code>:FREQ:EMIX:CENT 60 GHz</code> <code>:FREQ:EMIX:CENT?</code>
Notes	This command is the same in all modes, but the parameter is Measurement Global. So the value is independent in each mode and common across all the measurements in the mode.
Couplings	When returning to External Mixing after having been switched to one of the other inputs (e.g., RF), you will come back into the settings that you had when you left External Mixing. So you will come back to the band you were in with the Center Frequency that you had. However, Span is not an input-dependent parameter, therefore you will bring the span over from the other input. Therefore, the analyzer comes back with the span from the previous input, limited as necessary by the current mixer setup.
Preset	When a Mode Preset is performed while in External Mixing, the Start frequency of the current Mode is set to the nominal Min Freq of the lowest harmonic range in the Harmonic Table for the current mixer setup. Similarly, the Stop frequency of the current Mode is set to the nominal Max Freq of the highest harmonic range in the Harmonic Table. The Center Freq thus presets to the point arithmetically equidistant from these two frequencies. If the current measurement has a limited Span available to it, and cannot achieve the Span shown in the table (Span=Stop Freq - Start Freq), the analyzer uses the maximum Span the measurement allows, and still sets the Center Freq to the midpoint of the Start and Stop Freq values in the Harmonic Table.

	<p>When Restore Input/Output Defaults is performed, the mixer presets to the 11970A, whose Start and Stop frequencies are 26.5 and 40 GHz respectively. The center of these two frequencies is 33.25 GHz.</p> <p>Therefore, after a Restore Input/Output Defaults, if you go into External Mixing and do a Mode Preset while in the Spectrum Analyzer Mode, the resulting Center Freq is 33.25 GHz.</p>
State Saved	Saved in instrument state.
Min	The minimum frequency in the currently selected mixer band + 5 Hz
Max	<p>The maximum frequency in the currently selected mixer band – 5 Hz</p> <p>If the knob or step keys are being used, also depends on the value of the other three interdependent parameters Span, Start Frequency and Stop Frequency</p>
Initial S/W Revision	A.08.01

I/Q Center Freq

SCPI command for specifying the I/Q Center Frequency. This command will set the Center Frequency to be used when the I/Q input is selected, even if the I/Q input is not the input which is selected at the time the command is sent. Note that the Center Freq function in the Frequency menu on the front panel always applies to the currently selected input.

Scope	Meas Global
Remote Command	<pre>[:SENSe] :FREQuency:IQ:CENTer <freq></pre> <pre>[:SENSe] :FREQuency:IQ:CENTer?</pre>
Example	FREQ:IQ:CENT: 30 MHz
Notes	This command is the same in all modes, but the parameter is Measurement Global. So the value is independent in each mode and common across all the measurements in the mode.
Preset	0 Hz
State Saved	Saved in instrument state.
Min	-40.049995 MHz
Max	40.049995 MHz
Initial S/W Revision	Prior to A.02.00

CF Step

Changes the step size for the center frequency and start and stop frequency functions. Once a step size has been selected and the center frequency function is active, the step keys (and the UP|DOWN parameters for Center Frequency from remote commands) change the center frequency by the step-size value. The step size function is useful for finding harmonics and sidebands beyond the current frequency span of the analyzer.

Note that the start and stop frequencies also step by the CF Step value.

Key Path	FREQ Channel
Remote Command	[:SENSe]:FREQuency:CENTer:STEP[:INCRement] <freq> [:SENSe]:FREQuency:CENTer:STEP[:INCRement]? [:SENSe]:FREQuency:CENTer:STEP:AUTO OFF ON 0 1 [:SENSe]:FREQuency:CENTer:STEP:AUTO?
Example	FREQ:CENT:STEP:AUTO ON FREQ:CENT:STEP 500 MHz FREQ:CENT UP increases the current center frequency value by 500 MHz FREQ:CENT:STEP? FREQ:CENT:STEP:AUTO?
Notes	Preset and Max values are depending on Hardware Options (503, 507, 508, 513, 526)
Notes	Preset and Max values are dependent on Hardware Options (5xx)
Dependencies	Freq Offset is not available in External Mixing. In this case the Freq Offset key is grayed out and shows a value of zero. It will once again be available, and show the previously set value, when you return to the RF Input.
Dependencies	Span, RBW, Center frequency If the electronic/soft attenuator is enabled, any attempt to change the value of the center frequency >3.6 GHz by pressing the Up-arrow key, fails and results in an advisory message. If the equivalent SCPI command is sent, this same message is generated as part of a “-221, Settings conflict” warning.
Couplings	When auto-coupled in a non-zero span, the center frequency step size is set to 10% of the span. When auto-coupled in zero span, the center frequency step size is set to the equivalent -3 dB RBW value.
Preset	Auto ADEMOD: 1 MHz ON
State Saved	Saved in instrument state
Min	– (the maximum frequency of the instrument). That is, 27 GHz max freq instrument has a CF step range of +/- 27 GHz. Note that this is the maximum frequency given the current settings of the instrument, so in External Mixing, for example, it is the maximum frequency of the current mixer band.
Max	The maximum frequency of the instrument. That is, 27 GHz max freq instrument has a CF step range of +/- 27 GHz. Note that this is the maximum frequency given the current settings of the instrument, so in External Mixing, for example, it is the maximum frequency of the current mixer band.
Default Unit	Hz
Status Bits/OPC dependencies	non-overlapped
Initial S/W Revision	Prior to A.02.00
Modified at S/W Revision	A.03.00

Input/Output

See ["Input/Output" on page 224](#)

Marker

Accesses a menu that enables you to select, set up and control the markers for the current measurement.

Key Path	Front-panel key
Initial S/W Revision	Prior to A.02.00

Select Marker

Displays 12 markers available for selection.

Key Path	Marker
Initial S/W Revision	Prior to A.02.00

Marker Type

Sets the marker control mode to Normal, Delta, Fixed or Off. All interactions and dependencies detailed under the key description are enforced when the remote command is sent. If the selected marker is Off, pressing Marker sets it to Normal and places it at the center of the screen on the trace determined by the Marker Trace rules. At the same time, the Marker X Axis Value appears on the Active Function area.

The default active function is the active function for the currently selected marker control mode. If the current control mode is Off, there is no active function and the active function is turned off.

Key Path	Marker
Mode	BASIC, PNOISE, WCDMA, C2K, GSM, WIMAXOFDMA, TDSCDMA, 1XEVD0, DVB, DTMB, ISDBT, CMMB, LTE, LTE4DD, DCATV, WLAN,,LTEATDD, LTEAFDD
Remote Command	:CALCulate:WAVeform:MARKer[1] 2 ... 12:MODE POSition DELTa OFF :CALCulate:WAVeform:MARKer[1] 2 ... 12:MODE?
Example	CALC:WAV:MARK:MODE OFF CALC:WAV:MARK:MODE?
Notes	If the selected marker is Off, pressing Marker sets it to Normal and places it at the center of the screen on the trace determined by the Marker Trace rules. At the same time, Marker X Axis Value appears on the Active Function area. Default Active Function: the active function for the selected marker's current control mode. If the current control mode is Off, there is no active function and the active function is turned off. Active Function Display: the marker X axis value entered in the active function area displays the marker value to its full entered precision. You must be in a mode that includes the Waveform measurement to use this command. Use INSTRument:SElect to set the mode.
Preset	OFF
State Saved	Saved in instrument state.

Range	Normal Delta Off
Initial S/W Revision	Prior to A.02.00
Modified at S/W Revision	A.03.00

Properties

Accesses the marker properties menu.

Key Path	Marker
Initial S/W Revision	Prior to A.02.00

Select Marker

Displays 12 markers available for selection.

Key Path	Marker
Initial S/W Revision	Prior to A.02.00

Relative To

Selects the marker that the selected marker is relative to (its *reference marker*).

Key Path	Marker, Properties
Mode	BASIC, PNOISE, WCDMA, C2K, GSM, WIMAXOFDMA, TDSCDMA, 1XEVD0, DVB, DTMB, ISDBT, CMMB, LTE, LTETDD, DCATV, WLAN,,LTEATDD, LTEAFDD
Remote Command	:CALCulate:WAVeform:MARKer[1] 2 ... 12:REFerence <integer> :CALCulate:WAVeform:MARKer[1] 2 ... 12:REFerence?
Example	CALC:WAV:MARK:REF 8 CALC:WAV:MARK:REF?
Notes	A marker cannot be relative to itself so that choice is grayed out, and if sent from SCPI generates error -221: "Settings conflict; marker cannot be relative to itself." When queried a single value is returned (the specified marker numbers relative marker). You must be in a mode that includes the Waveform measurement to use this command. Use INSTRument:SElect to set the mode.
Preset	2 3 4 5 6 7 8 9 10 11 12 1
State Saved	Saved in instrument state.
Min	1
Max	12
Initial S/W Revision	Prior to A.02.00
Modified at S/W Revision	A.03.00

Marker Trace

Assigns the specified marker to the designated trace.

Key Path	Marker
Mode	BASIC, PNOISE, WCDMA, C2K, GSM, WIMAXOFDMA, TDSCDMA, 1XEVD0, DVB, DTMB, ISDBT, CMMB, LTE, LTETDD, DCATV, WLAN,,LTEATDD, LTEAFDD
Remote Command	:CALCulate:WAVeform:MARKer[1] 2 ... 12:TRACe RFENvelope I Q IQ :CALCulate:WAVeform:MARKer[1] 2 ... 12:TRACe?
Example	CALC:WAV:MARK:TRAC RFEN CALC:WAV:MARK:TRAC?
Notes	Assigns the specified marker to the designated trace. The IQ selection is for backward compatibility purposes. It is recommended that the users use the I and/or Q selection instead. You must be in a mode that includes the Waveform measurement to use this command. Use INSTRument:SElect to set the mode.
Preset	RFEN
State Saved	Saved in instrument state.
Range	RF Envelope I Q IQ
Initial S/W Revision	Prior to A.02.00
Modified at S/W Revision	A.03.00

Couple Markers

Toggles the state of the markers to be coupled On or Off. When this function is true (On), moving any marker causes an equal X-axis movement of every other marker which is not Off. “Equal X-axis movement” refers to the difference between each marker’s X-Axis value (in the fundamental x-axis units of the trace that marker is on) and the X-Axis value of the marker being moved (in the same fundamental x-axis units) are preserved.

Key Path	Marker
Mode	BASIC, PNOISE, WCDMA, C2K, GSM, WIMAXOFDMA, TDSCDMA, 1XEVD0, DVB, DTMB, ISDBT, CMMB, LTE, LTETDD, DCATV, WLAN,,LTEATDD, LTEAFDD
Remote Command	:CALCulate:WAVeform:MARKer:COUPle[:STATe] ON OFF 1 0 :CALCulate:WAVeform:MARKer:COUPle[:STATe]?
Example	CALC:WAV:MARK:COUP ON CALC:WAV:MARK:COUP ON
Notes	You must be in a mode that includes the Waveform measurement to use this command. Use INSTRument:SElect to set the mode.
Preset	OFF

State Saved	Saved in instrument state.
Range	On Off
Initial S/W Revision	Prior to A.02.00
Modified at S/W Revision	A.03.00

All Markers Off

Turns off all markers.

Key Path	Marker
Mode	BASIC, PNOISE, WCDMA, C2K, GSM, WIMAXOFDMA, TDSCDMA, 1XEVD0, DVB, DTMB, ISDBT, CMMB, LTE, LTETDD, DCATV, WLAN,LTEATDD, LTEAFDD
Remote Command	:CALCulate:WAVeform:MARKer:AOFF
Example	CALC:WAV:MARK:AOFF
Notes	You must be in a mode that includes the Waveform measurement to use this command. Use INSTRument:SElect to set the mode.
Initial S/W Revision	Prior to A.02.00
Modified at S/W Revision	A.03.00

Marker X Axis Value (Remote Command Only)

Sets the marker X Axis value in the current marker X Axis Scale unit. It has no effect if the control mode is Off, but is the SCPI equivalent of entering an X value if the control mode is Normal or Delta.

Mode	BASIC, PNOISE, WCDMA, C2K, GSM, WIMAXOFDMA, TDSCDMA, 1XEVD0, DVB, DTMB, ISDBT, CMMB, LTE, LTETDD, DCATV, WLAN,,LTEATDD, LTEAFDD
Remote Command	:CALCulate:WAVeform:MARKer[1] 2 ... 12:X <time> :CALCulate:WAVeform:MARKer[1] 2 ... 12:X?
Example	CALC:WAV:MARK:X 50 ms CALC:WAV:MARK:X?
Notes	If no suffix is sent, uses the fundamental units for the current marker X Axis Scale. If a suffix is sent that does not match the current marker X Axis Scale unit, an error "Invalid suffix" is generated. If the specified marker is Fixed and a Marker Function is on, error -221 "Settings conflict; cannot adjust Fixed marker while Marker Function is on" is generated. The query returns the marker's absolute X Axis value if the control mode is Normal, or the offset from the marker's reference marker if the control mode is Delta. The query is returned in the fundamental units for the current marker X Axis scale: Hz for Frequency and Inverse Time, seconds for Period and Time. If the marker is Off the response is not a number. You must be in a mode that includes the Waveform measurement to use this command. Use INSTRument:SElect to set the mode.
Preset	0

Preset	After a preset, all markers are turned OFF, so Marker X Axis Value query returns a not a number (NAN).
State Saved	No
Min	(9.9E+37
Max	9.9E+37
Initial S/W Revision	Prior to A.02.00
Modified at S/W Revision	A.03.00

Marker X Axis Position (Remote Command Only)

Sets the marker X position in trace points. It has no effect if the control mode is Off, but is the SCPI equivalent of entering a value if the control mode is Normal or Delta. The entered value is immediately translated into the current X Axis Scale units for setting the value of the marker.

Mode	BASIC, PNOISE, WCDMA, C2K, GSM, WIMAXOFDMA, TDSCDMA, 1XEVD0, DVB, DTMB, ISDBT, CMMB, LTE, LTETDD, DCATV, WLAN,,LTEATDD, LTEAFDD
Remote Command	:CALCulate:WAVeform:MARKer[1] 2 ... 12:X:POSition <real> :CALCulate:WAVeform:MARKer[1] 2 ... 12:X:POSition?
Example	CALC:WAV:MARK:X:POS 500 CALC:WAV:MARK:X:POS?
Notes	The query returns the marker's absolute X Axis value in trace points if the control mode is Normal or the offset from the marker's reference marker in trace points if the control mode is Delta. The value is returned as a real number, not an integer, corresponding to the translation from X Axis Scale units to trace points. You must be in a mode that includes the Waveform measurement to use this command. Use INSTRument:SElect to set the mode.
Preset	0
Preset	After a preset, all markers are turned OFF, so Marker X Axis Value query returns a not a number (NAN).
State Saved	No
Min	(9.9E+37
Max	9.9E+37
Initial S/W Revision	Prior to A.02.00
Modified at S/W Revision	A.03.00

Marker Y Axis Value (Remote Command Only)

Queries the marker Y Axis value in the current marker Y Axis unit.

Mode	BASIC, PNOISE, WCDMA, C2K, GSM, WIMAXOFDMA, TDSCDMA, 1XEVD0, DVB, DTMB, ISDBT, CMMB, LTE, LTETDD, DCATV, WLAN,,LTEATDD, LTEAFDD
------	---

Remote Command	:CALCulate:WAVeform:MARKer[1] 2 ... 12:Y?
Example	CALC:WAV:MARK11:Y?
Notes	<p>When the marker is on, IQ waveform returns I and Q values.</p> <p>Case #1 - Trace RF, I or Q: returns a single double value.</p> <p>>:CALC:WAV:MARK1:Y?</p> <p>-2.402406506109E+001</p> <p>Case #2 - Trace IQ: returns a double array of two values, the first is I, and the second is Q.</p> <p>>:CALC:WAV:MARK1:Y?</p> <p>-3.006944493834E-003,+9.9870666467354E-004</p> <p>The IQ selection is for backward compatibility purposes. It is recommended that the users use the I and/or Q selection instead.</p> <p>You must be in a mode that includes the Waveform measurement to use this command. Use INSTRument:SElect to set the mode.</p>
Preset	Result dependent on the marker setup and signal source.
State Saved	No
Backwards Compatibility SCPI	:CALCulate:WAVeform:MARKer[1] 2 ... 12:FUNction:RESult?
Initial S/W Revision	Prior to A.02.00
Modified at S/W Revision	A.03.00

Backward Compatibility SCPI Commands

Sets or queries the state of a marker. Setting a marker that is OFF to state ON or 1 puts it in Normal mode and places it at the center of the screen.

Mode	BASIC, PNOISE, WCDMA, CDMA2K, EDGE GSM, WIMAX OFDMA, TDSCDMA, CDMA1XEV, DVB, DTMB, ISDBT, CMMB, LTE, LTE TDD, DCATV, WLAN
Remote Command	:CALCulate:WAVeform:MARKer[1] 2 ... 12:STATe OFF ON 0 1 :CALCulate:WAVeform:MARKer[1] 2 ... 12:STATe?
Example	CALC:WAV:MARK:STAT ON CALC:WAV:MARK:STAT?
Notes	You must be in a mode that includes the Waveform measurement to use this command. Use INSTRument:SElect to set the mode.
Preset	OFF
State Saved	Saved in instrument state.
Range	On Off
Initial S/W Revision	Prior to A.02.00
Modified at S/W Revision	A.03.00

Marker ->

There is no 'Marker ->' functionality supported in Waveform measurements. The front-panel key displays a blank menu when pressed.

Key Path	Front-panel key
Initial S/W Revision	Prior to A.02.00

Marker Function

Accesses a menu of marker functions that perform post-processing operations on markers based on the measurement specifications. Marker functions are distinct from measurement functions, which automatically perform complex sequences of setup, data acquisition, and display operations in order to measure specified signal characteristics. Marker Functions are specified for each individual marker and may be turned on individually for each marker.

The Marker Function menu controls which marker functions are turned on and allows you to adjust the setup parameters for each function. These parameters include the following, but only one parameter can be assigned to a given marker:

- Marker Noise
- BandInterval Power
- Band/Interval Density
- Marker Function Off

Key Path	Front-panel key
Initial S/W Revision	Prior to A.02.00

Select Marker

Displays 12 markers available for selection.

Key Path	Marker
Initial S/W Revision	Prior to A.02.00

Marker Function Type

Sets the marker control function type to, Marker Noise, Band/Interval Power, Band Interval Density, or Marker Function Off

Key Path	Marker Function
Mode	BASIC, PNOISE, WCDMA, C2K, GSM, WIMAXOFDMA, TDSCDMA, 1XEVD0, DVB, DTMB, ISDBT, CMMB, LTE, LTETDD, DCATV, WLAN,,LTEATDD, LTEAFDD
Remote Command	:CALCulate:WAVeform:MARKer[1] 2 ... 12:FUNction BPower BDENsity OFF :CALCulate:WAVeform:MARKer[1] 2 ... 12:FUNction?
Example	CALC:WAV:MARK:FUNC BPOW CALC:WAV:MARK:FUNC?
Notes	You must be in a mode that includes the Waveform measurement to use this command. Use INSTRument:SElect to set the mode.
Preset	OFF

State Saved	Saved in instrument state.
Range	Band/Interval Power Band Interval Density Marker Function Off
Initial S/W Revision	Prior to A.02.00
Modified at S/W Revision	A.03.00

Band Adjust

Accesses a menu that enables you to set the frequency span width and the left and right edge, or time values, for the band or interval of the selected marker.

Key Path	Marker Function
Initial S/W Revision	Prior to A.02.00

Band/Interval Span for Time Domain

Sets the width of the frequency span for the selected marker.

Key Path	Marker Function
Mode	BASIC, PNOISE, WCDMA, C2K, GSM, WIMAXOFDMA, TDSCDMA, 1XEVD0, DVB, DTMB, ISDBT, CMMB, LTE, LTETDD, DCATV, WLAN,LTEATDD, LTEAFDD
Remote Command	:CALCulate:WAVEform:MARKer[1] 2 ... 12:FUNCTION:BAND:SPAN <time> :CALCulate:WAVEform:MARKer[1] 2 ... 12:FUNCTION:BAND:SPAN?
Example	CALC:WAV:MARK:FUNC:BAND:SPAN 20 ms CALC:WAV:MARK:FUNC:BAND:SPAN?
Notes	You must be in a mode that includes the Waveform measurement to use this command. Use INSTRUMENT:SElect to set the mode.
Couplings	Changing the Band/Interval Span necessarily changes the Band/Interval Left and Band/Interval Right values
Preset	0
Preset	10% of Meas Time
State Saved	Saved in instrument state.
Min	0
Max	100 s
Backwards Compatibility SCPI	:CALCulate:WAVEform:MARKer[1] 2 ... 4:X:SPAN
Initial S/W Revision	Prior to A.02.00
Modified at S/W Revision	A.03.00

Band/Interval Left for Time Domain

Sets the left edge frequency or time value for the band of the selected marker.

Key Path	Marker Function
Mode	BASIC, PNOISE, WCDMA, C2K, GSM, WIMAXOFDMA, TDSCDMA, 1XEVD0, DVB, DTMB, ISDBT, CMMB, LTE, LTETDD, DCATV, WLAN,,LTEATDD, LTEAFDD
Remote Command	:CALCulate:WAVeform:MARKer[1] 2 ... 12:FUNction:BAND:LEFT <time> :CALCulate:WAVeform:MARKer[1] 2 ... 12:FUNction:BAND:LEFT?
Example	CALC:WAV:MARK12:FUNC:BAND:LEFT 1 s CALC:WAV:MARK12:FUNC:BAND:LEFT?
Notes	You must be in a mode that includes the Waveform measurement to use this command. Use INSTRument:SElect to set the mode.
Couplings	Changing the Band/Interval Left necessarily changes the Band/Interval Span and Band/Interval Right values
Preset	0
Preset	5% of Meas Time
State Saved	Saved in instrument state.
Min	0
Max	100 s
Initial S/W Revision	Prior to A.02.00
Modified at S/W Revision	A.03.00

Band/Interval Right for Time Domain

Sets the right edge frequency or time value for the band of the selected marker.

Key Path	Marker Function
Mode	BASIC, PNOISE, WCDMA, C2K, GSM, WIMAXOFDMA, TDSCDMA, 1XEVD0, DVB, DTMB, ISDBT, CMMB, LTE, LTETDD, DCATV, WLAN,,LTEATDD, LTEAFDD
Remote Command	:CALCulate:WAVeform:MARKer[1] 2 ... 12:FUNction:BAND:RIGHT <time> :CALCulate:WAVeform:MARKer[1] 2 ... 12:FUNction:BAND:RIGHT?
Example	CALC:WAV:MARK12:FUNC:BAND:RIGH 1 s CALC:WAV:MARK12:FUNC:BAND:RIGH?
Notes	You must be in a mode that includes the Waveform measurement to use this command. Use INSTRument:SElect to set the mode.
Couplings	Changing the Band/Interval Left necessarily changes the Band/Interval Span and Band/Interval Right values
Preset	0
Preset	5% of Meas Time
State Saved	Saved in instrument state.

Min	0
Max	100 s
Initial S/W Revision	Prior to A.02.00
Modified at S/W Revision	A.03.00

Meas

The information in this section is common to all measurements. For key and remote command information for a specific measurement, refer to the section that describes the measurement of interest.

Measurements available under the Meas key are specific to the current Mode.

When viewing Help for measurements, note the following:

NOTE

Operation for some keys differs between measurements. The information displayed in Help pertains to the current measurement. To see how a key operates in a different measurement, exit Help (press the Cancel Esc key), select the measurement, then reenter Help (press the Help key) and press that key.

Key Path	Front-panel key
Initial S/W Revision	Prior to A.02.00

Remote Measurement Functions

This section contains the following topics:

["Measurement Group of Commands" on page 2771](#)

["Current Measurement Query \(Remote Command Only\)" on page 2773](#)

["Limit Test Current Results \(Remote Command Only\)" on page 2773](#)

["Data Query \(Remote Command Only\)" on page 2773](#)

["Calculate/Compress Trace Data Query \(Remote Command Only\)" on page 2774](#)

["Calculate Peaks of Trace Data \(Remote Command Only\)" on page 2779](#)

[Hardware-Accelerated Fast Power Measurement \(Remote Command Only\)](#)

["Format Data: Numeric Data \(Remote Command Only\)" on page 2780](#)

["Format Data: Byte Order \(Remote Command Only\)" on page 2781](#)

Initial S/W Revision	Prior to A.02.00
----------------------	------------------

Measurement Group of Commands

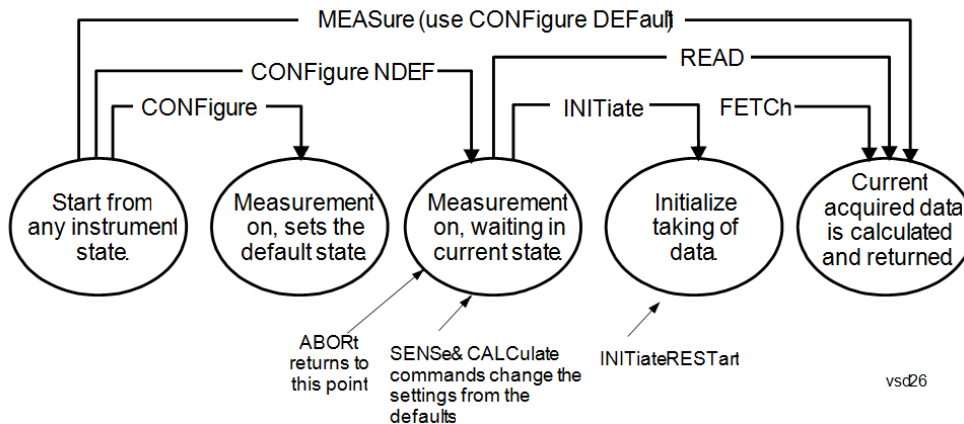

Measure Commands:

:MEASure:<measurement>[n]?

This is a fast single-command way to make a measurement using the factory default instrument settings. These are the settings and units that conform to the Mode Setup settings (e.g. radio standard) that you have currently selected.

- Stops the current measurement (if any) and sets up the instrument for the specified measurement using the factory defaults
- Initiates the data acquisition for the measurement
- Blocks other SCPI communication, waiting until the measurement is complete before returning results.
- If the function does averaging, it is turned on and the number of averages is set to 10.
- After the data is valid it returns the scalar results, or the trace data, for the specified measurement. The type of data returned may be defined by an [n] value that is sent with the command.
- The scalar measurement results will be returned if the optional [n] value is not included, or is set to 1. If the [n] value is set to a value other than 1, the selected trace data results will be returned. See each command for details of what types of scalar results or trace data results are available.
- ASCII is the default format for the data output. (Older versions of Spectrum Analysis and Phase Noise mode measurements only use ASCII.) The binary data formats should be used for handling large blocks of data since they are smaller and faster than the ASCII format. Refer to the FORMat:DATA command for more information.

If you need to change some of the measurement parameters from the factory default settings you can set up the measurement with the CONFIGure command. Use the commands in the SENSe:<measurement> and CALCulate:<measurement> subsystems to change the settings. Then you can use the READ? command to initiate the measurement and query the results.

If you need to repeatedly make a given measurement with settings other than the factory defaults, you can use the commands in the SENSe:<measurement> and CALCulate:<measurement> subsystems to set up the measurement. Then use the READ? command to initiate the measurement and query results.

Measurement settings persist if you initiate a different measurement and then return to a previous one. Use READ:<measurement>? if you want to use those persistent settings. If you want to go back to the default settings, use MEASure:<measurement>?.

Configure Commands:

:CONFigure:<measurement>

This command stops the current measurement (if any) and sets up the instrument for the specified measurement using

the factory default instrument settings. It does not initiate the taking of measurement data unless INIT:CONTinuous is ON. If you change any measurement settings after using the CONFigure command, the READ command can be used to initiate a measurement without changing the settings back to their defaults.

In the Swept SA measurement in Spectrum Analyzer mode the CONFigure command also turns the averaging function on and sets the number of averages to 10 for all measurements.

:CONFigure: <measurement>: NDEFault stops the current measurement and changes to the specified measurement. It does not change the settings to the defaults. It does not initiate the taking of measurement data unless INIT:CONTinuous is ON.

The CONFigure? query returns the current measurement name.

The CONFigure:CATalog? query returns a quoted string of all licensed measurement names in the current mode. For example, "SAN, CHP, OBW, ACP, PST, TXP, SPUR, SEM, LIST".

Fetch Commands:

:FETCh:<measurement>[n]?

This command puts selected data from the most recent measurement into the output buffer. Use FETCh if you have already made a good measurement and you want to return several types of data (different [n] values, for example, both scalars and trace data) from a single measurement. FETCh saves you the time of re-making the measurement. You can only FETCh results from the measurement that is currently active, it will not change to a different measurement. An error message is reported if a measurement other than the current one is specified.

If you need to get new measurement data, use the READ command, which is equivalent to an INITiate followed by a FETCh.

The scalar measurement results will be returned if the optional [n] value is not included, or is set to 1. If the [n] value is set to a value other than 1, the selected trace data results will be returned. See each command for details of what types of scalar results or trace data results are available. The binary data formats should be used for handling large blocks of data since they are smaller and transfer faster than the ASCII format. (FORMat:DATA)

FETCh may be used to return results other than those specified with the original READ or MEASure command that you sent.

INITiate Commands:

:INITiate:<measurement>

This command is not available for measurements in all the instrument modes:

- Initiates a trigger cycle for the specified measurement, but does not output any data. You must then use the FETCh<meas> command to return data. If a measurement other than the current one is specified, the instrument will switch to that measurement and then initiate it.
 - For example, suppose you have previously initiated the ACP measurement, but now you are running the channel power measurement. If you send INIT:ACP? it will change from channel power to ACP and will initiate an ACP measurement.
 - Does not change any of the measurement settings. For example, if you have previously started the ACP measurement and you send INIT:ACP? it will initiate a new ACP measurement using the same instrument settings as the last time ACP was run.
 - If your selected measurement is currently active (in the idle state) it triggers the measurement, assuming the trigger conditions are met. Then it completes one trigger cycle. Depending upon the measurement and the number of averages, there may be multiple data acquisitions, with multiple trigger events, for one full trigger cycle. It also holds off additional commands on GPIB until the acquisition is complete.
-

READ Commands:

:READ:<measurement>[n]?

- Does not preset the measurement to the factory default settings. For example, if you have previously initiated the ACP
-

measurement and you send READ:ACP? it will initiate a new measurement using the same instrument settings.

- Initiates the measurement and puts valid data into the output buffer. If a measurement other than the current one is specified, the instrument will switch to that measurement before it initiates the measurement and returns results.
 - For example, suppose you have previously initiated the ACP measurement, but now you are running the channel power measurement. Then you send READ:ACP? It will change from channel power back to ACP and, using the previous ACP settings, will initiate the measurement and return results.
 - Blocks other SCPI communication, waiting until the measurement is complete before returning the results
 - If the optional [n] value is not included, or is set to 1, the scalar measurement results will be returned. If the [n] value is set to a value other than 1, the selected trace data results will be returned. See each command for details of what types of scalar results or trace data results are available. The binary data formats should be used when handling large blocks of data since they are smaller and faster than the ASCII format. (FORMat:DATA)
-

Initial S/W Revision	Prior to A.02.00
----------------------	------------------

Current Measurement Query (Remote Command Only)

This command returns the name of the measurement that is currently running.

Remote Command	:CONFigure?
-----------------------	-------------

Example	CONF?
----------------	-------

Initial S/W Revision	Prior to A.02.00
----------------------	------------------

Limit Test Current Results (Remote Command Only)

Queries the status of the current measurement limit testing. It returns a 0 if the measured results pass when compared with the current limits. It returns a 1 if the measured results fail any limit tests.

Remote Command	:CALCulate:CLIMits:FAIL?
-----------------------	--------------------------

Example	CALC:CLIM:FAIL? queries the current measurement to see if it fails the defined limits. Returns a 0 or 1: 0 it passes, 1 it fails.
----------------	--

Initial S/W Revision	Prior to A.02.00
----------------------	------------------

Data Query (Remote Command Only)

Returns the designated measurement data for the currently selected measurement and subopcode.

n = any valid subopcode for the current measurement. See the measurement command results table for your current measurement, for information about what data is returned for the subopcodes.

This command uses the data setting specified by the FORMat:BORDER and FORMat:DATA commands and can return real or ASCII data. (See the format command descriptions under Input/Output in the Analyzer Setup section.)

Remote Command	:CALCulate:DATA[n]?
Notes	The return trace depends on the measurement. In CALCulate:<meas>:DATA[n], n is any valid subopcode for the current measurement. It returns the same data as the FETCH:<measurement>? query where <measurement> is the current measurement.
Initial S/W Revision	Prior to A.02.00

Calculate/Compress Trace Data Query (Remote Command Only)

Returns compressed data for the currently selected measurement and sub-opcode [n].

n = any valid sub-opcode for that measurement. See the MEASure:<measurement>? command description of your specific measurement for information on the data that can be returned.

The data is returned in the current Y Axis Unit of the analyzer. The command is used with a sub-opcode <n> (default=1) to specify the trace. With trace queries, it is best if the analyzer is not sweeping during the query. Therefore, it is generally advisable to be in Single Sweep, or Update=Off.

This command is used to compress or decimate a long trace to extract and return only the desired data. A typical example would be to acquire N frames of GSM data and return the mean power of the first burst in each frame. The command can also be used to identify the best curve fit for the data.

Remote Command	:CALCulate:DATA<n>:COMPRESS? BLOCK CFIT MAXimum MINimum MEAN DMEan RMS RMSCubed SAMPLE SDEVIation PPHase [,<soffset> [,<length>[,<roffset>[,<rlimit>]]]]
Example	To query the mean power of a set of GSM bursts: Supply a signal that is a set of GSM bursts. Select the IQ Waveform measurement (in IQ Analyzer Mode). Set the sweep time to acquire at least one burst. Set the triggers such that acquisition happens at a known position relative to a burst. Then query the mean burst levels using, CALC:DATA2:COMP? MEAN, 24e-6, 526e-6 (These parameter values correspond to GSM signals, where 526e-6 is the length of the burst in the slot and you just want 1 burst.)
Notes	The command supports 5 parameters. Note that the last 4 (<soffset>, <length>, <roffset>, <rlimit>) are optional. But these optional parameters must be entered in the specified order. For example, if you want to specify <length>, then you must also specify <soffset>. See details below for a definition of each of these parameters. This command uses the data in the format specified by FORMat:DATA, returning either binary or ASCII data.
Initial S/W Revision	Prior to A.02.00

- BLOCK or block data - returns all the data points from the region of the trace data that you specify. For example, it could be used to return the data points of an input signal over several timeslots, excluding the portions of the trace data that you do not want. (This is x,y pairs for trace data and I,Q pairs for complex data.)

- CFIT or curve fit - applies curve fitting routines to the data. <soffset> and <length> are required to define the data that you want. <roffset> is an optional parameter for the desired order of the curve equation. The query will return the following values: the x-offset (in seconds) and the curve coefficients ((order + 1) values).

MIN, MAX, MEAN, DME, RMS, RMSC, SAMP, SDEV and PPH return one data value for each specified region (or <length>) of trace data, for as many regions as possible until you run out of trace data (using <roffset> to specify regions). Or they return the number of regions you specify (using <rlimit>) ignoring any data beyond that.

- MINimum - returns the minimum data point (y value) for the specified region(s) of trace data. For I/Q trace data, the minimum magnitude of the I/Q pairs is returned.
- MAXimum - returns the maximum data point (y value) for the specified region(s) of trace data. For I/Q trace data, the maximum magnitude of the I/Q pairs is returned.
- MEAN - returns a single value that is the arithmetic mean of the data point values (in dB/ dBm) for the specified region(s) of trace data. For I/Q trace data, the mean of the magnitudes of the I/Q pairs is returned. See the following equations.

-

NOTE

If the original trace data is in dB, this function returns the arithmetic mean of those log values, not log of the mean power which is a more useful value. The mean of the log is the better measurement technique when measuring CW signals in the presence of noise. The mean of the power, expressed in dB, is useful in power measurements such as Channel Power. To achieve the mean of the power, use the RMS option.

Equation 1

Mean Value of Data Points for Specified Region(s)

$$\text{MEAN} = \frac{1}{n} \sum_{X_i \in \text{region}(s)} X_i$$

where X_i is a data point value, and n is the number of data points in the specified region(s).

Equation 2

Mean Value of I/Q Data Pairs for Specified Region(s)

$$\text{MEAN} = \frac{1}{n} \sum_{X_i \in \text{region}(s)} |X_i|$$

where $|X_i|$ is the magnitude of an I/Q pair, and n is the number of I/Q pairs in the specified region(s).

- DMEan - returns a single value that is the mean power (in dB/ dBm) of the data point values for the specified region(s) of trace data. See the following equation:

Equation 3

DMEan Value of Data Points for Specified Region(s)

$$\text{DME} = 10 \times \log_{10} \left(\frac{1}{n} \sum_{X_i \in \text{region}(s)} 10^{\frac{X_i}{10}} \right)$$

- RMS - returns a single value that is the average power on a root-mean-squared voltage scale (arithmetic rms) of the data point values for the specified region(s) of trace data. See the following equation.

NOTE

For I/Q trace data, the rms of the magnitudes of the I/Q pairs is returned. See the following equation. This function is very useful for I/Q trace data. However, if the original trace data is in dB, this function returns the rms of the log values which is not usually needed.

Equation 4

RMS Value of Data Points for Specified Region(s)

$$\text{RMS} = \sqrt{\frac{1}{n} \sum_{X_i \in \text{region}(s)} X_i^2}$$

where X_i is a data point value, and n is the number of data points in the specified region(s).

Equation 5

RMS Value of I/Q Data Pairs for Specified Region(s)

$$\text{RMS} = \sqrt{\frac{1}{n} \sum_{X_i \in \text{region}(s)} X_i X_i^*}$$

where X_i is the complex value representation of an I/Q pair, X_i^* its conjugate complex number, and n is the number of I/Q pairs in the specified region(s).

Once you have the rms value for a region of trace data (linear or I/Q), you may want to calculate the mean power. You must convert this rms value (peak volts) to power in dBm:

$$10 \times \log[10 \times (\text{rms value})^2]$$

- SAMPlE - returns the first data value (x,y pair) for the specified region(s) of trace data. For I/Q trace data, the first I/Q pair is returned.
- SDEViation - returns a single value that is the arithmetic standard deviation for the data point values for the specified region(s) of trace data. See the following equation.
- For I/Q trace data, the standard deviation of the magnitudes of the I/Q pairs is returned. See the following equation.

Equation 6

Standard Deviation of Data Point Values for Specified Region(s)

$$\text{SDEV} = \sqrt{\frac{1}{n} \sum_{X_i \in \text{region}(s)} (X_i - \bar{X})^2}$$

where X_i is a data point value, \bar{X} is the arithmetic mean of the data point values for the specified region (s), and n is the number of data points in the specified region(s).

$$\text{SDEV} = \sqrt{\frac{1}{n} \sum_{X_i \in \text{region}(s)} (|X_i| - \bar{X})^2}$$

where $|X_i|$ is the magnitude of an I/Q pair, \bar{X} is the mean of the magnitudes for the specified region(s), and n is the number of data points in the specified region(s).

- PPHase - returns the x,y pairs of both rms power (dBm) and arithmetic mean phase (radian) for every specified region and frequency offset (Hz). The number of pairs is defined by the specified number of regions. This parameter can be used for I/Q vector ($n=0$) in Waveform (time domain) measurement and all parameters are specified by data point in PPHase.

The rms power of the specified region may be expressed as:

$$\text{Power} = 10 \times \log [10 \times (\text{RMS I/Q value})] + 10.$$

The RMS I/Q value (peak volts) is:

$$\sqrt{\frac{1}{n} \sum_{X_i \in \text{region}} X_i X_i^*}$$

where X_i is the complex value representation of an I/Q pair, X_i^* its conjugate complex number, and n is the number of I/Q pairs in the specified region.

The arithmetic mean phase of the specified region may be expressed as:

$$\frac{1}{n} \sum_{Y_i \in \text{region}} Y_i$$

where Y_i is the unwrapped phase of I/Q pair with applying frequency correction and n is the number of I/Q pairs in the specified region.

The frequency correction is made by the frequency offset calculated by the arithmetic mean of every specified region's frequency offset. Each frequency offset is calculated by the least square method against the unwrapped phase of I/Q pair.

Sample Trace Data - Constant Envelope

(See below for explanation of variables.)

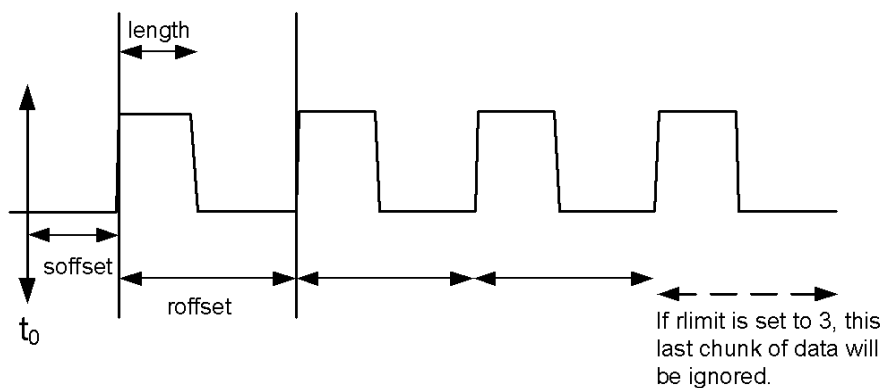

Sample Trace Data - Not Constant Envelope

(See below for explanation of variables.)

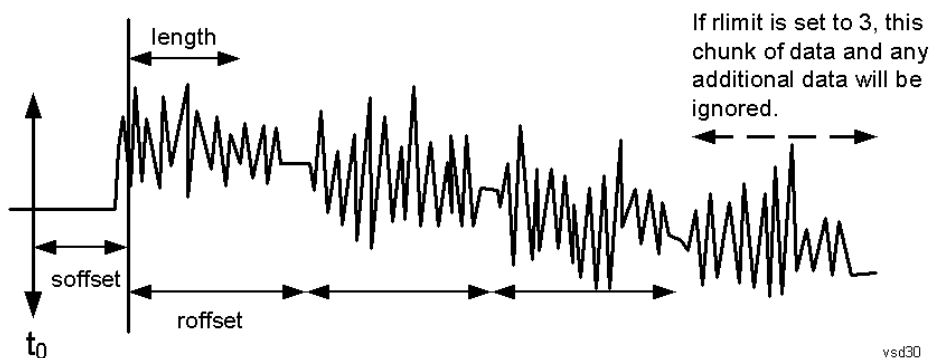

<soffset> - start offset is an optional real number. (It is in seconds for time-domain traces, and is a dimensionless index 0 to Npoints - 1, for frequency-domain traces). It specifies the amount of data at the beginning of the trace that will be ignored before the decimation process starts. It is the time or frequency change from the start of the trace to the point where you want to start using the data. The default value is zero.

<length> - is an optional real number. (It is in seconds for time-domain traces, and is a dimensionless index 0 to Npoints - 1, for frequency-domain traces). It defines how much data will be compressed into one value. This parameter has a default value equal to the current trace length.

<roffset> - repeat offset is an optional real number. (It is in seconds for time-domain traces, and is a dimensionless index 0 to Npoints - 1, for frequency-domain traces). It defines the beginning of the next field of trace elements to be compressed. This is relative to the beginning of the previous field. This parameter has a default value equal to the <length> variable. Note that this parameter is used for a completely different purpose when curve fitting (see CFIT above).

<rlimit> - repeat limit is an optional integer. It specifies the number of data items that you want returned. It will ignore any additional items beyond that number. You can use the Start offset and the Repeat limit to pick out exactly what part of the data you want to use. The default value is all the data.

Calculate Peaks of Trace Data (Remote Command Only)

Returns a list of all the peaks for the currently selected measurement and sub-opcode [n]. The peaks must meet the requirements of the peak threshold and excursion values.

n = any valid sub-opcode for the current measurement. See the MEASure:<measurement> command description of your specific measurement for information on the data that can be returned.

The command can only be used with specific sub-opcodes with measurement results that are trace data. Both real and complex traces can be searched, but complex traces are converted to magnitude in dBm. In many measurements the sub-opcode n=0, is the raw trace data which cannot be searched for peaks. And Sub-opcode n=1, is often calculated results values which also cannot be searched for peaks.

This command uses the data setting specified by the FORMat:BORDER and FORMat:DATA commands and can return real or ASCII data. If the format is set to INT,32, it returns REAL,32 data.

The command has four types of parameters:

- Threshold (in dBm)
- Excursion (in dB)
- Sorting order (amplitude, frequency, time)
- Optional in some measurements: Display line use (all, > display line, < display line)

Remote Command	<p>For Swept SA measurement:</p> <pre>:CALCulate:DATA[1] 2 ... 6:PEAKs? <threshold>,<excursion>[,AMPLitude FREQuency TIME[,ALL GTDLine LTDLine]]</pre> <p>For most other measurements:</p> <pre>:CALCulate:DATA[1] 2 ... 6:PEAKs? <threshold>,<excursion>[,AMPLitude FREQuency TIME]</pre>
-----------------------	--

Example	<p>Example for Swept SA measurement in Spectrum Analyzer Mode:</p> <p>CALC:DATA4:PEAK? -40, 10, FREQ, GTDL This will identify the peaks of trace 4 that are above -40 dBm, with excursions of at least 10 dB. The peaks are returned in order of increasing frequency, starting with the lowest frequency. Only the peaks that are above the display line are returned.</p> <p>Query Results 1:</p> <p>With FORMat:DATA REAL, 32 selected, it returns a list of floating-point numbers. The first value in the list is the number of peak points that are in the following list. A peak point consists of two values: a peak amplitude followed by its corresponding frequency (or time).</p> <p>If no peaks are found the peak list will consist of only the number of peaks, (0).</p>
----------------	---

Notes	<p><n> - is the trace that will be used</p> <p><threshold> - is the level below which trace data peaks are ignored. Note that the threshold value is required and is always used as a peak criterion. To effectively disable the threshold criterion for this command, provide a substantially low threshold value such as -200 dBm. Also note that the threshold value used in this command is independent of and has no effect on the threshold value stored under the Peak Criteria menu.</p> <p><excursion> - is the minimum amplitude variation (rise and fall) required for a signal to be identified as peak. Note that the excursion value is required and is always used as a peak criterion. To effectively disable the excursion criterion for this command, provide the minimum value of 0.0 dB. Also note that the excursion value used in this command is independent of and has no effect on the</p>
--------------	---

excursion value stored under the Peak Criteria menu.

Values must be provided for threshold and excursion. The sorting and display line parameters are optional (defaults are AMPLitude and ALL).

Note that there is always a Y-axis value for the display line, regardless of whether the display line state is on or off. It is the current Y-axis value of the display line which is used by this command to determine whether a peak should be reported

Sorting order:

AMPLitude - lists the peaks in order of descending amplitude, with the highest peak first (default if optional parameter not sent)

FREQuency - lists the peaks in order of occurrence, left to right across the x-axis.

TIME - lists the peaks in order of occurrence, left to right across the x-axis.

Peaks vs. Display Line:

ALL - lists all of the peaks found (default if optional parameter not sent).

GTDLine (greater than display line) - lists all of the peaks found above the display line.

LTDLine (less than display line) - lists all of the peaks found below the display line.

Initial S/W Revision Prior to A.02.00

Format Data: Numeric Data (Remote Command Only)

This command specifies the format of the trace data input and output. It specifies the formats used for trace data during data transfer across any remote port. It affects only the data format for setting and querying trace data for the :TRACe[:DATA], TRACe[:DATA]?, :CALCulate:DATA[n]? and FETCh:SANalyzer [n]? commands and queries.

Remote Command :FORMat [:TRACe] [:DATA] ASCii|INTeger,32|REAL,32 |REAL,64
:FORMat [:TRACe] [:DATA] ?

Notes The query response is:
ASCii: ASC,8
REAL,32: REAL,32
REAL,64: REAL,64
INTeger,32: INT,32

When the numeric data format is REAL or ASCii, data is output in the current Y Axis unit. When the data format is INTeger, data is output in units of m dBm (.001 dBm).

The INT,32 format returns binary 32-bit integer values in internal units (m dBm), in a definite length block.

Dependencies Sending a data format spec with an invalid number (for example, INT,48) generates no error. The analyzer simply uses the default (8 for ASCii, 32 for INTeger, 32 for REAL).

Sending data to the analyzer which does not conform to the current FORMat specified, results in an error. Sending ASCII data when a definite block is expected generates message -161 "Invalid Block Data" and sending a definite block when ASCII data is expected generates message -121 "Invalid Character in Number".

Preset ASCii

Backwards Compatibility Notes Note that the INT,32 format is only applicable to the command, TRACe:DATA. This preserves backwards compatibility for the Swept SA measurement. For all other commands/queries which honor FORMat:DATA, if INT,32 is sent the analyzer will behave as though it were set to REAL,32.

Initial S/W Revision Prior to A.02.00

The specs for each output type follow:

ASCIi - Amplitude values are in ASCII, in the current Y Axis Unit, one ASCII character per digit, values separated by commas, each value in the form:

SX.YYYYYEsZZ

Where:

S = sign (+ or -)

X = one digit to left of decimal point

Y = 5 digits to right of decimal point

E = E, exponent header

s = sign of exponent (+ or -)

ZZ = two digit exponent

REAL,32 - Binary 32-bit real values in the current Y Axis Unit, in a definite length block.

REAL,64 - Binary 64-bit real values in the current Y Axis Unit, in a definite length block.

Format Data: Byte Order (Remote Command Only)

This command selects the binary data byte order for data transfer and other queries. It controls whether binary data is transferred in normal or swapped mode. This command affects only the byte order for setting and querying trace data for the :TRACe[:DATA], TRACe[:DATA]? , :CALCulate:DATA[n]? and FETCh:SANalyzer[n]? commands and queries.

By definition any command that says it uses FORMat:DATA uses any format supported by FORMat:DATA.

The NORMal order is a byte sequence that begins with the most significant byte (MSB) first, and ends with the least significant byte (LSB) last in the sequence: 1|2|3|4. SWAPPed order is when the byte sequence begins with the LSB first, and ends with the MSB last in the sequence: 4|3|2|1.

Remote Command	:FORMat:BORDER NORMal SWAPPed :FORMat:BORDER?
Preset	NORMal
Initial S/W Revision	Prior to A.02.00

Meas Setup

Displays the setup menu keys that enable you to control the parameters for the current measurement.

Key Path	Front-panel key
Initial S/W Revision	Prior to A.02.00

Average/Hold Num

Sets the number of sweeps (average counts) that are averaged. After the specified number of sweeps, the averaging mode (terminal control) setting determines the averaging action.

Key Path	Meas Setup
Mode	BASIC, PNOISE, WCDMA, C2K, GSM, WIMAXOFDMA, TDSCDMA, 1XEVD0, DVB, DTMB, ISDBT, CMMB, LTE, LTETDD, DCATV, WLAN, MSR,LTEATDD, LTEAFDD
Remote Command	[:SENSe] :WAVeform:AVErAge:COUNt <integer> [:SENSe] :WAVeform:AVErAge:COUNt? [:SENSe] :WAVeform:AVErAge [:STATe] OFF ON 0 1 [:SENSe] :WAVeform:AVErAge [:STATe] ?
Example	WAV:AVER:COUN 1001 WAV:AVER:COUN? WAV:AVER ON WAV:AVER?
Notes	You must be in a mode that includes the Waveform measurement to use this command. Use INSTRument:SElect to set the mode.
Preset	10 OFF
State Saved	Saved in instrument state.
Min	1
Max	20001
Initial S/W Revision	Prior to A.02.00
Modified at S/W Revision	A.03.00

Avg Mode

Enables you to set the averaging mode.

- When set to Exponential (Exp) the measurement averaging continues using the specified number of averages to compute each averaged value. The average is displayed at the end of each sweep.
- When set to Repeat, the measurement resets the average counter each time the specified number of averages is reached.

Key Path	Meas Setup
Mode	BASIC, PNOISE, WCDMA, C2K, GSM, WIMAXOFDMA, TDSCDMA, 1XEVD0, DVB, DTMB, ISDBT, CMMB, LTE, LTETDD, DCATV, WLAN, MSR,LTEATDD, LTEAFDD
Remote Command	[:SENSe] :WAVeform:AVERage:TCONtrol EXPonential REPeat [:SENSe] :WAVeform:AVERage:TCONtrol?
Example	WAV:AVER:TCON REP WAV:AVER:TCON?
Notes	You must be in a mode that includes the Waveform measurement to use this command. Use INSTRument:SElect to set the mode.
Preset	EXPonential
State Saved	Saved in instrument state.
Range	Exp Repeat
Initial S/W Revision	Prior to A.02.00
Modified at S/W Revision	A.03.00

Avg Type

Selects the type of averaging.

Key Path	Meas Setup
Mode	BASIC, PNOISE, WCDMA, C2K, GSM, WIMAXOFDMA, TDSCDMA, 1XEVD0, DVB, DTMB, ISDBT, CMMB, LTE, LTETDD, DCATV, WLAN, MSR,LTEATDD, LTEAFDD
Remote Command	[:SENSe] :WAVeform:AVERage:TYPE LOG MAXimum MINimum RMS SCALar [:SENSe] :WAVeform:AVERage:TYPE?
Example	WAV:AVER:TYPE RMS WAV:AVER:TYPE?
Notes	The SCPI selection of MAX and MIN are kept for BWCC, but they are removed from the front panel access because they are not an Average function. You must be in a mode that includes the Waveform measurement to use this command. Use INSTRument:SElect to set the mode.
Preset	RMS
State Saved	Saved in instrument state.
Range	Pwr Avg(RMS) Log-Pwr Avg(Video) Voltage Avg
Initial S/W Revision	Prior to A.02.00
Modified at S/W Revision	A.03.00

Time Avg Num

Sets the number of HW averages to be executed per each data acquisition.

Key Path	Meas Setup
Mode	BASIC
Remote Command	[:SENSe] :WAVeform:AVERage:TACount <integer> [:SENSe] :WAVeform:AVERage:TACount?
Example	WAV:AVER:TAC 10WAV:AVER:TAC?
Notes	This feature is only available when Option DP2, B40, or wider IF Bandwidth option is installed.
Preset	1
State Saved	Saved in instrument state
Min	1
Max	65535
Default Unit	Enter

Meas Time

Sets how long the measurement is performed. X Scale only changes the representation of the display.

Key Path	Meas Setup
Mode	BASIC, PNOISE, WCDMA, C2K, GSM, WIMAXOFDMA, TDSCDMA, 1XEVDO, DVB, DTMB, ISDBT, CMMB, LTE, LTETDD, DCATV, WLAN, MSR,LTEATDD, LTEAFDD
Remote Command	[:SENSe] :WAVeform:SWEep:TIME <time> [:SENSe] :WAVeform:SWEep:TIME?
Example	WAV:SWE:TIME 50 ms WAV:SWE:TIME?
Notes	Specifies and returns how long the measurement is performed. It is the time record length of the measurement waveform. The Max time may be reduced when the sample frequency is high due to the memory limitation. You must be in a mode that includes the Waveform measurement to use this command. Use INSTRument:SElect to set the mode.
Preset	All except the following list: 2.000000 ms LTEAFDD, LTEATDD: 10 ms LTETDD: 10 ms
State Saved	Saved in instrument state.
Range	1.000 (s to 100.00 s
Min	1.000 us
Max	3200 s
Initial S/W Revision	Prior to A.02.00
Modified at S/W Revision	A.03.00, A.14.00

Sample Rate

Enables you to set an arbitrary sample rate for the acquired data to be processed.

Key Path	Meas Setup
Mode	BASIC
Remote Command	[:SENSe] :WAVeform:SRATe <freq> [:SENSe] :WAVeform:SRATe?
Example	WAV:SRAT 1.3636 MHz
Notes	Command and query available when Option DP2, B40, or wider IF Bandwidth option is installed. For other configuration, only query is available.
Couplings	The coupling between Sample Rate and IF BW depends on Physics implementation.
Preset	125.0 kHz
Min	12.5 Hz
Max	<ul style="list-style-type: none"> • (For Option DP2, B40 or wider IF Bandwidth option) • Digital IF 10 MHz path: 12.5 MHz • Digital IF 25 MHz path: 31.25 MHz • Digital IF 40 MHz path: 50 MHz • Option B85 85 MHz path: 106.25 MHz • Option B1A 125 MHz path: 156.25 MHz • Option B1X 140 MHz path: 175 MHz • Option B1Y 160 MHz path: 200 MHz • (For all other configuration) • 10 MHz path: 15 MHz • Option B25 25 MHz path: 45 MHz
Modified at S/W Revision	13.00

PhNoise Opt

Selects the LO (local oscillator) phase noise behavior for various desired operating conditions.

Key Path	Meas Setup
Remote Command	[:SENSe] :WAVeform:FREQuency:SYNThesis[:STATe] 1 2 3 [:SENSe] :WAVeform:FREQuency:SYNThesis[:STATe] ?
Example	WAV:FREQ:SYNT 2 Selects optimization for best wide offset phase noise
Notes	Parameter: 1 optimizes phase noise for small frequency offsets from the carrier. 2 optimizes phase noise for wide frequency offsets from the carrier. 3 optimizes LO for tuning speed

	(In PXA, the local oscillator hardware provides for extra-low phase noise at the expense of some speed.)
Dependencies	Does not appear in all models. The key is blank in those models, but the SCPI command is accepted for compatibility (although no action is taken).
Preset	Because this function is in Auto after preset, and because Digital IF BW after preset < 150 kHz for MXA/EXA and > 400 kHz for PXA the state of this function after Preset will be 1 for MXA/EXA and 2 for PXA.
State Saved	Saved in instrument state.
Min	1
Min	1
Max	3
Initial S/W Revision	Prior to A.07.00
Modified at S/W Revision	A.07.00

Auto

Selects the LO (local oscillator) phase noise behavior to optimize dynamic range and speed for various instrument operating conditions.

The X-Series has two grades of LO; a high performance LO that gives the best phase noise performance; and a medium-performance LO that gives excellent performance.

In models with the high performance LO, Auto will choose:

	Best Close in Phase Noise	Best Wide-offset Phase Noise
Filter BW	≤ 400 kHz	> 400 kHz

In models with the medium-performance LO, Auto will choose:

	Best Close in Phase Noise	Best Wide-offset Phase Noise
Filter BW	≤ 150 kHz	>150 kHz

Note that Fast Tuning will not be selected when in Auto.

Key Path	Meas Setup, PhNoise Opt
Remote Command	[:SENSe] :WAVeform:FREQuency:SYNThesis:AUTO[:STATe] OFF ON 0 1 [:SENSe] :WAVeform:FREQuency:SYNThesis:AUTO[:STATe] ?
Example	WAV:FREQ:SYNT:AUTO ON
Preset	ON
State Saved	Saved in instrument state.
Initial S/W Revision	Prior to A.07.00

Best Close-in P Noise

The LO phase noise is optimized for smaller offsets from the carrier, at the expense of phase noise farther out.

Key Path	Meas Setup, PhNoise Opt
Example	WAV:FREQ:SYNT 1
Couplings	<p>The frequency below which the phase noise is optimized is model dependent:</p> <ul style="list-style-type: none"> • CXA: n/a • EXA: [offset \leq150 kHz] • MXA: [offset \leq150 kHz] • PXA: [offset \leq400 kHz]
Readback	<p>Close-in.</p> <p>If manually selected, “Man” will be underlined. The actual frequency offset within which noise is optimized is shown with in square brackets, as this can vary depending on the hardware set in use. For example, in some analyzers this annotation appears as [offset <150 kHz]</p>
Initial S/W Revision	Prior to A.07.00

Best Wide-offset P Noise

The LO phase noise is optimized for wider offsets from the carrier. Closer offsets are compromised and the throughput of measurements (especially remote measurements where the center frequency is changing rapidly), is reduced.

Key Path	Meas Setup, PhNoise Opt
Example	WAV:FREQ:SYNT 2
Couplings	<p>The frequency below which the phase noise is optimized is model dependent:</p> <p>CXA: n/a</p> <p>EXA: [offset >150 kHz]</p> <p>MXA: [offset >150 kHz]</p> <p>PXA: [offset >400 kHz]</p>
Readback	<p>Wide-offset.</p> <p>If manually selected, “Man” will be underlined. The actual frequency offset beyond which noise is optimized is shown with in square brackets, as this can vary depending on the hardware set in use. For example, in some analyzers this annotation appears as [offset >150 kHz]</p>
Initial S/W Revision	Prior to A.07.00

Fast Tuning

In this mode, the LO behavior compromises phase noise at many offsets from the carrier in order to allow rapid measurement throughput when changing the center frequency. The term “fast tuning” refers to the time it takes to move the local oscillator to the start frequency and begin a capture; this setting does not impact the actual measurement time in any way.

Key Path	Meas Setup, PhNoise Opt
Example	WAV:FREQ:SYNT 3
State Saved	Saved in instrument state.
Readback	Fast Tuning. If manually selected the “Man” will be underlined.
Initial S/W Revision	Prior to A.07.00

Advanced

Accesses a menu of advanced functions that are used for specific applications. These settings should not be changed for most measurements.

Key Path	Meas Setup
Initial S/W Revision	Prior to A.02.00

ADC Dither

Accesses the ADC Dither control menu.

Key Path	Meas Setup, Advanced
Initial S/W Revision	Prior to A.02.00

ADC Dither Auto

Sets ADC dithering to automatically select whether dithering is needed.

Key Path	Meas Setup, Advanced, ADC Dither
Mode	BASIC, PNOISE, WCDMA, C2K, GSM, WIMAXOFDMA, TDSCDMA, 1XEVD0, DVB, DTMB, ISDBT, CMMB, LTE, LTETDD, DCATV, WLAN, MSR,LTEATDD, LTEAFDD
Remote Command	[:SENSe] :WAVeform:ADC:DITHer:AUTO [:STATe] OFF ON 0 1 [:SENSe] :WAVeform:ADC:DITHer:AUTO [:STATe] ?
Example	WAV:ADC:DITH:AUTO ON WAV:ADC:DITH:AUTO?
Notes	The dither function improves linearity for low level signals, at the expense of a higher noise floor. You must be in a mode that includes the Waveform measurement to use this command. Use

	INSTrument:SElect to set the mode.
Preset	OFF
State Saved	Saved in instrument state.
Range	On Off
Initial S/W Revision	Prior to A.02.00
Modified at S/W Revision	A.03.00

ADC Dither

Toggles the dither function On and Off. The dither function improves linearity for low level signals, at the expense of a higher noise floor.

The reduced clipping-to-noise ratio results in higher noise, because the clipping level of the ADC relative to the front terminals remains unchanged with the introduction of dither. The enhanced linearity is mostly improved scale fidelity.

With dither on, the third-order distortions are usually invisible for mixer levels below -35 dBm. With dither off, these distortions can be visible, with typical power levels of -110 dBm referred to the mixer. Detection nonlinearity can reach 1 dB for dither off at mixer levels around -70 dBm and lower, while the specified nonlinearity is many times smaller with dither on.

Key Path	Meas Setup, Advanced, ADC Dither
Mode	BASIC, PNOISE, WCDMA, C2K, GSM, WIMAXOFDMA, TDSCDMA, 1XEVD0, DVB, DTMB, ISDBT, CMMB, LTE, LTE4DD, DCATV, WLAN, MSR,LTEATDD, LTEAFDD
Remote Command	[:SENSe] :WAVeform:ADC:DITHer [:STATe] OFF ON 0 1 [:SENSe] :WAVeform:ADC:DITHer [:STATe] ?
Example	WAV:ADC:DITH ON WAV:ADC:DITH?
Notes	The dither function improves linearity for low level signals, at the expense of a higher noise floor. . You must be in a mode that includes the Waveform measurement to use this command. Use INSTrument:SElect to set the mode.
Preset	OFF
State Saved	Saved in instrument state.
Range	Auto Man
Backwards Compatibility SCPI	[:SENSe] :WAVeform:WBIF:ADC:DITHer [:SENSe] :WAVeform:PDITHer
Initial S/W Revision	Prior to A.02.00
Modified at S/W Revision	A.03.00

IF Gain

Accesses the keys to select the IF Gain settings.

When in Autorange mode, the IF checks its range once for data acquisition, to provide the best signal to noise ratio. You can specify the range for the best speed, and optimize for noise or for large signals.

When the IF Gain is set to Autorange, the IF Gain is set to High initially for each chunk of data. The data is then acquired. If the IF overloads, then the IF Gain is set to Low and the data is re-acquired. Because of this operation, the Autorange setting uses more measurement time as the instrument checks/resets its range. You can get faster measurement speed by forcing the range to either the high or low gain setting. But you must know that your measurement conditions will not overload the IF (in the high gain range) and that your signals are well above the noise floor (for the low gain range), and that the signals are not changing.

When Digital Bus Out (under the Input/Output menu) is ON, the IF Gain State Autorange selection is not allowed. Thus, in this case, IF Gain State will be set to Low.

This only applies to the RF input. It does not apply to baseband I/Q input.

Key Path	Meas Setup, Advanced
Initial S/W Revision	Prior to A.02.00

IF Gain Auto

Activates the auto rules for IF Gain

Key Path	Meas Setup, Advanced, IF Gain
Mode	BASIC, PNOISE, WCDMA, C2K, GSM, WIMAXOFDMA, TDSCDMA, 1XEVD0, DVB, DTMB, ISDBT, CMMB, LTE, LTETDD, DCATV, WLAN, MSR,LTEATDD, LTEAFDD
Remote Command	[:SENSe] :WAVeform:IF:GAIN:AUTO [:STATe] ON OFF 1 0 [:SENSe] :WAVeform:IF:GAIN:AUTO [:STATe] ?
Example	WAV:IF:GAIN:AUTO ON WAV:IF:GAIN:AUTO?
Notes	This only applies to the RF input. It does not apply to baseband I/Q input. You must be in a mode that includes the Waveform measurement to use this command. Use INSTRument:SElect to set the mode.
Preset	ON
State Saved	Saved in instrument state.
Range	On Off
Initial S/W Revision	Prior to A.02.00
Modified at S/W Revision	A.03.00

IF Gain State

Selects the range of IF gain.

Key Path	Meas Setup, Advanced, IF Gain
Mode	BASIC, PNOISE, WCDMA, C2K, GSM, WIMAXOFDMA, TDSCDMA, 1XEVD0, DVB, DTMB, ISDBT, CMMB, LTE, LTE4DD, DCATV, WLAN, MSR, LTEATDD, LTEAFDD
Remote Command	[:SENSe] :WAVeform:IF:GAIN [:STATe] AUToRange LOW HIGH [:SENSe] :WAVeform:IF:GAIN [:STATe] ?
Example	WAV:IF:GAIN HIGH WAV:IF:GAIN?
Notes	This only applies to the RF input and does not apply to baseband I/Q input. You must be in a mode that includes the Waveform measurement to use this command. Use INSTRUMENT:SElect to set the mode. If the user tries to select Autorange while Digital Bus Out is ON, an error message -221 "Settings conflict; "IF Gain Autorange not allowed when Digital Bus Out is ON" is displayed.
Couplings	If the user tries to select Autorange via SCPI while Digital Bus Out is ON, an error message -224, "Illegal parameter value; "IF Gain Autorange not allowed when Digital Bus Out is on" is displayed. If the user tries to select Autorange via front panel while Digital Bus Out is ON, an advisory message "IF Gain Autorange not allowed when Digital Bus Out is on" is displayed.
Preset	LOW
State Saved	Saved in instrument state.
Range	Autorange (Slower Follows Signals) Low (Best for Large Signals) High (Best Noise Level)
Readback Text	Autorange Low High
Initial S/W Revision	Prior to A.02.00
Modified at S/W Revision	A.03.00

IF Gain Offset

Sets the IF Gain offset in 2 dB step from -6 dB to +6 dB. Increasing the gain can increase the amplitude of small signals as long as you do not overdrive the hardware. Wideband gain should usually be adjusted after setting the input attenuation.

Internally, the IF Gain value will change based on the current configuration of the hardware. If you choose to offset this value, you may do so with this parameter. The value specified is not an absolute value but relative to the current internal IF Gain setting.

For example:

IF Gain Low + IF Gain Offset +4 dB = Total IF Gain of +4 dB (0 + 4 = 4)

IF Gain High + IF Gain Offset +4 dB = Total IF Gain of +14 dB (10 + 4 = 14)

IF Gain Low + IF Gain Offset -6 dB = Total IF Gain of -6 dB (0 - 6 = -6)

IF Gain High + IF Gain Offset -6 dB = Total IF Gain of +6 dB (10 - 6 = 4)

The total IF Gain range when IF Gain Offset is available is a minimum of $0 - 6 = -6$ dB and a maximum of $10 + 6 = 16$ dB. The available IF Gain depends on the IF Path and center frequency. The maximum IF Gain may not be achievable at all times depending on the configuration.

Key Path	Meas Setup, Advanced
Remote Command	<code>[:SENSe] :WAVeform:IF:GAIN:OFFSet <rel_ampl ></code> <code>[:SENSe] :WAVeform:IF:GAIN:OFFSet?</code>
Example	WAV:IF:GAIN:OFFS 2 Sets the IF Gain offset to 2
Preset	0
State Saved	Saved in instrument state.
Min	-6
Max	+6
Default Unit	dB

Meas Preset

Restores all the measurement parameters to their default values.

Key Path	Meas Setup
Mode	BASIC, PNOISE, WCDMA, C2K, GSM, WIMAXOFDMA, TDSCDMA, 1XEVD0, DVB, DTMB, ISDBT, CMMB, LTE, LTETDD, DCATV, WLAN, MSR,LTEATDD, LTEAFDD
Remote Command	<code>:CONFigure:WAVeform</code>
Example	CONF:WAV
Notes	Restore default values of all parameters. You must be in a mode that includes the Waveform measurement to use this command. Use INSTRument:SElect to set the mode.
Initial S/W Revision	Prior to A.02.00
Modified at S/W Revision	A.03.00

HW Averaging

Changes the number of time averages is to be made using hardware. This averaging is much faster than the standard averaging done in software. The hardware averaging is done on the complex voltage time trace data before any measurement application averaging is done. Both types of averaging (HW and SW) can be done on the same measurement data.

When time averaging is being done in HW, each trace update represents N fresh data acquisitions averaged together, where N is the number of averages. You cannot access the individual time data. Note that in the spectrum measurement this averaging is done prior to the standard averaging done within the application. Thus the yellow trace in this measurement shows the result of the time averaging. Subsequent averaging is orthogonal to this hardware based time averaging and its result is seen as the blue trace in this and other applications.

So it is possible to turn off the averaging within the application but still have the HW averaging set to a certain number. In other words, turning averaging off within the measurement will not affect HW averaging. If HW averaging needs to be turned off, simply set the HW Averaging parameter to 1.

Since it is time averaging, a trigger source something other than Free Run should be used to avoid cancelling out the signal to be measured. It is most useful for a periodic signal with known periods.

Time Avg Num

Sets the number of HW averages to be executed per each data acquisition.

Key Path	Meas Setup
Mode	BASIC
Remote Command	[:SENSe] :WAVeform:AVERage:TACount <integer> [:SENSe] :WAVeform:AVERage:TACount?
Example	WAV:AVER:TAC 10WAV:AVER:TAC?
Notes	This feature is only available when Option DP2, B40, or wider IF Bandwidth option is installed.
Preset	1
State Saved	Saved in instrument state
Min	1
Max	65535
Default Unit	Enter

Sample Period (Aperture) Setting (Remote Command Only)

Returns the time between samples (sample period or aperture).

Mode	BASIC
Remote Command	[:SENSe] :WAVeform:APERture?
Example	WAV:APER?
Notes	Query only.
Couplings	Coupled to Sample Rate by the following equation. Sample Period = 1/(Sample Rate)
Preset	1/(Sample Rate Default)
Min	1/(Max Sample Rate)
Max	1/(Min Sample Rate)

17 Waveform Measurement
Mode

Mode

See "[Mode](#)" on page 316

Mode Preset

Returns the active mode to a known state.

Mode Preset does the following for the currently active mode:

- Aborts the currently running measurement.
- Brings up the default menu for the mode, with no active function.
- Sets measurement Global settings to their preset values for the active mode only.
- Activates the default measurement.
- Brings up the default menu for the mode.
- Clears the input and output buffers.
- Sets Status Byte to 0.

Mode Preset does not:

- Cause a mode switch
- Affect mode persistent settings
- Affect system settings

See "[How-To Preset](#)" on page 2650 for more information.

Key Path	Front-panel key
Remote Command	:SYSTem:PRESet
Example	:SYST:PRES
Notes	*RST is preferred over :SYST:PRES for remote operation. *RST does a Mode Preset, as done by the :SYST:PRES command, and it sets the measurement mode to Single measurement rather than Continuous for optimal remote control throughput. Clears all pending OPC bits. The Status Byte is set to 0.
Couplings	A Mode Preset aborts the currently running measurement, activates the default measurement, and gets the mode to a consistent state with all of the default couplings set.
Backwards Compatibility Notes	In the X-Series, the legacy "Factory Preset" has been replaced with Mode Preset, which only presets the currently active mode, not the entire instrument. In the X-Series, the way to preset the entire instrument is by using System, Restore System Defaults All, which behaves essentially the same way as restore System Defaults does on ESA and PSA. There is also no "Preset Type" as there is on the PSA. There is a green Mode Preset front-panel key that does a Mode Preset and a white-with-green-letters User Preset front-panel key that does a User Preset. The old PRESet:TYPE command is ignored (without generating an error), and SYST:PRES without a parameter does a Mode Preset, which should cover most backward code compatibility issues. The settings and correction data under the Input/Output front-panel key (examples: Input Z Corr, Ext Amp Gain, etc.) are no longer part of any Mode, so they will not be preset by a Mode Preset. They are preset using Restore Input/Output Defaults, Restore System Defaults All. Note that because User Preset does a Recall State, and all of these settings are saved in State, they ARE recalled when using

	User Preset.
Initial S/W Revision	Prior to A.02.00

How-To Preset

The table below shows all possible presets, their corresponding SCPI commands and front-panel access (key paths). Instrument settings depend on the current measurement context. Some settings are local to the current measurement, some are global (common) across all the measurements in the current mode, and some are global to all the available modes. In a similar way, restoring the settings to their preset state can be done within the different contexts.

Auto Couple - is a measurement local key. It sets all Auto/Man parameter couplings in the measurement to Auto. Any Auto/Man selection that is local to other measurements in the mode will not be affected.

Meas Preset - is a measurement local key. Meas Preset resets all the variables local to the current measurement except the persistent ones.

Mode Preset - resets all the current mode's measurement local and measurement global variables except the persistent ones.

Restore Mode Defaults - resets ALL the Mode variables (and all the Meas global and Meas local variables), including the persistent ones.

Type Of Preset	SCPI Command	Front Panel Access
Auto Couple	:COUPle ALL	Auto Couple front-panel key
Meas Preset	:CONFigure:<Measurement>	Meas Setup Menu
Mode Preset	:SYSTem:PRESet	Mode Preset (green key)
Restore Mode Defaults	:INSTrument:DEFault	Mode Setup Menu
Restore All Mode Defaults	:SYSTem:DEFault MODes	System Menu; Restore System Default Menu
*RST	*RST	not possible (Mode Preset with Single)
Restore Input/Output Defaults	:SYSTem:DEFault INPUt	System Menu; Restore System Default Menu
Restore Power On Defaults	:SYSTem:DEFault PON	System Menu; Restore System Default Menu
Restore Alignment Defaults	:SYSTem:DEFault ALIGN	System Menu; Restore System Default Menu
Restore Miscellaneous Defaults	:SYSTem:DEFault MISC	System Menu; Restore System Default Menu
Restore All System Defaults	:SYSTem:DEFault [ALL] :SYSTem:PRESet:PERsistent	System Menu; Restore System Default Menu
User Preset	:SYSTem:PRESet:USER	User Preset Menu
User Preset All Modes	:SYSTem:PRESet:USER:ALL	User Preset Menu

Power On Mode Preset	:SYSTem:PON:TYPE MODE	System Menu
Power On User Preset	:SYSTem:PON:TYPE USER	System Menu
Power On Last State	:SYSTem:PON:TYPE LAST	System Menu

Preset Type (Remote Command Only)

As stated in the Backward Compatibility section, to be compatible with ESA/PSA the PRESet:TYPE command will be implemented as a no-op.

Mode	All
Remote Command	:SYSTem:PRESet:TYPE FACTory MODE USER :SYSTem:PRESet:TYPE?
Example	:SYST:PRESet:TYPE FACT
Notes	This command is supported for backward compatibility only. It is a no-op which does not change the behavior of any preset operation.
Preset	This is unaffected by Preset but is set to Mode on a “Restore System Defaults->All”
State Saved	No
Initial S/W Revision	Prior to A.02.00

Mode Setup

See "[Mode Setup](#)" on page 347

Peak Search

Places the selected marker on the trace point with the maximum y-axis value for that marker's trace and accesses a menu that enables you to select to do a next peak or minimum peak search.

Key Path	Front-panel key
Mode	BASIC, PNOISE, WCDMA, C2K, GSM, WIMAXOFDMA, TDSCDMA, 1XEVD0, DVB, DTMB, ISDBT, CMMB, LTE, LTETDD, DCATV, WLAN, MSR,LTEATDD, LTEAFDD
Remote Command	:CALCulate:WAVeform:MARKer[1] 2 ... 12:MAXimum
Example	CALC:WAV:MARK2:MAX
Notes	You must be in a mode that includes the Waveform measurement to use this command. Use INSTRument:SElect to set the mode.
Initial S/W Revision	Prior to A.02.00
Modified at S/W Revision	A.03.00

Next Peak

Moves the selected marker to the next highest local maximum with a value less than that of the current marker.

Key Path	Peak Search
Mode	BASIC, PNOISE, WCDMA, C2K, GSM, WIMAXOFDMA, TDSCDMA, 1XEVD0, DVB, DTMB, ISDBT, CMMB, LTE, LTETDD, DCATV, WLAN, MSR,LTEATDD, LTEAFDD
Remote Command	:CALCulate:WAVeform:MARKer[1] 2 ... 12:MAXimum:NEXT
Example	CALC:WAV:MARK:MAX:NEXT
Notes	You must be in a mode that includes the Waveform measurement to use this command. Use INSTRument:SElect to set the mode.
Initial S/W Revision	Prior to A.02.00
Modified at S/W Revision	A.03.00

Min Search

Moves the selected marker to the minimum y-axis value on the current trace.

Key Path	Peak Search
Mode	BASIC, PNOISE, WCDMA, C2K, GSM, WIMAXOFDMA, TDSCDMA, 1XEVD0, DVB, DTMB, ISDBT, CMMB, LTE, LTETDD, DCATV, WLAN, MSR,LTEATDD, LTEAFDD
Remote Command	:CALCulate:WAVeform:MARKer[1] 2 ... 12:MINimum
Example	CALC:WAV:MARK:MIN
Notes	You must be in a mode that includes the Waveform measurement to use this command. Use INSTRument:SElect to set the mode.

17 Waveform Measurement
Peak Search

Initial S/W Revision	Prior to A.02.00
Modified at S/W Revision	A.03.00

Print

See "Print" on page 365

Quick Save

The Quick Save front-panel key repeats the most recent save that was performed from the Save menu, with the following exceptions:

- Register saves are not remembered as Saves for the purpose of the Quick Save function
- If the current measurement does not support the last non-register save that was performed, an informational message is generated, “File type not supported for this measurement”

Quick Save repeats the last type of qualified save (that is, a save qualified by the above criteria) in the last save directory by creating a unique filename using the Auto File Naming algorithm described below.

If Quick Save is pressed after startup and before any qualified Save has been performed, the Quick Save function performs a Screen Image save using the current settings for Screen Image saves (current theme, current directory), which then becomes the “last save” for the purpose of subsequent Quick Saves.

The Auto File Naming feature automatically generates a file name for use when saving a file. The filename consists of a prefix and suffix separated by a dot, as is standard for the Windows® file system. A default prefix exists for each of the available file types:

Type	Default Prefix	Menu
State	State_	(Save/Recall)
Trace + State	State_	(Save/Recall)
Screen	Screen_	(Save/Recall)
Amplitude Corrections	Ampcor_	(Import/Export)
Traces	Trace_	(Import/Export)
Limit Lines	LLine_	(Import/Export)
Measurement Result	MeasR_	(Import/Export)
Capture Buffer	CapBuf_	(Import/Export)

A four digit number is appended to the prefix to create a unique file name. The numbering sequence starts at 0000 within each Mode for each file type and updates incrementally to 9999, then wraps to 0000 again. It remembers where it was through a Mode Preset and when leaving and returning to the Mode. It is reset by Restore Misc Defaults and Restore System Defaults and subsequent running of the instrument application. So, for example, the first auto file name generated for State files is State_0000.state. The next is State_0001, and so forth.

One of the key features of Auto File Name is that we guarantee that the Auto File Name will never conflict with an existing file. The algorithm looks for the next available number. If it gets to 9999, then it looks for holes. If it find no holes, that is no more numbers are available, it gives an error.

For example, if when we get to State_0010.state there is already a State_0010.state file in the current directory, it advances the counter to State_0011.state to ensure that no conflict will exist (and then it verifies that State_0011.state also does not exist in the current directory and advances again if it does, and so forth).

If you enter a file name for a given file type, then the prefix becomes the filename you entered instead of the default prefix, followed by an underscore. The last four letters (the suffix) are the 4-digit number.

For example, if you save a measurement results file as “fred.csv”, then the next auto file name chosen for a measurement results save will be fred_0000.csv.

NOTE Although 0000 is used in the example above, the number that is used is actually the current number in the Meas Results sequence, that is, the number that would have been used if you had not entered your own file name.

NOTE If the filename you entered ends with _dddd, where d=any number, making it look just like an auto file name, then the next auto file name picks up where you left off with the suffix being dddd + 1.

Key Path	Front-panel key
Notes	No remote command for this key specifically.
Initial S/W Revision	Prior to A.02.00

Recall

In the LTE TDD mode, four types of recall functions are available under the Data menu: “Limit Mask”, “E-UTRA Test Model”, “Signal Studio Setup” and “Vector Signal Analyzer”. “Limit Mask” enables setting of a preset limit mask for Power Suite-based measurements, and currently it is available for the SEM/ACP measurements with the LTE TDD mode. Recalling “E-UTRA Test Model” sets complicated RB settings for each Test Model for the Modulation Analysis and Conformance EVM measurements. Recalling “Signal Studio Setup” or “89600 Vector Signal Analyzer” enables you to recall parameters which have been set and saved on the external platform.

Key Path	Front Panel
Mode	LTETDD
Initial S/W Revision	Prior to A.02.00
Modified at S/W Revision	A.06.00

State

The Recall State menu lets you choose a register or file from which to recall the state.

The content of a state file includes all of the settings and data required to return the analyzer as closely as possible to the Mode it was in, with the exact settings that were in place, when the save occurred. The Mode settings in each state file include the settings that are affected by Mode Preset, as well as the additional settings affected by Restore Mode Defaults; all of the Mode’s settings. In addition, all of the settings of the Input/Output system are included, even though they are outside of the Mode’s state, because they are needed to restore the complete setup. Persistent System settings (for example, GPIB address) are not affected by either a Mode Preset or Restore Mode Defaults, nor are they included in a saved State file.

Since each state file is only for one Mode, the settings for other Modes are unaffected when it is loaded. Recall State will cause a mode switch if the state being recalled is not from the current active mode.

After the recall completes, the message "File <filename> recalled" or “Recalled State Register <register number>” is displayed.

For rapid recalls, the State menu lists 16 registers that you can choose from to recall. Pressing a Register key initiates the recall. You can also select a file from which to recall.

The default path for all State Files is:

My Documents\<<mode name>\state

where <mode name> is the parameter used to select the mode with the INST:SEL command (for example, SA for the Spectrum Analyzer).

See "[More Information](#)" on page 2659.

Key Path	Recall
Mode	All

Remote Command	:MMEMory:LOAD:STATe <filename>
Example	:MMEM:LOAD:STAT "myState.state" This recalls the file myState.state on the default path
Example	MMEM:LOAD:STAT "MyStateFile.state" This loads the state file data (on the default file directory path) into the instrument state.
Notes	<p>When you pick a file to recall, the analyzer first verifies that the file is recallable in the current instrument by checking the software version and model number of the instrument. If everything matches, a full recall proceeds by aborting the currently running measurement, clearing any pending operations, and then loading the State from the saved state file. You can open state files from any mode, so recalling a State file switches to the mode that was active when the save occurred. After switching to the mode of the saved state file, mode settings and data (if any for the mode) are loaded with values from the saved file. The saved measurement of the mode becomes the newly active measurement and the data relevant to the measurement (if there is any) is recalled.</p> <p>If there is a mismatch between file version or model number or instrument version or model number, the recall function tries to recall as much as possible and returns a warning message. It may limit settings that differ based on model number, licensing or version number.</p> <p>After recalling the state, the Recall State function does the following:</p> <ul style="list-style-type: none"> • Makes the saved measurement for the mode the active measurement. • Clears the input and output buffers. • Status Byte is set to 0. • Executes a *CLS <p>If the file specified is empty an error is generated. If the specified file does not exist, another error is generated. If there is a mismatch between the file and the proper file type, an error is generated. If there is a mismatch between file version or model number or instrument version or model number, a warning is displayed. Then it returns to the State menu and File Open dialog goes away.</p> <p>After the Recall, the analyzer exits the Recall menu and returns to the previous menu.</p>
Backwards Compatibility SCPI	:MMEMory:LOAD:STATe 1,<filename> For backwards compatibility, the above syntax is supported. The "1" is simply ignored.
Initial S/W Revision	Prior to A.02.00

More Information

In measurements that support saving Traces, for example, Swept SA, the Trace data is saved along with the State in the State file. When recalling the State, the Trace data is recalled as well. Traces are recalled exactly as they were stored, including the writing mode and update and display modes. If a Trace was updating and visible when the State was saved, it will come back updating and visible, and its data will be rewritten right away. When you use State to save and recall traces, any trace whose data must be preserved should be placed in View or Blank mode before saving.

The following table describes the Trace Save and Recall possibilities:

You want to recall state and one trace's data, leaving other traces unaffected.	Save Trace+State from 1 trace. Make sure that no other traces are updating (they should all be in View	On Recall, specify the trace you want to load the one trace's data into. This trace will load in View.
---	---	--

	or Blank mode) when the save is performed.	All other traces' data will be unaffected, although their trace mode will be as it was when the state save was performed.
You want to recall all traces	Save Trace+State from ALL traces.	On Recall, all traces will come back in View (or Blank if they were in Blank or Background when saved)
You want all traces to load exactly as they were when saved.	Save State	On recall, all traces' mode and data will be exactly as they were when saved. Any traces that were updating will have their data immediately overwritten.

From File...

When you press “From File”, the analyzer brings up a Windows dialog and a menu entitled “File Open.” This menu allows you to navigate to the various fields in the Windows dialog without using a keyboard or mouse. The Tab and Arrow keys can also be used for dialog navigation.

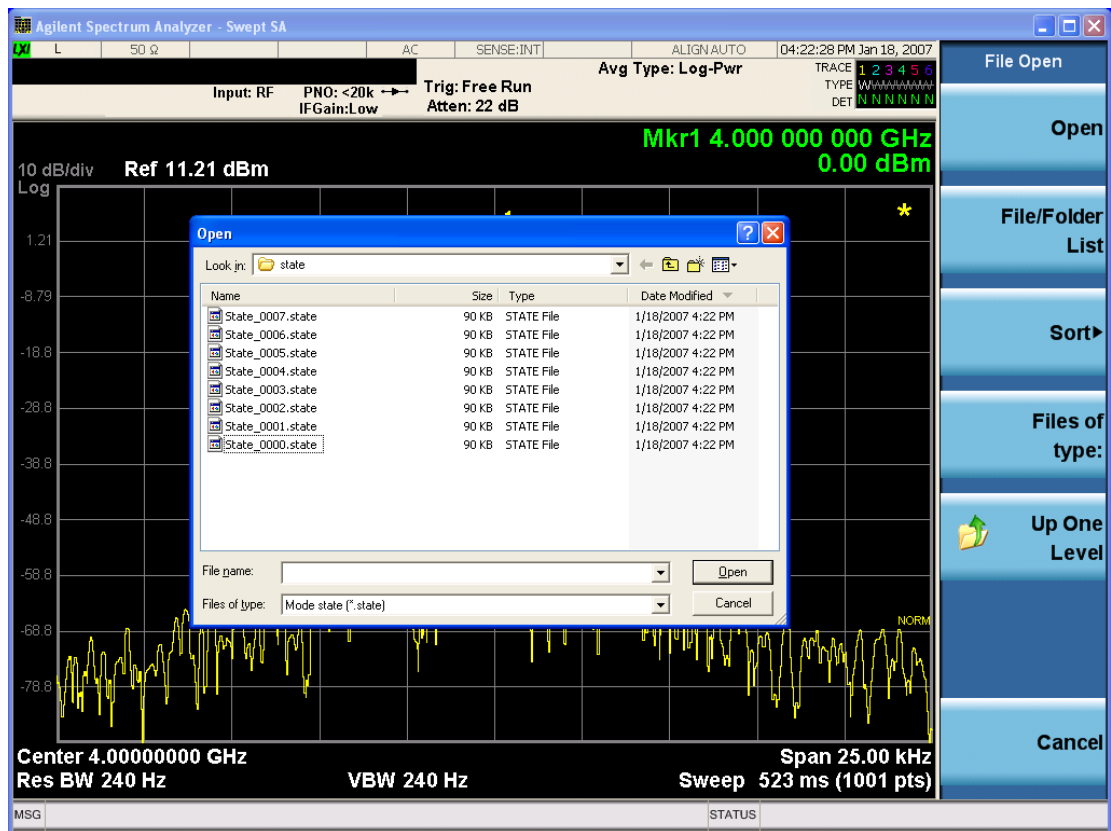

Listed below are the functions of the various fields in the dialog, and the corresponding softkeys:

Open

Performs the recall of the specified file. While the recall is being performed, the floppy icon appears briefly in the Meas bar.

File/Folder List

Enables you to navigate to the center of the dialog that contains the list of files and folders. Once here you can get information about the file and use the tab keys to navigate to the other fields in the dialog, such as Look In.

Look In

The Look In field shows the path from which the file will be recalled and allows you to change the path using the up and down arrow keys to navigate to other paths; the Enter key to open a directory; and the Backspace key to go back one directory. The **Look In field** first uses the last path from the Save As dialog **Save In:** path for that same file type. There is no softkey for directly navigating to the Look In field, but you can use the left tab to get here from the File/Folder List.

User specified paths are remembered when you leave and return to a Mode and are reset back to the default using Restore Mode Defaults.

Sort

Accesses a menu that enables you to sort the files within the File Open dialog. Only one sorting type can be selected at a time and the sorting happens immediately. The sorting types are By Date, By Name, By extension, and By Size.

Files of Type

This field shows the file suffix for the type of file you have selected to recall. For example, if you navigated here while recalling State, "Mode state (*.state)" is in the field. If you navigated here while recalling Trace, ""Mode state (*.trace)" is in the field. If you navigated here while importing a trace data file, "Trace Data (*.csv)" is in the field. For some file types, there is more than one choice in the dropdown menu, which you can select by using the up and down arrow keys and Enter.

Up One Level

This key corresponds to the icon of a folder with the up arrow that is in the tool bar of the dialog. When pressed, it causes the file and folder list to navigate up one level in the directory structure. The Backspace key does the same thing.

Cancel

This key corresponds to the Cancel selection in the dialog. It causes the current **Open** request to be cancelled. The ESC key does the same thing.

Key Path	Recall, State
Notes	Brings up the Open dialog for recalling a State Save Type
Initial S/W Revision	Prior to A.02.00

Edit Register Names

You may enter a custom name on any of the Register keys, to help you remember what you are using that state to save. To do this, press the Edit Register Names key, choose the register whose name you wish to edit, and then enter the desired label using the Alpha Editor or an external PC keyboard.

The maximum number of characters that can be added is 30. In most cases, 30 characters will fit on two lines of the key.

For more information and the SCPI command, see Edit Register Names under the Save, State function.

Key Path	Recall, State
Mode	All
Dependencies	N9060A-7FP or N9060B-2FP license required to edit the register names. When the feature is not licensed, sending the SCPI command generates an error, -221, "Settings conflict;Option not available"
Initial S/W Revision	A.11.00

Register 1 thru Register 16

Selecting any one of these register keys causes the State of the mode from the specified Register to be recalled. Each of the register keys annotates whether it is empty or at what date and time it was last modified. In addition, you can use the Edit Register Names key under Save, State to enter custom names for each register.

Registers are shared by all modes, so recalling from any one of the registers will cause a mode switch to the mode that was active when the save to the Register occurred.

Although these 16 registers are the only registers available from the front panel, there are 128 state registers available in the instrument. Registers 17-128 are only available from the SCPI interface, using the *RCL command.

After the recall completes, the message "Register <register number> recalled" appears in the message bar. If you are in the Spectrum Analyzer Mode, and you are recalling a register that was saved in the Spectrum Analyzer Mode, then after the recall, you will still be in the Recall Register menu. If the Recall causes you to switch modes, then after the Recall, you will be in the Frequency menu.

If a requested register is empty an error is generated.

Key Path	Recall, State
Example	*RCL 1
Range	1-16 from front panel, 1-128 from SCPI
Readback	Date and time with seconds resolution are displayed on the key OR A custom name of up to 30 characters entered using the Save, State,Edit Register Names key OR “(empty)” if no prior save operation has been performed to this register.
Initial S/W Revision	Prior to A.02.00
Modified at S/W Revision	Prior to A.11.00

Register 1 thru Register 16

Selecting any one of these register keys causes the State of the mode from the specified Register to be recalled. Each of the register keys annotates whether it is empty or at what date and time it was last modified. In addition, you can use the Edit Register Names key under Save, State to enter custom names for each register.

Registers are shared by all modes, so recalling from any one of the registers will cause a mode switch to the mode that was active when the save to the Register occurred.

Although these 16 registers are the only registers available from the front panel, there are 128 state registers available in the instrument. Registers 17–128 are only available from the SCPI interface, using the *RCL command.

After the recall completes, the message "Register <register number> recalled" appears in the message bar. If you are in the Spectrum Analyzer Mode, and you are recalling a register that was saved in the Spectrum Analyzer Mode, then after the recall, you will still be in the Recall Register menu. If the Recall causes you to switch modes, then after the Recall, you will be in the Frequency menu.

If a requested register is empty an error is generated.

Key Path	Recall, State
Example	*RCL 1
Range	1–16 from front panel, 1–128 from SCPI
Readback	Date and time with seconds resolution are displayed on the key OR A custom name of up to 30 characters entered using the Save, State, Edit Register Names key OR “(empty)” if no prior save operation has been performed to this register.
Initial S/W Revision	Prior to A.02.00
Modified at S/W Revision	Prior to A.11.00

Recall

In the LTE TDD mode, four types of recall functions are available under the Data menu: “Limit Mask”, “E-UTRA Test Model”, “Signal Studio Setup” and “Vector Signal Analyzer”. “Limit Mask” enables setting of a preset limit mask for Power Suite-based measurements, and currently it is available for the SEM/ACP measurements with the LTE TDD mode. Recalling “E-UTRA Test Model” sets complicated RB settings for each Test Model for the Modulation Analysis and Conformance EVM measurements. Recalling “Signal Studio Setup” or “89600 Vector Signal Analyzer” enables you to recall parameters which have been set and saved on the external platform.

Key Path	Front Panel
Mode	LTETDD
Initial S/W Revision	Prior to A.02.00
Modified at S/W Revision	A.06.00

Import Trace Data

Enables you to import previously saved trace data into a Data Register and optionally display it. Selecting this key displays a menu that enables you to select the destination data register, and also enables you to choose whether or not to display the recalled data in the currently selected trace. After making these selections, select Open... and use the file dialog to select the file you want to recall.

Recalling trace data into an already used Data Register overwrites the previous data. If the data register is displayed on any trace, the display is updated to reflect the new data.

The SCPI command

```
:MMEM:LOAD:TRAC:DATA D1|D2|D3|D4|D5|D6,<filename>
```

recalls data into a specified register, but does not display it in the selected trace. Use the command

```
:DISP:<meas>:TRAC<n>:FEED D1|D2|D3|D4|D5|D6
```

to display the register in the desired trace.

It is possible to recall trace data saved by other VXA measurements, or measurements made using the LTE, LTETDD, iDEN, or 89601 applications.

Key Path	Recall, Data (Import)
Mode	VSA, LTE, LTETDD, IDEN
Remote Command	:MMEMory:LOAD:TRACe:DATA D1 D2 D3 D4 D5 D6,<filename>[,CSV TXT SDF MAT4 MAT HDF5 BIN]
Example	:MMEM:LOAD:TRAC:DATA D1,"Trc1.txt",TXT
Notes	<p>The Open: dialog box has the following filter options when you are recalling trace data::</p> <ul style="list-style-type: none"> • CSV (Comma delimited) (*.csv) • SDF (Fast) (*.sdf;*.dat) • Text (Tab delimited) (*.txt) <p>The file must have the same format as that created by the Export Recorded Data command.</p> <p>The SCPI command has an optional file format parameter. If you do not include this parameter in the SCPI command, the file format is determined by the file name extension. If no file extension is recognized, the file is scanned to determine the format.</p> <p>If you are not licensed to recall a particular file type, then error -203.9010 is returned. If the file format cannot be determined or the file cannot be recalled successfully, then error -250.5290 is returned. If the recall is successful, then advisory 0.1600 is shown.</p>
State Saved	No
Readback	Data 1 Data 2 Data 3 Data 4 Data 5 Data 6

Data 1

Selects the Data 1 register as the destination for the imported data.

Key Path	Recall, Data (Import), Trace (to)
Mode	VSA, LTE, LTETDD, IDEN

Data 2

Selects the Data 2 register as the destination for the imported data.

Key Path	Recall, Data (Import), Trace (to)
Mode	VSA, LTE, LTETDD, IDEN

Data 3

Selects the Data 3 register as the destination for the imported data.

Key Path	Recall, Data (Import), Trace (to)
Mode	VSA, LTE, LTETDD, IDEN

Data 4

Selects the Data 4 register as the destination for the imported data.

Key Path	Recall, Data (Import), Trace (to)
Mode	VSA, LTE, LTETDD, IDEN

Data 5

Selects the Data 5 register as the destination for the imported data..

Key Path	Recall, Data (Import), Trace (to)
Mode	VSA, LTE, LTETDD, IDEN

Data 6

Selects the Data 6 register as the destination for the imported data.

Key Path	Recall, Data (Import), Trace (to)
Mode	VSA, LTE, LTETDD, IDEN

Display in Selected Trace

Enables you to select whether the recalled trace data is displayed in the current Trace.

Key Path	Recall, Data (Import), Trace (to)
----------	-----------------------------------

Mode	VSA, LTE, LTETDD, IDEN
State Saved	No

Signal Studio Setup

This key allows you to recall the Agilent Signal Studio setup file created on the Signal Studio (N7625B). This key is valid only for the Mod Analysis measurement. For E-TM test model signal, please use corresponding EVM setup file under My Documents\LTETDD\data\evmsetup.

For the supported carrier types, see the table below.

Signal Studio	Carrier Type
N7625B Signal Studio for 3GPP LTE TDD	Advanced LTE TDD(2009-03)
	Advanced LTE TDD(2009-12)
	Basic LTE TDD(2009-03)
	Basic LTE TDD(2009-12)

File Location and Extension

File location: "My Documents\LTETDD\data"

File type: xml

File extension: .scp

You need to place the Signal Studio Setup file created on N7625B in the above directory in advance. Pressing OPEN under the Import Data menu will open this directory from which you can select the setup file.

Example:

File Location: My Documents\LTETDD\data

File Name: Uplink PUSCH.scp

Key Path	Recall, Data
Mode	LTETDD
Remote Command	MMEemory:LOAD:SSSetup <string>
Example	MME:LOAD:SSS "Uplink PUSCH.scp"
Notes	Sets of parameters related to Signal Studio Setup are overwritten by the contents of the setup file.
Initial S/W Revision	A.06.00

89601 VSA Setup

Enables you to import the 89600 Vector Signal Analyzer Setup file created using the 89600 Vector Signal Analyzer Option BHE (LTE TDD). This key is valid only for the Mod Analysis measurement.

File Location and Extension

File location: “My Documents\LTETDD\data”

File type: text file

File extension: .set, .setx

Place the 89600 Vector Signal Analyzer Setup file that you saved on 89600 in the above directory. When you select OPEN under the Import Data menu, the directory opens enabling you to select your setup file.

Example:

File Location: My Documents\LTETDD\data

File Name: Uplink PRACH.set

Key Path	Recall, Data
Mode	LTETDD
Remote Command	MMEMory:LOAD:VSASetup <string>
Example	MMEM:LOAD:VSAS "Uplink PRACH.set"
Notes	Sets of parameters related to Vector Signal Analyzer Setup are overwritten by the contents of the setup file.
Initial S/W Revision	A.06.00
Modified at S/W Revision	A.10.00

Masks

This key allows you to recall a preset mask file from the list. The preset mask file contains configuration for only Carrier, Offset, Limit settings and the preset profile BW. Any set of values not specified by the preset mask file will not be overwritten.

You cannot change or create the preset mask file since it is a binary file. This key is valid for the Spectrum Emission Mask and ACP measurements.

File location: “My Documents\LTETDD\data\masks”

Note that “My Documents” is an alias to a directory and its place differs depending on which user is logged in. At XSA start up, XSA will overwrite all of the limit mask files to the current user’s “My Documents\LTETDD\data\masks” each time.

File type: Binary

Filename: The filename follows the rule below, in which the word is connected with underscores.

<Measurement>_<Direction>_<Bandwidth>_<Condition>.mask

Where

<Measurement> Measurement the limit mask file is applied to: SEM or ACP

<Direction> Direction: BS (Downlink) or MS (Uplink).

<Bandwidth> Bandwidth

<Condition> Condition. It depends on the measurement.

File extension: .mask

Pressing OPEN under the Import Data menu will open the above directory from which you can select a mask file. When you change the Bandwidth or Direction, all Power Suite measurement parameters are reset to the hard coded preset parameters. Thus you must recall the appropriate preset mask file again after the change.

You cannot read the contents of the provided preset mask file since it is a binary file. Detailed contents of the file are provided by a PDF format file located in the same directory as the preset mask file.

Example:

File Location: My Documents/LTETDD/data/masks/SEM_MS

File Name: SEM_MS_15MHz_Add_NS04.mask

The following table shows the sets of variables imported to the ACP measurement.

Offset	Start Freq (MHz)	Stop Freq (MHz)	Res BW (Hz)	Meas BW	Rel Start	Rel Stop	Fail Mask
A	5	7.14	30k	1	-8	-25	Rel
B	7.14	10.57	30k	1	-25	-27	Rel
C	10.57	20	30k	1	-27	-50	Rel
D	20	25	30k	1	-50	-50	Rel
E	25	30	30k	1	-50	-50	Rel

Key Path	Recall, Data
Mode	LTETDD
Remote Command	MMEemory:LOAD:MASK <string>
Example	MMEM:LOAD:MASK "ACP_BS\ACP_BS_3MHz_pairE-UTRA_CatA.mask"
Notes	Sets of parameters related to Limit, Carrier and Offset are overwritten by the contents of the preset mask file.
Initial S/W Revision	A.03.00

EVM Setup

This key allows you to recall EVM parameter setting to measure E-UTRA Test Model in 3GPP standard (36.141-810 6.1.1).

- E-UTRA Test Model 1.1 (E-TM1.1)
- E-UTRA Test Model 1.2 (E-TM1.2)
- E-UTRA Test Model 2 (E-TM2)
- E-UTRA Test Model 3.1 (E-TM3.1)

- E-UTRA Test Model 3.2 (E-TM3.2)
- E-UTRA Test Model 3.3 (E-TM3.3)

This key is valid for the Modulation Analysis and Conformance EVM measurements only.

File Location and Extension

File location: My Documents\LTETDD\data\evmsetup

Note that “My Documents” is an alias to a directory and its place differs depending on which user is logged in. At XSA start up, XSA will overwrite all of the EVM Setup files to the current user’s “My Documents\LTETDD\data\evmsetup” each time.

File type: binary

File extension: .evms

Pressing OPEN under the Import Data menu will open the above directory from which you can select an EVM Setup file. When you change the Bandwidth, parameters are reset to the hard coded preset parameters. Thus you must recall the appropriate EVM Setup file again after the change.

You cannot read the contents of the provided EVM Setup file since it is a binary file.

Example:

File Location: My Documents\LTETDD\data\evmsetup

Filename: TM3.1-BW1.4MHz.evms

Key Path	Recall, Data
Mode	LTETDD
Remote Command	MMEemory:LOAD:EVMSSetup <string>
Example	MMEM:LOAD:EVMS "TM2-BW15MHz.evms"
Notes	Sets of parameters related to EVM Setup are overwritten by the contents of the EVM Setup file.
Initial S/W Revision	A.03.00, A.08.00

Open...

When you press “Open”, the analyzer brings up a Windows dialog and a menu entitled “File Open.” This menu allows you to navigate to the various fields in the Windows dialog without using a keyboard or mouse. The Tab and Arrow keys can also be used for dialog navigation.

See "[From File...](#)" on page 2797 in Recall, State, for a full description of this dialog and menu.

Key Path	Recall, Data
Notes	The key location is mode-dependent and will vary. Brings up Open dialog for recalling a <mode specific> Save Type
Initial S/W Revision	Prior to A.02.00

Restart

The Restart function restarts the current sweep, or measurement, or set of averaged/held sweeps or measurements. If you are Paused, pressing Restart does a Resume.

The Restart function is accessed in several ways:

- Pressing the Restart key
- Sending the remote command INIT:IMMEDIATE
- Sending the remote command INIT:RESTART

See "[More Information](#)" on page 2670

Key Path	Front-panel key
Remote Command	:INITiate[:IMMEDIATE] :INITiate:RESTART
Example	:INIT:IMM :INIT:REST
Notes	:INITiate:RESTART and :INITiate:IMMEDIATE perform exactly the same function.
Couplings	Resets average/hold count k. For the first sweep overwrites all active (update=on) traces with new current data. For application modes, it resets other parameters as required by the measurement.
Status Bits/OPC dependencies	This is an Overlapped command. The STATus:OPERation register bits 0 through 8 are cleared. The STATus:QUESTionable register bit 9 (INTegrity sum) is cleared. The SWEEPING bit is set. The MEASURING bit is set.
Backwards Compatibility Notes	For Spectrum Analysis mode in ESA and PSA, the Restart hardkey and the INITiate:RESTART command restart trace averages (displayed average count reset to 1) for a trace in Clear Write, but did not restart Max Hold and Min Hold. In the X-Series, the Restart hardkey and the INITiate:RESTART command restart not only Trace Average, but MaxHold and MinHold traces as well. For wireless comms modes in ESA and PSA, the Restart hardkey and the INITiate:RESTART command restart every measurement, which includes all traces and numeric results. There is no change to this operation.
Initial S/W Revision	Prior to A.02.00

More Information

The **Restart** function first aborts the current sweep/measurement as quickly as possible. It then resets the sweep and trigger systems, sets up the measurement and initiates a new data measurement sequence with a new data acquisition (sweep) taken once the trigger condition is met.

If the analyzer is in the process of aligning when **Restart** is executed, the alignment finishes before the restart function is performed.

Even when set for Single operation, multiple sweeps may be taken when Restart is pressed (for example, when averaging/holding is on). Thus when we say that **Restart** "restarts a measurement," we may mean:

- It restarts the current sweep
- It restarts the current measurement
- It restarts the current set of sweeps if any trace is in Trace Average, Max Hold or Min Hold
- It restarts the current set of measurements if Averaging, or Max Hold, or Min Hold is on for the measurement
- depending on the current settings.

With **Average/Hold Number** (in **Meas Setup** menu) set to 1, or Averaging off, or no trace in Trace Average or Hold, a single sweep is equivalent to a single measurement. A single sweep is taken after the trigger condition is met; and the analyzer stops sweeping once that sweep has completed. However, with **Average/Hold Number** >1 and at least one trace set to **Trace Average, Max Hold, or Min Hold (SA Measurement)** or **Averaging on (most other measurements)**, multiple sweeps/data acquisitions are taken for a single measurement. The trigger condition must be met prior to each sweep. The sweep is stopped when the average count k equals the number N set for **Average/Hold Number**. A measurement average usually applies to all traces, marker results, and numeric results; but sometimes it only applies to the numeric results.

Once the full set of sweeps has been taken, the analyzer will go to idle state. To take one more sweep without resetting the average count, increment the average count by 1, by pressing the step up key while **Average/Hold Number** is the active function, or sending the remote command `CALC:AVER:TCON UP`.

Save

The Save menu lets you choose what you want to save and where you want to save it. Among the types of files you can save are **States**, **Traces**, and **Screen Images**. In addition, an Export (Data) option lets you save a number of data types as CSV files for easy import into Excel and other spreadsheet programs.

Key Path	Front-panel key
Mode	All
Notes	No remote command for this key specifically, but the :MMEM:STOR:STATe <filename> command is available for specific file types. An example is :MMEM:STOR:STATe <filename>.
Initial S/W Revision	Prior to A.02.00

State

The Save State menu lets you choose a register or file for saving the state.

The content of a state file includes all of the settings and data required to return the analyzer as closely as possible to the Mode it was in, with the exact settings which were in place, when the save occurred. The Mode settings in each state file include the settings that are affected by Mode Preset, as well as the additional settings affected by Restore Mode Defaults; all of the Mode's settings. In addition, all of the settings of the Input/Output system are included, even though they are outside of the Mode's state, because they are needed to restore the complete setup. Persistent System settings (for example, Verbose SCPI) are not affected by either Mode Preset or Restore Mode Defaults, nor are they included in a saved State file.

After the save completes, the message "File <filename> saved" or "State Register <register number> saved" is displayed.

For rapid saving, the State menu lists 16 registers to save to. Pressing a Register key initiates the save. You can also select a file to save to.

The default path for all State Files is:

My Documents\<<mode name>\state

where <mode name> is the parameter used to select the mode with the INST:SEL command (for example, SA for the Spectrum Analyzer).

Key Path	Save
Mode	All
Remote Command	:MMEMory:STORe:STATe <filename>
Example	MMEM:STOR:STATe "MyStateFile.state" This stores the current instrument state data in the file MyStateFile.state in the default directory.
Notes	Both single and double quotes are supported for any filename parameter over remote. After saving to a register, that register's menu key is updated with the date the time, unless a custom label has been entered for that key. After saving to a register, you remain in the Save State menu, so that you can see the Register key

update. After saving to a file, the analyzer automatically returns to the previous menu and any Save As dialog goes away.

Backwards Compatibility SCPI	:MMEMory:STORe:STATe 1,<filename>
Initial S/W Revision	Prior to A.02.00

To File . . .

When you press “To File”, the analyzer brings up a Windows dialog and a menu entitled “**Save As.**” This menu allows you to navigate to the various fields in the Windows dialog without using a keyboard or mouse. The Tab and Arrow keys can also be used for dialog navigation.

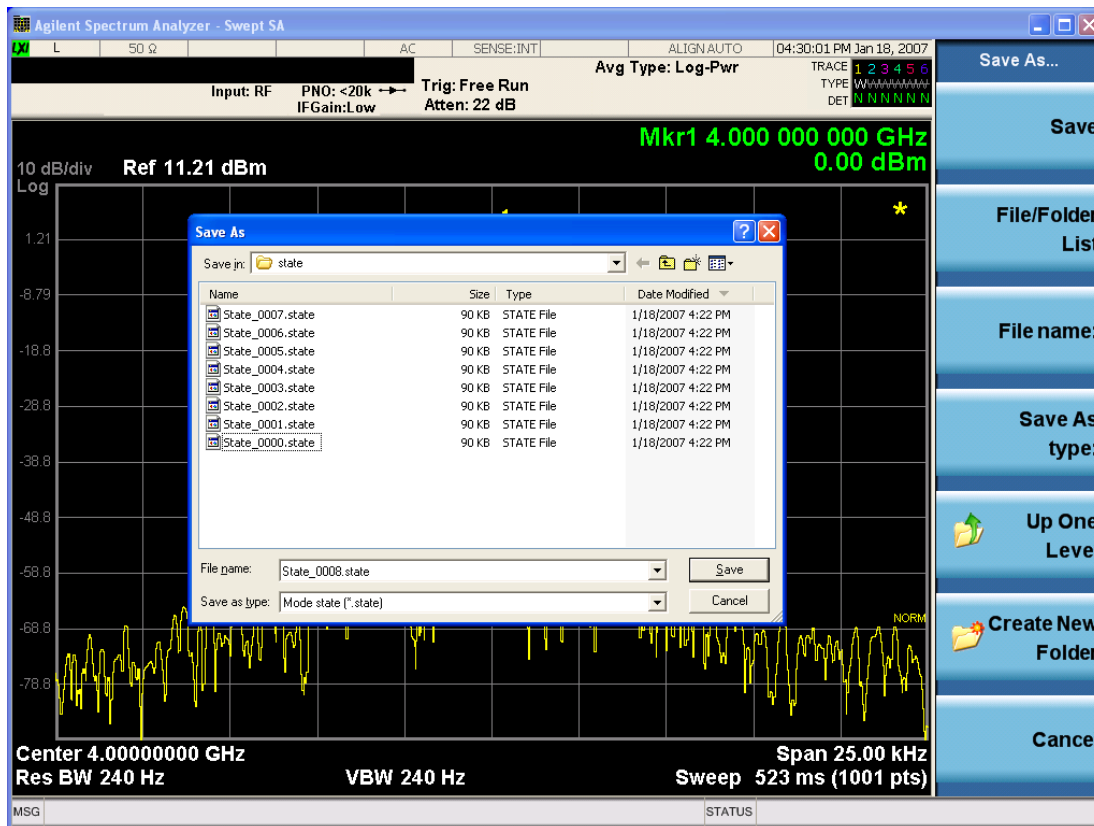

The Listed below

are the functions of the various fields in the dialog, and the corresponding softkeys:

Save

Performs the save to the specified file of the selected type. If the file already exists, a dialog will appear that allows you to replace the existing file by selecting OK, or you can Cancel the request. If you select OK, the file will be overwritten. Using the C: drive is strongly discouraged, since it runs the risk of being overwritten during an instrument software upgrade.

While the save is being performed, the floppy icon appears briefly in the Meas bar.

File/Folder List

Enables you to navigate to the center of the dialog that contains the list of files and folders. Once here you can get information about the file and use the tab keys to navigate to the other fields in the dialog, such as Save In.

Save In

The Save In field shows the path to which the file will be saved and allows you to change the path using the up and down arrow keys to navigate to other paths; the Enter key to open a directory; and the Backspace key to go back one directory. The **Save In field** defaults to the default path for this type of file and remembers the last path you used to save this type of file. There is no softkey for directly navigating to the Save In field but you can use left tab to get here from the File/Folder List.

User specified paths are remembered when you leave and return to a Mode and are reset back to the default using Restore Mode Defaults.

File Name

The File Name field is initially loaded with an automatically generated filename specific to the appropriate Save Type. The automatically generated filename is guaranteed not to conflict with any filename currently in the directory. You may replace or modify this filename using the File Name key. See the ["Quick Save " on page 2793](#) documentation for more on the automatic file naming algorithm.

When you press the File Name key the analyzer displays the Alpha Editor. Use the knob to choose the letter to add and the front-panel Enter key to add the letter to the file name. The BK character moves you back and the FW character moves you forward in the filename. The Select key on the front panel generates a space character. When you are done entering the filename press the Done softkey. This returns back to the **File Open** dialog and menu, but does not cause the save to occur.

Save As Type

This field shows the file suffix for the type of file you have selected to save. For example, if you navigated here while saving State, "Mode state (*.state)" is in the field. If you navigated here from saving Trace, ""Mode state (*.trace)" is in the field. If you navigated here while exporting a trace data file, "Trace Data (*.csv)" is in the field. For some file types, there is more than one choice in the dropdown, which you can select by using the up and down arrow keys and Enter.

Up One Level

This key corresponds to the icon of a folder with the up arrow that is in the tool bar of the dialog. When pressed, it causes the file and folder list to navigate up one level in the directory structure. The Backspace key does the same thing.

Create New Folder

This key corresponds to the icon of a folder with the "*" that is in the tool bar of the dialog. When pressed, a new folder is created in the current directory with the name **New Folder** and you can enter a new folder name using the Alpha Editor.

Cancel

This key corresponds to the Cancel selection in the dialog. It causes the current **Save As** request to be cancelled. The ESC key does the same thing.

Key Path	Save, State
Mode	All
Notes	Brings up Save As dialog for saving a State Save Type
Initial S/W Revision	Prior to A.02.00

Edit Register Names

You may enter a custom name on any of the Register keys, to help you remember what you are using that state to save. To do this, press the Edit Register Names key, choose the register whose name you wish to edit, and then enter the desired label using the Alpha Editor or an external PC keyboard.

The maximum number of characters that can be added is 30. In most cases, 30 characters will fit on two lines of the key.

See ["More Information" on page 2675](#)

Key Path	Save, State
Mode	All
Remote Command	:MMEMory:REGister:STATe:LABel <reg number>,"label" :MMEMory:REGister:STATe:LABel? <reg number>
Example	:MMEM:REG:STAT:LAB 1,"my label"
Notes	<reg number> is an integer from 1 to 16. If the SCPI specifies an invalid register number an error message is generated, -222,"Data out of range;Invalid register label number" "label" is a string from 0 to 30 characters in length. If a label exceeds 30 characters, an error message is generated, -150,"String data error;Label clipped to 30 characters" "label" of length 0 erases the custom label and restores the default (time and date) label. E.g.: :MMEM:REG:STAT:LAB 1,""
Dependencies	N9060A-7FP or N9060B-2FP license required to edit the register names. When the feature is not licensed, sending this command generates an error, -221,"Settings conflict;Option not available"
Preset	The names are unaffected by Preset or power cycle but are set to the default label (time and date) on a "Restore System Defaults->Misc"
Initial S/W Revision	A.11.00

More Information

When you edit one of the register names, the time and date field will be replaced by the custom name.

If you delete all the characters in the custom name, it restores the default (time and date).

The register names are stored within the state files, but they are not part of the instrument state; that is, once you have edited a register name, loading a new state will not change that register name. Another consequence of this is that the names will be persistent through a power cycle. Also, if a named state file is transferred to another analyzer, it will bring its custom name along with it.

If you try to edit the name of an empty register, the analyzer will first save the state to have a file to put the name in. If you load a named state file into an analyzer with older firmware it will ignore the metadata.

The *SAV and *RCL commands will not be affected by the custom register names, nor will the MMEM commands.

Register 1 thru Register 16

Selecting any one of these register menu keys causes the State of the currently active mode to be saved to the specified Register. The registers are provided for rapid saving and recalling, since you do not need to specify a filename or navigate to a file. Each of the register menu keys annotates whether it is empty or at what date and time it was last modified. In addition, you can use the Edit Register Names key to enter custom names for each register.

Although these 16 registers are the only registers available from the front panel, there are 128 state registers available in the instrument. Registers 17–128 are only available from the SCPI interface, using the *SAV command.

There is one set of 128 state registers in the instrument, not one set for each Mode. When a state is saved, the Mode it was saved from is saved with it; then when it is recalled, the instrument switches to that Mode.

After the save completes, the corresponding register menu key annotation is updated with the date and time and the message "Register <register number> saved" is displayed.

Key Path	Save, State
Mode	All
Example	*SAV 1
Range	1–16 from front panel, 1–128 from SCPI
Readback	Date and time with seconds resolution are displayed on the key OR A custom name of up to 30 characters entered using the Edit Register Names key OR “(empty)” if no prior save operation has been performed to this register.
Initial S/W Revision	Prior to A.02.00
Modified at S/W Revision	A.11.00

Register 1 thru Register 16

Selecting any one of these register menu keys causes the State of the currently active mode to be saved to the specified Register. The registers are provided for rapid saving and recalling, since you do not need to specify a filename or navigate to a file. Each of the register menu keys annotates whether it is empty or at what date and time it was last modified. In addition, you can use the Edit Register Names key to enter custom names for each register.

Although these 16 registers are the only registers available from the front panel, there are 128 state registers available in the instrument. Registers 17–128 are only available from the SCPI interface, using the *SAV command.

There is one set of 128 state registers in the instrument, not one set for each Mode. When a state is saved, the Mode it was saved from is saved with it; then when it is recalled, the instrument switches to that Mode.

After the save completes, the corresponding register menu key annotation is updated with the date and time and the message "Register <register number> saved" is displayed.

Key Path	Save, State
Mode	All
Example	*SAV 1
Range	1–16 from front panel, 1–128 from SCPI
Readback	Date and time with seconds resolution are displayed on the key OR A custom name of up to 30 characters entered using the Edit Register Names key OR “(empty)” if no prior save operation has been performed to this register.
Initial S/W Revision	Prior to A.02.00
Modified at S/W Revision	A.11.00

Data (Export)

Exporting a data file stores data from the current measurement to mass storage files. The Export Menu only contains data types that are supported by the current measurement.

Since the commonly exported data files are in .csv format, the data can be edited by you prior to importing. This allows you to export a data file, manipulate the data in Excel (the most common PC Application for manipulating .csv files) and then import it.

Selecting an Export Data menu key will not actually cause the exporting to occur, since the analyzer still needs to know where you wish to save the data. Pressing the Save As key in this menu brings up the Save As dialog and Save As menu that allows you to specify the destination file and directory. Once a filename has been selected or entered in the Open menu, the export will occur as soon as the Save key is pressed.

Key Path	Save
Mode	All
Notes	The menu is built from whatever data types are available for the mode. So the key locations in the sub menu will vary. No SCPI command directly controls the Data Type that this key controls. The Data Type is included in the MMEM:STORe commands.
Dependencies	If a file type is not used by a certain measurement, that type is grayed out for that measurement. The key for a file type will not show at all if there are no measurements in the Mode that support it.
Preset	Is not affected by a Preset or shutdown, but is reset during Restore Mode Defaults
Readback	The data type that is currently selected
Initial S/W Revision	Prior to A.02.00

Export Trace Data

Enables you to export trace data with (optional) associated headers. Selecting this key displays a menu that enables you to choose which Trace to save (default is the selected Trace) and whether or not to save headers with the data. The header information is used by the VXA application when saved trace data is recalled, and enables it to be displayed with the same formatting and scaling that it had when saved. If headers are not saved, the scaling and format are set to default values when the trace is recalled. After making these selections, press Save As... and use the file dialog to choose a file name and format for the saved data.

Trace data can be exported in several different formats. Text and comma-separated variable (CSV) formats are useful for viewing the data or importing it to a spreadsheet program. The other formats are binary and thus more compact. Trace data files can be recalled for viewing into other VXA, LTE, LTETDD, iDEN, or 89601 measurements.

Key Path	Save, Data (Export)
Mode	VSA, LTE, LTETDD, IDEN
Remote Command	:MMEMory:STORe:TRACe:DATA TRACE1 TRACE2 TRACE3 TRACE4 TRACE5 TRACE6, "<filename>" [,CSV TXT SDF MAT4 MAT HDF5 BIN[,OFF ON 0 1]]
Example	:MMEM:STOR:TRAC:DATA TRACE1, "TRC1.TXT", TXT, ON
Notes	<p>The Save As... dialog box has the following format options when you are saving trace data:</p> <ul style="list-style-type: none"> • CSV (Comma delimited) (*.csv) • SDF (Fast) (*.sdf;*.dat) • Text (Tab delimited) (*.txt) <p>File format saved depends on selection. The appropriate file extension is appended to the filename if it is not supplied by the user.</p> <p>If the SCPI command includes just a file name, the file format is determined by the filename extension, which must be one of the choices above. *.sdf or an unrecognized extension chooses the SDF fast format. If the optional file format enumerator is included in the command, then this determines the file format and the file extension is ignored. The optional binary parameter determines if file headers are saved. The default is ON. If file headers are not wanted, use the optional "OFF" parameter.</p> <p>The optional Boolean parameter determines whether headers are saved in the file. By default the headers are saved.</p> <p>If you are not licensed to save a particular file type, then error -203.9010 is returned. If an invalid file format is specified or the file cannot be saved successfully, then error -25x is returned. If the save is successful, then advisory 0.1500 is shown.</p>
State Saved	No
Readback	(Trace 1 Trace 2 Trace 3 Trace 4 Trace 5 Trace 6)(with without) headers

Trace 1

Selects the Trace 1 register as the destination for the imported data.

Key Path	Save, Data (Export), Trace
Mode	VSA, LTE, LTETDD, IDEN

Trace 2

Selects the Trace 2 register as the destination for the imported data.

Key Path	Save, Data (Export), Trace
Mode	VSA, LTE, LTETDD, IDEN

Trace 3

Selects the Trace 3 register as the destination for the imported data.

Key Path	Save, Data (Export), Trace
Mode	VSA, LTE, LTETDD, IDEN

Trace 4

Selects the Trace 4 register as the destination for the imported data.

Key Path	Save, Data (Export), Trace
Mode	VSA, LTE, LTETDD, IDEN

Include Header

Enables you to select whether or not the saved trace data includes header information describing scaling, formatting, etc.

Key Path	Save, Data (Export), Trace
Mode	VSA, LTE, LTETDD, IDEN
State Saved	No

Measurement Results

Pressing this key selects Meas Results as the data type to be exported. Pressing the key a second time brings up the Meas Results menu, which allows you to select which **Meas Result** to save. In the Swept SA measurement, there are three types of Measurement Results files: Peak Table, Marker Table and Spectrogram.

See ["Meas Results File Contents"](#) on page 2680.

See ["Marker Table"](#) on page 2680.

See ["Peak Table"](#) on page 2683.

See ["Spectrogram"](#) on page 2686

Remote Command	:MMEMoRy:STORe:RESuLts:MTABle PTABle SPEctrogram <filename>
Example	:MMEM:STOR:RES:MTAB "myResults.csv" Saves the results from the current marker table to the file myResults.csv in the current path. :MMEM:STOR:RES:PTAB "myResults.csv" Saves the results from the current peak table to the file myResults.csv in the current path. :MMEM:STOR:RES:SPEC "myResults.csv" Saves the results from the current Spectrogram display to the file myResults.csv in the current path. The default path is My Documents\SA\data\SAN\results
Notes	If the save is initiated via SCPI, and the file already exists, the file will be overwritten. Using the C: drive is strongly discouraged, since it runs the risk of being overwritten during an instrument software upgrade. Both single and double quotes are supported for any filename parameter over SCPI.
Dependencies	If a save of Marker Table results is requested and the Marker Table is not on, no file is saved and a message is generated If a save of Peak Table results is requested and the Peak Table is not on, no file is saved and a message is generated If a save of Spectrogram results is requested and the Spectrogram is not on, no file is saved and a message is generated. The Spectrogram choice only appears if option EDP is licensed.
Preset	Not part of Preset, but is reset to Peak Table by Restore Mode Defaults. Survives a shutdown.
Initial S/W Revision	Prior to A.02.00

Meas Results File Contents

All files are .csv files. The following section details the data in each file type.

Marker Table

This section discusses the Marker Table Meas Results file format.

Imagine that, at the point where a Marker Table Meas Result is requested, the following screen is showing:

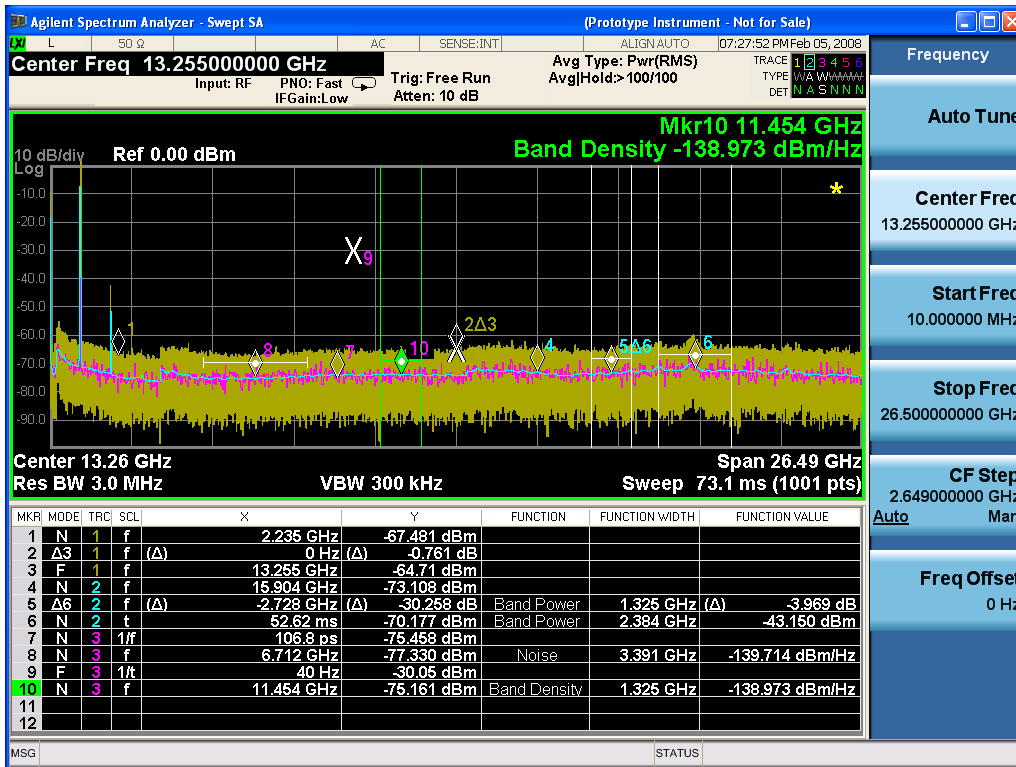

Then the Meas Results file, when opened, would show the following data:

MeasurementR result	
Swept SA	
A.01.40_R0017	N9020A
526 B25 PFR	1
P26 EA3	
Result Type	Marker Table
Ref Level	0
Number of Points	1001
Sweep Time	0.0662666 67
Start Frequency	10000000
Stop Frequency	26500000 000
Average Count	0
Average Type	LogPower (Video)
RBW	3000000

RBW Filter	Gaussian
RBW Filter BW	3dB
VBW	3000000
Sweep Type	Swept
X Axis Scale	Lin
PreAmp State	Off
PreAmp Band	Low
Trigger Source	Free
Trigger Level	1.2
Trigger Slope	Positive
Trigger Delay	1.00E-06
Phase Noise Optimization	Fast
Swept If Gain	Low
FFT If Gain	Autorange
RF Coupling	AC
FFT Width	411900
Ext Ref	10000000
Input	RF
RF Calibrator	Off
Attenuation	10
Ref Level Offset	0
External Gain	0
X Axis Units	Hz
Y Axis Units	dBm

DATA									
MKR	MODE	TRC	SCL	X	Y	FUNCTION	FUNCTION WIDTH	FUNCTION VALUE	FUNCTION UNIT
1	Normal	1	Frequency	2.2350E+09	-67.481	Off	0.0000E+00	0	None
2	Delta3	1	Frequency	0.0000E+00	-0.761	Off	0.0000E+00	0	None
3	Fixed	1	Frequency	1.3255E+10	-64.71	Off	0.0000E+00	0	None
4	Normal	2	Frequency	1.5904E+10	-73.1	Off	0.0000E+00	0	None

08									
5	Delta7	2	Frequency	- 2.7280E+ 09	- 30.2 58	Band Power	1.3250E+ 06	-3.969	dB
6	Normal	2	Time	5.2620E- 02	- 70.1 77	Band Power	2.3840E+ 06	-43.15	dBm
7	Normal	3	Period	1.0680E- 10	- 75.4 58	Off	0.0000E+ 00	0	None
8	Normal	3	Frequency	6.7120E+ 09	- 77.3 3	Noise	3.3910E+ 06	- 139.71 4	dBm/Hz
9	Fixed	3	Inverse Time	4.0000E+ 01	- 30.0 5	Off	0.0000E+ 00	0	None
10	Normal	3	Frequency	1.1454E+ 10	- 75.1 61	Band Density	1.3250E+ 06	- 138.97 3	dBm/Hz
11	Off	1	Frequency	0.0000E+ 00	0	Off	0.0000E+ 00	0	None
12	Off	1	Frequency	0.0000E+ 00	0	Off	0.0000E+ 00	0	None

The numbers appear in the file exactly as they appear onscreen. If it says 11.454 GHz onscreen, then in the file it is 11.454E+09.

The metadata header is very similar to the metadata used in the trace data .csv files. See Trace File Contents. The only new information concerns the 1-of-N fields in the marker table itself.

Peak Table

This section discusses the Peak Table Meas Results file format.

Imagine that, at the point where a Marker Table Meas Result is requested, the following screen is showing:

17 Waveform Measurement
Save

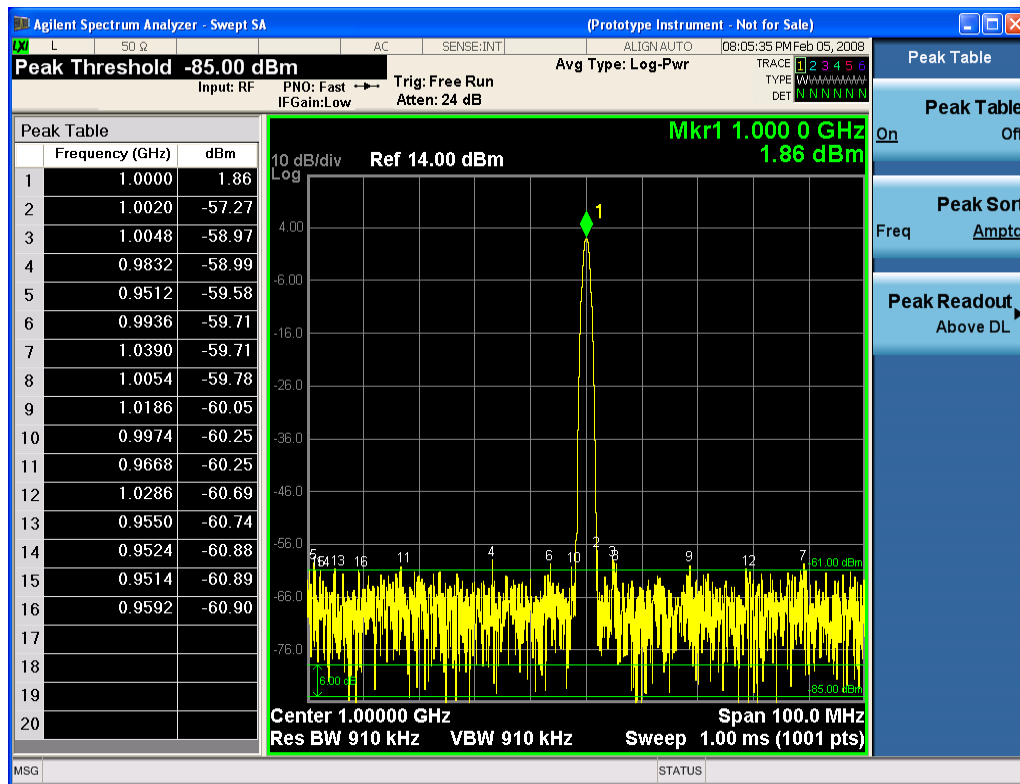

Then the Meas Results file, when opened, would show the header data (the same as for the Marker Table except that the Result Type is Peak Table) ending with a few fields of specific interest to Peak Table users:

- Peak Threshold
- Peak Threshold State (On|Off)
- Peak Excursion
- Peak Excursion State (On|Off)
- Display Line
- Peak Readout (All|AboveDL|BelowDL)
- Peak Sort (Freq|Amptd)

These fields are then followed by the data for the Peak Table itself.

Note that the label for the Frequency column changes to Time in 0 span.

Here is what the table for the above display looks like:

MeasurementResult	
Swept SA	
A.01.40_R0017	N9020A
526 B25 PFR P26 EA3	1

Result Type	Peak Table
Ref Level	0
Number of Points	1001
Sweep Time	0.066266667
Start Frequency	10000000
Stop Frequency	26500000000
Average Count	0
Average Type	LogPower(Video)
RBW	3000000
RBW Filter	Gaussian
RBW Filter BW	3dB
VBW	3000000
Sweep Type	Swept
X Axis Scale	Lin
PreAmp State	Off
PreAmp Band	Low
Trigger Source	Free
Trigger Level	1.2
Trigger Slope	Positive
Trigger Delay	1.00E-06
Phase Noise Optimization	Fast
Swept If Gain	Low
FFT If Gain	Autorange
RF Coupling	AC
FFT Width	411900
Ext Ref	10000000
Input	RF
RF Calibrator	Off
Attenuation	10
Ref Level Offset	0
External Gain	0
X Axis Units	Hz
Y Axis Units	dBm
Peak Threshold	-85
Peak Threshold State	On
Peak Excursion	6
Peak Excursion State	On

Display Line	-61	
Peak Readout	AboveDL	
Peak Sort	Amptd	
DATA		
Peak	Frequency	Amplitude
1	1.0000E+06	1.86
2	1.0020E+06	-57.27
3	1.0048E+06	-58.97
4	9.8320E+05	-58.99
5	9.5120E+05	-59.58
6	9.9360E+05	-59.71
7	1.0390E+06	-59.71
8	1.0054E+06	-59.78
9	1.1086E+06	-60.05
10	9.9740E+05	-60.25
11	9.6680E+05	-60.25
12	1.0286E+06	-60.69
13	9.5500E+05	-60.74
14	9.5240E+05	-60.88
15	9.5140E+05	-60.89
16	9.5920E+05	-60.90
17		
18		
19		
20		

Spectrogram

This section discusses the Spectrogram Results file format. The Spectrogram choice only appears if option EDP is licensed.

The Spectrogram results are the same as a Trace data export, except that instead of having just one trace's data, all 300 traces appear one after the other.

Each trace has its own data mark; the data for Spectrogram Trace 0 follows the row marked DATA, the data for Spectrogram Trace 1 follows the row marked DATA1, for Spectrogram Trace 2 follows the row marked DATA2, and so on.

Each DATA row has a timestamp in the second column (as of firmware revision A.11.01). So, for example, if Trace 0 had a relative start time of 1729.523 sec, then the first DATA row would look like this:

DATA,1729.523

And if Trace 13 had a relative start time of 100.45 sec, then the fourteenth data row would look like:

DATA13,100.453

To find the absolute time for the relative timestamps of each trace, the last row before the first DATA row gives the absolute start time of the Spectrogram, in the form YYYYMMDDHHMMSS

So, for example, if the absolute start time is 13:23:45:678 on January 30, 2012, this row would look like:

Start Time,20120130132345678

NOTE The resolution of the absolute time stored is 1 ms, which matches up with the fact that the fastest sweep time is also 1 ms. However, there is no specification for the absolute accuracy of the clock in the analyzer, nor is there any facility provided to allow the user to set this time to any particular degree of accuracy.

Traces that have not yet been filled in the Spectrogram display are empty; there is no DATA header for them. The file ends after the last non-empty trace.

Imagine that, at the point where a Spectrogram Meas Result is requested, the following screen is showing:



For the purpose of this example, we have set the Average/Hold Number to 10, thus we have only traces 0 thru 10. The Spectrogram was started at 02:28:08:700 pm on April 25, 2012 (that is, 700 ms after 2:28:08 pm), although the screen dump itself shows a different time, as it was taken ten minutes after the

Spectrogram data. Trace 0 is showing a start time of 5.30 seconds, meaning 5.3 seconds after the Spectrogram started (trace 10 has a start time of 0, as it was the first trace taken but has now rolled up into the tenth trace slot).

The Meas Results file, when opened, shows the header data and ten traces of trace data. Below is an extract from the result file for the above display. Note the start time of 20120425142808700 showing in the last row before the first DATA row, and the relative time of 5.299231048 showing in the first DATA row:

Result Type	Spectrogram
MeasResult	
Swept SA	
A.11.00.01	N9020A
503 508 513 526 ALL ALV B1C B1X B25 B2X B40 BAB BBA CR3 CRP DP2 DRD EA3 EDP EMC EP1 ERC ESC ESP EXM FSA HBA K03 LFE MPB P03 P08 P13 P26 PFR RTL RTS S40 SB1 SEC SM1 UK6 YAS YAV	1
Segment	0
Number of Points	1001
Sweep Time	0.523333333
Start Frequency	5999984415
Stop Frequency	6000009415
Average Count	0
Average Type	LogPower(Video)
RBW	240
RBW Filter	Gaussian
RBW Filter BW	3dB
VBW	240
Sweep Type	Swept
X Axis Scale	Lin
PreAmp State	Off
PreAmp Band	Low
Trigger Source	Free
Trigger Level	1.2
Trigger Slope	Positive
Trigger Delay	0
Phase Noise Optimization	Wide
Swept If Gain	Low
FFT If Gain	Autorange
RF Coupling	AC

Result Type	Spectrogram
FFT Width	411900
Ext Ref	10000000
Input	RF
RF Calibrator	Off
Attenuation	14
Ref Level Offset	0
External Gain	0
Trace Type	Clearwrite
Detector	Normal
Trace Math	Off
Trace Math Oper1	Trace5
Trace Math Oper2	Trace6
Trace Math Offset	0
Trace Name	Trace1
X Axis Units	Hz
Y Axis Units	dBm
Start Time	20120425142808700
DATA	5.299231048
5999984415	-76.34749519
5999984440	-77.28097006
5999984465	-75.32317869
5999984490	-73.64417681
5999984515	-72.67154604

- o
- o
- o

6000009315	-77.94423277
6000009340	-79.51829697
6000009365	-78.46108961
6000009390	-78.46108957
6000009415	-76.59570596
DATA2	4.708697055
5999984415	-80.98197882
5999984440	-80.98197879

5999984465	-75.83142132
5999984490	-74.02712079
5999984515	-73.57213005

○
○
○

6000009315	-75.9183103
6000009340	-79.53787488
6000009365	-78.82602191
6000009390	-78.82602188
6000009415	-76.37486709
DATA10	0
5999984415	-75.56751112
5999984440	-75.76485645
5999984465	-76.67718717
5999984490	-78.79238489
5999984515	-83.72680212

○
○
○

6000009315	-71.3942461
6000009340	-72.28308332
6000009365	-73.92684489
6000009390	-75.45548832
6000009415	-75.17904815

Save As . . .

When you press “Save As”, the analyzer brings up a Windows dialog and a menu entitled “**Save As.**” This menu allows you to navigate to the various fields in the Windows dialog without using a keyboard or mouse. The Tab and Arrow keys can also be used for dialog navigation.

See "[To File . . .](#)" on page 2810 in Save, State for a full description of this dialog and menu.

The default path for saving files is:

For all of the Trace Data Files:

My Documents\`<mode name>`\data\traces

For all of the Limit Data Files:

My Documents\`<mode name>`\data\limits

For all of the Measurement Results Data Files:

My Documents\`<mode name>`\data\`<measurement name>`\results

For all of the Capture Buffer Data Files:

My Documents\`<mode name>`\data\captureBuffer

Key Path	Save, Data
Mode	All
Notes	The key location is mode-dependent and will vary. Brings up the Save As dialog for saving a <code><mode specific></code> Save Type. The save is performed immediately and does not wait until the measurement is complete.
Initial S/W Revision	Prior to A.02.00

Screen Image

Pressing Screen Image accesses a menu of functions that enable you to specify a format and location for the saved screen image. It brings up a menu that allows you to specify the color scheme of the Screen Image (Themes) or navigate to the Save As dialog to perform the actual save.

Screen Image files contain an exact representation of the analyzer display. They cannot be loaded back onto the analyzer, but they can be loaded into your PC for use in many popular applications.

The image to be saved is actually captured when the Save front panel key is pressed, and kept in temporary storage to be used if you ask for a Screen Image save. When the Screen Image key is pressed, a "thumbnail" of the captured image is displayed, as shown below:

17 Waveform Measurement

Save

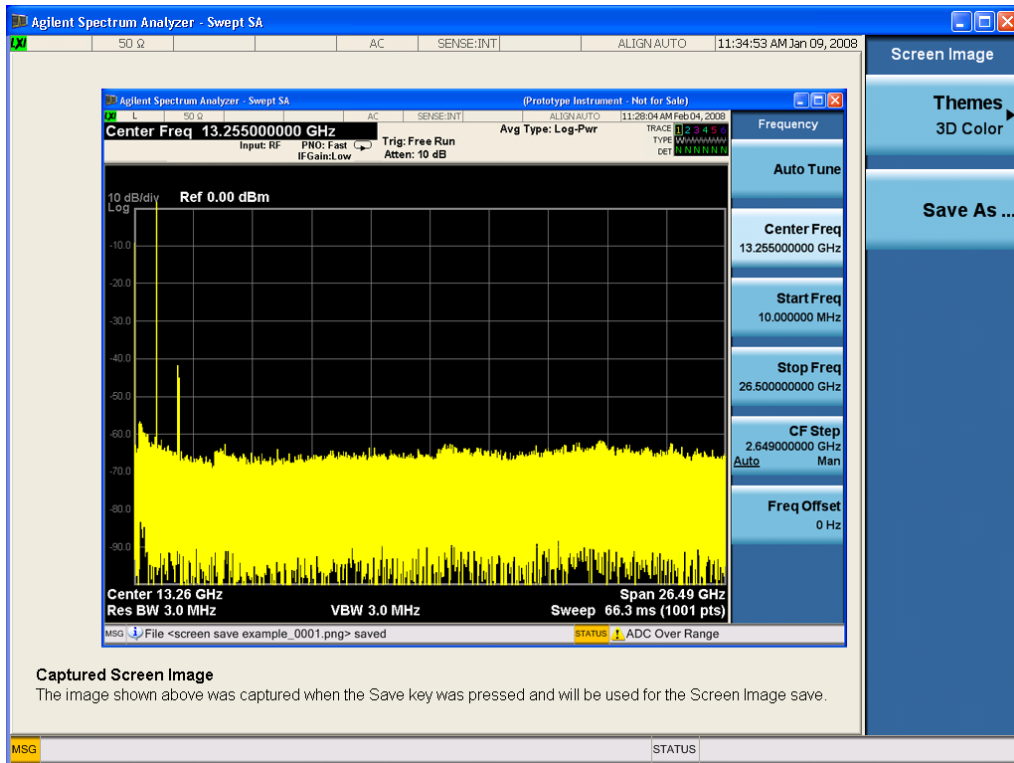

When you continue on into the Save As menu and complete the Screen Image save, the image depicted in the thumbnail is the one that gets saved, showing the menus that were on the screen before going into the Save menus. The save is performed immediately and does not wait until the measurement is complete.

After you have completed the save, the Quick Save front-panel key lets you quickly repeat the last save performed, using an auto-named file, with the current screen data.

NOTE

For versions previous to A.01.55, if you initiate a screen image save by navigating through the Save menus, the image that is saved will contain the Save menu softkeys, not the menus and the active function that were on the screen when you first pressed the Save front panel key.

Key Path	Save
Mode	All
Remote Command	:MMEMory:STORe:SCReem <filename>
Example	:MMEM:STOR:SCR "myScreen.png" This stores the current screen image in the file MyScreenFile.png in the default directory.
Initial S/W Revision	Prior to A.02.00

Themes

Accesses a menu of functions that enable you to choose the theme to be used when saving the screen image.

The **Themes** option is the same as the **Themes** option under the **Display** and **Page Setup** dialogs. It allows you to choose between themes to be used when saving the screen image.

Key Path	Save, Screen Image
Remote Command	:MMEMory:STORe:SCReen:THEMe TDColor TDMonochrome FCOLOR FMONochrome :MMEMory:STORe:SCReen:THEMe?
Example	:MMEM:STOR:SCR:THEM TDM
Preset	3D Color; Is not part of Preset, but is reset by Restore Misc Defaults or Restore System Defaults All and survives subsequent running of the modes.
Readback	3D Color 3D Mono Flat Color Flat Mono
Backwards Compatibility Notes	In ESA and PSA we offer the choice of "Reverse Bitmap" or "Reverse Metafile" when saving screen images. This is much like the "Flat Color" theme available in X-Series. Also, if you selected Reverse Bitmap AND a black & white screen image, that would be much like "Flat Monochrome". In other words, each of the X-Series themes has a similar screen image type in ESA/PSA. But they are not identical.
Initial S/W Revision	Prior to A.02.00

3D Color

Selects a standard color theme with each object filled, shaded and colored as designed.

Key Path	Save, Screen Image, Themes
Example	MMEM:STOR:SCR:THEM TDC
Readback	3D Color
Initial S/W Revision	Prior to A.02.00

3D Monochrome

Selects a format that is like 3D color but shades of gray are used instead of colors.

Key Path	Save, Screen Image, Themes
Example	MMEM:STOR:SCR:THEM TDM
Readback	3D Mono
Initial S/W Revision	Prior to A.02.00

Flat Color

Selects a format that is best when the screen is to be printed on an ink printer.

Key Path	Save, Screen Image, Themes
----------	----------------------------

Example	MMEM:STOR:SCR:THEM FCOL
Readback	Flat Color
Initial S/W Revision	Prior to A.02.00

Flat Monochrome

Selects a format that is like Flat Color. But only black is used (no colors, not even gray), and no fill.

Key Path	Save, Screen Image, Themes
Example	MMEM:STOR:SCR:THEM FMON
Readback	Flat Mono
Initial S/W Revision	Prior to A.02.00

Save As...

When you press “Save As”, the analyzer brings up a Windows dialog and a menu entitled “**Save As.**” This menu allows you to navigate to the various fields in the Windows dialog without using a keyboard or mouse. The Tab and Arrow keys can also be used for dialog navigation.

See "[To File . . .](#)" on page 2810 in Save, State for a full description of this dialog and menu.

The default path for Screen Images is

My Documents\<<mode name>\screen.

where <mode name> is the parameter used to select the mode with the INST:SEL command (for example, SA for the Spectrum Analyzer).

Key Path	Save, Screen Image
Notes	Brings up Save As dialog for saving a Screen Image Save Type
Initial S/W Revision	Prior to A.02.00

Mass Storage Catalog (Remote Command Only)

Key path	SCPI Only
Remote Command	:MMEMory:CATalog? [<directory_name>]
Notes	<p>The string must be a valid logical path.</p> <p>Queries disk usage information (drive capacity, free space available) and obtains a list of files and directories in a specified directory in the following format:</p> <p><numeric_value>,<numeric_value>,{<file_entry>}</p> <p>It returns two numeric parameters and as many strings as there are files and directories. The first parameter indicates the total amount of storage currently used in bytes. The second parameter</p>

indicates the total amount of storage available, also in bytes. The <file_entry> is a string. Each <file_entry> indicates the name, type, and size of one file in the directory list:

<file_name>,<file_type>,<file_size>

As the windows file system has an extension that indicates file type, <file_type> is always empty. <file_size> provides the size of the file in bytes. For directories, <file_entry> is surrounded by square brackets and both <file_type> and <file_size> are empty

Initial S/W Revision Prior to A.02.00

Mass Storage Change Directory (Remote Command Only)

Key path SCPI Only

Remote Command :MMEMory:CDIRectory [<directory_name>]
 :MMEMory:CDIRectory?

Notes The string must be a valid logical path.

Changes the default directory for a mass memory file system. The <directory_name> parameter is a string. If no parameter is specified, the directory is set to the *RST value.

At *RST, this value is set to the default user data storage area, that is defined as System.Environment.SpecialFolder.Personal.

Query returns full path of the default directory.

Initial S/W Revision Prior to A.02.00

Mass Storage Copy (Remote Command Only)

Key path SCPI Only

Remote Command :MMEMory:COPY <string>,<string>[,<string>,<string>]

Notes The string must be a valid logical path.

Copies an existing file to a new file or an existing directory to a new directory.

Two forms of parameters are allowed. The first form has two parameters. In this form, the first parameter specifies the source, and the second parameter specifies the destination.

The second form has four parameters. In this form, the first and third parameters specify the source. The second and fourth parameters specify the directories. The first pair of parameters specifies the source. The second pair specifies the destination. An error is generated if the source doesn't exist or the destination file already exists.

This command will generate an "access denied" error if the destination is a restricted folder (e.g., C:\Windows) and the current user does not have Power User or Administrator privileges.

Mass Storage Device Copy (Remote Command Only)

This command transfers data to/from a file and a peripheral device.

Key path	SCPI Only
Remote Command	:MMEMory:COpy:DEvice <source_string>,<dest_string>
Notes	The strings must be a valid logical path or a valid device keyword. If the dest_string is a device keyword, the data is copied from the source file to the device. If the source_string is a device keyword, the data is copied to the source file from the device. Valid device keywords are: SNS (smart noise source) An error is generated if the file or device is not found.

Mass Storage Delete (Remote Command Only)

Key path	SCPI Only
Remote Command	:MMEMory:DELeTe <file_name>[,<directory_name>]
Notes	The string must be a valid logical path. Removes a file from the specified directory. The <file_name> parameter specifies the file name to be removed. This command will generate an "access denied" error if the file is in a restricted folder (e.g., C:\Windows) and the current user does not have Power User or Administrator privileges.
Initial S/W Revision	Prior to A.02.00

Mass Storage Data (Remote Command Only)

Creates a file containing the specified data OR queries the data from an existing file.

Key path	SCPI Only
Remote Command	:MMEMory:DATA <file_name>, <data> :MMEMory:DATA? <file_name>
Notes	The string must be a valid logical path. The command form is MMEMory:DATA <file_name>,<data>. It loads <data> into the file <file_name>. <data> is in 488.2 block format. <file_name> is string data. The query form is MMEMory:DATA? <file_name> with the response being the associated <data> in block format.
Initial S/W Revision	Prior to A.02.00

Mass Storage Make Directory (Remote Command Only)

Key path	SCPI Only
Remote Command	:MMEMory:MDIRectory <directory_name>
Notes	The string must be a valid logical path. Creates a new directory. The <directory_name> parameter specifies the name to be created.

This command will generate an “access denied” error if the new directory would be in a restricted folder (e.g., C:\Windows) and the current user does not have Power User or Administrator privileges.

Initial S/W Revision Prior to A.02.00

Mass Storage Move (Remote Command Only)

Key path SCPI Only

Remote Command :MMEMory:MOVE <string>,<string>[,<string>,<string>]

Notes

The string must be a valid logical path.

Moves an existing file to a new file or an existing directory to a new directory.

Two forms of parameters are allowed. The first form has two parameters. In this form, the first parameter specifies the source, and the second parameter specifies the destination.

The second form has four parameters. In this form, the first and third parameters specify the source. The second and fourth parameters specify the directories. The first pair of parameters specifies the source. The second pair specifies the destination. An error is generated if the source doesn't exist or the destination file already exists.

This command will generate an “access denied” error if the destination is a restricted folder (e.g., C:\Windows) and the current user does not have Power User or Administrator privileges.

Initial S/W Revision Prior to A.02.00

Mass Storage Remove Directory (Remote Command Only)

Key path SCPI Only

Remote Command :MMEMory:RDIRECTory <directory_name>

Notes

The string must be a valid logical path.

Removes a directory. The <directory_name> parameter specifies the directory name to be removed. All files and directories under the specified directory shall also be removed.

This command will generate an “access denied” error if the folder is a restricted folder (e.g., C:\Windows) or is in a restricted folder and the current user does not have Power User or Administrator privileges.

Initial S/W Revision Prior to A.02.00

Single (Single Measurement/Sweep)

Sets the analyzer for Single measurement operation. The single/continuous state is Meas Global, so the setting will affect all the measurements. If you are Paused, pressing Single does a Resume.

See ["More Information" on page 2698](#)

Key Path	Front-panel key
Example	:INIT:CONT OFF
Notes	See Cont key description.
Backwards Compatibility Notes	<p>For Spectrum Analysis mode in ESA and PSA, the Single hardkey and the INITiate:IMM switched from continuous measurement to single measurement and restarted sweeps and averages (displayed average count reset to 1), but did not restart Max Hold and Min Hold. In the X-Series, the Single hardkey and the INITiate:IMM command initiate a sweep/ measurement/ average sequence/hold sequence including MaxHold and MinHold.</p> <p>For Spectrum Analysis mode in ESA and PSA, the Single hardkey restarted the sweep regardless of whether or not you were in an active sweep or sweep sequence. In the X-Series, Restart does this but Single only restarts the sweep or sweep sequence if you are in the idle state.</p> <p>INIT[:IMM] in ESA & PSA Spectrum Analysis Mode does an implied ABORT. In some other PSA Modes, INIT[:IMM] is ignored if not in the idle state. . The X-Series follows the ESA/PSA SA Mode model, which may cause some Modes to have compatibility problems.</p>
Initial S/W Revision	Prior to A.02.00

More Information

See ["Restart" on page 2807](#) for details on the INIT:IMMEDIATE (Restart) function.

If you are already in single sweep, the INIT:CONT OFF command has no effect.

If you are already in Single Sweep, then pressing the Single key in the middle of a sweep does not restart the sweep or sequence. Similarly, pressing the Single key does not restart the sweep or sequence if the sweep is not in the idle state (for example, if you are taking a very slow sweep, or the analyzer is waiting for a trigger). Instead, it results in a message. "Already in Single, press Restart to initiate a new sweep or sequence". Even though pressing the Single key in the middle of a sweep does not restart the sweep, sending INIT:IMMEDIATE does reset it.

To take one more sweep without resetting the average count, increment the average count by 1, by pressing the step up key while **Average/Hold Number** is the active function, or sending the remote command CALC:AVER:TCON UP.

Source

There is no Source control functionality for this measurement. When this key is pressed, the screen either displays a blank menu, or the previously-selected menu remains unchanged.

Key Path	Front-panel key
----------	-----------------

Span X Scale

Accesses a menu of functions that enable you to set the horizontal scale parameters.

Key Path	Front-panel key
Initial S/W Revision	Prior to A.02.00

Ref Value

Sets the reference value for time on the horizontal axis. When Auto Scaling is set to On, the displayed plots use a Scale/Div value determined by the analyzer, based on the measurement result.

Key Path	SPAN X Scale
Mode	BASIC, PNOISE, WCDMA, C2K, GSM, WIMAXOFDMA, TDSCDMA, 1XEVD0, DVB, DTMB, ISDBT, CMMB, LTE, LTETDD, DCATV, WLAN, MSR,LTEATDD, LTEAFDD
Remote Command	:DISPlay:WAVeform:VIEW[1] 2:WINDow[1]:TRACe:X[:SCALE]:RLEVel <time> :DISPlay:WAVeform:VIEW[1] 2:WINDow[1]:TRACe:X[:SCALE]:RLEVel?
Example	DISP:WAV:VIEW:WIND:TRAC:X:RLEV 10 ms DISP:WAV:VIEW:WIND:TRAC:X:RLEV?
Notes	You must be in a mode that includes the Waveform measurement to use this command. Use INSTRument:SElect to set the mode.
Couplings	If Auto Scaling is set to On, this value is automatically determined by the measurement result. When you set this value manually, Auto Scaling automatically changes to Off.
Preset	0.00 s
State Saved	Saved in instrument state.
Min	-1.000 s
Max	10.00 s
Initial S/W Revision	Prior to A.02.00
Modified at S/W Revision	A.03.00

Scale/Div

Sets the horizontal scale by changing a time value per division.

Key Path	SPAN X Scale
Mode	BASIC, PNOISE, WCDMA, C2K, GSM, WIMAXOFDMA, TDSCDMA, 1XEVD0, DVB, DTMB, ISDBT, CMMB, LTE, LTETDD, DCATV, WLAN, MSR,LTEATDD, LTEAFDD
Remote Command	:DISPlay:WAVeform:VIEW[1] 2:WINDow[1]:TRACe:X[:SCALE]:PDIVision <time> :DISPlay:WAVeform:VIEW[1] 2:WINDow[1]:TRACe:X[:SCALE]:PDIVision?
Example	DISP:WAV:VIEW:WIND:TRAC:X:PDIV 500 us DISP:WAV:VIEW:WIND:TRAC:X:PDIV?

Notes	You must be in a mode that includes the Waveform measurement to use this command. Use INSTRument:SElect to set the mode.
Couplings	If Auto Scaling is set to On, this value is automatically determined by the measurement result. When you set this value manually, Auto Scaling automatically changes to Off.
Preset	All except the following list: 200.0 us LTEAFDD, LTEATDD: 1.000 ms LTETDD: 1.000 ms
State Saved	Saved in instrument state.
Min	1.000 ns
Max	320 s
Initial S/W Revision	Prior to A.02.00
Modified at S/W Revision	A.03.00, A.14.00

Ref Position

Sets the reference position for the X axis to Left, Center or Right.

Key Path	SPAN X Scale
Mode	BASIC, PNOISE, WCDMA, C2K, GSM, WIMAXOFDMA, TDSCDMA, 1XEVD0, DVB, DTMB, ISDBT, CMMB, LTE, LTETDD, DCATV, WLAN, MSR,LTEATDD, LTEAFDD
Remote Command	:DISPlay:WAVeform:VIEW[1] 2:WINDow[1]:TRACe:X[:SCALe]:RPOSition LEFT CENTER RIGHT :DISPlay:WAVeform:VIEW[1] 2:WINDow[1]:TRACe:X[:SCALe]:RPOSition?
Example	DISP:WAV:VIEW:WIND:TRAC:X:RPOS LEFT DISP:WAV:VIEW:WIND:TRAC:X:RPOS?
Notes	Allows you to set the reference position to Left, Ctr (center) or Right. You must be in a mode that includes the Waveform measurement to use this command. Use INSTRument:SElect to set the mode.
Preset	LEFT
State Saved	Saved in instrument state.
Range	Left Ctr Right
Initial S/W Revision	Prior to A.02.00
Modified at S/W Revision	A.03.00

Auto Scaling

Toggles the scale coupling function between On and Off.

Key Path	SPAN X Scale
Mode	BASIC, PNOISE, WCDMA, C2K, GSM, WIMAXOFDMA, TDSCDMA, 1XEVD0, DVB, DTMB, ISDBT, CM MB, LTE, LTETDD, DCATV, WLAN, MSR,LTEATDD, LTEAFDD
Remote Command	:DISPlay:WAVeform:VIEW[1] 2:WINDow[1]:TRACe:X[:SCALE]:COUPle 0 1 OFF ON :DISPlay:WAVeform:VIEW[1] 2:WINDow[1]:TRACe:X[:SCALE]:COUPle?
Example	DISP:WAV:VIEW:WIND:TRAC:X:COUP ON DISP:WAV:VIEW:WIND:TRAC:X:COUP?
Notes	You must be in a mode that includes the Waveform measurement to use this command. Use INSTRument:SElect to set the mode.
Couplings	When Auto Scaling is On and the Restart front-panel key is pressed, this function automatically determines the scale per division and reference values based on the measurement results. When you set a value to either Scale/Div or Ref Value manually, Auto Scaling automatically changes to Off.
Preset	1
State Saved	Saved in instrument state.
Range	On Off
Initial S/W Revision	Prior to A.02.00
Modified at S/W Revision	A.03.00

Sweep/Control

Accesses a menu that enables you to configure the Sweep and Control functions of the analyzer, such as Sweep Time and Gating.

Key Path	Front-panel key
Initial S/W Revision	Prior to A.02.00

Pause/Resume

Pauses a measurement after the current data acquisition is complete.

When Paused, the label on the key changes to Resume. Pressing Resume un-pauses the measurement. When you are Paused, pressing Restart, Single or Cont does a Resume.

Key Path	Sweep/Control
Remote Command	:INITiate:PAUSE
Dependencies	Grayed out in Measurements that do not support Pausing. Blanked in Modes that do not support Pausing.
Initial S/W Revision	Prior to A.02.00

Key Path	Sweep/Control
Remote Command	:INITiate:RESume
Dependencies	Grayed out in Measurements that do not support Pausing. Blanked in Modes that do not support Pausing.
Initial S/W Revision	Prior to A.02.00

Abort (Remote Command Only)

This command is used to stop the current measurement. It aborts the current measurement as quickly as possible, resets the sweep and trigger systems, and puts the measurement into an "idle" state. If the analyzer is in the process of aligning when ABORT is sent, the alignment finishes before the abort function is performed. So ABORT does not abort an alignment.

If the analyzer is set for Continuous measurement, it sets up the measurement and initiates a new data measurement sequence with a new data acquisition (sweep) taken once the trigger condition is met.

If the analyzer is set for Single measurement, it remains in the "idle" state until an :INIT:IMM command is received.

Remote Command	:ABORt
Example	:ABOR

Notes	If :INITiate:CONTinuous is ON, then a new continuous measurement will start immediately, with sweep (data acquisition) occurring once the trigger condition has been met. If :INITiate:CONTinuous is OFF, then :INITiate:IMMEDIATE is used to start a single measurement; with sweep (data acquisition) occurring once the trigger condition has been met.
Dependencies	For continuous measurement, ABORt is equivalent to the Restart key. Not all measurements support the abort command.
Status Bits/OPC dependencies	The STATus:OPERation register bits 0 through 8 are cleared. The STATus:QUEStionable register bit 9 (INTegrity sum) is cleared. Since all the bits that feed into OPC are cleared by the ABORt, the ABORt will cause the *OPC query to return true.
Initial S/W Revision	Prior to A.02.00

System

See "System" on page 366

Trace/Detector

There is no Trace/Detector functionality supported in the Waveform measurement. The front-panel key displays a blank menu when pressed.

Key Path	Front-panel key
Initial S/W Revision	Prior to A.02.00

Trigger

See ["Trigger" on page 438](#)

Free Run

See ["Free Run " on page 445](#)

Video

See ["Video \(IF Envelope\) " on page 446](#)

Trigger Level

See ["Trigger Level " on page 446](#)

Trig Slope

See ["Trig Slope " on page 447](#)

Trig Delay

See ["Trig Delay " on page 448](#)

Line

See ["Line " on page 2503](#)

Trig Slope

See ["Trig Slope " on page 2503](#)

Trig Delay

See ["Trig Delay " on page 450](#)

External 1

See ["External 1 " on page 2516](#)

Trigger Level

See ["Trigger Level " on page 2516](#)

Trig Slope

See ["Trig Slope " on page 2517](#)

Trig Delay

See ["Trig Delay " on page 453](#)

Zero Span Delay Comp

See ["Zero Span Delay Comp On/Off" on page 2505](#)

External 2

See ["External 2 "](#) on page 2518

Trigger Level

See ["Trigger Level "](#) on page 2518

Trig Slope

See ["Trig Slope "](#) on page 2519

Trig Delay

See ["Trig Delay "](#) on page 455

Zero Span Delay Comp

See ["Zero Span Delay Comp On/Off"](#) on page 2507

RF Burst

See ["RF Burst "](#) on page 2519

Absolute Trigger

See ["Absolute Trigger Level"](#) on page 2520

Relative Trigger

See ["Relative Trigger Level"](#) on page 2509

Trig Slope

See ["Trigger Slope "](#) on page 2521

Trig Delay

See ["Trig Delay "](#) on page 460

Periodic Timer

See ["Periodic Timer \(Frame Trigger\) "](#) on page 2511

Period

See ["Period "](#) on page 2512

Offset

See ["Offset "](#) on page 2513

Offset Adjust (Remote Command Only)

See ["Offset Adjust \(Remote Command Only\)"](#) on page 2514

Reset Offset Display

See "Reset Offset Display " on page 2515

Sync Source

See "Sync Source " on page 2515

Off

See "Off " on page 2516

External 1

See "External 1 " on page 2516

Trigger Level

See "Trigger Level " on page 2516

Trig Slope

See "Trig Slope " on page 2517

External 2

See "External 2 " on page 2518

Trigger Level

See "Trigger Level " on page 2518

Trig Slope

See "Trig Slope " on page 2519

RF Burst

See "RF Burst " on page 2519

Absolute Trigger

See "Absolute Trigger Level" on page 2520

Trig Slope

See "Trigger Slope " on page 2521

Trig Delay

See "Trig Delay" on page 470

Auto/Holdoff

See "Auto/Holdoff " on page 471

Auto Trig

See "Auto Trig " on page 471

Trig Holdoff

See ["Trig Holdoff"](#) on page 472

Holdoff Type

See ["Holdoff Type"](#) on page 472

Baseband I/Q

See [___](#) on page X

I/Q Mag

See [___](#) on page X

Trigger Level

See [___](#) on page X

Trig Slope

See [___](#) on page X

Trig Delay

See [___](#) on page X

I

See [___](#) on page X

Trigger Level

See [___](#) on page X

Trig Slope

See [___](#) on page X

Trig Delay

See [___](#) on page X

Q

See [___](#) on page X

Trigger Level

See [___](#) on page X

Trig Slope

See [___](#) on page X

Trig Delay

See ___ on page X

Input I

See ___ on page X

Trigger Level

See ___ on page X

Trig Slope

See ___ on page X

Trig Delay

See ___ on page X

Input Q

See ___ on page X

Trigger Level

See ___ on page X

Trig Slope

See ___ on page X

Trig Delay

See ___ on page X

Aux Channel Center Freq

See ___ on page X

Trigger Level

See ___ on page X

Trig Slope

See ___ on page X

Trig Delay

See ___ on page X

Trigger Center Freq

See ___ on page X

Trigger BW

See ___ on page X

User Preset

Accesses a menu that gives you the following three choices:

- User Preset – recalls a state previously saved using the Save User Preset function.
- User Preset All Modes – presets all of the modes in the analyzer
- Save User Preset– saves the current state for the current mode

Key Path	Front-panel key
Backwards Compatibility Notes	<p>User Preset is actually loading a state, and in legacy analyzers, it was possible to load a state without affecting the trace data, limit lines or correction data. Similarly it was possible to do a User Preset without affecting the trace data, limit lines or correction data.</p> <p>In the X-Series, “state” always includes all of this data; so whenever state is loaded, or User Preset is executed, all of the traces, limit lines and corrections are affected. Although this differs from previous behavior, it is desirable behavior, and should not cause adverse issues for users.</p> <p>On ESA and PSA, User Preset affected the entire instrument’s state. In the X-Series, User Preset only recalls the state for the active mode. There is a User Preset file for each mode. User Preset can never cause a mode switch as it can in legacy analyzers. If you want to recall all modes to their user preset file state, you will need to do a User Preset after mode switching into each mode.</p> <p>User Preset recalls mode state which can now include data like traces; whereas on ESA and PSA, User Preset did not affect data.</p>
Initial S/W Revision	Prior to A.02.00

User Preset

User Preset sets the state of the currently active mode back to the state that was previously saved for this mode using the Save User Preset menu key or the SCPI command, SYST:PRES:USER:SAV. It not only recalls the Mode Preset settings, but it also recalls all of the mode persistent settings, and the Input/Output system setting that existed at the time Save User Preset was executed.

If a Save User Preset has not been done at any time, User Preset recalls the default user preset file for the currently active mode. The default user preset files are created if, at power-on, a mode detects there is no user preset file. There will never be a scenario when there is no user preset file to restore. For each mode, the default user preset state is the same state that would be saved if a Save User Preset is performed in each mode right after doing a Restore Mode Default and after a Restore Input/Output Defaults.

The User Preset function does the following:

- Aborts the currently running measurement.
- Sets the mode State to the values defined by Save User Preset.
- Makes the saved measurement for the currently running mode the active measurement.
- Brings up the saved menu for the power-on mode.
- Clears the input and output buffers.
- Sets the Status Byte to 0.

Key Path	User Preset
Remote Command	:SYSTem:PRESet:USER
Example	:SYST:PRES:USER:SAVE:SYST:PRES:USER
Notes	:SYST:PRES:USER:SAVE is used to save the current state as the user preset state. Clears all pending OPC bits. The Status Byte is set to 0. Pressing the User Preset front-panel key while already in the User Preset menu will cause the User Preset to get executed
Couplings	A user preset will cause the currently running measurement to be aborted and cause the saved measurement to be active. Recalling a User Preset file has the same issues that recalling a Save State file has. Some settings may need to be limited and therefore re-coupled, since the capabilities of the mode may have changes when the User Preset file was last saved.
Initial S/W Revision	Prior to A.02.00

User Preset All Modes

Recalls all of the User Preset files for each mode, switches to the power-on mode, and activates the saved measurement from the power-on mode User Preset file.

NOTE

When the instrument is secured, all of the user preset files are converted back to their default user preset files.

The User Preset function does the following:

- Aborts the currently running measurement.
- Switches the Mode to the power-on mode.
- Restores the User Preset files for each mode.
- Makes the saved measurement for the power-on mode the active measurement.
- Brings up the saved menu for the power-on mode.
- Clears the input and output buffers.
- Sets the Status Byte to 0.

Key Path	User Preset
Remote Command	:SYSTem:PRESet:USER:ALL
Example	:SYST:PRES:USER:SAVE:SYST:PRES:USER:ALL
Notes	Clears all pending OPC bits. The Status Byte is set to 0. :SYST:PRES:USER:SAVE is used to save the current state as the user preset state.
Couplings	A user preset will cause the currently running measurement to be aborted, cause a mode switch to the power-on mode, and cause the saved measurement to be active in the power-on mode. Recalling a User Preset file has the same issues that recalling a Save State file has. Some settings may need to be limited and therefore re-coupled, since the capabilities of the mode may have changes when the User Preset file was last saved.
Initial S/W Revision	Prior to A.02.00

Save User Preset

Saves the currently active mode and its State. You can recall this User Preset file by pressing the User Preset menu key or sending the SYST:PRES:USER remote command. This same state is also saved by the Save State function.

Key Path	User Preset
Remote Command	:SYSTem:PRESet:USER:SAVE
Example	:SYST:PRES:USER:SAVE
Notes	:SYST:PRES:SAVE creates the same file as if the user requested a *SAV or a MMEM:STOR:STAT, except User Preset Save does not allow the user to specify the filename or the location of the file.
Initial S/W Revision	Prior to A.02.00

View/Display

Accesses a menu of functions that enable you to set up and control the display parameters for the current measurement.

This topic contains the following sections:

["View Selection by name \(Remote Command Only\)" on page 2715](#)

["View Selection by number \(Remote Command Only\)" on page 2715](#)

View Selection by name (Remote Command Only)

Selects the results view.

Key Path	View/Display
Mode	BASIC, PNOISE, WCDMA, C2K, GSM, WIMAXOFDMA, TDSCDMA, 1XEVDO, DVB, DTMB, ISDBT, CMMB, LTE, LTE4G, DCATV, WLAN, MSR, LTE4G, LTE4G
Remote Command	:DISPlay:WAVeform:VIEW[:SElect] RFENvelope IQ :DISPlay:WAVeform:VIEW[:SElect]?
Example	DISP:WAV:VIEW RFEN DISP:WAV:VIEW?
Notes	You must be in a mode that includes the Waveform measurement to use this command. Use INSTRUMENT:SElect to set the mode.
Preset	RFENvelope
State Saved	Saved in instrument state.
Range	RF Envelope IQ Waveform
Initial S/W Revision	Prior to A.02.00
Modified at S/W Revision	A.03.00

View Selection by number (Remote Command Only)

Displays the numeric values of the measurement results.

Mode	BASIC, PNOISE, WCDMA, C2K, GSM, WIMAXOFDMA, TDSCDMA, 1XEVDO, DVB, DTMB, ISDBT, CMMB, LTE, LTE4G, DCATV, WLAN, MSR, LTE4G, LTE4G
Remote Command	:DISPlay:WAVeform:VIEW:NSElect <integer> :DISPlay:WAVeform:VIEW:NSElect?
Example	DISP:WAV:VIEW:NSEL 1 DISP:WAV:VIEW:NSEL?
Notes	You must be in a mode that includes the Waveform measurement to use this command. Use INSTRUMENT:SElect to set the mode.
Preset	1
State Saved	Saved in instrument state.

Min	1
Max	2
Initial S/W Revision	Prior to A.02.00
Modified at S/W Revision	A.03.00

Key Path	Front-panel key
Initial S/W Revision	Prior to A.02.00

Display

The Display menu is common to most measurements, and is used for configuring items on the display. Some Display menu settings apply to all the measurements in a mode, and some only to the current measurement. Those under the System Display Settings key apply to all measurements in all modes.

Key Path	Display
Key Path	View/Display
Initial S/W Revision	Prior to A.02.00

Annotation

Turns on and off various parts of the display annotation. The annotation is divided up into four categories:

1. Meas Bar: This is the measurement bar at the top of the screen. It does not include the settings panel or the Active Function. Turning off the Meas Bar turns off the settings panel and the Active Function. When the Meas Bar is off, the graticule area expands to fill the area formerly occupied by the Meas Bar.
2. Screen Annotation: this is the annotation and annunciation around the graticule, including any annotation on lines (such as the display line, the threshold line, etc.) This does NOT include the marker number or the N dB result. When off, the graticule expands to fill the entire graticule area.
3. Trace annotation: these are the labels on the traces, showing their detector (or their math mode).
4. Active Function annotation: this is the active function display in the meas bar, and all of the active function values displayed on softkeys.

See the figure below. Each type of annotation can be turned on and off individually.

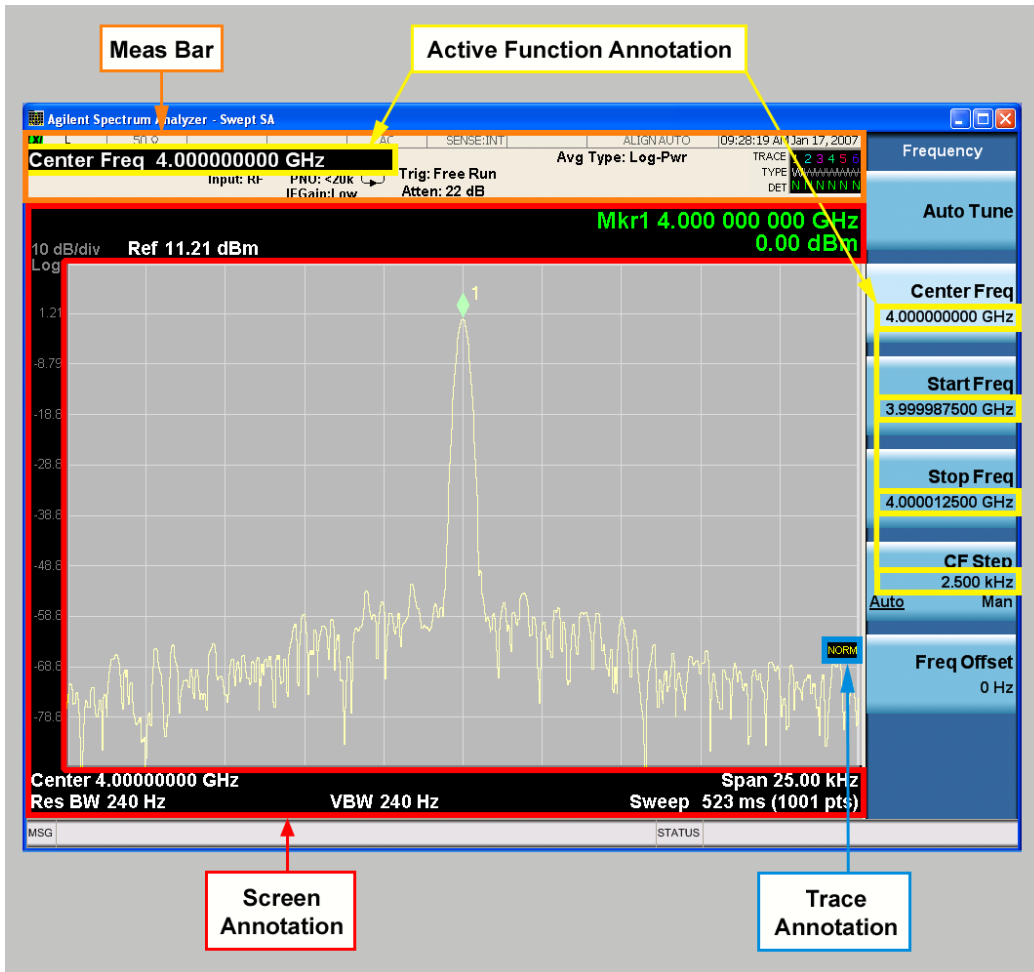

Key Path	View/Display, Display
Initial S/W Revision	Prior to A.02.00

Meas Bar On/Off

This function turns the Measurement Bar on and off, including the settings panel. When off, the graticule area expands to fill the area formerly occupied by the Measurement Bar.

Key Path	View/Display, Display, Annotation
Remote Command	:DISPlay:ANNotation:MBAR[:STATE] OFF ON 0 1 :DISPlay:ANNotation:MBAR[:STATE]?
Example	DISP:ANN:MBAR OFF
Dependencies	Grayed out and forced to OFF when System Display Settings, Annotation is set to Off.
Preset	On This should remain Off through a Preset when System DisplaySettings, Annotation is set to Off.
State Saved	Saved in instrument state.
Initial S/W Revision	Prior to A.02.00

Screen

This controls the display of the annunciation and annotation around the graticule, including any annotation on lines (such as the display line, the threshold line, etc.) and the y-axis annotation. This does NOT include marker annotation (or the N dB result). When off, the graticule expands to fill the entire graticule area, leaving only the 1.5% gap above the graticule as described in the Trace/Detector chapter.

Key Path	View/Display, Display, Annotation
Remote Command	:DISPlay:ANNotation:SCReen[:STATe] OFF ON 0 1 :DISPlay:ANNotation:SCReen[:STATe]?
Example	DISP:ANN:SCR OFF
Dependencies	Grayed-out and forced to OFF when System Display Settings, Annotation is set to Off.
Preset	On This should remain Off through a Preset when System DisplaySettings, Annotation is set to Off
State Saved	Saved in instrument state.
Initial S/W Revision	Prior to A.02.00

Active Function Values On/Off

Turns on and off the active function display in the Meas Bar, and all of the active function values displayed on the softkeys.

Note that all of the softkeys that have active functions have these numeric values blanked when this function is on. This is a security feature..

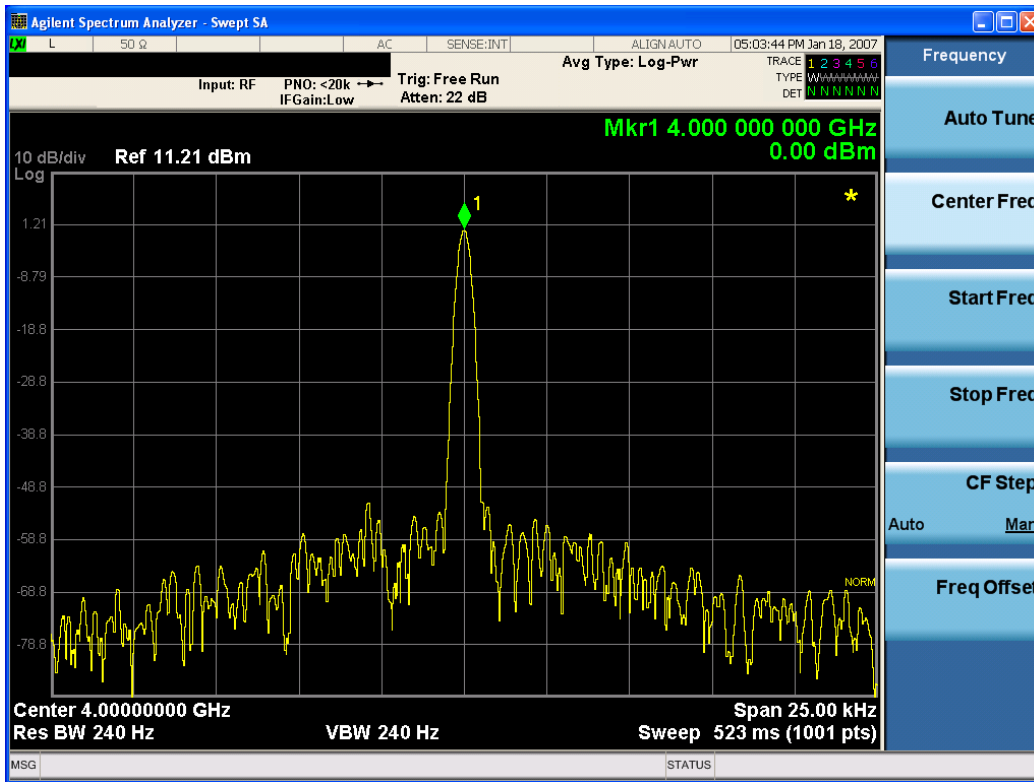

Key Path	View/Display, Display, Annotation
Remote Command	:DISPlay:ACTivefunc[:STATE] ON OFF 1 0 :DISPlay:ACTivefunc[:STATE]?
Example	DISP:ACT OFF
Dependencies	Grayed out and forced to OFF when System Display Settings, Annotation is set to Off.
Preset	On This should remain Off through a Preset when System DisplaySettings, Annotation is set to Off
State Saved	Saved in instrument state.
Initial S/W Revision	Prior to A.02.00

Title

Displays menu keys that enable you to change or clear a title on your display.

Key Path	View/Display, Display
Initial S/W Revision	Prior to A.02.00

Change Title

Writes a title into the "measurement name" field in the banner, for example, "Swept SA".

Press Change Title to enter a new title through the alpha editor. Press Enter or Return to complete the entry. Press ESC to cancel the entry and preserve your existing title.

The display title will replace the measurement name. It remains for this measurement until you press Change Title again, or you recall a state, or a Preset is performed. A title can also be cleared by pressing Title, Clear Title.

NOTE

Notice the inclusion of the <measurement> parameter in the command below. Because each measurement remembers the Display Title, the command must be qualified with the measurement name. For the Swept SA measurement this is not the case; no <measurement> parameter is used when changing the Display Title for the Swept SA measurement.

Key Path	View/Display, Display, Title
Mode	All
Remote Command	:DISPlay:<measurement>:ANNotation:TITLe:DATA <string> :DISPlay:<measurement>:ANNotation:TITLe:DATA?
Example	DISP:ANN:TITL:DATA "This Is My Title" This example is for the Swept SA measurement in the Spectrum Analyzer mode. The SANalyzer <measurement> name is not used. DISP:ACP:ANN:TITL:DATA "This Is My Title" This example is for Measurements other than Swept SA. Both set the title to: This Is My Title
Notes	Pressing this key cancels any active function. When a title is edited the previous title remains intact (it is not cleared) and the cursor goes at the end so that characters can be added or BKSP can be used to go back over previous characters.
Preset	No title (measurement name instead)
State Saved	Saved in instrument state.
Initial S/W Revision	Prior to A.02.00

Clear Title

Clears a title from the front-panel display. Once cleared, the title cannot be retrieved. After the title is cleared, the current Measurement Name replaces it in the title bar.

Key Path	View/Display, Display, Title
Example	The following commands clear the title and restore the measurement's original title: DISP:ANN:TITL:DATA "" This example is for the Swept SA measurement in the Spectrum Analyzer mode. The SANalyzer <measurement> name is not used. DISP:ACP:ANN:TITL:DATA "" This example is for ACP; in measurements other than Swept SA the measurement name is required.
Notes	Uses the :DISPlay:<measurement>:ANNotation:TITLe:DATA <string> command with an empty string (in the Swept SA, the <measurement> is omitted).
Preset	Performed on Preset.
Initial S/W Revision	Prior to A.02.00

Graticule

Pressing Graticule turns the display graticule On or Off. It also turns the graticule y-axis annotation on and off.

Key Path	View/Display, Display
Remote Command	:DISPlay:WINDow[1]:TRACe:GRATicule:GRID[:STATe] OFF ON 0 1 :DISPlay:WINDow[1]:TRACe:GRATicule:GRID[:STATe]?
Example	DISP:WIND:TRAC:GRAT:GRID OFF
Notes	The graticule is the set of horizontal and vertical lines that make up the grid/divisions for the x-axis and y-axis.
Preset	On
State Saved	Saved in instrument state
Initial S/W Revision	Prior to A.02.00

System Display Settings

These settings are "Mode Global" – they affect all modes and measurements and are reset only by Restore Misc Defaults or Restore System Defaults under System.

Key Path	View/Display, Display
Initial S/W Revision	Prior to A.02.00

Annotation Local Settings

This is a Mode Global override of the meas local annotation settings. When it is All Off, it forces ScreenAnnotation, Meas Bar, Trace, and Active Function Values settings to be OFF for all measurements in all modes. This provides the security based "annotation off" function of previous analyzers; hence it uses the legacy SCPI command.

When it is All Off, the Screen, Meas Bar, Trace, and Active Function Values keys under the Display, Annotation menu are grayed out and forced to Off. When Local Settings is selected, you are able to set the local annotation settings on a measurement by measurement basis.

Key Path	View/Display, Display, System Display Settings
Remote Command	:DISPlay:WINDow[1]:ANNOtation[:ALL] OFF ON 0 1 :DISPlay:WINDow[1]:ANNOtation[:ALL]?
Example	:DISP:WIND:ANN OFF
Preset	On (Set by Restore Misc Defaults)
State Saved	Not saved in instrument state.
Backwards Compatibility Notes	The WINDow parameter and optional subopcode is included for backwards compatibility but ignored – all windows are equally affected.
Initial S/W Revision	Prior to A.02.00

Themes

Accesses a menu of functions that enable you to choose the theme to be used when saving the screen image.

The **Themes** option is the same as the **Themes** option under the **Display** and **Page Setup** dialogs. It allows you to choose between themes to be used when saving the screen image.

Key Path	Save, Screen Image
Remote Command	:MMEMory:STORe:SCReem:THEMe TDColor TDMonochrome FCOLor FMONochrome :MMEMory:STORe:SCReem:THEMe?
Example	:MMEM:STOR:SCR:THEM TDM
Preset	3D Color; Is not part of Preset, but is reset by Restore Misc Defaults or Restore System Defaults All and survives subsequent running of the modes.
Readback	3D Color 3D Mono Flat Color Flat Mono
Backwards Compatibility Notes	In ESA and PSA we offer the choice of "Reverse Bitmap" or "Reverse Metafile" when saving screen images. This is much like the "Flat Color" theme available in X-Series. Also, if you selected Reverse Bitmap AND a black & white screen image, that would be much like "Flat Monochrome". In other words, each of the X-Series themes has a similar screen image type in ESA/PSA. But they are not identical.
Initial S/W Revision	Prior to A.02.00

3D Color

Selects a standard color theme with each object filled, shaded and colored as designed.

Key Path	Save, Screen Image, Themes
Example	MMEM:STOR:SCR:THEM TDC
Readback	3D Color
Initial S/W Revision	Prior to A.02.00

3D Monochrome

Selects a format that is like 3D color but shades of gray are used instead of colors.

Key Path	Save, Screen Image, Themes
Example	MMEM:STOR:SCR:THEM TDM
Readback	3D Mono
Initial S/W Revision	Prior to A.02.00

Flat Color

Selects a format that is best when the screen is to be printed on an ink printer.

Key Path	Save, Screen Image, Themes
Example	MMEM:STOR:SCR:THEM FCOL
Readback	Flat Color
Initial S/W Revision	Prior to A.02.00

Flat Monochrome

Selects a format that is like Flat Color. But only black is used (no colors, not even gray), and no fill.

Key Path	Save, Screen Image, Themes
Example	MMEM:STOR:SCR:THEM FMON
Readback	Flat Mono
Initial S/W Revision	Prior to A.02.00

Backlight

Accesses the display backlight on/off keys. This setting may interact with settings under the Windows "Power" menu.

When the backlight is off, pressing ESC, TAB, SPACE, ENTER, UP, DOWN, LEFT, RIGHT, DEL, BKSP, CTRL, or ALT turns the backlight on without affecting the application. Pressing any other key will turn backlight on and could potentially perform the action as well.

Key Path	View/Display, Display, System Display Settings
Remote Command	:DISPlay:BACKlight ON OFF :DISPlay:BACKlight?
Preset	ON (Set by Restore Misc Defaults)
Initial S/W Revision	Prior to A.02.00

Backlight Intensity

An active function used to set the backlight intensity. It goes from 0 to 100 where 100 is full on and 0 is off. This value is independent of the values set under the Backlight on/off key.

Key Path	View/Display, Display, System Display Settings
Remote Command	:DISPlay:BACKlight:INTensity <integer> :DISPlay:BACKlight:INTensity?
Example	DISP:BACK:INT 50

Preset	100 (Set by Restore Misc Defaults)
Min	0
Max	100
Initial S/W Revision	Prior to A.02.00

RF Envelope

This view shows an example of the RF Envelope result for the waveform (time domain) measurements in the graph window. The measured values for the mean power and peak-to-mean power are shown in the text window.

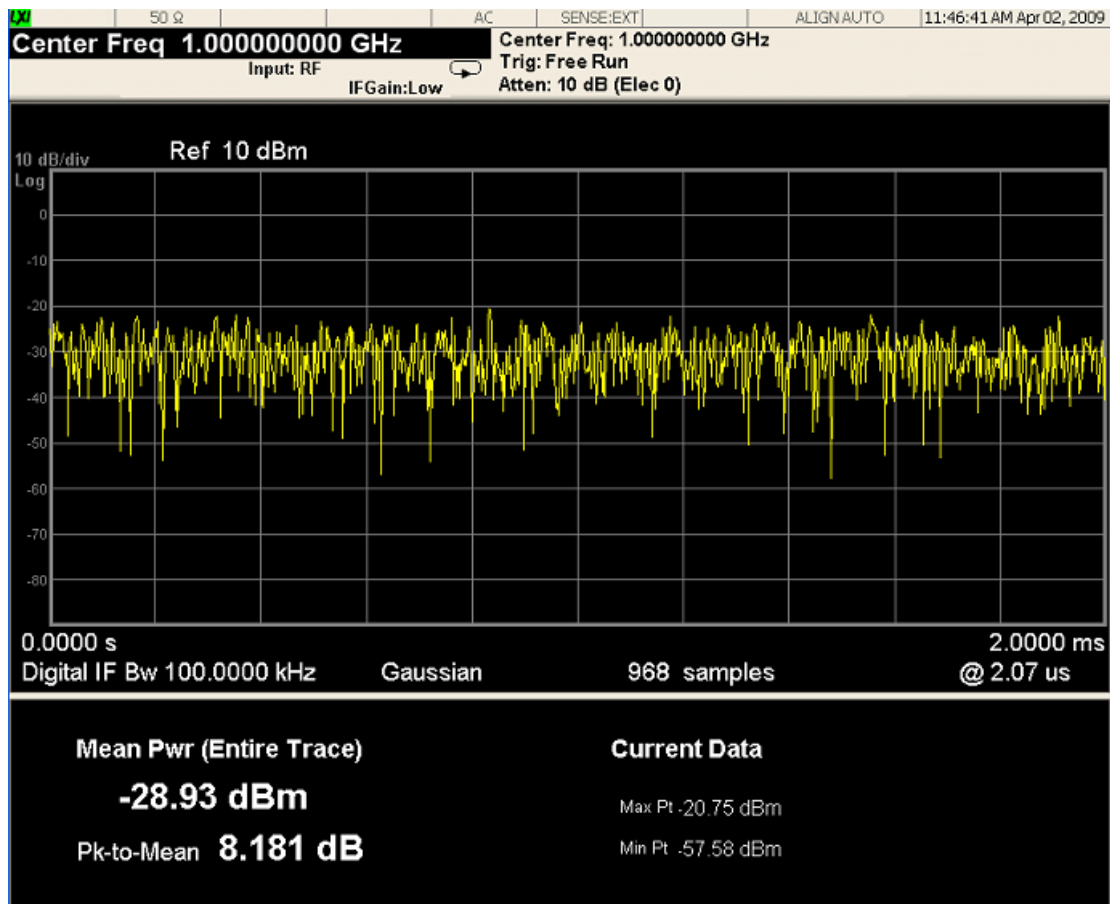

Numeric Results

Name	Type	Description	Unit	Format
Mean Pwr	Float64	The mean power (dBm). This is either the power across the entire trace, or the power between markers if the markers are enabled.	dBm	XX.XX dBm

Name	Type	Description	Unit	Format
Pk-to-Mean	Float64	This is the ratio of the maximum signal level to the mean power.	dB	XX.XX dB
Max Pt	Float64	The maximum of the most recently acquired data.	dBm	XX.XX dBm
Min Pt	Float64	The minimum of the most recently acquired data.	dBm	XX.XX dBm

Key Path	View/Display
Initial S/W Revision	Prior to A.02.00

I/Q Waveform

This view shows the I and Q signal waveforms in parameters of voltage versus time.

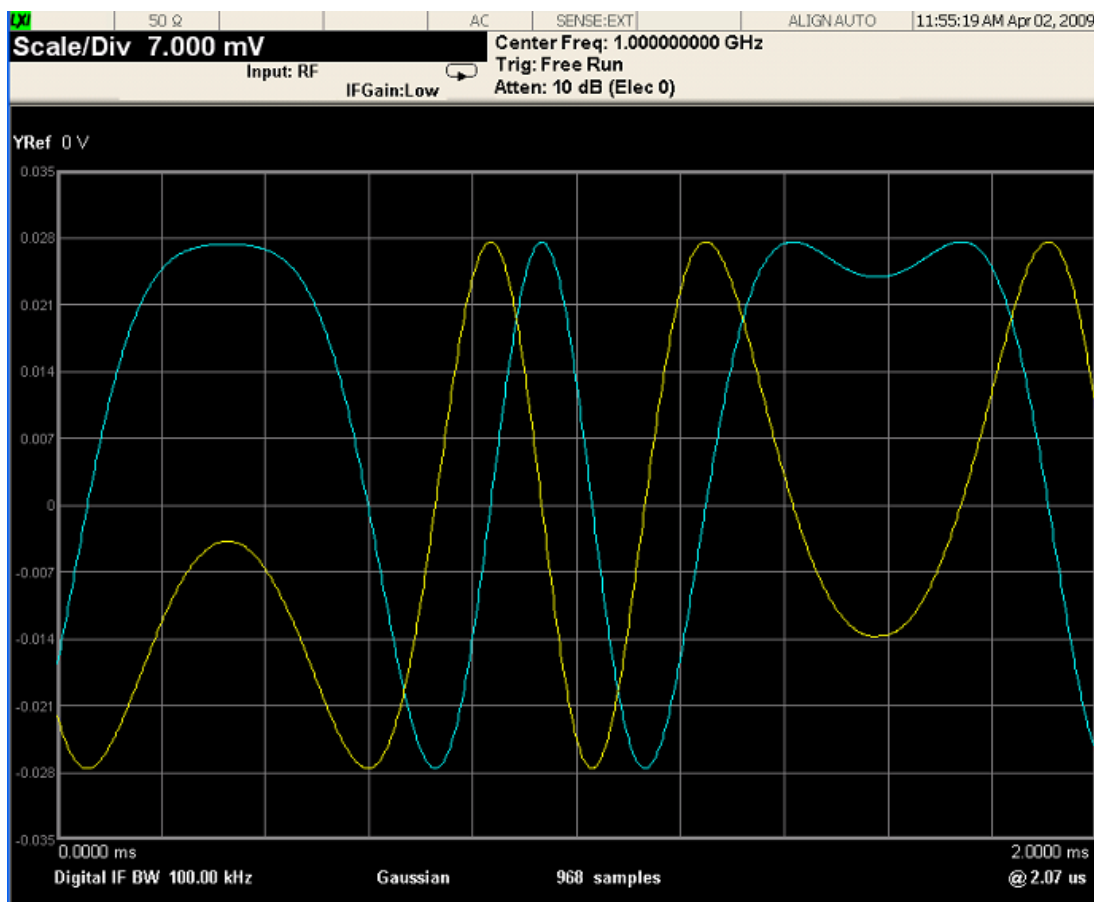

Key Path	View/Display
Initial S/W Revision	Prior to A.02.00

18 Conformance EVM

LTE-Advanced aggregates multiple LTE carriers (up to 5) to obtain a collective transmission bandwidth of up to 100 MHz. **The CEVM measurement allows you to measure LTE-Advanced signals according to 3GPP TS 36.211. The measurement supports aggregated carriers. Once you have configured the measurement, you can use these commands to initiate the measurement and retrieve the measurement results.**

["Measurement Commands for CEVM " on page 2728](#)

["Remote Command Results for CEVM Measurement" on page 2729](#)

Measurement Commands for CEVM

This section details remote commands and results. For the front-panel configuration and results, see View/Display.

`:CONFigure:CEVM`

`:CONFigure:CEVM:NDEFault`

`:FETCh:CEVM[n]?`

`:INITiate:CEVM`

`:MEASure:CEVM[n]?`

`:READ:CEVM[n]?`

See ["Remote SCPI Commands and Data Queries" on page 2861](#) and ["Data" on page 2297](#) in Common Functions for more measurement SCPI commands.

Remote Command Results for CEVM Measurement

The following table denotes the Conformance EVM specific results returned from the (FETCh|MEASure|READ):CEVM commands, indexed by subopcode. MEASure:CEVM<n> is equivalent to CONF:CEVM;INIT:IMM:FETCh:CEVM<n>, which gets you the default measurement, that is, 5 MHz downlink with auto detection of allocations.

Remote Command SCPI Results

For queries listed in section, the results returned depend on the value of n, as follows.

N	Results Returned
Not specified or n=1	<p>Returns measurement results of every active Component Carriers. The total number of Component Carriers is specified by Num Component Carriers in Component Carrier Setup menu on LTE-Advanced mode. The total result length is variable. Each Component Carrier can be specified as active or inactive by setting the Measure Carrier in Component Carriers Setup to ON or OFF. The results of each Component Carrier vary depending on the Link Direction and result values enable/disable setting (Downlink/Uplink Result Output Selection).</p> <p>For example, If the Num Component Carriers is 3 and number of result for each Component Carrier is 21 (determined by Result Output Selection), if all 3 Component Carriers are active, total number of return value is 63, first 21 results are for Component Carrier 0, and last 21 results are for Component Carrier 2. if Component Carrier 0 is specified as inactive by setting the Measure Carrier of CC0 to OFF, then the total number of return value is 42, first 21 results are for Component Carrier 1, and last 21 results are for Component Carrier 2.</p> <p>All the return values are floating points.</p> <p>LTE-Advanced Downlink Results For Each Component Carrier</p> <p>The result contents are customizable. See Downlink Result Output Selection (SCPI only) section for details. If no result is available, NaN (9.91E+37) is returned.</p> <ol style="list-style-type: none"> 1. EVM (%) 2. EVM Symbol Time Adjust 3. 1: Window Start 4. 2: Window End 5. 3: Center 6. 4: Custom 7. EVM Pk (%) 8. EVM Pk Index 9. EVM Peak Sub Car Index 10. Data EVM (%) – Not available when Detection is Manual and no User is added. 11. 3GPP-defined QPSK EVM (%) 12. 3GPP-defined 16QAM EVM (%) 13. 3GPP-defined 64QAM EVM (%) 14. RS EVM (%) 15. RS Tx. Power (dBm) 16. OFDM Symbol Tx. Power (dBm) 17. Frequency Error (Hz) 18. Sync Correlation (%) 19. Sync Type 20. 1: P-SS 21. 20: Ant Port 0 RS 22. 21: Ant Port 1 RS 23. 22: Ant Port 2 RS

N	Results Returned
	24. 23: Ant Port 3 RS
	25. Common Tracking Error (%)
	26. Symbol Clock Error (ppm)
	27. Time Offset (s)
	28. IQ Offset (dB)
	29. IQ Gain Imbalance (dB)
	30. IQ Quad Error (deg)
	31. IQ Timing Skew (s)
	32. CP Length Mode
	33. 1: Normal
	34. 2: Extended
	35. Cell ID
	36. Cell ID Group/Sector
	37. Integer part: Cell ID Group, After the decimal point: Cell ID Sector
	38. RS-OS/PRS
	39. 1: 3GPP
	40. 4: Custom
	41. Reference Signal Rx Power (dBm)
	42. Reference Signal Rx Quality (dB)
	43. Received Signal Strength Indicator (dBm)
	44. Channel Power(dBm)
	LTE-Advanced Uplink Results For Each Component Carrier
	The result contents are customizable. See Uplink Result Output Selection for details. If no result is available, NaN (9.91E+37) is returned.
	1. EVM (%)
	2. EVM Symbol Time Adjust
	3. 1: Window Start
	4. 2: Window End
	5. 3: Center
	6. 4: Custom
	7. EVM Pk (%)
	8. EVM Pk Index
	9. EVM Peak Sub Car Index
	10. Data EVM (%) – Not available when Detection is Manual and no User is added.
	11. 3GPP-defined QPSK EVM (%)
	12. 3GPP-defined 16QAM EVM (%)
	13. 3GPP-defined 64QAM EVM (%)
	14. RS EVM (%)
	15. NaN (9.91E+37) returned.
	16. NaN (9.91E+37) returned.

N	Results Returned
	17. Frequency Error (Hz) 18. Sync Correlation (%) 19. Sync Type 20. 2: PUSCH-DMRS 21. 3: PUCCH-DMRS 22. 4: SRS 23. 5: PRACH 24. Common Tracking Error (%) 25. Symbol Clock Error (ppm) 26. Time Offset (s) 27. IQ Offset (dB) 28. IQ Gain Imbalance (dB) 29. IQ Quad Error (deg) 30. IQ Timing Skew (s) 31. CP Length Mode 32. 1: Normal 33. 2: Extended 34. Channel Power (dBm) 35. In-band Emissions Result 0: PASS 1: FAIL 36. In-band Emissions worst Margin (dB) 37. In-band Emissions worst Slot 38. In-band Emissions worst RB 39. Spectral Flatness Result 0: PASS 1: FAIL 40. Spectral Flatness worst Margin (dB) 41. Spectral Flatness worst Slot 42. Spectral Flatness worst Subcarrier
2	Returns result of Equalizer Frequency Response Per Slot for CC0. The result length varies depending on the Bandwidth and Measurement Interval. For example, BW=5MHz and Result Length & Meas Interval Slot=20 slots, 12,000 points are returned. The first 600 points are 300 IQ pairs of EQ response of Slot 0 from the lowest to the highest frequency, and the second 600 points are those of Slot 1, and so on. Each slot (=EC(f)) is divided into EC_1(f) for Range1 and EC_2(f) for Range2, and then RP1, RP2, RP12 or RP21 is calculated in each region.
3	Error Information of each Component Carrier Returns total error information of each Component Carrier . The values are bitwise OR operated on the Error Information as follows:

N	Results Returned		
	No Error	0	0x00000000
	Parameter Setting Conflict	1	0x00000001
	ADC OverRange	2	0x00000010
	Sync Error	4	0x00000100
	Demod Error	8	0x00001000
	Burst Not Found	16	0x00010000

For example, if ADC Over Range and Sync Error occurred, the value is 6.

The total result length is variable. The returned contents vary depending on the total number of Component Carriers, which is specified by Num Component Carriers in Component Carriers Setup.

Returns the following scalar results:

43.Total Error Information of CC0.

44.Total Error Information of CC1.

45. ...

nCarr. Total Error Information of the last carrier.

Where nCarr is the number of carriers to be measured.

Key Path	Meas
Mode	LTEAFDD, LTEATDD
Initial S/W Revision	A.14.00

AMPTD Y Scale

The Amplitude front-panel key activates the Amplitude menu and selects Reference Level or Reference Value (depending on the measurement) as the active function.

Some features in the Amplitude menu apply to multiple measurements; others apply only to specific measurements. Keys that only apply to some measurements are blanked or grayed out in measurements that are not supported.

Key Path	Front-panel key
Initial S/W Revision	Prior to A.02.00

Attenuation

This menu controls the attenuator functions and interactions between the attenuation system components.

There are two attenuator configurations in the X-Series. One is a dual attenuator configuration consisting of a mechanical attenuator and an optional electronic attenuator. The other configuration uses a single attenuator with combined mechanical and electronic sections that controls all the attenuation functions. Different models in the X-Series come with different configurations.

See ["Dual Attenuator Configurations:" on page 2734](#)

See ["Single Attenuator Configuration:" on page 2735](#)

Most Attenuation settings are the same for all measurements – they do not change as you change measurements. Settings like these are called “Meas Global” and are unaffected by Meas Preset.

Key Path	AMPTD Y Scale
Scope	Meas Global
Dependencies	In measurements that support the I/Q inputs, this key is unavailable when I/Q is the selected input, and is replaced by the Range key in that case.
Readback Line	Contains a summary in [] brackets of the current total attenuation. See the descriptions of the , " (Mech) Atten " on page 2736, and " Enable Elec Atten " on page 2737 keys for more detail on the contributors to the total attenuation. Note that when "Pre-Adjust for Min Clip" is on, this value can change at the start of every measurement.
Initial S/W Revision	Prior to A.02.00
Modified at S/W Revision	A.03.00

Dual Attenuator Configurations:

Configuration 1: Mechanical attenuator + optional electronic attenuator

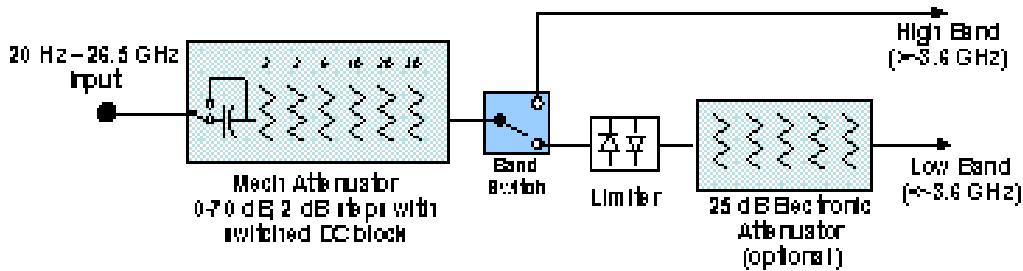

Configuration 2: Mechanical attenuator, no optional electronic attenuator

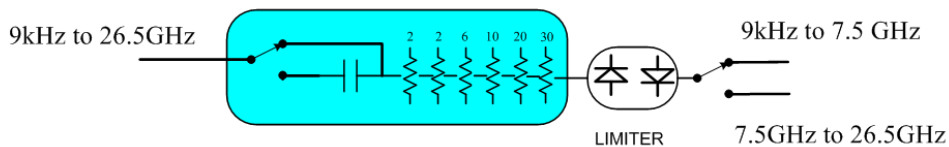

(note that Configuration 2 is not strictly speaking a dual-section attenuator, since there is no electronic section available. However, it behaves exactly like Configuration 1 without the Electronic Attenuator option EA3, therefore for the sake of this document it is grouped into the “Dual Attenuator” configuration)

Single Attenuator Configuration:

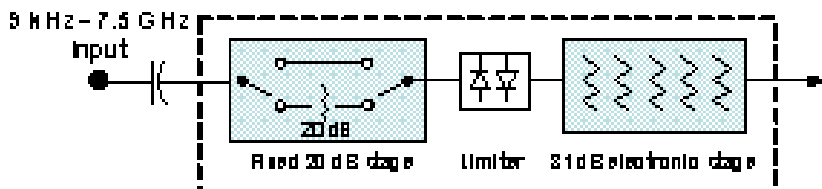

You can tell which attenuator configuration you have by pressing the Attenuation key, which (in most Modes) opens the Attenuation menu. If the first key in the Attenuation menu says Mech Atten you have the dual attenuator configuration. If the first key says Atten you have the single attenuator configuration.



Dual Attenuator

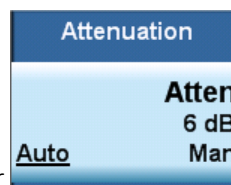

Single Attenuator

In the single attenuator configuration, you control the attenuation with a single control, as the fixed stage has only two states. In the dual attenuator configuration, both stages have significant range so you are given separate control of the mechanical and electronic attenuator stages.

When you have the dual attenuator configuration, you may still have only a single attenuator, because unless option EA3 (the Electronic Attenuator option) is available, and you purchase it, you will have only the mechanical attenuator.

(Mech) Atten

This key is labeled Mech Atten in dual attenuator models and Atten in single attenuator models. In the dual attenuator configuration, this key only affects the mechanical attenuator.

This key lets you modify the attenuation applied to the RF input signal path. This value is normally auto coupled to the Ref Level, the Internal Preamp Gain, any External Gain that is entered, and the Max Mixer Level, as described in the table below.

See "[Attenuator Configurations and Auto/Man](#)" on page 2737

Key Path	AMPTD Y Scale, Attenuation
Remote Command	<pre>[:SENSe] :POWer [:RF] :ATTenuation <rel_ampl> [:SENSe] :POWer [:RF] :ATTenuation? [:SENSe] :POWer [:RF] :ATTenuation:AUTO OFF ON 0 1 [:SENSe] :POWer [:RF] :ATTenuation:AUTO?</pre>
Example	<p>POW:ATT 20</p> <p>Dual attenuator configuration: sets the mechanical attenuator to 20 dB</p> <p>Single attenuator mode: sets the main attenuation to 20 dB (see below for definition of “main” attenuation).</p> <p>If the attenuator was in Auto, it sets it to Manual.</p>
Dependencies	<p>Some measurements do not support the Auto setting of (Mech) Atten. In these measurements, the Auto/Man selection is not available, and the Auto/Man line on the key disappears.</p> <p>In dual attenuator configurations, when the electronic attenuator is enabled, the mechanical attenuator has no auto setting and the Auto/Man line on the key disappears. The state of Auto/Man is remembered and restored when the electronic attenuator is once again disabled. This is described in more detail in the "Enable Elec Atten" on page 2737 key description.</p> <p>See "Attenuator Configurations and Auto/Man" on page 2737 for more information on the Auto/Man functionality of Attenuation.</p>
Couplings	<p>When (Mech) Atten is in Auto, it uses the following algorithm to determine a value:</p> <p>If the USB Preamp is connected to USB, use 0 dB.</p> <p>Otherwise, $Atten = ReferenceLevel + PreAmpGain + ExternalGain - RefLevelOffset - MaxMixerLevel + IF\ Gain$.</p> <p>Limit this value to be between 6 dB and the Max value. No value below 6 dB can ever be chosen by Auto.</p> <p>The resulting value is rounded up to the largest value possible given the attenuation step setting. That is, 50.01 dB would change to 60 dB (for a 10 dB attenuation step).</p> <p>The “IF Gain” term in the equation above is either 0 dB or +10 dB, depending on the settings of FFT IF Gain, Swept IF Gain, max Ref Level and the Auto/Man setting of Mech Atten.</p> <p>In External Mixing and BBIQ, where the Attenuator is not in the signal path, the Attenuator setting changes as described above when (Mech) Atten is in Auto, but no changes are made to the actual attenuator hardware setting until the input is changed back to the RF Input.</p>
Preset	<p>The preset for Mech Attenuation is “Auto.”</p> <p>The Auto value of attenuation is:</p> <p>CXA, EXA, MXA and PXA: 10 dB</p>

State Saved	Saved in instrument state
Min	0 dB The attenuation set by this key cannot be decreased below 6 dB with the knob or step keys. To get to a value below 6 dB it has to be directly entered from the keypad or via SCPI. This protects from adjusting the attenuation to a dangerously small value which can put the instrument at risk of damage to input circuitry. However, if the current mechanical attenuation is below 6 dB it can be increased with the knob and step keys, but not decreased.
Max	CXA N9000A-503/507: 50 dB CXA N9000A-513/526: 70dB EXA: 60 dB MXA and PXA: 70 dB In the single attenuator configuration, the total of ATT and EATT cannot exceed 50 dB, so if the EATT is set to 24 dB first, the main attenuation cannot be greater than 26 dB and will be reduced accordingly; if the main attenuator is set to 40 dB first, EATT cannot be greater than 10 dB.
Initial S/W Revision	Prior to A.02.00
Modified at S/W Revision	A.03.00

Attenuator Configurations and Auto/Man

As described in the Attenuation key description, there are two distinct attenuator configurations available in the X-Series, the single attenuator and dual attenuator configurations. In dual attenuator configurations, we have the mechanical attenuation and the electronic attenuation, and the current total attenuation is the sum of the electronic + mechanical attenuation. In single attenuator configurations, we refer to the attenuation set using the (Mech) Atten key (or POW:ATT SCPI) as the “main” attenuation; and the attenuation that is set by the SCPI command POW:EATT as the “soft” attenuation (the POW:EATT command is honored even in the single attenuator configuration, for compatibility purposes). Then the current total attenuation is the sum of the main + soft attenuation. See the Elec Atten key description for more on “soft” attenuation.

In the dual attenuator configuration, when the electronic attenuator is enabled, there is no Auto/Man functionality for the mechanical attenuator, and the third line of the key label (the Auto/Man line) disappears:

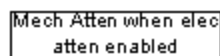
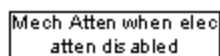
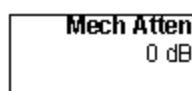
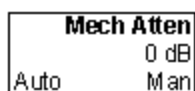

usdB

Enable Elec Atten

Enables the Electronic Attenuator.

The electronic attenuator offers finer steps than the mechanical attenuator, has no acoustical noise, is faster, and is less subject to wear. These advantages primarily aid in remote operation and are negligible

for front panel use. See ["Using the Electronic Attenuator: Pros and Cons" on page 2739](#) for a detailed discussion of the pros and cons of using the electronic attenuator.

For the single attenuator configuration, for SCPI backwards compatibility, the “soft” attenuation feature replaces the dual attenuator configuration’s electronic attenuator. All the same couplings and limitations apply. See ["Attenuator Configurations and Auto/Man" on page 2737](#)

See ["More Information" on page 2738](#)

Key Path	AMPTD Y Scale, Attenuation
Remote Command	[:SENSe] :POWer [:RF] :EATTenuation :STATe OFF ON 0 1 [:SENSe] :POWer [:RF] :EATTenuation :STATe ?
Example	POW:EATT:STAT ON
Dependencies	<p>This key only appears in Dual Attenuator models with an Electronic Attenuator installed. It does not appear in models with the Single Attenuator configuration, as in the single attenuator configuration there is no “electronic attenuator” there is only a single integrated attenuator (which has both a mechanical and electronic stage). However, in the single attenuator configuration, EATT SCPI commands are accepted for compatibility with other X-series instruments and set a “soft” attenuation as described in "Attenuator Configurations and Auto/Man" on page 2737.</p> <p>The electronic attenuator (and the “soft” attenuation function provided in single attenuator configurations) is unavailable above 3.6 GHz. Therefore, if the Stop Frequency of the analyzer is > 3.6 GHz then the Enable Elec Atten key will be OFF and grayed out.</p> <p>If the Internal Preamp is on, meaning it is set to Low Band or Full, the electronic attenuator (and the “soft” attenuation function provided in single attenuator configurations) is unavailable. In this case the Enable Elec Atten key will be OFF and grayed out.</p> <p>If either of the above is true, if the SCPI command is sent, an error indicating that the electronic attenuator is unavailable will be sent.</p> <p>If the electronic/soft Attenuator is enabled, then the Stop Freq of the analyzer is limited to 3.6 GHz and the Internal Preamp is unavailable.</p> <p>The SCPI-only “soft” electronic attenuation for the single-attenuator configuration is not available in all measurements; in particular, it is not available in the Swept SA measurement.</p>
Couplings	Enabling and disabling the Electronic Attenuator affects the setting of the Mechanical Attenuator (in dual attenuator configurations). This is described in more detail below this table.
Preset	OFF for Swept SA measurement; ON for all other measurements that support the electronic attenuator
State Saved	Saved in instrument state
Initial S/W Revision	Prior to A.02.00
Modified at S/W Revision	A.03.00

More Information

Mechanical Attenuator Transition Rules

When the Electronic Attenuator is enabled, the Mechanical Attenuator transitions to a state that has no Auto function. Below are the rules for transitioning the Mechanical Attenuator. NOTE that the information

below ONLY applies to the dual attenuator configurations, and ONLY when the Electronic Attenuator is installed:

When the Electronic Attenuation is enabled from a disabled state:

- The Mechanical Attenuator is initialized to 10 dB (this is its optimal performance setting). You can then set it as desired with SCPI, numeric keypad, step keys, or knob, and it behaves as it normally would in manual mode
- The Auto/Man state of (Mech) Atten is saved
- The Auto/Man line on the (Mech) Atten key disappears and the auto rules are disabled
- The Electronic Attenuator is set to 10 dB less than the previous value of the Mechanical Attenuator, within the limitation that it must stay within the range of 0 to 24 dB of attenuation.

Examples in the dual attenuator configuration:

- Mech Atten at 20 dB. Elec Atten enabled, Mech Atten set to 10 dB, and Elec Atten set to 10 dB. New total attenuation equals the value before Elec Atten enabled.
- Mech Atten at 0 dB. Elec Atten enabled, Mech Atten set to 10 dB, and Elec Atten set to 0 dB. New total attenuation does not equal the value before Elec Atten enabled.
- Mech Atten at 40 dB. Elec Atten enabled, Mech Atten set to 10 dB, and Elec Atten set to 24 dB. New total attenuation does not equal the value before Elec Atten enabled.

When the Electronic Attenuation is disabled from an enabled state:

- The Elec Atten key is grayed out
- The Auto/Man state of (Mech) Atten is restored
- If now in Auto, (Mech) Atten recouples
- If now in Man, (Mech) Atten is set to the value of total attenuation that existed before the Elec Atten was disabled. The resulting value is rounded up to the smallest value possible given the (Mech) Atten Step setting - (That is, 57 dB changes to 58 dB when (Mech) Atten Step is 2 dB.)

Using the Electronic Attenuator: Pros and Cons

The electronic attenuator offers finer steps than the mechanical attenuator, has no acoustical noise, is faster, and is less subject to wear.

The “finer steps” advantage of the electronic attenuator is beneficial in optimizing the alignment of the analyzer dynamic range to the signal power in the front panel as well as remote use. Thus, you can achieve improved relative signal measurement accuracy. Compared to a mechanical attenuator with 2 dB steps, the 1 dB resolution of the electronic attenuator only gives better resolution when the odd-decibel steps are used. Those odd-decibel steps are less accurately calibrated than the even-decibel steps, so one tradeoff for this superior relative accuracy is reduced absolute amplitude accuracy.

Another disadvantage of the electronic attenuator is that the spectrum analyzer loses its “Auto” setting, making operation less convenient.

Also, the relationship between the dynamic range specifications (TOI, SHI, compression and noise) and instrument performance are less well-known with the electrical attenuator. With the mechanical

attenuator, TOI, SHI and compression threshold levels increase dB-for-dB with increasing attenuation, and the noise floor does as well. With the electronic attenuator, there is an excess attenuation of about 1 to 3 dB between 0 and 3.6 GHz, making the effective TOI, SHI, and so forth, less well known. Excess attenuation is the actual attenuation relative to stated attenuation. Excess attenuation is accounted for in the analyzer calibration

Elec Atten

Controls the Electronic Attenuator in dual attenuator configurations. This key does not appear in single attenuator configurations, as the control of both the mechanical and electronic stages of the single attenuator is integrated into the single Atten key.

Key Path	AMPTD Y Scale, Attenuation
Remote Command	[:SENSe] :POWer [:RF] :EATTenuation <rel_ampl> [:SENSe] :POWer [:RF] :EATTenuation?
Notes	Electronic Attenuation's specification is defined only when Mechanical Attenuation is 6 dB.
Dependencies	This key only appears in Dual Attenuator models with an Electronic Attenuator installed. It does not appear in models with the Single Attenuator configuration, as in the single attenuator configuration there is no "electronic attenuator" there is only a single integrated attenuator (which has both a mechanical and electronic stage). However, in the single attenuator configuration, EATT SCPI commands are accepted for compatibility with other X-series instruments and set a "soft" attenuation as described in "Attenuator Configurations and Auto/Man" on page 2737 . The "soft" attenuation is treated as an addition to the "main" attenuation value set by the Atten softkey or the POW:ATT SCPI command and affects the total attenuation displayed on the Attenuation key and the Meas Bar. When Enable Elec Atten is off or grayed out, the Elec Atten key is grayed out.
Preset	0 dB
State Saved	Saved in instrument state
Min	0 dB
Max	Dual attenuator configuration: 24 dB Single attenuator configuration: the total of ATT and EATT cannot exceed 50 dB, so if the EATT is set to 24 dB first, the main attenuation cannot be greater than 26 dB and will be reduced accordingly; if the main attenuator is set to 40 dB first, EATT cannot be greater than 10 dB
Initial S/W Revision	Prior to A.02.00
Modified at S/W Revision	A.03.00

Adjust Atten for Min Clip

Sets the combination of mechanical and electronic attenuation and gain based on the current measured signal level so that clipping will be at a minimum.

This is an "immediate action" function, that is, it executes once, when the key is pressed.

This key is grayed out in measurements that do not support this functionality. The spectrum analyzer measurement, Swept SA, does not support this functionality.

Key Path	AMPTD Y Scale, Attenuation
Remote Command	[:SENSe] :POWer [:RF] :RANGe:OPTimize IMMEDIATE
Initial S/W Revision	Prior to A.02.00
Modified at S/W Revision	A.03.00

Pre-Adjust for Min Clip

If this function is on, it does the adjustment described under "[Adjust Atten for Min Clip](#)" on page 2740 each time a measurement restarts. Therefore, in Continuous measurement mode, it only executes before the first measurement.

In dual attenuator models, you can set Elec+Mech Atten, in which case both attenuators participate in the autoranging, or Elec Atten Only, in which case the mechanical attenuator does not participate in the autoranging. This latter case results in less wear on the mechanical attenuator and is usually faster.

This key is grayed out in measurements that do not support this functionality. The spectrum analyzer measurement, Swept SA, does not support this functionality.

Key Path	AMPTD Y Scale, Attenuation
Remote Command	[:SENSe] :POWer [:RF] :RANGe:OPTimize:ATTenuation OFF ELECTrical COMBined [:SENSe] :POWer [:RF] :RANGe:OPTimize:ATTenuation?
Notes	The SCPI parameter ELECTrical sets this function to On in single attenuator models. The SCPI parameter COMBined is mapped to ELECTrical in single attenuator models; if you send COMBined, it sets the function to On and returns ELEC to a query.
Dependencies	This key only appears in Dual Attenuator models with an Electronic Attenuator installed. In instruments with Dual Attenuator model, when Enable Elec Atten is off or grayed out, the Pre-Adjust for Min Clip key is grayed out.
Preset	OFF for Swept SA measurement; ON for all other measurements that support Pre-Adjust for Min Clip
State Saved	Saved in instrument state
Range	Dual attenuator models: Off Elec Atten Only Mech + Elec Atten Single attenuator models: Off On
Initial S/W Revision	Prior to A.02.00
Modified at S/W Revision	A.03.00

Remote Command	[:SENSe] :POWer [:RF] :RANGe:AUTO ON OFF 1 0 [:SENSe] :POWer [:RF] :RANGe:AUTO?
Notes	ON aliases to "Elec Atten Only" (:POW:RANG:OPT:ATT ELEC)

	OFF aliases to "Off" (:POW:RANG:OPT:ATT OFF) The query :POW:RANG:AUTO? returns true if :POW:RANG:OPT:ATT is not "Off"
Initial S/W Revision	Prior to A.02.00

Off

Turns Pre-Adjust for Min Clip off. This is the default setting.

This key is grayed out in measurements that do not support this functionality. The spectrum analyzer measurement, Swept SA, does not support this functionality.

Key Path	AMPTD Y Scale, Attenuation, Pre-Adjust for Min Clip
Example	:POW:RANGe:OPT:ATT OFF
Initial S/W Revision	Prior to A.02.00

Elec Atten Only

Selects only the electric attenuator to participate in auto ranging. This offers less wear on the mechanical attenuator and is usually faster.

This key is grayed out in measurements that do not support this functionality. The spectrum analyzer measurement, Swept SA, does not support this functionality.

Key Path	AMPTD Y Scale, Attenuation, Pre-Adjust for Min Clip
Example	:POW:RANGe:OPT:ATT ELEC
Initial S/W Revision	Prior to A.02.00

Mech + Elec Atten

In dual attenuator models, this selects both attenuators participate in the autoranging.

This key is grayed out in measurements that do not support this functionality. The spectrum analyzer measurement, Swept SA, does not support this functionality.

Key Path	AMPTD Y Scale, Attenuation, Pre-Adjust for Min Clip
Example	:POW:RANGe:OPT:ATT COMB
Initial S/W Revision	Prior to A.02.00

(Mech) Atten Step

This controls the step size used when making adjustments to the input attenuation.

This key is labeled Mech Atten Step in dual attenuator models and Atten Step in single attenuator models. In the dual attenuator configuration, this key only affects the step size of the mechanical attenuator.

Key Path	AMPTD Y Scale, Attenuation
Remote Command	[:SENSe] :POWer [:RF] :ATTenuation:STEP [:INCRement] 10 dB 2 dB [:SENSe] :POWer [:RF] :ATTenuation:STEP [:INCRement] ?
Example	POW:ATT:STEP 2
Notes	Note this feature works like a 1-N choice from the front panel, but it takes a specific value (in dB) when used remotely. The only valid values are 2 and 10.
Dependencies	Blanked in CXA and EXA if option FSA (2 dB steps) is not present. If blanked, attempts to set it via SCPI will yield an error.
Couplings	When the attenuation step size changes, the current mechanical attenuation value is adjusted (if necessary) to be quantized to the new step size. That is, if step is set to 10 dB, mech atten is increased if necessary so it is a multiple of 10 dB
Preset	PXA and MXA: 2 dB EXA and CXA: 10 dB (2 dB with option FSA)
State Saved	Saved in instrument state
Initial S/W Revision	Prior to A.02.00
Modified at S/W Revision	A.03.00

Presel Center

When this key is pressed, the centering of the preselector filter is adjusted to optimize the amplitude accuracy at the frequency of the selected marker. If the selected marker is not on when Presel Center is pressed, the analyzer will turn on the selected marker, perform a peak search, and then perform centering on the marker's center frequency. If the selected marker is already on and between the start and stop frequencies of the analyzer, the analyzer performs the preselector calibration on that marker's frequency. If the selected marker is already on, but outside the frequency range between Start Freq and Stop Freq, the analyzer will first perform a peak search, and then perform centering on the marker's center frequency.

The value displayed on the Presel Adjust key will change to reflect the new preselector tuning (see Presel Adjust).

A number of considerations should be observed to ensure proper operation. See ["Proper Preselector Operation" on page 2744](#).

Key Path	AMPTD Y Scale
Remote Command	[:SENSe] :POWer [:RF] :PCENter
Example	POW:PCEN
Notes	Note that the rules outlined above under the key description apply for the remote command as well as the key. The result of the command is dependent on marker position, and so forth. Any message shown by the key press is also shown in response to the remote command.
Dependencies	• Grayed out if the microwave preselector is off.)

	<ul style="list-style-type: none">• If the selected marker's frequency is below Band 1, advisory message 0.5001 is generated and no action is taken.• Grayed out if entirely in Band 0.• Blank in models that do not include a preselector, such as option 503. If the SCPI is sent in these instruments, it is accepted without error, and the query always returns 0.• Grayed out in the Spectrogram View.
Couplings	<p>The active marker position determines where the centering will be attempted.</p> <p>If the analyzer is in a measurement such as averaging when centering is initiated, the act of centering the preselector will restart averaging but the first average trace will not be taken until the centering is completed.</p>
Status Bits/OPC dependencies	<p>When centering the preselector, *OPC will not return true until the process is complete and a subsequent measurement has completed, nor will results be returned to a READ or MEASure command.</p> <p>The Measuring bit should remain set while this command is operating and should not go false until the subsequent sweep/measurement has completed.</p>
Initial S/W Revision	Prior to A.02.00
Modified at S/W Revision	A.03.00

Proper Preselector Operation

A number of considerations should be observed to ensure proper operation:

1. If the selected marker is off, the analyzer will turn on a marker, perform a peak search, and adjust the preselector using the selected marker's frequency. It uses the "highest peak" peak search method unqualified by threshold or excursion, so that there is no chance of a 'no peak found' error. It continues with that peak, even if it is the peak of just noise. Therefore, for this operation to work properly, there should be a signal on screen in a preselected range for the peak search to find.
2. If the selected marker is already on, the analyzer will attempt the centering at that marker's frequency. There is no preselector for signals below about 3.6 GHz, therefore if the marker is on a signal below 3.6 GHz, no centering will be attempted and an advisory message generated
3. In some models, the preselector can be bypassed. If it is bypassed, no centering will be attempted in that range and a message will be generated.

Preselector Adjust

Allows you to manually adjust the preselector filter frequency to optimize its response to the signal of interest. This function is only available when "**Presel Center**" on page 2743 is available.

For general purpose signal analysis, using Presel Center is recommended. Centering the filter minimizes the impact of long-term preselector drift. Presel Adjust can be used instead to manually optimize the preselector. One application of manual optimization would be to peak the preselector response, which both optimizes the signal-to-noise ratio and minimizes amplitude variations due to small (short-term) preselector drifting.

Key Path	AMPTD Y Scale
Scope	Meas Global
Remote Command	<code>[:SENSe] :POWer [:RF] :PADJust <freq></code> <code>[:SENSe] :POWer [:RF] :PADJust?</code>
Example	POW:PADJ 100KHz POW:PADJ?
Notes	The value on the key reads out to 0.1 MHz resolution.
Dependencies	<ul style="list-style-type: none"> • Grayed out if microwave preselector is off.) • Grayed out if entirely in Band 0. • Blank in models that do not include a preselector, such as option 503. If the SCPI is sent in these instruments, it is accepted without error, and the query always returns 0. • Grayed out in the Spectrogram View.
Preset	0 MHz
State Saved	The Presel Adjust value set by Presel Center, or by manually adjusting Presel Adjust, is not saved in instrument state, and does not survive a Preset or power cycle.
Min	-500 MHz
Max	500 MHz
Default Unit	Hz
Backwards Compatibility SCPI	<code>[:SENSe] :POWer [:RF] :MW :PADJust</code> <code>[:SENSe] :POWer [:RF] :MMW :PADJust</code> PSA had multiple preselectors, but the X-Series has only one. These commands simply alias to <code>[:SENSe] :POWer [:RF] :PADJust</code>
Initial S/W Revision	Prior to A.02.00
Modified at S/W Revision	A.03.00
Remote Command	<code>[:SENSe] :POWer [:RF] :PADJust :PRESelector MWAVE MMWave EXTernal</code> <code>[:SENSe] :POWer [:RF] :PADJust :PRESelector?</code>
Notes	PSA had multiple preselectors, and you could select which preselector to adjust. Since the X-Series has only one mm/uW preselector, the preselector selection softkey is no longer available. However, to provide backward compatibility, we accept the legacy remote commands. The command form has no effect, the query always returns MWAVE
Initial S/W Revision	Prior to A.02.00

μW Path Control

The μW Path Control functions include the μW Preselector Bypass (Option MPB) and Low Noise Path (Option LNP) controls in the High Band path circuits.

When the μW Preselector is bypassed, the user has better flatness, but will be subject to spurs from out of band interfering signals. When the Low Noise Path is enabled, the analyzer automatically switches around certain circuitry in the high frequency bands which can contribute to noise, when it is appropriate based on other analyzer settings.

For most applications, the preset state is Standard Path, which gives the best remote-control throughput, minimizes acoustic noise from switching and minimizes the risk of wear out in the hardware switches. For applications that utilize the wideband IF paths, the preset state is the μW Preselector Bypass path, if option MPB is present. This is because, when using a wideband IF such as the 140 MHz IF, the μW Preselector's bandwidth can be narrower than the available IF bandwidth, causing degraded amplitude flatness and phase linearity, so it is desirable to bypass the preselector in the default case.

Users may choose Low Noise Path Enable. It gives a lower noise floor, especially in the 21–26.5 GHz region, though without improving many measures of dynamic range, and without giving the best possible noise floor. The preamp, if purchased and used, gives better noise floor than does the Low Noise Path, however its compression threshold and third-order intercept are much poorer than that of the non-preamp Low Noise Path. There are some applications, typically for signals around –30 dBm, for which the third-order dynamic range of the standard path is good enough, but the noise floor is not low enough even with 0 dB input attenuation. When the third-order dynamic range of the preamp path is too little and the noise floor of the standard path is too high, the Low Noise Path can provide the best dynamic range.

Key Path	AMPTD Y Scale
Mode	SA, BASIC, PNOISE, VSA , LTE, LTETDD
Scope	Meas Global
Remote Command	[:SENSe] :POWer [:RF] :MW:PATH STD LNPath MPBypass FULL [:SENSe] :POWer [:RF] :MW:PATH?
Example	:POW:MW:PATH LNP Enables the Low Noise path
Notes	If a Presel Center is performed, the analyzer will momentarily switch to the Standard Path, regardless of the setting of μW Path Control The DC Block will always be switched in when the low noise path is switched in, to protect succeeding circuitry from DC. Note that this does not mean “when the low noise path is enabled” but when, based on the Low Noise Path rules, the path is actually switched in. This can happen when the selection is Low Noise Path Enable . In the case where the DC Block is switched in the analyzer is now AC coupled. However, if the user has selected DC coupling, the UI will still behave as though it were DC coupled, including all annunciation, warnings, status bits, and responses to SCPI queries. This is because, based on other settings, the analyzer could switch out the low noise path at any time and hence go back to being DC coupled. Alignment switching ignores the settings in this menu, and restores them when finished.
Dependencies	Unavailable in BBIQ and External Mixing
Preset	All modes other than IQ Analyzer mode and VXA: STD IQ Analyzer, VXA and WLAN mode: MPB option present and licensed: MPB

	MPB option not present and licensed: STD
State Saved	Save in instrument state
Readback	Value selected in the submenu
Initial S/W Revision	A.04.00
Modified at S/W Revision	A.10.00

Standard Path

This path gives the best remote-control throughput, minimizes acoustic noise from switching and minimizes the risk of wear in the hardware switches, particularly in remote test scenarios where both low band and high band setups will follow in rapid succession.

In this path, the bypass of the low band/high band switch and microwave preamp is never activated, which can cause some noise degradation but preserves the life of the bypass switch.

Key Path	AMPTD Y Scale, μ W Path Control
Example	:POW:MW:PATH STD
Readback Text	Standard Path
Initial S/W Revision	A.04.00

Low Noise Path Enable

You may choose Low Noise Path Enable, which gives a lower noise floor under some circumstances, particularly when operating in the 21–26.5 GHz region. With the Low Noise Path enabled, the low band/high band switch and microwave preamp are bypassed whenever all of the following are true:

- The analyzer is not in the Low Band, meaning:
- the start frequency is above 3.5 GHz and
- the stop frequency is above 3.6 GHz.
- the internal preamp is not installed or (if installed) is set to Off or Low Band

Note that this means that, when any part of a sweep is done in Low Band, the Low Noise Path is not used, whether or not the Low Noise Path Enable is selected in the user interface. Also, if the preamp is turned on, the Low Noise Path is not used, whether or not the Low Noise Path Enable is selected in the user interface. The only time the Low Noise Path is used is when Low Noise Path Enable is selected, the sweep is completely in High Band (> 3.6 GHz) and no preamp is in use.

See "[More Information](#)" on page 2748

Key Path	AMPTD Y Scale, μ W Path Control
Measurement	Swept SA
Example	:POW:MW:PATH LNP

Notes	<p>For measurements that use IQ acquisition, the low noise path is used when the Center Frequency is in High Band (> 3.6 GHz) and no preamp is in use.</p> <p>In other words, the rules above are modified to use only the center frequency to qualify which path to switch in.</p> <p>This is not the case for FFT's in the Swept SA measurement; they use the same rules as swept measurements.</p>
Dependencies	<p>Key is blanked if current mode does not support it.</p> <p>Key is grayed out if mode supports it but current measurement does not support it.</p> <p>Unless Option LNP is present and licensed, key is blank and if SCPI command sent, error -241, "Hardware missing; Option not installed" is generated.</p>
Readback Text	Low Noise Path Enable
Initial S/W Revision	A.04.00

More Information

The user should understand that the Low Noise Path, while giving improved DANL, has the disadvantage of decreased TOI performance and decreased gain compression performance relative to the standard path.

The user should also understand that the bypass switch is a mechanical switch and has finite life, so if the Low Noise Path is enabled, it is possible to cause frequent cycling of this switch by frequently changing analyzer settings such that the above conditions hold true only some of the time. A user making tests of this nature should consider opting for the Standard Path, which will never throw the bypass switch, at the expense of some degraded noise performance.

The low noise path is useful for situations where the signal level is so low that the analyzer performance is dominated by noise even with 0 dB attenuation, but still high enough that the preamp option would have excessive third-order intermodulation or compression. The preamp, if purchased and used, gives better noise floor than does the "Low Noise Path." However, its compression threshold and third-order intercept are much poorer than that of the non-preamp path. There are some applications, typically for signals around -30 dBm, for which the third-order dynamic range of the standard path is good enough, but the noise floor is not low enough even with 0 dB input attenuation. When the third-order dynamic range of the preamp path is too little and the noise floor of the standard path is too high, the Low Noise Path can provide the best dynamic range

The graph below illustrates the concept. It shows, in red, the performance of an analyzer at different attenuation settings, both with the preamp on and off, in a measurement that is affected by both analyzer noise and analyzer TOI. The green shows the best available dynamic range, offset by 0.5 dB for clarity. The blue shows how the best available dynamic range improves for moderate signal levels with the low noise path switched in. In this illustration, the preamp improves the noise floor by 15 dB while degrading the third-order intercept by 30 dB, and the low noise path reduces loss by 8 dB. The attenuator step size is 2 dB.

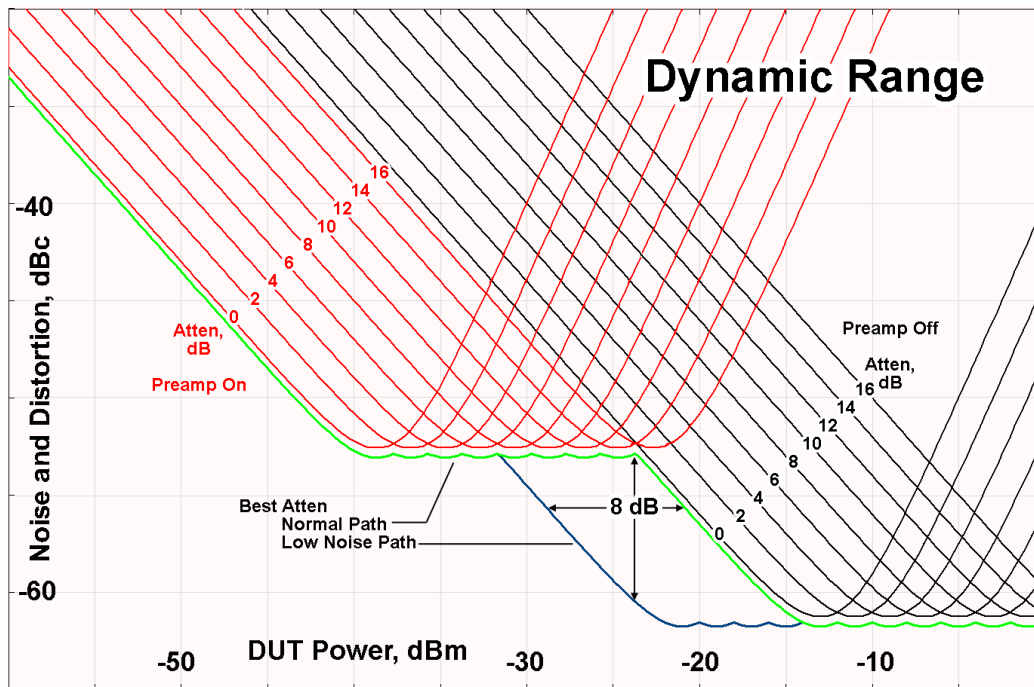

There are other times where selecting the low noise path improves performance, too. Compression-limited measurements such as finding the nulls in a pulsed-RF spectrum can profit from the low noise path in a way similar to the TOI-limited measurement illustrated. Accuracy can be improved when the low noise path allows the optimum attenuation to increase from a small amount like 0, 2 or 4 dB to a larger amount, giving better return loss at the analyzer input. Harmonic measurements, such as second and third harmonic levels, are much improved using the low noise path because of the superiority of that path for harmonic (though not intermodulation) distortion performance.

μW Preselector Bypass

This key toggles the preselector bypass switch for band 1 and higher. When the microwave preselector is on, the signal path is preselected. When the microwave preselector is off, the signal path is not preselected. The preselected path is the normal path for the analyzer.

The preselector is a tunable bandpass filter which prevents signals away from the frequency of interest from combining in the mixer to generate in-band spurious signals (images). The consequences of using a preselector filter are its limited bandwidth, the amplitude and phase ripple in its passband, and any amplitude and phase instability due to center frequency drift.

Option MPB or pre-selector bypass provides an unpreselected input mixer path for certain X-Series signal analyzers with frequency ranges above 3.6 GHz. This signal path allows a wider bandwidth and less amplitude variability, which is an advantage when doing modulation analysis and broadband signal analysis. The disadvantage is that, without the preselector, image signals will be displayed. Another disadvantage of bypassing the preselector is increased LO emission levels at the front panel input port.

Image responses are separated from the real signal by twice the 1st IF. For IF Paths of 10 MHz and 25 MHz, the 1st IF is 322.5 MHz, so the image response and the real signal will be separated by 645 MHz. The 1st IF will be different for other IF Path settings. When viewing a real signal and its corresponding image response in internal mixing, the image response will be to the left of the real signal.

Also, the image response and the real signal typically have the same amplitude and exhibit the same shape factor.

However, if Option FS1, Fast Sweep Capability, is enabled, the image response in the Swept SA measurement will appear lower in amplitude and have a much wider shape factor compared to the real signal.

Key Path	AMPTD Y Scale, μ W Path Control
Example	:POW:MW:PATH MPB
Dependencies	Key is blanked if current mode does not support it. Key is grayed out if mode supports it but current measurement does not support it. Key is blank unless Option MPB is present and licensed. If SCPI command sent when MPB not present, error -241, "Hardware missing; Option not installed" is generated.
Readback Text	μ W Preselector Bypass
Initial S/W Revision	A.04.00

Remote Command	[:SENSe] :POWeR [:RF] :MW :PRESelector [:STATe] ON OFF 0 1 [:SENSe] :POWeR [:RF] :MW :PRESelector [:STATe] ?
Example	:POW:MW:PRES OFF Bypasses the microwave preselector
Notes	The ON parameter sets the STD path (:POW:MW:PATH STD) The OFF parameter sets path MPB (:POW:MW:PATH MPB)
Preset	ON

Internal Preamp

Accesses a menu of keys that control the internal preamps. Turning on the preamp gives a better noise figure, but a poorer TOI to noise floor dynamic range. You can optimize this setting for your particular measurement.

The instrument takes the preamp gain into account as it sweeps. If you sweep outside of the range of the preamp the instrument will also account for that. The displayed result will always reflect the correct gain.

For some measurements, when the preamp is on and any part of the displayed frequency range is below the lowest frequency for which the preamp has specifications, a warning condition message appears in the status line. For example, for a preamp with a 9 kHz lowest specified frequency: "Preamp: Accy unspec'd below 9 kHz".

Key Path	AMPTD Y Scale
Scope	Meas Global
Remote Command	[:SENSe] :POWeR [:RF] :GAIN [:STATe] OFF ON 0 1 [:SENSe] :POWeR [:RF] :GAIN [:STATe] ?
Dependencies	Preamp is not available on all hardware platforms. If the preamp is not present or is unlicensed, the

key is not shown.
The preamp is not available when the electronic/soft attenuator is enabled.

Couplings	<p>The act of connecting the U7227A USB Preamplifier to one of the analyzer's USB ports will cause the Internal Preamp to be switched on. When this happens an informational message will be generated: "Internal Preamp turned on for optimal operation with USB Preamp." Note that if the Internal Preamp was already on, there will be no change to the setting, but if it was Off it will be switched On, to Full Range.</p> <p>Note that this same action occurs when the SA mode is selected while the USB Preamp is connected to one of the analyzer's USB ports, if it is the first time that the SA mode has run since powerup, or if the last time the SA mode was running the USB Preamp was NOT connected.</p> <p>Subsequently disconnecting the USB Preamp from USB does not change the Internal Preamp setting nor restore the previous setting.</p>
Preset	OFF
State Saved	Saved in instrument state
Initial S/W Revision	Prior to A.02.00
Modified at S/W Revision	A.14.00

Key Path	AMPTD Y Scale, Internal Preamp
Scope	Meas Global
Remote Command	<pre>[:SENSe] :POWer [:RF] :GAIN:BAND LOW FULL [:SENSe] :POWer [:RF] :GAIN:BAND?</pre>
Dependencies	<p>Preamp is not available on all hardware platforms. If the preamp is not present or is unlicensed, the key is not shown.</p> <p>If a POW:GAIN:BAND FULL command is sent when a low band preamp is available, the preamp band parameter is to LOW instead of FULL, and an "Option not installed" message is generated.</p>
Preset	LOW
State Saved	Saved in instrument state
Initial S/W Revision	Prior to A.02.00

Off

Turns the internal preamp off

Key Path	AMPTD Y Scale, Internal Preamp
Example	:POW:GAIN OFF
Readback	Off
Initial S/W Revision	Prior to A.02.00

Low Band

Sets the internal preamp to use only the low band.

The frequency range of the installed (optional) low-band preamp is displayed in square brackets on the Low Band key label.

Key Path	AMPTD Y Scale, Internal Preamp
Example	:POW:GAIN ON :POW:GAIN:BAND LOW
Readback	Low Band
Initial S/W Revision	Prior to A.02.00

Full Range

Sets the internal preamp to use its full range. The low band (0–3.6 GHz or 0–3GHz, depending on the model) is supplied by the low band preamp and the frequencies above low band are supplied by the high band preamp.

The frequency range of the installed (optional) preamp is displayed in square brackets on the Full Range key label. If the high band option is not installed the Full Range key does not appear.

Key Path	AMPTD Y Scale, Internal Preamp
Example	:POW:GAIN ON :POW:GAIN:BAND FULL
Readback	Full Range
Initial S/W Revision	Prior to A.02.00

Auto Couple

The Auto Couple feature provides a quick and convenient way to automatically couple multiple instrument settings. This helps ensure accurate measurements and optimum dynamic range. When the Auto Couple feature is activated, either from the front panel or remotely, all parameters of the current measurement that have an Auto/Manual mode are set to Auto mode and all measurement settings dependent on (or coupled to) the Auto/Man parameters are automatically adjusted for optimal performance.

However, the Auto Couple key actions are confined to the current measurement only. It does not affect other measurements in the mode, and it does not affect markers, marker functions, or trace or display attributes.

See ["More Information" on page 2753](#)

Key Path	Front-panel key
Remote Command	:COUPle ALL NONE
Example	:COUP ALL
Notes	:COUPle ALL puts all Auto/Man parameters in Auto mode (equivalent to pressing the Auto Couple key). :COUPLE NONE puts all Auto/Man parameters in manual mode. It decouples all the coupled instrument parameters and is not recommended for making measurements.
Initial S/W Revision	Prior to A.02.00

More Information

There are two types of functions that have Auto/Manual modes.

Auto/Man Active Function keys

An Auto/Man toggle key controls the binary state associated with an instrument parameter by toggling between Auto (where the parameter is automatically coupled to the other parameters it is dependent upon) and Man (where the parameter is controlled independent of the other parameters), as well as making the parameter the active function. The current mode is indicated on the softkey with either Auto or Man underlined as illustrated below.



Auto/Man 1-of-N keys

An Auto/Man 1-of-N key allows you to manually pick from a list of parameter values, or place the function in Auto, in which case the value is automatically selected (and indicated) as shown below. If in Auto, Auto is underlined on the calling key. If in manual operation, manual is indicated on the calling key. But the calling key does not actually toggle the function, it simply opens the menu.

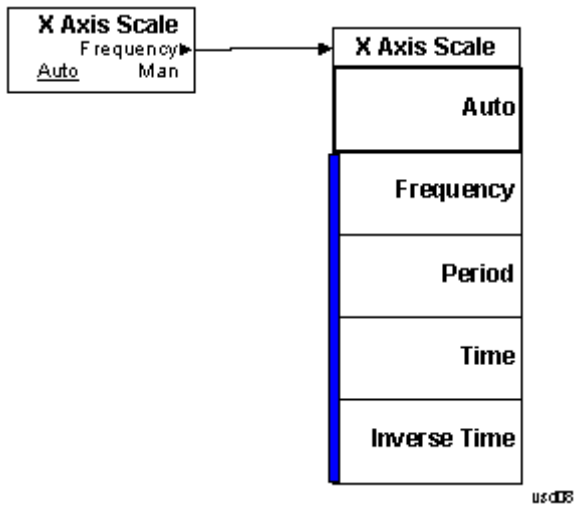

BW

Info BW is a SCPI only parameter. No softkey is available.

Key Path	Front-panel key
----------	-----------------

Cont (Continuous Measurement/Sweep)

Sets the analyzer for Continuous measurement operation. The single/continuous state is Meas Global so the setting will affect all measurements. If you are Paused, pressing Cont does a Resume.

Key Path	Front-panel key
Remote Command	:INITiate:CONTinuous OFF ON 0 1 :INITiate:CONTinuous?
Example	:INIT:CONT 0 puts analyzer in Single measurement operation. :INIT:CONT 1 puts analyzer in Continuous measurement operation
Preset	ON (Note that SYST:PRESet sets INIT:CONT to ON but *RST sets INIT:CONT to OFF)
State Saved	Saved in instrument state
Backwards Compatibility Notes	For Spectrum Analysis mode in ESA and PSA, there is no Cont hardkey, instead there is a Sweep Single/Cont key. In these analyzers, switching the Sweep Single/Cont key from Single to Cont restarts averages (displayed average count reset to 1), but does not restart Max Hold and Min Hold. The X-Series has Single and Cont keys in place of the SweepSingleCont key. In the X-Series, if in single measurement, the Cont key (and INIT:CONT ON) switches to continuous measurement, but never restarts a measurement and never resets a sweep.
Initial S/W Revision	Prior to A.02.00

In Swept SA Measurement (Spectrum Analysis Mode):

The analyzer takes repetitive sweeps, averages, measurements, etc., when in Continuous mode. When the average count reaches the Average/Hold Number the count stops incrementing, but the analyzer keeps sweeping. See the Trace/Detector section for the averaging formula used both before and after the Average/Hold Number is reached. The trigger condition must be met prior to each sweep. The type of trace processing for multiple sweeps, is set under the Trace/Detector key, with choices of Trace Average, Max Hold, or Min Hold.

In Other Measurements/Modes:

With Avg/Hold Num (in the Meas Setup menu) set to Off or set to On with a value of 1, a sweep is taken after the trigger condition is met; and the analyzer continues to take new sweeps after the current sweep has completed and the trigger condition is again met. However, with Avg/Hold Num set to On with a value >1, multiple sweeps (data acquisitions) are taken for the measurement. The trigger condition must be met prior to each sweep. The sweep is not stopped when the average count k equals the number N set for Avg/Hold Num is reached, but the number k stops incrementing. A measurement average usually applies to all traces, marker results, and numeric results. But sometimes it only applies to the numeric results.

If the analyzer is in Single measurement, pressing the Cont key does not change k and does not cause the sweep to be reset; the only action is to put the analyzer into Continuous measurement operation.

If it is already in continuous sweep:

the INIT:CONT 1 command has no effect

the INIT:CONT 0 command will place the analyzer in Single Sweep but will have no effect on the current sequence until $k = N$, at which point the current sequence will stop and the instrument will go to the idle state.

18 Conformance EVM
File

File

See "File" on page 360

FREQ Channel

Accesses a menu of keys that allow you to control the Frequency and Channel parameters of the instrument.

Some features in the Frequency menu are the same for all measurements – they do not change as you change measurements. Settings like these are called “Meas Global” and are unaffected by Meas Preset. For example, the Center Freq setting is the same for all measurements – it does not change as you change measurements.

Key Path	Front-panel key
Initial S/W Revision	Prior to A.02.00

Center Freq

Sets the frequency that corresponds to the horizontal center of the graticule (when frequency Scale Type is set to linear). While adjusting the Center Frequency the Span is held constant, which means that both Start Frequency and Stop Frequency will change.

Pressing Center Freq also sets the frequency entry mode to Center/Span. In Center/Span mode, the center frequency and span values are displayed below the graticule, and the default active function in the Frequency menu is Center Freq.

The center frequency setting is the same for all measurements within a mode, that is, it is Meas Global. Some modes are also able to share a Mode Global center frequency value. If this is the case, the Mode will have a Global Settings key in its Mode Setup menu.

The Center Freq function sets (and queries) the Center Frequency for the currently selected input. If your analyzer has multiple inputs, and you select another input, the Center Freq changes to the value for that input. SCPI commands are available to directly set the Center Freq for a specific input.

Center Freq is remembered as you go from input to input. Thus you can set a Center Freq of 10 GHz with the RF Input selected, change to BBIQ and set a Center Freq of 20 MHz, then switch to External Mixing and set a Center Freq of 60 GHz, and when you go back to the RF Input the Center Freq will go back to 10 GHz; back to BBIQ and it is 20 MHz; back to External Mixing and it is 60 GHz.

See ["RF Center Freq" on page 2762](#)

See [Ext Mix Center Freq](#)

See ["I/Q Center Freq" on page 2764](#)

See ["Center Frequency Presets" on page 2760](#)

Key Path	FREQ Channel
Scope	Meas Global
Remote Command	[:SENSe] :FREQuency:CENTer <freq> [:SENSe] :FREQuency:CENTer?

Example	<p>FREQ:CENT 50 MHz</p> <p>FREQ:CENT UP changes the center frequency to 150 MHz if you use FREQ:CENT:STEP 100 MHz to set the center frequency step size to 100 MHz</p> <p>FREQ:CENT?</p>
Notes	<p>This command sets either the RF or I/Q Center Frequency depending on the selected input.</p> <p>For RF input it is equivalent to FREQ:RF:CENT</p> <p>For I/Q input it is equivalent to FREQ:IQ:CENT</p> <p>Preset and Max values are dependent on Hardware Options (5xx)</p> <p>If no terminator (e.g. MHz) is sent the terminator Hz is used. If a terminator with unit other than Frequency is used, an invalid suffix error message is generated.</p>
Dependencies	<p>The Center Frequency can be limited by Start or Stop Freq limits, if the Span is so large that Start or Stop reach their limit.</p>
Couplings	<p>When operating in “swept span”, any value of the Center Frequency or Span that is within the frequency range of the analyzer is allowed when the value is being set through the front panel numeric key pad or the SCPI command. The other parameter is forced to a different value if needed, to keep the Start and the Stop Frequencies within the analyzer’s frequency range</p>
Preset	<p>Depends on instrument maximum frequency, mode, measurement, and selected input.</p> <p>See "Center Frequency Presets" on page 2760 and "RF Center Freq" on page 2762 and Ext Mix Center Freq and "I/Q Center Freq" on page 2764.</p>
State Saved	<p>Saved in instrument state</p>
Min	<p>Depends on instrument maximum frequency, mode, measurement, and selected input..</p> <p>See "Center Frequency Presets" on page 2760 and "RF Center Freq" on page 2762 and "I/Q Center Freq" on page 2764.</p>
Max	<p>Depends on instrument maximum frequency, mode, measurement, and selected input..</p> <p>See "Center Frequency Presets" on page 2760 and "RF Center Freq" on page 2762 and "I/Q Center Freq" on page 2764.</p>
Default Unit	<p>Hz</p>
Status Bits/OPC	<p>Non-overlapped</p>
Dependencies	
Initial S/W Revision	<p>Prior to A.02.00</p>

Center Frequency Presets

The following table provides the Center Frequency Presets for the Spectrum Analyzer mode, and the Max Freq, for the various frequency options:

Freq Option	CF after Mode Preset	Stop Freq after Mode Preset	Max Freq (can't tune)

			above)
503 (all but N9000A)	1.805 GHz	3.6 GHz	3.7 GHz
503 (N9000A)	1.505 GHz	3.0 GHz	3.08 GHz
507 (all but N9000A)	3.505 GHz	7.0 GHz	7.1 GHz
507 (N9000A)	3.755 GHz	7.5 GHz	7.58 GHz
508 (all but N9038A)	1.805 GHz	3.6 GHz	8.5 GHz
508 (N9038A)	4.205 GHz	8.4 GHz	8.5 GHz
513	6.805 GHz	13.6 GHz	13.8 GHz
526 (all but N9000A and N9038A)	13.255 GHz	26.5 GHz	27.0 GHz
526 (N9000A)	13.255 GHz	26.5 GHz	26.55 GHz
526 (N9038A)	1.805 GHz	3.6 GHz	27.0 GHz
532	16.005 GHz	32.0 GHz	32.5 GHz
543	21.505 GHz	43.0 GHz	TBD
544	22.005 GHz	44.0 GHz	44.5 GHz
550	25.005 GHz	50.0 GHz	51 GHz

Input 2:

Model	CF after Mode Preset	Stop Freq after Mode Preset	Max Freq (can't tune above)
N9000A opt C75	0.7505GHz	1.5 GHz	1.58 GHz
N9038A	505 MHz	1 GHz	1.000025 GHz

Tracking Generator Frequency Limits (N9000A only):

Tracking Generator Option	Min Freq (clips to this freq when turn TG on and	If above this Freq, Stop Freq clipped to this Freq when	Max Freq (can't tune above) while TG

	can't tune below while TG on)	TG turned on	on
T03	9 kHz	3.0 GHz	3.08 GHz
T06	9 kHz	6.0 GHz	6.05 GHz

The following table shows the Center Frequency Presets for modes other than Spectrum Analyzer:

Mode	CF Preset for RF
WCDMA	1 GHz
WIMAXOFDMA,	1 GHz
BASIC	1 GHz
ADEMOD	1 GHz
VSA	1 GHz
TDSCDMA	1 GHz
PNOISE	1 GHz
LTE	1 GHz
LTETDD	1 GHz
MSR	1 GHz
GSM	935.2 MHz
NFIGURE	1.505 GHz

RF Center Freq

SCPI command for specifying the RF Center Frequency. This command will set the Center Frequency to be used when the RF input is selected, even if the RF input is not the input that is selected at the time the command is sent. Note that the Center Freq function in the Frequency menu on the front panel always applies to the currently selected input.

Scope	Meas Global
Remote Command	<code>[:SENSe] :FREQuency:RF:CENTer <freq></code> <code>[:SENSe] :FREQuency:RF:CENTer?</code>
Example	FREQ:RF:CENT 30 MHz
Notes	This command is the same in all modes, but the parameter is Measurement Global. So the value is independent in each mode and common across all the measurements in the mode.
Dependencies	If the electronic/soft attenuator is enabled, any attempt to set Center Frequency such that the Stop Frequency would be >3.6 GHz fails and results in an advisory message. If the equivalent SCPI command is sent, this same message is generated as part of a “-221, Settings conflict” warning. If Source Mode is set to Tracking, and the Max or Min Center Freq is therefore limited by the limits of the source, a warning message is generated, “Data out of range;clipped to source max/min” if these limits are exceeded. Note that for an external source, these limits can be affected by the settings of

	Source Numerator, Source Denominator and Power Sweep.
Preset	See table above
State Saved	Saved in instrument state.
Min	-79.999995 MHz, unless Source Mode is set to Tracking, in which case it is limited by the minimum frequency of the Source
Max	See table above. Basically instrument maximum frequency - 5 Hz. Note that, if the Source Mode is set to Tracking, the effective instrument maximum frequency may be limited by the source maximum frequency. If the knob or step keys are being used, also depends on the value of the other three interdependent parameters Span, Start Frequency and Stop Frequency
Initial S/W Revision	Prior to A.02.00
Modified at S/W Revision	A.03.00

Ext Mix Center Freq

SCPI command for specifying the External Mixer Center Frequency. This command will set the Center Frequency to be used when the External Mixer is selected, even if the External Mixer input is not the input which is selected at the time the command is sent. Note that the Center Freq function in the Frequency menu on the front panel always applies to the currently selected input.

Scope	Meas Global
Remote Command	<code>[:SENSe] :FREQuency:EMIXer:CENTer <freq></code> <code>[:SENSe] :FREQuency:EMIXer:CENTer?</code>
Example	<code>:FREQ:EMIX:CENT 60 GHz</code> <code>:FREQ:EMIX:CENT?</code>
Notes	This command is the same in all modes, but the parameter is Measurement Global. So the value is independent in each mode and common across all the measurements in the mode.
Couplings	When returning to External Mixing after having been switched to one of the other inputs (e.g., RF), you will come back into the settings that you had when you left External Mixing. So you will come back to the band you were in with the Center Frequency that you had. However, Span is not an input-dependent parameter, therefore you will bring the span over from the other input. Therefore, the analyzer comes back with the span from the previous input, limited as necessary by the current mixer setup.
Preset	When a Mode Preset is performed while in External Mixing, the Start frequency of the current Mode is set to the nominal Min Freq of the lowest harmonic range in the Harmonic Table for the current mixer setup. Similarly, the Stop frequency of the current Mode is set to the nominal Max Freq of the highest harmonic range in the Harmonic Table. The Center Freq thus presets to the point arithmetically equidistant from these two frequencies. If the current measurement has a limited Span available to it, and cannot achieve the Span shown in the table ($\text{Span} = \text{Stop Freq} - \text{Start Freq}$), the analyzer uses the maximum Span the measurement allows, and still sets the Center Freq to the midpoint of the Start and Stop Freq values in the Harmonic Table.

	<p>When Restore Input/Output Defaults is performed, the mixer presets to the 11970A, whose Start and Stop frequencies are 26.5 and 40 GHz respectively. The center of these two frequencies is 33.25 GHz.</p> <p>Therefore, after a Restore Input/Output Defaults, if you go into External Mixing and do a Mode Preset while in the Spectrum Analyzer Mode, the resulting Center Freq is 33.25 GHz.</p>
State Saved	Saved in instrument state.
Min	The minimum frequency in the currently selected mixer band + 5 Hz
Max	<p>The maximum frequency in the currently selected mixer band – 5 Hz</p> <p>If the knob or step keys are being used, also depends on the value of the other three interdependent parameters Span, Start Frequency and Stop Frequency</p>
Initial S/W Revision	A.08.01

I/Q Center Freq

SCPI command for specifying the I/Q Center Frequency. This command will set the Center Frequency to be used when the I/Q input is selected, even if the I/Q input is not the input which is selected at the time the command is sent. Note that the Center Freq function in the Frequency menu on the front panel always applies to the currently selected input.

Scope	Meas Global
Remote Command	<pre>[:SENSe] :FREQuency:IQ:CENTer <freq></pre> <pre>[:SENSe] :FREQuency:IQ:CENTer?</pre>
Example	FREQ:IQ:CENT: 30 MHz
Notes	This command is the same in all modes, but the parameter is Measurement Global. So the value is independent in each mode and common across all the measurements in the mode.
Preset	0 Hz
State Saved	Saved in instrument state.
Min	-40.049995 MHz
Max	40.049995 MHz
Initial S/W Revision	Prior to A.02.00

CF Step

Changes the step size for the center frequency and start and stop frequency functions. Once a step size has been selected and the center frequency function is active, the step keys (and the UP|DOWN parameters for Center Frequency from remote commands) change the center frequency by the step-size value. The step size function is useful for finding harmonics and sidebands beyond the current frequency span of the analyzer.

Note that the start and stop frequencies also step by the CF Step value.

Key Path	FREQ Channel
Remote Command	[:SENSe] :FREQuency:CENTer:STEP [:INCRement] <freq> [:SENSe] :FREQuency:CENTer:STEP [:INCRement] ? [:SENSe] :FREQuency:CENTer:STEP:AUTO OFF ON 0 1 [:SENSe] :FREQuency:CENTer:STEP:AUTO?
Example	FREQ:CENT:STEP:AUTO ON FREQ:CENT:STEP 500 MHz FREQ:CENT UP increases the current center frequency value by 500 MHz FREQ:CENT:STEP? FREQ:CENT:STEP:AUTO?
Notes	Preset and Max values are depending on Hardware Options (503, 507, 508, 513, 526)
Notes	Preset and Max values are dependent on Hardware Options (5xx)
Dependencies	Freq Offset is not available in External Mixing. In this case the Freq Offset key is grayed out and shows a value of zero. It will once again be available, and show the previously set value, when you return to the RF Input.
Dependencies	Span, RBW, Center frequency If the electronic/soft attenuator is enabled, any attempt to change the value of the center frequency >3.6 GHz by pressing the Up-arrow key, fails and results in an advisory message. If the equivalent SCPI command is sent, this same message is generated as part of a “-221, Settings conflict” warning.
Couplings	When auto-coupled in a non-zero span, the center frequency step size is set to 10% of the span. When auto-coupled in zero span, the center frequency step size is set to the equivalent -3 dB RBW value.
Preset	Auto ADEMOD: 1 MHz ON
State Saved	Saved in instrument state
Min	– (the maximum frequency of the instrument). That is, 27 GHz max freq instrument has a CF step range of +/- 27 GHz. Note that this is the maximum frequency given the current settings of the instrument, so in External Mixing, for example, it is the maximum frequency of the current mixer band.
Max	The maximum frequency of the instrument. That is, 27 GHz max freq instrument has a CF step range of +/- 27 GHz. Note that this is the maximum frequency given the current settings of the instrument, so in External Mixing, for example, it is the maximum frequency of the current mixer band.
Default Unit	Hz
Status Bits/OPC dependencies	non-overlapped
Initial S/W Revision	Prior to A.02.00
Modified at S/W Revision	A.03.00

18 Conformance EVM
Input/Output

Input/Output

See ["Input/Output" on page 224](#)

Marker

There is no Marker functionality implemented in this measurement.

Key Path	Front-panel key
----------	-----------------

Marker > (Marker To)

There is no Marker To functionality implemented in this measurement.

Key Path

Front-panel key

Marker Fctn

There is no Marker functionality implemented in this measurement.

Key Path	Front-panel key
----------	-----------------

Meas

The information in this section is common to all measurements. For key and remote command information for a specific measurement, refer to the section that describes the measurement of interest.

Measurements available under the Meas key are specific to the current Mode.

When viewing Help for measurements, note the following:

NOTE

Operation for some keys differs between measurements. The information displayed in Help pertains to the current measurement. To see how a key operates in a different measurement, exit Help (press the Cancel Esc key), select the measurement, then reenter Help (press the Help key) and press that key.

Key Path	Front-panel key
Initial S/W Revision	Prior to A.02.00

Remote Measurement Functions

This section contains the following topics:

["Measurement Group of Commands" on page 2771](#)

["Current Measurement Query \(Remote Command Only\)" on page 2773](#)

["Limit Test Current Results \(Remote Command Only\)" on page 2773](#)

["Data Query \(Remote Command Only\)" on page 2773](#)

["Calculate/Compress Trace Data Query \(Remote Command Only\)" on page 2774](#)

["Calculate Peaks of Trace Data \(Remote Command Only\)" on page 2779](#)

[Hardware-Accelerated Fast Power Measurement \(Remote Command Only\)](#)

["Format Data: Numeric Data \(Remote Command Only\)" on page 2780](#)

["Format Data: Byte Order \(Remote Command Only\)" on page 2781](#)

Initial S/W Revision	Prior to A.02.00
----------------------	------------------

Measurement Group of Commands

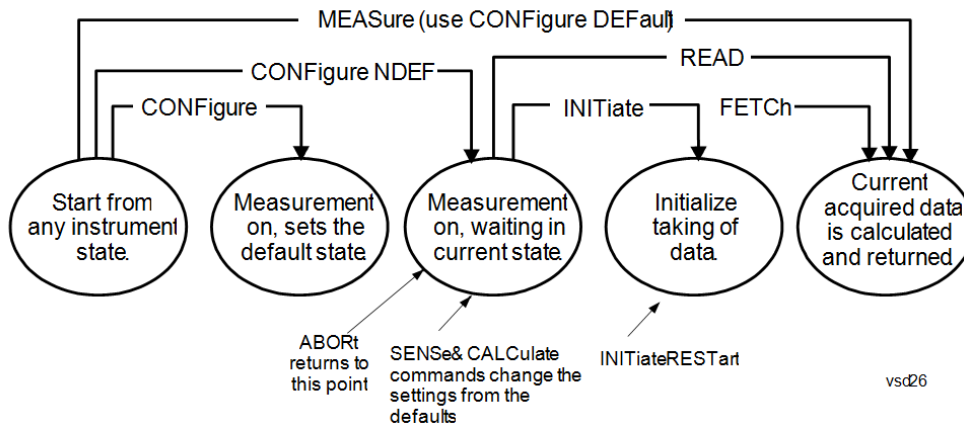

Measure Commands:

:MEASure:<measurement>[n]?

This is a fast single-command way to make a measurement using the factory default instrument settings. These are the settings and units that conform to the Mode Setup settings (e.g. radio standard) that you have currently selected.

- Stops the current measurement (if any) and sets up the instrument for the specified measurement using the factory defaults
- Initiates the data acquisition for the measurement
- Blocks other SCPI communication, waiting until the measurement is complete before returning results.
- If the function does averaging, it is turned on and the number of averages is set to 10.
- After the data is valid it returns the scalar results, or the trace data, for the specified measurement. The type of data returned may be defined by an [n] value that is sent with the command.
- The scalar measurement results will be returned if the optional [n] value is not included, or is set to 1. If the [n] value is set to a value other than 1, the selected trace data results will be returned. See each command for details of what types of scalar results or trace data results are available.
- ASCII is the default format for the data output. (Older versions of Spectrum Analysis and Phase Noise mode measurements only use ASCII.) The binary data formats should be used for handling large blocks of data since they are smaller and faster than the ASCII format. Refer to the FORMat:DATA command for more information.

If you need to change some of the measurement parameters from the factory default settings you can set up the measurement with the CONFigure command. Use the commands in the SENSe:<measurement> and CALCulate:<measurement> subsystems to change the settings. Then you can use the READ? command to initiate the measurement and query the results.

If you need to repeatedly make a given measurement with settings other than the factory defaults, you can use the commands in the SENSe:<measurement> and CALCulate:<measurement> subsystems to set up the measurement. Then use the READ? command to initiate the measurement and query results.

Measurement settings persist if you initiate a different measurement and then return to a previous one. Use READ:<measurement>? if you want to use those persistent settings. If you want to go back to the default settings, use MEASure:<measurement>?.

Configure Commands:

:CONFigure:<measurement>

This command stops the current measurement (if any) and sets up the instrument for the specified measurement using

the factory default instrument settings. It does not initiate the taking of measurement data unless INIT:CONTinuous is ON. If you change any measurement settings after using the CONFigure command, the READ command can be used to initiate a measurement without changing the settings back to their defaults.

In the Swept SA measurement in Spectrum Analyzer mode the CONFigure command also turns the averaging function on and sets the number of averages to 10 for all measurements.

:CONFigure: <measurement>: NDEFault stops the current measurement and changes to the specified measurement. It does not change the settings to the defaults. It does not initiate the taking of measurement data unless INIT:CONTinuous is ON.

The CONFigure? query returns the current measurement name.

The CONFigure:CATalog? query returns a quoted string of all licensed measurement names in the current mode. For example, "SAN, CHP, OBW, ACP, PST, TXP, SPUR, SEM, LIST".

Fetch Commands:

:FETCh:<measurement>[n]?

This command puts selected data from the most recent measurement into the output buffer. Use FETCh if you have already made a good measurement and you want to return several types of data (different [n] values, for example, both scalars and trace data) from a single measurement. FETCh saves you the time of re-making the measurement. You can only FETCh results from the measurement that is currently active, it will not change to a different measurement. An error message is reported if a measurement other than the current one is specified.

If you need to get new measurement data, use the READ command, which is equivalent to an INITiate followed by a FETCh.

The scalar measurement results will be returned if the optional [n] value is not included, or is set to 1. If the [n] value is set to a value other than 1, the selected trace data results will be returned. See each command for details of what types of scalar results or trace data results are available. The binary data formats should be used for handling large blocks of data since they are smaller and transfer faster than the ASCII format. (FORMat:DATA)

FETCh may be used to return results other than those specified with the original READ or MEASure command that you sent.

INITiate Commands:

:INITiate:<measurement>

This command is not available for measurements in all the instrument modes:

- Initiates a trigger cycle for the specified measurement, but does not output any data. You must then use the FETCh<meas> command to return data. If a measurement other than the current one is specified, the instrument will switch to that measurement and then initiate it.
 - For example, suppose you have previously initiated the ACP measurement, but now you are running the channel power measurement. If you send INIT:ACP? it will change from channel power to ACP and will initiate an ACP measurement.
 - Does not change any of the measurement settings. For example, if you have previously started the ACP measurement and you send INIT:ACP? it will initiate a new ACP measurement using the same instrument settings as the last time ACP was run.
 - If your selected measurement is currently active (in the idle state) it triggers the measurement, assuming the trigger conditions are met. Then it completes one trigger cycle. Depending upon the measurement and the number of averages, there may be multiple data acquisitions, with multiple trigger events, for one full trigger cycle. It also holds off additional commands on GPIB until the acquisition is complete.
-

READ Commands:

:READ:<measurement>[n]?

- Does not preset the measurement to the factory default settings. For example, if you have previously initiated the ACP
-

measurement and you send READ:ACP? it will initiate a new measurement using the same instrument settings.

- Initiates the measurement and puts valid data into the output buffer. If a measurement other than the current one is specified, the instrument will switch to that measurement before it initiates the measurement and returns results.
 - For example, suppose you have previously initiated the ACP measurement, but now you are running the channel power measurement. Then you send READ:ACP? It will change from channel power back to ACP and, using the previous ACP settings, will initiate the measurement and return results.
 - Blocks other SCPI communication, waiting until the measurement is complete before returning the results
 - If the optional [n] value is not included, or is set to 1, the scalar measurement results will be returned. If the [n] value is set to a value other than 1, the selected trace data results will be returned. See each command for details of what types of scalar results or trace data results are available. The binary data formats should be used when handling large blocks of data since they are smaller and faster than the ASCII format. (FORMat:DATA)
-

Initial S/W Revision	Prior to A.02.00
----------------------	------------------

Current Measurement Query (Remote Command Only)

This command returns the name of the measurement that is currently running.

Remote Command	:CONFigure?
-----------------------	-------------

Example	CONF?
----------------	-------

Initial S/W Revision	Prior to A.02.00
----------------------	------------------

Limit Test Current Results (Remote Command Only)

Queries the status of the current measurement limit testing. It returns a 0 if the measured results pass when compared with the current limits. It returns a 1 if the measured results fail any limit tests.

Remote Command	:CALCulate:CLIMits:FAIL?
-----------------------	--------------------------

Example	CALC:CLIM:FAIL? queries the current measurement to see if it fails the defined limits. Returns a 0 or 1: 0 it passes, 1 it fails.
----------------	--

Initial S/W Revision	Prior to A.02.00
----------------------	------------------

Data Query (Remote Command Only)

Returns the designated measurement data for the currently selected measurement and subopcode.

n = any valid subopcode for the current measurement. See the measurement command results table for your current measurement, for information about what data is returned for the subopcodes.

This command uses the data setting specified by the FORMat:BORDER and FORMat:DATA commands and can return real or ASCII data. (See the format command descriptions under Input/Output in the Analyzer Setup section.)

Remote Command	:CALCulate:DATA[n]?
Notes	The return trace depends on the measurement. In CALCulate:<meas>:DATA[n], n is any valid subopcode for the current measurement. It returns the same data as the FETCH:<measurement>? query where <measurement> is the current measurement.
Initial S/W Revision	Prior to A.02.00

Calculate/Compress Trace Data Query (Remote Command Only)

Returns compressed data for the currently selected measurement and sub-opcode [n].

n = any valid sub-opcode for that measurement. See the MEASure:<measurement>? command description of your specific measurement for information on the data that can be returned.

The data is returned in the current Y Axis Unit of the analyzer. The command is used with a sub-opcode <n> (default=1) to specify the trace. With trace queries, it is best if the analyzer is not sweeping during the query. Therefore, it is generally advisable to be in Single Sweep, or Update=Off.

This command is used to compress or decimate a long trace to extract and return only the desired data. A typical example would be to acquire N frames of GSM data and return the mean power of the first burst in each frame. The command can also be used to identify the best curve fit for the data.

Remote Command	:CALCulate:DATA<n>:COMPRESS? BLOCK CFIT MAXimum MINimum MEAN DMEan RMS RMSCubed SAMPLE SDEVIation PPHase [,<soffset> [,<length>[,<roffset>[,<rlimit>]]]]
Example	To query the mean power of a set of GSM bursts: Supply a signal that is a set of GSM bursts. Select the IQ Waveform measurement (in IQ Analyzer Mode). Set the sweep time to acquire at least one burst. Set the triggers such that acquisition happens at a known position relative to a burst. Then query the mean burst levels using, CALC:DATA2:COMP? MEAN, 24e-6, 526e-6 (These parameter values correspond to GSM signals, where 526e-6 is the length of the burst in the slot and you just want 1 burst.)
Notes	The command supports 5 parameters. Note that the last 4 (<soffset>, <length>, <roffset>, <rlimit>) are optional. But these optional parameters must be entered in the specified order. For example, if you want to specify <length>, then you must also specify <soffset>. See details below for a definition of each of these parameters. This command uses the data in the format specified by FORMat:DATA, returning either binary or ASCII data.
Initial S/W Revision	Prior to A.02.00

- BLOCK or block data - returns all the data points from the region of the trace data that you specify. For example, it could be used to return the data points of an input signal over several timeslots, excluding the portions of the trace data that you do not want. (This is x,y pairs for trace data and I,Q pairs for complex data.)

- CFIT or curve fit - applies curve fitting routines to the data. <soffset> and <length> are required to define the data that you want. <roffset> is an optional parameter for the desired order of the curve equation. The query will return the following values: the x-offset (in seconds) and the curve coefficients ((order + 1) values).

MIN, MAX, MEAN, DME, RMS, RMSC, SAMP, SDEV and PPH return one data value for each specified region (or <length>) of trace data, for as many regions as possible until you run out of trace data (using <roffset> to specify regions). Or they return the number of regions you specify (using <rlimit>) ignoring any data beyond that.

- MINimum - returns the minimum data point (y value) for the specified region(s) of trace data. For I/Q trace data, the minimum magnitude of the I/Q pairs is returned.
- MAXimum - returns the maximum data point (y value) for the specified region(s) of trace data. For I/Q trace data, the maximum magnitude of the I/Q pairs is returned.
- MEAN - returns a single value that is the arithmetic mean of the data point values (in dB/ dBm) for the specified region(s) of trace data. For I/Q trace data, the mean of the magnitudes of the I/Q pairs is returned. See the following equations.

-

NOTE

If the original trace data is in dB, this function returns the arithmetic mean of those log values, not log of the mean power which is a more useful value. The mean of the log is the better measurement technique when measuring CW signals in the presence of noise. The mean of the power, expressed in dB, is useful in power measurements such as Channel Power. To achieve the mean of the power, use the RMS option.

Equation 1

Mean Value of Data Points for Specified Region(s)

$$\text{MEAN} = \frac{1}{n} \sum_{X_i \in \text{region}(s)} X_i$$

where X_i is a data point value, and n is the number of data points in the specified region(s).

Equation 2

Mean Value of I/Q Data Pairs for Specified Region(s)

$$\text{MEAN} = \frac{1}{n} \sum_{X_i \in \text{region}(s)} |X_i|$$

where $|X_i|$ is the magnitude of an I/Q pair, and n is the number of I/Q pairs in the specified region(s).

- DMEan - returns a single value that is the mean power (in dB/ dBm) of the data point values for the specified region(s) of trace data. See the following equation:

Equation 3

DMEan Value of Data Points for Specified Region(s)

$$DME = 10 \times \log_{10} \left(\frac{1}{n} \sum_{X_i \in \text{region}(s)} 10^{\frac{X_i}{10}} \right)$$

- RMS - returns a single value that is the average power on a root-mean-squared voltage scale (arithmetic rms) of the data point values for the specified region(s) of trace data. See the following equation.

NOTE

For I/Q trace data, the rms of the magnitudes of the I/Q pairs is returned. See the following equation. This function is very useful for I/Q trace data. However, if the original trace data is in dB, this function returns the rms of the log values which is not usually needed.

Equation 4

RMS Value of Data Points for Specified Region(s)

$$RMS = \sqrt{\frac{1}{n} \sum_{X_i \in \text{region}(s)} X_i^2}$$

where X_i is a data point value, and n is the number of data points in the specified region(s).

Equation 5

RMS Value of I/Q Data Pairs for Specified Region(s)

$$RMS = \sqrt{\frac{1}{n} \sum_{X_i \in \text{region}(s)} X_i X_i^*}$$

where X_i is the complex value representation of an I/Q pair, X_i^* its conjugate complex number, and n is the number of I/Q pairs in the specified region(s).

Once you have the rms value for a region of trace data (linear or I/Q), you may want to calculate the mean power. You must convert this rms value (peak volts) to power in dBm:

$$10 \times \log[10 \times (\text{rms value})^2]$$

- SAMPlE - returns the first data value (x,y pair) for the specified region(s) of trace data. For I/Q trace data, the first I/Q pair is returned.
- SDEViation - returns a single value that is the arithmetic standard deviation for the data point values for the specified region(s) of trace data. See the following equation.
- For I/Q trace data, the standard deviation of the magnitudes of the I/Q pairs is returned. See the following equation.

Equation 6

Standard Deviation of Data Point Values for Specified Region(s)

$$\text{SDEV} = \sqrt{\frac{1}{n} \sum_{X_i \in \text{region}(s)} (X_i - \bar{X})^2}$$

where X_i is a data point value, \bar{X} is the arithmetic mean of the data point values for the specified region (s), and n is the number of data points in the specified region(s).

$$\text{SDEV} = \sqrt{\frac{1}{n} \sum_{X_i \in \text{region}(s)} (|X_i| - \bar{X})^2}$$

where $|X_i|$ is the magnitude of an I/Q pair, \bar{X} is the mean of the magnitudes for the specified region(s), and n is the number of data points in the specified region(s).

- PPHase - returns the x,y pairs of both rms power (dBm) and arithmetic mean phase (radian) for every specified region and frequency offset (Hz). The number of pairs is defined by the specified number of regions. This parameter can be used for I/Q vector (n=0) in Waveform (time domain) measurement and all parameters are specified by data point in PPHase.

The rms power of the specified region may be expressed as:

$$\text{Power} = 10 \times \log [10 \times (\text{RMS I/Q value})] + 10.$$

The RMS I/Q value (peak volts) is:

$$\sqrt{\frac{1}{n} \sum_{X_i \in \text{region}} X_i X_i^*}$$

where X_i is the complex value representation of an I/Q pair, X_i^* its conjugate complex number, and n is the number of I/Q pairs in the specified region.

The arithmetic mean phase of the specified region may be expressed as:

$$\frac{1}{n} \sum_{Y_i \in \text{region}} Y_i$$

where Y_i is the unwrapped phase of I/Q pair with applying frequency correction and n is the number of I/Q pairs in the specified region.

The frequency correction is made by the frequency offset calculated by the arithmetic mean of every specified region's frequency offset. Each frequency offset is calculated by the least square method against the unwrapped phase of I/Q pair.

Sample Trace Data - Constant Envelope

(See below for explanation of variables.)

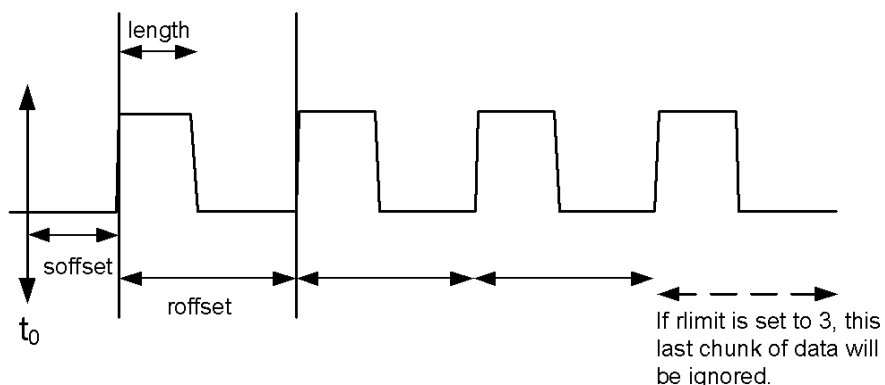

Sample Trace Data - Not Constant Envelope

(See below for explanation of variables.)

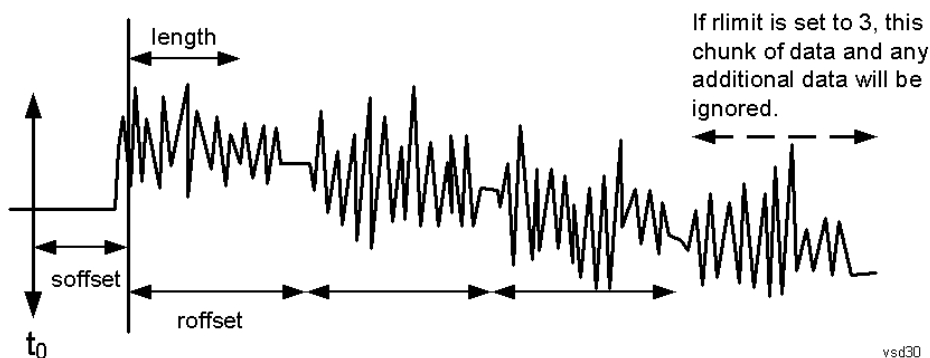

<soffset> - start offset is an optional real number. (It is in seconds for time-domain traces, and is a dimensionless index 0 to Npoints - 1, for frequency-domain traces). It specifies the amount of data at the beginning of the trace that will be ignored before the decimation process starts. It is the time or frequency change from the start of the trace to the point where you want to start using the data. The default value is zero.

<length> - is an optional real number. (It is in seconds for time-domain traces, and is a dimensionless index 0 to Npoints - 1, for frequency-domain traces). It defines how much data will be compressed into one value. This parameter has a default value equal to the current trace length.

<roffset> - repeat offset is an optional real number. (It is in seconds for time-domain traces, and is a dimensionless index 0 to Npoints - 1, for frequency-domain traces). It defines the beginning of the next field of trace elements to be compressed. This is relative to the beginning of the previous field. This parameter has a default value equal to the <length> variable. Note that this parameter is used for a completely different purpose when curve fitting (see CFIT above).

<rlimit> - repeat limit is an optional integer. It specifies the number of data items that you want returned. It will ignore any additional items beyond that number. You can use the Start offset and the Repeat limit to pick out exactly what part of the data you want to use. The default value is all the data.

Calculate Peaks of Trace Data (Remote Command Only)

Returns a list of all the peaks for the currently selected measurement and sub-opcode [n]. The peaks must meet the requirements of the peak threshold and excursion values.

n = any valid sub-opcode for the current measurement. See the MEASure:<measurement> command description of your specific measurement for information on the data that can be returned.

The command can only be used with specific sub-opcodes with measurement results that are trace data. Both real and complex traces can be searched, but complex traces are converted to magnitude in dBm. In many measurements the sub-opcode n=0, is the raw trace data which cannot be searched for peaks. And Sub-opcode n=1, is often calculated results values which also cannot be searched for peaks.

This command uses the data setting specified by the FORMat:BORDER and FORMat:DATA commands and can return real or ASCII data. If the format is set to INT,32, it returns REAL,32 data.

The command has four types of parameters:

- Threshold (in dBm)
- Excursion (in dB)
- Sorting order (amplitude, frequency, time)
- Optional in some measurements: Display line use (all, > display line, < display line)

Remote Command	<p>For Swept SA measurement:</p> <pre>:CALCulate:DATA[1] 2 ... 6:PEAKs? <threshold>,<excursion>[,AMPLitude FREQuency TIME[,ALL GTDLline LTDLine]]</pre> <p>For most other measurements:</p> <pre>:CALCulate:DATA[1] 2 ... 6:PEAKs? <threshold>,<excursion>[,AMPLitude FREQuency TIME]</pre>
-----------------------	---

Example	<p>Example for Swept SA measurement in Spectrum Analyzer Mode:</p> <p>CALC:DATA4:PEAK? -40, 10, FREQ, GTDL This will identify the peaks of trace 4 that are above -40 dBm, with excursions of at least 10 dB. The peaks are returned in order of increasing frequency, starting with the lowest frequency. Only the peaks that are above the display line are returned.</p> <p>Query Results 1:</p> <p>With FORMat:DATA REAL, 32 selected, it returns a list of floating-point numbers. The first value in the list is the number of peak points that are in the following list. A peak point consists of two values: a peak amplitude followed by its corresponding frequency (or time).</p> <p>If no peaks are found the peak list will consist of only the number of peaks, (0).</p>
----------------	---

Notes	<p><n> - is the trace that will be used</p> <p><threshold> - is the level below which trace data peaks are ignored. Note that the threshold value is required and is always used as a peak criterion. To effectively disable the threshold criterion for this command, provide a substantially low threshold value such as -200 dBm. Also note that the threshold value used in this command is independent of and has no effect on the threshold value stored under the Peak Criteria menu.</p> <p><excursion> - is the minimum amplitude variation (rise and fall) required for a signal to be identified as peak. Note that the excursion value is required and is always used as a peak criterion. To effectively disable the excursion criterion for this command, provide the minimum value of 0.0 dB. Also note that the excursion value used in this command is independent of and has no effect on the</p>
--------------	---

excursion value stored under the Peak Criteria menu.

Values must be provided for threshold and excursion. The sorting and display line parameters are optional (defaults are AMPLitude and ALL).

Note that there is always a Y-axis value for the display line, regardless of whether the display line state is on or off. It is the current Y-axis value of the display line which is used by this command to determine whether a peak should be reported

Sorting order:

AMPLitude - lists the peaks in order of descending amplitude, with the highest peak first (default if optional parameter not sent)

FREQuency - lists the peaks in order of occurrence, left to right across the x-axis.

TIME - lists the peaks in order of occurrence, left to right across the x-axis.

Peaks vs. Display Line:

ALL - lists all of the peaks found (default if optional parameter not sent).

GTDLine (greater than display line) - lists all of the peaks found above the display line.

LTDLine (less than display line) - lists all of the peaks found below the display line.

Initial S/W Revision Prior to A.02.00

Format Data: Numeric Data (Remote Command Only)

This command specifies the format of the trace data input and output. It specifies the formats used for trace data during data transfer across any remote port. It affects only the data format for setting and querying trace data for the :TRACe[:DATA], TRACe[:DATA]?, :CALCulate:DATA[n]? and FETCh:SANalyzer [n]? commands and queries.

Remote Command :FORMat [:TRACe] [:DATA] ASCii|INTeger, 32|REAL, 32 |REAL, 64
:FORMat [:TRACe] [:DATA] ?

Notes The query response is:
ASCii: ASC,8
REAL,32: REAL,32
REAL,64: REAL,64
INTeger,32: INT,32

When the numeric data format is REAL or ASCii, data is output in the current Y Axis unit. When the data format is INTeger, data is output in units of m dBm (.001 dBm).

The INT,32 format returns binary 32-bit integer values in internal units (m dBm), in a definite length block.

Dependencies Sending a data format spec with an invalid number (for example, INT,48) generates no error. The analyzer simply uses the default (8 for ASCii, 32 for INTeger, 32 for REAL).

Sending data to the analyzer which does not conform to the current FORMat specified, results in an error. Sending ASCII data when a definite block is expected generates message -161 "Invalid Block Data" and sending a definite block when ASCII data is expected generates message -121 "Invalid Character in Number".

Preset ASCii

Backwards Compatibility Notes Note that the INT,32 format is only applicable to the command, TRACe:DATA. This preserves backwards compatibility for the Swept SA measurement. For all other commands/queries which honor FORMat:DATA, if INT,32 is sent the analyzer will behave as though it were set to REAL,32.

Initial S/W Revision Prior to A.02.00

The specs for each output type follow:

ASCIi - Amplitude values are in ASCII, in the current Y Axis Unit, one ASCII character per digit, values separated by commas, each value in the form:

SX.YYYYYEsZZ

Where:

S = sign (+ or -)

X = one digit to left of decimal point

Y = 5 digits to right of decimal point

E = E, exponent header

s = sign of exponent (+ or -)

ZZ = two digit exponent

REAL,32 - Binary 32-bit real values in the current Y Axis Unit, in a definite length block.

REAL,64 - Binary 64-bit real values in the current Y Axis Unit, in a definite length block.

Format Data: Byte Order (Remote Command Only)

This command selects the binary data byte order for data transfer and other queries. It controls whether binary data is transferred in normal or swapped mode. This command affects only the byte order for setting and querying trace data for the :TRACe[:DATA], TRACe[:DATA]? , :CALCulate:DATA[n]? and FETCh:SANalyzer[n]? commands and queries.

By definition any command that says it uses FORMat:DATA uses any format supported by FORMat:DATA.

The NORMal order is a byte sequence that begins with the most significant byte (MSB) first, and ends with the least significant byte (LSB) last in the sequence: 1|2|3|4. SWAPPed order is when the byte sequence begins with the LSB first, and ends with the MSB last in the sequence: 4|3|2|1.

Remote Command	:FORMat:BORDER NORMal SWAPPed :FORMat:BORDER?
Preset	NORMal
Initial S/W Revision	Prior to A.02.00

Meas Setup

Only Copy from Mod Analysis and Meas Preset are available in the Meas Setup menu. The other functions are performed using Remote Commands documented in the following sections, or via setup tables, using the front-panel keys or a mouse and keyboard.

For more information on the measurement setup table screens, see:

Section ["Measurement List view" on page 2856](#) and

Section ["Parameter List view" on page 2857](#)

Key Path	Front-panel key
Initial S/W Revision	A.06.30

Meas Method (when 85 MHz or wider analysis bandwidth option is installed)

Selects the desired method for the CEVM measurement. This feature is available only when 85 MHz or wider analysis bandwidth option is installed.

NORMAL – Measurement speed is not optimized.

FAST – Measurement speed is optimized and faster than NORMAL. However, measurement settings are limited even in the valid combination of the parameter values. The limitations for Fast mode, See ["Fast Mode Limitation" on page 2782](#).

Key Path	Meas Setup
Mode	LTE
Remote Command	[:SENSe] :CEVM:METHod NORMal FAST [:SENSe] :CEVM:METHod?
Example	CEVM:METH FAST CEVM:METH?
Dependencies	This parameter is available only when the Wideband DIF (85 MHz or wider) hardware is installed in the instrument.
State Saved	Saved in instrument state.
Range	Normal Fast
Initial S/W Revision	A.10.01
Modified at S/W Revision	A.13.00

Fast Mode Limitation

- For downlink signals, Fast mode can be used only for E-UTRA test models, the setup files can be recalled by using Recall, Data, EVM Setup.

- For uplink signals, Fast mode only supports channel configuration for PUSCH, and other channels such as PUCCH are not supported. Multiple users are not supported in Fast mode. The auto function of the parameters must be OFF and see the table below for parameter values, others must be preset value.
- When Meas Method is FAST, EVM Minimization by IQ Imbalance is not valid and is always OFF to return the measurement results.

Name	SCPI	Fast Mode
RB Auto Detection	[:SENSe]:CEVM:PROFile:AUTO[:DETEct]	OFF
Analysis Boundary	[:SENSe]:CEVM:TIME:ASBoundary	FRAME
Meas Interval/Offset	[:SENSe]:CEVM:TIME:INTerval:SLOT [:SENSe]:CEVM:TIME:INTerval:SYMBol [:SENSe]:CEVM:TIME:OFFSet:SLOT [:SENSe]:CEVM:TIME:OFFSet:SYMBol	Same as Normal Mode
Sync Type	[:SENSe]:CEVM:ULINK:SYNC:TYPE	RS
Cyclic Prefix Length	[:SENSe]:CEVM:ULINK:SYNC:CPLength	NORMAL
Add User	[:SENSe]:CEVM:ULINK:PROFile:ADD:USER	Only USER[1] is valid.
Include PUSCH	[:SENSe]:CEVM:ULINK:PROFile:USER:PUSCh	INCLude
PUSCH Active	[:SENSe]:CEVM:ULINK:PROFile:USER:PUSCh:ACTIve	ON
Include PUSCH DMRS	[:SENSe]:CEVM:ULINK:PROFile:USER:PUSCh:DMRS	INCLude
PUSCH Auto Calc Params	[:SENSe]:CEVM:ULINK:PROFile:USER:PUSCh:DMRS:PARAmS	Same as Normal Mode
PUSCH n DMRS (1)	[:SENSe]:CEVM:ULINK:PROFile:USER:PUSCh:DMRS:ONE	Same as Normal Mode
PUSCH n DMRS (2)	[:SENSe]:CEVM:ULINK:PROFile:USER:PUSCh:DMRS:TWO	Same as Normal Mode
Delta SS	[:SENSe]:CEVM:ULINK:PROFile:USER:PUSCh:DSS	Same as Normal Mode
Add PUSCH Slot	[:SENSe]:CEVM:ULINK:PROFile:USER:PUSCh:ADD:SLOT	Same as Normal Mode
User PUSCH RB Start	[:SENSe]:CEVM:ULINK:PROFile:USER:PUSCh:RB:STARt	Same as Normal Mode
PUSCH Start RB Couple	[:SENSe]:CEVM:ULINK:PROFile:USER:PUSCh:RB:STARt:COUPlE	Same as Normal Mode
PUSCH Common	[:SENSe]:CEVM:ULINK:PROFile:USER:PUSCh:RB:END	Same as

RB End		Normal Mode
PUSCH End RB Couple	[:SENSe] :CEVM:ULINK:PROFile:USER:PUSCh:RB:END:COUPlE	Same as Normal Mode
PUSCH Sync Slot	[:SENSe] :CEVM:ULINK:PROFile:USER:PUSCh:SSLot	Same as Normal Mode
PUSCH Sync Slot Auto	[:SENSe] :CEVM:ULINK:PROFile:USER:PUSCh:SSLot:AUTO	OFF
PUSCH Common Mod Type	[:SENSe] :CEVM:ULINK:PROFile:USER1 50:PUSCh:MODulation:TYPE	Same as Normal Mode
Frequency Hopping	[:SENSe] :CEVM:ULINK:PROFile:USER:PUSCh:FHOpping	OFF
Group Hopping	[:SENSe] :CEVM:ULINK:PROFile:USER:HOPping:GROup	Same as Normal Mode
Seq Hopping	[:SENSe] :CEVM:ULINK:PROFile:USER1 50:HOPping:SEQuence	Same as Normal Mode
Equalizer Training	[:SENSe] :CEVM:EQUalizer:TRaining	RSData

Copy from Mod Analysis Measurement

This immediate action key provides parameter copy function from Mod Analysis Measurement to CEVM.

NOTE

This immediate action copies LTE demodulation parameters from the Mod Analysis Measurement to Conformance EVM Measurement. Note that the other parameters such as Attenuation(Range), Trigger, averaging parameters, IFBW, etc. are NOT copied from Mod Analysis Measurement.

Key Path	Meas Setup
Mode	LTE, LTETDD
Remote Command	[:SENSe] :CEVM:EVM:COpy [:IMMediate]
Example	CEVM:EVM:COpy
Initial S/W Revision	A.06.30

Meas Preset

This immediately sets all measurement parameters to their Preset values. For more information, see the Preset key in the System Functions section.

Key Path	Meas Setup
Mode	LTE, LTETDD
Initial S/W Revision	A.06.30

18 Conformance EVM
Mode

Mode

See "[Mode](#)" on page 316

Mode Preset

Returns the active mode to a known state.

Mode Preset does the following for the currently active mode:

- Aborts the currently running measurement.
- Brings up the default menu for the mode, with no active function.
- Sets measurement Global settings to their preset values for the active mode only.
- Activates the default measurement.
- Brings up the default menu for the mode.
- Clears the input and output buffers.
- Sets Status Byte to 0.

Mode Preset does not:

- Cause a mode switch
- Affect mode persistent settings
- Affect system settings

See "[How-To Preset](#)" on page 2788 for more information.

Key Path	Front-panel key
Remote Command	:SYSTem:PRESet
Example	:SYST:PRES
Notes	*RST is preferred over :SYST:PRES for remote operation. *RST does a Mode Preset, as done by the :SYST:PRES command, and it sets the measurement mode to Single measurement rather than Continuous for optimal remote control throughput. Clears all pending OPC bits. The Status Byte is set to 0.
Couplings	A Mode Preset aborts the currently running measurement, activates the default measurement, and gets the mode to a consistent state with all of the default couplings set.
Backwards Compatibility Notes	In the X-Series, the legacy "Factory Preset" has been replaced with Mode Preset, which only presets the currently active mode, not the entire instrument. In the X-Series, the way to preset the entire instrument is by using System, Restore System Defaults All, which behaves essentially the same way as restore System Defaults does on ESA and PSA. There is also no "Preset Type" as there is on the PSA. There is a green Mode Preset front-panel key that does a Mode Preset and a white-with-green-letters User Preset front-panel key that does a User Preset. The old PRESet:TYPE command is ignored (without generating an error), and SYST:PRES without a parameter does a Mode Preset, which should cover most backward code compatibility issues. The settings and correction data under the Input/Output front-panel key (examples: Input Z Corr, Ext Amp Gain, etc.) are no longer part of any Mode, so they will not be preset by a Mode Preset. They are preset using Restore Input/Output Defaults, Restore System Defaults All. Note that because User Preset does a Recall State, and all of these settings are saved in State, they ARE recalled when using

	User Preset.
Initial S/W Revision	Prior to A.02.00

How-To Preset

The table below shows all possible presets, their corresponding SCPI commands and front-panel access (key paths). Instrument settings depend on the current measurement context. Some settings are local to the current measurement, some are global (common) across all the measurements in the current mode, and some are global to all the available modes. In a similar way, restoring the settings to their preset state can be done within the different contexts.

Auto Couple - is a measurement local key. It sets all Auto/Man parameter couplings in the measurement to Auto. Any Auto/Man selection that is local to other measurements in the mode will not be affected.

Meas Preset - is a measurement local key. Meas Preset resets all the variables local to the current measurement except the persistent ones.

Mode Preset - resets all the current mode's measurement local and measurement global variables except the persistent ones.

Restore Mode Defaults - resets ALL the Mode variables (and all the Meas global and Meas local variables), including the persistent ones.

Type Of Preset	SCPI Command	Front Panel Access
Auto Couple	:COUPle ALL	Auto Couple front-panel key
Meas Preset	:CONFigure:<Measurement>	Meas Setup Menu
Mode Preset	:SYSTem:PRESet	Mode Preset (green key)
Restore Mode Defaults	:INSTrument:DEFault	Mode Setup Menu
Restore All Mode Defaults	:SYSTem:DEFault MODes	System Menu; Restore System Default Menu
*RST	*RST	not possible (Mode Preset with Single)
Restore Input/Output Defaults	:SYSTem:DEFault INPUt	System Menu; Restore System Default Menu
Restore Power On Defaults	:SYSTem:DEFault PON	System Menu; Restore System Default Menu
Restore Alignment Defaults	:SYSTem:DEFault ALIGN	System Menu; Restore System Default Menu
Restore Miscellaneous Defaults	:SYSTem:DEFault MISC	System Menu; Restore System Default Menu
Restore All System Defaults	:SYSTem:DEFault [ALL] :SYSTem:PRESet:PERsistent	System Menu; Restore System Default Menu
User Preset	:SYSTem:PRESet:USER	User Preset Menu
User Preset All Modes	:SYSTem:PRESet:USER:ALL	User Preset Menu

Power On Mode Preset	:SYSTem:PON:TYPE MODE	System Menu
Power On User Preset	:SYSTem:PON:TYPE USER	System Menu
Power On Last State	:SYSTem:PON:TYPE LAST	System Menu

Preset Type (Remote Command Only)

As stated in the Backward Compatibility section, to be compatible with ESA/PSA the PRESet:TYPE command will be implemented as a no-op.

Mode	All
Remote Command	:SYSTem:PRESet:TYPE FACTory MODE USER :SYSTem:PRESet:TYPE?
Example	:SYST:PRESet:TYPE FACT
Notes	This command is supported for backward compatibility only. It is a no-op which does not change the behavior of any preset operation.
Preset	This is unaffected by Preset but is set to Mode on a "Restore System Defaults->All"
State Saved	No
Initial S/W Revision	Prior to A.02.00

18 Conformance EVM
Mode Setup

Mode Setup

See "[Mode Setup](#)" on page 347

Peak Search

There is no Peak Search functionality implemented in this measurement.

Key Path	Front-panel key
----------	-----------------

18 Conformance EVM
Print

Print

See ["Print" on page 365](#)

Quick Save

The Quick Save front-panel key repeats the most recent save that was performed from the Save menu, with the following exceptions:

- Register saves are not remembered as Saves for the purpose of the Quick Save function
- If the current measurement does not support the last non-register save that was performed, an informational message is generated, “File type not supported for this measurement”

Quick Save repeats the last type of qualified save (that is, a save qualified by the above criteria) in the last save directory by creating a unique filename using the Auto File Naming algorithm described below.

If Quick Save is pressed after startup and before any qualified Save has been performed, the Quick Save function performs a Screen Image save using the current settings for Screen Image saves (current theme, current directory), which then becomes the “last save” for the purpose of subsequent Quick Saves.

The Auto File Naming feature automatically generates a file name for use when saving a file. The filename consists of a prefix and suffix separated by a dot, as is standard for the Windows® file system. A default prefix exists for each of the available file types:

Type	Default Prefix	Menu
State	State_	(Save/Recall)
Trace + State	State_	(Save/Recall)
Screen	Screen_	(Save/Recall)
Amplitude Corrections	Ampcor_	(Import/Export)
Traces	Trace_	(Import/Export)
Limit Lines	LLine_	(Import/Export)
Measurement Result	MeasR_	(Import/Export)
Capture Buffer	CapBuf_	(Import/Export)

A four digit number is appended to the prefix to create a unique file name. The numbering sequence starts at 0000 within each Mode for each file type and updates incrementally to 9999, then wraps to 0000 again. It remembers where it was through a Mode Preset and when leaving and returning to the Mode. It is reset by Restore Misc Defaults and Restore System Defaults and subsequent running of the instrument application. So, for example, the first auto file name generated for State files is State_0000.state. The next is State_0001, and so forth.

One of the key features of Auto File Name is that we guarantee that the Auto File Name will never conflict with an existing file. The algorithm looks for the next available number. If it gets to 9999, then it looks for holes. If it find no holes, that is no more numbers are available, it gives an error.

For example, if when we get to State_0010.state there is already a State_0010.state file in the current directory, it advances the counter to State_0011.state to ensure that no conflict will exist (and then it verifies that State_0011.state also does not exist in the current directory and advances again if it does, and so forth).

If you enter a file name for a given file type, then the prefix becomes the filename you entered instead of the default prefix, followed by an underscore. The last four letters (the suffix) are the 4-digit number.

For example, if you save a measurement results file as “fred.csv”, then the next auto file name chosen for a measurement results save will be fred_0000.csv.

NOTE

Although 0000 is used in the example above, the number that is used is actually the current number in the Meas Results sequence, that is, the number that would have been used if you had not entered your own file name.

NOTE

If the filename you entered ends with _dddd, where d=any number, making it look just like an auto file name, then the next auto file name picks up where you left off with the suffix being dddd + 1.

Key Path	Front-panel key
Notes	No remote command for this key specifically.
Initial S/W Revision	Prior to A.02.00

Recall

In the LTE TDD mode, four types of recall functions are available under the Data menu: “Limit Mask”, “E-UTRA Test Model”, “Signal Studio Setup” and “Vector Signal Analyzer”. “Limit Mask” enables setting of a preset limit mask for Power Suite-based measurements, and currently it is available for the SEM/ACP measurements with the LTE TDD mode. Recalling “E-UTRA Test Model” sets complicated RB settings for each Test Model for the Modulation Analysis and Conformance EVM measurements. Recalling “Signal Studio Setup” or “89600 Vector Signal Analyzer” enables you to recall parameters which have been set and saved on the external platform.

Key Path	Front Panel
Mode	LTETDD
Initial S/W Revision	Prior to A.02.00
Modified at S/W Revision	A.06.00

State

The Recall State menu lets you choose a register or file from which to recall the state.

The content of a state file includes all of the settings and data required to return the analyzer as closely as possible to the Mode it was in, with the exact settings that were in place, when the save occurred. The Mode settings in each state file include the settings that are affected by Mode Preset, as well as the additional settings affected by Restore Mode Defaults; all of the Mode’s settings. In addition, all of the settings of the Input/Output system are included, even though they are outside of the Mode’s state, because they are needed to restore the complete setup. Persistent System settings (for example, GPIB address) are not affected by either a Mode Preset or Restore Mode Defaults, nor are they included in a saved State file.

Since each state file is only for one Mode, the settings for other Modes are unaffected when it is loaded. Recall State will cause a mode switch if the state being recalled is not from the current active mode.

After the recall completes, the message "File <filename> recalled" or “Recalled State Register <register number>” is displayed.

For rapid recalls, the State menu lists 16 registers that you can choose from to recall. Pressing a Register key initiates the recall. You can also select a file from which to recall.

The default path for all State Files is:

My Documents\<<mode name>\state

where <mode name> is the parameter used to select the mode with the INST:SEL command (for example, SA for the Spectrum Analyzer).

See ["More Information" on page 2796](#).

Key Path	Recall
Mode	All

Remote Command	:MMEMory:LOAD:STATe <filename>
Example	:MMEM:LOAD:STAT "myState.state" This recalls the file myState.state on the default path
Example	MMEM:LOAD:STAT "MyStateFile.state" This loads the state file data (on the default file directory path) into the instrument state.
Notes	<p>When you pick a file to recall, the analyzer first verifies that the file is recallable in the current instrument by checking the software version and model number of the instrument. If everything matches, a full recall proceeds by aborting the currently running measurement, clearing any pending operations, and then loading the State from the saved state file. You can open state files from any mode, so recalling a State file switches to the mode that was active when the save occurred. After switching to the mode of the saved state file, mode settings and data (if any for the mode) are loaded with values from the saved file. The saved measurement of the mode becomes the newly active measurement and the data relevant to the measurement (if there is any) is recalled.</p> <p>If there is a mismatch between file version or model number or instrument version or model number, the recall function tries to recall as much as possible and returns a warning message. It may limit settings that differ based on model number, licensing or version number.</p> <p>After recalling the state, the Recall State function does the following:</p> <ul style="list-style-type: none"> • Makes the saved measurement for the mode the active measurement. • Clears the input and output buffers. • Status Byte is set to 0. • Executes a *CLS <p>If the file specified is empty an error is generated. If the specified file does not exist, another error is generated. If there is a mismatch between the file and the proper file type, an error is generated. If there is a mismatch between file version or model number or instrument version or model number, a warning is displayed. Then it returns to the State menu and File Open dialog goes away.</p> <p>After the Recall, the analyzer exits the Recall menu and returns to the previous menu.</p>
Backwards Compatibility SCPI	:MMEMory:LOAD:STATe 1,<filename> For backwards compatibility, the above syntax is supported. The "1" is simply ignored.
Initial S/W Revision	Prior to A.02.00

More Information

In measurements that support saving Traces, for example, Swept SA, the Trace data is saved along with the State in the State file. When recalling the State, the Trace data is recalled as well. Traces are recalled exactly as they were stored, including the writing mode and update and display modes. If a Trace was updating and visible when the State was saved, it will come back updating and visible, and its data will be rewritten right away. When you use State to save and recall traces, any trace whose data must be preserved should be placed in View or Blank mode before saving.

The following table describes the Trace Save and Recall possibilities:

You want to recall state and one trace's data, leaving other traces unaffected.	Save Trace+State from 1 trace. Make sure that no other traces are updating (they should all be in View	On Recall, specify the trace you want to load the one trace's data into. This trace will load in View.
---	---	--

	or Blank mode) when the save is performed.	All other traces' data will be unaffected, although their trace mode will be as it was when the state save was performed.
You want to recall all traces	Save Trace+State from ALL traces.	On Recall, all traces will come back in View (or Blank if they were in Blank or Background when saved)
You want all traces to load exactly as they were when saved.	Save State	On recall, all traces' mode and data will be exactly as they were when saved. Any traces that were updating will have their data immediately overwritten.

From File...

When you press “From File”, the analyzer brings up a Windows dialog and a menu entitled “File Open.” This menu allows you to navigate to the various fields in the Windows dialog without using a keyboard or mouse. The Tab and Arrow keys can also be used for dialog navigation.

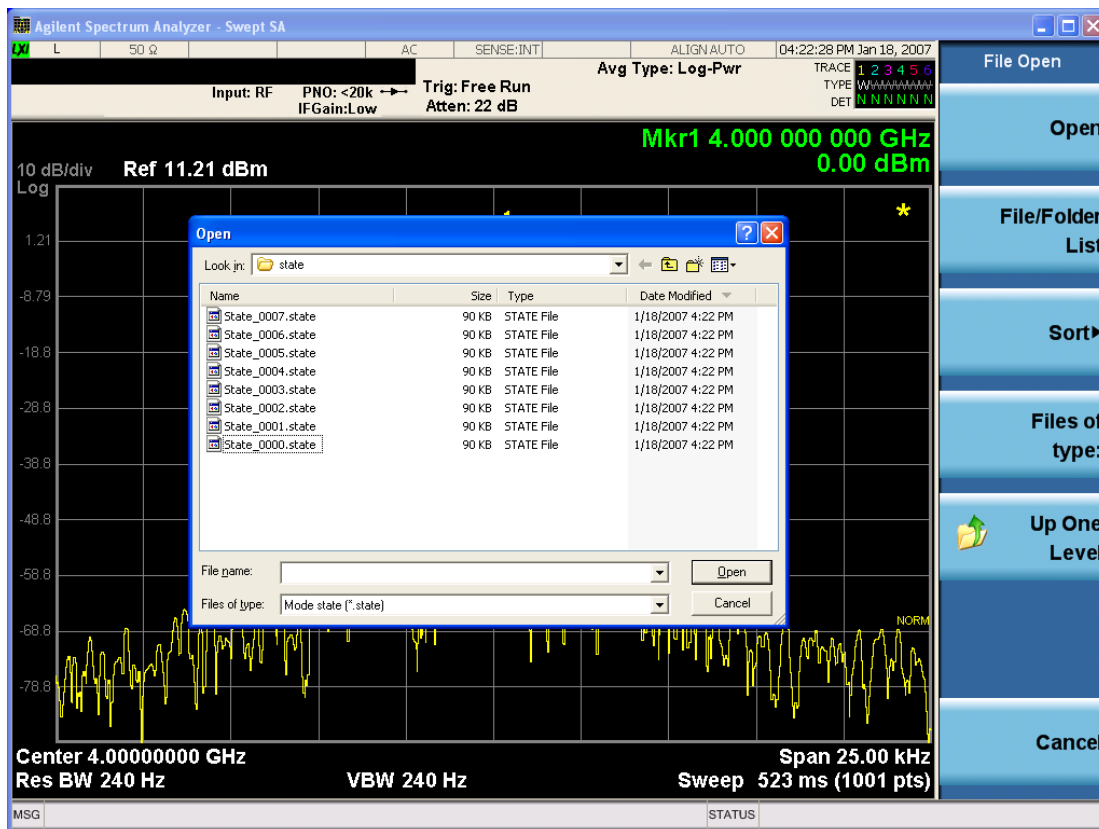

Listed below are the functions of the various fields in the dialog, and the corresponding softkeys:

Open

Performs the recall of the specified file. While the recall is being performed, the floppy icon appears briefly in the Meas bar.

File/Folder List

Enables you to navigate to the center of the dialog that contains the list of files and folders. Once here you can get information about the file and use the tab keys to navigate to the other fields in the dialog, such as Look In.

Look In

The Look In field shows the path from which the file will be recalled and allows you to change the path using the up and down arrow keys to navigate to other paths; the Enter key to open a directory; and the Backspace key to go back one directory. The **Look In field** first uses the last path from the Save As dialog **Save In:** path for that same file type. There is no softkey for directly navigating to the Look In field, but you can use the left tab to get here from the File/Folder List.

User specified paths are remembered when you leave and return to a Mode and are reset back to the default using Restore Mode Defaults.

Sort

Accesses a menu that enables you to sort the files within the File Open dialog. Only one sorting type can be selected at a time and the sorting happens immediately. The sorting types are By Date, By Name, By extension, and By Size.

Files of Type

This field shows the file suffix for the type of file you have selected to recall. For example, if you navigated here while recalling State, "Mode state (*.state)" is in the field. If you navigated here while recalling Trace, ""Mode state (*.trace)" is in the field. If you navigated here while importing a trace data file, "Trace Data (*.csv)" is in the field. For some file types, there is more than one choice in the dropdown menu, which you can select by using the up and down arrow keys and Enter.

Up One Level

This key corresponds to the icon of a folder with the up arrow that is in the tool bar of the dialog. When pressed, it causes the file and folder list to navigate up one level in the directory structure. The Backspace key does the same thing.

Cancel

This key corresponds to the Cancel selection in the dialog. It causes the current **Open** request to be cancelled. The ESC key does the same thing.

Key Path	Recall, State
Notes	Brings up the Open dialog for recalling a State Save Type
Initial S/W Revision	Prior to A.02.00

Edit Register Names

You may enter a custom name on any of the Register keys, to help you remember what you are using that state to save. To do this, press the Edit Register Names key, choose the register whose name you wish to edit, and then enter the desired label using the Alpha Editor or an external PC keyboard.

The maximum number of characters that can be added is 30. In most cases, 30 characters will fit on two lines of the key.

For more information and the SCPI command, see Edit Register Names under the Save, State function.

Key Path	Recall, State
Mode	All
Dependencies	N9060A-7FP or N9060B-2FP license required to edit the register names. When the feature is not licensed, sending the SCPI command generates an error, -221, "Settings conflict;Option not available"
Initial S/W Revision	A.11.00

Register 1 thru Register 16

Selecting any one of these register keys causes the State of the mode from the specified Register to be recalled. Each of the register keys annotates whether it is empty or at what date and time it was last modified. In addition, you can use the Edit Register Names key under Save, State to enter custom names for each register.

Registers are shared by all modes, so recalling from any one of the registers will cause a mode switch to the mode that was active when the save to the Register occurred.

Although these 16 registers are the only registers available from the front panel, there are 128 state registers available in the instrument. Registers 17–128 are only available from the SCPI interface, using the *RCL command.

After the recall completes, the message "Register <register number> recalled" appears in the message bar. If you are in the Spectrum Analyzer Mode, and you are recalling a register that was saved in the Spectrum Analyzer Mode, then after the recall, you will still be in the Recall Register menu. If the Recall causes you to switch modes, then after the Recall, you will be in the Frequency menu.

If a requested register is empty an error is generated.

Key Path	Recall, State
Example	*RCL 1
Range	1–16 from front panel, 1–128 from SCPI
Readback	Date and time with seconds resolution are displayed on the key OR A custom name of up to 30 characters entered using the Save, State,Edit Register Names key OR “(empty)” if no prior save operation has been performed to this register.
Initial S/W Revision	Prior to A.02.00
Modified at S/W Revision	Prior to A.11.00

Register 1 thru Register 16

Selecting any one of these register keys causes the State of the mode from the specified Register to be recalled. Each of the register keys annotates whether it is empty or at what date and time it was last modified. In addition, you can use the Edit Register Names key under Save, State to enter custom names for each register.

Registers are shared by all modes, so recalling from any one of the registers will cause a mode switch to the mode that was active when the save to the Register occurred.

Although these 16 registers are the only registers available from the front panel, there are 128 state registers available in the instrument. Registers 17–128 are only available from the SCPI interface, using the *RCL command.

After the recall completes, the message "Register <register number> recalled" appears in the message bar. If you are in the Spectrum Analyzer Mode, and you are recalling a register that was saved in the Spectrum Analyzer Mode, then after the recall, you will still be in the Recall Register menu. If the Recall causes you to switch modes, then after the Recall, you will be in the Frequency menu.

If a requested register is empty an error is generated.

Key Path	Recall, State
Example	*RCL 1
Range	1–16 from front panel, 1–128 from SCPI
Readback	Date and time with seconds resolution are displayed on the key OR A custom name of up to 30 characters entered using the Save, State, Edit Register Names key OR “(empty)” if no prior save operation has been performed to this register.
Initial S/W Revision	Prior to A.02.00
Modified at S/W Revision	Prior to A.11.00

Recall

In the LTE TDD mode, four types of recall functions are available under the Data menu: “Limit Mask”, “E-UTRA Test Model”, “Signal Studio Setup” and “Vector Signal Analyzer”. “Limit Mask” enables setting of a preset limit mask for Power Suite-based measurements, and currently it is available for the SEM/ACP measurements with the LTE TDD mode. Recalling “E-UTRA Test Model” sets complicated RB settings for each Test Model for the Modulation Analysis and Conformance EVM measurements. Recalling “Signal Studio Setup” or “89600 Vector Signal Analyzer” enables you to recall parameters which have been set and saved on the external platform.

Key Path	Front Panel
Mode	LTETDD
Initial S/W Revision	Prior to A.02.00
Modified at S/W Revision	A.06.00

Import Trace Data

Enables you to import previously saved trace data into a Data Register and optionally display it. Selecting this key displays a menu that enables you to select the destination data register, and also enables you to choose whether or not to display the recalled data in the currently selected trace. After making these selections, select Open... and use the file dialog to select the file you want to recall.

Recalling trace data into an already used Data Register overwrites the previous data. If the data register is displayed on any trace, the display is updated to reflect the new data.

The SCPI command

```
:MMEM:LOAD:TRAC:DATA D1|D2|D3|D4|D5|D6,<filename>
```

recalls data into a specified register, but does not display it in the selected trace. Use the command

```
:DISP:<meas>:TRAC<n>:FEED D1|D2|D3|D4|D5|D6
```

to display the register in the desired trace.

It is possible to recall trace data saved by other VXA measurements, or measurements made using the LTE, LTETDD, iDEN, or 89601 applications.

Key Path	Recall, Data (Import)
Mode	VSA, LTE, LTETDD, IDEN
Remote Command	:MMEMory:LOAD:TRACe:DATA D1 D2 D3 D4 D5 D6,<filename>[,CSV TXT SDF MAT4 MAT HDF5 BIN]
Example	:MMEM:LOAD:TRAC:DATA D1,"Trc1.txt",TXT
Notes	<p>The Open: dialog box has the following filter options when you are recalling trace data::</p> <ul style="list-style-type: none"> • CSV (Comma delimited) (*.csv) • SDF (Fast) (*.sdf;*.dat) • Text (Tab delimited) (*.txt) <p>The file must have the same format as that created by the Export Recorded Data command.</p> <p>The SCPI command has an optional file format parameter. If you do not include this parameter in the SCPI command, the file format is determined by the file name extension. If no file extension is recognized, the file is scanned to determine the format.</p> <p>If you are not licensed to recall a particular file type, then error -203.9010 is returned. If the file format cannot be determined or the file cannot be recalled successfully, then error -250.5290 is returned. If the recall is successful, then advisory 0.1600 is shown.</p>
State Saved	No
Readback	Data 1 Data 2 Data 3 Data 4 Data 5 Data 6

Data 1

Selects the Data 1 register as the destination for the imported data.

Key Path	Recall, Data (Import), Trace (to)
Mode	VSA, LTE, LTETDD, IDEN

Data 2

Selects the Data 2 register as the destination for the imported data.

Key Path	Recall, Data (Import), Trace (to)
Mode	VSA, LTE, LTETDD, IDEN

Data 3

Selects the Data 3 register as the destination for the imported data.

Key Path	Recall, Data (Import), Trace (to)
Mode	VSA, LTE, LTETDD, IDEN

Data 4

Selects the Data 4 register as the destination for the imported data.

Key Path	Recall, Data (Import), Trace (to)
Mode	VSA, LTE, LTETDD, IDEN

Data 5

Selects the Data 5 register as the destination for the imported data..

Key Path	Recall, Data (Import), Trace (to)
Mode	VSA, LTE, LTETDD, IDEN

Data 6

Selects the Data 6 register as the destination for the imported data.

Key Path	Recall, Data (Import), Trace (to)
Mode	VSA, LTE, LTETDD, IDEN

Display in Selected Trace

Enables you to select whether the recalled trace data is displayed in the current Trace.

Key Path	Recall, Data (Import), Trace (to)
----------	-----------------------------------

Mode	VSA, LTE, LTETDD, IDEN
State Saved	No

Signal Studio Setup

This key allows you to recall the Agilent Signal Studio setup file created on the Signal Studio (N7625B). This key is valid only for the Mod Analysis measurement. For E-TM test model signal, please use corresponding EVM setup file under My Documents\LTETDD\data\evmsetup.

For the supported carrier types, see the table below.

Signal Studio	Carrier Type
N7625B Signal Studio for 3GPP LTE TDD	Advanced LTE TDD(2009-03)
	Advanced LTE TDD(2009-12)
	Basic LTE TDD(2009-03)
	Basic LTE TDD(2009-12)

File Location and Extension

File location: "My Documents\LTETDD\data"

File type: xml

File extension: .scp

You need to place the Signal Studio Setup file created on N7625B in the above directory in advance. Pressing OPEN under the Import Data menu will open this directory from which you can select the setup file.

Example:

File Location: My Documents\LTETDD\data

File Name: Uplink PUSCH.scp

Key Path	Recall, Data
Mode	LTETDD
Remote Command	MMEMory:LOAD:SSSetup <string>
Example	MMEM:LOAD:SSS "Uplink PUSCH.scp"
Notes	Sets of parameters related to Signal Studio Setup are overwritten by the contents of the setup file.
Initial S/W Revision	A.06.00

89601 VSA Setup

Enables you to import the 89600 Vector Signal Analyzer Setup file created using the 89600 Vector Signal Analyzer Option BHE (LTE TDD). This key is valid only for the Mod Analysis measurement.

File Location and Extension

File location: "My Documents\LTETDD\data"

File type: text file

File extension: .set, .setx

Place the 89600 Vector Signal Analyzer Setup file that you saved on 89600 in the above directory. When you select OPEN under the Import Data menu, the directory opens enabling you to select your setup file.

Example:

File Location: My Documents\LTETDD\data

File Name: Uplink PRACH.set

Key Path	Recall, Data
Mode	LTETDD
Remote Command	MME ^M o ^R y:LOAD:VSAS ^E tup <string>
Example	MMEM:LOAD:VSAS "Uplink PRACH.set"
Notes	Sets of parameters related to Vector Signal Analyzer Setup are overwritten by the contents of the setup file.
Initial S/W Revision	A.06.00
Modified at S/W Revision	A.10.00

Masks

This key allows you to recall a preset mask file from the list. The preset mask file contains configuration for only Carrier, Offset, Limit settings and the preset profile BW. Any set of values not specified by the preset mask file will not be overwritten.

You cannot change or create the preset mask file since it is a binary file. This key is valid for the Spectrum Emission Mask and ACP measurements.

File location: "My Documents\LTETDD\data.masks"

Note that "My Documents" is an alias to a directory and its place differs depending on which user is logged in. At XSA start up, XSA will overwrite all of the limit mask files to the current user's "My Documents\LTETDD\data.masks" each time.

File type: Binary

Filename: The filename follows the rule below, in which the word is connected with underscores.

<Measurement>_<Direction>_<Bandwidth>_<Condition>.mask

Where

<Measurement> Measurement the limit mask file is applied to: SEM or ACP

<Direction> Direction: BS (Downlink) or MS (Uplink).

<Bandwidth> Bandwidth

<Condition> Condition. It depends on the measurement.

File extension: .mask

Pressing OPEN under the Import Data menu will open the above directory from which you can select a mask file. When you change the Bandwidth or Direction, all Power Suite measurement parameters are reset to the hard coded preset parameters. Thus you must recall the appropriate preset mask file again after the change.

You cannot read the contents of the provided preset mask file since it is a binary file. Detailed contents of the file are provided by a PDF format file located in the same directory as the preset mask file.

Example:

File Location: My Documents/LTETDD/data/masks/SEM_MS

File Name: SEM_MS_15MHz_Add_NS04.mask

The following table shows the sets of variables imported to the ACP measurement.

Offset	Start Freq (MHz)	Stop Freq (MHz)	Res BW (Hz)	Meas BW	Rel Start	Rel Stop	Fail Mask
A	5	7.14	30k	1	-8	-25	Rel
B	7.14	10.57	30k	1	-25	-27	Rel
C	10.57	20	30k	1	-27	-50	Rel
D	20	25	30k	1	-50	-50	Rel
E	25	30	30k	1	-50	-50	Rel

Key Path	Recall, Data
Mode	LTETDD
Remote Command	MMEemory:LOAD:MASK <string>
Example	MMEemory:LOAD:MASK "ACP_BS\ACP_BS_3MHz_pairE-UTRA_CatA.mask"
Notes	Sets of parameters related to Limit, Carrier and Offset are overwritten by the contents of the preset mask file.
Initial S/W Revision	A.03.00

EVM Setup

This key allows you to recall EVM parameter setting to measure E-UTRA Test Model in 3GPP standard (36.141–810 6.1.1).

- E-UTRA Test Model 1.1 (E-TM1.1)
- E-UTRA Test Model 1.2 (E-TM1.2)
- E-UTRA Test Model 2 (E-TM2)
- E-UTRA Test Model 3.1 (E-TM3.1)

- E-UTRA Test Model 3.2 (E-TM3.2)
- E-UTRA Test Model 3.3 (E-TM3.3)

This key is valid for the Modulation Analysis and Conformance EVM measurements only.

File Location and Extension

File location: My Documents\LTETDD\data\evmsetup

Note that “My Documents” is an alias to a directory and its place differs depending on which user is logged in. At XSA start up, XSA will overwrite all of the EVM Setup files to the current user’s “My Documents\LTETDD\data\evmsetup” each time.

File type: binary

File extension: .evms

Pressing OPEN under the Import Data menu will open the above directory from which you can select an EVM Setup file. When you change the Bandwidth, parameters are reset to the hard coded preset parameters. Thus you must recall the appropriate EVM Setup file again after the change.

You cannot read the contents of the provided EVM Setup file since it is a binary file.

Example:

File Location: My Documents\LTETDD\data\evmsetup

Filename: TM3.1-BW1.4MHz.evms

Key Path	Recall, Data
Mode	LTETDD
Remote Command	MME ^M MoRY:LOAD:EVMS ^E tuP <string>
Example	MME:LOAD:EVMS "TM2-BW15MHz.evms"
Notes	Sets of parameters related to EVM Setup are overwritten by the contents of the EVM Setup file.
Initial S/W Revision	A.03.00, A.08.00

Open...

When you press “Open”, the analyzer brings up a Windows dialog and a menu entitled “File Open.” This menu allows you to navigate to the various fields in the Windows dialog without using a keyboard or mouse. The Tab and Arrow keys can also be used for dialog navigation.

See "[From File...](#)" on page 2797 in Recall, State, for a full description of this dialog and menu.

Key Path	Recall, Data
Notes	The key location is mode-dependent and will vary. Brings up Open dialog for recalling a <mode specific> Save Type
Initial S/W Revision	Prior to A.02.00

Restart

The Restart function restarts the current sweep, or measurement, or set of averaged/held sweeps or measurements. If you are Paused, pressing Restart does a Resume.

The Restart function is accessed in several ways:

- Pressing the Restart key
- Sending the remote command INIT:IMMEDIATE
- Sending the remote command INIT:RESTART

See "[More Information](#)" on page 2807

Key Path	Front-panel key
Remote Command	:INITiate[:IMMEDIATE] :INITiate:RESTART
Example	:INIT:IMM :INIT:REST
Notes	:INITiate:RESTART and :INITiate:IMMEDIATE perform exactly the same function.
Couplings	Resets average/hold count k. For the first sweep overwrites all active (update=on) traces with new current data. For application modes, it resets other parameters as required by the measurement.
Status Bits/OPC dependencies	This is an Overlapped command. The STATUS:OPERation register bits 0 through 8 are cleared. The STATUS:QUESTIONable register bit 9 (INTEgrity sum) is cleared. The SWEEPING bit is set. The MEASURING bit is set.
Backwards Compatibility Notes	For Spectrum Analysis mode in ESA and PSA, the Restart hardkey and the INITiate:RESTART command restart trace averages (displayed average count reset to 1) for a trace in Clear Write, but did not restart Max Hold and Min Hold. In the X-Series, the Restart hardkey and the INITiate:RESTART command restart not only Trace Average, but MaxHold and MinHold traces as well. For wireless comms modes in ESA and PSA, the Restart hardkey and the INITiate:RESTART command restart every measurement, which includes all traces and numeric results. There is no change to this operation.
Initial S/W Revision	Prior to A.02.00

More Information

The **Restart** function first aborts the current sweep/measurement as quickly as possible. It then resets the sweep and trigger systems, sets up the measurement and initiates a new data measurement sequence with a new data acquisition (sweep) taken once the trigger condition is met.

If the analyzer is in the process of aligning when **Restart** is executed, the alignment finishes before the restart function is performed.

Even when set for Single operation, multiple sweeps may be taken when Restart is pressed (for example, when averaging/holding is on). Thus when we say that **Restart** "restarts a measurement," we may mean:

- It restarts the current sweep
- It restarts the current measurement
- It restarts the current set of sweeps if any trace is in Trace Average, Max Hold or Min Hold
- It restarts the current set of measurements if Averaging, or Max Hold, or Min Hold is on for the measurement
- depending on the current settings.

With **Average/Hold Number** (in **Meas Setup** menu) set to 1, or Averaging off, or no trace in Trace Average or Hold, a single sweep is equivalent to a single measurement. A single sweep is taken after the trigger condition is met; and the analyzer stops sweeping once that sweep has completed. However, with **Average/Hold Number** >1 and at least one trace set to **Trace Average, Max Hold, or Min Hold (SA Measurement)** or **Averaging on (most other measurements)**, multiple sweeps/data acquisitions are taken for a single measurement. The trigger condition must be met prior to each sweep. The sweep is stopped when the average count k equals the number N set for **Average/Hold Number**. A measurement average usually applies to all traces, marker results, and numeric results; but sometimes it only applies to the numeric results.

Once the full set of sweeps has been taken, the analyzer will go to idle state. To take one more sweep without resetting the average count, increment the average count by 1, by pressing the step up key while **Average/Hold Number** is the active function, or sending the remote command **CALC:AVER:TCON UP**.

Save

The Save menu lets you choose what you want to save and where you want to save it. Among the types of files you can save are **States**, **Traces**, and **Screen Images**. In addition, an Export (Data) option lets you save a number of data types as CSV files for easy import into Excel and other spreadsheet programs.

Key Path	Front-panel key
Mode	All
Notes	No remote command for this key specifically, but the :MMEM:STORe command is available for specific file types. An example is :MMEM:STOR:STATe <filename>.
Initial S/W Revision	Prior to A.02.00

State

The Save State menu lets you choose a register or file for saving the state.

The content of a state file includes all of the settings and data required to return the analyzer as closely as possible to the Mode it was in, with the exact settings which were in place, when the save occurred. The Mode settings in each state file include the settings that are affected by Mode Preset, as well as the additional settings affected by Restore Mode Defaults; all of the Mode's settings. In addition, all of the settings of the Input/Output system are included, even though they are outside of the Mode's state, because they are needed to restore the complete setup. Persistent System settings (for example, Verbose SCPI) are not affected by either Mode Preset or Restore Mode Defaults, nor are they included in a saved State file.

After the save completes, the message "File <filename> saved" or "State Register <register number> saved" is displayed.

For rapid saving, the State menu lists 16 registers to save to. Pressing a Register key initiates the save. You can also select a file to save to.

The default path for all State Files is:

My Documents\<>mode name>\state

where <mode name> is the parameter used to select the mode with the INST:SEL command (for example, SA for the Spectrum Analyzer).

Key Path	Save
Mode	All
Remote Command	:MMEMory:STORe:STATe <filename>
Example	MMEM:STOR:STATe "MyStateFile.state" This stores the current instrument state data in the file MyStateFile.state in the default directory.
Notes	Both single and double quotes are supported for any filename parameter over remote. After saving to a register, that register's menu key is updated with the date the time, unless a custom label has been entered for that key. After saving to a register, you remain in the Save State menu, so that you can see the Register key

update. After saving to a file, the analyzer automatically returns to the previous menu and any Save As dialog goes away.

Backwards Compatibility SCPI	:MMEMory:STORe:STATe 1,<filename>
Initial S/W Revision	Prior to A.02.00

To File . . .

When you press “To File”, the analyzer brings up a Windows dialog and a menu entitled “Save As.” This menu allows you to navigate to the various fields in the Windows dialog without using a keyboard or mouse. The Tab and Arrow keys can also be used for dialog navigation.

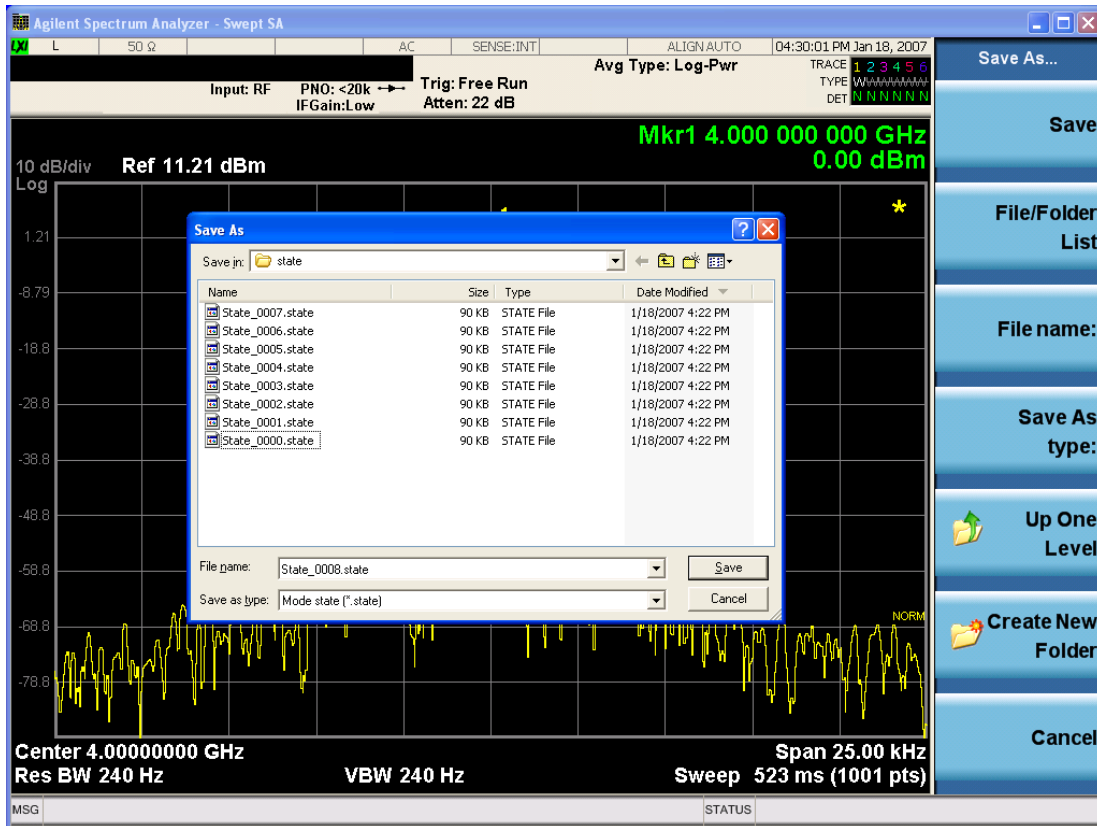

The Listed below

are the functions of the various fields in the dialog, and the corresponding softkeys:

Save

Performs the save to the specified file of the selected type. If the file already exists, a dialog will appear that allows you to replace the existing file by selecting OK, or you can Cancel the request. If you select OK, the file will be overwritten. Using the C: drive is strongly discouraged, since it runs the risk of being overwritten during an instrument software upgrade.

While the save is being performed, the floppy icon appears briefly in the Meas bar.

File/Folder List

Enables you to navigate to the center of the dialog that contains the list of files and folders. Once here you can get information about the file and use the tab keys to navigate to the other fields in the dialog, such as Save In.

Save In

The Save In field shows the path to which the file will be saved and allows you to change the path using the up and down arrow keys to navigate to other paths; the Enter key to open a directory; and the Backspace key to go back one directory. The **Save In field** defaults to the default path for this type of file and remembers the last path you used to save this type of file. There is no softkey for directly navigating to the Save In field but you can use left tab to get here from the File/Folder List.

User specified paths are remembered when you leave and return to a Mode and are reset back to the default using Restore Mode Defaults.

File Name

The File Name field is initially loaded with an automatically generated filename specific to the appropriate Save Type. The automatically generated filename is guaranteed not to conflict with any filename currently in the directory. You may replace or modify this filename using the File Name key. See the ["Quick Save " on page 2793](#) documentation for more on the automatic file naming algorithm.

When you press the File Name key the analyzer displays the Alpha Editor. Use the knob to choose the letter to add and the front-panel Enter key to add the letter to the file name. The BK character moves you back and the FW character moves you forward in the filename. The Select key on the front panel generates a space character. When you are done entering the filename press the Done softkey. This returns back to the **File Open** dialog and menu, but does not cause the save to occur.

Save As Type

This field shows the file suffix for the type of file you have selected to save. For example, if you navigated here while saving State, "Mode state (*.state)" is in the field. If you navigated here from saving Trace, ""Mode state (*.trace)" is in the field. If you navigated here while exporting a trace data file, "Trace Data (*.csv)" is in the field. For some file types, there is more than one choice in the dropdown, which you can select by using the up and down arrow keys and Enter.

Up One Level

This key corresponds to the icon of a folder with the up arrow that is in the tool bar of the dialog. When pressed, it causes the file and folder list to navigate up one level in the directory structure. The Backspace key does the same thing.

Create New Folder

This key corresponds to the icon of a folder with the "*" that is in the tool bar of the dialog. When pressed, a new folder is created in the current directory with the name **New Folder** and you can enter a new folder name using the Alpha Editor.

Cancel

This key corresponds to the Cancel selection in the dialog. It causes the current **Save As** request to be cancelled. The ESC key does the same thing.

Key Path	Save, State
Mode	All
Notes	Brings up Save As dialog for saving a State Save Type
Initial S/W Revision	Prior to A.02.00

Edit Register Names

You may enter a custom name on any of the Register keys, to help you remember what you are using that state to save. To do this, press the Edit Register Names key, choose the register whose name you wish to edit, and then enter the desired label using the Alpha Editor or an external PC keyboard.

The maximum number of characters that can be added is 30. In most cases, 30 characters will fit on two lines of the key.

See ["More Information" on page 2812](#)

Key Path	Save, State
Mode	All
Remote Command	:MMEMory:REGister:STATe:LABel <reg number>,"label" :MMEMory:REGister:STATe:LABel? <reg number>
Example	:MMEM:REG:STAT:LAB 1,"my label"
Notes	<reg number> is an integer from 1 to 16. If the SCPI specifies an invalid register number an error message is generated, -222,"Data out of range;Invalid register label number" "label" is a string from 0 to 30 characters in length. If a label exceeds 30 characters, an error message is generated, -150,"String data error;Label clipped to 30 characters" "label" of length 0 erases the custom label and restores the default (time and date) label. E.g.: :MMEM:REG:STAT:LAB 1,""
Dependencies	N9060A-7FP or N9060B-2FP license required to edit the register names. When the feature is not licensed, sending this command generates an error, -221,"Settings conflict;Option not available"
Preset	The names are unaffected by Preset or power cycle but are set to the default label (time and date) on a "Restore System Defaults->Misc"
Initial S/W Revision	A.11.00

More Information

When you edit one of the register names, the time and date field will be replaced by the custom name.

If you delete all the characters in the custom name, it restores the default (time and date).

The register names are stored within the state files, but they are not part of the instrument state; that is, once you have edited a register name, loading a new state will not change that register name. Another consequence of this is that the names will be persistent through a power cycle. Also, if a named state file is transferred to another analyzer, it will bring its custom name along with it.

If you try to edit the name of an empty register, the analyzer will first save the state to have a file to put the name in. If you load a named state file into an analyzer with older firmware it will ignore the metadata.

The *SAV and *RCL commands will not be affected by the custom register names, nor will the MMEM commands.

Register 1 thru Register 16

Selecting any one of these register menu keys causes the State of the currently active mode to be saved to the specified Register. The registers are provided for rapid saving and recalling, since you do not need to specify a filename or navigate to a file. Each of the register menu keys annotates whether it is empty or at what date and time it was last modified. In addition, you can use the Edit Register Names key to enter custom names for each register.

Although these 16 registers are the only registers available from the front panel, there are 128 state registers available in the instrument. Registers 17–128 are only available from the SCPI interface, using the *SAV command.

There is one set of 128 state registers in the instrument, not one set for each Mode. When a state is saved, the Mode it was saved from is saved with it; then when it is recalled, the instrument switches to that Mode.

After the save completes, the corresponding register menu key annotation is updated with the date and time and the message "Register <register number> saved" is displayed.

Key Path	Save, State
Mode	All
Example	*SAV 1
Range	1–16 from front panel, 1–128 from SCPI
Readback	Date and time with seconds resolution are displayed on the key OR A custom name of up to 30 characters entered using the Edit Register Names key OR “(empty)” if no prior save operation has been performed to this register.
Initial S/W Revision	Prior to A.02.00
Modified at S/W Revision	A.11.00

Register 1 thru Register 16

Selecting any one of these register menu keys causes the State of the currently active mode to be saved to the specified Register. The registers are provided for rapid saving and recalling, since you do not need to specify a filename or navigate to a file. Each of the register menu keys annotates whether it is empty or at what date and time it was last modified. In addition, you can use the Edit Register Names key to enter custom names for each register.

Although these 16 registers are the only registers available from the front panel, there are 128 state registers available in the instrument. Registers 17–128 are only available from the SCPI interface, using the *SAV command.

There is one set of 128 state registers in the instrument, not one set for each Mode. When a state is saved, the Mode it was saved from is saved with it; then when it is recalled, the instrument switches to that Mode.

After the save completes, the corresponding register menu key annotation is updated with the date and time and the message "Register <register number> saved" is displayed.

Key Path	Save, State
Mode	All
Example	*SAV 1
Range	1-16 from front panel, 1-128 from SCPI
Readback	Date and time with seconds resolution are displayed on the key OR A custom name of up to 30 characters entered using the Edit Register Names key OR “(empty)” if no prior save operation has been performed to this register.
Initial S/W Revision	Prior to A.02.00
Modified at S/W Revision	A.11.00

Data (Export)

Exporting a data file stores data from the current measurement to mass storage files. The Export Menu only contains data types that are supported by the current measurement.

Since the commonly exported data files are in .csv format, the data can be edited by you prior to importing. This allows you to export a data file, manipulate the data in Excel (the most common PC Application for manipulating .csv files) and then import it.

Selecting an Export Data menu key will not actually cause the exporting to occur, since the analyzer still needs to know where you wish to save the data. Pressing the Save As key in this menu brings up the Save As dialog and Save As menu that allows you to specify the destination file and directory. Once a filename has been selected or entered in the Open menu, the export will occur as soon as the Save key is pressed.

Key Path	Save
Mode	All
Notes	The menu is built from whatever data types are available for the mode. So the key locations in the sub menu will vary. No SCPI command directly controls the Data Type that this key controls. The Data Type is included in the MMEM:STORe commands.
Dependencies	If a file type is not used by a certain measurement, that type is grayed out for that measurement. The key for a file type will not show at all if there are no measurements in the Mode that support it.
Preset	Is not affected by a Preset or shutdown, but is reset during Restore Mode Defaults
Readback	The data type that is currently selected
Initial S/W Revision	Prior to A.02.00

Export Trace Data

Enables you to export trace data with (optional) associated headers. Selecting this key displays a menu that enables you to choose which Trace to save (default is the selected Trace) and whether or not to save headers with the data. The header information is used by the VXA application when saved trace data is recalled, and enables it to be displayed with the same formatting and scaling that it had when saved. If headers are not saved, the scaling and format are set to default values when the trace is recalled. After making these selections, press Save As... and use the file dialog to choose a file name and format for the saved data.

Trace data can be exported in several different formats. Text and comma-separated variable (CSV) formats are useful for viewing the data or importing it to a spreadsheet program. The other formats are binary and thus more compact. Trace data files can be recalled for viewing into other VXA, LTE, LTETDD, iDEN, or 89601 measurements.

Key Path	Save, Data (Export)
Mode	VSA, LTE, LTETDD, IDEN
Remote Command	:MMEMory:STORe:TRACe:DATA TRACE1 TRACE2 TRACE3 TRACE4 TRACE5 TRACE6, "<filename>"[,CSV TXT SDF MAT4 MAT HDF5 BIN[,OFF ON 0 1]]
Example	:MMEM:STOR:TRAC:DATA TRACE1, "TRC1.TXT", TXT, ON
Notes	<p>The Save As... dialog box has the following format options when you are saving trace data:</p> <ul style="list-style-type: none"> • CSV (Comma delimited) (*.csv) • SDF (Fast) (*.sdf;*.dat) • Text (Tab delimited) (*.txt) <p>File format saved depends on selection. The appropriate file extension is appended to the filename if it is not supplied by the user.</p> <p>If the SCPI command includes just a file name, the file format is determined by the filename extension, which must be one of the choices above. *.sdf or an unrecognized extension chooses the SDF fast format. If the optional file format enumerator is included in the command, then this determines the file format and the file extension is ignored. The optional binary parameter determines if file headers are saved. The default is ON. If file headers are not wanted, use the optional "OFF" parameter.</p> <p>The optional Boolean parameter determines whether headers are saved in the file. By default the headers are saved.</p> <p>If you are not licensed to save a particular file type, then error -203.9010 is returned. If an invalid file format is specified or the file cannot be saved successfully, then error -25x is returned. If the save is successful, then advisory 0.1500 is shown.</p>
State Saved	No
Readback	(Trace 1 Trace 2 Trace 3 Trace 4 Trace 5 Trace 6)(with without) headers

Trace 1

Selects the Trace 1 register as the destination for the imported data.

Key Path	Save, Data (Export), Trace
Mode	VSA, LTE, LTETDD, IDEN

Trace 2

Selects the Trace 2 register as the destination for the imported data.

Key Path	Save, Data (Export), Trace
Mode	VSA, LTE, LTETDD, IDEN

Trace 3

Selects the Trace 3 register as the destination for the imported data.

Key Path	Save, Data (Export), Trace
Mode	VSA, LTE, LTETDD, IDEN

Trace 4

Selects the Trace 4 register as the destination for the imported data.

Key Path	Save, Data (Export), Trace
Mode	VSA, LTE, LTETDD, IDEN

Include Header

Enables you to select whether or not the saved trace data includes header information describing scaling, formatting, etc.

Key Path	Save, Data (Export), Trace
Mode	VSA, LTE, LTETDD, IDEN
State Saved	No

Measurement Results

Pressing this key selects Meas Results as the data type to be exported. Pressing the key a second time brings up the Meas Results menu, which allows you to select which **Meas Result** to save. In the Swept SA measurement, there are three types of Measurement Results files: Peak Table, Marker Table and Spectrogram.

See "[Meas Results File Contents](#)" on page 2817.

See "[Marker Table](#)" on page 2817.

See "[Peak Table](#)" on page 2820.

See "[Spectrogram](#)" on page 2823

Remote Command	:MMEMory:STORe:RESults:MTABle PTABle SPEctrogram <filename>
Example	:MMEM:STOR:RES:MTAB "myResults.csv" Saves the results from the current marker table to the file myResults.csv in the current path. :MMEM:STOR:RES:PTAB "myResults.csv" Saves the results from the current peak table to the file myResults.csv in the current path. :MMEM:STOR:RES:SPEC "myResults.csv" Saves the results from the current Spectrogram display to the file myResults.csv in the current path. The default path is My Documents\SA\data\SAN\results
Notes	If the save is initiated via SCPI, and the file already exists, the file will be overwritten. Using the C: drive is strongly discouraged, since it runs the risk of being overwritten during an instrument software upgrade. Both single and double quotes are supported for any filename parameter over SCPI.
Dependencies	If a save of Marker Table results is requested and the Marker Table is not on, no file is saved and a message is generated If a save of Peak Table results is requested and the Peak Table is not on, no file is saved and a message is generated If a save of Spectrogram results is requested and the Spectrogram is not on, no file is saved and a message is generated. The Spectrogram choice only appears if option EDP is licensed.
Preset	Not part of Preset, but is reset to Peak Table by Restore Mode Defaults. Survives a shutdown.
Initial S/W Revision	Prior to A.02.00

Meas Results File Contents

All files are .csv files. The following section details the data in each file type.

Marker Table

This section discusses the Marker Table Meas Results file format.

Imagine that, at the point where a Marker Table Meas Result is requested, the following screen is showing:

18 Conformance EVM
Save

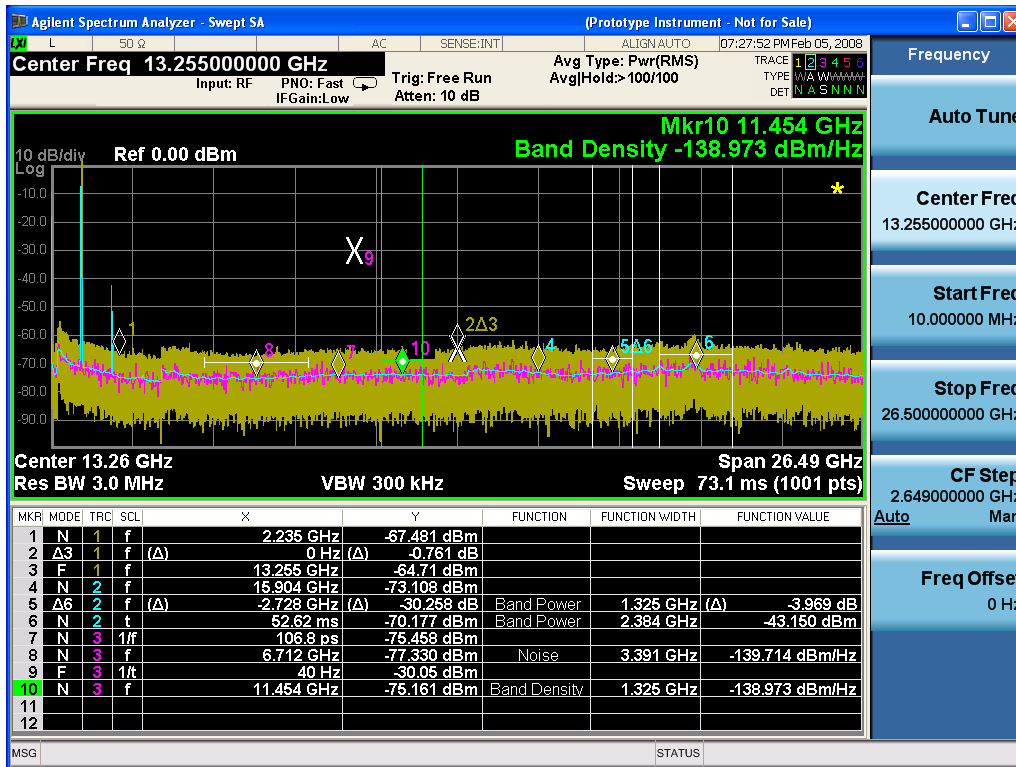

Then the Meas Results file, when opened, would show the following data:

MeasurementResult	
Swept SA	
A.01.40_R0017	N9020A
526 B25 PFR	1
P26 EA3	
Result Type	Marker Table
Ref Level	0
Number of Points	1001
Sweep Time	0.0662666 67
Start Frequency	10000000
Stop Frequency	26500000 000
Average Count	0
Average Type	LogPower (Video)
RBW	3000000

RBW Filter	Gaussian
RBW Filter BW	3dB
VBW	3000000
Sweep Type	Swept
X Axis Scale	Lin
PreAmp State	Off
PreAmp Band	Low
Trigger Source	Free
Trigger Level	1.2
Trigger Slope	Positive
Trigger Delay	1.00E-06
Phase Noise Optimization	Fast
Swept If Gain	Low
FFT If Gain	Autorange
RF Coupling	AC
FFT Width	411900
Ext Ref	10000000
Input	RF
RF Calibrator	Off
Attenuation	10
Ref Level Offset	0
External Gain	0
X Axis Units	Hz
Y Axis Units	dBm

DATA									
MKR	MODE	TR C	SCL	X	Y	FUNCTI ON	FUNCTIO N WIDTH	FUNCTI ON VALUE	FUNCTI ON UNIT
1	Normal	1	Freque ncy	2.2350E+09	- 67.481	Off	0.0000E+00	0	None
2	Delta3	1	Freque ncy	0.0000E+00	- 0.761	Off	0.0000E+00	0	None
3	Fixed	1	Freque ncy	1.3255E+10	- 64.71	Off	0.0000E+00	0	None
4	Normal	2	Freque ncy	1.5904E+10	- 73.1	Off	0.0000E+00	0	None

08									
5	Delta7	2	Frequ ncy	- 2.7280E+ 09	- 30.2 58	Band Power	1.3250E+ 06	-3.969	dB
6	Normal	2	Time	5.2620E- 02	- 70.1 77	Band Power	2.3840E+ 06	-43.15	dBm
7	Normal	3	Period	1.0680E- 10	- 75.4 58	Off	0.0000E+ 00	0	None
8	Normal	3	Frequ ncy	6.7120E+ 09	- 77.3 3	Noise	3.3910E+ 06	- 139.71 4	dBm/Hz
9	Fixed	3	Inverse Time	4.0000E+ 01	- 30.0 5	Off	0.0000E+ 00	0	None
10	Normal	3	Frequ ncy	1.1454E+ 10	- 75.1 61	Band Density	1.3250E+ 06	- 138.97 3	dBm/Hz
11	Off	1	Frequ ncy	0.0000E+ 00	0	Off	0.0000E+ 00	0	None
12	Off	1	Frequ ncy	0.0000E+ 00	0	Off	0.0000E+ 00	0	None

The numbers appear in the file exactly as they appear onscreen. If it says 11.454 GHz onscreen, then in the file it is 11.454E+09.

The metadata header is very similar to the metadata used in the trace data .csv files. See Trace File Contents. The only new information concerns the 1-of-N fields in the marker table itself.

Peak Table

This section discusses the Peak Table Meas Results file format.

Imagine that, at the point where a Marker Table Meas Result is requested, the following screen is showing:

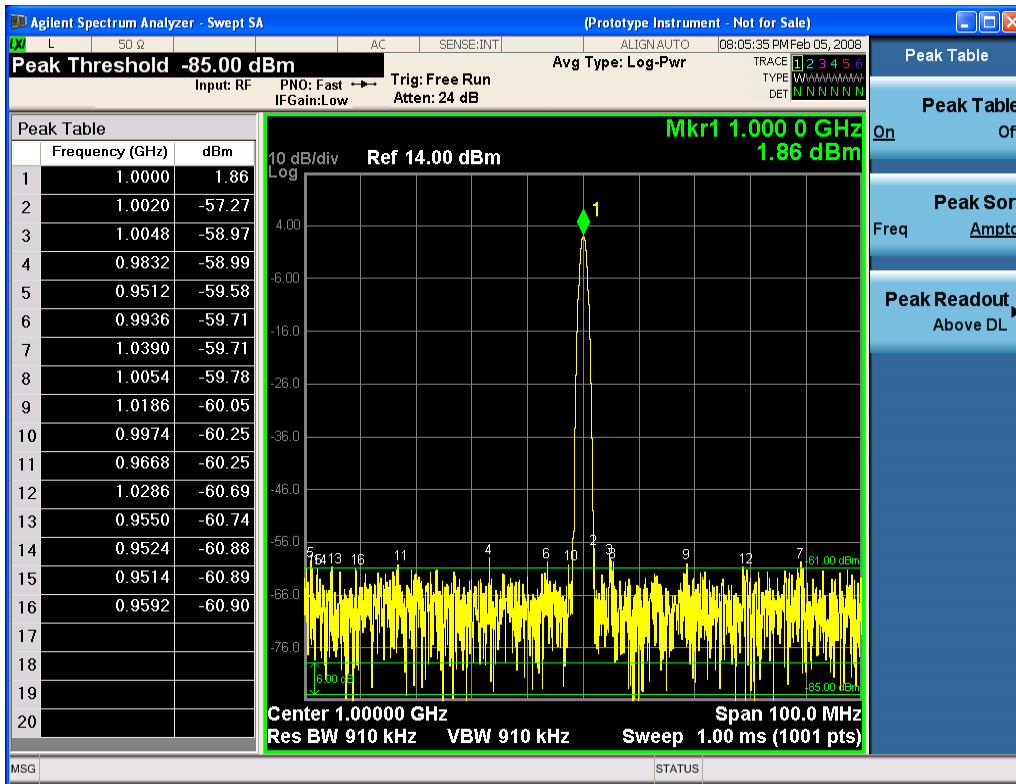

Then the Meas Results file, when opened, would show the header data (the same as for the Marker Table except that the Result Type is Peak Table) ending with a few fields of specific interest to Peak Table users:

- Peak Threshold
- Peak Threshold State (On|Off)
- Peak Excursion
- Peak Excursion State (On|Off)
- Display Line
- Peak Readout (All|AboveDL|BelowDL)
- Peak Sort (Freq|Amptd)

These fields are then followed by the data for the Peak Table itself.

Note that the label for the Frequency column changes to Time in 0 span.

Here is what the table for the above display looks like:

MeasurementResult	
Swept SA	
A.01.40_R0017	N9020A
526 B25 PFR P26 EA3	1

Result Type	Peak Table
Ref Level	0
Number of Points	1001
Sweep Time	0.066266667
Start Frequency	10000000
Stop Frequency	26500000000
Average Count	0
Average Type	LogPower(Video)
RBW	3000000
RBW Filter	Gaussian
RBW Filter BW	3dB
VBW	3000000
Sweep Type	Swept
X Axis Scale	Lin
PreAmp State	Off
PreAmp Band	Low
Trigger Source	Free
Trigger Level	1.2
Trigger Slope	Positive
Trigger Delay	1.00E-06
Phase Noise Optimization	Fast
Swept If Gain	Low
FFT If Gain	Autorange
RF Coupling	AC
FFT Width	411900
Ext Ref	10000000
Input	RF
RF Calibrator	Off
Attenuation	10
Ref Level Offset	0
External Gain	0
X Axis Units	Hz
Y Axis Units	dBm
Peak Threshold	-85
Peak Threshold State	On
Peak Excursion	6
Peak Excursion State	On

Display Line	-61	
Peak Readout	AboveDL	
Peak Sort	Amptd	
DATA		
Peak	Frequency	Amplitude
1	1.0000E+06	1.86
2	1.0020E+06	-57.27
3	1.0048E+06	-58.97
4	9.8320E+05	-58.99
5	9.5120E+05	-59.58
6	9.9360E+05	-59.71
7	1.0390E+06	-59.71
8	1.0054E+06	-59.78
9	1.1086E+06	-60.05
10	9.9740E+05	-60.25
11	9.6680E+05	-60.25
12	1.0286E+06	-60.69
13	9.5500E+05	-60.74
14	9.5240E+05	-60.88
15	9.5140E+05	-60.89
16	9.5920E+05	-60.90
17		
18		
19		
20		

Spectrogram

This section discusses the Spectrogram Results file format. The Spectrogram choice only appears if option EDP is licensed.

The Spectrogram results are the same as a Trace data export, except that instead of having just one trace's data, all 300 traces appear one after the other.

Each trace has its own data mark; the data for Spectrogram Trace 0 follows the row marked DATA, the data for Spectrogram Trace 1 follows the row marked DATA1, for Spectrogram Trace 2 follows the row marked DATA2, and so on.

Each DATA row has a timestamp in the second column (as of firmware revision A.11.01). So, for example, if Trace 0 had a relative start time of 1729.523 sec, then the first DATA row would look like this:

DATA,1729.523

And if Trace 13 had a relative start time of 100.45 sec, then the fourteenth data row would look like:

DATA13,100.453

To find the absolute time for the relative timestamps of each trace, the last row before the first DATA row gives the absolute start time of the Spectrogram, in the form YYYYMMDDHHMMSS

So, for example, if the absolute start time is 13:23:45:678 on January 30, 2012, this row would look like:

Start Time,20120130132345678

NOTE

The resolution of the absolute time stored is 1 ms, which matches up with the fact that the fastest sweep time is also 1 ms. However, there is no specification for the absolute accuracy of the clock in the analyzer, nor is there any facility provided to allow the user to set this time to any particular degree of accuracy.

Traces that have not yet been filled in the Spectrogram display are empty; there is no DATA header for them. The file ends after the last non-empty trace.

Imagine that, at the point where a Spectrogram Meas Result is requested, the following screen is showing:



For the purpose of this example, we have set the Average/Hold Number to 10, thus we have only traces 0 thru 10. The Spectrogram was started at 02:28:08:700 pm on April 25, 2012 (that is, 700 ms after 2:28:08 pm), although the screen dump itself shows a different time, as it was taken ten minutes after the

Spectrogram data. Trace 0 is showing a start time of 5.30 seconds, meaning 5.3 seconds after the Spectrogram started (trace 10 has a start time of 0, as it was the first trace taken but has now rolled up into the tenth trace slot).

The Meas Results file, when opened, shows the header data and ten traces of trace data. Below is an extract from the result file for the above display. Note the start time of 20120425142808700 showing in the last row before the first DATA row, and the relative time of 5.299231048 showing in the first DATA row:

Result Type	Spectrogram
MeasResult	
Swept SA	
A.11.00.01	N9020A
503 508 513 526 ALL ALV B1C B1X B25 B2X B40 BAB BBA CR3 CRP DP2 DRD EA3 EDP EMC EP1 ERC ESC ESP EXM FSA HBA K03 LFE MPB P03 P08 P13 P26 PFR RTL RTS S40 SB1 SEC SM1 UK6 YAS YAV	1
Segment	0
Number of Points	1001
Sweep Time	0.523333333
Start Frequency	5999984415
Stop Frequency	6000009415
Average Count	0
Average Type	LogPower(Video)
RBW	240
RBW Filter	Gaussian
RBW Filter BW	3dB
VBW	240
Sweep Type	Swept
X Axis Scale	Lin
PreAmp State	Off
PreAmp Band	Low
Trigger Source	Free
Trigger Level	1.2
Trigger Slope	Positive
Trigger Delay	0
Phase Noise Optimization	Wide
Swept If Gain	Low
FFT If Gain	Autorange
RF Coupling	AC

Result Type	Spectrogram
FFT Width	411900
Ext Ref	10000000
Input	RF
RF Calibrator	Off
Attenuation	14
Ref Level Offset	0
External Gain	0
Trace Type	Clearwrite
Detector	Normal
Trace Math	Off
Trace Math Oper1	Trace5
Trace Math Oper2	Trace6
Trace Math Offset	0
Trace Name	Trace1
X Axis Units	Hz
Y Axis Units	dBm
Start Time	20120425142808700
DATA	5.299231048
5999984415	-76.34749519
5999984440	-77.28097006
5999984465	-75.32317869
5999984490	-73.64417681
5999984515	-72.67154604

- o
- o
- o

6000009315	-77.94423277
6000009340	-79.51829697
6000009365	-78.46108961
6000009390	-78.46108957
6000009415	-76.59570596
DATA2	4.708697055
5999984415	-80.98197882
5999984440	-80.98197879

5999984465	-75.83142132
5999984490	-74.02712079
5999984515	-73.57213005

○
○
○

6000009315	-75.9183103
6000009340	-79.53787488
6000009365	-78.82602191
6000009390	-78.82602188
6000009415	-76.37486709
DATA10	0
5999984415	-75.56751112
5999984440	-75.76485645
5999984465	-76.67718717
5999984490	-78.79238489
5999984515	-83.72680212

○
○
○

6000009315	-71.3942461
6000009340	-72.28308332
6000009365	-73.92684489
6000009390	-75.45548832
6000009415	-75.17904815

Save As . . .

When you press “Save As”, the analyzer brings up a Windows dialog and a menu entitled “**Save As.**” This menu allows you to navigate to the various fields in the Windows dialog without using a keyboard or mouse. The Tab and Arrow keys can also be used for dialog navigation.

See ["To File . . ." on page 2810](#) in Save, State for a full description of this dialog and menu.

The default path for saving files is:

For all of the Trace Data Files:

My Documents\<<mode name>\data\traces

For all of the Limit Data Files:

My Documents\<<mode name>\data\limits

For all of the Measurement Results Data Files:

My Documents\<<mode name>\data\<<measurement name>\results

For all of the Capture Buffer Data Files:

My Documents\<<mode name>\data\captureBuffer

Key Path	Save, Data
Mode	All
Notes	The key location is mode-dependent and will vary. Brings up the Save As dialog for saving a <mode specific> Save Type. The save is performed immediately and does not wait until the measurement is complete.
Initial S/W Revision	Prior to A.02.00

Screen Image

Pressing Screen Image accesses a menu of functions that enable you to specify a format and location for the saved screen image. It brings up a menu that allows you to specify the color scheme of the Screen Image (Themes) or navigate to the Save As dialog to perform the actual save.

Screen Image files contain an exact representation of the analyzer display. They cannot be loaded back onto the analyzer, but they can be loaded into your PC for use in many popular applications.

The image to be saved is actually captured when the Save front panel key is pressed, and kept in temporary storage to be used if you ask for a Screen Image save. When the Screen Image key is pressed, a "thumbnail" of the captured image is displayed, as shown below:

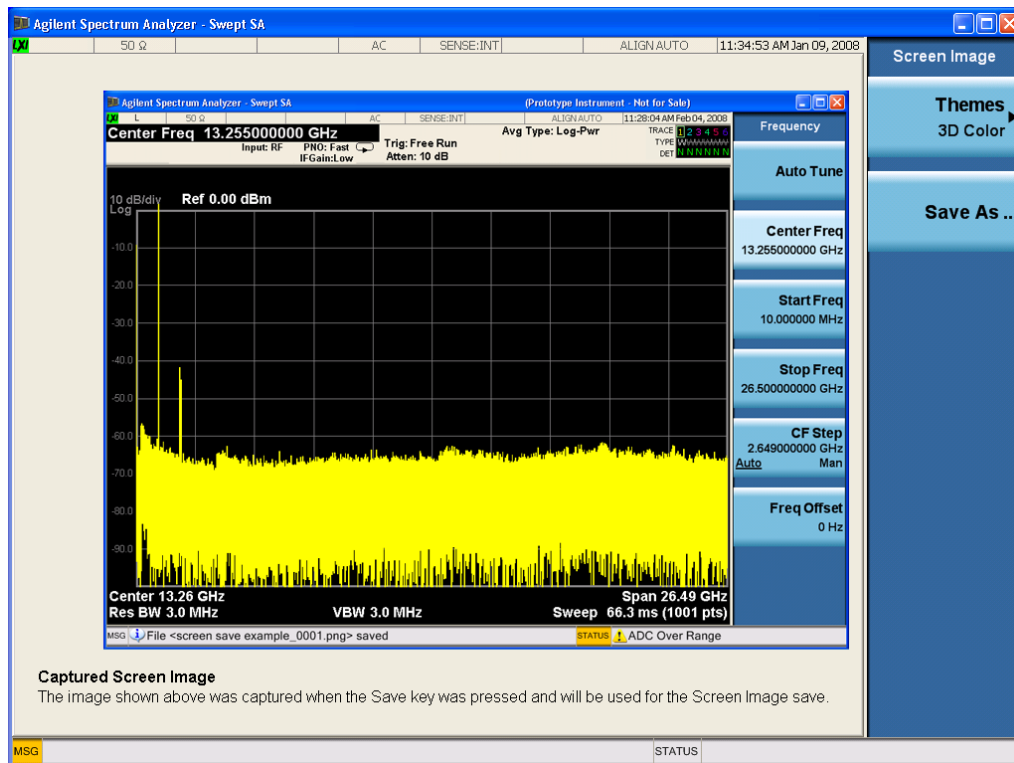

When you continue on into the Save As menu and complete the Screen Image save, the image depicted in the thumbnail is the one that gets saved, showing the menus that were on the screen before going into the Save menus. The save is performed immediately and does not wait until the measurement is complete.

After you have completed the save, the Quick Save front-panel key lets you quickly repeat the last save performed, using an auto-named file, with the current screen data.

NOTE

For versions previous to A.01.55, if you initiate a screen image save by navigating through the Save menus, the image that is saved will contain the Save menu softkeys, not the menus and the active function that were on the screen when you first pressed the Save front panel key.

Key Path	Save
Mode	All
Remote Command	:MMEMory:STORe:SCREen <filename>
Example	:MMEM:STOR:SCR "myScreen.png" This stores the current screen image in the file MyScreenFile.png in the default directory.
Initial S/W Revision	Prior to A.02.00

Themes

Accesses a menu of functions that enable you to choose the theme to be used when saving the screen image.

The **Themes** option is the same as the **Themes** option under the **Display** and **Page Setup** dialogs. It allows you to choose between themes to be used when saving the screen image.

Key Path	Save, Screen Image
Remote Command	:MMEMory:STORe:SCReen:THEMe TDColor TDMonochrome FCOLor FMONochrome :MMEMory:STORe:SCReen:THEMe?
Example	:MMEM:STOR:SCR:THEM TDM
Preset	3D Color; Is not part of Preset, but is reset by Restore Misc Defaults or Restore System Defaults All and survives subsequent running of the modes.
Readback	3D Color 3D Mono Flat Color Flat Mono
Backwards Compatibility Notes	In ESA and PSA we offer the choice of "Reverse Bitmap" or "Reverse Metafile" when saving screen images. This is much like the "Flat Color" theme available in X-Series. Also, if you selected Reverse Bitmap AND a black & white screen image, that would be much like "Flat Monochrome". In other words, each of the X-Series themes has a similar screen image type in ESA/PSA. But they are not identical.
Initial S/W Revision	Prior to A.02.00

3D Color

Selects a standard color theme with each object filled, shaded and colored as designed.

Key Path	Save, Screen Image, Themes
Example	MMEM:STOR:SCR:THEM TDC
Readback	3D Color
Initial S/W Revision	Prior to A.02.00

3D Monochrome

Selects a format that is like 3D color but shades of gray are used instead of colors.

Key Path	Save, Screen Image, Themes
Example	MMEM:STOR:SCR:THEM TDM
Readback	3D Mono
Initial S/W Revision	Prior to A.02.00

Flat Color

Selects a format that is best when the screen is to be printed on an ink printer.

Key Path	Save, Screen Image, Themes
-----------------	----------------------------

Example	MMEM:STOR:SCR:THEM FCOL
Readback	Flat Color
Initial S/W Revision	Prior to A.02.00

Flat Monochrome

Selects a format that is like Flat Color. But only black is used (no colors, not even gray), and no fill.

Key Path	Save, Screen Image, Themes
Example	MMEM:STOR:SCR:THEM FMON
Readback	Flat Mono
Initial S/W Revision	Prior to A.02.00

Save As...

When you press "Save As", the analyzer brings up a Windows dialog and a menu entitled "**Save As.**" This menu allows you to navigate to the various fields in the Windows dialog without using a keyboard or mouse. The Tab and Arrow keys can also be used for dialog navigation.

See "[To File . . .](#)" on page 2810 in Save, State for a full description of this dialog and menu.

The default path for Screen Images is

My Documents\`<mode name>`\screen.

where `<mode name>` is the parameter used to select the mode with the INST:SEL command (for example, SA for the Spectrum Analyzer).

Key Path	Save, Screen Image
Notes	Brings up Save As dialog for saving a Screen Image Save Type
Initial S/W Revision	Prior to A.02.00

Mass Storage Catalog (Remote Command Only)

Key path	SCPI Only
Remote Command	:MMEMory:CATalog? [<code><directory_name></code>]
Notes	<p>The string must be a valid logical path.</p> <p>Queries disk usage information (drive capacity, free space available) and obtains a list of files and directories in a specified directory in the following format:</p> <pre><numeric_value>,<numeric_value>,{<file_entry>}</pre> <p>It returns two numeric parameters and as many strings as there are files and directories. The first parameter indicates the total amount of storage currently used in bytes. The second parameter</p>

	<p>indicates the total amount of storage available, also in bytes. The <file_entry> is a string. Each <file_entry> indicates the name, type, and size of one file in the directory list: <file_name>,<file_type>,<file_size></p> <p>As the windows file system has an extension that indicates file type, <file_type> is always empty. <file_size> provides the size of the file in bytes. For directories, <file_entry> is surrounded by square brackets and both <file_type> and <file_size> are empty</p>
Initial S/W Revision	Prior to A.02.00

Mass Storage Change Directory (Remote Command Only)

Key path	SCPI Only
Remote Command	<pre>:MMEMory:CDIRectory [<directory_name>] :MMEMory:CDIRectory?</pre>
Notes	<p>The string must be a valid logical path.</p> <p>Changes the default directory for a mass memory file system. The <directory_name> parameter is a string. If no parameter is specified, the directory is set to the *RST value.</p> <p>At *RST, this value is set to the default user data storage area, that is defined as System.Environment.SpecialFolder.Personal.</p> <p>Query returns full path of the default directory.</p>
Initial S/W Revision	Prior to A.02.00

Mass Storage Copy (Remote Command Only)

Key path	SCPI Only
Remote Command	<pre>:MMEMory:COPY <string>,<string>[,<string>,<string>]</pre>
Notes	<p>The string must be a valid logical path.</p> <p>Copies an existing file to a new file or an existing directory to a new directory.</p> <p>Two forms of parameters are allowed. The first form has two parameters. In this form, the first parameter specifies the source, and the second parameter specifies the destination.</p> <p>The second form has four parameters. In this form, the first and third parameters specify the source. The second and fourth parameters specify the directories. The first pair of parameters specifies the source. The second pair specifies the destination. An error is generated if the source doesn't exist or the destination file already exists.</p> <p>This command will generate an "access denied" error if the destination is a restricted folder (e.g., C:\Windows) and the current user does not have Power User or Administrator privileges.</p>

Mass Storage Device Copy (Remote Command Only)

This command transfers data to/from a file and a peripheral device.

Key path	SCPI Only
Remote Command	:MMEMory:COpy:DEvice <source_string>,<dest_string>
Notes	<p>The strings must be a valid logical path or a valid device keyword. If the dest_string is a device keyword, the data is copied from the source file to the device. If the source_string is a device keyword, the data is copied to the source file from the device.</p> <p>Valid device keywords are:</p> <p>SNS (smart noise source)</p> <p>An error is generated if the file or device is not found.</p>

Mass Storage Delete (Remote Command Only)

Key path	SCPI Only
Remote Command	:MMEMory:DElete <file_name>[,<directory_name>]
Notes	<p>The string must be a valid logical path.</p> <p>Removes a file from the specified directory. The <file_name> parameter specifies the file name to be removed. This command will generate an “access denied” error if the file is in a restricted folder (e.g., C:\Windows) and the current user does not have Power User or Administrator privileges.</p>
Initial S/W Revision	Prior to A.02.00

Mass Storage Data (Remote Command Only)

Creates a file containing the specified data OR queries the data from an existing file.

Key path	SCPI Only
Remote Command	:MMEMory:DATA <file_name>, <data> :MMEMory:DATA? <file_name>
Notes	<p>The string must be a valid logical path.</p> <p>The command form is MMEMory:DATA <file_name>,<data>. It loads <data> into the file <file_name>. <data> is in 488.2 block format. <file_name> is string data.</p> <p>The query form is MMEMory:DATA? <file_name> with the response being the associated <data> in block format.</p>
Initial S/W Revision	Prior to A.02.00

Mass Storage Make Directory (Remote Command Only)

Key path	SCPI Only
Remote Command	:MMEMory:MDIRectory <directory_name>
Notes	<p>The string must be a valid logical path.</p> <p>Creates a new directory. The <directory_name> parameter specifies the name to be created.</p>

	This command will generate an “access denied” error if the new directory would be in a restricted folder (e.g., C:\Windows) and the current user does not have Power User or Administrator privileges.
Initial S/W Revision	Prior to A.02.00

Mass Storage Move (Remote Command Only)

Key path	SCPI Only
Remote Command	:MMEMory:MOVE <string>,<string>[,<string>,<string>]
Notes	<p>The string must be a valid logical path.</p> <p>Moves an existing file to a new file or an existing directory to a new directory.</p> <p>Two forms of parameters are allowed. The first form has two parameters. In this form, the first parameter specifies the source, and the second parameter specifies the destination.</p> <p>The second form has four parameters. In this form, the first and third parameters specify the source. The second and fourth parameters specify the directories. The first pair of parameters specifies the source. The second pair specifies the destination. An error is generated if the source doesn't exist or the destination file already exists.</p> <p>This command will generate an “access denied” error if the destination is a restricted folder (e.g., C:\Windows) and the current user does not have Power User or Administrator privileges.</p>
Initial S/W Revision	Prior to A.02.00

Mass Storage Remove Directory (Remote Command Only)

Key path	SCPI Only
Remote Command	:MMEMory:RDIRECTory <directory_name>
Notes	<p>The string must be a valid logical path.</p> <p>Removes a directory. The <directory_name> parameter specifies the directory name to be removed. All files and directories under the specified directory shall also be removed.</p> <p>This command will generate an “access denied” error if the folder is a restricted folder (e.g., C:\Windows) or is in a restricted folder and the current user does not have Power User or Administrator privileges.</p>
Initial S/W Revision	Prior to A.02.00

Single (Single Measurement/Sweep)

Sets the analyzer for Single measurement operation. The single/continuous state is Meas Global, so the setting will affect all the measurements. If you are Paused, pressing Single does a Resume.

See "[More Information](#)" on page 2835

Key Path	Front-panel key
Example	:INIT:CONT OFF
Notes	See Cont key description.
Backwards Compatibility Notes	<p>For Spectrum Analysis mode in ESA and PSA, the Single hardkey and the INITiate:IMM switched from continuous measurement to single measurement and restarted sweeps and averages (displayed average count reset to 1), but did not restart Max Hold and Min Hold. In the X-Series, the Single hardkey and the INITiate:IMM command initiate a sweep/ measurement/ average sequence/hold sequence including MaxHold and MinHold.</p> <p>For Spectrum Analysis mode in ESA and PSA, the Single hardkey restarted the sweep regardless of whether or not you were in an active sweep or sweep sequence. In the X-Series, Restart does this but Single only restarts the sweep or sweep sequence if you are in the idle state.</p> <p>INIT[:IMM] in ESA & PSA Spectrum Analysis Mode does an implied ABORT. In some other PSA Modes, INIT[:IMM] is ignored if not in the idle state. . The X-Series follows the ESA/PSA SA Mode model, which may cause some Modes to have compatibility problems.</p>
Initial S/W Revision	Prior to A.02.00

More Information

See "[Restart](#)" on page 2807 for details on the INIT:IMMEDIATE (Restart) function.

If you are already in single sweep, the INIT:CONT OFF command has no effect.

If you are already in Single Sweep, then pressing the Single key in the middle of a sweep does not restart the sweep or sequence. Similarly, pressing the Single key does not restart the sweep or sequence if the sweep is not in the idle state (for example, if you are taking a very slow sweep, or the analyzer is waiting for a trigger). Instead, it results in a message. "Already in Single, press Restart to initiate a new sweep or sequence". Even though pressing the Single key in the middle of a sweep does not restart the sweep, sending INIT:IMMEDIATE does reset it.

To take one more sweep without resetting the average count, increment the average count by 1, by pressing the step up key while **Average/Hold Number** is the active function, or sending the remote command CALC:AVER:TCON UP.

Source

There is no Source control functionality for this measurement. When this key is pressed, the screen either displays a blank menu, or the previously-selected menu remains unchanged.

Key Path	Front-panel key
----------	-----------------

SPAN X Scale

There is no Span X Scale functionality implemented for this measurement.

Key Path	Front-panel key
----------	-----------------

Sweep/Control

There is no Sweep/Control functionality implemented in this measurement.

Key Path	Front-panel key
----------	-----------------

System

See "System" on page 366

Trace/Detector

There is no Trace/Detector functionality implemented for this measurement.

Key Path

Front-panel key

Trigger

See ["Trigger" on page 438](#)

Free Run

See ["Free Run " on page 445](#)

Video

See ["Video \(IF Envelope\) " on page 446](#)

Trigger Level

See ["Trigger Level " on page 446](#)

Trig Slope

See ["Trig Slope " on page 447](#)

Trig Delay

See ["Trig Delay " on page 448](#)

Line

See ["Line " on page 2503](#)

Trig Slope

See ["Trig Slope " on page 2503](#)

Trig Delay

See ["Trig Delay " on page 450](#)

External 1

See ["External 1 " on page 2516](#)

Trigger Level

See ["Trigger Level " on page 2516](#)

Trig Slope

See ["Trig Slope " on page 2517](#)

Trig Delay

See ["Trig Delay " on page 453](#)

Zero Span Delay Comp

See ["Zero Span Delay Comp On/Off" on page 2505](#)

External 2

See ["External 2 "](#) on page 2518

Trigger Level

See ["Trigger Level "](#) on page 2518

Trig Slope

See ["Trig Slope "](#) on page 2519

Trig Delay

See ["Trig Delay "](#) on page 455

Zero Span Delay Comp

See ["Zero Span Delay Comp On/Off"](#) on page 2507

RF Burst

See ["RF Burst "](#) on page 2519

Absolute Trigger

See ["Absolute Trigger Level"](#) on page 2520

Relative Trigger

See ["Relative Trigger Level"](#) on page 2509

Trig Slope

See ["Trigger Slope "](#) on page 2521

Trig Delay

See ["Trig Delay "](#) on page 460

Periodic Timer

See ["Periodic Timer \(Frame Trigger\) "](#) on page 2511

Period

See ["Period "](#) on page 2512

Offset

See ["Offset "](#) on page 2513

Offset Adjust (Remote Command Only)

See ["Offset Adjust \(Remote Command Only\)"](#) on page 2514

Reset Offset Display

See "Reset Offset Display " on page 2515

Sync Source

See "Sync Source " on page 2515

Off

See "Off " on page 2516

External 1

See "External 1 " on page 2516

Trigger Level

See "Trigger Level " on page 2516

Trig Slope

See "Trig Slope " on page 2517

External 2

See "External 2 " on page 2518

Trigger Level

See "Trigger Level " on page 2518

Trig Slope

See "Trig Slope " on page 2519

RF Burst

See "RF Burst " on page 2519

Absolute Trigger

See "Absolute Trigger Level" on page 2520

Trig Slope

See "Trigger Slope " on page 2521

Trig Delay

See "Trig Delay" on page 470

Auto/Holdoff

See "Auto/Holdoff " on page 471

Auto Trig

See "Auto Trig " on page 471

18 Conformance EVM
Trigger

Trig Holdoff

See "[Trig Holdoff](#)" on page 472

Holdoff Type

See "[Holdoff Type](#)" on page 472

User Preset

Accesses a menu that gives you the following three choices:

- User Preset – recalls a state previously saved using the Save User Preset function.
- User Preset All Modes – presets all of the modes in the analyzer
- Save User Preset– saves the current state for the current mode

Key Path	Front-panel key
Backwards Compatibility Notes	<p>User Preset is actually loading a state, and in legacy analyzers, it was possible to load a state without affecting the trace data, limit lines or correction data. Similarly it was possible to do a User Preset without affecting the trace data, limit lines or correction data.</p> <p>In the X-Series, “state” always includes all of this data; so whenever state is loaded, or User Preset is executed, all of the traces, limit lines and corrections are affected. Although this differs from previous behavior, it is desirable behavior, and should not cause adverse issues for users.</p> <p>On ESA and PSA, User Preset affected the entire instrument’s state. In the X-Series, User Preset only recalls the state for the active mode. There is a User Preset file for each mode. User Preset can never cause a mode switch as it can in legacy analyzers. If you want to recall all modes to their user preset file state, you will need to do a User Preset after mode switching into each mode.</p> <p>User Preset recalls mode state which can now include data like traces; whereas on ESA and PSA, User Preset did not affect data.</p>
Initial S/W Revision	Prior to A.02.00

User Preset

User Preset sets the state of the currently active mode back to the state that was previously saved for this mode using the Save User Preset menu key or the SCPI command, SYST:PRES:USER:SAV. It not only recalls the Mode Preset settings, but it also recalls all of the mode persistent settings, and the Input/Output system setting that existed at the time Save User Preset was executed.

If a Save User Preset has not been done at any time, User Preset recalls the default user preset file for the currently active mode. The default user preset files are created if, at power-on, a mode detects there is no user preset file. There will never be a scenario when there is no user preset file to restore. For each mode, the default user preset state is the same state that would be saved if a Save User Preset is performed in each mode right after doing a Restore Mode Default and after a Restore Input/Output Defaults.

The User Preset function does the following:

- Aborts the currently running measurement.
- Sets the mode State to the values defined by Save User Preset.
- Makes the saved measurement for the currently running mode the active measurement.
- Brings up the saved menu for the power-on mode.
- Clears the input and output buffers.
- Sets the Status Byte to 0.

Key Path	User Preset
Remote Command	:SYSTem:PRESet:USER
Example	:SYST:PRES:USER:SAVE:SYST:PRES:USER
Notes	:SYST:PRES:USER:SAVE is used to save the current state as the user preset state. Clears all pending OPC bits. The Status Byte is set to 0. Pressing the User Preset front-panel key while already in the User Preset menu will cause the User Preset to get executed
Couplings	A user preset will cause the currently running measurement to be aborted and cause the saved measurement to be active. Recalling a User Preset file has the same issues that recalling a Save State file has. Some settings may need to be limited and therefore re-coupled, since the capabilities of the mode may have changes when the User Preset file was last saved.
Initial S/W Revision	Prior to A.02.00

User Preset All Modes

Recalls all of the User Preset files for each mode, switches to the power-on mode, and activates the saved measurement from the power-on mode User Preset file.

NOTE

When the instrument is secured, all of the user preset files are converted back to their default user preset files.

The User Preset function does the following:

- Aborts the currently running measurement.
- Switches the Mode to the power-on mode.
- Restores the User Preset files for each mode.
- Makes the saved measurement for the power-on mode the active measurement.
- Brings up the saved menu for the power-on mode.
- Clears the input and output buffers.
- Sets the Status Byte to 0.

Key Path	User Preset
Remote Command	:SYSTem:PRESet:USER:ALL
Example	:SYST:PRES:USER:SAVE:SYST:PRES:USER:ALL
Notes	Clears all pending OPC bits. The Status Byte is set to 0. :SYST:PRES:USER:SAVE is used to save the current state as the user preset state.
Couplings	A user preset will cause the currently running measurement to be aborted, cause a mode switch to the power-on mode, and cause the saved measurement to be active in the power-on mode. Recalling a User Preset file has the same issues that recalling a Save State file has. Some settings may need to be limited and therefore re-coupled, since the capabilities of the mode may have changes when the User Preset file was last saved.
Initial S/W Revision	Prior to A.02.00

Save User Preset

Saves the currently active mode and its State. You can recall this User Preset file by pressing the User Preset menu key or sending the SYST:PRES:USER remote command. This same state is also saved by the Save State function.

Key Path	User Preset
Remote Command	:SYSTem:PRESet:USER:SAVE
Example	:SYST:PRES:USER:SAVE
Notes	:SYST:PRES:SAVE creates the same file as if the user requested a *SAV or a MMEM:STOR:STAT, except User Preset Save does not allow the user to specify the filename or the location of the file.
Initial S/W Revision	Prior to A.02.00

View/Display

Allows you to select the desired measurement view from the following selections:

- MLISt – "Measurement List view" on page 2856
- PARAmeter – "Parameter List view" on page 2857
- RESult – "Result Metrics view" on page 2858
- RFENvelope – "RF Envelope view" on page 2858

Key Path	View/Display
Mode	LTE,LTETDD
Remote Command	:DISPlay:CEVM:VIEW[:SElect] MLISt PARAmeter RESult RFENvelope :DISPlay:CEVM:VIEW[:SElect]?
Example	DISP:CEVM:VIEW RES DISP:CEVM:VIEW?
Preset	RESult
State Saved	Saved in instrument state.
Range	Measurement List Parameter List Result Metrics RF Envelope
Initial S/W Revision	A.06.30

Display

The Display menu is common to most measurements, and is used for configuring items on the display. Some Display menu settings apply to all the measurements in a mode, and some only to the current measurement. Those under the System Display Settings key apply to all measurements in all modes.

Key Path	Display
Key Path	View/Display
Initial S/W Revision	Prior to A.02.00

Annotation

Turns on and off various parts of the display annotation. The annotation is divided up into four categories:

1. Meas Bar: This is the measurement bar at the top of the screen. It does not include the settings panel or the Active Function. Turning off the Meas Bar turns off the settings panel and the Active Function. When the Meas Bar is off, the graticule area expands to fill the area formerly occupied by the Meas Bar.
2. Screen Annotation: this is the annotation and annunciation around the graticule, including any annotation on lines (such as the display line, the threshold line, etc.) This does NOT include the marker number or the N dB result. When off, the graticule expands to fill the entire graticule area.
3. Trace annotation: these are the labels on the traces, showing their detector (or their math mode).

4. Active Function annotation: this is the active function display in the meas bar, and all of the active function values displayed on softkeys.

See the figure below. Each type of annotation can be turned on and off individually.

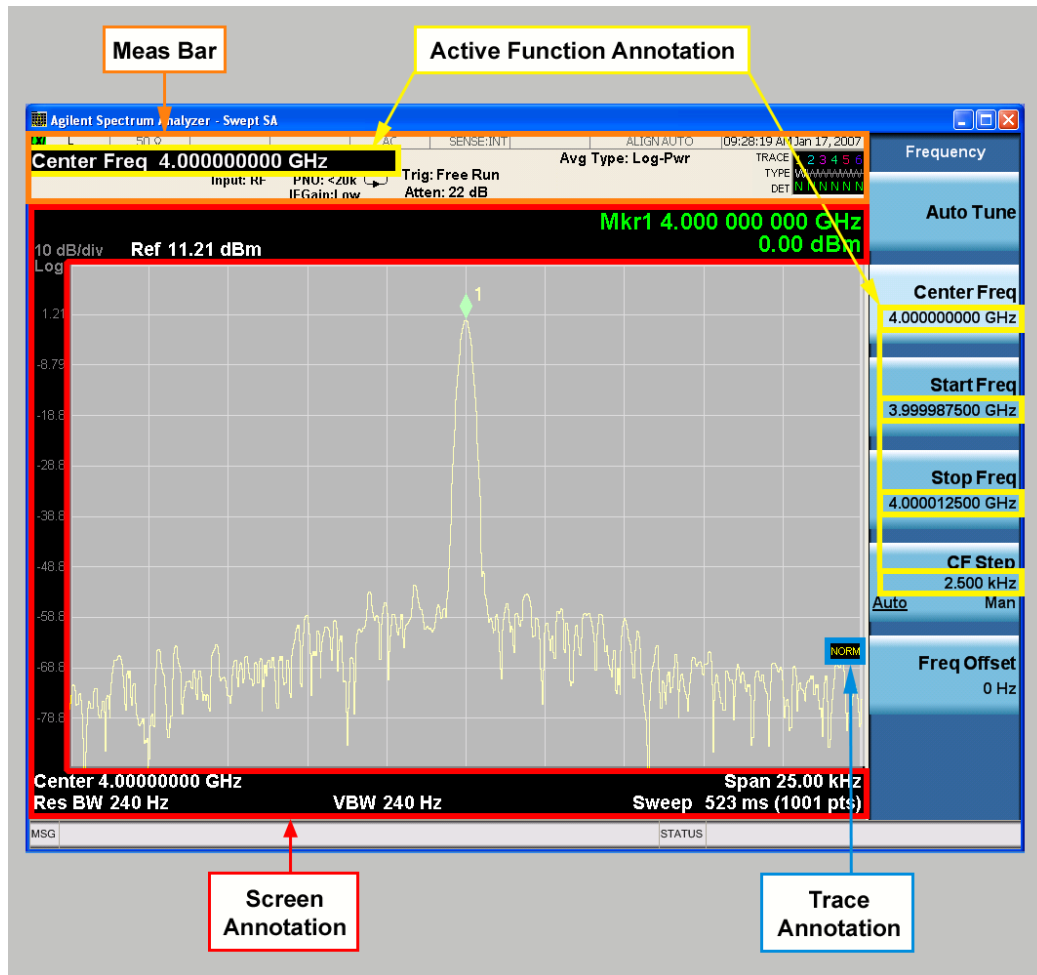

Key Path	View/Display, Display
Initial S/W Revision	Prior to A.02.00

Meas Bar On/Off

This function turns the Measurement Bar on and off, including the settings panel. When off, the graticule area expands to fill the area formerly occupied by the Measurement Bar.

Key Path	View/Display, Display, Annotation
Remote Command	:DISPlay:ANNotation:MBAR[:STATe] OFF ON 0 1 :DISPlay:ANNotation:MBAR[:STATe]?
Example	DISP:ANN:MBAR OFF

Dependencies	Grayed out and forced to OFF when System Display Settings, Annotation is set to Off.
Preset	On This should remain Off through a Preset when System DisplaySettings, Annotation is set to Off.
State Saved	Saved in instrument state.
Initial S/W Revision	Prior to A.02.00

Screen

This controls the display of the annunciation and annotation around the graticule, including any annotation on lines (such as the display line, the threshold line, etc.) and the y-axis annotation. This does NOT include marker annotation (or the N dB result). When off, the graticule expands to fill the entire graticule area, leaving only the 1.5% gap above the graticule as described in the Trace/Detector chapter.

Key Path	View/Display, Display, Annotation
Remote Command	:DISPlay:ANNotation:SCReen[:STATe] OFF ON 0 1 :DISPlay:ANNotation:SCReen[:STATe]?
Example	DISP:ANN:SCR OFF
Dependencies	Grayed-out and forced to OFF when System Display Settings, Annotation is set to Off.
Preset	On This should remain Off through a Preset when System DisplaySettings, Annotation is set to Off
State Saved	Saved in instrument state.
Initial S/W Revision	Prior to A.02.00

Active Function Values On/Off

Turns on and off the active function display in the Meas Bar, and all of the active function values displayed on the softkeys.

Note that all of the softkeys that have active functions have these numeric values blanked when this function is on. This is a security feature..

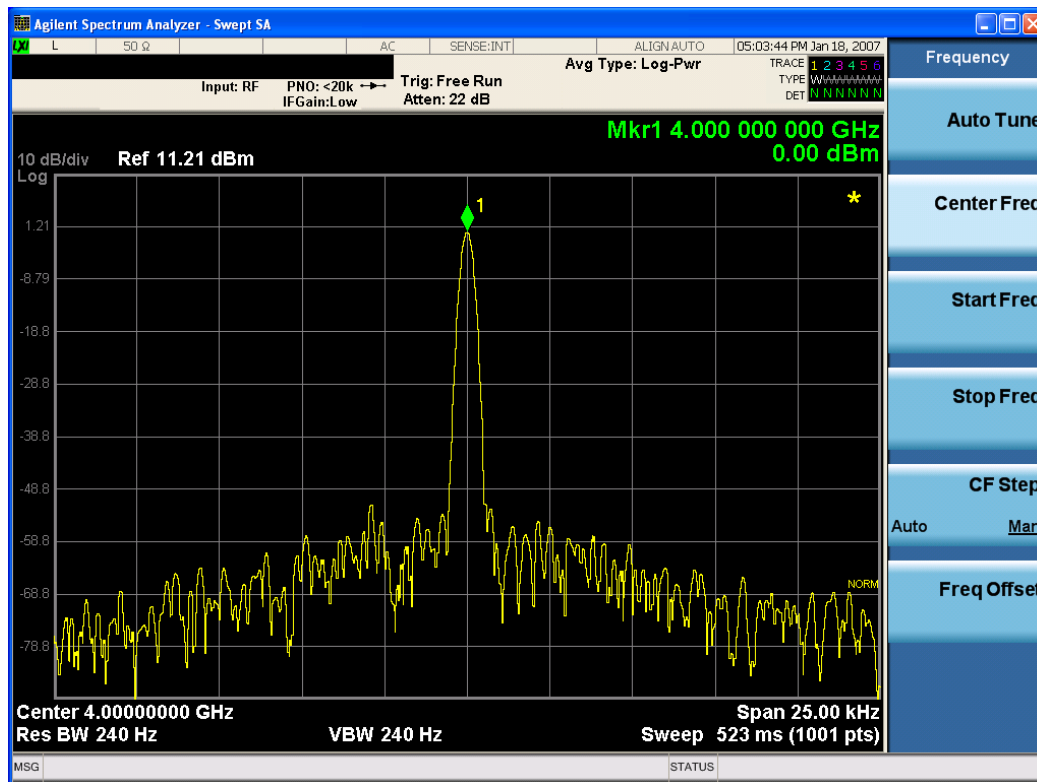

Key Path	View/Display, Display, Annotation
Remote Command	:DISPlay:ACTivefunc[:STATE] ON OFF 1 0 :DISPlay:ACTivefunc[:STATE]?
Example	DISP:ACT OFF
Dependencies	Grayed out and forced to OFF when System Display Settings, Annotation is set to Off.
Preset	On This should remain Off through a Preset when System DisplaySettings, Annotation is set to Off
State Saved	Saved in instrument state.
Initial S/W Revision	Prior to A.02.00

Title

Displays menu keys that enable you to change or clear a title on your display.

Key Path	View/Display, Display
Initial S/W Revision	Prior to A.02.00

Change Title

Writes a title into the "measurement name" field in the banner, for example, "Swept SA".

Press Change Title to enter a new title through the alpha editor. Press Enter or Return to complete the entry. Press ESC to cancel the entry and preserve your existing title.

The display title will replace the measurement name. It remains for this measurement until you press Change Title again, or you recall a state, or a Preset is performed. A title can also be cleared by pressing Title, Clear Title.

NOTE

Notice the inclusion of the <measurement> parameter in the command below. Because each measurement remembers the Display Title, the command must be qualified with the measurement name. For the Swept SA measurement this is not the case; no <measurement> parameter is used when changing the Display Title for the Swept SA measurement.

Key Path	View/Display, Display, Title
Mode	All
Remote Command	:DISPlay:<measurement>:ANNotation:TITLe:DATA <string> :DISPlay:<measurement>:ANNotation:TITLe:DATA?
Example	DISP:ANN:TITL:DATA "This Is My Title" This example is for the Swept SA measurement in the Spectrum Analyzer mode. The SANalyzer <measurement> name is not used. DISP:ACP:ANN:TITL:DATA "This Is My Title" This example is for Measurements other than Swept SA. Both set the title to: This Is My Title
Notes	Pressing this key cancels any active function. When a title is edited the previous title remains intact (it is not cleared) and the cursor goes at the end so that characters can be added or BKSP can be used to go back over previous characters.
Preset	No title (measurement name instead)
State Saved	Saved in instrument state.
Initial S/W Revision	Prior to A.02.00

Clear Title

Clears a title from the front-panel display. Once cleared, the title cannot be retrieved. After the title is cleared, the current Measurement Name replaces it in the title bar.

Key Path	View/Display, Display, Title
Example	The following commands clear the title and restore the measurement's original title: DISP:ANN:TITL:DATA "" This example is for the Swept SA measurement in the Spectrum Analyzer mode. The SANalyzer <measurement> name is not used. DISP:ACP:ANN:TITL:DATA "" This example is for ACP; in measurements other than Swept SA the measurement name is required.
Notes	Uses the :DISPlay:<measurement>:ANNotation:TITLe:DATA <string> command with an empty string (in the Swept SA, the <measurement> is omitted).
Preset	Performed on Preset.
Initial S/W Revision	Prior to A.02.00

Graticule

Pressing Graticule turns the display graticule On or Off. It also turns the graticule y-axis annotation on and off.

Key Path	View/Display, Display
Remote Command	:DISPlay:WINDow[1]:TRACe:GRATicule:GRID[:STATe] OFF ON 0 1 :DISPlay:WINDow[1]:TRACe:GRATicule:GRID[:STATe]?
Example	DISP:WIND:TRAC:GRAT:GRID OFF
Notes	The graticule is the set of horizontal and vertical lines that make up the grid/divisions for the x-axis and y-axis.
Preset	On
State Saved	Saved in instrument state
Initial S/W Revision	Prior to A.02.00

System Display Settings

These settings are "Mode Global" – they affect all modes and measurements and are reset only by Restore Misc Defaults or Restore System Defaults under System.

Key Path	View/Display, Display
Initial S/W Revision	Prior to A.02.00

Annotation Local Settings

This is a Mode Global override of the meas local annotation settings. When it is All Off, it forces ScreenAnnotation, Meas Bar, Trace, and Active Function Values settings to be OFF for all measurements in all modes. This provides the security based "annotation off" function of previous analyzers; hence it uses the legacy SCPI command.

When it is All Off, the Screen, Meas Bar, Trace, and Active Function Values keys under the Display, Annotation menu are grayed out and forced to Off. When Local Settings is selected, you are able to set the local annotation settings on a measurement by measurement basis.

Key Path	View/Display, Display, System Display Settings
Remote Command	:DISPlay:WINDow[1]:ANNOtation[:ALL] OFF ON 0 1 :DISPlay:WINDow[1]:ANNOtation[:ALL]?
Example	:DISP:WIND:ANN OFF
Preset	On (Set by Restore Misc Defaults)
State Saved	Not saved in instrument state.
Backwards Compatibility Notes	The WINDow parameter and optional subopcode is included for backwards compatibility but ignored – all windows are equally affected.
Initial S/W Revision	Prior to A.02.00

Themes

Accesses a menu of functions that enable you to choose the theme to be used when saving the screen image.

The **Themes** option is the same as the **Themes** option under the **Display** and **Page Setup** dialogs. It allows you to choose between themes to be used when saving the screen image.

Key Path	Save, Screen Image
Remote Command	:MMEMory:STORe:SCReem:THEMe TDColor TDMonochrome FCOLor FMONochrome :MMEMory:STORe:SCReem:THEMe?
Example	:MMEM:STOR:SCR:THEM TDM
Preset	3D Color; Is not part of Preset, but is reset by Restore Misc Defaults or Restore System Defaults All and survives subsequent running of the modes.
Readback	3D Color 3D Mono Flat Color Flat Mono
Backwards Compatibility Notes	In ESA and PSA we offer the choice of "Reverse Bitmap" or "Reverse Metafile" when saving screen images. This is much like the "Flat Color" theme available in X-Series. Also, if you selected Reverse Bitmap AND a black & white screen image, that would be much like "Flat Monochrome". In other words, each of the X-Series themes has a similar screen image type in ESA/PSA. But they are not identical.
Initial S/W Revision	Prior to A.02.00

3D Color

Selects a standard color theme with each object filled, shaded and colored as designed.

Key Path	Save, Screen Image, Themes
Example	MMEM:STOR:SCR:THEM TDC
Readback	3D Color
Initial S/W Revision	Prior to A.02.00

3D Monochrome

Selects a format that is like 3D color but shades of gray are used instead of colors.

Key Path	Save, Screen Image, Themes
Example	MMEM:STOR:SCR:THEM TDM
Readback	3D Mono
Initial S/W Revision	Prior to A.02.00

Flat Color

Selects a format that is best when the screen is to be printed on an ink printer.

Key Path	Save, Screen Image, Themes
Example	MMEM:STOR:SCR:THEM FCOL
Readback	Flat Color
Initial S/W Revision	Prior to A.02.00

Flat Monochrome

Selects a format that is like Flat Color. But only black is used (no colors, not even gray), and no fill.

Key Path	Save, Screen Image, Themes
Example	MMEM:STOR:SCR:THEM FMON
Readback	Flat Mono
Initial S/W Revision	Prior to A.02.00

Backlight

Accesses the display backlight on/off keys. This setting may interact with settings under the Windows "Power" menu.

When the backlight is off, pressing ESC, TAB, SPACE, ENTER, UP, DOWN, LEFT, RIGHT, DEL, BKSP, CTRL, or ALT turns the backlight on without affecting the application. Pressing any other key will turn backlight on and could potentially perform the action as well.

Key Path	View/Display, Display, System Display Settings
Remote Command	:DISPlay:BACKlight ON OFF :DISPlay:BACKlight?
Preset	ON (Set by Restore Misc Defaults)
Initial S/W Revision	Prior to A.02.00

Backlight Intensity

An active function used to set the backlight intensity. It goes from 0 to 100 where 100 is full on and 0 is off. This value is independent of the values set under the Backlight on/off key.

Key Path	View/Display, Display, System Display Settings
Remote Command	:DISPlay:BACKlight:INTensity <integer> :DISPlay:BACKlight:INTensity?
Example	DISP:BACK:INT 50

Preset	100 (Set by Restore Misc Defaults)
Min	0
Max	100
Initial S/W Revision	Prior to A.02.00

Measurement List view

By default, this view shows the current status of enabled measurements and results.

When “Show All Items” parameter is enabled from the soft key, all available measurements and items are displayed. The measurement name and items which belong to the unavailable measurements are grayed out.

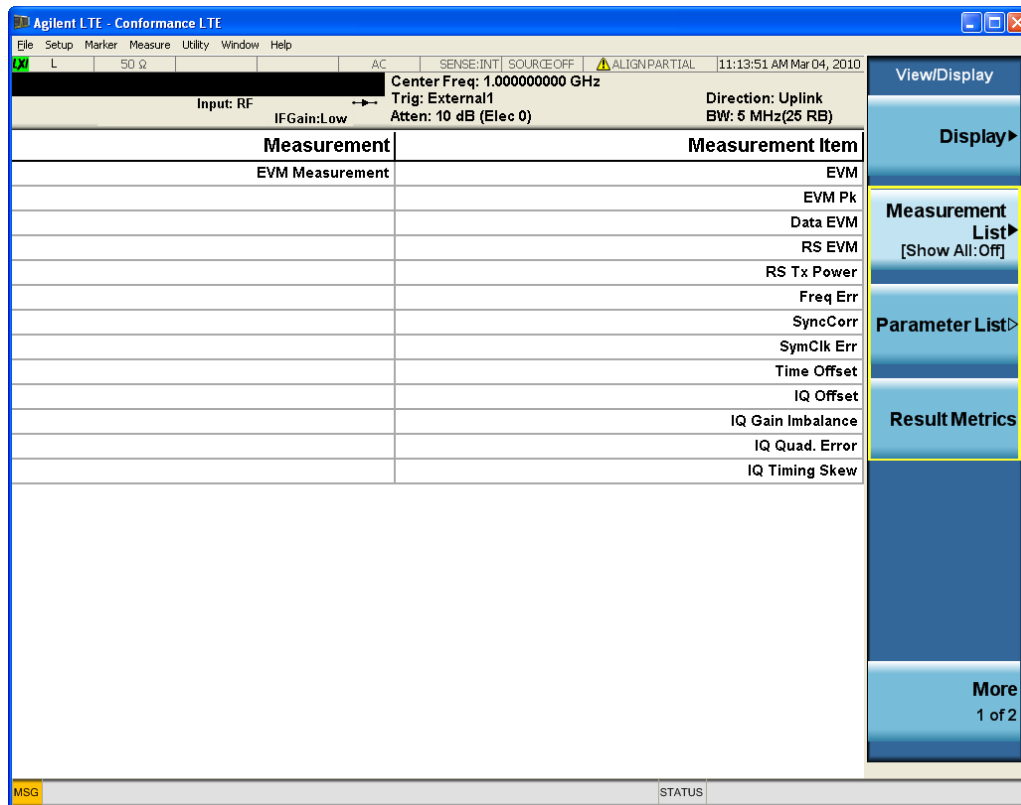

Key Path	View/Display
Initial S/W Revision	A.06.30

Show All Items

When “Show All Items” is enabled, all available measurements and items are displayed.

The measurement name and items which belong to the unavailable measurements are grayed out.

Key Path	View/Display, Measurement List
Initial S/W Revision	A.06.30

Parameter List view

This view shows name, remote command and value of available commands for this measurement. You can verify and change values by using the menu, the front panel keys or by using a mouse and keyboard.

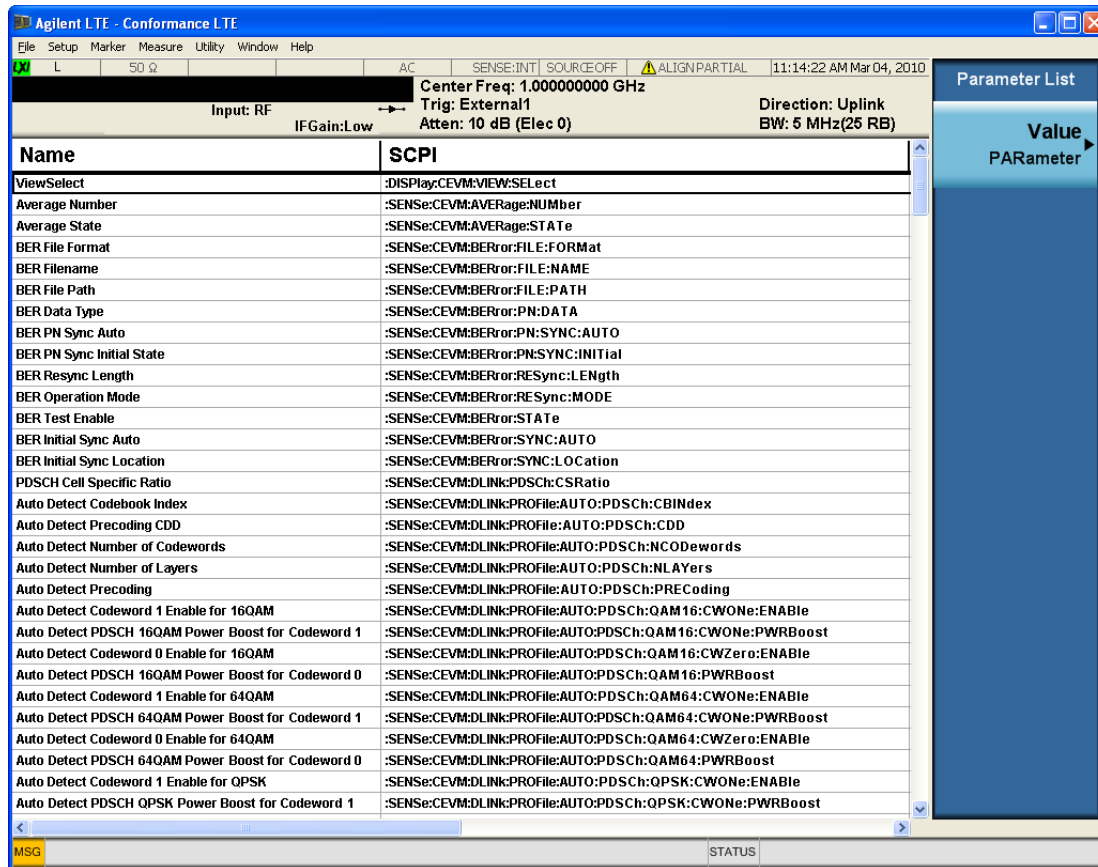

Figure - Parameter List view

Key Path	View/Display
Initial S/W Revision	A.06.30

Value

Allows you to refer to and modify the value on the selected row.

Key Path	View/Display, Parameter List
Initial S/W Revision	A.06.30

Result Metrics view

This view shows measurement results in the same order as the remote command measurement results returned when index (n=1) is sent.



Key Path	View/Display
Initial S/W Revision	A.06.30

RF Envelope view

For diagnostic purposes, the RF Envelope view shows a time-domain magnitude plot of each frequency.

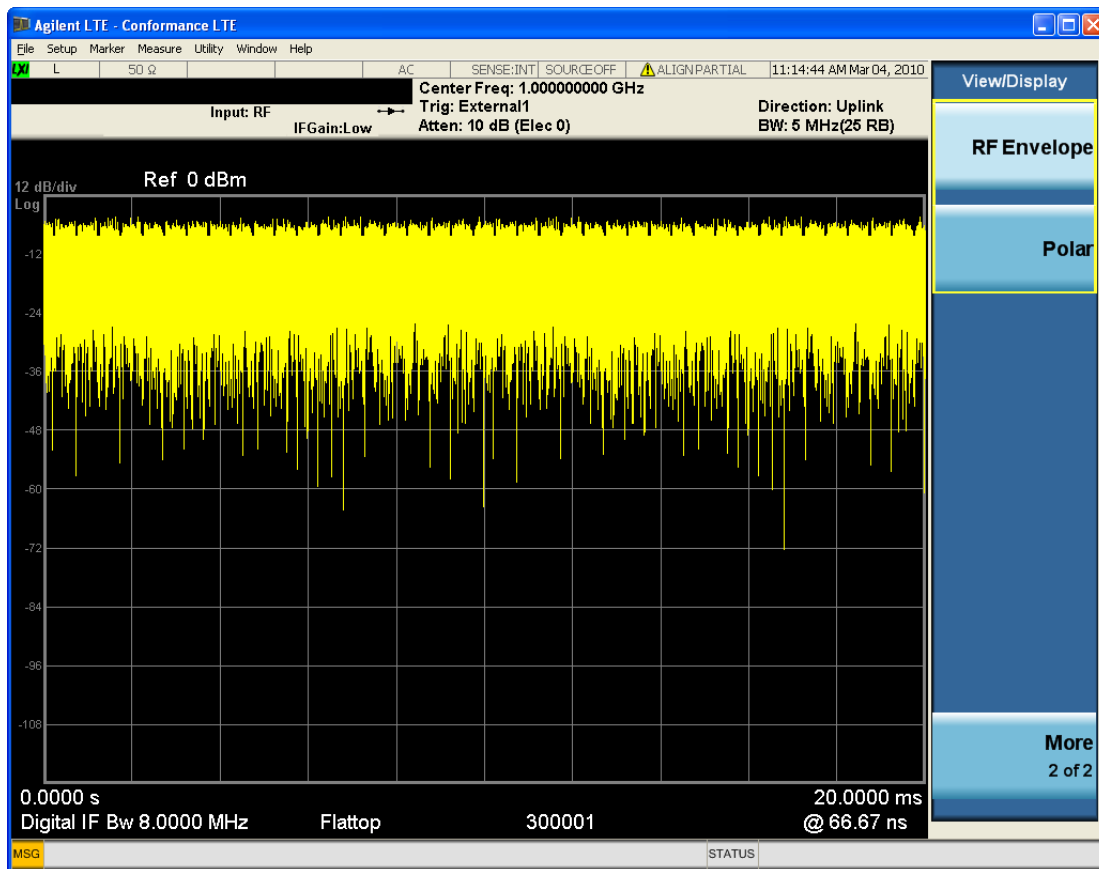

Key Path View/Display

Initial S/W Revision A.06.30

19 Remote SCPI Commands and Data Queries

Remote SCPI Results described in this section include:

[":READ and :FETCh Commands" on page 2862](#)

[":CALCulate:DATA" on page 2865](#)

[":CALCulate:DATA:RAW" on page 2867](#)

[":CALCulate:DATA:RAW:COMPLex" on page 2868](#)

[":CALCulate:DATA:POINts commands" on page 2869](#)

[":CALCulate:DATA:TABL commands" on page 2870](#)

[":CALCulate:DATA:HEADer commands" on page 2874](#)

[":CALC:CLIMits:FAIL?" on page 2876](#)

["IQ Data Transfers " on page 2877](#)

VSA based Measurements produce a rich variety of results that can be displayed in any of 4 traces. A result can consist of an array of X,Y trace data that is typically shown as a graph or scalar results that are displayed as a table. The Symbol/Error result that is part of many demodulation measurements actually displays both a trace table (the error statistics) and trace data (the symbol information, which is not graphed but listed). The CALC:<meas>:DATA<n> commands enable you to retrieve any trace data or trace table. This family of commands also enable you to get information about the names of data results available and the units associated with them, as well as names and results of meta-data associated with traces.

Selected results are available via the FETCh and READ SCPI interfaces. These commands refer to data results by arbitrary index number rather than by trace number.

Key Path	SCPI Only
Mode	LTE, LTETDD, IDEN, VSA

:READ and :FETCh Commands

The SCPI MEASure, READ, and FETCh are typically offered by applications with focus on manufacturing test, where a fixed set of desired results is known in advance and seldom changes. The VSA based measurements are many, due to a focus on development. Thus, for most VSA based measurements there is no standard configuration that yields a useful measurement 90% of the time. Thus, the MEASure function is not offered for most measurements in the VSA Application. However, READ and FETCh can be implemented for select results. Note that these results are also still available using the CALC:<meas>:DATA:TABLE family of commands.

ACP and OBW are available in all VSA based measurements. To retrieve the ACP or OBW data, the function must be enabled on a frequency-domain trace and the associated summary data table must be assigned to another trace. Note however, the index n in the following commands is not trace number but an index picked out of the tables shown below.

:FETCh:<meas> [n] ?

:READ:<meas> [n] ?

The results available for various values of n are shown below:

Condition	N	Results Returned
Mode = VSA LTE IDEN	Not specified or n=1	Reserved for selected results of VSA measurements. If not used for a particular measurement, no result is returned and error -114 Header suffix out of range is generated.
Mode = VSA LTE IDEN	2 - 50	Reserved for selected results of VSA measurements. If not used for a particular measurement, no result is returned and error -114 Header suffix out of range is generated.
Mode = VSA LTE IDEN, ACP on trace 1	51	ACP Summary for trace 1 Returns 28 comma-separated scalar results, corresponding to the swept ACP results where possible; n/a elsewhere: Returns 28 comma-separated scalar results, in the following order. 1. 0.0 2. Total carrier power (dBm) (same as item 4, because only 1 carrier supported) 3. 0.0 4. Reference carrier power (dBm) 5. Lower offset A - relative power (dB) 6. Lower offset A - absolute power (dBm) 7. Upper offset A - relative power (dB) 8. Upper offset A - absolute power (dBm) 9. Lower offset B - relative power (dB) 10. Lower offset B - absolute power (dBm) 11. Upper offset B - relative power (dB) 12. Upper offset B - absolute power (dBm) ... 21. Lower offset E - relative power (dB)

		22. Lower offset E - absolute power (dBm)
		23. Upper offset E - relative power (dB)
		24. Upper offset E - absolute power (dBm)
		25. n/a
		26. n/a
		27. n/a
		28. n/a
		29. Overall ACP test result summary (0 indicates at least 1 failure, 1 indicates all passed) If any result is not available, NaN (9.91 E 37) is returned. This can happen if ACP is turned off (all results unavailable) or when an offset is entirely off-screen. In the case where it is partially off-screen, the measured result is returned even though its validity is questionable.
Mode = VSA LTE IDEN, ACP on trace 2	52	ACP Summary for trace 2 see list for trace 1 summary
Mode = VSA LTE IDEN, ACP on trace 3	53	ACP Summary for trace 3 see list for trace 1 summary
Mode = VSA LTE IDEN, ACP on trace 4	54	ACP Summary for trace 4 see list for trace 1 summary
Mode = VSA LTE IDEN, ACP on trace 5	55	ACP Summary for trace 5 see list for trace 1 summary
Mode = VSA LTE IDEN, ACP on trace 6	56	ACP Summary for trace 6 see list for trace 1 summary
	57-60	no result returned; error -114, Header suffix out of range generated
Mode = VSA LTE IDEN, OBW on trace 1	61	OBW Summary for trace 1 Returns 9 comma-separated scalar results corresponding exactly to the items in the OBW Summary trace: 1. OBW (Hz) 2. Pwr (dBm) 3. Total Pwr (dBm) 4. Pwr Ratio (no unit, E.g. 0.99) 5. OBW upper freq (Hz) 6. OBW lower freq (Hz) 7. Centroid freq (Hz) 8. Offset freq (Hz) 9. OBW Test Result (0 for fail, 1 for pass) If the results are not available, NaN (9.91 E 37) is returned.
Mode = VSA LTE IDEN,	62	OBW Summary for trace 2 see list for trace 1 summary

OBW on trace 2		
Mode = VSA LTE IDEN, OBW on trace 3	63	OBW Summary for trace 3 see list for trace 1 summary
Mode = VSA LTE IDEN, OBW on trace 4	64	OBW Summary for trace 4 see list for trace 1 summary
Mode = VSA LTE IDEN, OBW on trace 5	65	OBW Summary for trace 5 see list for trace 1 summary
Mode = VSA LTE IDEN, OBW on trace 6	66	OBW Summary for trace 6 see list for trace 1 summary

Key Path	SCPI Only
Mode	LTE, LTETDD, IDEN, VSA

:CALCulate:DATA

Once measurement data result is assigned to a trace, the data can be retrieved by using one of the following commands (where <n> is the trace number and <meas> is the current VSA based measurement).

:CALC:<meas>:DATA<n>?

:CALC:<meas>:DATA<n>:RAW?

The first form of the command retrieves the data as formatted on the display. For example, if (in a vector measurement) you have the Spectrum result in LogMag format on trace 1, then

:CALC:VECT:DATA1?

returns an array of spectrum amplitude (Y data) in units of dBm, and

:CALC:VECT:DATA1:RAW?

returns the Y data in its underlying units of Volts (peak) squared.

(To get data from displayed tables, see "[:CALCulate:DATA:TABL commands](#)" on page 2870.)

The CALC:<meas>:DATA commands get data from traces. There are many results available from a VSA based measurement and only 4 traces in which to view them. View Preset commands are one way of displaying frequently-used results in standard trace locations. Or you can assign any measurement result to any trace using the softkeys under Trace/Detector, Data. The SCPI command for doing this is:

:DISP:<meas>:TRAC<n>:FEED "<data_name>"

For example, if (in a vector measurement) you want to view the CCDF result in trace 4, you send:

:DISP:VECT:TRAC4:FEED "CCDF1"

(If the measurement has not run yet, use INIT:IMM to run it.) Then the CCDF data can be retrieved using

CALC:VECT:DATA4?

or

CALC:VECT:DATA4:RAW?

Key Path	SCPI Only
Mode	VSA, LTE, LTETDD, IDEN
Measurement	<meas>:=VECTor ADEMod DDEMod W11A W11B EVM IPOWER IDEMod MOTotalk
Remote Command	:CALCulate:<meas>:DATA[1] 2 ...4? [Y X XY[,OFF ON 0 1] LL UL]
Example	CALC:VECT:DATA1? CALC:VECT:DATA1? Y,ON CALC:VECT:DATA1? X CALC:VECT:DATA1? XY
Notes	Query only. This retrieves the data in the designated trace as displayed. For example, if Trace 1 is assigned Spectrum data and formatted as LogMag, then :CALC:VECT:DATA1? returns the Y data in dBm. If the X axis is scaled to show only a portion of the

trace data, only the data shown is returned.

The numeric format of the returned data is controlled by `FORMat[:TRACe][:DATA]` command

The optional parameters control what data is returned.

`:CALC:VECT:DATA1? Y` is the same as `:CALC:VECT:DATA1?` with no parameter. It returns an array of Y values.

`:CALC:VECT:DATA1? X` returns an array of X values that correspond to the Y values above.

`:CALC:VECT:DATA1? XY` returns interleaved X and Y data. That is: `<x1><y1><x2><y2>...`

Normally, this command only returns the data between the current X scale limits. If the optional ",OFF" or ",0" switch is included at the end of the command, then all data is returned (regardless of X scaling or the state of All Frequency Points).

`:CALC:EVM:DATA1? LL|UL` returns an array of Lower/Upper Limit values when Limit Test is enabled and the trace includes limit values. When Limit Test is disabled or the trace does not include limit value, this query is the same as `:CALC:EVM:DATA1?` with no parameter.

Note: LL and UL are available only for the EVM measurement in the LTE/LTE TDD modes.

Note: the X and Y parameters in this command refer to the display's horizontal and vertical axes.

Normally the X axis is the independent variable, but if the display format is Constellation or IQ, then `CALC:<meas>:DATA<n>? [Y]` returns the imaginary part of the data and `CALC:<meas>:DATA<n>? X` returns the real part of the data. If you want the values of the independent variable, change to a non-vector format (such as Log Mag) and use `CALC:<meas>:DATA<n>? X`

Initial S/W Revision	Prior to A.02.00
Modified at S/W Revision	A.02.00, A.08.00

:CALCulate:DATA:RAW

Retrieves trace data in its underlying units, before the formatting calculation that converts it to displayed units. Underlying units are typically Volts peak (for signal results) or Volts peak squared (for power results). All data points are returned, whether or not they are displayed.

Key Path	SCPI Only
Mode	VSA, LTE, LTETDD, IDEN
Measurement	<meas>:=VECTor ADEMod DDEMod W11A W11B EVM IPOWER IDEMod MOTotalk
Remote Command	:CALCulate:<meas>:DATA[1] 2 ...4:RAW?
Example	CALC:VECT:DATA1:RAW?
Notes	Query only. This retrieves the unformatted Y data in the designated trace. If Y data is complex, it is returned as <y_real1><y_imag1><y_real2><y_imag2> etc.
Initial S/W Revision	Prior to A.02.00
Modified at S/W Revision	A.02.00

:CALCulate:DATA:RAW:COMPLex

Determines if the data retrieved by CALC:<meas>:DATA:RAW<n>? is complex.

Key Path	SCPI Only
Mode	VSA, LTE, LTETDD, IDEN
Measurement	<meas>:=VECTor ADEMod DDEMod W11A W11B EVM IPOWER IDEMod MOTotalk
Remote Command	:CALCulate:<meas>:DATA[1] 2 ...4:RAW:COMPLex?
Example	CALC:VECT:DATA1:RAW:COMP?
Notes	Query only. Returns 1 if the trace data is complex, 0 if it is real.
Initial S/W Revision	Prior to A.02.00
Modified at S/W Revision	A.02.00

:CALCulate:DATA:POINTS commands

Returns the number of points that are returned by

CALCulate:<meas>:DATA<n>?

X axis scaling and whether All Frequency Points is on or off can affect this number.

NOTE For the CALCulate:<meas>:DATA<n>? XY command there are 2 numbers returned per data point.

Key Path	SCPI Only
Mode	VSA, LTE, LTETDD, IDEN
Measurement	<meas>:=VECTor ADEMod DDEMod W11A W11B EVM IPOWER IDEMod MOTotalk
Remote Command	:CALCulate:<meas>:DATA [1] 2 . . . 4 :POINTS? [OFF ON 0 1]
Example	CALC:VECT:DATA1:POINTS?
Notes	<p>Query only.</p> <p>Use the optional "OFF 0" parameter to determine the number of points that are returned by the optional command form:</p> <p>:CALCulate:<meas>:DATA<n>? Y X XY,OFF 0</p> <p>Note that this is points, not array size. If the XY parameter is included, there are 2 numbers returned per point.</p> <p>(ON or 0, which means use the X-scaled version, is the default and the result is the same as if the parameter is omitted).</p>
Initial S/W Revision	Prior to A.02.00
Modified at S/W Revision	A.02.00

This query returns the number of points that are returned by

CALCulate:<meas>:DATA:RAW<n>?

NOTE For complex trace data, there are 2 numbers returned per data point.

Key Path	SCPI Only
Mode	VSA, LTE, LTETDD, IDEN
Measurement	<meas>:=VECTor ADEMod DDEMod W11A W11B EVM IPOWER IDEMod MOTotalk
Remote Command	:CALCulate:<meas>:DATA [1] 2 . . . 4 :RAW:POINTS?
Example	CALC:VECT:DATA1:RAW:POINTS?
Notes	Query only.
Initial S/W Revision	Prior to A.02.00
Modified at S/W Revision	A.02.00

:CALCulate:DATA:TABL commands

Some traces have tabular data associated with them. In fact, there may be only a table and no trace data. Each entry in the table consists of a name, a measured value, and units. The units are sometimes not shown. You can programmatically retrieve arrays of all the names, all the values, and all the units of a table. These arrays are all ordered so that corresponding indices have associated values, for example, the 4th name in the names array corresponds to the 4th value in the results array. (Note that the array order cannot be the same as the displayed order.) You can also get a particular result from the table by name. Here is a summary of the remote table data commands.

Command	Returns	Example
CALCulate:<meas>:DATA<n>:TABL?	All table data results (as an array)	CALC:DDEM:DATA4:TABL?
CALCulate:<meas>:DATA<n>:TABL? "<name>"	The table data result referred to by name	CALC:DDEM:DATA4:TABL? "EvmPeak"
CALCulate:<meas>:DATA<n>:TABL:NAMes?	Comma-separated list of all table data names	CALC:DDEM:DATA4:TABL:NAM?
CALCulate:<meas>:DATA<n>:TABL:UNIT?	Comma-separated list of all table data units	CALC:DDEM:DATA4:TABL:UNIT?

For example, if within the Vector Analysis measurement, you have an OBW Summary Table displayed in trace 2, CALC:DDEM:DATA2:TABL:NAM? would return the table names as follows:

```
"Obw,Pwr,TotalPwr,PwrRatio,ObwUpper,ObwLower,Centroid,Offset"
```

and CALC:DDEM:DATA2:TABL:UNIT? would return the units. (A null string means the result is unitless.)

```
"Hz,Vrms^2,Vrms^2,,Hz,Hz,Hz,Hz"
```

You can then get all the table results by sending

```
CALC:DDEM:DATA2:TABL?
```

Result number 1 is Obw and has units of Hz, result number 2 is Pwr with units of Vrms^2, and so on.

You can also get individual table entries by asking for them by name. Any name returned from the CALC:DDEM:DATA2:TABL:NAM? query can be used. For example, to get TotalPwr you can send the following query:

```
CALC:DDEM:DATA2:TABL? "TotalPwr"
```

Query Table Data as Number

Gets data from a table shown in the designated trace. Tables shown on the display typically have the name of a parameter followed by its measured value

Key Path	SCPI Only
Mode	VSA, LTE, LTETDD, IDEN
Measurement	<meas>:=VECTor ADEMod DDEMod W11A W11B EVM IPOWER IDEMod MOTotalk
Remote Command	:CALCulate:<meas>:DATA[1] 2 ...4:TABLE[:NUMBer]? [<string>]
Example	CALC:DDEM:DATA2:TABL? "Obw"
Notes	Query only. If sent without a string specifier, this returns the entire table for the designated trace. If sent with a string specifier, returns a specific table entry in the designated trace. The string specifier must be delimited by single or double quotes. A list of valid strings can be obtained using CALC:<meas>:DATA:TABL:NAM? If an invalid string is sent, an error is generated. The returned results are in numeric format, under control of the FORMat[:TRACe][:DATA] command. For table data that is non-numeric, NaN is returned. To get the value of these data, use the CALC:<meas>:DATA2:TABL:STR? command.
Initial S/W Revision	Prior to A.02.00
Modified at S/W Revision	A.02.00

Query Table Data as String

Some tables have string data. The above Trace Table Data query cannot return it and sends NaN in its place. Here is a form of Trace Table Data query that can return string data from tables.

Key Path	SCPI Only
Mode	VSA, LTE, LTETDD, IDEN
Measurement	<meas>:=VECTor ADEMod DDEMod W11A W11B EVM IPOWER IDEMod MOTotalk
Remote Command	:CALCulate:<meas>:DATA[1] 2 ...4:TABLE:STRing? [<string>]
Example	CALC:DDEM:DATA2:TABL:STR? "Obw"
Notes	Query only. If sent without a string specifier, this returns the entire table for the designated trace in comma-separated format. If sent with a string specifier, returns a specific table entry in the designated trace. The string specifier must be delimited by single or double quotes. A list of valid strings can be obtained using CALC:<meas>:DATA:TABL:NAM? If an invalid string is sent, an error is generated.
Initial S/W Revision	Prior to A.02.00
Modified at S/W Revision	A.02.00

Query Table Names

Returns a comma-separated list of names of the table data entries for the designated trace. Each of the names can be used (surrounded by quotes or double quotes) as a parameter in the Trace Table Data commands. The names appear in the same order as the corresponding data values returned by the CALC:<meas>:DATA<n>:TABL[:NUMB|STR]? query.

Key Path	SCPI Only
Mode	VSA, LTE, LTETDD, IDEN
Measurement	<meas>:=VECTor ADEMod DDEMod W11A W11B EVM IPOWER IDEMod MOTotalk
Remote Command	:CALCulate:<meas>:DATA[1] 2 ...4:TABLE:NAMEs?
Example	CALC:VECT:DATA1:TABL:NAME?
Notes	Query only. This retrieves the names of the table entries for the designated trace. Each of these names can be used in the CALC:<meas>:DATA:TABL? '<name>' command to access a single table entry.
Initial S/W Revision	Prior to A.02.00
Modified at S/W Revision	A.02.00

Query Table Units

Returns a comma-separated list of all the units for the table data entries for the designated trace. If a data result is unitless, an empty string appears in the list for that result. The units appear in the same order as the corresponding data values returned by the CALC:<meas>:DATA<n>:TABL[:NUMB|STR]? query.

Key Path	SCPI Only
Mode	VSA, LTE, LTETDD, IDEN
Measurement	<meas>:=VECTor ADEMod DDEMod W11A W11B EVM IPOWER IDEMod MOTotalk
Remote Command	:CALCulate:<meas>:DATA[1] 2 ...4:TABLE:UNIT?
Example	CALC:VECT:DATA1:TABL:UNIT?
Notes	Query only. This retrieves a list of units for table entries for the designated trace. The units are given in the order that the entries are sent from the :CALC:<meas>:DATA:TABL? command.
Initial S/W Revision	Prior to A.02.00
Modified at S/W Revision	A.02.00

The following table data is available in all measurements when the ACP function is turned on and the associated summary table is shown in a trace:

Result name	Displayed Unit	Remote Name	Remote Unit
Reference Bandwidth	Hz	RefBw	Hz
Reference Alpha		RefAlpha	
Reference Power	dBm	RefPwr	Vrms^2

Offset	Hz	Offset1, Offset2, Offset3, Offset4, Offset5	Hz
BW	Hz	Bw1, Bw2, Bw3, Bw4, Bw5	Hz
Alpha		Alpha1, Alpha2, Alpha3, Alpha4, Alpha5	
Lower Pwr	dBm	LowPwr1, LowPwr2, LowPwr3, LowPwr4, LowPwr5	Vrms^2
Lower ACPR	dB	LowRatio1, LowRatio2, LowRatio3, LowRatio4, LowRatio5	
Upper Pwr	dBm	HiPwr1, HiPwr2, HiPwr3, HiPwr4, HiPwr5	Vrms^2
Upper ACPR	dB	HiRatio1, HiRatio2, HiRatio3, HiRatio4, HiRatio5	
Max ACPR	dB	MaxRatio1, MaxRatio2, MaxRatio3, MaxRatio4, MaxRatio5	

The following table data is available in all measurements when the OBW function is turned on and the associated summary table is shown in a trace:

Result name	Displayed Unit	Remote Name	Remote Unit
Occupied Bandwidth	Hz	Obw	Hz
Power	dBm	Pwr	Vrms^2
Total Power	dBm	TotalPwr	Vrms^2
Power Ratio	%	PwrRatio	
Upper Freq	Hz	ObwUpper	Hz
Lower Freq	Hz	ObwLower	Hz
Centroid Freq	Hz	Centroid	Hz
Offset Freq	Hz	Offset	Hz

:CALCulate:DATA:HEADer commands

Trace data also has meta-data associated with it, called headers, which is visible if you export trace data in text format. The headers have a name and a value that can be obtained from any trace by using the CALCulate:<meas>:DATA:HEADer commands described in this section.

The following Remote Commands are described in this section:

"Query Header Names" on page 2874

"Query Header Type" on page 2874

"Query Header as String" on page 2875

"Query Numeric Header" on page 2875

":CALC:CLIMits:FAIL?" on page 2876

Query Header Names

Returns a comma-separated list of all the header names associated with the designated trace. Each of the names can be used (surrounded by quotes or double quotes) as a parameter in the other CALC:<meas>:DATA<n>:HEAD queries.

Key Path	SCPI Only
Mode	VSA, LTE, LTETDD, IDEN
Measurement	<meas>:=VECTor ADEMod DDEMod W11A W11B EVM IPOWER IDEMod MOTotalk
Remote Command	:CALCulate:<meas>:DATA[1] 2 ...4:HEADer:NAMes?
Example	CALC:VECT:DATA1:HEAD:NAM?
Notes	Query only. Returns a comma-separated list of header names.
Initial S/W Revision	Prior to A.02.00
Modified at S/W Revision	A.02.00

Query Header Type

Returns whether the designated header on the designated trace can be queried as a number or by a string only.

Key Path	SCPI Only
Mode	VSA, LTE, LTETDD, IDEN
Measurement	<meas>:=VECTor ADEMod DDEMod W11A W11B EVM IPOWER IDEMod MOTotalk
Remote Command	:CALCulate:<meas>:DATA[1] 2 ...4:HEADer:TYPE? <string>
Example	CALC:VECT:DATA1:HEAD:TYPE? 'XDelta'
Notes	Query only. This retrieves the type of the named header for the designated trace. The name (delimited by single or double quotes) is one of the names returned by CALC:<meas>:DATA:HEAD:NAMes? If a valid header name is passed in, the return value from this query is either STR or NUMB. NONE is

	returned if there is no such header.
Initial S/W Revision	Prior to A.02.00
Modified at S/W Revision	A.02.00

Query Header as String

Gets a header by name from the designated trace and returns its value as a string.

Key Path	SCPI Only
Mode	VSA, LTE, LTETDD, IDEN
Measurement	<meas>:=VECTor ADEMod DDEMod W11A W11B EVM IPOWER IDEMod MOTotalk
Remote Command	:CALCulate:<meas>:DATA[1] 2 ...4:HEADer:STRing? <string>
Example	CALC:VECT:DATA1:HEAD:STR? 'WindowType'
Notes	Query only. This retrieves the named header for the designated trace. The name (delimited by single or double quotes) is one of the names returned by the CALC:<meas>:DATA:HEAD:NAMes? The return value is a string. If the requested header value is a numeric or if there is no such header, an empty string is returned.
Initial S/W Revision	Prior to A.02.00
Modified at S/W Revision	A.02.00

Query Numeric Header

Gets a numeric header by name from the designated trace and returns its value in a format determined by the last FORM command.

Key Path	SCPI Only
Mode	VSA, LTE, LTETDD, IDEN
Measurement	<meas>:=VECTor ADEMod DDEMod W11A W11B EVM IPOWER IDEMod MOTotalk
Remote Command	:CALCulate:<meas>:DATA[1] 2 ...4:HEADer[:NUMBer]? <string>
Example	CALC:VECT:DATA1:HEAD? 'XDelta'
Notes	Query only. This retrieves the named header for the designated trace. This form of the HEAD? query is for headers whose type is NUMB (as determined by :CALC:<meas>:DATA:HEAD:TYPE?). The name parameter (delimited by single or double quotes) is one of the names returned by CALC:<meas>:DATA:HEAD:NAMes? The format of the return data is determined by the FORMat [:TRACe][:DATA] command. If used to query a header whose type is STR or there is no such header, NaN (9.91e37) is returned
Initial S/W Revision	Prior to A.02.00
Modified at S/W Revision	A.02.00

19 Remote SCPI Commands and Data Queries
:CALC:CLIMits:FAIL?

:CALC:CLIMits:FAIL?

If one or more ACP or OBW limit tests are active, then the CALC:CLIMits:FAIL? command returns the aggregate pass or fail status.

IQ Data Transfers

Fast capture/transfer of a large amount of IQ data is supported over SCPI. To do this, first set up the desired measurement range, center frequency, span, triggering, and so on. Use a time length that is convenient for setting up the measurement. The time length for the captured data is set indirectly as shown below.

To perform the capture, a typical SCPI sequence is as follows:

```
FCAP:LENG <num_samples>
```

This command sets the length for the next capture in samples. The sample rate is proportional to the current span and can be determined by a SCPI query, for example, in the Vector measurement the query:

```
VECT:SWE:ISR?
```

returns the input sample rate. For the IQAnalyzer (Basic) mode, the sample rate SCPI query is defined as follows:

```
:SPEC:SRAT? (Complex spectrum measurement)
```

```
:WAV:SRAT? (Waveform measurement)
```

Multiply the time length desired for the captured data by this sample rate to get the number of samples needed.

```
INIT:FCAP
```

pauses the current measurement and starts capturing IQ data using the current setup and trigger conditions. (The instrument front panel display does not change nor show the captured data.)

To read the captured data via SCPI in blocks, set the read block size using the command:

```
FCAP:BLOC <num_points_per_read_block>
```

The maximum read block size is typically less than the total fast capture buffer size and can be determined by the query "FCAP:BLOC? MAX". Now you can repeatedly use the following query to read out successive blocks of data:

```
FETC:FCAP?
```

The returned data is formatted according to the most recent :FORMat[:DATA] and :FORMat:BORDER commands. A read pointer that indicates the next sample to be transferred is advanced automatically following each FETC:FCAP? query. This pointer position can be read or manually set via the SCPI commands:

```
FCAP:POIN?
```

```
FCAP:POIN <read_pointer_position>
```

The fast capture data can be read as long as you use only the commands to set read block size and pointer position, or queries that return the state of the current measurement. The capture data is cleared by any command that changes the measurement state or initiates a new measurement, or via SCPI device clear or :ABORT commands.

Fast capture data word size can be set to either 32 bit or 64 bit via the FCAP:WLEN command. This enables you to trade off precision for total capture length.

Note: when the word size is 32 bit, points can only be retrieved on even sample number boundaries, that is, the pointer and block length should be even numbers. Therefore, when the word size is set to auto, it is recommended that the pointer and block size be only set to even numbers.

Fast Capture Length

Sets the length of the SCPI Fast Capture in samples (points). This is constrained to be an even number.

Query returns the most recent length setting.

Key Path	SCPI Only
Mode	VSA, BASIC
Remote Command	[:SENSe] :FCAPture:LENGth <integer> [:SENSe] :FCAPture:LENGth?
Example	FCAP:LENG 1000 FCAP:LENG?
Notes	This is affected by the IF path currently used, which can in turn be affected by span. It is also affected by the internal Fast Capture Word Length. The current maximum fast capture length can be found by using the query: FCAP:LENG? MAX Changing the Capture Length after initiating a fast capture clears the capture memory in preparation for a new fast capture of a different length. No Front panel access; SCPI only
Preset	1048576 Samples
Min	2
Max	536 870 908 Samples for internal 40 MHz and 140 MHz options with FCAP:WLEN BIT32
Initial S/W Revision	A.04.00

Fast Capture Word Length

Enables choice of internal fast capture word length. Shorter word length enables twice the time length to be captured at the cost of quantization noise. Note that this does not affect the format of data returned by FETCh:FCAPture, only the internal representation.

Key Path	SCPI Only
Mode	VSA, BASIC
Remote Command	[:SENSe] :FCAPture:WLENGth AUTO BIT32 BIT64 [:SENSe] :FCAPture:WLENGth?
Example	FCAP:WLEN AUTO FCAP:WLEN?
Notes	No Front panel access; SCPI only.

Preset	AUTO
Initial S/W Revision	A.04.00

Initiate Fast Capture

Waits for the sweep to trigger and then captures the fast capture data. Sweep is then set to pause. The amount of data captured is controlled by the Fast Capture Length command (FCAP:LENG).

Key Path	SCPI Only
Mode	VSA, BASIC
Remote Command	:INITiate:FCAPture
Example	INIT:FCAP
Notes	This is an overlapped command. It returns immediately, but the capture may not be complete. Use *OPC?, *WAI, or *OPC to determine when the capture is complete.
Notes	No Front panel access; SCPI only This command resets the Fast Capture Pointer to 0
Initial S/W Revision	A.04.00

Fast Capture Block

Sets the block size for the Fast Capture transfer in samples (points). This is the number of points that are returned from the Capture buffer by the FETC:FCAP? command. This is constrained to be an even number.

Query returns most recent block size setting.

Key Path	SCPI Only
Mode	VSA, BASIC
Remote Command	[:SENSe] :FCAPture:BLOCK <integer> [:SENSe] :FCAPture:BLOCK?
Example	FCAP:BLOC 100 FCAP:BLOC?
Notes	No Front panel access. SCPI only.
Preset	1024 Samples
Min	0
Max	131072 or Fast Capture Length, whichever is smaller
Initial S/W Revision	A.04.00

Fast Capture Pointer

Sets the pointer position for the Fast Capture transfer in samples (points). The pointer is incremented by the block size each time the fetch is performed. Preset value (0) is the first sample in the record. Thus repetitive fetches result in contiguous data without needing to increment the pointer over SCPI. This is constrained to be an even number. Query returns most recent pointer setting.

Key Path	SCPI Only
Mode	VSA, BASIC
Remote Command	[:SENSe] :FCAPture:POINter <integer> [:SENSe] :FCAPture:POINter?
Example	FCAP:POIN 100 FCAP:POIN?
Notes	INIT:FCAP or FCAP:ABOR resets the pointer to 0. No front panel access; SCPI only.
Preset	0 Samples
Min	0
Max	Must be less than the Fast Capture length
Initial S/W Revision	A.04.00

Fetch Fast Capture

Transfers the block of data starting at the pointer. The number of samples transferred is set with the block size. The pointer is incremented by the block size after the fetch.

Key Path	SCPI Only
Mode	VSA, BASIC
Remote Command	:FETCh:FCAPture?
Example	FETC:FCAP?
Notes	The returned data is formatted according to the most recent :FORMat[:DATA] and :FORMat:BORDER commands. If the read pointer position plus read block size exceeds the Fast Capture Length, only the data between the pointer and the end of the fast capture buffer are returned, and error -200 is reported. If Fetch is attempted before an INIT:FCAP or if the captured data is cleared by some other operation (e.g., REC), error -230 is reported and no data is returned. No front panel access; SCPI only.
Initial S/W Revision	A.04.00

Input Sample Rate Query

Returns the complex sample rate in Hz for the current VXA measurement setup conditions. The sample rate can be used to convert between time and number of sample points when using the Fast Capture feature.

Sample rate depends on the settings for `FREQ:SPAN` and `IFPath`. You need to set these before making this query. Though the measurement name is specified in the query, you can only query the currently configured measurement. That is, if you have sent `CONF:VECT`, the query `ADEM:SWE:ISR?` generates an error.

Key Path	SCPI Only
Mode	VSA
Measurement	<meas>:=VECTor ADEMod DDEMod W11A W11B
Remote Command	[:SENSe] :<meas>:SWEep:ISRate?
Example	VECT:SWE:ISR?
Notes	<p>Query returns the complex sample rate in Hz for the current VXA Vector measurement setup conditions.</p> <p>If the measurement in the query is not the active measurement, error -230 is reported and no data is returned.</p> <p>This query is SCPI only, no Front Panel softkey.</p>
Preset	Depends on the licensed IF path
Initial S/W Revision	A.04.00

Parameter Update Enable

Refers only to measurements that use the VSA measurement engine. These are all the measurements in the Vector Signal Analyzer (VXA) Application and the EVM measurement in the LTE Applications.

When a measurement parameter is changed, the new value is used to update any dependent parameters and measurement results. This update process is normally done after every parameter change. This enables visual feedback during interactive GUI operation. However, with SCPI controlled measurements, typically a lot of parameter changes are done at once with the measurement stopped and then the measurement is run once and data retrieved. Here, is not necessary, and the accumulated update time for each parameter change can become significant. The Parameter Update Enable command enables you to postpone update while sending setup commands and then enable one update to occur just before the measurement.

For example, if you are programmatically setting up a complex LTE measurement, you could save some setup time by first sending EVM:PUPD:ENAB OFF, then sending the whole group of measurement setup commands. When you are done with the setup, send EVM:PUPD:ENAB:ON. This causes the measurement state to be updated with all dependencies resolved. After this, you can read back the parameters' actual values. As a convenience, starting or continuing a measurement (INITiate:REStart, INITiate:IMMEDIATE, INITiate:<meas> or INITiate:RESume) automatically sets <meas>:PUPD:ENAB to ON. So does CONFigure:<meas> or any of the reset and recall state commands.

This command should be used with caution.

It is only valid to turn <meas>:PUPD:ENAB OFF when <meas> is the currently active measurement and the measurement is paused (i.e., INIT:CONT is OFF).

If you try to set and then read back a parameter value while Parameter Update Enable is off, you are not guaranteed to get back the true value that is used in the measurement because no parameter limiting is being done nor are any dependencies between parameters being resolved.

If you try to set coupled parameters independently when Parameter Update Enable is off, then when it is turned on, at most one of the parameter settings remain the same and the others change due to dependency resolution.

Key Path	SCPI Only
Mode	VSA, LTE, LTETDD, IDEN
Measurement	<meas>:=VECTor ADEMod DDEMod W11A W11B EVM IPOWer IDEMod MOTotalk
Remote Command	[:SENSe] : <meas> : PUPDate : ENABle OFF ON 0 1 [:SENSe] : <meas> : PUPDate : ENABle ?
Example	EVM:PUPD:ENAB OFF
Notes	Commands that cause a measurement to run, that switch measurements, or that preset or recall measurement state, set Parameter Update state to ON. These include INIT:IMM, INIT:REST, INIT:RES, INIT:<meas>, and CONF:<meas>.
Preset	1
State Saved	No
Initial S/W Revision	A.03.00