

Keysight X-Series Signal Analyzers

This manual provides documentation for the following Analyzers:

PXA Signal Analyzer N9030A

MXA Signal Analyzer N9020A

EXA Signal Analyzer N9010A

CXA Signal Analyzer N9000A

Notice: This document contains references to Agilent. Please note that Agilent's Test and Measurement business has become Keysight Technologies. For more information, go to www.keysight.com.

N9083A/W9083A
Multi-Standard Radio
Measurement
Application
Measurement Guide

Notices

© Keysight Technologies 2008-2014

No part of this manual may be reproduced in any form or by any means (including electronic storage and retrieval or translation into a foreign language) without prior agreement and written consent from Keysight Technologies as governed by United States and international copyright laws.

Trademark Acknowledgements

cdma2000® is a US registered certification mark of the Telecommunications Industry Association.

Manual Part Number

N9083-90002

Print Date

August 2014

Supersedes: July 2013

Printed in USA

Keysight Technologies
1400 Fountaingrove Parkway
Santa Rosa, CA 95403

Warranty

THE MATERIAL CONTAINED IN THIS DOCUMENT IS PROVIDED “AS IS,” AND IS SUBJECT TO BEING CHANGED, WITHOUT NOTICE, IN FUTURE EDITIONS. FURTHER, TO THE MAXIMUM EXTENT PERMITTED BY APPLICABLE LAW, KEYSIGHT DISCLAIMS ALL WARRANTIES, EITHER EXPRESS OR IMPLIED WITH REGARD TO THIS MANUAL AND ANY INFORMATION CONTAINED HEREIN, INCLUDING BUT NOT LIMITED TO THE IMPLIED WARRANTIES OF MERCHANTABILITY AND FITNESS FOR A PARTICULAR PURPOSE. KEYSIGHT SHALL NOT BE LIABLE FOR ERRORS OR FOR INCIDENTAL OR CONSEQUENTIAL DAMAGES IN CONNECTION WITH THE FURNISHING, USE, OR PERFORMANCE OF THIS DOCUMENT OR ANY INFORMATION CONTAINED HEREIN. SHOULD KEYSIGHT AND THE USER HAVE A SEPARATE WRITTEN AGREEMENT WITH WARRANTY TERMS COVERING THE MATERIAL IN THIS DOCUMENT THAT CONFLICT WITH THESE TERMS, THE WARRANTY TERMS IN THE SEPARATE AGREEMENT WILL CONTROL.

Technology Licenses

The hardware and/or software described in this document are furnished under a license and may be used or copied only in accordance with the terms of such license.

Restricted Rights Legend

If software is for use in the performance of a U.S. Government prime contract or subcontract, Software is delivered and licensed as “Commercial computer software” as defined in DFAR 252.227-7014 (June 1995), or as a “commercial item” as defined in FAR 2.101(a) or as “Restricted computer software” as defined in FAR 52.227-19 (June 1987) or any equivalent agency regulation or contract clause. Use, duplication or disclosure of Software is subject to Keysight Technologies’ standard commercial license terms, and non-DOD Departments and Agencies of the U.S. Government will receive no greater than Restricted Rights as defined in FAR 52.227-19(c)(1-2) (June 1987). U.S. Government users will receive no greater than Limited Rights as defined in FAR 52.227-14 (June 1987) or DFAR 252.227-7015 (b)(2) (November 1995), as applicable in any technical data.

Safety Notices

CAUTION

A **CAUTION** notice denotes a hazard. It calls attention to an operating procedure, practice, or the like that, if not correctly performed or adhered to, could result in damage to the product or loss of important data. Do not proceed beyond a CAUTION notice until the indicated conditions are fully understood and met.

WARNING

A **WARNING** notice denotes a hazard. It calls attention to an operating procedure, practice, or the like that, if not correctly performed or adhered to, could result in personal injury or death. Do not proceed beyond a WARNING notice until the indicated conditions are fully understood and met.

Where to Find the Latest Information

Documentation is updated periodically. For the latest information about these products, including instrument software upgrades, application information, and product information, browse to one of the following URLs, according to the name of your product:

<http://www.keysight.com/find/pxa>

<http://www.keysight.com/find/mxa>

<http://www.keysight.com/find/exa>

<http://www.keysight.com/find/cxa>

To receive the latest updates by email, subscribe to Keysight Email Updates at the following URL:

<http://www.keysight.com/find/emailupdates>

Information on preventing analyzer damage can be found at:

<http://www.keysight.com/find/tips>

Is your product software up-to-date?

Periodically, Keysight releases software updates to fix known defects and incorporate product enhancements. To search for software updates for your product, go to the Keysight Technical Support website at:

<http://www.keysight.com/find/techsupport>

Table of Contents

1 About the MSR Measurement Application

2 Making MSR Measurements

| | |
|---|----|
| Setting Up and Making a Measurement | 10 |
| Making the Initial Signal Connection | 10 |
| Using Analyzer Mode and Measurement Presets | 10 |
| 3 Steps to Setting Up and Making Measurements | 10 |
| MSR Downlink Signal Measurement | 12 |
| Configuring the Measurement System | 12 |
| Setting the Downlink Signal | 14 |
| Common Measurement Procedure (Downlink) | 16 |
| Monitor Spectrum Measurements | 18 |
| IQ Waveform (Time Domain) Measurements | 21 |
| Channel Power Measurements | 24 |
| Occupied Bandwidth Measurements | 27 |
| ACP Measurements | 29 |
| Spectrum Emission Mask Measurements | 32 |
| Spurious Emissions Measurement | 36 |
| Power Statistics CCDF Measurements | 40 |
| Conformance EVM Measurement | 43 |

3 Concepts

| | |
|-----------------------------|----|
| MSR Overview | 48 |
| MSR Specification Documents | 48 |
| Band Category | 49 |
| RF Bandwidth | 51 |
| Channel Raster | 53 |
| Channel Spacing | 53 |
| MSR Test Configurations | 53 |

Contents

| | |
|--|----|
| MSR Measurement Concepts | 55 |
| Channel Power Measurement Concepts | 56 |
| Occupied Bandwidth Measurement Concepts | 57 |
| Adjacent Channel Power (ACP) Measurement Concepts | 58 |
| Power Statistics CCDF Measurement Concepts | 59 |
| Spurious Emissions Measurement Concepts | 61 |
| Spectrum Emission Mask Measurement Concepts | 62 |
| IQ Waveform Measurement Concepts | 64 |
| Monitor Spectrum (Frequency Domain) Measurement Concepts | 65 |
| MSR Conformance EVM Measurement Concepts | 66 |
| Carrier Power Measurement Bandwidth and Filter | 68 |
| Offset/Limit Presets | 68 |
| Carrier Info Table | 69 |
| Carrier Conf Presets | 69 |
| Format Parameter List in Mode Setup | 70 |
| Instrument Updates at www.keysight.com | 91 |

1 About the MSR Measurement Application

This chapter provides overall information on MSR (Multi-Standard Radio) communications systems, and describes MSR measurements made by the analyzer.

What Does the MSR Application Do?

This analyzer can be used for testing a MSR downlink signal in base station continuous spectrum operation or non-contiguous operation complying with the standards listed below. Because they are continually changed, each release will support the most recent version of these standards:

- 3GPP TS 37.141 v.10.6.0 (2012-03) E-UTRA, UTRA and GSM/EDGE; Multi-Standard Radio (MSR) Base Station (BS) conformance testing (Release 10)
- 3GPP TS 37.104 V9.4.0 (2010-12) E-UTRA, UTRA and GSM/EDGE; Multi-Standard Radio (MSR) Base Station (BS) transmission and reception (Release 9)

The instrument automatically makes these measurements using the measurement methods and limits defined in the documents. The detailed results displayed by the measurements enable you to analyze MSR signals performance. You may alter the measurement parameters for specific analysis.

This analyzer makes the following measurements providing power measurements and modulation analysis for the MSR signals:

- Channel Power
- Occupied BW
- Adjacent Channel Power (ACP)
- Spectrum Emission Mask
- Spurious Emissions
- MSR Conformance EVM
- Power Stat CCDF
- Monitor Spectrum

About the MSR Measurement Application

- IQ Waveform (Time Domain)

The following description are the guidelines for this application.

- E-UTRA and UTRA FDD are names of radio formats defined and used in the 3GPP documents. In this application, LTE and W-CDMA are used instead of E-UTRA and UTRA.
- The Multi-Standard Radio mode needs a license N9083A-1FP on the X-Series instrument. It requires licenses of the other modes to enable Radio Formats.

Table 1-1 MSR Related Licenses

| Radio Format | Required Option |
|---------------------|--|
| GSM/EDGE | N/W9071A-2FP GSM/EDGE Measurement Application N/W9071A-3FP EDGE Evolution Measurement Application |
| W-CDMA | N/W9073A-1FP W-CDMA Measurement Application N/W9073A-2FP HSDPA/HSUPA Measurement Application N/W9073A-3FP HSPA+ Measurement Application |
| LTE FDD | N/W9080A-1FP LTE Measurement Application |
| cdma2000® | N/W9072A-2FP cdma2000 Measurement Application |
| 1xEV-DO | N/W9076A-1FP CDMA 1xEVDO Measurement Application |

- If you need to make valid measurements on Multi-Standard Radio signal bandwidths greater than 10 MHz, WB (25MHz or wider) option needs to be installed in PXA/MXA/EXA/CXA.

2 Making MSR Measurements

This chapter begins with instructions common to all measurements including equipment configuration, simple steps for making a measurement, then details how to make the measurements available by pressing the **MSR** mode and Meas key for MSR Downlink signal.

NOTE Currently only BTS is supported for Radio Device in MSR mode, so all the measurement examples are based on MSR downlink signals.

- “Setting Up and Making a Measurement” on page 10
- “MSR Downlink Signal Measurement” on page 12
 - “Configuring the Measurement System” on page 12
 - “Setting the Downlink Signal” on page 14
 - “Common Measurement Procedure (Downlink)” on page 16
 - “Monitor Spectrum Measurements” on page 18
 - “IQ Waveform (Time Domain) Measurements” on page 21
 - “Channel Power Measurements” on page 24
 - “Occupied Bandwidth Measurements” on page 27
 - “ACP Measurements” on page 29
 - “Spurious Emissions Measurement” on page 36
 - “Spectrum Emission Mask Measurements” on page 32
 - “Power Statistics CCDF Measurements” on page 40
 - “Conformance EVM Measurement” on page 43

Setting Up and Making a Measurement

Making the Initial Signal Connection

CAUTION

Before connecting a signal to the analyzer, make sure the analyzer can safely accept the signal level provided. The signal level limits are marked next to the RF Input connectors on the front panel.

See the Input Key menu for details on selecting input ports, and the AMPTD Y Scale menu, for details on setting internal attenuation to prevent overloading the analyzer.

Using Analyzer Mode and Measurement Presets

To set your current measurement mode to a known factory default state, press **Mode Preset**. This initializes the analyzer by returning the mode setup and all of the measurement setups in the mode to the factory default parameters.

To preset the parameters that are specific to an active, selected measurement, press **Meas Setup, Meas Preset**. This returns all the measurement setup parameters to the factory defaults, but only for the currently selected measurement.

3 Steps to Setting Up and Making Measurements

All measurements can be set up using the following three steps. The sequence starts at the Mode level, is followed by the Measurement level, then finally, the result displays may be adjusted.

Table 2-1 *3 Steps to Setting Up and Making a Measurement*

| Step | Action | Notes |
|--|---|--|
| 1 Select and Set Up the Mode | <ol style="list-style-type: none">Press Mode.Press a mode key, like Spectrum Analyzer, W-CDMA with HSDPA/HSUPA, or MSR.Press Mode Preset.Press Mode Setup. | <p>All licensed, installed modes available are shown under the Mode key.</p> <p>Using Mode Setup, make any required adjustments to the mode settings. These settings will apply to all measurements in the mode.</p> |
| 2 Select and Set Up the Measurement | <ol style="list-style-type: none">Press Meas.Select the specific measurement to be performed.Press Meas Setup. | <p>The measurement begins as soon as any required trigger conditions are met. The resulting data is shown on the display or is available for export.</p> <p>Use Meas Setup to make any required adjustment to the selected measurement settings. The settings only apply to this measurement.</p> |

Table 2-1 3 Steps to Setting Up and Making a Measurement

| Step | Action | Notes |
|--|---|--|
| 3 Select and Set Up a View of the Results | Press View/Display . Select a display format for the current measurement data. | Depending on the mode and measurement selected, other graphical and tabular data presentations may be available. X-Scale and Y-Scale adjustments may also be made now. |

NOTE A setting may be reset at any time, and will be in effect on the next measurement cycle or view.

Table 2-2 Main Keys and Functions for Making Measurements

| Step | Primary Key | Setup Keys | Related Keys |
|---|---------------------|------------------------------------|---|
| 1 Select and set up a mode. | Mode | Mode Setup, FREQ Channel | System |
| 2 Select and set up a measurement. | Meas | Meas Setup | Sweep/Control, Restart, Single, Cont |
| 3 Select and set up a view of the results. | View/Display | SPAN X Scale, AMPTD Y Scale | Peak Search, Quick Save, Save, Recall, File, Print |

MSR Downlink Signal Measurement

The section describes how to make measurements for MSR Downlink Signal, the measurement procedure with screen shots of the measurement example are provided.

NOTE For the SCPI commands and detailed description of keys and parameters, refer to N9083A MSR Measurement Application User's and Programmer's Reference.

Configuring the Measurement System

There are two kinds of measurement setups to test the DUT (Device Under Test): Component Measurement System and Base Station Measurement System.

Component Measurement System

This system is used for preamplifier and repeater. See the connection of the equipment below.

Figure 2-1 Component Test System

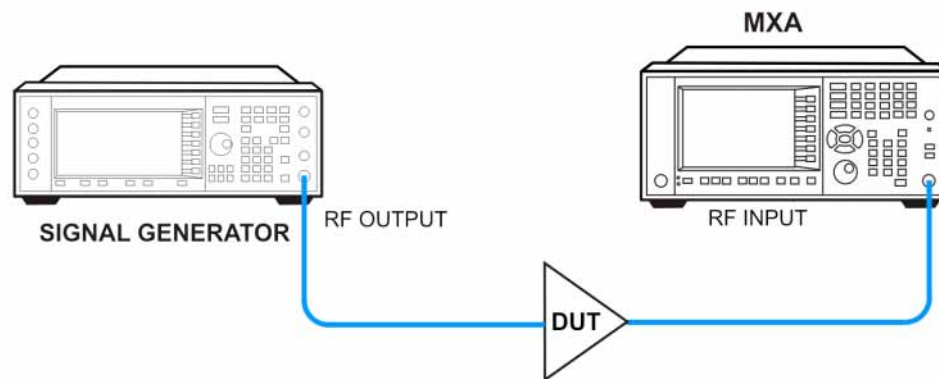

1. Connect the RF Output of the Signal Generator to the Input port of the Component.
2. Connect the Output port of the Component to the RF Input of the Signal Analyzer.

Base Station Measurement System

See the connection of the equipment below.

Figure 2-2 Base Station Test System

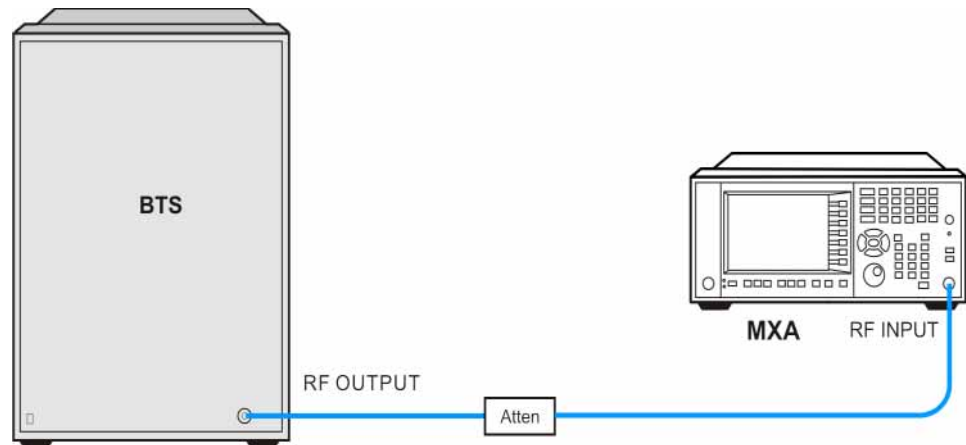

Connect the RF Output of the BTS to the RF Input of the analyzer using the appropriate attenuator.

Setting the Downlink Signal

In this example, the test signal is created according to MSR test configuration TC4c of standard 3GPP TS 37.141. Keysight Signal Studio N7624B, is used to generate the MSR waveform for testing.

Figure 2-3

MSR Downlink Signal - Example of TC4c

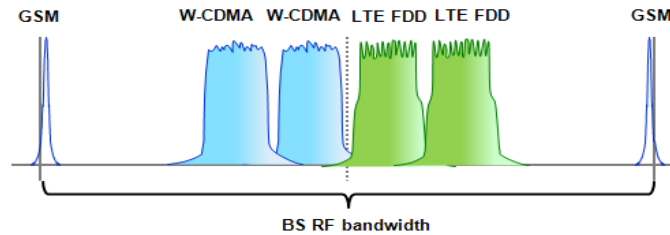

E-UTRA Band: 8

Operation Band (RF bandwidth): 925 MHz - 960 MHz

Output Power: -10 dBm

Carriers: 6

The carriers are placed using TC4c generation and test models in 3GPP TS 37.141: a GSM carrier at the high end and a GSM carrier at the low end of the RF bandwidth, two W-CDMA carriers and two 5 MHz LTE FDD carriers in the middle of the RF bandwidth. GSM carriers are configured according to the definition in 3GPP TS 51.021 subclause 6.2.2, W-CDMA carriers are configured according to TM1 in 3GPP TS 25.141 subclause 6.1.1.1, LTE FDD carriers are configured according to E-TM1 in 3GPP TS 36.141 subclause 6.1.1.1.

Figure 2-4

N7624B Signal Studio Configuration (MSR Downlink Signal)

Configuration : LTE DL 1 Carrier (2010-06) (Modified)

| Carrier | State | Radio Format | Configuration | Frequency Offset | Power |
|-------------|-------|----------------------------------|--|------------------|----------|
| Carrier 1 | On | Imported Waveform | Imported Waveform | -17.300000 MHz | 0.000 dB |
| Carrier 2 | On | Imported Waveform | Imported Waveform | -7.500000 MHz | 0.000 dB |
| Carrier 3 | On | Imported Waveform | Imported Waveform | -2.500000 MHz | 0.000 dB |
| Carrier 4 * | On | Basic LTE FDD Downlink (2009-12) | Full filled QPSK 5MHz (25 RB) (Modified) | 2.500000 MHz | 0.000 dB |
| Carrier 5 * | On | Basic LTE FDD Downlink (2009-12) | Full filled QPSK 5MHz (25 RB) (Modified) | 7.500000 MHz | 0.000 dB |
| Carrier 6 | On | Imported Waveform | Imported Waveform | 17.300000 MHz | 0.000 dB |

Waveform Attributes

1. Basic

- Waveform Name: Untitled
- Comment:
- Total Sample Points: 5529600
- I/Q Map: Normal

2. Marker

- Marker 1 Source: Frame
- Marker 2 Source: None
- Marker 3 Source: **RF ALC Control**
- Marker 4 Source: None

CCDF | Waveform

Spectrum

0 dB
-20 dB
-40 dB
-60 dB
-80 dB
-100 dB
-120 dB

Center

Common Measurement Procedure (Downlink)

NOTE The following procedures are common and need to set up for all measurements.

| Step | Action | Notes |
|--|--|--|
| 1 Enable the MSR measurements. | Press Mode, Multi-Standard Radio (MSR) . | |
| 2 Preset the Mode. | Press Mode Preset . | Only do this to return the measurement settings to a known state for all measurements in the MSR mode. |
| 3 Select the operating band. | Press Mode Setup, Radio, Band, Operating Band, Band 8-14, Band 8 . Then the OB Start Freq is automatically changed to 925 MHz and OB Stop Freq is 960 MHz . | Operating band affects the frequency ranges and limits of Spectrum Emission Mask and Spurious Emission measurement. When in Auto mode, the Band Category is automatically set depending on Band selection |
| 4 Set the carrier reference frequency. | Press FREQ Channel, Carrier Ref Freq, 942.5, MHz . | In MSR mode, the measurements are implemented based on carrier center frequency and its band width. Center Frequency is defined by Carrier Ref Freq and Center Freq Offset and available in three measurements, Monitor Spectrum, IQ Waveform and Power Stat CCDF. |
| 5 Set the RF bandwidth. | Press FREQ Channel, Carrier Setup, Carrier Conf Presets, Max BS RF Bandwidth, 35 MHz . | |

| Step | Action | Notes |
|------|--|--|
| 6 | Configure the carriers. Then press MSR Test Config, TC4c(FDD) . And the arrow in the key turns from hollow to solid. Press TC4c(FDD) again so the menu under it displays. Then enter 2 for Max LTE FDD Carriers, Max W-CDMA Carriers and Max GSM/EDGE Carriers . Select 5 MHz (default value) for LTE FDD BW . In LTE FDD Location , select Upper (Higher than W-CDMA) (default value) for the location of LTE FDD carriers. | <p>Carrier Conf Presets are defined based on 3GPP TS 37.104 standard configuration. It is used to quickly configure the carriers. If you use specified carriers, Carriers and Configure Carriers under Carrier Setup is used for manually setup.</p> <p>You can also use the parameters under Carrier Setup and Configure Carriers to manually configure the carriers.</p> |

Monitor Spectrum Measurements

This section explains how to make a Monitor Spectrum measurement on a LTE TDD downlink signal. The Monitor Spectrum measurement is the default measurement in MSR mode. It shows a spectrum domain display of the test signal. The primary use of Monitor Spectrum is to allow you to visually make sure you have the RF carrier available to the instrument, and the instrument is tuned to the frequency of interest. For more information on this measurement, see “[Monitor Spectrum \(Frequency Domain\) Measurement Concepts](#)” on page 65.

For signal setting, see “[Setting the Downlink Signal](#)” on page 14.

Measurement Procedure

| Step | Action | Notes |
|--|--|---|
| 1 Perform the common configuration. | See “ Common Measurement Procedure (Downlink) ” on page 16. | It is not necessary if you already did it in other measurements. |
| 2 Initiate the Monitor Spectrum measurement. | Press Meas, Monitor Spectrum . | Monitor Spectrum is the default view of MSR. This step is not necessary if you first open MSR application. The default display shows the Current (yellow trace) data. You can compare current trace with Max Hold trace, Min Hold trace or Average trace using setup under Trace/Detector. |
| 3 Set the measurement span frequency. | Press SPAN X Scale , enter a numerical span using the front-panel keypad, and select a units key, such as MHz . Here 40 MHz is used. | |
| 4 Set the measurement average. | Press Meas Setup, Avg Number, On , enter a number (such as 50) using the front-panel keypad. The measurement result should look like Figure 2-5 . | The attribute of carrier 2 to 5 are displayed on spectrum, since there is not enough space for displaying texts for Carrier 1 and 6, only vertical lines and arrows are displayed. |

| Step | Action | Notes |
|------|--------|-------|
|------|--------|-------|

Figure 2-5 MSR Downlink Monitor Spectrum Measurement Result - Result Trace

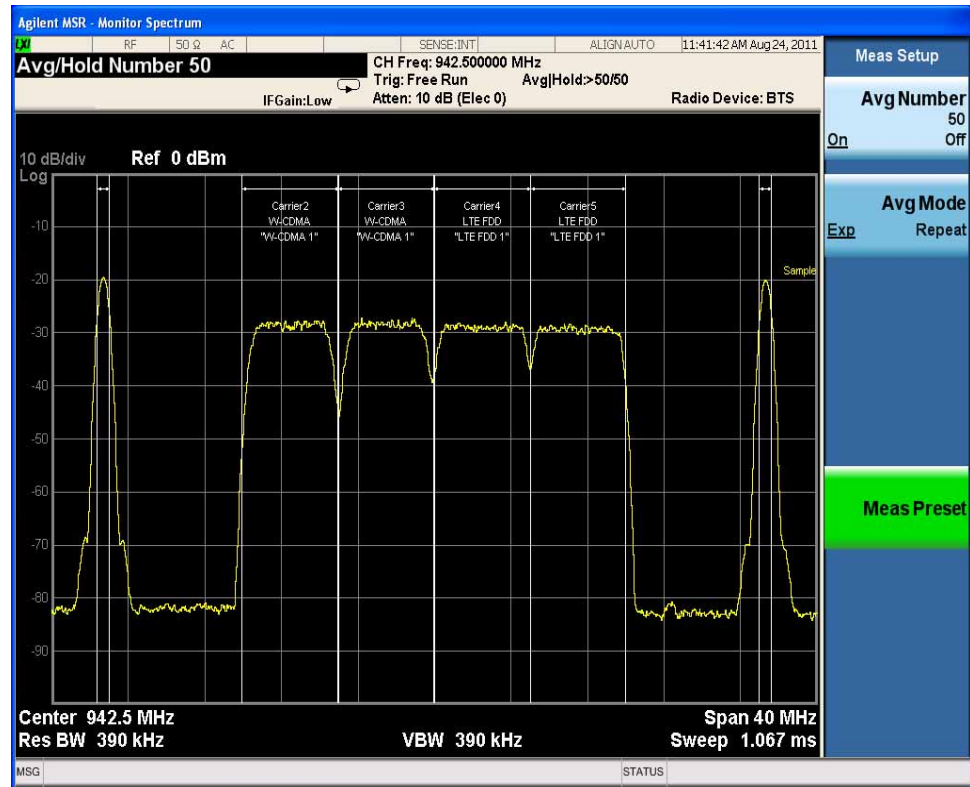

- | | | |
|---|-------------------------------|--|
| 5 | Select the Carrier Info view. | Press View/Display, Carrier Info . This view contains the spectrum trace and the carriers information table, see Figure 2-6 . You can choose to display offset or absolute frequency under the menu Carrier Info. |
|---|-------------------------------|--|

Making MSR Measurements
MSR Downlink Signal Measurement

Step Action Notes

Figure 2-6 MSR Downlink Monitor Spectrum Measurement Result - Carrier Info

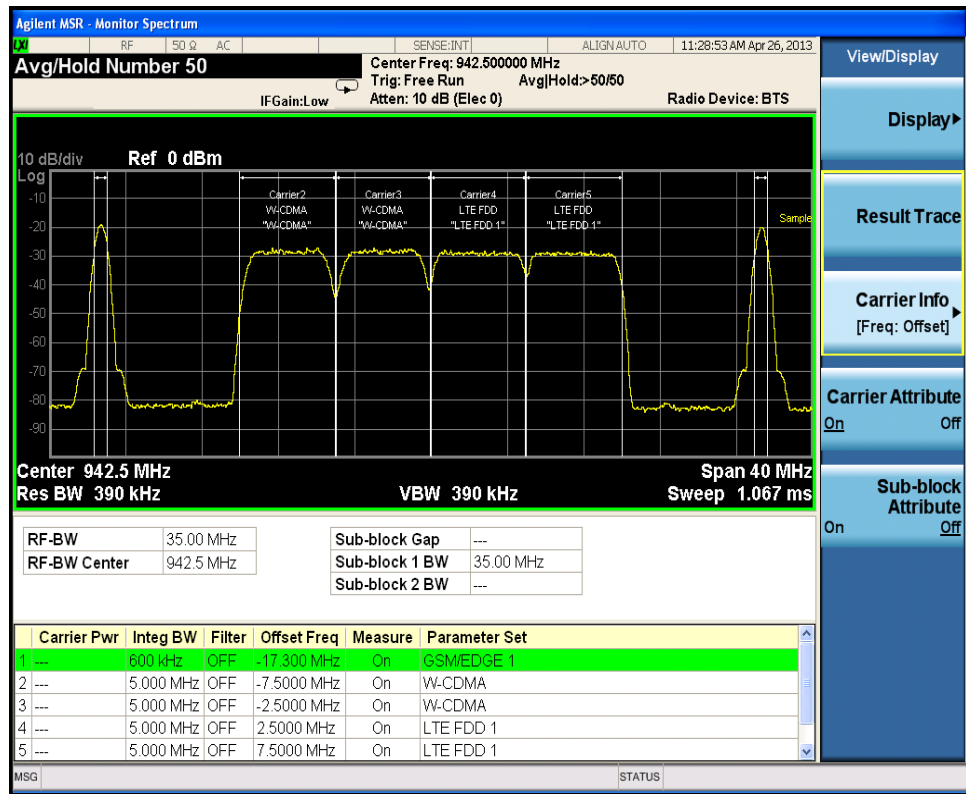

6 (Optional) Turn on Marker function.

Press **Marker Function, Marker Noise.**

You can choose Marker Noise, Band/Interval Power, Band/Interval Density or Marker Function Off. You can use Band Adjust to set the frequency span for analysis.

If you have a problem, and get an error message, see the guide “**Instrument Messages**”, which is provided on the Documentation CD ROM, and in the instrument here:

C:\Program Files\Keysight\SignalAnalysis\Infrastructure\Help\bookfiles.

IQ Waveform (Time Domain) Measurements

This section explains how to make a Waveform (time domain) Measurement on a MSR downlink signal. The measurement of I and Q modulated waveforms in the time domain disclose the voltages which comprise the complex modulated waveform of a digital signal. For more information on this measurement, see [“IQ Waveform Measurement Concepts”](#) on page 64.

For signal setting, see [“Setting the Downlink Signal”](#) on page 14.

Measurement Procedure

| Step | Action | Notes |
|---|---|--|
| 1 Perform the common configuration. | See “Common Measurement Procedure (Downlink)” on page 16. | It is not necessary if you already did it in other measurements. |
| 2 Initiate the IQ Waveform measurement. | Press Meas, IQ Waveform . | The default display in Figure 2-7 shows the RF Envelope with the current data. The measured values for the mean power and peak-to-mean power are shown in the text window. |

Figure 2-7

MSR Downlink IQ Waveform Measurement Result - RF Envelope View



Making MSR Measurements
MSR Downlink Signal Measurement

| Step | Action | Notes |
|------|------------------------------|---|
| 3 | Adjust the scale. | Press the AMPTD Y Scale and SPAN X Scale and configure the setup until the waveforms are shown at a convenient voltage scale for viewing. |
| 4 | Select the IQ Waveform view. | Press View/Display, IQ Waveform . The IQ Waveform window provides a view of the I (yellow trace) and Q (blue trace) waveforms on the same graph in terms of voltage versus time in linear scale |

Figure 2-8 MSR Downlink Waveform Measurement - I/Q Waveform View



| | | |
|---|--|---|
| 5 | Turn on Marker functions. | Press the Maker Function key to use Maker Noise, Band/Interval Power, Band/Interval Density and Marker Function Off. You can use Band Adjust to set the frequency span for analysis. |
| 6 | (Optional) Change measurement parameters from their default condition. | Press the Meas Setup key to see the keys available to change. |

If you have a problem, and get an error message, see the guide “**Instrument Messages**”, which is provided on the Documentation CD ROM, and in the instrument here:

C:\Program Files\Keysight\SignalAnalysis\Infrastructure\Help\bookfiles.

Channel Power Measurements

This section explains how to make a Channel Power measurement on a MSR downlink signal. This test measures the total RF power present in the channel. The results are shown in a graph window and in a text window. For more information on this measurement, see “Channel Power Measurement Concepts” on page 56.

For signal setting, see “Setting the Downlink Signal” on page 14.

Measurement Procedure

| Step | Action | Notes |
|------|---|--|
| 1 | Perform the common configuration. | See “Common Measurement Procedure (Downlink)” on page 16. It is not necessary if you already did it in other measurements. |
| 2 | Initiate the channel power measurement. | Press Meas, Channel Power . |

Figure 2-9

MSR Downlink Channel Power Measurement Result - Power Results View

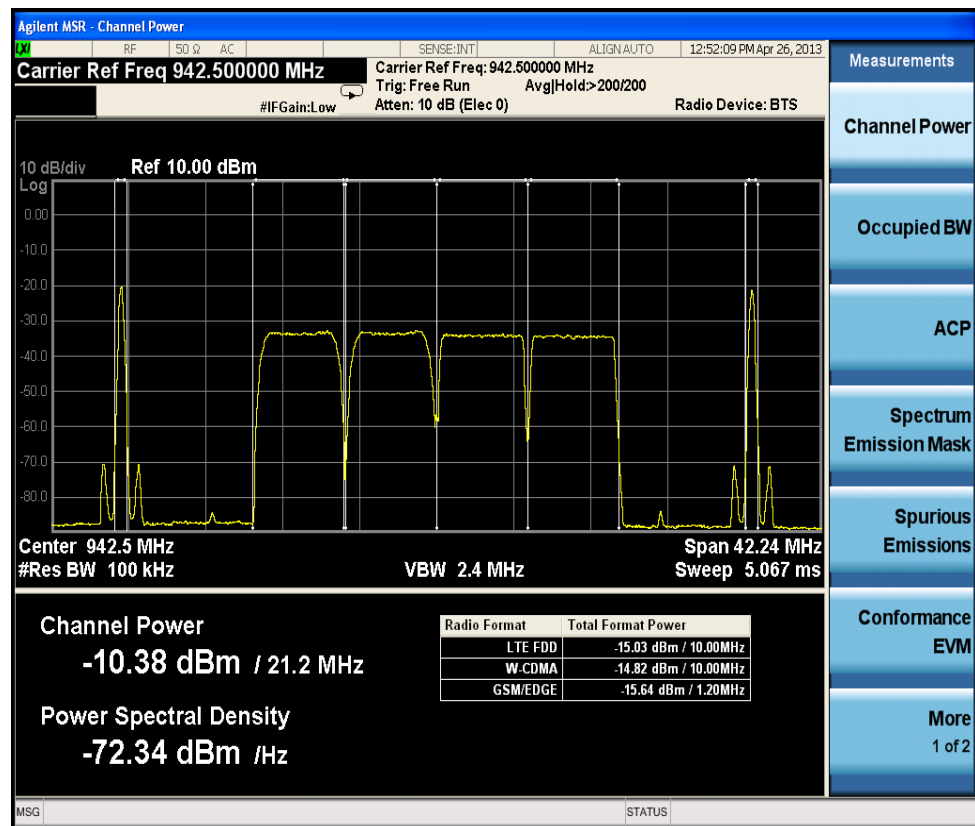

| | | |
|---|---------------------------|--|
| 3 | Select Carrier Info view. | Press View/Display, Carrier Info . This view contains the spectrum trace and the carriers information table, see Figure 2-10. You can choose to display offset or absolute frequency under the menu Carrier Info. |
|---|---------------------------|--|

Step Action Notes

Figure 2-10 MSR Downlink Channel Power Measurement Result - Carrier Info View

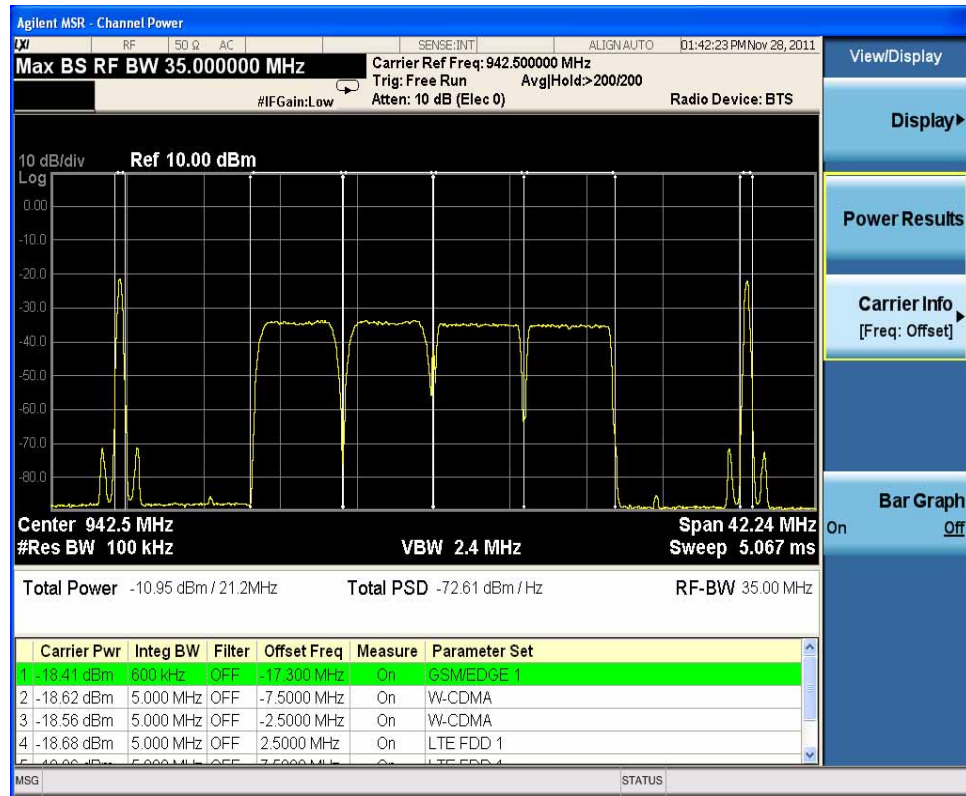

- 4 (Optional) Display the Channel Power Bar Graph view. Press **View/Display, Bar Graph**. The Bar Graph view result should look like [Figure 2-11](#).

Step

Action

Notes

Figure 2-11

Channel Power Measurement Result - Bar Graph View (Default)

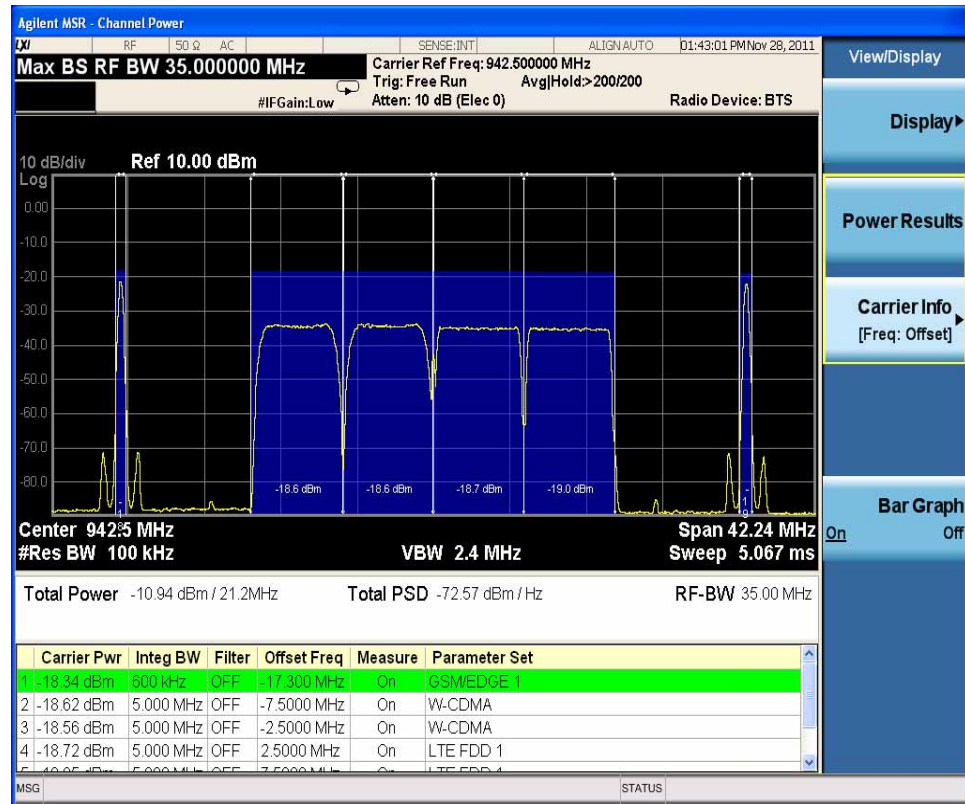

5 (Optional) Change measurement parameters from their default condition.

Press **Meas Setup** to see the keys that are available to change.

The **Carrier Result** allows you scroll through the carrier power results.

If you have a problem, and get an error message, see the guide “**Instrument Messages**”, which is provided on the Documentation CD ROM, and in the instrument here:

C:\Program Files\Keysight\SignalAnalysis\Infrastructure\Help\bookfiles.

Occupied Bandwidth Measurements

This section explains how to make the Occupied Bandwidth measurement on MSR downlink signal. The instrument measures power across the band, and then calculates its 99.0% power bandwidth. For more information on this measurement, see [“Occupied Bandwidth Measurement Concepts” on page 57](#).

For signal setting, see [“Setting the Downlink Signal” on page 14](#).

Measurement Procedure

| Step | Action | Notes |
|--|--|---|
| 1 Perform the common configuration. | See “Common Measurement Procedure (Downlink)” on page 16 . | It is not necessary if you already did it in other measurements. |
| 2 Initiate the Occupied Bandwidth measurement. | Press Meas, Occupied BW . | A Spectrum display is shown, with white vertical lines to indicate the various offset settings, and a measurement summary below. The Occupied BW measurement results should look like Figure 2-10 . |

Figure 2-12

MSR Downlink Occupied BW Measurement Result

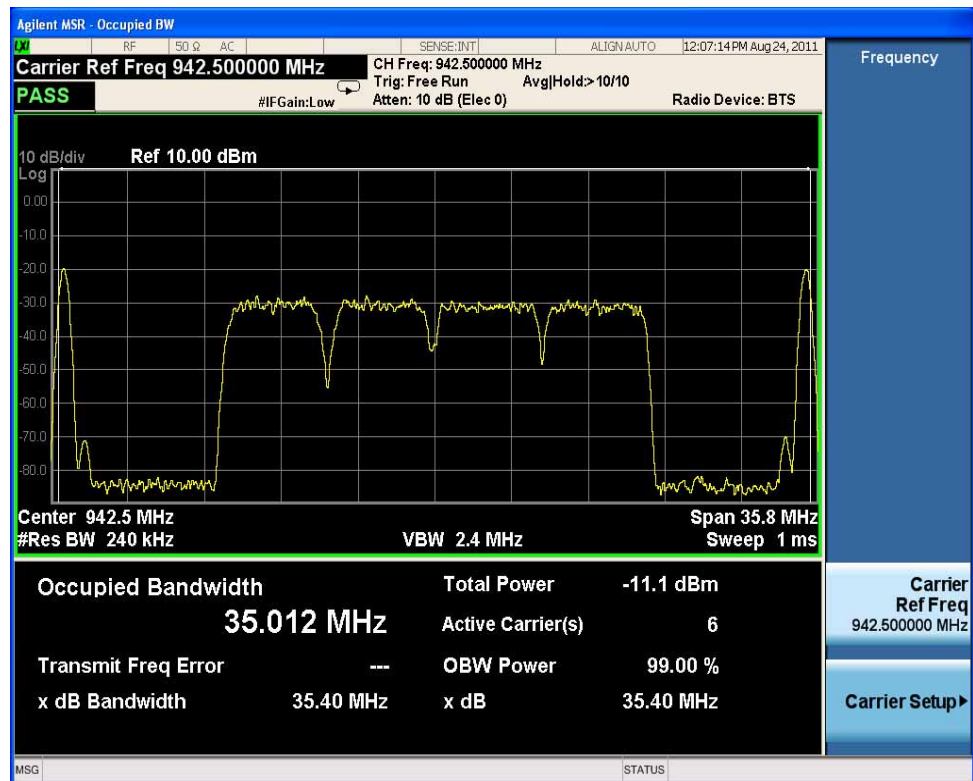

| Step | Action | Notes |
|------|--|---|
| 3 | Optimize the span for your signal. | Press SPAN X Scale to adjust the span. The span is auto detected by default, you can change it using SPAN (Man) . |
| 4 | (Optional) Change measurement parameters from their default condition. | Press Meas Setup, Occ BW % Pwr to change the value of the BW % to another value to suit your test. The default is 99% . |

If you have a problem, and get an error message, see the guide “**Instrument Messages**”, which is provided on the Documentation CD ROM, and in the instrument here:

C:\Program Files\Keysight\SignalAnalysis\Infrastructure\Help\bookfiles.

Troubleshooting Hints

Any distortion such as harmonics or intermodulation, for example, produces undesirable power outside the specified bandwidth.

Shoulders on either side of the spectrum shape indicate spectral regrowth and intermodulation. Rounding or sloping of the top shape can indicate filter shape problems.

ACP Measurements

This section explains how to make the Adjacent Channel Leakage Power Ratio (ACLR or ACPR) measurement for MSR downlink signal. ACPR is a measurement of the amount of interference, or power, in an adjacent frequency channel. The results are displayed as a bar graph or as spectrum data, with measurement data at specified offsets. For more information on this measurement, see “Adjacent Channel Power (ACP) Measurement Concepts” on page 58.

For signal setting, see “Setting the Downlink Signal” on page 14.

Measurement Procedure

| Step | Action | Notes |
|-------------------------------------|--|---|
| 1 Perform the common configuration. | See “Common Measurement Procedure (Downlink)” on page 16. | It is not necessary if you already did it in other measurements. |
| 2 Recall the masks. | Press Meas, ACP . | The ACP measurement results including the bar graph with the spectrum trace graph overlay. The graph (referenced to the total power) and a text window are displayed. The text window shows the absolute total power reference, while the lower and upper offset channel power levels are displayed in both absolute and relative readings. The indicator PASS/FAIL is on the top left of the screen. |
| 3 Recall the masks. | Press Recall, Data, Mask then Open... , a file open dialog appears. Select the appropriate file under masks\ACP_BS and click open. This will apply the Offset/Limit settings quickly. The other parameters will not be changed. | At the bottom of the screen, there is a message to indicate which mask file is recalled. In this example, ACP_BS_MSR_Carr_both_5MHz_pairE-U TRA_both_5MHz_CarB.mask is used. |

Making MSR Measurements
MSR Downlink Signal Measurement

Step Action Notes

Figure 2-13 MSR Downlink ACP Measurement Result - Result Trace View

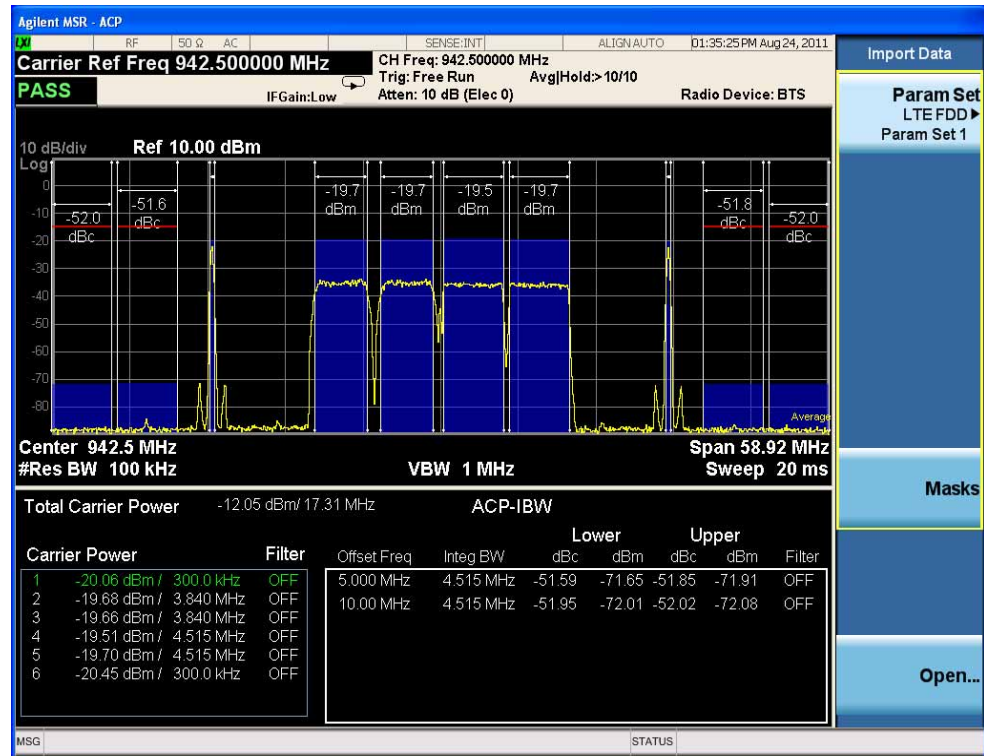

4 Select Carrier Info view.

Press **View/Display, Carrier Info**. This view contains the spectrum trace and the carriers information table, see [Figure 2-10](#). You can choose to display offset or absolute frequency under the menu Carrier Info.

Noise Correction can reduce the noise contribution of the analyzer to the measurement results as much as 10 dB. When the measured power is close to the noise floor, turning on the Noise Correction under the Meas Setup menu can make the measurement more accurate. The correction will be valid for only the current measurement parameters.

CAUTION

To correctly use the **Noise Correction** feature, you **MUST** re-calibrate the correction (set to **Off**, then **On**) after ANY measurement parameters are changed. Failure to re-calibrate the Noise Correction will provide invalid data. When **Noise Correction** is **On**, the screen annotation NCORR is shown below the Input .

| Step | Action | Notes |
|------|--------|-------|
|------|--------|-------|

Figure 2-14 MSR Downlink ACP Measurement Result - Carrier Info View

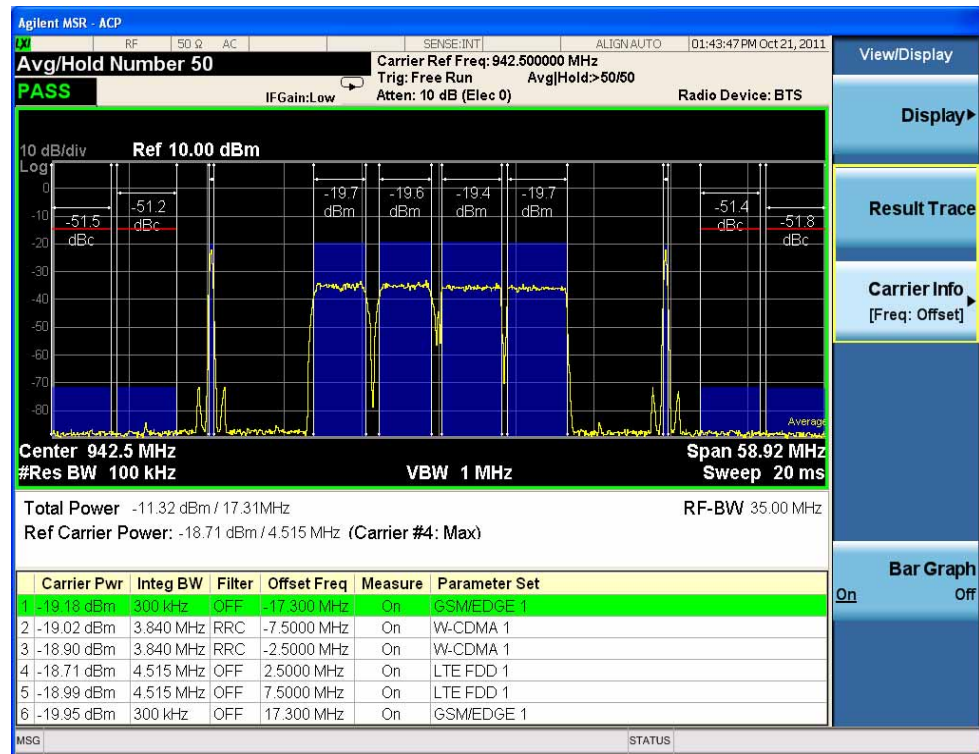

| | | |
|--|---|---|
| 5 (Optional) Adjust the dynamic range. | Press AMPTD and adjust the Attenuation to 0 dB. | This allows greater dynamic range for this level of input signal. |
|--|---|---|

TIP For the most accurate ACP measurement results, you maybe able to optimize the level of the signal measured by the analyzer. Adjust the input attenuation using the Up/Down keys, while watching the ACP levels shown at the offsets to see if the measurement results improve with another setting.

| | | |
|--|---|---|
| 6 (Optional) Change measurement parameters from their default condition. | Press Meas Setup to see the keys that are available to change. | Press Offset/Limits to configure the settings for each offset . The default value for parameters are defined according to the standard. |
|--|---|---|

If you have a problem, and get an error message, see the guide “**Instrument Messages**”, which is provided on the Documentation CD ROM, and in the instrument here:

C:\Program Files\Keysight\SignalAnalysis\Infrastructure\Help\bookfiles.

Spectrum Emission Mask Measurements

This section explains how to make the Spectrum Emission Mask (SEM) measurement on a MSR downlink signal. SEM compares the total power level within the defined carrier bandwidth and the given offset channels on both sides of the carrier frequency to levels allowed by the standard. Results of the measurement of each offset segment can be viewed separately. For more information on this measurement, see [“Spectrum Emission Mask Measurement Concepts” on page 62.](#)

For signal setting, see [“Setting the Downlink Signal” on page 14.](#)

Measurement Procedure

| Step | Action | Notes |
|--|---|--|
| 1 Perform the common configuration. | See “Common Measurement Procedure (Downlink)” on page 16. | It is not necessary if you already did it in other measurements. |
| 2 Initiate the Spectrum Emission Mask measurement. | Press Meas, Spectrum Emission Mask. | The Spectrum Emission Mask measurement result should look like Figure 2-14 . The text window shows the reference total power and the absolute peak power levels which correspond to the frequency bands on both sides of the reference channel. The cyan line is the absolute limit line and the purple line is the relative limit line. The limit lines are turned on by default. |
| NOTE | You can choose to either recall the mask to set up limit automatically according to standard TS37.141 or setup the parameters manually. Go to “Recall the masks.” for using recall function. Go to “Setup the limit.” for manual setup. | |
| 3 Recall the masks. | Press Recall, Data, Mask then Open... , a file open dialog appears. Select the appropriate file under masks\SEM_BS and click open. This will apply the Offset/Limit settings quickly. The other parameters will not be changed. At the bottom of the screen, there is a message to indicate which mask file is recalled. In this example, SEM_BS_MSR_BC2.mask is used. | |

| Step | Action | Notes |
|------|--------|-------|
|------|--------|-------|

Figure 2-15

MSR Downlink Spectrum Emission Mask Measurement Result

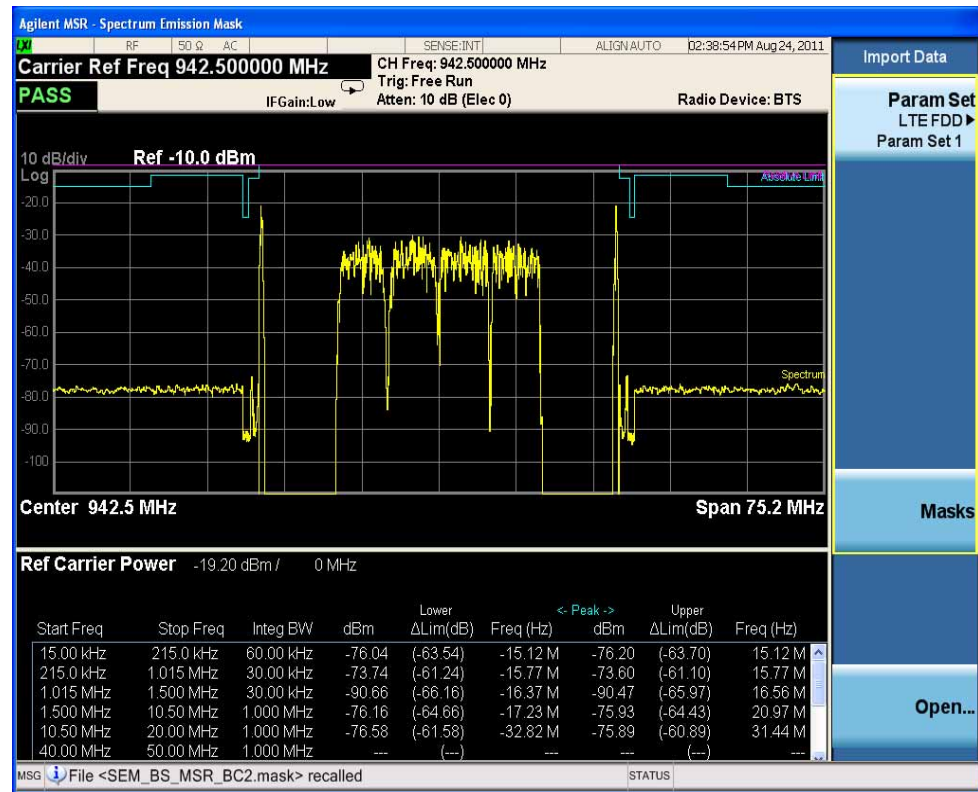

4 Setup the limit.

Press **Meas Setup, Offset/Limit, More, Limits** then enter the **limit value for each offset.**

The Lower or Upper ΔLim result is the minimum margin from limit line which is decided by Fail Mask setting. There are four settings for Fail Mask: Absolute, Relative, Abs AND Rel, Abs OR Rel.

- For Absolute mask, the Lower or Upper Lim is compared with the Absolute limit line.
- For Relative mask, the Lower or Upper Lim is compared with the Relative limit line.
- For Abs AND Rel mask, the Lower or Upper Lim is compared with the higher limit line.
- For Abs OR Rel mask, the Lower or Upper Lim is compared with the lower limit line.

Making MSR Measurements
MSR Downlink Signal Measurement

| Step | Action | Notes |
|------|--|--|
| 5 | Select the desired offset pairs. Press Meas Setup, Offset/Limit, Select Offset . Select the offset you want to turn on and press Start Freq, On. You can change the Start Freq, Stop Freq and other values for the offset. | When there are many offsets to measure, you can increase the Res BW under Meas Setup, Offset/Limit to increase the measurement speed. |
| 6 | Select the view and measurement result. Press View/Display and select the desired view. | For views of Absolute Peak Power & Frequency, Relative Peak Power & Frequency and Integrated Power, you can use three measurement types (select using Measure Setup, Meas Type): Total Power Reference, PSD Reference and Spectrum Peak Reference. For Carrier Info view, it contains the spectrum trace and the carriers information table, see Figure 2-16 . You can choose to display offset or absolute frequency under the menu Carrier Info. |

Figure 2-16

MSR Downlink Spectrum Emission Mask Measurement Result - Carrier Info View

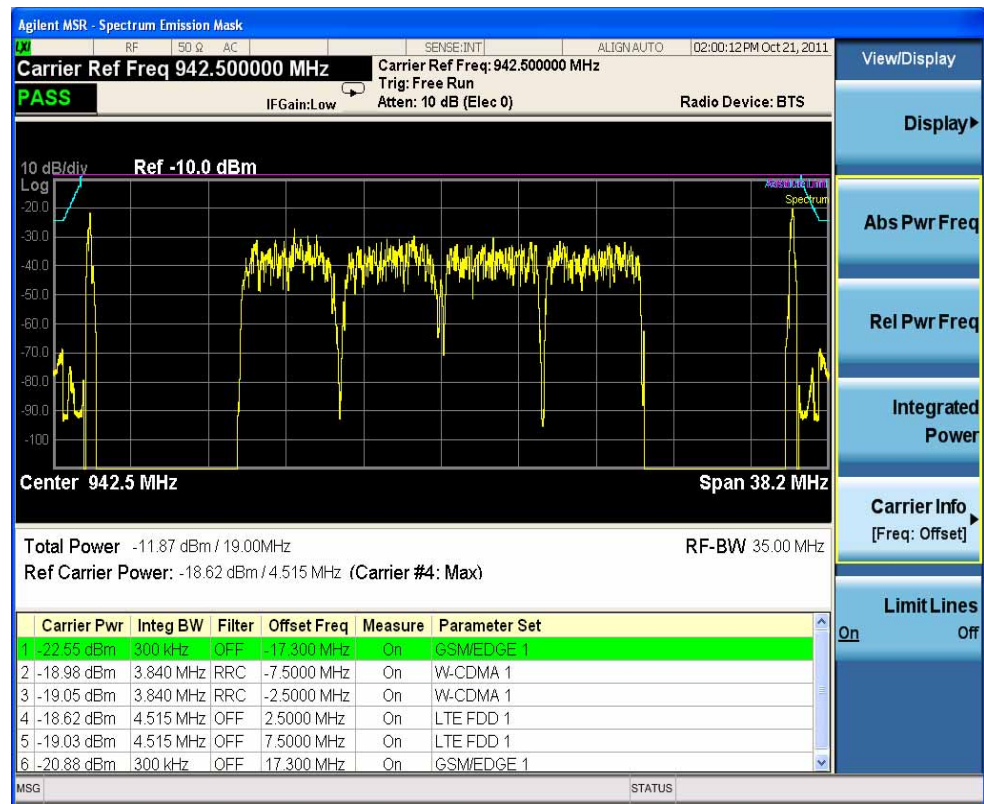

| Step | Action | Notes |
|--|---|---|
| 7 (Optional) Change measurement parameters from their default condition. | Press Meas Setup to see the keys that are available to change. | For example, you can change the Meas Type to PSD Ref : Press Meas Setup , Meas Type , and select PSD Ref to display the Integrated Power view for the spectrum emission mask measurement with a PSD reference. The PSD reference is shown below the spectrum graph in dBm/Hz. |

If you have a problem, and get an error message, see the guide “**Instrument Messages**”, which is provided on the Documentation CD ROM, and in the instrument here:

C:\Program Files\Keysight\SignalAnalysis\Infrastructure\Help\bookfiles.

Troubleshooting Hints

This Spectrum Emission Mask measurement can reveal degraded or defective parts in the transmitter section of the unit under test (UUT). The following are examples of typical causes for poor performance.

- Faulty DC power supply control of the transmitter power amplifier.
- RF power controller of the pre-power amplifier stage.
- I/Q control of the baseband stage.
- Degradation in the gain and output power level of the amplifier due to the degraded gain control or increased distortion, or both.
- Degradation of the amplifier linearity or other performance characteristics.

Power amplifiers are one of the final stage elements of a base or mobile transmitter and are a critical part of meeting the important power and spectral efficiency specifications. Since spectrum emission mask measures the spectral response of the amplifier to a complex wideband signal, it is a key measurement linking amplifier linearity and other performance characteristics to the stringent system specifications.

Spurious Emissions Measurement

This section explains how to make the Spurious Emission measurement on a LTE TDD downlink signal. The measurement procedure for uplink signal is similar. This measurement identifies and determines the power level of spurious emissions in certain frequency bands. For more information on this measurement, see [“Spurious Emissions Measurement Concepts” on page 61.](#)

For signal setting, see [“Setting the Downlink Signal” on page 14.](#)

Measurement Procedure

| Step | Action | Notes |
|---|---|---|
| 1 Perform the common configuration. | See “Common Measurement Procedure (Downlink)” on page 16. | It is not necessary if you already did it in other measurements. |
| 2 Initiate the Spurious Emission measurement. | Press Meas, Spurious Emission. | Depending on the current settings, the instrument will begin making the selected measurements. The resulting data is shown on the display. |
| 3 Toggle the RF Coupling to DC. | Press Input/Output, RF Input, RF Coupling, DC. | In AC coupling mode, you can view signals less than 10 MHz but the amplitude accuracy is not specified. To accurately see a signal of less than 10 MHz, you must switch to DC coupling. When operating in DC coupled mode, ensure protection of the External Mixer by limiting the DC part of the input level to within 200 mV of 0 Vdc. |

| Step | Action | Notes |
|------|-------------------|---|
| 4 | Recall the masks. | <p>Press Recall, Data, Mask then Open..., a file open dialog appears. Select the appropriate file under masks\SPUR_BS\examples and click open. This will apply the Limit settings quickly. The other parameters will not be changed. At the bottom of the screen, there is a message to indicate which mask file is recalled. In this example, SPUR_BS_MSR_Band2_wGSM_Cat B.mask is used.</p> <p>The Spurious Emissions measurement results should look like Figure 2-17. The spectrum window and the text window show the spurs that are within the current value of the Marker Peak Excursion setting of the absolute limit. Any spur that has failed the absolute limit will have an 'F' beside it.</p> <p>The measurement result shows the largest spur which is yellow. You can select the other spur by pressing Meas Setup, Spur and enter the number of the spur.</p> <p>If you set the Meas Type to Examine, the trace is continuously updating to show the latest spectrum range which has the worst spurious. However, the table always shows the last reported trace information. Press Restart to update the table to show the latest result.</p> |

Figure 2-17

MSR Downlink Spurious Emissions Measurement - Spur Table

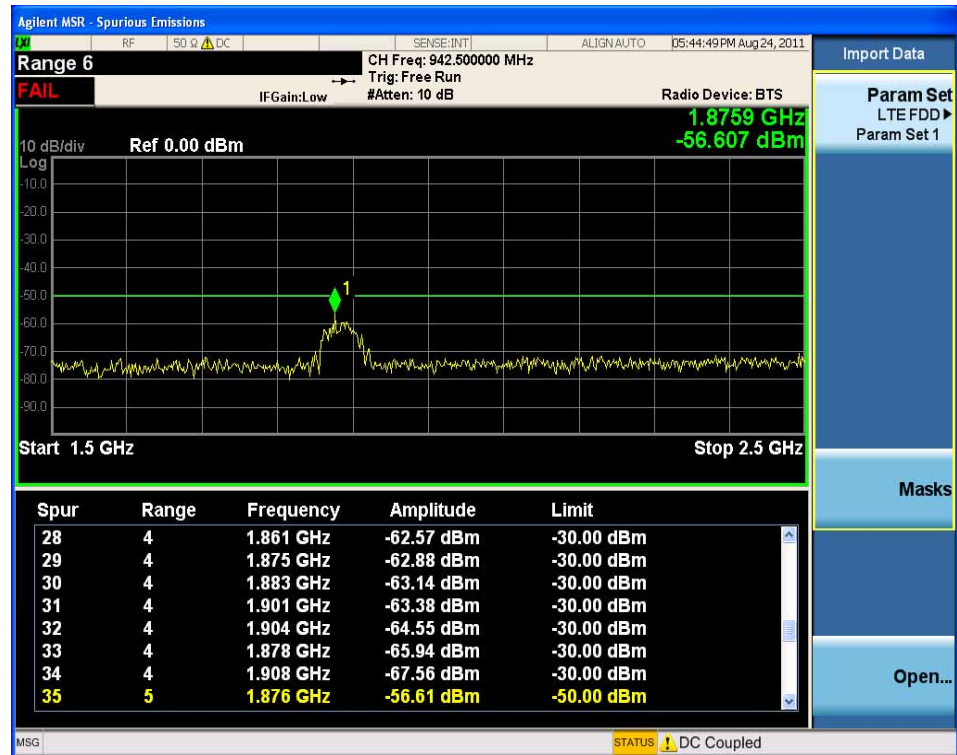

You can use the window control keys below the screen to zoom the result screen. See [Figure 2-18](#).

Making MSR Measurements
MSR Downlink Signal Measurement

Step Action Notes

Figure 2-18

MSR Downlink Spurious Emissions Measurement - Numeric Result Screen

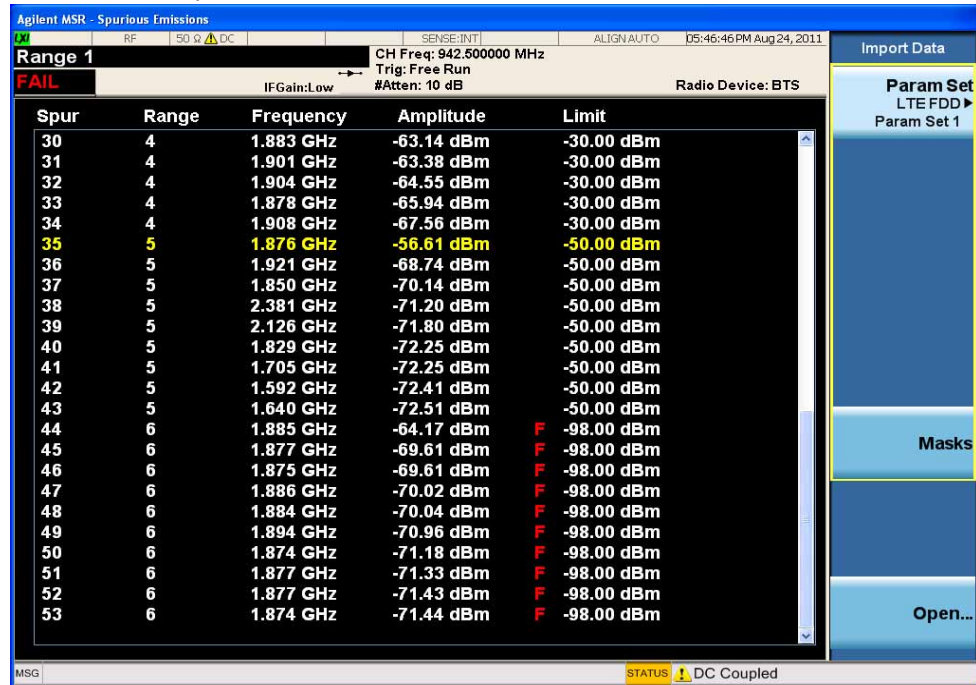

5 Select the Range Table view and edit the Range Table.

Press **View/Display, Range Table**, then **Meas Setup, Range Table**.

You can enter the settings for up to twenty ranges.

The result highlights the selected range. If you want to see the result for different ranges, you can press Range, then enter the range number you like.

Step Action Notes

Figure 2-19 MSR Downlink Spurious Emissions Measurement - Range Table

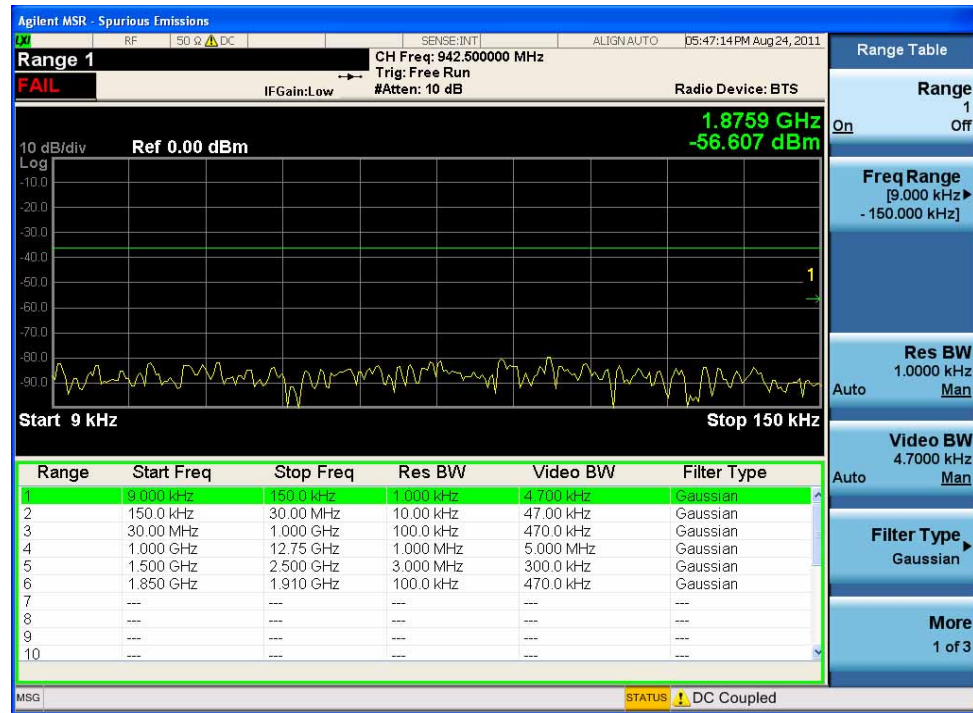

6 (Optional) Change measurement parameters from their default condition. Press Meas Setup to see the keys that are available to change.

If you have a problem, and get an error message, see the guide “Instrument Messages”, which is provided on the Documentation CD ROM, and in the instrument here:

C:\Program Files\Keysight\SignalAnalysis\Infrastructure\Help\bookfiles.

Power Statistics CCDF Measurements

This section explains how to make the Power Statistics Complementary Cumulative Distribution Function (Power Stat CCDF) measurement on a MSR downlink signal. Power Stat CCDF curves characterize the higher level power statistics of a digitally modulated signal. For more information on this measurement, see [“Power Statistics CCDF Measurement Concepts”](#) on page 59.

For signal setting, see [“Setting the Downlink Signal”](#) on page 14.

Measurement Procedure

| Step | Action | Notes |
|------|---|---|
| 1 | Perform the common configuration. | See “Common Measurement Procedure (Downlink)” on page 16. It is not necessary if you already did it in other measurements. |
| 2 | Initiate the power statistics CCDF measurement. | Press Meas, Power Stat CCDF . The CCDF measurement result should look like Figure 2-20 . The blue line is the Gaussian trace and the yellow line is the measurement result. The Info BW is the channel bandwidth that will be used for data acquisition. You can manually change the Info BW under the BW menu. |

Figure 2-20

MSR Downlink Power Statistics CCDF Measurement Result

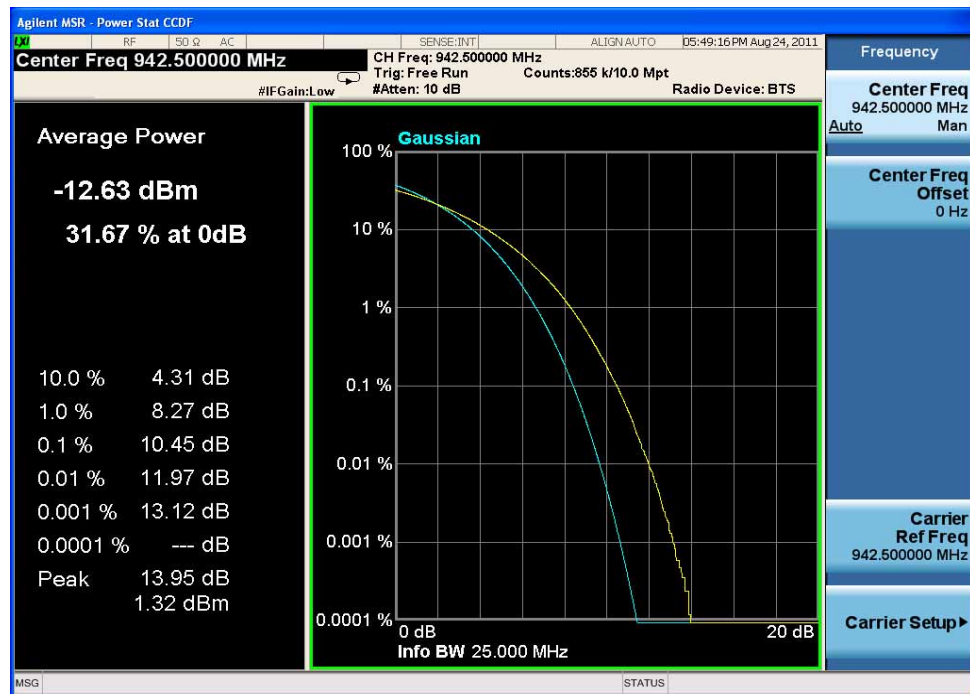

| Step | Action | Notes |
|------|--|---|
| 3 | Turn reference trace on. Press Trace/Detector, Ref Trace (On) to represent the user-definable reference trace (violet line). | The reference trace is the same as the measurement trace. You can use the Store Ref Trace key to copy the currently measured curve as the reference trace. It will not change until you store the reference trace again or choose the other mode. The CCDF measurement result with the reference trace should look like Figure 2-21 . |

Figure 2-21

MSR Downlink Power Statistics CCDF Measurement Result



- | | | |
|---|---|--|
| 4 | Optimize the measurement for your signal level. | Press Meas Setup, IF Gain to optimize the measurement for your signal level. If you have a very high or low level signal, selecting Low Gain or High Gain can improve your accuracy. The default is Auto . |
|---|---|--|

If you have a problem, and get an error message, see the guide “**Instrument Messages**”, which is provided on the Documentation CD ROM, and in the instrument here:

C:\Program Files\Keysight\SignalAnalysis\Infrastructure\Help\bookfiles.

Troubleshooting Hints

The power statistics CCDF measurement can assist in setting the signal power specifications for design criteria for systems, amplifiers, and other components. For example, it can help determine the optimum operating point to adjust each code timing for appropriate peak or average power ratio, or both, for the transmitter.

Conformance EVM Measurement

This section explains how to make the Conformance EVM measurement on a MSR downlink signal. For the detailed instruction about this measurement, see “MSR Conformance EVM Measurement Concepts” on page 66.

For signal setting, see “Setting the Downlink Signal” on page 14.

Measurement Procedure

| Step | Action | Notes |
|--|---|---|
| 1 Perform the common configuration. | See “Common Measurement Procedure (Downlink)” on page 16. | It is not necessary if you already did it in other measurements. |
| 2 Initial Conformance EVM measurement. | Press Meas, Conformance EVM . | <p>The conformance EVM measurement result should look like Figure 2-20. The blue line is the Gaussian trace and the yellow line is the measurement result.</p> <p>The Info BW is the channel bandwidth that will be used for data acquisition. You can manually change the Info BW under the BW menu.</p> |
| 3 Configure the parameter set. | <p>Press Mode Setup, Format, LTE FDD then Select LTE FDD Param Set.</p> <p>Choose 1 to 3 for parameter set, then you can check and change the parameter value by pressing Format Parameter List.</p> <p>Configure the other modes (under Mode Setup, Format) using the same way.</p> | <p>For more information about Format Parameter List settings, see “Format Parameter List in Mode Setup” on page 70.</p> <p>The parameter name, related SCPI and value are listed in Parameter List with tabular form. You can send the SCPI to change them or you can manually change them by selecting the parameter using knob or up and down arrows then enter the value using front panel keys.</p> <p>If you use a test model to do the measurement, the Recall function is provided for E-URTA Test Models (E-TM) to setup the LTE FDD parameters automatically. See “Recall EVM setup.”.</p> |

Making MSR Measurements
MSR Downlink Signal Measurement

Step Action Notes

Figure 2-22 MSR Downlink Conformance EVM - Format Parameter List

| Name | SCPI (LTE FDD 1) | Value |
|----------------------|--|------------|
| ACP Measurement... | :Radio:Format:LTEFDD1:ACPpower:CARRIER(12):BANDwidth:INtegration | Values |
| Demod Bandwidth | :Radio:Format:LTEFDD1:BANDwidth | B5M |
| CHP Integration BW | :Radio:Format:LTEFDD1:CHPower:BANDwidth:INtegration | 5.0000 MHz |
| Number of Ant Ele... | :Radio:Format:LTEFDD1:DLINK:AENumber | 2 |
| Ant Element Spaci... | :Radio:Format:LTEFDD1:DLINK:AESpacing | 0.500 |
| DL, PDSCH Cell S... | :Radio:Format:LTEFDD1:DLINK:PDSCH:CSRatio | R1 |
| Downlink Add User | :Radio:Format:LTEFDD1:DLINK:PROFile:ADD:USER | Immediate |
| DL RB Auto Det M... | :Radio:Format:LTEFDD1:DLINK:PROFile:AUTO:DETECT:MODE | POWER |
| DL RB Auto Det P... | :Radio:Format:LTEFDD1:DLINK:PROFile:AUTO:DETECT:POWER | On |
| DL, Power Boost... | :Radio:Format:LTEFDD1:DLINK:PROFile:AUTO:DETECT:POWER:ROUND | On |
| DL Auto, PDSCH... | :Radio:Format:LTEFDD1:DLINK:PROFile:AUTO:PDSCH:CBINdex | 0 |
| DL Auto, PDSCH... | :Radio:Format:LTEFDD1:DLINK:PROFile:AUTO:PDSCH:CDD | WOCDd |
| DL Auto, Number... | :Radio:Format:LTEFDD1:DLINK:PROFile:AUTO:PDSCH:NCODEwords | 1 |
| DL Auto, Number... | :Radio:Format:LTEFDD1:DLINK:PROFile:AUTO:PDSCH:NLAYers | 1 |
| DL Auto, PDSCH... | :Radio:Format:LTEFDD1:DLINK:PROFile:AUTO:PDSCH:PRECoding | OFF |
| CW1 16QAM Enable | :Radio:Format:LTEFDD1:DLINK:PROFile:AUTO:PDSCH:QAM16:CWONe:ENABle | On |
| CW1 16QAM Pow... | :Radio:Format:LTEFDD1:DLINK:PROFile:AUTO:PDSCH:QAM16:CWZerO:PWRBoost | 0.000 dB |
| CW0 16QAM Enable | :Radio:Format:LTEFDD1:DLINK:PROFile:AUTO:PDSCH:QAM16:CWZerO:ENABle | On |
| PDSCH 16QAM E... | :Radio:Format:LTEFDD1:DLINK:PROFile:AUTO:PDSCH:QAM16:EPRE | 0.000 dB |
| CW0 16QAM Pow... | :Radio:Format:LTEFDD1:DLINK:PROFile:AUTO:PDSCH:QAM16:PWRBoost | 0.000 dB |
| CW1 64QAM Enable | :Radio:Format:LTEFDD1:DLINK:PROFile:AUTO:PDSCH:QAM64:CWONe:ENABle | On |
| CW1 64QAM Pow... | :Radio:Format:LTEFDD1:DLINK:PROFile:AUTO:PDSCH:QAM64:CWZerO:PWRBoost | 0.000 dB |
| CW0 64QAM Enable | :Radio:Format:LTEFDD1:DLINK:PROFile:AUTO:PDSCH:QAM64:CWZerO:ENABle | On |
| PDSCH 64QAM E... | :Radio:Format:LTEFDD1:DLINK:PROFile:AUTO:PDSCH:QAM64:EPRE | 0.000 dB |
| CW0 64QAM Pow... | :Radio:Format:LTEFDD1:DLINK:PROFile:AUTO:PDSCH:QAM64:PWRBoost | 0.000 dB |
| CW1 QPSK Enable | :Radio:Format:LTEFDD1:DLINK:PROFile:AUTO:PDSCH:QPSK:CWONe:ENABle | On |
| CW0 QPSK Power... | :Radio:Format:LTEFDD1:DLINK:PROFile:AUTO:PDSCH:QPSK:CWONe:PWRBoost | 0.000 dB |
| CW0 QPSK Enable | :Radio:Format:LTEFDD1:DLINK:PROFile:AUTO:PDSCH:QPSK:CWZerO:ENABle | On |
| PDSCH QPSK EPRE | :Radio:Format:LTEFDD1:DLINK:PROFile:AUTO:PDSCH:QPSK:EPRE | 0.000 dB |
| CW0 QPSK Power... | :Radio:Format:LTEFDD1:DLINK:PROFile:AUTO:PDSCH:QPSK:PWRBoost | 0.000 dB |

4 Recall EVM setup.

Press **Recall, Data, Param Set** then choose the format and parameter set and **Open...**, a file open dialog appears. Select the appropriate file under params directory and click open. This will apply the EVM settings quickly. The other parameters will not be changed. At the bottom of the screen, there is a message to indicate which mask file is recalled. In this example, LTEFDD-TM1.1-BW5MHz.fps is used.

If you have parameter set file for other modes, you can also use the same way to recall the setup for their parameter list automatically.

The measurement result should look like [Figure 2-20](#).

Step Action Notes

Figure 2-23 MSR Downlink Conformance EVM Result - Carrier1

| Category | Measurement Item | Result |
|-----------------------------------|---------------------------------|------------|
| Carrier 1 (GSM/EDGE) | RMS 95th %tile EVM | 5.95 % |
| | Average RMS EVM | 3.68 % |
| | Maximum RMS EVM | 3.68 % |
| | Average Peak EVM | 6.46 % |
| | Maximum Peak EVM | 6.46 % |
| | Symbol Position of the Peak EVM | 3.1 |
| | Average RMS Magnitude Error | 3.04 % |
| | Maximum RMS Magnitude Error | 3.04 % |
| | Average RMS Phase Error | 1.17 ° |
| | Maximum RMS Phase Error | 1.17 ° |
| | Average Frequency Error | 38.6807 Hz |
| | Maximum Frequency Error | 38.6807 Hz |
| | Average IQ Origin Offset | -56.10 dB |
| | Amplitude Droop Error | 0.13 dB |
| Trigger to T0 | 721.131 µs | |
| Timing Offset of AM/PM path | --- | |
| Detected TSC | 4 | |
| Detected Mod Scheme | NB GMSK | |
| Maximum IQ Origin Offset | -56.10 dB | |
| Average Absolute Peak Phase Error | 2.92 ° | |
| Maximum Absolute Peak Phase Error | 2.92 ° | |
| Carrier 2 (W-CDMA) | RMS EVM | 4.31 % |
| | Peak EVM | 14.90 % |
| | Magnitude Error | 3.03 % |
| | Phase Error | 5.29 ° |
| | I/Q Origin Offset | -61.45 dB |
| Frequency Error | 37.11 Hz | |

5 Select result for different carriers.

Press **View/Display, Result Metrics Carrier Index** then enter the carrier number you want to see.

Here 4 is entered and the result for carrier 4 (LTE FDD) is displayed. You can also scroll down the table to see the results for all the carriers.

Making MSR Measurements
MSR Downlink Signal Measurement

Step Action Notes

Figure 2-24 MSR Downlink Conformance EVM Result - Carrier4

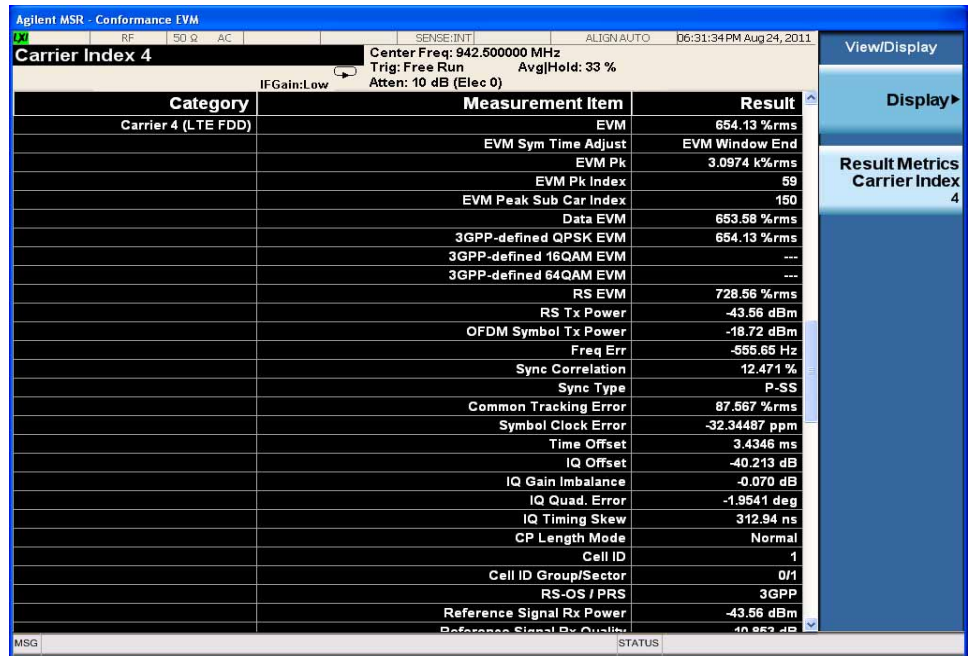

- 6 (Optional) Change measurement parameters from their default condition. Press **Meas Setup** to see the keys that are available to change, such as Avg/Hold Num.

If you have a problem, and get an error message, see the guide “**Instrument Messages**”, which is provided on the Documentation CD ROM, and in the instrument here:

C:\Program Files\Keysight\SignalAnalysis\Infrastructure\Help\bookfiles.

3 Concepts

This chapter presents an overview of the Multi-Standard Radio concepts. It also describe measurement concepts and details how various measurements are performed by the instrument for MSR signal to help you have better understanding of tests and do the measurements correctly and quickly. It contains the following sections:

- “MSR Overview” on page 48
- “MSR Measurement Concepts” on page 55
- “Instrument Updates at www.keysight.com” on page 91

MSR Overview

The Multi-Standard Radio (MSR) BTS transmits Multicarriers with Multi-standards among the RF Bandwidth simultaneously. The following concepts are described in this section.

NOTE This section provides overall MSR information, however the tests for UL or Band Category 3 is not supported currently in product.

- “MSR Specification Documents” on page 48
- “Band Category” on page 49
- “RF Bandwidth” on page 51
- “Channel Raster” on page 53
- “Channel Spacing” on page 53
- “MSR Test Configurations” on page 53

MSR Specification Documents

Standard documents identify relevant Base Station operation scenarios and specify test requirements applicable to MSR Base Station with multi-carriers and/or multi-RATs.

- 3GPP TR 37.900 V9.0.1 (2010-07)
Technical Specification Group Radio Access Network; Radio Frequency (RF) requirements for Multicarrier and Multiple Radio Access Technology (Multi-RAT) Base Station (BS)
- 3GPP TS 37.141 V10.6.0 (2012-03)
E-UTRA, UTRA and GSM/EDGE; Multi-Standard Radio (MSR) Base Station (BS) conformance testing (Release 10)
- 3GPP TS 37.104 V9.2.0 (2010-12)
E-UTRA, UTRA and GSM/EDGE; Multi-Standard Radio (MSR) Base Station (BS) transmission and reception (Release 9)

The latest version of the 37-series documents can be found at http://www.3gpp.org/ftp/specs/archive/37_series/.

Band Category

In MSR, the operation bands are grouped into Band Category in which the same MSR scenarios apply.

Table 3-1 *Band Category Definition*

| Band Category (BC) | Spectrum (Duplex) | GSM/EDGE (FDD) | W-CDMA/HSPA (UTRA FDD) | TD-SCDMA (UTRA TDD) | LTE FDD (E-UTRA FDD) | LTE TDD (E-UTRA TDD) |
|--------------------|-------------------|----------------|------------------------|---------------------|----------------------|----------------------|
| BC1 | Paired (FDD) | | X | | X | |
| BC2 | Paired (FDD) | X | X | | X | |
| BC3 | Unpaired (TDD) | | | X | | X |

Table 3-2 *Paired bands in LTE (E-UTRA), W-CDMA (UTRA FDD) and GSM/EDGE*

| E-UTRA Band | UTRA Band | GSM/E DGE Band | Downlink (DL) BS transmit UE receive | Band category |
|-------------|-----------|----------------|---|---------------|
| 1 | I | - | 2110 MHz - 2170 MHz | 1 |
| 2 | II | PCS 1900 | 1930 MHz - 1990 MHz | 2 |
| 3 | III | DCS 1800 | 1805 MHz - 1880 MHz | 2 |
| 4 | IV | - | 2110 MHz - 2155 MHz | 1 |
| 5 | V | GSM 850 | 869 MHz - 894MHz | 2 |
| 6 * | VI | - | 875 MHz - 885 MHz | 1 * |
| 7 | VII | - | 2620 MHz - 2690 MHz | 1 |
| 8 | VIII | E-GSM | 925 MHz - 960 MHz | 2 |
| 9 | IX | - | 1844.9 MHz - 1879.9 MHz | 1 |
| 10 | X | - | 2110 MHz - 2170 MHz | 1 |
| 11 | XI | - | 1475.9 MHz - 1495.9 MHz | 1 |
| 12 | XII | - | 728 MHz - 746 MHz | 1 |
| 13 | XIII | - | 746 MHz - 756 MHz | 1 |
| 14 | XIV | - | 758 MHz - 768 MHz | 1 |
| 15 | XV | - | Reserved | |
| 16 | XVI | - | Reserved | |

Table 3-2 Paired bands in LTE (E-UTRA), W-CDMA (UTRA FDD) and GSM/EDGE

| E-UTRA Band | UTRA Band | GSM/E DGE Band | Downlink (DL) BS transmit UE receive | Band category |
|--------------------------------------|-----------|----------------|---|---------------|
| 17 | - | - | 734 MHz - 746 MHz | 1 ** |
| 18 | - | - | 860 MHz - 875 MHz | 1 ** |
| 19 | XIX | - | 875 MHz - 890 MHz | 1 |
| 20 | XX | - | 791 MHz - 821 MHz | 1 |
| 21 | XXI | - | 1495.9 MHz - 1510.9 MHz | 1 |
| 22 | XXII | | 3510 MHz - 3590 MHz | 1 |
| 23 | XXIII | | 2180 MHz - 2200 MHz | 1** |
| 24 | XXIV | | 1525 MHz - 1559 MHz | 1** |
| 25 | XXV | | 1930 MHz - 1995 MHz | 1 |
| * NOTE:The band is for UTRA only. | | | | |
| ** NOTE:The band is for E-UTRA only. | | | | |

Table 3-3 Unpaired bands in E-UTRA and UTRA

| E-UTRA Band | UTRA Band | Downlink (DL) BS transmit UE receive | Band category |
|-------------|-----------|---|---------------|
| 33 | a) | 1900 MHz - 1920 MHz | 3 |
| 34 | a) | 2010 MHz - 2025 MHz | 3 |
| 35 | b) | 1850 MHz - 1910 MHz | 3 |
| 36 | b) | 1930 MHz - 1990 MHz | 3 |
| 37 | c) | 1910 MHz - 1930 MHz | 3 |
| 38 | d) | 2570 MHz - 2620 MHz | 3 |
| 39 | f) | 1880 MHz - 1920 MHz | 3 |
| 40 | e) | 2300 MHz - 2400 MHz | 3 |
| 41 | - | 2496 MHz - 2690 MHz | 3 |
| 42 | h) | 3400 MHz - 3600 MHz | 3 |
| 43 | i) | 3600 MHz - 3800 MHz | 3 |

RF Bandwidth

Base station RF Bandwidth in continuous spectrum operation is defined as shown in the figure below. $F_{C,low}$ and $F_{C,high}$ denote center frequencies of lowermost and uppermost carriers respectively. $F_{Offset,RAT}$ for each format is defined in 3GPP TS 37.141 and also described in “[FOffset,RAT](#)” on page 52 as well.

Carriers are placed to have a specified base station RF bandwidth in the carrier config preset process. Since carriers are placed to meet the raster conditions, the base station RF bandwidth might be smaller than the specified one.

Spectrum Emission Mask measurement is done based on base station RF bandwidth.

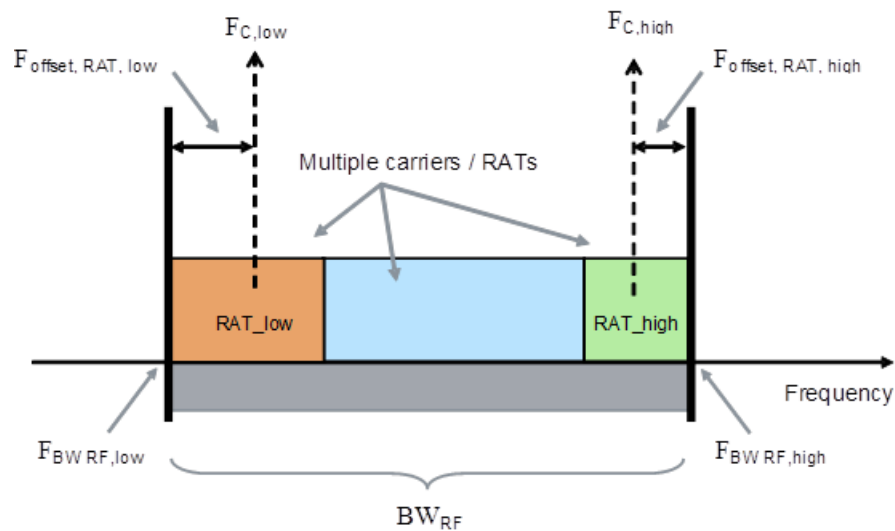

Base Station in non-contiguous operation has sub-blocks defined in 3GPP TS 37.141 as shown in the figure below:

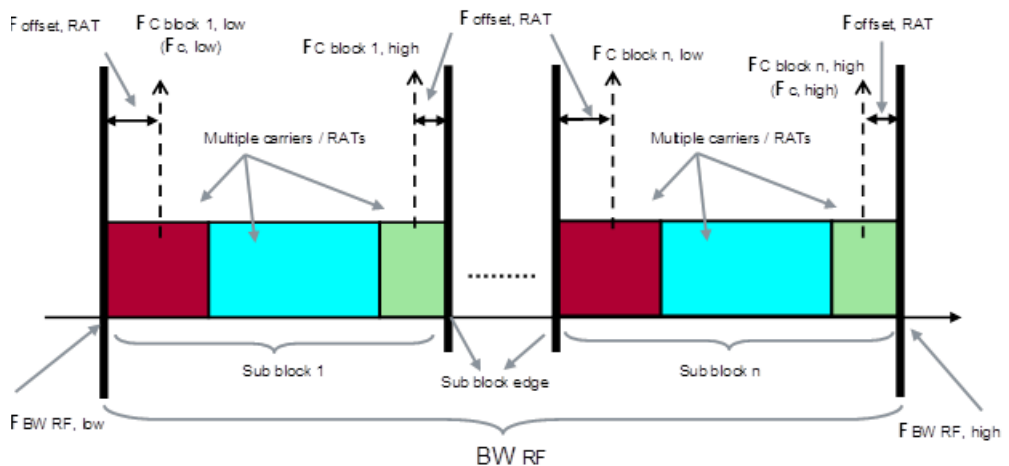

FOffset,RAT

$F_{\text{offset,RAT}}$ values are defined in 3GPP TS 37.141 and shown here.

Table 3-4 $F_{\text{offset,RAT}}$ for band category 1

| RAT | $F_{\text{offset, RAT}}$ |
|--------------------------------|---|
| 1.4, 3 MHz LTE (E-UTRA) | $BW_{\text{Channel}}/2 + 200 \text{ kHz}$ |
| 5, 10, 15, 20 MHz LTE (E-UTRA) | $BW_{\text{Channel}}/2$ |
| W-CDMA (UTRA FDD) | 2.5 MHz |

Table 3-5 $F_{\text{offset,RAT}}$ for band category 2

| RAT | $F_{\text{offset, RAT}}$ |
|-------------------|--------------------------|
| LTE (E-UTRA) | $BW_{\text{Channel}}/2$ |
| W-CDMA (UTRA FDD) | 2.5 MHz |
| GSM/EDGE | 200 kHz |

Table 3-6 $F_{\text{offset,RAT}}$ for band category 3

| RAT | $F_{\text{offset, RAT}}$ |
|--------------------------------|---|
| 1.4, 3 MHz LTE (E-UTRA) | $BW_{\text{Channel}}/2 + 200 \text{ kHz}$ |
| 5, 10, 15, 20 MHz LTE (E-UTRA) | $BW_{\text{Channel}}/2$ |
| TD-SCDMA (1.28 Mcps UTRA TDD) | 1 MHz |

cdma2000 and 1xEV-DO are not the 3GPP standard, $F_{\text{Offset,RAT}}$ is not defined for these formats. In MSR application, the following values are used.

Table 3-7 $F_{\text{offset,RAT}}$ for cdma2000 and 1xEV-DO

| RAT | $F_{\text{offset, RAT}}$ |
|----------|--------------------------|
| cdma2000 | 0.625 MHz |
| 1xEV-DO | 0.625 MHz |

Channel Raster

If channel raster is 100 kHz, that means the carrier center frequency must be an integer multiple of 100 kHz. Channel raster of each format is listed below.

E-UTRA (LTE): 100 kHz

UTRA (W-CDMA, TD-SCDMA): 200 kHz

GSM/EDGE: 200 kHz

cdma2000: 1 kHz

1xEV-DO: 1 kHz

Channel Spacing

Carriers are placed based on corresponding channel spacing when they are configured by the carrier config preset. Default channel spacings are listed below.

E-UTRA (LTE): Channel BW

UTRA FDD (W-CDMA): 5 MHz

GSM/EDGE: 600 kHz

cdma2000: 1.25 MHz

1xEV-DO: 1.25 MHz

Channel spacing can be adjusted using channel spacing delta parameters.

MSR Test Configurations

In the standard, it defines many test configurations to verify the Multi-RAT capability and performance. The table below is a summary, for details, see the standard documentation 3GPP TS 37.141.

Table 3-8 MSR Test Configuration

| Section in standard | TC | BC | W-CDMA/HSPA (UTRA FDD) | TD-SCDMA (UTRA TDD) | LTE FDD (E-UTRA FDD) | LTE TDD (E-UTRA TDD) | GSM |
|---------------------|----------------|---------|------------------------|---------------------|----------------------|----------------------|-----|
| 4.8.1 | TC1a/N TC1a | 1, 2 | X | | | | |
| 4.8.1 | TC1b | 3 | | X | | | |
| 4.8.2 | TC2 /NTC2 | 1, 2, 3 | | | X | X | |
| 4.8.3 | TC3a/N TC3a | 1, 2 | X | X | | | |
| 4.8.3 | TC3b | 3 | | X | | X | |

Table 3-8 MSR Test Configuration

| | | | | | | | |
|-------|----------------|---------|---|---|---|---|---|
| 4.8.4 | TC4a/N TC4a | 2 | X | | | | X |
| 4.8.4 | TC4b/ NTC4b | 2 | | | X | | X |
| 4.8.4 | TC4c/ NTC4c | 2 | X | | X | | X |
| 4.8.4 | TC4d | 2 | X | | | | X |
| 4.8.4 | TC4e | 2 | | | X | | X |
| 4.8.5 | TC5a/N TC5a | 2 | X | | | | X |
| 4.8.5 | TC5b/ NTC5b | 2 | | | X | | X |
| 4.8.5 | NTC5c | 2 | X | | X | | X |
| 4.8.6 | TC6a | 2 | X | | | | |
| 4.8.6 | TC6b | 1, 2 | | | X | X | |
| 4.8.6 | TC6c | 1, 2, 3 | | X | | | |

MSR Measurement Concepts

The following sections describe the purpose, measurement method for the MSR measurements.

- “Channel Power Measurement Concepts” on page 56
- “Occupied Bandwidth Measurement Concepts” on page 57
- “Adjacent Channel Power (ACP) Measurement Concepts” on page 58
- “Power Statistics CCDF Measurement Concepts” on page 59
- “Spurious Emissions Measurement Concepts” on page 61
- “Spectrum Emission Mask Measurement Concepts” on page 62
- “IQ Waveform Measurement Concepts” on page 64
- “Monitor Spectrum (Frequency Domain) Measurement Concepts” on page 65
- “MSR Conformance EVM Measurement Concepts” on page 66
- “Carrier Power Measurement Bandwidth and Filter” on page 68
- “Offset/Limit Presets” on page 68
- “Carrier Info Table” on page 69
- “Carrier Conf Presets” on page 69
- “Format Parameter List in Mode Setup” on page 70

Channel Power Measurement Concepts

Purpose

The Channel Power measurement is a common test used in the wireless industry to measure the total transmitted power of a radio within a defined frequency channel. This procedure measures the total power within the defined channel. This measurement is applied to design, characterize, evaluate, and verify transmitters and their components or devices for uplink and downlink signals.

Measurement Method

The Channel Power measurement reports the total transmitted power and the calculated power spectral density within the integration bandwidth. It takes a sweep and the measurement acquires power in the channel.

The power calculation method used to determine the channel power is a traditional method known as the integration bandwidth (IBW) method. The measurement uses the frequency sweep mode, the RBW filter is set narrow relative to the desired integration bandwidth. You can change the RBW and VBW settings. It is important to correctly set the RBW before making this measurement, because if the RBW filter setting is too narrow the signal will be under-sampled and not all of the signal power will be measured. If the setting is too wide, it will reduce the accuracy of the Channel Power measurement.

Span keys are not supported in MSR channel power because the span is calculated automatically from integration bandwidths pre-defined for all formats. Pre-defined integration BW values are the same as the defaults of channel spacing. Therefore Integ BW in Meas Setup is not supported either. The predefined Integ BW and RRC Filter values are defined in “Carrier Power Measurement Bandwidth and Filter” on page 68.

To improve repeatability, you can increase the number of averages. The channel power graph is shown in the graph window, while the absolute channel power in dBm and the mean power spectral density in dBm/Hz are shown in the text window.

Occupied Bandwidth Measurement Concepts

Purpose

Occupied bandwidth measurements express the percentage of the transmitted power within a specified bandwidth. This percentage is typically 99%.

The spectrum shape of a signal can give useful qualitative insight into transmitter operation. Any distortion to the spectrum shape can indicate problems in transmitter performance.

Occupied bandwidth in MSR is designed to measure occupied bandwidth of multiple carriers of different formats, although it is required by the 3GPP MSR standard and the other single format standards that it is measured with a single carrier with specified span.

Measurement Method

The instrument uses sweep mode to capture the data and the total power within the measurement frequency span is integrated for its 100% of power. The frequencies of 0.5% of the total power are then calculated to get 99.0% bandwidth.

Span auto detection is supported in MSR mode OBW. When in auto detection mode, the frequency range determined by Measure Carrier on of carrier #1 to Carriers is roughly examined to determine the span of OBW. FOffset,OBW is defined for each format as below.

- FOffset,OBW for LTE 1.4, 3, 5 MHz: 10 MHz
- FOffset,OBW for LTE other BW: BWchannel MHz
- FOffset,OBW for W-CDMA: 5MHz
- FOffset,OBW for GSM/EDGE: 300 kHz

FOffset,OBW of LTE (E-UTRA) and W-CDMA (UTRA FDD) are determined from occupied bandwidth test methods defined in the 3GPP standard. For GSM/EDGE it is based on the default channel spacing. Center frequencies of active carriers and corresponding FOffset,OBW determine the span. Since FOffset,OBW value is based on the standard, the span is set to the one required by the standard for OBW test of corresponding format when only one carrier is detected by the auto detection.

Adjacent Channel Power (ACP) Measurement Concepts

Purpose

Adjacent Channel Power (ACP), as it applies to LTE, is the power contained in a specified frequency channel bandwidth relative to the total carrier power. It may also be expressed as a ratio of power spectral densities between the carrier and the specified offset frequency band.

As a composite measurement of out-of-channel emissions, ACP combines both in-band and out-of-band specifications to provide useful figures-of-merit for spectral regrowth and emissions produced by components and circuit blocks without the rigor of performing a full spectrum emissions mask measurement.

To maintain a quality call by avoiding channel interference, it is important to measure and reduce any adjacent channel leakage power transmitted from a mobile phone. The characteristics of adjacent channel leakage power are mainly determined by the transmitter design, particularly the low-pass filter.

Measurement Method

This ACP measurement analyzes the total power levels within the defined carrier bandwidth and at given frequency offsets on both sides of the carrier frequency. Carrier bandwidth is automatically determined from radio format and its parameter and each of the offset frequency pairs up to 6. Each pair may be defined with unique measurement bandwidths.

For Meas Method of RBW, it uses an appropriate RBW and capture all of the power in the carrier channel and the offsets. For Meas Method of integration bandwidth (IBW), the channel integration bandwidth is analyzed using the user defined resolution bandwidth (RBW), which is much narrower than the channel bandwidth. The measurement computes an average power of the channel over a specified number of data acquisitions, automatically compensating for resolution bandwidth and noise bandwidth. The predefined Measurement Noise BW and Method for Carrier values are defined in [“Carrier Power Measurement Bandwidth and Filter” on page 68](#).

If **Total Pwr Ref** is selected as the measurement type, the results are displayed as relative power in dBc and as absolute power in dBm. If **PSD Ref** (Power Spectral Density Reference) is selected, the results are displayed as relative power in dB, and as absolute power in dBm/Hz.

Power Statistics CCDF Measurement Concepts

Purpose

Many of the digitally modulated signals appear noise-like in the time and frequency domain. This means that statistical measurements of the signals can be a useful characterization. Power Complementary Cumulative Distribution Function (CCDF) curves characterize the higher-level power statistics of a digitally-modulated signal. The curves can be useful in determining design parameters for digital communications systems.

The power statistics CCDF measurement can be affected by many factors. For example, modulation filtering, modulation format, combining the multiple signals at different frequencies, number of active codes and correlation between symbols on different codes with spread spectrum systems. These factors are all related to modulation and signal parameters. External factors such as signal compression and expansion by non-linear components, group delay distortion from filtering, and power control within the observation interval also affect the measurement.

CCDF curves can help you in several situations:

- To determine the headroom required when designing a component.
- To confirm the power statistics of a given signal or stimulus. CCDF curves allow you to verify if the stimulus signal provided by another design team is adequate. For example, RF designers can use CCDF curves to verify that the signal provided by the digital signal processing (DSP) section is realistic.
- To confirm that a component design is adequate or to troubleshoot your subsystem or system design, you can make CCDF measurements at several points of a system. For example, if the ACLR of a transmitter is too high, you can make CCDF measurements at the input and output of the PA. If the PA design is correct, the curves will coincide. If the PA compresses the signal, the PAR of the signal is lower at the output of the PA.

Measurement Method

The power measured in power statistics CCDF curves is actually instantaneous envelope power defined by the equation:

$$P = (I^2 + Q^2)/Z_0$$

(where I and Q are the quadrature voltage components of the waveform and Z_0 is the characteristic impedance).

A CCDF curve is defined by how much time the waveform spends at or above a given power level. The percent of time the signal spends at or above the level defines the probability for that particular power level. To make the power statistics CCDF measurement, the instrument uses digital signal processing (DSP) to sample the input signal in the channel bandwidth.

Concepts

MSR Measurement Concepts

The Gaussian distribution line as the band-limited gaussian noise CCDF reference line, the user-definable reference trace, and the currently measured trace can be displayed on a semi-log graph. If the currently measured trace is above the user reference trace, it means that the higher peak power levels against the average power are included in the input signal.

Spurious Emissions Measurement Concepts

Purpose

Spurious signals can be caused by different combinations of signals in the transmitter. The spurious emissions from the transmitter should be minimized to guarantee minimum interference with other frequency channels in the system. Harmonics are distortion products caused by nonlinear behavior in the transmitter. They are integer multiples of the transmitted signal carrier frequency.

This measurement verifies the frequency ranges of interest are free of interference by measuring the spurious signals specified by the user defined range table.

Measurement Method

The table-driven measurement has the flexibility to set up custom parameters such as frequency, span, resolution bandwidth, and video bandwidth.

For each range that you specify and activate, the analyzer scans the band using the specified Range Table settings. Then using the Peak Excursion and Peak Threshold values determines which spurs to report.

As each band is swept, any signal which is above the Peak Threshold value and has a peak excursion of greater than the Peak Excursion value will be added to a list of spurs displayed in the lower results window. A total of 200 spurs can be recorded for one measurement, with a limit of 10 spurs per frequency range. To improve repeatability, you can increase the number of averages.

From the spurs in the list, those with peak amplitude greater than the Absolute Limit for that range will be logged as a measurement failure and denoted by an 'F' in the 'Amplitude' column of the table. If no spurs are reported, but the measured trace exceeds the limit line for any range, the fail flag is set to fail.

This measurement has the ability to display two traces using different detectors on the display simultaneously. All spur detection and limit line testing are only applied to the trace associated with Detector 1, which will be colored yellow. The trace associated with Detector 2 will be colored cyan.

If the sweep time for the range exceeds 2 seconds, a flashing message "Sweeping...Please Wait" will appear in the annunciator area. This advises you that the time to complete the sweep is between 2 and 2000 seconds, and is used as without it the display would appear stagnant and you may think the measurement is not functional.

In the MSR, frequency range from 10 MHz below OB Start Freq to 10 MHz above OB Stop Freq is excluded from the measurement frequency range even when offset ranges include it unless Operating Band is None. Intermodulation test is supported in this measurement. The intermodulation interference frequency range specified by the parameters under the Intermod menu is excluded from the measurement when interference power present is on.

Spectrum Emission Mask Measurement Concepts

Purpose

Spectrum Emission Mask measurements include the in-band and out-of-band spurious emissions. It is the power contained in a specified frequency bandwidth at certain offsets relative to the total carrier power. It may also be expressed as a ratio of power spectral densities between the carrier and the specified offset frequency band.

As a composite measurement of out-of-channel emissions, the spectrum emission mask measurement combines both in-band and out-of-band specifications to provide useful figures-of-merit for spectral regrowth and emissions produced by components and circuit blocks without the rigor of performing a full spectrum emissions mask measurement.

Measurement Method

The spectrum emission mask measurement measures spurious signal levels in up to 12 pairs of offset/region frequencies and relates them to the carrier power. The reference channel integration bandwidth method is used to measure the carrier channel power and offset/region powers. When “Offset” is selected, spectrum emission mask measurements are made, relative to the carrier channel frequency bandwidth. When “Region” is selected, spurious emission absolute measurements are made, set by specifying start and stop RF frequencies.

The channel integration bandwidth is analyzed using the user defined resolution bandwidth (RBW), which is much narrower than the channel bandwidth. The measurement computes an average power of the channel or offset/region over a specified number of data acquisitions, automatically compensating for resolution bandwidth and noise bandwidth. The predefined carrier integ BW and Method are defined in [“Carrier Power Measurement Bandwidth and Filter” on page 68](#).

Intermodulation test is supported in this measurement. The intermodulation interference frequency range specified by the parameters under the Intermod menu is excluded from the measurement when interference power present is on. The measured points in the excluded region are set to negative infinity.

In the MSR, frequency below OB Start Freq - 10 MHz and above OB Stop Freq + 10 MHz is excluded from the measurement frequency range even when offset ranges include it unless Operating Band is None.

Carrier powers are measured only for carriers specified by Power Ref. When max power carrier is selected, all carriers with Measure Carrier on are measured to determine the max power. For example, when Left & Right Carriers is selected, only the edge carriers are measured and displayed.

In the MSR Total power is the sum of carrier powers which are calculated by the integration power of the specified bandwidth with the specified weight. Total power is available only when powers of all the carriers with Measure Carrier On are calculated.

This measurement requires the user to specify measurement bandwidths of the carrier channel and each of the offset/region frequency pairs up to 12 (A - L). Each pair may be defined with unique measurement bandwidths. The results are displayed both as relative power in dBc, and as absolute power in dBm. The measurement supports the limit preset as described in [“Offset/Limit Presets” on page 68](#).

IQ Waveform Measurement Concepts

Purpose

The waveform measurement is a generic measurement for viewing the input signal waveforms in the time domain. This measurement is how the instrument performs the zero span functionality found in traditional spectrum analyzers.

Basic mode waveform measurement data may be displayed using either a Signal Envelope window, or an I/Q window which shows the I and Q signal waveforms in parameters of voltage versus time. The advantage of having an I/Q view available while making a waveform measurement is that it allows you to view complex components of the same signal without changing settings or measurements.

The waveform measurement can be used to perform general purpose power measurements in the time domain with excellent accuracy.

Measurement Method

The instrument makes repeated power measurements at a set frequency, similar to the way a swept-tuned spectrum analyzer makes zero span measurements. The input analog signal is converted to a digital signal, which then is processed into a representation of a waveform measurement. The measurement relies on a high rate of sampling to create an accurate representation of a time domain signal.

Monitor Spectrum (Frequency Domain) Measurement Concepts

Purpose

The Monitor Spectrum measurement provides spectrum analysis capability for the instrument. The control of the measurement was designed to be familiar to those who are accustomed to using swept spectrum analyzers. The primary use of Monitor Spectrum is to allow you to visually make sure you have the RF carrier available to the instrument, and the instrument is tuned to the frequency of interest.

Measurement Method

The analyzer sweeps the LO to generate a heterodyned IF signal which can be detected for the purpose of analyzing the signal content of a range of frequencies. The x-axis of the display is frequency, the Y Axis is amplitude.

MSR Conformance EVM Measurement Concepts

Purpose

The Conformance EVM measurement (CEVM) analyzes characteristics of MSR carriers which consist of various radio formats. This measurement measures all configured carriers at one measurement cycle (assuming all configured carriers are active and output power level is not dynamically changed throughout the acquisition). The aim of this measurement is to optimize the measurement speed.

Measurement Method

All available measurement parameters are accessible through RUI (SCPI). CEVM doesn't have softkeys for setting parameters except for some common keys. Basically it has one view: Result Metrics view.

Currently, the following measurement items are supported in this measurement.

- EDGE EVM in the GSM/EDGE mode
- Mod Accuracy in the W-CDMA mode
- Conformance EVM in the LTE FDD mode
- Mod Accuracy (Composite Rho) in the cdma2000 mode
- Forward Link Mod Accuracy (Waveform Quality) in the 1xEV-DO mode

Although the core functionalities of these measurement items are almost the same as the original measurements, the measurement algorithm and items of the results are tailored for the speed and therefore, some functionalities and results are excluded or limited. See [“Format Parameter List in Mode Setup” on page 70](#).

Differences from Original Measurement

Functions are almost the same as the original measurement; however, some features are different between the original measurement and this measurement as shown below.

GSM/EDGE EDGE EVM

- No graphical view (such as I/Q Measured Polar Graph, I/Q Error, Data Bits) available.
- No limit judge functionality.
- Some SCPI commands in the original measurement are not available in this measurement.
- Some SCPI commands are newly added to this measurement. See [“Format Parameter List in Mode Setup” on page 70](#) for details.

W-CDMA Mod Accuracy

- No graphical view (such as I/Q Measured Polar Graph, I/Q Error, Code Domain Power, Peak/Avg Metrics, Capture Time Summary, Slot CDE/EVM) available.
- No limit judge functionality.
- Some SCPI commands in the original measurement are not available in this measurement.
- Some SCPI commands are newly added to this measurement. See [“Format Parameter List in Mode Setup” on page 70](#) for details.

LTE FDD Mod Analysis

- Functions are almost the same as the LTE Conformance EVM (CEVM) measurement.
- No BER measurement.
- No RF Envelope view available.

cdma2000/1xEV-DO Mod Accuracy

- No graphical view (such as I/Q Measured Polar Graph, I/Q Error, Code Domain Power, Peak/Avg Metrics, Capture Time Summary, Slot CDE/EVM) available.
- No limit judge functionality.
- Some SCPI commands in the original measurement are not available in this measurement.
- Some SCPI commands are newly added to this measurement. See [“Format Parameter List in Mode Setup” on page 70](#) for details.

Carrier Power Measurement Bandwidth and Filter

Carrier powers are measured in some common swept measurements, i.e. CHP, ACP and SEM. These measurements have parameters for measurement bandwidth and RRC filter in all or most of the other modes. In the MSR these parameters are not supported and carrier powers are measured with the predefined bandwidths and filter states because they depend on the radio format and because the MSR is designed to have the simpler UI. If it is required to support them in the future release, they would be parameters of format parameter set. Here are tables that show predefined measurement bandwidths and filter states.

Table 3-9 Carrier power measurement bandwidth (MHz)

| | LTE BWch (MHz) | | | | | | W-CDMA | GSM/EDGE | cdma2000 | 1xEV-DO |
|-------------------|----------------|-------|-------|-------|--------|--------|--------|----------|----------|---------|
| | 1.4 | 3 | 5 | 10 | 15 | 20 | | | | |
| ACP Meas Noise BW | 1.095 | 2.715 | 4.515 | 9.015 | 13.515 | 18.015 | 3.84 | 0.3 | 1.23 | 1.23 |
| SEM Integ BW | 1.095 | 2.715 | 4.515 | 9.015 | 13.515 | 18.015 | 3.84 | 0.3 | 1.23 | 1.23 |
| CHP Integ BW | 1.4 | 3 | 5 | 10 | 15 | 20 | 5.0 | 0.6 | 1.23 | 1.23 |

Table 3-10 Filter states of carrier power measurement

| | LTE | W-CDMA | GSM/EDGE | cdma2000 | 1xEV-DO |
|----------------|----------|------------|----------|----------|----------|
| ACP Method | Integ BW | RRC (0.22) | Integ BW | Integ BW | Integ BW |
| SEM Method | Integ BW | RRC (0.22) | Integ BW | Integ BW | Integ BW |
| CHP RRC Filter | OFF | OFF | OFF | OFF | OFF |

Offset/Limit Presets

Immediate action keys/commands are provided for Offset/Limit Presets. When one of these keys is pressed or a corresponding SCPI command is sent, Offset/Limit parameters of corresponding measurements are set to predefined values depending on the carrier configuration and mode setup parameters. There are two types of this preset command, meas global and local. Apply to Meas Offset/Limits on Carrier Setup menu is the meas global one. Pressing it would have ACP, SEM and SPUR recall mask files to set their offset or range parameters. The meas local keys exist on their Meas Setup menu. They preset only their local offset/limit parameters when the key is pressed. This preset is done by recalling mask files provided with XA FW which can be found under My Document/MSR folder. ACP, SEM and SPUR support Offset/Limit Preset.

Parameters affect the limit preset is listed below.

- ACP: Assumed Adj Channels, Carriers, Carrier Offset, LTE FDD BW, Radio Format
- SEM: Band Category, Carriers, Carrier Offset, Radio Format and Bandwidth of LTE FDD parameter set
- SPUR: Band Category, Carriers, Radio Format

Carrier Info Table

Several measurements have Carrier Info Table view in which the carrier setup summary is displayed with measured carrier powers in the order of carrier index in one of the view windows. Though carrier powers and some power results such as total power or reference power are displayed in the table view, this is basically considered as setup summary table and thus its background is white.

One of the rows is highlighted with green. This is a selected row and it is specified either by Select Carrier on Config Carrier menu under Freq/Chan, Carrier Setup or by a meas local parameter, e.g. Carrier Result in ACP. Selected row number and these parameters are not coupled. The row highlight moves to the specified one only when either of these parameters is changed. For example, ACP is active and the carrier table is shown with the first row highlighted. Carrier Result is 1 now. When the meas global parameter Select Carrier is set to 2, the highlight moves to the second row. The meas local parameter Carrier Result remains 1 because it is not coupled with any parameter. Then if Carrier Result is changed to 3, the third row is selected.

A vertical scroll bar appears if there are too many carriers to be displayed in the window. The scroll bar moves so that the highlighted row is displayed in the window when the row highlight is changed. You can control the table scroll using those two parameters that change the row selection.

| Total Power -10.99 dBm / 21.2MHz | | Total PSD -72.69 dBm / Hz | | RF-BW 35.00 MHz | |
|---|-----------|----------------------------------|-------------|------------------------|---------------|
| Carrier Pwr | Integ BW | Filter | Offset Freq | Measure | Parameter Set |
| 1 -18.58 dBm | 600 kHz | OFF | -17.300 MHz | On | GSM/EDGE 1 |
| 2 -18.67 dBm | 5.000 MHz | OFF | -7.5000 MHz | On | W-CDMA |
| 3 -18.58 dBm | 5.000 MHz | OFF | -2.5000 MHz | On | W-CDMA |
| 4 -18.70 dBm | 5.000 MHz | OFF | 2.5000 MHz | On | LTE FDD 1 |
| 5 -18.95 dBm | 5.000 MHz | OFF | 7.5000 MHz | On | LTE FDD 1 |
| 6 -19.21 dBm | 600 kHz | OFF | 17.300 MHz | On | GSM/EDGE 1 |

Carrier Conf Presets

The 3GPP standard for multi-standard radio requires that many tests are done with pre-defined carrier configurations. This carrier configuration is called Test Configuration in the 3GPP documents and there are several ones defined. For example, a test configuration for UTRA multi carrier tests is called Test Configuration 1a which is abbreviated as TC1a. MSR mode provides partial presets to set up carriers in the ways specified in the standard. It also provides presets for non standard carrier configuration which just puts single RAT carriers as many as allowed.

Carrier Config Presets set up following parameters.

Carrier parameters under Configure Carriers

Format set parameters under Mode Setup, Format menu

Offset/Limits of ACP, SEM (Limit Preset)

Carrier parameters are dynamically calculated using values of other parameters under Carrier Config Presets menu such as Max RF Bandwidth and max carrier of each radio format. Presets of format parameter set and measurement local parameters related to the limit calculations in ACP and SEM are done with partial state files provided with the FW.

The partial preset for carrier configuration is initiated every time when a value of any parameter under Carrier Config Presets is changed. For example, when TC1a (FDD) is selected with Max BS RF Bandwidth 40MHz, eight W-CDMA carriers are placed by default. Then if Max BS RF Bandwidth is reduced 30MHz, the partial preset is initiated to put six W-CDMA carriers.

Format Parameter List in Mode Setup

All parameters for each radio format can be modified in Format Parameter List in Mode Setup individually. There are three Format Parameter Lists for each radio format. You can assign one Format Parameter List to each carrier.

Basically, parameters are based on the measurement in each application as follows:

| Original Application / Measurement | Measurement SCPI node of Original Measurement |
|------------------------------------|---|
| GSM/EDGE / EDGE EVM | EEVM |
| W-CDMA / Mod Accuracy | RHO |
| LTE FDD / Conformance EVM | CEVM |
| cdma2000 / Mod Accuracy | RHO |
| 1xEV-DO / Mod Accuracy | RHO |

However, some parameters are from the original application's mode parameters and some are newly added.

If you have a set of SCPI lists to set up the original measurement, you can easily convert it for this measurement by simply replacing the measurement node name with "RADio:FORMat:<Radio Format node>" as follows:

| Radio Format | SCPI node in Original Measurement | Radio Format node |
|--------------|-----------------------------------|--------------------|
| GSM/EDGE | :EEVM | :GSM{List Index} |
| W-CDMA | :RHO | :WCDMa{List Index} |

| | | |
|----------|-------|--------------------------------|
| LTE FDD | :CEVM | :LTEFdd{List Index} |
| cdma2000 | :RHO | :RADio:FORMat:CDMA{List Index} |
| 1xEV-DO | :RHO | :RADio:FORMat:EVDO{List Index} |

For example,

GSM/EDGE mode – Frequency Error Tolerance Range in the EDGE EVM measurement

`[:SENSe]:EEVM:FERRor:TRANge`

--> `[:SENSe]:RADio:FORMat:GSM1:FERRor:TRANge (convert node)`

LTE mode – Detection in the Conformance EVM measurement

`[:SENSe]:CEVM:PROFile:AUTO:DETECT`

--> `[:SENSe]:RADio:FORMat:LTEFdd3:PROFile:AUTO:DETECT (convert node)`

For parameters from the original application's mode, you need to convert or insert the SCPI node individually. For example,

GSM/EDGE mode – Mod Scheme in the GSM/EDGE mode

`[:SENSe]:SYNC:NORMal:MODulation`

--> `[:SENSe]:RADio:FORMat:GSM1:SYNC:NORMal:MODulation (insert node)`

LTE mode - Spectrum in the LTE mode

`:SPECTrum`

--> `[:SENSe]:RADio:FORMat:LTEFdd3:SPECTrum (insert node)`

See the details about each format parameter list:

[“LTE FDD Format Parameter List” on page 71](#)

[“W-CDMA Format Parameter List” on page 73](#)

[“GSM/EDGE Format Parameter List” on page 77](#)

[“cdma2000 Format Parameter List” on page 81](#)

[“1xEV-DO Format Parameter List” on page 84](#)

LTE FDD Format Parameter List

Since most parameters are the same as those used in the original measurement, the SCPI commands in the original measurement can be used in this measurement by converting the measurement node.

Concepts

MSR Measurement Concepts

The following SCPI commands in the LTE FDD Conformance EVM measurement are converted for this measurement as follows:

| SCPI Command in LTE FDD CEVM | SCPI Command in this measurement |
|--------------------------------|---------------------------------------|
| [[:SENSe]:CEVM:AVERage:COUNT | [[:SENSe]:CEVM:LTEFdd:AVERage:COUNT |
| [[:SENSe]:CEVM:AVERage[:STATe] | [[:SENSe]:CEVM:LTEFdd:AVERage[:STATe] |

These commands above are not in the Format Parameter List.

The preset of the following command differs between the LTE FDD CEVM and MSR CEVM.

| SCPI Command in LTE FDD CEVM | SCPI Command in this measurement | Preset in this measurement |
|-------------------------------|---|----------------------------|
| [[:SENSe]:CEVM:MCFilter:STATe | [[:SENSe]:RADio:FORMat:LTEFdd{1:3}:MCFilter:STATe | 1 |

The following SCPI commands in the LTE FDD Conformance EVM measurement are not available in this measurement.

| SCPI Command not available in this Measurement |
|--|
| :DISPlay:CEVM:VIEW1 VIEW[:SElect] |
| [[:SENSe]:CEVM:AVERage:NUMBER |
| [[:SENSe]:CEVM:AVERage:TCONtrol |
| [[:SENSe]:CEVM:BERate:FILE:FORMat |
| [[:SENSe]:CEVM:BERate:FILE:NAME |
| [[:SENSe]:CEVM:BERate:FILE:PATH |
| [[:SENSe]:CEVM:BERate:FILE:Q:NAME |
| [[:SENSe]:CEVM:BERate:FILE:SEParated |
| [[:SENSe]:CEVM:BERate:OSRatio |
| [[:SENSe]:CEVM:DLINK:DECode:DFINclude |
| [[:SENSe]:CEVM:DLINK:DECode:RNTI:MAXimum:RA |
| [[:SENSe]:CEVM:DLINK:DECode:RNTI:MAXimum:TPC |
| [[:SENSe]:CEVM:DLINK:DECode:RNTI:MINimum:RA |
| [[:SENSe]:CEVM:DLINK:DECode:RNTI:MINimum:TPC |

| |
|--|
| [:SENSe]:CEVM:DLINK:RESult |
| [:SENSe]:CEVM:EVM:COPI[:IMMediate]/nquery/ |
| [:SENSe]:CEVM:ULINK:BERate:DECoder:CONFigure |
| [:SENSe]:CEVM:ULINK:BERate:DECoder:ITERation |
| [:SENSe]:CEVM:ULINK:BERate:DECoder[:STATe] |
| [:SENSe]:CEVM:ULINK:BERate:PRBS:SYNC:AUTO |
| [:SENSe]:CEVM:ULINK:BERate:PRBS:SYNC:INITial |
| [:SENSe]:CEVM:ULINK:BERate:PRBS[:TYPE] |
| [:SENSe]:CEVM:ULINK:BERate:RESult |
| [:SENSe]:CEVM:ULINK:BERate:RESYnc:LENGth |
| [:SENSe]:CEVM:ULINK:BERate:RESYnc:MODE |
| [:SENSe]:CEVM:ULINK:BERate[:STATe] |
| [:SENSe]:CEVM:ULINK:BERate:SYNC:AUTO |
| [:SENSe]:CEVM:ULINK:BERate:SYNC:FOFFset |
| [:SENSe]:CEVM:ULINK:BERate:SYNC:LOCation |
| [:SENSe]:CEVM:ULINK:DECode:PUSCh |
| [:SENSe]:CEVM:ULINK:RESult |

W-CDMA Format Parameter List

Since most parameters are the same as those used in the original measurement, the SCPI commands in the original measurement can be used in this measurement by converting the measurement node.

The following SCPI commands in the W-CDMA application are converted for this measurement as follows:

| Parameter Name | SCPI Command in W-CDMA mode | SCPI Command in W-CDMA Format Parameter List |
|----------------|--|--|
| HSPA Enable | [:SENSe]:RADio:CONFigure:EHSPa[:STATe] | [:SENSe]:RADio:FORMat:WCDMa{1:3}:CONFigure:EHSPa[:STATe] |
| HSPA+ Enable | [:SENSe]:RADio:CONFigure:HSDPa[:STATe] | [:SENSe]:RADio:FORMat:WCDMa{1:3}:CONFigure:HSDPa[:STATe] |

The following SCPI commands in the W-CDMA Mod Accuracy measurement are converted for this measurement as follows:

| SCPI Command in Mod Accuracy | SCPI Command in this measurement |
|------------------------------|-------------------------------------|
| [:SENSe]:RHO:AVERAge:COUnT | [:SENSe]:CEVM:WCDMa:AVERAge:COUnT |
| [:SENSe]:RHO:AVERAge[:STATe] | [:SENSe]:CEVM:WCDMa:AVERAge[:STATe] |

These commands above are not in the Format Parameter List.

The following SCPI commands in the W-CDMA Mod Accuracy measurement are not available in this measurement.

| |
|---|
| SCPI Command not available in this measurement |
| :CALCulate:RHO:LIMit:CDERror |
| :CALCulate:RHO:LIMit:CPICH[:BTS] |
| :CALCulate:RHO:LIMit:CPICH[:BTS]:POWEr |
| :CALCulate:RHO:LIMit:FERRor |
| :CALCulate:RHO:LIMit:PEAK |
| :CALCulate:RHO:LIMit:RHO |
| :CALCulate:RHO:LIMit:RMS |
| :CALCulate:RHO:MARKer{1:12}:AOFF/nquery/ |
| :CALCulate:RHO:MARKer{1:12}:CHIP |
| :CALCulate:RHO:MARKer{1:12}:COUPlE[:STATe] |
| :CALCulate:RHO:MARKer{1:12}:CPEak[:STATe] |
| :CALCulate:RHO:MARKer{1:12}:FUNCTion:RESult?/qonly/ |
| :CALCulate:RHO:MARKer{1:12}:MAXimum/nquery/ |
| :CALCulate:RHO:MARKer{1:12}:MAXimum:HIGHer/nquery/ |
| :CALCulate:RHO:MARKer{1:12}:MAXimum:LEFT/nquery/ |
| :CALCulate:RHO:MARKer{1:12}:MAXimum:LOWer/nquery/ |
| :CALCulate:RHO:MARKer{1:12}:MAXimum:NEXT/nquery/ |
| :CALCulate:RHO:MARKer{1:12}:MAXimum:RIGht/nquery/ |
| :CALCulate:RHO:MARKer{1:12}:MINimum/nquery/ |
| :CALCulate:RHO:MARKer{1:12}:MODE |
| :CALCulate:RHO:MARKer{1:12}:PTPeak/nquery/ |

| |
|---|
| :CALCulate:RHO:MARKer{1:12}:REFerence |
| :CALCulate:RHO:MARKer{1:12}:STATe |
| :CALCulate:RHO:MARKer{1:12}:TRACe |
| :CALCulate:RHO:MARKer{1:12}:X |
| :CALCulate:RHO:MARKer{1:12}:X:POSition |
| :CALCulate:RHO:MARKer{1:12}:Y?/qonly/ |
| :DISPlay:RHO:CDOMain:SPAN:START |
| :DISPlay:RHO:CDOMain:SPAN:STOP |
| :DISPlay:RHO:VIEW1 VIEW:NSElect |
| :DISPlay:RHO:VIEW1 VIEW[:SElect] |
| :DISPlay:RHO:VIEW1 VIEW:WINDow:TEXT:TFUNit |
| :DISPlay:RHO:VIEW1 VIEW:WINDow2:TRACe:COFFset |
| :DISPlay:RHO:VIEW1 VIEW:WINDow2:TRACe:FVECTor[:STATe] |
| :DISPlay:RHO:VIEW1 VIEW:WINDow2:TRACe:IQCHips |
| :DISPlay:RHO:VIEW1 VIEW:WINDow2:TRACe:POLar |
| :DISPlay:RHO:VIEW1 VIEW:WINDow2:TRACe:ROTQpi[:STATe] |
| :DISPlay:RHO:VIEW2:WINDow1 WINDow:TRACe:X[:SCALe]:COUPle |
| :DISPlay:RHO:VIEW2:WINDow1 WINDow:TRACe:X[:SCALe]:PDIVision |
| :DISPlay:RHO:VIEW2:WINDow1 WINDow:TRACe:X[:SCALe]:RLEVel |
| :DISPlay:RHO:VIEW2:WINDow1 WINDow:TRACe:X[:SCALe]:RPOSition |
| :DISPlay:RHO:VIEW2:WINDow1 WINDow:TRACe:Y[:SCALe]:COUPle |
| :DISPlay:RHO:VIEW2:WINDow1 WINDow:TRACe:Y[:SCALe]:PDIVision |
| :DISPlay:RHO:VIEW2:WINDow1 WINDow:TRACe:Y[:SCALe]:RLEVel |
| :DISPlay:RHO:VIEW2:WINDow1 WINDow:TRACe:Y[:SCALe]:RPOSition |
| :DISPlay:RHO:VIEW2:WINDow2:TRACe:X[:SCALe]:COUPle |
| :DISPlay:RHO:VIEW2:WINDow2:TRACe:X[:SCALe]:PDIVision |
| :DISPlay:RHO:VIEW2:WINDow2:TRACe:X[:SCALe]:RLEVel |
| :DISPlay:RHO:VIEW2:WINDow2:TRACe:X[:SCALe]:RPOSition |
| :DISPlay:RHO:VIEW2:WINDow2:TRACe:Y[:SCALe]:COUPle |
| :DISPlay:RHO:VIEW2:WINDow2:TRACe:Y[:SCALe]:PDIVision |

Concepts
MSR Measurement Concepts

| |
|--|
| :DISPlay:RHO:VIEW2:WINDow2:TRACe:Y[:SCALe]:RLEVel |
| :DISPlay:RHO:VIEW2:WINDow2:TRACe:Y[:SCALe]:RPOSition |
| :DISPlay:RHO:VIEW2:WINDow3:TRACe:X[:SCALe]:COUPle |
| :DISPlay:RHO:VIEW2:WINDow3:TRACe:X[:SCALe]:PDIVision |
| :DISPlay:RHO:VIEW2:WINDow3:TRACe:X[:SCALe]:RLEVel |
| :DISPlay:RHO:VIEW2:WINDow3:TRACe:X[:SCALe]:RPOSition |
| :DISPlay:RHO:VIEW2:WINDow3:TRACe:Y[:SCALe]:COUPle |
| :DISPlay:RHO:VIEW2:WINDow3:TRACe:Y[:SCALe]:PDIVision |
| :DISPlay:RHO:VIEW2:WINDow3:TRACe:Y[:SCALe]:RLEVel |
| :DISPlay:RHO:VIEW2:WINDow3:TRACe:Y[:SCALe]:RPOSition |
| :DISPlay:RHO:VIEW3:WINDow:TRACe:Y[:SCALe]:PDIVision |
| :DISPlay:RHO:VIEW3:WINDow:TRACe:Y[:SCALe]:RLEVel |
| :DISPlay:RHO:VIEW6:WINDow:TRACe:Y[:SCALe]:COUPle |
| :DISPlay:RHO:VIEW6:WINDow:TRACe:Y[:SCALe]:PDIVision |
| :DISPlay:RHO:VIEW6:WINDow:TRACe:Y[:SCALe]:RLEVel |
| :DISPlay:RHO:VIEW6:WINDow:TRACe:Y[:SCALe]:RPOSition |
| :DISPlay:RHO:VIEW6:WINDow2:TRACe:Y[:SCALe]:COUPle |
| :DISPlay:RHO:VIEW6:WINDow2:TRACe:Y[:SCALe]:PDIVision |
| :DISPlay:RHO:VIEW6:WINDow2:TRACe:Y[:SCALe]:RLEVel |
| :DISPlay:RHO:VIEW6:WINDow2:TRACe:Y[:SCALe]:RPOSition |
| :DISPlay:RHO:VIEW6:WINDow3:TRACe:Y[:SCALe]:COUPle |
| :DISPlay:RHO:VIEW6:WINDow3:TRACe:Y[:SCALe]:PDIVision |
| :DISPlay:RHO:VIEW6:WINDow3:TRACe:Y[:SCALe]:RLEVel |
| :DISPlay:RHO:VIEW6:WINDow3:TRACe:Y[:SCALe]:RPOSition |
| [:SENSe]:RHO:AVERAge:TCONtrol |
| [:SENSe]:RHO:AVERAge:TYPE |
| [:SENSe]:RHO:SBOundary:LIST[:BTS]:APPend |
| [:SENSe]:RHO:SBOundary:LIST[:BTS]:INIT |
| [:SENSe]:RHO:SBOundary:LIST[:BTS]:PRESet |
| [:SENSe]:RHO:SBOundary:LIST[:BTS]:REPLace |

| |
|--|
| [.SENSe]:RHO:SBOundary:LIST:MS:APPend |
| [.SENSe]:RHO:SBOundary:LIST:MS:INIT |
| [.SENSe]:RHO:SBOundary:LIST:MS:REPLace |
| [.SENSe]:RHO:SPECTrum |

GSM/EDGE Format Parameter List

Since most parameters are the same as those used in the original measurement, the SCPI commands in the original measurement can be used in this measurement by converting the measurement node.

The following SCPI commands in the GSM/EDGE application are converted for this measurement as follows:

| Parameter Name | SCPI Command in GSM/EDGE mode | SCPI Command in GSM/EDGE Format Parameter List |
|-------------------------|---------------------------------------|--|
| Burst Type | [.SENSe]:CHANnel:BURSt | [.SENSe]:RADio:FORMat:GSM{1:3}:CHANnel:BURSt |
| Time Slot | [.SENSe]:CHANnel:SLOT | [.SENSe]:RADio:FORMat:GSM{1:3}:CHANnel:SLOT |
| Time Slot State | [.SENSe]:CHANnel:SLOT:AUTO | [.SENSe]:RADio:FORMat:GSM{1:3}:CHANnel:SLOT:AUTO |
| TSC | [.SENSe]:CHANnel:TSCode | [.SENSe]:RADio:FORMat:GSM{1:3}:CHANnel:TSCode |
| TSC Auto Detection | [.SENSe]:CHANnel:TSCode:AUTO | [.SENSe]:RADio:FORMat:GSM{1:3}:CHANnel:TSCode:AUTO |
| Carrier Bandpass Filter | [.SENSe]:RADio:CARRier:NUMBER | [.SENSe]:RADio:FORMat:GSM{1:3}:RADio:CARRier:NUMBER |
| Carrier | [.SENSe]:RADio:CARRier[:TYPE] | [.SENSe]:RADio:FORMat:GSM{1:3}:RADio:CARRier[:TYPE] Note that the preset of this command is MULTI, while that of the original SCPI command is SING. |
| HSR Pulse Shape Filter | [.SENSe]:RADio:PSHape | [.SENSe]:RADio:FORMat:GSM{1:3}:RADio:PSHape |
| RF Sync Delay | [.SENSe]:SYNC:BURSt:RFAMplitude:DELay | [.SENSe]:RADio:FORMat:GSM{1:3}:SYNC:BURSt:RFAMplitude:DELay |
| Burst Search Threshold | [.SENSe]:SYNC:BURSt:STHReshold | [.SENSe]:RADio:FORMat:GSM{1:3}:SYNC:BURSt:STHReshold |
| Manual Method | [.SENSe]:SYNC:CONFigure:METHOD | [.SENSe]:RADio:FORMat:GSM{1:3}:SYNC:CONFigure:METHOD |

Concepts
MSR Measurement Concepts

| | | |
|---------------------|---|---|
| Mod Scheme HSR | [:SENSe]:SYNC:HSRate:MODulation | [:SENSe]:RADio:FORMat:GSM{1:3}:SYNC:HSRate:MODulation |
| Mod Scheme HSR Auto | [:SENSe]:SYNC:HSRate:MODulation:AUTO | [:SENSe]:RADio:FORMat:GSM{1:3}:SYNC:HSRate:MODulation:AUTO |
| Mod Scheme | [:SENSe]:SYNC:NORMal:MODulation | [:SENSe]:RADio:FORMat:GSM{1:3}:SYNC:NORMal:MODulation |
| AQPSK SCPIR | [:SENSe]:SYNC:NORMal:MODulation:AQPSk:ALPHa:SCPIr | [:SENSe]:RADio:FORMat:GSM{1:3}:SYNC:NORMal:MODulation:AQPSk:ALPHa:SCPIr |
| Mod Scheme Auto | [:SENSe]:SYNC:NORMal:MODulation:AUTO | [:SENSe]:RADio:FORMat:GSM{1:3}:SYNC:NORMal:MODulation:AUTO |
| AQPSK AutoDet | [:SENSe]:SYNC:NORMal:MODulation:AUTO:AQPSk | [:SENSe]:RADio:FORMat:GSM{1:3}:SYNC:NORMal:MODulation:AUTO:AQPSk |

The following SCPI commands in the GSM/EDGE EDGE EVM measurement are converted for this measurement as follows:

| SCPI Command in EDGE EVM | SCPI Command in this measurement |
|-------------------------------|-----------------------------------|
| [:SENSe]:EEVM:AVERage:COUNT | [:SENSe]:CEVM:GSM:AVERage:COUNT |
| [:SENSe]:EEVM:AVERage[:STATe] | [:SENSe]:CEVM:GSM:AVERage[:STATe] |

These commands above are not in the Format Parameter List.

The following SCPI commands in the GSM/EDGE EDGE EVM measurement are not available in this measurement.

| |
|--|
| SCPI Command not available in this measurement |
| :CALCulate:EEVM:LIMit:BTS:EXTRemE:EVMP95 |
| :CALCulate:EEVM:LIMit:BTS:EXTRemE:FERRor |
| :CALCulate:EEVM:LIMit:BTS:EXTRemE:IQOOffset |
| :CALCulate:EEVM:LIMit:BTS:EXTRemE:PEVM |
| :CALCulate:EEVM:LIMit:BTS:EXTRemE:PPERror |
| :CALCulate:EEVM:LIMit:BTS:EXTRemE:REVM |
| :CALCulate:EEVM:LIMit:BTS:EXTRemE:REVM:HSRate |
| :CALCulate:EEVM:LIMit:BTS:EXTRemE:REVM:NSRate |
| :CALCulate:EEVM:LIMit:BTS:EXTRemE:RPERror |
| :CALCulate:EEVM:LIMit:BTS:NORMal:EVMP95 |

| |
|--|
| :CALCulate:EEVM:LIMit:BTS:NORMal:FERRor |
| :CALCulate:EEVM:LIMit:BTS:NORMal:IQOOffset |
| :CALCulate:EEVM:LIMit:BTS:NORMal:PEVM |
| :CALCulate:EEVM:LIMit:BTS:NORMal:PPERror |
| :CALCulate:EEVM:LIMit:BTS:NORMal:REVM |
| :CALCulate:EEVM:LIMit:BTS:NORMal:REVM:HSRate |
| :CALCulate:EEVM:LIMit:BTS:NORMal:REVM:NSRate |
| :CALCulate:EEVM:LIMit:BTS:NORMal:RPERror |
| :CALCulate:EEVM:LIMit:MBTS:EXTReme:FERRor |
| :CALCulate:EEVM:LIMit:MBTS:NORMal:FERRor |
| :CALCulate:EEVM:LIMit:MS:EXTReme:EVMP95 |
| :CALCulate:EEVM:LIMit:MS:EXTReme:FERRor |
| :CALCulate:EEVM:LIMit:MS:EXTReme:IQOOffset |
| :CALCulate:EEVM:LIMit:MS:EXTReme:PEVM |
| :CALCulate:EEVM:LIMit:MS:EXTReme:PPERror |
| :CALCulate:EEVM:LIMit:MS:EXTReme:REVM |
| :CALCulate:EEVM:LIMit:MS:EXTReme:REVM:HSRate |
| :CALCulate:EEVM:LIMit:MS:EXTReme:REVM:NSRate |
| :CALCulate:EEVM:LIMit:MS:EXTReme:RPERror |
| :CALCulate:EEVM:LIMit:MS:NORMal:EVMP95 |
| :CALCulate:EEVM:LIMit:MS:NORMal:FERRor |
| :CALCulate:EEVM:LIMit:MS:NORMal:IQOOffset |
| :CALCulate:EEVM:LIMit:MS:NORMal:PEVM |
| :CALCulate:EEVM:LIMit:MS:NORMal:PPERror |
| :CALCulate:EEVM:LIMit:MS:NORMal:REVM |
| :CALCulate:EEVM:LIMit:MS:NORMal:REVM:HSRate |
| :CALCulate:EEVM:LIMit:MS:NORMal:REVM:NSRate |
| :CALCulate:EEVM:LIMit:MS:NORMal:RPERror |
| :CALCulate:EEVM:LIMit:PBTS:EXTReme:FERRor |
| :CALCulate:EEVM:LIMit:PBTS:NORMal:FERRor |

Concepts
MSR Measurement Concepts

| |
|---|
| :CALCulate:EEVM:LIMit:TEST[:STATe] |
| :CALCulate:EEVM:LIMit:TYPE |
| :CALCulate:EEVM:MARKer{1:12}:AOFF/nquery/ |
| :CALCulate:EEVM:MARKer{1:12}:COUPle[:STATe] |
| :CALCulate:EEVM:MARKer{1:12}:FUNction:RESult?/qonly/ |
| :CALCulate:EEVM:MARKer{1:12}:MAXimum/nquery/ |
| :CALCulate:EEVM:MARKer{1:12}:MINimum/nquery/ |
| :CALCulate:EEVM:MARKer{1:12}:MODE |
| :CALCulate:EEVM:MARKer{1:12}:REFerence |
| :CALCulate:EEVM:MARKer{1:12}:STATe |
| :CALCulate:EEVM:MARKer{1:12}:TRACe |
| :CALCulate:EEVM:MARKer{1:12}:X |
| :CALCulate:EEVM:MARKer{1:12}:X:POSition |
| :CALCulate:EEVM:MARKer{1:12}:Y?/qonly/ |
| :DISPlay:EEVM:SDERotation[:STATe] |
| :DISPlay:EEVM:SDOTs[:STATe] [:SENSe]:EEVM:SDOTs[:STATe] (BWCC) |
| :DISPlay:EEVM:TEXT:TFUNit |
| :DISPlay:EEVM:VIEW1 VIEW:NSElect |
| :DISPlay:EEVM:VIEW1 VIEW[:SElect] |
| :DISPlay:EEVM:VIEW1 VIEW:WINDow2:TRACe:POLar |
| :DISPlay:EEVM:VIEW2:WINDow:TRACe:MAXHold[:STATe] |
| :DISPlay:EEVM:VIEW2:WINDow:TRACe:MINHold[:STATe] |
| :DISPlay:EEVM:VIEW2:WINDow:TRACe:X[:SCALE]:COUPle |
| :DISPlay:EEVM:VIEW2:WINDow:TRACe:X[:SCALE]:PDIVision |
| :DISPlay:EEVM:VIEW2:WINDow:TRACe:X[:SCALE]:RLEVel |
| :DISPlay:EEVM:VIEW2:WINDow:TRACe:X[:SCALE]:RPOSition |
| :DISPlay:EEVM:VIEW2:WINDow:TRACe:Y[:SCALE]:COUPle |
| :DISPlay:EEVM:VIEW2:WINDow:TRACe:Y[:SCALE]:PDIVision |
| :DISPlay:EEVM:VIEW2:WINDow:TRACe:Y[:SCALE]:RLEVel |

| |
|---|
| :DISPlay:EEVM:VIEW2:WINDow:TRACe:Y[:SCALe]:RPOSition |
| :DISPlay:EEVM:VIEW2:WINDow2:TRACe:X[:SCALe]:COUPle |
| :DISPlay:EEVM:VIEW2:WINDow2:TRACe:X[:SCALe]:PDIVision |
| :DISPlay:EEVM:VIEW2:WINDow2:TRACe:X[:SCALe]:RLEVel |
| :DISPlay:EEVM:VIEW2:WINDow2:TRACe:X[:SCALe]:RPOSition |
| :DISPlay:EEVM:VIEW2:WINDow2:TRACe:Y[:SCALe]:COUPle |
| :DISPlay:EEVM:VIEW2:WINDow2:TRACe:Y[:SCALe]:PDIVision |
| :DISPlay:EEVM:VIEW2:WINDow2:TRACe:Y[:SCALe]:RLEVel |
| :DISPlay:EEVM:VIEW2:WINDow2:TRACe:Y[:SCALe]:RPOSition |
| :DISPlay:EEVM:VIEW2:WINDow3:TRACe:X[:SCALe]:COUPle |
| :DISPlay:EEVM:VIEW2:WINDow3:TRACe:X[:SCALe]:PDIVision |
| :DISPlay:EEVM:VIEW2:WINDow3:TRACe:X[:SCALe]:RLEVel |
| :DISPlay:EEVM:VIEW2:WINDow3:TRACe:X[:SCALe]:RPOSition |
| :DISPlay:EEVM:VIEW2:WINDow3:TRACe:Y[:SCALe]:COUPle |
| :DISPlay:EEVM:VIEW2:WINDow3:TRACe:Y[:SCALe]:PDIVision |
| :DISPlay:EEVM:VIEW2:WINDow3:TRACe:Y[:SCALe]:RLEVel |
| :DISPlay:EEVM:VIEW2:WINDow3:TRACe:Y[:SCALe]:RPOSition |
| [:SENSe]:EEVM:AVERAge:TCONtrol |
| [:SENSe]:EEVM:AVERAge:TYPE |

cdma2000 Format Parameter List

Since most parameters are the same as those used in the original measurement, the SCPI commands in the original measurement can be used in this measurement by converting the measurement node.

The following SCPI commands in the cdma2000 Mod Accuracy measurement are converted for this measurement as follows:

| SCPI Command in Mod Accuracy | SCPI Command in this measurement |
|------------------------------|------------------------------------|
| [:SENSe]:RHO:AVERAge:COUNT | [:SENSe]:CEVM:CDMA:AVERAge:COUNT |
| [:SENSe]:RHO:AVERAge[:STATe] | [:SENSe]:CEVM:CDMA:AVERAge[:STATe] |
| [:SENSe]:RHO:SPECTrum | [:SENSe]:CEVM:SPECTrum |

These commands above are not in the Format Parameter List.

Concepts
MSR Measurement Concepts

The following SCPI commands in the cdma2000 Mod Accuracy are not available in this measurement.

| |
|---|
| SCPI Command not available in this measurement |
| :CALCulate:RHO:DTXBurst |
| :CALCulate:RHO:LIMit:CDERror |
| :CALCulate:RHO:LIMit:PEAK |
| :CALCulate:RHO:LIMit:PHASe |
| :CALCulate:RHO:LIMit:RHO |
| :CALCulate:RHO:LIMit:RMS |
| :CALCulate:RHO:LIMit:TIMing |
| :CALCulate:RHO:MARKer{1:12}:AOFF/nquery/ |
| :CALCulate:RHO:MARKer{1:12}:CHIP |
| :CALCulate:RHO:MARKer{1:12}:COUPle[:STATe] |
| :CALCulate:RHO:MARKer{1:12}:CPEak[:STATe] |
| :CALCulate:RHO:MARKer{1:12}:FUNCTion:RESult?/qonly/ |
| :CALCulate:RHO:MARKer{1:12}:MAXimum/nquery/ |
| :CALCulate:RHO:MARKer{1:12}:MAXimum:HIGHer/nquery/ |
| :CALCulate:RHO:MARKer{1:12}:MAXimum:LEFT/nquery/ |
| :CALCulate:RHO:MARKer{1:12}:MAXimum:LOWer/nquery/ |
| :CALCulate:RHO:MARKer{1:12}:MAXimum:NEXT/nquery/ |
| :CALCulate:RHO:MARKer{1:12}:MAXimum:RIGHT/nquery/ |
| :CALCulate:RHO:MARKer{1:12}:MINimum/nquery/ |
| :CALCulate:RHO:MARKer{1:12}:MODE |
| :CALCulate:RHO:MARKer{1:12}:PTPeak/nquery/ |
| :CALCulate:RHO:MARKer{1:12}:REFerence |
| :CALCulate:RHO:MARKer{1:12}:STATe |
| :CALCulate:RHO:MARKer{1:12}:TRACe |
| :CALCulate:RHO:MARKer{1:12}:X |
| :CALCulate:RHO:MARKer{1:12}:X:POSition |
| :CALCulate:RHO:MARKer{1:12}:Y?/qonly/ |

| |
|---|
| :DISPlay:RHO:ANNOtation:TITLe:DATA |
| :DISPlay:RHO:VIEW1 VIEW:NSElect |
| :DISPlay:RHO:VIEW1 VIEW[:SElect] |
| :DISPlay:RHO:VIEW1 VIEW:WINDow:TEXT:TFUNit |
| :DISPlay:RHO:VIEW1 VIEW:WINDow:TRACe:COFFset |
| :DISPlay:RHO:VIEW1 VIEW:WINDow:TRACe:FVEctor[:STATe] |
| :DISPlay:RHO:VIEW1 VIEW:WINDow:TRACe:IQCHips |
| :DISPlay:RHO:VIEW1 VIEW:WINDow:TRACe:POLar |
| :DISPlay:RHO:VIEW1 VIEW:WINDow:TRACe:ROTQpi[:STATe] |
| :DISPlay:RHO:VIEW2:WINDow1 WINDow:TRACe:X[:SCALe]:COUPle |
| :DISPlay:RHO:VIEW2:WINDow1 WINDow:TRACe:X[:SCALe]:PDIVision |
| :DISPlay:RHO:VIEW2:WINDow1 WINDow:TRACe:X[:SCALe]:RLEVel |
| :DISPlay:RHO:VIEW2:WINDow1 WINDow:TRACe:X[:SCALe]:RPOStion |
| :DISPlay:RHO:VIEW2:WINDow1 WINDow:TRACe:Y[:SCALe]:COUPle |
| :DISPlay:RHO:VIEW2:WINDow1 WINDow:TRACe:Y[:SCALe]:PDIVision |
| :DISPlay:RHO:VIEW2:WINDow1 WINDow:TRACe:Y[:SCALe]:RLEVel |
| :DISPlay:RHO:VIEW2:WINDow1 WINDow:TRACe:Y[:SCALe]:RPOStion |
| :DISPlay:RHO:VIEW2:WINDow2:TRACe:X[:SCALe]:COUPle |
| :DISPlay:RHO:VIEW2:WINDow2:TRACe:X[:SCALe]:PDIVision |
| :DISPlay:RHO:VIEW2:WINDow2:TRACe:X[:SCALe]:RLEVel |
| :DISPlay:RHO:VIEW2:WINDow2:TRACe:X[:SCALe]:RPOStion |
| :DISPlay:RHO:VIEW2:WINDow2:TRACe:Y[:SCALe]:COUPle |
| :DISPlay:RHO:VIEW2:WINDow2:TRACe:Y[:SCALe]:PDIVision |
| :DISPlay:RHO:VIEW2:WINDow2:TRACe:Y[:SCALe]:RLEVel |
| :DISPlay:RHO:VIEW2:WINDow2:TRACe:Y[:SCALe]:RPOStion |
| :DISPlay:RHO:VIEW2:WINDow3:TRACe:X[:SCALe]:COUPle |
| :DISPlay:RHO:VIEW2:WINDow3:TRACe:X[:SCALe]:PDIVision |
| :DISPlay:RHO:VIEW2:WINDow3:TRACe:X[:SCALe]:RLEVel |
| :DISPlay:RHO:VIEW2:WINDow3:TRACe:X[:SCALe]:RPOStion |
| :DISPlay:RHO:VIEW2:WINDow3:TRACe:Y[:SCALe]:COUPle |

| |
|--|
| :DISPlay:RHO:VIEW2:WINDow3:TRACe:Y[:SCALe]:PDIVision |
| :DISPlay:RHO:VIEW2:WINDow3:TRACe:Y[:SCALe]:RLEVel |
| :DISPlay:RHO:VIEW2:WINDow3:TRACe:Y[:SCALe]:RPOStion |
| [:SENSe]:RHO:AVERAge:TCONtrol |
| [:SENSe]:RHO:AVERAge:TYPE |
| [:SENSe]:RHO:TRIGger:SOURce |

1xEV-DO Format Parameter List

Since most parameters are the same as those used in the original measurement, the SCPI commands in the original measurement can be used in this measurement by converting the measurement node.

The following SCPI commands in the 1xEV-DO application are converted for this measurement as follows:

| Parameter Name | SCPI Command in 1xEV-DO mode | SCPI Command in 1xEV-DO Format Parameter List |
|------------------------|------------------------------|---|
| Physical Layer Subtype | [:SENSe]:RADio:PLSubtype | [:SENSe]:RADio:FORMat:EVDO{1:3}:PLSubtype |

The following SCPI commands in the 1xEV-DO Mod Accuracy measurement are converted for this measurement as follows:

| SCPI Command in Mod Accuracy | SCPI Command in this measurement |
|---|------------------------------------|
| [:SENSe]:RHO[:BTS]:AVERAge:COUNT [:SENSe]:RHO:MS:AVERAge:COUNT | [:SENSe]:CEVM:EVDO:AVERAge:COUNT |
| [:SENSe]:RHO[:BTS]:AVERAge[:STATe] [:SENSe]:RHO:MS:AVERAge[:STATe] | [:SENSe]:CEVM:EVDO:AVERAge[:STATe] |
| [:SENSe]:RHO[:BTS]:SPECTrum [:SENSe]:RHO:MS:SPECTrum | [:SENSe]:CEVM:SPECTrum |

These commands are not in the Format Parameter List.

The following SCPI commands in the 1xEV-DO Mod Accuracy measurement are not available in this measurement.

| |
|---|
| SCPI Command not available in this measurement |
| :CALCulate:RHO[:BTS]:LIMit:DATA[:ACTIve]:LOWer |
| :CALCulate:RHO[:BTS]:LIMit:DATA[:ACTIve]][:UPPer] |

| |
|---|
| :CALCulate:RHO[:BTS]:LIMit:FREQuency |
| :CALCulate:RHO[:BTS]:LIMit:MAC:INACTive[:UPPer] |
| :CALCulate:RHO[:BTS]:LIMit:PEAK |
| :CALCulate:RHO[:BTS]:LIMit:PHASe |
| :CALCulate:RHO[:BTS]:LIMit:POFFset |
| :CALCulate:RHO[:BTS]:LIMit:PRESet |
| :CALCulate:RHO[:BTS]:LIMit:RHO:ALL |
| :CALCulate:RHO[:BTS]:LIMit:RHO:DATA |
| :CALCulate:RHO[:BTS]:LIMit:RHO:MAC |
| :CALCulate:RHO[:BTS]:LIMit:RHO:PILOt |
| :CALCulate:RHO[:BTS]:LIMit:RHO:PREamble |
| :CALCulate:RHO[:BTS]:LIMit:RMS |
| :CALCulate:RHO[:BTS]:LIMit:TIMing |
| :CALCulate:RHO[:BTS]:MARKer{1:12}:AOFF/nquery/ |
| :CALCulate:RHO[:BTS]:MARKer{1:12}:CHIP |
| :CALCulate:RHO[:BTS]:MARKer{1:12}:COUPlE[:STATe] |
| :CALCulate:RHO[:BTS]:MARKer{1:12}:MAXimum/nquery/ |
| :CALCulate:RHO[:BTS]:MARKer{1:12}:MAXimum:LEFT/nquery/ |
| :CALCulate:RHO[:BTS]:MARKer{1:12}:MAXimum:NEXT/nquery/ |
| :CALCulate:RHO[:BTS]:MARKer{1:12}:MAXimum:RIGHt/nquery/ |
| :CALCulate:RHO[:BTS]:MARKer{1:12}:MINimum/nquery/ |
| :CALCulate:RHO[:BTS]:MARKer{1:12}:MODE |
| :CALCulate:RHO[:BTS]:MARKer{1:12}:PTPeak/nquery/ |
| :CALCulate:RHO[:BTS]:MARKer{1:12}:REFerence |
| :CALCulate:RHO[:BTS]:MARKer{1:12}:STATe |
| :CALCulate:RHO[:BTS]:MARKer{1:12}:TRACe |
| :CALCulate:RHO[:BTS]:MARKer{1:12}:X |
| :CALCulate:RHO[:BTS]:MARKer{1:12}:X:POSition |
| :CALCulate:RHO[:BTS]:MARKer{1:12}:Y?/qonly/ |
| :CALCulate:RHO[:BTS]:WCODe:ORDer |

Concepts

MSR Measurement Concepts

| |
|---|
| :CALCulate:RHO[:BTS]:IQ:COMBined[:STATe] |
| :DISPlay:RHO[:BTS]:ANNOtation:TITLe:DATA |
| :DISPlay:RHO[:BTS]:CDEScramble[:STATe] |
| :DISPlay:RHO[:BTS]:CHANnel:TYPE |
| :DISPlay:RHO[:BTS]:FVECTor[:STATe] |
| :DISPlay:RHO[:BTS]:INTErpolate |
| :DISPlay:RHO[:BTS]:IQCHIps |
| :DISPlay:RHO[:BTS]:IQPTYPE |
| :DISPlay:RHO[:BTS]:OFFSet |
| :DISPlay:RHO[:BTS]:ROTQpi[:STATe] |
| :DISPlay:RHO[:BTS]:VIEW:NSElect |
| :DISPlay:RHO[:BTS]:VIEW[:SElect] |
| :DISPlay:RHO[:BTS]:VIEW5:WINDow1 WINDow:TRACe:X[:SCALe]:COUPlE |
| :DISPlay:RHO[:BTS]:VIEW5:WINDow1 WINDow:TRACe:X[:SCALe]:PDIVision |
| :DISPlay:RHO[:BTS]:VIEW5:WINDow1 WINDow:TRACe:X[:SCALe]:RLEVel |
| :DISPlay:RHO[:BTS]:VIEW5:WINDow1 WINDow:TRACe:X[:SCALe]:RPOStion |
| :DISPlay:RHO[:BTS]:VIEW5:WINDow1 WINDow:TRACe:Y[:SCALe]:COUPlE |
| :DISPlay:RHO[:BTS]:VIEW5:WINDow1 WINDow:TRACe:Y[:SCALe]:PDIVision |
| :DISPlay:RHO[:BTS]:VIEW5:WINDow1 WINDow:TRACe:Y[:SCALe]:RLEVel |
| :DISPlay:RHO[:BTS]:VIEW5:WINDow1 WINDow:TRACe:Y[:SCALe]:RPOStion |
| :DISPlay:RHO[:BTS]:VIEW5:WINDow2:TRACe:X[:SCALe]:COUPlE |
| :DISPlay:RHO[:BTS]:VIEW5:WINDow2:TRACe:X[:SCALe]:PDIVision |
| :DISPlay:RHO[:BTS]:VIEW5:WINDow2:TRACe:X[:SCALe]:RLEVel |
| :DISPlay:RHO[:BTS]:VIEW5:WINDow2:TRACe:X[:SCALe]:RPOStion |
| :DISPlay:RHO[:BTS]:VIEW5:WINDow2:TRACe:Y[:SCALe]:COUPlE |
| :DISPlay:RHO[:BTS]:VIEW5:WINDow2:TRACe:Y[:SCALe]:PDIVision |
| :DISPlay:RHO[:BTS]:VIEW5:WINDow2:TRACe:Y[:SCALe]:RLEVel |
| :DISPlay:RHO[:BTS]:VIEW5:WINDow2:TRACe:Y[:SCALe]:RPOStion |
| :DISPlay:RHO[:BTS]:VIEW5:WINDow3:TRACe:X[:SCALe]:COUPlE |
| :DISPlay:RHO[:BTS]:VIEW5:WINDow3:TRACe:X[:SCALe]:PDIVision |

| |
|---|
| :DISPlay:RHO[:BTS]:VIEW5:WINDow3:TRACe:X[:SCALe]:RLEVel |
| :DISPlay:RHO[:BTS]:VIEW5:WINDow3:TRACe:X[:SCALe]:RPOSition |
| :DISPlay:RHO[:BTS]:VIEW5:WINDow3:TRACe:Y[:SCALe]:COUPle |
| :DISPlay:RHO[:BTS]:VIEW5:WINDow3:TRACe:Y[:SCALe]:PDIVision |
| :DISPlay:RHO[:BTS]:VIEW5:WINDow3:TRACe:Y[:SCALe]:RLEVel |
| :DISPlay:RHO[:BTS]:VIEW5:WINDow3:TRACe:Y[:SCALe]:RPOSition |
| :DISPlay:RHO[:BTS]:VIEW6:WINDow1 WINDow:TRACe:X[:SCALe]:COUPle |
| :DISPlay:RHO[:BTS]:VIEW6:WINDow1 WINDow:TRACe:X[:SCALe]:PDIVision |
| :DISPlay:RHO[:BTS]:VIEW6:WINDow1 WINDow:TRACe:X[:SCALe]:RLEVel |
| :DISPlay:RHO[:BTS]:VIEW6:WINDow1 WINDow:TRACe:X[:SCALe]:RPOSition |
| :DISPlay:RHO[:BTS]:VIEW6:WINDow1 WINDow:TRACe:Y[:SCALe]:COUPle |
| :DISPlay:RHO[:BTS]:VIEW6:WINDow1 WINDow:TRACe:Y[:SCALe]:PDIVision |
| :DISPlay:RHO[:BTS]:VIEW6:WINDow1 WINDow:TRACe:Y[:SCALe]:RLEVel |
| :DISPlay:RHO[:BTS]:VIEW6:WINDow1 WINDow:TRACe:Y[:SCALe]:RPOSition |
| :DISPlay:RHO[:BTS]:VIEW6:WINDow2:TRACe:X[:SCALe]:COUPle |
| :DISPlay:RHO[:BTS]:VIEW6:WINDow2:TRACe:X[:SCALe]:PDIVision |
| :DISPlay:RHO[:BTS]:VIEW6:WINDow2:TRACe:X[:SCALe]:RLEVel |
| :DISPlay:RHO[:BTS]:VIEW6:WINDow2:TRACe:X[:SCALe]:RPOSition |
| :DISPlay:RHO[:BTS]:VIEW6:WINDow2:TRACe:Y[:SCALe]:COUPle |
| :DISPlay:RHO[:BTS]:VIEW6:WINDow2:TRACe:Y[:SCALe]:PDIVision |
| :DISPlay:RHO[:BTS]:VIEW6:WINDow2:TRACe:Y[:SCALe]:RLEVel |
| :DISPlay:RHO[:BTS]:VIEW6:WINDow2:TRACe:Y[:SCALe]:RPOSition |
| :DISPlay:RHO[:BTS]:VIEW7:WINDow1 WINDow:TRACe:X[:SCALe]:PDIVision |
| :DISPlay:RHO[:BTS]:VIEW7:WINDow1 WINDow:TRACe:X[:SCALe]:RLEVel |
| :DISPlay:RHO[:BTS]:VIEW7:WINDow1 WINDow:TRACe:X[:SCALe]:RPOSition |
| :DISPlay:RHO[:BTS]:VIEW7:WINDow1 WINDow:TRACe:Y[:SCALe]:COUPle |
| :DISPlay:RHO[:BTS]:VIEW7:WINDow1 WINDow:TRACe:Y[:SCALe]:PDIVision |
| :DISPlay:RHO[:BTS]:VIEW7:WINDow1 WINDow:TRACe:Y[:SCALe]:RLEVel |
| [:SENSe]:RHO[:BTS]:AVERAge:TCONtrol |
| [:SENSe]:RHO[:BTS]:TRIGger:SOURce |

Concepts
MSR Measurement Concepts

| |
|---|
| [.SENSe]:RHO:SWEEp:POINts |
| :CALCulate:RHO:MS:IQ:COMBined[:STATe] |
| :CALCulate:RHO:MS:LIMit:ACDPower[:SUB0] |
| :CALCulate:RHO:MS:LIMit:ACDPower:SUB2 |
| :CALCulate:RHO:MS:LIMit:ACK:GAIN[:SUB0] |
| :CALCulate:RHO:MS:LIMit:ACK:GAIN:SUB2 |
| :CALCulate:RHO:MS:LIMit:AUXPilot:GAIN:SUB2 |
| :CALCulate:RHO:MS:LIMit:CDERror[:SUB0] |
| :CALCulate:RHO:MS:LIMit:CDERror:SUB2 |
| :CALCulate:RHO:MS:LIMit:DATA:GAIN[:SUB0] |
| :CALCulate:RHO:MS:LIMit:DRC:GAIN[:SUB0] |
| :CALCulate:RHO:MS:LIMit:DRC:GAIN:SUB2 |
| :CALCulate:RHO:MS:LIMit:DSC:GAIN:SUB2 |
| :CALCulate:RHO:MS:LIMit:FERRor[:SUB0] |
| :CALCulate:RHO:MS:LIMit:FERRor:SUB2 |
| :CALCulate:RHO:MS:LIMit:ICDPower[:SUB0] |
| :CALCulate:RHO:MS:LIMit:ICDPower:SUB2 |
| :CALCulate:RHO:MS:LIMit:PEAK[:SUB0] |
| :CALCulate:RHO:MS:LIMit:PEAK:SUB2 |
| :CALCulate:RHO:MS:LIMit:POFFset[:SUB0] |
| :CALCulate:RHO:MS:LIMit:POFFset:SUB2 |
| :CALCulate:RHO:MS:LIMit:RHO[:SUB0] |
| :CALCulate:RHO:MS:LIMit:RHO:SUB2 |
| :CALCulate:RHO:MS:LIMit:RMS[:SUB0] |
| :CALCulate:RHO:MS:LIMit:RMS:SUB2 |
| :CALCulate:RHO:MS:LIMit:RRI:GAIN:SUB2 |
| :CALCulate:RHO:MS:LIMit:RRI[:SUB0] |
| :CALCulate:RHO:MS:LIMit:T2P:TOTal:GAIN:SUB2 |
| :CALCulate:RHO:MS:MARKer{1:12}:AOFF |
| :CALCulate:RHO:MS:MARKer{1:12}:CHIP |

| |
|--|
| :CALCulate:RHO:MS:MARKer{1:12}:COUPle[:STATe] |
| :CALCulate:RHO:MS:MARKer{1:12}:MAXimum |
| :CALCulate:RHO:MS:MARKer{1:12}:MAXimum:LEFT |
| :CALCulate:RHO:MS:MARKer{1:12}:MAXimum:NEXT |
| :CALCulate:RHO:MS:MARKer{1:12}:MAXimum:RIGHT |
| :CALCulate:RHO:MS:MARKer{1:12}:MINimum |
| :CALCulate:RHO:MS:MARKer{1:12}:MODE |
| :CALCulate:RHO:MS:MARKer{1:12}:PTPeak |
| :CALCulate:RHO:MS:MARKer{1:12}:REFerence |
| :CALCulate:RHO:MS:MARKer{1:12}:STATe |
| :CALCulate:RHO:MS:MARKer{1:12}:TRACe |
| :CALCulate:RHO:MS:MARKer{1:12}:X |
| :CALCulate:RHO:MS:MARKer{1:12}:X:POSition |
| :CALCulate:RHO:MS:MARKer{1:12}:Y?/qonly/ |
| :CALCulate:RHO:MS:WCODe:ORDer |
| :DISPlay:RHO:MS:ANNOtation:TITLe:DATA |
| :DISPlay:RHO:MS:FVECTor[:STATe] |
| :DISPlay:RHO:MS:INTerpolate |
| :DISPlay:RHO:MS:IQCHeads |
| :DISPlay:RHO:MS:IQPType |
| :DISPlay:RHO:MS:MARKer:CONSolidated |
| :DISPlay:RHO:MS:OFFSet |
| :DISPlay:RHO:MS:PointPerChip |
| :DISPlay:RHO:MS:ROTQpi[:STATe] |
| :DISPlay:RHO:MS:VIEW1 VIEW:NSElect |
| :DISPlay:RHO:MS:VIEW1 VIEW[:SElect] |
| :DISPlay:RHO:MS:VIEW3:WINDow1 WINDow:TRACe:X[:SCALe]:COUPle |
| :DISPlay:RHO:MS:VIEW3:WINDow1 WINDow:TRACe:X[:SCALe]:PDIVision |
| :DISPlay:RHO:MS:VIEW3:WINDow1 WINDow:TRACe:X[:SCALe]:RLEVel |
| :DISPlay:RHO:MS:VIEW3:WINDow1 WINDow:TRACe:X[:SCALe]:RPOSition |

Concepts

MSR Measurement Concepts

| |
|--|
| :DISPlay:RHO:MS:VIEW3:WINDow1 WINDow:TRACe:Y[:SCALe]:COUPle |
| :DISPlay:RHO:MS:VIEW3:WINDow1 WINDow:TRACe:Y[:SCALe]:PDIVision |
| :DISPlay:RHO:MS:VIEW3:WINDow1 WINDow:TRACe:Y[:SCALe]:RLEVel |
| :DISPlay:RHO:MS:VIEW3:WINDow1 WINDow:TRACe:Y[:SCALe]:RPOSition |
| :DISPlay:RHO:MS:VIEW3:WINDow2:TRACe:X[:SCALe]:COUPle |
| :DISPlay:RHO:MS:VIEW3:WINDow2:TRACe:X[:SCALe]:PDIVision |
| :DISPlay:RHO:MS:VIEW3:WINDow2:TRACe:X[:SCALe]:RLEVel |
| :DISPlay:RHO:MS:VIEW3:WINDow2:TRACe:X[:SCALe]:RPOSition |
| :DISPlay:RHO:MS:VIEW3:WINDow2:TRACe:Y[:SCALe]:COUPle |
| :DISPlay:RHO:MS:VIEW3:WINDow2:TRACe:Y[:SCALe]:PDIVision |
| :DISPlay:RHO:MS:VIEW3:WINDow2:TRACe:Y[:SCALe]:RLEVel |
| :DISPlay:RHO:MS:VIEW3:WINDow2:TRACe:Y[:SCALe]:RPOSition |
| :DISPlay:RHO:MS:VIEW3:WINDow3:TRACe:X[:SCALe]:COUPle |
| :DISPlay:RHO:MS:VIEW3:WINDow3:TRACe:X[:SCALe]:PDIVision |
| :DISPlay:RHO:MS:VIEW3:WINDow3:TRACe:X[:SCALe]:RLEVel |
| :DISPlay:RHO:MS:VIEW3:WINDow3:TRACe:X[:SCALe]:RPOSition |
| :DISPlay:RHO:MS:VIEW3:WINDow3:TRACe:Y[:SCALe]:COUPle |
| :DISPlay:RHO:MS:VIEW3:WINDow3:TRACe:Y[:SCALe]:PDIVision |
| :DISPlay:RHO:MS:VIEW3:WINDow3:TRACe:Y[:SCALe]:RLEVel |
| :DISPlay:RHO:MS:VIEW3:WINDow3:TRACe:Y[:SCALe]:RPOSition |
| :DISPlay:RHO:MS:VIEW4:WINDow1 WINDow:TRACe:X[:SCALe]:PDIVision |
| :DISPlay:RHO:MS:VIEW4:WINDow1 WINDow:TRACe:X[:SCALe]:RLEVel |
| :DISPlay:RHO:MS:VIEW4:WINDow1 WINDow:TRACe:X[:SCALe]:RPOSition |
| :DISPlay:RHO:MS:VIEW4:WINDow1 WINDow:TRACe:Y[:SCALe]:COUPle |
| :DISPlay:RHO:MS:VIEW4:WINDow1 WINDow:TRACe:Y[:SCALe]:PDIVision |
| :DISPlay:RHO:MS:VIEW4:WINDow1 WINDow:TRACe:Y[:SCALe]:RLEVel |
| [:SENSe]:RHO:MS:AVERAge:TCONtrol |
| [:SENSe]:RHO:MS:TRIGger:SOURce |

Instrument Updates at www.keysight.com

These web locations can be used to access the latest information about the instrument, including the latest firmware version.

<http://www.keysight.com/find/pxa>

<http://www.keysight.com/find/mxa>

<http://www.keysight.com/find/exa>

<http://www.keysight.com/find/cxa>