

Keysight X-Series Signal Analyzers

This manual provides documentation for the following Analyzers:

PXA Signal Analyzer N9030A
EXA Signal Analyzer N9010A

MXA Signal Analyzer N9020A
CXA Signal Analyzer N9000A

Notice: This document contains references to Agilent. Please note that Agilent's Test and Measurement business has become Keysight Technologies. For more information, go to www.keysight.com.

N9072 & W9072
cdma2000
Measurement
Application
Measurement
Guide

Notices

© Keysight Technologies, Inc.
2008-2014

No part of this manual may be reproduced in any form or by any means (including electronic storage and retrieval or translation into a foreign language) without prior agreement and written consent from Keysight Technologies, Inc. as governed by United States and international copyright laws.

Trademark Acknowledgements

Manual Part Number

N9072-90005

Print Date

August 2014

Supersedes: April 2011

Printed in USA

Keysight Technologies Inc.
1400 Fountaingrove Parkway
Santa Rosa, CA 95403

Warranty

THE MATERIAL CONTAINED IN THIS DOCUMENT IS PROVIDED “AS IS,” AND IS SUBJECT TO BEING CHANGED, WITHOUT NOTICE, IN FUTURE EDITIONS. FURTHER, TO THE MAXIMUM EXTENT PERMITTED BY APPLICABLE LAW, KEYSIGHT DISCLAIMS ALL WARRANTIES, EITHER EXPRESS OR IMPLIED WITH REGARD TO THIS MANUAL AND ANY INFORMATION CONTAINED HEREIN, INCLUDING BUT NOT LIMITED TO THE IMPLIED WARRANTIES OF MERCHANTABILITY AND FITNESS FOR A PARTICULAR PURPOSE. KEYSIGHT SHALL NOT BE LIABLE FOR ERRORS OR FOR INCIDENTAL OR CONSEQUENTIAL DAMAGES IN CONNECTION WITH THE FURNISHING, USE, OR PERFORMANCE OF THIS DOCUMENT OR ANY INFORMATION CONTAINED HEREIN. SHOULD KEYSIGHT AND THE USER HAVE A SEPARATE WRITTEN AGREEMENT WITH WARRANTY TERMS COVERING THE MATERIAL IN THIS DOCUMENT THAT CONFLICT WITH THESE TERMS, THE WARRANTY TERMS IN THE SEPARATE AGREEMENT WILL CONTROL.

Technology Licenses

The hardware and/or software described in this document are furnished under a license and may be used or copied only in accordance with the terms of such license.

Restricted Rights Legend

If software is for use in the performance of a U.S. Government prime contract or subcontract, Software is delivered and licensed as “Commercial computer software” as defined in DFAR 252.227-7014 (June 1995), or as a “commercial item” as defined in FAR 2.101(a) or as “Restricted computer software” as defined in FAR 52.227-19 (June 1987) or any equivalent agency regulation or contract clause. Use, duplication or disclosure of Software is subject to Keysight Technologies’ standard commercial license terms, and non-DOD Departments and Agencies of the U.S. Government will receive no greater than Restricted Rights as defined in FAR 52.227-19(c)(1-2) (June 1987). U.S. Government users will receive no greater than Limited Rights as defined in FAR 52.227-14 (June 1987) or DFAR 252.227-7015 (b)(2) (November 1995), as applicable in any technical data.

Safety Notices

CAUTION

A **CAUTION** notice denotes a hazard. It calls attention to an operating procedure, practice, or the like that, if not correctly performed or adhered to, could result in damage to the product or loss of important data. Do not proceed beyond a CAUTION notice until the indicated conditions are fully understood and met.

WARNING

A **WARNING** notice denotes a hazard. It calls attention to an operating procedure, practice, or the like that, if not correctly performed or adhered to, could result in personal injury or death. Do not proceed beyond a WARNING notice until the indicated conditions are fully understood and met.

Where to Find the Latest Information

Documentation is updated periodically. For the latest information about these products, including instrument software upgrades, application information, and product information, browse to one of the following URLs, according to the name of your product:

<http://www.keysight.com/find/pxa>

<http://www.keysight.com/find/mxa>

<http://www.keysight.com/find/exa>

<http://www.keysight.com/find/cxa>

To receive the latest updates by email, subscribe to Keysight Email Updates at the following URL:

<http://www.keysight.com/find/emailupdates>

Information on preventing analyzer damage can be found at:

<http://www.keysight.com/find/tips>

Is your product software up-to-date?

Periodically, Keysight releases software updates to fix known defects and incorporate product enhancements. To search for software updates for your product, go to the Keysight Technical Support website at:

<http://www.keysight.com/find/techsupport>

Table of Contents

1 Making cdma2000 Measurements

Setting Up and Making a Measurement	10
Making the Initial Signal Connection	10
Using Analyzer Mode and Measurement Presets	10
The 3 Steps to Set Up and Make Measurements	10

2 Channel Power Measurements

Setting Up and Making a Measurement	14
Configuring the Measurement System	14
Setting the MS (Example)	14
Measurement Procedure	15

3 ACP Measurements

Setting Up and Making a Measurement	18
Configuring the Measurement System	18
Setting the MS (Example)	18
Measurement Procedure	19

4 Spectrum Emission Mask Measurements

Setting Up and Making a Measurement	24
Configuring the Measurement System	24
Setting the MS (Example)	24
Measurement Procedure	25
Troubleshooting Hints	27

5 Spurious Emissions Measurement

Setting Up and Making a Measurement	30
Configuring the Measurement System	30
Setting up the MS (Example)	30
Measurement Procedure	31

Contents

Measurement Results	31
6 Occupied Bandwidth Measurements	
Setting Up and Making a Measurement	36
Configuring the Measurement System	36
Setting the MS (Example)	36
Measurement Procedure	37
Troubleshooting Hints	37
7 Code Domain Measurements	
Setting Up and Making a Measurement	40
cdma2000 Measurement Example (MS)	40
cdma2000 Measurement Example (BTS)	49
Troubleshooting Hints	54
8 Modulation Accuracy (Composite Rho) Measurements	
Setting Up and Making a Measurement	56
cdma2000 Measurement Example (MS)	56
cdma2000 Measurement Example (BTS)	61
Troubleshooting Hints	64
9 Power Statistics CCDF Measurements	
Setting Up and Making a Measurement	68
Configuring the Measurement System	68
Setting the MS (Example)	68
Measurement Procedure	69
Troubleshooting Hints	70
10 QPSK EVM Measurements	
Setting Up and Making a Measurement	72
Configuring the Measurement System	72
Setting the MS	72

Measurement Procedure	73
Troubleshooting Hints	75

11 Monitor Spectrum Measurements

Setting Up and Making a Measurement	78
Configuring the Measurement System	78
Setting the MS (Example)	78
Measurement Procedure	79

12 IQ Waveform (Time Domain) Measurements

Setting Up and Making Measurements	82
Configuring the Measurement System	82
Setting the MS (Example)	82
Measurement Procedure	83

13 Using Option BBA Baseband I/Q Inputs

Baseband I/Q Measurements Available for X-Series Signal Analyzers	88
Baseband I/Q Measurement Overview	89

14 Concepts

What Is the cdma2000 Communication System?	92
Introduction	92
Spreading Rate	93
Radio Configuration	93
Forward Link Air Interface	93
Reverse link air interface – HPSK	95
Forward link power control	97
Differences between cdma2000 and W-CDMA	98
Adjacent Channel Power (ACP) Measurement Concepts	99
Purpose	99
Measurement Method	99
Channel Power Measurement Concepts	101
Purpose	101

Contents

Measurement Method	101
Code Domain Measurement Concepts	102
Purpose	102
Measurement Method	102
Modulation Accuracy (Composite Rho) Measurement Concepts	104
Purpose	104
Measurement Method	104
Occupied Bandwidth Measurement Concepts	105
Purpose	105
Measurement Method	105
Power Statistics CCDF Measurement Concepts	106
Purpose	106
Measurement Method	108
QPSK EVM Measurement Concepts	109
Purpose	109
Measurement Method	112
Monitor Spectrum Measurement Concepts	113
Purpose	113
Measurement Method	113
Troubleshooting Hints	113
Spectrum Emission Mask Measurement Concepts	114
Purpose	114
Measurement Method	114
Spurious Emissions Measurement Concepts	115
Purpose	115
Measurement Method	115
IQ Waveform Measurement Concepts	116
Purpose	116
Measurement Method	116
Other Sources of Measurement Information	117
Instrument Updates at www.keysight.com	117
References	118

1 Making cdma2000 Measurements

This chapter begins with instructions common to all measurements, then details all the measurements available by pressing the **Meas** key when the **cdma2000** mode is selected. For information specific to individual measurements, see the sections at the page numbers below.

- “Channel Power Measurements” on page 13
- “ACP Measurements” on page 17
- “Spectrum Emission Mask Measurements” on page 23
- “Spurious Emissions Measurement” on page 29
- “Occupied Bandwidth Measurements” on page 35
- “Power Statistics CCDF Measurements” on page 67
- “Code Domain Measurements” on page 39
- “Modulation Accuracy (Composite Rho) Measurements” on page 55
- “QPSK EVM Measurements” on page 71
- “Monitor Spectrum Measurements” on page 77
- “Using Option BBA Baseband I/Q Inputs” on page 87

Setting Up and Making a Measurement

Making the Initial Signal Connection

CAUTION

Before connecting a signal to the analyzer, make sure the analyzer can safely accept the signal level provided. The signal level limits are marked next to the RF Input connectors on the front panel.

See the Input Key menu for details on selecting input ports and the AMPTD Y Scale menu for details on setting internal attenuation to prevent overloading the analyzer.

Using Analyzer Mode and Measurement Presets

To set your current measurement mode to a known factory default state, press **Mode Preset**. This initializes the analyzer by returning the mode setup and all of the measurement setups in the mode to the factory default parameters.

To preset the parameters that are specific to an active, selected measurement, press **Meas Setup, Meas Preset**. This returns all the measurement setup parameters to the factory defaults, but only for the currently selected measurement.

The 3 Steps to Set Up and Make Measurements

All measurements can be set up using the following three steps. The sequence starts at the Mode level, is followed by the Measurement level, then finally, the result displays may be adjusted.

Step	Action	Notes
1 Select and Set Up the Mode	a. Press Mode	All licensed, installed modes available are shown under the Mode key.
	b. Press a mode key, like Spectrum Analyzer, cdma2000 GSM/EDGE .	Using Mode Setup , make any required adjustments to the mode settings.
	c. Press Mode Preset .	These settings will apply to all measurements in the mode.
	d. Press Mode Setup	
2 Select and Set Up the Measurement	a. Press Meas .	The measurement begins as soon as any required trigger conditions are met.
	b. Select the specific measurement to be performed.	The resulting data is shown on the display or is available for export.
	c. Press Meas Setup	Use Meas Setup to make any required adjustment to the selected measurement settings. The settings only apply to this measurement.

Step	Action	Notes
3 Select and Set Up a View of the Results	Press View/Display . Select a display format for the current measurement data.	Depending on the mode and measurement selected, other graphical and tabular data presentations may be available. X-Scale and Y-Scale adjustments may also be made now.

NOTE A setting may be reset at any time, and will be in effect on the next measurement cycle or view.

Table 1-1 Main Keys and Functions for Making Measurements

Step	Primary Key	Setup Keys	Related Keys
1 Select and set up a mode.	Mode	Mode Setup, FREQ Channel	System
2 Select and set up a measurement.	Meas	Meas Setup	Sweep/Control, Restart, Single, Cont
3 Select and set up a view of the results.	View/Display	SPAN X Scale, AMPTD Y Scale	Peak Search, Quick Save, Save, Recall, File, Print

Making cdma2000 Measurements
Setting Up and Making a Measurement

2 Channel Power Measurements

This chapter explains how to make a channel power measurement on a cdma2000 mobile station (MS). This test measures the total RF power present in the channel. The results are shown in a graph window and in a text window.

Setting Up and Making a Measurement

Configuring the Measurement System

The MS under test must be set to transmit the RF power remotely through the system controller. This transmitting signal is connected to the RF input port of the instrument. Connect the equipment as shown.

Figure 2-1 Channel Power Measurement System

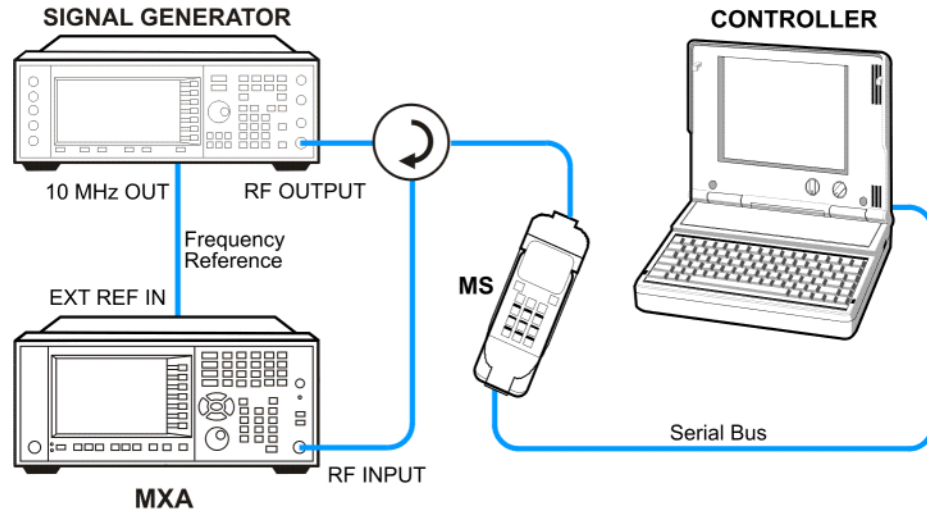

1. Using the appropriate cables, adapters, and circulator, connect the output signal from the MS to the RF input port of the analyzer.
2. Connect the base transceiver station simulator or signal generator to the MS through the circulator to initiate a link constructed with the sync and pilot channels, if required.
3. Connect a BNC cable between the 10 MHz OUT port of the signal generator and the EXT REF IN port of the analyzer.
4. Connect the system controller to the MS through the serial bus cable to control the MS operation.

Setting the MS (Example)

From the transceiver station simulator or the system controller, or both, perform all of the call acquisition functions required for the MS to transmit the RF power as follows:

Frequency: 1855 MHz (Channel Number: 100)
(=100 × 0.05 + 1850 MHz)

Physical Channels: R-Pilot, R-FCH and R-SCH1(W2(1))

Output Power: -20 dBm (at analyzer input)

Measurement Procedure

Step	Action	Notes
1 Select the mode.	a. Press Mode , cdma2000 .	
2 Preset the mode.	a. Press Mode Preset .	
3 Toggle the device to MS .	a. Press Mode Setup , Radio, Device . b. Toggle Device until MS is selected.	
4 Set the center frequency.	a. Press FREQ Channel , 1855, MHz .	
5 Initiate the measurement.	a. Press Meas, Channel Power .	The Channel Power measurement result should look similar to Figure 2-2 . The graph window and the text window show the absolute power and its mean power spectral density values over 1.23 MHz

Figure 2-2

Channel Power Measurement Result

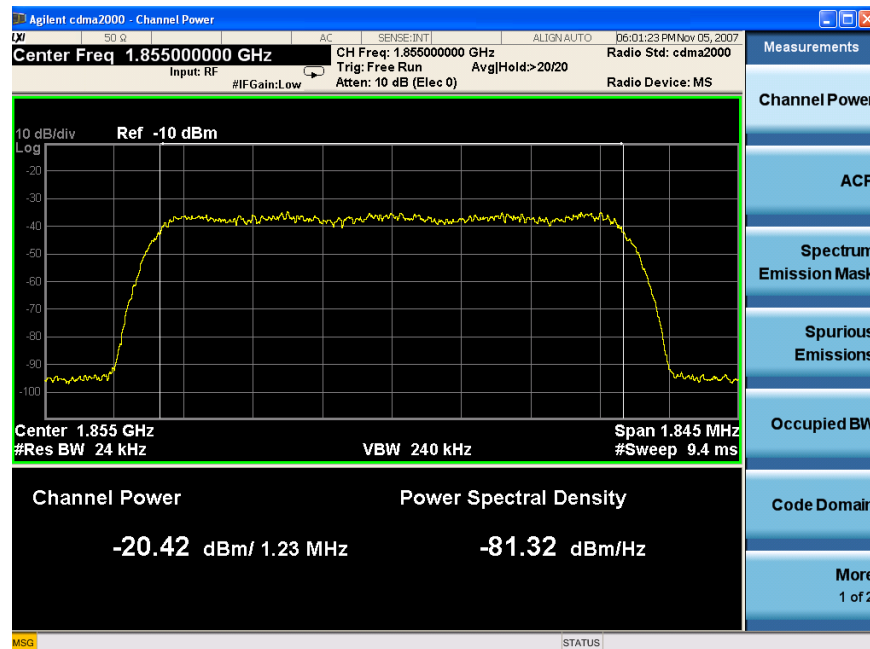

- | | |
|--|------------------------------|
| 6 Examine the keys that are available to change the measurement parameters from the default condition. | a. Press Meas Setup . |
|--|------------------------------|

Channel Power Measurements
Setting Up and Making a Measurement

If you have a problem, and get an error message, see the “**Error Messages Guide**”.

3 ACP Measurements

This chapter explains how to make the adjacent channel leakage power ratio (ACLR or ACPR) measurement on a cdma2000 mobile station (MS). ACPR is a measurement of the amount of interference, or power, in an adjacent frequency channel. The results are shown as a bar graph or as spectrum data, with measurement data at specified offsets.

Setting Up and Making a Measurement

Configuring the Measurement System

The MS under test must be set to transmit the RF power remotely through the system controller. This transmitting signal is connected to the RF input port of the instrument. Connect the equipment as shown.

Figure 3-1 *Adjacent Channel Power Ratio Measurement System*

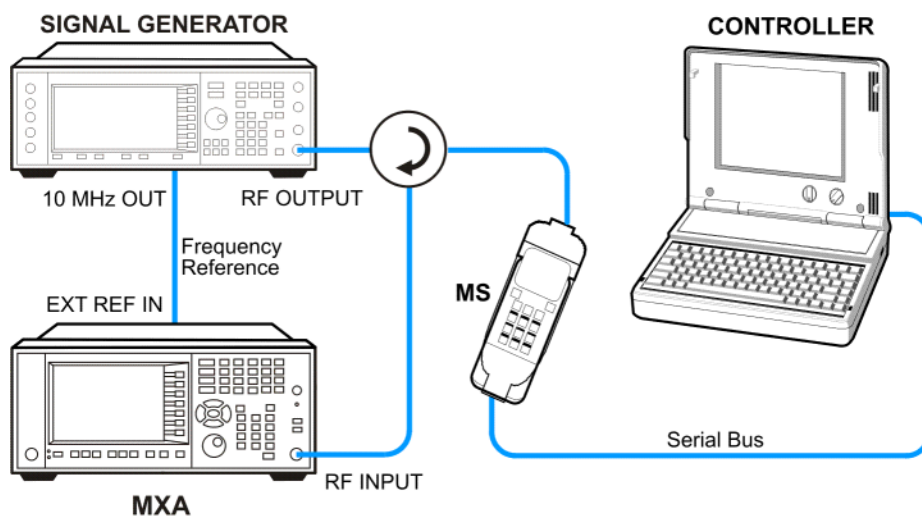

1. Using the appropriate cables, adapters, and circulator, connect the output signal from the MS to the RF input port of the analyzer.
2. Connect the base transceiver station simulator or signal generator to the MS through the circulator to initiate a link constructed with the sync and pilot channels, if required.
3. Connect a BNC cable between the 10 MHz OUT port of the signal generator and the EXT REF IN port of the analyzer.
4. Connect the system controller to the MS through the serial bus cable to control the MS operation.

Setting the MS (Example)

From the transceiver station simulator or the system controller, or both, perform all of the call acquisition functions required for the MS to transmit the RF power as follows:

Frequency: 1855 MHz (Channel Number: 100)
(=100 × 0.05 + 1850 MHz)

Physical Channels: R-Pilot, R-FCH and R-SCH1(W2(1))

Output Power: -20 dBm (at analyzer input)

Measurement Procedure

Step	Action	Notes
1 Select the mode.	a. Press Mode , cdma2000 .	
2 Preset the mode.	a. Press Mode Preset .	
3 Toggle the device to MS .	a. Press Mode Setup , Radio, Device . b. Toggle Device until MS is selected.	
4 Set the center frequency.	a. Press FREQ Channel , 1855, MHz .	
5 Initiate the measurement.	a. Press Meas, ACP .	The Adjacent Channel Power measurement result should look similar to Figure 3-2 .

Figure 3-2

Measurement Result - ACP-RBW View (Default)

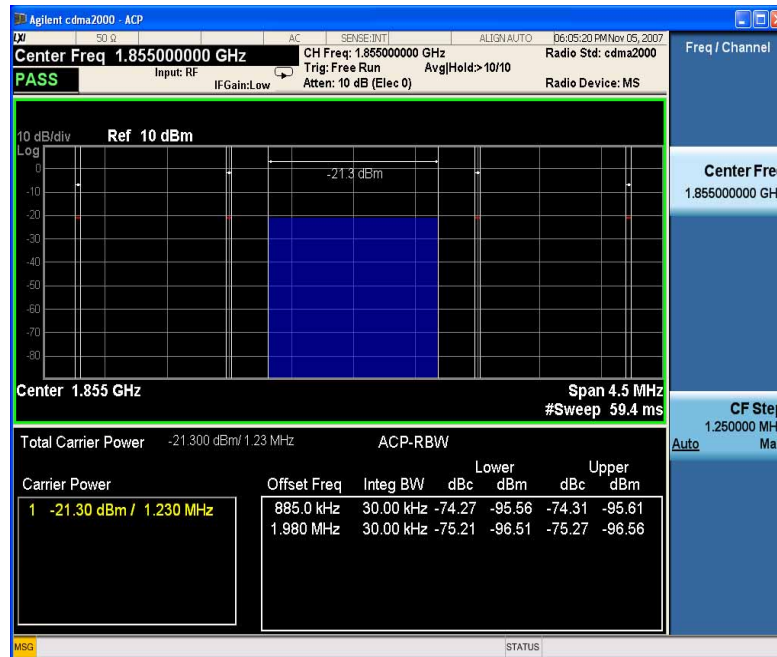

6 Change the Meas Method.	a. Press Meas Setup , More, Meas Method , IBW to see the bar graph with the spectrum trace graph overlay.	The spectrum graph measurement result should look similar to Figure 3-3 . The graph (referenced to the total power) and a text window are displayed. The text window shows the absolute total power reference, while the lower and upper offset channel power levels are displayed in both absolute and relative readings
---------------------------	--	--

ACP Measurements
Setting Up and Making a Measurement

Step Action Notes

Figure 3-3 Measurement Result - ACP-RBW View (Default)

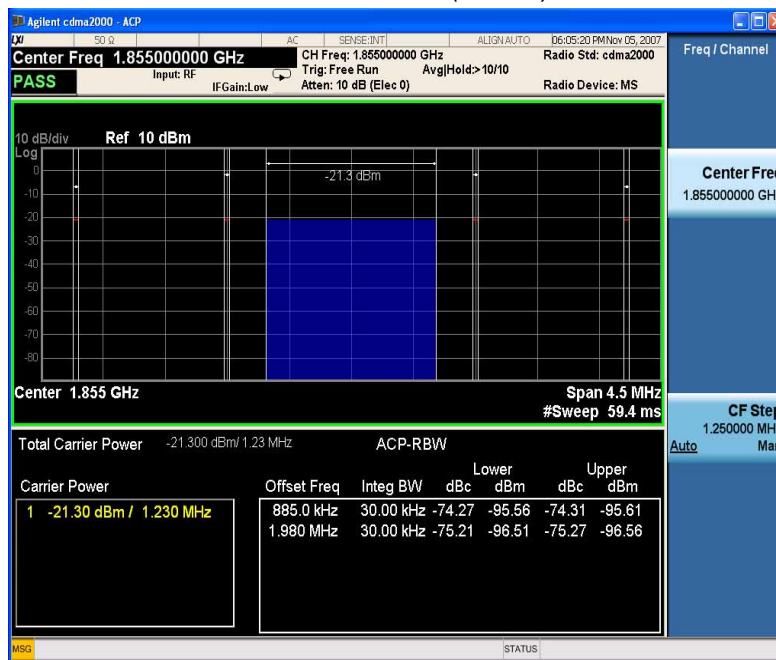

7 Switch off the Bar Graph.

a. Press **View/Display**, and toggle the **Bar Graph** key to **Off** to see the spectrum trace graph.

The corresponding measured data is also shown in the text window. See Figure 3-4.
In the graph, the small white lines show the offset band width. The red lines indicate the limits you set.

Figure 3-4 Measurement Result - Spectrum Trace Graph View

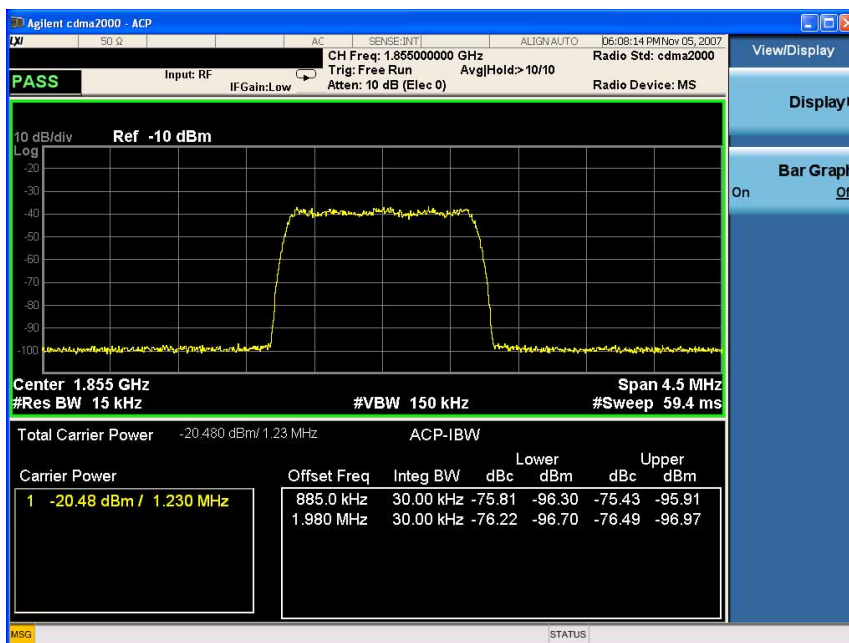

Step	Action	Notes
8	Examine the keys that are available to change the measurement parameters from the default condition.	a. Press Meas Setup .

Figure 3-5 shows the spectrum trace graph view for 6 carriers. The measurement result of Carrier Power for the selected Carrier Result (1 in this case) turns yellow.

Figure 3-5

Measurement Result - 6 Carriers Spectrum Trace Graph View

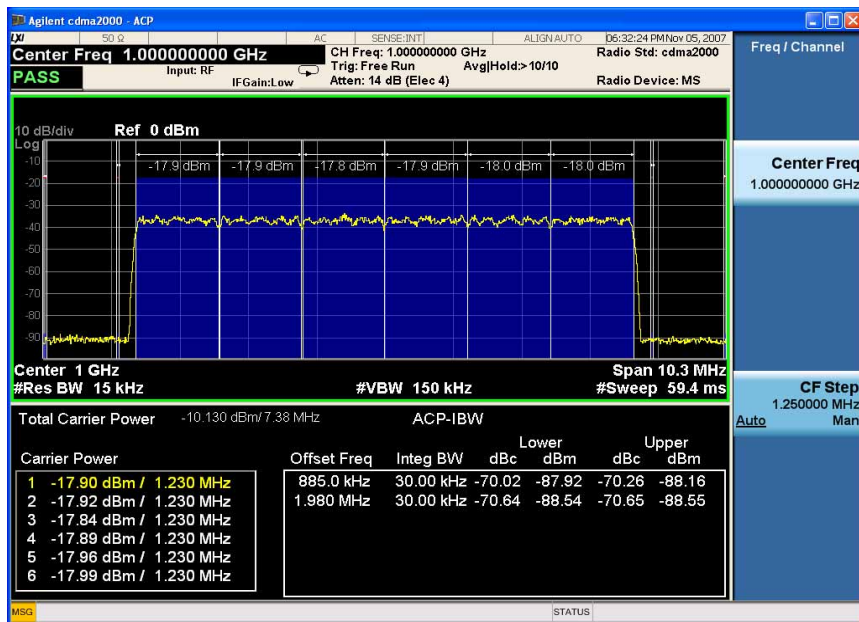

NOTE

When the measured power is close to the noise floor, turning on the Noise Correction under the Meas Setup menu can make the measurement more accurate.

If you have a problem, and get an error message, see the “*Error Messages Guide*”.

ACP Measurements
Setting Up and Making a Measurement

4 Spectrum Emission Mask Measurements

This chapter explains how to make the spectrum emission mask (SEM) measurement on a cdma2000 mobile station (MS). SEM compares the total power level within the defined carrier bandwidth and the given offset channels on both sides of the carrier frequency, to levels allowed by the standard. Results of the measurement of each offset segment can be viewed separately.

Setting Up and Making a Measurement

Configuring the Measurement System

The MS under test must be set to transmit the RF power remotely through the system controller. This transmitting signal is connected to the RF input port of the instrument. Connect the equipment as shown.

Figure 4-1 *Spectrum Emission Mask Measurement System*

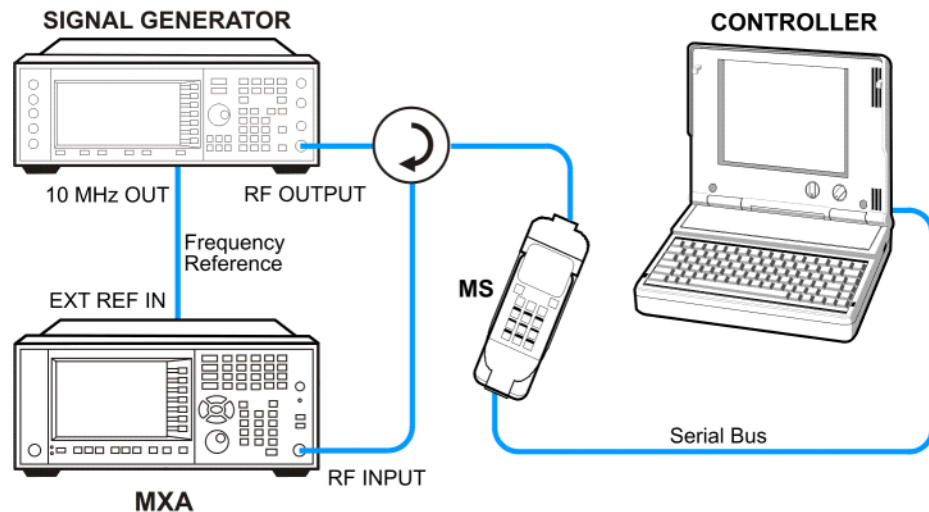

1. Using the appropriate cables, adapters, and circulator, connect the output signal from the MS to the RF input port of the analyzer.
2. Connect the base transceiver station simulator or signal generator to the MS through the circulator to initiate a link constructed with the sync and pilot channels, if required.
3. Connect a BNC cable between the 10 MHz OUT port of the signal generator and the EXT REF IN port of the analyzer.
4. Connect the system controller to the MS through the serial bus cable to control the MS operation.

Setting the MS (Example)

From the base transceiver station simulator or the system controller, or both, perform all of the call acquisition functions required for the MS to transmit the RF power as follows:

Frequency: 1855 MHz (Channel Number: 100)
(=100 × 0.05 + 1850 MHz)

Output Power: -20 dBm (at analyzer input)

Measurement Procedure

Step	Action	Notes
1	Select the mode.	a. Press Mode , cdma2000 .
2	Preset the mode.	a. Press Mode Preset .
3	Toggle the device to MS .	a. Press Mode Setup , Radio, Device . b. Toggle Device until MS is selected.
4	Set the center frequency.	a. Press FREQ Channel , 1855, MHz .
5	Initiate the measurement.	a. Press Meas, Spectrum Emission Mask . The Spectrum Emission Mask measurement result should look similar to Figure 4-2 . The text window shows the reference total power and the absolute peak power levels which correspond to the frequency bands on both sides of the reference channel. The Start Freq value (900 kHz for offset A) is the start frequency of the offset to center. The Start Freq in the text window (885 kHz for offset A) is the start frequency of the offset to edge. There is a 15 kHz difference between them. The same as the Stop Freq. The Lower or Upper Lim is the minimum margin from limit line which is decided by Fail Mask setting. There are four settings for Fail Mask: Absolute, Relative, Abs AND Rel, Abs OR Rel. <ul style="list-style-type: none"> ▪ For Absolute mask, the Lower or Upper Lim is compared with the Absolute Limit line. ▪ For Relative mask, the Lower or Upper Lim is compared with the Relative Limit line. ▪ For Abs AND Rel mask, the Lower or Upper Lim is compared with the higher Limit line. ▪ For Abs OR Rel mask, the Lower or Upper Lim is compared with the lower Limit line.

Troubleshooting Hints

This spectrum emission mask measurement can reveal degraded or defective parts in the transmitter section of the unit under test (UUT). The following examples are those areas to be checked further.

- Faulty DC power supply control of the transmitter power amplifier.
- RF power controller of the pre-power amplifier stage.
- I/Q control of the baseband stage.
- Degradation in the gain and output power level of the amplifier due to the degraded gain control or increased distortion, or both.
- Degradation of the amplifier linearity or other performance characteristics.

Power amplifiers are one of the final stage elements of a base or mobile transmitter and are a critical part of meeting the important power and spectral efficiency specifications. Since spectrum emission mask measures the spectral response of the amplifier to a complex wideband signal, it is a key measurement linking amplifier linearity and other performance characteristics to the stringent system specifications.

Spectrum Emission Mask Measurements
Setting Up and Making a Measurement

5 Spurious Emissions Measurement

This section explains how to make the spurious emission measurement on a cdma2000 mobile station (MS). This measurement identifies and determines the power level of spurious emissions in certain frequency bands.

Setting Up and Making a Measurement

Configuring the Measurement System

The MS under test must be set to transmit the RF power remotely through the system controller. This transmitting signal is connected to the RF input port of the instrument. Connect the equipment as shown.

Figure 5-1 Mobile Station Equipment Measurement System Setup

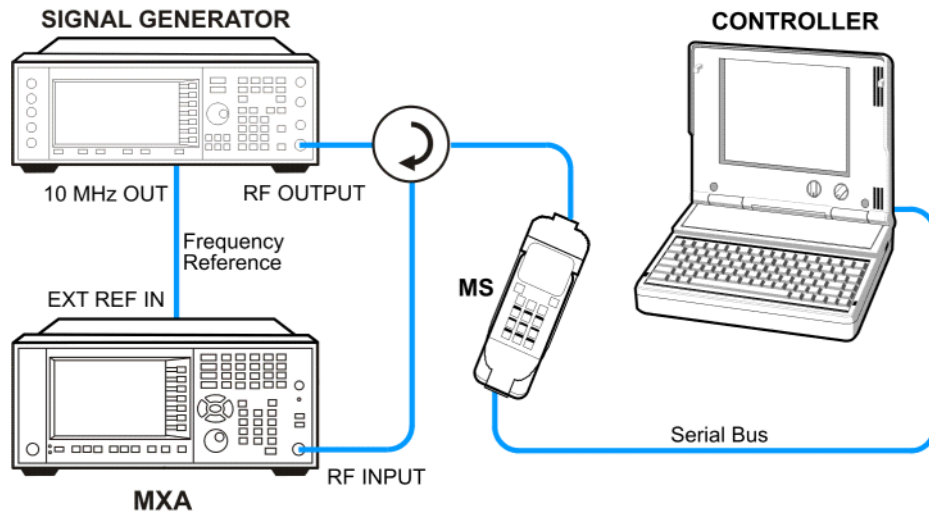

1. Using the appropriate cables, adapters, and circulator, connect the output signal from the MS to the RF input port of the analyzer.
2. Connect the base transceiver station simulator or signal generator to the MS through the circulator to initiate a link constructed with the sync and pilot channels, if required.
3. Connect a BNC cable between the 10 MHz OUT port of the signal generator and the EXT REF IN port of the analyzer.
4. Connect the system controller to the MS through the serial bus cable to control the MS operation.

Setting up the MS (Example)

From the system controller, perform all of the call acquisition functions required for the MS to transmit the RF power as required.

Measurement Procedure

Step	Action	Notes
1 Select the mode.	a. Press Mode, cdma2000 .	
2 Preset the mode.	a. Press Mode Preset .	
3 Toggle the RF Coupling.	a. Press Input/Output, RF Input, RF Coupling, DC .	
4 Toggle the device to MS.	a. Press Mode Setup, Radio, Device . Toggle Device until MS is selected.	
5 Set the center frequency.	a. Press FREQ Channel , enter a numerical frequency using the front-panel keypad, and select a units key, such as MHz .	
6 Initiate the measurement.	a. Press Meas, Spurious Emission .	Depending on the current settings, the instrument will begin making the selected measurements. The resulting data is shown on the display or available for export.
7 Setup the Range Table.	a. Press Meas Setup, Range Table .	You can enter the settings for up to twenty ranges. Press Meas Setup to return the screen from range table to spur table. If you want to change the measurement parameters from other default condition for a customized measurement, press Meas Setup to see the parameter keys that are available.

Measurement Results

The Spurious Emissions measurement results should look like [Figure 5-2](#). The spectrum window and the text window show the spurs that are within the current value of the Marker Peak Excursion setting of the absolute limit. Any spur that has failed the absolute limit will have an 'F' beside it.

The measurement result of the selected spur in Spur under Meas Setup is shown in yellow.

The measurement result of the selected range in Range under Meas Setup, Range Table is shown in yellow.

Spurious Emissions Measurement
Setting Up and Making a Measurement

Figure 5-2 Spurious Emissions Measurement

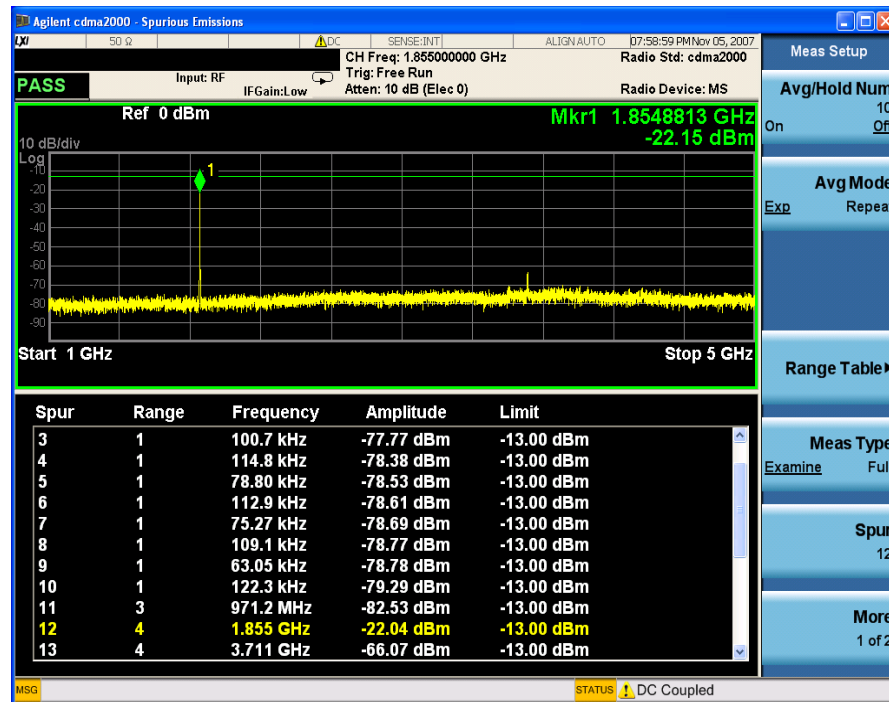

NOTE

If you set the Meas Type to Examine, the trace is kept updating to show the latest spectrum where the range which has the worst spurious. However, the table is shown the last report. Press Restart to update the table to show the latest result.

For the Meas Type of Examine, if you want to see the measurement result for different ranges, you can press Meas Setup, Range Table, Range, then enter the range number you care.

You can use the window control keys below the screen to zoom the result screen. See Figure 5-3.

Figure 5-3

Spurious Emissions Measurement - Numeric Result Screen

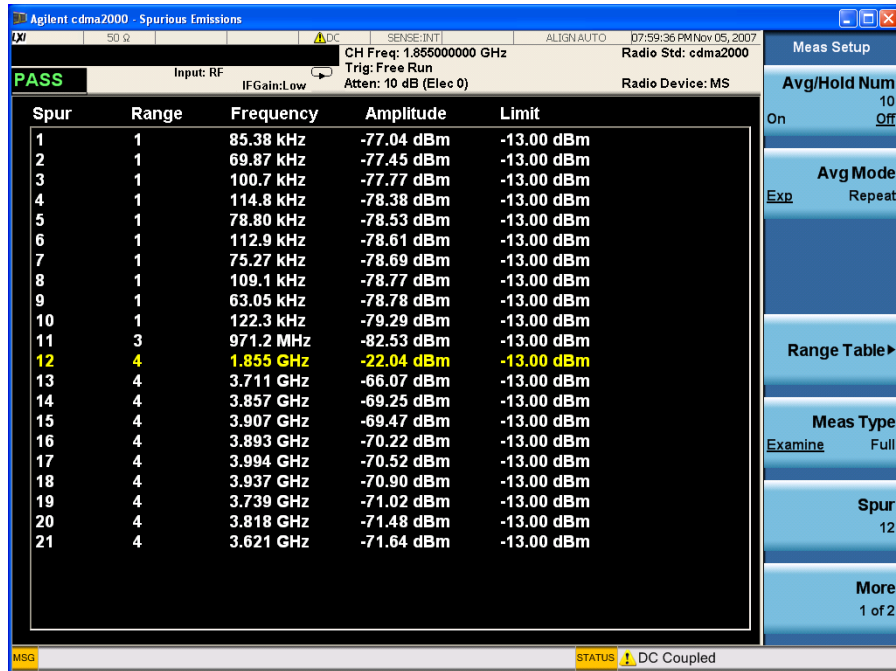

If you have a problem, and get an error message, see the “**Error Messages Guide**”.

Spurious Emissions Measurement
Setting Up and Making a Measurement

6 Occupied Bandwidth Measurements

This chapter explains how to make the occupied bandwidth measurement on a cdma2000 mobile station (MS). The instrument measures power across the band, and then calculates its 99.0% power bandwidth.

Setting Up and Making a Measurement

Configuring the Measurement System

The MS under test must be set to transmit the RF power remotely through the system controller. This transmitting signal is connected to the RF input port of the instrument. Connect the equipment as shown.

Figure 6-1 Occupied Bandwidth Measurement System

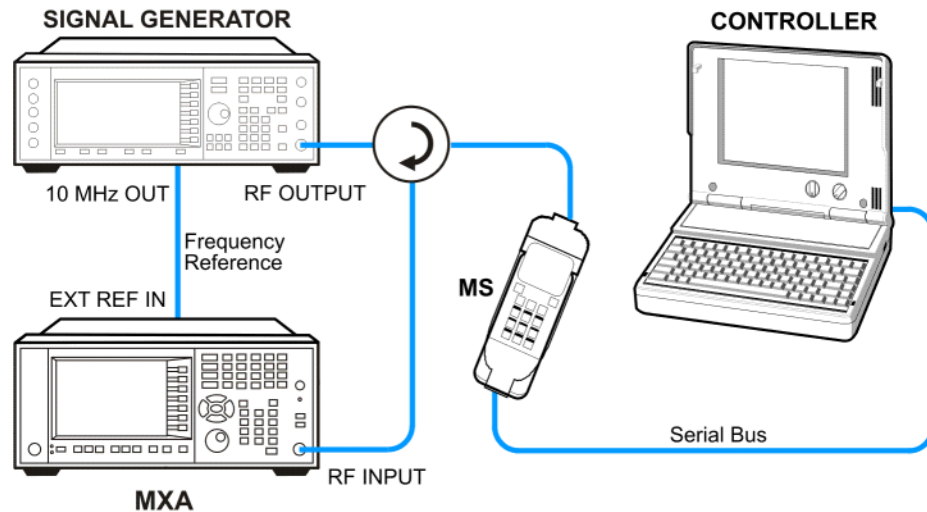

1. Using the appropriate cables, adapters, and circulator, connect the output signal of the MS to the RF input of the analyzer.
2. Connect the base transceiver station simulator or signal generator to the MS through the circulator to initiate a link constructed with the sync and pilot channels, if required.
3. Connect a BNC cable between the 10 MHz OUT port of the signal generator and the EXT REF IN port of the analyzer.
4. Connect the system controller to the MS through the serial bus cable to control the MS operation.

Setting the MS (Example)

From the base transceiver station simulator or the system controller, or both, perform all of the call acquisition functions required for the MS to transmit the RF power as follows:

Frequency: 1855 MHz (Channel Number: 100)
(=100 × 0.05 + 1850 MHz)

Output Power: -20 dBm (or other power level for the MS)

Measurement Procedure

Step	Action	Notes
1	Select the mode. a. Press Mode , cdma2000 .	
2	Preset the mode. a. Press Mode Preset .	
3	Toggle the device to MS . a. Press Mode Setup , Radio, Device . b. Toggle Device until MS is selected.	
4	Set the center frequency. a. Press FREQ Channel , 1855, MHz .	
5	Initiate the measurement. a. Press Meas, Occupied BW .	The Occupied BW measurement result should look like Figure 6-2 .

Figure 6-2

Occupied Bandwidth Measurement Result

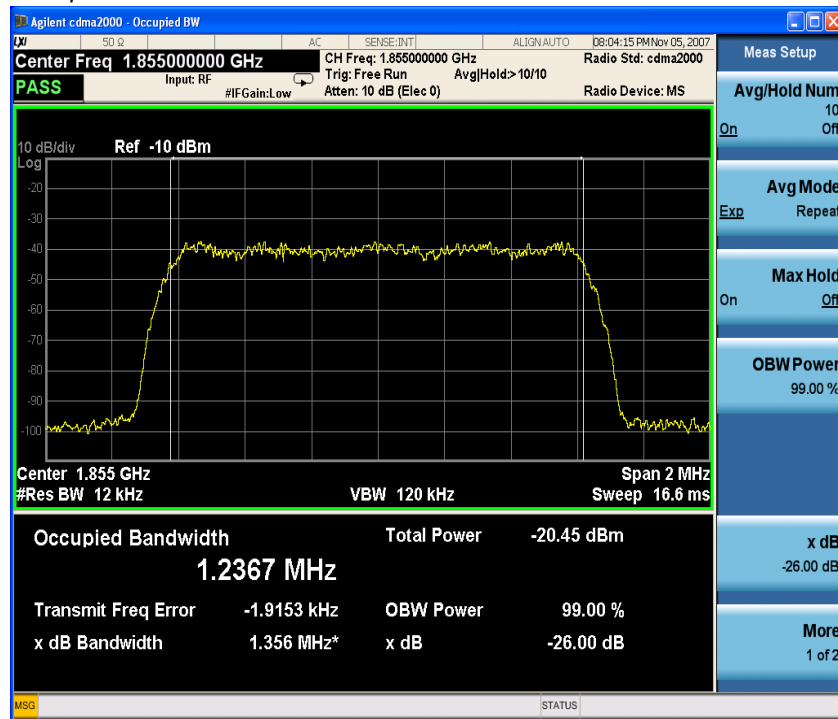

If you have a problem, and get an error message, see the “[Error Messages Guide](#)”.

Troubleshooting Hints

Any distortion such as harmonics or intermodulation, for example, produces undesirable power outside the specified bandwidth.

Occupied Bandwidth Measurements Setting Up and Making a Measurement

Shoulders on either side of the spectrum shape indicate spectral regrowth and intermodulation. Rounding or sloping of the top shape can indicate filter shape problems.

7 Code Domain Measurements

This chapter explains how to make a code domain measurement on a cdma2000 mobile station (MS) and a base transceiver station (BTS). This is the measurement of power levels of the spread code channels across composite RF channels, relative to the total power within the 1.23 MHz channel bandwidth centered at the center frequency.

Setting Up and Making a Measurement

cdma2000 Measurement Example (MS)

Configuring the Measurement System

The MS under test must be set to transmit the RF power remotely through the system controller. This transmitting signal is connected to the RF input port of the instrument. Connect the equipment as shown.

Figure 7-1

Code Domain Power Measurement System

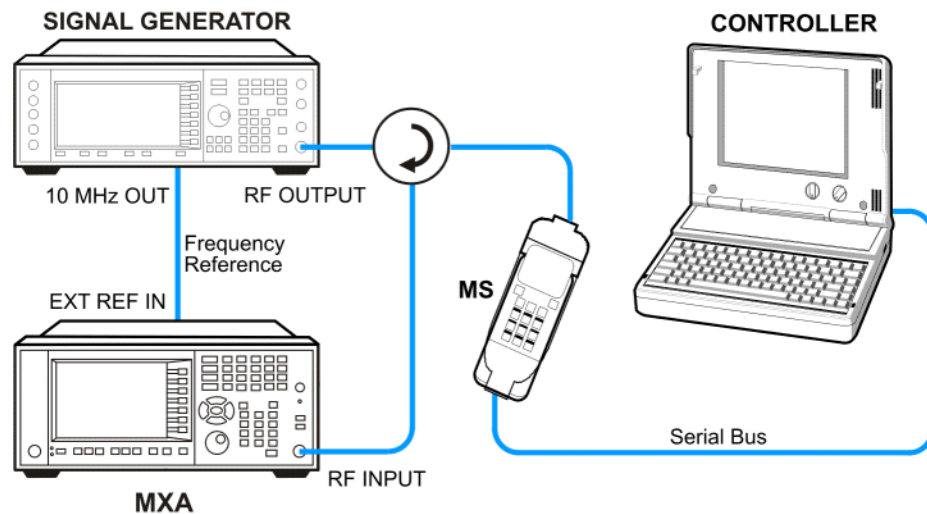

1. Using the appropriate cables, adapters, and circulator, connect the output signal of the MS to the RF input of the instrument.
2. Connect the base transceiver station simulator or signal generator to the MS through the circulator to initiate a link constructed with the sync and pilot channels, if required.
3. Connect a BNC cable between the 10 MHz OUT port of the signal generator and the EXT REF IN port of the instrument.
4. Connect the system controller to the MS through the serial bus cable to control the MS operation.

Setting the MS (Example)

From the mobile station simulator or the system controller, or both, perform all of the call acquisition functions required for the MS to transmit the RF power as follows:

Frequency: 1855 MHz (Channel Number: 100)
(=100 × 0.05 + 1850 MHz)

Physical Channels: R-Pilot, R-FCH and R-SCH1(W2(1))

Long Code Mask: 0000000000

Output Power: -20 dBm (at analyzer input)

Measurement Procedure

Step	Action	Notes
1	Select the mode. a. Press Mode , cdma2000 .	
2	Preset the mode. a. Press Mode Preset .	
3	Toggle the device to MS . a. Press Mode Setup , Radio, Device . b. Toggle Device until MS is selected.	
4	Set the center frequency to 1.855 GHz. a. Press FREQ Channel , 1855, MHz .	
5	Initiate the measurement. a. Press Meas, Code Domain .	The measurement result should look like Figure 7-2 . The graph window is displayed with a text window below it. The text window shows the total power level along with the relative power levels of the various channels.

Figure 7-2 Code Domain Measurement Result - Power Graph & Metrics (Default) View

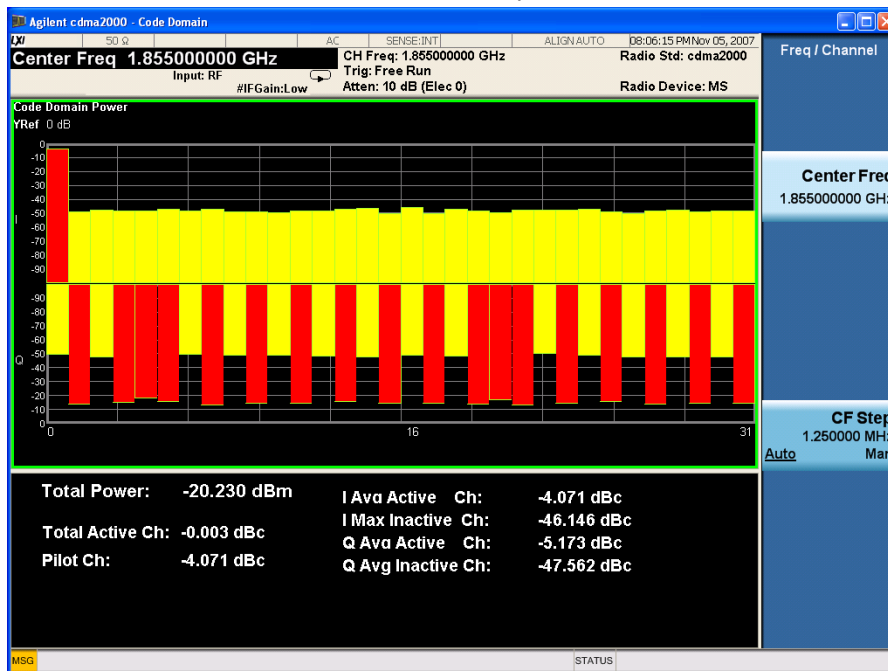

Code Domain Measurements
Setting Up and Making a Measurement

Step	Action	Notes
6	Identify the Walsh code channels. a. Press Peak Search, Next Peak.	Because the Consolidated Marker (under View/Display, Power Graph & Metrics menu) is On, the Walsh code channel with the marker is in blue color and the corresponding Walsh code channels are marked with pearl blue. The measurement result should look like Figure 7-3 .

Figure 7-3 Code Domain Measurement Result - Power Graph & Metrics (Consolidated Marker) View

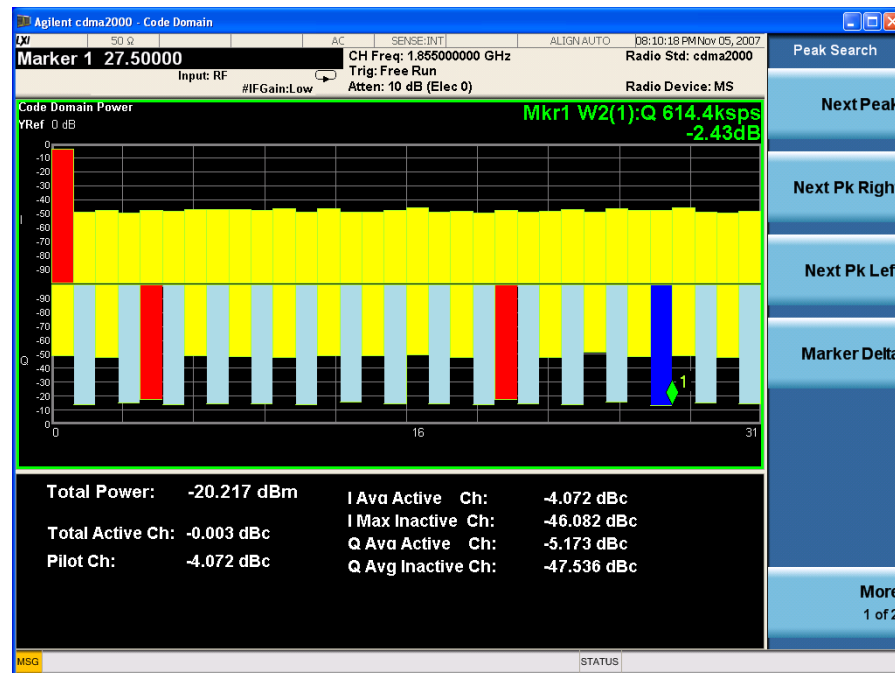

7	To view the same signal with the related code channels adjacent to each other.	a. Press View/Display, Power Graph & Metrics, Code Order, Bit Reverse.	The measurement result should look like Figure 7-4 .
---	--	---	--

Step Action Notes

Figure 7-4 Code Domain Measurement Result - Power Graph & Metrics (Bit Reverse) View

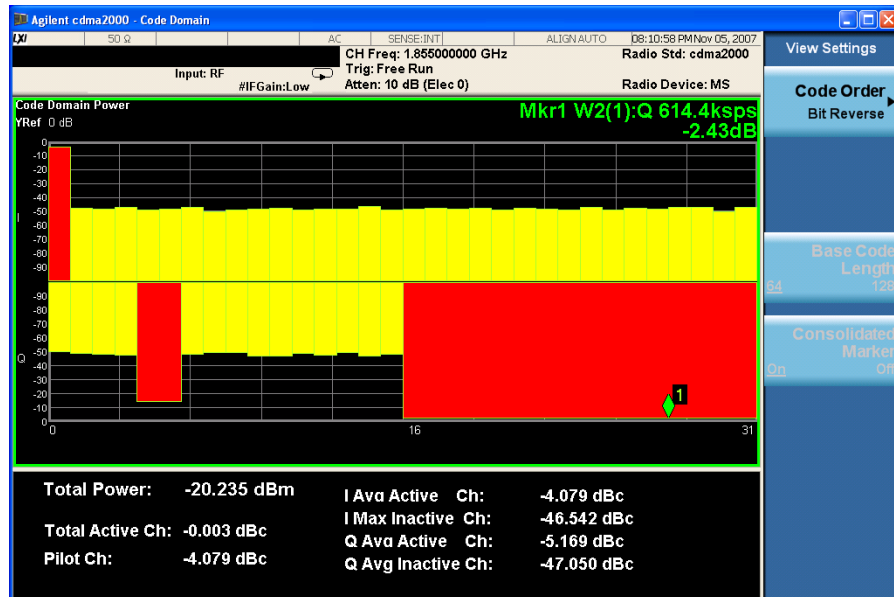

- 8 Put a marker on the highest power channel.
- a. Press **Peak Search**. See Figure 7-5. The marker 1 measurement data shows W2(1), which indicates the code channel number. It also indicates the channel data rate at 614.4 kpsps, and provides the power measurement of -2.43 dB in the channel relative to the total code power of the signal.

Figure 7-5 Code Domain Measurement Result - Power Graph & Metrics View - Uplink (MS) Peak Marker

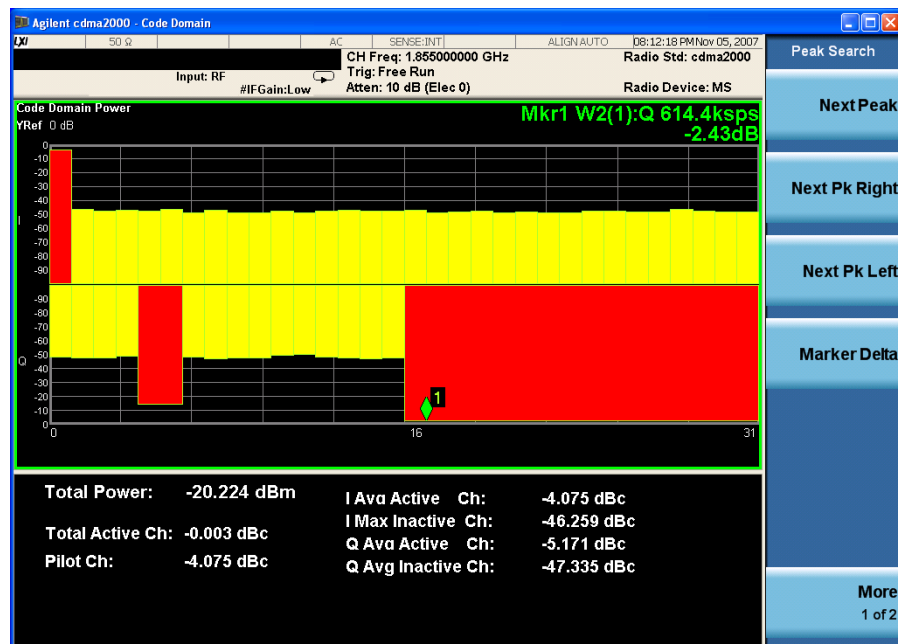

Code Domain Measurements
Setting Up and Making a Measurement

Step	Action	Notes
9	<p>Display a combination view of the code domain power and code domain error,</p> <p>a. Press View/Display, CDP Graph & CDE Graph.</p>	See Figure 7-6 .

Figure 7-6 Code Domain Measurement Result - CDP Graph & CDE Graph View



10	<p>Initiate the despreading and decoding of the marked channel,</p> <p>a. Press Marker->, Mkr-> Despread.</p>	This allows EVM and other error measurements to be conducted on the channel.
11	<p>Display a combination view of the magnitude error vs. symbol and EVM vs. symbol graph windows, with the modulation summary results window,</p> <p>a. Press View/Display, I/Q Error (Quad View).</p>	<p>See Figure 7-7.</p> <p>The results screen shows the data for the same code domain channel W2(1) that was selected for despreading by the marker in the Code Domain Quad View in the previous step.</p>

Step Action Notes

Figure 7-7 Code Domain Measurement Result - I/Q Error Quad View

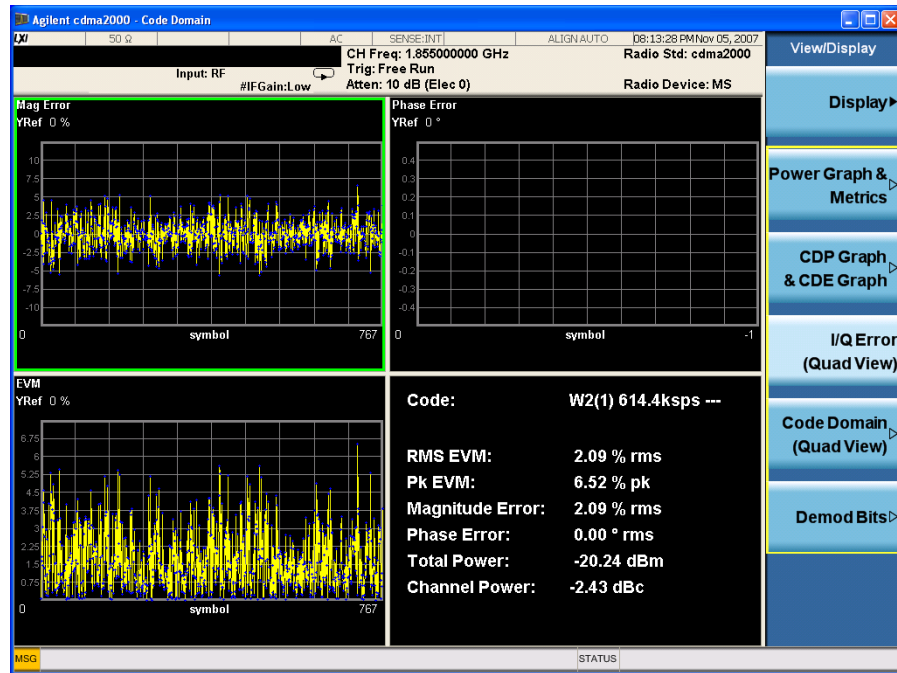

- 12 Display phase error vs. symbol graph results window.
- Press **Meas Setup, I/Q Branch** until **IQC** is underlined.
- See Figure 7-8.

Figure 7-8 Code Domain Measurement Result - I/Q Error Quad View (with phase error)

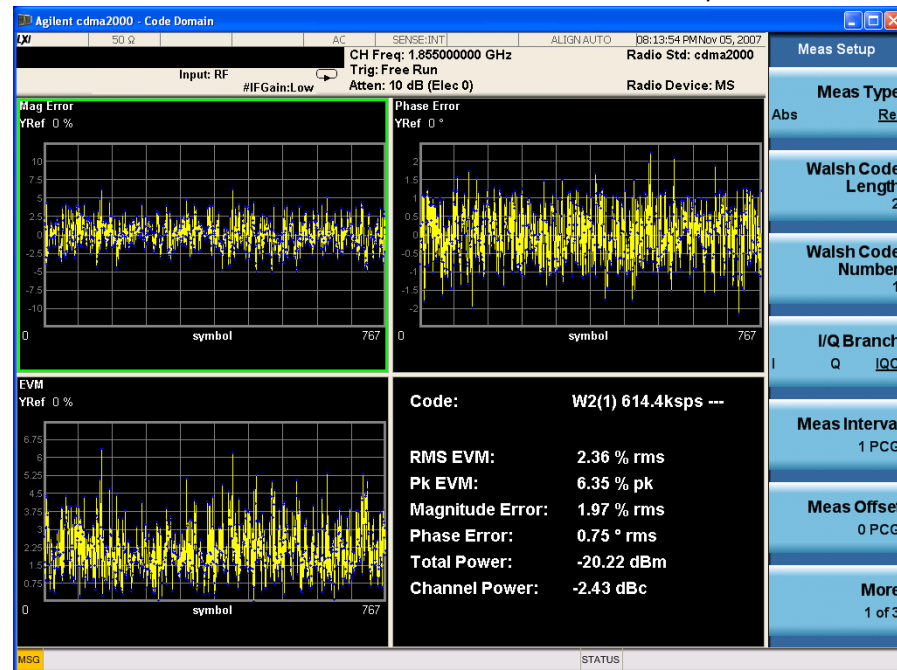

Code Domain Measurements
Setting Up and Making a Measurement

Step	Action	Notes
13 Display a combination view of the code domain power, symbol power, and I/Q symbol polar vector graph windows, with a summary results window.	a. Press View/Display, Code Domain (Quad View) .	<p>See Figure 7-9.</p> <p>In Figure 7-9, the original Code Domain Measurement is shown at the top left, while the Symbol Power measurement of the marked Q-data channel is at the top right (You can select I-data, Q-data or combined I and Q data in the I/Q Branch of Meas Setup). The solid area below the first graticule (blue on the instrument display) is the composite chip power versus time over the entire capture interval, while the yellow area is symbol power versus time for W2(1). The Capture Interval is 5 PCG, but the measured interval is 1 PCG (if there is only 1 PCG for the measured interval, it is marked with red vertical lines, if there are several PCG, the first measured PCG is marked with red vertical lines, and there is a white vertical line for the others). The Capture Interval and the Meas Interval can be set in the Meas Setup menu.</p> <p>The graph of the I/Q vector trajectory for W2(1) during the measurement interval is shown at the lower left. As the constellation diagram shows, this example uses Q-only data that is effectively BPSK modulation for channel W2(1), so the phase error must be zero.</p> <p>The summary data at the lower right indicates peak and RMS EVM, magnitude and phase errors, powers of the signal and the channel.</p>

Step Action Notes

Figure 7-9 Code Domain Measurement Result - Code Domain Quad View

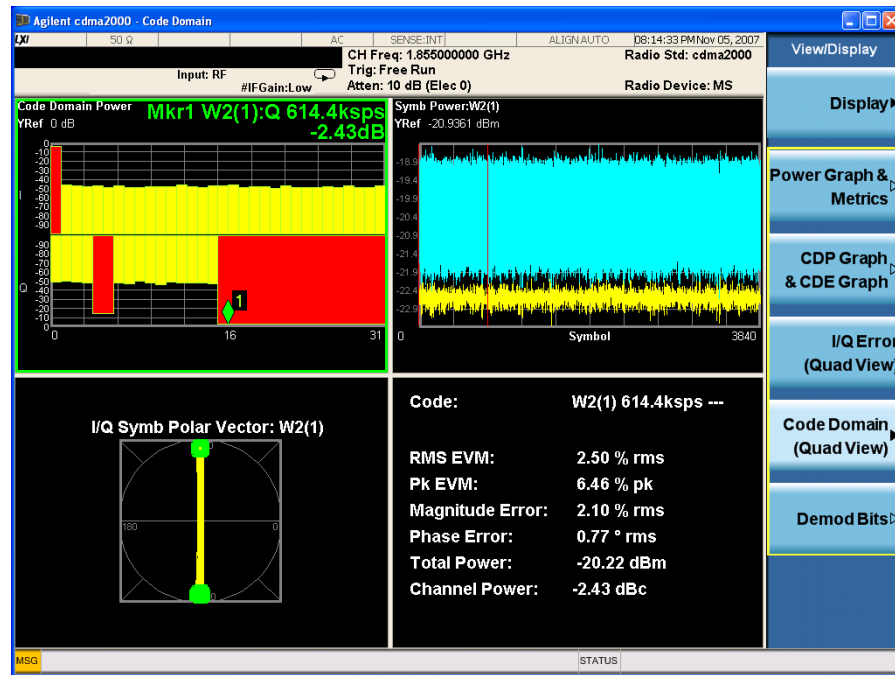

14 Display a combination view of the code domain power, symbol power graph windows, and the I/Q demodulated bit stream data for the symbol power slots selected by the measurement interval and measurement offset parameters.

a. Press **View/Display**, Demod Bits.

The Demod Bits View displays the same Code Domain Power and Symbol Power windows as the Code Domain (Quad View) shown in Figure 7-10.

The demodulated bit stream displayed is the data contained in the Measurement Interval, 1 PCG. In the Symbol Power graph, this is the data between the red vertical lines; 1 PCG, with no offset, so it is the first PCG of the capture interval of 5 PCG.

Code Domain Measurements
Setting Up and Making a Measurement

Step Action Notes

Figure 7-10 Code Domain Measurement Result - Demod Bits View

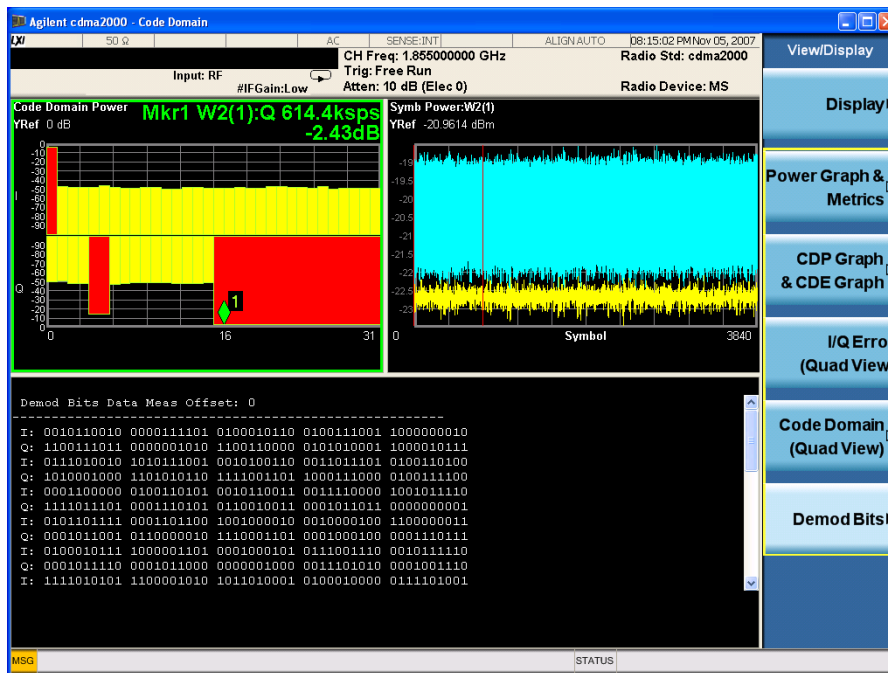

NOTE To place Marker on the different traces of the different views, press **Marker, Properties, Marker Trace**, then select the trace you want to put the marker on. There are 8 traces for selecting: Code Domain Power, Code Domain Error, Symbol Power, Chip Power, EVM, Phase Error, Mag Error and I/Q Symb Polar Vector.

If you have a problem, and get an error message, see the “**Error Messages Guide**”.

cdma2000 Measurement Example (BTS)

Configuring the Measurement System

Use the system controller to remotely control the base transceiver station (BTS) under test to transmit the RF power. The cdma2000 modulated interference signal is injected to the antenna output port of the BTS through an attenuator and circulator. The transmitting signal from the BTS is connected to the RF input port of the instrument from the circulator port. Connect the equipment as shown.

Figure 7-11

Code Domain Measurement System

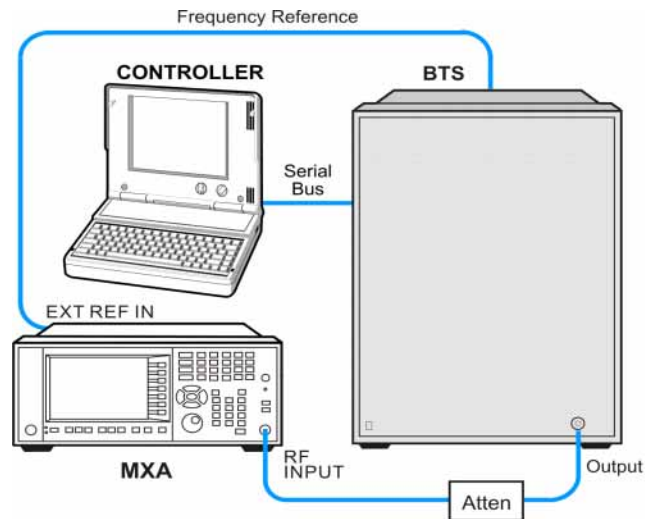

1. Connect the BTS output signal to the RF input port of the analyzer through the attenuator.
2. Connect a BNC cable between the frequency reference port of the BTS and the EXT REF IN port of the analyzer.
3. Connect the system controller to the BTS through the serial bus cable.

NOTE

If you want to test the Time Offset (the time from the trigger point to the PN offset), you need to connect the trigger output of the BTS to the trigger input of the analyzer.

Setting the BTS (Example)

From the BTS simulator or the system controller, or both, perform all of the call acquisition functions required for the BTS to transmit the RF power as follows:

Frequency: 1000 MHz

Physical Channels: F-Pilot, F-Paging, F-Sync with 6 F-Traffic

Scramble Code: 0

Output Power: -10 dBm

Measurement Procedure

Step	Action	Notes
1	Select the mode.	Press Mode , cdma2000 .
2	Preset the mode.	Press Mode Preset .
3	Toggle the device to BTS .	Press Mode Setup , Radio , Device . Toggle Device until BTS is selected.
4	Set the center frequency to 1.000 GHz.	Press FREQ Channel , 1000 , MHz .
5	Initiate the measurement.	Press Meas , Code Domain . The Code Domain Power measurement result should look like Figure 7-12 . The graph window is displayed with a text window below it. The text window shows the total power level along with the relative power levels of the various channels.

Figure 7-12

Code Domain Measurement Result - Power Graph & Metrics (Default) View - Downlink (BTS)

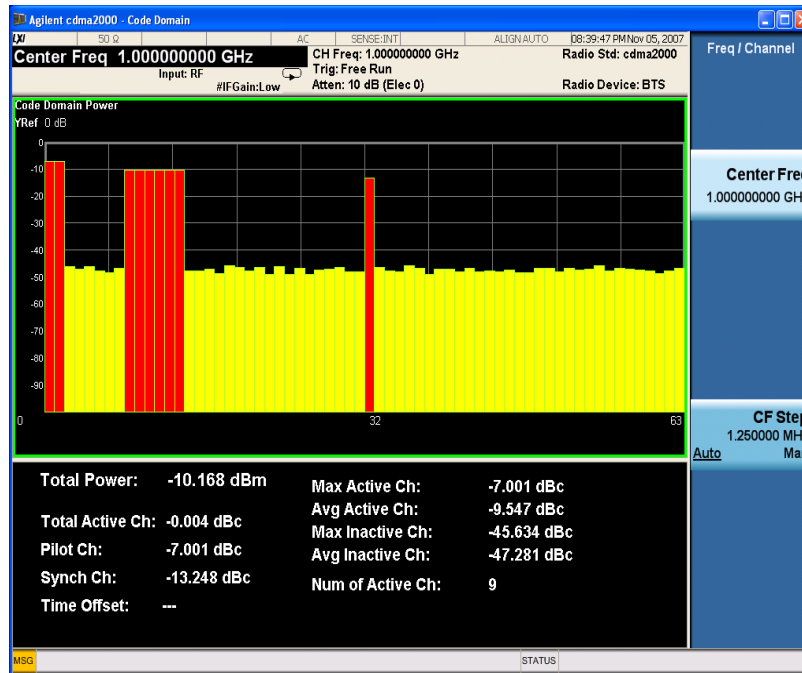

6	Display the code domain power view and the code domain error view.	Press View/Display , CDP Graph & CDE Graph . See Figure 7-13 .
---	--	--

Step	Action	Notes
------	--------	-------

Figure 7-13

Code Domain Measurement Result - CDP Graph & CDE Graph

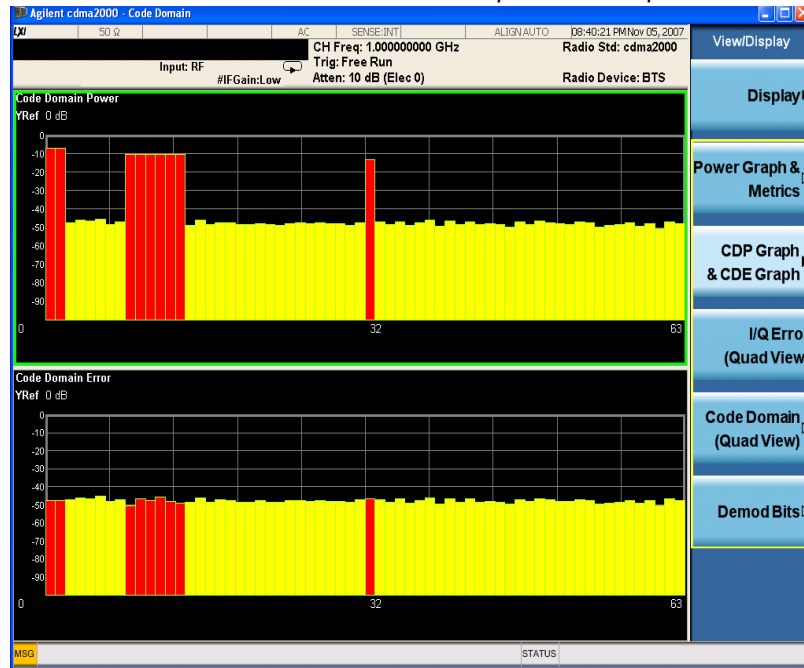

- | | | |
|---|--|---|
| 7 Place a marker. | Press Marker , and enter 8 using the front panel keypad.

Press Enter . | |
| 8 Initiate the despreading and decoding of the marked channel. | Press Marker , Mkr-> , Mkr-> Despread . | Allows EVM and other error measurements to be conducted on the channel. |
| 9 Display a combination view of the magnitude error vs. symbol, phase error vs. symbol, and EVM vs. symbol graph windows, with the modulation summary results window. | Press View/Display , I/Q Error (Quad View) . | See Figure 7-14 .

The results screen shows the data for the same code domain channel W64(8) that was selected for despreading by the marker in the Code Domain Quad View in the previous step. |

Code Domain Measurements
Setting Up and Making a Measurement

Step Action Notes

Figure 7-14 Code Domain Measurement Result - I/Q Error Quad View

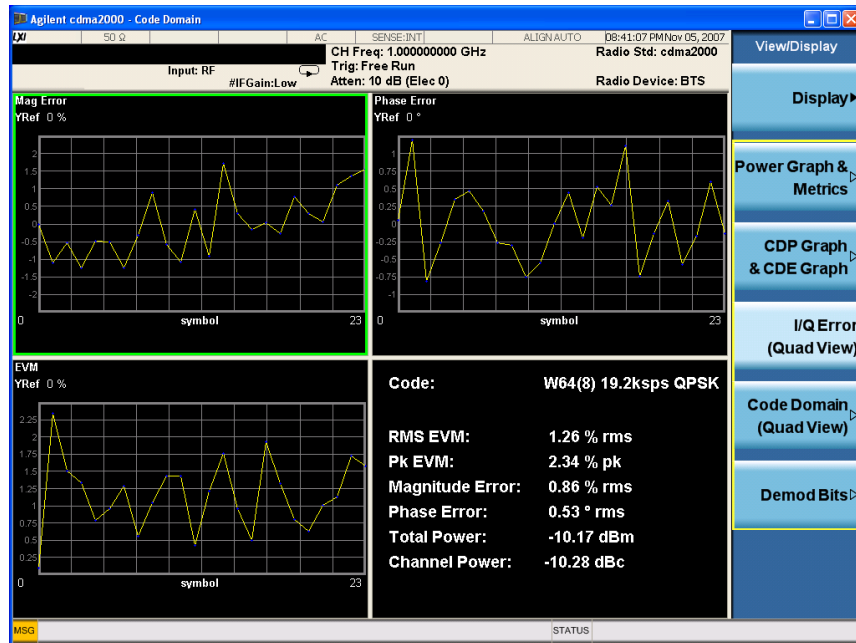

10 Display the combination view of the code domain power, symbol power, and I/Q symbol polar vector graph windows, and summary results window

Press View/Display, Code Domain (Quad View).

See Figure 7-15.

The original Code Domain Measurement with the marker at code channel 8 is shown at the top left, while the Symbol Power measurement of the marked channel is at the top right. The solid area below the first graticule (blue on the instrument display) is the composite symbol power over the entire capture interval, while the (yellow) horizontal line is Symbol power for W64(8).

The vertical red line in the graph indicates the measurement interval, with the default measurement offset 0 PCG. The graph of the I/Q vector trajectory for W64(8) during the measurement interval is shown at lower left. The summary data at lower right indicates peak and RMS EVM, magnitude and phase errors, powers of signal and channel.

Step Action Notes

Figure 7-15 Code Domain Measurement Result - Code Domain Quad View

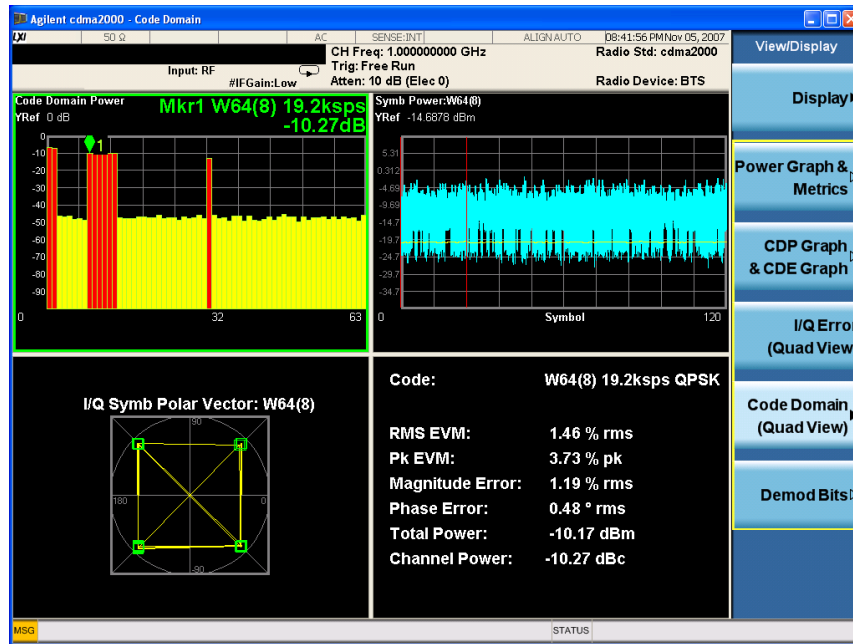

11 Display the combination view of the code domain power, symbol power graph windows, and the I/Q demodulated bit stream data for the symbol power slots selected by the measurement interval and measurement offset parameters,

Press **View/Display, Demod Bits.**

The Demod Bits View, show in Figure 7-16, displays the Code Domain Power and Symbol Power windows as in Code Domain (Quad View), Figure 7-15.

The demodulated bit stream displayed is the data contained in the Measurement Interval (1 PCG, with no offset, so it is the first PCG) of the Capture Interval of 5 PCGs.

Step	Action	Notes
------	--------	-------

Figure 7-16 Code Domain Measurement Result - Demod Bits View

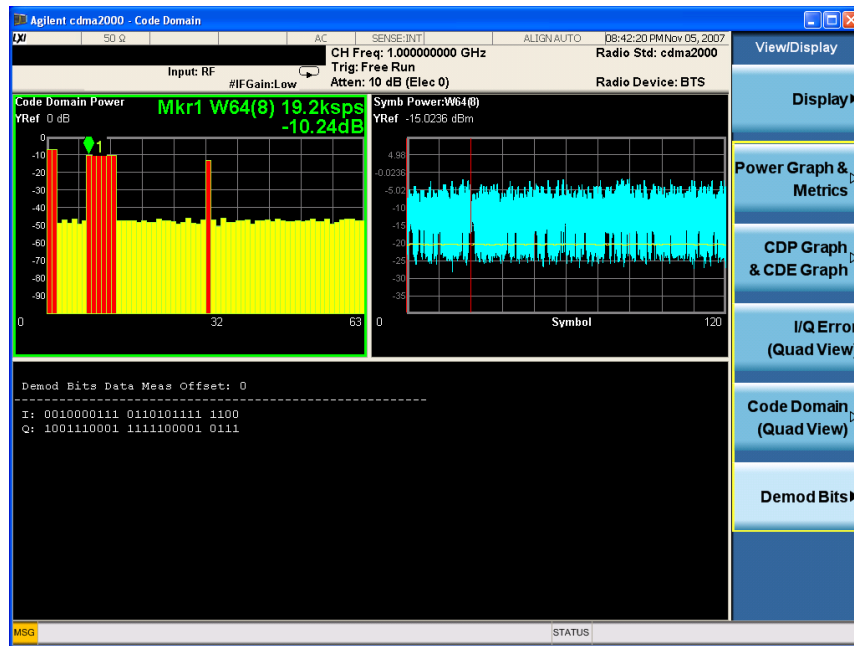

NOTE To place Marker on the different traces of the different views, press **Marker, Properties**, Marker Trace, then select the trace you want to put the marker on. There are 8 traces for selecting: Code Domain Power, Code Domain Error, Symbol Power, Chip Power, EVM, Phase Error, Mag Error and I/Q Symb Polar Vector.

If you have a problem, and get an error message, see the “**Error Messages Guide**”.

Troubleshooting Hints

Uncorrelated interference may cause CW interference, such as local oscillator feed through or spurs. Another cause of uncorrelated noise can be I/Q modulation impairments. Correlated impairments can be due to the phase noise on the local oscillator in the upconverter or I/Q modulator of the unit under test (UUT). These will be analyzed by the code domain measurements along with the QPSK EVM measurements and others.

Poor phase error indicates a problem at the I/Q baseband generator, filter, or modulator in the transmitter circuitry of the UUT, or both. The output amplifier in the transmitter can also create distortion that causes unacceptably high phase error. In a real system, poor phase error will reduce the ability of a receiver to correctly demodulate the received signal, especially in marginal signal conditions.

8 Modulation Accuracy (Composite Rho) Measurements

This section explains how to make the modulation accuracy (composite Rho) measurement on a cdma2000 mobile station (MS) and a base transceiver station (BTS). Modulation accuracy is the ratio of the correlated power in a multi-coded channel to the total signal power.

Setting Up and Making a Measurement

cdma2000 Measurement Example (MS)

Configuring the Measurement System

The MS under test must be set to transmit the RF power remotely through the system controller. This transmitting signal is connected to the RF input port of the instrument. Connect the equipment as shown.

Figure 8-1

Modulation Accuracy Measurement System

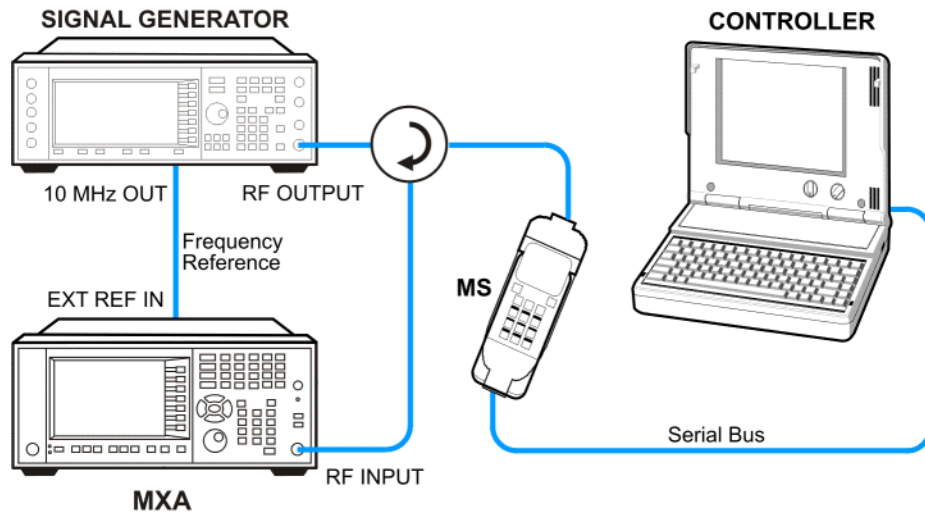

1. Using the appropriate cables, adapters, and circulator, connect the output signal of the MS to the RF input of the analyzer.
2. Connect the base transceiver station simulator or signal generator to the MS through the circulator to initiate a link constructed with the sync and pilot channels, if required.
3. Connect a BNC cable between the 10 MHz OUT port of the signal generator and the EXT REF IN port of the analyzer.
4. Connect the system controller to the MS through the serial bus cable to control the MS operation.

Setting the MS (Example)

From the base transceiver station simulator or the system controller, or both, perform all of the call acquisition functions required for the MS to transmit the RF power as follows:

Frequency: 1855 MHz (Channel Number: 100)
(=100 × 0.05 + 1850 MHz)

Physical Channels: R-Pilot, R-FCH and R-SCH1(W2(1))

Long Code Mask: 0000000000

Output Power: -20 dBm (at analyzer input)

Measurement Procedure

Step	Action	Notes
1	Select the mode. a. Press Mode , cdma2000 .	
2	Preset the mode. a. Press Mode Preset .	
3	Toggle the device to MS . a. Press Mode Setup , Radio, Device . b. Toggle Device until MS is selected.	
4	Set the center frequency to 1.855 GHz. a. Press FREQ Channel , 1855, MHz .	
5	Initiate the measurement. a. Press Meas, Mod Accuracy (Composite Rho) .	The Mod Accuracy I/Q Polar Vector Constellation measurement result should look similar to Figure 8-2 . The modulation constellation is shown, along with summary data for Rho, EVM, Peak Code Domain Error, and phase and magnitude errors. For the test of reverse link, if the IS95 signal is measured, you need to select IS95 in Radio Config (Meas Setup, More).

Modulation Accuracy (Composite Rho) Measurements
Setting Up and Making a Measurement

Step	Action	Notes
------	--------	-------

Figure 8-2 Modulation Accuracy Measurement Result - I/Q Measured Polar Graph (Default) View

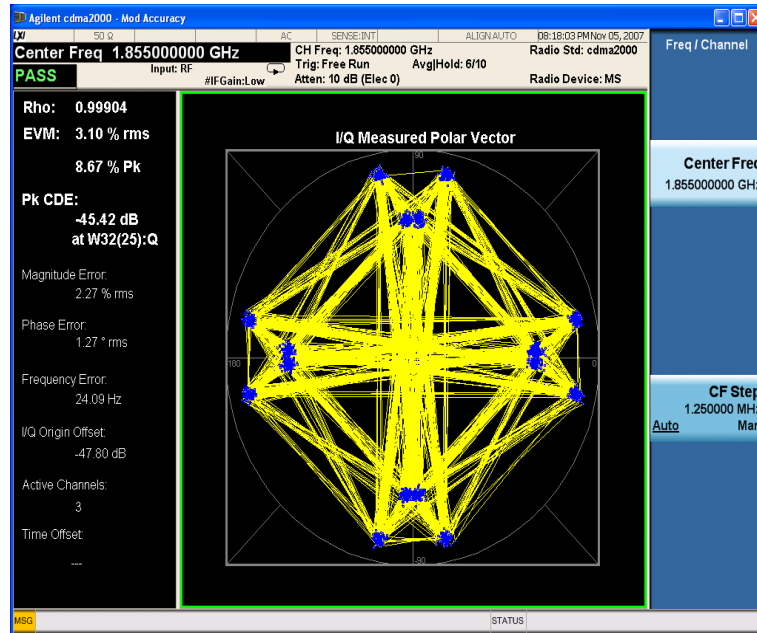

- | | | |
|---|--|---|
| <p>6 Examine the keys that are available to change the measurement parameters from the default condition.</p> | <p>a. Press Meas Setup.</p> | <p>The PASS/FAIL in the top left corner indicates the limit test result. You can manually set the Limits (under Meas Setup menu) of RMS EVM, Peak EVM, Rho, Peak Code Domain Error, Timing Error and Phase Error. If some items do not pass the limit test, the related item will be marked with red “F”.</p> <p>In the Advanced menu, you can use the EVM Result I/Q Offset key to include or exclude the I/Q origin offset in the measurement results. Also you can set the threshold relative to the channel total power to identify the active channel.</p> |
| <p>7 Display a view of the I/Q measured polar constellation graph window and the modulation summary result window</p> | <p>a. Press View/Display, I/Q Measured Polar Graph, I/Q PolarVec/Constln, Constellation</p> | <p>The measurement result should look similar to Figure 8-3.</p> |

Step	Action	Notes
------	--------	-------

Figure 8-3 Modulation Accuracy Measurement Result - Polar Constellation View

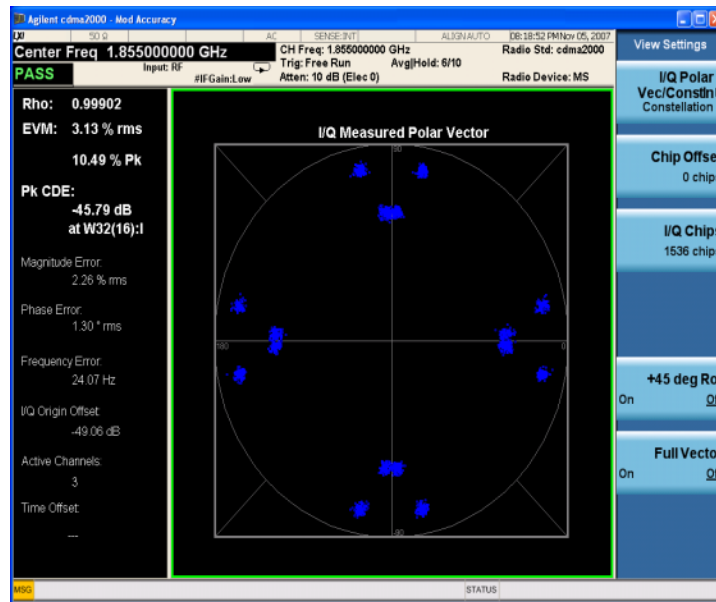

- | | | |
|---|---|--|
| <p>8 Display a combination view of the magnitude error, phase error, and EVM graph windows.</p> | <p>a. Press View/Display, I/Q Error.</p> | <p>The measurement result should look similar to Figure 8-4.</p> |
|---|---|--|

Figure 8-4 Modulation Accuracy Measurement Result - I/Q Error View

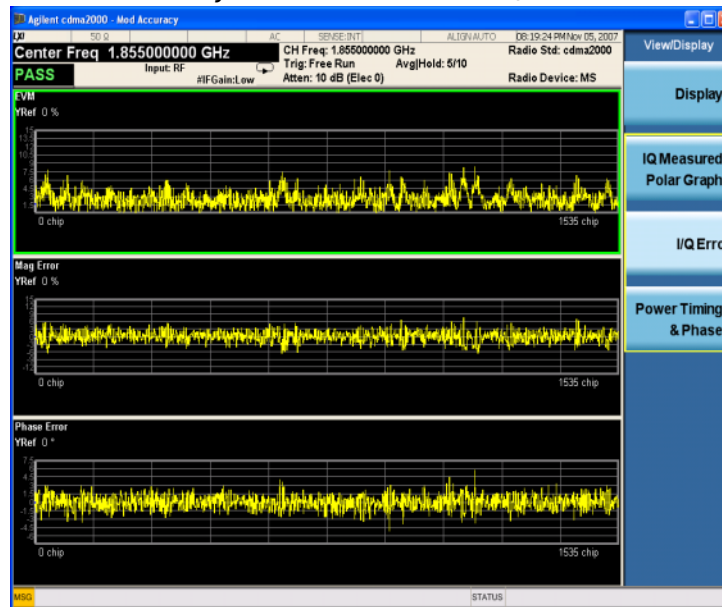

Modulation Accuracy (Composite Rho) Measurements
Setting Up and Making a Measurement

Step	Action	Notes
9	Initiate the Multi Channel Estimator	<p>a. Press View/Display, Power Timing & Phase.</p> <p>This displays the power of the code channels, and time/phase of the code channels to pilot channel, and also CDE of each code channel using the Multi Channel Estimator.</p> <p>There will be a message “Press Meas Setup, Advanced and turn Multi Channel Estimator On to see the data” when you first use this view, after the Multi Channel Estimator is set to On, you will see the measurement result.</p> <p>The measurement result should look like Figure 8-5. The color of the data turns to yellow when it is maximum compared to other code channels.</p>

Figure 8-5

Modulation Accuracy Measurement Result - Power Timing & Phase



10	Display a combination view of the code domain power and code domain error,	<p>a. Press View/Display, CDP Graph & CDE Graph.</p> <p>See Figure 7-6.</p>
----	--	--

NOTE To place Marker on the different traces of the different views, press **Marker, Properties**, Marker Trace, then select the trace you want to put the marker on. There are 4 traces for selecting: I/Q measured Polar, EVM, Mag Error and Phase Error.

If you have a problem, and get an error message, see the “**Error Messages Guide**”.

cdma2000 Measurement Example (BTS)

Configuring the Measurement System

Use the system controller to remotely control the base transceiver station (BTS) under test to transmit the RF power. The cdma2000 modulated interference signal is injected to the antenna output port of the BTS through an attenuator and circulator. The transmitting signal from the BTS is connected to the RF input port of the instrument from the circulator port. Connect the equipment as shown.

Figure 8-6

Modulation Accuracy Measurement System

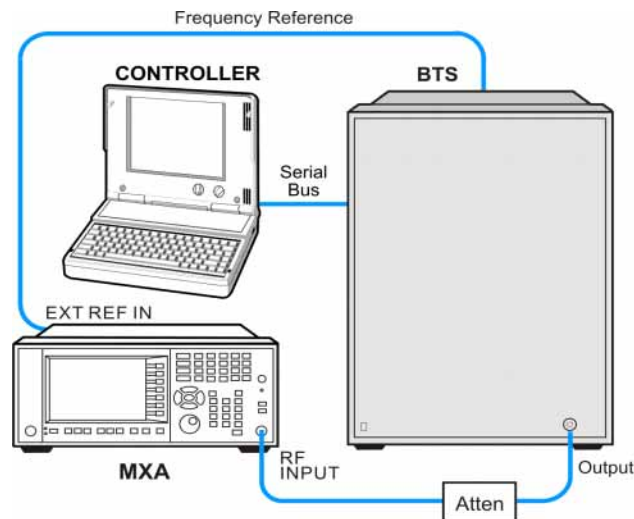

ba88a

1. Connect the BTS output signal to the RF input port of the analyzer through the attenuator.
2. Connect a BNC cable between the frequency reference port of the BTS and the EXT REF IN port of the analyzer.
3. Connect the system controller to the BTS through the serial bus cable.

NOTE

If you want to test the Time Offset (the time from the trigger point to the PN offset), you need to connect the trigger output of the BTS to the trigger input of the analyzer.

Setting the BTS (Example)

From the BTS simulator or the system controller, or both, perform all of the call acquisition functions required for the BTS to transmit the RF power as follows:

Frequency: 1000 MHz

Physical Channels: F-Pilot, F-Paging, F-Sync with 6 F-Traffic

Scramble Code: 0

Modulation Accuracy (Composite Rho) Measurements
Setting Up and Making a Measurement

Output Power: -10 dBm

Measurement Procedure

Step	Action	Notes
1	Select the mode.	Press Mode , cdma2000 .
2	Preset the mode.	Press Mode Preset .
3	Toggle the device to BTS .	Press Mode Setup , Radio , Device . Toggle Device until BTS is selected.
4	Set the center frequency to 1.000 GHz.	Press FREQ Channel , 1000 , MHz .
5	Initiate the measurement.	Press Meas , Mod Accuracy (Composite RHO) . The Mod Accuracy I/Q Polar Vector Constellation measurement result should look like Figure 8-7 . The modulation constellation is shown, along with summary data for Rho, EVM, Peak Code Domain Error, and phase and magnitude errors.

Figure 8-7 Modulation Accuracy Measurement Result - I/Q Measured Polar Graph (Default) View

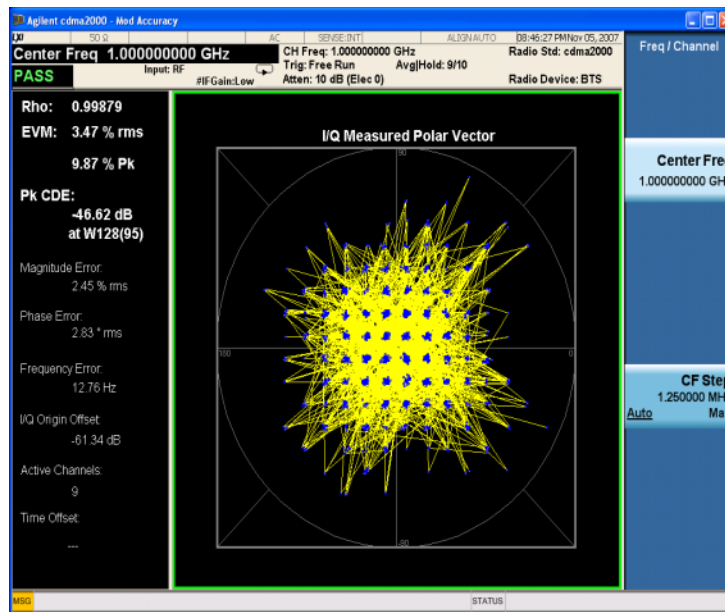

6	Display a view of the I/Q measured polar constellation graph window and the modulation summary result window.	Press View/Display , I/Q Measured Polar Graph , I/Q PolarVec/Constln , Constellation . See Figure 8-8 .
---	---	--

Step	Action	Notes
------	--------	-------

Figure 8-8 Modulation Accuracy Measurement Result - Polar Constellation View

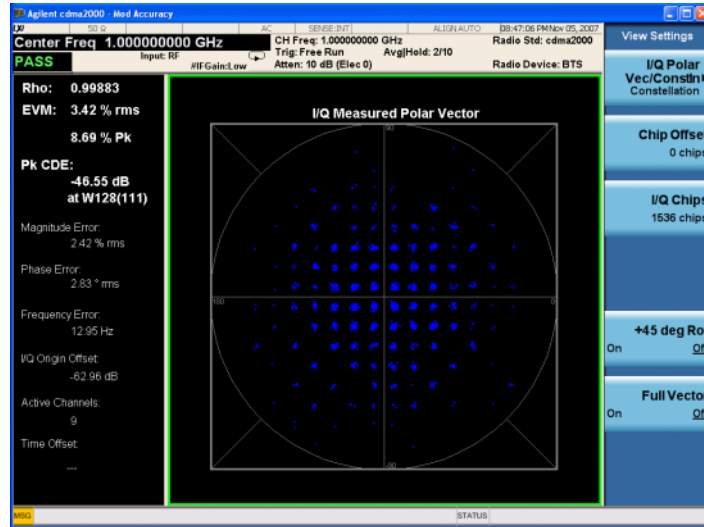

7	Display a combination view of the magnitude error, phase error, and EVM graph window.	Press View/Display, I/Q Error.	See Figure 8-9.
---	---	--------------------------------	-----------------

Figure 8-9 Modulation Accuracy Measurement Result - I/Q Error View

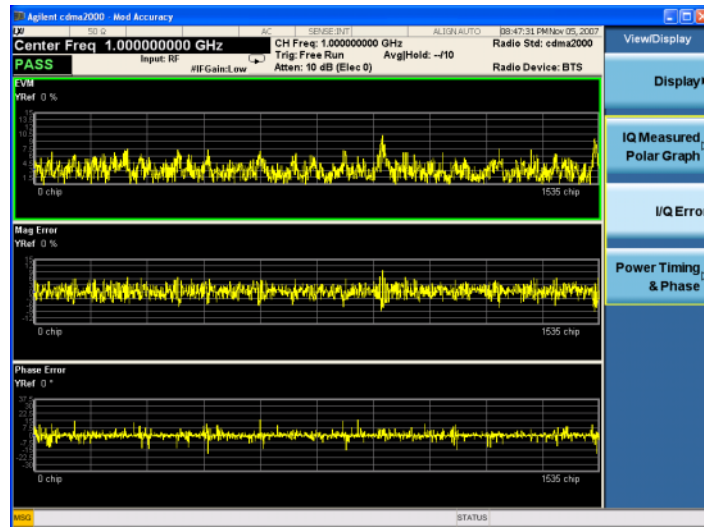

Modulation Accuracy (Composite Rho) Measurements Setting Up and Making a Measurement

Step	Action	Notes
8	Initiate the Multi Channel Estimator	<p>Press View/Display, Power Timing & Phase.</p> <p>This displays the power of the code channels, and time/phase of the code channels to pilot channel, and also CDE of each code channel using the Multi Channel Estimator.</p> <p>There will be a message “Press Meas Setup, Advanced and turn Multi Channel Estimator On to see the data” when you first use this view, after the Multi Channel Estimator is set to On, you will see the measurement result.</p> <p>The measurement result should look like Figure 8-10. The color of the data turns to yellow when it is maximum compared to other code channels.</p>

Figure 8-10

Modulation Accuracy Measurement Result - Power Timing & Phase

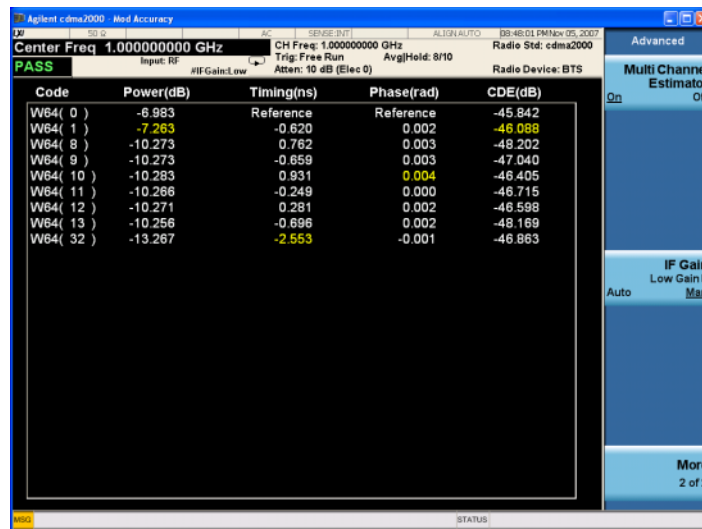

NOTE

To place Marker on the different traces of the different views, press **Marker**, **Properties**, Marker Trace, then select the trace you want to put the marker on. There are 4 traces for selecting: I/Q measured Polar, EVM, Mag Error and Phase Error.

If you have a problem, and get an error message, see the “**Error Messages Guide**”.

Troubleshooting Hints

Poor phase error often indicates a problem with the I/Q baseband generator, filters, modulator, or all three, in the transmitter circuitry of the unit under test (UUT). The output amplifier in the transmitter can also create distortion that causes high phase error. In a real system, a poor phase error will reduce the ability of a receiver to correctly demodulate the received signal, especially in marginal signal conditions.

Modulation Accuracy (Composite Rho) Measurements Setting Up and Making a Measurement

If the error “Can not correlate to input signal” is shown, it means that your measurement has failed to find any active channels due to the lack of correlation with the input signal. The input signal level, scramble code, or both, may need to be adjusted to obtain correlation.

Modulation Accuracy (Composite Rho) Measurements
Setting Up and Making a Measurement

9 Power Statistics CCDF Measurements

This section explains how to make the Power Statistics Complementary Cumulative Distribution Function (Power Stat CCDF) measurement on a cdma2000 mobile station (MS). Power Stat CCDF curves characterize the higher level power statistics of a digitally modulated signal.

Setting Up and Making a Measurement

Configuring the Measurement System

The mobile station (MS) under test must be set to transmit the RF power remotely through the system controller. This transmitting signal is connected to the RF input port of the instrument. Connect the equipment as shown.

Figure 9-1

Power Statistics (CCDF) Measurement System

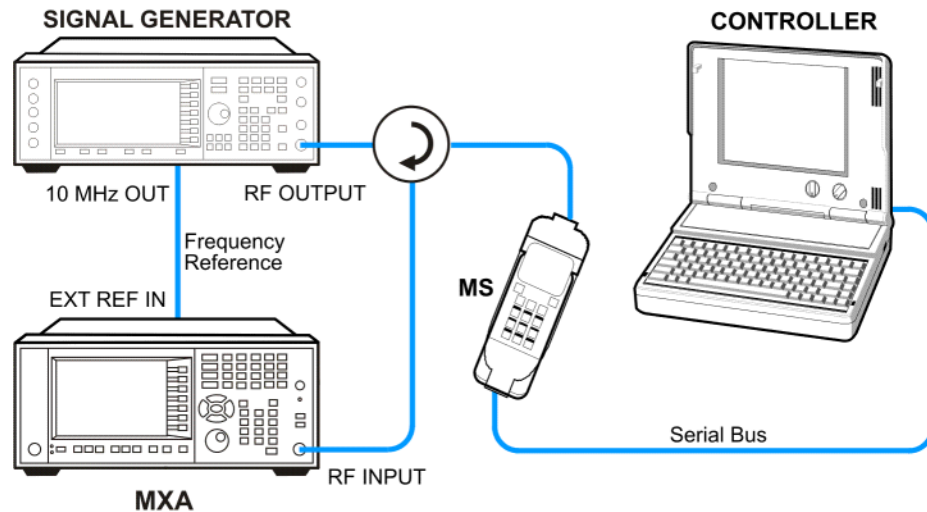

1. Using the appropriate cables, adapters, and circulator, connect the output signal of the MS to the RF input of the analyzer.
2. Connect the base transceiver station simulator or signal generator to the MS through the circulator to initiate a link constructed with the sync and pilot channels, if required.
3. Connect a BNC cable between the 10 MHz OUT port of the signal generator and the EXT REF IN port of the analyzer.
4. Connect the system controller to the MS through the serial bus cable to control the MS operation.

Setting the MS (Example)

From the base transceiver station simulator or the system controller, or both, perform all of the call acquisition functions required for the MS to transmit the RF power as follows:

Frequency: 1855 MHz (Channel Number: 100)
(=100 × 0.05 + 1850 MHz)

Physical Channels: R-Pilot, R-FCH and R-SCH1(W2(1))

Output Power: -20 dBm (at analyzer input)

Measurement Procedure

Step	Action	Notes
1	Select the mode. a. Press Mode , cdma2000 .	
2	Preset the mode. a. Press Mode Preset .	
3	Toggle the device to MS . a. Press Mode Setup , Radio, Device . b. Toggle Device until MS is selected.	
4	Set the center frequency. a. Press FREQ Channel , 1855, MHz .	
5	Initiate the measurement. a. Press Meas, Power Stat CCDF .	The CCDF measurement result should look like Figure 9-2 . The blue line is the Gaussian trace and the yellow line is the measurement result. The Info BW is the channel band width that will be used for data acquisition, the default value is 1.5MHz. You can manually change the Info BW under the BW menu.

Figure 9-2

Power Statistics CCDF Result

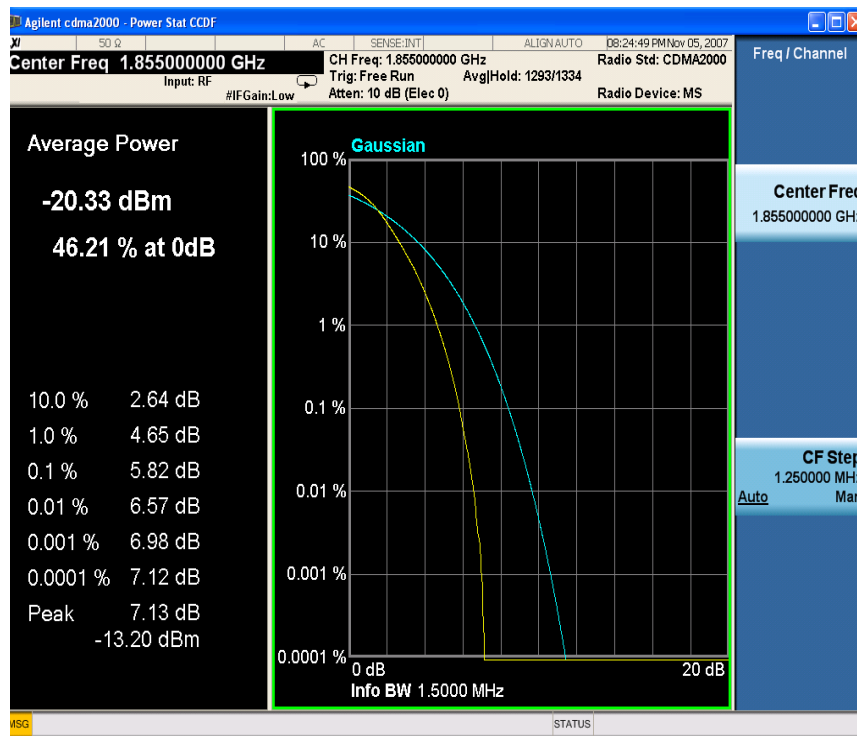

Power Statistics CCDF Measurements
Setting Up and Making a Measurement

Step	Action	Notes
6	Initiate the reference trace (violet line). a. Press Trace/Detector, Ref Trace (On) .	The reference trace is the same as the measurement trace. You can use the Store Ref Trace key to copy the currently measured curve as the reference trace. It will not change until you store the reference trace again or choose the other mode. The CCDF measurement result with the reference trace should look like Figure 9-3 .

Figure 9-3 Power Statistics CCDF Result

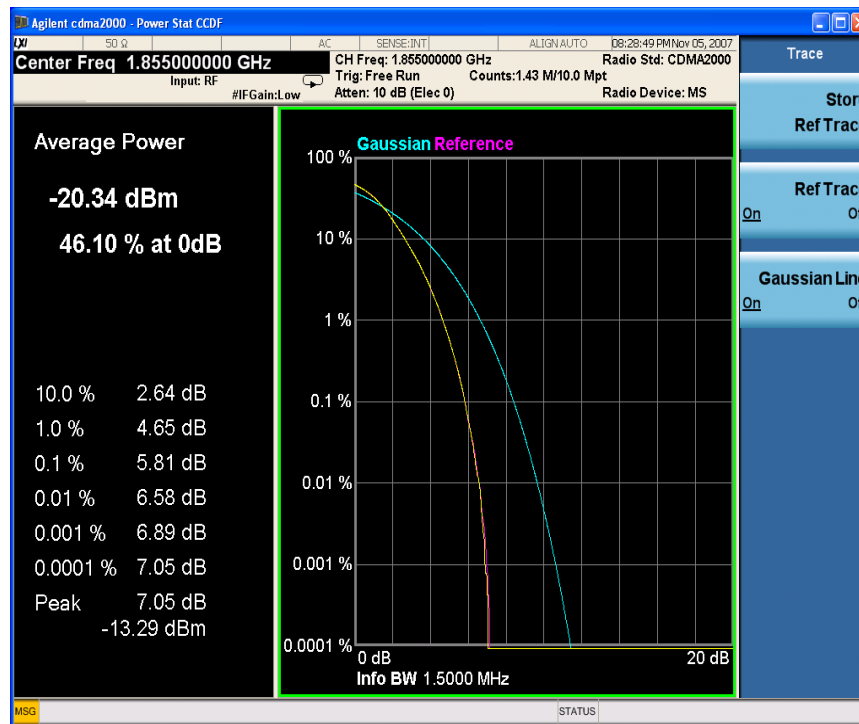

If you have a problem, and get an error message, see the “**Error Messages Guide**”.

Troubleshooting Hints

The power statistics CCDF measurement can contribute in setting the signal power specifications for design criteria for systems, amplifiers, and other components. For example, it can help determine the optimum operating point to adjust each code timing for appropriate peak or average power ratio, or both, for the transmitter in a cdma2000 system.

10 QPSK EVM Measurements

This chapter explains how to make the QPSK error vector magnitude (EVM) measurement on a cdma2000 mobile station (MS). QPSK EVM is a measure of the phase and amplitude modulation quality relates the performance of an actual signal compared to an ideal signal as a percentage, calculated over the course of the ideal constellation.

Setting Up and Making a Measurement

Configuring the Measurement System

The mobile station (MS) under test must be set to transmit the RF power remotely through the system controller. This transmitting signal is connected to the RF input port of the instrument. Connect the equipment as shown.

Figure 10-1

QPSK EVM Measurement System

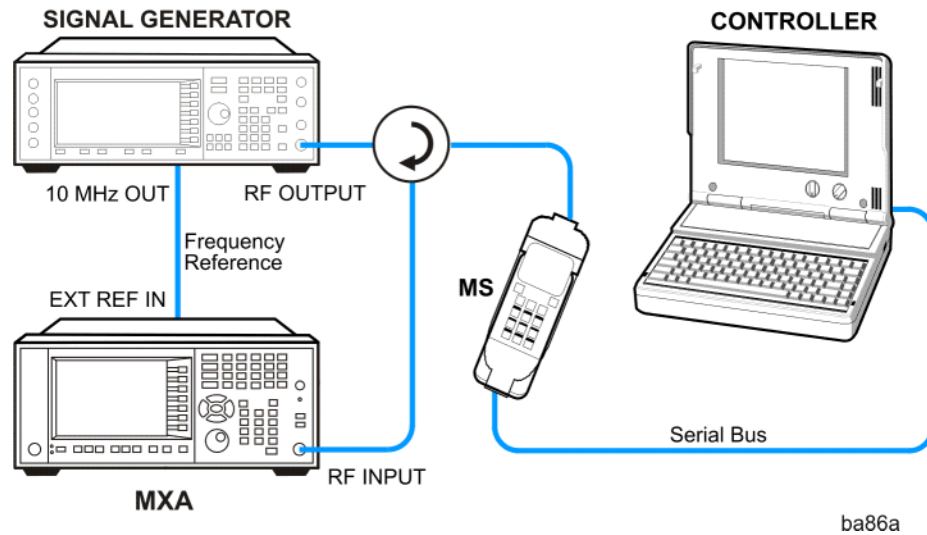

1. Using the appropriate cables, adapters, and circulator, connect the output signal of the MS to the RF input of the analyzer.
2. Connect the base transceiver station simulator or signal generator to the MS through the circulator to initiate a link constructed with the sync and pilot channels, if required.
3. Connect a BNC cable between the 10 MHz OUT port of the signal generator and the EXT REF IN port of the analyzer.
4. Connect the system controller to the MS through the serial bus cable to control the MS operation.

Setting the MS

From the base transceiver station simulator or the system controller, or both, perform all of the call acquisition functions required for the MS to transmit the RF power as follows:

Frequency: 1855 MHz (Channel Number: 100)
(=100 × 0.05 + 1850 MHz)

Physical Channels: R-Pilot

Scramble Code: 0

Output Power: -20 dBm (at analyzer input)

Measurement Procedure

Step	Action	Notes
1 Select the mode.	a. Press Mode , cdma2000 .	
2 Preset the mode.	a. Press Mode Preset .	
3 Toggle the device to MS .	a. Press Mode Setup , Radio, Device . Toggle Device until MS is selected.	
4 Set the center frequency to 1.855 GHz.	a. Press FREQ Channel , 1855, MHz .	
5 Initiate the measurement.	a. Press Meas , QPSK EVM .	The QPSK EVM I/Q Measured Polar Vector measurement result should look like Figure 10-2 . The measurement values for modulation accuracy are shown in the summary result window.

Figure 10-2

QPSK EVM Result - Polar Vector/Constellation (Default) View

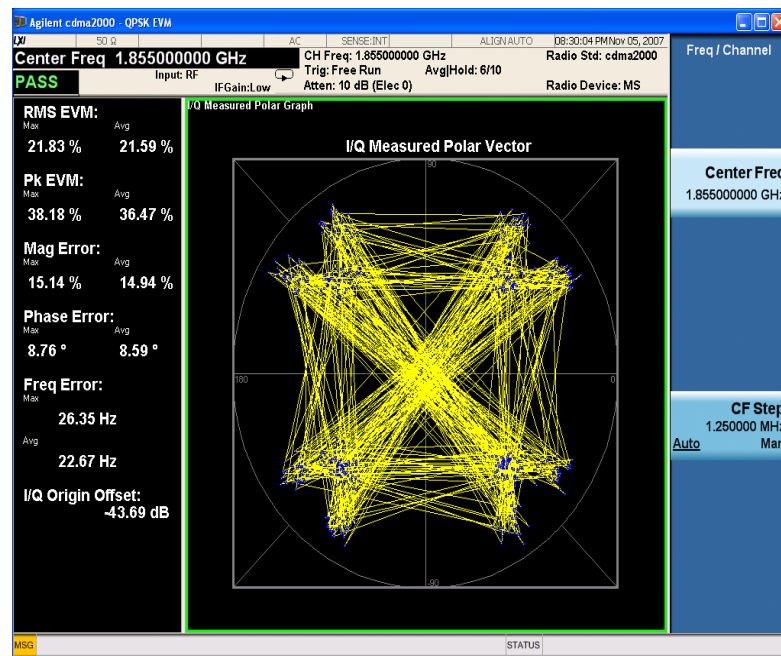

QPSK EVM Measurements
Setting Up and Making a Measurement

Step	Action	Notes
6	<p>Display a view of the I/Q measured polar constellation graph window and the modulation summary result window</p> <p>a. Press View/Display, I/Q Measured Polar Graph, I/Q Polar Vec/Constln, Constellation</p>	<p>The measurement result should look similar to Figure 10-3.</p>

Figure 10-3

QPSK EVM Result - Polar Constellation View

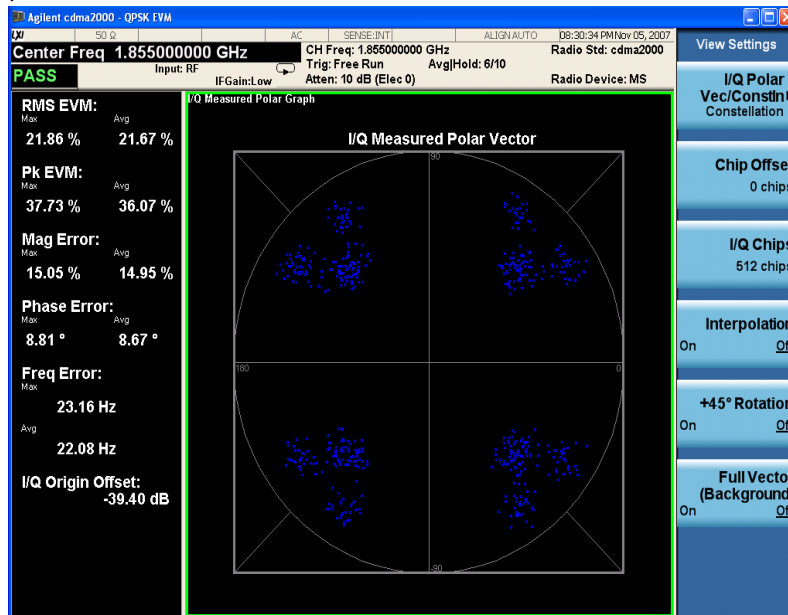

7	<p>Display a combination view of the magnitude error, phase error, EVM graph windows, and the modulation summary result window.</p> <p>a. Press View/Display, I/Q Error.</p>	<p>The measurement result should look similar to Figure 10-4.</p>
---	---	---

Step	Action	Notes
------	--------	-------

Figure 10-4

QPSK EVM Result - I/Q Error Quad View

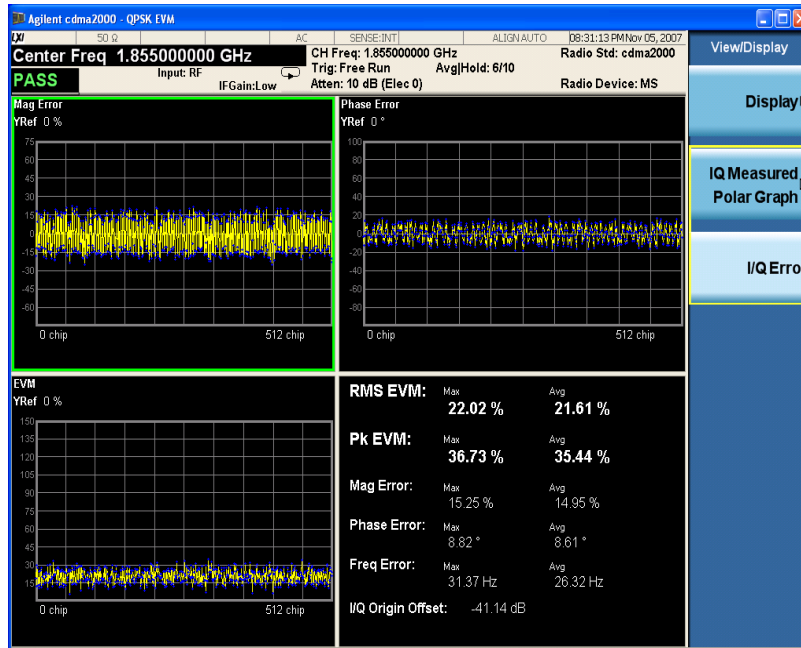

- | | | |
|---|------------------------------------|--|
| <p>8 Examine the keys that are available to change the measurement parameters from the default condition.</p> | <p>a. Press Meas Setup.</p> | <p>The PASS/FAIL in the top left corner indicates the limit test result. You can manually set the Limits (under Meas Setup menu) of RMS EVM and Freq Error. If some items do not pass the limit test, the related item will be marked with red “F”.</p> <p>In the Advanced menu, you can use the EVM Result I/Q Offset key to include or exclude the I/Q origin offset in the measurement results.</p> |
|---|------------------------------------|--|

NOTE In the View/Display menu, the Display key and the IQ Measured Polar Graph key has an arrow in the right middle of the button. If the arrow is hollow, you need to press the key to select the view and the hollow arrow turns solid. If you press the key again, the view settings about this view will be displayed.

If you have a problem, and get an error message, see the “**Error Messages Guide**”.

Troubleshooting Hints

Poor phase error indicates a problem with the I/Q baseband generator, filters, or modulator, or all, in the transmitter circuitry of the unit under test (UUT). The output amplifier in the transmitter can also create distortion that causes unacceptably high phase error. In a real system, a poor phase error will reduce the ability of a receiver to correctly demodulate the received signal, especially in marginal signal conditions.

QPSK EVM Measurements
Setting Up and Making a Measurement

11 Monitor Spectrum Measurements

This chapter explains how to make a Monitor Spectrum measurement on a cdma2000 MS (Mobile Station). Monitor Spectrum measurements show a spectrum domain display of the cdma2000 signal.

This example shows a MS under test set up to transmit RF power, and controlled remotely by a system controller. The transmitting signal is connected to the RF input port of the instrument. Connect the equipment as shown.

Setting Up and Making a Measurement

Configuring the Measurement System

The MS under test must be set to transmit the RF power remotely through the system controller. This transmitting signal is connected to the RF input port of the instrument. Connect the equipment as shown.

Figure 11-1 Modulation Accuracy Measurement System

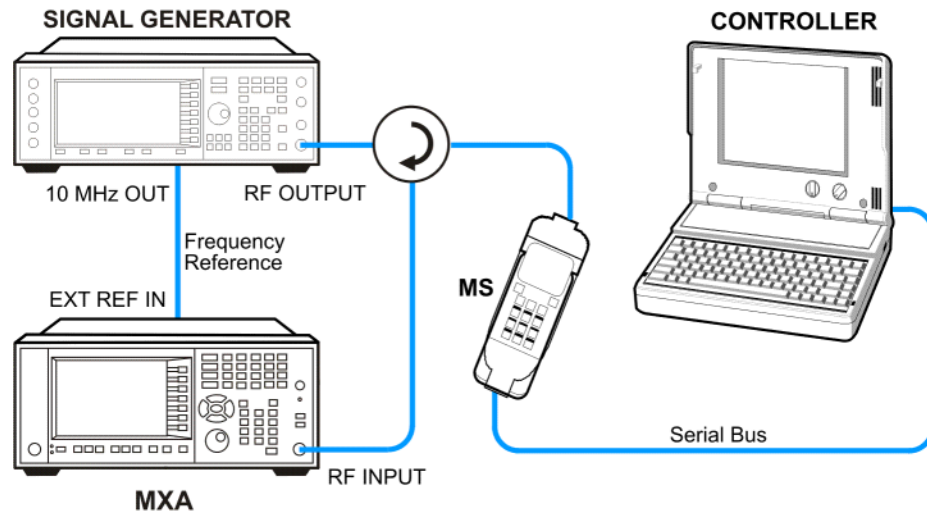

1. Using the appropriate cables, adapters, and circulator, connect the output signal of the MS to the RF input of the analyzer.
2. Connect the base transceiver station simulator or signal generator to the MS through the circulator to initiate a link constructed with the sync and pilot channels, if required.
3. Connect a BNC cable between the 10 MHz OUT port of the signal generator and the EXT REF IN port of the analyzer.
4. Connect the system controller to the MS through the serial bus cable to control the MS operation.

Setting the MS (Example)

From the base transceiver station simulator or the system controller, or both, perform all of the call acquisition functions required for the MS to transmit the RF power as follows:

Frequency: 1855 MHz (Channel Number: 100)
(=100 × 0.05 + 1850 MHz)

Physical Channels: R-Pilot, R-FCH and R-SCH1(W2(1))

Output Power: -20 dBm (at analyzer input)

Measurement Procedure

Step	Action	Notes
1	Select the mode. a. Press Mode , cdma2000 .	
2	Preset the mode. a. Press Mode Preset .	
3	Set the center frequency. a. Press FREQ Channel , enter a numerical frequency using the front-panel keypad, and select a units key, such as MHz .	
4	Set the span frequency a. Press SPAN X Scale , enter a numerical span using the front-panel keypad, and select a units key, such as MHz .	
5	Initiate the measurement. a. Press Meas, Monitor Spectrum .	The default display shows the Current (yellow trace) data. To make viewing the display easier, you can view either the Current trace or Average separately.

Figure 11-2

Monitor Spectrum Measurement - Spectrum View

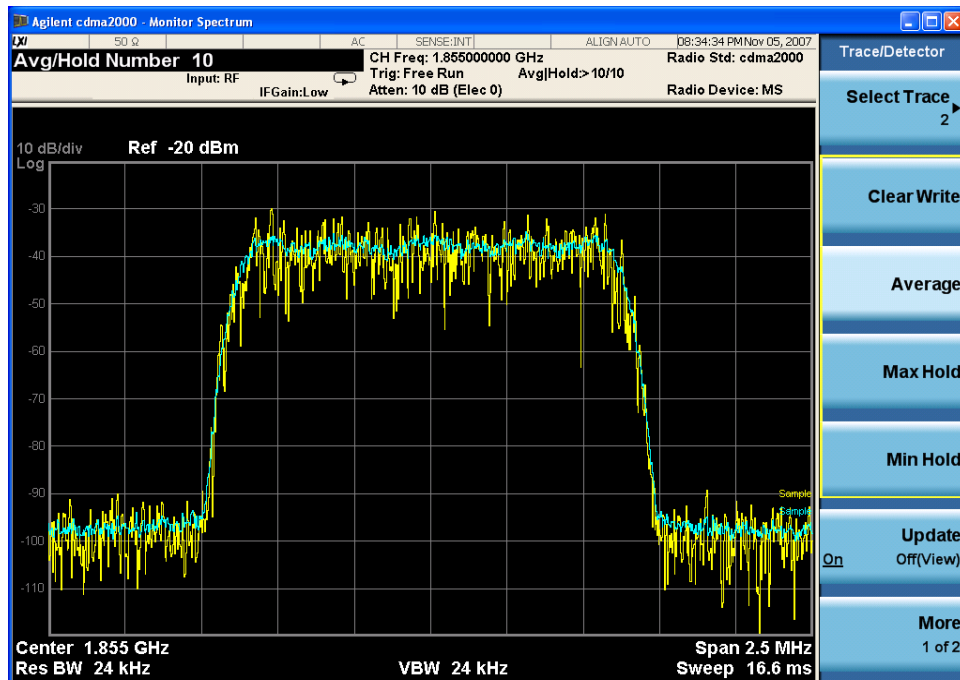

Monitor Spectrum Measurements
Setting Up and Making a Measurement

Step	Action	Notes
6 To see the timely update trace.	a. Press Trace/Detector , Select Trace , select the trace(s) desired for display, and toggle Display to Show . b. Press Update to On	

12 IQ Waveform (Time Domain) Measurements

This chapter explains how to make a waveform (time domain) measurement on a cdma2000 mobile station. The measurement of I and Q modulated waveforms in the time domain disclose the voltages which comprise the complex modulated waveform of a digital signal.

Setting Up and Making Measurements

Configuring the Measurement System

The MS under test must be set to transmit the RF power remotely through the system controller. This transmitting signal is connected to the RF input port of the instrument. Connect the equipment as shown.

Figure 12-1 Waveform Measurement System

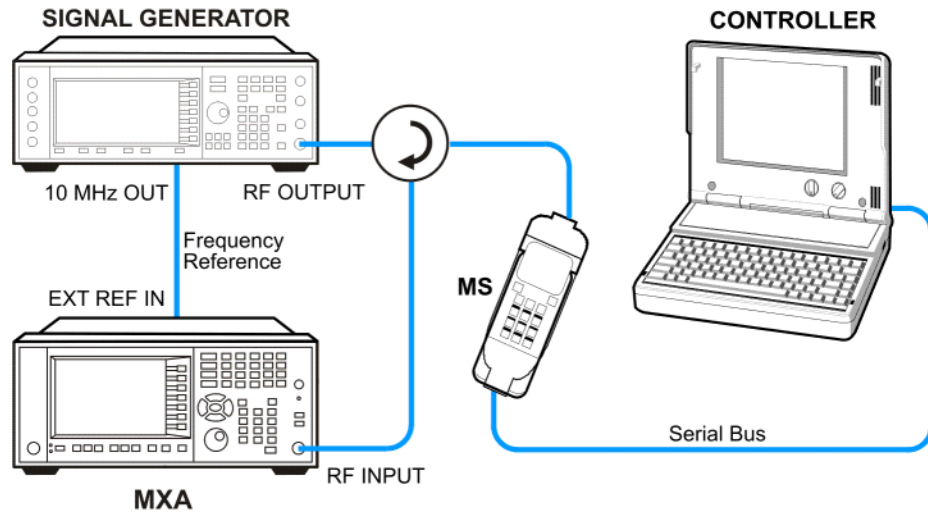

1. Using the appropriate cables, adapters, and circulator, connect the output signal from the MS to the RF input port of the analyzer.
2. Connect the base transceiver station simulator or signal generator to the MS through the circulator to initiate a link constructed with the sync and pilot channels, if required.
3. Connect a BNC cable between the 10 MHz OUT port of the signal generator and the EXT REF IN port of the analyzer.
4. Connect the system controller to the MS through the serial bus cable to control the MS operation.

Setting the MS (Example)

From the base transceiver station simulator or the system controller, or both, perform all of the call acquisition functions required for the MS to transmit the RF power as follows:

Frequency: 1855 MHz (Channel Number: 100)
(=100 × 0.05 + 1850 MHz)

Output Power: -20 dBm (at analyzer input)

Measurement Procedure

Step	Action	Notes
1	Select the mode. a. Press Mode , cdma2000 .	
2	Preset the mode. a. Press Mode Preset .	
3	Set the center frequency. a. Press FREQ Channel , enter a numerical frequency using the front-panel keypad, and select a units key, such as MHz .	
4	Set the span frequency a. Press SPAN X Scale , enter a numerical span using the front-panel keypad, and select a units key, such as MHz .	
5	Initiate the measurement. a. Press Meas , IQ Waveform .	The default display shows the RF Envelope with the current data. The measured values for the mean power and peak-to-mean power are shown in the text window.

Figure 12-2

Waveform Measurement - RF Envelope (Default View)

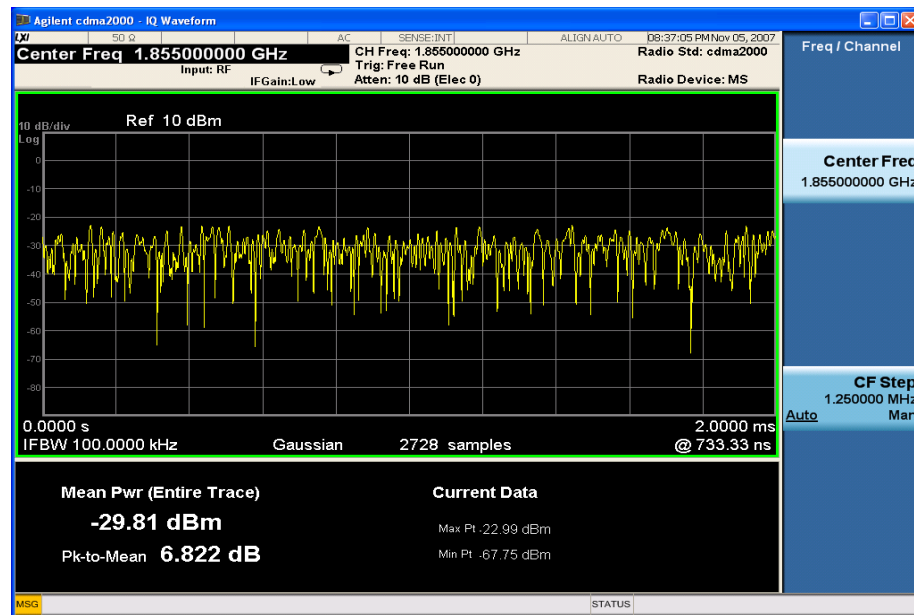

6	Select the view. a. Press View/Display , IQ Waveform	The IQ Waveform window provides a view of the I (yellow trace) and Q (blue trace) waveforms on the same graph in terms of voltage versus time in linear scale.
---	---	--

IQ Waveform (Time Domain) Measurements
 Setting Up and Making Measurements

Step	Action	Notes
------	--------	-------

Figure 12-3 Waveform Measurement - I/Q Waveform View

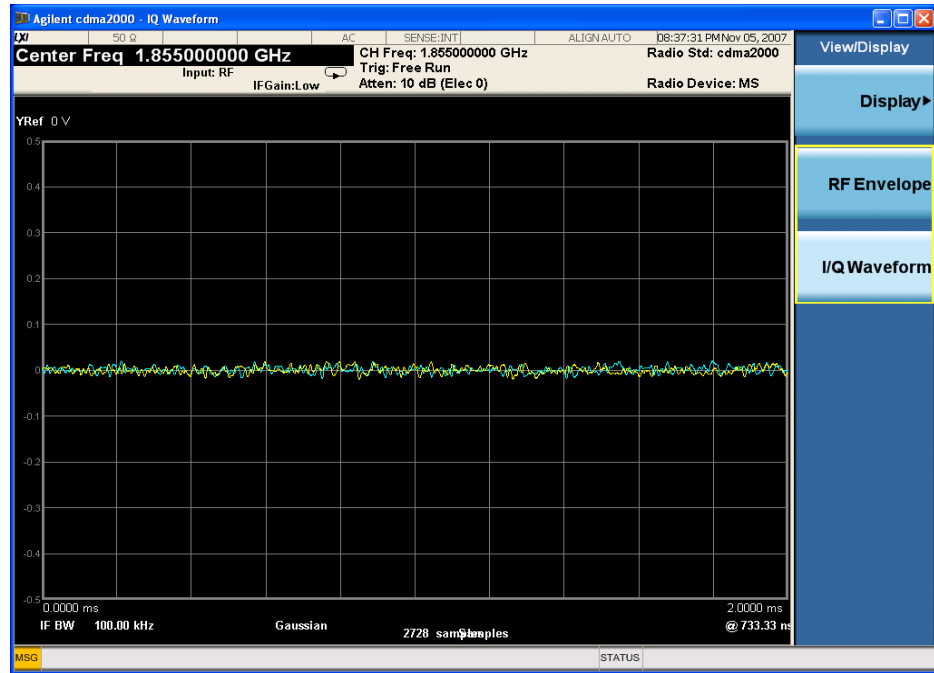

- | | | |
|--|--|--|
| 7 Adjust the amplitude. | a. Press AMPTD Y Scale , and the down arrow keys until the waveforms are shown at a convenient voltage scale for viewing. | |
| 8 Adjust the span. | a. Press SPAN X Scale , and the down arrow keys until the waveforms are shown at a convenient time scale for viewing. | |
| 9 Initiate a marker. | a. Press Marker, Select Marker , | Rotate the RPG knob until the marker is shown at a desired time in the waveform for viewing the trace values at the time position of the marker. |
| 10 Set measurement to continuous mode. | a. Press Cont . | |

Step	Action	Notes
11 Examine the keys that are available to change the measurement parameters from the default condition.	a. Press Meas Setup .	

Using the Waveform Measurement to Set Up Triggering (for burst signals)

You can use the waveform measurement to view your signal in the time domain and to help select the appropriate trigger to acquire your signal.

Step	Action	Notes
1 Initiate the measurement.	a. Press Meas, IQ Waveform .	
2 Adjust the x-axis scale to view the complete signal waveform.	a. Press SPAN X Scale, Scale/Div . b. Use the front-panel keypad to input the scale/div, and press a units key, for example μs , to complete the entry.	
3 Select a trigger source (free run is the default setting).	a. Press Trigger , and select one of the available trigger sources	You can also setup trigger holdoff and auto trigger timing.

IQ Waveform (Time Domain) Measurements
Setting Up and Making Measurements

13 Using Option BBA Baseband I/Q Inputs

Baseband I/Q Measurements Available for X-Series Signal Analyzers

The following table shows the measurements that can be made using Baseband I/Q inputs:

Table 13-1 *BBIQ Supported Measurements vs. Mode*

Mode	Measurements
GSM	IQ Waveform GMSK Phase & Freq EDGE EVM
802.16 OFDMA	IQ Waveform Power Stat CCDF Modulation Analysis
TD-SCDMA	IQ Waveform Power Stat CCDF Code Domain Mod Accuracy
cdma2000	IQ Waveform Power Stat CCDF Code Domain Mod Accuracy QPSK EVM
IQ Analyzer (Basic)	IQ Waveform Complex Spectrum

Baseband I/Q Measurement Overview

The Baseband I/Q functionality is a hardware option, Option BBA. If the option is not installed in the instrument, the I/Q functionality cannot be enabled.

The Baseband I/Q option provides four input ports and one Calibration Output port. The input ports are I, I-bar, Q, and Q-bar. The I and I-bar together compose the I channel and the Q and Q-bar together compose the Q channel. Each channel has two modes of operation:

Mode	Description
Single Ended (unbalanced)	In this mode, only the main port (I or Q) is used and the complementary ports (I-bar or Q-bar) is ignored. The I and Q ports are in single-ended mode when Differential "Off" is selected.
Differential (balanced)	In this mode, both main and complementary ports are used. To activate this mode, select Differential "On" from the I and Q Setup softkey menus.

The system supports a variety of input passive probes as well as the Keysight 1153A active differential probe using the infinimax probe interface.

NOTE To avoid duplication, this section describes only the details unique to using the baseband I/Q inputs. For generic measurement details, refer to the previous "Making Measurements" sections.

To make measurements using baseband I/Q Inputs, make the following selections:

Step	Action	Notes	
1	Select a measurement	a. Select a measurement that supports baseband I/Q inputs.	
2	Select the I/Q Path	a. Press Input/Output, I/Q, I/Q Path . b. Select from the choices present on the screen.	The path selected is shown at the top of the measurement screen.
3	Select the appropriate circuit location and probe(s) for measurements.		

Using Option BBA Baseband I/Q Inputs
Baseband I/Q Measurement Overview

Step	Action	Notes
4 Set up the I Path (if required).	a. If you have set the I/Q Path to I+jQ or to I Only , press I Setup . <ol style="list-style-type: none"> <li data-bbox="574 386 1073 449">I. Select whether Differential (Balanced) inputs is On or Off. <li data-bbox="574 470 1032 497">II. Select the input impedance, Input Z. <li data-bbox="574 518 963 546">III. Input a Skew value in seconds. <li data-bbox="574 567 1045 821">IV. Set up the I Probe by pressing I Probe <ol style="list-style-type: none"> <li data-bbox="613 625 948 653">i. Select probe Attenuation <li data-bbox="613 674 1084 737">ii. Calibrate the probe. Press Calibrate... to start the calibration procedure. <li data-bbox="613 758 1068 821">iii. Follow the calibration procedure, clicking Next at the end of each step. 	
5 Set up the Q Path (if required).	a. If you have set the I/Q Path to I+jQ or to Q Only , press Q Setup . <ol style="list-style-type: none"> <li data-bbox="574 942 1073 1005">I. Select whether Differential (Balanced) inputs is On or Off. <li data-bbox="574 1026 1032 1054">II. Select the input impedance, Input Z. <li data-bbox="574 1075 963 1102">III. Input a Skew value in seconds. <li data-bbox="574 1123 1065 1377">IV. Set up the Q Probe by pressing Q Probe <ol style="list-style-type: none"> <li data-bbox="613 1182 948 1209">i. Select probe Attenuation <li data-bbox="613 1230 1084 1293">ii. Calibrate the probe. Press Calibrate... to start the calibration procedure. <li data-bbox="613 1314 1068 1377">iii. Follow the calibration procedure, clicking Next at the end of each step. 	
6 Select the reference impedance.	a. Press Reference Z , then input a value from one ohm to one megohm.	The impedance selected is shown at the top of the measurement screen.
7 Calibrate the cable (if required).	a. If you using cables that were not calibrated in the probe calibration step, press I/Q Cable Calibrate... b. Follow the calibration procedure, clicking Next at the end of each step.	
8 Make the desired measurement.		

14 Concepts

This chapter provides details about the cdma2000 communications systems, and explains how the various measurements are performed by the instrument. Suggestions for optimizing and troubleshooting your setup are provided, along with a list of related Keysight documents that are referenced for further information.

What Is the cdma2000 Communication System?

Introduction

Code Division Multiple Access 2000 (cdma2000) is a wideband CDMA standard that has been adopted by 3GPP2. It provides a wideband air interface for third generation global wireless communications systems. cdma2000 is a derivative of the IS-95-B CDMA system, also known as cdmaOne, and provides an upgrade path to support IMT-2000. This section will present the basics of cdma2000 as it differs from IS-95, and will assume the reader has some familiarity with IS-95 technology.

cdma2000 is defined in the following Telecommunications Industry Association (TIA) and Electronics Industry Alliance (EIA) document: TIA/EIA/IS-2000-1 through TIA/EIA/IS-2000-6.

cdma2000 relies on the Global Positioning System (GPS) for intercell synchronization. Both reverse and forward transmitter power controls are implemented with 1.25 ms intervals. cdma2000 is a direct sequence spread-spectrum digital communications technique that supports wider RF bandwidths from 1.25 to 15 MHz. The main advantages of cdma2000 over other types of digital communication schemes are:

- greater capacity
- immunity to signal loss and degradation due to high-level broadband interference, multipath, and fading
- strict minimization of power consumption for mobile stations by both base station and mobile controls
- support for variable data rates; up to 144 kbits/second for mobile (vehicular) data rate, up to 384 kbits/second for portable (pedestrian) data rate, and up to 2 Mbits/second for fixed installations
- increased security

cdma2000 uses correlative codes to distinguish one user from another. Frequency division is still used, as is done with Frequency Division Multiple Access (FDMA) and Time Division Multiple Access (TDMA), but in a much larger bandwidth such as 1.25 MHz or greater. cdma2000 realizes increased capacity from 1:1 frequency reuse and sectored cells. The capacity limit is soft. That is, capacity can be increased with some degradation of the error rate or voice quality.

In cdma2000, a single user's channel consists of a specific frequency combined with a unique Walsh code channel. Correlative Walsh codes allow each user to operate in the presence of substantial interference. The interference is the sum of all other users on the same cdma2000 frequency, both from within and outside of the home cell, and from delayed versions of these signals. It also includes the usual thermal noise and atmospheric disturbances. Delayed signals caused by multipath are separately received and combined in cdma2000. One of the major differences in access is that any cdma2000 frequency can be used in all sectors of all cells. This is possible because cdma2000 is designed to decode the proper signal in the presence of high interference.

Also, cdma2000 offers a number of RF structures to accommodate almost any conceivable application. These options include direct spreading to support those applications where clear spectrum is available, and multi-carrier arrangements using 1.25 MHz wide channels to allow overlays with TIA/EIA-95-B systems.

Spreading Rate

Spreading rate (SR) defines the final spread chip rate in terms of 1.2288 Mcps (Mega Chips Per Second). The two spreading rates are SR1 and SR3. An SR1 signal has a chip rate of 1.2288 Mcps and occupies the same bandwidth as cdmaOne signals. The SR1 system doubles the system capacity, therefore, it can be considered an improved cdmaOne system.

There are two main differences between cdmaOne and cdma2000. The first difference is fast power control and quadrature phase shift keying (QPSK) modulation rather than dual binary phase shift keying (BPSK) in the forward link. The second difference is the presence of a pilot signal, to allow coherent demodulation, and hybrid phase shift keying (HPSK) spreading in the reverse link.

An SR3 cdma2000 signal has a rate of 3.6864 Mcps (3 x 1.2288 Mcps) and occupies three times the bandwidth of cdmaOne. Originally, the SR3 system appeared to be viable. Upon further investigation the SR3 cdma2000 system was determined not to be viable and is no longer receiving any commercial attention at this time. Therefore, we will not cover SR3 in this section.

Radio Configuration

Radio configuration (RC) defines the physical channel configuration based upon a specific channel data rate. Each RC specifies a set of data rates based on either 9.6 or 14.4 kbps bit streams, the two existing data rates supported for cdmaOne. Each RC also specifies the spreading rate (either SR1 or SR3) and the physical coding. Currently there are nine radio configurations defined in the cdma2000 system for the forward link and six for the reverse link. Examples include:

- RC1 is the backwards-compatible mode of cdmaOne for 9600-bps voice traffic. It includes 9.6, 4.8, 2.4, and 1.2 kbps data rates and operates at SR1. It does not use any of the cdma2000 coding improvements.
- RC3 is a cdma2000-specific configuration based on 9.6 kbps that also supports 4.8, 2.7, and 1.5 kbps for voice, while supporting data at 19.2, 38.4, 76.8, and 153.6 kbps and operates at SR1. Each base transceiver station (BTS) or MS must be capable of transmitting using different RCs at the same SR. Refer to [2] for detailed information on the different RCs.

Forward Link Air Interface

The forward link air interface for a cdma2000 SR1 channel is very similar to that of cdmaOne. In order to preserve compatibility, cdma2000 uses the same structure as cdmaOne for the forward pilot (F-Pilot), forward sync (F-Sync), and forward paging (F-Paging) channels. In cdma2000, each user is assigned a forward traffic (F-Traffic) channel, which consists of

Concepts

What Is the cdma2000 Communication System?

- zero to one forward fundamental channel (F-FCH)
- zero to seven forward supplemental code channels (F-SCCHs) for RC1 and RC2
- zero to two forward supplemental channels (F-SCHs) for RC3 to RC9
- zero to one forward dedicated control channels (F-DCCHs)

The F-FCHs are used for voice and the F-FCCHs and F-SCHs are used for data. The BTS may also send zero or one F-DCCHs. An F-DCCH is associated with traffic channels (either FCH, SCH, or SCCH) and may carry signaling data and power control data.

One of the main differences between cdmaOne and cdma2000 is that the latter uses true quadrature phase shift keying (QPSK) modulation (as opposed to dual-BPSK) for all traffic channels from RC3 to RC9. As an example, [“Coding and Air Interface for a cdma2000 RC4 F-FCH” on page 94](#) shows the forward link structure for an RC4 F-FCH. The coding is identical to cdmaOne up through the long code scrambling of the voice data. The F-FCH is optionally punctured with the reverse link power control data bits. The data is then converted from a serial bit stream into a two-bit wide parallel data stream to produce true QPSK modulation. This reduces the data rate of each stream by a factor of two. Each branch is spread with a 128 Walsh code to generate a spreading rate of 1.2288 Mcps. In this case, the processing gain is doubled for each channel relative to cdmaOne. Each channel is transmitted at one-half the power used before, but there are now two of them for no apparent gain. The actual processing gain for each channel depends on its data rate and RC. The outputs of the I and Q Walsh spreaders are then complex multiplied against the same I and Q channel short codes used in cdmaOne. Complex scrambling is used in the forward link instead of regular scrambling because it is a more robust scheme against interference.

Figure 14-1 Coding and Air Interface for a cdma2000 RC4 F-FCH

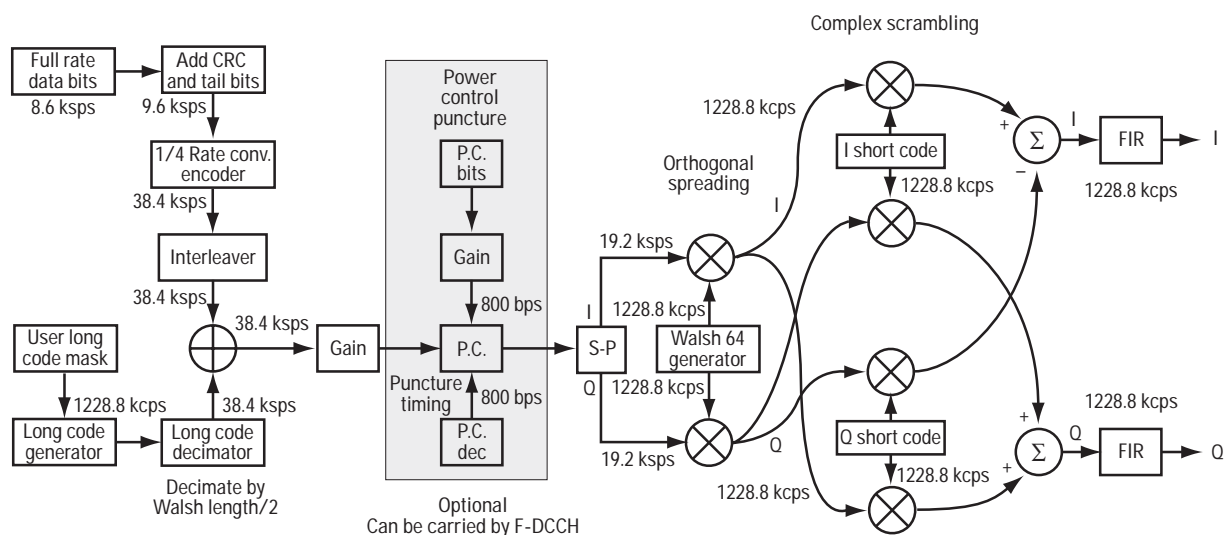

Reverse link air interface — HPSK

The cdma2000 reverse link is very different from cdmaOne. The MS can transmit more than one code channel to accommodate the high data rates. The minimum configuration consists of a reverse pilot (R-Pilot) channel to allow the BTS to perform synchronous detection and a reverse fundamental channel (R-FCH) for voice. Additional channels, such as the reverse supplemental channels (R-SCHs) and the reverse dedicated control channel (R-DCCH) can be used to send data or signaling information, respectively.

The different channels are assigned to either the I or Q path. For example, for RC3 to RC6, the R-Pilot is assigned to I and R-FCH is assigned to Q (see [Figure 14-2 on page 96](#)).

Concepts

What Is the cdma2000 Communication System?

Figure 14-2 Example of Channel Summing and HPSK spreading for cdma2000 reverse link (SR1)

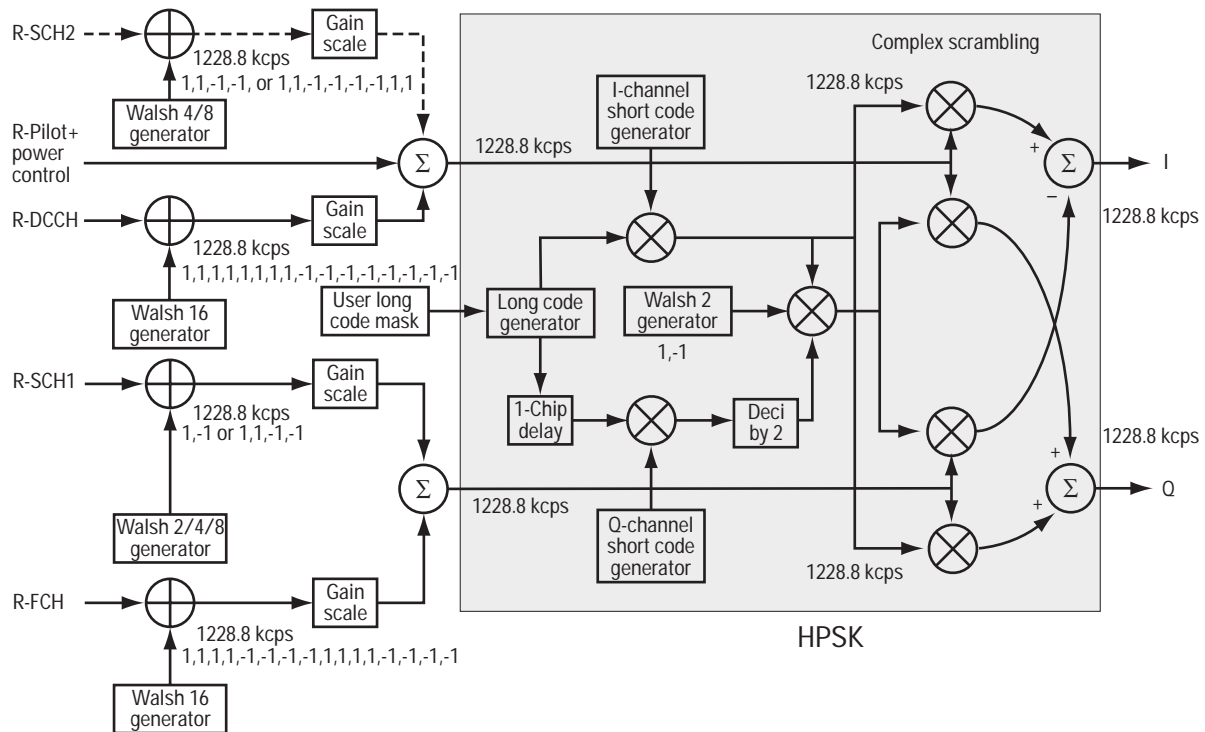

Channels can be at different rates and different power levels. Complex scrambling facilitates this by continuously phase rotating the constellation and thus distributing the power evenly between the axes.

Without scrambling, unequal channel powers would result in a rectangular four-quadrature amplitude modulation (QAM) constellation (assuming that only R-Pilot and R-FCH are active). With complex scrambling, the constellation for two channels generally has eight points distributed around a circle, with the angular distribution determined by the relative powers of the two channels. For example, an amplitude difference of 6 dB between the two channels results in the constellation shown in Figure 14-3 on page 97, which is close to an 8-PSK (8-phase shift keying) constellation (an amplitude difference of 7.65 dB would result in a perfect 8-PSK constellation). If the amplitudes for the two channels are equal, then pairs of constellation points merge to give a QPSK-like constellation.

Figure 14-3

Reverse Link cdma2000 SR1 Signal w/ R-Pilot and R-FCH

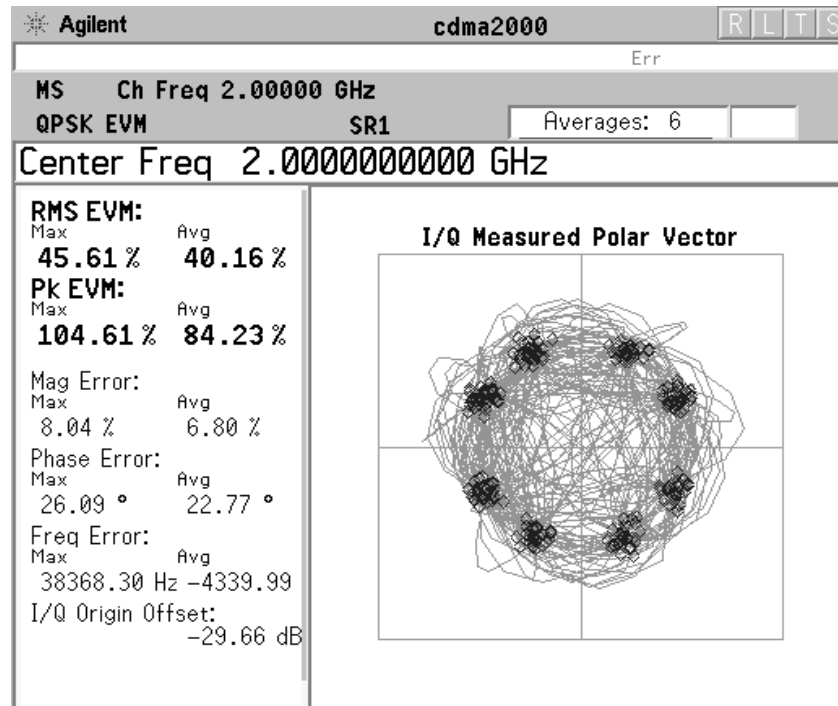

Basic complex scrambling applies a phase rotation of 0 , $\pm\pi/2$, or π radians to each chip. HPSK takes this idea a stage further and defines the complex scrambling so that for every second chip, the phase rotation is restricted to $\pm\pi/2$. This constraint on the phase transitions entering the baseband pulse shaping filter reduces the peak-to-average ratio of the signal (about 1 to 1.5 dB) compared to regular complex scrambling (or regular QPSK). The HPSK technique continues to be advantageous even when the signal has more than two channels. For more information on HPSK, see [3].

Forward link power control

A key improvement in cdma2000 is forward link power control. The MS sends power control data back to the BTS by time multiplexing it with the R-Pilot channel. Like the existing reverse link closed loop power control of cdmaOne, the cdma2000 forward link closed loop power control sends 800 power control bits each second. These bits indicate whether the BTS should raise or lower its power in 1 dB, 0.5 dB, or 0.25 dB. The finer steps allow tighter power control for low mobility or stationary phones. Tighter control (less power ripple) lowers the average power and thus raises the capacity of the system.

Differences between cdma2000 and W-CDMA

The Third-Generation Partnership Project (3GPP) W-CDMA is the other main wideband CDMA technology competing for the 3G cellular market. There has been much discussion about the need to harmonize W-CDMA and cdma2000 in an attempt to facilitate global use of 3G phones. However, even though both systems are based on a similar CDMA technology, they are significantly different. The main differences are:

- spreading rate - (3.84 Mcps for W-CDMA versus 1.2288 Mcps for cdma2000 SR1)
- synchronization and BTS identification methodology - W-CDMA does not use GPS, or Global Positioning System. For information on-CDMA user equipment (UE)¹ design and test issues, refer to [4].

1. W-CDMA specifications use the term UE to refer to mobile phones or other computing devices that provide wireless access to the W-CDMA system.

Adjacent Channel Power (ACP) Measurement Concepts

Purpose

Adjacent Channel Power (ACP), as it applies to cdma2000, is the power contained in a specified frequency channel bandwidth relative to the total carrier power. It may also be expressed as a ratio of power spectral densities between the carrier and the specified offset frequency band.

As a composite measurement of out-of-channel emissions, ACP combines both in-band and out-of-band specifications to provide useful figures-of-merit for spectral regrowth and emissions produced by components and circuit blocks without the rigor of performing a full spectrum emissions mask measurement.

To maintain a quality call by avoiding channel interference, it is important to measure and reduce any adjacent channel leakage power transmitted from a mobile phone. The characteristics of adjacent channel leakage power are mainly determined by the transmitter design, particularly the low-pass filter.

Measurement Method

This ACP measurement analyzes the total power levels within the defined carrier bandwidth and at given frequency offsets on both sides of the carrier frequency. This measurement requires the user to specify measurement bandwidths of the carrier channel and each of the offset frequency pairs up to 5. Each pair may be defined with unique measurement bandwidths.

For Meas Method of RBW, it uses an appropriate RBW and capture all of the power in the carrier channel and the offsets. For Meas Method of integration bandwidth (IBW), the channel integration bandwidth is analyzed using the user defined resolution bandwidth (RBW), which is much narrower than the channel bandwidth. The measurement computes an average power of the channel over a specified number of data acquisitions, automatically compensating for resolution bandwidth and noise bandwidth.

If **Total Pwr Ref** is selected as the measurement type, the results are displayed as relative power in dBc and as absolute power in dBm. If **PSD Ref** (Power Spectral Density Reference) is selected, the results are displayed as relative power in dB, and as absolute power in dBm/Hz.

Recommended Offset Frequencies and Reference Bandwidths

While the user sets the specific offsets and reference bandwidths, the radio specifications recommend some common setups as shown in the following table. The offset frequency is titled as `Offset to Edge` in the measurement result window. For example, if the measurement bandwidth is set to 30 kHz, the first offset center frequency can be 765 kHz and the offset to edge frequency can be 750 kHz.

Concepts

Adjacent Channel Power (ACP) Measurement Concepts

Table 14-1

ACP Setup Recommendation

Band	Test Device	Offset Frequency	Integration Band width	Result Reference
cdma2000	Mobile	±900.0 kHz	30 kHz	Total Power in 1.230 MHz
		±1.995 MHz	30 kHz	
	Base	±765.0 kHz	30 kHz	
		±1.995 MHz	30 kHz	

Channel Power Measurement Concepts

Purpose

The Channel Power measurement is a common test used in the wireless industry to measure the total transmitted power of a radio within a defined frequency channel. This procedure measures the total power within the defined channel for cdma2000. This measurement is applied to design, characterize, evaluate, and verify transmitters and their components or devices for base stations and mobile stations.

Measurement Method

The Channel Power measurement reports the total transmitted power within the channel bandwidth, 1.23000 MHz for the cdma2000 mode. It takes a sweep and the measurement acquires power in the carrier channel.

The measurement uses the frequency sweep mode, you can change the RBW and VBW settings.

To improve repeatability, you can increase the number of averages. The channel power graph is shown in the graph window, while the absolute channel power in dBm and the mean power spectral density in dBm/Hz are shown in the text window.

Code Domain Measurement Concepts

Purpose

Since the code domain measurements despread and descramble the cdma2000 signal into its physical channels, the number of active channels of various symbol rates (which are denoted by widths) can be observed. The width of the channel is inversely proportional to the Walsh code length in number of bits. In the code domain, there is a fixed amount of code space for a given chip rate. Therefore, by using the different Walsh codes, the system can dynamically allocate the code space for lower rate voice users versus high speed data users.

This code domain power composite view provides information about the in-channel characteristics of the cdma2000 signal. It informs the user of the active channels with their individual channel powers. The composite view also shows which data rates are active and the corresponding amount of code space used. The following are conditions under which a general unlock can occur: the Pilot signal is too low in power or no Pilot signal available, an incorrect long code is used for despreading, the frequency error is too large, or a frequency inversion is present.

When the level of the code domain noise floor is too high, relative to a reference or an expected level, one of the possible causes might be due to CW interference, like local oscillator feedthrough or spurs. I/Q modulation impairments can be another source of this uncorrelated noise. The I/Q demodulation measurements can reveal errors such as I/Q gain imbalance or I/Q quadrature error.

Measurement Method

This procedure measures the power levels of the spread channels in composite RF channels.

The code domain measurement displays the power for each of the spread channels, relative to the total power within the 1.230 MHz channel bandwidth centered at the center frequency. Each spread channel level is displayed as an individual vertical bar with a different width determined by a spread rate. Because this is a relative measurement, the unit of measure is dB (not dBm or watts). This allows a comparison of signal levels between the Pilot and Traffic channels.

If **Device** is set to **MS**, the demodulated I and Q signals are individually shown in the code domain power graph window. Depending on the test equipment for MS, it is recommended that you use the trigger output signal from the instrument for synchronization.

The following displays are available for this measurement:

- Power Graph & Metrics - The transmitted energy associated with each of the symbol rates and Walsh codes is shown in the graph window. The following powers along with the total power are shown in the text window depending on the device selection:

Table 14-2

Code Domain Channel Power Metrics

For BTS	For MS
Total active channel power Pilot channel power Synch channel power Time offset Maximum active channel power Average active channel power Maximum inactive channel power Average inactive channel power Number of active channels	Total active channel power Pilot channel power I average active channel power I maximum inactive channel power Q average active channel power Q maximum inactive channel power

- I/Q Error (Quad View) - The magnitude error, phase error, and EVM graphs are individually shown in the graph windows. The summary data for these parameters are also shown in the text window.
- Code Domain (Quad View) - The graphs of the code domain power, the symbol power for the selected spread channel, and the I/Q symbol power polar vector for the symbol power range selected by the measurement interval and measurement offset parameters, are shown in the graph windows. The symbol EVM summary data is also shown in the text window.
- Demod Bits - In addition to the graphs of the code domain power and the symbol power for the selected spread channel, the demodulated bit stream data can be shown for the selected slots of the symbol power in the text window.

Modulation Accuracy (Composite Rho) Measurement Concepts

Purpose

Rho is one of the primary modulation quality metrics, along with EVM and code domain power. Rho is the ratio of the correlated power in a single coded channel to the total signal power. This is a simplified case of code domain power since this measurement is made on a single coded channel. This measurement takes into account all possible error mechanisms in the entire transmission chain including baseband filtering, I/Q modulation anomalies, filter amplitude and phase non-linearities, and power amplifier distortion. This provides an overall indication of the performance level of the transmitter of the UUT.

Measurement Method

This procedure measures the performance of the transmitter's modulation circuitry.

In a digitally modulated signal, it is possible to predict what the ideal magnitude and phase of the carrier should be at any time, based on the transmitted data sequence. The transmitter's modulated signal is compared to an ideal signal vector. The difference between these two vectors is sampled and processed using DSP. Rho values are in the range of 0 to 1. A value of 1 indicates perfect correlation to the reference (high modulation quality). The cdma2000 base station standards require that transmitters have a Rho performance of 0.912 or greater.

Depending on the test equipment for MS, it is recommended that you use the trigger output signal from the instrument for synchronization.

If the error code 604 "Can not correlate to input signal" is shown, it means that your measurement has failed to find any active channels due to the lack of correlation with the input signal. The input signal level, for example, may need to be adjusted to obtain correlation.

With the Rho measurement, the following data is provided:

- Rho - modulation quality representing the ratio of the correlated power in a single coded channel to the total signal power
- EVM - peak and rms error vector magnitude
- Peak CDE - peak code domain error with that code number
- Magnitude Error - rms magnitude error
- Phase Error - rms phase error
- Freq Error - the frequency difference between the transmitter's actual center frequency and the frequency (or channel) that you entered
- I/Q Origin Offset - the origin offset for I/Q signals, in dB
- No. of Active Channels
- Time Offset - the time offset between the I and Q signals

Occupied Bandwidth Measurement Concepts

Purpose

Occupied bandwidth measurements express the percentage of the transmitted power within a specified bandwidth. This percentage is typically 99%.

The spectrum shape of a cdma2000 signal can give useful qualitative insight into transmitter operation. Any distortion to the spectrum shape can indicate problems in transmitter performance.

Measurement Method

The instrument uses sweep mode to capture the data and the total power within the measurement frequency span is integrated for its 100% of power. The frequencies of 0.5% of the total power are then calculated to get 99.0% bandwidth.

Power Statistics CCDF Measurement Concepts

Purpose

Many of the digitally modulated signals appear noise-like in the time and frequency domain. This means that statistical measurements of the signals can be a useful characterization. Power Complementary Cumulative Distribution Function (CCDF) curves characterize the higher-level power statistics of a digitally-modulated signal. The curves can be useful in determining design parameters for digital communications systems.

Long battery life is a key competitive advantage for the mobile phone. cdmaOne uses offset quadrature phase shift keying (OQPSK) as the modulation format for the reverse link. OQPSK minimizes the peak-to-average power ratio by avoiding signal envelope transitions through zero. Peak-to-average power ratio is the ratio of the peak envelope power to the average envelope power of a signal. If the peak-to-average power ratio is small, the headroom required in the amplifier to prevent compression of the signal and interference with the adjacent frequency channels is small. Thus, the amplifier can operate more efficiently.

In cdma2000 the handset can transmit multiple channels to accommodate the high data rates. Modulation schemes such as OQPSK or Gaussian minimum shift keying (GMSK) do not prevent zero-crossings for multiple channels and are no longer suitable. Instead, QPSK is used in combination with HPSK (Hybrid Phase Shift Keying) to minimize the peak-to-average power ratio. (For more information on HPSK see [3].) With this technique, the peak-to-average power ratio for the basic configuration (an R-Pilot channel and an R-FCH) is equal to or larger than 4 dB during 0.1 percent of the time (see [Figure 14-4](#)). Even though HPSK reduces the peak-to-average power ratio, it still increases as code channels are activated for higher data rates because the amplitude vectors of each code channel add to each other.

A severe case occurs if two supplemental channels at high data rates are required. In this case, the benefits of HPSK may be lost. This is rarely expected to happen since the forward link will carry most of the high data rate traffic.

The amplifier must be capable of handling the different peak-to-average power ratios the signal exhibits for the different channel configurations, while maintaining good adjacent channel power (ACP) performance. From the measurement perspective, the statistics of the signal may impact the result of the measurement, particularly in the case of adjacent channel power ratio (ACPR). Therefore, it is important to choose the signal's channel configuration carefully. You need to cover the real-life worst cases, such as those with the most stressful signal configurations or highest peak-to-average power ratios. To do that, you need a way to define the statistics of cdma2000 reverse link signals. The complementary cumulative distribution function (CCDF) does that for you.

CCDF measurement fully characterizes the power statistics of the signal. It provides the distribution of particular peak-to-average power ratios versus probability. [Figure 14-4](#) compares the CCDF curves for a signal with R-Pilot and R-FCH, and a signal with R-Pilot, R-FCH, R-SCH1 at 153.6 kbps, and R-SCH2 at

153.6 kbps. For a probability of 0.1 percent, the signal with two supplemental channels has a peak-to-average power ratio 2 dB higher than the signal with only an R-Pilot and an R-FCH. As mentioned earlier, adding code channels, in general, increases the peak-to-average power ratio of the signal.

Figure 14-4 CCDF curves for two cdma2000 SR1 reverse link signals with different channel configurations.

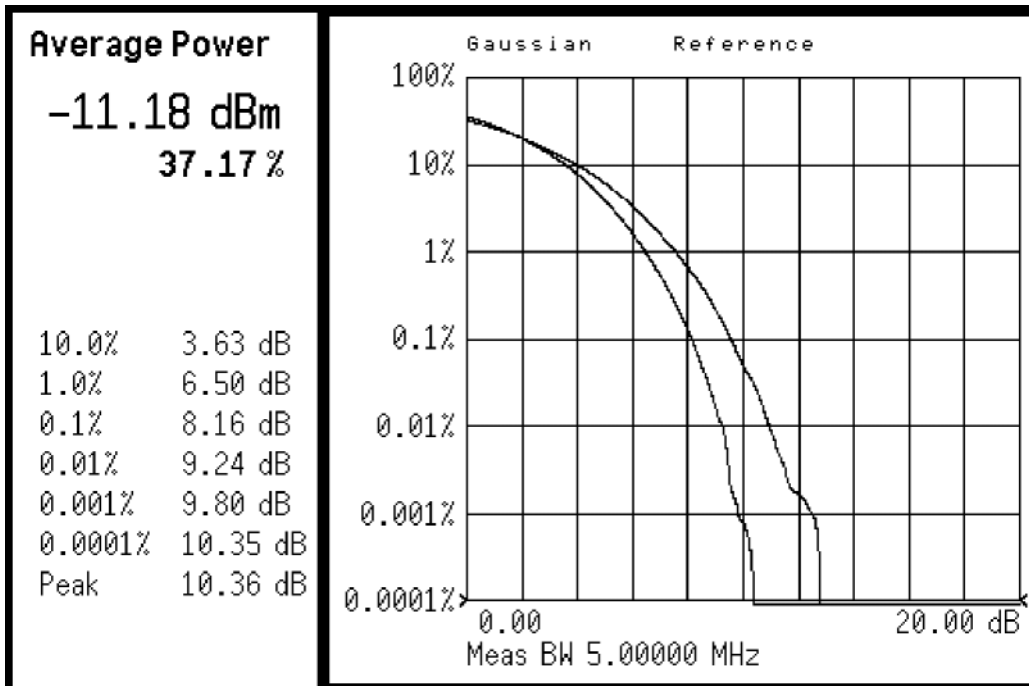

The power statistics CCDF measurement can be affected by many factors. For example, modulation filtering, modulation format, combining the multiple signals at different frequencies, number of active codes and correlation between symbols on different codes with spread spectrum systems. These factors are all related to modulation and signal parameters. External factors such as signal compression and expansion by non-linear components, group delay distortion from filtering, and power control within the observation interval also affect the measurement.

CCDF curves can help you in several situations:

- To determine the headroom required when designing a component.
- To confirm the power statistics of a given signal or stimulus. CCDF curves allow you to verify if the stimulus signal provided by another design team is adequate. For example, RF designers can use CCDF curves to verify that the signal provided by the digital signal processing (DSP) section is realistic.
- To confirm that a component design is adequate or to troubleshoot your subsystem or system design, you can make CCDF measurements at several points of a system. For example, if the ACLR of a transmitter is too high, you can make CCDF measurements at the input and output of the PA. If the PA design is correct, the curves will coincide. If the PA compresses the signal, the PAR of the signal is lower at the output of the PA (Figure 14-4 on page 107).

Measurement Method

The power measured in power statistics CCDF curves is actually instantaneous envelope power defined by the equation:

$$P = (I^2 + Q^2)/Z_0$$

(where I and Q are the quadrature voltage components of the waveform and Z_0 is the characteristic impedance).

A CCDF curve is defined by how much time the waveform spends at or above a given power level. The percent of time the signal spends at or above the level defines the probability for that particular power level. To make the power statistics CCDF measurement, the instrument uses digital signal processing (DSP) to sample the input signal in the channel bandwidth.

The Gaussian distribution line as the band-limited gaussian noise CCDF reference line, the user-definable reference trace, and the currently measured trace can be displayed on a semi-log graph. If the currently measured trace is above the user reference trace, it means that the higher peak power levels against the average power are included in the input signal.

QPSK EVM Measurement Concepts

Purpose

In constant amplitude modulation schemes, such as GMSK, the phase and frequency error are the metrics for modulation quality. However, these metrics are not very effective for non-constant amplitude modulation formats that can also have errors in amplitude.

Phase and frequency errors are measures of modulation quality for the cdma2000 system. This modulation quality is quantified through QPSK Error Vector Magnitude (EVM) measurements. Since the base stations in cdma2000 systems use Quadrature Phase Shift Keying (QPSK) modulation, the phase and frequency accuracies of the transmitter are critical to the communications system performance and ultimately affect range.

cdma2000 receivers rely on the phase and frequency quality of the QPSK modulation signal in order to achieve the expected carrier to noise ratio. A transmitter with high phase and frequency errors will often still be able to support phone calls during a functional test. However, it will tend to cause difficulty for mobiles trying to maintain service at the edge of the cell with low signal levels or under difficult fading and Doppler conditions.

The accuracy of non-constant amplitude modulation schemes, such as quadrature amplitude modulation (QAM), or quadrature phase shift keying (QPSK), can be assessed very effectively by looking at the constellation of the signal. Signal impairment can be objectively assessed by taking the displacement of each measured symbol from the reference position as an error phasor (or vector), as shown in [Figure 14-5](#).

Figure 14-5

Error Vector and Related Parameters

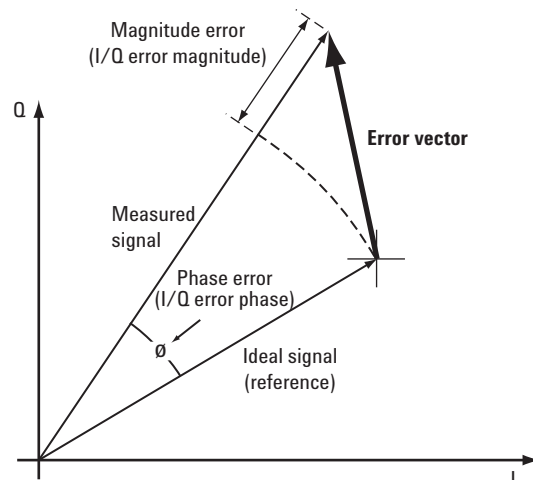

The reference position is determined from a reference signal that is synthesized by demodulating the data bits from the received signal and then re-modulating these bits "perfectly" for a generic QPSK signal, as shown in Figure 14-6.

Figure 14-6 Process to Calculate EVM for a Generic QPSK Signal

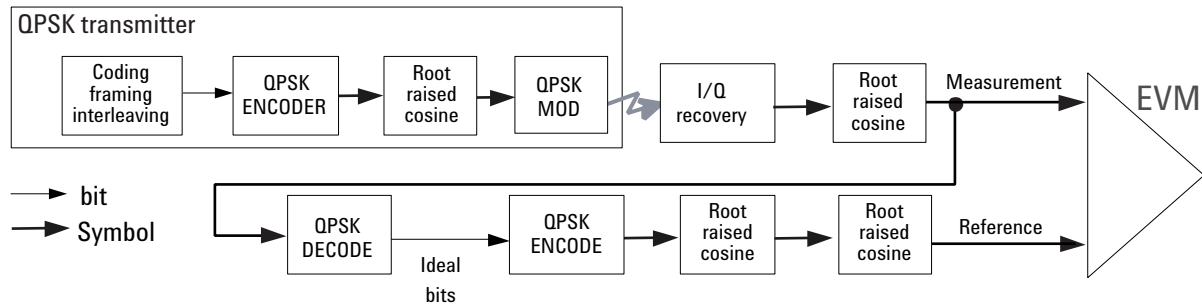

The root mean square (RMS) of the error vectors is computed and expressed as a percentage of the square root of the mean power of the ideal signal¹. This is the error vector magnitude (EVM). EVM is a common modulation quality metric widely used in digital communication systems. (See [16] for more information on how to use EVM as a troubleshooting tool.)

For a regular QAM or a phase shift keying (PSK) signal the ideal symbol points always map onto a few specific locations in the I/Q plane. The cdma2000 reverse link signal can consist of multiple channels that are I/Q multiplexed. This means the one-bit symbols for each channel are BPSK encoded² for either the I or the Q path. Several channels can be added to the I and/or the Q paths. The resulting I and Q signals are then spread and HPSK scrambled (see Figure 3). The complex-valued chip sequence is then filtered and the result is applied to the QPSK modulator³. The cdma2000 MS transmitter in Figure 11 illustrates this process.

The resulting constellation depends on the physical channel configuration. The constellation typically does not look like QPSK or any other known constellation. Except for some very specific channel configurations, for example, a signal with a single R-Pilot (or a single R-FCH) does map onto a QPSK constellation. A signal with both a R-Pilot and a R-FCH at the same amplitude level maps onto a 45°-rotated QPSK constellation [3]. Since the receiver does not care about the absolute phase rotation, it effectively sees a QPSK constellation.

1. The actual calculation method of the percentage depends on the specific standard. The EVM may be normalized to the amplitude of the outermost symbol, the square root of the average symbol power, or the square root of the mean power of the ideal signal. In the case of cdma2000, the specifications require normalization to the square root of the mean power of the ideal signal (see section on Composite EVM).
2. BPSK encoding, in this case, refers to the process of mapping the one-bit symbols for a channel onto the I (or the Q) path in serial. This means the symbols for a channel are directly converted into I (or Q) levels. For example, 1001 would be converted to 1 -1 -1 1.
3. QPSK modulation, in this case, refers to the upconversion process (the process of modulating the radio frequency (RF) carrier with the I/Q baseband signal).

You can use a regular QPSK EVM measurement to evaluate the modulation quality of the transmitter for a single R-Pilot, a single R-FCH, or a signal with both at the same amplitude level. More complex signals cannot be analyzed with this measurement.

The signal analyzer may use either of the following methodologies to make a QPSK EVM measurement:

- Measure QPSK EVM on the received signal. Filter the recovered I/Q signal with the equalizer and complementary receiver filters and compare it with a reference signal calculated by filtering the demodulated signal with the transmitter, equalizer, and receiver filters See (a) in [Figure 14-7 on page 112](#).
- Measure QPSK EVM on the transmitted signal. Compare the I/Q recovered signal directly with a reference signal calculated by filtering the ideal chips with the transmitter filter. See (b) in [Figure 14-7 on page 112](#).

Both methods yield similar EVM results and you can use either of them to make valid modulation quality measurements of the MS transmitter; however, the resulting constellation looks different. The first method results in four discrete constellation points. The second method results in a fuzzy constellation, as shown in Figure 12a. The constellations for both methods are correct. The reason for the difference is that, for the first method, the constellation displays what the receiver sees after filtering, while the second method displays the constellation of the transmitted signal before applying any receiver filtering.

Figure 14-7 Process to Calculate QPSK EVM for a cdma2000 Forward Link Signal.

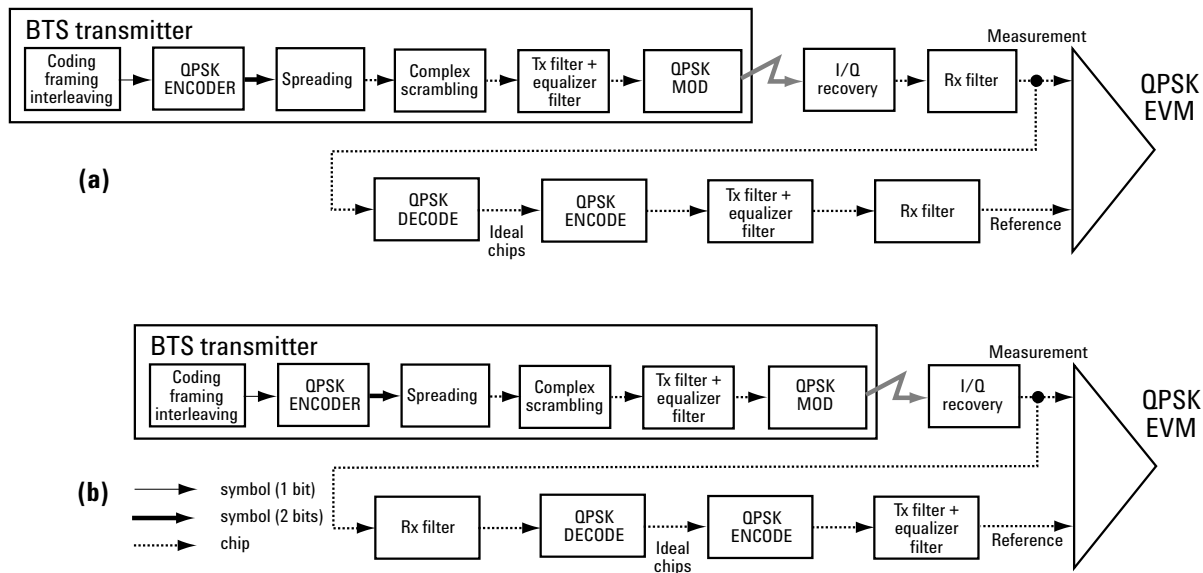

Measurement Method

The input signal needs to be a single coded signal, such as a pilot channel.

The phase error of the unit under test is measured by computing the difference between the phase of the transmitted signal and the phase of a theoretically perfect signal. The instrument samples the transmitter output in order to capture the actual phase trajectory. This is then demodulated and the ideal phase trajectory is mathematically derived using detected bits and channel filtering. Subtracting one from the other results in a phase error signal.

This measurement allows you to display these errors numerically and graphically on the instrument display. There are graphs for EVM, Phase Error and Mag Error in the graph windows. In the text window, there are both maximum and average data for Evm: in % rms, in % peak, RMS Mag Error: in %, Phase Error: in degrees, Freq Error: in Hz, and IQ Offset: in dB.

Monitor Spectrum Measurement Concepts

Purpose

The monitor spectrum measurement provides spectrum analysis capability for the instrument. It is used as a quick, convenient means of looking at the entire spectrum. While the look and feel are similar to the Spectrum Analyzer mode, the functionality is greatly reduced for easy operation. The main purpose of the measurement is to show the spectrum. The default span should cover an appropriate frequency range of the application.

Measurement Method

The measurement takes the sweep and acquires the data between the start frequency and stop frequency, then trace is displayed in the measurement window.

Troubleshooting Hints

Changes made by the user to advanced spectrum settings, particularly to ADC range settings, can inadvertently result in spectrum measurements that are invalid and cause error messages to appear. Care needs to be taken when using advanced features.

Spectrum Emission Mask Measurement Concepts

Purpose

Spectrum Emission Mask measurements include the in-band and out-of-band spurious emissions. As it applies to cdma2000, it is the power contained in a specified frequency bandwidth at certain offsets relative to the total carrier power. It may also be expressed as a ratio of power spectral densities between the carrier and the specified offset frequency band.

As a composite measurement of out-of-channel emissions, the spectrum emission mask measurement combines both in-band and out-of-band specifications to provide useful figures-of-merit for spectral regrowth and emissions produced by components and circuit blocks without the rigor of performing a full spectrum emissions mask measurement.

Measurement Method

The spectrum emission mask measurement measures spurious signal levels in up to six pairs of offset/region frequencies and relates them to the carrier power. The reference channel integration bandwidth method is used to measure the carrier channel power and offset/region powers. When “Offset” is selected, spectrum emission mask measurements are made, relative to the carrier channel frequency bandwidth. When “Region” is selected, spurious emission absolute measurements are made, set by specifying start and stop RF frequencies. The upper frequency range limit is 3.678 GHz. The measurement screen is titled *Spurious Emission*.

The channel integration bandwidth is analyzed using the user defined resolution bandwidth (RBW), which is much narrower than the channel bandwidth. The measurement computes an average power of the channel or offset/region over a specified number of data acquisitions, automatically compensating for resolution bandwidth and noise bandwidth.

This measurement requires the user to specify measurement bandwidths of the carrier channel and each of the offset/region frequency pairs up to 5. Each pair may be defined with unique measurement bandwidths. The results are displayed both as relative power in dBc, and as absolute power in dBm.

Spurious Emissions Measurement Concepts

Purpose

Spurious signals can be caused by different combinations of signals in the transmitter. The spurious emissions from the transmitter should be minimized to guarantee minimum interference with other frequency channels in the system. Harmonics are distortion products caused by nonlinear behavior in the transmitter. They are integer multiples of the transmitted signal carrier frequency.

This measurement verifies the frequency ranges of interest are free of interference by measuring the spurious signals specified by the user defined range table.

Measurement Method

The table-driven measurement has the flexibility to set up custom parameters such as frequency, span, resolution bandwidth, and video bandwidth.

For each range that you specify and activate, the analyzer scans the band using the specified Range Table settings. Then using the Peak Excursion and Peak Threshold values determines which spurs to report.

As each band is swept, any signal which is above the Peak Threshold value and has a peak excursion of greater than the Peak Excursion value will be added to a list of spurs displayed in the lower results window. A total of 200 spurs can be recorded for one measurement, with a limit of 10 spurs per frequency range. To improve repeatability, you can increase the number of averages.

From the spurs in the list, those with peak amplitude greater than the Absolute Limit for that range will be logged as a measurement failure and denoted by an 'F' in the 'Amplitude' column of the table. If no spurs are reported, but the measured trace exceeds the limit line for any range, the fail flag is set to fail.

This measurement has the ability to display two traces using different detectors on the display simultaneously. All spur detection and limit line testing are only applied to the trace associated with Detector 1, which will be colored yellow. The trace associated with Detector 2 will be colored cyan.

If the sweep time for the range exceeds 2 seconds, a flashing message "Sweeping...Please Wait" will appear in the annunciator area. This advises you that the time to complete the sweep is between 2 and 2000 seconds, and is used as without it the display would appear stagnant and you may think the measurement is not functional.

IQ Waveform Measurement Concepts

Purpose

The waveform measurement is a generic measurement for viewing the input signal waveforms in the time domain. This measurement is how the instrument performs the zero span functionality found in traditional spectrum analyzers.

Basic mode waveform measurement data may be displayed using either a Signal Envelope window, or an I/Q window which shows the I and Q signal waveforms in parameters of voltage versus time. The advantage of having an I/Q view available while making a waveform measurement is that it allows you to view complex components of the same signal without changing settings or measurements.

The waveform measurement can be used to perform general purpose power measurements in the time domain with excellent accuracy.

Measurement Method

The instrument makes repeated power measurements at a set frequency, similar to the way a swept-tuned spectrum analyzer makes zero span measurements. The input analog signal is converted to a digital signal, which then is processed into a representation of a waveform measurement. The measurement relies on a high rate of sampling to create an accurate representation of a time domain signal.

Other Sources of Measurement Information

Additional measurement application information is available through your local Keysight Technologies sales and service office. The following application notes treat digital communications measurements in much greater detail than discussed in this measurement guide.

- Application Note 1298
Digital Modulation in Communications Systems - An Introduction
Keysight part number 5965-7160E
- Application Note 1311
Understanding CDMA Measurements for Base Stations and Their Components
Keysight part number 5968-0953E
- Application Note 1335
HPSK Spreading for 3G
Keysight part number 5968-8438E
- Application Note 1357
Designing and Testing cdma2000 Base Stations
Keysight part number 5980-1303E
- Application Note 1358
Designing and Testing cdma2000 Mobile Stations
Keysight part number 5980-1237E
- Application Note
Characterizing Digitally Modulated Signals with CCDF Curves
Keysight part number 5968-5858E

Instrument Updates at www.keysight.com

These web locations can be used to access the latest information about the instrument, including the latest firmware version.

<http://www.keysight.com/find/mxa>

References

- [1] Understanding CDMA Measurements for Base Stations and Their Components, Application Note 1311, literature number 5968-0953E.
- [2] Ken Thompson, "Concepts of cdma2000," Wireless Symposium, 999.
- [3] HPSK Spreading for 3G, Application Note 1335, literature number 5968-8438E.
- [4] Designing and Testing W-CDMA Base Stations, Application Note 1355, literature number 5980-1239E.