

Agilent U1231A, U1232A, and U1233A Handheld Digital Multimeter

User's Guide



Agilent Technologies

Notices

© Agilent Technologies, Inc. 2011–2014

No part of this manual may be reproduced in any form or by any means (including electronic storage and retrieval or translation into a foreign language) without prior agreement and written consent from Agilent Technologies, Inc. as governed by United States and international copyright laws.

Manual Part Number

U1231-90026

Edition

Ninth Edition, June 20, 2014

Agilent Technologies, Inc.
5301, Stevens Creek Blvd.
Santa Clara, CA 95051 USA

Warranty

The material contained in this document is provided “as is,” and is subject to change, without notice, in future editions. Further, to the maximum extent permitted by the applicable law, Agilent disclaims all warranties, either express or implied, with regard to this manual and any information contained herein, including but not limited to the implied warranties of merchantability and fitness for a particular purpose. Agilent shall not be liable for errors or for incidental or consequential damages in connection with the furnishing, use, or performance of this document or of any information contained herein. Should Agilent and the user have a separate written agreement with warranty terms covering the material in this document that conflict with these terms, the warranty terms in the separate agreement shall control.

Technology Licenses

The hardware and/or software described in this document are furnished under a license and may be used or copied only in accordance with the terms of such license.

Restricted Rights Legend

U.S. Government Restricted Rights. Software and technical data rights granted to the federal government include only those rights customarily provided to end user customers. Agilent provides this customary commercial license in Software and technical data pursuant to FAR 12.211 (Technical Data) and 12.212 (Computer Software) and, for the Department of Defense, DFARS 252.227-7015 (Technical Data - Commercial Items) and DFARS 227.7202-3 (Rights in Commercial Computer Software or Computer Software Documentation).

Safety Notices

CAUTION





A **CAUTION** notice denotes a hazard. It calls attention to an operating procedure, practice, or the likes of that, if not correctly performed or adhered to, could result in damage to the product or loss of important data. Do not proceed beyond a **CAUTION** notice until the indicated conditions are fully understood and met.

WARNING

A **WARNING** notice denotes a hazard. It calls attention to an operating procedure, practice, or the likes of that, if not correctly performed or adhered to, could result in personal injury or death. Do not proceed beyond a **WARNING** notice until the indicated conditions are fully understood and met.

Safety Symbols

The following symbols on the instrument and in the documentation indicate precautions which must be taken to maintain safe operation of the instrument.

	DC (Direct current or voltage)
	AC (Alternating current or voltage)
	Earth (ground) terminal
	Caution, risk of danger (refer to this manual for specific Warning or Caution information)
	Equipment protected throughout by double insulation or reinforced insulation
CAT III 600 V	Category III 600 V overvoltage protection

Safety Considerations

Read the information below before using this instrument.

The following general safety precautions must be observed during all phases of operation, service, and repair of this instrument. Failure to comply with these precautions or with specific warnings elsewhere in this manual violates safety standards for design, manufacture, and intended use of the instrument. Agilent Technologies assumes no liability for the customer's failure to comply with these requirements.

CAUTION

- Disconnect circuit power and discharge all high-voltage capacitors before testing resistance, continuity, diodes, or capacitance.
- Use the proper terminals, function, and range for your measurements.
- This device is for use at altitudes of up to 2,000 m.
- Never measure voltage when current measurement is selected.
- Always use the specified battery type. The power for the meter is supplied with four standard AAA 1.5 V batteries. Observe the correct polarity markings before you insert the batteries to ensure proper insertion of the batteries in the meter.

WARNING

- **Do not exceed any of the measurement limits defined in the specifications to avoid instrument damage and the risk of electric shock.**
- **Do not use the meter if it is damaged. Before you use the meter, inspect the case. Look for cracks or missing plastic. Pay particular attention to the insulation surrounding the connectors.**
- **Inspect the test leads for damaged insulation or exposed metal. Check the test leads for continuity. Replace damaged test leads before you use the meter.**
- **Do not operate the meter around explosive gas, vapor, or wet environments.**

WARNING

- Do not apply more than the rated voltage (as marked on the meter) between terminals, or between terminal and earth ground.
 - If the equipment is used in a manner not specified by the manufacturer, the protection provided by the equipment may be impaired.
 - Never use the meter in wet conditions or when there is water on the surface. If the meter is wet, ensure that the meter is dried only by trained personnel.
 - Before use, verify the meter's operation by measuring a known source, for example, voltage.
 - When measuring current, turn off the circuit power before connecting the meter in the circuit. Remember to place the meter in series with the circuit.
 - When servicing the meter, use only the specified replacement parts.
 - Use caution when working above 60 V DC, 30 V AC rms, or 42.4 V peak. Such voltages pose a shock hazard.
 - Do not use the VZ_{LOW} (low input impedance) function to measure voltages in circuits that could be damaged by this function's low input impedance of 3 k Ω .
 - When using the probes, keep your fingers behind the finger guards on the probes.
 - Connect the common test lead before you connect the live test lead. When you disconnect the leads, disconnect the live test lead first.
 - Remove the test leads from the meter before you open the battery cover.
 - Do not operate the meter with the battery cover or portions of the cover removed or loosened.
 - To avoid false readings, which may lead to possible electric shock or personal injury, replace the battery as soon as the low battery indicator appears and flashes.
-

Environmental Conditions

This instrument is designed for indoor use and in an area with low condensation. The table below shows the general environmental requirements for this instrument.





Environmental condition	Requirement
Operating temperature	Full accuracy from $-10\text{ }^{\circ}\text{C}$ to $55\text{ }^{\circ}\text{C}$
Operating humidity	Full accuracy up to 80% RH (relative humidity) for temperature up to $30\text{ }^{\circ}\text{C}$, decreasing linearly to 50% RH at $55\text{ }^{\circ}\text{C}$
Storage temperature	$-40\text{ }^{\circ}\text{C}$ to $60\text{ }^{\circ}\text{C}$
Altitude	Up to 2000 meters
Pollution degree	2

NOTE

The U1231A/U1232A/U1233A Handheld Digital Multimeter complies with the following safety and EMC requirements:

- IEC 61010-1:2010/EN 61010-1:2010
- USA: UL 61010-1 (3rd Edition)
- Canada: CSA C22.2 No. 61010-1:2012

Regulatory Markings

 <p>ISM 1-A</p>	<p>The CE mark is a registered trademark of the European Community. This CE mark shows that the product complies with all the relevant European Legal Directives.</p>	 <p>N10149</p>	<p>The C-tick mark is a registered trademark of the Spectrum Management Agency of Australia. This signifies compliance with the Australia EMC Framework regulations under the terms of the Radio Communication Act of 1992.</p>
<p>ICES/NMB-001</p>	<p>ICES/NMB-001 indicates that this ISM device complies with the Canadian ICES-001. Cet appareil ISM est conforme a la norme NMB-001 du Canada.</p>		<p>This instrument complies with the WEEE Directive (2002/96/EC) marking requirement. This affixed product label indicates that you must not discard this electrical or electronic product in domestic household waste.</p>
 <p>C US</p>	<p>The CSA mark is a registered trademark of the Canadian Standards Association.</p>		<p>This symbol indicates the time period during which no hazardous or toxic substance elements are expected to leak or deteriorate during normal use. Forty years is the expected useful life of the product.</p>

Waste Electrical and Electronic Equipment (WEEE) Directive 2002/96/EC

This instrument complies with the WEEE Directive (2002/96/EC) marking requirement. This affixed product label indicates that you must not discard this electrical or electronic product in domestic household waste.

Product Category:

With reference to the equipment types in the WEEE directive Annex 1, this instrument is classified as a “Monitoring and Control Instrument” product.

The affixed product label is as shown below.



Do not dispose in domestic household waste.

To return this unwanted instrument, contact your nearest Agilent Service Center, or visit

www.agilent.com/environment/product

for more information.

Declaration of Conformity (DoC)

The Declaration of Conformity (DoC) for this instrument is available on the Agilent Web site. You can search the DoC by its product model or description at the Web address below.

<http://regulations.corporate.agilent.com/DoC/search.htm>

NOTE

If you are unable to search for the respective DoC, please contact your local Agilent representative.

THIS PAGE HAS BEEN INTENTIONALLY LEFT BLANK.

Table of Contents

1 Introduction

About This Manual	2
Documentation map	2
Safety notes	2
Preparing Your Multimeter	3
Checking the shipment	3
Installing the batteries	3
Turning on your multimeter	6
Automatic Power-Off (APO)	6
Enabling the backlight	7
Enabling the flashlight	7
Selecting the range	9
Alerts and warnings during measurement	10
Adjusting the tilt stand	11
Connecting the IR-USB cable	11
Power-on options	13
Your Multimeter in Brief	15
Dimensions	15
Overview	17
Rotary switch	19
Keypad	22
Display screen	24
Input terminals	28
Cleaning Your Multimeter	30

2 Making Measurements

Measuring AC Voltage	32
Measuring DC Voltage	34

Measuring AC/DC mV	34
Using VZ _{LOW} for Voltage Measurements	36
Measuring Resistance	39
Testing for Continuity	41
Testing Diodes	45
Measuring Capacitance	49
Measuring Temperature	51
Measuring AC or DC Current	57
Measuring Frequency	62

3 Multimeter Features

Detecting AC Voltage Presence (Vsense)	66
Making Relative Measurements (Null)	68
Capturing Maximum and Minimum Values (MaxMin)	70
Freezing the Display (Trig Hold-Log and Auto Hold-Log)	72
Trig Hold-Log operation	72
Auto Hold-Log operation	72
Recalling Previously Recorded Readings (Recall)	74
Making Scale Transfers (Scale)	76

4 Multimeter Setup Options

Using the Setup Menu	80
Editing numerical values	81
Setup Menu Summary	82
Setup Menu Items	84
Changing the variation count	84
Enabling and changing the Smooth refresh rate	85

Enabling and changing the voltage alert level	86
Changing the beep frequency	87
Changing the auto power-off (APO) timeout	88
Changing the LCD backlight timeout	89
Adjusting the LCD backlight intensity	90
Enabling the LED flashlight timeout	91
Adjusting the LED flashlight intensity	92
Changing the minimum measurable frequency	93
Changing the continuity test alerts	93
Changing the power-on greeting tone	95
Resetting the Setup items	96
Changing the scale conversion value	96
Enable the AC/DC mV measurement	98
Enable open continuity test by default	99
Changing the temperature unit	99

5 Characteristics and Specifications

Product Characteristics	102
Specification Assumptions	103
Measurement Category	104
Measurement category definition	104
Electrical Specifications	106
DC specifications	106
AC specifications	109
Capacitance specifications	110
Temperature specifications	111
Frequency specifications	112
Frequency sensitivity specifications	112
Scale transfer (mV)	113
Display update rate (approximate)	114

THIS PAGE HAS BEEN INTENTIONALLY LEFT BLANK.

List of Figures

Figure 1-1	Installing the batteries	4
Figure 1-2	Powering on the multimeter	6
Figure 1-3	Tilt-stand adjustment and IR-USB cable connection	11
Figure 1-4	Agilent GUI Data Logger Software	12
Figure 1-5	Width dimension	15
Figure 1-6	Height and depth dimensions	16
Figure 1-7	Front panel	17
Figure 1-8	Rear panel	18
Figure 2-1	AC voltage display	32
Figure 2-2	Measuring AC voltage	33
Figure 2-3	DC voltage display	34
Figure 2-4	Measuring DC voltage	35
Figure 2-5	V _{ZLOW} voltage display	36
Figure 2-6	Measuring V _{ZLOW} voltage	37
Figure 2-7	V _{ZLOW} auto identification flow	38
Figure 2-8	Resistance display	39
Figure 2-9	Measuring resistance	40
Figure 2-10	Continuity test flow	42
Figure 2-11	Testing for continuity	44
Figure 2-12	Diode display	45
Figure 2-13	Open diode display	46
Figure 2-14	Testing forward bias diode	47
Figure 2-15	Testing reverse bias diode	48
Figure 2-16	Capacitance display	49
Figure 2-17	Measuring capacitance	50
Figure 2-18	Temperature display	52
Figure 2-19	Measuring the surface temperature	53
Figure 2-20	Using the Auxillary Temperature measurement function (Only applicable for the U1231A and U1232A models)	54
Figure 2-21	Temperature measurement without ambient compensation	56
Figure 2-22	DC current display	58
Figure 2-23	AC current display	58
Figure 2-24	Measuring DC/AC current (up to A)	59

Figure 2-25	Measuring AC/DC current (up to μA)	60
Figure 2-26	Frequency definition	63
Figure 2-27	Frequency display	63
Figure 2-28	Measuring frequency	64
Figure 3-1	Detecting voltage presence	67
Figure 3-2	Null display	68
Figure 3-3	Null operation	69
Figure 3-4	MaxMin display	71
Figure 3-5	Trig Hold-Log display	72
Figure 3-6	Auto Hold-Log display	73
Figure 3-7	View display	74
Figure 3-8	Empty view display	75
Figure 4-1	Changing the variation count	84
Figure 4-2	Enabling and changing the Smooth refresh rate	85
Figure 4-3	Enabling and changing the voltage alert level	86
Figure 4-4	Changing the beep frequency	87
Figure 4-5	Changing the auto power-off timeout	88
Figure 4-6	Changing the LCD backlight timeout	89
Figure 4-7	Changing the LCD backlight intensity	90
Figure 4-8	Changing the LED flashlight timeout	91
Figure 4-9	Changing the LED flashlight intensity	92
Figure 4-10	Changing the minimum measurable frequency	93
Figure 4-11	Changing the continuity test alerts	94
Figure 4-12	Changing the power-on greeting tone	95
Figure 4-13	Resetting the Setup items	96
Figure 4-14	Changing the scale conversion value	97
Figure 4-15	Enable the AC/DC mV measurement	98
Figure 4-16	Enable open continuity test by default	99
Figure 4-17	Changing the temperature unit	100

List of Tables

Table 1-1	Battery level indicator	5
Table 1-2	Power-on options	13
Table 1-3	Front panel parts	17
Table 1-4	Rear panel parts	18
Table 1-5	U1231A/U1232A/U1233A rotary switch functions	20
Table 1-6	Keypad functions	22
Table 1-7	General annunciators	24
Table 1-8	Measurement units display	26
Table 1-9	Analog bar graph display	27
Table 1-10	U1231A terminal connections for different measuring functions	28
Table 1-11	U1232A and U1233A terminal connections for different measuring functions	29
Table 2-1	Threshold resistance values	41
Table 2-2	Functions allowing frequency measurement	62
Table 3-1	Available scale conversions	76
Table 4-1	Setup menu key functions	80
Table 4-2	Setup menu item descriptions	82
Table 5-1	DC specifications	106
Table 5-2	AC specifications	109
Table 5-3	Capacitance specifications	110
Table 5-4	Temperature specifications	111
Table 5-5	Frequency specifications	112
Table 5-6	Frequency sensitivity and trigger level specifications for voltage measurements	112
Table 5-7	Frequency sensitivity and trigger level specifications for current measurements	113
Table 5-8	Scale transfer (mV) specifications	113
Table 5-9	Display update rate (approximate)	114

THIS PAGE HAS BEEN INTENTIONALLY LEFT BLANK.



1 Introduction

About This Manual	2
Documentation map	2
Safety notes	2
Preparing Your Multimeter	3
Checking the shipment	3
Installing the batteries	3
Turning on your multimeter	6
Automatic Power-Off (APO)	6
Enabling the backlight	7
Enabling the flashlight	7
Selecting the range	9
Alerts and warnings during measurement	10
Adjusting the tilt stand	11
Connecting the IR-USB cable	11
Power-on options	13
Your Multimeter in Brief	15
Dimensions	15
Overview	17
Rotary switch	19
Keypad	22
Display screen	24
Input terminals	28
Cleaning Your Multimeter	30

This chapter teaches you how to set up your multimeter for the first time. An introduction to all the features of the multimeter is also given.



About This Manual

The descriptions and instructions in this manual apply to the Agilent U1231A, U1232A, and U1233A handheld digital multimeters (hereafter referred to as the multimeter).

The model U1233A appears in all illustrations.

Documentation map

The following manuals and software are available for your multimeter. For the very latest version, please visit our website at: <http://www.agilent.com/find/hhTechLib>.

Check the manual revision on the first page of each manual.

- **User's Guide.** This manual.
- **Quick Start Guide.** Printed copy for outdoor use, included with shipment.
- **Service Guide.** Free download at the Agilent website.
- **Agilent GUI Data Logger Software, Help, and Quick Start Guide.** Free download at the Agilent website.

Safety notes

Safety notes are used throughout this manual (see the “[Safety Notices](#)” section for format examples). Familiarize yourself with each of the notes and its meaning before operating your multimeter.

More pertinent safety notes for using this product are located under the “[Safety Considerations](#)” section.

Do not proceed beyond a safety notice until the indicated conditions are fully understood and met.

Preparing Your Multimeter

Checking the shipment

When you receive your multimeter, check the shipment according to the following procedure.

- 1 Inspect the shipping container for damage. Signs of damage may include a dented or torn shipping container or cushioning material that indicates signs of unusual stress or compacting. Save the packaging material in case the multimeter needs to be returned.
- 2 Carefully remove the contents from the shipping container, and verify that the standard accessories and your ordered options are included in the shipment according to the standard shipped items list found in the printed copy of the *U1231A/U1232A/U1233A Quick Start Guide*.
- 3 For any question or problems, refer to the Agilent contact numbers on the back of this manual.

Installing the batteries

Your multimeter is powered by four 1.5 V AAA alkaline batteries (included with the shipment). When you receive your multimeter, the AAA alkaline batteries are not installed.

Use the following procedure to install the batteries.

CAUTION

Before you proceed with the batteries installation, remove all cable connections to the terminals and ensure that the rotary switch is at the OFF position. Use only the battery type specified in the “[Product Characteristics](#)” on page 102.

- 1 Open the battery cover.** Loosen the screw with a suitable Phillips screwdriver and remove the battery cover as shown in [Figure 1-1](#).
- 2 Insert the batteries.** Observe the proper battery polarity. The terminal ends of each battery are indicated inside the battery compartment.
- 3 Close the battery cover.** Place the battery cover back in its original position and tighten the screw.

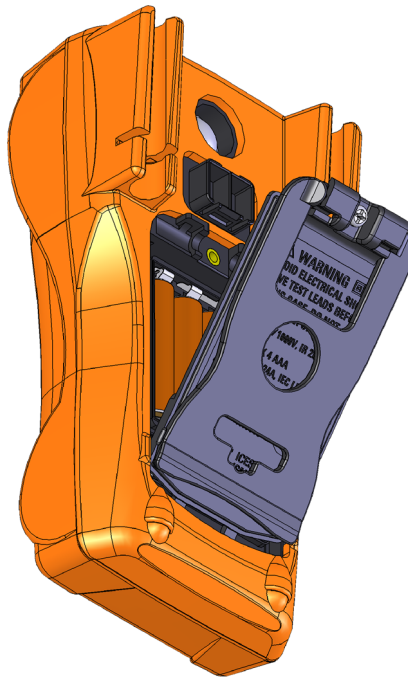





Figure 1-1 Installing the batteries

The battery level indicator in the lower right-hand corner of the display indicates the relative condition of the batteries. [Table 1-1](#) describes the various battery levels the indicator represents.

Table 1-1 Battery level indicator

Indication	Battery capacity
	Full capacity
	2/3 capacity
	1/3 capacity
 <i>(Flashing periodically)</i>	Almost empty ^[1]

[1] Batteries change advised. Always use the specified battery type listed in [page 102](#).

WARNING

To avoid false readings, which could lead to possible electric shock or personal injury, replace the batteries as soon as the low battery indicator appears. Do not discharge the batteries by shorting the batteries or reversing the batteries polarity.

CAUTION

To avoid instruments being damage from battery leakage:

- Always remove dead batteries immediately.
- Always remove the batteries and store them separately if the multimeter is not going to be used for a long period.

Turning on your multimeter

To power ON your multimeter, turn the rotary switch to any other position (other than the **OFF** position). The model number of your multimeter will be shown on the display briefly.

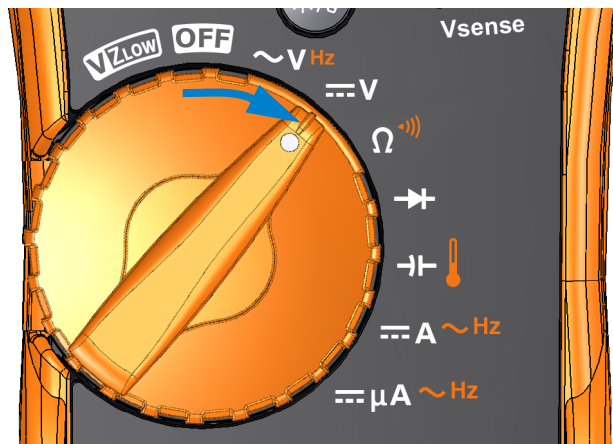

Figure 1-2 Powering on the multimeter

To power OFF your multimeter, turn the rotary switch to the **OFF** position.

Automatic Power-Off (APO)

Your multimeter automatically turns off if the rotary switch is not moved or a key is not pressed for 15 minutes (default). Pressing any key will turn the multimeter back on after it is powered off automatically.

The **APO** symbol is shown on the bottom left of the display when the automatic power-off function is enabled.

NOTE

To change the timeout period or completely disable the automatic power-off, refer to [“Changing the auto power-off \(APO\) timeout”](#) on page 88.

Enabling the backlight

If viewing the display becomes difficult in low-light conditions, press  to activate the LCD backlight.

Press  again to deactivate the LCD backlight.

NOTE

- To conserve battery life, a user-adjustable timeout controls how long the backlight stays on. The default timeout is 15 seconds. To change the timeout period or completely disable the backlight timeout, refer to [“Changing the LCD backlight timeout”](#) on page 89.
 - You can also adjust the backlight’s intensity to conserve battery life. The default intensity is high. To change the backlight’s intensity level refer to [“Adjusting the LCD backlight intensity”](#) on page 90.
-

Enabling the flashlight

If you are using the multimeter in dark places, press and hold  for more than 1 second to activate the LED flashlight for greater visibility on your test points.





Press  for more than 1 second to deactivate the LED flashlight.

CAUTION

VISION ADVISORY CLAIM



The LED light source is safe for normal usage. However, staring directly into the LED light source is not recommended as prolonged direct exposure may be harmful to the eyes.

NOTE

- To conserve battery life, a user-adjustable timeout can be set to control how long the flashlight stays on. To set a timeout period, refer to “Enabling the LED flashlight timeout” on page 91.
- You can also adjust the flashlight’s intensity to conserve battery life. The default intensity is high. To change the flashlight’s intensity level refer to “Adjusting the LED flashlight intensity” on page 92.
- Use the power-on option (hold  while powering on the multimeter) to enable the flashlight without multimeter operation. In this mode, you can adjust the flashlight intensity using the  or  keys, as well as cycle between the **HELP** mode, **dEMo** mode, or flashlight mode using the  or  keys. To learn more, see “HELP and dEMo modes” on page 8 and “Power-on options” on page 13.



HELP and dEMo modes

The **HELP** and **dEMo** modes can be enabled through the power-on options (see page 13).

- 1 While in the flashlight power-on mode, press  or  until **HELP** is shown to enable the **HELP** mode.



NOTE

When the **HELP** mode is enabled, the multimeter flashes the international Morse code distress signal (· · · — — — · · ·) repeatedly. Use this option to send a visual alert or notification of a distress in progress.

- 2 While in the flashlight power-on mode, press  or  until **dEMo** is shown to enable the **dEMo** mode.

NOTE

When the **dEMo** mode is enabled, the multimeter demonstrates the flashlight and beeper abilities by flashing the flashlight repeatedly accompanied by a melody tone.

- 3 Press  or  to cycle between the **HELP**, **dEMo**, or flashlight mode. Press and hold  for more than 1 second to toggle the flashlight on or off (for any of the modes — **HELP**, **dEMo**, or flashlight mode).

Selecting the range

The multimeter's selected range is always displayed above the right-hand end of the bar graph, as the range indicator.

Pressing  switches the multimeter between manual and autoranging. It also cycles through the available multimeter ranges when manual ranging is enabled.

Autoranging is convenient because the multimeter automatically selects an appropriate range for sensing and displaying each measurement. However, manual ranging results in better performance, since the multimeter does not have to determine which range to use for each measurement.

NOTE

The range is fixed for diode tests, temperature, VZ_{LOW} , and AC/DC mV measurements.

In autorange, the multimeter selects the lowest range to display the highest available precision (resolution) for the input signal. If manual range is already enabled, press  for more than 1 second to enter the autoranging mode.

If autoranging is enabled, press  to enter the manual range mode.

Each additional press of  sets the multimeter to the next higher range, unless it is already in the highest range, at which point the range switches to the lowest range.

Alerts and warnings during measurement

Voltage alert

WARNING

For your own safety, please do not ignore the voltage alert. When the multimeter cautions you with a voltage alert, you are advised to take note of the existence of high voltage and pay closer attention when performing measurements.

Your multimeter provides a voltage alert for voltage measurements in both autoranging and manual range modes. The multimeter starts beeping periodically once the measured voltage exceeds the alert value (regardless of polarity) set in the Setup menu.

By default, this feature is turned off. Be sure to set the alert voltage according to your test requirements. To change the alert voltage level, refer to [“Enabling and changing the voltage alert level”](#) on page 86.

Hazardous voltage indication

The multimeter will also display the hazardous voltage () symbol as an early precaution when the measured voltage is equal to or greater than 30 V in all voltage measurement modes.

Adjusting the tilt stand

To adjust the multimeter to a 60° standing position, pull the tilt stand outward as shown in [Figure 1-3](#).

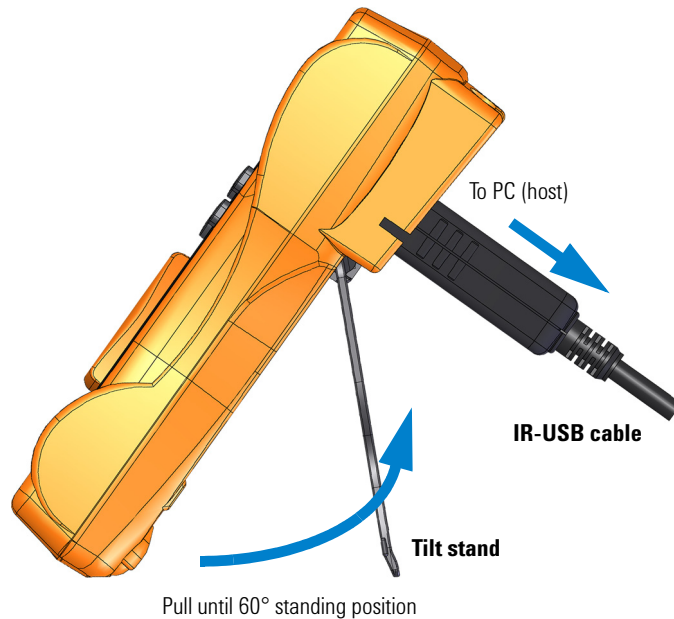

Figure 1-3 Tilt-stand adjustment and IR-USB cable connection

Connecting the IR-USB cable

You can use the IR communication link (IR communication port, located at the rear panel) and the Agilent GUI Data Logger software to control your multimeter remotely, perform data logging operations, and transfer the contents of your multimeter's memory to a PC.

Ensure that the Agilent logo on the U1173A IR-USB cable (purchased separately) connected to the multimeter is facing up. Firmly push the IR head into the multimeter's IR communication port until it snaps into place (see [Figure 1-3](#)).

NOTE

Communication settings for U1231A/U1232A/U1233A

The baud rate, data bits, and parity bit are fixed respectively to 9600 bps, 8-bit, and none for the U1231A/U1232A/U1233A handheld digital multimeter. Ensure that the communication settings on the Agilent GUI Data Logger match the communication settings mentioned in this note.

Refer to the *Agilent GUI Data Logger Software Help* and *Quick Start Guide* for more information on the IR communication link and the Agilent GUI Data Logger software.



Figure 1-4 Agilent GUI Data Logger Software

The Agilent GUI Data Logger software and its supporting documents (Help and Quick Start Guide) are available as free downloads from <http://www.agilent.com/find/hhTechLib>.

You may purchase a U1173A IR-USB cable from an Agilent Sales Office nearest to you.

Power-on options

Some options can be selected only while you turn the multimeter on. These power-on options are listed in the table below.

To select a power-on option, press and hold the specified key in [Table 1-2](#) while turning the rotary switch from OFF to any other position. Power-on options remain selected until the multimeter is turned off.

Table 1-2 Power-on options















Key	Description
	Enters the multimeter's Setup menu. See Chapter 4 , "Multimeter Setup Options," starting on page 79 for more information. Press and hold  for more than 1 second to exit this mode.
	Enables Smooth until the multimeter is turned off. To permanently enable Smooth, see " Enabling and changing the Smooth refresh rate " on page 85.
	Tests the LCD. All annunciators are displayed in the LCD. Press any key to exit this mode.
	Checks the firmware version. The multimeter's firmware version will be shown on the primary display. Press any key to exit this mode.

Table 1-2 Power-on options (continued)

Key	Description
	<p>Enables Scale until the multimeter is turned off.</p> <p>To learn more about Scale, see “Making Scale Transfers (Scale)” on page 76.</p>
	<p>Activates the LED flashlight without multimeter operation.</p> <ul style="list-style-type: none"> Press  or  to adjust the LED flashlight’s intensity level (either Lo, 02, 03, ME, 05, 06, or Hi). Press  to save your changes, or press  to discard your changes. Press  or  to cycle between the flashlight’s HELP mode, dEMo mode, or flashlight mode. To learn more about these modes, see “HELP and dEMo modes” on page 8. Press and hold  for more than 1 second to toggle the flashlight on or off (for any of the modes — HELP, dEMo, or flashlight mode). Press and hold  for more than 1 second to exit this mode.

Your Multimeter in Brief

Dimensions

Front view



Figure 1-5 Width dimension

Rear and side view

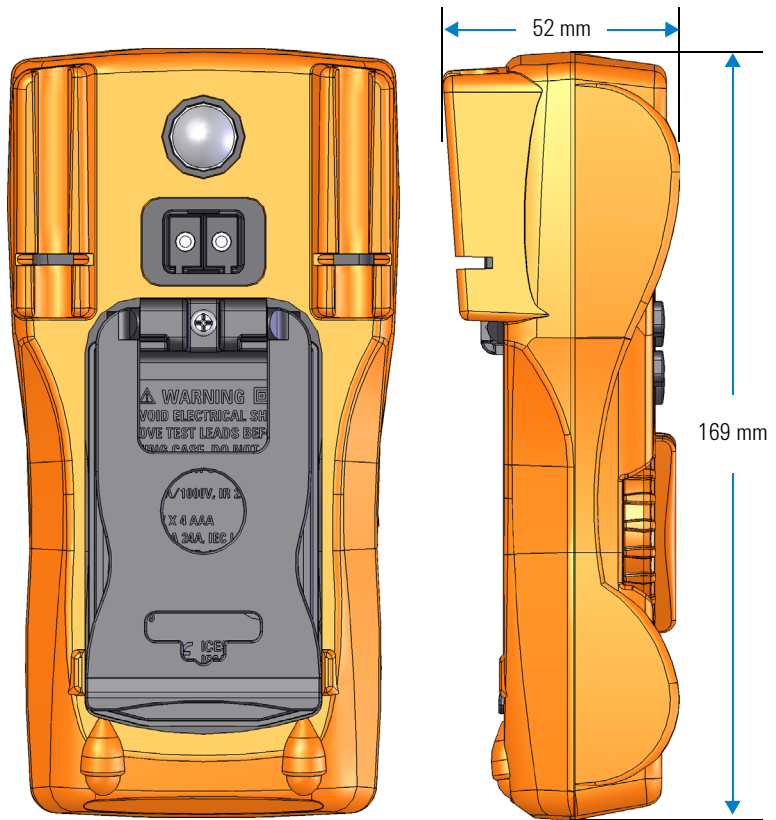

Figure 1-6 Height and depth dimensions

Overview

Front panel

The front panel parts of your multimeter are described in this section. Click the respective “Learn more” pages in [Table 1-3](#) for more information on each part.



Figure 1-7 Front panel

Table 1-3 Front panel parts

Legend	Description	Learn more on:
1	Display screen	page 24
2	Keypad	page 22
3	Terminals	page 28
4	Voltage presence indicator (U1233A only)	page 66
5	Rotary switch	page 19

Rear panel

The rear panel parts of your multimeter are described in this section. Click the respective “Learn more” pages in [Table 1-4](#) for more information on each part.

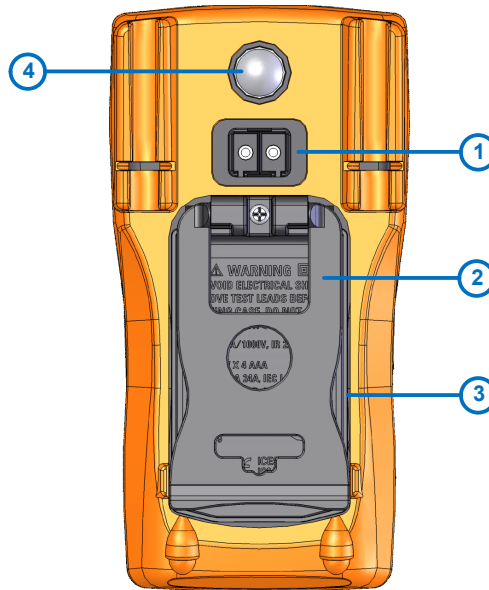

Figure 1-8 Rear panel

Table 1-4 Rear panel parts



Legend	Description	Learn more on:
1	IR communication port	page 11
2	Tilt stand	page 11
3	Battery and fuse access cover	page 3
4	Flashlight	page 7

Rotary switch

The measurement functions for each rotary switch position are described in [Table 1-5](#) on page 20. Turning the rotary switch changes the measurement function and resets all other measurement options.

Click the respective “Learn more” pages in [Table 1-5](#) for more information on each function.

NOTE

Some rotary switch positions have a *shifted* function printed in **orange**. Press  to switch between the shifted and regular function. See [page 23](#) for more information on the  key.

WARNING

Remove the test leads from the measuring source or target before changing the rotary switch position.

Each position of the U1231A, U1232A, and U1233A rotary switch (shown in [Figure 1-7](#)) is described in [Table 1-5](#).

NOTE

A list of some of the abbreviations used in [Table 1-5](#) is given below.

- **VZ_{Low}**: Low input impedance voltage measurement for eliminating ghost voltages
- **AC V**: AC voltage measurement
- **DC V**: DC voltage measurement
- **AC Hz**: AC coupling frequency measurement
- **AC A**: AC current measurement
- **DC A**: DC current measurement
- **Clamp-on AC A (Aux)**: Clamp-on AC auxiliary current measurement
- **Clamp-on DC A (Aux)**: Clamp-on DC auxiliary current measurement
- **AC μ A**: AC current measurement (up to microamperes)
- **DC μ A**: DC current measurement (up to microamperes)

1 Introduction

Your Multimeter in Brief

Table 1-5 U1231A/U1232A/U1233A rotary switch functions





























Legend			Functions shown in the primary display		Learn more on:
U1233A	U1232A	U1231A	Default	When  is pressed	
			VZ _{LOW} Auto (AC/DC) V	Cycles between <ul style="list-style-type: none"> • VZ_{LOW} DC (AC) V, • VZ_{LOW} AC (DC) V, or • VZ_{LOW} Auto (AC/DC) V. 	page 36
			Off	Off	page 5
			AC V	AC Hz	page 32 and page 62
			DC V	N/A	page 34
			Resistance measurement (Ω)	Cycles between <ul style="list-style-type: none"> • Short (⌚) continuity, • Open (⌚) continuity^[1], or • Resistance measurement (Ω) 	page 39 and page 41
			Diode test (V)	N/A	page 45
			U1233A: Capacitance measurement (F) U1232A: Capacitance measurement (F) U1231A: Capacitance measurement (F)	U1233A: Temperature measurement U1232A: Auxiliary temperature measurement U1231A: N/A	page 49 and page 51

Table 1-5 U1231A/U1232A/U1233A rotary switch functions (continued)

Legend			Functions shown in the primary display		Learn more on:
U1233A	U1232A	U1231A	Default	When  is pressed	
			U1233A/U1232A: DC A U1231A: Clamp-on AC A (Aux)	U1233A/U1232A: Cycles between <ul style="list-style-type: none"> • AC A, • AC Hz, or • DC A U1231A: Cycles between <ul style="list-style-type: none"> • Clamp-on DC A (Aux), • AC Hz, or • Clamp-on AC A (Aux) 	page 57 and page 62
			U1233A/U1232A: DC μ A U1231A: Auxiliary temperature measurement	U1233A/U1232A: Cycles between <ul style="list-style-type: none"> • AC μA, • AC Hz, or • DC μA U1231A: N/A	

[1] The open continuity test option must be enabled through the Setup menu. To learn more, see [“Enable open continuity test by default”](#) on page 99. The open continuity test option is disabled by default.

Keypad

The operation of each key is explained below. Pressing a key enables a function, displays a related symbol, and emits a beep. Turning the rotary switch to another position resets the current operation of the key.

Click the respective “Learn more” pages in [Table 1-6](#) for more information on each function.

Table 1-6 Keypad functions



























Legend	Function when pressed for:		Learn more on:
	Less than 1 second	More than 1 second	
	<p>Sets the Null/Relative mode.</p> <ul style="list-style-type: none"> While in Null mode, press  again to view the stored reference value that has been saved. The display will return to normal after 3 seconds. Pressing  while the relative value is being displayed will cancel the Null mode. 	<p>Enters the Hold-Log Recall menu.</p> <ul style="list-style-type: none"> Press  to jump to the last record. Press and hold  for more than 1 second to jump to the first record. Press  or  to scroll through each record. Press  for more than 1 second to store all records into the multimeter’s non-volatile memory. Press  for more than 1 second to clear all records. Press  for more than 1 second to exit this mode. 	<p>page 68 and page 74</p>
	<p>Starts the MaxMin recording.</p> <ul style="list-style-type: none"> Press  again to cycle through maximum (Max), minimum (Min), average (Avg), or present (MaxMinAvg) readings. Press  to restart the recording session. 	<p>Stops the MaxMin recording.</p> <ul style="list-style-type: none"> Press  for more than 1 second to exit this mode. 	<p>page 70</p>
	<p>Sets a manual range and disables autoranging.</p> <ul style="list-style-type: none"> Press  again to cycle through each available measurement range. 	<p>Enables autoranging.</p>	<p>page 9</p>

Table 1-6 Keypad functions (continued)

Legend	Function when pressed for:		Learn more on:
	Less than 1 second	More than 1 second	
	<p>Freezes and stores the present reading in the display ( mode).</p> <ul style="list-style-type: none"> In Trig Hold-Log mode, press  to manually trigger the holding of the next measured value. Press  for more than 1 second to exit this mode. 	<p>Automatically freezes the present reading once the reading is stable ( mode)</p> <ul style="list-style-type: none"> In Auto Hold-Log mode, the reading is updated automatically once the reading is stable and the count setting is exceeded. Press  for more than 1 second to exit this mode. 	<p>page 72</p>
	<p>Turns the LCD backlight on for 15 seconds (default) or off.</p>	<p>Turns the LED flashlight on or off.</p>	<p>page 7 and page 7</p>
	<p>Switches between the regular and <i>shifted</i> measurement function (icon printed in orange on the rotary switch function — if available). Press  again to switch back to the regular measurement function.</p>	<p>For U1233A only: Enables the non-contact voltage presence indicator. Press  for more than 1 second to exit this mode.</p>	<p>page 66</p>

Display screen

The display annunciators of your multimeter are described in this section. See also “[Measurement units](#)” on page 26 for a list of available measurement signs and notations and “[Analog bar graph](#)” on page 27 for a tutorial on the analog bar graph located at the bottom of your display screen.

General display annunciators

The general display annunciators of your multimeter are described in the table below.

Click the respective “Learn more” pages in [Table 1-7](#) for more information on each annunciator.

Table 1-7 General annunciators





Legend	Description	Learn more on:
ZLow	Low impedance measurement enabled	page 36
	Hazardous voltage sign for measuring voltage ≥ 30 V or overload	page 10
	DC (direct current) and AC (alternating current) indication	-
	<ul style="list-style-type: none"> Capacitor is charging (during capacitance measurement) Open continuity test 	page 49 and page 41
	<ul style="list-style-type: none"> Capacitor is discharging (during capacitance measurement) Short continuity test 	
Cal	Calibration enabled	-
Scale	Scale transfer enabled	page 76
	Smooth mode enabled	page 85
APO	APO (Auto Power-Off) enabled	page 6

Table 1-7 General annunciators (continued)







Legend	Description	Learn more on:
Trig Hold	Trigger hold enabled	page 72
Auto Hold	Auto hold enabled	page 72
Max	Maximum reading shown on primary display	page 70
Min	Minimum reading shown on primary display	
Avg	Averaged reading shown on primary display	
MaxMinAvg	Present reading shown on primary display	
	Relative (Null) enabled	page 68
-8888	Primary measurement display	-
	Analog bar graph	page 27
	Remote control enabled	page 11
°F °C mVAnF MkΩHz	Measuring units	-
0°C	Temperature measurement without ambient compensation selected	page 51
Auto	Autoranging enabled	page 9
	Diode test selected	page 45
10600 mVA	Measurement range selected	page 9
	Audible continuity test selected	page 41
Rcl	Hold-Log recall mode enabled	page 74

Table 1-7 General annunciators (continued)

Legend	Description	Learn more on:
	Battery capacity indication	page 5
	Overload (the reading exceeds the display range)	-

Measurement units

The available signs and notations for each measurement function in your multimeter are described in [Table 1-8](#). The units listed below are applicable to the primary display measurements of your multimeter.

Table 1-8 Measurement units display

Sign/Notation	Description
M	Mega 1E+06 (1000000)
k	kilo 1E+03 (1000)
n	nano 1E-09 (0.000000001)
μ	micro 1E-06 (0.000001)
m	milli 1E-03 (0.001)
mV, V	Voltage units for voltage measurement
A, μA	Ampere units for current measurement
nF, μF, mF	Farad units for capacitance measurement
Ω, kΩ, MΩ	Ohm units for resistance measurement
MHz, kHz, Hz	Hertz units for frequency measurement
°C	Degree Celsius, unit for temperature measurement
°F	Degree Fahrenheit, unit for temperature measurement



Analog bar graph

The analog bar emulates the needle on an analog multimeter, without displaying the overshoot. When measuring peak or null adjustments and viewing fast-changing inputs, the bar graph provides a useful indication because it has a faster updating rate^[1] to cater for fast-response applications.

For example, when frequency is displayed on the primary display during voltage or current measurement, the bar graph represents the voltage or current value (not the frequency value).

The “-” sign indicates whether the measured or calculated value negative. Each segment represents 33.34 or 200 counts depending on the range indicated on the peak bar graph.

Table 1-9 Analog bar graph display

Range	Counts/ Segments	Used for the function
	33.34	A, \rightarrow
	200	V, A, Ω , \rightarrow

An unstable bar graph and unmatched primary display when measuring DC voltage usually means the presence of AC voltages in the circuit.

[1] The analog bar graph display update rate is approximately 33 times/second for DC voltage, current, and resistance measurements.

Input terminals

The terminal connections for the different measurement functions of your multimeter are described in the table below. Observe the rotary switch position of your multimeter before connecting the test leads to the connector terminals.

WARNING

Ensure that the probe accessories are connected to the correct input terminals for the selected measurement function before starting any measurement.





CAUTION

To avoid damaging this device, do not exceed the rated input limit.

Table 1-10 U1231A terminal connections for different measuring functions

Rotary switch position	Input terminals	Overload protection
U1231A		
		600 Vrms
		600 Vrms for short circuit <0.3 A

Table 1-11 U1232A and U1233A terminal connections for different measuring functions

Rotary switch position		Input terminals	Overload protection
U1233A	U1232A		
$\sim V_{Hz}$	$\sim V_{Hz}$		600 Vrms
$\equiv V$	$\equiv V$		
$\sqrt{Z_{Low}}$	$\sqrt{Z_{Low}}$		
Ω	Ω		600 Vrms for short circuit <0.3 A
\rightarrow	\rightarrow		
\rightarrow	\rightarrow		
\rightarrow	\rightarrow AUX		
$\equiv \mu A \sim Hz$	$\equiv \mu A \sim Hz$		
$\equiv A \sim Hz$	$\equiv A \sim Hz$	 	11 A/1000 V, fast-acting fuse

Cleaning Your Multimeter

WARNING

To avoid electrical shock or damage to the multimeter, ensure that the insides of the casing stay dry at all times.

Dirt or moisture in the terminals can distort readings. Follow the steps below to clean your multimeter.

- 1 Turn the multimeter off and remove the test leads.
- 2 Turn the multimeter over and shake out any dirt that may have accumulated in the terminals.

Wipe the case with a damp cloth and mild detergent – do not use abrasives or solvents. Wipe the contacts in each terminal with a clean swab dipped in alcohol.



2 Making Measurements

Measuring AC Voltage	32
Measuring DC Voltage	34
Measuring AC/DC mV	34
Using $V_{Z_{LOW}}$ for Voltage Measurements	36
Measuring Resistance	39
Testing for Continuity	41
Testing Diodes	45
Measuring Capacitance	49
Measuring Temperature	51
Measuring AC or DC Current	57
Measuring Frequency	62

This chapter describes how to take measurements with your multimeter.



2 Making Measurements

Measuring AC Voltage

Measuring AC Voltage

Set up your multimeter to measure AC voltage as shown in [Figure 2-2](#). Probe the test points and read the display.

NOTE

AC voltage measurements measured with this multimeter are returned as true rms (root mean square) readings. These readings are accurate for sine waves and other waveforms (with no DC offset) such as square waves, triangle waves, and staircase waves.

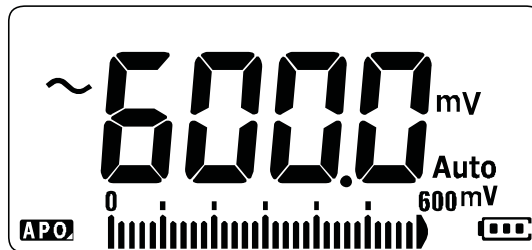



Figure 2-1 AC voltage display

NOTE

Press  to measure the frequency of the AC voltage source. See [“Measuring Frequency”](#) on page 62 to learn more.

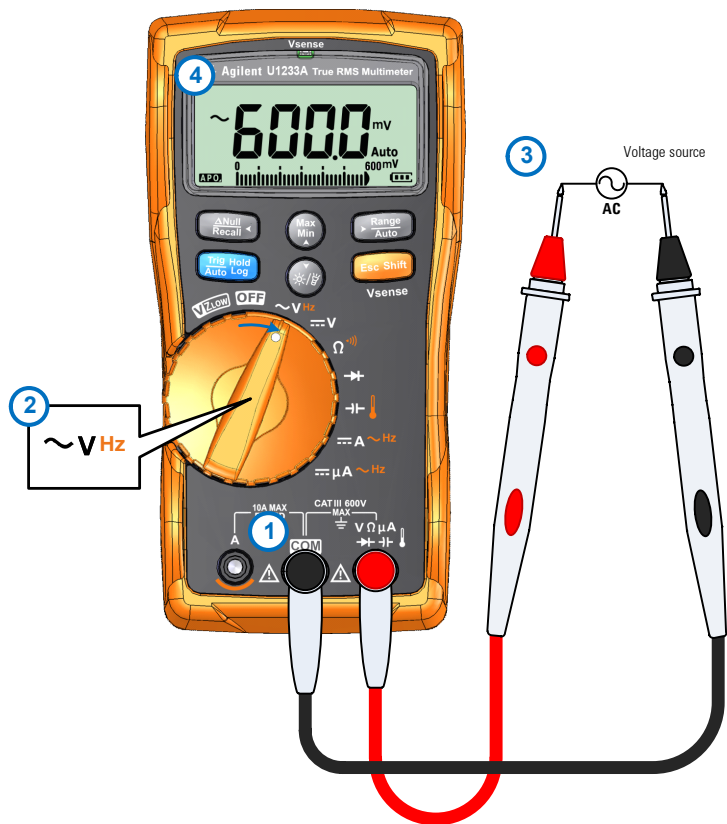

Figure 2-2 Measuring AC voltage

Measuring DC Voltage

Set up your multimeter to measure DC voltage as shown in [Figure 2-4](#). Probe the test points and read the display.

NOTE

This multimeter displays DC voltage values as well as their polarity. Negative DC voltages will return a negative sign on the left of the display.

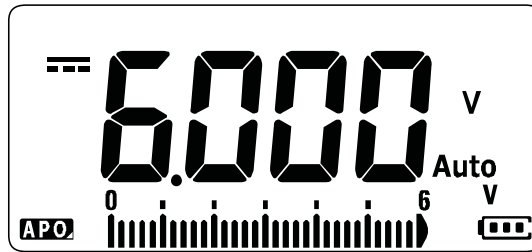

Figure 2-3 DC voltage display

Measuring AC/DC mV

You can choose to set the multimeter to measure AC or DC mV at the rotary positions shown below.

- U1233A: $\overline{\text{H}}$ \downarrow
- U1232A: $\overline{\text{H}}$ \downarrow AUX
- U1231A: \sim \downarrow Hz AUX

Use the Setup menu to enable AC/DC mV measurements. See [“Enable the AC/DC mV measurement”](#) on page 98 to learn more.

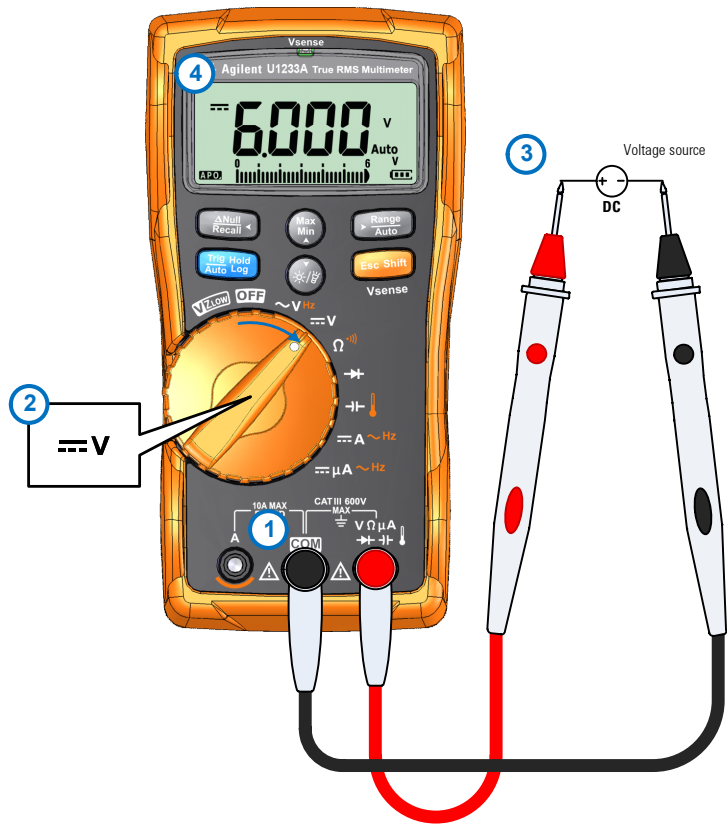

Figure 2-4 Measuring DC voltage

2 Making Measurements

Using VZ_{LOW} for Voltage Measurements

Using VZ_{LOW} for Voltage Measurements

Set up your multimeter to make a VZ_{LOW} (low input impedance) voltage measurement as shown in [Figure 2-6](#). Probe the test points and read the display.

CAUTION

Do not use the VZ_{LOW} function to measure voltages in circuits that could be damaged by this function's low impedance ($\approx 3\text{ k}\Omega$).

NOTE

Use the VZ_{LOW} function to remove ghost or induced voltages from your measurements

Ghost voltages are voltages present on a circuit that should not be energized. They are usually caused by capacitive coupling between energized wiring and adjacent unused wiring. The VZ_{LOW} function can remove ghost voltages from your measurements by dissipating the coupling voltage. Use the VZ_{LOW} function to reduce the possibility of false readings in areas where the presence of ghost voltages are suspected.

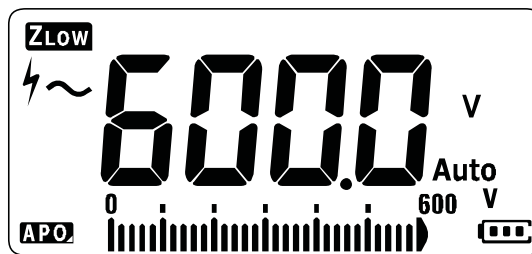

Figure 2-5 VZ_{LOW} voltage display

NOTE

During VZ_{LOW} measurements, the multimeter's range is locked to 600 V. The analog bar graph represents the AC+DC voltage value combined.

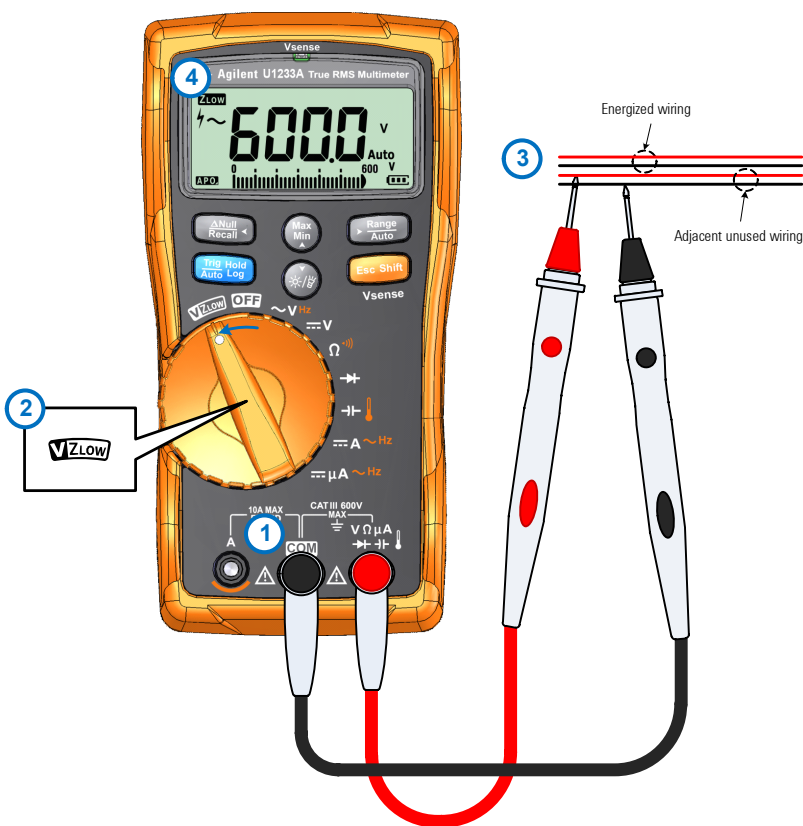

Figure 2-6 Measuring $V_{Z_{LOW}}$ voltage

NOTE

- The multimeter will automatically identify the voltage measurement based on the following criteria:
 - If AC V > 0.5 V or AC V ≥ the absolute of DC V, AC V will be selected.
 - Otherwise, DC V will be selected.
- Press **Esc Shift** once to lock the initial signal identification (AC V or DC V). Press **Esc Shift** again to exchange the AC and DC voltage indication on the primary display. Pressing **Esc Shift** for the third time will restart the auto identification of the signal. See [Figure 2-7](#) to learn more.

2 Making Measurements

Using VZ_{LOW} for Voltage Measurements

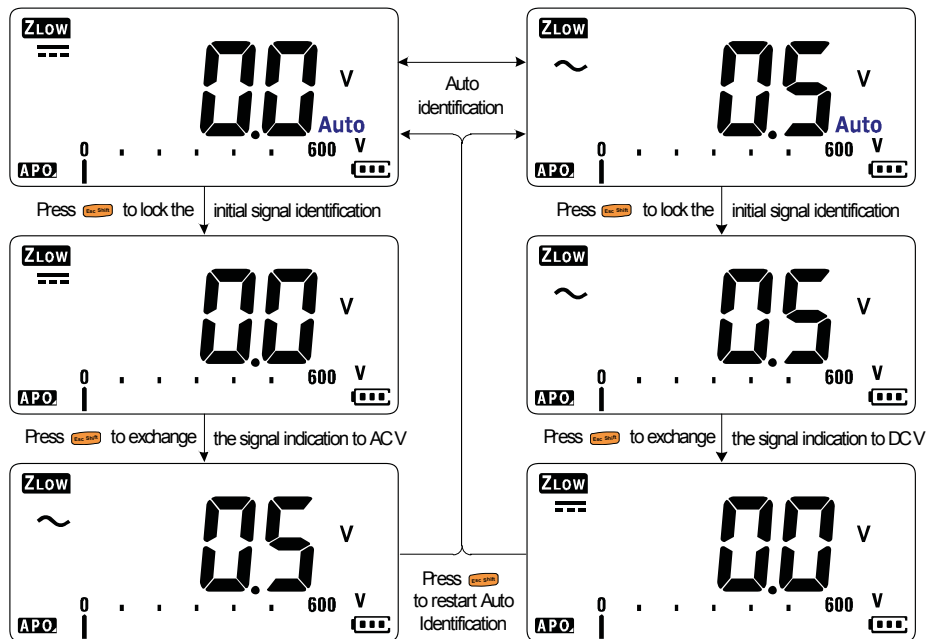

Figure 2-7 VZ_{LOW} auto identification flow

Using VZ_{LOW} to test a battery's health

Aside from reading a battery's voltage level using the DC voltage measurement function, you can also use the VZ_{LOW} function to test a battery's health.

If you detect that the measured battery's voltage shown in the VZ_{LOW} function is declining gradually, this means that the capacity of the battery-under-test is not enough to support regular functions. Use this simple and quick test to determine if a battery has enough voltage capacity to support regular activities.

NOTE

Prolonged use of the VZ_{LOW} function will consume the capacity of the battery-under-test.

Measuring Resistance

Set up your multimeter to measure resistance as shown in Figure 2-9. Probe the test points and read the display.

CAUTION

To avoid possible damage to your multimeter or to the equipment under test, disconnect the circuit power and discharge all high-voltage capacitors before measuring resistance.

NOTE

Resistance (opposition to the current flow) is measured by sending a small current out through the test leads to the circuit under test. Because this current flows through all possible paths between the leads, the resistance reading represents the total resistance of all paths between the leads. Resistance is measured in ohms (Ω).

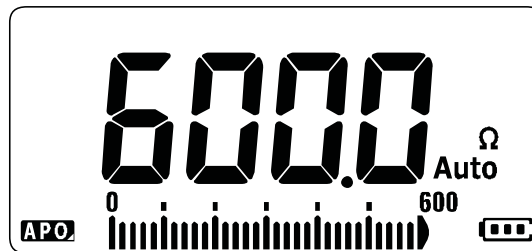



Figure 2-8 Resistance display

NOTE

Keep the following in mind when measuring resistance.

- The test leads can add 0.1 Ω to 0.2 Ω of error to resistance measurements. To test the leads, touch the probe tips together and read the resistance of the leads. To remove lead resistance from the measurement, hold the test lead tips together and press . Now the resistance at the probe tips will be subtracted from all future display readings.

2 Making Measurements

Measuring Resistance

NOTE

- Because the multimeter's test current flows through all possible paths between the probe tips, the measured value of a resistor in a circuit is often different from the resistor's rated value.
- The resistance function can produce enough voltage to forward-bias silicon diodes or transistor junctions, causing them to conduct. If this is suspected, press  to apply a lower current in the next higher range.

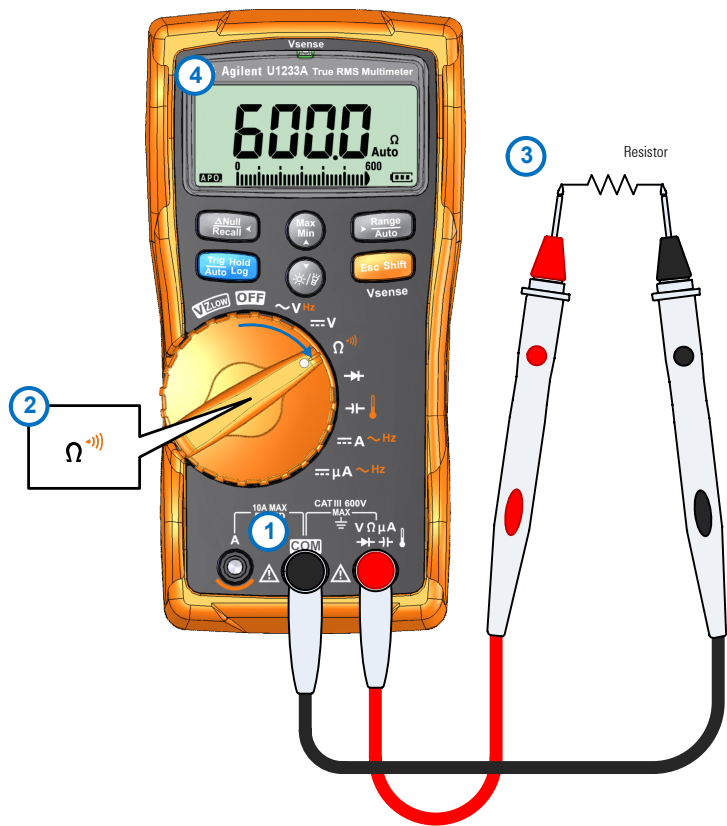

Figure 2-9 Measuring resistance

Testing for Continuity

Set up your multimeter to test for continuity as shown in [Figure 2-11](#). Probe the test points and read the display.

CAUTION

To avoid possible damage to your multimeter or to the equipment under test, disconnect the circuit power and discharge all high-voltage capacitors before testing for continuity.



NOTE

Continuity is the presence of a complete path for current flow. The continuity test features a beeper that sounds and a backlight that flashes as long as a circuit is complete if short continuity is selected (or broken if open continuity is selected). The audible and visual alert allows you to perform quick continuity tests without having to watch the display.

In continuity, a short means a measured value is less than the threshold resistance values listed in [Table 2-1](#).

Table 2-1 Threshold resistance values

Measuring range	Threshold resistance
600.0 Ω	<23 \pm 10 Ω
6.000 k Ω	<230 \pm 100 Ω
60.00 k Ω	<2.3 \pm 1 k Ω
600.0 k Ω	<23 \pm 10 k Ω
6.000 M Ω	<131 \pm 60 k Ω
60.00 M Ω	<131 \pm 60 k Ω

Press  to switch between resistance measurement, short continuity test () , or open continuity test () . See [Figure 2-10](#) to learn more.

2 Making Measurements

Testing for Continuity

NOTE

Open continuity is disabled by default

The open continuity test option must be enabled in the Setup menu before it can be selected via the **ESC/SHR** key. See “Enable open continuity test by default” on page 99 to learn more.

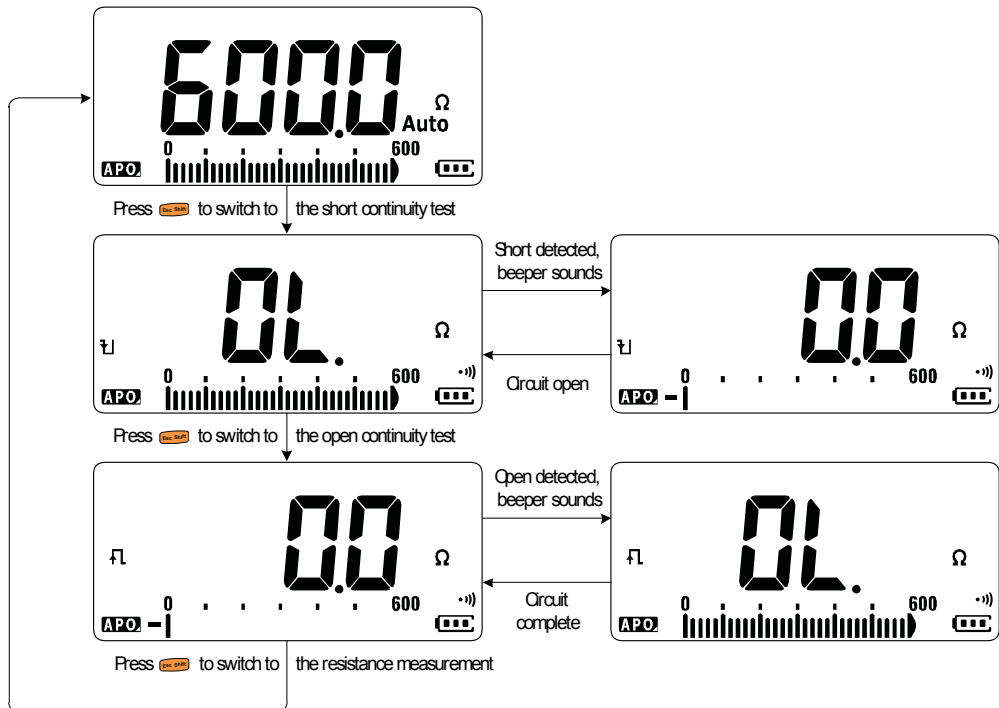

Figure 2-10 Continuity test flow

NOTE

- You can set the beeper to sound and the backlight to flash as a continuity indication whether the circuit-under-test is less than (short) or more than or equal to (open) the threshold resistance.
 - The continuity function detects intermittent shorts and opens lasting as short as 1 ms. A brief short or open causes the multimeter to emit a short beep and flash.
 - You can enable or disable the audible and visual alert via the Setup menu. See [“Changing the continuity test alerts”](#) on page 93 for more information on the audible and visual alert options.
-

2 Making Measurements

Testing for Continuity

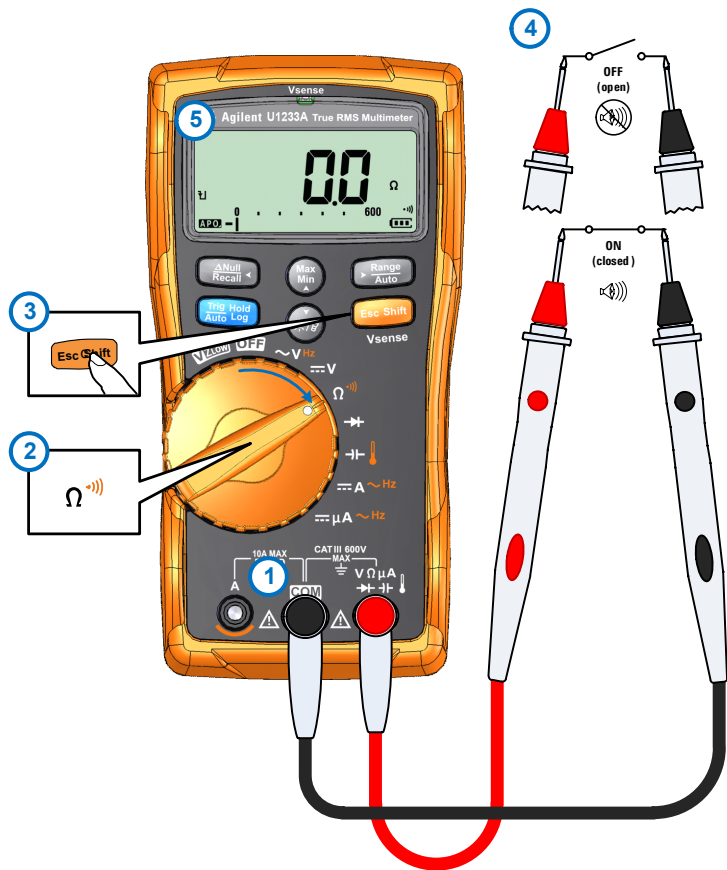

Figure 2-11 Testing for continuity

Testing Diodes

Set up your multimeter to test diodes as shown in [Figure 2-14](#). Probe the test points and read the display.

CAUTION

To avoid possible damage to your multimeter or to the equipment under test, disconnect the circuit power and discharge all high-voltage capacitors before testing diodes.

NOTE

- Use the diode test to check diodes, transistors, silicon controlled rectifiers (SCRs), and other semiconductor devices. A good diode allows current to flow in one direction only.
- This test sends a current through a semiconductor junction, and then measures the junction's voltage drop.
- Connect the red test lead to the positive terminal (anode) of the diode and the black test lead to the negative terminal (cathode). The cathode of a diode is indicated with a band.



Figure 2-12 Diode display

NOTE

Your multimeter can display the forward bias of a diode up to approximately 2.1 V. The forward bias of a typical diode is within the range of 0.3 V to 0.8 V; however, the reading can vary depending on the resistance of other pathways between the probe tips.

2 Making Measurements

Testing Diodes

NOTE

If the beeper is enabled during diode test, the multimeter will beep briefly for a normal junction and sound continuously for a shorted junction, below 0.050 V. See “[Changing the beep frequency](#)” on page 87 to disable the beeper.

Reverse the probes (as shown in [Figure 2-15](#)) and measure the voltage across the diode again. Assess the diode according to the following guidelines:

- A diode is considered good if the multimeter displays ∞ in reverse bias mode.
- A diode is considered shorted if the multimeter displays approximately 0 V in both forward and reverse bias modes, and the multimeter beeps continuously.
- A diode is considered open if the multimeter displays ∞ in both forward and reverse bias modes.

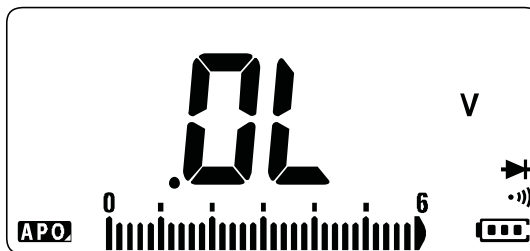

Figure 2-13 Open diode display

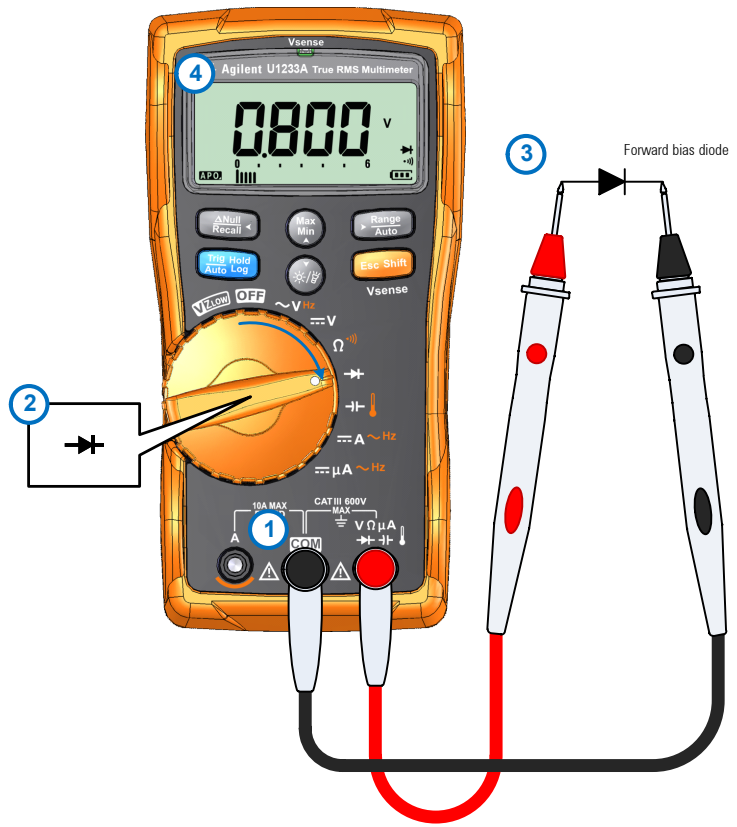

Figure 2-14 Testing forward bias diode

2 Making Measurements

Testing Diodes

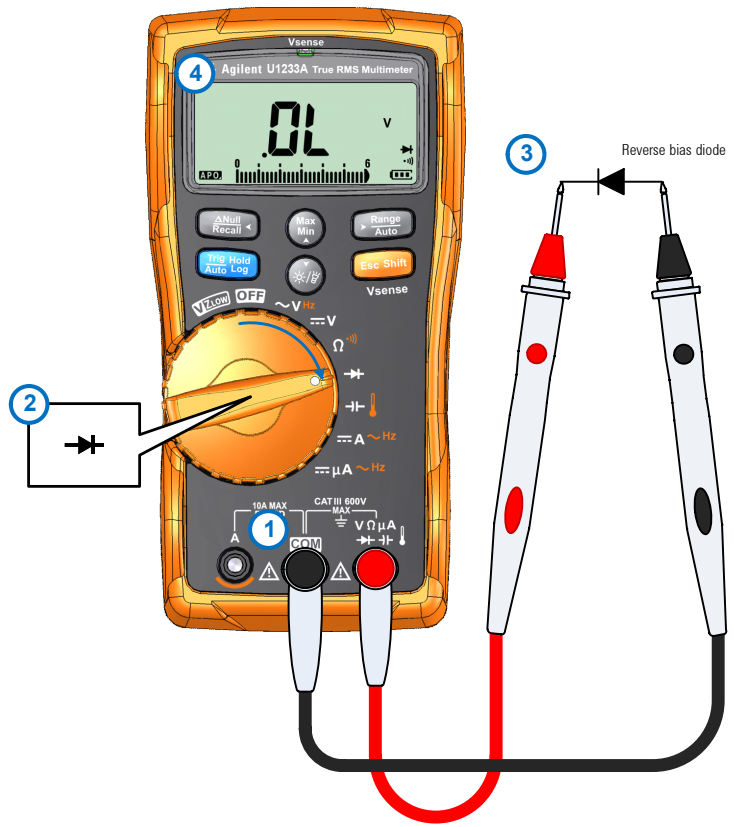

Figure 2-15 Testing reverse bias diode

Measuring Capacitance

Set up your multimeter to measure capacitance as shown in Figure 2-17. Probe the test points and read the display.

CAUTION

To avoid possible damage to the multimeter or to the equipment under test, disconnect circuit power and discharge all high-voltage capacitors before measuring capacitance. Use the DC voltage function to confirm that the capacitor is fully discharged.

NOTE

- The multimeter measures capacitance by charging the capacitor with a known current for a known period of time, measuring the resulting voltage, and then calculating the capacitance.
- $\uparrow\downarrow$ is shown on the left of the display when the capacitor is charging, and $\downarrow\uparrow$ is shown when the capacitor is discharging.

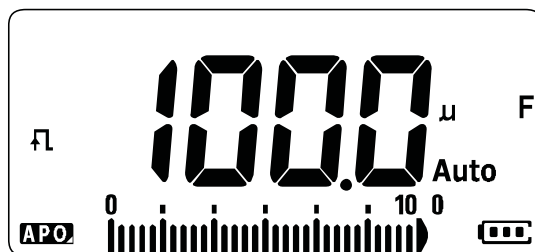



Figure 2-16 Capacitance display

NOTE

- To improve measurement accuracy of small value capacitors, press  with the test leads open to subtract the residual capacitance of the multimeter and leads.
- For measuring capacitance values greater than 1000 μF , discharge the capacitor first, then select a suitable range for measurement. This will speed up the measurement time and also ensures that the correct capacitance value is obtained.

2 Making Measurements

Measuring Capacitance

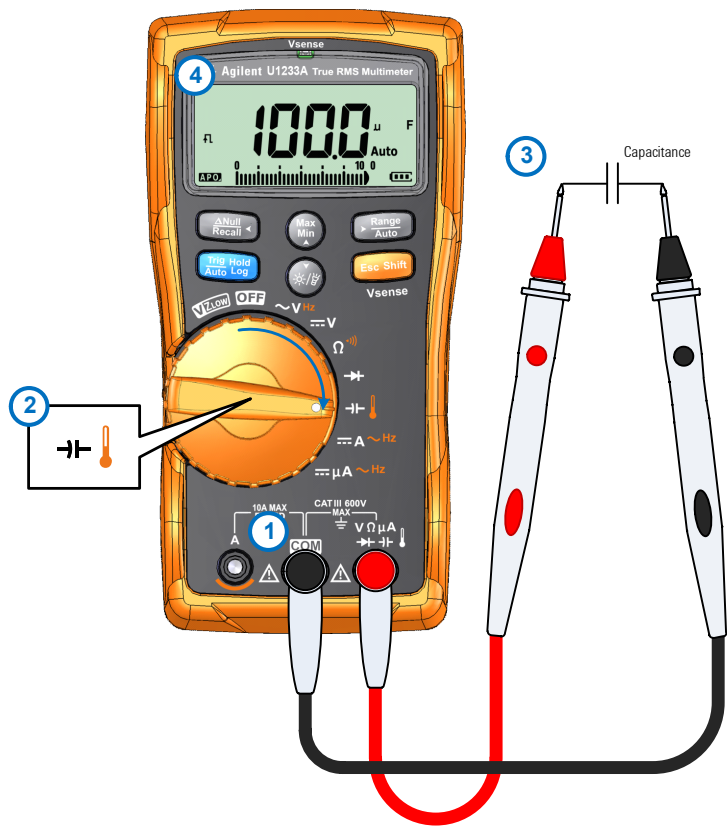

Figure 2-17 Measuring capacitance

Measuring Temperature

For the U1233A, set up your multimeter to measure temperature as shown in [Figure 2-19](#). For the U1231A and U1232A, refer to [Figure 2-20](#). Probe the test points and read the display.

WARNING

Do not connect the thermocouple to electrically live circuits. Doing so will potentially cause fire or electric shock.

CAUTION

Do not bend the thermocouple leads at sharp angles. Repeated bending over a period of time can break the leads.

NOTE

- The multimeter uses a type-K (default setting) temperature probe for measuring temperature.
- For temperature measurement on the U1233A, a type-K thermocouple probe and adapter such as the U1186A (purchased separately) is recommended. It is only compatible with the U1233A.
- For auxiliary temperature measurement on the U1231A and U1232A, a temperature module such as the U1586B (purchased separately) is required.
- The approximate ambient temperature (cold-junction compensation) is shown on the display when you have an open thermocouple. The open thermocouple message may be due to a broken (open) probe or because no probe is installed into the input jacks of the multimeter.
- Shorting the  terminal to the **COM** terminal will display the temperature at the multimeter's terminals.

2 Making Measurements

Measuring Temperature



Figure 2-18 Temperature display

Press  to change the temperature units between °C or °F (you must first change the temperature unit from °C only to °C°F or °F°C). See [“Changing the temperature unit”](#) on page 99 for more information.

NOTE

The option to toggle between °C and °F is only available for the U1233A model.

CAUTION

Always set the temperature unit display per the official requirements and in compliance with the national laws of your region.

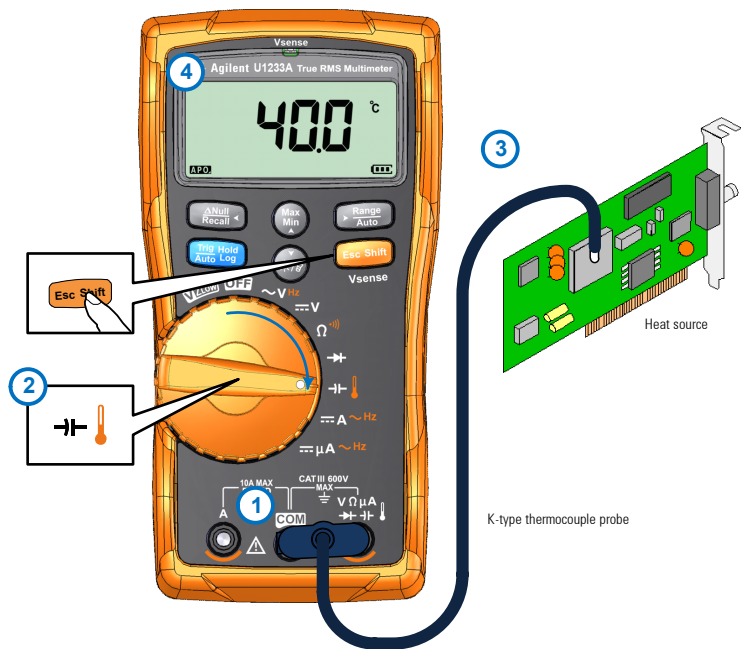

Figure 2-19 Measuring the surface temperature

2 Making Measurements

Measuring Temperature

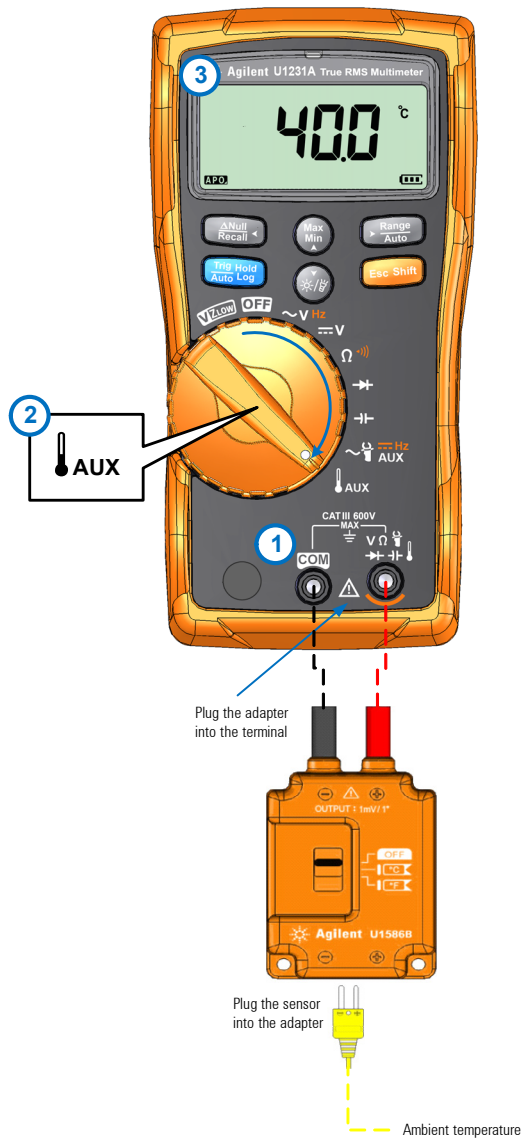



Figure 2-20 Using the Auxillary Temperature measurement function (Only applicable for the U1231A and U1232A models)

NOTE





The bead-type thermocouple probe is suitable for measuring temperatures from $-40\text{ }^{\circ}\text{C}$ to $204\text{ }^{\circ}\text{C}$ ($399\text{ }^{\circ}\text{F}$) in PTFE-compatible environments. Above this temperature range, the probe may emit toxic gas. Do not immerse this thermocouple probe in any liquid. For best results, use a thermocouple probe designed for each specific application — an immersion probe for liquid or gel, and an air probe for air measurement.

Observe the following measurement techniques:





- Clean the surface to be measured and ensure that the probe is securely touching the surface. Remember to disable the applied power.
- When measuring above ambient temperatures, move the thermocouple along the surface until you get the highest temperature reading.
- When measuring below ambient temperatures, move the thermocouple along the surface until you get the lowest temperature reading.
- Place the multimeter in the operating environment for at least 1 hour as the multimeter is using a non-compensation transfer adapter with miniature thermal probe.
- For quick measurement, use the  compensation to view the temperature variation of the thermocouple sensor. The  compensation assists you in measuring relative temperature immediately.

Changing the default temperature unit

You can change the temperature unit (Celsius only, Celsius/Fahrenheit, Fahrenheit only, or Fahrenheit/Celsius) from the Setup menu.

- 1 Press and hold  while powering on the multimeter to enter the Setup menu.
- 2 Press and hold  for more than 1 second until  is shown on the display.
- 3 Press  or  to change the default temperature unit shown on the display.

Available options:

- °C - Temperature measured in °C only.
 - °C°F - During temperature measurements, press  to switch between °C and °F.
 - °F - Temperature measured in °F only.
 - °F°C - During temperature measurements, press  to switch between °F and °C.
- 4 Press  to save the changes. Press and hold  until the multimeter restarts

Temperature measurement without ambient compensation

If you are working in a constantly varying environment, where ambient temperatures are not constant, do the following:



- 1 Press and hold  for more than 1 second to select the 0 °C compensation (). This allows a quick measurement of the relative temperature.
- 2 Avoid contact between the thermocouple probe and the surface to be measured.
- 3 After a constant reading is obtained, press  to set the reading as the relative reference temperature.
- 4 Touch the surface to be measured with the thermocouple probe and read the display.



Figure 2-21 Temperature measurement without ambient compensation

Measuring AC or DC Current

Set up your multimeter to measure AC or DC current as shown in [Figure 2-24](#) and [Figure 2-25](#). Probe the test points and read the display.

WARNING

Never attempt an in-circuit current measurement where the open-circuit potential to earth is greater than 1000 V. Doing so will cause damage to the multimeter and possible electric shock or personal injury.

CAUTION

To avoid possible damage to the multimeter or to the equipment under test:

- Check the multimeter's fuses before measuring current.
 - Use the proper terminals, function, and range for your measurement.
 - Never place the probes across (in parallel with) any circuit or component when the leads are plugged into the current terminals.
-

NOTE

- To measure current, you must open the circuit under test, then place the multimeter in series with the circuit.
 - Insert the black test lead into the **COM** terminal. Insert the red test lead in an input appropriate for the measurement range.
 - Set the positive input terminal to the **A** terminal and set the rotary switch position to $\text{=A} \sim \text{Hz}$ for currents above 600 μA .
 - Set the positive input terminal to the μA terminal and set the rotary switch position to $\text{=}\mu\text{A} \sim \text{Hz}$ for currents below 600 μA .
 - Press  to cycle between DC current measurement, AC current measurement, or to measure the frequency of the AC current source. See "[Measuring Frequency](#)" on page 62 to learn more.
-

2 Making Measurements

Measuring AC or DC Current

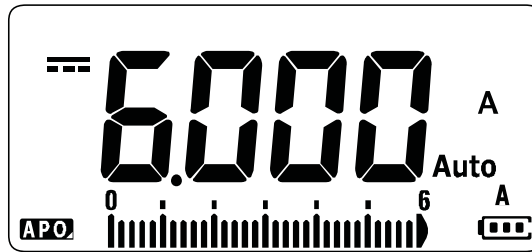

Figure 2-22 DC current display

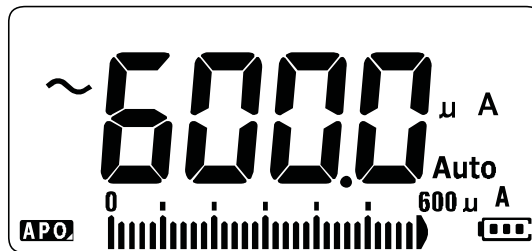

Figure 2-23 AC current display

NOTE

Reversing the leads will produce a negative reading, but will not damage the multimeter.

CAUTION

Placing the probes across (in parallel with) a powered circuit when a lead is plugged into a current terminal can damage the circuit you are testing and blow the multimeter's fuse. This happens because the resistance through the multimeter's current terminals is very low, resulting in a short circuit.

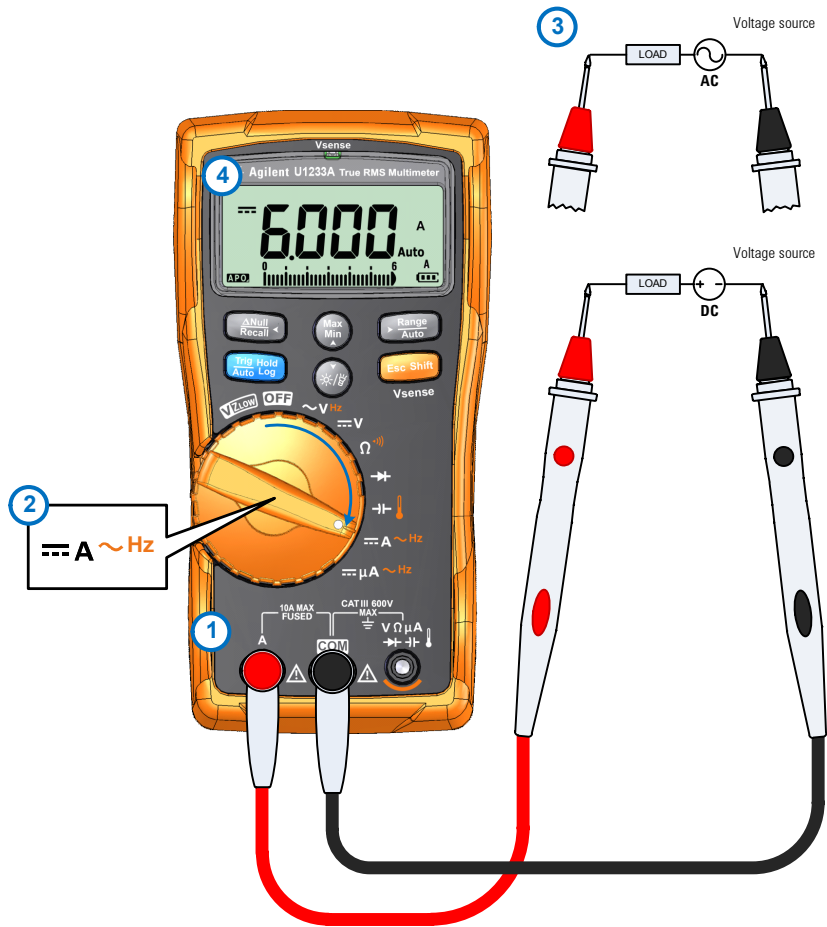

Figure 2-24 Measuring DC/AC current (up to A)

2 Making Measurements

Measuring AC or DC Current

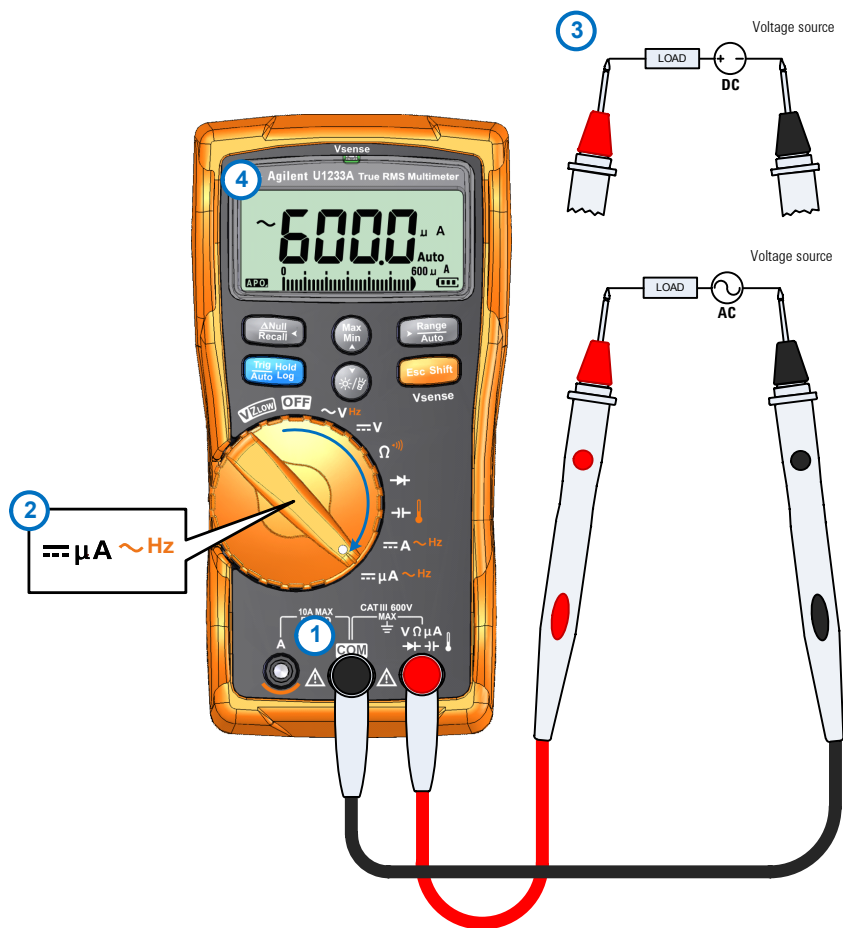

Figure 2-25 Measuring AC/DC current (up to μA)

Using the μA function to measure flame rectification circuits

The multimeter's μA measurement function can be used to measure flame rectification circuits (flame sensors) down to $0.01 \mu\text{A}$.

Flame sensors, whether they are used in a home furnace or on a large industrial boiler, indicate the presence of a flame and are part of the safety circuit. These types of flame sensors use a process of flame rectification to sense that the flame is lit. Typically, these flame sensors must be engulfed in the burner flame to function.

Flame rectification uses the fact that a flame will rectify an AC voltage to DC voltage and allow the DC current to flow through a flame to detect a flame.

Normally, an AC voltage is applied to the flame sensor with a wire coming from the ignition module. When the flame sensor is engulfed by a flame, the AC voltage is rectified and a DC current, commonly 4 to $12 \mu\text{A}$, flows from the ignition module through the wire to the flame sensor, through the flame to the ground on the furnace chassis.

The ignition control module has a circuit to detect the DC current, and it commonly closes a relay when the DC current is detected, that verifies that the burner is properly lit. If the burner fails to light or is extinguished for any reason, that DC current disappears and the control module takes suitable action to turn off the burner.

To measure flame rectification circuits:

- 1 Set up your multimeter to measure μA measurements as shown in [Figure 2-25](#).
- 2 Connect the multimeter between the flame sensor probe (**COM** terminal) and the ignition control module (**μA** terminal).
- 3 Probe the test points and read the display.

Measuring Frequency

Your multimeter allows simultaneous monitoring of real-time voltage or current with frequency measurements. [Table 2-2](#) highlights the functions allowing frequency measurements in your multimeter.

Table 2-2 Functions allowing frequency measurement

Legend		
U1233A	U1232A	U1231A
~VHz	~VHz	~VHz
≡A ~Hz	≡A ~Hz	~VHz AUX
≡μA ~Hz	≡μA ~Hz	

WARNING

Never measure the frequency where the voltage or current level exceeds the specified range. Manually set the voltage or current range if you want to measure frequencies below 20 Hz.

NOTE

- Measuring the frequency of a signal helps detect the presence of harmonic currents in neutral conductors and determines whether these neutral currents are the result of unbalanced phases or non-linear loads.
- Frequency is the number of cycles a signal completes each second. Frequency is defined as 1/Period. Period is defined as the time between the middle threshold crossings of two consecutive, like-polarity edges, as shown in [Figure 2-26](#).
- The multimeter measures the frequency of a voltage or current signal by counting the number of times the signal crosses a threshold level within a specified period of time.

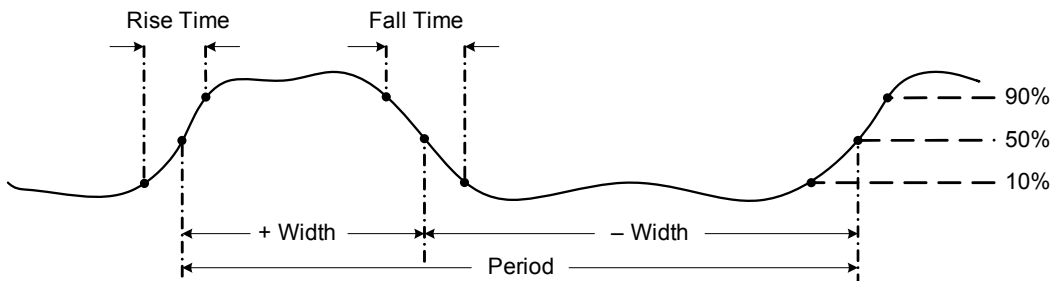



Figure 2-26 Frequency definition

NOTE

- Pressing  controls the input range of the primary function (voltage or ampere) and not the frequency range.
- The frequency of the input signal is shown in the primary display, and the bar graph does not indicate the frequency value but indicates the voltage or ampere value of the input signal.

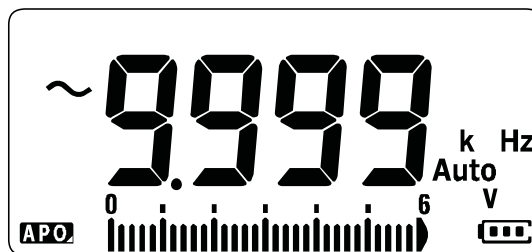

Figure 2-27 Frequency display

NOTE

Observe the following measurement techniques:

- If a reading shows as 0 Hz or is unstable, the input signal may be below or near the trigger level. You can usually correct these problems by manually selecting a lower input range, which increases the sensitivity of the multimeter.

2 Making Measurements

Measuring Frequency

NOTE

- If a reading seems to be a multiple of what you expect, the input signal may be distorted. Distortion can cause multiple triggerings of the frequency counter. Selecting a higher voltage range might solve this problem by decreasing the sensitivity of the multimeter. In general, the lowest frequency displayed is the correct one.

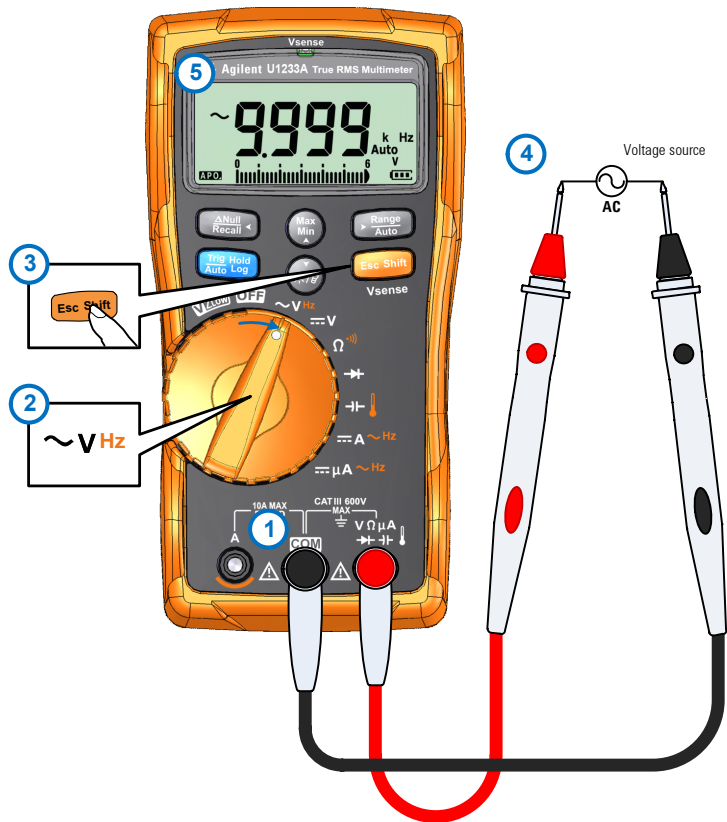

Figure 2-28 Measuring frequency



3 Multimeter Features

Detecting AC Voltage Presence (Vsense)	66
Making Relative Measurements (Null)	68
Capturing Maximum and Minimum Values (MaxMin)	70
Freezing the Display (Trig Hold-Log and Auto Hold-Log)	72
Trig Hold-Log operation	72
Auto Hold-Log operation	72
Recalling Previously Recorded Readings (Recall)	74
Making Scale Transfers (Scale)	76

The chapter describes the additional features available in your multimeter.



3 Multimeter Features

Detecting AC Voltage Presence (Vsense)

Detecting AC Voltage Presence (Vsense)

The Vsense detector is a non-contact voltage detector (for U1233A model only) that detects the presence of AC voltages nearby.

WARNING

You are advised to test on a known live circuit within the rated AC voltage range of this product before and after each use to ensure that the Vsense detector works.

Voltage could still be present even if there is no Vsense alert indication. Do not rely on Vsense detector with shielded wire. Never touch live voltage or conductor without the necessary insulation protection or power off the voltage source.

The Vsense detector may be affected by differences in socket design, insulation thickness, and insulation type.

CAUTION

You are advised to measure voltage by using test leads through the VZ_{LOW} , AC V, or DC V function after using the Vsense function, even if there is no alert indication.

Press and hold  for more than 1 second to enable the Vsense function (on any position of the rotary switch except **OFF**).

NOTE

If the presence of AC voltage is sensed, the multimeter's beeper will sound and the Vsense red LED at the top of the multimeter will turn on. The audible and visual alert allows you to easily sense nearby AC voltage presence.

No resolution and accuracy of voltage measurement will be displayed in this mode.

Press  to toggle the Vsense detector's sensitivity between **H.5E** (high sensitivity) or **Lo5E** (low sensitivity).

NOTE

- Place the top of the multimeter (with the **Vsense** indicator) close to a conductor when sensing for AC voltages (as low as 24 V in the **Hi.SE** setting).
- The low sensitivity setting can be used on flush mounted wall sockets or outlets and various power strips or cords.
- The high sensitivity setting allows for AC voltage sensing on other styles of recessed power connectors or sockets where the actual AC voltage is recessed within the connector itself.

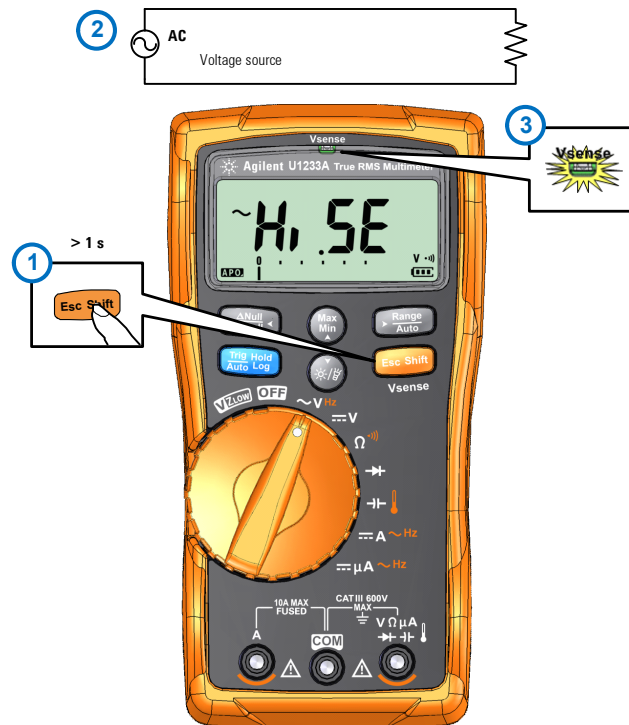

Figure 3-1 Detecting voltage presence

Press and hold **Esc Shift** for more than 1 second to disable the Vsense function.

Making Relative Measurements (Null)

When making Null measurements, also called relative, each reading is the difference between a stored (measured) null value and the input signal.

One possible application is to increase the accuracy of a resistance measurement by nulling the test lead resistance. Nulling the leads is also particularly important prior to making capacitance measurements.

NOTE

Null can be set for both auto and manual range settings, but not in the case of an overload.





- 1 To activate the relative mode, press the  key. The measurement value at the time, when Null (Δ) is enabled, is stored as the reference value.



Figure 3-2 Null display

- 2 Press  again to view the stored reference value. The display will return to normal after 3 seconds.
- 3 To disable the Null function, press  while the stored reference value is shown (step 2).

For any measurement function, you can directly measure and store the null value by pressing  with the test leads open (nulls the test lead capacitance), shorted (nulls the test lead resistance), or across a desired null value circuit.

NOTE

- In resistance measurement, the multimeter will read a non-zero value even when the two test leads are in direct contact because of the resistance of these leads. Use the Null function to zero-adjust the display.
- For DC voltage measurements, the thermal effect will influence the accuracy of the measurements. Short the test leads and press  when the displayed value is stable to zero-adjust the display.

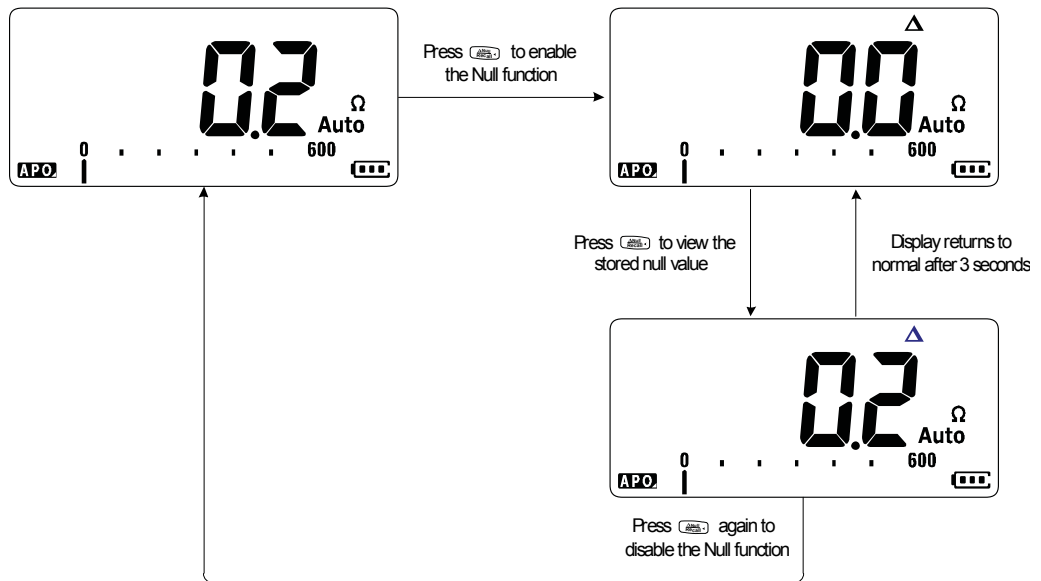

Figure 3-3 Null operation

Capturing Maximum and Minimum Values (MaxMin)

The MaxMin operation stores the maximum, minimum, and average input values during a series of measurements.





When the input goes below the recorded minimum value or above the recorded maximum value, the multimeter beeps and records the new value. The multimeter also calculates an average of all readings taken since the MaxMin mode was activated.

From the multimeter's display, you can view the following statistical data for any set of readings:

- Max: highest reading since the MaxMin function was enabled
- Min: lowest reading since the MaxMin function was enabled
- Avg: average or mean of all readings since the MaxMin function was enabled
- MaxMinAvg: present reading (actual input signal value)

NOTE

This function is applicable to all measurements except for V_{ZLOW} .

- 1 Press  to enable the MaxMin operation.
- 2 Press  again to cycle through the Max, Min, Avg, or present (MaxMinAvg) input values.
- 3 Press  to restart the recording session.
- 4 Press  for more than 1 second to disable the MaxMin function.

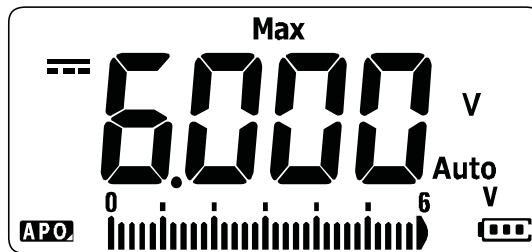



Figure 3-4 MaxMin display

NOTE

- Changing the range manually will also restart the recording session.
- If an overload is recorded, the averaging function will be stopped.  is shown in place of the average value.
- The APO (auto power-off) function is disabled when MaxMin is enabled.

This mode is useful for capturing intermittent readings, recording minimum and maximum readings unattended, or recording readings while equipment operation keeps you from observing the multimeter display.

The true average value displayed is the arithmetic mean of all readings taken since the start of recording. The average reading is useful for smoothing out unstable inputs, calculating power consumption, or estimating the percentage of time a circuit is active.

3 Multimeter Features

Freezing the Display (Trig Hold-Log and Auto Hold-Log)

Freezing the Display (Trig Hold-Log and Auto Hold-Log)

NOTE

Trig Hold-Log and Auto Hold-Log readings are recorded automatically for future review or analysis by default. See [“Recalling Previously Recorded Readings \(Recall\)”](#) on page 74 to learn more.

Trig Hold-Log operation

To freeze the display for any function, press the  key.

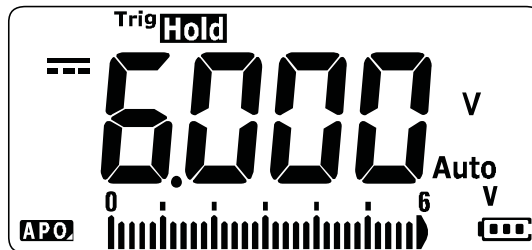



Figure 3-5 Trig Hold-Log display

Press  again to automatically update the display to reflect data that was acquired during the hold.

NOTE

The **Trig Hold** annunciator will flash while attempting to acquire a stable reading.

Press and hold  for more than 1 second to exit this mode.

Auto Hold-Log operation

Pressing the  for more than 1 second activates the Auto Hold-Log function.

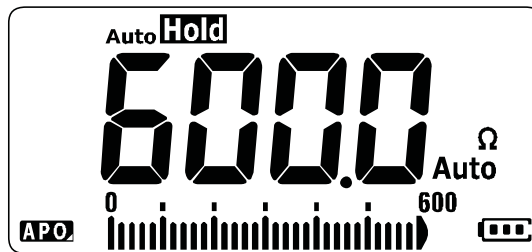







Figure 3-6 Auto Hold-Log display

NOTE

- The Auto Hold-Log operation monitors the input signal and updates the display and, if enabled, emits a beep whenever a new stable measurement is detected. The multimeter is ready to update the display once the variation of the reading exceed the setting of the variation count.
- The **Auto Hold** annunciator will flash while attempting to acquire a stable reading.

Press and hold  for more than 1 second to exit this mode.

Changing the default Auto Hold-Log variation count

- 1 Press and hold  while powering on the multimeter to enter the Setup menu.
- 2 Ensure that the **Auto Hold** annunciator is shown on the display.
- 3 Press  or  to edit the variation count value shown on the display.
- 4 Press  to save the changes. Press and hold  until the multimeter restarts.

NOTE

If the reading value is unable to reach a stable state (when exceeding the preset variation), the reading value will not be updated.

Recalling Previously Recorded Readings (Recall)

Trig Hold-Log and Auto Hold-Log readings are recorded automatically for future review or analysis by default.

NOTE

- Up to a maximum of 10 records can be stored at a time. The Trig Hold-Log and Auto Hold-Log records share the same memory space. When the memory's index is full, the next reading to be recorded will overwrite the last reading recorded (the 10th index).
- By default, each Trig Hold-Log and Auto Hold-Log reading is stored temporarily in the multimeter's volatile memory. All temporary records will be erased when the multimeter is turned OFF.
- You can choose to save the temporary records in the multimeter's nonvolatile memory by pressing and holding  for more than 1 second. Records stored through this method remains saved even when the multimeter is turned OFF or if the battery is replaced.

Recalling readings stored in the multimeter's memory is performed through the  key.

- 1 Press  for more than 1 second to enter the Recall menu. The last recorded reading is shown on the display. The analog bar graph is used to indicate the record index.

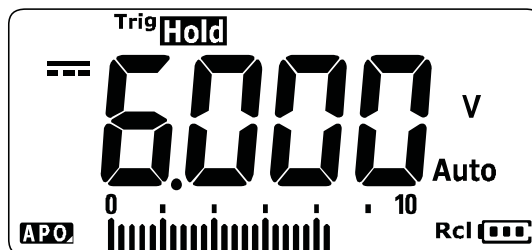

Figure 3-7 View display

If nothing has been recorded, nonE is displayed instead.

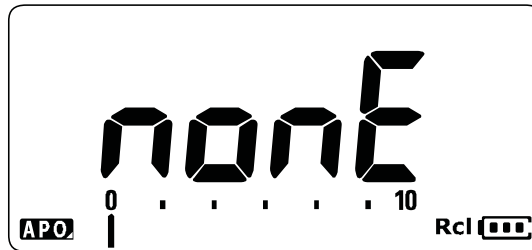

Figure 3-8 Empty view display

- 2 Use the following steps to navigate the Recall menu.
 - i Press to jump to the last stored entry, or press and hold for more than 1 second to jump to the first stored entry.
 - ii Press to view the next stored entry or press to view the previous stored entry. The index number (shown by the analog bar graph) increases or decreases by one.
 - iii Press for more than 1 second to permanently store all data entries in the multimeter's nonvolatile memory. **PRSS** is shown on the display if the data entries are successfully stored.
 - iv Press for more than 1 second to clear the temporary data entries. **none** is shown on the display if the data entries are successfully cleared. Cycle the multimeter's power again to view the permanent data entries.

NOTE

To clear the permanent data entries

- 1 Press for more than 1 second until **none** is shown on the display.
- 2 Then, press for more than 1 second until **PRSS** is shown on the display.
- 3 All data entries stored in the multimeter's nonvolatile memory will be erased.

- 3 Press for more than 1 second to exit the Recall menu.

Making Scale Transfers (Scale)

The Scale operation emulates a transducer by helping you to convert the measured readings proportionally to the specified ratio and unit display. Use Scale to transfer voltage readings to proportional readings when using clamp-on current probes, high voltage probes, or temperature auxiliary probes. The available scale conversions are shown in the table below.

Table 3-1 Available scale conversions

Scale item	Multiplier ^[1]	Unit	Best resolution	Start range
1000 V/V ^[2]	1000.0	V	0.1 V	600.0 V
1 °C/mV ^[3] or 1 °F/mV ^[3]	1000.0	°C or °F	0.1 °C or 0.1 °F	600.0 °C or 600.0 °F
1 A/mV	1000.0	A	0.1 A	600.0 A
0.1 A/mV	100.0	A	0.01 A	60.00 A
0.01 A/mV	10.0	A	0.001 A	6.000 A
1 mA/ mV	1.0	A	0.1 mA	600.0 mA
0.1 mA/ mV	0.1	A	0.01 mA	60.00 mA

[1] The transfer formula used is: Display = Multiplier × Measurement

[2] The scale item is selected from the Setup menu. See [“Changing the scale conversion value”](#) on page 96 for more information.

[3] Dependent on temperature unit setup.

If °C or °C°F is selected, 1 °C/mV is shown as the selected scale item. If °F or °F°C is selected, 1 °F/mV is shown as the selected scale item instead.

- 1 Press and hold  while powering on the multimeter to enable the Scale operation.
- 2 If successful, the **Scale** annunciator is shown on the left of the display. The multimeter automatically starts the conversion of the selected Scale item for all voltage measurements.
- 3 You can only change the selected Scale item from the Setup menu. See “[Changing the scale conversion value](#)” on page 96 to learn more.
- 4 The Scale operation is enabled until the multimeter’s power is cycled.

3 Multimeter Features

Making Scale Transfers (Scale)

THIS PAGE HAS BEEN INTENTIONALLY LEFT BLANK.



4 Multimeter Setup Options

Using the Setup Menu	80
Editing numerical values	81
Setup Menu Summary	82
Setup Menu Items	84
Changing the variation count	84
Enabling and changing the Smooth refresh rate	85
Enabling and changing the voltage alert level	86
Changing the beep frequency	87
Changing the auto power-off (APO) timeout	88
Changing the LCD backlight timeout	89
Adjusting the LCD backlight intensity	90
Enabling the LED flashlight timeout	91
Adjusting the LED flashlight intensity	92
Changing the minimum measurable frequency	93
Changing the continuity test alerts	93
Changing the power-on greeting tone	95
Resetting the Setup items	96
Changing the scale conversion value	96
Enable the AC/DC mV measurement	98
Enable open continuity test by default	99
Changing the temperature unit	99

The chapter describes how to change the preset features of your multimeter.

















Using the Setup Menu

The Setup menu allows you to change a number of nonvolatile preset features. Modifying these settings affects the general operation of your multimeter across several functions. Select a setting to edit to perform one of the following:



- Switch between two values, such as on or off.
- Cycle through multiple values from a predefined list.
- Decrease or increase a numerical value within a fixed range.



The contents of the Setup menu are summarized in [Table 4-2](#) on page 82.



Table 4-1 Setup menu key functions



Legend	Description
	<p>Press and hold  while powering on the multimeter to access the Setup menu.</p> <p>Press and hold  for more than 1 second to exit this mode.</p>
	<p>Press  or  to step through the menu items.</p>
	<p>Press  or  at each menu item to change the preset settings. The menu item (in the secondary display) will flash to indicate that you can now change the menu item values.</p> <p>Press  or  again to switch between two values, to cycle through multiple values from a list, or to decrease or increase a numerical value.</p>
	<p>While the menu item is flashing, press  to save your changes.</p> <p>While the menu item is flashing, press  to discard your changes.</p>



Editing numerical values



When editing numerical values, first press  or  to position the cursor over the first numerical digit (most right digit).

Next, use the  and  to move the cursor to the other numerical digit(s).

- Press  to move the cursor to the left, and
- Press  to move the cursor to the right.

When the cursor is positioned over a digit, use the  and  keys to change the numerical digit.

- Press  to increment the digit, and
- Press  to decrement the digit.

When you have completed your changes, save the new numerical value by pressing . (Or alternatively, if you wish to discard the changes you made, press .)

Setup Menu Summary

The Setup menu items are summarized in the table below. Click the respective “Learn more” pages in [Table 4-2](#) for more information on each menu item.

Table 4-2 Setup menu item descriptions













Legend	Available settings	Description	Learn more on:
 050	(001 to 999) counts	Set the multimeter’s Auto Hold-Log variation count from 1 count to 999 counts. Default is 50 counts.	page 72 and page 84
 009d	(001 to 999) or disabled	Set the display’s settling value from 1 to 999. Enable the Smooth function by selecting E (enabled). Default is disabled (009.d).	page 13 and page 85
 030d ^v	(001 to 660) V or disabled	Set the multimeter’s voltage alert value from 1 V to 660 V. Enable the voltage alert function by selecting E (enabled). Default is disabled (030.d) V.	page 10 and page 86
 bF38 ^{Hz}	(3.2, 3.4, 3.8, 4.2) kHz or — (off)	Set the multimeter’s beep frequency (3.2 kHz, 3.4 kHz, 3.8 kHz, 4.2 kHz, or off). Default is 3.8 kHz.	page 87
 R 15E ^m	(01 to 99) mins or disabled	Set the auto power-off timeout period from 1 to 99 minutes (1 hour, 39 minutes). Disable the auto power-off function by selecting d (disabled). Default is 15 minutes.	page 6 and page 88
 b 15E	(01 to 99) s or disabled	Set the LCD backlight timeout period from 1 to 99 seconds (1 minute, 39 seconds). Disable the LCD backlight timeout by selecting d (disabled). Default is 15 seconds.	page 7 and page 89
 bLH _i	Lo, 02, 03, ME, 05, 06, or Hi	Set the LCD backlight brightness (Lo, 02, 03, ME, 05, 06, or Hi). Default is Hi.	page 7 and page 90
 L 15E	(01 to 99) s or disabled	Set the LED flashlight timeout period from 1 to 99 seconds (1 minute, 39 seconds). Enable the LED flashlight timeout by selecting E (enabled). Default is disabled (15.d).	page 7 and page 91
 L L H _i	Lo, 02, 03, ME, 05, 06, or Hi	Set the LED flashlight brightness (Lo, 02, 03, ME, 05, 06, or Hi). Default is Hi.	page 7 and page 92
 Fr 05 ^{Hz}	(0.5 or 5.0) Hz	Set the minimum measurement frequency (0.5 Hz or 5.0 Hz). Default is 0.5 Hz.	page 62 and page 93

Table 4-2 Setup menu item descriptions (continued)

Legend	Available settings	Description	Learn more on:
bEBL	bE.bL, --.bL, to.nE, ---.---, or bE.--	Enable or disable the continuity test alerts (beeping sound and/or flashing backlight). Default is enabled for both beeper and backlight (bE.bL).	page 41 and page 93
ñELo	MELo, USEr, bEEE, or oFF	Change or disable the power-on greeting tone (melody, user, beep, or off). Default is melody (MELo).	page 5 and page 95
rESn	rES.n or rES.Y	Reset the multimeter to its factory default settings. Default is no (rES.n).	page 96
1000	1000 A/V, 1000 °C(°F)/V, 1000 V/V, 100 A/V, 10 A/V, 1 A/V, or 0.1 A/V	Set the scale conversion value. Default is 1000 A/V.	page 76 and page 96
oFF	on or oFF	Set the multimeter to measure AC or DC mV at the rotary positions shown below. Default is off. <ul style="list-style-type: none"> U1233A:  U1232A:  U1231A:  	page 34 and page 98
oPnd	oPn.d or oPn.E	Enable or disable the open continuity test. Default is disabled (oPn.d).	page 41 and page 99
°C	°C, °C°F, °F, or °F°C	Set the multimeter's temperature unit (Celsius, Celsius/Fahrenheit, Fahrenheit, Fahrenheit/Celsius). Default is °C (Celsius).	page 51 and page 99

Setup Menu Items

Changing the variation count

This setting is used with the Auto Hold-Log function (see [page 72](#)). When the variation of the measured value exceeds the value of the variation count, the Auto Hold-Log function will be ready to trigger.

Use this Setup item to change the variation count for the Auto Hold-Log function between 1 to 999 counts.

Parameter	Range	Default setting
AutoHold	(001 to 999) counts	50 counts

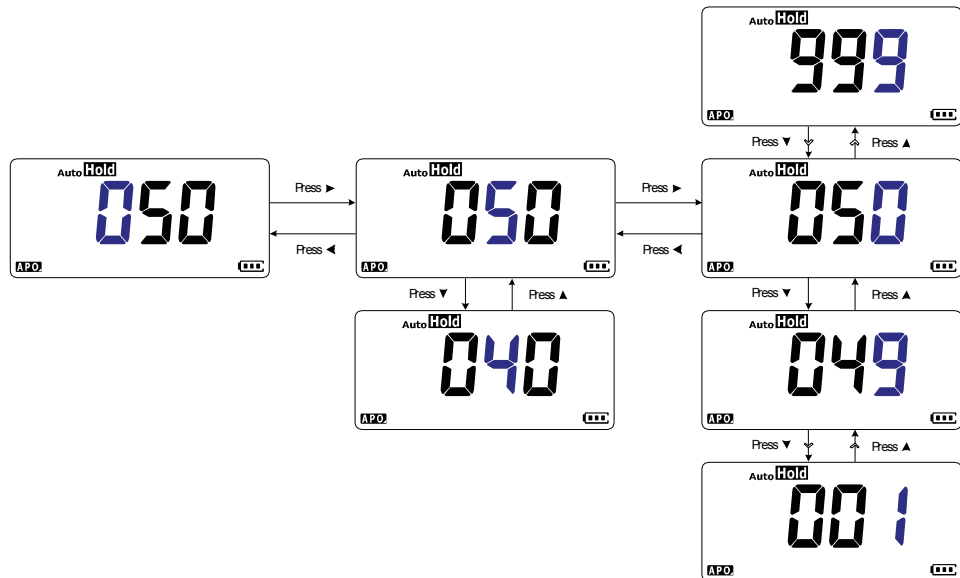

Figure 4-1 Changing the variation count

Enabling and changing the Smooth refresh rate

Smooth is used to smoothen the refresh rate of the readings in order to reduce the impact of unexpected noise and to help you achieve a stable reading.

Use this Setup item to enable or disable Smooth, and to change the refresh rate for Smooth between 1 to 999.

Parameter	Range	Default setting
Smooth	(001 to 999).(d or E)	009.d (disabled)

NOTE

You can enable Smooth by holding  while turning on the multimeter (see [page 13](#)). This method, however, is temporary and Smooth will be turned off when the multimeter's power is cycled.

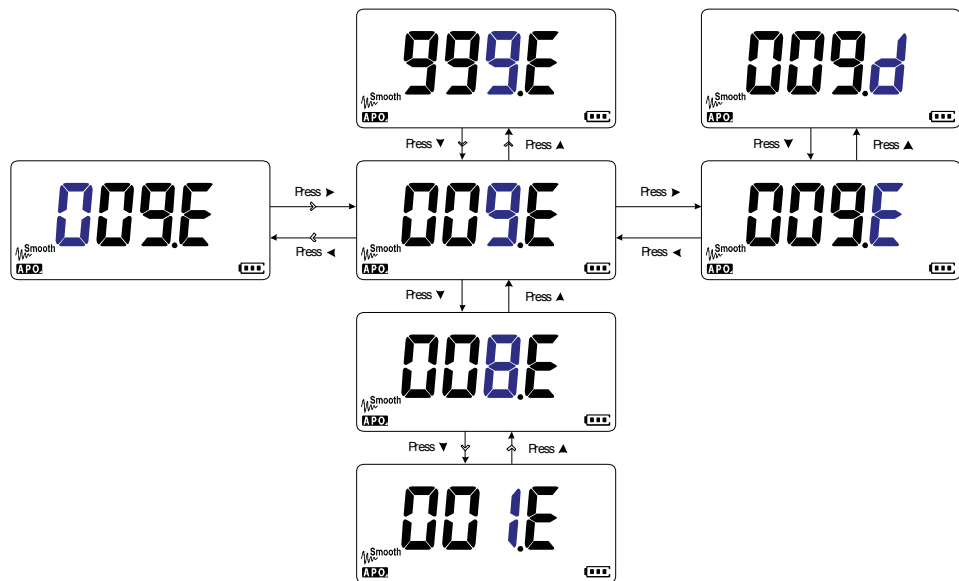

Figure 4-2 Enabling and changing the Smooth refresh rate

Enabling and changing the voltage alert level

This setting is used with the multimeter's voltage alert (see [page 10](#)). The multimeter will start beeping periodically once the measured voltage exceeds the level set, regardless of polarity.

Use this Setup item to enable or disable the voltage alert, and to change the voltage alert level between 1 to 660 V.

Parameter	Range	Default setting
V(oltage Alert)	(1 to 660).(d or E) V	030.d V (disabled)

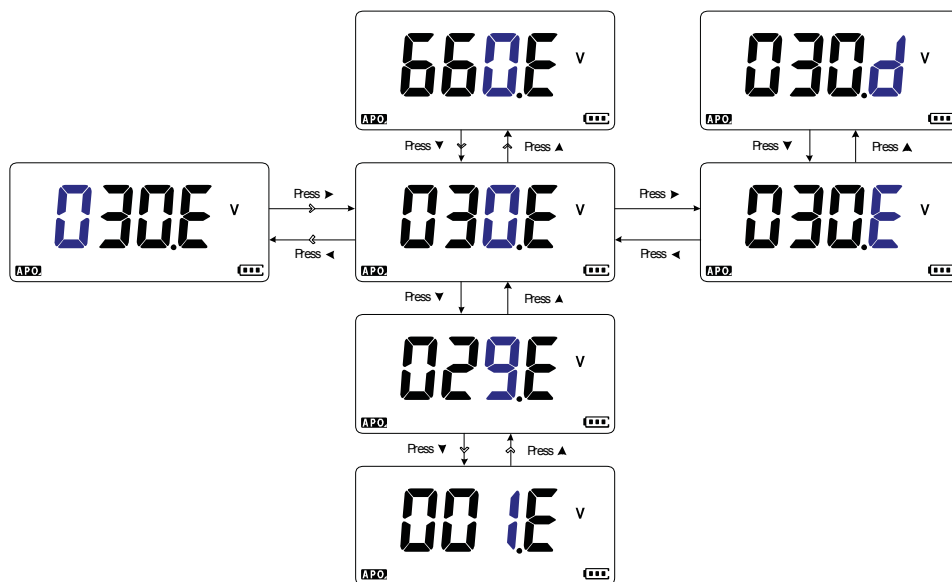

Figure 4-3 Enabling and changing the voltage alert level

Changing the beep frequency

The multimeter's beeper alerts users to the presence of newly sensed values for static recordings, sensed values that are out of tolerance or limits set, and invalid key operations.

Use this Setup item to change the driving frequency of the beeper (either 3.2, 3.4, 3.8, or 4.2 kHz), or to disable the beeper (--)

Parameter	Range	Default setting
bF	(3.2, 3.4, 3.8, 4.2) kHz or -- (off)	3.8 kHz

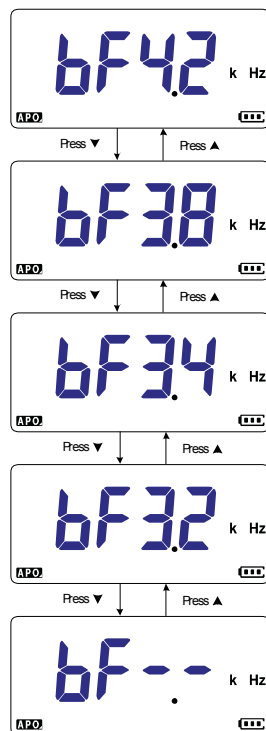

Figure 4-4 Changing the beep frequency

Changing the auto power-off (APO) timeout

The multimeter's automatic power-off (see [page 6](#)) function uses a timer to determine when to automatically turn the multimeter off.

Use this Setup item to enable or disable the auto power-off function and to change its timeout period from 1 to 99 minutes.

Parameter	Range	Default setting
A(PO)	(01 to 99).(d or E) minutes	(15.E) minutes (enabled)

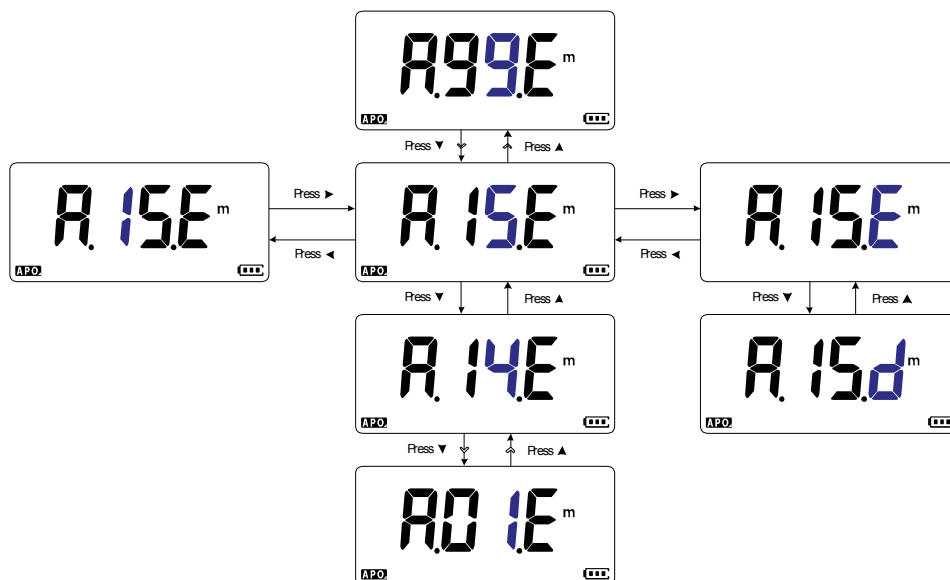

Figure 4-5 Changing the auto power-off timeout

Changing the LCD backlight timeout

The multimeter’s LCD backlight (see [page 7](#)) uses a timer to determine when to turn off the LCD backlight.

Use this Setup item to adjust the LCD backlight timeout and to change its timeout period from 1 to 99 seconds.

Parameter	Range	Default setting
b(acklight)	(01 to 99).(d or E) seconds	(15.E) seconds (enabled)

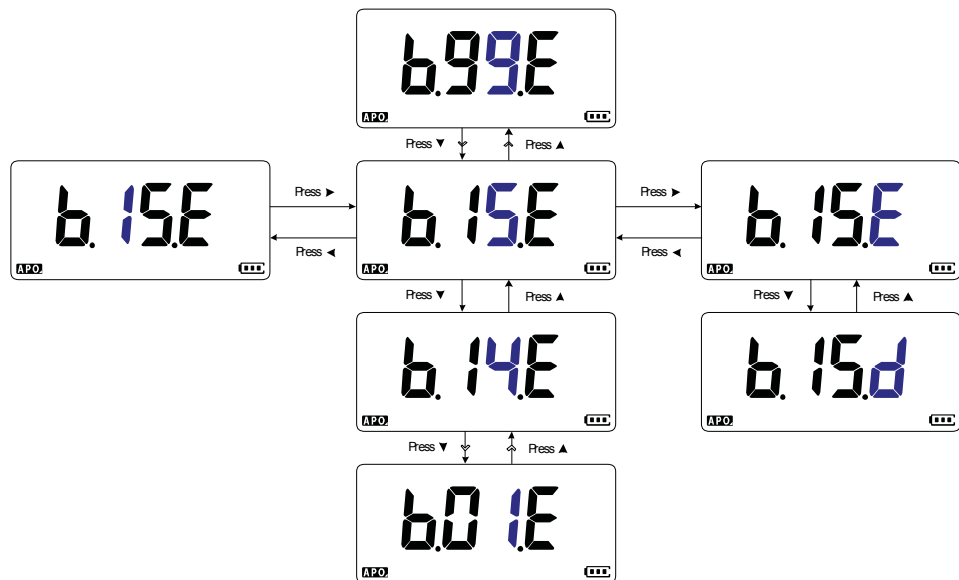

Figure 4-6 Changing the LCD backlight timeout

Adjusting the LCD backlight intensity

The multimeter's LCD backlight (see [page 7](#)) can be adjusted to seven different intensity levels.

Use this Setup item to adjust the LCD backlight's intensity level (either Lo, 02, 03, ME, 05, 06, or Hi).

Parameter	Range	Default setting
bL	Lo, 02, 03, ME, 05, 06, or Hi	Hi

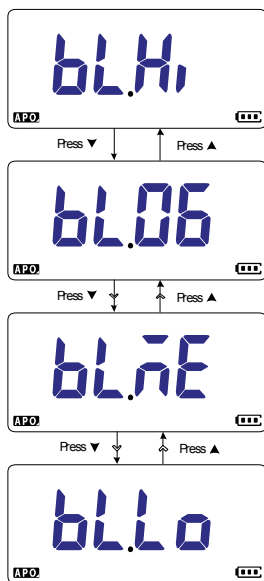

Figure 4-7 Changing the LCD backlight intensity

Enabling the LED flashlight timeout

The multimeter’s LED flashlight (see [page 7](#)) uses a timer to determine when to turn off the LED flashlight.

Use this Setup item to enable or disable the LED flashlight timeout and to change its timeout period from 1 to 99 seconds.

Parameter	Range	Default setting
t(orchlight)	(01 to 99).(d or E) seconds	(15.d) seconds (disabled)

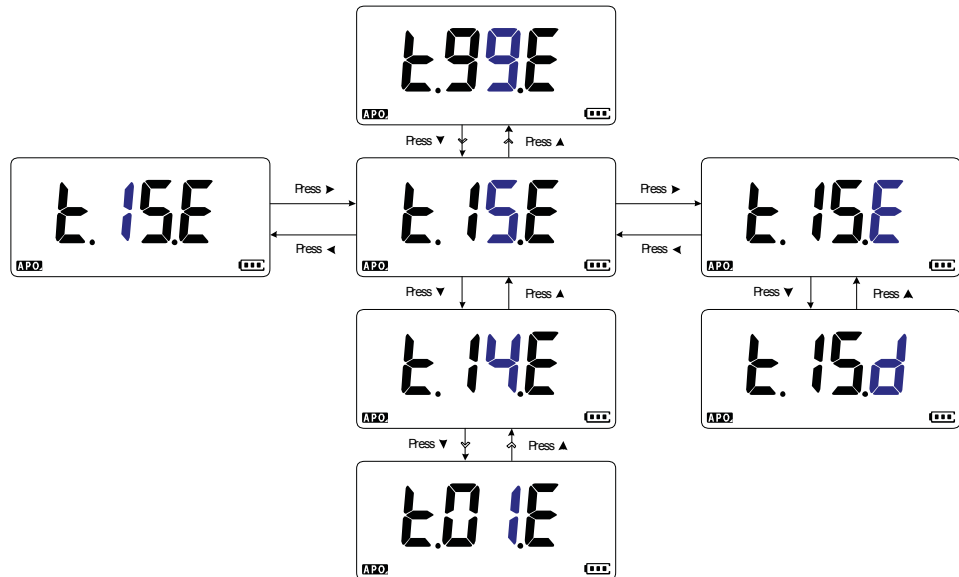

Figure 4-8 Changing the LED flashlight timeout

Adjusting the LED flashlight intensity

The multimeter's LED flashlight (see [page 7](#)) can be adjusted to seven different intensity levels.

Use this Setup item to adjust the LED flashlight's intensity level (either Lo, 02, 03, ME, 05, 06, or Hi).

Parameter	Range	Default setting
tL	Lo, 02, 03, ME, 05, 06, or Hi	Hi



Figure 4-9 Changing the LED flashlight intensity

Changing the minimum measurable frequency

This setting is used with frequency tests (see [page 62](#)). Changing the minimum measurable frequency will influence the display update rates for frequency measurements. The typical display update rate as defined in the specification is based on a minimum measurable frequency of 0.5 Hz.

Use this Setup item to adjust the minimum measurable frequency value (either 0.5 Hz or 5.0 Hz).

Parameter	Range	Default setting
FrEq	0.5 Hz or 5.0 Hz	0.5 Hz

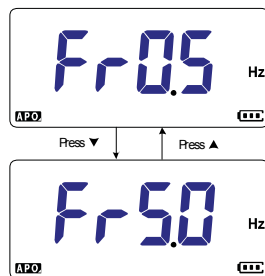

Figure 4-10 Changing the minimum measurable frequency

Changing the continuity test alerts

This setting is used with continuity tests (see [page 41](#)). You can set the beeper to sound and the backlight to flash as a continuity indication whether the circuit-under-test is less than (short) or more than or equal to (open) the threshold resistance.

4 Multimeter Setup Options

Setup Menu Items

Use this Setup item to change the continuity test alerts (either beeper and backlight, backlight only, tone, or beeper only), or to disable the alerts (---).---

Parameter	Range	Default setting
•))	bE.bL, --.bL, to.nE, ---.--, or bE.--	bE.bL

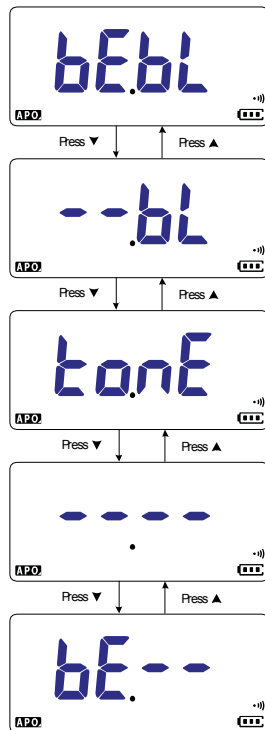

Figure 4-11 Changing the continuity test alerts

Changing the power-on greeting tone

The multimeter plays a short greeting tone each time it is powered up.

Use this Setup item to change the greeting tone (either melody, user, or beep), or to disable the greeting tone (off).

Parameter	Range	Default setting
m(elody)	MELo, USEr, bEEE, or oFF	MELo



Figure 4-12 Changing the power-on greeting tone

Resetting the Setup items

The Setup items can be reset to their default values through this Setup item.

Select **rESY** and press  to perform the reset. The multimeter will beep once and return to the first Setup item.

Parameter	Range	Default setting
rSt	rES.n or rES.Y	rES.n

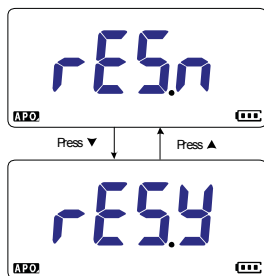

Figure 4-13 Resetting the Setup items

Changing the scale conversion value

This setting is used with the Scale function (see [page 76](#)). You can choose to set the scale conversion value from seven different selections.

Use this Setup item to change the scale conversion value (either 1000 A/V, 1000 °C(°F)/V, 1000 V/V, 100 A/V, 10 A/V, 1 A/V, or 0.1 A/V).

Parameter	Range	Default setting
Scale	1000 A/V, 1000 °C(°F)/V, 1000 V/V, 100 A/V, 10 A/V, 1 A/V, or 0.1 A/V	1000 A/V

NOTE

The temperature-voltage scale conversion 1000 °C/V or 1000 °F/V is dependent on the temperature unit setup (see [page 99](#)).

- If °C or °C°F is selected, 1000 °C/V is shown during the scale conversion.
- If °F or °F°C is selected, 1000 °F/V is shown during the scale conversion.

Changing the temperature unit (via the  key) is disabled when Scale is enabled for voltage measurements.

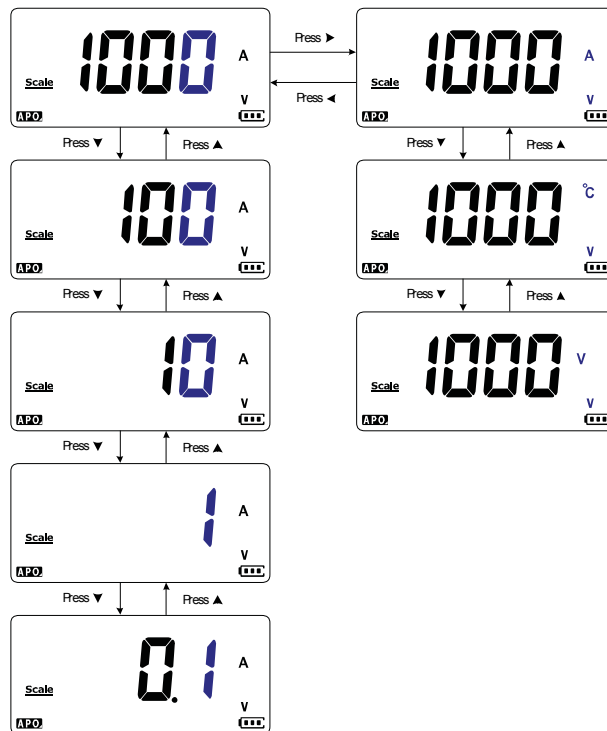





Figure 4-14 Changing the scale conversion value

Enable the AC/DC mV measurement

You can choose to set the multimeter to measure AC or DC mV at the rotary positions shown below.

- U1233A: 
- U1232A: 
- U1231A: 

Use this Setup item to enable AC/DC mV measurements. You are recommended to use the AC/DC mV measurements to precisely measure low voltages.

Parameter	Range	Default setting
mV	on or off	off

NOTE

- When this Setup item is enabled, the original functions of the rotary switch positions shown above are disabled and replaced by AC/DC mV measurements.
- For AC/DC mV measurements, the measurement range is fixed at 600 mV and the input impedance is typically 10 M Ω .
- Press  to switch between DC mV, AC mV, and frequency measurements.

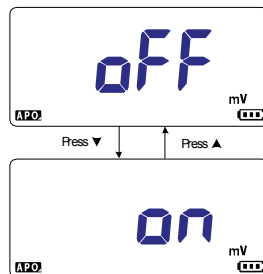

Figure 4-15 Enable the AC/DC mV measurement

Enable open continuity test by default

This setting is used with continuity tests (see [page 41](#)). Enable this option for the beeper to sound and the backlight to flash as a continuity indication when the circuit-under-test is more than or equal to (open) the threshold resistance.

Use this Setup item to enable the open continuity tests. During continuity tests, press **Esc SHRT** to switch between resistance measurement, short continuity test (**⏏**), or open continuity test (**⏏**).

Parameter	Range	Default setting
oPn	oPn.d or oPn.E	oPn.d

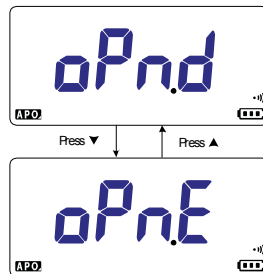

Figure 4-16 Enable open continuity test by default

Changing the temperature unit

This setting is used with temperature measurements (see [page 51](#)). Four combinations of displayed temperature unit(s) are available:

- Celsius only: Temperature measured in °C.
- Celsius/Fahrenheit: During temperature measurements, press **Range/Auto** to switch between °C and °F.

4 Multimeter Setup Options

Setup Menu Items

- Fahrenheit only: Temperature measured in °F.
- Fahrenheit/Celsius: During temperature measurements, press  to switch between °F and °C.

Use this Setup item to change the default temperature unit for temperature measurements.

Press and hold  for more than 1 second to enter this Setup item.

Parameter	Range	Default setting
°C	°C, °C°F, °F, or °F°C	°C

CAUTION

Always set the temperature unit display per the official requirements and in compliance with the national laws of your region.

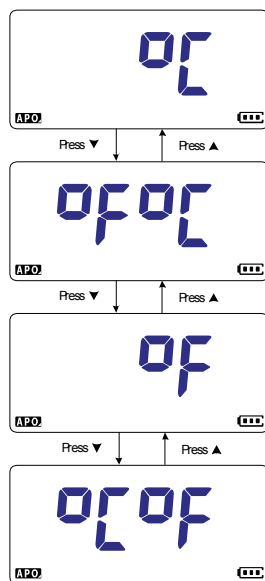
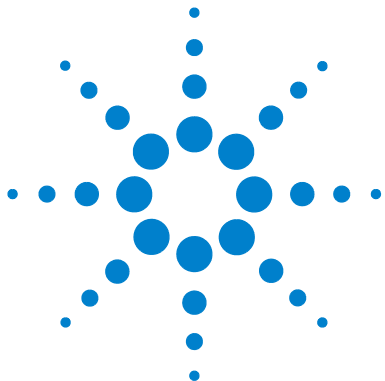

Figure 4-17 Changing the temperature unit



5 Characteristics and Specifications

Product Characteristics	102
Specification Assumptions	103
Measurement Category	104
Measurement category definition	104
Electrical Specifications	106
DC specifications	106
AC specifications	109
Capacitance specifications	110
Temperature specifications	111
Frequency specifications	112
Frequency sensitivity specifications	112
Scale transfer (mV)	113
Display update rate (approximate)	114

This chapter lists the characteristics, assumptions, and specifications of the U1231A, U1232A, and U1233A handheld digital multimeters.



Product Characteristics

NOTE

Product characteristics specified in the table below are applicable for both U1231A, U1232A, and U1233A models unless stated otherwise.

POWER SUPPLY

Battery type:

- 4 × 1.5 V AAA Alkaline battery (ANSI/NEDA 24A or IEC LR03), or
- 4 × 1.5 V AAA Zinc Chloride battery (ANSI/NEDA 24D or IEC R03)

Battery life:

- 500 hours typical (based on new Alkaline batteries (1000 mAH) for DC voltage measurement, with backlight and flashlight disabled)
- Low battery indicator will flash when the battery voltage drops below 4.4 V (approximately)

POWER CONSUMPTION

450 mVA maximum (with backlight and flashlight enabled)

FUSE

10 × 38 mm 11 A/1000 V fast-acting fuse

DISPLAY

Liquid crystal display (LCD) (with maximum reading of 6600 counts)

FLASHLIGHT

Cool white LED (5500 K typical); luminous intensity from 2240 mcd to 5600 mcd

OPERATING ENVIRONMENT

- Operating temperature from -10 °C to 55 °C, 0% to 80% RH
- Full accuracy up to 80% RH for temperatures up to 30 °C, decreasing linearly to 50% RH at 55 °C
- Altitude up to 2000 meters
- Pollution degree 2

STORAGE COMPLIANCE

-40 °C to 60 °C, 0% to 80% RH without batteries

SAFETY COMPLIANCE

- IEC 61010-1-2010/EN 61010-1:2010
 - USA: UL 61010-1 (3rd Edition)
 - Canada: CSA C22.2 No. 61010-1:2012
-

MEASUREMENT CATEGORY

CAT III 600 V

ELECTROMAGNETIC COMPATIBILITY (EMC)

Commercial limits compliance with EN61326-1

TEMPERATURE COEFFICIENT

0.1 × (specified accuracy) / °C (from –10 °C to 18 °C, or 28 °C to 55 °C)

COMMON MODE REJECTION RATIO (CMRR)

>100 dB at DC, 50/60 Hz (1 kΩ unbalanced)

NORMAL MODE REJECTION RATIO (NMRR)

>60 dB at 50/60 Hz

DIMENSIONS (W × H × D)

86 × 169 × 52 mm

WEIGHT

- U1232A and U1233A: 371 grams (with batteries and holster)
- U1231A: 365 grams (with batteries and holster)

WARRANTY

Please refer to http://www.agilent.com/go/warranty_terms

- Three years for product
- Three months for product's standard accessories, unless otherwise specified
- Please take note that for the product, the warranty does not cover:
 - Damage from contamination
 - Normal wear and tear of mechanical components
 - Manuals, fuses, and standard disposable batteries

CALIBRATION CYCLE

One year

Specification Assumptions

- Accuracy is given as \pm (% of reading + counts of least significant digit) at $23\text{ }^{\circ}\text{C} \pm 5\text{ }^{\circ}\text{C}$, with relative humidity less than 80% RH.
- AC V and AC A specifications are AC coupled, true rms and are valid from 5% of range to 100% of range.
- The crest factor may be up to 3.0 at full-scale (4000 counts)
- For non-sinusoidal waveforms, add (2% reading + 2% full scale) typical.
- After VZ_{LOW} (low input impedance) voltage measurements, wait at least 20 minutes for thermal impact to cool before proceeding with any other measurement.

WARNING

Exceeding the crest factor limit may result in an incorrect or a lower reading. Do not exceed the crest factor limit to avoid instrument damage and the risk of electric shock.

Measurement Category

The Agilent U1231A/U1232A/U1233A Handheld Digital Multimeters have a safety rating of CAT III, 600 V.

Measurement category definition

Measurement CAT I are for measurements performed on circuits not directly connected to the AC mains. Examples are measurements on circuits not derived from the AC mains and specially protected (internal) mains-derived circuits.

Measurement CAT II are measurements performed on circuits directly connected to a low-voltage installation. Examples are measurements on household appliances, portable tools, and similar equipment.

Measurement CAT III are measurements performed in building installations. Examples are measurements on distribution boards, circuit-breakers, wiring, including cables, bus-bars, junction boxes, switches, socket outlets in the fixed installation, and equipment for industrial use, and some other equipment including stationary motors with permanent connection to the fixed installation.

Measurement CAT IV are measurements performed at the source of low-voltage installations. Examples are electricity meters and measurements on primary over current protection devices and ripple control units.

Electrical Specifications

NOTE

Specification assumptions are given on [page 103](#).

DC specifications

Table 5-1 DC specifications

Function	Range	Resolution	Accuracy			Test current	Burden voltage	Input impedance
			U1231A	U1232A	U1233A			
Voltage	600 mV ^[1]	0.1 mV	0.5% + 2	0.5% + 2	0.5% + 2	-	-	11.18 MΩ
	6 V	0.001 V	0.5% + 2	0.5% + 2	0.5% + 2	-	-	11.18 MΩ
	60 V	0.01 V	0.5% + 2	0.5% + 2	0.5% + 2	-	-	10.1 MΩ
	600 V	0.1 V	0.5% + 2	0.5% + 2	0.5% + 2	-	-	10 MΩ
	600 V (VZ _{LOW}) ^[2]	0.1 V	2% + 3	2% + 3	2% + 3	-	-	3 kΩ

Notes for DC voltage specifications:

- 1 The accuracy of the 600 mV range is specified after the Null function is used to subtract the thermal effect (by shorting the test leads).
- 2 For VZ_{LOW} (low input impedance) measurements, autoranging is disabled and the multimeter's range is set to 600 V in the manual ranging mode.

Table 5-1 DC specifications (continued)

Function	Range	Resolution	Accuracy			Test current	Burden voltage	Input impedance
			U1231A	U1232A	U1233A			
Resistance	600 Ω ^[4]	0.1 Ω	0.9% + 3	0.9% + 3	0.9% + 3	0.57 mA	-	-
	6 kΩ ^[4]	0.001 kΩ	0.9% + 3	0.9% + 3	0.9% + 3	57 μA	-	-
	60 kΩ	0.01 kΩ	0.9% + 3	0.9% + 3	0.9% + 3	5.7 μA	-	-
	600 kΩ	0.1 kΩ	0.9% + 3	0.9% + 3	0.9% + 3	570 nA	-	-
	6 MΩ ^[5]	0.001 MΩ	0.9% + 3	0.9% + 3	0.9% + 3	100 nA //10 MΩ	-	-
	60 MΩ ^[5]	0.01 MΩ	1.5% + 3	1.5% + 3	1.5% + 3	100 nA //10 MΩ	-	-

Notes for resistance specifications:

- 1 Overload protection: 600 Vrms for short circuits with <0.3 A current.
- 2 Maximum open voltage is <+3 V
- 3 Built-in buzzer beeps when the resistance measured is less than 23 Ω ± 10 Ω. The multimeter can capture intermittent measurements longer than 1 ms.
- 4 The accuracy of the 600 Ω to 6 kΩ range is specified after the Null function is used to subtract the test lead resistance and thermal effect (by shorting the test leads).
- 5 For the ranges of 6 MΩ and 60 MΩ, the RH is specified for <60%.

Diode	2 V	0.001 V	0.9% + 2	0.9% + 2	0.9% + 2	0.57 mA	-	-
-------	-----	---------	----------	----------	----------	---------	---	---

Notes for diode specifications:

- 1 Overload protection: 600 Vrms for short circuits with <0.3 A current.
- 2 Built-in buzzer beeps continuously when the voltage measured is less than 50 mV and beeps once for forward-biased diode or semiconductor junctions measured between 0.3 V and 0.8 V (0.3 V ≤ reading ≤ 0.8 V).
- 3 Open voltage for diode: <+3 V DC
- 4 The maximum display for diode measurements is 2100 counts.

5 Characteristics and Specifications

Electrical Specifications

Table 5-1 DC specifications (continued)

Function	Range	Resolution	Accuracy			Test current	Burden voltage	Input impedance
			U1231A	U1232A	U1233A			
Current	60 μA ^[1]	0.01 μA	-	1.0% + 2	1.0% + 2	-	<2.5 V	-
	600 μA ^[1]	0.1 μA	-	1.0% + 2	1.0% + 2	-	<2.5 V	-
	6 A ^{[2][4]}	0.001 A	-	1.0% + 3	1.0% + 3	-	<0.2 V	-
	10 A ^{[2][3]}	0.01 A	-	1.0% + 3	1.0% + 3	-	<0.4 V	-

Notes for DC current specifications:

- 1 Overload protection for 60 μA to 600 μA range: 600 Vrms for short circuits with <0.3 A current.
- 2 Overload protection for 6 A to 10 A range: 11 A/1000 V; 10 \times 38 mm fast-acting fuse.
- 3 Specification for 10 A range: 10 A continuous. Add 0.3% to the specified accuracy when measuring signals >10 A to 20 A for 30 seconds maximum. After measuring currents >10 A, cool down the multimeter for twice the duration of the measured time before proceeding with low current measurements.
- 4 DC current range of 0.6 mA to 1 mA is not measureable on the U1232A and U1233A models.

AC specifications

Table 5-2 AC specifications

Function	Range	Resolution	Accuracy		Burden voltage
			45 Hz to 500 Hz	500 Hz to 1 kHz	(where applicable)
Voltage	600 mV	0.1 mV	1.0% + 3	2.0% + 3	-
	6 V	0.001 V	1.0% + 3	2.0% + 3	-
	60 V	0.01 V	1.0% + 3	2.0% + 3	-
	600 V	0.1 V	1.0% + 3	2.0% + 3	-
	600 V (V _{ZLOW}) ^[3]	0.1 V	2.0% + 3	4.0% + 3	-

Notes for true rms AC voltage specifications:

- 1 Overload protection: 600 Vrms. For millivolt measurements, 600 Vrms for short circuits with <0.3 A current.
- 2 Input impedance: 10 MΩ (nominal) in parallel with <100 pF.
- 3 V_{ZLOW} input impedance: 3 kΩ (nominal).

Current ^[1]	60 μA ^[2]	0.01 μA	1.5% + 3	-	<2.5 V
	600 μA ^[2]	0.1 μA	1.5% + 3	-	<2.5 V
	6 A ^{[3][5]}	0.001 A	1.5% + 3	-	<0.2 V
	10 A ^{[3][4]}	0.01 A	1.5% + 3	-	<0.4 V

Notes for AC current specifications:

- 1 AC current measurement not available for U1231A model.
- 2 Overload protection for 60 μA to 600 μA range: 600 Vrms for short circuits with <0.3 A current.
- 3 Overload protection for 6 A to 10 A range: 11 A/1000 V; 10 × 38 mm fast-acting fuse.
- 4 Specification for 10 A range: 10 A continuous. Add 0.3% to the specified accuracy when measuring signals >10 A to 20 A for 30 seconds maximum. After measuring currents >10 A, cool down the multimeter for twice the duration of the measured time before proceeding with low current measurements.
- 5 AC current range of 0.6 mA to 300 mA is not measurable on the U1232A and U1233A models.

5 Characteristics and Specifications

Electrical Specifications

Capacitance specifications

Table 5-3 Capacitance specifications

Range	Resolution	Accuracy			Measuring rate (at full scale)
		U1231A	U1232A	U1233A	
1000 nF	1 nF	1.9% + 2	1.9% + 2	1.9% + 2	4 times/second
10 μ F	0.01 μ F	1.9% + 2	1.9% + 2	1.9% + 2	
100 μ F	0.1 μ F	1.9% + 2	1.9% + 2	1.9% + 2	
1000 μ F	1 μ F	1.9% + 2	1.9% + 2	1.9% + 2	1 time/second
10 mF	0.01 mF	1.9% + 2	1.9% + 2	1.9% + 2	0.1 times/second

Notes for capacitance specifications:

- 1 Overload protection: 600 Vrms for short circuits with <0.3 A current.
- 2 The accuracy of for all ranges is specified based on a film capacitor or better, and after the Null function is used to subtract the residual values (by opening the test leads).
- 3 The maximum display is 1200 counts.

Temperature specifications

Table 5-4 Temperature specifications

Thermal type	Range	Resolution	Accuracy
			U1233A
K	–40 °C to 1372 °C	0.1 °C	1% + 1 °C
	–40 °F to 2502 °F	0.1 °F	1% + 1.8 °F

Notes for temperature specifications:

- 1 The specification above is specified after the multimeter has been left stationary in the same operating environment for 1 hour at least. If the unit is exposed during storage in a high humidity (condensing) environment, ensure that the multimeter has been in the same operating environment for 2 hours at least.
- 2 The accuracy does not include the tolerance of the thermocouple probe.
- 3 Do not allow the temperature sensor to contact a surface that is energized above 30 Vrms or 60 V DC. Such voltages poses a shock hazard.
- 4 Ensure that the ambient temperature is stable within ± 1 °C and that the Null function is used to reduce the test lead's thermal effect and temperature offset. Before using the Null function, set the multimeter to measure temperature without ambient compensation (**000**) and keep the thermocouple probe as close to the multimeter as possible (avoid contact with any surface that has a different temperature from the ambient temperature).
- 5 When measuring temperature with respect to any temperature calibrator, try to set both the calibrator and multimeter with an external reference (without internal ambient compensation). If both the calibrator and multimeter are set with internal reference (with internal ambient compensation), some deviations may show between the readings of the calibrator and multimeter, due to differences in ambient compensation between the calibrator and multimeter. Keeping the multimeter close to the output terminal of calibrator will help reduce the deviation.
- 6 The temperature calculation is specified according to the safety standards of EN/IEC-60548-1 and NIST175.

Frequency specifications

Table 5-5 Frequency specifications

Range	Resolution	Accuracy			Minimum input frequency
		U1231A	U1232A	U1233A	
99.99 Hz	0.01 Hz	0.1% + 2	0.1% + 2	0.1% + 2	5 Hz
999.9 Hz	0.1 Hz	0.1% + 2	0.1% + 2	0.1% + 2	
9.999 kHz	0.001 kHz	0.1% + 2	0.1% + 2	0.1% + 2	
99.99 kHz	0.01 kHz	0.1% + 2	0.1% + 2	0.1% + 2	

Notes for frequency specifications:

1 Overload protection: 600 V; input signal is $<20,000,000 \text{ V} \times \text{Hz}$ (product of voltage and frequency).

Frequency sensitivity specifications

For voltage measurements

Table 5-6 Frequency sensitivity and trigger level specifications for voltage measurements

Input range	Minimum sensitivity (rms sine wave)		
	5 Hz to 50 kHz		
Maximum input for specified accuracy ^[1]	U1231A	U1232A	U1233A
600 mV in Scale mode	50 mV	50 mV	50 mV
600 mV	120 mV	120 mV	120 mV
6 V	0.6 V	0.6 V	0.6 V
60 V	5.0 V	5.0 V	5.0 V
600 V	50 V	50 V	50 V

Notes for frequency sensitivity specifications for voltage measurements:

1 Maximum input for specified accuracy, refer to “AC specifications” on page 109.

For current measurements

Table 5-7 Frequency sensitivity and trigger level specifications for current measurements

Input range Maximum input for specified accuracy ^[1]	Minimum sensitivity (rms sine wave)	
	45 Hz to 5 kHz	
	U1232A	U1233A
60 μ A	30 μ A	30 μ A
600 μ A	30 μ A	30 μ A
6 A	0.5 A	0.5 A
10 A	0.5 A	0.5 A

Notes for frequency sensitivity specifications for current measurements:

1 Maximum input for specified accuracy, refer to “AC specifications” on page 109.

Scale transfer (mV)

Table 5-8 Scale transfer (mV) specifications

Range	Resolution	Accuracy		
		U1231A	U1232A	U1233A
DC 600 mV	0.1 mV	0.5% + 2 ^[2]	0.5% + 2 ^[2]	0.5% + 2 ^[2]
AC 600 mV	0.1 mV	1.0% + 3 @ 45 Hz to 500 Hz	1.0% + 3 @ 45 Hz to 500 Hz	1.0% + 3 @ 45 Hz to 500 Hz
		2.0% + 3 @ 500 Hz to 1 kHz	2.0% + 3 @ 500 Hz to 1 kHz	2.0% + 3 @ 500 Hz to 1 kHz

Notes for scale transfer (mV) specifications:

- 1 Overload protection: 600 Vrms for short circuits with <0.3 A current.
- 2 The accuracy of the DC 600 mV range is specified after the Null function is used to subtract the thermal effect (by shorting the test leads).
- 3 Input impedance: 10 M Ω (typical)

5 Characteristics and Specifications

Electrical Specifications

Display update rate (approximate)

Table 5-9 Display update rate (approximate)

Function	Times/second		
	U1231A	U1232A	U1233A
AC V (V or mV)	5	5	5
DC V (V or mV)	5	5	5
AC V/DC V (VZ _{LOW})	1	1	1
Scale transfer (mV)	5	5	5
Ω	5	5	5
Diode	5	5	5
Capacitance	4 (<100 μ F)	4 (<100 μ F)	4 (<100 μ F)
DC A (μ A, mA, or A)	-	5	5
AC A (μ A, mA, or A)	-	5	5
Frequency	1 (>10 Hz)	1 (>10 Hz)	1 (>10 Hz)

www.agilent.com

Contact us

To obtain service, warranty, or technical assistance, contact us at the following phone or fax numbers:

United States:

(tel) 800 829 4444 (fax) 800 829 4433

Canada:

(tel) 877 894 4414 (fax) 800 746 4866

China:

(tel) 800 810 0189 (fax) 800 820 2816

Europe:

(tel) 31 20 547 2111

Japan:

(tel) (81) 426 56 7832 (fax) (81) 426 56 7840

Korea:

(tel) (080) 769 0800 (fax) (080) 769 0900

Latin America:

(tel) (305) 269 7500

Taiwan:

(tel) 0800 047 866 (fax) 0800 286 331

Other Asia Pacific Countries:

(tel) (65) 6375 8100 (fax) (65) 6755 0042

Or visit the Agilent World Wide Web at:

www.agilent.com/find/assist

Product specifications and descriptions in this document are subject to change without notice. Always refer to the English version on the Agilent Web site for the latest revision.

© Agilent Technologies, Inc. 2011–2014

Ninth Edition, June 20, 2014
U1231-90026



Agilent Technologies