

Agilent U2701A/U2702A USB Modular Oscilloscopes

User's Guide



Agilent Technologies

Notices

© Agilent Technologies, Inc. 2009–2013

No part of this manual may be reproduced in any form or by any means (including electronic storage and retrieval or translation into a foreign language) without prior agreement and written consent from Agilent Technologies, Inc. as governed by United States and international copyright laws.

Manual Part Number

U2702-90013

Edition

Eighth Edition, July 26, 2013

Printed in Malaysia

Agilent Technologies, Inc.
5301 Stevens Creek Blvd.
Santa Clara, CA 95051 USA

Trademark Acknowledgements

Pentium is a U.S. registered trademark of Intel Corporation.

Microsoft, Visual Studio, Windows, and MS Windows are trademarks of Microsoft Corporation in the United States and/or other countries.

Warranty

The material contained in this document is provided “as is,” and is subject to being changed, without notice, in future editions. Further, to the maximum extent permitted by applicable law, Agilent disclaims all warranties, either express or implied, with regard to this manual and any information contained herein, including but not limited to the implied warranties of merchantability and fitness for a particular purpose. Agilent shall not be liable for errors or for incidental or consequential damages in connection with the furnishing, use, or performance of this document or of any information contained herein. Should Agilent and the user have a separate written agreement with warranty terms covering the material in this document that conflict with these terms, the warranty terms in the separate agreement shall control.

Technology Licenses

The hardware and/or software described in this document are furnished under a license and may be used or copied only in accordance with the terms of such license.

Restricted Rights Legend

U.S. Government Restricted Rights. Software and technical data rights granted to the federal government include only those rights customarily provided to end user customers. Agilent provides this customary commercial license in Software and technical data pursuant to FAR 12.211 (Technical Data) and 12.212 (Computer Software) and, for the Department of Defense, DFARS 252.227-7015 (Technical Data - Commercial Items) and DFARS 227.7202-3 (Rights in Commercial Computer Software or Computer Software Documentation).

Safety Notices

CAUTION

















A **CAUTION** notice denotes a hazard. It calls attention to an operating procedure, practice, or the like that, if not correctly performed or adhered to, could result in damage to the product or loss of important data. Do not proceed beyond a **CAUTION** notice until the indicated conditions are fully understood and met.

WARNING

A **WARNING** notice denotes a hazard. It calls attention to an operating procedure, practice, or the like that, if not correctly performed or adhered to, could result in personal injury or death. Do not proceed beyond a **WARNING** notice until the indicated conditions are fully understood and met.

Safety Symbols

The following symbols on the instrument and in the documentation indicate precautions which must be taken to maintain safe operation of the instrument.

	Direct current (DC)		Off (supply)
	Alternating current (AC)		On (supply)
	Both direct and alternating current		Caution, risk of electric shock.
	Three-phase alternating current		Caution, risk of danger (refer to this manual for specific Warning or Caution information).
	Earth (ground) terminal		Caution, hot surface.
	Protective conductor terminal		Out position of a bi-stable push control.
	Frame or chassis terminal		In position of a bi-stable push control.
	Equipotentiality	CAT I	Category I Overvoltage Protection
	Equipment protected throughout by double insulation or reinforced insulation.		

General Safety Information

The following general safety precautions must be observed during all phases of operation, service and repair of this instrument. Failure to comply with these precautions or with specific warnings elsewhere in this manual violates safety standards of design, manufacturer and intended use of the instrument. Agilent Technologies assumes no liability for the customer's failure to comply with these requirements.

WARNING

- **Observe all markings on the equipment before connecting any wiring to the equipment.**
- **This equipment is under CAT1 measurement category, do not connect the test probe to MAIN.**



CAT1:

Maximum Working Voltage: 30 Vrms or 42 Vpeak or 60 Vdc

- **Do not measure more than rated voltage (as marked on the equipment).**
 - **Inspect the test probe for damaged insulation or expose metal and check for continuity. Do not use test probe if found damaged.**
 - **Do not operate the equipment in an explosive atmosphere or in the presence of flammable gases or fumes.**
 - **Do not use the equipment if it does not operate properly. Have the equipment inspected by qualified service personal. If necessary, return the equipment to Agilent for service and repair to ensure that safety features are maintained.**
-

CAUTION

- Always disconnect the probes from the measuring circuit before disconnecting the adapter.
 - Use the device with the cables provided.
 - Repair or service that is not covered in this manual should only be performed by qualified personnels.
 - Applying excessive voltage or overloading the device will cause irreversible damage to the circuitry.
-

Environment Conditions

This instrument is designed for indoor use only. Table 1 shows general environmental requirements for this instrument.

Table 1 Environment Requirements





Environmental Conditions	Requirements
Operating Temperature	0 °C to 50 °C
Storage Temperature	-20 °C to 70 °C
Operating Humidity	20 to 85% RH (non-condensing)
Storage Humidity	5 to 90% RH (non-condensing)

CAUTION

The Agilent U2701A/U2702A are safety-certified in compliance with the following safety and EMC requirements:

- IEC 61010-1: 2001/EN 61010-1: 2001 (2nd edition)
- CAN/CSA-C22.2 No. 61010-1-04
- IEC 61326-2002/EN 61326: 1997+A1: 1998+A2: 2001+A3: 2003
- ICES-001: 2004
- AS/NZS CISPR11: 2004
- USA: ANSI/UL 61010-1:2004

Regulatory Markings

	<p>The CE mark is a registered trademark of the European Community. This CE mark shows that the product complies with all the relevant European Legal Directives.</p>		<p>The C-tick mark is a registered trademark of the Spectrum Management Agency of Australia. This signifies compliance with the Australia EMC Framework regulations under the terms of the Radio Communication Act of 1992.</p>
<p>ICES/NMB-001</p>	<p>ICES/NMB-001 indicates that this ISM device complies with Canadian ICES-001.</p> <p>Cet appareil ISM est conforme à la norme NMB-001 du Canada.</p>		<p>This instrument complies with the WEEE Directive (2002/96/EC) marking requirement. This affixed product label indicates that you must not discard this electrical/electronic product in domestic household waste.</p>
	<p>The CSA mark is a registered trademark of the Canadian Standards Association.</p>		

Waste Electrical and Electronic Equipment (WEEE) Directive 2002/96/EC

This instrument complies with the WEEE Directive (2002/96/EC) marking requirement. This affixed product label indicates that you must not discard this electrical/electronic product in domestic household waste.

Product Category:

With reference to the equipment types in the WEEE directive Annex 1, this instrument is classified as a "Monitoring and Control Instrument" product. The affixed product label is shown as below:

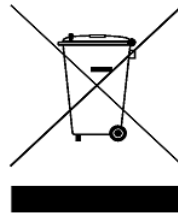

Do not dispose in domestic household waste

To return this unwanted instrument, contact your nearest Agilent office, or visit:

www.agilent.com/environment/product

for more information.

Declaration of Conformity (DoC)

The Declaration of Conformity (DoC) for this instrument is available on the Agilent website. You can search the DoC by its product model or description at the web address below.

<http://regulations.corporate.agilent.com/DoC/search.htm>

NOTE

If you are unable to search for the respective DoC, please contact your local Agilent representative.

Contents

1	Getting Started	
	Introduction	2
	Product Overview	4
	Product Dimension	5
	Package Contents Checklist	6
	Installations and Configurations	7
	L-Mount Kit Installation	8
	Modular Products Chassis	10
2	Scope Features and Functions	
	Analog Controls	14
	Vertical Controls	14
	Horizontal Controls	21
	Trigger Controls	25
	Trigger Modes	26
	Trigger Source	26
	Trigger Settings	27
	Trigger Options	33
	Measurements and Cursors Controls	34
	Markers	35
	Cursors	35
	Measurements Controls	39
	FFT & Math Controls	45
	Fast Fourier Transform Function	46
	FFT Settings	47
	Math Function	52
	Options Controls	55

Acquisition Mode	56
Display Options	57
AutoScale and Run/Stop buttons	60
Pan and Zoom	61
3 Characteristics and Specifications	
Specifications	66
Characteristics	67
Product Characteristics and General Specifications	71
Normal mode	73
Measurement Category Definition	77

List of Figures

- Figure 1-1 55-pin backplane connector pin configuration 10
- Figure 2-1 Soft front panel vertical system controls 14
- Figure 2-2 The waveform before inversion 17
- Figure 2-3 The waveform after inversion 18
- Figure 2-4 Soft front panel horizontal system controls 21
- Figure 2-5 Soft front panel of the Trigger Controls 25
- Figure 2-6 Soft front panel of the Measurements & Cursors Controls 34
- Figure 2-7 Auto marker automatically marks the maximum value of the waveform when Maximum measurement is selected 37
- Figure 2-8 Automatic measurements on the Measurements & Cursors panel 39
- Figure 2-9 Measurements panel and Measurements Results panel 44
- Figure 2-10 Soft front panel of the FFT & Math controls. 45
- Figure 2-11 FFT controls 46
- Figure 2-12 Waveform obtained with Hanning window selected 49
- Figure 2-13 First Peak 51
- Figure 2-14 Next Peak 51
- Figure 2-15 Acquired waveform using Subtract function 54
- Figure 2-16 Soft front panel of the Options Controls 55
- Figure 2-17 The waveform before interpolation 58
- Figure 2-18 The waveform after interpolation 58
- Figure 2-19 Zoom reference panel 62
- Figure 2-20 Zoom In 62
- Figure 2-21 Zoom Out 63
- Figure 2-22 Panning a waveform 64

Figures

THIS PAGE HAS BEEN INTENTIONALLY LEFT BLANK.

List of Tables

Table 1-1	Descriptions of the User Interface	12
Table 2-1	Probe attenuation factors and its corresponding settings.	19
Table 2-2	Edge Trigger menu	27
Table 2-3	Pulse Width Trigger menu	29
Table 2-4	TV Trigger Menu	30
Table 2-5	Line (or count for Generic) numbers per field for each non-HDTV/EDTV video standard	32
Table 2-6	List of Time Measurements and Voltage Measurements	40
Table 2-7	List of Time Measurements and Voltage Measurements for FFT	42
Table 2-8	Comparison between the four FFT windows	47
Table 2-9	List of Acquisition Modes	56

THIS PAGE HAS BEEN INTENTIONALLY LEFT BLANK.



1 Getting Started

Introduction	2
Product Overview	4
Product Dimension	5
Package Contents Checklist	6
Installations and Configurations	7
L-Mount Kit Installation	8
Modular Products Chassis	10

Chapter 1 provides an overview of the U2701A and U2702A USB modular oscilloscopes, the product outlook, and product dimensions. This chapter also includes information on checklist, system requirements, and installation of hardware.



Introduction

The Agilent U2701A/U2702A USB modular oscilloscopes are PC-based, dual play, low cost and mobile digital troubleshooting tools for bench and field site work. These two channels, 8-bit oscilloscopes come in 100 MHz and 200 MHz models respectively. The dual play functionality allows user to use the oscilloscope as standalone or modular unit that enhanced the applications flexibility. The product is a great personal troubleshooting tool that allows R&D personnel, manufacturing personnel and field engineers to analyze and troubleshoot analog or digital circuit designs flawlessly.

The U2701A/U2702A also feature a large memory up to 32 Mpts and high sampling rate up to 500 M/S/ch. This two features allowing a longer capture time, as well as enabling more signals to be captured and analyzed in-depth. The U2701A/U2702A are equipped with USB 2.0 high speed interface for easy setup and hot swappable connectivity. On the other hand, the soft front panel offers a simple interface for quick setup, configuration and measurement controls.

The U2701A/U2702A are compatible with a wide range of Application Development Environment (ADE), such as Agilent VEE, Agilent T&M Toolkit, TM Toolkits Patch, Microsoft Visual Studio, C/C++, .Net, Visual Basic 6.0, and Labview . This will minimizes the time required by the developers as they can directly program their work using IVI drivers.

Warm-up Procedures

Before performing any measurements, ensure that oscilloscope has gone through the following warm-up procedures,

- 1 Connect the oscilloscope to the PC using a USB cable.
- 2 Power-up the oscilloscope.
- 3 Run the Agilent Measurement Manager.
- 4 Toggle channel 1 or channel 2 on.
- 5 Click on the Run button.

Test Considerations

For optimum performance, all procedures should comply with the following recommendations,

- Ensure that the ambient temperature is stable.
- Ensure that the ambient relative humidity is less than 80%.
- Allow a 30 minutes warm-up period before calibration.
- Keep all the test connection cables as short as possible.

NOTE



Under standalone use, users are only allowed to measure up to CAT1 30 Vrms maximum.

For high voltage measurement up to CAT1 300 Vrms, users must install the L-mount kit on the U2701A/U2702A. Before plugging into the instrument chassis, ensure that the L-Mount kit installed on your modular oscilloscope is screwed to the instrument chassis for chassis grounding purpose (see [L-Mount Kit Installation](#)). It is required to use the provided 10:1 probes (N2862A/N2863A) for high voltage measurements.

Product Overview

Product Outlook

Top View

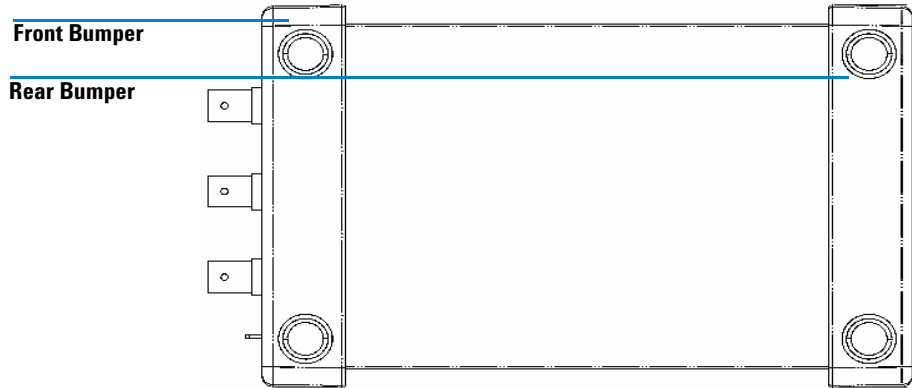

Front View

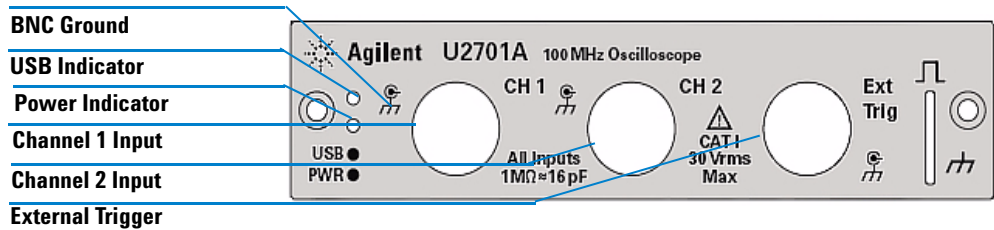

Rear View

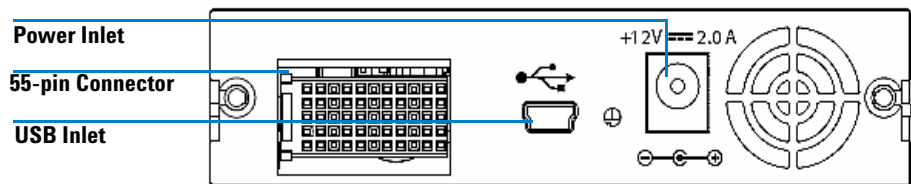

Product Dimension

With Front and Rear Bumper
Top View

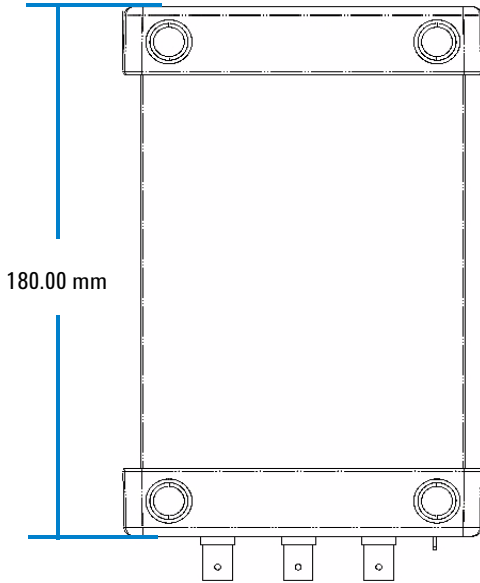

Without Front and Rear Bumper
Top View

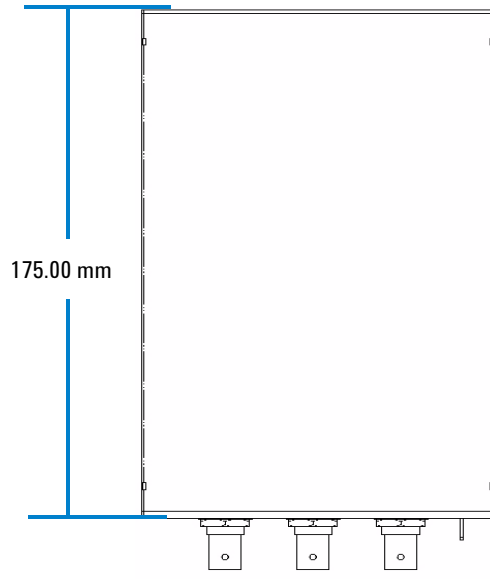

Front View

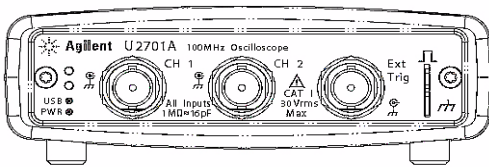

Front View

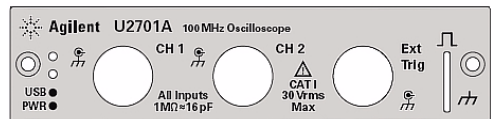

Rear View

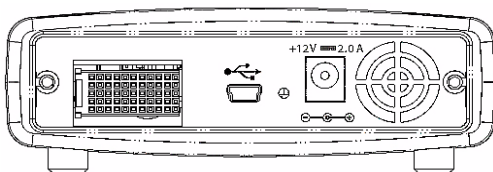

Rear View

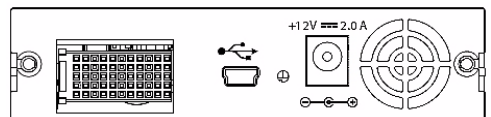

Package Contents Checklist

Inspect and verify the following standard shipped items of the U2701A/U2702A USB modular oscilloscope. If there are missing items, contact the nearest Agilent Sales Office.

- ✓ 24 W AC/DC Power Adapter
- ✓ Power Cord
- ✓ USB Standard A to Mini-B Interface Cable
- ✓ 2 x 10:1 Passive Probe 150 MHz 1.2m (only applicable for U2701A), N2862A
- ✓ 2 x 10:1 Passive Probe 300 MHz 1.2m (only applicable for U2702A), N2863A
- ✓ L-Mount Kit (used with modular instrument chassis)
- ✓ Agilent Automation-Ready CD-ROM (contains the Agilent IO Libraries Suite)
- ✓ Agilent USB Modular Products and Systems Quick Start Guide
- ✓ Agilent USB Modular Products and Systems Product Reference DVD-ROM
- ✓ Agilent USB Modular Products Quick Reference Card
- ✓ Certificate of Calibration

Installations and Configurations

If you are using the U2701A/U2702A USB modular oscilloscopes with the Agilent Measurement Manager, follow the step-by-step instructions as shown in the *Agilent USB Modular Products and Systems Quick Start Guide*.

NOTE

- If you do not wish to specifically use the U2701A/U2702A USB modular oscilloscopes with the Agilent Measurement Manager, and use the modular oscilloscope with Agilent VEE, Labview or Microsoft Visual Studio only, you can skip steps E and H in the following flowchart.
 - You need to install the IVI-COM driver if you are going to use the modular product with Agilent VEE Pro, LabVIEW, or Microsoft® Visual Studio®.
-

L-Mount Kit Installation

The L-Mount kit is to be installed on your U2701A/U2702A USB modular oscilloscopes. The following instructions describe the simple procedure of installing the L-Mount kit and your modular oscilloscopes into the chassis.



- 1 Unpack the L-Mount kit from the packaging.

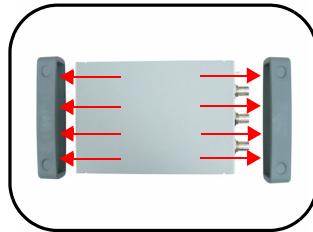

- 2 Remove both the rubber bumpers from the modular oscilloscope.

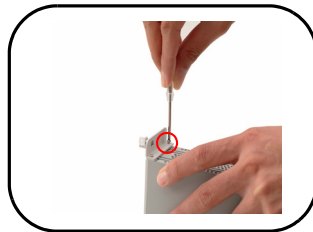

- 3 Using the *Philip* screw driver, screw the L-Mount kit to your USB modular oscilloscope.

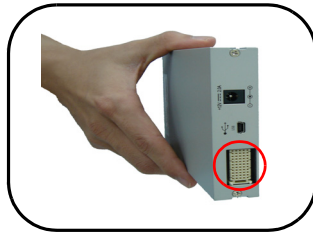

- 4** To slot in the modular oscilloscope to your chassis, turn your USB oscilloscope model perpendicularly and ensure that the 55-pin back pane connector is at the bottom side of the modular oscilloscope.



- 5** Your modular oscilloscope is ready to be plug into an instrument chassis. Using the *Philip* screw driver, screw the L-Mount kit installed on your modular oscilloscope to the instrument chassis (for protective grounding purpose).

Modular Products Chassis

55-Pin Backplane Connector Pin Configuration

The 55-pin backplane connector is used when your module is slotted into the U2781A USB modular instrument chassis. For more details, refer to the *Agilent U2781A USB Modular Instrument Chassis User's Guide*.

GND	GND	GND	GND	GND	GND	GND	GND	GND	GND	GND	F
NC	NC	NC	NC	NC	NC	NC	NC	VBUS	GND	USB_D-	E
GND	TRIG3	GND	TRIG2	GND	TRIG1	GND	TRIG0	GND	GND	USB_D+	D
TRIG4	GND	TRIG5	GND	TRIG6	GND	TRIG7	GND	+12 V	+12 V	GND	C
nBPUB	CLK10M	GND	STAR_TRIG	GA2	GA1	GA0	NC	+12 V	+12 V	+12 V	B
NC	NC	NC	NC	NC	NC	NC	NC	+12 V	+12 V	+12 V	A
11	10	9	8	7	6	5	4	3	2	1	

Figure 1-1 55-pin backplane connector pin configuration

SSI timing signal	Functionality
GND	Ground
NC	Not connected
VBUS	USB bus power sensing input
USB_D+, USB_D-	USB differential pair
TRIG0~TRIG7	Trigger bus
+12 V	+12 V power with 4 A current
nBPUB	USB backplane input detect
CLK10M	10 MHz clock source
STAR_TRIG	Star trigger
GA0,GA1,GA2	Geographical address pin

Soft Front Panel and User Interface Descriptions

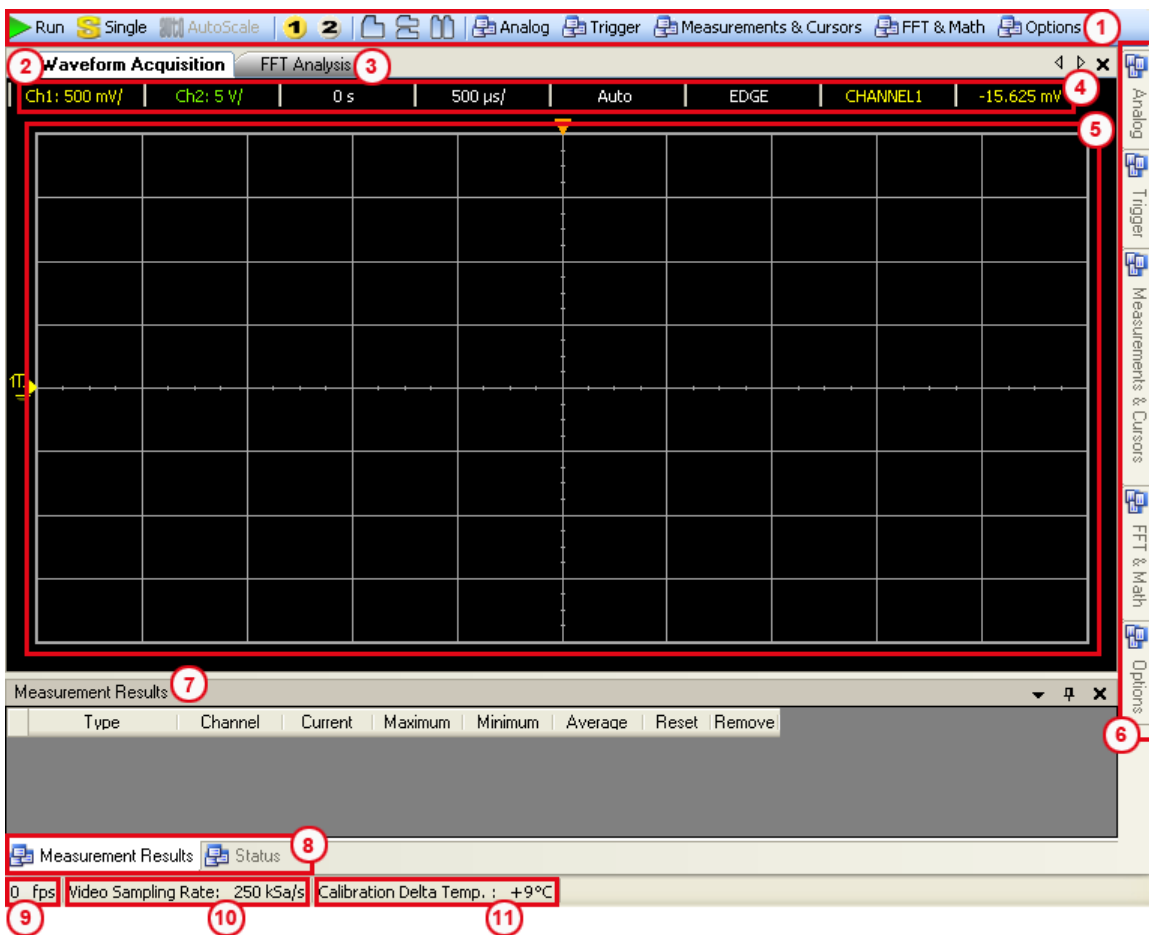

1 Getting Started

Table 1-1 Descriptions of the User Interface

No.	Panel	Description
1	Oscilloscope Toolbar	Consists of oscilloscope tools
2	Waveform Acquisition Tab	Displays time domain waveform for the oscilloscope
3	FFT Analysis Tab	Displays the FFT spectrum of the signal
4	Configuration Summary	Displays the configured functions and settings
5	Waveform graph display	Displays the output of the data acquired
6	Scope control tabs	Consists of all the sub functions of the oscilloscope
7	Measurement Results panel	Displays the measurement results of the scope operations
8	Status tab	Displays the status panel, which shows the history of operations
9	Refresh rate	Displays the graph update rate in frame/sec.
10	Video Sampling Rate	Displays video sampling rate (in number of samples per second taken from a continuous signal)
11	Calibration Delta Temp. indicator	Displays the calibration delta temperature of the connected device



2 Scope Features and Functions

Analog Controls	14
Trigger Controls	25
Measurements and Cursors Controls	34
FFT & Math Controls	45
Options Controls	55
AutoScale and Run/Stop buttons	60
Pan and Zoom	61



Analog Controls

The analog controls panel consists of vertical control and horizontal control, which are used to set the waveform of the graph display.

Vertical Controls

Vertical control is used to change the vertical scale and position of the waveform. This section of the manual describes the vertical controls provided in the user interface.

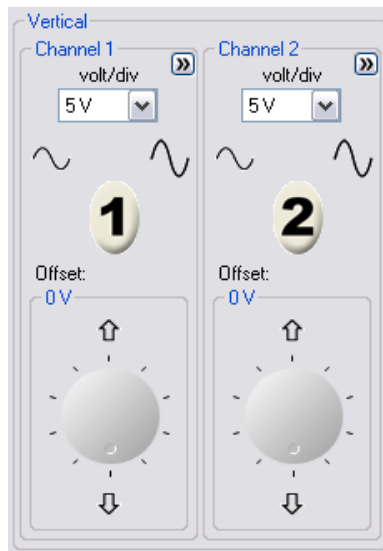



Figure 2-1 Soft front panel vertical system controls





Channel Selection for Waveform Display

To display waveform from channel 1, click on  or press F5.

To display waveform from channel 2, click on  or press F6.

Toggle Channel On/Off

Click on the channel buttons on the vertical control panel or on the toolbar to toggle the channel on or off.

- To toggle channel on, click on  or  (these images are in off mode).
- To toggle channel off, click on  or  (these images are in on mode).

Channel Options

Channel options provide four types of adjustment to the channel's waveform:

- AC Coupling
- Invert
- BW Limit and
- Attenuation (1X, 10X, 100X)

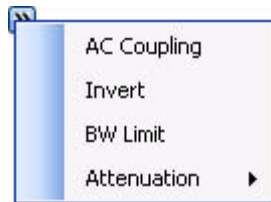

Channel Coupling Control

The AC coupling control is used to remove any DC offset voltage on a waveform. By setting the coupling control to **AC**, the DC offset voltage is removed from the input waveform.

To remove any DC offset voltage from channel 1, click on the **1** button on the soft front panel. Click on the **Channel Options**  button and select **AC Coupling** from the options list.

NOTE

When AC coupling is not selected, the oscilloscope is always set to DC coupling mode by default.

Invert Control

The invert control inverts the displayed waveform with respect to the ground level. When the oscilloscope is triggered on the inverted waveform, the trigger is also inverted as well.

Click on the Stop button to stop the signal acquisition. To invert the waveform on channel 1, click on the **1** button on the soft front panel. Click on the **»»** channel options button and select **Invert** from the options list.

Figure 2-2 and Figure 2-3 show the changes before and after conversion.

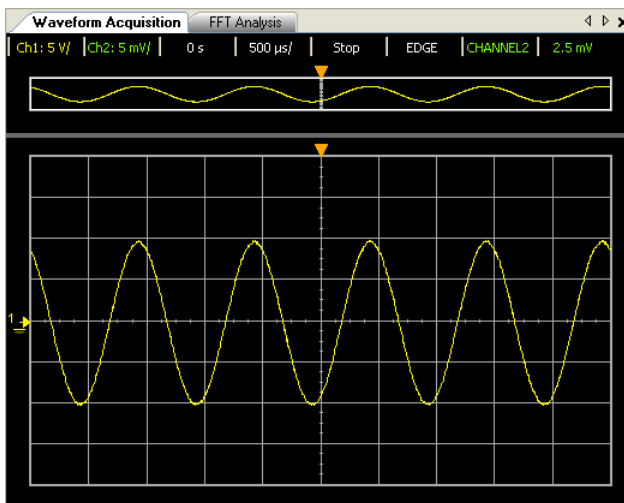

Figure 2-2 The waveform before inversion

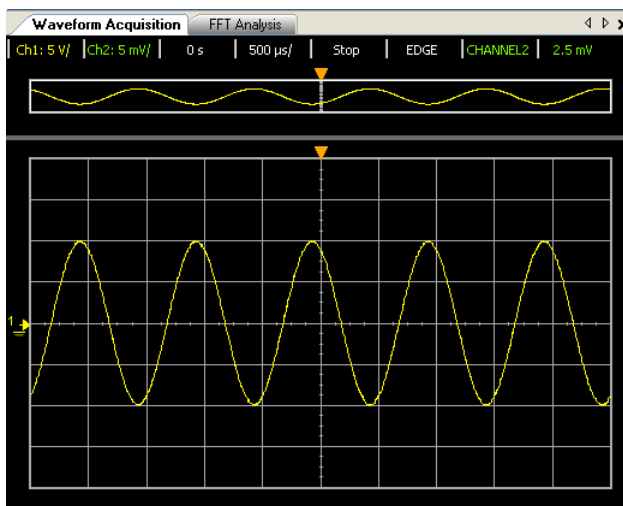

Figure 2-3 The waveform after inversion

Bandwidth Limit Control

The bandwidth limit control can be used to removed high frequency components on a waveform that are not important to the analysis of the waveform.

To remove high frequency components from the waveform on channel 1, click on the **1** button on the soft front panel. Click on the **Channel Options** **»»** button and select **BW Limit** from the options list. The LowPass cutoff is at 25 MHz.

NOTE

When the BW limit control is not selected, the oscilloscope is set to full bandwidth.

Probe Attenuation Control

The probe attenuation control changes the attenuation factor for the probe. The attenuation factor changes the vertical scaling of the oscilloscope so that the measurement results will reflect the actual voltage levels at the probe tip.



To change the probe attenuation factor for channel 1, click on the  button on the soft front panel. Click on the  channel options button and select **Attenuation** from the options list. An option list containing the attenuation factors in 1X, 10X, 100X will appear, select the desired factor.

Table 2-1 Probe attenuation factors and its corresponding settings.

Probe attenuation factors and corresponding settings	
1:1	1X
10:1	10X
100:1	100X

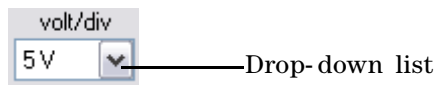

Volt/Div Control

The Volt/Div control sets the sensitivity of the channel. You can select the channel sensitivity from the drop-down list.





You can also use the following buttons or shortcut keys to set the sensitivity of the channel.

Channel 1

- Click on the  or press **Ctrl+Minus** to increase the sensitivity of the channel.
- Click on the  or press **Ctrl+Plus** to decrease the sensitivity of the channel.

Channel 2

- Click on the  or press **Alt+Minus** to increase the sensitivity of the channel.
- Click on the  or press **Alt+Plus** to decrease the sensitivity of the channel.

Offset

Offset is used to configure the position of the ground relative to the center of the display.

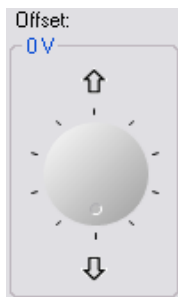

Horizontal Controls

The oscilloscope shows the time per division in the scale readout. As all waveforms use the same time base, the oscilloscope only displays one value for all channels, except for when Delayed Sweep is being used.

Horizontal controls allows you to adjust the horizontal scale and position of waveforms. The horizontal center of the screen is the time reference for waveforms. Changing the horizontal scale causes the waveform to expand or contract around the screen center.

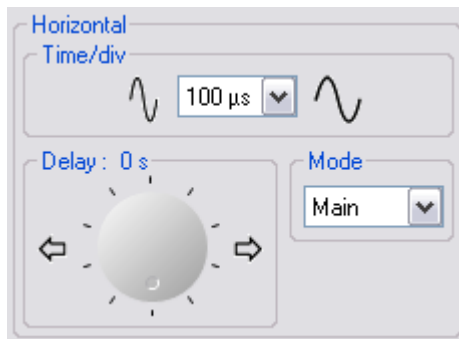
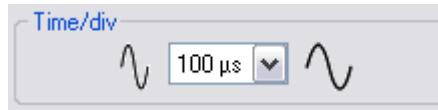

Figure 2-4 Soft front panel horizontal system controls



Horizontal control provides functions of time base, delay, and mode for the horizontal scale adjustment.

Time Base

Time base allows you to control how often the values are digitized.



To control the horizontal sweep speed,

- Click on  or press **Ctrl+[** to increase sweep speed.
- Click on  or press **Ctrl+]** to decrease sweep speed.
- Select the time base from the drop-down list provided to adjust the horizontal sweep speed.

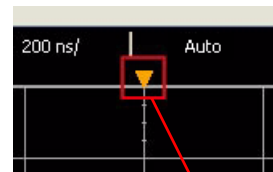

Delay

Delay setting allows you to set the specific location of the trigger event with respect to the time reference position. When the delay time knob is turned, the trigger point will move to left or right of the waveform graph display.



Trigger point

To adjust the delay time,

- Click on  or press **Ctrl+Left** to increase the delay time.
- Click on  or press **Ctrl+Right** to decrease the delay time.

Horizontal Mode Functions

The oscilloscope offers three types of horizontal mode functions— Main mode, Roll mode, and XY mode.



Main Mode

Main mode displays the normal viewing mode for the waveform graph display.

NOTE

The oscilloscope is always set to Main mode by default.



Roll Mode

Roll mode causes the waveforms to move slowly across the oscilloscope's display from right to left. It allows dynamic changes (like adjusting a potentiometer) on a low frequency waveforms to be seen by the user. When the oscilloscope is in Roll mode, the waveforms are not triggered and run continuously. Measurements can be made while in roll mode.

The Roll mode only operates on time base of 500 ms/div and slower. If the current time base setting is faster than the 500 ms/div limit, it will be set to 500 ms/div when the Roll mode is entered.

Use Roll mode on low-frequency waveforms to yield a display much like a strip chart recorder. It allows the waveform to roll across the display.

To enter Roll mode on channel 1,

- 1 Click on the  button on the soft front panel. Click on the  at the left of the Mode option. Select Roll from the drop-down list.
- 2 To pause and display in Roll mode, click on the  button.

NOTE

In Roll mode, triggering and averaging functions are disabled.

XY Mode

In XY mode, voltage levels of two waveforms are compared point by point. The display is changed from a volts-versus-time display to a volts-versus-volts display. The time base is turned off. This mode only applies to channels 1 and 2. Channel 1 amplitude is plotted on the X-axis and channel 2 amplitude is plotted on the Y-axis. The cursors can be used to make measurements on XY mode waveforms.

To use the XY horizontal mode

- 1 Connect a sine wave signal to channel 1, and a sine wave signal of the same frequency but out of phase to channel 2.
- 2 Center the signal on the display using the channel 1 and 2 Offset knobs. To expand the signal for convenient viewing, use the channel 1 and 2 volts/div drop-down list.

NOTE

In XY mode, the time base, delay and triggering functions are disabled. The Normal trigger mode is enabled.

Trigger Controls

The trigger determines when the oscilloscope starts to obtain data and display a waveform. When the trigger is set up correctly, it can convert unstable displays or blank screens into meaningful waveforms. The oscilloscope acquires data while waiting for the trigger condition to occur. After it detects a trigger, the oscilloscope continues to obtain enough data so it can draw the waveform on the display.

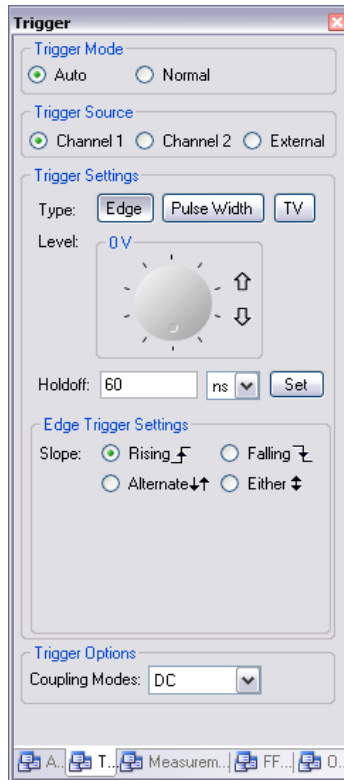
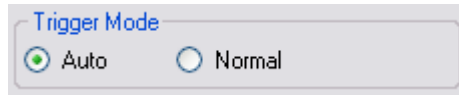

Figure 2-5 Soft front panel of the Trigger Controls

Trigger Modes

The oscilloscope provides two trigger modes: Auto Trigger Mode and Normal Trigger Mode.



Auto Trigger Mode

In Auto trigger mode, the oscilloscope automatically triggers and captures waveforms when you click on the Run button.

In many cases, a triggered display is not needed to check signal levels or activity. For these applications, use Auto trigger mode (which is the default setting). Since there are no edges on which to trigger, Auto trigger mode is used to display a DC signal.

Normal Trigger Mode

If you only want to acquire specific events as specified by the trigger settings, use **Normal** trigger mode. If you click on the Run button when the oscilloscope is in Normal trigger mode, a trigger must be detected before an acquisition can be completed.

Trigger Source

There are three types of trigger source: Channel 1, Channel 2 and External. The external trigger source can be used as a source in several trigger types. The trigger source will be the analog channel available on your oscilloscope.

Trigger Settings

The oscilloscope provides three trigger modes: edge, pulse, and TV. Pulse width trigger is used to find pulses with certain pulse widths. TV is used to trigger on fields or lines for standard video waveforms.

Edge Trigger

Edge trigger can be used with analog and digital circuits. An edge trigger occurs when the trigger input passes through a specified voltage level with the specified slope.



Table 2-2 Edge Trigger menu

Edge Trigger Panel Controls		
Menu	Settings	Comments
Trigger Mode	Auto	Able to acquire waveform even when no trigger occurs
	Normal	Acquires waveform only when trigger occurs
Source	Channel 1	Sets Channel 1 as the trigger source
	Channel 2	Sets Channel 2 as the trigger source
	External	Sets External as the trigger source
Settings	Level	Sets the voltage point on the waveform where trigger occurs
	Holdoff	Sets the waiting period before starting a new trigger
Trigger Settings	Rising	Trigger on rising edge
	Falling	Trigger on falling edge
	Alternate	Trigger on alternate edge
	Either	Trigger on either edge
Coupling	DC	Sets the input coupling to DC
	AC	Sets the input coupling to AC

Table 2-2 Edge Trigger menu

Edge Trigger Panel Controls		
Coupling	LF-Reject	Sets the input coupling to low frequency reject
	HF-Reject	Sets the input coupling to high frequency reject

To configure edge triggering

- 1 Select the desired trigger source on the trigger source panel.
- 2 On the Trigger Settings panel, click on the Edge button.
- 3 Select the trigger level by adjusting the knob or by clicking on  or .
- 4 Enter the desired holdoff time and unit, then click on Set to proceed.

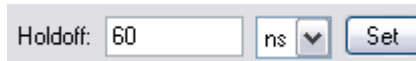

- 5 Select the desired slope on the Edge Trigger Settings panel.





NOTE

- To trigger both edges of a clock, use *Alternating* edge mode.
- To trigger on any activity of a selected source, use *Either* edge mode.

Pulse Width Trigger



A pulse trigger occurs when a pulse is found in a waveform that matches the pulse definition.

Table 2-3 Pulse Width Trigger menu

Pulse Width Trigger Panel Controls		
Menu	Settings	Comments
Trigger Mode	Auto	Able to acquire waveform even when no trigger occurs
	Normal	Acquires waveform only when trigger occurs
Source	Channel 1	Sets Channel 1 as the trigger source
	Channel 2	Sets Channel 2 as the trigger source
	External	Sets External as the trigger source
Settings	Level	Sets the voltage point on the waveform where trigger occurs
	Holdoff	Sets the waiting period before starting a new trigger
Polarity	Positive 	Trigger on the positive pulse
	Negative 	Trigger on the negative pulse
Mode	> Greater than	Pulse width greater than pulse width setting
	< Less than	Pulse width less than pulse width setting
	>< In range of	Pulse width within the pulse width setting range
	<> Out of range	Pulse width out of the pulse width setting range

To configure pulse width triggering

- 1 Select the desired trigger source on the Trigger Source panel.
- 2 On the Trigger Settings panel, click on the Pulse Width button.

- 3 Select the trigger level by adjusting the knob or by clicking on  or .
- 4 Select the desired polarity on the Pulse Width Trigger Settings panel.

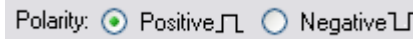

- 5 Select the preferred time qualifier by selecting the range from the Mode drop-down list.
- 6 Enter the desired range value and unit then click on Set.

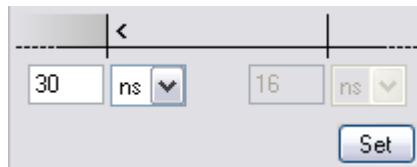

TV Trigger

TV triggering is used to trigger on fields or lines of NTSC, PAL, or SECAM standard video waveforms. When **TV** is selected, the trigger coupling is set to **AC**.

Table 2-4 TV Trigger Menu

TV Trigger Panel Controls		
Menu	Settings	Comments
Trigger Mode	Auto	Able to acquire waveform even when no trigger occurs
	Normal	Acquires waveform only when trigger occurs
Source	Channel 1	Sets Channel 1 as the trigger source
	Channel 2	Sets Channel 2 as the trigger source

Table 2-4 TV Trigger Menu

TV Trigger Panel Controls		
Settings	Holdoff	Sets the waiting period before starting a new trigger
Standard	NTSC/PAL/SECAM/Generic	Trigger on an NTSC, PAL, SECAM, or GENERIC TV waveform
Mode	Odd Field	Trigger on the rising edge of the first serration pulse of odd field.
	Even Field	Trigger on the rising edge of the first serration pulse of even field.
	All Fields	Trigger on the rising edge of the first pulse in the vertical sync interval (not available in Generic Mode)
	All Lines	Trigger on all horizontal sync pulses
	Custom Line	Trigger on selected line number

To configure TV triggering

- 1 Select the desired trigger source on the Trigger Source panel.
- 2 On the Trigger Settings panel, click on the TV button.
- 3 Select the desired video standard on the TV Trigger Setting panel.

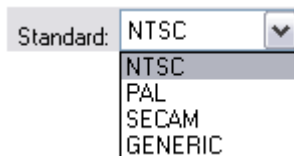

- 4 Select a mode to define the portion of the video signal to trigger on.

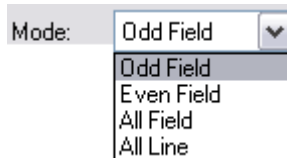

Table 2-5 Line (or count for Generic) numbers per field for each non-HDTV/EDTV video standard

Video standard	Field 1	Field 2
NTSC	1 to 263	1 to 262
PAL	1 to 313	314 to 625
SECAM	1 to 313	314 to 625
Generic	1 to 1024	1 to 1024

NOTE

Line Number Represents Count

In **Generic** mode, the line number represents the number of a count instead of a real line number. **Line:Field 1** and **Line:Field 2** are used to indicate where the counting starts. For an interlaced video signal, the counting starts from the rising edge of the first vertical serration pulse of Field 1 and/or Field 2.

Trigger Options

Coupling Modes

The oscilloscope offers four types of coupling modes— Direct Current (DC), Alternating Current (AC), Low Frequency-Reject (LF-Reject), and High Frequency-Reject (HF-Reject).

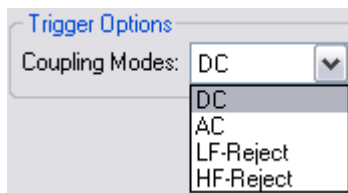

DC coupling allows DC and AC signals into the trigger path. When DC coupling is selected, both DC and AC components of the input waveform are transferred to the oscilloscope. DC coupling enables the triggering waveforms of as low as 0 Hz without large DC offsets to be captured.

AC coupling enables the triggering waveforms with large DC offsets to be captured.

LF-Reject coupling places a 35 kHz high-pass filter in series with the trigger waveform. The LF-Reject coupling will remove any unwanted low frequency components from a triggered waveform, such as power line frequencies that can interfere with proper triggering.

HF-Reject coupling places a low-pass filter with the 3 dB point at 35 kHz. HF-Reject removes high-frequency noise such as AM or FM broadcast stations from the trigger path.

Measurements and Cursors Controls

The **Measurements & Cursors** button is located on the toolbar of the soft front panel. Click on the

 **Measurements & Cursors** to activate the automatic measurements and cursors system.

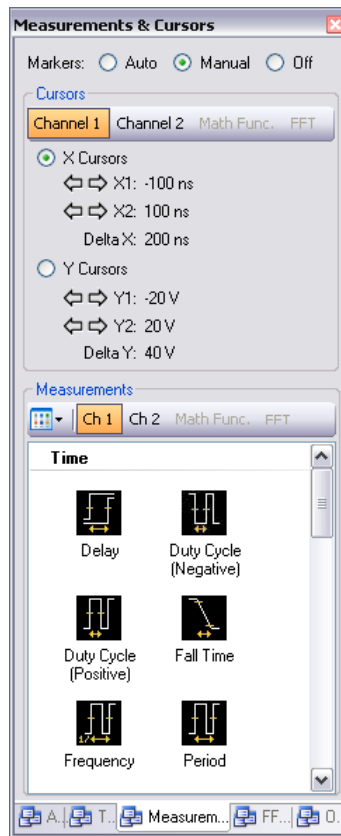

Figure 2-6 Soft front panel of the Measurements & Cursors Controls

Markers

The oscilloscope provides three types of settings for marker property.

Markers: Auto Manual Off

- **Auto** marker automatically places the cursors on the graph based on the selected measurements.
- **Manual** marker allows the cursors to be placed manually on the graph for customized measurements. This will enable the Cursors panel.
- **Off** will disable the graph markers from the graph display.

Cursors

Cursors are used to make custom voltage or time measurements on the scope signals.

Markers: Auto Manual Off

Source

Under cursors measurement, there are four available sources:

- Channel 1
- Channel 2
- Math Func.
- FFT

Math Func. and FFT sources are only available when the functions are activated on the FFT & Math control panel.

X and Y Cursors

To enable Cursors control, the Manual option on the Markers property must be selected as shown below.

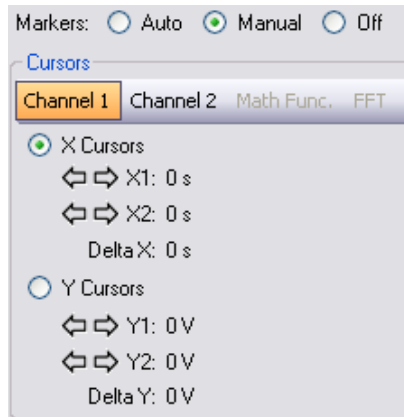

- **X cursors** places two cursors on the X-Axis of the waveforms to measure the time difference between the two cursors (X2 minus X1). Delta X denotes the time difference.
- **Y cursors** places two cursors on the Y-Axis of the waveforms to measure the voltage difference between the two cursors (Y2 minus Y1). Delta Y denotes the voltage difference.

To configure Auto marker

The Auto marker function will automatically place indicators on the waveforms displayed on the graph to show the selected measurements.

- 1 Obtain and establish a stable signal on the waveform acquisition graph.
- 2 Click on the Measurements & Cursors button and select Auto at the Markers property.
- 3 Proceed to select your desired measurements on the Measurements panel.

- 4 Markers will be automatically placed on the waveform to indicate the measurements made.
- 5 Browse the measurement results on the Measurement Results panel to view different markers for different measurements.

Figure 2-7 shows the sample marker (horizontal line in orange color) automatically marks the maximum value of the waveform displayed when Maximum measurement type is selected.

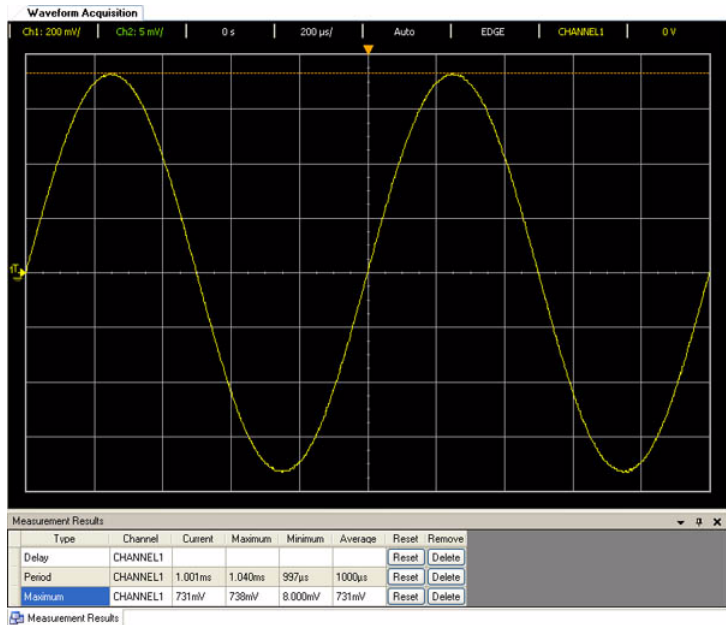

Figure 2-7 Auto marker automatically marks the maximum value of the waveform when Maximum measurement is selected

To configure Manual marker

The Manual marker function allows you to manually place indicators on the waveforms displayed on the graph to show the selected measurements.

- 1** Obtain and establish a stable signal on the waveform acquisition graph.
- 2** Click on the Measurements & Cursors button and select Manual at the Markers property. The Cursors panel will be activated once Manual is selected.
- 3** Select Channel 1 or Channel 2 as desired. Then select X Cursors or Y Cursors to define the measurements you would like to perform.
- 4** Use the navigation arrows to adjust the cursors position.

To adjust the first cursor (X1 or Y1), left-click and drag the cursor on the graph.

To adjust the second cursor (X2 or Y2), right-click and drag the cursor on the graph. Delta measurements of the Cursors can be obtained on the Cursors panel.

Measurements Controls

The U2701A/ U2702A modular oscilloscopes offers 26 types of automatic measurements. You can select any of the following predefined measurements to measure the waveforms.



Figure 2-8 Automatic measurements on the Measurements & Cursors panel

2 Scope Features and Functions

Table 2-6 List of Time Measurements and Voltage Measurements

Measurements Selection List		
Menu	Settings	Comments
Display	Large Icon Small Icon List Tile	Change how measurement icons are displayed
Source	Ch 1 Ch 2 Math	Selects Channel 1, Channel 2, or Math as the waveform to be measured.
Time	Width (Negative)	Measure the negative pulse width of a waveform (The time from the mid-threshold of the first falling edge to the mid-threshold of the next rising edge)
	Width (Positive)	Measure the positive pulse width of a waveform (the time from the mid-threshold of the first rising edge to the mid-threshold of the next falling edge)
	Frequency	Measure the frequency of a waveform
	Period	Measure the period of a waveform (the time between the mid-threshold crossings of two consecutive, like-polarity edge)
	Rise Time	Measure the rise time of a waveform (the time at the upper threshold minus the time at the lower threshold of the edge)
	Fall Time	Measure the fall time of a waveform (the time at the lower threshold minus the time at the upper threshold on the edge)
	Duty Cycle (Positive) Duty Cycle (Negative)	Measure the positive and negative duty cycle of a waveform Duty Cycle is defined as $(Pwidth / Period) * (100)$ which is the percentage of the period that the waveform is high
	T Max	The first time that the maximum voltage occurs on display
	T Min	The first time that the minimum voltage occurs on the display

Table 2-6 List of Time Measurements and Voltage Measurements

Measurements Selection List		
Time	Delay	Measures the time difference from the selected edge on Channel 1 and the selected edge on Channel 2 closest to the trigger reference point at the middle threshold points on the waveforms
	Phase Shift	The calculated phase shift from Channel 1 to Channel 2 (in degrees)
Voltage	Amplitude	Measure voltage between Vtop and Vbase of a waveform
	Average	Measure average voltage of a waveform
	Base	Measure a flat base voltage of a waveform
	Maximum	Measure the absolute maximum voltage of a waveform
	Minimum	Measure the absolute minimum voltage of a waveform
	Overshoot	Measure the overshoot voltage in percentage of a waveform Overshoot is a waveform distortion which follows a major edge transition
	Peak to Peak	Measure peak-to-peak voltage of a waveform ($V_{Max} - V_{Min}$)
	Preshoot	Measure the preshoot voltage in percentage of a waveform Preshoot is a waveform distortion which precedes an edge transition
	VRMS (AC)	The AC VRMS (Root Mean Square Voltage) is a modified RMS measurement and removes the DC component of the waveform from the calculation of the RMS voltage
	VRMS (DC)	The DC VRMS (Root Mean Square Voltage) measurement is the classic way of making an RMS voltage measurement
	Cycle Mean	Takes VRMS (DC) for one cycle
	CREST	Defined as Peak/RMS (Maximum/VRMS (DC))
Top	Measure a flat top voltage of a waveform	
Std Deviation	Standard Deviation is an RMS measurement across the full screen with the DC component removed.	

Table 2-7 List of Time Measurements and Voltage Measurements for FFT

Measurements Selection list		
Menu	Settings	Comments
Time	X at Max	The first time that the maximum magnitude occurs on display
	X at Min	The first time that the minimum magnitude occurs on the display
Voltage	Average	Measure average magnitude of a waveform
	Maximum	Measure the absolute maximum magnitude of a waveform
	Minimum	Measure the absolute minimum magnitude of a waveform
	Peak to Peak	Measure peak-to-peak magnitude of a waveform

NOTE

FFT Measurements

When you make an X at Max or X at Min measurement on a math FFT function, the resultant units will be in Hertz. No other time related automatic measurement can be made on the FFT math function. Use the cursors to make other measurements on FFT

Automatic Measurement Procedures

Automatic measurements can be used on any channel source or any running math function. Cursors are turned on to focus on the most recently selected measurement.

- 1** Select the markers for your measurement.

Markers enable you to expand the time base around the start and stop events of the time interval to be measured, thus achieving more time resolution than the automatic measurements.

- 2** Select either Channel 1 or Channel 2 according to the waveform you want to measure. Math function and FFT channel can be selected if they are enabled.

- 3** Select the desired measurement from the Measurements panel. The Measurements Results panel is displayed at bottom of the graph.

To select single or multiple measurements,

- 1** Drag and drop a measurement

Click on the desired measurement icon, while holding the selected measurement, drag it over to the Measurements Results panel. Drop the selection on the panel.

- 2** Drag and drop multiple measurements

On the Measurements panel, hold down the mouse button, drag and select multiple measurements. Drag all the selected measurements and drop the selections on the Measurement Results panel.

- 3** Double-click on a measurement

Go to your desired measurement and double click on the icon.

- 4** Select the measurement and press Enter

Click on the desired measurement icon and press Enter. To select more than one measurement, press Ctrl and click on the desired measurements icons then press Enter.

2 Scope Features and Functions

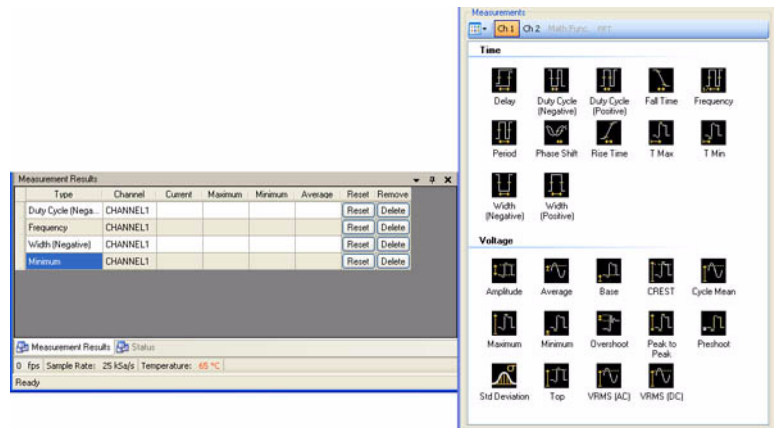

Figure 2-9 Measurements panel and Measurements Results panel

To reset the selected measurements on the Measurements Results panel, select the measurement that you would like to reset and click on the **Reset** button. To reset all measurements, click on the header of the reset column, **Reset**.

To delete a measurement, select the measurement that you would like to remove from the Measurements Results panel and click on the **Delete** button. To delete all measurements, click on the header of the delete column, **Remove**.

FFT & Math Controls

The **FFT & Math** button is located on the toolbar of the soft front panel.

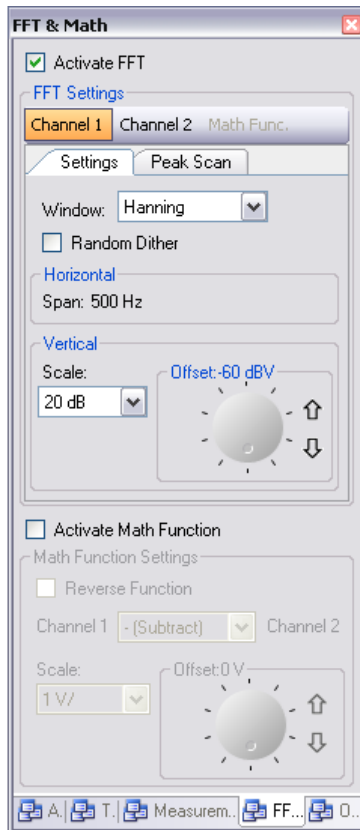

Figure 2-10 Soft front panel of the FFT & Math controls.

Fast Fourier Transform Function

FFT is used to compute the fast Fourier transform using analog input channels or math functions. FFT takes the digitized time record of the specified source and transforms it to the frequency domain. When the FFT function is selected, the FFT spectrum is plotted on the graph display as magnitude in dBV versus frequency. The readout for the horizontal axis changes from time to frequency (Hertz) and the vertical readout changes from volts to dB.

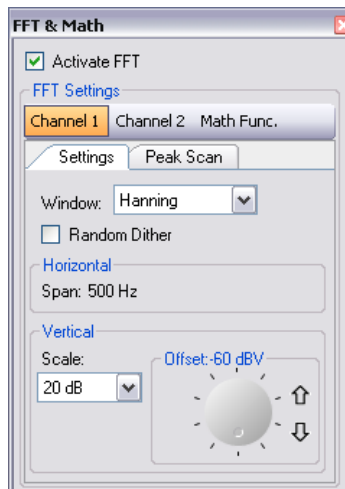

Figure 2-11 FFT controls

NOTE

When the FFT source is channel 1 or channel 2, FFT units will be displayed in dBV.

FFT Settings

Selecting an FFT Window

There are four FFT windows. Each window has trade-offs between frequency resolution and amplitude accuracy. Use the following guidelines to select the best window.

Table 2-8 Comparison between the four FFT windows

Window	Characteristics	Best for measuring
Rectangular	Best frequency resolution, worst magnitude resolution. This is essentially the same as no window.	Transients or bursts, the waveform levels before and after the event are nearly equal. Equal-amplitude sine waves with fixed frequencies. Broadband random noise with a relatively slow varying spectrum.
Hanning Hamming	Better frequency, poorer magnitude accuracy than Rectangular. Hamming has slightly better frequency resolution than Hanning.	Sine, periodic, and narrow-band random noise. Transients or bursts where the waveform levels before and after the events are significantly different.
Blackman Harris	Best magnitude, worst frequency resolution.	Single frequency waveforms, to find higher order harmonics.
Flattop	Best amplitude accuracy, poor frequency resolution when compared with the Hanning window.	Amplitude of single frequency components with little nearby spectral energy in the signal

The **Random Dither** option enables the reduction of noise floor. To enable this option, click on the Random Dither checkbox.

Horizontal scaling is automatically calculated. It will span the entire range of spectrum horizontally for best-fit display.

Vertical **Scale** option allows you to scale your spectrum vertically. Vertical **Offset** allows you to adjust the vertical offset of your spectrum.

To make FFT measurements

- 1 On the FFT & Math control panel, click Activate FFT checkbox to enable the FFT function.
- 2 On the FFT Settings panel, select the desired channel source or Math function that you would like to perform FFT on.
- 3 On the Settings tab, select the desired Window (Rectangular, Hanning, Hamming, BlackmanHarris, Flattop).

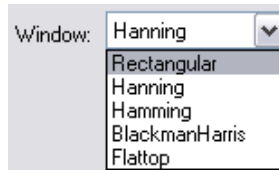

- 4 To reduce the noise floor of the waveform, click on the Random Dither checkbox. The horizontal scale (span), which is the entire range of the spectrum, will be automatically calculated, as shown in the image above.
- 5 Set the vertical scale factors for the spectrum in the Scale property box. Then, set the offset of the spectrum by using the knob or the arrow keys to adjust the offset value.

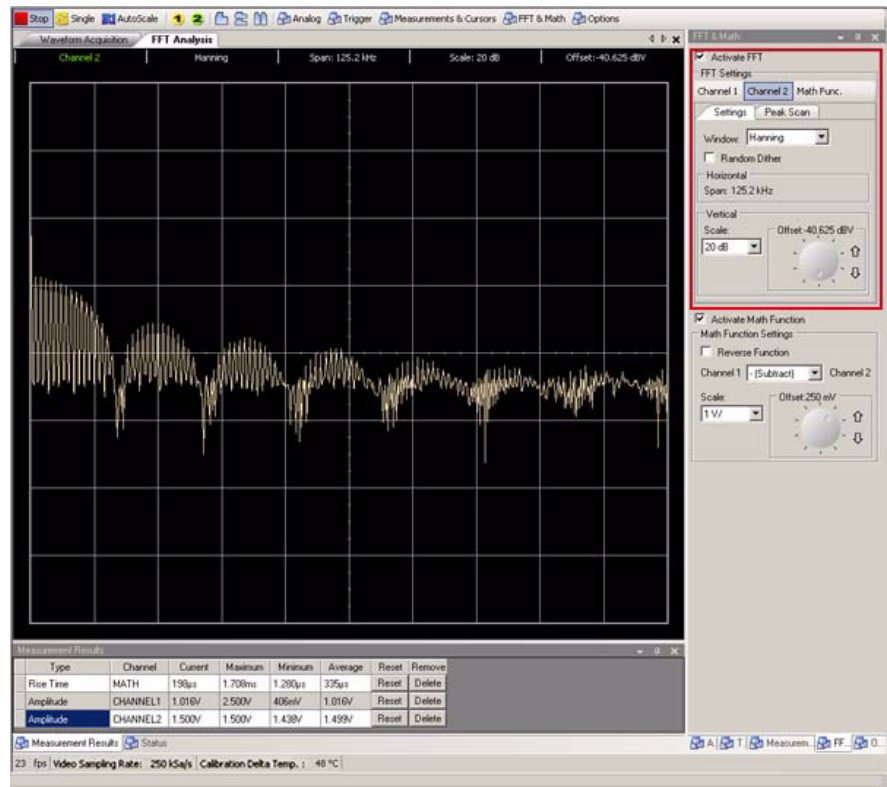

Figure 2-12 Waveform obtained with Hanning window selected

Peak Scan

After performing FFT measurements, you can obtain the peak information of your spectrum by following the steps below.

NOTE

To use the Peak Scan function, the oscilloscope signal acquisition must be stopped. This is because in Run mode, you will not see proper subsequent peaks as the spectrum is being refreshed.

- 1 Click on the Stop button on the oscilloscope toolbar to stop the signal acquisition, then click on the FFT & Math button.
- 2 On the FFT Settings panel, click on the Peak Scan tab, then select the Peak Scan checkbox to enable peak scan.

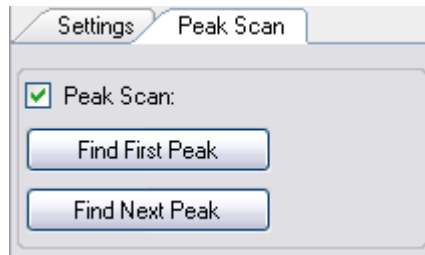

- 3 Once the Peak Scan is enabled, you will see an indicator on your spectrum pointing at the first peak of your spectrum as shown [Figure 2-13](#).
- 4 To find the subsequent peaks (in descending order) of your spectrum, click on the Find Next Peak button. You will see an indicator on your spectrum pointing at the next highest peak of your spectrum as shown [Figure 2-14](#).
- 5 To get the first peak once again, click on the Find First Peak button.

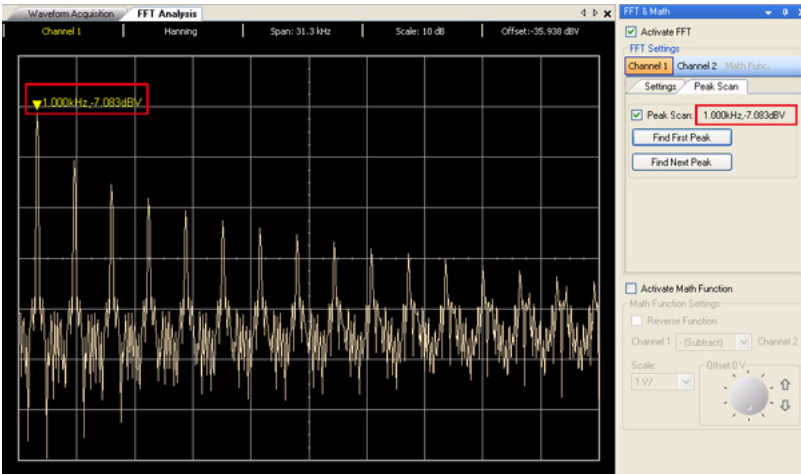

Figure 2-13 First Peak

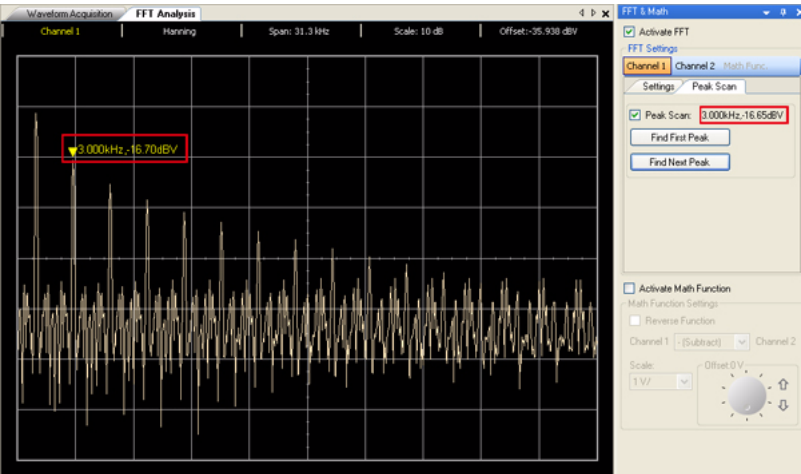
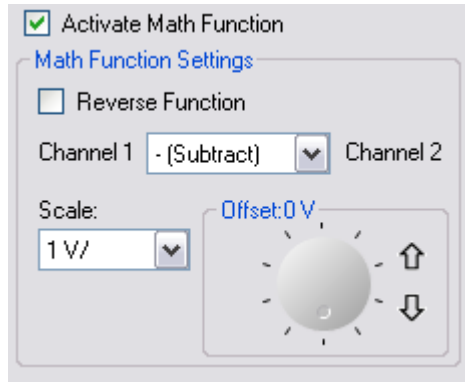

Figure 2-14 Next Peak

Math Function

The math functions control allows the selection of the math functions add, subtract, multiply, divide, and FFT for CH1 and CH2. The mathematical result can also be measured using the grid and cursor control.



Math Function Settings

Reverse Function allows you to toggle the orientation of the channel math computation when selected.

By default the orientation is Channel 1 <Math operation> Channel 2. When this option is enabled, the orientation will be reversed to Channel 2 <Math operation> Channel 1, whereby Math operation is based on your choice of selection.

Math Functions

Math Functions	Comments
+ (Add)	Adds Channel 1 and Channel 2 voltage values, point by point (CH1 + CH2)
- (Subtract)	Subtracts Channel 1 with Channel 2 voltage values, point by point (CH1 – CH2, CH2 – CH1)

Math Functions	Comments
x (Multiply)	Multiplies Channel 1 and Channel 2 voltage values, point by point (CH1 * CH2)
/ (Divide)	Divides Channel 1 and Channel 2 voltage values, point by point (CH1 / CH2, CH2 / CH1). If zero divide by zero, the result will be 1. If either Channel 1 or Channel 2 is positive and it is divided by zero, the result will be in positive infinity. If either Channel 1 or Channel 2 is negative and it is divided by zero, the result will be in negative infinity.

The **Scale** options allows you to scale the computed waveform.

The **Offset** option allows you to set the offset on the computed waveform.

To perform math computation of acquired waveform

- 1 On the FFT & Math control panel, click on the Activate Math Function checkbox to enable the Math function.
- 2 On the Math Function Settings panel, select the function (Add, Subtract, Multiply, Divide) as desired.

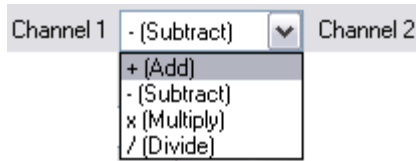

- 3 Set the vertical scale factors for the selected Math function in the Scale property box. Then, set the offset of the computed waveform by using the knob or the arrow keys to adjust the offset value.
- 4 Click on the Active Reverse Function checkbox to reverse the channels' computation if desired. This allows you to flip the order of operation for the channels.

2 Scope Features and Functions

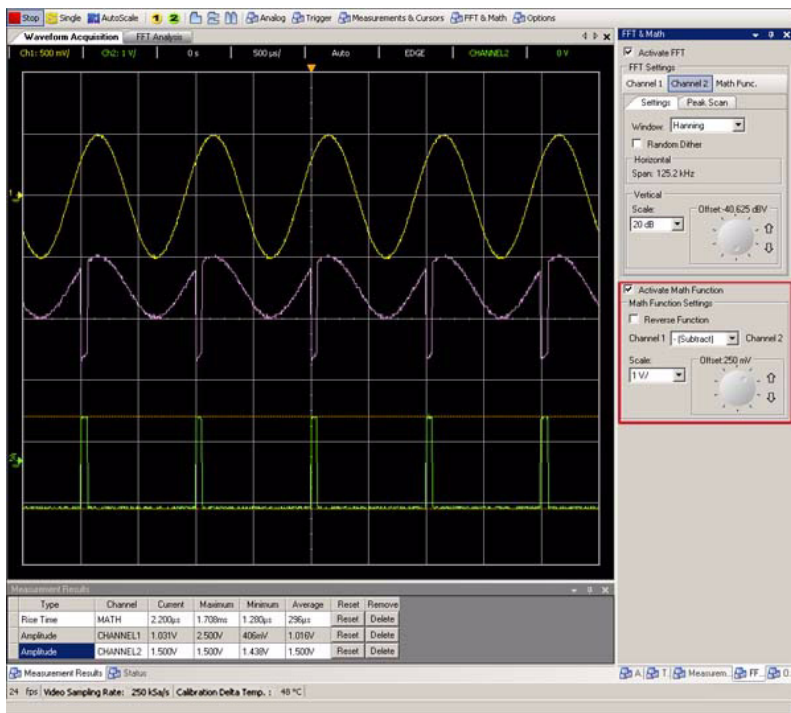



Figure 2-15 Acquired waveform using Subtract function

Options Controls

To display the **Acquisition Mode** menu and **Display Options** menu, click on the  Options button on the toolbar on the soft front panel.

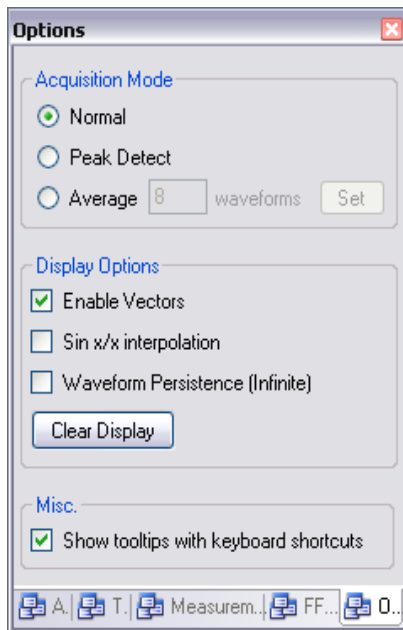
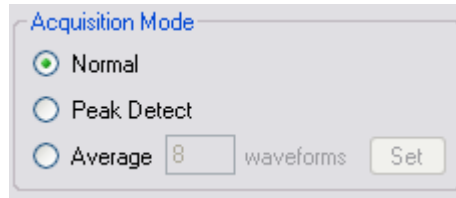

Figure 2-16 Soft front panel of the Options Controls

Acquisition Mode

The figure below shows the Acquisition Mode on the soft front panel.



The U2701A/U2702A scopes have the following acquisition modes.

Table 2-9 List of Acquisition Modes

Menu	Settings	Comments
Mode	Normal	Normal acquisition mode is for most waveforms with normal decimating at slower sweep speeds, no averaging.
	Peak Detect	Peak Detect acquisition mode is for displaying narrow pulses that occur infrequently (at slower sweep speeds).
	Average	Average acquisition mode is for reducing noise and increasing resolution (at all sweep speeds without bandwidth or rise time degradation).

To reduce the displayed random noise, select **Average** acquisition. This mode will decrease the screen refresh rate.

To avoid waveform aliasing, select **Peak Detect** acquisition. Peak Detect mode captures the maximum and minimum values of a waveform over multiple acquisitions.

Display Options

The figure below shows the **Display Options** menu on the soft front panel.

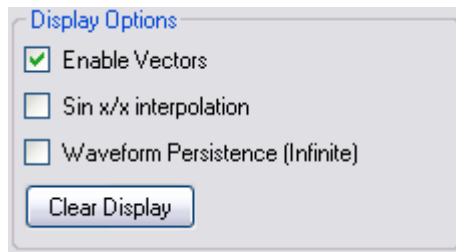

The three types of display options offered are:

- **Vector** connects the sample points by using digital interpolation.
- **Sin x/x interpolation** is used to expand the horizontal signal resolution when the horizontal scale is set to 100 ns or faster.

2 Scope Features and Functions

To perform interpolation using $\sin(x)/x$ filter to maintain the linearity of the waveform, enable the **Sin x/x interpolation** option. Once enabled, a smoother waveform will be displayed.

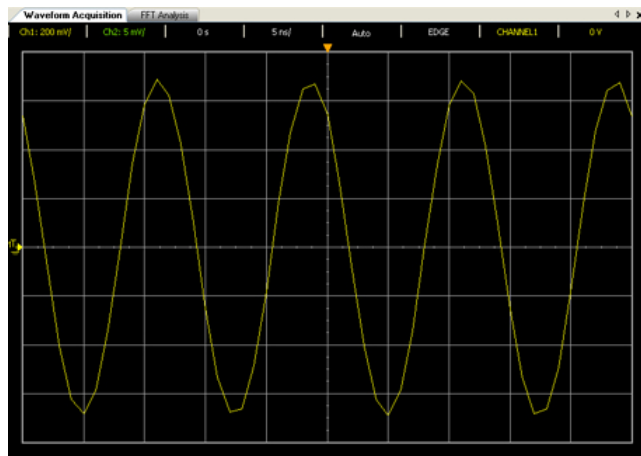

Figure 2-17 The waveform before interpolation

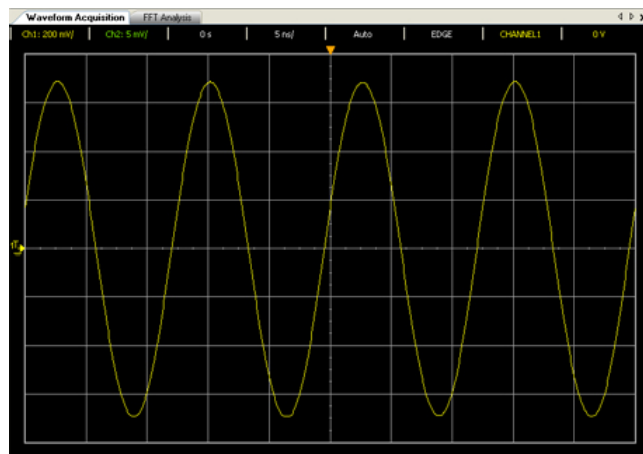
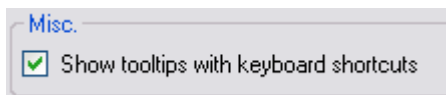

Figure 2-18 The waveform after interpolation

- **Waveform persistence (infinite)** enables the oscilloscope to update the display with new acquisitions, but does not erase the results of previous acquisitions. Waveform persistence is not kept beyond the display area boundary. Use infinite persistence to measure noise and jitter, to see the worst-case extremes of varying waveforms, to look for timing violations, or to capture events that occur infrequently.

Clear Display clears the previous acquisitions on the graph display. Then, the oscilloscope will again start to accumulate acquisitions. Turn off infinite persistence, then press the Clear Display key to return the oscilloscope to the normal display mode.

Miscellaneous menu contains an option to display tooltips with keyboard shortcuts. When this option is enabled, by hovering the mouse cursor over most of the controls, a tooltip with the appropriate keyboard shortcut to access the particular function will appear.



AutoScale and Run/Stop buttons

AutoScale



AutoScale automatically configures the oscilloscope to best display the input signal by analyzing any waveforms connected to the channel and external trigger inputs.

If AutoScale fails, your current setup will remain unchanged. The following steps will teach you how to perform auto scaling on your acquired signals.

- 1 Once you have obtained a running signal, click on  AutoScale on the oscilloscope toolbar or via Tools menu.
- 2 The auto scaling may take awhile for the application to analyze and adjust the waveform.
- 3 Once the auto scaling has completed, you will see a best-fit waveform displayed on your graph.

Run/Stop Button

The Run/Stop button is used to manually start or stop the oscilloscope's acquisition system from acquiring waveform data.



- Click  on to start acquiring waveform.
- Click on  to stop acquiring waveform.

Pan and Zoom

The ability to pan (move horizontally) and zoom (expand or compress horizontally) an acquired waveform is important because of the additional insight it can reveal about the captured waveform. This additional insight is often gained from seeing the waveform at different levels of abstraction. You may want to view both the big picture and the specific little picture details.

The ability to examine waveform detail after the waveform has been acquired is a benefit generally associated with digital oscilloscopes. Often this is simply the ability to freeze the display for the purpose of measuring with cursors or printing the screen.

To zoom an acquired waveform

- 1 Click on the Stop button to stop the signal acquisition.
- 2 Go to Analog panel by clicking the Analog button on the toolbar or press Ctrl + 1.
- 3 On the Horizontal panel, click on  to zoom in or  to zoom out. You may also use the drop-down list to select the zoom value.
- 4 Alternatively, you can use the zoom reference panel above the waveform graph display to zoom in and out of the graph.

2 Scope Features and Functions

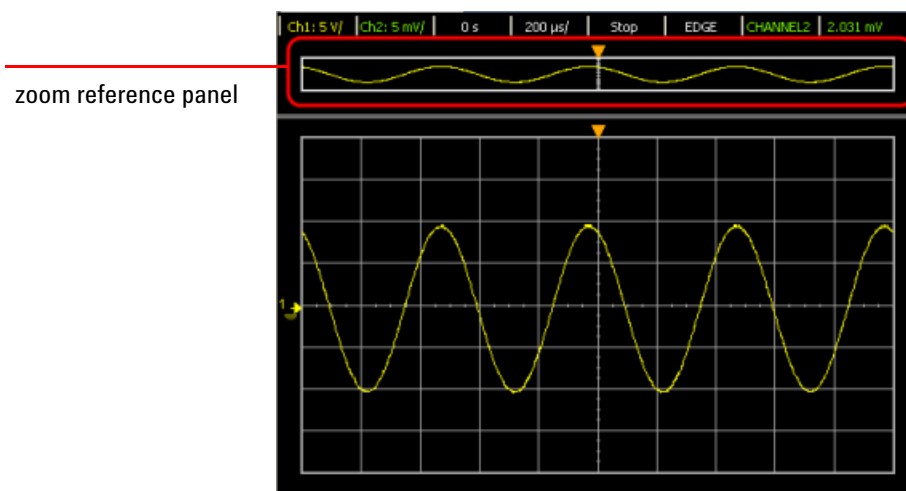

Figure 2-19 Zoom reference panel

- 5 To zoom in, right-click on the zoom reference panel and select **Zoom In** from the menu. Repeat the same action to further increase the zoom level.

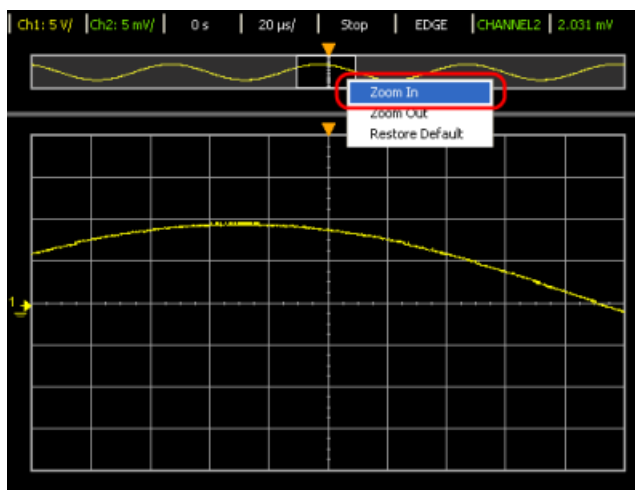

Figure 2-20 Zoom In

- 6 To zoom out, right-click on the zoom reference panel and select **Zoom Out** from the menu. Repeat the same action to further decrease the zoom level.

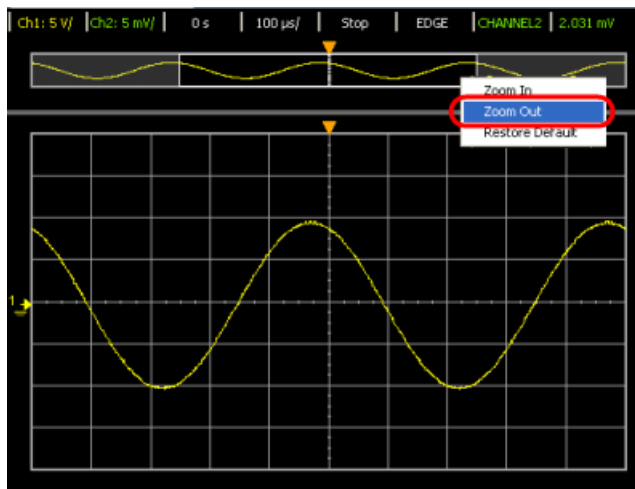



Figure 2-21 Zoom Out

- 7 Select **Restore Default** from the menu to reset the zoom level to default.

To pan an acquired waveform

- 1 Click on the Stop button to stop the signal acquisition.
- 2 Go to Analog panel by clicking the Analog button on the toolbar or press Ctrl + 1.
- 3 On Delay panel, use the  or  arrow key to pan your graph right or left. You may also turn the knob to control the panning.
- 4 Alternatively, you can use the zoom reference panel above the waveform graph display to pan the graph. Click and hold the area in the zoom area selection bar, then drag left or right to pan the graph. The analog trigger point will move in respond to the panning of the graph.

2 Scope Features and Functions

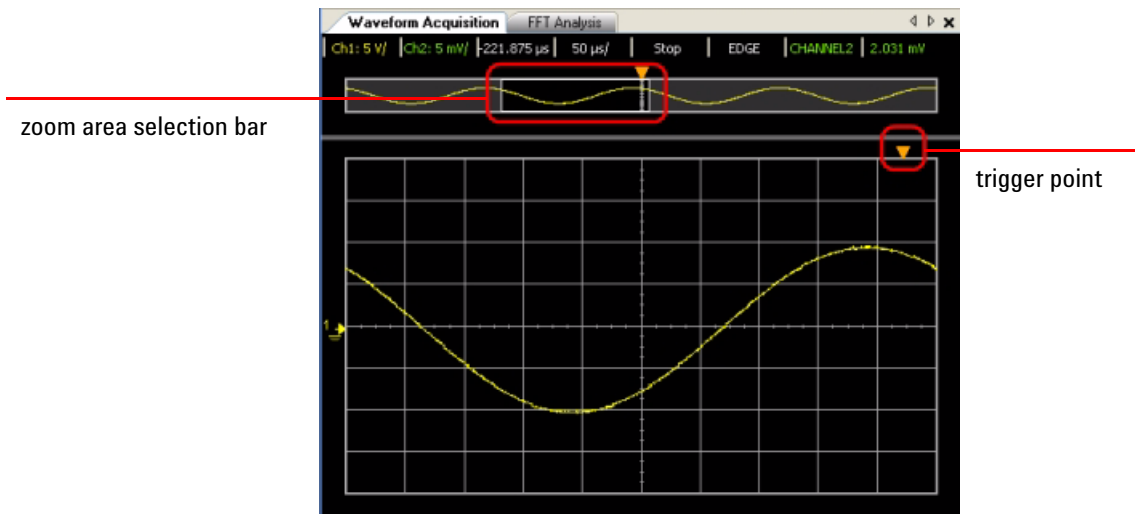

Figure 2-22 Panning a waveform



3 Characteristics and Specifications

Specifications	66
Characteristics	67
Product Characteristics and General Specifications	71
Normal and Single Mode Chart	73
Measurement Category	77

This chapter specifies the characteristics and specifications of Agilent U2701A/U2702A USB modular oscilloscope.



Specifications

All specifications are warranted. Specifications are valid after a 30-minute warm-up period and within $\pm 10^{\circ}\text{C}$ from firmware calibration temperature.

Vertical System: oscilloscope channels

Bandwidth (-3 dB)	U2701A: DC to 100 MHz U2702A: DC to 200 MHz
-------------------	--

Scope channel triggering

Trigger sensitivity	<10 mV/div: greater of 1 div or 5 mV; ≥ 10 mV/div: 0.6 div
---------------------	---

Characteristics

All characteristics are typical performance values and are not warranted. Characteristics are valid after a 30-minute warm-up period and within $\pm 10^{\circ}\text{C}$ from firmware calibration temperature.

Acquisition: oscilloscope channels

Real time sample rate		
2 channels interleaved	1 GSa/s	
Each channel	500 MSa/s	
Standard memory depth		
2 channels interleaved	Normal	Single-shot
Each channel	32 Mpts	64 Mpts
	16 Mpts	32 Mpts
Vertical resolution	8 bits	
Peak detection	Yes	
Averaging	Any number from 1 to 999	
Filter	Sin(x)/x interpolation for time base 1 ns to 100 ns	
Sweep modes	Auto, normal, single	

Vertical system: oscilloscope channels

Scope channels	U2701A/U2702A: Ch 1 and 2 simultaneous acquisition	
AC coupled	U2701A: 3.5 Hz to 100 MHz U2702A: 3.5 Hz to 200 MHz	
Calculated rise time (= 0.35/bandwidth)	U2701A: 3.5 ns U2702A: 1.75 ns	
Single-shot bandwidth	U2701A: 100 MHz U2702A: 200 MHz	
Range	2 mV/div to 5 V/div (1 M Ω)	
Maximum input	CAT I 30 Vrms, 42 Vpk	
Offset range	± 4 div	

3 Characteristics and Specifications

Vertical system: oscilloscope channels (continued)

Dynamic range	±4 div
Input impedance	1 MΩ: ≈ 16 pF
Coupling	AC, DC, Ground
BW limit	≈ 25 MHz
Standard probes	10:1 Passive Probe 150 MHz 1.2 m 10:1 Passive Probe 300 MHz 1.2 m
ESD tolerance	±2 kV
Noise peak-to-peak	3 mVpp
DC vertical offset accuracy	≤ 200 mV/div: ±0.1 div ±2.0 mV ±0.5% offset value; > 200 mV/div: ±0.1 div ±2.0 mV ±1.5% offset value
DC vertical gain accuracy	±4.0% of Full Scale
Single cursor accuracy	±{DC vertical gain accuracy + DC vertical offset accuracy + 0.2% full scale (~1/2 LSB)} Example: for 50 mV signal, scope set to 10 mV/div (80 mV full scale), 5 mV offset, accuracy = ±{4.0% (80 mV) + 0.1(10 mV) + 2.0 mV + 0.5% (5 mV) + 0.2% (80 mV)} = ±6.385 mV
Dual cursor accuracy	±{DC vertical gain accuracy + 0.4% full scale (~1 LSB)} Example: for 50 mV signal, scope set to 10 mV/div (80 mV full scale), 5 mV offset, accuracy = ±{4.0% (80 mV) + 0.4% (80 mV)} = ±3.52 mV

Horizontal

Range	1 ns/div to 50 s/div
Time base accuracy	20 ppm
Delay range	Pre-trigger: -100% Post-trigger: +100%
Modes	Main, roll, XY
XY	Yes
Reference position	Center
Modes	Normal, single, auto trigger
Holdoff time	60 ns

Trigger system

Sources	Ch 1, Ch 2, Ext (not applicable for TV trigger)
Selections	Edge, pulse width, TV
Edge	Triggers on a rising or falling edge, alternating or either edge of any source
Pulse Width	Triggers on a pulse width greater than, equal to, or less than a specified time limit, with time limits ranging from 16 ns to 10 s. Minimum lowerlimit: 8 ns Minimum upperlimit: 16 ns Maximum pulse width setting: 10 s
TV	Triggers on one of three standard television waveforms: NTSC, PAL, SECAM TV trigger sensitivity: 0.6 division of sync signal. Modes supported include Field 1, Field 2, all fields, or any line within a field.
AutoScale	Single button automatic setup of all channels

Oscilloscope channel triggering

Range (internal)	± 4 div from center screen
Coupling	AC (< 15 Hz) LF reject (~ 35 kHz) HF reject (~ 35 kHz)

External (EXT) triggering

Input impedance	1 M Ω : \approx 16 pF
Maximum input	CAT I 30 Vrms, 42 Vpk
Range	DC coupling: trigger level ± 1.25 V and ± 2.5 V
EXT trigger pulse width	> 2.5 ns
Trigger Level Sensitivity	For ± 1.25 V range setting: DC to 100 MHz: 100 mV > 100 MHz: 200 mV For ± 2.5 V range setting: DC to 100 MHz: 250 mV > 100 MHz: 500 mV

3 Characteristics and Specifications

Display

Interpolation	Sin(x)/x
Display types	Dots and vectors
Persistence	Off, infinite
Format	XY, roll

Measurement features

Automatic measurements	Measurements are continuously updated. Cursors track last selected measurement.
Voltage	Peak-to-peak, maximum, minimum, average, amplitude, top, base, Vrms, overshoot, preshoot, crest, standard deviation, cycle RMS, RMS AC
Time	Frequency, period, +width, -width, +duty cycle, -duty cycle, rise time, fall time, delay, phase
Frequency	Maximum Peak
Cursors	Modes: Manual Type: Time, voltage and frequency (FFT) Measurements: ΔT , ΔV , frequency, Peak Scan (FFT), $\Delta Peak$
Math functions	Add, subtract, multiply, FFT, divide

FFT

Points	1250 points (for 500 ns and above)
Source of FFT	Source channels 1 or 2
Window	Hanning, Hamming, Blackman-Harris, rectangular, Flattop
Noise floor	-50 to -90 dB depending on averaging
Amplitude	Display in dBV
Maximum frequency	250 MHz

Product Characteristics and General Specifications

Remote Interface

- Hi-Speed USB 2.0
- USBTMC Class Device^{1 2}

Power Consumption

- +12 V DC, 2 A
- Isolated ELV supply source

Measurement Category

- CAT I 30 Vrms

Operating Environment

- Operating temperature from 0 °C to 50 °C
- Operating humidity at 20 ~ 85% R.H. (Non-condensing)
- Altitude up to 2000 meters (Operating and non-operating)
- Pollution degree 2
- For indoor use only

Storage Compliance

- Storage temperature from –20 °C to 70 °C
- Storage humidity at 5 ~ 90% R.H. (Non-condensing)

Safety Compliance

- IEC 61010-1: 2001/EN 61010-1: 2001 (2nd edition)
- Canada: CAN/CSA-C22.2 No. 61010-1-04
- USA: ANSI/UL 61010-1:2004

EMC Compliance

- IEC 61326-2002/EN 61326:1997+A1: 1998+A2: 2001+A3: 2003
- Canada: ICES-001: 2004
- Australia/New Zealand: AS/NZS CISPR11: 2004

Shock & Vibration

- Tested to IEC/EN 60068-2

IO Connector

- BNC connector

3 Characteristics and Specifications

Dimension

- 117.00 mm x 180.00 mm x 41.00 mm (with rubber bumpers)
- 105.00 mm x 175.00 mm x 25.00 mm (without rubber bumpers)

Weight

- 534 g (with rubber bumpers)
- 482 g (without rubber bumpers)

Warranty

- Please refer to http://www.agilent.com/go/warranty_terms
 - 3 years for the product
 - 3 months for the product's standard accessories, unless otherwise specified
 - Please take note that for the product, the warranty does not cover:
 - Damage from contamination
 - Normal wear and tear of mechanical components
 - Manuals
- 1 Compatible with Microsoft Windows operating systems only.
 - 2 Requires a direct USB connection to the PC so the appropriate driver can be installed in the USB modular instrument or USB DAQ module.

Normal and Single Mode Chart

Normal mode

Table 3-10 Normal mode

Time/div	Frame period	Sampling rate	Video sampling rate
1 ns	10 ns	500M	500M
2 ns	20 ns	500M	500M
5 ns	50 ns	500M	500M
10 ns	100 ns	500M	500M
20 ns	200 ns	500M	500M
50 ns	500 ns	500M	500M
100 ns	1 μ s	500M	500M
200 ns	2 μ s	500M	500M
500 ns	5 μ s	500M	250M
1 μ s	10 μ s	500M	125M
2 μ s	20 μ s	500M	62.5M
5 μ s	50 μ s	500M	25M
10 μ s	100 μ s	500M	12.5M
20 μ s	200 μ s	500M	6.25M
50 μ s	500 μ s	500M	2.5M
100 μ s	1 ms	500M	1.25M
200 μ s	2 ms	500M	625k
500 μ s	5 ms	500M	250k
1 ms	10 ms	500M	125k
2 ms	20 ms	500M	62.5k

3 Characteristics and Specifications

Table 3-10 Normal mode (continued)

Time/div	Frame period	Sampling rate	Video sampling rate
5 ms	50 ms	250M	25k
10 ms	100 ms	125M	12.5k
20 ms	200 ms	62.5M	6.25k
50 ms	500 ms	31.25M	2.5k
100 ms	1 s	12.5M	1250
200 ms	2 s	6.25M	625
500 ms	5 s	2.5M	250
1 s	10 s	1.25M	125
2 s	20 s	625k	62.5
5 s	50 s	250k	25
10 s	100 s	125k	12.5
20 s	200 s	62.5k	6.25
50 s	500 s	25k	2.5

Single mode (rolling mode)

Table 3-11 Single mode (rolling mode)

Time/div	Frame period	Sampling rate	Video sampling rate
1 ns	10 ns	500M	500M
2 ns	20 ns	500M	500M
5 ns	50 ns	500M	500M
10 ns	100 ns	500M	500M
20 ns	200 ns	500M	500M
50 ns	500 ns	500M	500M
100 ns	1 μ s	500M	500M
200 ns	2 μ s	500M	500M
500 ns	5 μ s	500M	250M
1 μ s	10 μ s	500M	125M
2 μ s	20 μ s	500M	62.5M
5 μ s	50 μ s	500M	25M
10 μ s	100 μ s	500M	12.5M
20 μ s	200 μ s	500M	6.25M
50 μ s	500 μ s	500M	2.5M
100 μ s	1 ms	500M	1.25M
200 μ s	2 ms	500M	625k
500 μ s	5 ms	500M	250k
1 ms	10 ms	500M	125k
2 ms	20 ms	500M	62.5k
5 ms	50 ms	500M	25k
10 ms	100 ms	250M	12.5k
20 ms	200 ms	125M	6.25k

3 Characteristics and Specifications

Table 3-11 Single mode (rolling mode)

Time/div	Frame period	Sampling rate	Video sampling rate
50 ms	500 ms	62.5M	2.083k
100 ms	1 s	25M	1250
200 ms	2 s	12.5M	625
500 ms	5 s	5M	250
1 s	10 s	2.5M	125
2 s	20 s	1.25M	62.5
5 s	50 s	500k	25
10 s	100 s	250k	10
20 s	200 s	125k	5
50 s	500 s	50k	2

Measurement Category

The U2701A and U2702A USB modular oscilloscopes are intended to be used for measurement in Measurement Category I, 30 V for scope measurement.

Measurement Category Definition

Measurement CAT I is for measurements performed on circuits not directly connected to MAINS. Examples are measurements on circuits not derived from MAINS, and specially protected (internal) mains-derived circuits.

Measurement CAT II are measurements performed on circuits directly connected to the low voltage installation. Examples are measurements on household appliances, portable tools, and similar equipment.

Measurement CAT III are measurements performed in the building installation. Examples are measurements on distribution boards, circuit-breakers, wiring, including cables, bus-bars, junction boxes, switches, socket outlets in the fixed installation, and equipment for industrial use, and some other equipment including stationary motors with permanent connection to the fixed installation.

Measurement CAT IV are measurements performed at the source of the low-voltage installation. Examples are electricity meters and measurements on primary over current protection devices and ripple control units.

THIS PAGE HAS BEEN INTENTIONALLY LEFT BLANK.

www.agilent.com

Contact us

To obtain service, warranty or technical support assistance, contact us at the following phone numbers:

United States:

(tel) 800 829 4444 (fax) 800 829 4433

Canada:

(tel) 877 894 4414 (fax) 800 746 4866

China:

(tel) 800 810 0189 (fax) 800 820 2816

Europe:

(tel) 31 20 547 2111

Japan:

(tel) (81) 426 56 7832 (fax) (81) 426 56 7840

Korea:

(tel) (080) 769 0800 (fax) (080) 769 0900

Latin America:

(tel) (305) 269 7500

Taiwan:

(tel) 0800 047 866 (fax) 0800 286 331

Other Asia Pacific Countries:

(tel) (65) 6375 8100 (fax) (65) 6755 0042

Or visit Agilent World Wide Web at:
www.agilent.com/find/assist

Product specifications and descriptions in this document are subject to change without notice. Always refer to the English version at the Agilent Web site for the latest revision.

© Agilent Technologies, Inc. 2009–2013

Printed in Malaysia
Eighth Edition, July 26, 2013

U2702-90013



Agilent Technologies