

7020/7021

7020/7021

PROGRAMMABLE SIGNAL SOURCE

INSTRUCTION MANUAL

HIOKI E.E. CORPORATION

— Contents —

Introduction	1
Part Names and Functions	2
1. General Description	1 - 1
1.1 Product Outline	1 - 2
1.2 Features	1 - 2
2. Specifications	2 - 1
2.1 Generation Ranges	2 - 2
2.2 General Specifications	2 - 4
3. Explanation of Each Part	3 - 1
3.1 Displays	3 - 2
3.2 Function Keys	3 - 3
3.3 Data Input Keys	3 - 4
3.4 OUTPUT Switch	3 - 5
3.5 OUTPUT Terminals	3 - 6
3.6 Memory Keys	3 - 7
3.7 SHIFT/LOCAL Key	3 - 8
3.8 OSC. IN Terminal	3 - 10
3.9 REMOTE Terminal	3 - 13
4. Operation	4 - 1
4.1 Precautions	4 - 2
4.2 Operation	4 - 3
4.3 Setting the Output with the Numerical Keys	4 - 5
4.4 Setting the Output with the Rotary Knob	4 - 5
4.5 The Limiter	4 - 6
4.6 The Monitor	4 - 7
4.7 Setting the Frequency	4 - 7
4.8 Protection Function	4 - 8
4.9 AC Output with the 7021	4 - 8
4.10 Using the Bypass Function	4 - 9
4.11 Using the Unit as a Load	4 - 9
4.12 Output Setting Examples	4 - 10
4.13 Examples Using an External Input	4 - 12
5. Memory Function	5 - 1
5.1 Memory Structure	5 - 2
5.2 Storage Mode	5 - 2
5.3 Recall Mode	5 - 4
5.4 Auto Scan Recall	5 - 5
5.5 Examples of Memory Usage	5 - 6
6. Using the GP-IB	6 - 1
7. Characteristics	7 - 1
8. Inspection and Maintenance	8 - 1

⚠ WARNING

This instrument is designed to prevent accidental shock to the operator when properly used. However, no engineering design can render safe an instrument which is used carelessly. Therefore, this manual must be read carefully and completely before making any measurement. Failure to follow directions can result in a serious or fatal accident.

Introduction

Thank you for choosing the Hioki 7020 Programmable AC/DC Signal Source or 7021 Programmable DC Signal Source. In order to take full advantage of the unit and extend its service life, please read this manual thoroughly before use.

Precautions on Operation

Please observe the points below to ensure a safe and efficient operation.

Inspection

Upon receiving the unit, check to make sure that it has not been damaged during transportation. Inspect the panel switches and terminals with special care. If the unit is damaged or it does not operate according to the specifications, contact your nearest dealer.

Before Turning Power On

Confirm that your power supply matches unit ratings, and that a proper fuse is installed in the unit.

Protection Ground Terminal

No additional grounding is required if you plug a 3-pin-plug power cord to a power outlet with ground terminal. Otherwise, be sure to connect the ground terminal to ground.

Transporting the Unit

When transporting the unit, use the original packing materials. In case these are not available, proceed as follows.

1. Wrap the unit in vinyl plastic or the like.
2. Wrap the unit with shock-absorbent material at least 100-mm thick, then put it in a carton at least 7-mm thick.
3. Put the accessories in, fill any empty spaces with more shock-absorbent material, and close the carton securely with adhesive tape, etc. If necessary, tie the carton with packing string.

Others

Also observe cautions found elsewhere in this manual.

Part Names and Functions. . . . Front Panel

This section introduces controls and displays required for basic operation. Part numbers refer to Figures 1 and 2 in page 5.

For details on operation, refer to the respective chapters.

Power On

- ① POWER Switch
Turns power on and off.

Displays

See 3.1 on page 3-2.

- ② Output Block
Normally, it shows the output setting. In the memory mode, it indicates the number of scans.
- ③ Limiter Block
Displays the limiter setting. During output, it shows the monitor reading. In the memory mode, it indicates the address.
- ④ Frequency Block
Shows the frequency during AC generation (only 7020). In the memory mode, it indicates the address.
- ⑤ Cursor
The digit at the cursor position can be changed continuously with the rotary knob. Numbers can also be directly input with the numerical keys to the block where the cursor is located. The cursor will flash intermittently, then remain lit when the unit setting is input.





Output Terminals

See 3.5 on page 3-6.

- ⑥ Output Terminals
Five terminals are provided: OUTPUT +/-, SENSE +/- and GUARD. The signal is output through the OUTPUT +/- terminals.

Function Key

See 3.2 on page 3-3.

- ⑦  Switches alternately between constant voltage (CV) and constant current (CC) output.
- ⑧  (7020) Switches alternately between direct current (DC) and alternating current (AC) output.
-  (7021) Effective when SHIFT 2 is set to 1 (external reference voltage input). Switches alternately between direct current (DC) and alternating current (AC) output.
- ⑨   To change the range.

⑩

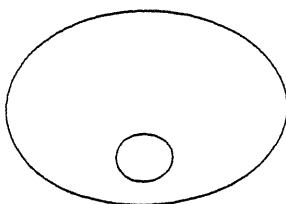

Continuously changes the digit on the cursor position.

⑪

DIGIT

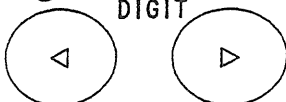

Moves the cursor within a block.

⑫

BLOCK

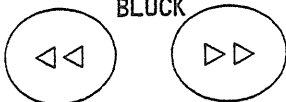

Moves the cursor among blocks.

⑬

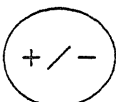

Changes output polarity.
Inoperative when AC output is used.

⑭

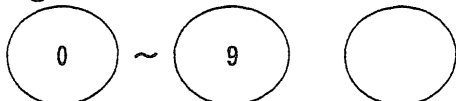

Used for direct number input to the block where the cursor is located.

⑮

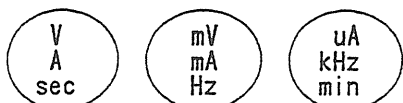

After entering a number with the numerical keys, input the unit setting with these keys. The value will be confirmed.

⑯



If you make a mistake when entering a value with the numerical keys, press this key. The previous setting will be displayed.

⑰



When this key is pressed, the "LOCK" indication lights, and no key entries will be accepted except the ON/OFF key. Press it again to release the lock.

OUTPUT ON/OFF Switch

See 3.4 on page 3-5.

⑱ OUTPUT



Turns output on and off. When set to ON, the OUTPUT indication lights. In the memory storage mode, however, no signal is output when the OUTPUT indication lights.





Others

See 3.7 on page 3-8 and 6.3 on page 6-4.

⑲



Selects and sets the external oscillator input and other functions. In GP-IB remote mode, it works as a local key to cancel remote control.

- ⑳  Stores data in the memory.
- ㉑  Retrieves stored data from the memory.
- ㉒  Outputs stored data by automatic scan.
- ㉓  Confirms data after the memory address and the number of scans have been input with the numerical keys.
- ㉔  Cancels the storage, recall and scan modes.

— Part Names and Functions. . . Rear Panel —

- ⑳ Power Input Connector
Connect the power cord here. Push it in firmly to prevent it from coming off.
- ㉑ Fuse and Fuse Holder
Always use a fuse matching the power voltage. When replacing the fuse, refer to 8.1 Replacing the Fuse.
- ⑳ Ground Terminal
This terminal is connected to the unit case. Be sure to ground it to ensure the safety of the operator and prevent disturbance.
- ㉑ Electric Fan (air outlet)
For cooling. Leave an open space of at least 30 cm behind it.
- ⑳ OSC. IN (external oscillator input) Terminal ⇒ See 3.8 on page 3-9.
BNC jack for input of an external oscillator signal. It is effective when:
- ⑳ SHIFT 1 is set to 1 (on) (7020)
 - ⑳ SHIFT 2 is set to 1 (on) (7021)
- This terminal is insulated from the case.
- ㉑ REMOTE (external control) Terminal ⇒ See 3.9 on page 3-12.
Used for output on/off, memory recall and scan external control, as well as for external reference voltage and DC bias signal input.
- ㉑ GP-IB Connector
For GP-IB connection.

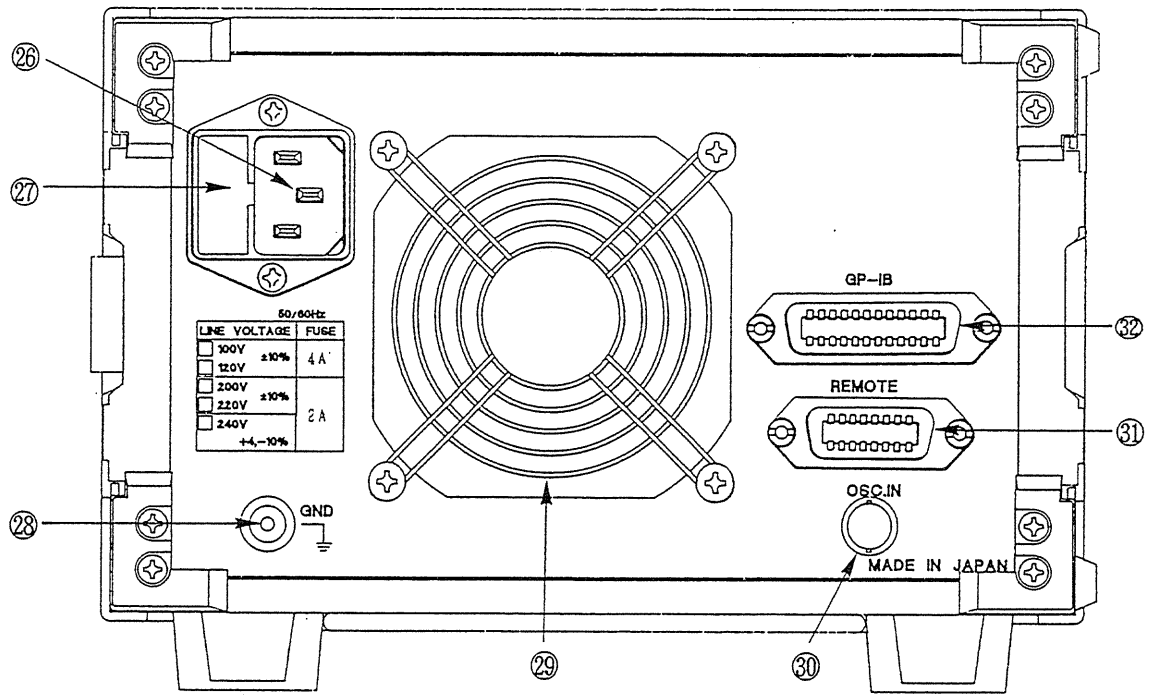

Fig. 1 Rear Panel

Chapter 1

General Description

1.1 Product Outline

The 7020 Programmable AC/DC Signal Source and the 7020 Programmable DC Signal Source supply bipolar voltage and current outputs.

Their wide output range, high precision, adjustable limiter, monitor and bias functions, 500-step memory, and GP-IB compatibility, make them ideal for a wide variety of applications from the laboratory to the production line, not only as signal sources but also as power supply or electronic load devices.

This section introduces controls and displays required for basic operation. Part numbers refer to Figures 1 and 2 in page 5.

For details on operation, refer to the respective chapters.

1.2 Features

- Wide output range

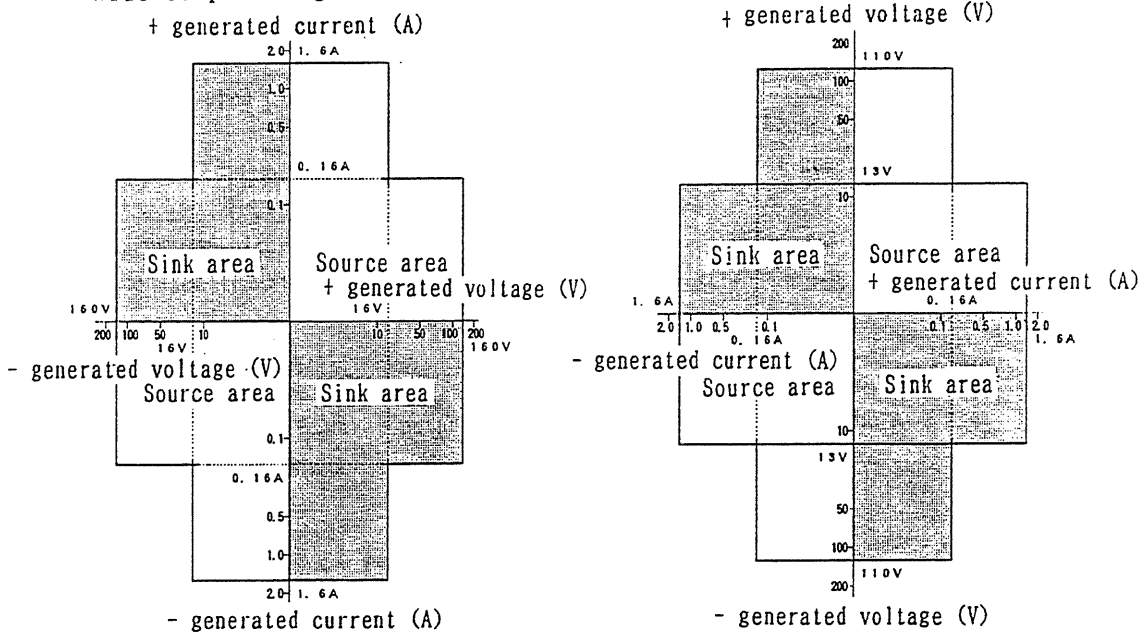

During DC constant current output
Generated current $0 \pm 1.6A$

During DC constant current output
Generated current $0 \pm 110V$

Fig. 1-1 Generation Range

Five ranges, maximum output 25 VA

For AC generation with the 7020, maximum output 12 VA

- Bipolar output

As shown in Fig. 1-1, it permits both current supply (source) and sinking.

- AC output with the 7020

In addition to bipolar DC output, the 7020 is provided with AC constant voltage and current outputs, as well as a limiter function. It is also equipped with an AC rms value monitor that gives accurate readings even for distorted waveforms.

- High-precision output
- High-speed response (1 ms)
- Limiter function

The adjustable voltage and current limiter of this unit protects the load by restricting overloads.

- Voltage and current monitor

Constant voltage (CV) mode Monitors the load current.

Constant current (CC) mode Monitors the load voltage.

- Amplifier function

Works as a power amplifier to boost the input signal.

- Bias function

To superpose an external signal before output.

- 500-step memory

Stores generation conditions in up to 500 steps. Equipped with recall auto scan, convenient for automatic testing. Stored data are backed up by a lithium battery.

- Lock function

Prevents misoperation by locking unit settings.

- Remote Control

Permits external control of output on/off, as well as memory data recall and scan.

- GP-IB

Complies with the IEEE 488-1978 standard. Listener function allowing for control of all operations except power on/off. Output monitor talker function.

Service request function to indicate unit troubles.

Chapter 2

Specifications

2.1 Generation Ranges

When temperature is $+23^{\circ}\text{C} \pm 3^{\circ}\text{C}$, humidity is 80% RH or less, and warm-up time is 30 minutes or more

Voltage generation range

	Range	Output range	Resolution	Maximum output *1	Accuracy (of range)	Temperature coefficient *3
DC V	16mV	0 ~ ±16.000mV	1 μV	1 Ω *2	0.08% + 1 μV	100ppm
	160mV	0 ~ ±160.00mV	10 μV	Approx. ±1.6A	0.06% + 10 μV	200ppm
	1.6V	0 ~ ±1.6000V	100 μV	Approx. ±1.6A	0.025% + 100 μV	50ppm
	16V	0 ~ ±16.000V	1mV	Approx. ±1.6A	0.025% + 1mV	50ppm
	160V	0 ~ ±160.00V	10mV	Approx. ±160mA	0.03% + 10mV	50ppm
DC A	160 μV	0 ~ ±160.00 μA	10 nA	Approx. ±110V	0.05% + 10 nA	100ppm
	1.6mA	0 ~ ±1.6000mA	100 nA	Approx. ±110V	0.03% + 100 nA	50ppm
	16mA	0 ~ ±16.000mA	1 μA	Approx. ±110V	0.03% + 1 μA	50ppm
	160mA	0 ~ ±160.00mA	10 μA	Approx. ±110V	0.08% + 10 μA	50ppm
	1.6A	0 ~ ±1.6000A	100 μA	Approx. ±13V	0.08% + 100 μA	100ppm
AC V	110mV	5m ~ 110.00mV	10 μV	Approx. 1.1A	0.5% ≤ 1kHz, 0.6% ≤ 10kHz	200ppm
	1.1V	0 ~ 1.1000V	100 μV	Approx. 1.1A	0.15% 0.2 %	150ppm
	11V	0 ~ 11.000V	1mV	Approx. 1.1A	0.15% 0.2 %	150ppm
	110V	0 ~ 110.00V	10mV	Approx. 110m	0.15% 0.8 %	150ppm
AC A	1.1mA	0 ~ 1.1000mA	100 nA	Approx. 78V	0.3% ≤ 1kHz, 0.6% ≤ 3kHz	150ppm
	11mA	0 ~ 11.000mA	1 μA	Approx. 78V	0.25% 0.5%	150ppm
	110mA	0 ~ 110.00mA	10 μA	Approx. 78V	0.25% 0.5%	150ppm
	1.1A	0 ~ 1.1000A	100 μA	Approx. 9V	0.3% 0.6%	200ppm

*1 Output range: 500 dgt. or more *2 Resistance output: 1-ohm *3 /°C of range

Monitor

	Range	Display range	Resolution	Accuracy *
Current monitor	DC160mV, 1.6V, 16V DC160V	0 ~ Approx. ±1.600A 0 ~ Approx. ±160.0mA	1mA 0.1mA	±8dgt. ±8dgt.
	AC110mV, 1.1V, 11V AC110V	0 ~ Approx. 1.100A 0 ~ Approx. 110.0A	1mA 0.1mA	50Hz ~ 1kHz: 1kHz ~ 10kHz ±8dgt. : ±15dgt. ±8dgt. : Not stipulated
Voltage monitor	DC160 μA, 1.6mA, 16mA, 160mA DC1.6A	0 ~ Approx. ±110.V 0 ~ Approx. ±13.00V	0.1V 0.01V	±8dgt. ±40dgt.
	AC1.1mA, 11mA, 110mA AC1.1A	0 ~ Approx. 78.0V 0 ~ Approx. 9.00V	0.1V 0.01V	±8dgt. ±30dgt.

* Not stipulated for 40 Hz or less. Not applicable during limiter operation.

Load regulation (added to the basic accuracy)

	Range	Accuracy (of range)		
Voltage	DC16mV, DC160mV, 1.61V DC16V, 160V	Not stipulated $\pm 400 \mu\text{V}$ $\pm 0.05\%$		
	AC	10Hz~1kHz $\pm 0.08\%$ $\pm 1\text{mV}$	1kHz~10kHz $\pm 0.08\%$ $\pm 10\text{mV}$	
Current	DC	$\pm 0.001\% \times V_z$		
	AC11mA, 110mA, AC1.1mA, 1.1A	10Hz~100Hz $\pm 0.001\% \times V_z$	100Hz~1kHz $\pm 0.001\% \times V_z \times f/100$ $\pm 0.005\% \times V_z \times f/100$	1kHz~3kHz Not stipulated

V_z : Output voltage f : Output frequency

Limiter (peak value)

	Setting range	Resolution	Range, function
Current limiter	0.01A ~ 1.60A	0.01A	DC160mV~16V, AC110mV~11V
	0.01A ~ 0.16A	0.01A	DC160V, AC110V
Voltage limiter	1V ~ 110V	1V	DC160 μA ~160mA, AC1.1mA~110mA
	1V ~ 13V	1V	DC1.6A, AC1.1A

During limiter operation, output is limited according to the limit setting. Operation is automatically restored when the cause of limiter operation is limited.

Output response time

FAST: 1ms

SLOW: 10 ms (voltage range) /4 ms (current range)

Times indicated are those required for the output to reach +0.1% of the set value following a change when the load is a pure resistance and the output setting is 500 dgt (for voltage range), or the maximum setting (for current ranges). Polarity reversal time is doubled. (However, this does not apply in the 160 μA range.)

7020 · 7021

Output noise
data table

Range Constant-Voltage Output	Output noise value	
	(rms)	(p-p)
16 mV	150 μV	2.5 mV
160 mV (110 mV)	160 μV	6.0 mV
1.6 V (1.1 V)	180 μV	6.0 mV
16 V (11 V)	300 μV	9.0 mV
160 V (110 V)	14 mV	500 mV

Parenthesis indicates AC range.

Range Constant-Current Output		
	(rms)	(p-p)
160 μA	2.5 μA	120 μA
1.6 mA (1.1 mA)	4.0 μA	130 μA
16 mA (11 mA)	20 μA	380 μA
160 mA (110 mA)	55 μA	1.1 mA
1.6 A (1.1 A)	92 μA	1.7 mA

Parenthesis indicates AC range.

Output noise ripple

Caution that the value is influenced by environment in use(power source, load).

AC section(7020 only)

Oscillator frequency:10 Hz to 10.00 kHz Resolution: 10Hz

* The current range is 10 Hz to 3 kHz.

Accuracy : +0.3% \pm 0.4Hz

2.2 General Specifications

Displays

Output displays	: Polarity (AC/+/-) 5 digits of 7 segments each Unit
Limiter display	: 4 digits of 7 segments each Unit
Monitor display	: Polarity (AC/+/-) 4 digits of 7 segments each Unit
Frequency display	: 3 digits of 7 segments each Unit
Unit indications	: V, mV, A, mA, μ A, min, sec (Hz, kHz only for the 7020)

Output Setting

Rotary knob	: Continuous setting
Numerical keys	: Direct setting
Memory	: Built-in 500-step memory Backed up by a lithium battery (approx. 5 years)
GP-IB	: Complies with IEEE 488-1978 standard.
Calibration Interval	: 3 months
Warmup Time	: Min. 30 minutes (to obtain the specified accuracy)
Output Modes	: AC/DC (7020), DC (7021) Constant voltage (CV)/Constant current (CC)
Protection Function	: Overload, overheat, power trouble
Output Terminals	: Guarded five-terminal cluster
Operating Temperature and Humidity:	0°C to 40°C, 80% max. (no condensation)
Storage Temperature and Humidity:	-25°C to 70°C, 85% max. (no condensation)

2.2 General Specifications

Power Requirements	: AC 100 \pm 10%, 50/60 Hz (120, 200, 220, 240 V models available by special order)
Insulation Resistance	: 100 M Ω min. at 500 Vdc (between the power supply and the chassis) 100 M Ω min. at 500 Vdc (between the guarded terminals and the chassis)
Dielectric Resistance	: 1500 Vac/one minute (between the power supply and the chassis) 250 Vac/one minute (between the guarded terminals and the chassis)
Power Consumption	: 200VA max.
Dimensions	: 132 H \times 215 W \times 415 D (mm) (not including protrusions)
Weight	: Approx. 10 kg
Attached Accessories	: Power cord 1 Instruction Manual 1 Spare fuse 1 (attached to the power inlet) 100V/120V ...4A/250V 5.2 dia. \times 20 mm 200V/220V/240V...2A/250A 5.2 dia. \times 20 mm midget fuse
Optional Accessories	: 9151-02 GP-IB connection cable (2 m) 9151-04 GP-IB connection cable (4 m)

7020 AC Generation Mode

Oscillation Frequency Ranges:

10 Hz to 10 kHz (constant voltage generation)

10 Hz to 3 kHz (constant current generation)

(the internal AGC circuit is not used between 10 Hz and 40 Hz)

Frequency Setting Resolution:

10 Hz

Frequency Accuracy : 0.3%

Chapter 3

Explanation of Each Part

3.1 Displays

The following indications are given during operation in each mode.

Mode	②Output Block	③Limiter Block	④Frequency Block
Constant Voltage (CV)	Voltage setting	Current limiter current monitor setting	Frequency(7020 AC)
Constant Current (CC)	Current setting	Voltage limiter voltage monitor setting	Frequency(7020 AC)
Memory Storage	(1) Storage mode (STORE) indication (2) Current/voltage setting	(1) Storage address (ADRS) indication (2) Limiter setting	(1) Data output time (2) Frequency (7020 AC)
Memory Scan	(1) Scan mode (SCAN) indication Number of repeats (CYCL) indication (2) Output data indication	(1) Start address (START ADRS) indication (2) Limiter/monitor indication	(1) End address (END ADRS) indication (2) Frequency (7020 AC)
Memory Recall	(1) Recall mode (RECALL) indication (2) " " (3) Output data indication	(1) Start address (START ADRS) indication (2) Recall address (ADRS) indication (0.5 s) (3) Limiter/monitor indication	(1) End address (END ADRS) indication (2) _____ (3) Frequency (7020AC)
Shift	_____	Mode	On1 Off.....0

Table 3-1 Displayed Data.

* In the constant voltage output mode, 16-mVdc range, the current monitor reading is not displayed. Numbers between brackets indicate the number of times the key has to be pressed in each mode.

* If the limit value set for the output is attained, the monitor value flickers and is displayed.

Cursor (⑤)

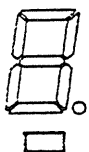

- The digit at the cursor position can be changed continuously with the rotary knob.
- Numbers can also be directly input with the numerical keys to the block where the cursor is located.
- The cursor will flash intermittently to indicate numerical key input, then remain lit when the unit key is pressed, completing the input.
- The cursor does not light during memory scan or GP-IB control.

3.2 Function Keys

⑦ Constant Voltage/Constant Current Output Switch



Switches alternately between constant voltage (CV) and constant current (CC) output. Data are kept when leaving the CV or CC mode.

⑧ DC/AC Output Selection Switch (only 7020)



Switches alternately between DC and AC output. When using DC generation, set output polarity with the polarity inversion key ⑬. Data are kept when leaving the DC or AC mode.

⑨ External Input Mode Switch (only 7021)



This key is used to switch the 7021 display to AC mode when using an AC output. It switches alternately between DC and AC. When set to AC, set SHIFT 2 to 1 (on) and input an 7-Vrms AC sinewave to the rear panel OSC. IN terminal. The unit will not enter the AC mode if SHIFT. 2 is 0 (off). With an input voltage of 7 V, the output level will be within the 7020 AC output range. To set the DC mode, switch the display to DC by pressing this key, then set SHIFT 2 to 0 (OFF).

Refer to 3.8 (2)
on page 3-11.

⑩ Range Selector Keys

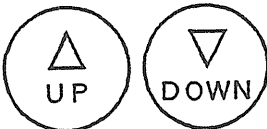

Used to change the range when setting the generation level in each mode. Ranges are shown in Table 3-2 below.

	DC Constant Voltage (CV)	DC Constant Current (CC)	AC Constant Voltage (CV)	AC Constant Current (CC)
UP △	1 6 0 V	1. 6 A	1 1 0 V	1. 1 A
	1 6 V	1 6 0 mA	1 1 V	1 1 0 mA
DOWN ▽	1. 6 V	1 6 mA	1. 1 V	1 1 mA
	1 6 0 mV	1. 6 mA	1 1 0 mV	1. 1 mA
	1 6 mV	1 6 0 μA		

Table 3-2 Ranges

3.3 Data Input Keys

⑩ Rotary Knob

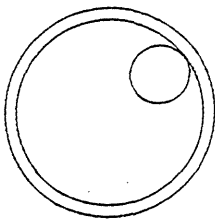

Turn it to increment or decrement the digit indicated by the cursor.

⇒ Refer to 4.4 on page 4-5.

⑪ Cursor Keys

DIGIT

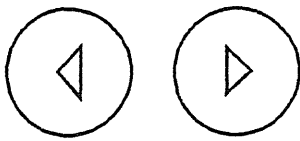

Move the cursor ⑤ within each block. Press them once to move the cursor one position right or left. If the cursor is on the

end right or left position, it will jump to the other end. It will not move, however, to digits that cannot be set.

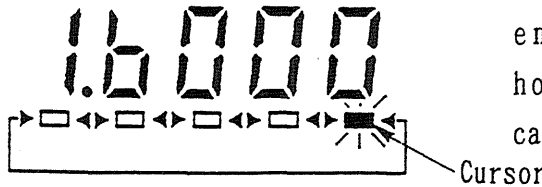

⑫ Block Selection Keys

BLOCK

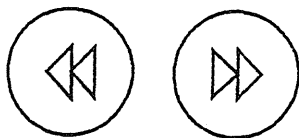

Move the cursor ⑤ between blocks. Data input with the numerical keys is only possible to the block where the cursor is located.

Use these keys to move the cursor to the desired block.

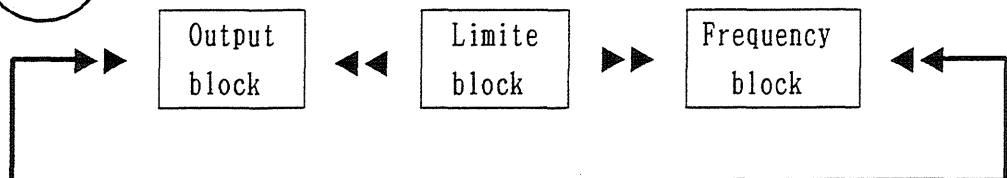

⑬ Sign Inversion Key

Selects the sign of DC constant current and voltage outputs. The sign is changed regardless of output on/off condition.

⑭ Numerical Keys (0 to 9) and Decimal Point Key

Use these keys to enter numerical values.

⇒ Refer to 4.3 on page 4-5.

⑮ Unit Keys

After entering a value, press one of these keys to select the unit and confirm your entry. If the input value is not valid, it will be cleared when the unit setting is entered.

⇒ Refer to 4.3 on page 4-5.

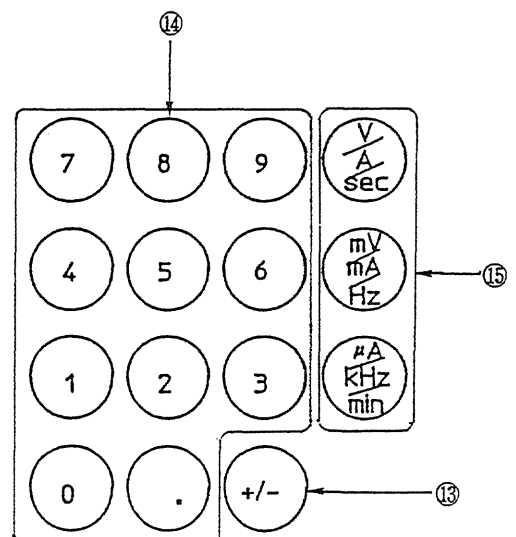

⑩ CLEAR Key



If you make a mistake when entering a value with the numerical keys ⑭, press this key to clear your entry. This is only possible while the cursor is flashing, before entering the unit setting. After the value is cleared, the display will show the previously set data.

⑪ LOCK Key



Disables front panel controls to protect unit settings. When activated, the "LOCK" indication appears and no entries will be accepted except the output ON/OFF key. If power is turned off in the locked condition, the unit will remain locked when turned on again. At this time, output will be off.

To unlock, push the LOCK key again.

3.4 OUTPUT Switch

⑫ ON/OFF Key



Turns output of set data alternately on and off. When turned on, the red "OUTPUT" indication lights.

⚠ CAUTION

- If output is turned on in the memory storage mode, the "OUTPUT" indication lights, but no actual output is delivered. It is, however, when SHIFT. 6 is set to 1 (on). Refer to 5.2 on page 5-2.
- During recall and scan operations, the set value is output.

3.5 OUTPUT Terminals

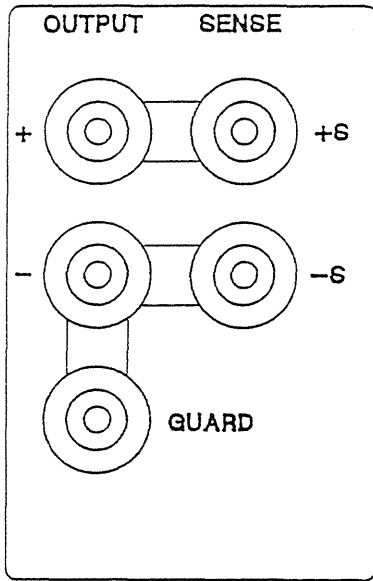

Fig. 3-1

Output Terminals

Output is performed through the OUTPUT terminals.

- (1) When using a constant voltage (CV) output (except in the DC 16 - mV range), connect
 - OUTPUT+ to SENSE+S.
 - OUTPUT- to SENSE-S and GUARD. In this case, the SENSE terminals are used to send the output voltage to the internal circuit.
- (2) When using constant current (CC) or voltage (CV) output in the DC 16-mV range, remove the shorting bars and connect the load to the OUTPUT terminals. If the OUTPUT and SENSE terminals are kept connected, error will occur at low output levels.
- (3) When output is off, the OUTPUT+ and - terminals are short-circuited with a resistance of 24 kohms/2 W (1 ohm/0.5 W in the 16 mVdc range. The SENSE+S AND -S terminals are open.
- (4) To cancel the influence of line resistance, use the 4-terminal output connection method described on page 4-4.

⚠ WARNING

- To prevent electric shocks, do never touch the output terminals when output is on.

⚠ CAUTION

- When using a constant voltage output (except in the DC 16-mV range), never connect the load to the SENSE terminals without shorting them with the OUTPUT terminals.
- Be sure to observe the proper polarity when connecting the OUTPUT and SENSE terminals. Always connect OUTPUT+ to SENSE+S, and OUTPUT- to SENSE-S. The abnormal output produced when OUTPUT+ is connected to SENSE-S and OUTPUT- to SENSE+S may damage the load or result in unit trouble.
- Leaving the OUTPUT and SENSE terminals open or shorting them with a resistance when using a constant voltage output (except in the DC 16-mV range) may produce error.
- Do not apply a voltage to the output terminals when output is off.
- The OUTPUT- terminal is connected to the internal circuitry even when the output is off.

3.6 Memory Keys

⑳ STORE Key

⇒See 5.2 on page 5-2.



(1)Normal Storage Mode (SHIFT 6•0)

- When pressed once, the address and output time of data to be stored are displayed.
- When pressed twice, the output time is stored, and the data input mode is set.
- When pressed three times, data displayed on the front panel are stored, then the next address and output time are displayed. This operation is then repeated.
- Press the MEMO. OFF key ㉔ to leave the storage mode.

(2)Panel Data Storage (SHIFT 6•1)

- When pressed once, the address and output time of data to be stored are displayed.
- When pressed twice times, data previously displayed on the front panel are shown again and stored.
- Press the MEMO. OFF key ㉔ to leave the storage mode.

㉑ RECALL Key

⇒See 5.3 on page 5-5.



- When pressed once, recall start and end addresses are displayed.
- When pressed twice, the address to be recalled is displayed 0.5 seconds, then stored data are displayed and output. This operation is then repeated.
- Press the MEMO. OFF key ㉔ to leave the recall mode.

㉒ SCAN Key

⇒See 5.4 on page 5-6.



- When pressed once, the number of repeated scans and the scan start and end addresses are displayed.
- When pressed twice, scan is executed.
- Press the MEMO. OFF key ㉔ to leave the scan mode.

㉓ Address/Cycle Key



- After entering an address or number of repeats (cycles) in the storage, recall or scan mode, press this key to confirm your entry and complete the setting operation.
- In the recall mode, the address is displayed first. To output the data stored in a certain address, input the address with the rotary knob or the numerical keys, then press the RECALL key ㉑.

㉔ Memory Off Key

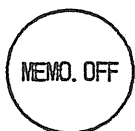

Press this key to leave the storage, recall and scan modes. If pressed during the scan operation, it will be interrupted.

3. 7 SHIFT/LOCAL Key

⑬ SHIFT/LOCAL Key * See 6.3 on page 6-4 for details on the LOCAL function.



(1) Press the SHIFT/LOCAL key once to set the mode selection standby mode. The SHIFT indicator will light.

(2) Set the desired mode with the numerical keys. The selected mode will be displayed on the limiter block, and data corresponding to that mode will appear on the frequency block.

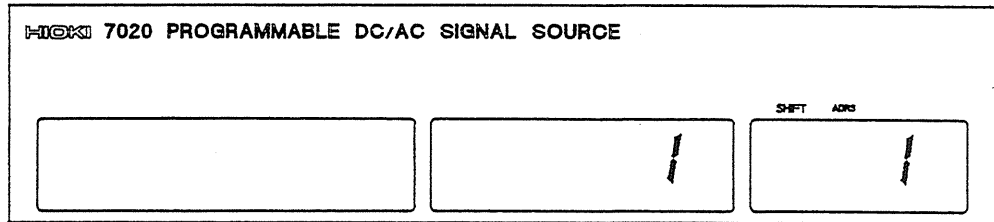

(3) Enter 0 or 1 (SHIFT 1 to 4, 6) and the address (00 to 30, SHIFT 5) with the numerical keys.

(4) Press the SHIFT key again to complete the setting. The signal from an external oscillator, an external reference voltage or a bias voltage are input from the rear panel REMOTE (external control) connector.

SHIFT No.	Mode	Set		Description
1	Internal/external oscillator selection	Internal 0 (off)	External 1 (on)	Switch to 1 when using the signal from an external oscillator for AC output. (only 7020)
2	Internal/external reference voltage selection	Internal 0 (off)	External 1 (on)	Switch to 1 when using an external reference voltage. In the 7021, switch to 1 when an AC output is required.
3	Bias input on/off	0 (off)	1 (on)	Use to add an external DC bias signal to the output set value.
4	Oscillator block AGC on/off	0 (on)	1 (off)	Turn it off when frequency of the 7020 oscillator is below 50 Hz to prevent instability of the AGC (automatic gain control) circuit. At higher frequencies, turn it on.
5	GP-IB address setting	00 to 30		Sets the GP-IB address of this unit.
6	Storage mode selection	Normal 0	Panel data 1	Sets the mode for storing data into memory.
7	Start speed selection	Fast 0	Slow 1	Sets output response time.

Table 3-3 Shift Functions

⚠ CAUTION

- Shift functions cannot be used in the memory mode.
- Modes 1 and 4 are valid only for AC generation with the 7020.
- For AC output, set SHIFT7 to 0 ; otherwise, the desired output may not be obtained.

3.8 OSC. IN Terminal

The input circuit of this unit is shown in Fig. 3-2. For operation details, refer to Chapter 4. Operation.

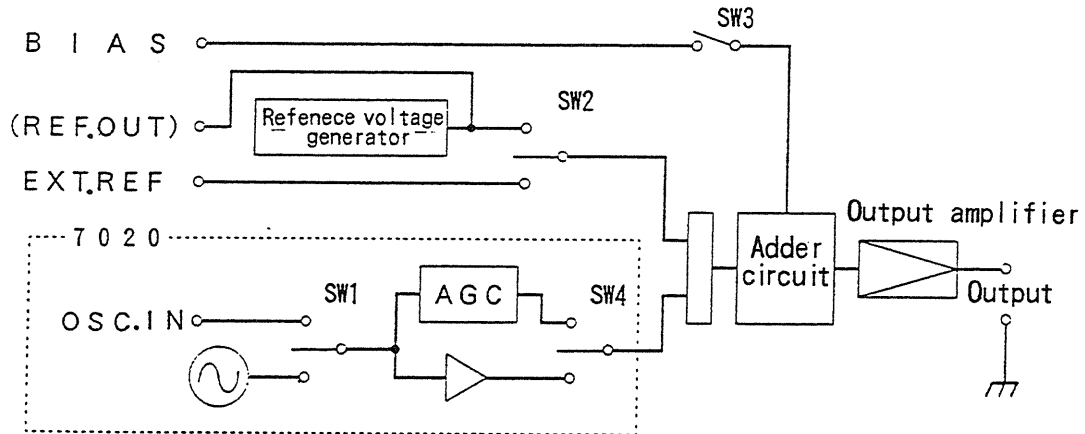

Fig. 3-2 Input Circuit

Signals are input through the OSC. IN (external oscillator input) terminal ③⑩ and the REMOTE (external control) terminal ③⑪, then they are used as follows according to the SHIFT setting.

- (1) External oscillator input, selected waveform output (only 7020)
- (2) External reference voltage input, output adjustment
AC input and amplification (7021)
- (3) External DC bias signal input and amplification

(1) SHIFT 1: Internal/External Oscillator Selection (only 7020)

Make this connection to use an external oscillator instead of the internal 7020 oscillator in the AC mode. It can also be used to obtain a waveform other than a sine wave.

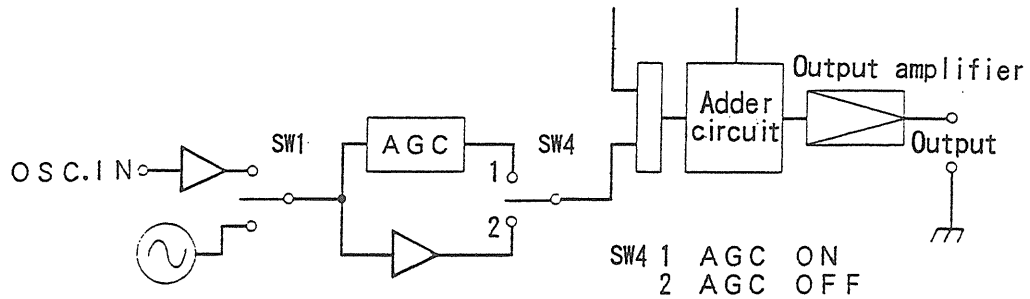

Fig. 3-3 7020 Internal Structure.

Select external oscillator input by setting SHIFT 1 to 1, and connect the oscillator

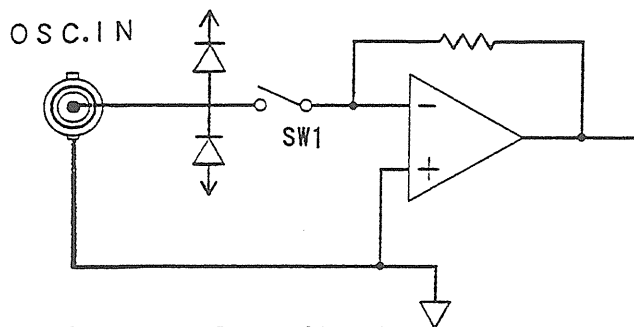

Fig. 3-4 Input Circuit

* Input signal

Frequency range: Up to 10kHz (DC)

Input level: 1 Vrms \pm 5%

Input impedance: Approx. 600 Ω

Distortion: 0.03% max.

⚠ CAUTION

- When the AGC is on, always set the input voltage from the oscillator to 1 Vrms. Normal operation is not possible at other voltages.
- When the AGC is off, the output voltage (or current) is equal to the set level when the input voltage is 1 V. Thus, the output voltage is equal to the input voltage times the panel setting.
- Input impedance of OSC. IN depends on the SHIFT 1 setting, being approx. 600 Ω when SHIFT 1 is 1.
- In case frequency is lower than 50 Hz, set SHIFT 4 to 1 (off) to prevent AGC (automatic gain control) circuit instability.
- When a special waveform is input, the AGC circuit may become unstable, resulting in a distorted or unstable output waveform. In that case, set SHIFT 4 to 1(off).
- If a special waveform contains harmonic components, the output waveform may be very distorted.
- When SHIFT 1 is set to 1, frequency is not shown on the display.

(2) SHIFT 2: Internal/External Reference Voltage Selection

To use an external reference voltage. (± 10 V max.)

Also used to obtain an AC output with the 7021. (refer to 4.9 on page 4-8)

Input the reference voltage between pins 6 and 7 of the REMOTE terminal, set SHIFT 2 to 1, and input the AC signal. (in the 7021, the signal can also be input through the OSC. IN terminal)

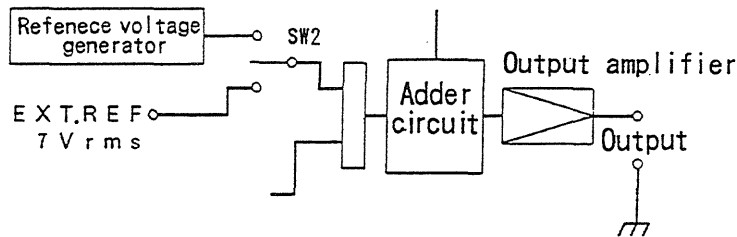

Fig. 3-5 External Reference Voltage Input Circuit

⚠ CAUTION

- When a 7-Vrms voltage is input to amplify an AC waveform, the output will follow the front panel setting.
- In the 7020 and 7021, internal reference voltage is set to 7 V. Therefore, if an external reference voltage VR1 is used, the output will be:

$$\text{Front panel setting} \times \text{VR1}/7$$
- For example, in case a signal of half (3.5 V) the internal reference voltage is input, output voltage will be half of the front panel setting.
- When SHIFT 2 is set to 1 (on), frequency is not shown on the display.

(3) SHIFT 3: Bias Input On/Off

Used to amplify the signal by adding an external bias signal.

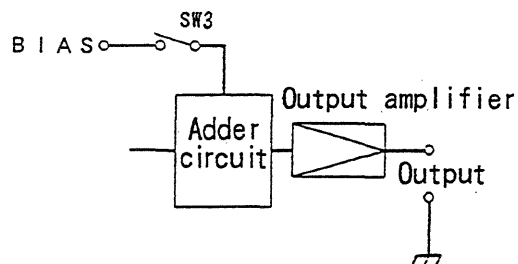

Fig. 3-6 Bias Input Circuit

⚠ CAUTION

- When applying a DC bias, check carefully the connector pin configuration in 3.9 REMOTE Terminal.

⚠ WARNING

- The maximum applicable bias voltage is 8 V. Higher voltages may result in damage to the load and/or this unit.

3.9 REMOTE Terminal

- (1) Various unit operations can be performed by connecting the pins of the rear panel REMOTE terminal shown in Table 3-3 for at least 20 ms. Make the connections using a 14-pin plug with hood (DDK type 57-30140 or equivalent). (This does not work in the GP-IB remote control mode)

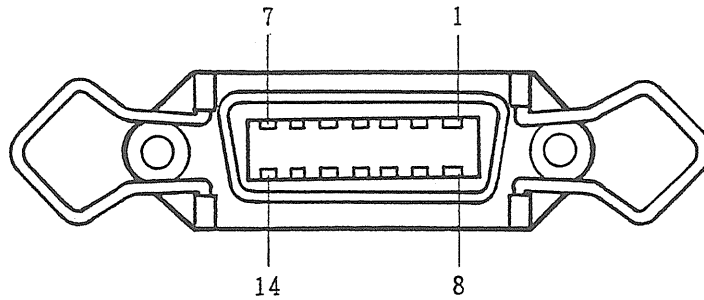

Fig. 3-7 REMOTE (External Control) Terminal

Connect pins	Operation
1-8	Same as the ON/OFF switch ⑱.
2-8	Same as the RECALL key ㉑.
3-8	Same as the MEMO. OFF key ㉒.
9-8	Same as the SCAN key ㉓.
10-4, 11	* Once scan is completed, a high-level signal is output for approx. 20 ms. (except during GP-IB remote control)

Table 3-3 External Control Functions

⚠ CAUTION

- * Pins 4 and 11 are the digital circuit ground.
- * Level at pin 10 is low during scan, and high after scan is finished.

- (2) The following are used as I/O terminals.

Terminal	Application
* 4, 11	Digital circuit ground.
* 7, 14	Analog circuit ground.
5-7, 14	7V REF. out. Outputs the 7-V internal reference voltage.
6-7, 14	EXT REF. in. External reference voltage input terminal. refer to SHIFT. 2
13-7, 14	BIAS. External DC bias signal input terminal. refer to SHIFT. 3

Table 3-4 External I/O Terminals

Chapter 4

Operation

4.1 Precautions

⚠ WARNING

- Never touch the output terminals during output. There is danger of electric shock.
- Never touch the electric fan.

⚠ CAUTION

- Make sure there is nothing connected to the output terminals before turning the power on.
- Power voltage is indicated on the rear panel. Operation at other voltages is not possible.
- Always turn power off before connecting the GP-IB connector.
- Never apply a voltage or current beyond the limit value to the output terminals when output is on.
- Never apply a voltage in the constant voltage (CV) mode, or a current in the constant current (CC) mode.
- Always use a fuse of the specified rating.
- Never connect a load to the SENSE terminals without short-circuiting the OUTPUT and SENSE terminals during constant-voltage output (except in the DC 16-mV range).
- When connecting the OUTPUT and SENSE terminals to each other, pay attention to polarity and connect OUTPUT + to SENSE +S, and OUTPUT - to SENSE -S. If OUTPUT+ and SENSE-S and OUTPUT- and SENSE+S are connected, the resulting abnormal output may damage the load and/or the unit.
- Do not apply voltage to the output terminals with the output off.
- Do not apply external voltage to the SENSE terminals.
- With output on, the following may result in arcing at the output, or damage to the load or unit.
 - (1) Abrupt change of the load
 - (2) Use with the power switch off and power interrupted
- When switching between 40 and 50 Hz during AC generation with the 7020, overshoot occurs due to AGC on/off switching which may result in an excessive output. To prevent this, output is temporarily turned off for about 1 sec. by the unit. However, the OUTPUT indicator remains lit, and SHIFT4 is 0 (AGC circuit ON).
- When using the unit as a load, never connect a voltage or current source exceeding the maximum output at the selected range and the limiter setting.
- The maximum applicable DC bias voltage is 8 V. Higher voltages may damage the load and/or this unit.
- If continuous output is maintained when the power supply voltage and the ambient temperature are high and the internal loss is great, the output will go off due to the internal heat rise and 4444 is flashed and displayed.

4.2 Operation

- (1) Let the unit warm up for at least 30 minutes after turning power on. When power is turned on, the unit is initialized according to the stored settings.

⚠ CAUTION

- If power is turned off during output, output will be off when power is turned on again.
- If power is turned off during recall or scan, the respective address setting will be recalled when power is turned on again.
- If power is turned off in the locked condition, output will be off, and all other settings will be locked when power is turned on again.

- (2) Perform range, function, limiter and frequency settings. This can be done directly with the numerical keys, or using the rotary knob. Refer to sections 4.3 and 4.4 respectively.
- (3) Connect the load to the output terminals.

⚠ CAUTION

When using a constant-voltage output (except in the DC 16-mV range), be sure to insert the shorting bars firmly. Otherwise, error may result.

- (4) Press the output ON/OFF key. The output display lights red and data set is output. At the same time, the output value is monitored and displayed.

⚠ CAUTION

- If the output exceeds the limit setting, the limiter operates. At this time, the output may differ greatly from the set value. For details, see the description of the limiter.
- If the unit is used as follows with the output on, arcing may occur at the output, resulting in possible destruction of the load or damage to the unit.
 - (1) If the load changes abruptly
 - (2) If the power switch is turned off or the power supply is interrupted.

○ Connection for 4-terminal Output

When using a constant-voltage output (except in the DC 16-mV range) and the voltage drop between the unit and the load cannot be ignored, connect as follows.

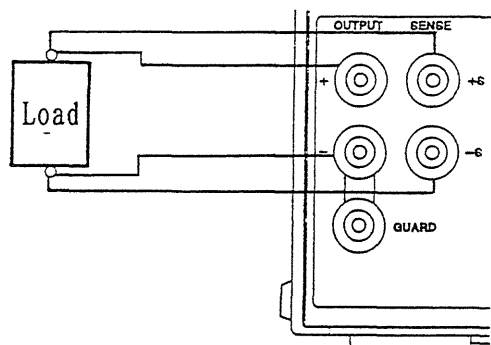

- ① Remove the shorting bars inserted into the front panel OUTPUT and SENSE + and - terminals.
- ② Connect cables to the OUTPUT and SENSE terminals and connect the + and - ends respectively at both sides of the load.

Fig. 4-1 Connection for 4-terminal Output

⚠ CAUTION

- When connecting the OUTPUT and SENSE terminals to each other, pay attention to polarity and connect OUTPUT + with SENSE +, and OUTPUT - to SENSE-. If polarity is reversed, the resulting abnormal output may damage the load and/or the unit.
- Do not apply an external voltage to the SENSE terminals.
- If long cables are used for connection, oscillation may damage the load. Always check the output.
- When using a constant-current (CC) or constant-voltage (CV) output in the DC 16-mV range, the SENSE terminals are not employed. In this case, 4-terminal connection is not necessary.
- If problems with oscillation are experienced during 4-terminal connection, either use a shielded cable or leak off current by connecting a small load. If you use a shielded cable, connect the shield to OUTPUT and the center conductor to SENSE.

4.3 Setting the Output with the Numerical Keys

- (1) Move the cursor to the block where you want to make an entry.
- (2) Input the value with the numerical keys. If you make a mistake, press the CLEAR key. Your entry will be erased, and the previous data displayed again.
- (3) Press the desired unit setting key. This completes the setting procedure.
- (4) To output, press the OUTPUT ON/OFF key next.

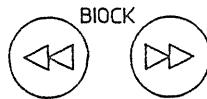
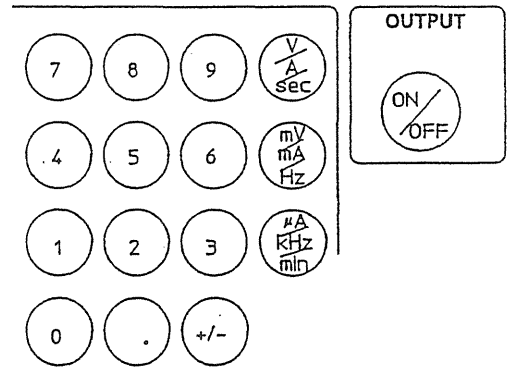

Fig. 4-2 Numerical Keys

CAUTION

- When the numerical keys are used for input, the range is set automatically.
- Always enter a unit setting after numerical input. Otherwise, the input condition will not be released, and no other key entries will be accepted.
- Settings outside the output range and those impossible to output are detected when the unit setting is input, and the entry is automatically cleared.
- An output setting of "0" is + polarity.

4.4 Setting the Output with the Rotary Knob

Settings can be continuously changed with the rotary knob on the front panel. This is convenient for fine adjustment during output.

- (1) Move the cursor to the block you want to adjust.
- (2) Move the cursor to the digit you want to adjust.
- (3) Turn the knob clockwise to increment the displayed value, or counterclockwise to decrement it.

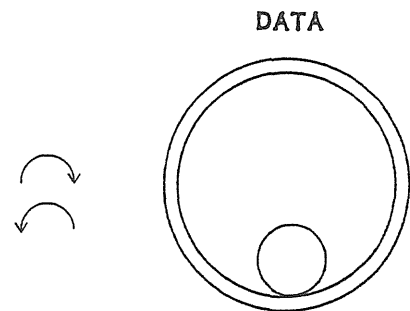

Fig. 4-3 Rotary Knob

CAUTION

- Digits can be incremented with the rotary knob up to the maximum value in each range, and decremented to zero (0).
- For DC setting, digits can be adjusted up to the q limit values in each range.
- Settings can be continuously adjusted with the rotary knob during output.

4.5 The Limiter

- (1) Constant-voltage (CV) output: Controls the current that flows into the load.
Constant-current (CC) output: Controls the voltage applied to the load.
- (2) When current flowing into the load is going to exceed the limit setting, the current limiter of this unit makes the unit keep supplying current at that limit level. On the other hand, when voltage applied to the load is going to exceed the limit setting, the unit keeps applying voltage at that limit level.
- (3) When the load current or voltage falls under the limit value, the limiter is released and output returns to the set value.

⚠ CAUTION

- The limiter always works on the basis of an absolute value. Therefore, it will be activated at both the + and - sides during DC output, and operate also according to an absolute (not rms) value during AC output. Take this into consideration when making your settings.
- Note that the value displayed by the monitor continues flashing for 1 second after the limiter is reset.

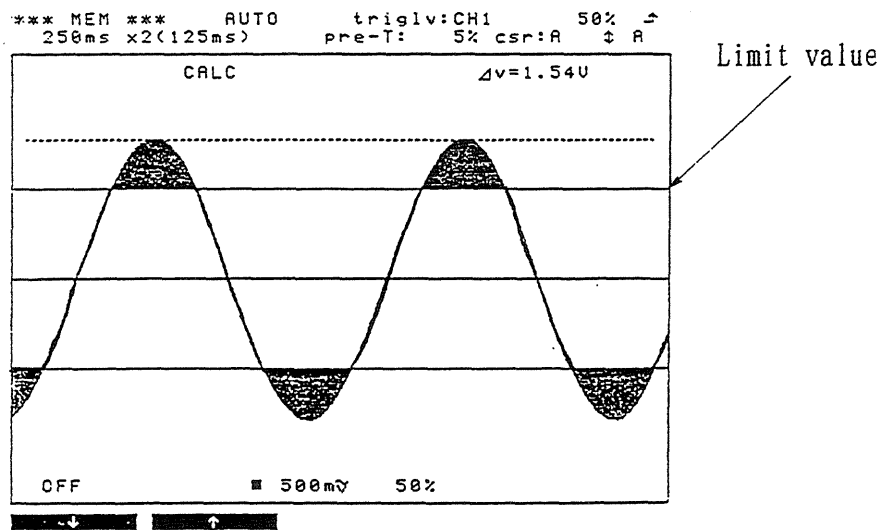

Fig. 4-4 Limiter Operation

4.6 The Monitor

- (1) Constant-voltage (CV) output: Output current is monitored.
Constant-current (CC) output: Output voltage is monitored.
Monitor readings are only displayed when output is on. Even during output, the limit value will be displayed when the cursor is moved to the limiter block to change the limit value.
- (2) The current and voltage monitor of this unit works with rms values. Therefore, it will give an accurate reading even for distorted waveforms.
- (3) The monitor reading is an average taken over approx. 0.5-s periods. This value is transferred as it is when requested through the GP-IB.
- (4) If the limiter operates when the output reaches the limit setting, the monitor display flashes.

⚠ CAUTION

- 7020 monitor frequency characteristic is 50 Hz min. for both AC and DC. Under 50 Hz AC, take the monitor reading only as a reference.
- The monitor may not function during scanning at a short interval settings.

4.7 Setting the Frequency (7020)

The 7020 has a built-in oscillator with a frequency range of 10 Hz to 10 kHz and a resolution of 10 Hz. At frequencies below 50 Hz, however, the AGC function is automatically turned off to prevent instability. Above that threshold, it is automatically turned on.

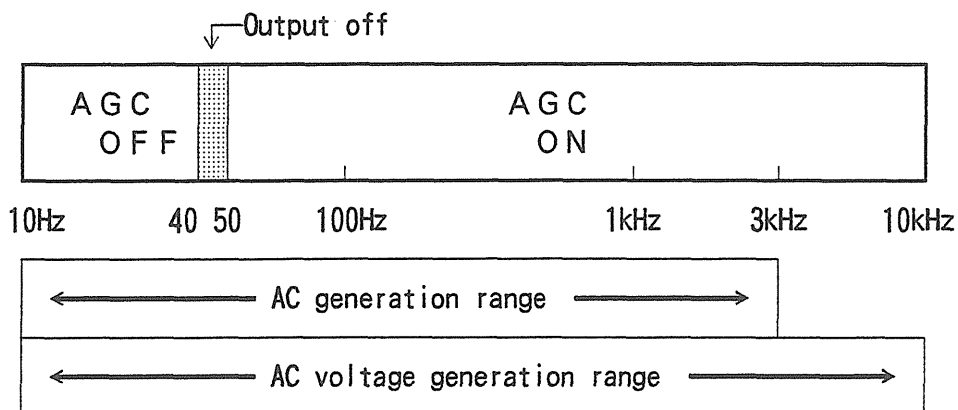

Fig. 4-5 AGC On/Off Switching

⚠ CAUTION

When switching between 40 and 50 Hz, overshoot occurs due to AGC on/off switching which may result in an excessive output. To prevent this, output is temporarily turned off by the unit. However, the OUTPUT indication remains lit.

4.8 Protection Function

When a trouble among those in Table 4-1 is detected, output is automatically turned off and the corresponding code is displayed flashing.

Trouble Code	表示コード
Power line trouble	3 3 3 3 3
Internal overheat	4 4 4 4 4
Overload/overvoltage/ oscillator trouble	5 5 5 5 5
Memory data trouble (only 7021)	8 8 8 8 8
Memory trouble	9 9 9 9 9

Table 4-1 Trouble Codes

- When power line trouble, internal overheating, or an overload/overvoltage/oscillator trouble condition occurs, the trouble code continues flashing until the problem is corrected. When the problem is corrected, pressing output ON/OFF key returns the unit to its normal state.
However, note that overload/overvoltage/oscillator trouble is detected only when output is on.
- With the 7021, memory data errors can be reset by setting the AC data to the EXT. REF mode at recall or scan.
- When a memory error occurs, the code flashes for approx. 3 seconds, then memory contents are totally cleared and normal operating conditions are restored.
- If a memory error occurs, see Chapter 8.3 Monitor Offset Cancel.

⚠ CAUTION

- If the continuous output is performed when the power-supply-voltage and ambient temperature are high and the internal loss is great, the output is off due to the internal heat rise, and 44444 is flashed and displayed.
- The overload detector protects the unit in cases when the limiter cannot protect it. The overvoltage detector protects the unit when excessive voltage is applied. The oscillator trouble detector protects the load when the standard ac voltage is high. These detectors operate when the OUTPUT switch is ON.

4.9 AC Output with the 7021.

- (1) Set SHIFT 2 to 1 (on).
- (2) Connect an oscillator (7 Vrms, with a 600-j load) to the rear panel OSC. INterminal.
- (3) Connect an DMM (5+ digits, set to ACV range) to the output terminals.
- (4) Set the 7021 to AC1. 1-V range and output a 1.0000-V voltage.
- (5) Adjust the oscillator output voltage so that the DMM reading becomes 1.00000 V.
- (6) Output the amplified AC signal according to front panel settings.

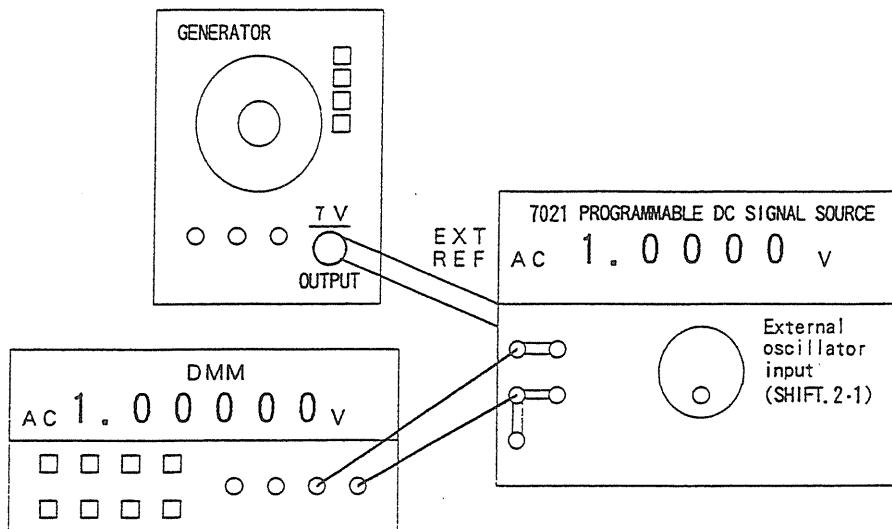

Fig. 4-6 AC Reference Voltage Input

⚠ CAUTION

- When using a DC output, set SHIFT 2 to 0 (off).
- Output accuracy will be close to that of 7020 AC output.
- Since fluctuations in the oscillator output voltage will affect the 7021 output, use of a stable oscillator is recommended.

4.10 Using the Bias function

- (1) Set SHIFT 3 to 1 (on).
- (2) Apply a bias voltage between pin 13 of the rear panel REMOTE terminal and ground (pin 7). The applicable voltage V_B is as follows.

- DC setting + DC bias

$$\left| \frac{\text{Output setting}}{2000} + V_B \right| \leq 8V$$

- DC setting + AC bias

$$\left| \frac{\text{Output setting}}{2000} + \sqrt{2}V_B \right| \leq 8V$$

- AC setting + DC bias

$$\left| \frac{\text{Output setting}}{2000} + \sqrt{2} + V_B \right| \leq 8V$$

- AC setting + AC bias

$$\left| \sqrt{2} \left(\frac{\text{Output setting}}{2000} + V_B \right) \right| \leq 8V$$

⚠ CAUTION

The output setting is the value displayed on the output block, regardless of the decimal point and the unit. For example, it will be "5000" for an AC50.00mV indication.

4.11 Using the Unit as a Load

- (1) Constant-current Load.
 - Set the unit to constant-current DC output.
 - Set an output level equal to the load current with a minus sign.
 - Set a limit value larger than the connected voltage source.
- (2) Constant-voltage Load
 - Set the unit to constant-voltage DC output.
 - Set an output level equal to the load current with a minus sign.
 - Set a limit value larger than the connected current source.

⚠ CAUTION

- Before using this unit as a load, make sure you have mastered its basic constant-voltage and constant-current operations, as well as the use of its limiter function.
- Do not connect a voltage or current source beyond the maximum output in the selected range or the limiter setting.
- This unit cannot be connected to an AC voltage or current source, nor used as a load in the AC mode.

4.12 Output Setting Examples

* Example 1

Setting the unit to constant voltage 110 V AC, frequency 5 kHz and limit value 160 mA.

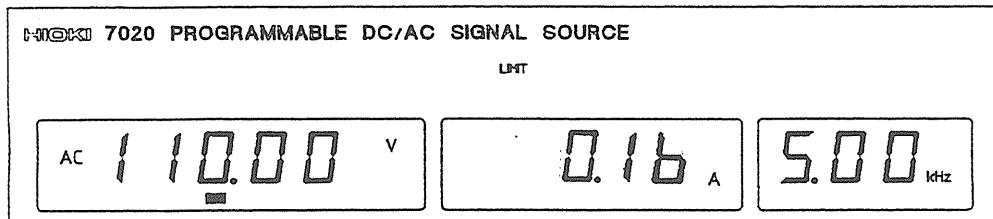
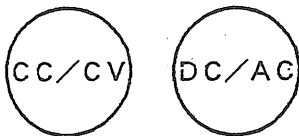

Fig. 4-7 Example 1 Displays

Setting output voltage to 110 V

(1)



Set the constant-voltage (CV) output mode and the AC output mode.

(2)

BLOCK

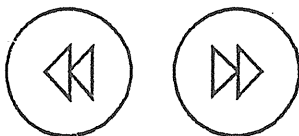

Move the cursor to the output block.

(3) Enter "110" with the numerical keys, then input the "V" unit setting.

Setting the limit value to 160 mA

(4) Move the cursor to the limiter block.

(5) Enter "160" with the numerical keys, then input the "mA" unit setting.

Setting frequency to 5 kHz

(6) Move the cursor to the frequency block.

(7) Enter "5" with the numerical keys, then input the "kHz" unit setting.

(8) Press the OUTPUT ON/OFF key. The OUTPUT indicator will light, and output will start.

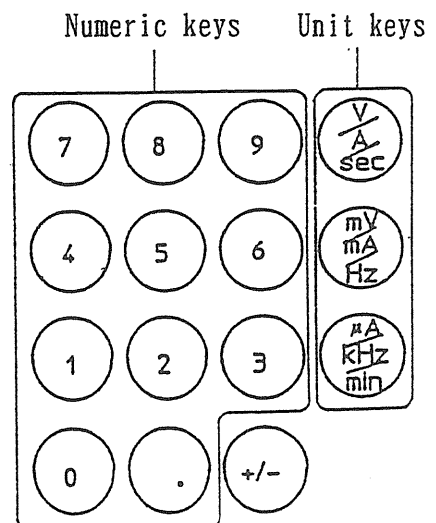

* Example 2

Setting the unit to DC constant current 1.6 A and limit value 13 V.

Setting output current to 1.6 A

- (1) Set the constant-current (CC) output mode and the DC output mode.
- (2) Move the cursor to the output block.
- (3) Set output to positive (+) with the +/- (polarity inversion) key.
- (4) Enter "1.6" with the numerical keys, then input the "A" unit setting.
- (5) Enter the 16 V limit value as in Example 1. This completes the setting procedure.
- (6) Press the OUTPUT ON/OFF key. The OUTPUT indicator will light, and output will start.

* Example 3

• Current settings: AC constant voltage 110 V, frequency 5 kHz, limit value 160 mA.

• New settings: AC constant voltage 105 V, frequency 10 kHz, limit value 160 mA.

- (1) Move the cursor to the output block.
- (2)



As shown in the figure, place the cursor on the third digit from the left.

- (3) Turn the rotary knob counterclockwise. The displayed output setting will change to 105.00 V.
- (4) Move the cursor to the frequency block.
- (5) Place the cursor on the left end digit.
- (6) Turn the rotary knob clockwise. The displayed setting will change to 10.0 kHz. This completes the setting procedure.

4.13 Examples Using an External Input

This section shows examples using the external input function of this unit. For details on operation, etc., see the previous chapter.

- (1) Set SHIFT 1 to 1 (on), input 16-Hz sine and rectangular waves from an external oscillator. They will be amplified and output by the 7020.

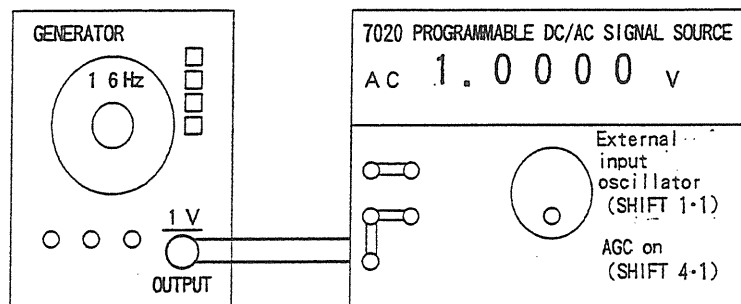

Fig. 4-8 Oscillator Input

⚠ CAUTION

- Make sure that input voltage from the oscillator is 1 Vrms. The unit will not work properly at other voltages.
- If problems with oscillation are experienced during 4-terminal connection, either use a shielded cable or leak off current by connecting a small load. If you use a shielded cable, connect the shield to OUTPUT and the center conductor to SENSE.
- When frequency is under 50 Hz, set SHIFT 4 to 1 (off) to prevent AGC (automatic gain control) circuit instability.

- (2) Evaluation of input fluctuation removal at constant voltage and current circuits, etc.

Set SHIFT 3 to 1 (on). Input fluctuation removal at constant voltage and current circuits, etc., as well as operation of the three-terminal regulator and other components can be evaluated using the DC bias superpose function of the 7020.

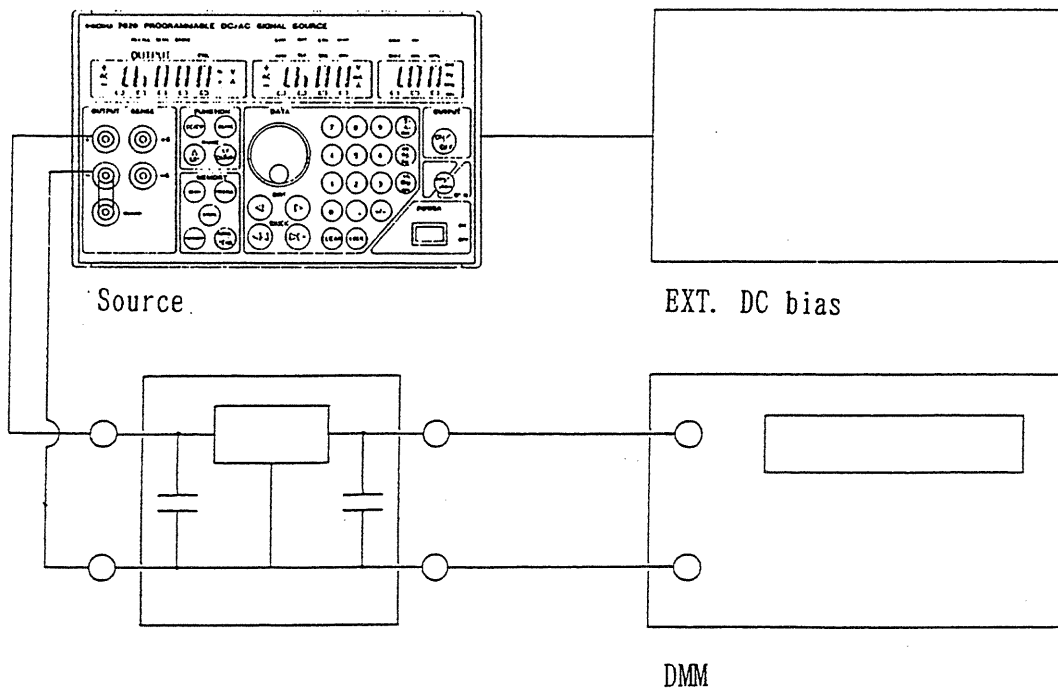

Fig. 4-9 Bias Input

⚠ CAUTION

- When applying a DC bias, check the connector pin configuration shown in 3.9 REMOTE Terminal.
- In case a large-capacity capacitor is connected to the evaluation circuit, its operation as a capacitor may be hampered by the sink function of this unit. To evaluate including the capacitor, use a diode to prevent current feedback due to the sink function.
- The maximum applicable DC bias voltage is 8 V. Higher voltages may damage the load and/or the unit.

Chapter 5

Memory Function

5.1 Memory Structure

The 500-step memory of this unit can hold output settings, limit values, frequency values, output times and output on/off settings.

Since data are stored in a CMOS RAM backed up by a lithium battery, they will be kept for approx. 5 years after purchase.

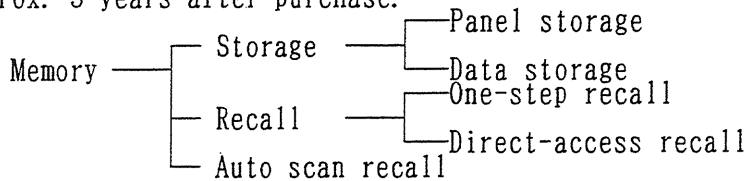

Fig. 5-1 Memory Structure

5.2 Storage Mode

(1) Data Storage (SHIFT 6•0)

- ① Press the STORE key to set the storage mode.
- ② The storage destination address and data output time (interval) are displayed. Set them with the numerical keys and/or the rotary knob. If you use the numerical keys, be sure to complete your entry by pressing the ADRS/CYCL key.

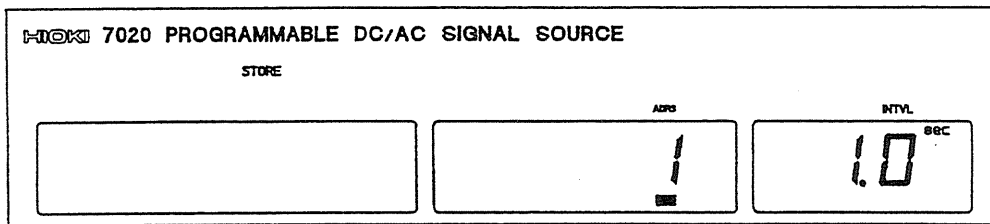

Fig. 5-2 Storage Address and Interval Display

- ③ When you press the STORE key, the unit enters the output data setting mode. Make your settings following the basic procedures.
- ④ Press the STORE key again, and the next address to be used for storage will be displayed, together with the corresponding interval. To store more data, repeat the above procedure.
- ⑤ After inputting the last data, press the STORE key to display the next address and store data in the previous address.
- ⑥ To leave the storage mode, press the MEMO. OFF key.

CAUTION

- To store data in a certain address, set the address at step 2 above, then input the corresponding data.
- In the storage mode, no signal is delivered through the output terminals even in the output mode (OUTPUT indicator lit). To actually output the signal, switch to the panel storage mode.

(2) Panel Storage (SHIFT 6•1)

Stores the present settings during output.

- ① During output, set SHIFT 6 to 1 (on). (enter SHIFT ▷ 6 ▷ 1 ▷ SHIFT)
- ② Press the STORE key. The address and interval will be displayed. Enter the destination address and output time, respectively.
- ③ Press the STORE key again, and the display will return to the present settings. Press the OUTPUT ON/OFF key and press the STORE key again to store the settings in the address selected at step ② above.
- ④ The next address will be displayed. To store more data, repeat steps ② and ③. To end the operation, press the MEMO. OFF key.

⚠ CAUTION

- SHIFT 6 is off (0) when power is turned on.
- In the panel storage mode, data are updated regardless of whether or not the memory is already occupied. Check the address carefully before storing.
- SHIFT settings cannot be stored in memory.

Confirming Memory Contents.

Memory contents can be checked simply by recalling them, without having to actually output them.

- ① Set SHIFT 6 to 0 (off).
- ② Press the STORE key repeatedly to display the address, output time and output data.

⚠ CAUTION

- Memory contents are checked in the data storage mode. Be careful not to modify stored data by mistake.

Clearing the memory contents

The memory contents (including the backup data in memory) can be cleared as follows:

- ① Turn off the power supply.
- ② While pressing MEMO. OFF key, turn off the power switch.
At this time, all LEDs flash for 3 seconds.
- ③ Press the polarity inversion key while the LEDs are flashing.
- ④ "9999" flashes on the display and the memory contents are cleared.

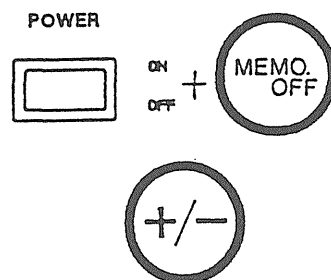

When the memory contents are cleared and a memory error occurs, the memory contents are set to the default values shown below.

(1) Backup data in ordinary output mode

① CVDC mode

(output off, 1.6V range, output value 0.0000V, limit value 0.01A)

② CCDC mode

(output off, 16mA range, output value 00.000mA, limit value 1V)

③ CVAC mode

(output off, 1.1V range, output value 0.0000V, limit value 0.01A frequency 50 Hz, (frequency only for the 7020))

④ CCAC mode

(output off, 11mA range, output value 00.000mA, limit value 1V, frequency 50 Hz (frequency only for the 7020))

(2) Shift function, etc.

- | | | |
|---|---------------------------|-------------------------------|
| ① | EXT. OSC | off (SHIFT1.0) (7020 only) |
| ② | EXT. REF | off (SHIFT2.0) |
| ③ | BIAS | off (SHIFT3.0) |
| ④ | AGC | on (SHIFT4.0) (only for 7020) |
| ⑤ | GP-IB address | 01 (SHIFT5.01) |
| ⑥ | Store mode | Data mode (SHIFT6.0) |
| ⑦ | Start speed | FAST (SHIFT6.0) |
| ⑧ | Lock | Unlock |
| ⑨ | Service request mask | 0 |
| ⑩ | Output format bit setting | 255 (7020)
251 (7021) |

(3) Memory (all addresses 1 to 500)

Output off, DCC voltage, 1.6V range, output value 0.0000V, limit value 0.01A, interval time 1.0 sec.

(4) Memory mode

Recall mode

Start address: End address → (1:1)

Recall autoscan mode

Number of scans: Start address: End address → (1:1:1)

5.3 Recall Mode

⚠ WARNING

- In this unit, current is output when the RECALL key is pressed. Always check the load before recalling data, and never touch the output terminals.

(1) One-step Recall

- ① Press the RECALL key to set the recall mode.

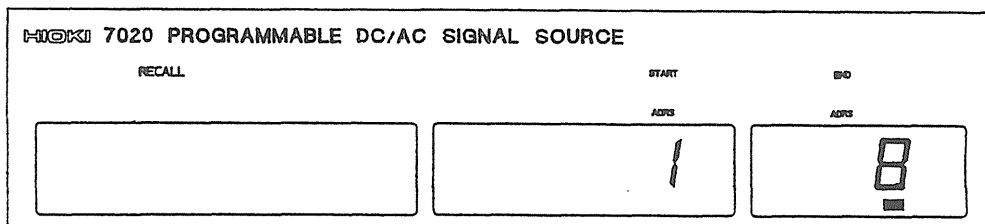

Fig. 5-3 Recall Start and End Addresses

- ② The start and end addresses will be displayed as shown in Fig. 5-3. Set the range to be recalled.
- ③ Press the RECALL key again. Data in the first address selected at step ② will be recalled, displayed and output.

⚠ CAUTION

- In the recall mode, data can be modified as in the normal mode.
- Only data within the address range set at step ② above can be recalled.
- With the 7021, a flashing "8" appears when the RECALL key is pressed if any AC data is present in memory and data is not recalled.
Set SHIFT 2 to 1 (external input) and select the EXT.REF mode.

- ④ Press the RECALL key again, and the next address number will be displayed for 0.5 second, then the contained data will be displayed and output.
- ⑤ After end address data are recalled, operation will restart from the first address.
- ⑥ To end the recall operation, press the MEMO. OFF key.

(2) Direct-access Recall

- ① To recall data from any desired address, press the ADRS/CYCL during recall.
- ② The address number will be displayed. Set the recall address and press the RECALL key. The contents of that address will be recalled, displayed and output.

5.4 Auto Scan Recall

Stored data can be automatically recalled for certain intervals by specifying the start and end addresses, as well as the number of repeats (cycles).

▷ Preparations

Confirm that the proper interval, output data, limiter value, etc. are stored in the address to be recalled.

① Press the SCAN key to set the scan mode.

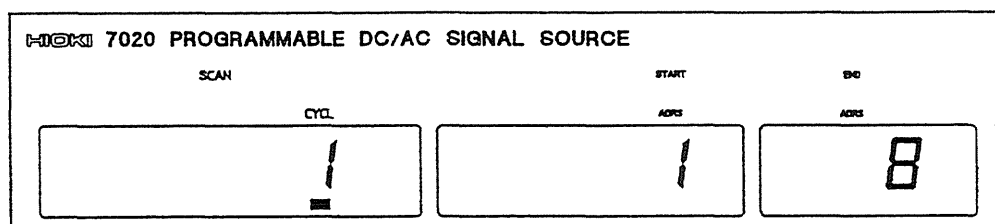

Fig. 5-4 Scan Cycle and Start/End Addresses

- ② The cycle and the start and end addresses will be displayed. Set them.
(The scan cycle can be set within 0 to 9999. If set to 0, operation will be repeated an unlimited number of times.)
- ③ Press the SCAN key again. Auto scan recall will be executed according to settings done at step ②.
- ④ When scan is completed, the display will return to step ②. To repeat scan, press the SCAN key again.
- ⑤ To end or suspend operation, press the MEMO. OFF key. The unit will return to the normal mode.

⚠ CAUTION

- Confirm the following before performing auto scan recall.
 - Are data to be recalled properly set?
 - Is the interval correctly set?
 - Is the scan cycle properly set?
 - ⇒ Confirming Memory Contents
- If the function or the output on/off setting have been changed, operation will take several dozen milliseconds extra for internal processing.
Frequency switching also takes about 1 second longer at 50 Hz.
 - ⇒ 4.7 Setting the Frequency
- As with RECALL, a flashing "8" appears with the 7021 and data is not recalled if any AC data is present in memory. Set SHFT 2 to 1 (external input) and select the EXT. REF mode.
The cursor does not light up at scan.
When scan is completed, about 20 ms signal is output to the REMOTE terminal (between 10-4.11 pins).

5.5 Examples of Memory Usage

▷ Data Storage

Example 1

Storing the following setting in address 5: DC +160 V, limit value 160 mA, output time 1 second, output on.

- ①Set the data storage mode (SHIFT 6·0 off).
- ②Set address to 5 and output time to 1 second, then press the STORE key.
- ③Enter the output data CV, (DC), +160 V, limit value 160 mA, then turn output on.

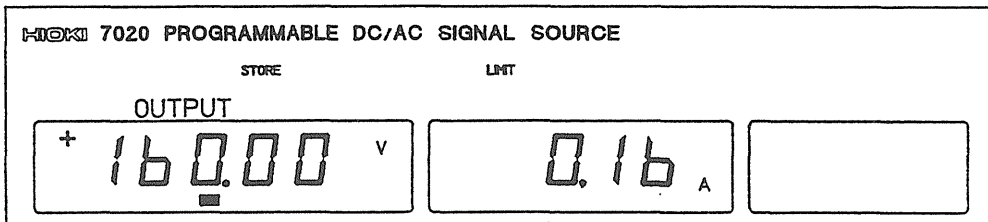

Fig. 5-5 Example 1: Stored Data (Data Storage Mode)

- ④Press the STORE key. This completes storage to address 5.
- ⑤Press the MEMO. OFF key. This ends the storage procedure.

▷ Data Storage

Example 2

Storing the following setting in addresses 11 to 20: DC +1 to 10 V, limit value 1.6 A, and output time 2 seconds, output on.

- ①Set the data storage mode (SHIFT 6·0 off).
- ②Set address to 11 and output time to 2 seconds, then press the STORE key.
- ③Enter the output data CV, (DC), +1 V, and limit value 1.6 A, then turn output on.

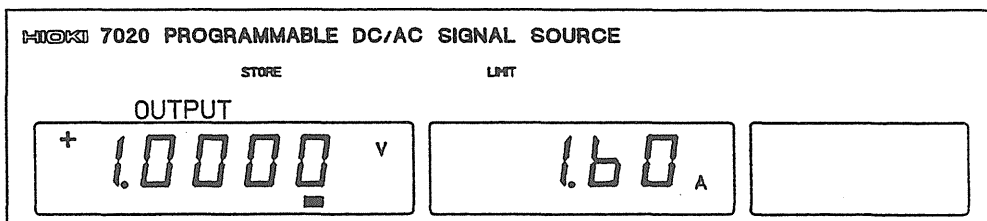

Fig. 5-6 Example 2: Stored Data (Data Storage Mode)

⚠ CAUTION

- When the 1 V setting is entered with the numerical keys, the unit is set to 1 V in the 1.6-V range.
- Since range switching takes about 50 ms, use the same range all through when performing high-speed scan.

④ Press the STORE key. Address 12 will be displayed.

Set output time to 2 seconds.

⑤ Press the STORE key again and enter the next output data: CV, (DC), +2 V, and limit value 1.6 A, then turn output on. Repeat this procedure for the remaining addresses, up to address 20.

⑥ When address 21 is displayed after setting address 20 data and pressing the STORE key, press the MEMO. OFF to leave the storage mode.

▷ Panel Storage

Example 3

Storing the data currently used for output in address 30 (CV, DC, +160 mV, limit value 1 A, output on).

① Set the panel storage mode (SHIFT 6 · 1 on).

② Set address to 30 and output time to 1 second (this can be selected freely), then press the STORE key.

③ Set data (CV, DC, +160 mV, limit value 1 A) will be displayed. Output is off at this stage, so turn it on.

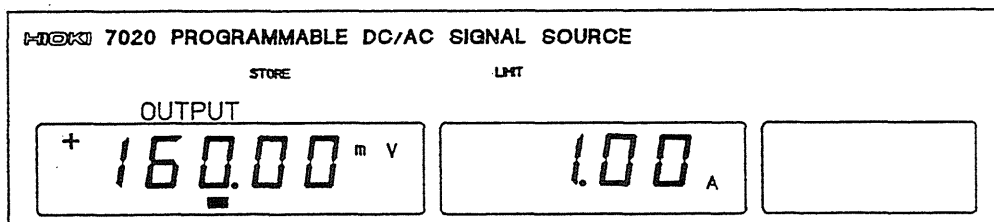

Fig. 5-7 Example 3: Stored Data (Panel Storage)

④ Press the STORE key. This completes storage to address 30.

⑤ Press the MEMO. OFF key. This ends the storage procedure.

⚠ WARNING

- When SHIFT 6 is set to 1 (on), current will actually be output also in the storage mode. Never touch the output terminals.

⚠ CAUTION

- When SHIFT 6 is 1 (on), data are updated regardless of whether or not the memory is already occupied. Check the address carefully before storing.
- SHIFT 6 is automatically turned 0 (off) when power is turned on.

▷ Memory Contents

Address	Output Time	Output Data	Limit Value	OUTPUT
5	1 s	CV · DC · +1 6 0 V	1 6 0 mA	ON
1 1	2 s	CV · DC · +1 V	1. 6 A	ON
1 2	2 s	CV · DC · +2 V	1. 6 A	ON
1 3	2 s	CV · DC · +3 V	1. 6 A	ON
1 4	2 s	CV · DC · +4 V	1. 6 A	ON
1 5	2 s	CV · DC · +5 V	1. 6 A	ON
1 6	2 s	CV · DC · +6 V	1. 6 A	ON
1 7	2 s	CV · DC · +7 V	1. 6 A	ON
1 8	2 s	CV · DC · +8 V	1. 6 A	ON
1 9	2 s	CV · DC · +9 V	1. 6 A	ON
2 0	2 s	CV · DC · +1 0 V	1. 6 A	ON
3 0	1 s	CV · DC · +1 6 0 mV	1 A	ON

Table 5-1 Memory Contents

▷ Direct-access Recall

Example 4

Recalling from address 5 the data stored in Example 1.

- ① Press the RECALL key and set both the start and addresses to 5. If you use the numerical keys, do not forget to press the ADRS/CYCL key to complete your entry.

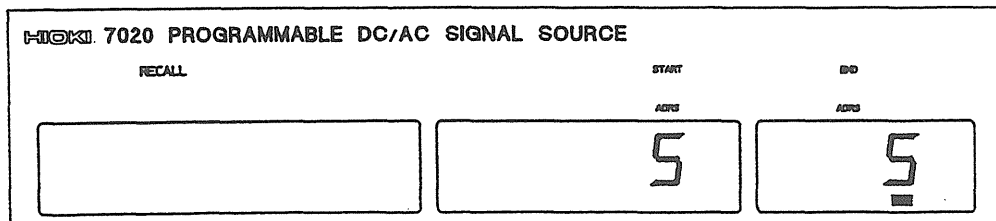

Fig. 5-8 Direct-access Recall

- ② Press the RECALL key again. The data stored in example 1 will be set and output at the same time.
- ③ To finish the procedure, press the MEMO. OFF key.

▷ One-step Recall

Example 5

Recalling the data stored in addresses 12 to 16 in Example 2.

- ① Press the RECALL key, and set the start address to 12 and the end address to 16.

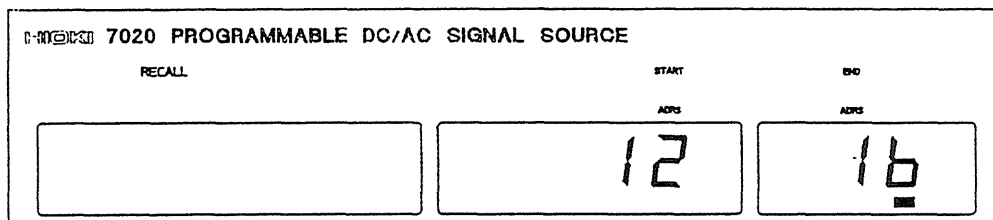

Fig. 5-9 One-step Recall

- ② Press the RECALL key again. The address number "12" will be shown by 0.5 second, then data in that address will be displayed and set.
- ③ Press the RECALL key repeatedly. The subsequent address numbers will be displayed in order by 0.5 second each, followed by their respective data contents.
- ④ After the end address 16 has been recalled, operation will return to address 12, and restart from there.
- ⑤ To finish the procedure, press the MEMO. OFF key.

▷ Auto Scan Recall

Example 6

Recalling by auto scan the data stored in addresses 11 to 20 in Example 2.

- ① Press the SCAN key to set the auto scan mode.

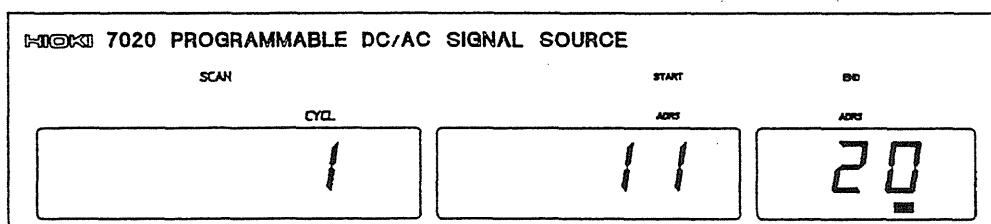

Fig. 5-10 Auto Scan Recall

- ② Set the cycle to 1, the start address to 11 and the end address to 20. See Fig. 5-10.
- ③ Press the SCAN key again. Data will be recalled from address 11 during the set output time (2 seconds).
- ④ After data have been recalled from the end address 20, the display will return to the condition shown in Fig. 5-10 (to continue scanning, press the SCAN key.)
- ⑤ To finish the procedure, press the MEMO. OFF key.

▷ Special Application

Example 7

Simulating instant power failures, power surges and drops, etc. (7020) using the memory function of this unit.

This unit can be used as a 100-V AC, approx. 10-VA power source. Using this generation capability and its high-speed memory readout function, instant power failures, power surges/drops and other phenomena can be simulated.

- ① Store the following data in address 40: 100 V AC, limit value 160 mA, output time 60 s, frequency 50 Hz, output on.
- ② Store the following data in address 41: 0 V AC, limit value 160 mA, output time 20 ms, frequency 50 Hz, output on.

Address	Output time	Output data	Limit value	OUTPUT
40	60 sec	CV · AC · 100 V · 50 Hz	160 mA	ON
41	20m sec	CV · DC · 0 V · 50 Hz	160 mA	ON

- ▷ Recall and output addresses 40 and 41 alternately. Power will be interrupted by 20 ms every 60 seconds.

△ CAUTION

- Phase sync with the generated AC signal cannot be guaranteed.
- If data are stored in address 41 with the output off, memory readout time may change due to relay operation, etc. (See Chapter 7.)

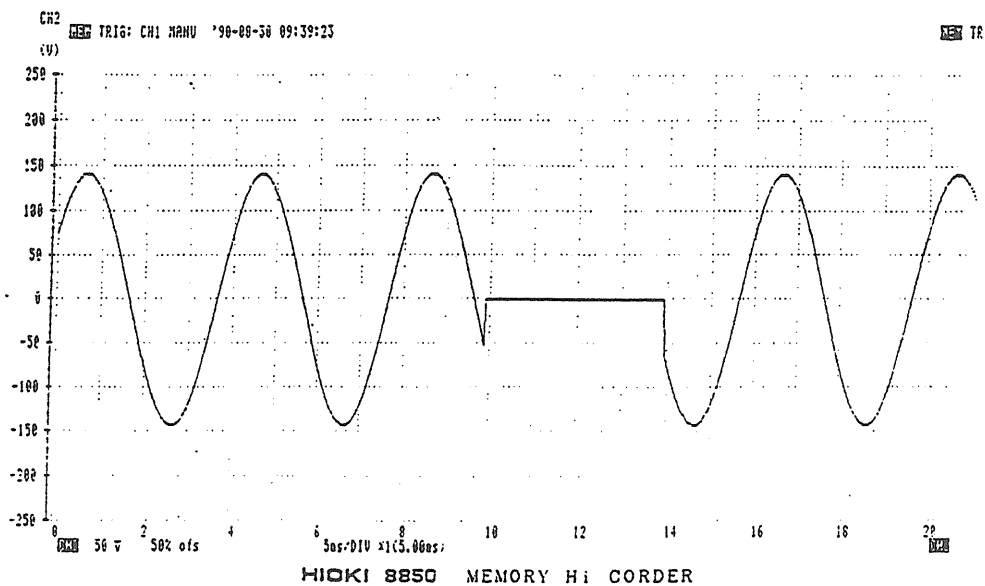

Fig. 5-11 Instant Power Failure Simulating Circuit

Chapter 6

Using the GP-IB

6. GP-IB

6.1	Outline	6-3
6.2	General Specifications.....	6-3
6.3	Parts of the Unit Related to the GP-IB.....	6-4
	Address Setting	6-5
6.4	Listener Function	6-6
	6.4.1 Normal Setting	6-6
	6.4.2 Memory Mode.....	6-7
	6.4.3 Shift Function	6-8
	6.4.4 Others	6-8
	6.4.5 Output Setting Examples	6-10
6.5	Talker Function	6-12
6.6	Output Format Programming	6-14
6.7	Information Request Codes	6-16
6.8	Service Request	6-17
6.9	GP-IB Commands.....	6-17
6.10	Sample Programs	6-18
6.11	GP-IB Command List.....	6-24

6.1 Outline

This unit can be externally controlled through the GP-IB (General Purpose Interface Bus, IEEE standard 488-1978).

6.2 General Specifications

Applicable Standard: IEEE 488-1978

Interface Functions.

Applied code: ASCII

Function	Sub Set	Description
Source handshake	SH 1	All transmission handshake functions
Acceptor handshake	AH 1	All reception handshake functions
Talker	T 6	Basic talker function, serial port, talker release by MLA
Listener	L 4	Basic listener function, listener release by MLA
Service request	SR 1	All service request functions
Remote/local	RL 1	All remote/local functions
Parallel port	PP 0	No parallel port functions
Device clear	DC 1	All device clear functions
Device trigger	DT 1	All device trigger function
Controller function	C 0	No controller function

Table 6-1 Interface Functions

6.3 Parts of the Unit Related to the GP-IB

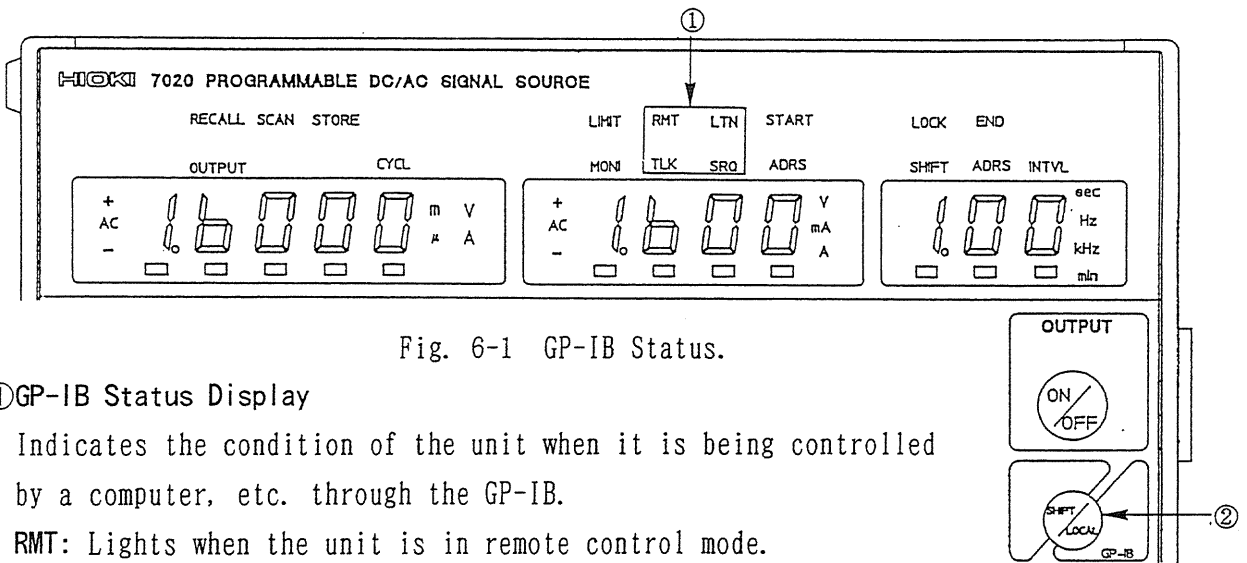

Fig. 6-1 GP-IB Status.

①GP-IB Status Display

Indicates the condition of the unit when it is being controlled by a computer, etc. through the GP-IB.

RMT: Lights when the unit is in remote control mode.

LTN: Lights when the unit is in listener (data reception) mode.

TLK: Lights when the unit is in talker (data transmission) mode.

SRQ: Lights when the unit is in service request mode.

②SHIFT/LOCAL Key

(works as LOCAL key when under GP-IB control)

Press this key to cancel the GP-IB remote control mode, returning the unit to local mode. This is not possible, however, if the local lockout command has been issued by the controller.

③GP-IB Connector

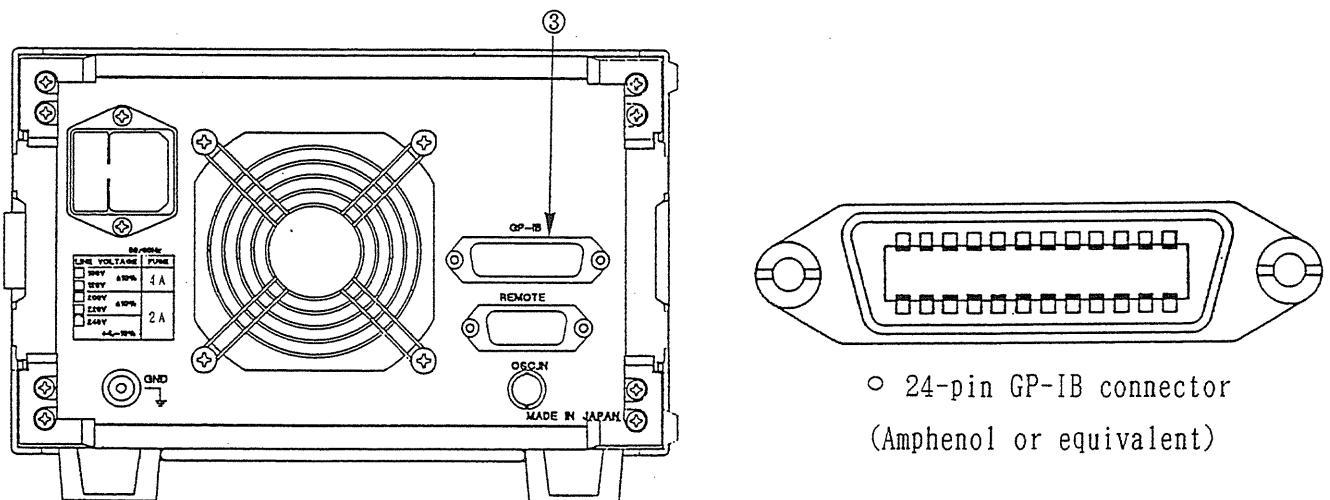

○ 24-pin GP-IB connector
(Amphenol or equivalent)

Fig. 6-2 GP-IB Connector

★ Address Setting

The GP-IB address of this unit is set using the front panel SHIFT. 5 mode.

Procedure

- (1) Press the SHIFT key once. The SHIFT indicator will light, showing that the unit is waiting for you to specify the mode.
- (2) Enter 5 to set mode 5 (GP-IB address setting.)
- (3) The display will look as shown in Fig. 6-3. Enter the unit address with the numerical key 5.
- (4) Press the SHIFT key again. This completes the setting procedure.

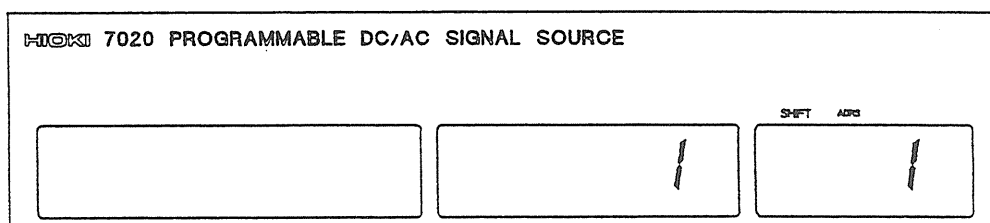

Fig. 6-3 Address Display

⚠ CAUTION

- The address is set to 01 at the factory.
- Address setting range is from 00 to 30. A flashing number indicates wrong input; restart the input procedure from the beginning.
- The set address is kept in memory by the backup battery when power is turned off.
- When this unit is connected to a controller through a GP-IB cable, the case is in electrical contact with the controller.

6.4 Listener Function

Output parameters and other conditions of this unit can be set with an external controller.

6.4.1 Normal Setting





Item	Code	Description	Corresponding Key		
Function	M 0 M 1	DC output AC output (7020)	 		
	C 0 C 1	CV (Constant Voltage) output CC (Constant Current) output			
Polarity	P 0 P 1	DC + (plus) output DC - (minus) output			
Range		DC/CV	CD/CC	AC/CV	AC/CC
	R 5	1 6 0 V	1. 6 A	1 1 0 V	1. 1 A
	R 4	1 6 V	1 6 0 mA	1 1 V	1 1 0 mA
	R 3	1. 6 V	1 6 mA	1. 1 V	1 1 mA
	R 2	1 6 0 mV	1. 6 mA	1 1 0 mV	1. 1 mA
	R 1	1 6 mV	1 6 0 μA	—	—
Output on/off	O 0 O 1	Off On			
Output Value D d. d. d. d. d		"d" stands for numerical data. The output value is composed of 5 digits, and the limit value of 3 digits max. Set the decimal point as appropriate for the selected range.			
Limit Value L d. d. d		"D0" has + polarity irrespective of "P0" and "P1".			
Frequency (7020) F H d d. d F K d. d d		10 to 990 Hz 1.00 to 10.0 kHz (constant voltage output) 1.00 to 3.0 kHz (constant current output)			
Output Time I S d. d. d I M d d		0.01 to 0.99, 1.0 to 9.9, 10 to 99 sec. 1 to 99 min.			

Table 6-2 GP-IB Codes

6.4.2 Memory Mode

Item	Code	Description	Corresponding Key
Store Mode (store data mode only)			
Data S d d d : O n M n C n R n P n D d d d d d L d d d F K d d d I S d d d			
Sddd: ddd is the storage address.			
However, data after : are not in the same order.			
Recall Mode			
	J A	ChangeS to the Recall Mode.	
	J A d d d : d d d	J A <u>ddd</u> : <u>ddd</u> Start:End address setting	
	J I	One-step recall: Data stored in the specified address range are recalled each time the command is received.	
	J R d d d	Direct-access recall: Data in address ddd is recalled.	
Scan Mode			
	A A } A C }	Changes to the Scan Mode.	
	A A d d d : d d d	A A <u>ddd</u> : <u>ddd</u> Start:End address setting	
	A C d d d d	dddd indicates the number of scans.	
	A E	Scan end	
	A S	Scan start	
Memory mode off			
	Z	Cancels the memory mode.	

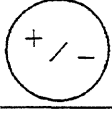
Table 6-3 GP-IB Codes

Memory backup of the address and number of scans is set only with the "AA", "JA", and "AC" codes.

Precautions for setting the address are basically the same as for entry from the front panel. See also Chapter 4.

When using GP-IB control, the only storage mode possible is the data store mode. (See 5.2 Store mode.)

6.4.3 Shift Function

It is not possible to set the SHIFT command simultaneously with another SHIFT command or an other command.

Item	Code	Description
SHIFT. 1 (7020)	E 0 E 1	Internal oscillator Normal External oscillator
SHIFT. 2	V 0 V 1	Internal reference voltage Normal External reference voltage
SHIFT. 3	B 0 B 1	Bias input off Normal Bias output on
SHIFT. 4 (7020)	G 0 G 1	AGC circuit on Normal AGC circuit off
SHIFT. 6	Y 0 Y 1	Data store mode Normal Panel store mode
SHIFT. 7	X 0 X 1	Start speed FAST Normal SLOW

Table 6-4 GP-IB Codes

6.4.4 Others

Item	Code	Description
Lock function	N 0 N 1	Lock on Lock off
Service request mask	U 0 U n	Off On (n = mask bit setting) Default value; 0
Output format bit setting	T 0 T n	Off On (n=output format bit setting, Initial value; 255 (7020) 251 (7021)

Table 6-5 GP-IB Codes

For the service request mask and mask format bit setting, see Chapters 6.6 and 6.8 respectively.

6.4.5 Output Setting Examples

The following program examples run on the NEC PC9801 computer. They must be executed from the initial condition. (address is 1 for the 7020).

(1) Setting the unit to +160 V DC, limit value 160 mA and output on.

```
1 0 PRINT @1 ; "M0C0P0R5O1D160.00L0.16"
2 0 END
```

DC output
CV (Constant Voltage) output
+ (plus) output
160 V range
Output on
Output value
Limit value

(2) Setting the unit to 110 mA AC, limit value 110 V, frequency 3 kHz and output on.

```
1 0 PRINT @1 ; "M1C1R4O1D110.00L110FK3"
2 0 END
```

AC output
CC (Constant Current) output
110 mA range
Output on
Output value
Limit value
Limit value
Frequency

(3) Storing data in (1) above to address 100.

```
1 0 PRINT @1 ; "S100:M0C0P0R5O1D160.00L0.16"
2 0 END
```

Store subsequent data in address 100.
DC output
CV (Constant Voltage) output
+ (plus) output
160 V range
Output on
Output value
Limit value
Limit value

※At this time, the interval time stored in address 100 is stored as it stands.

(4) Scanning addresses 50 to 60 ten times.

```

1 0 PRINT @1 ; "AA50 : 60"
      |
      | Scan start address: end address
2 0 PRINT @1 ; "AC10"
      |
      | Number of scans (10)
3 0 PRINT @1 ; "AS"
      |
      | Start scan.
4 0 END

```

Scanning starts immediately upon execution of the program.

Note

① The code transmission in the normal setting is not the same in sequence.

With the PC9801, the following have the same setting:

```

PRINT @1 ; "O1M1C0R5D110. 00L0. 16FH60"
PRINT @1 ; "M1C0D110L0. 16FH60R501"

```

② If the same code is sent two or more times at once, only the last one sent is valid.

```

PRINT @1 ; "O0D16. 000O1"
      |           |
      | Valid     | Invalid

```

After this command is executed, 16 V is actually output.

③ For the memory mode, shift function, and other code transmission, send one command at a time. If two or more commands are sent, an error will occur.

④ Code transmission in the Store mode is processed the same as for Data Store Mode settings made from the panel. Therefore, send the following command if you only want to change the time to 5 sec when address 10 is set to +5.000V, the limiter value is set to 1.60A, and interval time 1 sec output is on:

```

PRINT @1 ; "S10 : IS5. 0" .

```

6.5 Talker Function

When this unit is designated as talker by the controller, it outputs according to the following data format.

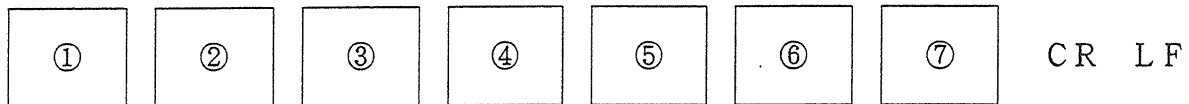

※Data are separated by the secondary delimiter “,”.

※CR (ODh) and LF (OAh) are output as primary delimiter. EOI is output together with LF.

※When the service request 1 (Q1:ddd) code is received, the interval time is output as data ⑧.

Example

```
1 0  LINE INPUT @1 ; T$
2 0  PRINT T$
3 0  END
```

10 Designates the unit as talker, and outputs data to the controller.
 20 Displays data.
 30 End

When this program is executed, the current settings are output to the controller as follows.

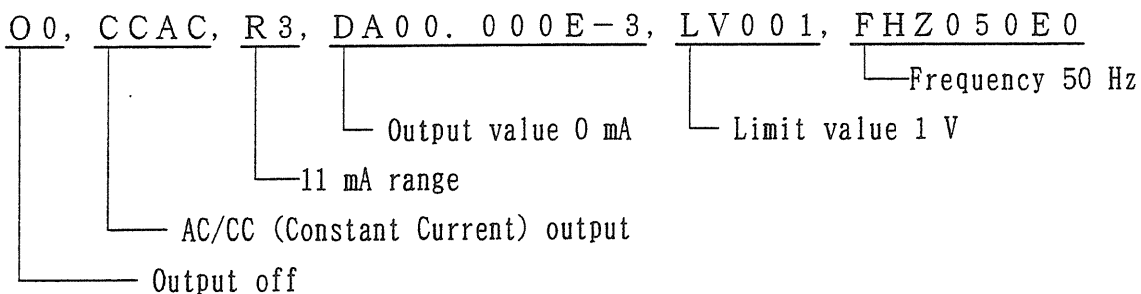

Thus, current settings are output to the controller.

※ Provided that the output format is set to 255.

6.6 Output Format Programming

With this unit, only the necessary data can be output by setting output format conditions. The setting is obtained by adding the values for each bit.

bit 7 (128)	bit 6 (64)	bit 5 (32)	bit 4 (16)	bit 3 (8)	bit 2 (4)	bit 1 (2)	bit 0 (1)
On/off	Function	Range	Output setting	Limit value	Freque- ncy	Monitor value	Monitor value header on

BitNo.	Value (decimal)	Description	Meaning
0	1	Header	Header on/off
1	2	Monitor data	Voltage/current monitor value
2	4	Frequency	Frequency setting (7020)
3	8	Limit value	Limiter setting
4	16	Output setting	Output setting
5	32	Range	Set range
6	64	Function	Set function
7	128	Output on/off	Output on/off

Table 6-7 Output Format

○ Default Setting of the Output Format Byte

• 7020

Bit No.	7	6	5	4	3	2	1	0
Setting	1	1	1	1	1	1	1	1

The default setting is 255 (decimal) or 11111111 (binary).

• 7021

Bit No.	7	6	5	4	3	2	1	0
Setting	1	1	1	1	1	0	1	1

The default setting is 251 (decimal) or 11111011 (binary).

○ Output Format Setting Procedure

Example

```

1 0 PRINT @1 ; "T147"
2 0 END
    
```

└─ Output format#
(sum of all bits)

bit 0 Header on
bit 1 Monitor data
bit 4 Output setting
bit 7 On/off

When the above program is executed, output format is set to 147.

Bit No.	7	6	5	4	3	2	1	0
Setting	1	0	0	1	0	0	1	1
Value (decimal)	128	64	32	16	8	4	2	1

The output format setting code consists of a T followed by the (decimal) sum of all bits corresponding to data items to be input to the controller.

In this example:

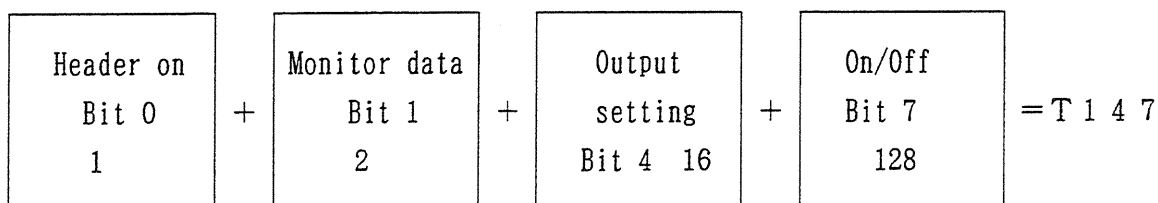

The monitor header is MV for the voltage monitor, and MA for the current monitor. Even if the monitor value output is set, the monitor value is not output when the output is off.

6.7 Information Request Codes

Seven kinds of functional contents can be read out from this unit using the information request codes from Q0 to Q6. Information is output in the format shown in Table 6-8 when the unit is first designated as talker after sending the request code.

○ Example

Using the information request code Q4 to check shift (on/off) condition.

```
1 0 PRINT @1 ; "Q4"
2 0 LINE INPUT @1 ; Q$
3 0 PRINT Q$
4 0 END
```

10	Set information request code Q4.
20	Input corresponding code to the controller.
30	Display it.
40	End

When the above program is executed, the codes NO, XO, YO, GO, BO, VO and EO (lock off, start speed FAST, data store mode, AGC circuit on, bias input off, external reference voltage input off and external oscillator input off) are input to the controller.

Code	output Format	Description
Q 0	Tddd	Output format setting
Q 1	S : ddd ____	Data stored in address ddd of the memory
Q 2	ADRS:ddd	Currently recalled or scanned address
Q 3	CYCLE:dddd START:ddd END :ddd	Number of scans Scan start address Scan end address
Q 4	Nn En Vn Bn Gn Xn Yn	Panel settings lock on/off SHIFT. 1 (external oscillator input on/off) SHIFT. 2 (reference voltage input on/off) SHIFT. 3 (bias input on/off) SHIFT. 4 (internal AGC circuit on/off) SHIFT. 6 Store mode (1:Panel 0: Data) selection SHIFT. 7 Start speed (1: SLOW, 0: FAST)
Q 5	Uddd	SRQ mask setting
Q 6	SETTING-ERROR POWER-LINE FAILURE LIMIT OVER-HEAT OVER-ROAD SCAN-END	Command setting error Power line trouble Limiter operating Temperature rise error Overload or overvoltage Standard ac voltage trouble (7020 only) Scan completion

Table 6-8 Information Request Codes

The "n" number attached to Q4 is 0 for off and 1 for on, except for Gn.

6.8 Service Request

In response to serial polls from the controller, this unit outputs the status bytes shown in Fig. 6-9. The output value is obtained by adding the values for each bit.

BitNo.	Value (decimal)	Name	Condition	Meaning
0	1	SE	Setting error	Wrong program code setting
1	2	DE	Device error	Unit trouble
2	4	SCEND	Scan end	Scan end
3	8	LIMIT	Limit	Limit operating
4	16			
5	32			
6	64	SRQ	SRQ	Service request
7	128			

Table 6-9 Bits of the Status Byte

SRQ Mask Setting

This unit allows to set conditions under which an SRQ is generated.

The setting is the sum of the values corresponding to each bit.

Since the initial value is $(0)_{10}$, $(00000000)_2$, be sure to set the SRQ mask when generating SRQ.

bit 7 (128)	bit 6 (64)	bit 5 (32)	bit 4 (16)	bit 3 (8)	bit 2 (4)	bit 1 (2)	bit 0 (1)
	SRQ			LIMIT	SCEND	DE	SE

○ Example

Receiving the scan end code by means of a service request.

```
10 PRINT @1; "U68"
```

```
20 END
```

└─ The U indicates SRQ mask command

68 is the sum of masked bits (6 and 2).

When the above program is executed, bits 6 and 4 are masked, and a service request is issued after scan is completed.

Bit No.	7	6	5	4	3	2	1	0
Setting	0	1	0	0	0	1	0	0
Value (decimal)	128	64	32	16	8	4	2	1

Mask Setting: $64 + 4 = 68$

6.9 GP-IB Commands

(1) **GET** (Group Execute Trigger)

When this command is received, output is turned on.

(2) **DCL** (Device Clear)

When this command is received, the unit is reset to the following default values.

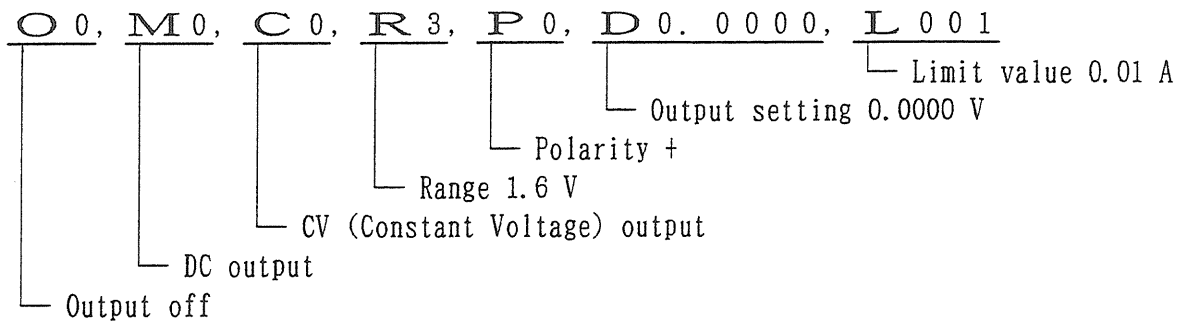

6.10 Sample programs

Program Example 1

Using an HP 9000 to increase voltage from 3 to 15 V at 0.5-V steps and intervals of 3 s while monitoring the output level.

```
10 DIM A$(100)
20 CLEAR 701
30 OUTPUT 701;"MOCOR4P0D00.000L1.6"
40 OUTPUT 701;"O1"
50 OUTPUT 701;"T255"
60 FOR I=3 TO 15 STEP .5
70     BEEP
80     OUTPUT 701;"D"&VAL$(I)
90     ENTER 701;A$
100    DISP A$
110    WAIT 3
120    NEXT I
130    OUTPUT 701;"O0"
140    END
```

Program Explanation

10: Specifies the length of the character string to carry data.

20: Initializes the unit.

30: Set the unit as follows:

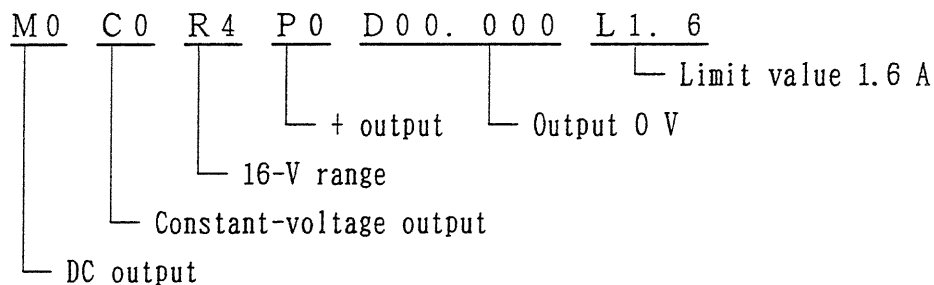

40: Turns output on.

50: Sets output format to T255 (output all data).

60: Defines the loop to increase voltage from 3 to 15 in 0.5-V steps.

70: Sounds the beeper at the beginning of each loop.

80: Sets the output value.

90: Writes output level into A\$.

100: Displays A\$ on the screen.

110: Waits for 3 seconds.

120: Returns to step 60 if voltage is less than 15 V.

130: When voltage reaches 15 V, that level is output for 3 seconds, then output is turned off.

140: End

Program Example 2

This program performs the same processing as Program Example 1. Address 1 is used for the signal source.

```

10 ISET IFC
20 ISET REN
30 PRINT @1;"M0 C0 P0 R4 D00.000 L1.6"
40 PRINT @1;"O1"
50 PRINT @1;"T255"
60 FOR I=3 TO 15 STEP .5
70     BEEP
80     PRINT @1;"D"+STR$(I)
90     INPUT @1;A$
100    PRINT A$
110    FOR T=0 TO 10000:NEXT T
120 NEXT I
130 PRINT @1;"00"
140 END

```

Program Explanation

- 10: Sends the IFC (interface clear) command.
 20: Sets the REN (remote enable line) to TRUE.
 30: Set the unit as follows:

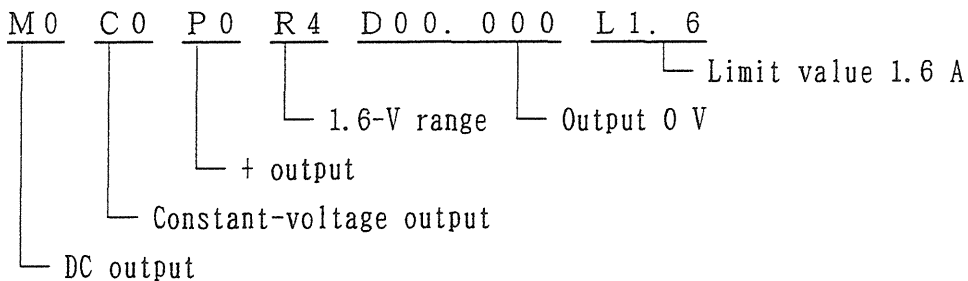

- 40: Turns output on.
 50: Sets output format to T255 (output all data).
 60: Defines the loop to increase voltage from 3 to 15 in 0.5-V steps.
 70: Sounds the beeper at the beginning of each loop.
 80: Sets the output value.
 90: Writes output level into A\$.
 100: Displays A\$ on the screen.
 110: Waits for approx. 3 seconds.
 120: Returns to step 60 if voltage is less than 15 V.
 130: When voltage reaches 15 V, that level is output for 3 seconds, then output is turned off.
 140: End

Program Example 3

This program runs on the NEC PC-9801.

It generates a sine wave using the 10-ms-step memory of the 7021.

Since in this example one cycle is divided in 200 10-ms sections, frequency is 0.5 Hz.

```

10 ISET IFC
20 ISET REN
30 FOR N=101 TO 300
40   ADRS=N
50     PI=3.14159
60     A=((N-100)*.01)*PI
70     S=SIN(A)
80     H=(CINT(S*10000))/10000
90   IF H<0 THEN 130 ELSE 100
100  VDATA=H
110  PRINT @1;"SD"+STR$(ADRS)+":01MOCOR3D"+STR$(VDATA)+"L1.60ISO.01"
120  GOTO 150
130  VDATA=H*-1
140  PRINT @1;"SD"+STR$(ADRS)+":01MOCOR3P1D"+STR$(VDATA)+"L1.60ISO.01"
150 NEXT N
160 PRINT @1;"Z"
170 END

```

Program Explanation

- 10 : Sends the IFC (interface clear) command.
- 20 : Sets the REN (remote enable line) to TRUE.
- 30 : Sets the loop for storing data into addresses 101 to 300 of the memory.
- 40 : Substitutes N for the variable ADRS.
- 50 : Sets the variable PI to 3.14159.
- 60 : Calculates the angle as $A = ((\text{address}-100) \times 0.01) \times \text{PI}$.
- 70 : Calculates the output setting as $S = \sin A$.
- 80 : Since the 1.6-V range is used, fixes the number of decimal positions to four.
- 90 : If the result of step 80 is negative, jumps to 130. Otherwise, proceeds to 100.
- 100 : In case the output setting is positive, substitutes H for the variable VDATA.
- 110 : Sets the 7021 as follows:

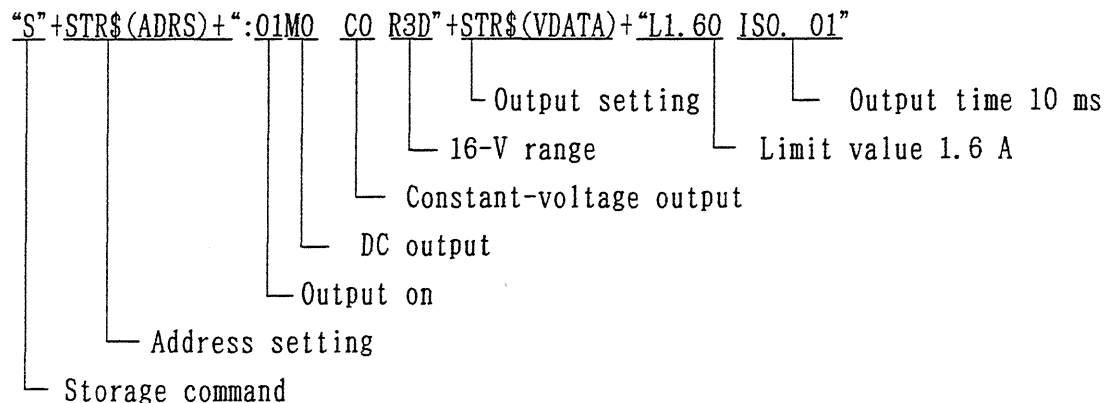

120: Returns to step 30, proceeding to the next loop.
 130: In case the output setting is negative, polarity is set by PI. Therefore, data is given a positive value here:
 140: Sets the unit as in step 110, adding the polarity setting.
 150: Returns to step 30, proceeding to the next loop.
 160: After all data have been stored, cancels the storage mode with the Z code.
 170: End

After running this program, a waveform like the one shown below can be obtained by auto-scanning addresses 101 to 300 of the memory.

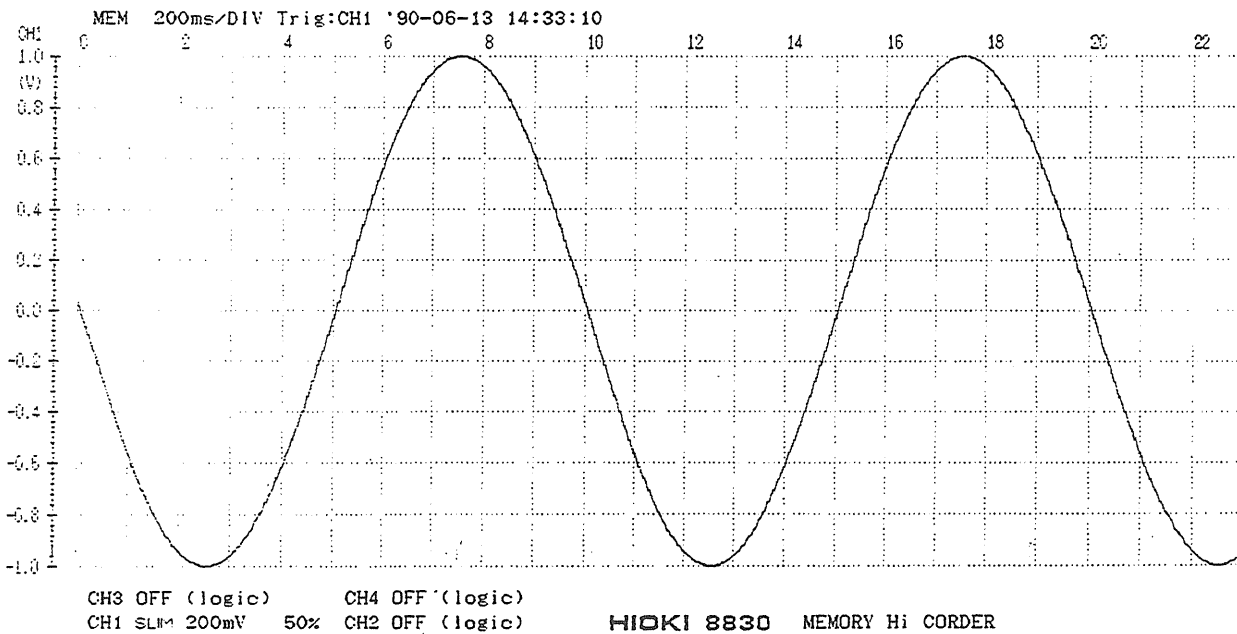

Program Example 4.

This program runs on the NEC PC-9801.

It performs a 9-V battery discharge test using the 7021 sync function. The unit is set to a DC constant-current output of 300 mA, then the battery is discharged. Battery voltage is monitored at 1-minute intervals and recorded with a printer.

```

10 '*****
20 '   HIOKI 7020 GP-IB
30 '       サンプル プログラム
40 '*****
50 '
60 '*****
70 '       初期設定
80 '*****
90 '
100 ISET IFC
110 ISET REN
120 CLS : CONSOLE 0,25,0,1
130 PRINT @1;"MOC1P1R D   00 L  "
140 LOCATE 20,2 : PRINT " 7020 バッテリー 放電試験 "
150 LPRINT " 7020 バッテリー 放電試験 "
160 LOCATE 10,6 : PRINT "   測定時刻           モニタ電圧 "
170 LOCATE 12,8 : PRINT TIMES$
180 '
190 '*****
200 '       測 定
210 '*****
220 '
230 LOCATE 51,3 : PRINT "試験開始時刻 ";TIMES$
240 LPRINT :LPRINT "試験開始時刻 ";TIMES$
250 LPRINT :LPRINT "   測定時刻 "; " モニタ電圧 "
260 PRINT @1;"01"
270 LOCATE 12,8 : PRINT TIMES$
280 T$=TIMES$
290 A$=RIGHT$(T$,2)
300 IF A$ ="00" THEN 320
310 GOTO 270
320 PRINT @1;"T2"
330 INPUT @1;M
340 LOCATE 33,8 : PRINT M
350 LPRINT TIMES$ " " ; M
360 IF M =< THEN 420
370 T$=TIMES$
380 A$=RIGHT$(T$,2)
390 IF A$>"00" THEN 260
400 LOCATE 12,8 : PRINT TIMES$
410 GOTO 370
420 PRINT @1;"00"
430 LOCATE 51,4 : PRINT "試験終了時刻 ";T$
440 LPRINT "試験終了時刻 ";T$
450 END

```

6. 11 GP-IB Command List

Type	Function	Format	Type	Function	Format
Normal output	DC/AC	Mn	Shift	Oscillator Internal/ External	En (7020)
	CV/CC	Cn		Reference voltage Internal/ External	Vn
	+/-	Pn		Bias input On/Off	Bn
	Range	Rd		AGC circuit On/Off	Gn (7020)
	On/Off	On		Store mode Data/panel	Yn
	Setting data	Dd.d.d.d.d.		Start speed Fast/Slow	Xn
	Limit value	Ld.d.d.			
Memory Mode	Frequency (Hz) (kHz)	FHddd FKd.d.d (7020)	Others	Lock function	Nn
	Output time (sec.) (min.)	ISd.d.d. IMdd		Service request, masking	Uddd
	*Store mode Store address	S Sddd:		Output format	Tddd
	*Recall mode Start:End address	JA JAAdd:ddd		Information request code	Qd
	One-step Direct-access	JI JRddd			
	*Scan mode Start:End address	AA or AC AAAdd:ddd			
	Scan cycle	ACdddd			
	Scan end	AE			
	Scan start	AS			
	*Memory mode off	Z			

- * n is 0 or 1.
- * ddd is a numeric value.
- * If the service request mask and output format are set to 0, off is set.

Chapter 7

Characteristics

7.1 Load

⚠ CAUTION

If a C or L component is included in the load of the 7020 or 7021, oscillation may occur, destroying the load. Even if the value is less than the following holding oscillation values, oscillation may occur, so before use check that there is no output trouble during monitoring.

With a C load or L load, the values for holding oscillation are shown below for reference.

(1) C load at constant voltage output

In FAST mode

DC 160 mV,	AC 110 mV.....	1000 pF or less
1.6 V	1.1 V	} 0.01 μ F or less
16 V	11 V	
160 V	110 V	

In SLOW mode

- Film capacitor 10 μ F or less
- Electrolytic capacitor 0.1 F or less

If oscillation occurs, it can be stopped by inserting a resistance of a few ohms into the circuit in series.

In SLOW mode, the frequency characteristics of the output value deteriorate and output ripple increases.

(2) L load at constant current output

10 mH or less

Four terminal method in the 7020 and 7021 takes the remote sensing system when extending the output code.

Further, if oscillation occurs easily because of extended wiring, insert the condenser between SENSE and SOURCE terminals as showing below. It can avoid oscillating.

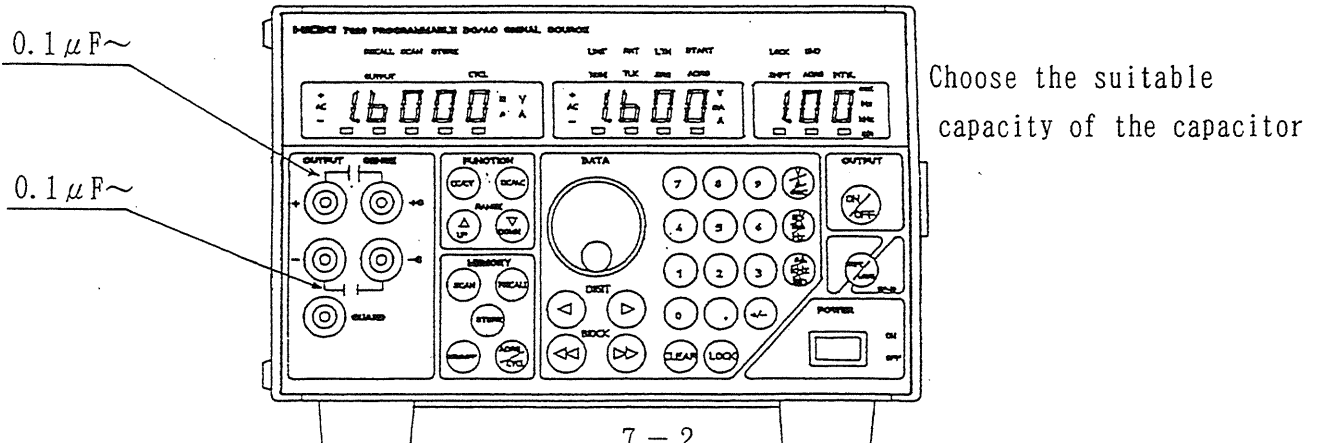

Chapter 8

Inspection and Maintenance

8.1 Replacing the Fuse

⚠ CAUTION

- In case the fuse blows out, check the cause before replacing it.
- Before replacing the fuse, unplug the power cord from the connector and make sure that nothing is connected to the output terminals.
- Always use a fuse of the specified ratings. These are indicated on the rear panel.

- (1) Unplug the power cord.
- (2) Remove the fuse holder cover with a screwdriver.
- (3) After checking fuse ratings, replace the fuse.
- (4) A spare fuse is provided in the fuse holder.

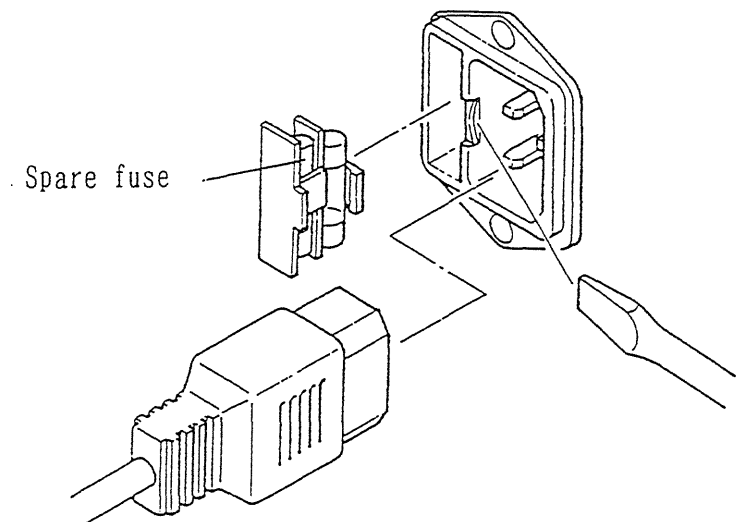

Fig. 8-1 Fuse Replacement

Designated Fuses

100 / 120 V.	4 A / 250 V φ 5. 2 × 20 (mm)	midget Fuse
200 / 220 / 240 V	2 A / 250 V φ 5. 2 × 20 (mm)	midget Fuse

8.2 Troubleshooting

In case the unit does not operate properly, check the following.

The LEDs do not lit when power is turned on.	<ul style="list-style-type: none"> ○ Is the power cord properly connected ? ○ Is the fuse in good condition ?
Key entries are not accepted.	<ul style="list-style-type: none"> ○ Is the unit is locked (LOCK LED lit) condition ? Press the LOCK key to unlock. ○ Is the unit being externally controlled through the GP-IB ?
No output even though the OUTPUT indicator is lit.	<ul style="list-style-type: none"> ○ Is the unit set for external input or other similar mode with the SHIFT function ? ○ Are output terminal shorting bars firmly attached ? ○ Is data being stored in the memory storage mode ?
The actual output does not match output settings, or poor output accuracy.	<ul style="list-style-type: none"> ○ Is the limiter operating ? Reset to a higher limit value, or reduce the load. ○ Are the OUTPUT and SENSE terminals open ? (see page 4-4).
The display shows the previous data when a unit setting key is pressed after entering a value with the numerical keys.	<ul style="list-style-type: none"> ○ Is your entry within the output range ? Check the output range and resolution for the selected range (see page 2-2).
Output is not monitored when turned on.	<ul style="list-style-type: none"> ○ Is the cursor in the limiter block ? When the cursor is in the limiter block, you can only display and set the limit value. Move the cursor to the output or frequency block.
AC output value is not as set.	<ul style="list-style-type: none"> ○ Is the start speed set to SLOW (SHIFT7•1). ○ Set the start speed to FAST (SHIFT7•0).
When power is on, 9999 flashes.	<ul style="list-style-type: none"> ○ The backup battery is worn out. Please contact your Hioki dealer. (See 8.3 Monitor Offset Cancel).

8.3 Monitor Offset Cancel

In this unit, the offset of the current and voltage monitor is cancelled by software. Upon factory shipment, this cancellation value is stored in the built-in memory. If memory trouble (flashing 9999) occurs, all memory, including this value, is cleared. Thus, in the event of memory trouble, take the following steps to correct the monitor offset cancellation value:

- (1) Turn on the power supply and perform warmup for 30 min. or more.
- (2) Current monitor offset cancel

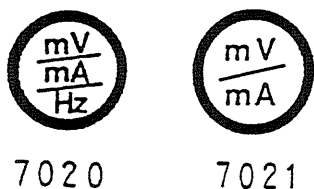
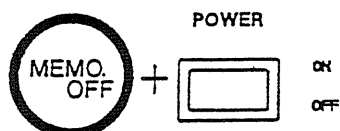
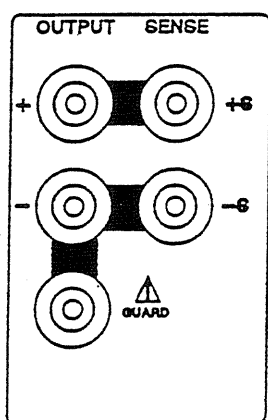

- ① As shown at left, connect a short bar and nothing else to the output terminal.
- ② Pressing the MEMO.OFF key, turn on the power.
- ③ At this time, all LEDs flash for about 3 sec. While the LEDs are flashing, press the mV/mA/Hz key (mV/mA key for 7021).
- ④ Subsequently, the offset value is absorbed together with the output over a span of about 30 sec. (About 20 sec. for the 7021.)
- ⑤ Next, do voltage monitor offset cancellation.

(3) Voltage monitor offset cancel

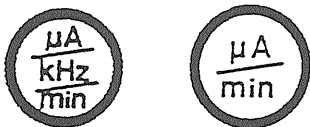
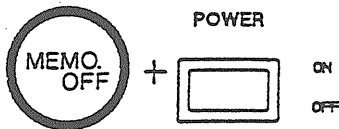
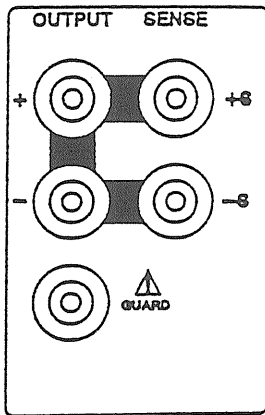

7020

7021

① As shown at left, connect a short bar and nothing else to the output terminal.

② Pressing the MEMO.OFF key, turn on the power supply.

③ All LEDs flash for 3 sec. While the LEDs are flashing, press the $\mu\text{A}/\text{kHz}/\text{min}$ key.

④ Now the offset value is absorbed together with the output in about 30 sec. (About 20 sec. for the 7021.)

(4) With the above procedure, offset cancellation of the current-voltage monitor is completed.

⚠ WARNING

- Output is present while the current-voltage offset cancellation values are being absorbed. At this time, do not connect anything to the output terminals (including the SENSE and GUARD terminals.)
Also, never touch the output terminal; there is danger of electric shock.

⚠ CAUTION

- If memory trouble (flashing 9999) occurs, all the memory contents are cleared, including the current-voltage offset cancel value. At such time, be sure to do current-voltage offset cancellation. If such trouble occurs frequently, the backup battery may be worn out. Please contact your nearest Hioki dealer.

Sep. 1990

Edition 1

Nov. 1993

Revised edition 3

HIOKI E.E. CORPORATION

81 Koizumi, Ueda, Nagano 386-11, Japan

TEL:0268-28-0562 FAX:0268-28-0568

TLX:3327508 HIOKI J CABLE: HEWLOV, Ueda