



# AM/FM SIGNAL GENERATOR

2023A

2023B

2025

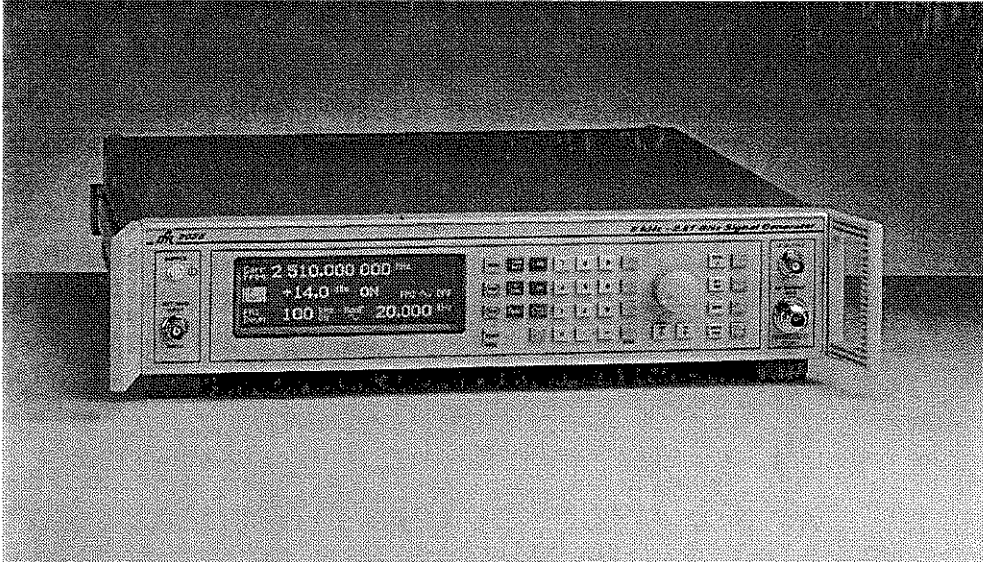

Operating Manual

46882-373

---

# AM/FM SIGNAL GENERATOR

## 2023A

9 kHz–1.2 GHz

## 2023B

9 kHz–2.05 GHz

## 2025

9 kHz–2.51 GHz

Includes information on:

- Option 1: No attenuator.
- Option 2: DC operation.
- Option 3: High power.
- Option 4: High stability frequency standard.
- Option 5: Rear panel connectors.
- Option 7: Fast pulse modulation.
- Option 10: 1 V peak mod input.
- Option 11: Fast pulse and high power.
- Option 12: SINAD measurement.

This manual applies to instruments with software issues of 1.01 and higher.

© IFR Ltd. 1999

*No part of this book may be reproduced or transmitted in any form or by any means, electronic or mechanical, including photocopying, or recorded by any information storage or retrieval system, without permission in writing by IFR Ltd.*

Printed in the UK

Manual part no. 46882-373  
Issue 5

24 September 1999

---

# About this manual

This manual explains how to use the 2023A, 2023B and 2025 AM/FM Signal Generators.

## Intended audience

Persons engaged on work relating to equipment who have a need for accurately-generated signals in the VHF and UHF spectrum.

## Structure

### Chapter 1

Main features and Data Sheet.

### Chapter 2

Installation details.

### Chapter 3

Operation for the experienced user.

### Chapter 4

Detailed operation including first time usage.

### Chapter 5

GPIB operation with keywords and sample programs.

### Chapter 6

Brief technical description.

### Chapter 7

Instructions for doing acceptance testing.

### Annex A

Option 7 – Fast pulse modulation.

### Annex B

Option 11 – Fast pulse and high power.

## Document conventions

The following conventions apply throughout this manual:

RF OUTPUT	Titles marked on the instrument's front panel are shown in capital letters
[MENU]	Key titles are as shown on the key-caps in square brackets
<i>Carr Freq</i>	Messages on the display are shown in italic letters.

## Associated publications

Other publications covering specific aspects of this equipment are:

<b>Maintenance Manual</b>	(46882-377)	Covers maintenance and repair of the equipment.
<b>Service Manual</b>	(46880-088)	Consists of operating manual (this document) plus maintenance manual.

# CONTENTS

Preface

Precautions

Chapter 1 GENERAL INFORMATION

Chapter 2 INSTALLATION

Chapter 3 PRINCIPLES OF OPERATION

Chapter 4 LOCAL OPERATION

Chapter 5 REMOTE OPERATION

Chapter 6 TECHNICAL DESCRIPTION

Chapter 7 ACCEPTANCE TESTING

Annex A OPTION 7 – FAST PULSE MODULATION

Annex B OPTION 11 – FAST PULSE AND HIGH POWER

Index

Note: Option 12 is included in Chapter 4.

GENERAL  
INFORMAT

INSTALLATION

PRINCIPLES OF  
OPERATION

LOCAL  
OPERATION

REMOTE  
OPERATION

TECHNICAL  
DESCRIPTION

ACCEPTANCE  
TESTING

INDEX

---

# Preface

## Patent protection

The 2023A, 2023B and 2025 Signal Generators are protected by the following patents:

EP 0322139  
GB 2214012  
US 4870384  
EP 0125790  
GB 2140232  
US 4609881

# Precautions

**WARNING**

**CAUTION**

**Note**

These terms have specific meanings in this manual:

**WARNING**

information to prevent personal injury.

**CAUTION**



information to prevent damage to the equipment.

**Note**

important general information.

## Hazard symbols

The meaning of hazard symbols appearing on the equipment is as follows:

Symbol	Description
	General hazard
	Dangerous voltage
	Toxic hazard

## General conditions of use

This product is designed and tested to comply with the requirements of IEC/EN61010-1 'Safety requirements for electrical equipment for measurement, control and laboratory use', for Class I, portable equipment and is for use in a pollution degree 2 environment. The equipment is designed to operate from an installation category I and II supply.

Equipment should be protected from the ingress of liquids and precipitation such as rain, snow, etc. When moving the equipment from a cold to a hot environment, it is important to allow the temperature of the equipment to stabilize before it is connected to the supply to avoid condensation forming. The equipment must only be operated within the environmental conditions specified in the Data Sheet (following Chapter 1) in the Operating/Instruction manual, otherwise the protection provided by the equipment may be impaired.

This product is not approved for use in hazardous atmospheres or medical applications. If the equipment is to be used in a safety-related application, e.g. avionics or military applications, the suitability of the product must be assessed and approved for use by a competent person.

**WARNING**



### Electrical hazards (AC supply voltage)

This equipment conforms with IEC Safety Class I, meaning that it is provided with a protective grounding lead. To maintain this protection the supply lead must always be connected to the source of supply via a socket with a grounded contact.

Be aware that the supply filter contains capacitors that may remain charged after the equipment is disconnected from the supply. Although the stored energy is within the approved safety requirements, a slight shock may be felt if the plug pins are touched immediately after removal.

Do not remove covers, no user serviceable parts inside. See list of IFR Ltd International Service Centers at rear of manual.

## Fuses

Note that the internal supply fuse is in series with the live conductor of the supply lead. If connection is made to a 2-pin unpolarized supply socket, it is possible for the fuse to become transposed to the neutral conductor, in which case, parts of the equipment could remain at supply potential even after the fuse has ruptured.

**WARNING**



**Fire hazard**

Make sure that only fuses of the correct rating and type are used for replacement.

If an integrally fused plug is used on the supply lead, ensure that the fuse rating is commensurate with the current requirements of this equipment. See the Data Sheet (following Chapter 1) for power requirements.

**WARNING**



**Toxic hazards**

Some of the components used in this equipment may include resins and other materials which give off toxic fumes if incinerated. Take appropriate precautions, therefore, in the disposal of these items.

**WARNING**



**Beryllia**

Beryllia (beryllium oxide) is used in the construction of some of the components in this equipment.

This material, when in the form of fine dust or vapor and inhaled into the lungs, can cause a respiratory disease. In its solid form, as used here, it can be handled quite safely although it is prudent to avoid handling conditions which promote dust formation by surface abrasion.

Because of this hazard, you are advised to be very careful in removing and disposing of these components. Do not put them in the general industrial or domestic waste or dispatch them by post. They should be separately and securely packed and clearly identified to show the nature of the hazard and then disposed of in a safe manner by an authorized toxic waste contractor.

**WARNING**



**Beryllium copper**

Some mechanical components within this instrument are manufactured from beryllium copper. This is an alloy with a beryllium content of approximately 5%. It represents no risk in normal use.

The material should not be machined, welded or subjected to any process where heat is involved.

It must be disposed of as "special waste".

It must NOT be disposed of by incineration.

**WARNING**



**Tilt facility**

When the instrument is in the tilt position, it is advisable, for stability reasons, not to stack other instruments on top of it.

**CAUTION**



**Static sensitive components**

This equipment contains static sensitive components which may be damaged by handling - refer to the Maintenance Manual for handling precautions.

**CAUTION**

**Suitability for use**

This equipment has been designed and manufactured by IFR Ltd. to generate low-power VHF and UHF signals for the testing of radio communications apparatus. IFR Ltd. has no control over the use of this equipment and cannot be held responsible for events arising from its use other than for its intended purpose.

# Chapter 1 GENERAL INFORMATION

## Contents

Introduction.....	1-2
Main features.....	1-2
Operation .....	1-2
Display.....	1-2
Frequency selection.....	1-2
Output .....	1-2
Calibration .....	1-3
Modulation.....	1-3
Incrementing .....	1-3
Frequency sweep.....	1-3
SINAD measurement (Option 12).....	1-3
Memory.....	1-3
Programming.....	1-4
Calibration data.....	1-4

**2023A, 2023B, 2025 Data Sheet**  
**Option 12 SINAD measurement Data Sheet**



## Introduction

The 2023A, 2023B and 2025 are portable and lightweight synthesized signal generators covering the frequency range 9 kHz to 1.2 GHz (2023A), 9 kHz to 2.05 GHz (2023B), and 9 kHz to 2.51 GHz (2025). A dot matrix display with a comprehensive set of utility menus allows flexibility of operation and ease of use. The RF output can be amplitude, frequency, phase or pulse modulated. An internal programmable AF source is capable of generating simultaneous two-tone modulation.

All parameters can be entered from a front panel keyboard, and a rotary control can be used to adjust most settings. Microprocessor control ensures that the instrument is flexible and easy to use and allows programming by either the General Purpose Interface Bus (GPIB) or by RS-232. The GPIB is designed to IEEE Standard 488.2. The interfaces allow remote control of all functions except the supply switch, and allow the instrument to be used either manually or as part of a fully automated test system.

## Main features

### Operation

Selection of parameters on the screen may involve one or more of the numeric, hard or menu selection keys or the rotary control knob. Parameters may be set to specific values by numeric key entry, while values may be varied in steps of any size using the DOWN/UP keys or altered by moving the control knob, set to a particular sensitivity.

### Display

The display is a dot matrix liquid crystal panel, with backlighting. Display contrast may be varied to accommodate differing lighting conditions and the setting saved in memory. A graphical display test is available to the user.

### Frequency selection

Carrier frequency is either selected directly via the keyboard or remotely via the interfaces. Frequency resolution is 1 Hz across the band. A series of carrier frequencies can be stored in non-volatile memory for recall when required.

### Output

RF output up to +13 dBm can be set by direct keyboard entry with a resolution of 0.1 dB over the entire range. For instruments fitted with the high power option, RF output is increased to +25 dBm. A carrier ON/OFF key is provided to completely disable the output.

A choice of level units is available to the user and provision is made for the conversion of units (for example, dBm to  $\mu\text{V}$ ) by a simple keypress.

An electronic trip protects the generator output against reverse power of up to 50 W. This prevents damage to output circuits when RF or DC power is accidentally applied to the RF OUTPUT connector.

To facilitate testing of receiver squelch systems, an attenuator hold function allows control of the RF output without introducing RF level drop-outs from the step attenuator.

The RF output level can be offset by up to  $\pm 5.0$  dB to compensate for cable or switching losses, or standardize a group of instruments.

Maximum RF output level can be set so as to protect sensitive devices connected to the RF OUTPUT socket.

### Spectral purity

With an SSB phase noise performance of typically  $-121$  dBc/Hz at 20 kHz offset from a 1 GHz carrier, this instrument can be used for both in-channel and adjacent channel receiver measurements. Harmonically related signals and non-harmonics are typically better than  $-25$  dBc and  $-60$  dBc respectively.

## Calibration

This instrument has a recommended two year calibration interval after which it should be returned for recalibration (for addresses refer to 'Addresses' section at end of manual).

## Modulation

Comprehensive amplitude, frequency and phase modulations are available. Pulse modulation can be applied to the carrier from an external pulse source. The instrument also accepts one or two logic level inputs to produce a 2-level or 4-level FSK modulated output. An internal modulation oscillator is provided, having a frequency range of 0.01 Hz to 20 kHz. The oscillator is capable of generating one or two modulation tones simultaneously in one modulation channel. An independent BNC input on the front panel allows external modulation signals to be combined with the internal signal(s). These sources can be combined to give a number of modulation modes. The pulse modulation can be used in combination with the other forms of modulation.

The frequency modulation range provides a 1 dB bandwidth of typically 100 kHz and provides FM deviation up to a maximum of 100 kHz. AC or DC coupled FM can be selected. Phase modulation is also available with a 9 kHz bandwidth up to a maximum of 10 radians.

Amplitude modulation with a 1 dB bandwidth of typically 30 kHz and with modulation depths of up to 99.9% is available with a resolution of 0.1%. Pulse modulation is available as standard with typical rise and fall times of less than 10  $\mu$ s and 40 dB on/off ratio.

The external input voltage required for 100% modulation is 1 V RMS or, optionally, 1 V peak. To accommodate other signal levels, Automatic Level Control (ALC) can be selected which provides correctly calibrated modulation for inputs between 0.75 and 1.25 V RMS.

A MOD ON/OFF key simplifies the testing of signal to noise ratio.

An optional fast pulse modulator improves the rise/fall times to typically 10 ns.

## Incrementing

All major parameters can be incremented or decremented in step sizes entered via keyboard entry or remotely. If no step size is entered for a parameter, the steps are preset to 1 kHz for carrier frequency, 1 kHz for modulation oscillator, 1 kHz for FM deviation, 0.1% for AM depth, 0.01 rad for  $\Phi$ M and 1 dB for output level.

In addition, the rotary control knob can be used to vary the parameter with the sensitivity of the knob being changed by means of the  $\times 10$  and  $+10$  keys.

## Frequency sweep

The sweep capability of the instrument allows comprehensive testing of systems. Sweeps may be logarithmic or linear. Four parameters are used to specify sweep: start, stop, step size and time per step and a percentage increment in the case of logarithmic sweep, all of which may be specified by the user. The sweep can be paused at any time. During the sweep the RF level can be altered using the rotary control. Sweep triggering can be single shot or continuous and can be initiated directly or on the detection of a trigger. The triggering signal may either be programmed or from a TTL signal applied to the rear panel TRIGGER input.

## SINAD measurement (Option 12)

The instrument measures the SINAD ratio (the ratio of signal + noise + distortion to noise + distortion) using an internal 1 kHz notch filter. A choice of unweighted, C-MESS or CCITT filters is available and the amount of averaging is selectable. The measurement can be made with the instrument in manual or auto level-seeking modes.

## Memory

The instrument provides both non-volatile and volatile memory for storing instrument settings. The non-volatile memory provides 100 instrument settings and 100 settings of carrier frequency only. The volatile memory (RAM) also provides 100 instrument settings. Any one of the non-volatile instrument settings can be selected as the power-up setting for the instrument.

### **Memory cloning**

The stored settings in one instrument can be easily transferred (without the use of a controller) to another instrument using the RS-232 interface, or to several other instruments using the GPIB interface.

### **Memory sequencing**

A software facility allows sequences of stored instrument settings to be defined. The incrementing facilities can then be used to cycle through the settings in manually operated test systems or be operated via an external trigger.

### **Memory protection**

To prevent accidental change of the contents of the stored settings, individual memories or ranges of memories can be write-protected.

### **Programming**

A GPIB interface is fitted so that all functions are controllable via the interface bus which is designed to IEEE Standard 488.2. The instrument can function both as talker and listener. The instrument also has an RS-232 interface which uses the common GPIB command set. The interfaces enable the instrument to be remotely controlled as well as being used to transfer settings (cloning) from one instrument to another.

### **Calibration data**

All alignment data is digitally derived. Realignment can be undertaken, without removing covers, by protected front-panel functions or via the GPIB interface.

## EC Declaration of Conformity

**Certificate Ref. No.**

**EEA00025**

The undersigned, representing:

<b>Manufacturer:</b>	<b>IFR Ltd.</b>
<b>Address:</b>	<b>Longacres House, Norton Green Road, Stevenage, Hertfordshire, U. K. SG1 2BA</b>

Herewith declares that the product:

<b>Equipment Description:</b>	<b>AM/FM Signal Generator</b>
<b>Model No.</b>	<b>2023A/2023B/2025</b>
<b>Options:</b>	<b>1, 2, 3, 4, 5, 7, 10, 11, 12, 100 and 105</b>

is in conformity with the following EC directive(s)  
(including all applicable amendments)

<b>Reference No.</b>	<b>Title:</b>
73/23/EEC	Low Voltage Directive
89/336/EEC	EMC Directive

and that the standards and/or technical specifications referenced below have been applied:

<b>Safety:</b>	<b>EMC:</b>	
IEC/EN61010-1	EN55011:1991 Class B	
	EN50082-1:1992	
	EN60555-2:1987	

IFR Stevenage (Place)

1st October 1998 (Date)

*Roger Dixon*

(Signature)

Roger Dixon - Product Liability Manager



## 2023A/B, 2025

### 9 kHz to 1.2/2.05/2.51 GHz Signal Generators

*With its level of performance, this compact general purpose signal generator delivers outstanding value for money*



- Wide frequency coverage:-
  - 9 kHz to 1.2 GHz (2023A)
  - 9 kHz to 2.05 GHz (2023B)
  - 9 kHz to 2.51 GHz (2025)
- Excellent spectral purity
- Linear and logarithmic sweep mode
- RPP to 50 W
- Sine, triangular and square wave two tone modulation source
- RS232 and GPIB control
- Comprehensive modulation:-
  - AM, FM,  $\emptyset$ M, Pulse & FSK
- 3.9 kHz Bessel filtered FSK
- Optional +25 dBm RF output
- SINAD Measurement Option

The 2023A/B and 2025 signal generators are portable and lightweight, offering carrier frequencies from 9 kHz to 1.2 GHz (2023A), 9 kHz to 2.05 GHz (2023B) and 9 kHz to 2.51 GHz (2025) with a wide choice of modulation modes.

The instruments are suitable for a wide range of applications in laboratory, production, and maintenance environments.

The GPIB facility allows the unit to be included in ATE systems for faster manufacturing throughput.

An RS-232 interface is provided with a command set in common with the GPIB to simplify remote control of the signal generator in basic test systems or via a modem.

#### Operation

Front panel control is achieved through a flexible combination of keyboard selection, cursor selection and a rotary control in conjunction with a clear and intuitive menu presentation on a bright panel display. This ensures the instrument can be set up into any desired mode of operation quickly and simply.

#### Frequency Selection

Frequency resolution of 1 Hz across the complete frequency range of 1.2 GHz, 2.05 GHz or 2.51 GHz ensures adequate resolution to characterize narrow band communication systems and components.

#### RF Output

Peak RF output levels of between +13 dBm and -140 dBm can be set accurately with a resolution of 0.1 dB. An attenuator hold function allows control of the RF output without introducing RF level dropouts from the step attenuator to facilitate testing of receiver squelch systems, and during EMI investigations. A RF level limit can be set to limit the output power to avoid damage to external, power sensitive devices. RF level offsets up to  $\pm 5$  dB can be applied to counter the effects of test system losses etc. A carrier ON/OFF key is provided to completely disable the output.

#### 50 W Protection

An electronic trip protects the generator output against reverse power of up to 50 W from a source with a VSWR's of up to 5:1, preventing damage to output circuits if a RF transmitter or DC power supply is accidentally applied to the output connector. This feature contributes to long service life and low cost of ownership.

#### Size and Weight

The 2023A/B and 2025 occupy a full rack width, but only 2 units high to minimize rack occupancy in manufacturing and test systems and for instrument stacks in benchtop use.

The low weight of the product makes it ideal for portable applications within maintenance environments.

#### Spectral Purity

Measurement of receiver selectivity and ultimate signal to noise ratio requires good spectral purity. The 2023A/B and 2025 have a low residual FM of typically 3 Hz and a commendable sideband noise of typically -121 dBc/Hz at 1 GHz, (20 kHz offset) to allow demanding measurements to be made at an affordable cost. Good close in phase noise is also achieved with results at 100 Hz offsets typically < -85 dBc.

#### Modulation

Comprehensive amplitude, frequency, phase, FSK and pulse modulation facilities are provided for testing all types of receivers. A MOD ON/OFF key simplifies the testing of signal to noise ratio.

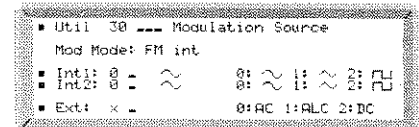

#### Amplitude and Pulse Modulation

Amplitude modulation with a 1 dB bandwidth of 30 kHz and modulation depths of up to 99.9% with a resolution of 0.1% ensures the generator is suitable for testing AM systems and undertaking EMC immunity measurements. The standard pulse modulation facility has an on/off ratio

# 2023A/B, 2025

of better than 40 dB and a rise/fall time of less than 10  $\mu$ s enabling characterization of TDMA or TDD bursts in RF amplifiers and modules. The internal square wave modulation source may be used to self pulse modulate the generator for use in EMI applications.

An optional Fast Pulse modulator improves the on/off ratio to typically >80 dB with rise and fall times of <20 ns.

## Frequency and Phase Modulation

With a 1 dB FM bandwidth of 275 kHz and a deviation range of 0 to 12.8 MHz, the 2023A/B and 2025 signal generators offer a wide range frequency modulation capability. AC or DC coupled FM can be selected with very low carrier frequency error and drift in the DC coupled mode ideal for testing paging and DCS (Digitally Coded Squelch) equipment accurately.

The phase modulation facility is ideal for testing narrow band analog radios with a deviation range of 0 to 10 radians and a 3 dB bandwidth up to 10 kHz.

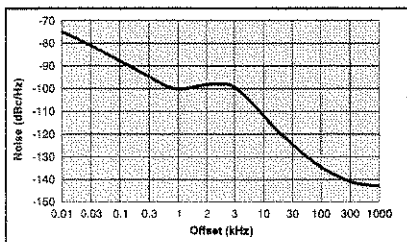

Typical SSB Phase noise at 1 GHz (OCXO fitted)

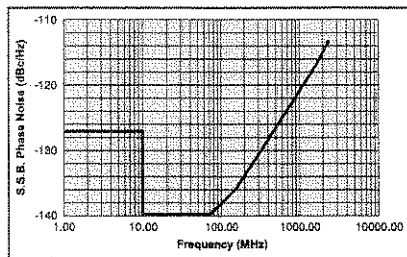

Typical SSB Phase noise at 20 kHz offset

## FSK

The generation of 2 level and 4 level FSK signals is possible directly from external logic inputs. The TTL data is automatically filtered using a 8th Order 3.9 kHz Bessel filter to reduce spectral spreading, as required by both ERMES and FLEX™ paging systems. The required FM deviation is set from the front panel.

## Modulation Oscillator

An internal modulation oscillator is provided which is capable of generating one or two tones in the frequency range of 0.01 Hz to 20 kHz. In addition to a sine wave output, a triangular or square wave is provided. Internal and external modulation sources may be combined to produce more complex modulation types.

## Sweep

The sweep facility of the 2023A/B and 2025 offers linear and logarithmic sweeps. The user can program all sweep parameters including start and stop

frequency, size of step, time per step and a percentage increment in the case of logarithmic sweep.

The sweep can be paused and the frequency varied by the rotary control to investigate a problem area.

The sweep can be initiated from the keyboard or by an external trigger input and can be set to single, continuous, stepped or start/stop operation.

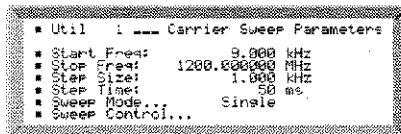

The frequency sweep facility is particularly well suited to EMI testing. During a frequency sweep, the RF level can be altered using the rotary control to manually correct the level at the output of amplifiers. The square wave modulation source allows the generation of square wave amplitude modulation to simulate the effect of TDMA bursts from communication systems on devices being tested for EMI.

The optional high RF output power to +25 dBm can eliminate the need for external amplifiers when using small test cells.

## Instrument Stores

The 2023A/B and 2025 signal generators provide extensive storage facilities for simplifying repetitive tests. Up to 100 carrier frequency values and 100 complete instrument settings can be saved to non-volatile stores. Storage is achieved without the need for batteries and so avoids problems of periodic replacement.

A software protection system ensures that individual stored settings cannot be accidentally overwritten.

A further 100 volatile stores are available for complete instrument settings. Their contents can be downloaded over GPIB and then recalled by store number to reduce the time overhead introduced by the handling of the GPIB protocol.

## Sequencing

A software facility allows 9 sequences of stored instrument settings to be defined. The incrementing facilities can then be used to cycle through the settings in manually operated test systems or be operated via an external trigger.

## Calibration Data

All alignment data, including the internal frequency standard adjustment, is digitally derived and realignment can be undertaken without removal of external covers, by protected front panel functions or via the GPIB. Use of digitally stored realignment eliminates the use of mechanical adjusters to minimize long term drift and vulnerability to mechanical shock.

Status information is stored, including an identity string (type and serial number), choice of internal or external standard and GPIB address.

An elapsed time facility allows the monitoring of the number of hours the product has been in use. A recommended calibration interval of 2 years helps towards

low cost of ownership.

## Programming

A GPIB interface is fitted as standard with all functions controllable over the bus. The protocol and syntax of GPIB commands are designed in accordance with IEEE 488.2 standard to simplify the generation of ATE programs.

In talk mode, the current settings, instrument status and the identity string can be read.

A RS-232 interface is fitted as standard with a common command set to GPIB commands. RS-232 control is particularly suitable for use with simple external controllers or RF modems when the instrument is being used in a remote location.



## Memory Cloning

The stored settings in one signal generator can be transferred to others without the use of an external controller using the direct interconnection of GPIB or RS-232 interfaces. This facility is particularly useful for duplicating test set ups on manual production lines.

## OPTIONS

The standard features of the signal generator can be enhanced by taking advantage of the various options available.

### No Attenuator Option

This option reduces the instrument cost by deleting the internal attenuator. An RF output range from -2 dBm to +15 dBm is provided and is a very economic solution for applications requiring a local oscillator.

### High Power

A high power option is available which extends the RF output up to +25 dBm ideal for use as a local oscillator or for testing passive and active components.

### SINAD Measurement

A fully independent high performance SINAD meter with selectable weighting filters can be fitted for receiver sensitivity measurements.

### Fast Pulse Modulator

A pulse modulator suitable for generating fast pulses with high isolation for applications in radar and EMI.

### High Stability Frequency Standard

An OCXO internal reference can replace the standard TCXO where improved frequency stability is required.

### DC Operation

The DC supply option allows the signal generator to be used in vehicles, remote areas or where the integrity of the AC supply is not guaranteed.

### Rear Panel Connectors

All front panel connectors may be removed and fitted to the rear panel for

use in production racks.

## Specification

### General Description

The 2023A/B and 2025 cover the frequency range 9 kHz to 1.2 GHz, 2.05 GHz and 2.51 GHz respectively. The RF output can be amplitude, frequency, phase or pulse modulated. An internal synthesized programmable AF source is capable of generating single or simultaneous two tone modulation. GPIB and RS-232 are included as standard to enable remote control of all functions except the supply switch.

### Carrier Frequency

**Range**  
9 kHz to 1.2 GHz (2023A)  
9 kHz to 2.05 GHz (2023B)  
9 kHz to 2.51 GHz (2025)

**Resolution**  
1 Hz

**Accuracy**  
As frequency standard.

**Phase incrementing**  
The carrier phase can be advanced or retarded in steps as low as 0.09° using the rotary control.

### RF Output

**Range**  
-140 dBm to +13 dBm, 0.1 dB resolution. When AM is selected, the maximum RF output level decreases linearly with increasing AM depth to +7 dBm at 99.9% depth.

### RF Level Units

Units may be set to  $\mu$ V, mV, EMF or PD; dB relative to 1  $\mu$ V, 1 mV EMF or PD; or dBm. Conversion between dB and linear units may be achieved by pressing the appropriate units key (dB or V, mV,  $\mu$ V). The output level can be normalized for 75  $\Omega$  operation with an impedance converter.

### Level Accuracy(1)

Frequency	>-127 dBm	>-100 dBm	Temp Coefficient
9 kHz to 1.2 GHz	$\pm 0.8$	$\pm 0.8$	$\pm 0.02$ dB/°C
1.2 GHz to 2.05 GHz	$\pm 1.4$	$\pm 1.2$	$\pm 0.03$ dB/°C
2.05 GHz to 2.51 GHz	$\pm 1.6$	$\pm 1.6$	$\pm 0.03$ dB/°C

(1) Over range +17°C to +27°C

### Attenuator Hold

Selection of Attenuator hold provides for uncalibrated level reduction of at least 10 dB without the Mechanical Attenuator operating.

### VSWR

For output levels less than -5 dBm, output VSWR is less than 1.3:1 for carrier frequencies up to 1.2 GHz and less than 1.5:1 for carrier frequencies up to 2.51 GHz. For output levels greater than -5 dBm output VSWR is less than 1.5:1 for all carrier frequencies.

### RF Output Connector

50  $\Omega$  type N connector to MIL 390123D.

### Output Protection

Protected from a source of reverse power up to 50 W from 50  $\Omega$  or 25 W from a source VSWR of 5:1. Protection circuit can be reset from the front panel or via the GPIB/RS-232 interfaces.

### Spectral Purity

At RF levels up to +7 dBm:

### Harmonics

Typically better than -30 dBc for RF levels up to +7 dBm.  
Typically better than -25 dBc for RF levels up to +13 dBm.

### Non-Harmonics (for offsets >3 kHz)

Better than -70 dBc to 1 GHz, better than -64 dBc between 1 and 2.05 GHz better than -60 dBc above 2.05 GHz.

### Residual FM (FM off)

Less than 4.5 Hz RMS deviation in a 300 Hz to 3.4 kHz unweighted bandwidth at 1 GHz.

### SSB Phase Noise

Better than -124 dBc/Hz at 20 kHz offset from a carrier frequency of 470 MHz, typically -121 dBc/Hz at 20 kHz offset from a carrier frequency of 1 GHz.

### Carrier leakage

Less than 0.5  $\mu$ V PD at the carrier frequency in a two turn 25 mm diameter loop, 25 mm from the surface of the signal generator.

### $\Phi$ m on AM

Typically 0.1 radians at 30% depth at 470 MHz.

### Modulation Modes

Internal and external modulation can be simultaneously enabled to allow combined amplitude and frequency (or phase) modulation. Pulse modulation can be used in combination with the other forms of modulation from an external pulse source.

### Frequency Modulation

**Resolution**  
1 Hz

### Deviation

CW Range (MHz)	Max Deviation (kHz)
1200 - 2510	12800
600 - 1200	6400
300 - 600	3200
150 - 300	1600
75 - 150	800
37.5 - 75	400
18.75 - 37.5	200
0.009 - 18.75	100

**Accuracy at 1 kHz**  
 $\pm 4\%$

### Bandwidth (1 dB)

DC to 275 kHz (DC coupled)  
10 Hz to 275 kHz (AC coupled)  
20 Hz to 275 kHz (AC coupled with ALC).

### Group delay

Less than 5  $\mu$ s to 100 kHz.

### Carrier frequency offset (DC coupled)

Less than 1% of the set frequency deviation.

### Distortion

<1% at 1 kHz rate for deviations up to 20% of max available deviation, typically 0.1% for deviations of 2% of max available deviation and <3% at max available deviation

### Modulation source

Internal LF generator or external via front panel BNC.

### FSK

### Modes

2 level or 4 level FSK

### Data source

External data connected to TRIGGER connector (2 level) or TRIGGER and PULSE connectors (4 level). Note with option 7 fitted, rear panel PULSE input is labelled FSK2.

### Frequency shift

Settable up to  $\pm 100$  kHz

### Accuracy

As FM deviation accuracy.

### Timing jitter

$\pm 3.2$   $\mu$ s

### Filter

8th order Bessel, -3 dB at 3.9 MHz

### Phase Modulation

### Deviation

0 to 10 radians, 3 digits or 0.01 resolution.

### Accuracy at 1 kHz

$\pm 4\%$  of indicated deviation excluding residual phase modulation.

### 3 dB bandwidth

100 Hz to 10 kHz

### Distortion

Less than 3% at 10 radians at 1 kHz modulation rate. Typically <0.5% for deviations up to 1 radian

at 1 kHz

### Modulation source

Internal LF generator or external via front panel BNC.

### Amplitude Modulation

For carrier frequencies <500 MHz, useable to 2 GHz.

### Range

0 to 99.9%, 0.1% resolution.

### Accuracy

$\pm 5\%$  of set depth at 1 kHz (at +17°C to 27°C ambient temperature), temperature coefficient <  $\pm 0.02\%/^{\circ}\text{C}$ .

### 1 dB bandwidth

DC to 30 kHz (DC coupled)  
10 Hz to 30 kHz (AC coupled)  
20 Hz to 30 kHz (AC coupled with ALC)

### Distortion

<2.5% at 1 kHz rate for modulation depths up to 80% and <1.5% at 1 kHz rate for modulation depths up to 30%.

### Modulation source

Internal LF generator or external via front panel BNC.

### Pulse Modulation

For Fast Pulse Modulator see options.

### Frequency range

32 MHz to 2.51 GHz, useable to 10 MHz

### RF output range

Maximum guaranteed output is reduced to +8 dBm. (+20 dBm or +14 dBm with high power option when pulse modulation is selected)

### RF level accuracy

When pulse modulation is enabled, adds  $\pm 0.5$  dB to the RF level accuracy specification.

### On/off ratio

Better than 45 dB below 1.2 GHz, better than 40 dB above 1.2 GHz.

### Rise and fall times

Less than 10  $\mu$ s

### Control

Pulse input is on a rear panel BNC with 10 k $\Omega$  nominal input impedance. A HCT logic 0 (0 V to 0.8 V) turns the carrier off, a HCT logic 1 (2.0 V to 5 V) turns the carrier on. Max safe input is  $\pm 15$  V

### Internal LF Generator

### Frequency range

0.01 Hz to 20 kHz

### Resolution

5 digit

### Frequency accuracy

As frequency standard

### Distortion

Less than 0.1% THD at 1 kHz

### Waveforms

Sine wave to 20 kHz and a triangular or square wave to 3 kHz

### Square wave jitter

<6.4  $\mu$ s on any edge

### Audio output

The modulation oscillator signal is available on a front panel BNC connector at a level of 2 V RMS EMF from a 600  $\Omega$  source impedance.

### External Modulation

Input on the front panel via BNC connector. 1 V RMS (1.414 V pk) sine wave for set deviation. Input sensitivity may be optionally specified for 1 V pk (option 10). Input impedance is 100 k $\Omega$  nominal.

### Modulation ALC

The external modulation input can be levelled by a peak levelling ALC system over the input voltage range of 0.5 V to 1.25 V RMS sine wave. High and low indicators on the display indicate when the input is outside the levelling range.

### Sweep Mode

### Control parameters

Start and stop values of carrier frequency.

### Linear sweep

Frequency step size of 1 Hz minimum.

### Logarithmic sweep

Percentage increment of 0.01% to 50% in 0.01% steps.

# 2023A/B, 2025

**Step time**  
50 ms to 10 s per step.

**Trigger**

A trigger input is available on a rear panel BNC connector and can be used for single, continuous, start/stop or single step mode.

**Frequency Standard**

**TCXO**

10 MHz

**Temperature Stability**

Better than  $\pm 5$  in  $10^7$  over the operating range of 0 to 55°C.

**Ageing rate**

Less than  $\pm 1$  in  $10^6$  per year

**External input**

Rear panel BNC connector accepts an external input of 1 MHz or 10 MHz at a level of 220 mV RMS to 1.8 V RMS into 1 k $\Omega$ .

**Output**

Rear panel BNC connector provides an output of 10 MHz at a nominal level of 2 V pk-pk into 50  $\Omega$ .

**General**

**REMOTE CONTROL**

**GPIB**

All functions except the supply switch are remotely programmable.

**Capabilities**

Designed in accordance with IEEE 488.2. The GPIB interface complies with the following subsets as defined in IEEE standard 488.1: SH1, AH1, T6, TE0, L4, LE0 SR1, RL1, PPO, DC1, DT1, CO, E2

**RS-232**

All functions except the supply switch are remotely programmable.

**Connector**

9 way male D-type.

**Bit rate**

300 to 9600 bits/s

**Handshake**

Hardware: DTR, RTS, CTS and DSR  
Software: XON and XOFF

**Electrical**

Interface to EIA-232-D

**ELECTRO-MAGNETIC COMPATIBILITY**

Conforms with European Directive 89/336/EEC and associated International Standards. Complies with the limits specified in the following standards:  
EN55011 Class B CISPR II  
EN50082-1 IEC 801-2,3,4  
EN60555-2 IEC 555-2

**SAFETY**

Complies with IEC 1010-1, BS EN61010-1 class 1 portable equipment and is for use in a pollution degree 2 environment. The instrument is designed to operate from an installation category 1 or 2 supply.

**RATED RANGE OF USE**

(Over which full specification is met)

**Temperature**

0 to 55°C

**Humidity**

Up to 93% at 40°C

**Altitude**

Up to 3050 m (10,000 ft)

**CONDITIONS OF STORAGE AND TRANSPORT**

**Temperature**

-40°C to +71°C

**Humidity**

Up to 95% at 40°C

**Altitude**

Up to 4600 m (15,000 ft)

**POWER REQUIREMENTS**

**AC Supply**

90 to 132 V or 188 to 264 V  
47 Hz to 63 Hz 175 VA maximum

**CALIBRATION INTERVAL**

2 years

**DIMENSIONS AND WEIGHT**

(over projections but excluding front panel handles)  
Height Width Depth Weight  
107 mm 419 mm 440 mm <8 kg

**Options**

**NO ATTENUATOR**

(cannot be specified with option 7 or option 3)  
Omits the internal step attenuator. Specification as standard instrument with following exceptions:

**RF output range**

From -2 dBm to +15 dBm. When AM is selected the maximum output level reduces linearly with AM depth to +9 dBm at maximum AM depth.

**Pulse modulation**

Not available with option 1.

**Output protection**

Reverse power protection is not provided.

**DC OPERATION**

Allows for operation from an external DC power source in addition to an AC power source. Specification as standard instrument with the following additions:

**DC supply range**

11 V to 32 V.

**AC Supply Frequency**

47 Hz to 440 Hz at 90 to 132 V  
47 Hz to 63 Hz at 188 to 264 V  
200 VA maximum

**DC consumption**

70 W with option 3 not fitted. 95 W with option 3 and 4 fitted.

**HIGH POWER**

Specifications as standard instrument with the following exceptions:

**RF output range**

-140 dBm to +25 dBm (Output power is uncalibrated above +19 dBm for carrier frequencies above 1.2 GHz and above +14 dBm above 2.4 GHz). Maximum output is reduced by 5 dB when standard pulse modulation is selected and/or by up to 6 dB dependent upon set AM depth.

**RF Level Accuracy Above +7 dBm (over temperature range 17°C to 27°C)**

	<1.2 GHz	<2.51 GHz
	$\pm 1$ dB	$\pm 2$ dB
Temperature Stability dB/°C	$\leq \pm 0.02$	$\leq \pm 0.03$

**Harmonics**

Typically better than -25 dBc for levels 6 dB below the maximum specified output.

**HIGH STABILITY FREQUENCY STANDARD**

Replaces the internal TCXO with a high stability OCXO. Specification as standard instrument with the following exceptions:

**Ageing rate**

$\pm 2.5$  in  $10^7$  per year,  $\pm 5$  in  $10^6$  per day after 2 months continuous use.

**Stability**

Better than  $\pm 5$  in  $10^6$  over the temperature range 0 to 50°C.

**Warm up time**

Within 2 in  $10^7$  of final frequency 10 minutes after switch on at a temperature of 20°C.

**REAR PANEL CONNECTORS**

RF output, modulation input and LF output connectors are transferred to the rear panel. The signal generator specification is not altered.

**FAST PULSE MODULATOR**

With option 7 fitted, a BNC Pulse input connector is fitted to the front panel and the existing front panel LF output connector becomes a combined modulation input/output connector. Specification as standard instrument with the following exceptions.

**Frequency range**

100 kHz to 2.51 GHz. (useable to 9 kHz)

**RF output range**

-140 dBm to +10 dBm (useable to +13 dBm) when pulse enabled.

**RF level accuracy**

Additional  $\pm 0.01$  dB/°C temperature coefficient when pulse enabled.

**On/Off ratio**

>80 dB below 1.2 GHz  
>70 dB up to 2.05 GHz (typically >80 dB)  
>65 dB up to 2.51 GHz (typically >70 dB at 2.51 GHz)

**Rise & fall times**

<20 ns (typically 10 ns)

**Maximum repetition frequency**

10 MHz

**Control**

TTL levels into 50  $\Omega$  input impedance. A HCT logic 0 (0 V to 0.8 V) turns the carrier off, a HCT logic 1 (2.0 V to 5 V) turns the carrier on. Maximum input is  $\pm 10$  V

**FAST PULSE MODULATOR WITH HIGH POWER**

Pulse operation as Option 7. RF output as Option 3 with the following exception.

**RF output range**

Maximum output level is reduced by 3 dB when Pulse is selected.

**SINAD MEASUREMENT**

See separate SINAD Measurement data sheet 46891-002

**Versions and Accessories**

When ordering please quote the full ordering number information.

**Ordering Numbers**

**Versions**

2023A	9 kHz to 1.2 GHz Signal Generator
2023B	9 kHz to 2.05 GHz Signal Generator
2025	9 kHz to 2.51 GHz Signal Generator
<b>Options</b>	
Option 1	No attenuator (not available with option 3, 7 or 11)
Option 2	DC operation
Option 3	High power (not available with option 1, 7 or 11)
Option 4	High stability frequency standard
Option 5	Rear panel outputs
Option 7	Fast Pulse Modulator (not available with option 1, 3 or 11)
Option 10	Mod input sensitivity 1 V pk
Option 11	Fast Pulse with High Power (not available with options 1, 3 or 7)
Option 12	SINAD Measurement
<b>Supplied with</b>	
46882/373	AC power supply lead
43130/119	Operating Manual
	DC supply lead (option 2 only)
<b>Accessories</b>	
54311/208	50/75 $\Omega$ adapter. N type (m) to BNC (f). 5.7 dB loss DC to 1 GHz.
46880/068	Service manual
46884/792	Front bracket handle mounting kit
46662/601	Transit case
46662/602	Soft carry case
46884/650	RS-232 cable, 9-way female to 9-way female, 1.5 m
43129/189	1 m GPIB lead
59999/724	TC5010 TEM Cell (see separate sheet)
59000/317	VISA Plug 'n' Play driver software



IFR Americas, Inc., 10200 West York Street, Wichita, Kansas  
67215-8999, USA. E-mail: info@ifrsys.com  
Tel: +1 316 522 4981 Toll Free USA: 1 800 835 2352 Fax: +1 316 522 1360

IFR Ltd, Longacres House, Norton Green Road, Stevenage, Herts  
SG1 2BA, United Kingdom. E-mail: info@ifrinternational.co.uk  
Tel: +44 (0) 1438 742200 Freephone UK: 0800 282 388 Fax: +44 (0) 1438 727601







## 2023A/B, 2025 Option 12 SINAD Measurement

*Option 12 further enhances the versatility of the 2023A/B, 2025 range providing a complete receiver sensitivity test solution in an economical, space saving package*

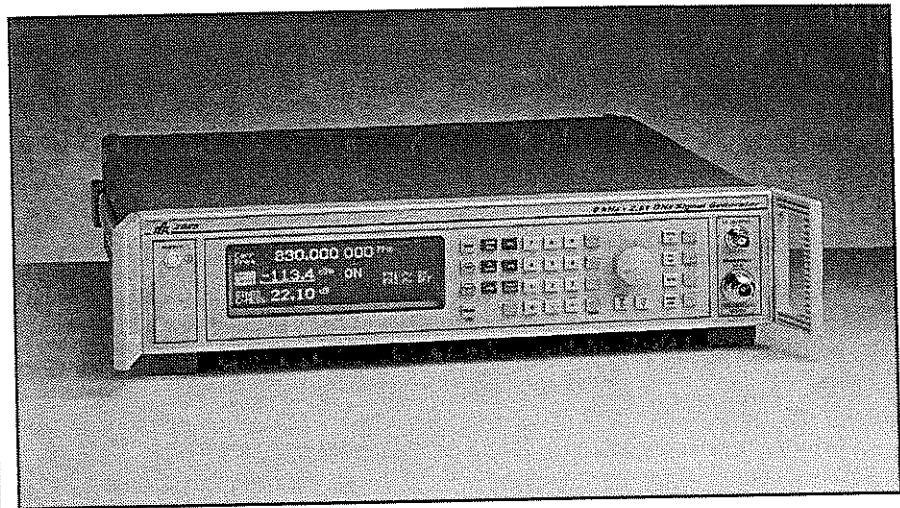

- High performance SINAD measurement
- 50 dB measurement range
- Accurate DSP based CMESS, CCITT P53 and un-weighted filters
- RS-232 and GPIB control
- User selectable measurement averaging
- Simple menu set up
- Over/under range indication

Option 12 provides the user with a high performance SINAD measurement function which can be used for receiver testing in development, production and servicing.

The SINAD function can be used independently of the signal source as a genuine second instrument. Alternatively the SINAD measurement can be operated with the source in manual or automatic control of RF level mode.

### Simple Operation

Set up of the measurement selections from a utility menu ensures simple and fast operation.

```

■ Util 49 --- SINAD Measurement
■ Averaged 22 --- (1 - 127)
■ Weighting Filter: 2 - C-MESS
  0: Unweighted 1: CCITT 2: C-MESS
■ SINAD: 1 - Enabled
  0: Disable 1: Enable 2: AUTO
    
```

2023A/B and 2025 simultaneously displays the signal RF source parameters and the SINAD measurement result. The user is able to manually control the source amplitude and frequency and see at a

glance the resulting SINAD. Input level over range and under range warning messages confirm valid measurement values.

```

Carr Freq 850.000 000 MHz
RF Level -115.0 dBm ON FM1 ~ ON
SINAD 20.0 dB FM2 ~ OFF
C-MESS
    
```

### Automatic RF Level Coupled Operation

An automatic RF level adjustment mode to achieve a user defined SINAD value for a receiver under test is available for even simpler bench operation. In this mode the RF level is automatically reduced from a pre-set level until the measured SINAD value matches the user input value.

```

Carr Freq 850.000 000 MHz
RF Level -115.0 dBm ON Mod Disable
SINAD 20.0 dB AUTO 12.0 dB FM1 ~ ON
C-MESS SINAD SEEKING FM2 ~ OFF
    
```

### Weighting Filters

SINAD measurements can be made un-weighted or through accurate and stable DSP based CMESSAGE or CCITT P53 psophometric weighting filters.

### Result Averaging

A user selectable result averaging function in the range 1-127 can be applied to the displayed SINAD result.

### Instrument Stores

The extensive volatile and non-volatile storage facilities on 2023A/B and 2025 are available for use with Option 12 SINAD to simplify repetitive test sequences for

manual or GPIB operation.

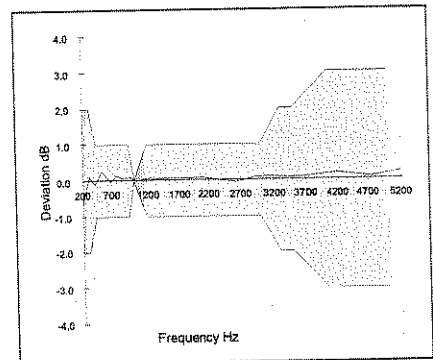

Filter response compared to CMESSAGE standard error band

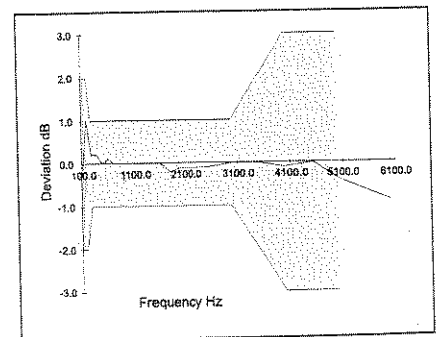

Filter response compared to CCITT standard error band

# Option 12

## Specification

### General Description

This option provides an independent high performance SINAD measurement function featuring 50 dB SINAD measurement range, with automatic over/under range indication, user selectable weighting filters and result averaging. An automatic generator level seek mode from a user SINAD input value is included. Available with all existing 2023A/B and 2025 family options.

### Measurement Range

50 dB

### Accuracy

±0.5 dB

### Display

#### Resolution

0.01 dB

#### Averaging

User selectable result averaging from 1-127 measurements - Default setting is 5 measurements.

#### Over/under range indication

Automatic display warning when input signal level is out of range.

### Weighting Filters

Selectable CMESS, CCITT P53 weighted measurement filters or un-weighted measurement (50 Hz - 7.0 kHz 3 dB bandwidth)

### Modulation Frequency

1 kHz ±20 Hz notch filter range

### Input Signal

#### Sensitivity

50 mV RMS - 3.0 V RMS (250 mV RMS for 50 dB SINAD). Max. safe input level ± 15 V

#### Input impedance

100 kΩ (nominal)

#### Input Connectivity

SINAD baseband input is via front panel Ext Mod input connector, (MOD I/O connector when option 7 or 11 are fitted).

## Versions and Accessories

When ordering please quote the full ordering number information.

### Ordering

#### Numbers

2023A 9 kHz to 1.2 GHz Signal Generator  
2023B 9 kHz to 2.05 GHz Signal Generator  
2025 9 kHz to 2.51 GHz Signal Generator

#### Options

Option 1 No attenuator (not available with option 3, 7 or 11)  
Option 2 DC operation  
Option 3 High power (not available with option 1, 7 or 11)  
Option 4 High stability frequency standard  
Option 5 Rear panel outputs  
Option 7 Fast Pulse Modulator (not available with option 1, 3 or 11)  
Option 10 Mod input sensitivity 1 V Pk  
Option 11 Fast Pulse Modulator with High Power (not available with options 1,3 or 7)  
Option 12 SINAD Measurement

#### Supplied with

46882/373 AC power supply lead  
43130/119 Operating Manual  
DC supply lead (option 2 only)

#### Accessories

54311/208 50/75 Ω adapter, N type (m) to BNC (f), 5.7 dB loss DC to 1 GHz.  
46880/088 Service manual  
46884/792 Front bracket handle mounting kit  
46662/601 Transit case  
46662/602 Soft carry case  
46884/650 RS-232 cable, 9-way female to 9-way female, 1.5m  
43129/189 1m GPIB lead  
59999/724 TC5010 TEM Cell (see separate sheet)  
59000/317 VISA Plug 'n' Play driver software



IFR Americas, Inc., 10200 West York Street, Wichita, Kansas  
67215-8999, USA. E-mail: info@ifrsys.com  
Tel: +1 316 522 4981 Toll Free USA: 1 800 835 2352 Fax: +1 316 522 1360

IFR Ltd, Longacres House, Norton Green Road, Stevenage, Herts  
SG1 2BA, United Kingdom. E-mail: info@ifrinternational.co.uk  
Tel: +44 (0) 1438 742200 Freephone UK: 0800 282 388 Fax: +44 (0) 1438 727601



# Chapter 2 INSTALLATION

## Contents

Initial visual inspection .....	2-2
Installation requirements .....	2-2
Mounting arrangements.....	2-2
Ventilation .....	2-2
Power cords.....	2-2
Goods-in checks.....	2-4
Instrument operating position.....	2-5
AC operation.....	2-5
Connecting to supply.....	2-5
AC fuse .....	2-5
Internal fuse .....	2-5
DC operation (Option 2).....	2-5
Connecting to supply.....	2-5
DC fuse .....	2-5
DC supply cable.....	2-5
General purpose interface bus (GPIB) .....	2-6
GPIB cable connection .....	2-6
GPIB connector contact assignments.....	2-6
IEEE to IEC conversion .....	2-6
Interface bus connection .....	2-7
RS-232 interface .....	2-7
RS-232 connector.....	2-7
Rack mounting .....	2-7
Routine maintenance.....	2-8
Safety testing and inspection.....	2-8
Cleaning .....	2-9
Cleaning the LCD window.....	2-9
Putting into storage .....	2-9
Disk installation/loading instructions .....	2-9
Operation .....	2-10

## List of figures

Fig. 2-1 DC input socket showing connector polarity (viewed from rear of instrument).....	2-5
Fig. 2-2 GPIB connector contact assignments (viewed from rear of instrument).....	2-6
Fig. 2-3 IEEE to IEC conversion .....	2-6
Fig. 2-4 RS-232 connector contact assignments (viewed from rear of instrument).....	2-7

## **WARNING**

### **Initial visual inspection**

After unpacking the instrument, inspect the shipping container and its cushioning material for signs of stress or damage. If damage is identified, retain the packing material for examination by the carrier in the event that a claim is made. Examine the instrument for signs of damage; do not connect the instrument to a supply when damage is present, internal electrical damage could result in shock if the instrument is turned on.

## **CAUTION**

### **Installation requirements**

#### **Mounting arrangements**

Excessive temperatures may affect the performance of the instrument. Completely remove the plastic cover, if one is supplied over the case, and avoid standing the instrument on or close to other equipment which is hot.

#### **Ventilation**

This instrument is forced air cooled by a fan mounted on the rear panel. Air must be allowed to circulate freely through the ventilator grills located on the side and underside of the instrument. Before switching on the instrument, ensure that the fan outlet on the rear panel is not restricted (i.e., clearance of at least 75 mm at the rear, 25 mm at each side, 15 mm on the underside). Failure to provide to adequate clearances will increase internal temperatures and reduce the instrument reliability, so its performance may not meet specification.

### **Power cords**

#### **Class I power cords (3-core)**

##### **General**

When the equipment has to be plugged into a Class II (ungrounded) 2-terminal socket outlet, the cable should either be fitted with a 3-pin Class I plug and used in conjunction with an adapter incorporating a ground wire, or be fitted with a Class II plug with an integral ground wire. The ground wire must be securely fastened to ground. Grounding one terminal on a 2-terminal socket will not provide adequate protection.

In the event that a molded plug has to be removed from a lead, it must be disposed of immediately. A plug with bare flexible cords is hazardous if engaged in a live socket outlet.

Power cords with the following terminations are available from IFR Ltd. Please check with your local sales office for availability.

This equipment is provided with a 3-wire (grounded) cordset which includes a molded IEC 320 connector for connection to the equipment. The cable must be fitted with an approved plug which, when plugged into an appropriate 3-terminal socket outlet, grounds the case of the equipment. Failure to ground the equipment may expose the operator to hazardous voltage levels. Depending upon the destination country, the color coding of the wires will differ:

Wire ended

Country	IEC 320 plug type	IFR part number
Universal	Straight through	23424-158
Universal	Right angled	23424-159

	North America	Harmonized
Line (Live)	Black	Brown
Neutral	White	Blue
Ground (Earth)	Green	Green/Yellow

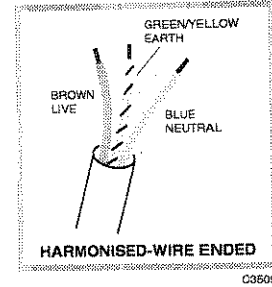

INSTALLATION

British

Country	IEC 320 plug type	IFR part number
United Kingdom	Straight through	23422-001
United Kingdom	Right angled	23422-002

The UK lead is fitted with an ASTA approved molded plug to BS 1363. A replaceable 13 A fuse to BS 1362 is contained within the plug. This fuse is only designed to protect the lead assembly. Never use the plug with the detachable fuse cover omitted or if the cover is damaged.

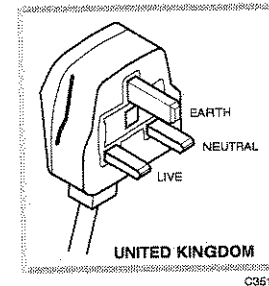

The fuse(s) or circuit breaker to protect the equipment is fitted at the back of the equipment.

North American

Country	IEC 320 plug type	IFR part number
North American	Straight through	23422-004
North American	Right angled	23422-005

The North American lead is fitted with a NEMA 5-15P (Canadian CS22.2 No 42) plug and carries approvals from UL and CSA for use in the USA and Canada.

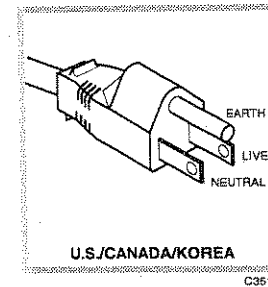

Continental Europe

Country	IEC 320 plug type	IFR part number
Europe	Straight through	23422-006
Europe	Right angled	23422-007

The Continental European lead is fitted with a right angle IEC83 standard C4 plug (CEE 7/7) which allows it to be used in sockets with either a male earth pin (standard C 3b) or side earth clips (standard C 2b) the latter is commonly called the German 'Schuko' plug. In common with other Schuko style plugs, the plug is not polarized when fitted into a Schuko socket. The lead carries approvals for use in Austria, Belgium, Finland, France, Germany, Holland, Italy, Norway and Sweden. Note that this plug will not fit Italian standard CEI 23-16 outlets. The lead should not be used in Denmark given that the earth connection will not be made.

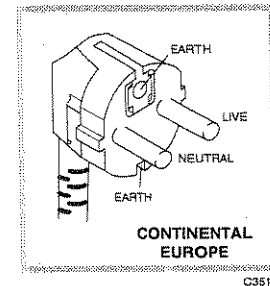

Français

Le câble d'alimentation d'Europe Continentale est muni d'un connecteur mâle à angle droit type CEI83, standard C4 (CEE 7/7), qui peut être utilisé dans une prise femelle à ergot de terre (standard C 3b) ou à clips latéraux (standard C 2b), cette dernière étant communément appelée prise "Schuko" allemande. De la même façon que les autres connecteurs de type Schuko, celui-ci

n'est pas polarisé lorsqu'il s'adapte à une prise femelle Schuko. Ce câble d'alimentation est homologué en Allemagne, Autriche, Belgique, Finlande, France, Hollande, Italie, Norvège et Suède. A noter que ce connecteur n'est pas compatible avec les prises de courant italiennes au standard CEI 23-16. Ce câble ne doit pas être utilisé au Danemark à cause du défaut de connexion de masse.

### Deutsch

Das kontinentaleuropäische Netzkabel ist mit einem rechtwinkligen Stecker nach IEC83 C4 (CEE7/7) Standard versehen, welcher sowohl in Steckdosen mit Erde-Stift (Standard C 3b) oder seitlichen Erdeklemmen, im allgemeinen "Schukosteckdose" genannt, paßt. Üblicherweise ist der Schukostecker bei Verwendung in Schukosteckdosen nicht gepolt. Dieses Netzkabel besitzt Zulassung für Österreich, Belgien, Finnland, Frankreich, Deutschland, Holland, Italien, Norwegen und Schweden.

Hinweis: Dieser Schukostecker paßt nicht in die italienischen Standardsteckdosen nach CEI 23-16 Norm. Dieses Netzkabel sollte nicht in Dänemark verwendet werden, da hier keine Erdeverbindung hergestellt wird.

### Español

El cable de alimentación tipo Europeo Continental dispone de una clavija C4 normalizada IEC83 (CEE 7/7) que permite su utilización tanto en bases de enchufe con toma de tierra macho (tipo C 3b) o con toma de tierra mediante contactos laterales (tipo C 2b) que, en este último caso, suele denominarse "Schuko". Al igual que cualquier otra clavija tipo Schuko, las conexiones a red no están polarizadas cuando se conectan a una base tipo Schuko. El cable lleva autorización para su uso en Austria, Bélgica, Finlandia, Francia, Alemania, Holanda, Italia, Noruega y Suecia. Observe que este cable no se adapta a la norma italiana CEI 23-16. El cable no debe utilizarse en Dinamarca en el caso de no efectuarse conexión a tierra.

### Italiano

I cavi d'alimentazione per l'Europa continentale vengono forniti terminati con una spina ad angolo retto del tipo C4 secondo lo standard IEC83 (CEE 7/7) che può essere usato in prese in cui la terra può essere fornita o tramite connettore maschio (C 3b) o tramite clips laterali (C 2b), quest'ultima comunemente detta di tipo tedesca "Schuko". Questa spina, quando collegata ad una presa Schuko, non è polarizzata.

Il cavo può essere usato in Austria, Belgio, Finlandia, Francia, Germania, Olanda, Norvegia, Svezia ed Italia. E' da notare che per l'Italia questo non risponde allo standard CEI 23-16.

Questa spina non dovrebbe invece essere usata in Danimarca in quanto non realizza il collegamento di terra.

## Goods-in checks

The following goods-in check verifies that the instrument is functioning correctly, but does not verify conformance to the listed specification. To verify that the instrument conforms to the specification given in Chapter 1, refer to Chapter 7, 'Acceptance testing'.

- (1) Ensure that the correct fuse is fitted (accessible from the rear panel) and connect the instrument to the supply.
- (2) Switch on and check that a display is present.
- (3) If the instrument appears to be completely dead, carry out the following:

Check that the mains power supply line is providing power to the instrument.

Check that the mains fuses have not blown.

## Instrument operating position

For reasons of stability and ventilation the instrument must only be operated on its underside feet (with or without the tilt stands).

## AC operation

### Connecting to supply

Ensure that the AC supply is correctly connected to the POWER SUPPLY socket. For supplies in the range 90–132 V and 188–264 V the PSU automatically selects the appropriate range. There is no manual voltage range selection provided.

Note that for AC operation when Option 2: DC operation is fitted, the AC supply frequency range is extended to 440 Hz within the AC supply range of 90 to 132 V.

### AC fuse

For the AC voltage range of 90 to 264 V the fuse rating is 2 A-T (time lag). The AC fuse is a cartridge type measuring 20 mm x 5 mm.

The fuse-holder is integral with the rear panel 3-pin supply plug. For access to change the fuse, use a screwdriver to lever out the holder.

### Internal fuse

Note that there is an additional, non-operator-replaceable internal, fuse fitted in the switched mode power supply (not applicable to instruments fitted with Option 2, DC operation, which have a different power supply).

## DC operation (Option 2)

### Connecting to supply

Before connecting the instrument to a DC supply, for an instrument fitted with Option 2, check that the DC supply is within the following range:

11 to 32 V

If, however, the DC supply is to provide a back-up for the AC supply, the following DC supply range must be used:

18 to 32 V

### DC fuse

For the DC voltage range of 11 to 32 V the fuse rating is 10 A-T (time lag). Fuses are cartridge type measuring 20 mm x 5 mm.

### DC supply cable

Connection is made to a 3-pin polarized plug on the instrument (see Fig. 2-1). Note that the negative (–) connector is internally connected to the chassis of the instrument. A suitable lead is available as a supplied accessory (see 'Versions and Accessories' in Data Sheet at end of Chap. 1).

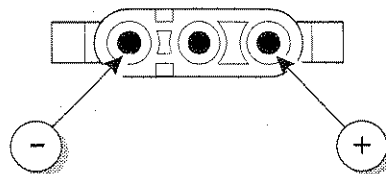

Fig. 2-1 DC input socket showing connector polarity (viewed from rear of instrument)

## General purpose interface bus (GPIB)

The GPIB interface built into the instrument enables the signal generator to be remotely controlled to form part of an automatic measuring system, as well as being used to dump memory (cloning) from one instrument to another.

### GPIB cable connection

Connection to other equipment which has a 24-way connector to IEEE Standard 488 is made using the rear-panel IEEE 488-2 socket. For this purpose the GPIB cable assembly, available as an optional accessory (see 'Versions and Accessories' in Data Sheet at end of Chap. 1), may be used.

### GPIB connector contact assignments

The contact assignments of the GPIB cable connector are as given in the table below and shown in Fig. 2-2.

Contact	Function	Contact	Function
1	Data I/O 1	13	Data/O 5
2	Data I/O 2	14	Data/O 6
3	Data I/O 3	15	Data/O 7
4	Data I/O 4	16	Data/O 8
5	EOI	17	REN
6	DAV	18	Pair with 6
7	NRFD	19	Pair with 7
8	NDAC	20	Pair with 8
9	IFC	21	Pair with 9
10	SRQ	22	Pair with 10
11	ATN	23	Pair with 11
12	Ground shield	24	Logic ground

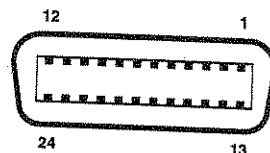

Fig. 2-2 GPIB connector contact assignments (viewed from rear of instrument)

### IEEE to IEC conversion

An optional IEEE to IEC adapter is also available (see 'Accessories' in Data Sheet at end of Chap. 1) for interfacing with systems using a 25-way bus connector to IEC Recommendation 625. The method of use is shown in Fig. 2-3.

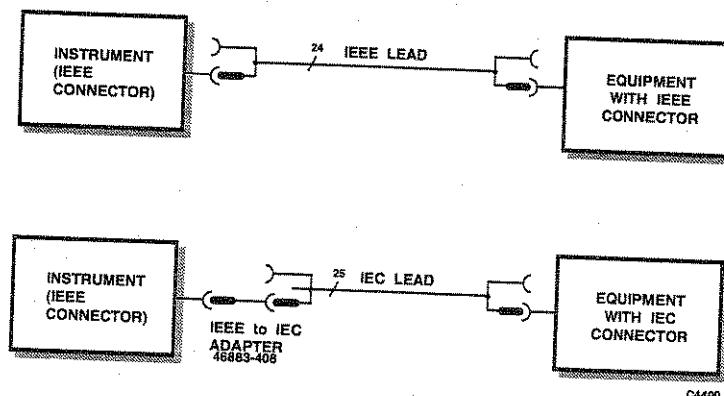

Fig. 2-3 IEEE to IEC conversion



### Interface bus connection

The cables for the interface bus use special male-female connectors at both ends. This allows several connectors to be stacked one on top of another, permitting several cables to be connected to the same source and secured by a lockscrew mechanism. Too large a stack, however, may form a cantilevered structure which might cause damage and should be avoided. The piggyback arrangement permits star or linear interconnection between the devices with the restriction that the total cable length for the system must be:

- (1) No greater than 20 m (65 ft).
- (2) No greater than 2 m (6 ft) times the total number of devices (including the controller) connected to the bus.

### RS-232 interface

The RS-232 interface built into the instrument enables the signal generator to be remotely controlled as well as being used to dump memory (cloning) from one instrument to another.

#### RS-232 connector

The rear panel male D-type RS-232 connector is shown in Fig. 2-4.

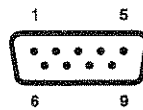

Fig. 2-4 RS-232 connector contact assignments (viewed from rear of instrument)

The pin-outs for the 9-way RS-232 connector are shown below:

Contact		Signal
1	DCD	Data carrier detect
2	RXD	Receive data
3	TXD	Transmit data
4	DTR	Data terminal ready
5	SG	Signal ground
6	DSR	Data set ready
7	RTS	Request to send
8	CTS	Clear to send
9	RI	Ring indicator

The RS-232 interface can be connected to a personal computer's AT connector using a null-modem cable. A suitable cable is available from IFR – see 'Versions and Accessories' in Data Sheet at end of Chap. 1.

### Rack mounting

The instrument, which is normally supplied for bench mounting, may be mounted in a standard 19 inch rack (see 'Versions and Accessories' in Data Sheet at end of Chap. 1).

INSTALLATION

---

**CAUTION**

## Routine maintenance

### Safety testing and inspection

In the UK the 'Electricity at Work Regulations' (1989) section 4(2) places a requirement on the users of equipment to maintain it in a safe condition. The explanatory notes call for regular inspections and tests together with a need to keep records.

The following electrical tests and inspection information is provided for guidance purposes and involves the use of voltages and currents that can cause injury. It is important that these tests are only performed by competent personnel.

Prior to carrying out any inspection and tests the instruments must be disconnected from the mains supply and all external signal connections removed. All tests should include the instrument's own supply lead, all covers must be fitted and the supply switch must be in the 'ON' position.

The recommended inspection and tests fall into three categories and should be carried out in the following sequence:

1. Visual inspection
2. Earth bonding test
3. Insulation resistance test.

### 1. Visual inspection

A visual inspection should be carried out on a periodic basis. This interval is dependent on the operating environment, maintenance and use, and should be assessed in accordance with guidelines issued by the Health and Safety Executive (HSE). As a guide, this equipment, when used indoors in a relatively clean environment, would be classified as 'low risk' equipment and hence should be subject to safety inspections on an annual basis. If the use of the equipment is contrary to the conditions specified, you should review the safety re-test interval.

As a guide, the visual inspection should include the following where appropriate:

Check that the equipment has been installed in accordance with the instructions provided (e.g. that ventilation is adequate, supply isolators are accessible, supply wiring is adequate and properly routed).

- The condition of the mains supply lead and supply connector(s).
- The correct rating and type of supply fuses.
- Security and condition of covers and handles.
- Check the presence and condition of all warning labels and markings and supplied safety information.
- Check the wiring in re-wireable plugs and appliance connectors.
- Check the cleanliness and condition of any ventilation fan filters.
- Check that the mains supply switch isolates the equipment from the supply.
- Check the supply indicator functions (if fitted).

If any defect is noted this should be rectified before proceeding with the following electrical tests.

### 2. Earth bonding tests

Earth bonding tests should be carried out using a 25 A (12 V maximum open circuit voltage) DC source. Tests should be limited to a maximum duration of 5 seconds and have a pass limit of 0.1  $\Omega$  after allowing for the resistance of the supply lead. Exceeding the test duration can cause damage to the equipment. The tests should be carried out between the supply earth and exposed case metalwork, no attempt should be made to perform the tests on functional earths (e.g. signal carrying connector shells or screen connections) as this will result in damage to the equipment.

### 3. Insulation tests

A 500 V DC test should be applied between the protective earth connection and combined live and neutral supply connections with the equipment supply switch in the 'on' position. It is advisable to make the live/neutral link on the appliance tester or its connector to avoid the possibility of returning the equipment to the user with the live and neutral poles linked with an ad-hoc strap. The test voltage should be applied for 5 seconds before taking the measurement.

IFR Ltd employs reinforced insulation in the construction of its products and hence a minimum pass limit of 7 M $\Omega$  should be achieved during this test.

Where a DC power adapter is provided with the equipment, the adapter must pass the 7 M $\Omega$  test limit.

We do not recommend dielectric flash testing during routine safety tests. Most portable appliance testers use AC for the dielectric strength test which can cause damage to the supply input filter capacitors.

### 4. Rectification

It is recommended that the results of the above tests are recorded and checked during each repeat test. Significant differences between the previous readings and measured values should be investigated.

If any failure is detected during the above visual inspection or tests, the equipment should be disabled and the fault should be rectified by an experienced Service Engineer who is familiar with the hazards involved in carrying out such repairs.

Safety critical components should only be replaced with equivalent parts, using techniques and procedures recommended by IFR Ltd.

The above information is provided for guidance only. IFR Ltd designs and constructs its products in accordance with International Safety Standards such that in normal use they represent no hazard to the operator. IFR Ltd reserves the right to amend the above information in the course of its continuing commitment to product safety.

## Cleaning

Before commencing any cleaning, switch off the instrument and disconnect it from the supply. The exterior surface of the case may be cleaned using a soft cloth moistened in water. Do not use aerosol or liquid solvent cleaners.

## Cleaning the LCD window

To prevent damage to the LCD window, care should be taken not to scratch the surface during use and also when cleaning. The LCD window should be cleaned by wiping a slightly damp, soft, lint-free cloth gently over the surface

## Putting into storage

If the instrument is to be put into storage, ensure that the following conditions are maintained:

Temperature range:	-40 to +70°C
Humidity:	Less than 93% at 40°C

## Disk installation/loading instructions

There are two disks supplied with this instrument, labeled 'IFR2025 VXI Plug&play Driver'. These contain the LabWindows/CVI Instrument Driver for the 2023A, 2023B and 2025, and the VXI Plug and Play Soft Panel.

The IFR2025 driver makes use of the National Instruments (NI) VISA interface and I/O software, which must be installed before running the driver. VISA is freely available at the NI Website or on the NI Labview CD.

Read the instructions given on the label of the appropriate disk before inserting it into your disk drive. The disks contain self-extracting Zip files that create the path C:\Vxipnp\Winnt *or* Win95\ifr2025. Once extracted, the following entries are created in the Start menu under Vxipnp:

Ifr2025 Front Panel (Runs the soft front panel)

Ifr2025 SFP Help

Uninstall ifr2025 instrument driver

If problems arise, check that:

NI VISA is installed correctly (refer to the 'Readme' document);

the instrument is connected to the controller with the correct GPIB or RS232 cable;

the instrument is set up to GPIB or RS232 as required;

the GPIB address (GPIB) or COM port, baud rate, parity and timeout (RS232) supplied to the initialize function match the settings on the instrument;

the correct instrument is selected (displayed at the top right-hand corner on the soft front panel; highlight and click to select);

any ports present in the system that will not be used for instrument control (for example, your mouse port) are disabled under visacnf.exe in the Vxipnp\Winnt *or* Win95\NIvisa folder. Disabling ports in this way should not affect the operation of the port itself, but allow VISA's device/instrument search functions to skip this port (which might otherwise cause a problem when certain devices are attached to it).

Ifr2025.doc, included in the ifr2025 folder, lists all possible functions and error codes concerned with opening, configuring, taking measurements from, and closing the instrument.

## Operation

Change instrument settings by selecting with the mouse, entering the new value, then pressing ENTER on your keyboard. Select different functions under the 'Panel' menu.

---

## Chapter 3

# PRINCIPLES OF OPERATION

### Contents

Introduction.....	3-2
Main screen operation.....	3-2
Utility menu operation.....	3-2
Menu grouping.....	3-3
Family tree.....	3-3
Memory operation.....	3-3

### List of figures

Fig. 3-1 Utility menu operation summary showing a modulation selection example.....	3-5
Fig. 3-2 Utility menu family tree.....	3-7

## Introduction

This chapter is specifically for use by the experienced signal generator user and therefore the operation of the instrument is not explained in detail. Since the instrument has been designed to be easy to use, the experienced user may need to refer only to this chapter to use the instrument efficiently.

The operation of the instrument is based on using the main screen and using the menus. The main screen is used in association with six function keys while menu operation is entered using the [MENU] key. Four of the function keys [CARR FREQ], [RF LEVEL], [MOD] and [MOD SOURCE] enable you to set the basic parameters of a signal. The remaining two function keys [STO] and [RCL] control memory store and recall operations. The blue [MENU] key enables you to select utility menu operation which provides access to a wide range of utilities.

## Main screen operation

The main screen is displayed at switch-on and after one of the dark gray function keys has been pressed. Pressing a function key highlights the area of the screen appropriate to that key and the instrument awaits either parameter entry or menu operation.

Both the [MOD] and [MOD SOURCE] function keys operate in a cyclic fashion as shown by the arrows marked on the keys. Repeated pressing of the [MOD] key steps through each modulation of the currently selected modulation mode, together with full source information for that mode.

As each modulation mode is displayed, the signal source for that modulation can be selected. For internal sources, repeated pressing of the [MOD SOURCE] key steps through and selects each of the available waveforms. If the displayed modulation mode is external, repeated pressing of the key displays and selects each of the external types of coupling.

## Utility menu operation

The instrument provides a range of utilities for such applications as setting the GPIB address, adjusting the LCD contrast, poking the latches and selecting the modulation mode. Utility menu operation is summarized in Fig. 3-1 which uses a modulation selection example. This is intended to be opened out and used in conjunction with the explanatory text which follows.

The function keys are closely connected with the utility menus for greater efficiency of operation. This means that when you press a function key followed by the [MENU] key, those utilities associated with that function are called up for immediate use. Thus pressing [MOD][MENU] takes you to the modulation group of menus.

Within the menus, pressing [SELECT] will take you down the menu chain, pressing [MENU] will take you back up.

Moving between items on a menu is done by means of the [NEXT] and [PREV] keys.

Once you are familiar with the use of the utility menus, you can immediately call up commonly used menus by using the sequence:

[MENU] Utility number [ENTER]

To return to the main screen, press any one of the function keys.

With the main screen displayed, pressing [SELECT] will either display your last selected utility or, if you have just switched on, display the software status of the instrument.

## Menu grouping

To save you having to memorize specific utility numbers the utilities are split into the 11 groups listed below:

Utility number	Utility group
01-09	FREQUENCY/SWEEP
10-19	RF LEVEL
20-29	MODULATION (Normal and FSK)
30-39	MODULATION SOURCE
40-48	MEMORY
49	SPECIAL
50-59	SETUP
60-69	INFORMATION
70-79	DIAGNOSTICS
80-89	LOCK/UNLOCK
100 onwards	CALIBRATION

## Family tree

Menu operation is graphically presented in Fig. 3-2.

## Memory operation

During operation, either the current carrier frequency or the current instrument settings can be saved by means of the memory store [STO] key and recalled when required by means of the recall [RCL] key. The type of store is determined by the location number selected:

Carrier store	non-volatile	0-99
Full store	non-volatile	100-199
Full store	volatile	200-299

Note that the instrument factory settings can be recalled from memory location 999.

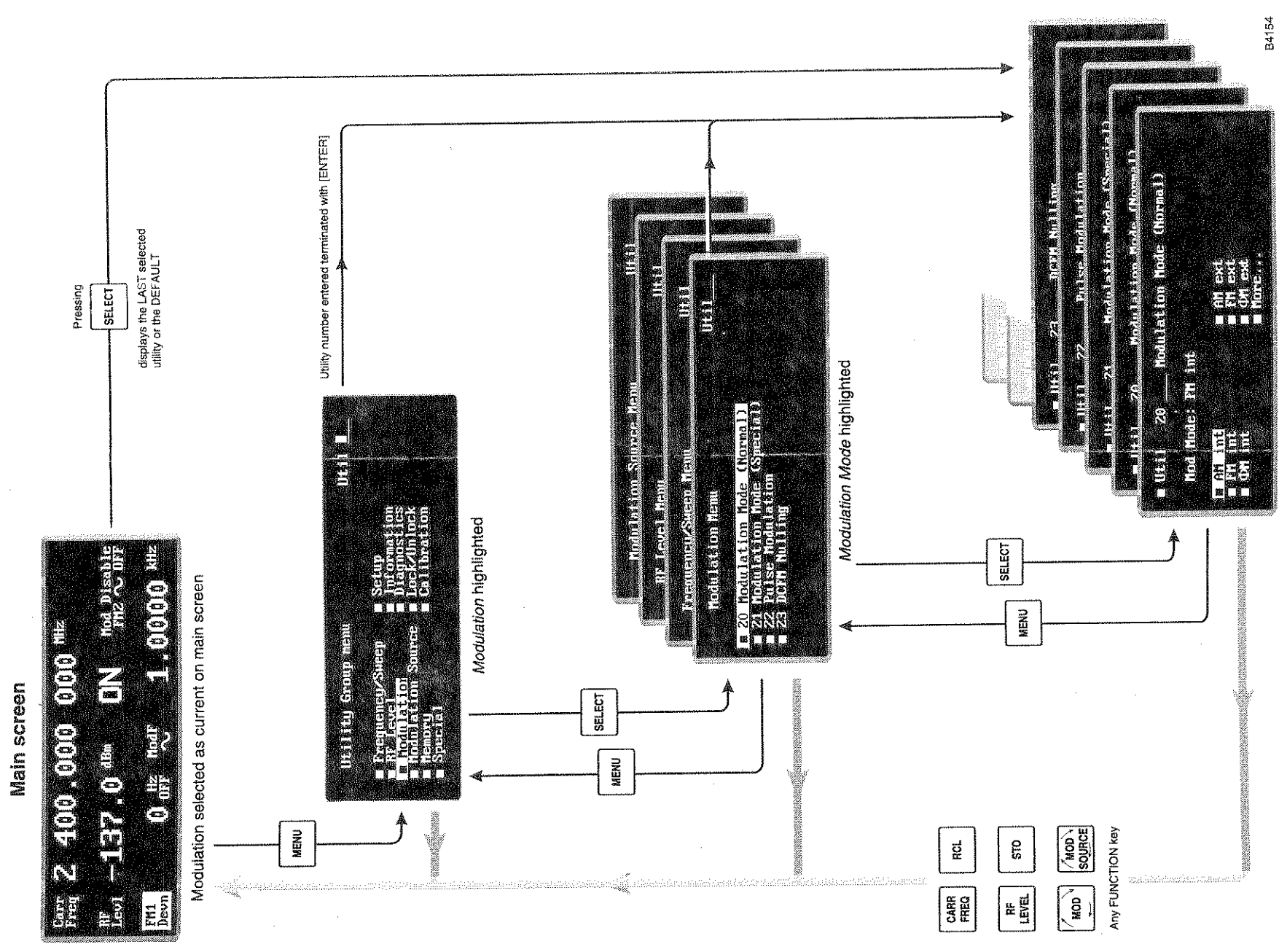

Fig. 3-1 Utility menu operation summary showing a modulation selection example



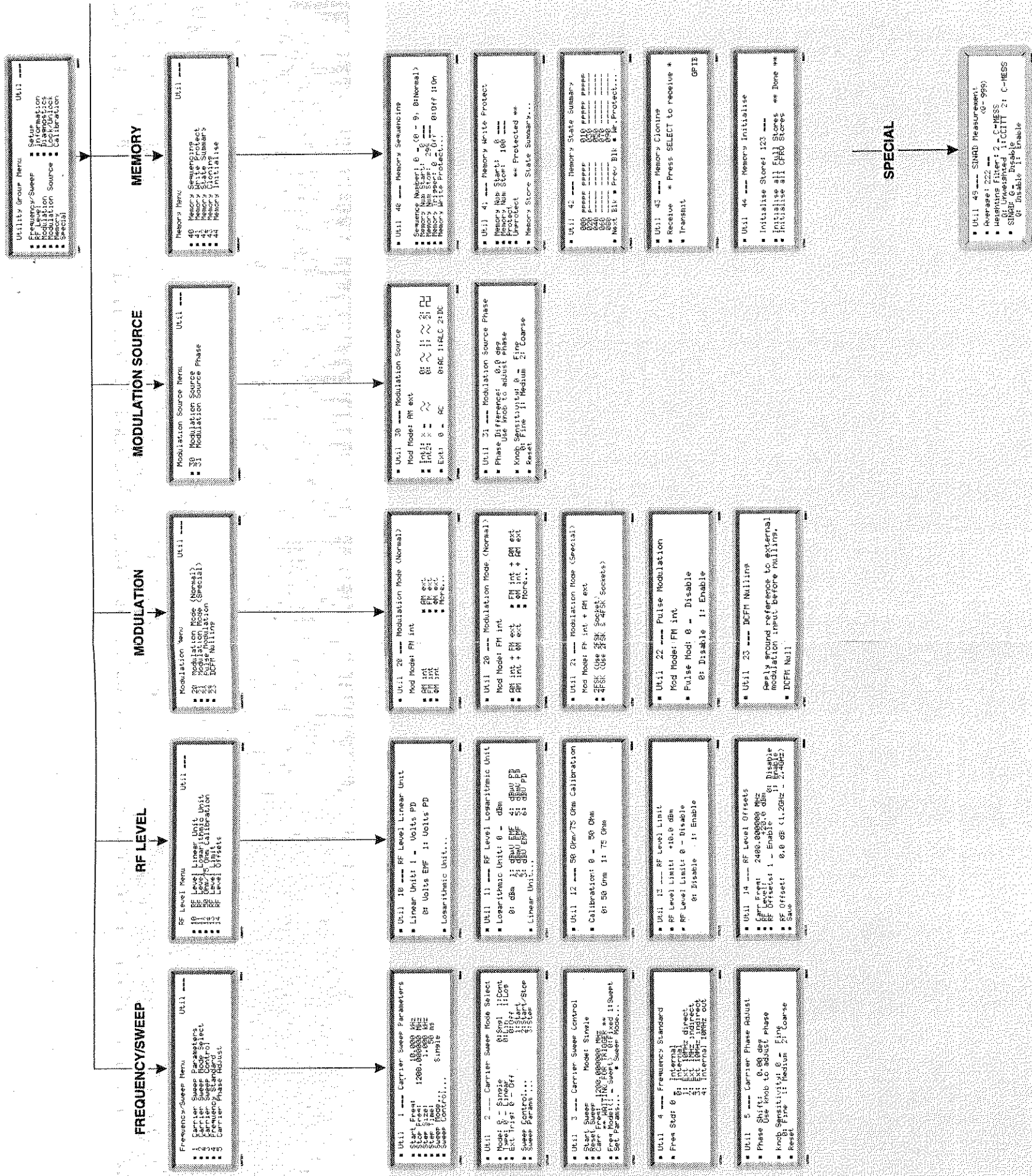

Fig 3-2 Utility menu family tree

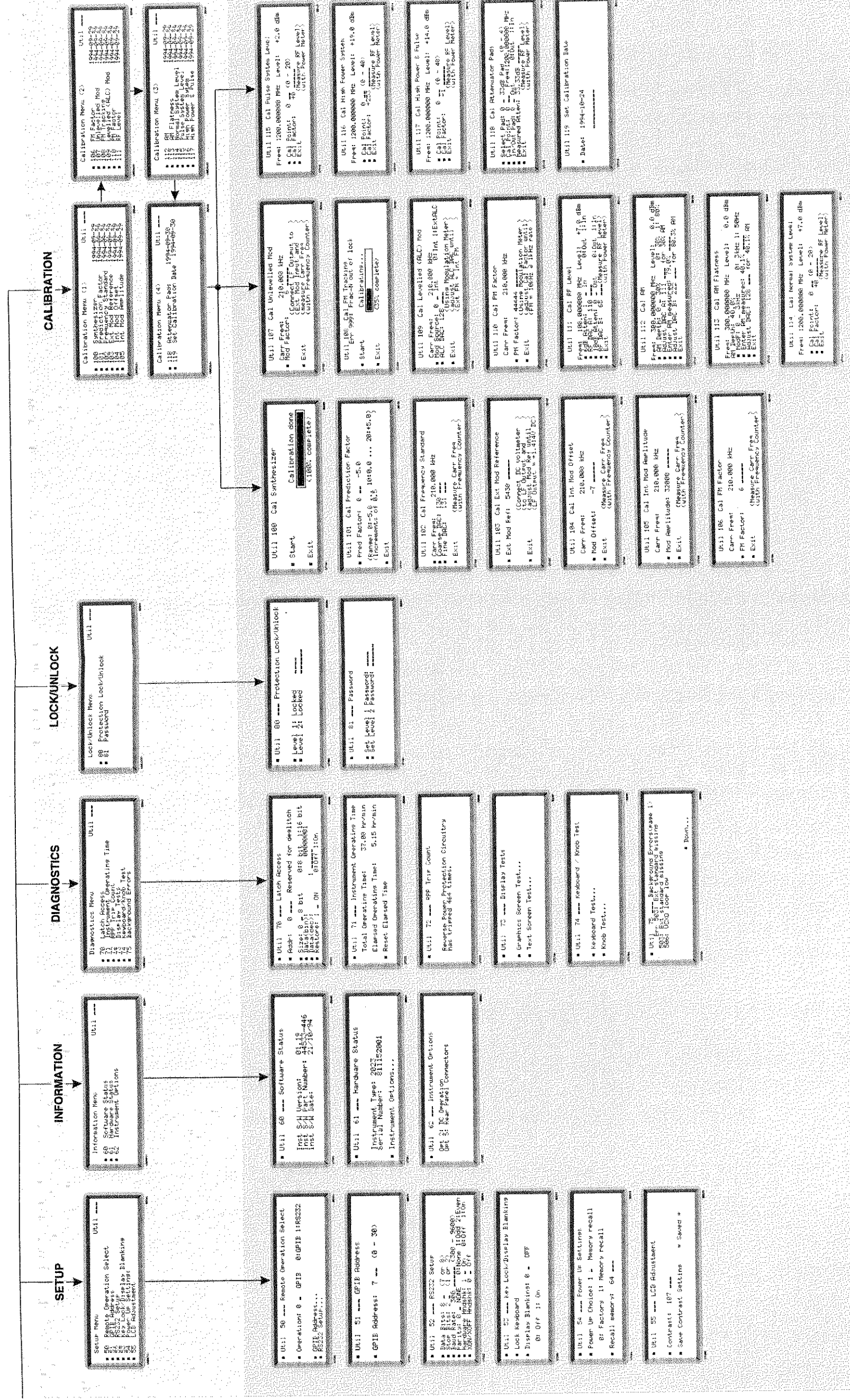

Fig. 3-2 Utility menu family tree

# Chapter 4

## LOCAL OPERATION

### Contents

Introduction.....	4-4
Front-panel controls and connectors .....	4-4
Connectors .....	4-4
Keyboard.....	4-5
Rear-panel connectors.....	4-7
<b>FIRST-TIME USE .....</b>	<b>4-9</b>
Switching on.....	4-9
Display .....	4-10
Selecting functions and keyboard entry.....	4-12
Carrier frequency .....	4-12
RF level.....	4-12
Modulation.....	4-12
Using [NEXT] and [PREV] to select a function .....	4-12
Using the [ $\uparrow$ +10] and [ $\downarrow$ ×10] keys .....	4-12
With the control knob .....	4-13
With steps .....	4-13
Using the utility menus.....	4-14
Menu conventions .....	4-15
<b>DETAILED OPERATION.....</b>	<b>4-16</b>
Selecting carrier frequency.....	4-16
Carrier on/off .....	4-16
Carrier sweep operation .....	4-16
Sweep parameters .....	4-16
Sweep mode.....	4-17
Sweep control.....	4-18
Carrier phase adjustment.....	4-19
Selecting RF level .....	4-20
Choice of units .....	4-20
Attenuator hold .....	4-20
Reverse power protection.....	4-20
RF level linear units .....	4-21
RF level logarithmic units .....	4-22
Modulation modes.....	4-23
Mode selection .....	4-23
Source selection – internal .....	4-24
Source selection – external .....	4-25
Modulation enable/disable .....	4-26
Modulation source phase adjustment .....	4-26
Modulation selection.....	4-27
Amplitude modulation selection – internal .....	4-27
Frequency modulation selection – internal .....	4-28
Phase modulation selection – internal.....	4-29
Pulse modulation selection.....	4-30
FSK selection .....	4-31
Default settings.....	4-32
<b>MEMORY .....</b>	<b>4-33</b>
Memory stores.....	4-33
Memory recall .....	4-34
Recalling data.....	4-34
Recalling default settings .....	4-34
Memory sequencing .....	4-35

contd./...

LOCAL  
OPERATION

## Contents (continued)

Memory write protection .....	4-36
Memory state summary.....	4-37
Memory cloning.....	4-38
<b>GENERAL .....</b>	<b>4-39</b>
Frequency standard selection.....	4-39
50 $\Omega$ /75 $\Omega$ impedance selection.....	4-40
RF level limit.....	4-41
RF level offsets.....	4-42
DCFM nulling.....	4-43
SINAD measurement (Option 12) .....	4-44
Keyboard locking and display blanking.....	4-46
Power-up options.....	4-47
Adjusting the display.....	4-48
Software information.....	4-49
Hardware information.....	4-49
Instrument options .....	4-50
Protection locking and unlocking.....	4-51
Changing the password.....	4-52
<b>ERROR MESSAGES .....</b>	<b>4-53</b>
Error handling.....	4-53
Background errors:.....	4-53
Foreground errors:.....	4-53
Error message priority:.....	4-53
GPIB errors .....	4-53

## List of tables

Table 4-1 Instrument default settings.....	4-32
Table 4-2 Background errors (500–599) in priority order.....	4-54
Table 4-3 Foreground errors (0–399).....	4-54
Table 4-3 Foreground errors (0–399)(continued).....	4-55
Table 4-4 GPIB errors (400–499).....	4-56

## List of figures

Fig. 4-1 2025 front panel showing SUPPLY switch and connectors.....	4-4
Fig. 4-2 Instrument front panel showing keyboard.....	4-5
Fig. 4-3 Instrument rear panel showing connectors.....	4-7
Fig. 4-4 2023A main screen in normal operation showing default display.....	4-9
Fig. 4-5 2023B main screen in normal operation showing default display.....	4-9
Fig. 4-6 2025 main screen in normal operation showing default display.....	4-10
Fig. 4-7 Division of the display into fields.....	4-11
Fig. 4-8 Step setting display showing default settings.....	4-14
Fig. 4-9 Utility group menu.....	4-14
Fig. 4-10 Frequency/sweep menu.....	4-14
Fig. 4-11 Frequency standard menu.....	4-15
Fig. 4-12 Carrier sweep parameters menu.....	4-16
Fig. 4-13 Carrier sweep mode select menu.....	4-17
Fig. 4-14 Carrier sweep control menu (shown with sweep enabled).....	4-18
Fig. 4-15 Carrier phase adjust menu.....	4-19
Fig. 4-16 RPP tripped display.....	4-20
Fig. 4-17 RF level linear units menu.....	4-21
Fig. 4-18 RF level logarithmic units menu.....	4-22
Fig. 4-19 Modulation mode menu – first page.....	4-23
Fig. 4-20 Modulation mode menu – second page.....	4-23
Fig. 4-21 Modulation source menu.....	4-24

Fig. 4-22	Modulation source menu – shown with an external source selected.....	4-25
Fig. 4-23	Modulation source phase menu .....	4-26
Fig. 4-24	Pulse modulation menu.....	4-30
Fig. 4-25	Modulation mode (special) menu .....	4-31
Fig. 4-26	Memory sequencing menu.....	4-35
Fig. 4-27	Memory write protection menu (showing stores 0 to 100 protected) .....	4-36
Fig. 4-28	Memory state summary (showing carrier stores 0 to 20 protected) .....	4-37
Fig. 4-29	Memory cloning menu (showing instrument ready to receive via the GPIB).....	4-38
Fig. 4-30	Frequency standard menu .....	4-39
Fig. 4-31	50 $\Omega$ /75 $\Omega$ calibration menu .....	4-40
Fig. 4-32	RF level limit menu .....	4-41
Fig. 4-33	RF level offsets menu .....	4-42
Fig. 4-34	DCFM nulling display .....	4-43
Fig. 4-35	SINAD measurement interconnections.....	4-44
Fig. 4-36	Special menu.....	4-44
Fig. 4-37	SINAD measurement menu.....	4-45
Fig. 4-38	Main screen during auto SINAD operation .....	4-45
Fig. 4-39	Key lock/display blanking menu.....	4-46
Fig. 4-40	Power-up settings menu.....	4-47
Fig. 4-41	LCD adjustment menu (with the setting saved for automatic recall at switch-on).....	4-48
Fig. 4-42	Software status.....	4-49
Fig. 4-43	Hardware status .....	4-49
Fig. 4-44	Instrument options display.....	4-50
Fig. 4-45	Protection locking and unlocking .....	4-51
Fig. 4-46	Password selection menu.....	4-52
Fig. 4-47	Background errors display .....	4-53

## Introduction

All operations of the signal generator are carried out from the front-panel keyboard which is color-coded. An extensive suite of utility menus make this a very versatile instrument. The built-in GPIB and RS-232 interfaces enable the instrument to be remotely operated.

## Front-panel controls and connectors

Parameters are selected by means of keys which have their functions printed on them, a numerical key pad and a rotary control knob. The numerical keys are used to set parameters to specific values which can also be varied in steps of any size by using the [ $\uparrow+10$ ] and [ $\downarrow\times 10$ ] keys or the rotary control knob.

## Connectors

The front-panel connectors are shown in Fig. 4-1 below:

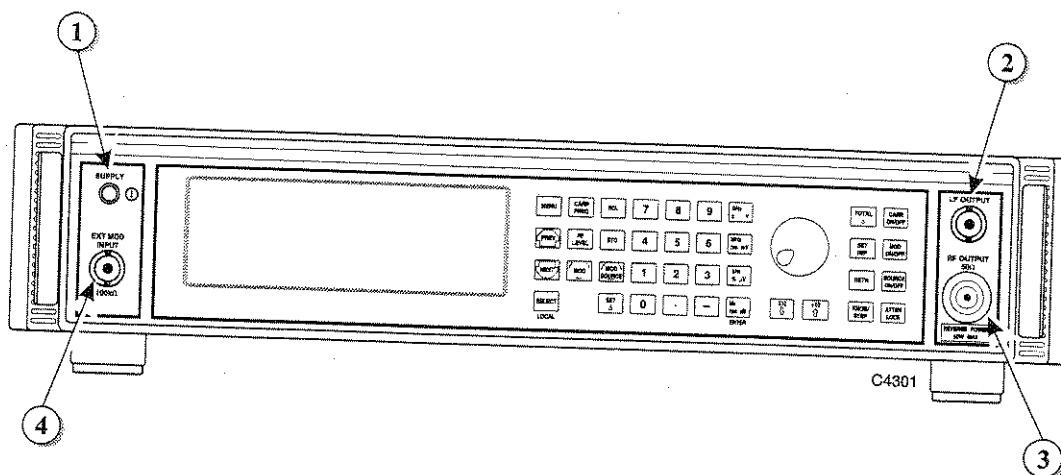

Fig. 4-1 2025 front panel showing SUPPLY switch and connectors

- |                   |  |
|-------------------|--|
| (1) SUPPLY switch | Switches the supply on and off using a press on, press off action.   |
| (2) LF OUTPUT     | 600 $\Omega$ BNC socket which monitors the modulation oscillator. With Option 5 this socket is fitted on the rear panel.   |
| (3) RF OUTPUT     | 50 $\Omega$ N-type socket. Protected against the application of reverse power of up to 50 W. With Option 5 this socket is fitted on the rear panel.              |
| (4) EXT MOD INPUT | 100 k $\Omega$ BNC socket. An independent input which allows an external modulating signal to be applied. With Option 5 this socket is fitted on the rear panel. |

Note: connector positions differ for Options 7 and 11 – see Annexes A and B.

## Keyboard

The keyboard is functionally color-coded. The keys for the primary functions of carrier frequency, level and modulation are dark gray. Secondary functions such as unit selection and on/off keys are medium gray. Menu selection, which plays such a prominent part in this instrument, has keys which are colored blue.

The front-panel keyboard is shown in Fig. 4-2 below:

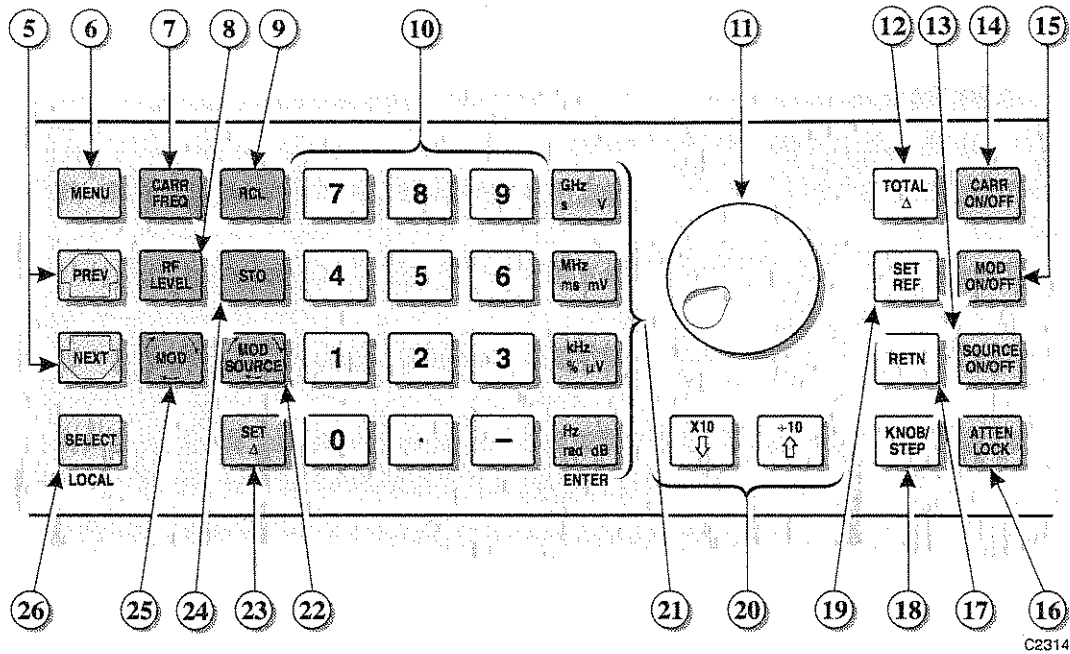

C2314

**LOCAL OPERATION**

Fig. 4-2 Instrument front panel showing keyboard

- |      |                   |   |
|------|-------------------|---|
| (5)  | [PREV]            | A key used to scrolls backwards through a menu list or the function list.   |
|      | [NEXT]            | A menu key used to scroll forwards through a menu list or the function list.  |
| (6)  | [MENU]            | Selects the main utility menu, or within utility menus steps back up through the menus.   |
| (7)  | [CARR FREQ]       | Selects carrier frequency as the current function and causes the main screen to be displayed.   |
| (8)  | [RF LEVEL]        | Selects RF level as the current function and causes the main screen to be displayed.  |
| (9)  | [RCL]             | Used to recall a previously stored instrument setting from memory.  |
| (10) | Numerical key pad | For entering the value of a selected parameter. Minus sign and decimal point are included.  |
| (11) | Control knob      | When enabled by the [KNOB/STEP] key, adjusts the value of the selected parameter.   |
| (12) | [TOTAL Δ]         | While the key is held down, displays the total shift from the keyed-in value.   |
| (13) | [SOURCE ON/OFF]   | Switches the current modulation source on and off.  |
| (14) | [CARR ON/OFF]     | Switches the carrier output on and off.   |
| (15) | [MOD ON/OFF]      | Switches ALL modulation on and off.   |
| (16) | [ATTEN LOCK]      | Holds the attenuator at the current setting with <i>Atten Lock</i> displayed. Allows the RF level to be decreased by a further 10 dB without the step attenuator operating. |

- (17) [RETN] After using the [ $\uparrow+10$ ] or [ $\downarrow\times 10$ ] keys or the control knob returns the setting of the function to the last keyed-in value.
- (18) [KNOB/STEP] Switches between enabling the control knob and enabling the step operation.
- (19) [SET REF] Transfers the current value as the keyed-in setting.
- (20) [ $\uparrow+10$ ] When KNOB is enabled, increases the knob resolution by a factor of 10.  
When STEP is enabled, increments the current function by one step.
- [ $\downarrow\times 10$ ] When KNOB is enabled, decreases the knob resolution by a factor of 10.  
When STEP is enabled, decrements the current function by one step.
- (21) [ENTER]/Units keys Determine the units of the set parameters; also used to terminate a numerical entry.
- (22) [MOD SOURCE] Selects modulation source as the current function and causes the main screen to be displayed.  
For internal modulation repetitive pressing of this key cycles through the currently selected modulation sources while displaying the appropriate wave shape on the screen.  
For external modulation it cycles through the currently selected external coupling modes.
- (23) [SET  $\Delta$ ] Press to obtain the step setting display. To change the step size, press the relevant function key.
- (24) [STO] Used to store the current instrument settings in memory.
- (25) [MOD] Selects modulation as the current function and causes the main screen to be displayed. Repetitive pressing of this key cycles through each of the modulations of the current mode together with their source values.
- (26) [SELECT] Selects an item highlighted on a utility menu.  
With the main screen displayed selects the last utility accessed.  
After power-up causes the software status to be displayed.
- [LOCAL] Transfers control from the GPIB to the front panel (providing local lockout not asserted).



## Rear-panel connectors

The rear-panel connectors are shown in Fig. 4-3 below.

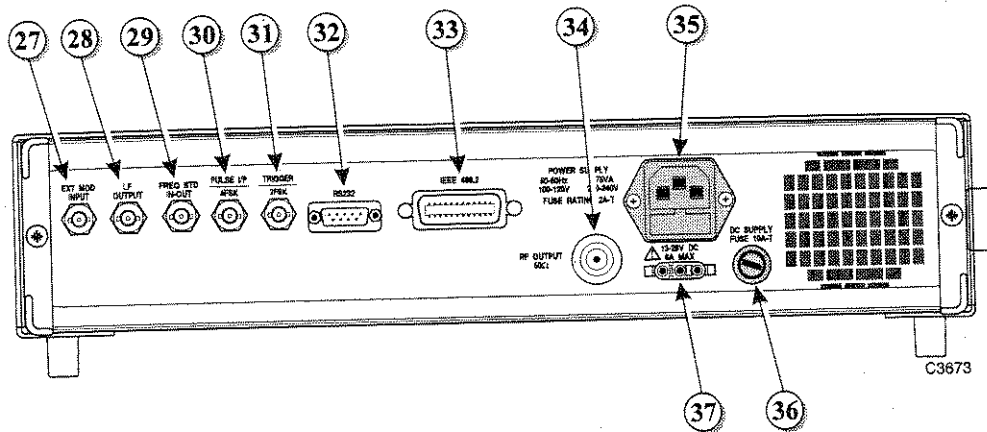

Fig. 4-3 Instrument rear panel showing connectors

- |                                |   |
|--------------------------------|---|
| (27) EXT MOD INPUT (optional)  | An Option 5 BNC socket which allows an external modulating signal to be applied. When fitted, replaces the front-panel socket.            |
| (28) LF OUTPUT (optional)      | An Option 5 BNC socket which monitors the modulation oscillator. When fitted, replaces the front-panel socket.                            |
| (29) FREQ STD IN-OUT           | BNC socket for the input of external standard frequencies of either 1 MHz or 10 MHz. Can also supply a 10 MHz internal standard output.   |
| (30) <u>PULSE I/P</u><br>4FSK  | 10 k $\Omega$ BNC socket which accepts a pulsed input. Also used as one logic input (the other is the TRIGGER input) for 4FSK modulation. |
| (31) <u>TRIGGER</u><br>2FSK    | BNC socket which has three uses; in priority order these are:<br>FSK logic input<br>Memory sequencing<br>Sweep trigger                    |
| (32) RS232                     | 9-way RS-232 connector for remote control of the instrument. For contact allocation see Chapter 2.  |
| (33) IEEE 488.2                | 24-pin socket accepts the standard GPIB connector to allow remote control of the instrument. For contact allocation see Chapter 2.        |
| (34) RF OUTPUT (optional)      | An Option 5 50 $\Omega$ N-type socket. When fitted, replaces the front-panel socket.  |
| (35) POWER SUPPLY              | 3-pin plug integral with fuse holder. Mates with AC supply lead socket.   |
| (36) DC SUPPLY FUSE (optional) | When Option 2 fitted, fuses the DC input socket.  |
| (37) DC input (optional)       | When Option 2 fitted, the socket allows operation from an external 11 to 32 V DC source. For contact polarity see Chapter 2.              |

LOCAL  
OPERATION



# FIRST-TIME USE

First-time users can quickly become familiar with the principles of control and display by carrying out the following exercise, which demonstrates how to set up a typical basic signal having the following parameters:

Carrier frequency:	100 MHz
Output level:	10 dBm
Frequency modulation:	100 kHz deviation at 500 Hz mod.

## Switching on

Before switching the instrument on, check that the power supply is connected and ensure that no external signal sources are connected.

Switch on by means of the SUPPLY switch and check that the display is similar to that shown in Fig. 4-4, Fig. 4-5 or Fig. 4-6. This shows the main screen as it appears during normal operation.

If a default display as shown in Fig. 4-4, Fig. 4-5 or Fig. 4-6 is not obtained, a previous user may have set the instrument to switch on with one of the user memories recalled, rather than using the default factory settings.

To reset to the factory settings press the [RCL] hard key. RCL appears highlighted at the top right of the screen with the cursor blinking awaiting your entry. Enter 999 on the keyboard and press [ENTER]. (Note that any one of the units keys can be used to perform the [ENTER] function.) The *RESET* annunciator is shown and the factory settings are now recalled from memory location 999 and displayed on the screen.

LOCAL  
OPERATION

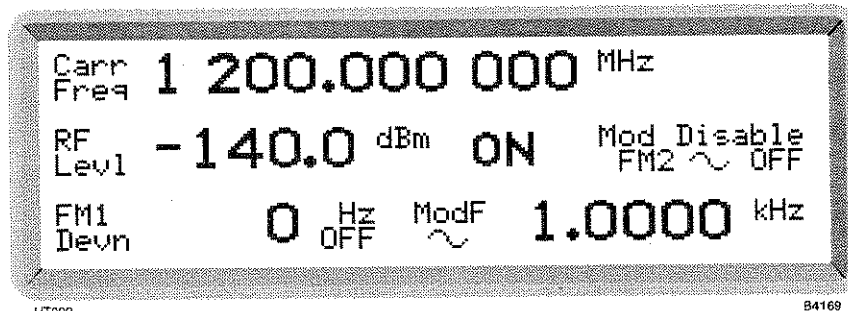

Fig. 4-4 2023A main screen in normal operation showing default display

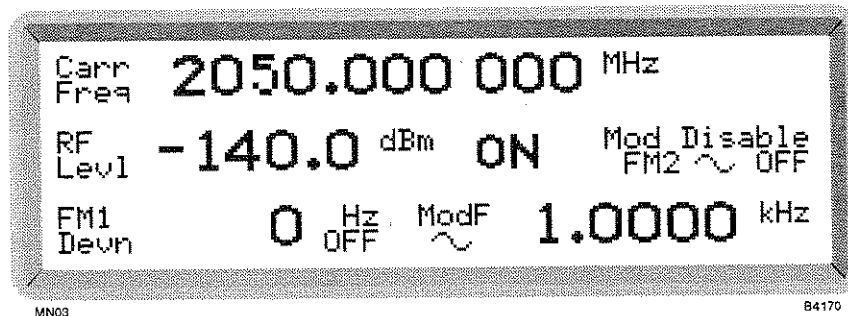

Fig. 4-5 2023B main screen in normal operation showing default display

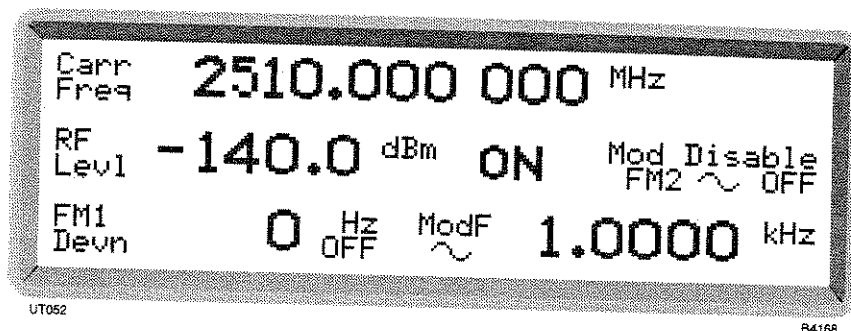

Fig. 4-6 2025 main screen in normal operation showing default display

## Display

Before entering any parameters it is useful to look at the effect that pressing various keys has on the display. The display is divided into a number of fields as shown in Fig. 4-7.

### Carrier frequency field

When you press [CARR FREQ] it causes *Carr Freq* to be highlighted and your data entry is recognized as a frequency setting. *Ext* is displayed when the instrument is locked to an external standard.

### Memory field

When you press the [STO] or [RCL] key it causes *STO* or *RCL* to be highlighted respectively. Your data entry is recognized as a memory location number. The type of recall – *FREQ*, *FULL* or *RAM* (or sequence number for memory sequencing) – is also shown.

### Error message field

Error messages are displayed when, for example, you exceed a parameter limit. A list of error messages is given at the end of this chapter.

### RF level field

When you press [RF LEVEL] it causes *RF Level* to be highlighted and your data entry is recognized as a level setting. Units and unit type are displayed together with the carrier *ON* or *OFF* state. When selected, *Atten Lock* is displayed unless overwritten by *Offs* when an RF level offset has been enabled. This field is also used to display the SINAD measurement and weighting filter used.

### Modulation field

When you press [MOD] it causes the currently selected type of modulation to be highlighted and your data entry is recognized as a modulation depth or deviation setting. Modulation *ON* or *OFF* is also shown.

### Modulation source field

When you press [MOD SOURCE] it causes the currently selected internal modulation source or external coupling to be highlighted. For an internal source a sine, triangle or square wave symbol is shown. Your data entry is recognized as a modulating frequency. For an external source *AC*, *DC* or *ALC* coupling is shown.

When the instrument is operating under remote control *REM* is displayed.

## Modulation summary field

In this field are shown your other selected modulation sources. All your settings – types of modulation, waveforms, current *ON* or *OFF* states, as well as modulation enabled or disabled – are shown.

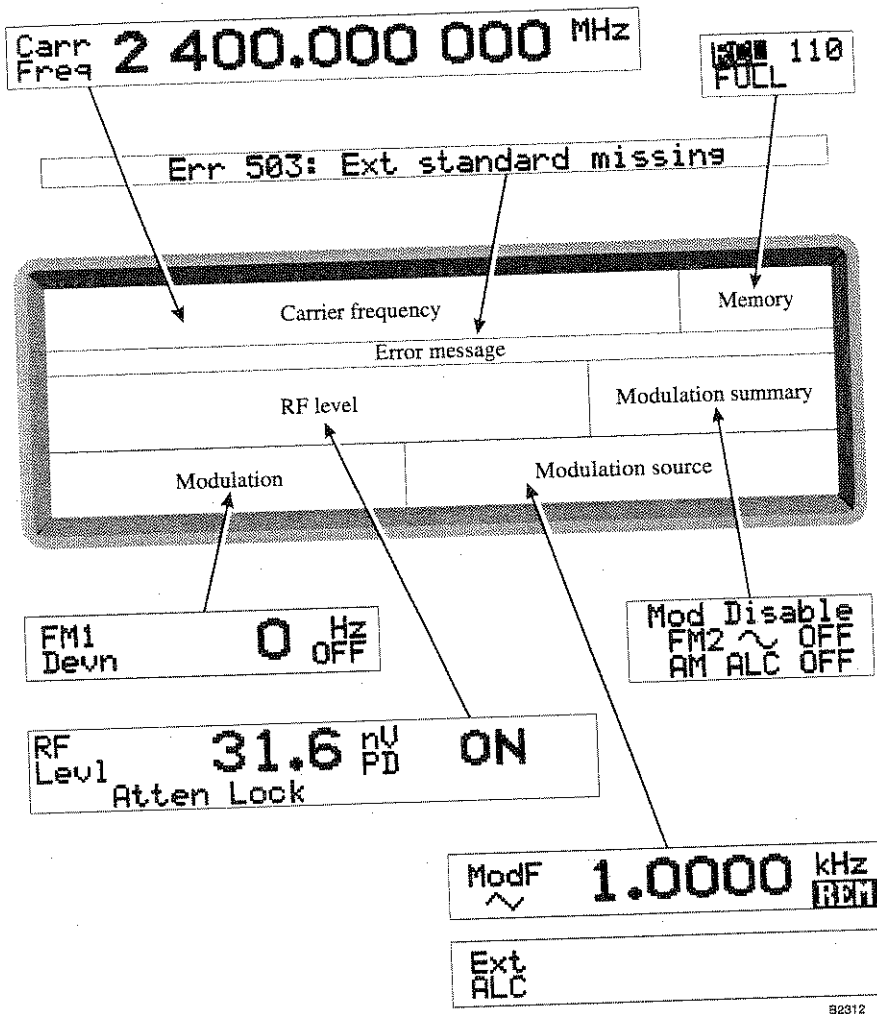

LOCAL  
OPERATION

Fig. 4-7 Division of the display into fields

---

## Selecting functions and keyboard entry

Whenever one of the main functions – carrier frequency, RF level, modulation, modulation source – is highlighted on the main screen, making any terminated numerical entry will be accepted as being a changed parameter for that function. This enables you to enter, for example, a sequence of carrier frequencies without having to re-press the [CARR FREQ] function key for each entry.

### Carrier frequency

- (1) Press [CARR FREQ] to select carrier frequency as the current function. *Carr Freq* is highlighted on the screen.
- (2) Using the numerical key pad, enter 100 MHz by entering 100 on the key pad and terminate with [MHz]. Observe that the *Carr Freq* display changes to *100.000 000 MHz*.

If you make an error when keying in, press the function key again and key in the correct value. If this causes an error message (e.g. *Err 100: Carrier limit*) to be displayed, it can be canceled by a correct entry (e.g. by entering a value which is within limits).

### RF level

- (3) Press [RF LEVEL] to select RF level as the current function. *RF Levl:* is now highlighted on the screen.
- (4) Using the numerical key pad, enter 10 dBm by entering 10 on the key pad and terminate with [dB]. Observe that the *RF Levl* display changes to *+10.0 dBm*.
- (5) Press [CARR ON/OFF]. Repeated pressing toggles between the on and off states as shown by *ON* and *OFF* at the centre of the screen. Select *ON*. A 100 MHz, 10 dBm carrier is now being generated from the RF OUTPUT socket.

### Modulation

- (6) Press [MOD] which highlights *FM Devn*. Repeated pressing of the key alternates between FM1 and FM2. Select *FM1 Devn*. Enter 100 on the key pad and terminate with [kHz]. *100 kHz* is displayed.
- (7) Press [MOD ON/OFF]. Repeated pressing toggles between the off state (when *Mod Disable* is displayed) and the on state. Select *ON*.
- (8) Press [MOD SOURCE] which highlights *ModF* with a waveform displayed. Repeated pressing of the key cycles through sine, triangle and square waveforms. Select sine wave. Enter 500 on the key pad and terminate with Hz. *500.00 Hz* is displayed.
- (9) Press [SOURCE ON/OFF]. Repeated pressing toggles between the on and off states. Select *ON*. A 100 MHz, 10 dBm carrier is now being generated at a 100 kHz deviation, modulated at 500 Hz, from the RF OUTPUT socket.

## Using [NEXT] and [PREV] to select a function

The operating example above was carried out by pressing the four function keys in turn in order to enter the parameter values. Another method is to repeatedly press either the [NEXT] or [PREV] key. This enables you to access each of the four functions CARR FREQ, RF LEVEL, MOD, MOD SOURCE in either forward or reverse rotation.

## Using the [ $\uparrow$ +10] and [ $\downarrow$ ×10] keys

When you have entered a parameter value using the numerical key pad, you can adjust its value either in single steps or continuous steps.

As an example of its use we will adjust the carrier frequency using the knob for continuous adjustment as well as in selected increments/decrements using single steps.

- (1) Press [CARR FREQ] to select carrier frequency as the current function. Note that the frequency is displayed as *100.000 000 MHz*. The number of digits behind the decimal point shows the maximum resolution and indicates that the frequency can be changed in 1 Hz steps.

### With the control knob

- (2) Select the control knob for adjustment by toggling the [KNOB/STEP] key so that the carrier frequency is displayed underlined by a bracket. With the bracket displayed the control knob is enabled and its sensitivity can be set.
- (3) Adjust the control knob sensitivity by pressing either the [ $\uparrow+10$ ] key or the [ $\downarrow\times 10$ ] key. Pressing the [ $\uparrow+10$ ] key increases the bracket length by one decimal place. Pressing the [ $\downarrow\times 10$ ] key shortens the bracket length by one decimal place. In this way the resolution of the control knob is respectively increased or decreased by a factor of ten.
- (4) Move the control knob in either direction and note how the displayed carrier frequency changes by the desired amount.
- (5) To check the current amount of offset from the reference carrier frequency press and hold [TOTAL  $\Delta$ ]. For the duration of the key-press the offset is displayed as either a negative or positive value.
- (6) You can return at any time to the reference carrier frequency by pressing [RETN]. *100.000 000 MHz* is displayed.
- (7) Alternatively, you can make the currently displayed frequency the reference carrier frequency by pressing [SET REF]. Subsequently pressing [RETN] will then return you to this frequency.

### With steps

- (8) Press [KNOB/STEP] to disable the control knob (as indicated by the bracket no longer being displayed).
- (9) Press [SET  $\Delta$ ]. The screen changes to display the default step settings for frequency, level and modulation as shown in Fig. 4-8.
- (10) Press [CARR FREQ]. *Freq Step* is highlighted. Enter the step value on the key pad and terminate with the [MHz], [kHz] or [Hz] key.
- (11) Press [CARR FREQ] again to return to the main screen.  
Note that pressing one of the function keys at any time will at once return you to the main screen.
- (12) Now repeatedly press the [ $\uparrow+10$ ] and [ $\downarrow\times 10$ ] keys and note how the displayed carrier frequency changes in steps of the desired amount. Holding either of these keys pressed provides continuous stepping.
- (13) As for control knob operation, you can check the current amount of offset from the reference carrier frequency by pressing and holding [TOTAL  $\Delta$ ].
- (14) As for control knob operation, pressing [RETN] returns you to the reference carrier frequency; pressing [SET REF] selects the currently displayed frequency as the reference frequency.

LOCAL  
OPERATION

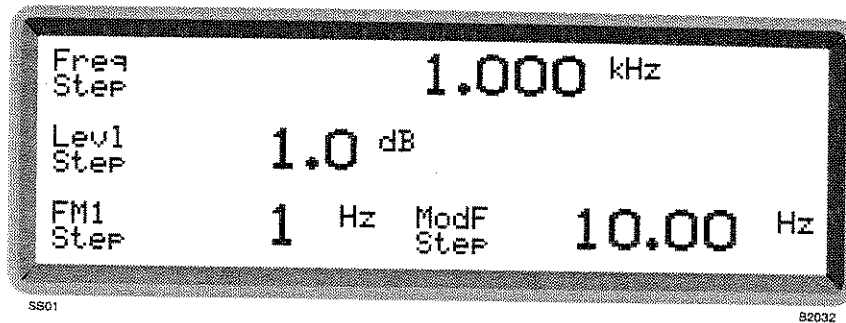

Fig. 4-8 Step setting display showing default settings

## Using the utility menus

As an exercise in the use of the utility menus we will perform the operation of selecting an alternative frequency standard.

- (1) Press [CARR FREQ] followed by [MENU] to display the *Utility Group Menu* shown in Fig. 4-9. This is the top level menu of a 3-tier menu chain. Since the [CARR FREQ] function key preceded the [MENU] key, the required *Frequency/Sweep* group is already highlighted on the menu.

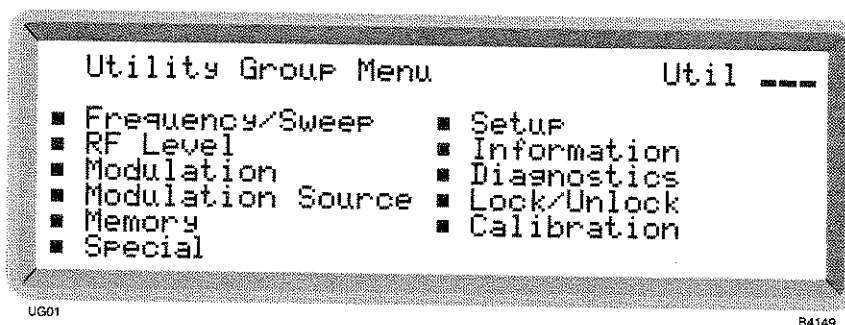

Fig. 4-9 Utility group menu

- (2) Use the [NEXT] and [PREV] keys to move around the menu.
- (3) Highlight *Frequency/Sweep* again and press [SELECT]. This causes the 2nd-level *Frequency/Sweep Menu* shown in Fig. 4-10 to be displayed.

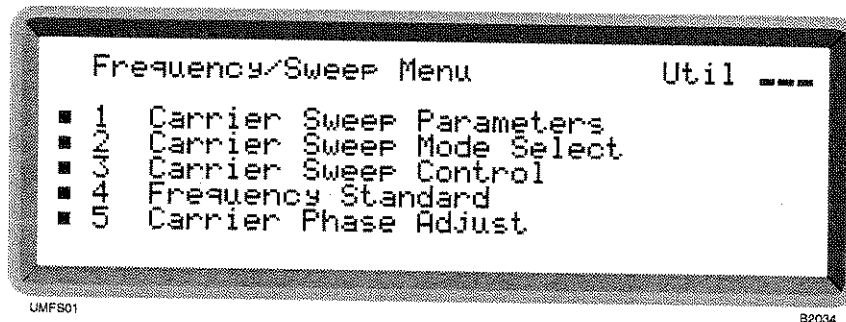

Fig. 4-10 Frequency/sweep menu

- (4) Highlight utility 4 *Frequency Standard* and press [SELECT]. This displays the 3rd-level menu used for internal and external standard selection shown in Fig. 4-11. A flashing cursor awaiting entry is shown against the current selection.



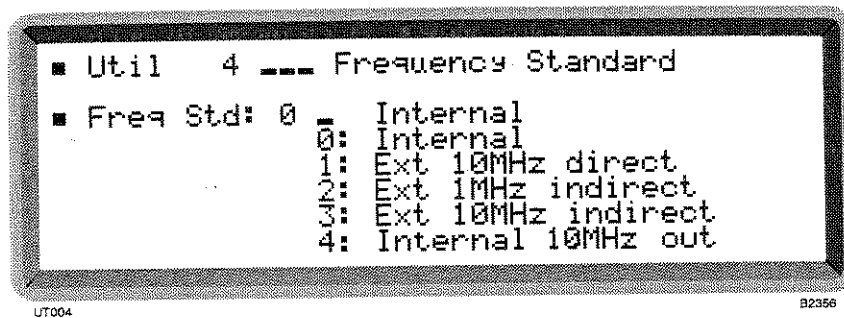

Fig. 4-11 Frequency standard menu

- (5) Step through the selections using the [ $\uparrow+10$ ] and [ $\downarrow\times 10$ ] keys or by direct entry on the key pad. Each time, the highlighted selection becomes the current selection (no terminator is required).

Since no external standard is connected, the message *Err 503: Ext standard missing* is displayed every time you select an external standard.

- (6) Select *0: Internal* to restore the instrument to normal operation. *Internal* is displayed as the current selection.
- (7) Press any function key which returns you again to the main display. Pressing [SELECT] at any time from now on will always return you to your last selected utility menu.

### Short cut

Note that for the top and 2nd-level menus *Util* is shown each time at the top right. This allows you to use a short cut. Since you now know the utility number for the *Frequency Standard* utility, enter 4 on the key pad for this menu followed by [ENTER] which takes you straight to the requested menu.

### Moving within the menus

When you are using the menus, pressing [SELECT] will take you down the menu chain, pressing [MENU] will take you back up.

### Looking through the list of menus

To see what utilities are available to you, display the top level menu then press [SELECT] to display the numbered list of menus. Now you can use the [NEXT] and [PREV] keys to browse through the complete list.

Menu operation is summarized graphically in Chapter 3.

## Menu conventions

The following simple conventions apply to the menus:

- A filled-in square indicates an unprotected function.
- An open, unfilled, square indicates a protected function.
- An ellipsis (...) indicates a continuation to another screen.

Additionally, the following are used for memory operation:

- A dash (-) indicates an unprotected memory store.
- A lower-case **p** indicates a protected memory store.

# DETAILED OPERATION

## Selecting carrier frequency

Carrier frequency can be entered in the range 9 kHz to 1.2 GHz (2023A), 9 kHz to 2.05 GHz (2023B), or 9 kHz to 2.51 GHz (2025) to a resolution of 1 Hz.

- (1) Press [CARR FREQ] to select carrier frequency as the current function. *Carr Freq:* is highlighted on the screen.
- (2) Enter the required value using the numerical key pad. Terminate using the [Hz], [kHz], [MHz] or [GHz] key.
- (3) The frequency can then be adjusted either in steps or by using the control knob for continuous adjustment. The default increment/decrement is 1 kHz.
- (4) You can check the current amount of offset from the reference carrier frequency by pressing and holding [TOTAL Δ].
- (5) Pressing [RETN] returns you to the reference carrier frequency; pressing [SET REF] selects the currently displayed frequency as the reference frequency.

## Carrier on/off

The carrier may be switched *ON* or *OFF* at any time via the [CARR ON/OFF] key. This effectively switches the output on and off, retaining the 50 Ω output impedance.

## Carrier sweep operation

The sweep capability allows the comprehensive testing of systems, since measurements at single points will not necessarily give an overall indication of the performance. Sweep operation is carried out in this instrument by means of three utility menus.

## Sweep parameters

Carrier start and stop frequencies together with step size and time are set as follows:

- (1) Select the *Util 1: Carrier Sweep Parameters* menu. This shows the currently selected parameter values (see Fig. 4-12) as well as the currently selected mode.
- (2) Enter the sweep start and stop frequencies.
- (3) Enter the step size. For linear sweeps enter the step size in the range 1 Hz to the instrument maximum frequency to a resolution of 1 Hz.

For log sweeps enter the step size in the range 0.01% to 50.00% to a resolution of 0.01%. Enter step time in the range 50 ms to 10 s (5 s when Option 100 fitted).

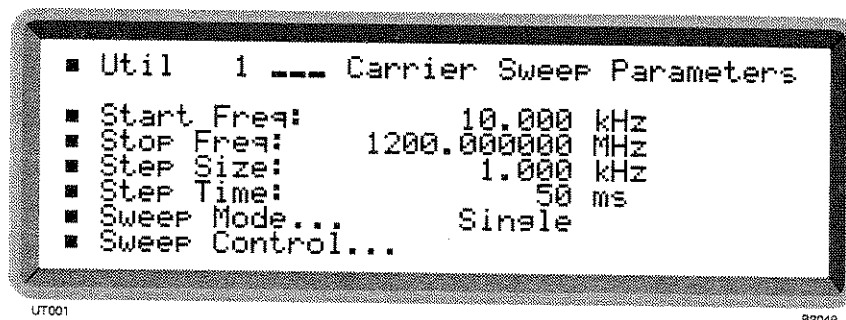

Fig. 4-12 Carrier sweep parameters menu

- (4) To change the mode of sweeping, highlight *Sweep Mode...* and press [SELECT]. This gives you immediate access to the *Util 2: Carrier Sweep Mode Select* menu shown below.
- (5) To carry out the sweeping operation, highlight *Sweep Control...* and press [SELECT]. This gives you immediate access to the *Util 3: Carrier Sweep Control* menu shown below.

## Sweep mode

The following menu allows you to set the carrier sweep mode to either single shot or continuous sweep, to logarithmic or linear sweep and to select the mode of external triggering. For external operation, connect a TTL trigger signal to the rear-panel TRIGGER connector. Ensure however, that this socket is not disabled by a higher priority mode having been selected. The order of priority is as follows:

FSK logic input  
Memory recall  
Sweep trigger.

All three modes of operation may be enabled at the same time, but only one mode will be active, the one with the highest priority. Therefore ensure that FSK and memory recall are not enabled, otherwise selecting sweep triggering will have no effect. Sweep mode selection is as follows:

- (1) Select the *Util 2: Carrier Sweep Mode Select* menu. This shows the currently selected sweep mode (See Fig. 4-13).

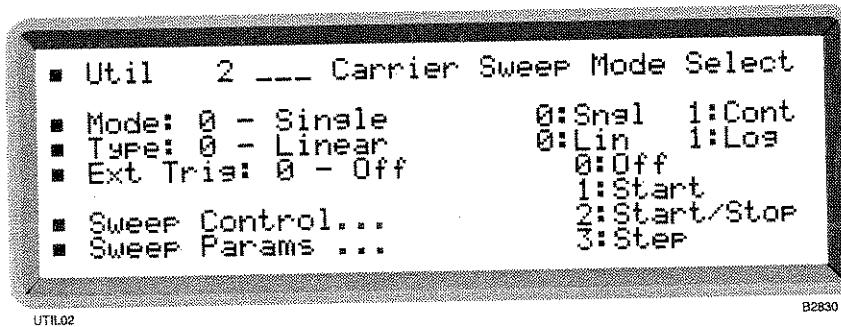

Fig. 4-13 Carrier sweep mode select menu

- (2) Select the required sweep mode by setting *Mode* to either *1* for continuous sweep or *0* for single shot.
- (3) Select the required sweep type by setting *Type* to either *1* for logarithmic sweep or *0* for linear sweep.
- (4) For external triggering set *Ext Trig* to *0* to inhibit the external trigger, or to *1*, *2*, or *3* to select one of the following triggering modes:

*Start:* The first trigger input causes the carrier sweep to commence sweeping. Any other trigger inputs whilst sweeping are ignored. Only at the end of each sweep is the trigger latch reset ready for the next input.

*Start/Stop:* The first trigger input starts the carrier sweep and the following trigger input pauses it, so that the user can investigate a particular point of interest. The next trigger input continues the sweep from where it was paused. At the start of each sweep the trigger latch is reset ready for the next input.

*Step:* Each trigger input steps the sweep on by one frequency step. The trigger latch is reset after each step ready for the next step.

- (5) To carry out the sweeping operation highlight *Sweep Control...* and press [SELECT] to access the *Util 3: Carrier Sweep Control* menu.
- (6) To return to the *Carrier Sweep Parameters* menu, highlight *Sweep Params...* and press [SELECT].

LOCAL  
OPERATION

## Sweep control

Control of the sweep: start, stop, reset and continue is performed as follows:

- (1) Select the *Util 3: Carrier Sweep Control* menu. Initially this shows *Start Sweep* and the start *Carr Freq:* value together with the currently selected *Freq Mode:* (see Fig. 4-14).

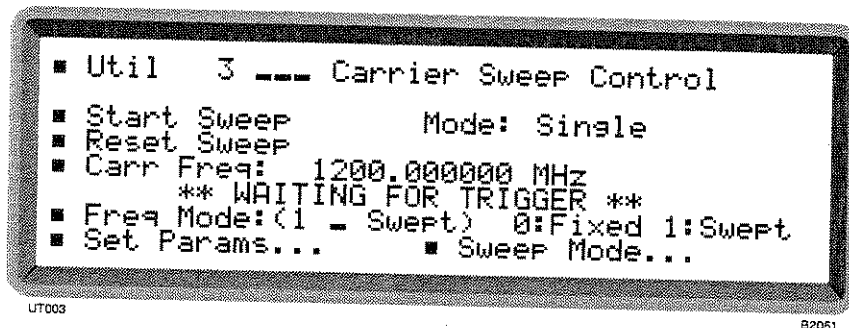

Fig. 4-14 Carrier sweep control menu (shown with sweep enabled)

- (2) Enable the sweep operation by setting *Freq Mode:* to 1 (no terminator is necessary). **\*\* WAITING FOR TRIGGER \*\*** is displayed.
- (3) To start the sweep, select *Start Sweep*. The selection changes to *Stop Sweep*, the frequency is shown changing and **\*\* SWEEPING \*\*** is displayed.
- (4) During the sweep, *Reset Sweep* may be selected to discontinue the sweep and reset it to the start frequency. Note that during the sweep all of the function keys are still accessible.
- (5) Selecting *Stop Sweep* causes the selection to change to *Continue Sweep* and **\*\* PAUSED \*\*** is displayed.
- (6) Selecting *Continue Sweep* allows the sweep to continue. At the end of a single sweep, the stop frequency is shown and the selection changes to *Restart Sweep* with **\*\* COMPLETE \*\*** displayed. For continuous sweep, the sweep automatically recommences from the start frequency.
- (7) To change the sweep parameters, highlight *Set Parameters...* and press [SELECT] to return to the *Carrier Sweep Parameters* menu.
- (8) To change the sweep mode, highlight *Sweep Mode...* and press [SELECT] to return to the *Carrier Sweep Mode Select* menu.

## Carrier phase adjustment

The phase offset of the carrier can be adjusted in degrees as follows:

- (1) Select the *Util 5: Carrier Phase Adjust* menu. This shows the currently selected phase shift setting (see Fig. 4-15).

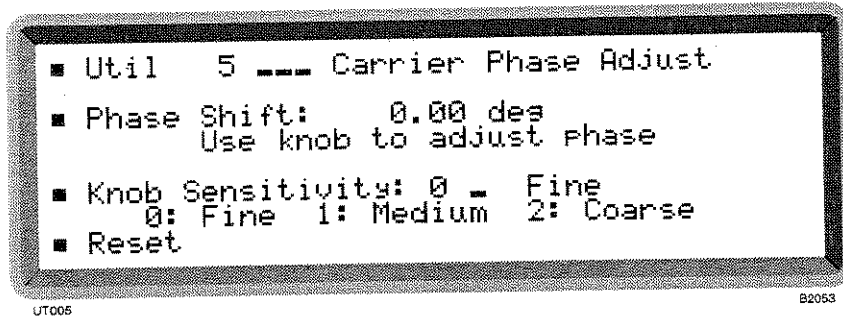

Fig. 4-15 Carrier phase adjust menu

- (2) Select the required control knob sensitivity between *Fine* (0.09°), *Medium* (0.9°) and *Coarse* (2.7°).
- (3) Highlight *Phase Shift* and adjust the phase using the control knob. Adjustment is in the range -359.91° to +359.91° (fine sensitivity). Note that if you have set the carrier phase and subsequently adjusted the carrier frequency, the menu *Phase Shift* value will be blanked. This is because the value will then be indeterminate due to the adjustment.
- (4) To establish a reference the displayed phase shift can be reset to 0° by highlighting *Reset* and pressing [SELECT].

LOCAL  
OPERATION

## Selecting RF level

RF level can be entered in the range  $-140$  to  $+13$  dBm (or to  $+25$  dBm for the High Power Option).

- (1) Select the RF level from the main screen by pressing [RF LEVEL]. *RF Level:* is highlighted on the screen.
- (2) Enter the required value using the numerical key pad.
- (3) For voltage terminate using the [ $\mu$ V], [mV] or [V] key. For dBm terminate using the [dB] key. RF levels in linear (PD or EMF) and logarithmic units are selected from the utilities.
- (4) The level can then be adjusted either in steps or by using the control knob for continuous adjustment. The default increment/decrement is 1 dB.
- (5) You can check the current amount of offset from the reference level by pressing and holding [TOTAL  $\Delta$ ].
- (6) Pressing [RETN] returns you to the reference level; pressing [SET REF] selects the currently displayed level as the reference level.
- (7) The RF output level may be toggled on and off by means of the [CARR ON/OFF] key.

## Choice of units

Conversion can be made between dB and V by pressing the appropriate units key. Selection of linear and logarithmic units is made using Util 10 and Util 11 respectively (see below).

## Attenuator hold

Pressing the [ATTEN LOCK] key inhibits operation of the step attenuator from the level at which the key is enabled. This is usable for a level reduction of at least 10 dB. Whilst in operation the display shows *Atten Lock*.

## Reverse power protection

Accidental application of power to the RF OUTPUT socket trips the reverse power protection (RPP) circuit (unless Option 1: No Attenuator is fitted, which has no protection) and causes Fig. 4-16 to be displayed.

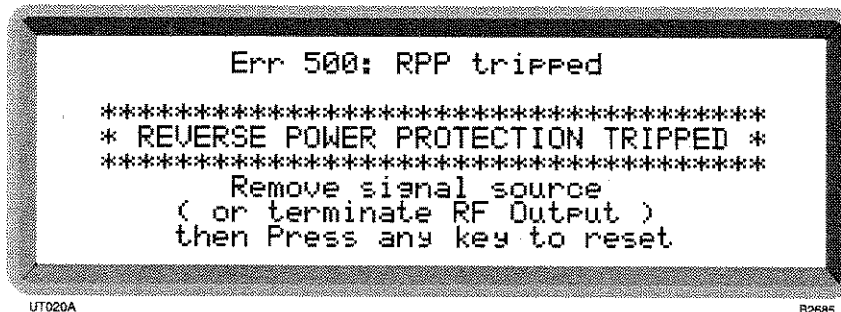

Fig. 4-16 RPP tripped display

The protection circuit can be reset by pressing any key after having removed the power source. The display then returns to the menu in use at the time that the RPP was tripped.

Note that the protection circuit may be activated when the generator is set to a high level and the RF OUTPUT socket has no terminating load.

## RF level linear units

You can set the RF level in linear units of volts PD or volts EMF as follows:

- (1) Select the *Util 10: RF Level Linear Unit* menu. This shows the currently selected linear unit (see Fig. 4-17).

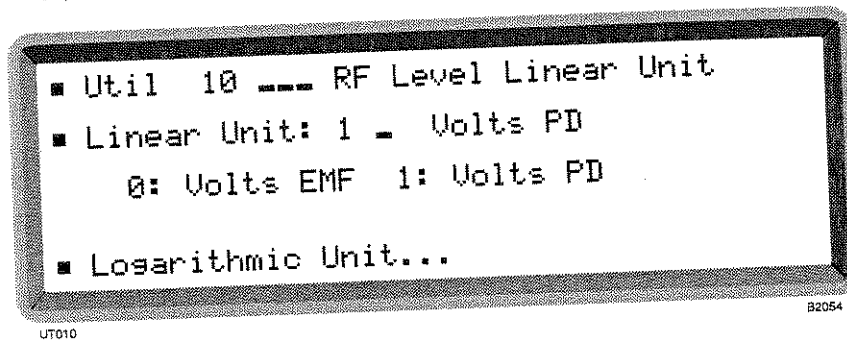

Fig. 4-17 RF level linear units menu

- (2) Enter *1* for *Volts PD* or *0* for *Volts EMF* (no terminator is necessary).
- (3) To select a logarithmic unit, highlight *Logarithmic Unit...* and press [SELECT]. This gives you immediate access to the *Util 11: RF Level Logarithmic Unit* menu shown below.

LOCAL  
OPERATION

## RF level logarithmic units

You can set the RF level in logarithmic units as follows:

- (1) Select the *Util 11: RF Level Logarithmic Unit* menu. This shows the currently selected logarithmic unit (see Fig. 4-18).

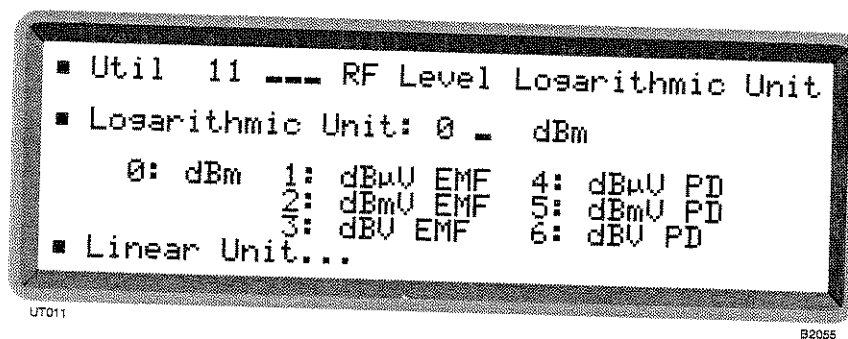

Fig. 4-18 RF level logarithmic units menu

- (2) Enter a number in the range 0 to 6 (no terminator is necessary) to select between volts (dBV), millivolts (dBmV), microvolts (dB $\mu$ V) – in EMF or PD – and 1 milliwatt into 50  $\Omega$  (dBm).
- (3) To select a linear unit, highlight *Linear Unit...* and press [SELECT]. This gives you immediate access to the *Util 10: RF Level Linear Unit* menu shown above.



## Modulation modes

The EXT MOD INPUT socket allows an external modulation signal to be summed with the signals from the internal oscillator. This allows up to three modulations to be available: for example, external FM with a combined internal AM1 and AM2.

Modulation source can be internal or external. If internal, the modulation can be the sum of two signals – AM1 + AM2, FM1 + FM2 or  $\Phi$ M1 +  $\Phi$ M2 – each of which can have its own depth/deviation and modulation frequency.

The common carrier wave can be modulated by two different types of modulation, where one uses an internal source and the other an external source. The internal source may be composed of two signals. Allowed combinations are:

internal AM + external FM ; internal FM + external AM  
internal AM + external  $\Phi$ M ; internal  $\Phi$ M + external AM

Note that pulse modulation may be selected in addition to any normal modulation combination.

## Mode selection

Modulation mode may be selected as follows:

- (1) Select the *Util 20: Modulation Mode (Normal)* menu. This shows the currently selected modulation mode against *Mod Mode:*. If pulse modulation is enabled this will also be displayed.
- (2) From the menu select the desired modulation mode by highlighting the item and then pressing [SELECT]. The current modulation mode changes accordingly. Select single on the first menu page (shown in Fig. 4-19) or dual on the second (shown in Fig. 4-20).

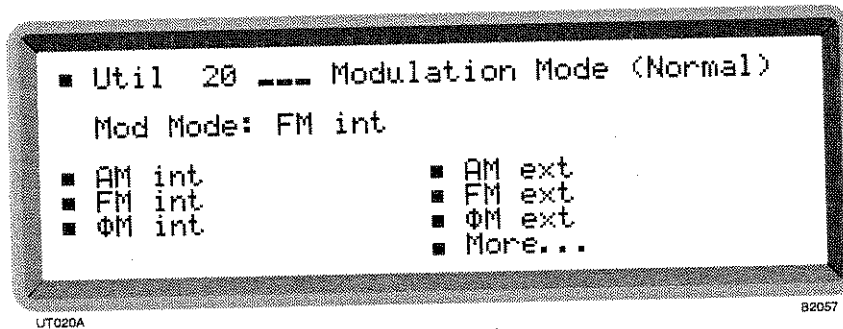

Fig. 4-19 Modulation mode menu – first page

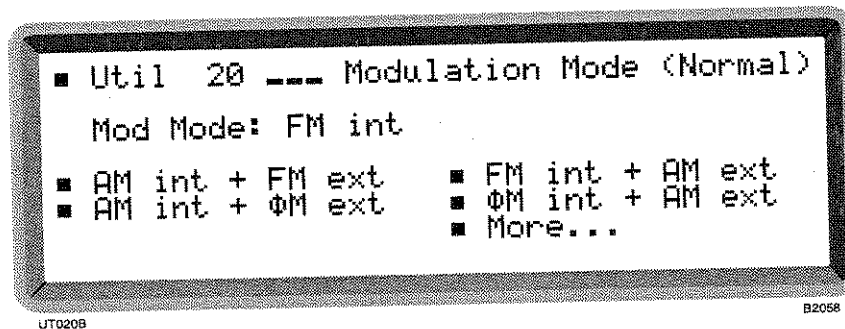

Fig. 4-20 Modulation mode menu – second page

- (3) Press [MOD] to return to the main screen. Repeatedly pressing [MOD] will now step through each modulation of your selected modulation mode.

LOCAL  
OPERATION

## Source selection – internal

Having previously selected internal modulation from the *Util 20: Modulation Mode* menu, select the waveform and modulating frequency as follows:

- (1) Press [MOD SOURCE] to highlight the current modulation source selection.
- (2) Repeatedly press [MOD SOURCE] to cycle through and select a sine, square or triangular waveform.
- (3) Enter the required modulating frequency on the keypad and terminate with the [Hz] or [kHz] key. If the modulation requested exceeds 20 kHz the modulation is set to the maximum value.

The output waveform can be switched in a different sequence to that allowed by the [MOD SOURCE] key. For instance it may be required to switch from sine to square wave without the necessity of switching via the triangular wave. For this requirement, use the *Util 30: Modulation Source* menu shown in Fig. 4-21.

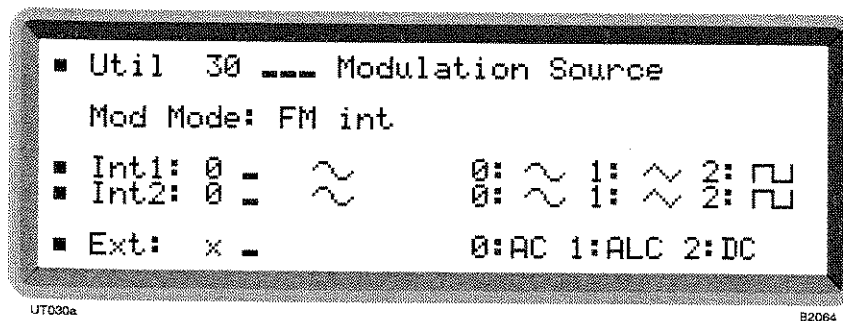

Fig. 4-21 Modulation source menu

## SOURCE SELECTION - EXTERNAL

AC or DC coupling or automatic leveling control (ALC) can be used in conjunction with an external source. Having previously selected external modulation from the *Util 20 Modulation Mode* menu continue as follows:

- (1) Press [MOD SOURCE] for modulation source selection.
- (2) Repeatedly press [MOD SOURCE] to cycle through the selections *Ext DC*, *Ext AC* and *Ext ALC*.
- (3) Apply a signal to the EXT MOD INPUT socket. Note that on switch-on this socket is disabled.
- (4) If *EXT ALC* has been selected and the error message *Err 511: ALC too high* or *Err 512: ALC too low* is displayed the signal input is outside the 0.75 to 1.25 V RMS ALC range of the instrument.
- (5) If *EXT DC* has been selected, note that a DCFM nulling facility is available (refer to 'DCFM nulling' in the 'General' section below).

External source selection may also be made by means of the *Util 30: Modulation Source* menu shown in Fig. 4-22.

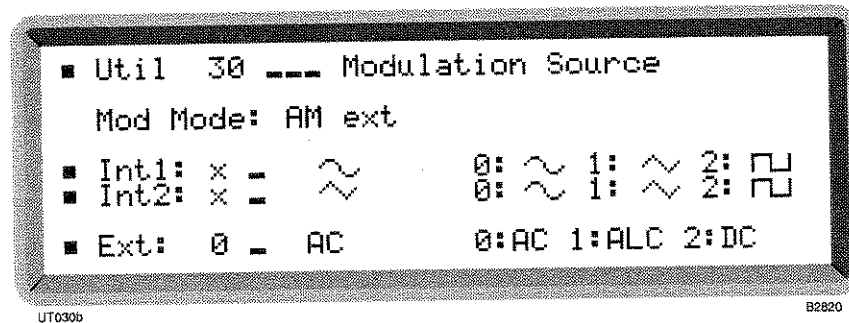

Fig. 4-22 Modulation source menu – shown with an external source selected

LOCAL  
OPERATION

## Modulation enable/disable

[SOURCE ON/OFF] switches the current modulation channel on or off. To switch all modulation on or off press [MOD ON/OFF]; this function is mainly used when more than one modulation source is enabled. Switching all modulation off causes *Mod Disable* to appear on the main screen.

## Modulation source phase adjustment

The phase difference of the modulation oscillator channel 2 relative to channel 1 can be adjusted in degrees as follows:

- (1) Select the *Util 31: Modulation Source Phase* menu. This shows the currently selected phase difference setting (see Fig. 4-23).

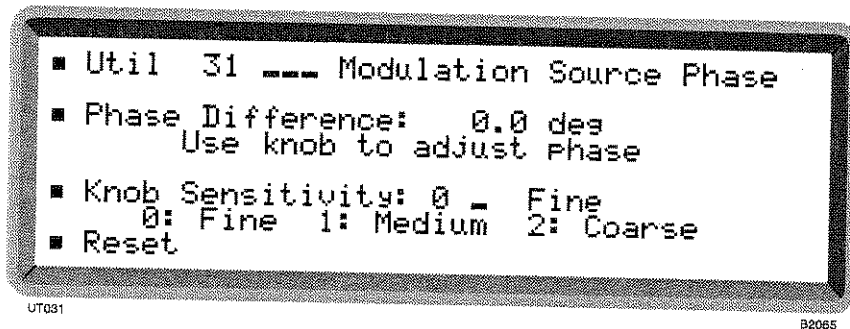

Fig. 4-23 Modulation source phase menu

- (2) Select the required control knob sensitivity between *Fine* ( $0.1^\circ$ ), *Medium* ( $1^\circ$ ) and *Coarse* ( $3^\circ$ ).
- (3) Highlight *Phase Difference* and adjust the phase using the control knob. Adjustment is in the range  $-359.9^\circ$  to  $+359.9^\circ$  (fine sensitivity). Note that if you have set the source phase and subsequently adjusted the source frequency or changed the waveform, the menu *Phase Difference* value will be blanked. This is because the value will then be indeterminate due to the adjustment or changed waveform.
- (4) To establish a reference the displayed phase shift can be reset to  $0^\circ$  by highlighting *Reset* and pressing [SELECT].

## Modulation selection

The carrier can be frequency, amplitude or phase modulated from an internal or external source. Additionally pulse modulation is available from an external source. The internal modulation oscillator is capable of generating two tones simultaneously in one modulation channel and has a frequency range of 0.01 Hz to 20 kHz.

### Amplitude modulation selection – internal

Having previously selected the modulation mode (see 'Mode selection' above) select amplitude modulation as follows:

- (1) Press [MOD] to display the main screen with *AM1 Depth* highlighted.
- (2) Enter the required internal modulation depth via the numerical key pad and terminate with the [%] key. If you exceed the 99.9% modulation depth it is reset by default to the maximum value.
- (3) If the internal modulation is to be the sum of two signals (selected from the *Util 30* menu), press the [MOD] key again to highlight *AM2 Depth*. Enter the required modulation depth for the second signal. If you exceed the (99.9% – AM1) modulation depth limit it is reset by default to the maximum allowed value.

LOCAL  
OPERATION

## Frequency modulation selection – internal

Having previously selected the modulation mode (see 'Mode selection' above) select frequency modulation as follows:

- (1) Press [MOD] to display the main screen with *FM1 Devn* highlighted.
- (2) Enter the required internal FM deviation via the numerical key pad and terminate with the [Hz] or [kHz] key. If you exceed the 100 kHz deviation limit it is reset by default to the maximum value.
- (3) If the internal modulation is to be the sum of two signals (selected from the *Util 30* menu), press the [MOD] key again to highlight *FM2 Devn*. Enter the required deviation for the second signal. If you exceed the (100 kHz – FM1) deviation limit it is reset by default to the maximum allowed value.

## Phase modulation selection – internal

Having previously selected the modulation mode (see 'Mode selection' above) select phase modulation as follows:

- (1) Press [MOD] to display the main screen with  $\Phi M1 Devn$  highlighted.
- (2) Enter the required internal  $\Phi M$  deviation via the numerical key pad and terminate with the [rad] key. If you exceed the 10 radians deviation limit it is reset by default to the maximum value.
- (3) If the internal modulation is to be the sum of two signals, press the [MOD] key again to highlight  $\Phi M2 Devn$ . Enter the required deviation for the second signal. If you exceed the (10 rad –  $\Phi M1$ ) deviation limit it is reset by default to the maximum allowed value.

LOCAL  
OPERATION

## Pulse modulation selection

Pulse modulation may be selected in addition to any other normal modulation modes. The source is external only from the rear-panel PULSE I/P socket. (Note that using this socket prevents 4FSK operation.) Selection may be made as follows:

- (1) Select the *Util 22: Pulse Modulation* menu. This shows the currently selected modulation mode against *Mod Mode*: (see Fig. 4-24).

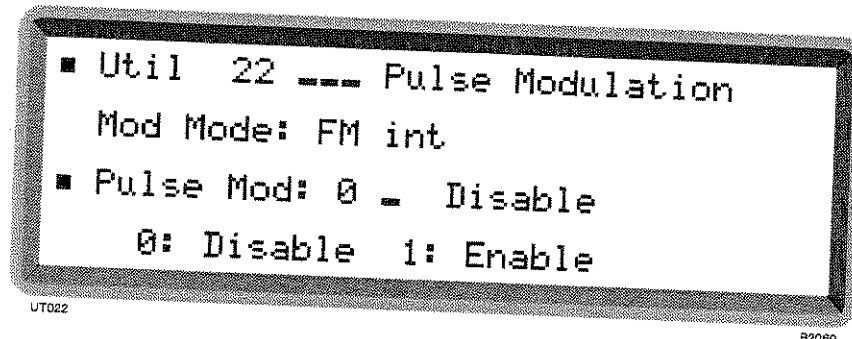

Fig. 4-24 Pulse modulation menu

- (2) Enter 1 on the key pad (no terminator is required) to *Enable* the external modulation. The display changes to show the current modulation plus *Pulse* (for example, *Mod Mode: AM int + FM ext + Pulse*).
- (3) Press [MOD] to return to the main screen with *Pulse* displayed together with its *ON* or *OFF* state.

When *ON* the carrier is controlled by the logic level applied to the PULSE I/P socket. A logical '1' (5 V) allows carrier output, a logical '0' (0 V) suppresses it. Turning pulse mod *OFF* effectively applies a logical '1', allowing carrier output.



## FSK selection

The instrument accepts one or two logic level inputs to produce an FSK modulated output signal. The input data is sampled at 156 kHz and produces a 2 or 4 level shift waveform which is filtered by a 20 kHz Bessel filter and applied to the carrier. Frequency shift keying is selected as follows:

- (1) Select the *Util 21: Modulation Mode (Special)* menu. This shows the currently selected modulation mode against *Mod Mode*: (see Fig. 4-25).

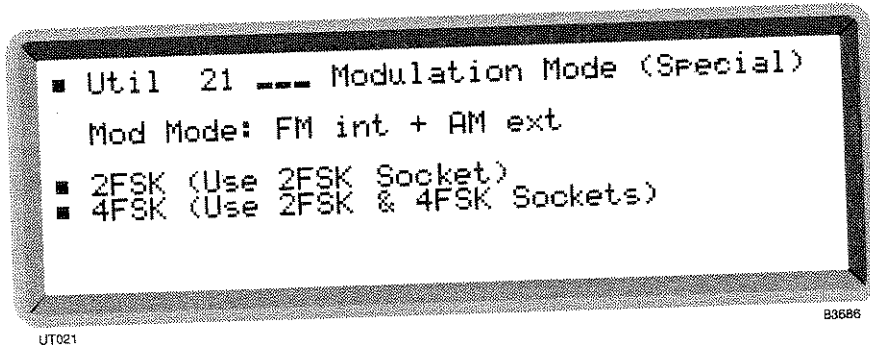

Fig. 4-25 Modulation mode (special) menu

- (2) Select the type of FSK. Either *2FSK* or *4FSK* is shown against *Mod Mode*.
- (3) For *2FSK* apply a TTL signal to the *2FSK* socket. For *4FSK* apply the signals to the *2FSK* and *4FSK* sockets.
- (4) Press [MOD] to return to the main screen with *FM Devn* displayed. Enter the required deviation via the numerical key pad and terminate with the [Hz] or [kHz] key. If you exceed the 100 kHz deviation limit it is reset by default to the maximum value.
- (5) Either *2FSK Ext* or *4FSK Ext* is shown in the modulation source field. Note that for FSK operation pressing [MOD SOURCE] has no effect on the instrument.
- (6) If FSK is turned *OFF* no frequency shift is applied to the carrier.

The frequency shifts produced by the applied data are as follows:

<u>2FSK</u>	
2FSK	SHIFT
1	+D
0	-D

<u>4FSK</u>		
2FSK	4FSK	SHIFT
1	0	+D
1	1	+D/3
0	1	-D/3
0	0	-D

Where D is the set deviation value.

LOCAL  
OPERATION

## Default settings

The instrument is reset to the factory default settings in the following cases:

- (1) At power-up.
- (2) Following execution of the RCL 999 command.
- (3) Following execution of the \*RST command.

The default settings are shown in Table 4-1 .

**Table 4-1 Instrument default settings**

Carrier frequency	:	(Maximum available) 1.2 GHz/2.05 GHz/2.51 GHz
Step	:	1 kHz
RF level	:	-140 dBm (or -2 dBm with the No Attenuator option)
Step	:	1 dB      Status: ON
Modulation mode	:	Internal FM, modulation disabled
Modulations	:	FM1 : Deviation: 0 Hz, OFF : Internal source, frequency: 1 kHz, sine
	:	FM2 : Deviation: 0 Hz, OFF : Internal source, frequency: 400 Hz, sine
	:	$\Phi$ M1 : Deviation: 0 rad, OFF : Internal source, frequency: 1 kHz, sine
	:	$\Phi$ M2 : Deviation: 0 rad, OFF : Internal source, frequency: 400 Hz, sine
	:	AM1 : Deviation: 0%, OFF : Internal source, frequency: 1 kHz, sine
	:	AM1 : Deviation: 0%, OFF : Internal source, frequency: 400 Hz, sine
	:	Pulse : OFF
	:	SINAD : OFF
Modulation steps	:	$\Delta$ FM 1 kHz, $\Delta\Phi$ M 0.1 rad, $\Delta$ AM 1%
Mod frequency steps	:	10 Hz
Carrier sweep	:	
Freq mode	:	Fixed
Mode	:	Single sweep
Type	:	Linear
Ext trigger	:	Off
Start	:	9 kHz
Stop	:	(Maximum available)
Step size	:	1 kHz
Time	:	50 ms
SINAD	:	
Averages	:	5
Weighting filter	:	CMESS

# MEMORY

## Memory stores

There are three types of store: carrier, full and RAM. Both carrier and full stores are non-volatile. The contents of the RAM store are lost when the instrument is switched off.

### Carrier store

The non-volatile carrier frequency store has 100 locations numbered 0 to 99 for the storage of carrier frequency only. This store can be used to apply a set of test conditions to a range of frequencies. For example, if you wish to use the same modulation at a variety of frequencies you can use the carrier store to set the instrument to each of the frequencies in turn. When a carrier store is used it will only replace the current carrier frequency – all the other settings will remain unchanged.

### Full store

The non-volatile full store has 100 locations numbered 100 to 199 for the storage of instrument settings. This store is used to store those parameters which currently affect the RF output: carrier frequency, RF level, modulations in use, on/off and source information and the two modulation oscillator frequencies in use.

A full store contains the following information:

- Carrier frequency setting
- Carrier frequency step size
- RF level setting
- RF level step size
- All modulation settings
- All modulation step sizes
- Modulation mode and status
- The active modulation frequencies
- The modulation frequency step size
- All sweep settings.

### RAM store

The volatile RAM store has locations numbered from 200 to 299 for the full storage of instrument settings. The parameters stored are the same as those for the full store. However, the RAM store has no long-term wear-out mechanism and is therefore recommended for use in ATE programs where all the settings to be used in a test sequence are initially declared and then recalled. This results in a reduction of the GPIB/RS-232 overhead.

### Storing data

To store data, press the [STO] key and enter the location number on the key pad then press [ENTER]. Depending on which location range the number falls in, the display shows *FREQ* (for carrier store), *FULL* or *RAM*. If you make a mistake, and have not yet pressed [ENTER], press [STO] again and re-enter the location number.

LOCAL  
OPERATION

## Memory recall

There are three types of recall: carrier, full and RAM. Both carrier and full stores are non-volatile. The contents of the RAM store are lost when the instrument is switched off.

### Carrier recall

The non-volatile carrier frequency store has 100 locations numbered 0 to 99 for carrier frequency only. These can be recalled and used in conjunction with full recall to apply a set of test conditions to a range of frequencies.

### Full recall

The non-volatile full store has 100 locations numbered 100 to 199 for the storage of instrument settings. These stores may be recalled and used to reset the instrument's parameters to those which affect the RF output: carrier frequency, RF level, modulations in use, on/off and source information and the two modulation oscillator frequencies in use.

### RAM recall

The volatile RAM store has locations numbered 200 onwards for the full storage of instrument settings. The parameters that are recalled are the same as those for full recall.

## Recalling data

To recall data, press the [RCL] key and enter the location number on the key pad, then press [ENTER]. Depending on which location range the number falls in, the display shows *FREQ* (for carrier store), *FULL* or *RAM*. The [ $\uparrow+10$ ] and [ $\downarrow\times 10$ ] keys as well as the control knob can be used to recall the next and previous locations.

## Recalling default settings

To recall the factory default settings, press the [RCL] key and enter 999 on the keypad, then press [ENTER]. The *RESET* annunciator is shown and the instrument is reset to the settings shown in Table 4-1.

## Memory sequencing

You can step the memory up in a sequence from a start location using a TTL input connected to the rear-panel TRIGGER socket. Note that the triggering order of priority is as follows:

FSK logic input  
Memory recall  
Sweep trigger.

Therefore ensure that FSK is not enabled, otherwise selecting memory recall triggering will have no effect. The memory sequencing operation is as follows:

- (1) Select *Util 40: Memory Sequencing* to display the menu shown in Fig. 4-26.

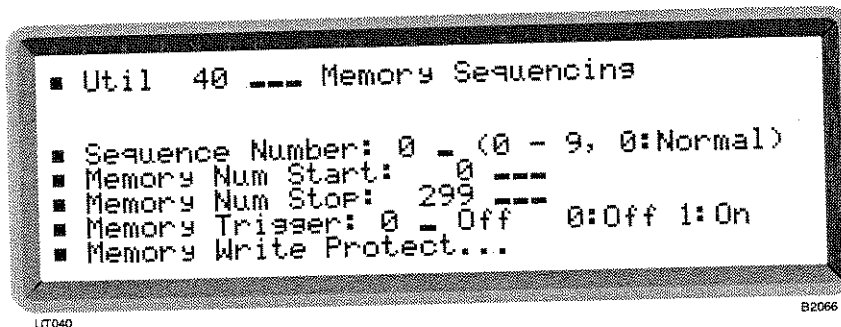

Fig. 4-26 Memory sequencing menu

- (2) Select one of up to 9 sequences by entering a number in the range 1 to 9. Select 0 to turn sequence off (normal mode).
- (3) Enter the *Memory Num Start* and *Mem Num Stop* store numbers for the selected sequence within the ranges:

0-99	Carrier store
100-199	Full store
200-299	RAM store.
- (4) To enable memory recall sequencing set *Memory Trigger* to 1. Each trigger will then recall the next memory store. When the end of the sequence is reached the carrier and full stores will wrap around to the start.
- (5) To protect your selected memory sequence against accidental overwriting, highlight *Memory Write Protect...* and press [SELECT]. This gives immediate access to the *Util 41: Memory Write Protect* menu shown below.

LOCAL  
OPERATION

## Memory write protection

To use the memory protection utility first ensure that the instrument is unlocked to Level 1 using *Util 80: Protection Lock/Unlock*. Then you can either write protect a block of stores (or a single store) to prevent accidental overwriting or unprotect it as follows:

- (1) Select *Util 41: Memory Write Protect* to display the menu shown in Fig. 4-27.

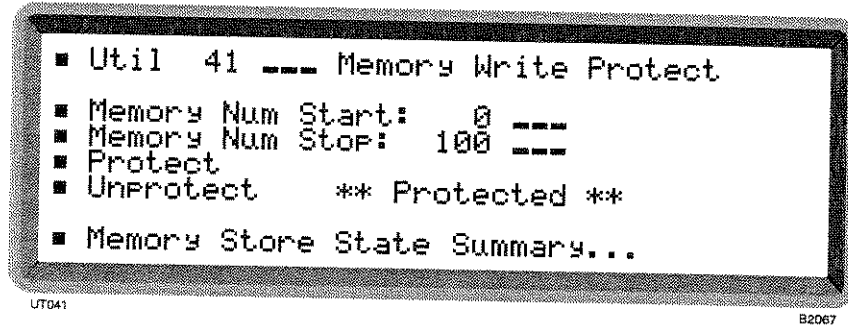

Fig. 4-27 Memory write protection menu (showing stores 0 to 100 protected)

- (2) For a memory block enter the *Memory Num Start* and *Memory Num Stop* store numbers. For a single store make both numbers the same.
- (3) Select *Protect* or *Unprotect* as required. This action is acknowledged by the message *\*\* Protected \*\** or *\*\* Unprotected \*\** appearing respectively.
- (4) You can see which areas of the memory are protected by highlighting *Memory Store State Summary...* and pressing [SELECT]. This gives immediate access to the *Util 42: Memory State Summary* shown below.

Note that at power-on the volatile RAM stores are unprotected to allow immediate use.

## Memory state summary

The memory state summary enables you to look at blocks of 100 stores at a time to see their protection states as follows:

- (1) Select *Util 42: Memory State Summary* to display the summary shown in Fig. 4-28.

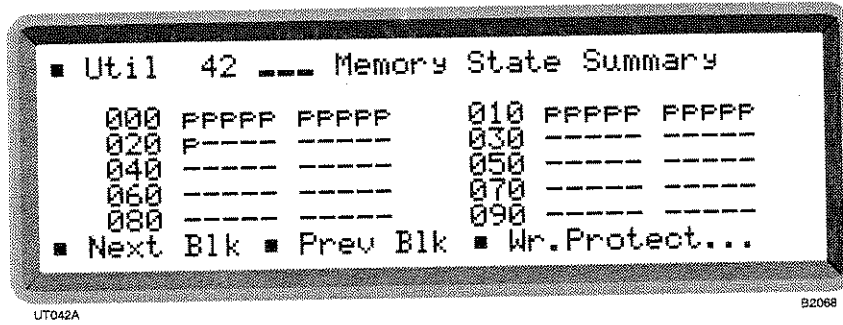

```
■ Util 42 --- Memory State Summary
000 FFFFF FFFFF 010 FFFFF FFFFF
020 P----- 030 -----
040 ----- 050 -----
060 ----- 070 -----
080 ----- 090 -----
■ Next Blk ■ Prev Blk ■ Wr.Protect...
```

UT042A B2068

Fig. 4-28 Memory state summary (showing carrier stores 0 to 20 protected)

- (2) Choose which of the three blocks you require by selecting *Next Blk* or *Prev Blk*.
- (3) An unprotected store is indicated by a dash, a protected store is indicated by a letter *p*. To change the protection status select *Wr.Protect...* This gives immediate access to the *Util 41: Memory Write Protect* menu above.

LOCAL  
OPERATION

## Memory cloning

You can transfer the stored settings from one signal generator to another by using either the GPIB or the RS-232 interface. These stored settings are the full and carrier stores together with their currently protected states. This means that after cloning has been performed all of the non-protected memory stores on the receiving instrument will have been overwritten.

For GPIB operation the transmitting instrument is automatically configured as a talker sending to one or more automatically configured listeners. It does not matter which addresses the instruments are set to.

For RS-232 operation the transmitting instrument can only send to one receiving instrument. The settings of the serial ports of the two instruments do not matter except that data transfer will be at the higher baud rate.

To use this utility first of all ensure that the instrument is unlocked to Level 1 using *Util 80: Protection Lock/Unlock*. Then proceed as follows:

- (1) Ensure that the correct mode of operation, either GPIB or RS-232, has been selected for both instruments using *Util 50: Remote Operation Select*.
- (2) Select *Util 43: Memory Cloning* on transmitting and receiving instruments to display the menu shown in Fig. 4-29. Check that all instruments show the same remote mode – either *GPIB* or *RS232*.

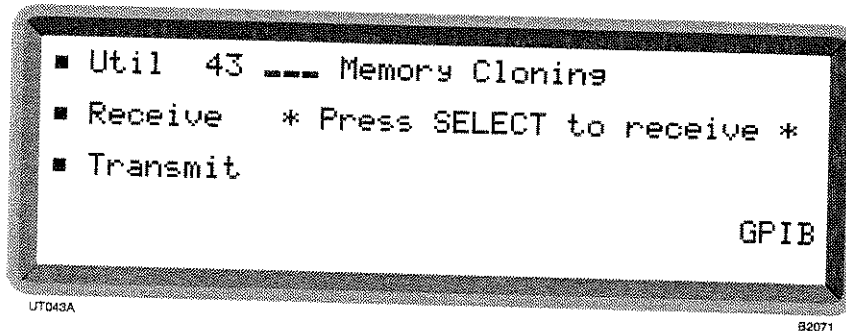

Fig. 4-29 Memory cloning menu (showing instrument ready to receive via the GPIB)

- (3) On the receiving instrument highlight *Receive* and press [SELECT]. The message *\* Press SELECT to receive \** changes to *\* Ready to receive \** and the instrument enters the remote mode (displays *REM*).
- (4) On the transmitting instrument highlight *Transmit* and press [SELECT]. The message *\* Press SELECT \** changes to *\* Transmitting \**, *REM* is displayed and data transfer takes place. Cloning times via GPIB and RS-232 are approximately 4 s and 14 s respectively.
- (5) At the end of the data transfer process *\* Transfer complete \** is displayed by all participating instruments.



# GENERAL

## Frequency standard selection

This utility enables you to select a 10 MHz output to provide a standard for use with associated equipment. It also enables you to select a standard (either external or internal) for use by the instrument. When an external standard is selected, the internal TCXO is locked to the external standard using a phase locked loop. In this case, the menu allows you to select between *direct* and *indirect*. When *direct* is selected the internal standard for the RF tray is provided directly from the external standard. When *indirect* is selected this standard is provided from the TCXO locked to the external standard. Frequency standard selection is as follows:

- (1) Select the *Util 4: Frequency Standard* menu shown in Fig. 4-30.

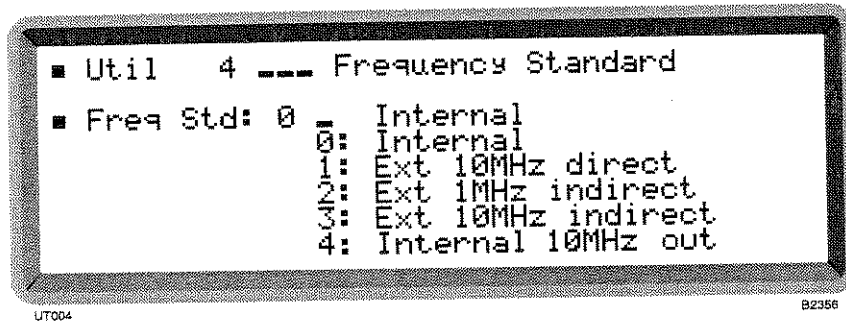

Fig. 4-30 Frequency standard menu

- (2) To select the standard for the instrument, choose between *Internal* or one of the three external standard selections. When an external standard is selected, *Ext* is displayed on the main screen.
- (3) To obtain an internally generated 10 MHz standard from the instrument's FREQ STD IN-OUT socket, select *Internal 10MHz out*.
- (4) To provide an externally generated 1 or 10 MHz standard for the instrument, connect the signal to the rear-panel FREQ STD IN-OUT socket. Then with an external standard selected, you can choose between *direct* and *indirect*. You should select *direct* if your provided standard is better than that fitted in the instrument.

LOCAL  
OPERATION

## 50 $\Omega$ /75 $\Omega$ impedance selection

The performance specification of the instrument assumes operation into 50  $\Omega$  loads. By means of this menu in association with the 75  $\Omega$  adapter (see 'Versions and Accessories' in Data Sheet at end of Chapter 1) you can select operation into 75  $\Omega$  loads whilst maintaining correct voltage calibration. It also enables the reverse power protection circuit to function correctly. But note that in the event of an overload the RPP will function but the adapter will NOT be protected. To use this utility ensure that the instrument is unlocked to Level 1 using *Util 80:Protection Lock/Unlock*. Then proceed as follows:

- (1) First of all connect the 50  $\Omega$ /75  $\Omega$  adapter to the front-panel RF OUTPUT socket.
- (2) Select the *Util 12: 50 Ohm/75 Ohm Calibration* menu. This shows the currently selected impedance (see Fig. 4-31).

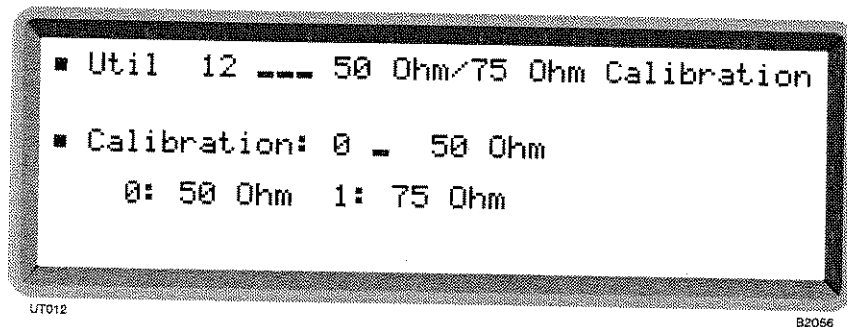

Fig. 4-31 50  $\Omega$ /75  $\Omega$  calibration menu

- (3) Select *1* for 75  $\Omega$  or *0* for 50  $\Omega$  (no terminator is necessary). When 75  $\Omega$  is selected, the value of the displayed output level is reduced by 5.7 dB to compensate for the 50  $\Omega$ /75  $\Omega$  adapter loss.

## RF level limit

To use the RF level limit utility first ensure that the instrument is unlocked to Level 1 using *Util 80: Protection Lock/Unlock*. This utility enables you to set your own maximum output power limit which allows you to protect sensitive devices connected to the RF OUTPUT socket.

Proceed as follows:

- (1) Select the *Util 13: RF Level Limit* menu. This shows the currently selected RF level limit (see Fig. 4-32).

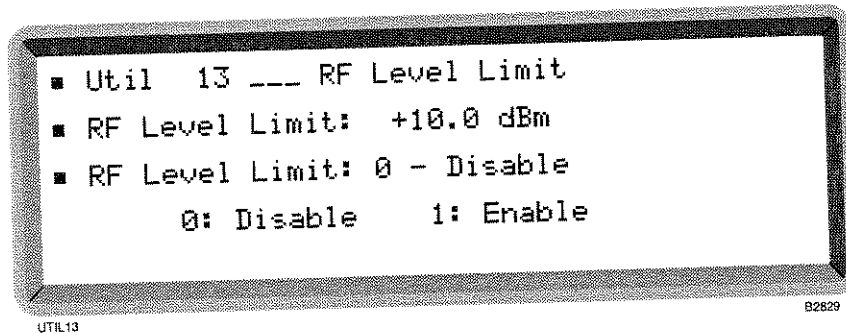

Fig. 4-32 RF level limit menu

- (2) Set the required *RF Level Limit* in the range  $-125$  to  $+13$  dBm to a resolution of  $0.1$  dB. For the High Power Option (Option 3), the maximum calibrated output level is  $+25.1$  dBm up to  $1.2$  GHz and  $+19$  dBm above this frequency. Above  $1.2$  GHz an uncalibrated level up to  $+25.1$  dBm is allowed but an *RF Level Uncalibrated* message will be displayed.
- (3) Enter  $0$  to disable or  $1$  to enable the function.

The setting will be saved in non-volatile memory so that when subsequently the instrument is switched on again it will be set with your specified RF level limit.

LOCAL  
OPERATION

## RF level offsets

To use the RF level offsets utility first ensure that the instrument is unlocked to Level 1 using *Util 80: Protection Lock/Unlock*. This utility enables you to offset the RF output level to compensate for cable or switching losses, or to standardize a group of instruments so that they give identical measurements. The offsets do not change the displayed RF level but do change the RF output level. Setting a negative offset decreases the level from the RF OUTPUT socket.

One offset is allowed in each of the following frequency ranges (applicable to all instruments except where shown):

9 kHz	–	150 MHz
150 MHz	–	300 MHz
300 MHz	–	600 MHz
600 MHz	–	1.2 GHz
1.2 GHz	–	2.05 GHz (2023B only)
1.2 GHz	–	2.51 GHz (2025 only)

Proceed as follows:

- (1) Select the *Util 14: RF Level Offsets* menu. This shows the selected RF level offset for the currently selected carrier frequency (see Fig. 4-33).

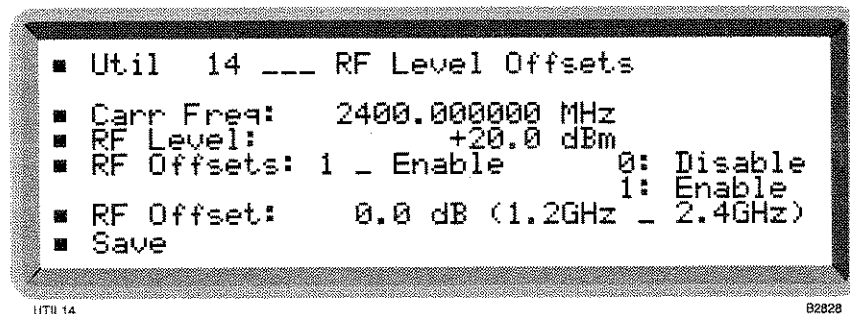

Fig. 4-33 RF level offsets menu

- (2) Enter the required carrier frequency (which automatically selects the appropriate frequency range).
- (3) Set the required positive or negative RF offset in the range 0 to 5.0 dB to a resolution of 0.1 dB using either the key pad or control knob. The applicable frequency range follows in brackets.
- (4) Repeat steps (2) and (3) above for each required additional range.
- (5) Enter 0 to disable or 1 to enable all ranges.
- (6) Select *Save* which causes *\* Saved \** to be displayed. Now all your offsets are saved in non-volatile memory so that when subsequently the instrument is switched on again it will be set with your specified offsets.

Note that setting an RF level offset may cause the RF level displayed to decrease, so that the absolute limits of the instrument are not exceeded.

## DCFM nulling

For a DC-coupled external FM signal, small frequency offsets can be reduced by using the DCFM nulling facility. Operation is as follows:

- (1) First of all select external FM from *Util 20: Modulation Mode (Normal)*. Then select DC coupling from *Util 30: Modulation Source*.
- (2) Select the *Util 23: DCFM Nulling* utility shown in Fig. 4-34 below.

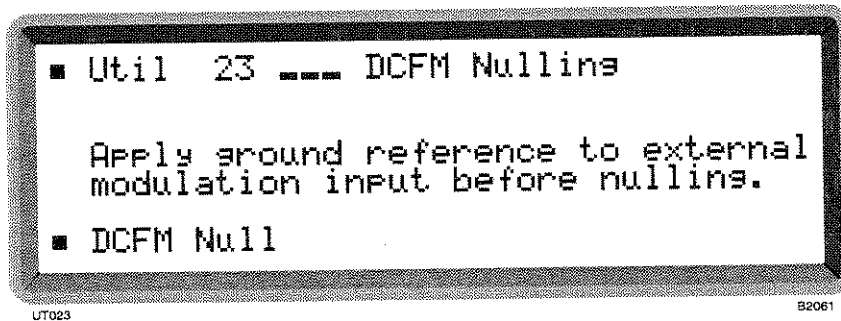

Fig. 4-34 DCFM nulling display

- (3) Follow the on-screen directions by connecting your ground reference to the EXT MOD INPUT socket.
- (4) With *DCFM Null* highlighted press [SELECT]. \* *DCFM Nulling* \* appears during the nulling process and when it disappears the process is completed.

LOCAL  
OPERATION

## SINAD measurement (Option 12)

When this option is fitted you may make measurements of the SINAD ratio on an audio frequency signal applied to the EXT MOD INPUT socket. Ensure that no external modulation mode has been selected from Util 20, since external modulation has priority over SINAD.

You can make the measurement in a flat bandwidth of 7 kHz or have it weighted according to the C-MESS or CCITT standards. You can select the amount of averaging so as to reduce variation in results and to control the update rate.

An automatic mode is available which uses a simple algorithm to adjust the RF output level of the signal generator until a target SINAD ratio is achieved.

The SINAD ratio is defined as:

$$10 \log_{10}[(\text{Signal} + \text{Noise} + \text{Distortion Power})/(\text{Noise} + \text{Distortion Power})]$$

The SINAD ratio provides a quantitative measure of signal quality, a noisy signal has a low SINAD ratio which increases as the signal quality improves. This measurement determines the RF signal level required to produce a given SINAD ratio at the receiver output. Typically SINAD ratio targets of 12 and 20 dB are used.

Proceed as follows:

- (1) First of all interconnect the receiver under test and the instrument as shown in Fig. 4-35 below.

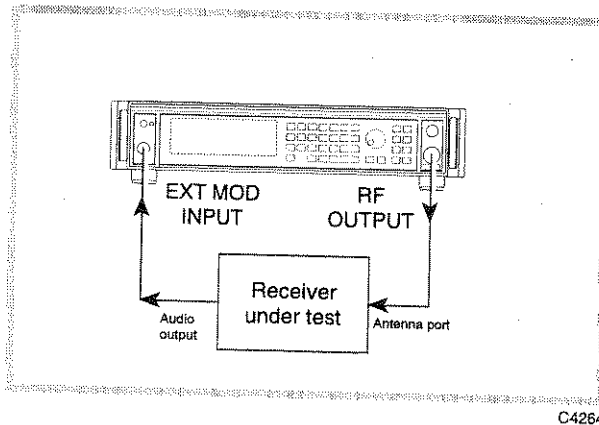

Fig. 4-35 SINAD measurement interconnections

- (2) Press [MENU] to display the *Utility Group Menu*. Then select *Special* to display the *Special Menu* shown in Fig. 4-36 below.

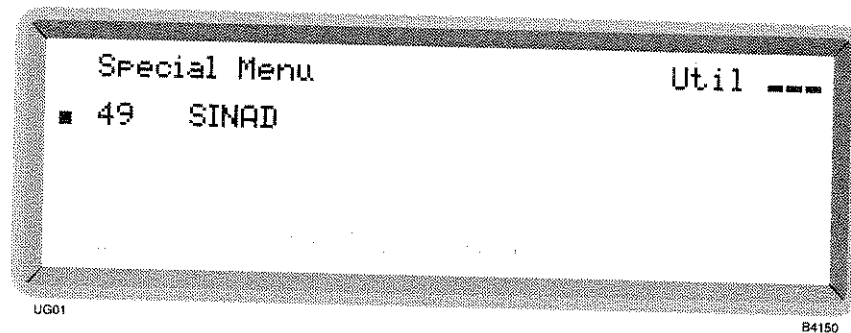

Fig. 4-36 Special menu

- (3) Highlight *Util 49: SINAD* and press [SELECT] to display the *Util 49: SINAD Measurement* menu shown in Fig. 4-37 below.

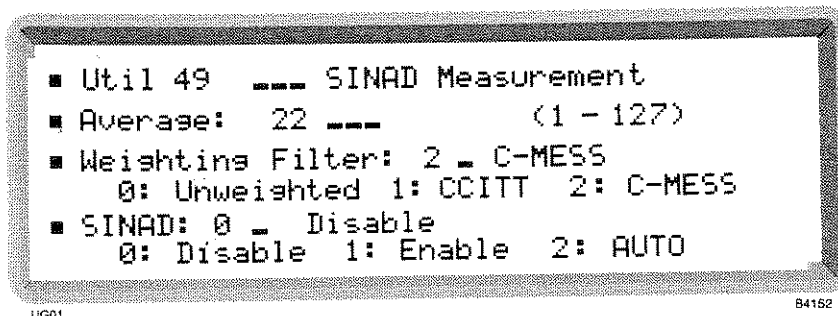

Fig. 4-37 SINAD measurement menu

- (4) Select the number of samples to be averaged by highlighting *Average* and entering a number on the key pad in the range 1 to 127. But note that although a more accurate measurement results from selecting a high number, it also increases the measurement time.
- (5) Select the weighted filter between 1 for *CCITT* and 2 for *C-MESS*. 0 selects *Unweighted*. When no filter or averaging has been selected, by default the C-MESS filter is selected and 5 samples are averaged.
- (6) Enter 1 to enable manual SINAD or 2 to enable auto SINAD measurements.
- (7) Press [MOD] to return to the main screen. Repeatedly press this key until SINAD is displayed.

### Manual SINAD

- (8) The measured SINAD is constantly updated and is proportional to the amount of RF level set. Adjust the RF level until the desired SINAD measurement is achieved.

### Automatic SINAD

- (9) Set the target SINAD value by pressing [MOD SOURCE] and entering the target value in the range 6.0 to 60 dB.
- (10) Set the RF level so that the measured SINAD is several dBs greater than the target SINAD.
- (11) Start automatic leveling by pressing [SOURCE ON/OFF]. The RF level will decrement by the step size previously set (default 1 dB). During leveling the display will show *SEEKING* (as shown in Fig. 4-38) then *COMPLETE* when finished. The [SOURCE ON/OFF] key may be used to both pause and continue the process. At the conclusion pressing [SOURCE ON/OFF] will repeat the measurement.

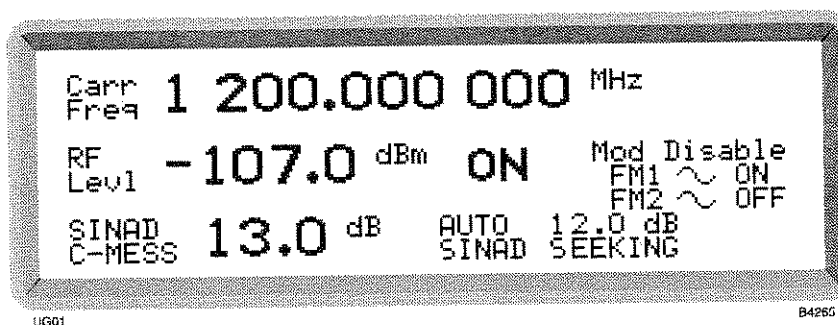

Fig. 4-38 Main screen during auto SINAD operation

*SINAD set-up incorrect* (Error 206) will be displayed if the first SINAD reading is lower than the target. The indicated RF level is unlikely to be correct. Probable causes are:

- Initial RF level set is too low.
- Radio is disconnected, incorrectly set up or malfunctioning.
- Signal generator [CARR ON/OFF] is OFF.
- Signal generator carrier is at the wrong frequency.

LOCAL OPERATION

Signal generator carrier frequency is unmodulated, or modulation is not a 1 kHz sinewave.

[MOD ON/OFF] is OFF.

[SOURCE ON/OFF] is OFF.

If required, check that the correct CTCSS frequency, deviation and level are supplied to the unit under test.

## Keyboard locking and display blanking

You may lock the keyboard to prevent unauthorized use of the instrument. Additionally you may blank the display to prevent sensitive data from being displayed. Selection is made as follows:

- (1) Unlock the protection by selecting *Util 80: Protection Lock/Unlock* and entering the 4-digit password for Level 1 using the keypad and pressing [ENTER].
- (2) Select the *Util 53: Key Lock/Display Blanking* menu shown in Fig. 4-39.

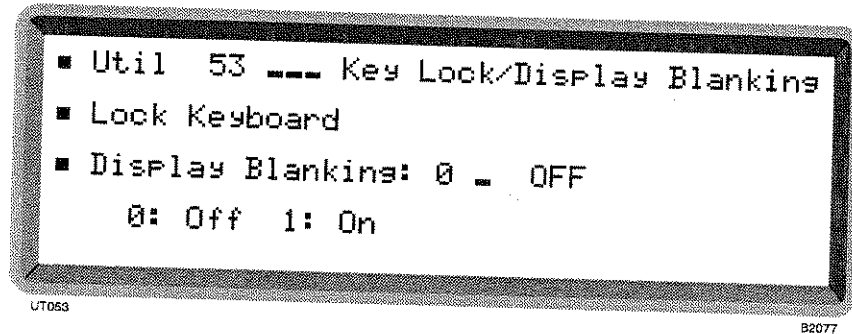

Fig. 4-39 Key lock/display blanking menu

## Keyboard locking/unlocking

- (3) To lock the keyboard highlight *Lock Keyboard* and press [SELECT]. The instrument automatically returns to the main screen which indicates the locked status by displaying a key-shaped icon at the top right of the display. Now the keyboard is locked, although the instrument still responds to GPIB or RS-232 commands.
- (4) To unlock the keyboard enter the 4-digit password for Level 1 using the keypad and pressing [ENTER].

## Display blanking

- (5) To blank the display highlight *Display Blanking* and press 1 [ENTER]. Press any function key to return to the main screen. Here it can be seen that the main parameters are blanked and replaced by dashes. This also applies to *Util 1: Carrier Sweep Parameters* where the start and stop frequencies are blanked, and to *Util 3: Carrier Sweep Control* where the carrier frequency is blanked.
- (6) To unblank the display re-enter *Util 53* and press 0 [ENTER].
- (7) You may lock the display in the blank state by using *Util 80* to enter an incorrect password.



## Power-up options

The instrument can power-up in one of two states: with the factory settings or with the settings of your choice stored in one of the full memory locations. Selection is made as follows:

- (1) Select the *Util 54: Power Up Settings* menu. This shows the currently selected power-up choice (see Fig. 4-40).

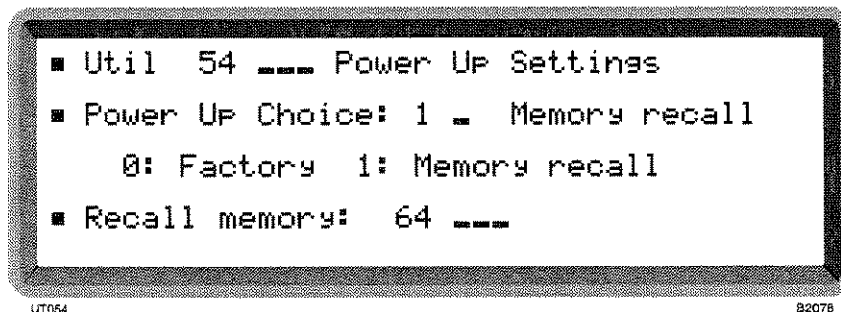

Fig. 4-40 Power-up settings menu

- (2) Enter 1 for *Memory Recall* or 0 for *Factory* (no terminator is necessary).
- (3) The current recall memory location is shown. To change, highlight *Recall Memory* and enter the required location number (in the range 0 to 199) and terminate with [ENTER].

LOCAL  
OPERATION

## Adjusting the display

Display contrast may be set to suit different lighting conditions and the setting saved in memory as follows:

- (1) Select the *Util 55: LCD Adjustment* menu. This shows the currently selected contrast setting (see Fig. 4-41).

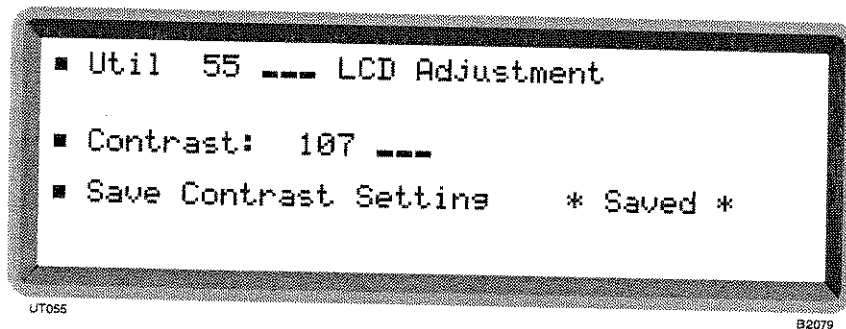

Fig. 4-41 LCD adjustment menu (with the setting saved for automatic recall at switch-on)

- (2) Enter a number in the low- to high-contrast range 0–255 (the default setting is 127). The setting can be adjusted by use of the [ $\uparrow+10$ ] and [ $\downarrow\times 10$ ] keys or the control knob.
- (3) If required, you can save the setting by selecting *Save Contrast Setting*. The instrument responds with **\*\* SAVED \*\*** and from now on whenever the instrument is switched on, the contrast will be at your individual setting.

## Software information

You can obtain a description of the instrument's software by selecting *Util 60: Software Status*. This causes the software version and date as well as the programmed EPROM part number to be displayed (see Fig. 4-42).

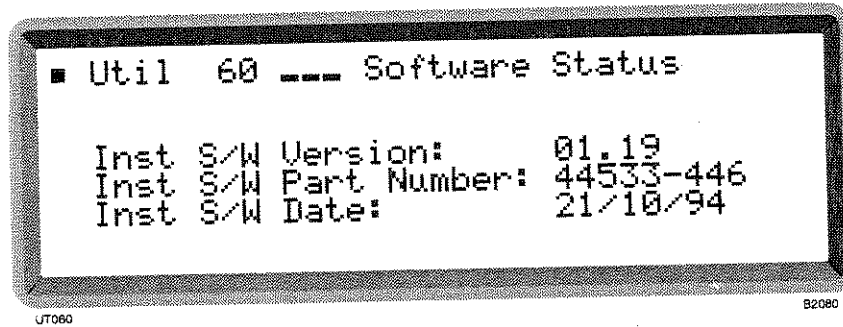

Fig. 4-42 Software status

## Hardware information

You can obtain a description of the instrument's hardware by selecting *Util 61*. This causes the instrument type and serial number to be displayed (see Fig. 4-43).

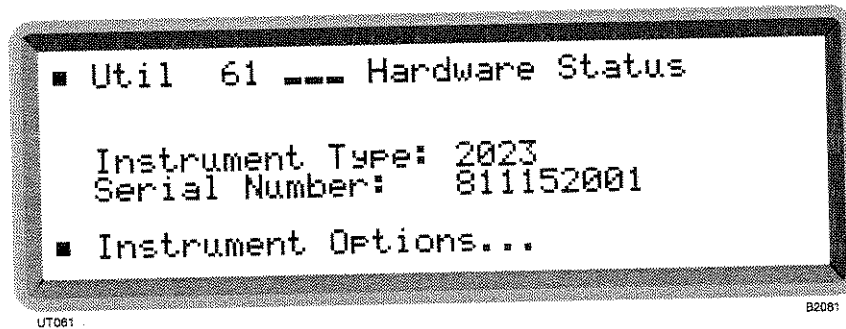

Fig. 4-43 Hardware status

- (1) Highlight *Instrument Options...* and press [SELECT]. This give you immediate access to the *Util 62: Instrument Options* display shown below.

LOCAL  
OPERATION

## Instrument options

You can obtain a list of the options fitted in the instrument by selecting *Util 62: Instrument Options* (see Fig. 4-44). For available options refer to 'Options' in Data Sheet at end of Chapter 1.

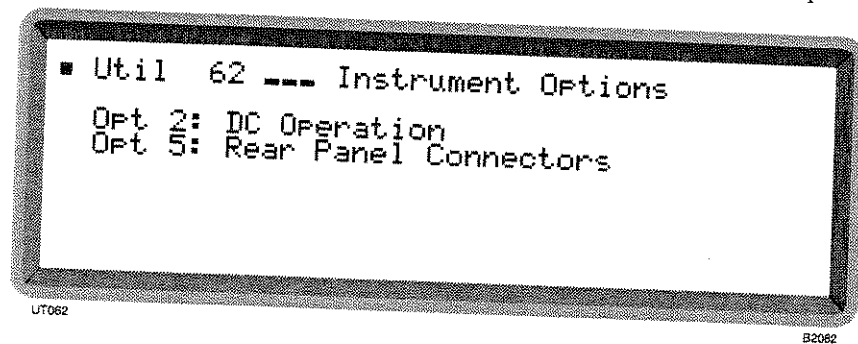

Fig. 4-44 Instrument options display

**Note that if no attenuator is fitted reverse power protection is not provided.**

## Protection locking and unlocking.

To prevent accidental interference with the contents of internal memories, internal data is protected by secure key sequences. There are two levels of protection. The most secure, Level 2, used for servicing, is reserved for features such as altering the calibration data of the instrument. Level 1 protection is used for locking the keyboard, blanking the display and for memory protection. A filled-in square indicates an unprotected function. An open, unfilled square indicates a protected function.

To lock or unlock the protection select the *Util 80: Protection Lock/Unlock* menu shown in Fig. 4-45.

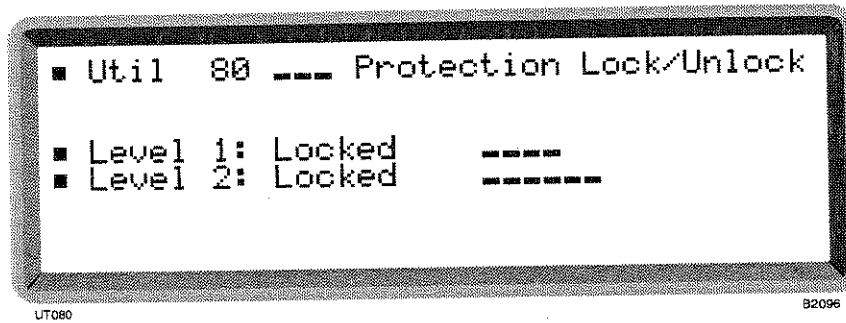

Fig. 4-45 Protection locking and unlocking

- (1) Highlight *Level 1*: and enter the 4-figure password on the keypad and press [ENTER]. *Locked* changes to *Unlocked*. The default password is 1234.
- (2) Highlight *Level 2*: and enter the 6-figure password on the keypad and press [ENTER]. *Locked* changes to *Unlocked*.
- (3) If the entered password is not recognized by the instrument the password will have been changed by operating personnel.
- (4) To lock the instrument, highlight either *Level 1*: or *Level 2*: and enter an incorrect password. Both levels will then become locked.

LOCAL  
OPERATION

## Changing the password

To change the password first ensure that the instrument is unlocked to Level 2 using *Util 80: Protection Lock/Unlock*. Then select the *Util 81: Password* menu shown in Fig. 4-46 and proceed as follows:

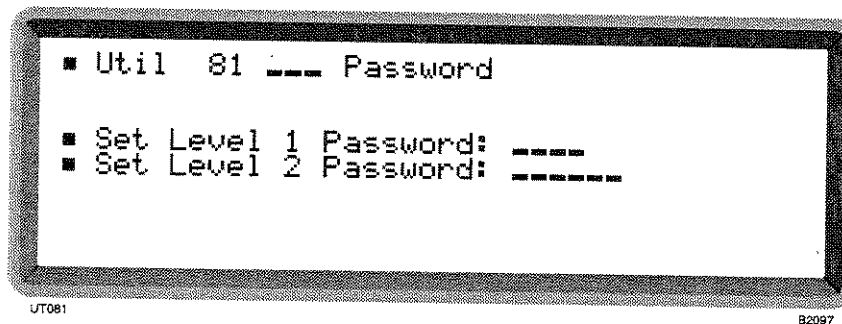

Fig. 4-46 Password selection menu

- (1) Highlight *Set Level 1 Password:* and enter a 4-figure password on the keypad then press [ENTER].
- (2) Highlight *Set Level 2 Password:* and enter a 6-figure password on the keypad and press [ENTER].

Keep a copy of your passwords in a safe place and remember to update the copy whenever the passwords are changed. In the event that you have forgotten your password(s) get in touch with your local Service Centre (for address refer to the end of this manual).

# ERROR MESSAGES

## Error handling

Error messages are divided into four groups:

- (1) Background errors – represent a condition of the instrument.
- (2) Foreground errors – generally caused by the user.
- (3) GPIB errors – generated by incorrect programming.
- (4) Fatal errors – caused by failure associated with the main RAM or the PROM. These errors may or may not be displayed according to the severity of the failure or corruption.

### Background errors:

These are generated due to an incorrect operating condition within the instrument. These errors are generated automatically to warn the operator. For example if the reverse power protection circuit should trip the message: *Err 500: RPP tripped* will be displayed on the main screen. Background errors are listed in Table 4-2. Only one error will be displayed, that with the highest priority. To obtain a full list of errors occurring on your instrument in priority order, select *Util 75: Background Errors* (see Fig. 4-47). Select *Down...* if the list is continued on a subsequent page.

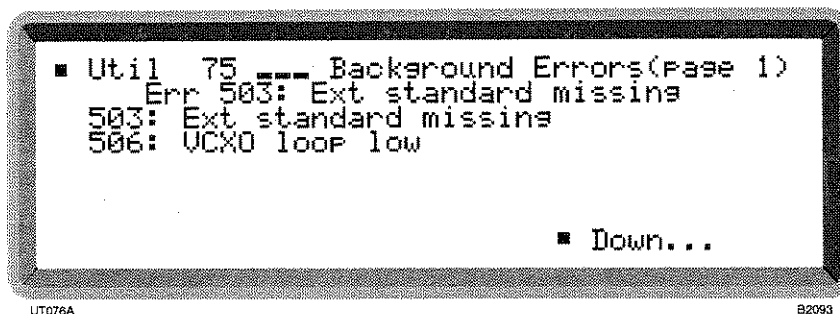

Fig. 4-47 Background errors display

### Foreground errors:

These are typically generated when an entered parameter value is outside the valid range or for some other invalid operation. For example trying to set the carrier frequency above or below the specified range will display the following message *Err 100: Carrier limit* on the screen. The foreground errors are cleared upon function selection or by re-entering the parameter correctly. Foreground errors are listed in Table 4-3.

### Error message priority:

A background error has a priority bit set which is used to determine which message needs to be displayed. A foreground error will temporarily overwrite the background error if currently displayed, but will return to displaying that error once the foreground error has been cleared.

### GPIB errors

When an error occurs the error number is put into the error queue and the error message is displayed. Clearing the error message from the screen does not clear the error queue, which is only cleared by the GPIB command *ERROR?* query, which returns the error at the head of the queue, or by the *\*CLS* command which clears the whole error queue. GPIB errors are listed in Table 4-4.

LOCAL  
OPERATION

The queue holds a maximum of 64 error message error numbers. If an error occurs while the queue is full the last error number is replaced with 399 to indicate that the queue is full. The ERROR? query returns a value of 399 for queue full and 0 for queue empty.

When an error number is written into the queue, a bit (<erb>) in the status byte register is set, and an appropriate bit in the standard event register is also set (one of <cme>, <exe>, <dde> or <qye>). These errors will also generate SRQ if the relevant bit in the status register is set. Many background errors are also reported in the Hardware and Coupling Status Registers.

**Table 4-2 Background errors (500-599) in priority order**

-	-	-	591	ftl	Main PROM faulty
590	ftl	Main RAM faulty	-	-	-
-	-	-	-	-	-
-	-	-	-	-	-
500	dde	RPP tripped	501	dde	Fractional-N loop low
502	dde	Fractional-N loop high	503	dde	Ext standard missing
504	dde	External std frequency low	505	dde	External std frequency high
506	dde	VCXO loop low	507	dde	VCXO loop high
508	dde	Amplitude modulator unlevelled	509	dde	Output unlevelled
510	dde	Power Amp Fail or Unterminated	511	dde	ALC too high
512	dde	ALC too low	513	dde	DSP not responding
514	dde	SINAD DSP not responding	515	dde	SINAD underrange
516	dde	SINAD overload	517	-	-
-	-	-	-	-	-
-	-	-	549	exe	RF level uncalibrated
550	exe	RF level limited by AM	551	exe	AM2 limited by AM1
552	exe	FM2 limited by FM1	553	exe	ΦM2 limited by ΦM1

**Table 4-3 Foreground errors (0-399)**

0	dde	No error	1	dde	EEPROM checksum
2	dde	Pad cal checksum	3	dde	RF cal checksum
4	dde	Freq std checksum	5	dde	Synthesizer cal checksum
6	dde	Mod ref checksum	7	dde	Mod offset checksum
8	dde	Mod amp checksum	9	dde	ALC cal checksum
10	dde	FM cal factor checksum	11	dde	FM tracking checksum
12	dde	ΦM cal factor checksum	13	dde	System cal checksum
14	dde	AM cal checksum	15	dde	Store checksum
16	dde	Image checksum	-	-	-
20	dde	Frac-N out of lock at <freq>	21	dde	VCO cal fail at <freq>
22	dde	VTF tune cal fail at <freq>	23	dde	FM tracking cal fail at <freq>
-	-	-	51	dde	Keyboard buffer overflow
52	dde	Display buffer overflow	53	dde	Display missing
-	-	-	-	-	-
100	exe	Carrier limit	101	exe	Carrier step limit
102	exe	RF level limit	103	exe	RF level step limit
104	exe	Invalid modulation mode	105	exe	AM limit
106	exe	AM2 limit	107	exe	AM step limit
108	exe	AM2 step limit	109	exe	FM limit

*contd./...*



Table 4-3 Foreground errors (0-399)(continued)

110	exe	FM2 limit	111	exe	FM step limit
112	exe	FM2 step limit	113	exe	ΦM limit
114	exe	ΦM2 limit	115	exe	ΦM step limit
116	exe	ΦM2 step limit	117	exe	Memory limit
118	exe	AM mod freq limit	119	exe	AM mod step limit
120	exe	AM2 mod freq limit	121	exe	AM2 mod step limit
122	exe	FM mod freq limit	123	exe	FM mod step limit
124	exe	FM2 mod freq limit	125	exe	FM2 mod step limit
126	exe	ΦM mod freq limit	127	exe	ΦM mod step limit
128	exe	ΦM2 mod freq limit	129	exe	ΦM2 mod step limit
130	exe	Return/Transfer not allowed	131	exe	Util limit
132	exe	Start freq limit	133	exe	Stop freq limit
134	exe	Sweep time limit	135	exe	Sweep mode disabled
136	exe	Carrier phase limit	137	exe	AM phase limit
138	exe	FM phase limit	139	exe	ΦM phase limit
140	exe	Memory store limit	141	exe	Memory recall limit
142	exe	Display blanking limit	143	exe	GPIB address limit
144	exe	Latch address limit	145	exe	Latch data limit
146	exe	Freq std carrier limit	147	exe	Freq std course adj limit
148	exe	Freq std fine adj limit	149	exe	Mod ref adj limit
170	exe	Util not available	171	exe	Entry outside limits
172	exe	Data out of range	173	exe	Units not valid
174	exe	Unlev fact limited by FM fact	175	exe	invalid baud rate
176	exe	Data overrun	177	exe	Data parity
178	exe	Data framing	179	exe	Break in data
180	exe	Transmit buffer full	181	exe	Receiver not enabled
182	exe	Protected utility – Level 1	183	exe	Protected utility – Level 2
184	-	-	185	exe	This store is Read Only
186	-	-	187	-	-
188	exe	Pulse unavailable in 4FSK mode	189	exe	Pulse has been disabled
190	exe	No attenuator fitted	191	exe	No high power amp fitted
198	exe	No SINAD fitted	199	-	-
202	-	-	203	exe	SINAD unavailable with Ext Mod
204	exe	SINAD has been disabled	205	exe	RF level too low
206	exe	SINAD setup incorrect	207	-	-
398	-	-	399	exe	Error queue full

LOCAL OPERATION

**Table 4-4 GPIB errors (400-499)**

400	cme	Syntax error	401	cme	Unrecognized mnemonic
402	cme	Numeric syntax	403	cme	Data expected
404	cme	Illegal data	405	cme	Too much data
406	cme	Incorrect data type	407	cme	Unrecognized character data
408	cme	Character data not unique	409	cme	Block definition
410	cme	Block size	411	cme	Missing quote
412	cme	Terminator expected	413	cme	Invalid unit
414	cme	Unit not expected	415	cme	No header match found
416	cme	Header not unique	417	cme	Illegal star command
418	cme	Sub-command not allowed	419	cme	Action not allowed with header
420	cme	Query not allowed with header	421	cme	Parser decode
-	-	-	-	-	-
-	-	-	-	-	-
-	-	-	-	-	-
-	-	-	-	-	-
450	qye	Query INTERRUPTED	451	qye	Query UNTERMINATED
452	qye	Query DEADLOCK	453	qye	Query lost after arbitrary char
-	-	-	-	-	-
-	-	-	-	-	-
-	-	-	-	-	-

# Chapter 5

## REMOTE OPERATION

### Contents

Preparing the instrument for remote operation .....	5-3
Introduction .....	5-3
Plug and Play driver .....	5-3
Local lockout .....	5-3
Remote/local operation .....	5-3
Remote operation selection .....	5-3
RS-232 operation .....	5-4
RS-232 control port .....	5-4
Handshaking .....	5-4
Software only .....	5-4
Hardware only .....	5-4
Hardware and software .....	5-4
Control characters .....	5-4
Setting RS-232 parameters .....	5-4
GPIB operation .....	5-6
GPIB control port .....	5-6
Setting GPIB address .....	5-6
GPIB functions .....	5-6
Device listening elements .....	5-7
Device talking elements .....	5-7
Programming .....	5-8
Program messages .....	5-8
Compound headers .....	5-8
Program data .....	5-9
Message exchange protocol .....	5-9
Common commands and queries (IEEE 488.2) .....	5-10
Device-dependent commands .....	5-11
Default settings .....	5-11
Carrier frequency .....	5-12
RF level .....	5-13
Output control .....	5-15
Modulation mode .....	5-16
Modulation control .....	5-16
Frequency modulation (and FSK) .....	5-17
Phase modulation .....	5-19
Amplitude modulation .....	5-21
Pulse modulation .....	5-23
Memory – store .....	5-24
Memory – recall .....	5-24
Memory – erase .....	5-24
Memory – sequencing .....	5-25
Memory – triggering .....	5-26
Memory – protection .....	5-26
Sweep operation .....	5-27
Sweep mode .....	5-27
Sweep control .....	5-28
SINAD mode .....	5-29
Miscellaneous commands .....	5-30
Status byte .....	5-34
Status data structure – register model .....	5-35
Standard event registers .....	5-36

contd./...

REMOTE  
OPERATION

**Contents (continued)**

Hardware event registers .....	5-37
Coupling event registers .....	5-38
Instrument event registers .....	5-39
Queue flag details .....	5-40
Status byte when read by *STB? .....	5-41
Status byte when read by serial poll .....	5-42
Summary of status reporting commands and queries .....	5-43

**List of figures**

Fig. 5-1 Remote operation select menu .....	5-3
Fig. 5-2 RS-232 setup menu .....	5-5
Fig. 5-3 GPIB address menu .....	5-6

# Preparing the instrument for remote operation

## Introduction

The instrument can be controlled remotely using either the RS-232 interface or the GPIB (General Purpose Interface Bus) interface. The command set used is designed to comply with IEEE 488.2. In RS-232 mode some IEEE 488.2 features are not implemented due to the restrictions of the interface.

Programs to control the instrument remotely over the two interfaces have much in common, the main difference being the way in which characters are transmitted.

## Plug and Play driver

Information is provided in Chapter 2 for installing the LabWindows/CVI Instrument Driver and the VXI Plug and Play Soft Panel software supplied with this manual.

## Local lockout

In the remote mode the controller can set the instrument into Local Lockout state. When Local Lockout is set the front panel is disabled and the [LOCAL] key is made ineffective. This state is often used when the instrument is part of an automatic test system and left unattended. In this state the instrument cannot be affected by operation of the front panel. The keyboard can only be re-enabled by releasing Local Lockout over the remote interface or by switching the supply off and on again.

## Remote/local operation

When the instrument is addressed by the GPIB controller it will enter its remote mode and the screen will display the [REM] annunciator at the lower right corner. Only one key, [Go To Local], will have any effect. Pressing this key returns the instrument to normal manual operation, unless Local Lockout (LLO) has been asserted by the controller

When the instrument is addressed by the RS-232 controller, the remote mode is normally not entered (and thus no [REM] annunciator appears on the screen), although RS-232 operation is taking place.

In order to go to remote mode via the RS-232 it is necessary to transmit a control character (^A or 01H – connect or go to remote) following which the [REM] annunciator appears. Subsequently pressing [Go To Local] or transmitting a control character (^D or 04H – disconnect or go to local) will return the instrument to normal manual operation (unless Local Lockout has been asserted).

REMOTE  
OPERATION

## Remote operation selection

Remote operation can be selected between RS-232 and GPIB as follows:

- (1) Select the *Util 50: Remote Operation Select* menu. This shows the currently selected remote mode of operation (see Fig. 5-1).

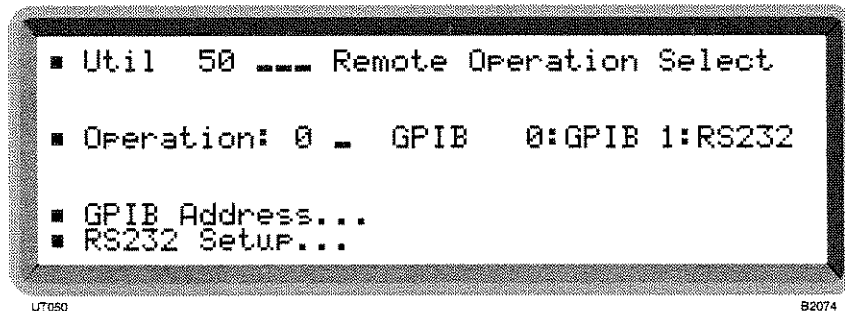

Fig. 5-1 Remote operation select menu

- (2) Select between RS232 and GPIB remote operation.
- (3) To set the RS-232 parameters highlight *RS232 Setup...* and press [SELECT]. This causes the *Util 52: RS232 Setup* menu shown in Fig. 5-2 to be displayed.
- (4) To set the GPIB address highlight *GPIB Address...* and press [SELECT]. This causes the *Util 51: GPIB Address* menu shown in Fig. 5-3 to be displayed.

## RS-232 operation

### RS-232 control port

The connections required between the RS-232 serial port and the controlling device are described in Chapter 2 under 'RS-232 interface'.

### Handshaking

#### Software only

Flow control is achieved by XON/XOFF.

**Note**

All control lines are normally in the OFF state and are ignored.

#### Hardware only

Flow control is achieved by DSR or CTS to suspend transmission from the instrument and using DTR to suspend transmission from the controller.

**Note**

The instrument will try to stop the controller from transmitting when the instrument's input buffer is nearly full and will allow further transmission when the buffer has enough room for new data.

The instrument will continue to transmit for a few characters after receiving the command to stop transmission, the controller must have enough buffer space to cope with this extra data.

#### Hardware and software

Normally used in conjunction with a modem. The flow control between the instrument and modem is achieved with the control lines, and the flow control to the remote control is achieved by XON/XOFF.

### Control characters

The following list shows the control characters that are used over the RS-232 system to simulate certain features of the IEEE 488 interface:

- ^A (control A 01H) – connect or go to remote
- ^D (control D 04H) – disconnect or go to local
- ^R (control R 12H) – local lockout
- ^P (control P 10H) – release local lockout
- ^Q (control Q 11H) – XON char for software handshake
- ^S (control S 13H) – XOFF char for software handshake

Note that power on (PON) also clears the local lockout states.

### Setting RS-232 parameters

The RS-232 settings can be changed as follows:

- (1) First of all ensure that *RS233 Setup* has been selected from the *Util 50: Remote Operation Select* menu.
- (2) Select the *Util 52: RS232 Setup* menu. This shows the current RS-232 settings (see Fig. 5-2).

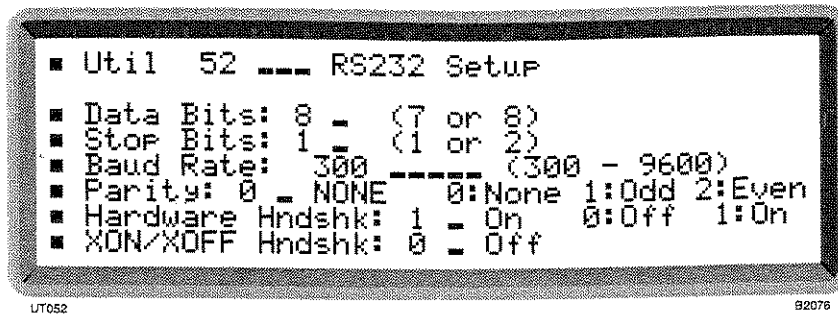

Fig. 5-2 RS-232 setup menu

- (3) Set the *Data Bits* to either 7 or 8.
- (4) Set the *Stop Bits* to either 1 or 2.
- (5) Set the *Baud Rate* in the range 300 to 9600 bit/s. But note that if the entered value is not one of the following standard settings, the next higher value will be selected by default:

300  
600  
1200  
2400  
4800  
9600.

- (6) Set *Parity* between *None*, *Odd* and *Even*.
- (7) Set the *Hardware Hndshk* and the *XON/XOFF Hndshk* as required to any handshake combination from both off to both on.

**REMOTE  
OPERATION**

## GPIB operation

The instrument can be operated remotely from a personal computer fitted with a GPIB interface card or a dedicated GPIB controller. All functions can be controlled by coded messages sent over the interface bus via the 24-way socket on the rear panel of the instrument. IEEE Standard 488.2 (1987) is implemented, which defines the protocols and syntax of commands.

The instrument can function either as a talker or a listener. In the listen mode, it will respond to IEEE 488.2 common commands and queries and device-specific commands and queries. These allow various device functions to be controlled and operating parameters to be set. In the talk mode, device status information and parameter settings can be read from the instrument.

For full information on the IEEE protocols and syntax the IEEE 488.2 standard should be consulted.

## GPIB control port

The connections required between the GPIB interface port and the controlling device are described in Chapter 2 under 'General Purpose Interface Bus (GPIB)'.

## Setting GPIB address

The instrument must be given an address code before it can be used by remote control over the GPIB. This address is selected as follows:

- (1) Select the *Util 51: GPIB Address* menu. This shows the current GPIB address (see Fig. 5-3).

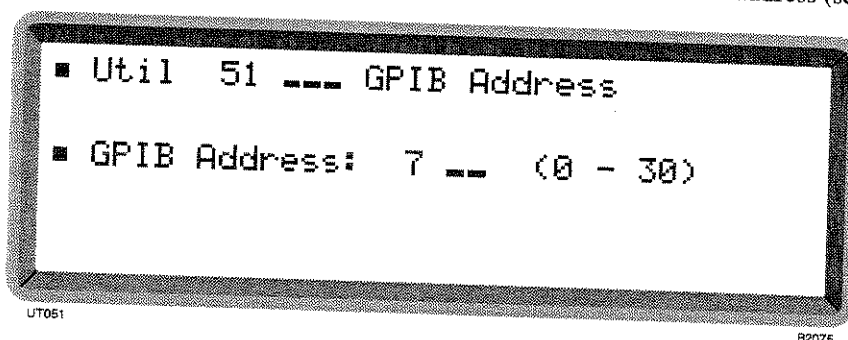

Fig. 5-3 GPIB address menu

- (2) Enter the address which must be unique on the system to the instrument and within the range 0 to 30.

## GPIB functions

The IEEE 488.1 interface functions offered by the instrument are as follows:

Source handshake (SH1)	complete capability.
Acceptor handshake (AH1)	complete capability.
Talker (T6)	basic talker, serial poll, unaddress if MLA.
Listener (L4)	basic listener, unaddress if MTA.
Service Request (SR1)	complete capability.
Remote/Local (RL1)	complete capability.
Device clear (DC1)	complete capability.
Device trigger (DT1)	complete capability.
Parallel Poll (PP0)	no capability.
Controller (C0)	no capability.
Tri-state drivers (E2)	as opposed to open-collector drivers.



## Device listening elements

The following is a list of the device listening elements (as defined in the IEEE 488.2 standard) which are used in the instrument:

- <PROGRAM MESSAGE>
- <PROGRAM MESSAGE TERMINATOR>
- <PROGRAM MESSAGE UNIT>
- <PROGRAM MESSAGE UNIT SEPARATOR>
- <COMMAND MESSAGE UNIT>
- <QUERY MESSAGE UNIT>
- <COMPOUND COMMAND PROGRAM HEADER>
- <COMPOUND QUERY PROGRAM HEADER>
- <PROGRAM HEADER SEPARATOR>
- <PROGRAM DATA>
- <PROGRAM DATA SEPARATOR>
- <DECIMAL NUMERIC PROGRAM DATA>
- <CHARACTER PROGRAM DATA>
- <SUFFIX PROGRAM DATA>
- <STRING PROGRAM DATA>
- <ARBITRARY BLOCK PROGRAM DATA>

## Device talking elements

The following is a list of the device talking elements (as defined in the IEEE 488.2 standard) which are used in the instrument:

- <RESPONSE MESSAGE>
- <RESPONSE MESSAGE TERMINATOR>
- <RESPONSE MESSAGE UNIT>
- <RESPONSE MESSAGE UNIT SEPARATOR>
- <COMPOUND RESPONSE HEADER>
- <RESPONSE HEADER SEPARATOR>
- <RESPONSE DATA>
- <RESPONSE DATA SEPARATOR>
- <NR1 NUMERIC RESPONSE DATA>
- <NR2 NUMERIC RESPONSE DATA>
- <ARBITRARY ASCII RESPONSE DATA>
- <CHARACTER RESPONSE DATA>
- <STRING RESPONSE DATA>
- <DEFINITE LENGTH ARBITRARY BLOCK RESPONSE DATA>

REMOTE  
OPERATION

# Programming

## Program messages

A message consists of one or more message units. Message units are separated by a semi-colon (;). The whole message is ended by the Program Message Terminator (or End Of Message) defined as one of the following:

- (1) <newline> (ASCII 10 – often known as ‘line feed’) or
- (2) <newline> + END (the EOI line is asserted as well) or
- (3) + END (EOI is asserted in the last data byte of the message)

### Note

A response message is always terminated by <EOM> consisting of <newline> + END.

A message unit consists of a mnemonic header which may be followed by data. If data follows, it must be separated from its header by at least one space:

<header><SPACE><data>

e.g. RFLV:INC 6.0 dB

Spaces may be freely inserted in a message to improve readability, except within a header or within data.

A header may be a command or a query. A query has a ‘?’ as its final character and causes the generation of a response message which will be read by the controller. Common commands and queries (defined in IEEE 488.2) begin with a ‘\*’.

Upper and lower case characters are considered equivalent (so FM fm Fm fM are all interpreted by the instrument in the same way).

## Compound headers

The instrument implements compound headers which allows a complex set of commands to be built up from a small set of basic elements in a ‘tree and branch’ structure. The elements of a compound header are separated by a colon (:). Spaces are not allowed within a header.

Special rules apply when more than one compound header is used in one message. When the separator ‘;’ is encountered, all headers except the trailing element of the previous header in the message are assumed to precede the following header, for example:

AM:DEPTH 30PCT;ON

is equivalent to the two commands:

AM:DEPTH 30PCT

and AM:ON

This does not apply to common commands (\*RST etc.). The rule may be overridden by preceding a header with a colon, for example:

AM:ON::FM:ON

Most main functions have a short form of header which may be used for clarity and brevity in simple messages, for example:

CFRQ 1.25GHZ is the same as CFRQ:VALUE 1.25GHZ

## Program data

Data can take many forms, as follows:

- Decimal Numeric Data is a flexible numeric format which encompasses integer, fixed point and floating point (mantissa and exponent) representations. Data is rounded to a resolution appropriate to the function. Decimal data can, in most cases, be followed by the appropriate units. If no units are present, the specified default units are assumed.
- Character Data is an alphanumeric word.
- String Data consists of a number of 7-bit ASCII characters enclosed in quotes, either a pair of single ('ASCII 39') or double ("ASCII 34") quotes may be used.
- Some commands can accept Multiple Data items which are separated by commas, for example MODE FM,AM.

## Message exchange protocol

The controller should not attempt to read a response until it has sent the entire query message (terminated by EOM). Also, it should not start to send a new message until it has read the entire response (terminated by EOM). The query message may contain more than one query message unit, but only one response message (containing several response message units) is generated.

Failure to follow the protocol will generate a query error:

- INTERRUPTED (error 450) occurs when the controller starts to send a new message before having read the response to a preceding query.
- UNTERMINATED (error 451) occurs when the controller attempts to read a response without having sent a query.
- DEADLOCK (error 452) can only occur if the input and output buffers are both filled by the controller having sent an extra long message containing several query message units. These instruments have an input buffer of 256 characters and an output buffer of 256 characters.

REMOTE  
OPERATION

## Common commands and queries (IEEE 488.2)

The IEEE 488.2 standard defines a set of common commands and queries which implement common system functions.

Common command and query mnemonics are preceded by an asterisk (\*) to distinguish them from device-dependent data such as instrument programming strings. The following common commands and queries are implemented in the instrument:

Mnemonic	Name and Description
*IDN?	<p>Identification Query. Returns an arbitrary ASCII response comprising four data fields in the format:</p> <p>&lt;manufacturer&gt;,&lt;model&gt;,&lt;serial number&gt;,&lt;software part number and issue number&gt;</p> <p>where: &lt;manufacturer&gt; is IFR, &lt;model&gt; is the instrument model number, which is one of 2023A, 2023B or 2025.            &lt;serial number&gt; is the instrument serial number in the form nnnnnn/nnn, where n is an ASCII digit in the range 0 to 9.            &lt;software part number and issue number&gt; is in the form nnnnn/nnn/n.nn, where n is an ASCII digit in the range 0 to 9.</p> <p>Example: IFR,2025,811152/011,44533/446/01.00&lt;EOM&gt;</p>
*OPT?	<p>Option Identification Query. Returns an arbitrary ASCII response containing a data field for each fitted option in the format:</p> <p>&lt;option a&gt;,&lt;option b&gt;, ... ,&lt;option n&gt;&lt;EOM&gt;</p> <p>Example: HIGH POWER,REAR PANEL CONNECTORS &lt;EOM&gt;</p> <p>If no options are fitted, ASCII '0' is returned.</p>

### Note

Because an Arbitrary ASCII Response ends with the Response Message Terminator (<EOM>) either \*IDN? or \*OPT? must be the last Query Message Unit in a Program Message.

*RST	Reset Command. Sets the instrument functions to the factory default power up state.
*TST?	Self Test Query. Returns a '0' when the GPIB interface and processor are operating.
*OPC	Operation Complete Command. Sets the Operation Complete bit in the Standard Event Status Register when execution of the preceding operation is complete.
*OPC?	Operation Complete Query. Returns a '1' when the preceding operation has been completed.
*WAI	Wait to Continue Command. Inhibits execution of an overlapped command until the execution of the preceding operation has been completed.
*TRG	Trigger Command. Equivalent to Group Execute Trigger.
*STB?	Read Status Byte Query. Returns the value of the Status Byte as an nr1 number (0-255).
*SRE <nr1>	Service Request Enable Command. Sets the Service Request Enable Register.
*SRE?	Service Request Enable Query. Returns the value of the Service Request Enable Register as nr1.
*ESR?	Standard Event Status Register Query. Returns the value of the Status Event Status Register as nr1.
*ESE <nr1>	Standard Event Status Enable Command. Sets the Standard Event Enable Register.
*ESE?	Standard Event Status Enable Query. Returns the value of the Standard Event Status Enable Register as nr1.
*CLS	Clear Status Command. Clears all the Status Event registers and clears the Error Queue. Does not affect the Enable Registers.

## Device-dependent commands

The following list describes the features of the device-dependent mnemonics for the instrument together with simple examples of their use within each major section (Carrier frequency, RF level, etc.) The root mnemonic is listed first followed by the lower level mnemonics. Each group is followed by a list of requirements for data type and suffix.

In addition to the normal listen commands the instrument accepts query commands which cause it to prepare a message which will be sent to the controller when the instrument is next addressed to talk. For each query an example of a response is given. Where responses are similar for a group of queries not all are listed. Some queries can produce more than one type of response – an example of each is usually given.

In the list which follows, the abbreviations <char>, <nrf> and <str> have the following meanings:

<char>	=	Character Program Data
<nrf>	=	Decimal Numeric Program Data
<str>	=	String Program Data

Where the data format is Decimal Numeric Program Data, the value may be expressed as a signed or unsigned number in any of the following formats:

nr1:	Decimal integer, e.g. 1234 or -567
nr2:	Floating point number, e.g. 1.234 or -56.789
nr3:	Floating point number with exponent, e.g. 1.2345E5 or -12.47E-8

## Default settings

These are the settings assigned to instrument functions in the following cases:

- (i) Power-up to factory default settings.
- (ii) Execution of \*RST command.
- (iii) Recall Store 999.

REMOTE  
OPERATION

## Carrier frequency

### CFRQ

Set Carrier Frequency (short form)

:VALUE

Set Carrier Frequency

:INC

Set Carrier Frequency step size

Data type : Decimal Numeric Program Data  
 Allowed suffices : Any one of: GHZ, MHZ, KHZ or HZ  
 Default suffix : HZ

:UP

Go UP one step

:DN

Go DOWN one step

:RETN

Return to original setting

:XFER

Transfer current value to be the new setting

Data type : None  
 Allowed suffices : None  
 Default suffix : None

:MODE

Selects the mode of carrier frequency operation. SWEPT enables swept carrier frequency operation, while FIXED disables it

Data type : Character Program Data (FIXED – non swept mode, SWEPT – swept mode).  
 Allowed suffices : None  
 Default suffix : None

:START

Set Start Frequency for use in sweep

:STOP

Set Stop Frequency for use in sweep

Data type : Decimal Numeric Program Data  
 Allowed suffices : Any one of: GHZ, MHZ, KHZ or HZ  
 Default suffix : HZ

:TIME

Set time per sweep step

Data type : Decimal Numeric Program Data  
 Allowed suffices : MS or S  
 Default suffix : MS

:PHASE

Adjust Phase Offset of Carrier in degrees

Data type : Decimal Numeric Program Data  
 Allowed suffices : DEG  
 Default suffix : DEG

Examples: CFRQ:VALUE 2.51MHZ;INC 10KHZ  
 CFRQ:UP;XFER  
 CFRQ:START 1MHZ;STOP 10MHZ;TIME 100MS  
 CFRQ:MODE SWEPT

### CFRQ?

Prepares message containing information on Carrier Frequency setting in the following format:

:CFRQ:VALUE <nr2>;INC <nr2>;MODE<mode>

where: <mode> is character program data indicating whether carrier frequency operation is swept or fixed

Example: :CFRQ:VALUE 1000000000.0;INC 25000.0;MODE FIXED

# RF level

<b>RFLV</b>	Set RF Output Level (short form)
<b>:VALUE</b>	Set RF Output Level
	Data type : Decimal Numeric Program Data
	Allowed suffices : Any one of: DBM, DBV, DBMV, DBUV, V, MV or UV
	Default suffix : DBM unless changed by UNITS command
<b>:INC</b>	Set RF Level step (dB)
	Data type : Decimal Numeric Program Data
	Allowed suffices : DB only
	Default suffix : DB
<b>:UP</b>	Go UP one step
<b>:DN</b>	Go DOWN one step
<b>:RETN</b>	Return to original setting
<b>:XFER</b>	Transfer current value to be the new setting
<b>:ON</b>	Turn RF Output ON
<b>:OFF</b>	Turn RF Output OFF
	Data type : None
	Allowed suffices : None
	Default suffix : None
<b>:TYPE</b>	Selects EMF or PD for voltage related units
	Data type : Character Program Data (EMF or PD)
	Allowed suffices : None
	Default suffix : None
<b>:UNITS</b>	Select default RF level units.
	Data type : Character Program Data (DBM, DBV, DBMV, DBUV, V, MV or UV)
	Allowed suffices : None
	Default suffix : None
	Examples: RFLV:VALUE -27.3DBM;ON RPLV:TYPE PD;VALUE 1.23UV
<b>:LIMIT</b>	Set RF Level max limit (short form)
<b>:VALUE</b>	Set RF Level max limit
	Data type: Decimal Numeric Program Data
	Allowed suffices: Any one of: DBM, DBV, DBMV, DBUV, V, MV or UV
	Default suffix: DBM unless changed by UNITS command
<b>:ENABLE</b>	Enable limit
<b>:DISABLE</b>	Disable limit
<b>:OFFS</b>	Set RF Level offset for given frequency band (short form)
<b>:VALUE</b>	Set RF Level offset for given frequency band
	Data type: Decimal Numeric Program Data
	Allowed suffices: DB only
	Default suffix: DB
<b>:ENABLE</b>	Enable offsets
<b>:DISABLE</b>	Disable offsets
<b>:SAVE</b>	Save offsets in non-volatile memory

**REMOTE OPERATION**

**RFLV?**

Prepares message containing information on RF Level setting in the following format:

:RFLV:UNITS <unit>;TYPE <type>;VALUE <nr2>;INC <nr2>;<status>

where: <unit> is character program data defining the default RF level units (DBM, DBV, DBMV, DBUV, V, MV or UV), <type> is character program data indicating EMF or PD and <status> is a program mnemonic indicating whether the RF output is ON or OFF

Examples: :RFLV:UNITS DBM;TYPE PD;VALUE -103.5;INC 2.0;ON  
:RFLV:UNITS DBV;TYPE EMF;VALUE -83.2;INC 0.5;ON

**RFLV:LIMIT?**

Prepares message containing information on RF Level max limit setting in the following format:

:RFLV:LIMIT:VALUE <nr2>;<status>

Example: :RFLV:LIMIT:VALUE-20.0;ENABLE

**RFLV:OFFS?**

Prepares message containing information on RF Level offset in the following format:

:RFLV:OFFS:VALUE <nr2>;<status>

Example: :RFLV:OFFS:VALUE-3.2;ENABLE



# Output control

These commands allow you to download and store settings without the output changing.

**OUTPUT** [not used alone]

**:DISABLE** Allows user to download and store settings in the normal way without the output of the instrument changing until the OUTPUT:ENABLE command is received.

**:ENABLE** Enables the instrument outputs such that the outputs will adjust to the values specified by commands sent while the outputs were disabled.

**Note:** It is up to the user to ensure that the last command sent, prior to OUTPUT:ENABLE, is such that the RF output is set to a safe level.

Data type : None  
Allowed suffices : None  
Default suffix : None

**Examples:** OUTPUT:DISABLE  
CFRQ 300MHZ; RFLV 10DBM; MODE AM; AM 40PCT;  
AM:ON; MOD:ON; STO 200  
CFRQ 400MHZ; RFLV 7DBM; STO 201  
CFRQ 500MHZ; RFLV 5DBM; STO 202  
CFRQ 600MHZ; RFLV 4DBM; STO 203  
OUTPUT;ENABLE  
RCL 200  
RCL 201  
RCL 202  
RCL 203

**OUTPUT?** Prepares message containing information on output control setting in the following format:  
:OUTPUT: <status>

where: <status> is a program mnemonic indicating whether the output control is ENABLED or DISABLED

**Examples:** :OUTPUT:ENABLE  
:OUTPUT:DISABLE

REMOTE  
OPERATION

## Modulation mode

### MODE

Set modulation mode

Data type : Character Program Data (valid combinations of AM, FM, PM, FSK2L, FSK4L or PULSE. See table below.)  
Allowed suffices : None  
Default suffix : None

Examples: MODE AM, FM  
MODE FM, PULSE

#### VALID MODE COMBINATIONS TABLE

AM [,PULSE]  
FM [,PULSE]  
PM [,PULSE]  
AM,FM [,PULSE]  
AM,PM [,PULSE]  
FSK2L [,PULSE]  
FSK4L

#### Note...

Order is not important, for example AM,FM is equivalent to FM,AM. Pulse modulation can be used with any of the AM,FM,PM and FSK2L modes, but not with FSK4L

FSK2L and FSK4L parameters are controlled using the FM commands

### MODE?

Prepares message containing information on Modulation Mode in the following format:

:MODE <mode>

where: <mode> is character program data indicating the modulation mode settings

Example: :MODE AM, FM

## Modulation control

### MOD

[not used alone]

:ON

Turn modulation globally ON

:OFF

Turn modulation globally OFF

Examples: MOD:ON  
MOD:OFF

### MOD?

Prepares message containing information on Modulation Control in the following format:

:MOD:<status>

where: <status> is a program mnemonic indicating whether the Modulation is globally ON or OFF

Example: :MOD:ON

# Frequency modulation (and FSK)

## FM or FM1 or FM2

Set FM Deviation (short form)  
 Set FM Deviation  
 Set FM step size  
 Data type : Decimal Numeric Program Data  
 Allowed suffices : Any one of: GHZ, MHZ, KHZ or HZ  
 Default suffix : HZ  
 Select modulation source where <src> is any one of: INT, EXTAC, EXTALC, or EXTDC  
 Turn FM ON (locally)  
 Turn FM OFF (locally)  
 Go UP one step  
 Go DOWN one step  
 Return to original setting  
 Transfer current value to be the new setting  
 Data type : None  
 Allowed suffices : None  
 Default suffix : None

Examples: FM:DEVN 25KHZ;INT;ON  
 FM1:DEVN 15KHZ;INC 1KHZ;EXTDC

Set FM modulation oscillator frequency (short form)

Set FM modulation oscillator frequency  
 Set FM modulation oscillator frequency step size

Data type : Decimal Numeric Program Data  
 Allowed suffices : Any one of: GHZ, MHZ, KHZ or HZ  
 Default suffix : HZ

Go UP one step  
 Go DOWN one step  
 Return to original setting  
 Transfer current value to be the new setting  
 Select sinusoidal waveform  
 Select triangle waveform  
 Select square waveform

Data type : None  
 Allowed suffices : None  
 Default suffix : None

Set phase offset of FM2 relative to FM1

Data type : Decimal Numeric Program Data  
 Allowed suffices : DEG  
 Default suffix : DEG

Examples: FM2:MODF:VALUE 1.5KHZ;SIN  
 FM:MODF:PHASE 1.2DEG



**DCFMNL**

Perform DC FM null operation

Data type : None  
Allowed suffices : None  
Default suffix : None

Example: DCFMNL

**FM? or FM1? or FM2?**

Prepares message containing information on FM setting in one of the following formats:

:FM:DEVN <nr2>;<src>;<status>;INC <nr2>

:FM1:DEVN <nr2>;<src>;<status>;INC <nr2>

:FM2:DEVN <nr2>;<src>;<status>;INC <nr2>

where: <src> is a program mnemonic representing the source of the modulation signal and <status> is a program mnemonic indicating whether the frequency modulation is locally ON or OFF

Example: :FM1:DEVN 25000.0;INT;ON;INC 1000.0

**FM:MODF? or FM1:MODF?  
or FM2:MODF?**

Prepares message containing information on FM modulation oscillator setting in one of the following formats:

:FM:MODF:VALUE <nr2>;<shape>;INC <nr2>

:FM1:MODF:VALUE <nr2>;<shape>;INC <nr2>

:FM2:MODF:VALUE <nr2>;<shape>;INC <nr2>

where: <shape> is a program mnemonic representing the waveform shape

Example: :FM1:MODF:VALUE 5750.00;SIN;INC 1000.00

# Phase modulation

## PM or PM1 or PM2

:DEVN

:INC

Set Phase Modulation Deviation (short form)

Set Phase Modulation Deviation

Set Phase Modulation step size

Data type : Decimal Numeric Program Data  
Allowed suffices : RAD  
Default suffix : RAD

:<src>

Select modulation source where <src> is any one of: INT, EXTAC, EXTALC, or EXTDC

:ON

Turn PM ON (locally)

:OFF

Turn PM OFF (locally)

:UP

Go UP one step

:DN

Go DOWN one step

:RETN

Return to original setting

:XFER

Transfer current value to be the new setting

Data type : None  
Allowed suffices : None  
Default suffix : None

Examples: PM:DEVN 2.38RAD;INT;ON  
PM1:DEVN 1.5RAD;INC 0.1RAD;EXTAC

:MODF

:VALUE

:INC

Set PM modulation oscillator frequency (short form)

Set PM modulation oscillator frequency

Set PM modulation oscillator frequency step size

Data type : Decimal Numeric Program Data  
Allowed suffices : Any one of: GHZ, MHZ, KHZ or HZ  
Default suffix : HZ

:UP

Go UP one step

:DN

Go DOWN one step

:RETN

Return to original setting

:XFER

Transfer current value to be the new setting

:SIN

Select sinusoidal waveform

:TRI

Select triangle waveform

:SQR

Select square waveform

Data type : None  
Allowed suffices : None  
Default suffix : None

:PHASE

Set phase offset of PM2 relative to PM1

Examples: PM1:MODF:VALUE 10.5KHZ;SQR  
PM2:MODF:PHASE 2.0DEG

## PM? or PM1? or PM2?

Prepares message containing information on Phase Modulation setting in one of the following formats:

:PM:DEVN <nr2>;<src>;<status>;INC <nr2>

:PM1:DEVN <nr2>;<src>;<status>;INC <nr2>

:PM2:DEVN <nr2>;<src>;<status>;INC <nr2>

where <src> is a program mnemonic representing the source of the modulation signal and <status> is a program mnemonic indicating whether the phase modulation is locally ON or OFF

Example: :PM2:DEVN 2.30;INT;OFF;INC 0.05

REMOTE  
OPERATION

**PM:MODF? or PM1:MODF?  
or PM2:MODF?**

Prepares message containing information on PM modulation oscillator setting in one of the following formats:

:PM:MODF:VALUE <nr2>;<shape>;INC <nr2>

:PM1:MODF:VALUE <nr2>;<shape>;INC <nr2>

:PM2:MODF:VALUE <nr2>;<shape>;INC <nr2>

where: <shape> is a program mnemonic representing the waveform shape

Example: :PM2:MODF:VALUE 2500.00;TRI;INC 500.00

# Amplitude modulation

## AM or AM1 or AM2

:DEPTH Set AM Depth (short form)  
Set AM Depth  
:INC Set AM step size  
Data type : Decimal Numeric Program Data  
Allowed suffices : PCT  
Default suffix : PCT  
<src> Select modulation source where <src> is any one of: INT, EXTAC, EXTALC, or EXTDC  
:ON Turn AM ON (locally)  
:OFF Turn AM OFF (locally)  
:UP Go UP one step  
:DN Go DOWN one step  
:RETN Return to original setting  
:XFER Transfer current value to be the new setting

Data type : None  
Allowed suffices : None  
Default suffix : None

Examples: AM:DEPTH 30.5PCT;EXTAC;ON  
AM1:DEPTH 40PCT;INT;OFF  
Set AM modulation oscillator frequency (short form)  
Set AM modulation oscillator frequency  
Set AM modulation oscillator frequency step size

## :MODF

:VALUE  
:INC

Data type : Decimal Numeric Program Data  
Allowed suffices : Any one of: GHZ, MHZ, KHZ or HZ  
Default suffix : HZ

:UP Go UP one step  
:DN Go DOWN one step  
:RETN Return to original setting  
:XFER Transfer current value to be the new setting  
:SIN Select sinusoidal waveform  
:TRI Select triangle waveform  
:SQR Select square waveform

Data type : None  
Allowed suffices : None  
Default suffix : None

## :PHASE

Set phase offset of AM2 relative to AM1

Examples: AM2:MODF:VALUE 15.5KHZ;TRI;INC 500HZ  
AM:MODF:PHASE 5DEG

REMOTE  
OPERATION

### AM? or AM1? or AM2?

Prepares message containing information on Amplitude Modulation setting in one of the following formats:

```
:AM:DEPTH <nr2>;<src>;<status>;INC <nr2>  
:AM1:DEPTH <nr2>;<src>;<status>;INC <nr2>  
:AM2:DEPTH <nr2>;<src>;<status>;INC <nr2>
```

where <src> is a program mnemonic representing the source of the modulation signal and <status> is a program mnemonic indicating whether the amplitude modulation is locally ON or OFF

Example: :AM:DEPTH 56.6;INT;ON;INC 5.0

### AM:MODF? or AM1:MODF? or AM2:MODF?

Prepares message containing information on AM modulation oscillator setting in one of the following formats:

```
:AM:MODF:VALUE <nr2>;<shape>;INC <nr2>  
:AM1:MODF:VALUE <nr2>;<shape>;INC <nr2>  
:AM2:MODF:VALUE <nr2>;<shape>;INC <nr2>
```

where: <shape> is a program mnemonic representing the waveform shape

Example: :AM:MODF:VALUE 5000.00;TRI;INC 1000.00



# Pulse modulation

## PULSE

[not used alone]

:ON

Turn Pulse modulation ON

:OFF

Turn Pulse modulation OFF

Data type : None  
Allowed suffixes : None  
Default suffix : None

Examples: PULSE:ON  
PULSE:OFF

## PULSE?

Prepares message containing information on Pulse Modulation setting in the following format:

:PULSE:<status>

where: <status> is a program mnemonic indicating whether the pulse modulation is ON or OFF

Examples: :PULSE:ON  
:PULSE:OFF

REMOTE  
OPERATION

## Memory – store

**STO** Store 0–299 (short form)  
:MEM Store 0–299  
:CFRQ Carrier Freq Store 0–99  
:FULL Full Store 100–199  
:RAM RAM Store 200–299

Data type : Decimal Numeric Program Data  
Allowed suffices : None  
Default suffix : None

Examples: STO:FULL 112  
STO:CFRQ 83

## Memory – recall

**RCL** Recall Store 0–299 (short form)  
:MEM Recall Store 0–299  
:CFRQ Recall Carrier Freq Store 0–99  
:FULL Recall Full Store 100–199  
:RAM Recall RAM Store 200–299

Data type : Decimal Numeric Program Data  
Allowed suffices : None  
Default suffix : None

:UP Step up through stores. Use this command for memory sequencing  
:DN Step down through stores. Use this command for memory sequencing

Data type : None  
Allowed suffices : None  
Default suffix : None

**RCL?** Prepares message containing information on last memory store that was recalled in the following format:  
:RCL:MEM <nri>

Examples: :RCL:MEM 126

## Memory – erase

**ERASE** [not used alone]  
:CFRQ Erase all Carrier Freq Stores (0–99)  
:FULL Erase all Full Stores (100–199)  
:RAM Erase all RAM Stores (200–299)  
:ALL Erase all Stores (0–299)

Data type : None  
Allowed suffices : None  
Default suffix : None

Examples: ERASE:FULL  
ERASE:ALL

# Memory – sequencing

## MSEQ

:MODE

[not used alone]

Select sequencing mode of operation. When a sequence is selected, the user can step through the sequence using the RCL:UP and RCL:DN commands. The sequence modes are SEQ1 to SEQ9, and the sequencing can be disabled with the OFF parameter.

Data type : Character Program Data  
Allowed suffices : None  
Default suffix : None

Examples: MSEQ:MODE OFF  
MSEQ:MODE SEQ2

:SEQ1...:SEQ9  
:START  
:STOP

Set the memory store for the start of the sequencing loop  
Set the memory store for the end of the sequencing loop

Data type : Decimal Numeric Program Data  
Allowed suffices : None  
Default suffix : None

Example: MSEQ:SEQ2:START 50;STOP 70

## MSEQ?

Prepares message containing information on the current memory sequencing mode in the following format:

:MSEQ:MODE <mode>

where: <mseq> is character program data indicating the sequence mode selection

Examples: :MSEQ:MODE SEQ4  
:MSEQ:MODE OFF

MSEQ:SEQ1?

.....

MSEQ:SEQ9?

Prepares message containing information on the start and stop settings of the given memory sequence in the following format:

:MSEQ:SEQn:START <nr1>;STOP <nr1>

where *n* is between 1 and 9 inclusive

Example: :MSEQ:SEQ4:START 120;STOP 155

REMOTE  
OPERATION

## Memory – triggering

### MTRIG

:ON

Enables memory recall triggering to be activated by \*TRG command or by external triggering. The triggering order of priority is as follows:

FSK logic input

Memory recall

Sweep trigger

Therefore ensure that FSK is not enabled, otherwise selecting memory recall triggering will have no effect.

:OFF

Disable memory recall triggering

Data type : None  
Allowed suffices : None  
Default suffix : None

Examples: MTRIG:ON  
MTRIG:OFF

### MTRIG?

Prepares message containing information on memory triggering state in the following format:

:MTRIG:<status>

where: <status> is a program mnemonic indicating whether the memory recall triggering is enabled (:ON) or disabled (:OFF)

Example: :MTRIG:ON

## Memory – protection

### MPROT

:START

[not used alone]

Set the start of the memory block which is to be protected/unprotected

:STOP

Set the end of the memory block which is to be protected/unprotected

Data type : Decimal Numeric Program Data  
Allowed suffices : None  
Default suffix : None

:ON

Set memory protection ON for the selected memory block

:OFF

Set memory protection OFF (i.e. unprotected) for the selected memory block

Data type : None  
Allowed suffices : None  
Default suffix : None

Examples: MPROT:START 100;STOP 150  
MPROT:ON

## Sweep operation

To make these commands operational they must first be enabled by the CFRQ:MODE SWEPT command.

**SWEEP** [not used alone]

:CFRQ Optional command (may be omitted)

:START Set Start Frequency

:STOP Set Stop Frequency

:INC Set Carrier Frequency sweep step size

Data type : Decimal Numeric Program Data  
Allowed suffices : Any one of: GHZ, MHZ, KHZ or HZ  
Default suffix : HZ

:LOGINC PCT

:TIME Select time per sweep step

Data type : Decimal Numeric Program Data  
Allowed suffices : MS, S  
Default suffix : MS

Example: SWEEP:CFRQ:START 100KHZ;STOP 500KHZ;INC 100HZ;TIME 60MS

### SWEEP:CFRQ?

Prepares message containing information on Carrier Frequency Sweep settings in the following format:

:SWEEP:CFRQ:START <nr2>;STOP <nr2>;INC <nr2>;  
LOGINC<nr2>;TIME <nr2>

Example: :SWEEP:CFRQ:START 1230000.0;STOP 1330000.0;INC 100.0;LOGINC 50.00;TIME 20.0

## Sweep mode

To make these commands operational they must first be enabled by the CFRQ:MODE SWEPT command. Note that for triggering the order of priority is as follows:

FSK logic input  
Memory recall  
Sweep trigger

Therefore ensure that FSK and memory recall are not enabled, otherwise selecting sweep triggering will have no effect.

**SWEEP** [not used alone]

:MODE Select Mode of operation for Sweep generator (single or continuous)

Data type : Character Program Data (either SNGL or CONT)  
Allowed suffices : None  
Default suffix : None

Example: SWEEP:MODE SNGL

:TYPE Select type of sweep (linear or logarithmic)

Data type : Character Program Data (LIN or LOG)  
Allowed suffices : None  
Default suffix : None

Example: SWEEP:TYPE LOG

REMOTE  
OPERATION

:TRIG

Data type : Character Program Data (any one of OFF, START, STARTSTOP, STEP)  
Allowed suffices : None  
Default suffix : None

Example: SWEEP:TRIG STARTSTOP

**SWEEP?**

Prepares message containing information on Sweep Mode Type and Trigger in the following format:

:SWEEP:MODE <mode>;TYPE<type>;TRIG <trig>

where: <mode> is character program data indicating the sweep mode selected, <type> is character program data indicating type selected, and <trig> is character program data indicating the trigger type selected

Example: :SWEEP:MODE CONT;TYPE LOG;TRIG STEP

**Sweep control**

**SWEEP**

- :GO [not used alone] Commence Sweep
- :HALT Pause Sweep
- :CONT Continue Sweep
- :RESET Reset sweep to Start Value
- :RETN Return to original setting
- :XFER Transfer current value as the new setting
- :UP Go UP one sweep step while paused
- :DN Go DOWN one sweep step while paused

Data type : None  
Allowed suffices : None  
Default suffix : None

Examples: SWEEP:GO  
SWEEP:RESET

# SINAD mode

## SINAD

[not used alone]

:AVERAGE Set number of averages (1 to 127)

Data type : Decimal Numeric Program Data

Allowed suffices : None

Default suffix : None

Example: :SINAD:AVERAGE 10

:UNWTD Set no weighting filter

:CCITT Set CCITT weighting filter

:CMESS Set C-MESS weighting filter

:ENABLE Enable SINAD mode

:DISABLE Disable SINAD mode

:AUTO

:VALUE <nrf> Select and set auto SINAD target value

:SEEK Select and start auto SINAD

:PAUSE Select and stop auto SINAD

Examples: :SINAD:AVERAGE 10 Sets 10 averages  
:SINAD:CMESS Sets C-MESS weighting filter  
:SINAD:ENABLE Start SINAD measurements  
:SINAD:AUTO:VALUE 20.0 Select and set 20 dB auto SINAD

## SINAD?

Prepares message containing information on SINAD mode in the following format:

:SINAD:AVERAGE <nrl>;<filter type>;<mode>

Example response: :SINAD:AVERAGE 10;CMESS;AUTO

## SINAD:VALUE?

Returns measured SINAD in dBs

Example: :SINAD:VALUE?  
22.57

## SINAD:AUTO:VALUE?

Returns target SINAD set in dBs

Example: :SINAD:AUTO:VALUE?  
20.0

REMOTE  
OPERATION

## Miscellaneous commands

### ERROR?

Prepares message relating to the next error in the error queue in the following format:

<nrl>, <string>

Where <string> is a descriptive error message. The numeric value returned is that of the next error number, or 0 if the queue is empty, or 399 if the queue is full

Example: 100, "Carrier Limit"

### GPIB

Set the GPIB Address (between 0 and 30 inclusive)

Data type : Decimal Numeric Program Data  
Allowed suffixes : None  
Default suffix : None

Example: GPIB 7

### RPP

:RESET

Reset reverse power protection trip (short form)

Reset RPP trip

Data type : None  
Allowed suffixes : None  
Default suffix : None

Example: RPP:RESET

### RPP:TRIPPED?

Prepares message containing information on whether the RPP Circuitry is currently tripped in the following format:

<nrl>

(0 = not tripped, 1 = tripped)

Example: 1

### RPP:COUNT?

Prepares message containing information on the number of times the RPP circuitry has tripped in the following format:

<nrl>

Example: 3

### FSTD

Select internal or external frequency standard

Data type : Character program data (any one of INT, EXT10DIR, EXT1IND, EXT10IND or INT10OUT)  
Allowed suffixes : None  
Default suffix : None

Examples: FSTD INT  
FSTD EXT10IND

### FSTD?

Prepares message containing information on frequency standard selection in the format:

:FSTD <char>

Example: :FSTD EXT10IND



## BLANK

Blank or unblank display parameters: Carrier Frequency, RF Level, Modulation Depth and Deviations, and Modulation Frequency

Data type : None  
Allowed suffices : None  
Default suffix : None

Examples: BLANK:ON  
BLANK:OFF

## BLANK?

Prepares message containing information on the display blanking setting in the following format:

:BLANK:<state>

where: <state> is program mnemonic indicating whether the blanking is ON or OFF

Examples: BLANK:OFF

## CONTRAST

Sets the LCD contrast, over a scale of 0 to 255

Data type : Decimal Numeric Program Data  
Allowed suffices : none  
Default suffix : none

Examples: CONTRAST 120

## CONTRAST?

Prepares message containing information on LCD contrast setting in the following format:

:CONTRAST <nr1>

Example: :CONTRAST 78

## ELAPSED

:RESET

Reset elapsed operating hours to zero

Data type : None  
Allowed suffices : None  
Default suffix : None

Example: ELAPSED:RESET

## ELAPSED?

Prepares message containing information on elapsed operating hours since last reset. Fractional part is in 15 minute intervals (0.25, 0.50, 0.75). Format is as follows:

<nr2>

Example: 454.50

## OPER?

Prepares message containing information on total operating hours. Fractional part is in 15 minute intervals (0.25, 0.50, 0.75). Format is as follows:

<nr2>

Example: 1453.00

REMOTE  
OPERATION

**KLOCK**

Disables keyboard entry except RPP Reset and Go to Local

Data type : None  
 Allowed suffices : None  
 Default suffix : None

**KUNLOCK**

Enables keyboard entry

Data type : None  
 Allowed suffices : None  
 Default suffix : None

**POWUP**

[not used alone]

:MODE

Select the power up mode. The instrument can power up in either the factory preset mode or from a selected memory

Data type : Character program data (FACTORY or MEMORY)  
 Allowed suffices : None  
 Default suffix : None

:MEM

Set the memory location for a memory power up

Data type : Decimal Numeric Program Data  
 Allowed suffices : None  
 Default suffix : None

Examples: POWUP:MODE MEMORY  
 POWUP:MEM 172

**POWUP?**

Prepares message containing information on the instrument power up selection in the following format:

Example: :POWUP:MODE MEMORY;MEM 135

**ATTEN**

[not used alone]

:LOCK

Lock the attenuators

:UNLOCK

Unlock the attenuators

Data type : None  
 Allowed suffices : None  
 Default suffix : None

Example: ATTEN:LOCK

**ATTEN?**

Prepares message containing information on whether the attenuators are locked or unlocked in the following format:

:ATTEN:<status>

where <status> is a program mnemonic indicating whether the attenuators are locked or unlocked

Example: :ATTEN:LOCK

**IMPEDANCE**

Set 50  $\Omega$  or 75  $\Omega$  adapter mode

Data type : Character program data (Z50R or Z75R)  
 Allowed suffices : None  
 Default suffix : None

Example: IMPEDANCE Z75R

## IMPEDANCE?

Prepares message containing information on which adapter mode is selected  
in the following format:

:IMPEDANCE <char>

Example: :IMPEDANCE 275R

REMOTE  
OPERATION

## Status byte

The Status Byte provides information about events and conditions within the instrument. It may be read by a conventional Serial Poll or its value obtained as a response to the \*STB? query. Bits 0 to 5 and bit 7 are each single bit Summary Messages which may be of two types (or not used at all).

- (i) Queue Status – a '1' indicates that an associated Queue is non-empty and has data available to be read.
- (ii) Status Register Summary – reports the occurrence of an enabled event monitored by a Status Register Structure.

The Service Request Enable Register determines which of the bits can generate an SRQ. This register may be set by \*SRE or read by \*SRE?. If the bitwise -AND of the Status Byte and the Enable Register is non-zero the Flag Master Summary Status (<mss>) is True. Bit 6 of the Status Byte value read by \*STB? holds <mss>. However bit 6 of the Status Byte when Serial Polled is the Request For Service bit used to determine which device on the Bus has asserted SRQ, and is cleared by a Serial Poll.

The IEEE 488.2 Standard defines bit 4 as Message Available (<mav>), the Queue Summary for the Output Buffer, indicating whether any part of a Response Messages is available to be read. Bit 5 is the Event Summary Bit (<esb>), the Summary Message from the Standard Event Status Register.

With this instrument, bit 7 is a Queue Summary for the Error Queue. Bits 1, 2, and 3 are Status summaries for the Instrument Status, Coupling Status and Hardware Status Registers. Bit 0 is unused.

# Status data structure – register model

Below is a generalized model of the Register Set which funnels the monitored data into a single summary bit to set the appropriate bit in the Status Byte.

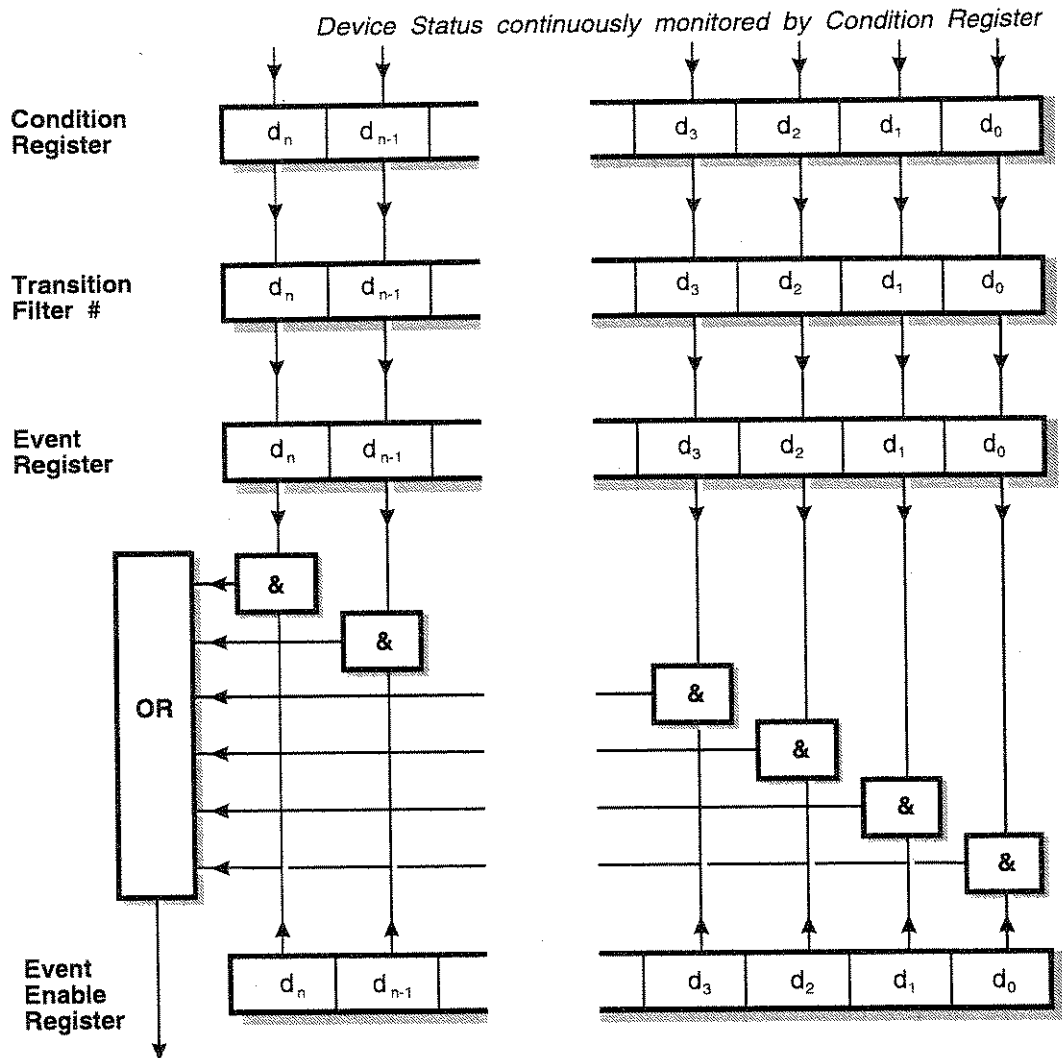

**REMOTE OPERATION**

### Summary Message

C0072

**Notes**

The Device Status is continuously monitored by the Condition Register. If a Query to read a Condition Register is provided, the Response represents the Status of the instrument at the moment the Response is generated. A Condition Register cannot be written to.

The Transition Filter determines which transition of the Condition Register data bits will set the corresponding bit in the Event Register. Either positive-going, negative-going or both transitions can set bits in an Event Register. But with this instrument the Transition Filters are pre-set as either Positive or Negative, as described in the following pages.

The bits in an Event Register are "latched". Once set they remain set, regardless of subsequent changes in the associated condition bit until the Event Register is cleared by being read or by the \*CLS common command. Once cleared, an Event Register bit will only be set again if the appropriate change in the Condition bit occurs.

The Event Enable Register may be both written to and read from. It is bitwise AND-ed with the Event Register and if the result is non-zero the Summary Message is true, otherwise the Summary Message is false. Enable Registers are not affected by \*CLS but are however clear at power-on.

# Standard event registers

This register is defined by IEEE 488.2 and each bit has the meaning shown below:

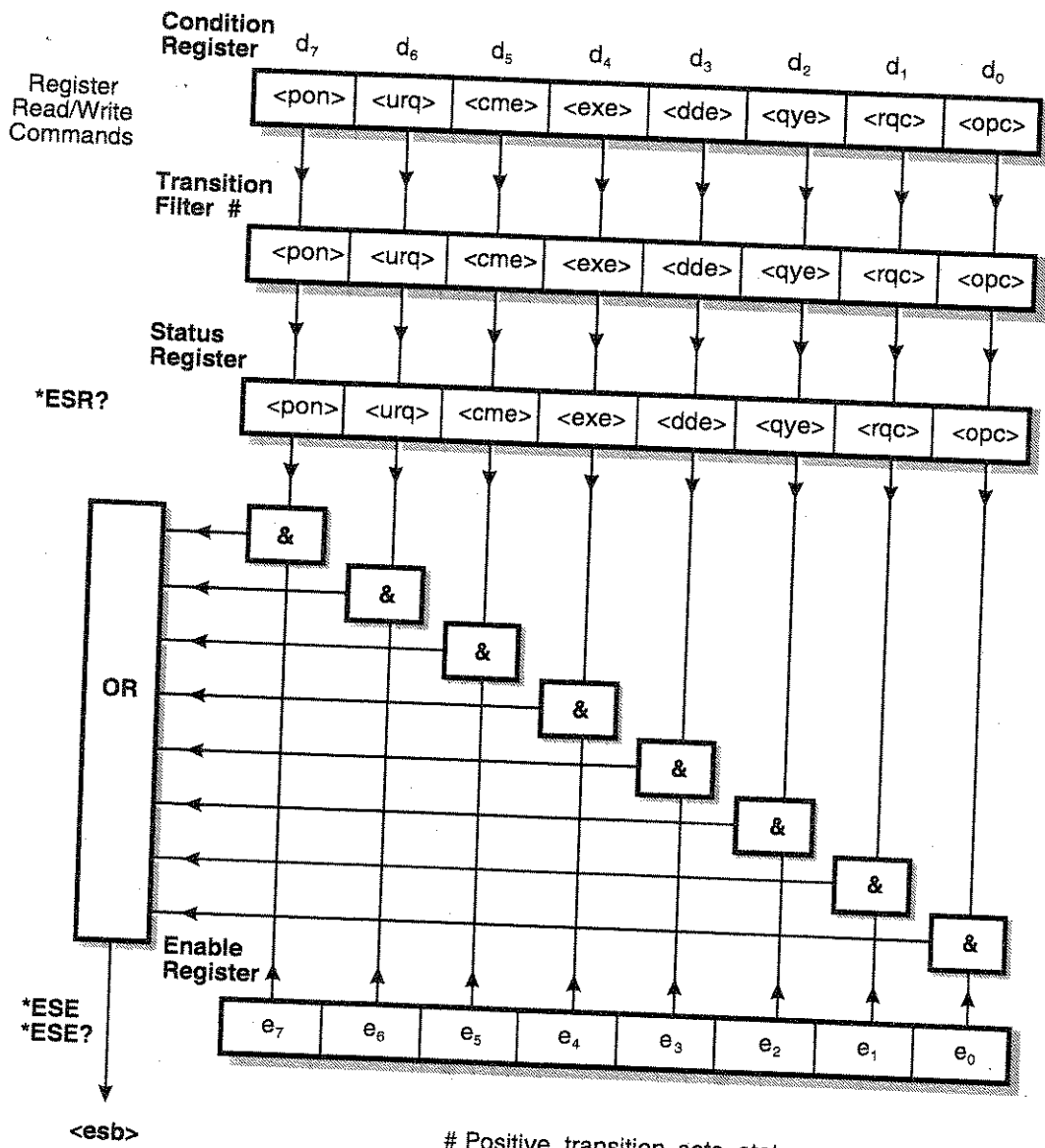

C0069

- <pon> power on
- <urq> user request – not implemented in this product
- <cme> command error
- <exe> execution error
- <dde> device-dependent error
- <qye> query error
- <rqc> request control – not implemented in this product
- <opc> operation complete – set in response to the \*OPC command for synchronization.
- <esb> standard event register summary bit

# Hardware event registers

This is a device-dependent register and the bits have meanings as shown in the list at the bottom of the page.

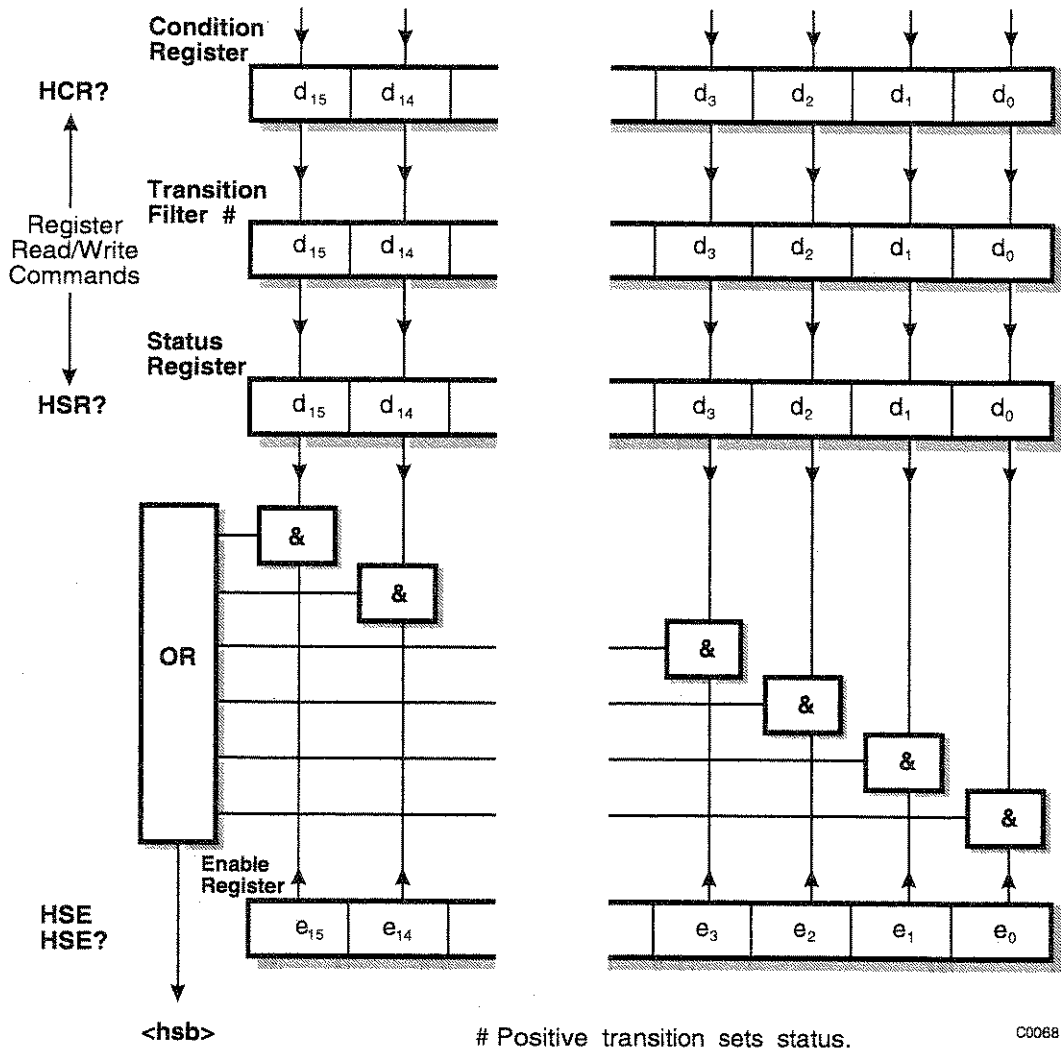

**REMOTE OPERATION**

- |    |                                      |     |                             |
|----|--------------------------------------|-----|-----------------------------|
| d0 | reverse power protection tripped     | d8  | filter unleveled            |
| d1 | fractional-n loop low                | d9  | output unleveled            |
| d2 | fractional-n loop high               | d10 | high power amplifier failed |
| d3 | external standard missing            | d11 | ALC too high                |
| d4 | external standard frequency too low  | d12 | ALC too low                 |
| d5 | external standard frequency too high | d13 | DSP not responding          |
| d6 | VCXO loop low                        | d14 | RF level uncalibrated       |
| d7 | VCXO loop high                       | d15 | not used                    |

<hsb> hardware event register summary bit

# Coupling event registers

This is a device-dependent register and the bits have meanings as shown in the list at the bottom of the page.

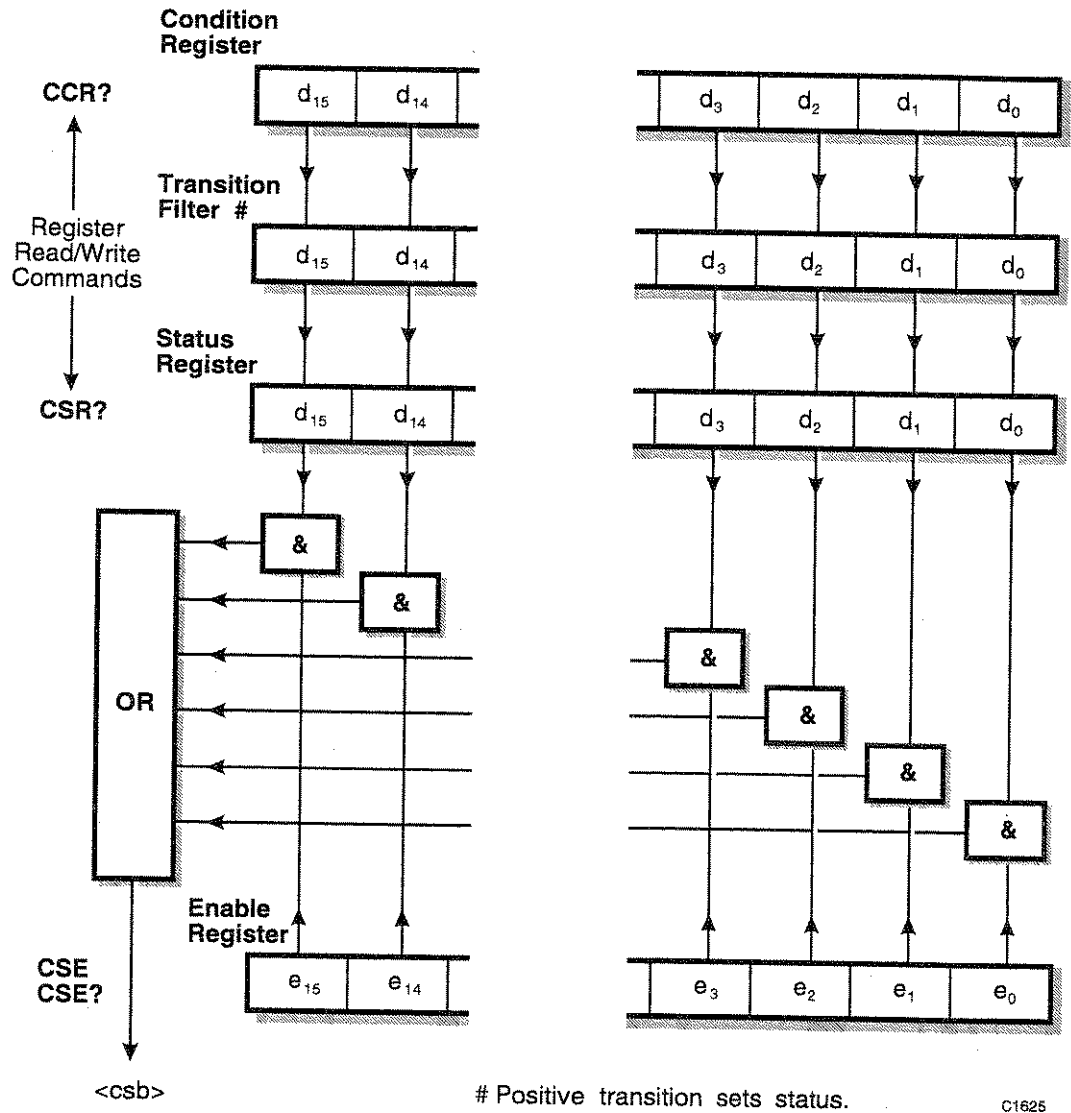

- $d_0$  RF level restricted by requested AM depth
- $d_1$  not used
- $d_2$  not used
- $d_3$  AM2 depth restricted by requested AM1 depth
- $d_4$  FM2 deviation restricted by requested FM1 deviation
- $d_5$   $\Phi$ M2 deviation restricted by requested  $\Phi$ M1 deviation
- $d_6$  not used
- $d_7-d_{15}$  not used

<csb> coupling event register summary bit



# Instrument event registers

This is a device-dependent register and the bits have meanings as shown in the list at the bottom of the page.

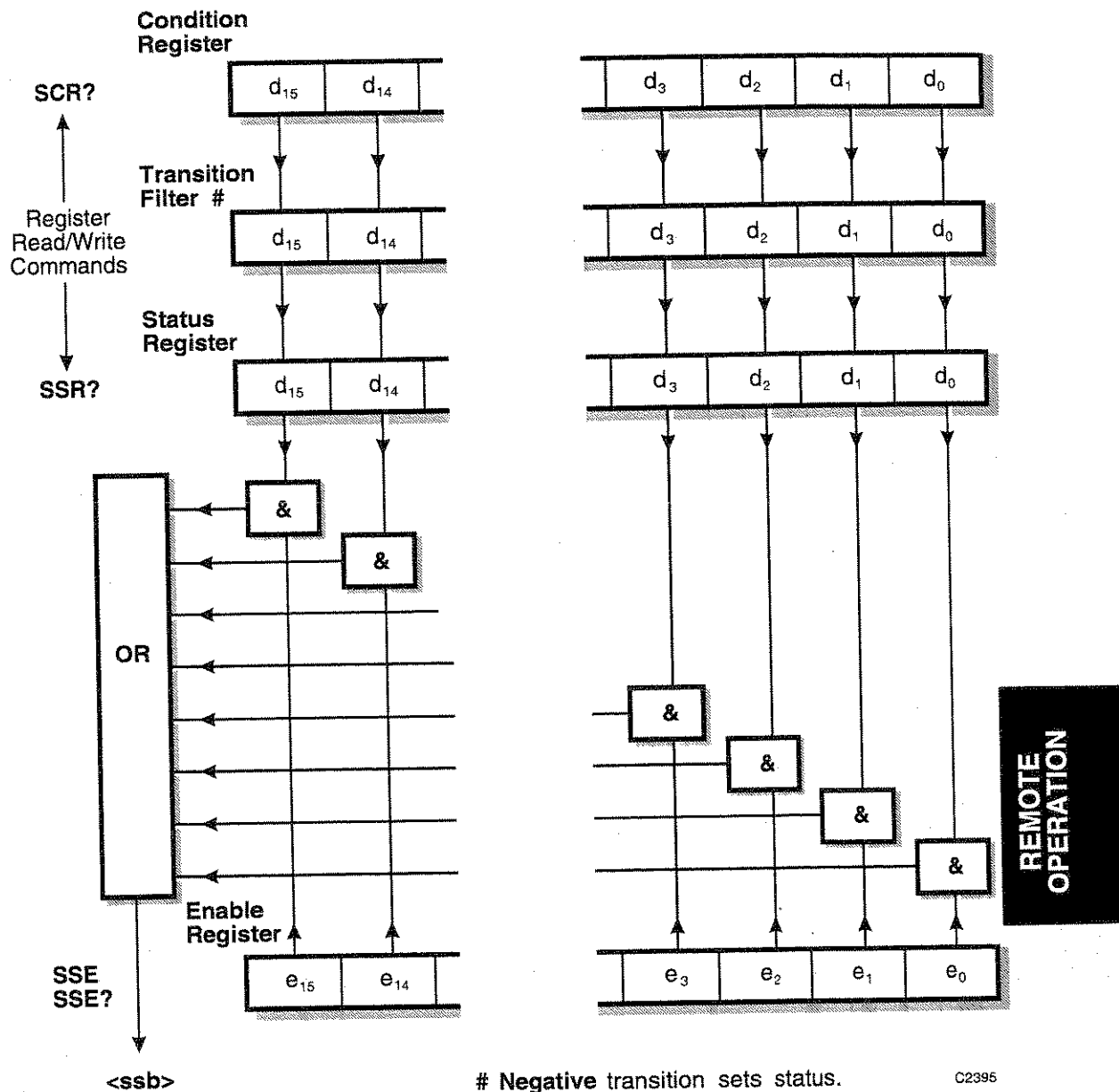

# Negative transition sets status.

C2395

	<u>Condition (SCR?)</u>	<u>Event Status (SSR?)</u>
d0	sweep in progress	end of sweep
d1	not used	not used
d2	selfcal in progress	selfcal completed
d3	DC FM null in progress	DC FM null completed
d4	AUTO SINAD in progress	AUTO SINAD completed
d5	this bit is always zero	new SINAD reading ready
d6-d15	not used	
<ssb>	instrument event register summary bit	

## Queue flag details

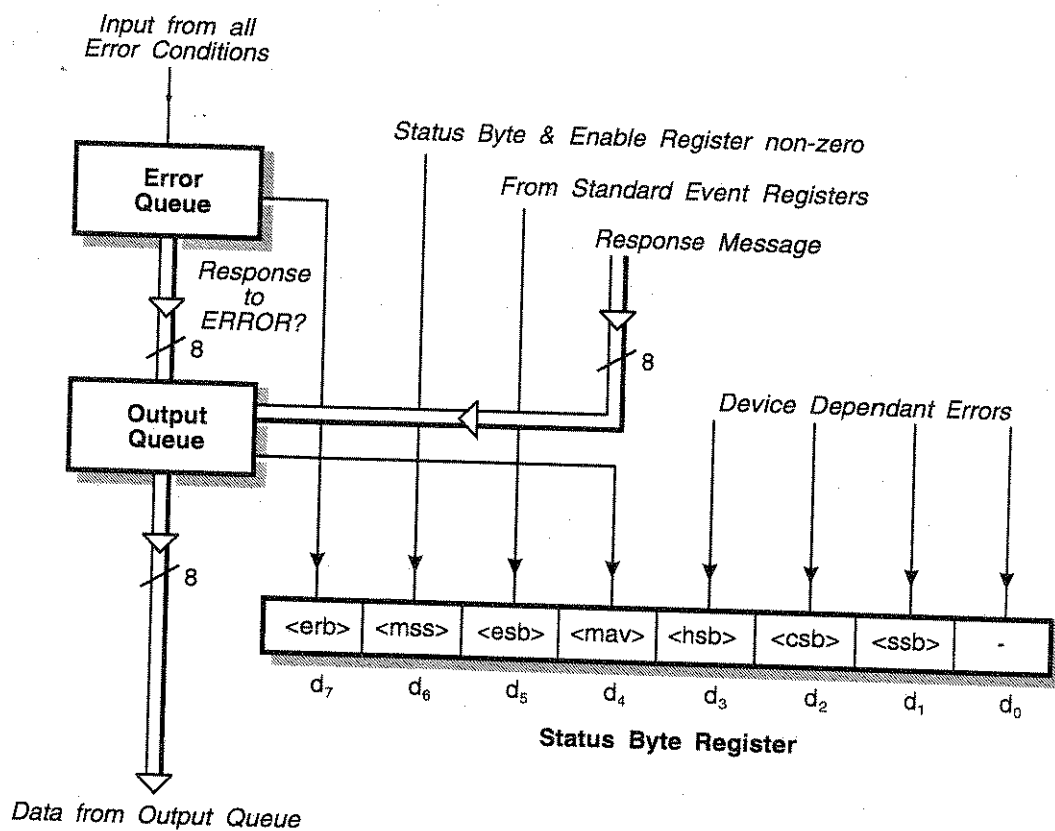

C0075

The <mav> status bit is set when one or more bytes are available to be read from the Output Queue.

The <erb> status bit is set when one or more errors are present in the Error Queue. The ERROR? query will place a nr1 and string response message in the Output Queue representing the error at the head of the queue. If the queue is empty this message will be 0, "No error".

# Status byte when read by \*STB?

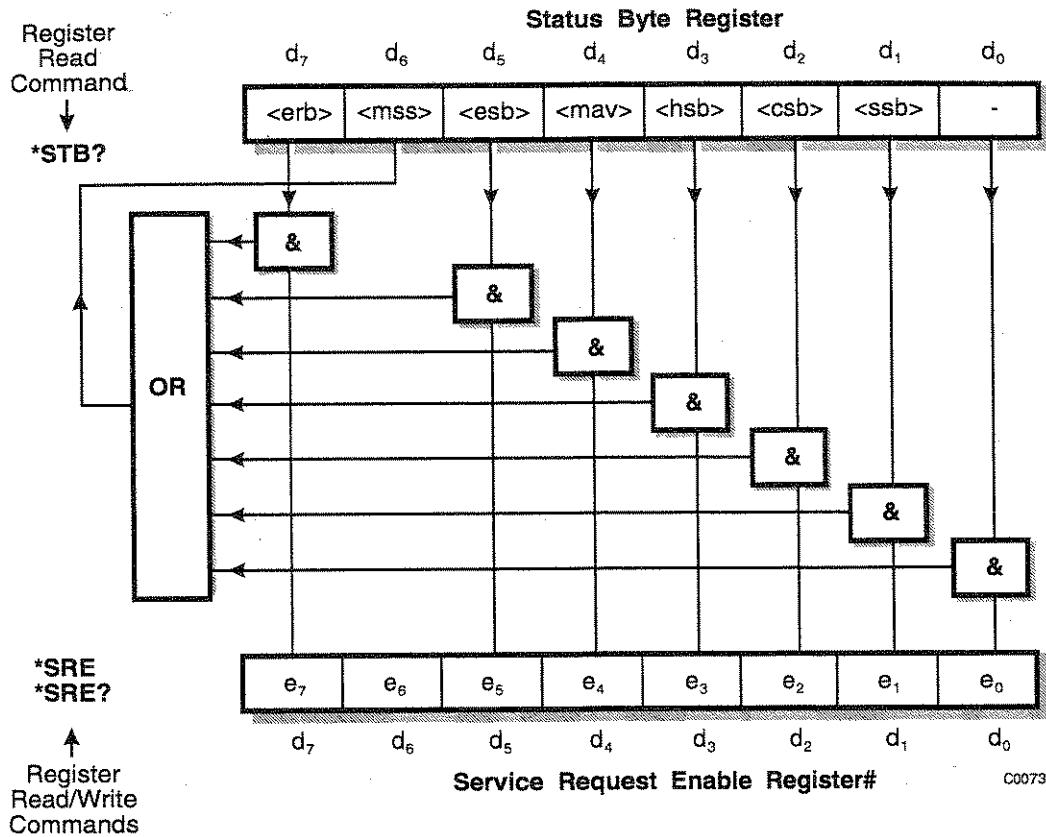

# Bit 6 in this register ignores data sent by \*SRE and always returns 0 in response to \*SRE?

<rq>, <esb> and <mav> are defined in IEEE 488.2

- <erb> is a device defined queue summary bit indicating that the error queue is non-empty.
- <mss> is true when (Status Byte) AND (Enable register) > 0.
- <esb> is the standard event register summary bit.
- <mav> is 'message available' indicating that the output queue is non-empty.
- <hsb> is 'hardware status' summary bit
- <csb> is 'coupling status' summary bit
- <ssb> is 'instrument status' summary bit

## Note

The Status Byte Register is Not cleared by the \*STB? query.

REMOTE  
OPERATION

## Status byte when read by serial poll

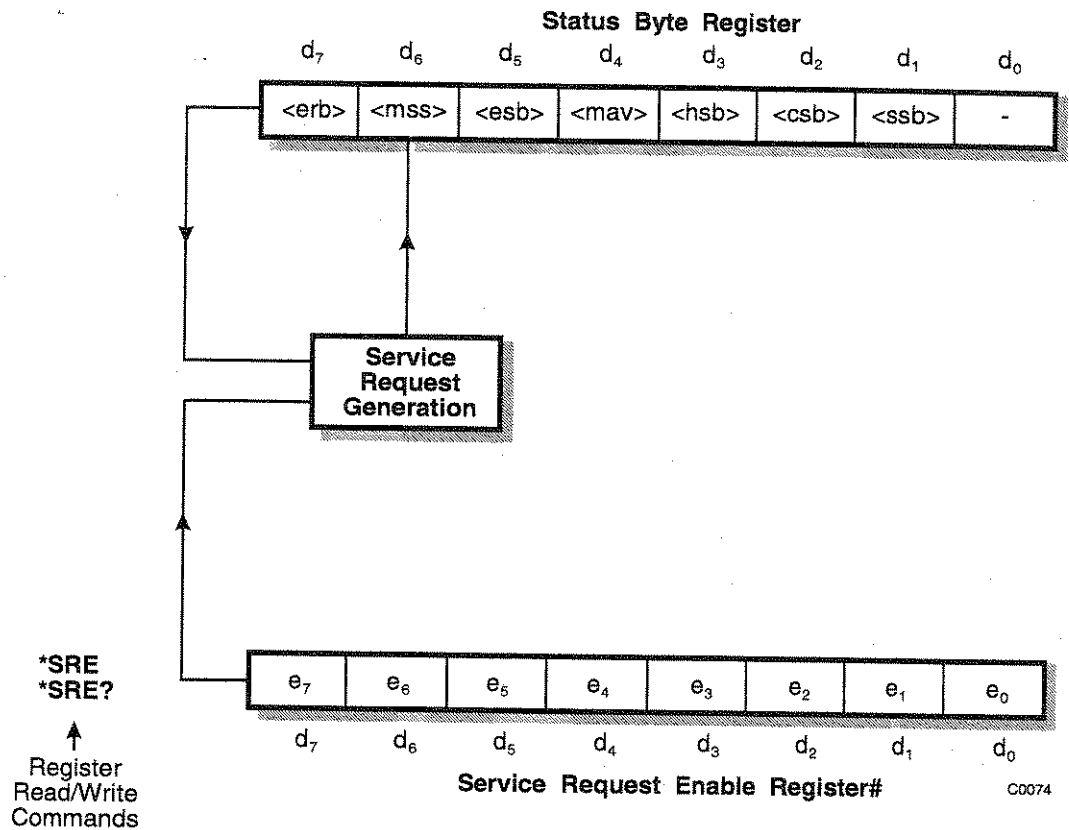

# Bit 6 in this register ignores data sent by \*SRE and always returns 0 in response to \*SRE?

- <erb> is a device defined queue summary bit indicating that the error queue is non-empty.
- <rq> is set by a request for service and is cleared by the poll.
- <esb> is the standard event register summary bit.
- <mav> is 'message available' indicating that the output queue is non-empty.
- <hsb> is 'hardware status' summary bit
- <csb> is 'coupling status' summary bit
- <ssb> is 'instrument status' summary bit

<rq>, <esb> and <mav> are defined in IEEE 488.2

<rq> (request for service) will produce an SRQ at the controller. It is set by a change to either the Status Byte or the Service Enable Register that results in a New Reason for Service. It is cleared when <mss> goes FALSE (i.e. no reason for service) or by Serial Poll.

## Summary of status reporting commands and queries

<b>*CLS</b>	Clears Status Registers and the Error Queue
<b>*ESE&lt;nrf&gt;</b>	Writes to Standard Event Enable Register
<b>*ESE?</b>	Reads from Standard Event Enable Register
<b>*ESR?</b>	Reads from Standard Event Status Register
<b>*SRE&lt;nrf&gt;</b>	Writes to Service Request Enable Register
<b>*SRE?</b>	Reads from Service Request Enable Register
<b>*STB?</b>	Reads from Status Byte Register
<b>CCR?</b>	Reads from Coupling Condition Register
<b>CSE&lt;nrf&gt;</b>	Writes to Coupling Status Enable Register
<b>CSE?</b>	Reads from Coupling Status Enable Register
<b>CSR?</b>	Reads from Coupling Status Register
<b>HCR?</b>	Reads from Hardware Condition Register
<b>HSE&lt;nrf&gt;</b>	Writes to Hardware Status Enable Register
<b>HSE?</b>	Reads from Hardware Status Enable Register
<b>HSR?</b>	Reads from Hardware Status Register
<b>SCR?</b>	Reads from Instrument Condition Register
<b>SSE&lt;nrf&gt;</b>	Writes to Instrument State Enable Register
<b>SSE?</b>	Reads from Instrument State Enable Register
<b>SSR?</b>	Reads from Instrument State Status Register
<b>&lt;nrf&gt;</b>	Decimal Numeric Program Data

All of the above queries respond with a nrl numeric format.

REMOTE  
OPERATION

---

# Chapter 6

## BRIEF TECHNICAL DESCRIPTION

### Contents

Introduction.....	6-1
Modulation.....	6-1
Frequency generation.....	6-1
Display.....	6-1
Control.....	6-1

### List of figures

Fig. 6-1 Block schematic diagram.....	6-2
---------------------------------------	-----

### Introduction

The 2023A, 2023B and 2025 Signal Generators cover the wide range of frequencies from 9 kHz to 1.2 GHz (2023A), to 2.05 GHz (2023B) and to 2.51 GHz (2025). Output levels range from -140 dBm to +13 dBm (with Option 3 fitted +25 dBm). A block schematic for the instrument is shown in Fig. 6-1.

### Modulation

The carrier frequency can be frequency, phase or amplitude modulated from internal or external sources. The internal source can be the sum of two signals and used in combination with an external source connected to the front panel EXT MOD INPUT connector. In addition to analogue FM, 2-level and 4-level FSK signals are available, using rear panel logic inputs.

### Frequency generation

A voltage controlled oscillator (VCO) covering the frequency range 400 to 533 MHz is phase locked to a 10 MHz temperature compensated crystal oscillator using a fractional-N synthesizer system. Additional frequency coverage is achieved by means of frequency division or multiplication. Low frequencies are generated by a beat frequency oscillator (BFO) system.

### Display

The display is a high definition dot matrix liquid crystal panel with backlighting to cater for variations in ambient light conditions. The display contrast can be adjusted.

### Control

The instrument uses function keys for setting the main parameters of a generated signal in conjunction with an extensive set of utility menus. Internal control of the instrument is achieved by a microprocessor which receives data from the various controls and sends instructions via an internal 8-bit data bus to the signal processing circuits.

The instruments can also be controlled by the built-in General Purpose Interface Bus (GPIB) or the RS-232 interface. The interfaces enable the instrument to be used both as a manually operated bench mounted instrument and as part of a fully automated test system.

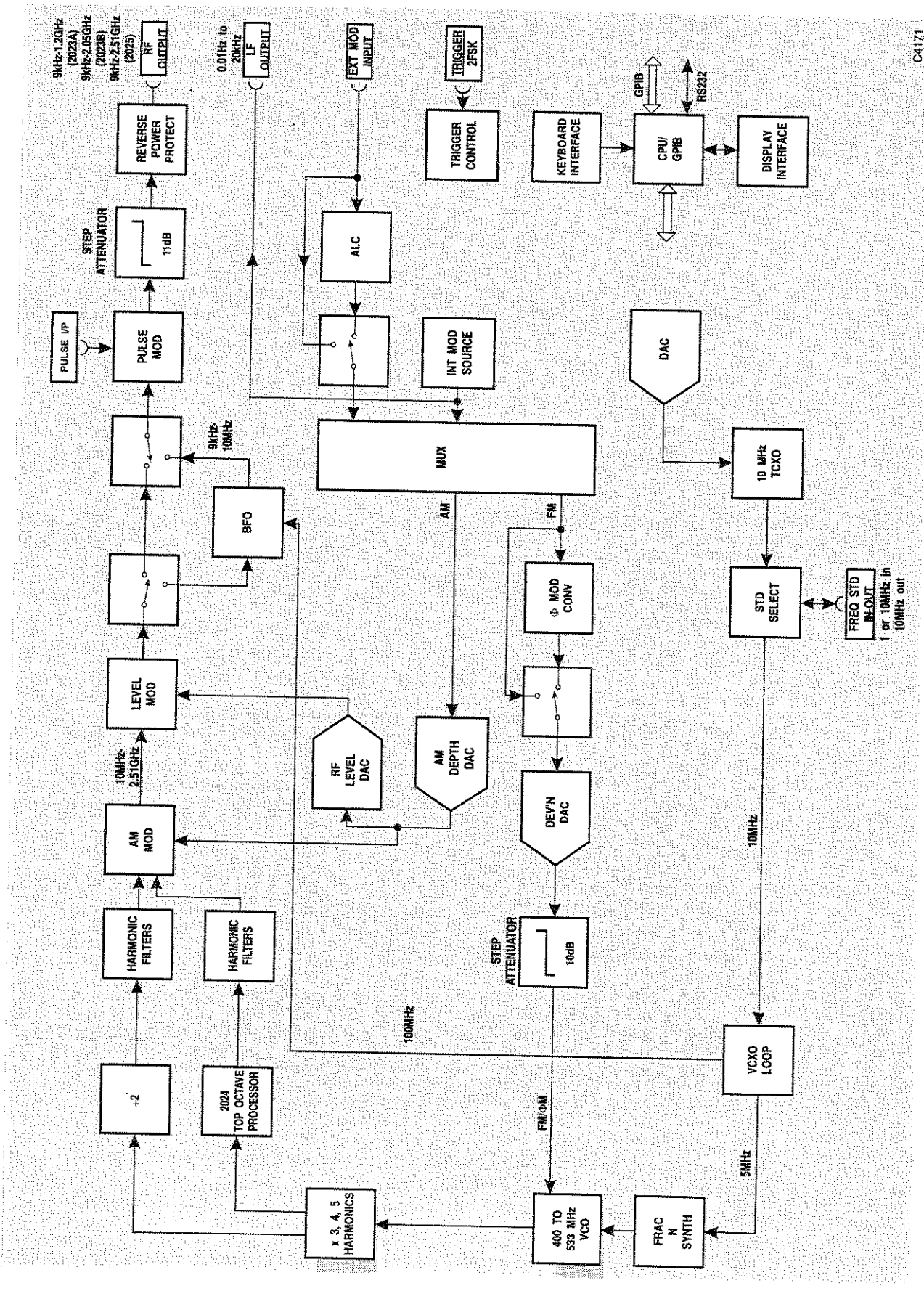

C4171

Fig. 6-1 Block schematic diagram

# Chapter 7

## ACCEPTANCE TESTING

### Contents

Introduction .....	7-4
Test precautions .....	7-4
Recommended test equipment.....	7-5
<b>TEST PROCEDURES .....</b>	<b>7-6</b>
RF output .....	7-6
RF level frequency response .....	7-7
ALC linearity .....	7-7
Attenuator accuracy .....	7-8
Carrier frequency accuracy .....	7-9
Spectral purity .....	7-10
Harmonics.....	7-11
Non-harmonics.....	7-12
Residual FM.....	7-12
SSB phase noise.....	7-13
RF leakage .....	7-14
Internal FM .....	7-15
FM deviation and distortion.....	7-15
FM scale shape.....	7-16
Carrier error .....	7-16
External FM frequency response (ALC off, DC coupled) .....	7-17
External FM frequency response (ALC on) .....	7-18
Phase modulation .....	7-19
Phase modulation .....	7-19
Phase modulation flatness.....	7-19
Amplitude modulation.....	7-20
AM depth and distortion .....	7-21
AM scale shape.....	7-21
External AM frequency response (ALC off, DC coupled).....	7-22
Pulse modulation.....	7-24
Pulse modulation RF level frequency response.....	7-24
Pulse modulation on/off ratio.....	7-25
Pulse modulation rise and fall time .....	7-26
Modulation oscillator .....	7-26
Modulation oscillator frequencies.....	7-27
Modulation oscillator distortion and LF output flatness .....	7-27
External frequency standard input.....	7-28
<b>TEST PROCEDURES FOR INSTRUMENTS FITTED WITH OPTION 3 .....</b>	<b>7-29</b>
RF output .....	7-29
RF level frequency response .....	7-29
ALC linearity .....	7-30
Carrier harmonics.....	7-30
<b>TEST PROCEDURES FOR INSTRUMENTS FITTED WITH OPTION 12 .....</b>	<b>7-32</b>
SINAD .....	7-32
Measurement accuracy.....	7-32
<b>ACCEPTANCE TEST RESULTS TABLES .....</b>	<b>7-34</b>
<b>ACCEPTANCE TEST RESULTS TABLES OPTION 3.....</b>	<b>7-62</b>
<b>ACCEPTANCE TEST RESULTS TABLES OPTION 12.....</b>	<b>7-71</b>

**ACCEPTANCE TESTING**



## List of tables

Table 7-1	RF output at 0 dBm (not Option 3)	7-35
Table 7-2	RF output at +7 dBm (not Option 3)	7-36
Table 7-3	RF output at +13 dBm (not Option 3)	7-37
Table 7-4	ALC linearity at 2.5 MHz (not Option 3)	7-38
Table 7-5	ALC linearity at 500 MHz (not Option 3)	7-39
Table 7-6	ALC linearity at 2050 MHz (2023B and 2025, not Option 3)	7-40
Table 7-7	ALC linearity at 2510 MHz (2025 only, not Option 3)	7-41
Table 7-8	Attenuator test at 2.6 MHz	7-42
Table 7-9	Attenuator test at 540 MHz	7-42
Table 7-10	Attenuator test at 1140 MHz	7-43
Table 7-11	Attenuator test at 1740 MHz (2023B and 2025)	7-43
Table 7-12	Attenuator test at 2050 MHz (2023B) or 2510 MHz (2025)	7-44
Table 7-13	Alternative attenuator functional test at 10 MHz	7-44
Table 7-14	Carrier frequency tests	7-45
Table 7-15	Carrier harmonic tests at -4 dBm (not Option 3)	7-46
Table 7-16	Carrier harmonic tests at 0 dBm (not Option 3)	7-47
Table 7-17	Carrier harmonic tests at +7 dBm (not Option 3)	7-48
Table 7-18	Carrier non-harmonic tests	7-49
Table 7-19	Residual FM test	7-49
Table 7-20	SSB phase noise test	7-49
Table 7-21	RF leakage test	7-50
Table 7-22	Internal FM deviation and distortion tests at 100 kHz deviation	7-50
Table 7-23	FM scale shape tests at 15 MHz carrier	7-51
Table 7-24	Carrier error test at 1.2 GHz, FM deviation 100 kHz	7-51
Table 7-25	External FM frequency response (ALC off, DC coupled), 50 kHz deviation	7-51
Table 7-26	External FM frequency response (ALC on), 10 kHz deviation, 0.75 V input	7-52
Table 7-27	External FM frequency response (ALC on), 10 kHz deviation, 1.25 V input	7-52
Table 7-28	Internal $\Phi$ M and distortion test at 10.5 MHz carrier, 10 rad deviation	7-52
Table 7-29	Internal $\Phi$ M flatness test	7-53
Table 7-30	Internal AM depth and distortion tests at -4 dBm	7-53
Table 7-31	Internal AM depth and distortion tests at 0 dBm	7-54
Table 7-32	Internal AM depth and distortion tests at +7 dBm	7-55
Table 7-33	AM scale shape test	7-56
Table 7-34	External AM frequency response (ALC off, DC coupled), RF level -4 dBm	7-57
Table 7-35	External AM frequency response (ALC off, DC coupled), RF level +7 dBm	7-57
Table 7-36	Pulse modulation RF output at -7 dBm (not Option 7 or 11)	7-58
Table 7-37	Pulse modulation RF output at +4 dBm (not Option 7 or 11)	7-59
Table 7-38	Pulse modulation on/off ratio test (not Option 7 or 11)	7-60
Table 7-39	Pulse modulation rise and fall time test (not Option 7)	7-60
Table 7-40	Modulation oscillator frequency tests	7-60
Table 7-41	Modulation oscillator distortion and LF output tests	7-61
Table 7-42	External frequency standard tests	7-61
Table 7-43	RF output at 0 dBm	7-62
Table 7-44	RF Output at +7 dBm	7-63
Table 7-45	RF Output at +13 dBm	7-64
Table 7-46	RF Output at +25 dBm	7-65
Table 7-47	ALC linearity at 2.5 MHz	7-66
Table 7-48	ALC linearity at 500 MHz	7-67
Table 7-49	ALC linearity at 2050 MHz	7-68
Table 7-50	ALC linearity at 2510 MHz	7-69
Table 7-51	Carrier harmonic tests at +19 dBm	7-70
Table 7-52	SINAD measurement accuracy	7-71
Table 7-53	SINAD sensitivity	7-71

# List of figures

Fig. 7-1	RF output test set-up.....	7-7
Fig. 7-2	RF output test set-up.....	7-8
Fig. 7-3	Carrier frequency accuracy test set-up.....	7-10
Fig. 7-4	Carrier harmonics and non-harmonics test set-up.....	7-11
Fig. 7-5	Residual FM test set-up.....	7-12
Fig. 7-6	SSB phase noise test set-up.....	7-13
Fig. 7-7	RF leakage test set-up.....	7-14
Fig. 7-8	Internal modulation and modulation distortion test set-up.....	7-15
Fig. 7-9	External modulation and modulation distortion test set-up.....	7-17
Fig. 7-10	0 Hz external AM and distortion test set-up.....	7-23
Fig. 7-11	Pulse modulation test set-up.....	7-24
Fig. 7-12	Pulse modulation on/off ratio test set-up.....	7-25
Fig. 7-13	Pulse modulation rise and fall time test set-up.....	7-26
Fig. 7-14	Modulation oscillator frequency test set-up.....	7-27
Fig. 7-15	Modulation oscillator distortion test set-up.....	7-27
Fig. 7-16	External standard test set-up.....	7-28
Fig. 7-17	RF output test set-up.....	7-29
Fig. 7-18	Carrier harmonics test set-up.....	7-31
Fig. 7-19	SINAD test set-up.....	7-32

**ACCEPTANCE  
TESTING**

## Introduction

The test procedures in this chapter enable you to verify that the electrical performance of the signal generator complies with the Specification given in the Data Sheet (following Chapter 1). For convenience, the test equipment and specification for each test are summarized before the test procedure.

Apart from the UUT, (Unit Under Test), no specific set-up procedures will be included for the test equipment unless the measurement is dependent on specific instrument settings or special measurement techniques.

## Test precautions

To ensure minimum errors and uncertainties when making measurements, it is important to observe the following precautions:

- (1) Always use recently calibrated test equipment, with any correction figures taken into account, so as to establish a known traceable limit of performance uncertainty. This uncertainty must be allowed for in determining the accuracy of measurements.
- (2) A common external frequency standard, with an accuracy of  $\pm 1$  part in  $10^9$  should be used for any frequency-controlled test equipment.
- (3) Use the shortest possible connecting leads.
- (4) Some areas of the specification which are labeled 'typical', rather than having clearly defined limits, are *not* tested.

## Recommended test equipment

The test equipment recommended for acceptance testing is shown below. Alternative equipment may be used provided it complies with the stated minimum specification.

### Recommended test equipment

Description	Minimum specification	Example
Power meter	$\pm 0.1$ dB from 9 kHz to 2.51 GHz	IFRT† 6960B with 6912 and 6932 sensors #
Measuring receiver	0 dBm to -127 dBm; 2.5 MHz to 2.51 GHz. Capable of measuring residual FM <2 Hz and SSB phase noise <-124 dBc/Hz at 20 kHz offset from a 1 GHz carrier	HP 8902A with Option 037 * and 11722A sensor and 11793A down converter ##
Signal generator	+8 dBm from 32.5 MHz to 2.54 GHz	IFRT† 2041
Frequency counter	10 Hz to 2.51 GHz	EIP 535B or IFRT† 2440
Audio analyzer	Capable of measuring THD of 0.01% from 100 Hz to 20 kHz	Rhode & Schwarz UPA3
Spectrum analyzer	DC to 7.53 GHz, 3 Hz resolution bandwidth	Anritsu MS2602A or IFRT† 2386
Modulation meter	AM, FM and $\Phi$ M 50 kHz to 2.32 GHz, accuracy $\pm 1\%$ at 1 kHz modulation frequency.	IFRT† 2305 plus distortion option **
Function generator	DC to 100 kHz sine, $\pm 0.6$ dB flatness, 100 kHz square wave	HP 3325B
Digital voltmeter	DC voltage measurement	Solartron 7150+
50 $\Omega$ load (termination)	1 W, 50 $\Omega$ nominal impedance, DC to 2.51 GHz	Lucas Weinschel M1404N
2 turn loop	25 mm diameter	
Oscilloscope	100 MHz bandwidth	Tektronix TAS 465

†IFR Ltd was previously known as Marconi Instruments Ltd

# The 6932 sensor is only required when testing instruments fitted with Option 3 (high power).

\* Option 037 is necessary to measure SSB phase noise.

## If the receiver and down converter are not available, an alternative procedure to ensure attenuator pad accuracy using a power meter is given.

\*\* The distortion option of the 2305 Modulation Meter allows modulation distortion tests to be carried out with greater ease. If a 2305 with the distortion option is not available, the audio analyzer may be connected to the modulation meter LF output and set to measure distortion.

ACCEPTANCE  
TESTING

# TEST PROCEDURES

At the end of this chapter are a set of results tables (Tables 7-1 onwards) which give all the test points for each of the tests. These tables should be photocopied and used to record the results of all the measurements taken.

Tests for the options, where necessary, are included with the tests for the standard instrument, with the exception of the following:

Option 3 (high power option) which has a dedicated section (page 7-29) for RF level accuracy and carrier harmonics.

Option 7 (fast pulse modulation) whose tests are included in Annex A.

Option 11 (fast pulse and high power) whose tests are included in Annex B.

Option 12 (SINAD option) which has a dedicated section (page 7-32) for measurement accuracy and sensitivity.

## Instrument default settings

Each test procedure relies on the UUT starting with its factory default settings. To avoid switching the instrument off and back on, reset the UUT by selecting:

[RCL] 999 [ENTER]

Carry this out before each test.

## RF output

### Specification

<b>Level range:</b>	-140 dBm to +13 dBm		
<b>Accuracy:</b>	Over the temperature range of 17°C to 27°C:		
	<1.2 GHz	<2.05 GHz (2023B/5)	<2.51 GHz (2025 only)
>-127 dBm	±0.8 dB	±1.4 dB	±1.6 dB
>-100 dBm	±0.8 dB	±1.2 dB	±1.6 dB
	Temperature coefficient:		
	±0.02 dB/°C	±0.03 dB/°C	±0.03 dB/°C
<b>Output impedance:</b>	50 ohms		
	VSWR for output levels less than -5 dBm		
	<1.3:1 to 1.2 GHz		
	<1.5:1 to 2.51 GHz (2023B/5)		
	VSWR for output levels greater than -5 dBm		
	<1.5:1		

## Test equipment

Description	Minimum specification	Example
Power meter	±0.1 dB from 9 kHz to 2.51 GHz	IFR 6960B and 6912
Measuring receiver	0 dBm to -127 dBm; 2.5 MHz to 2.55 GHz	HP 8902A with 11722A sensor and 11793A down converter
Signal generator	+8 dBm from 32.5 MHz to 2.55 GHz	IFR 2041

**RF level frequency response** (not Option 3, refer to 'Test procedure for instruments fitted with Option 3' on page 7-29)

**Test procedure**

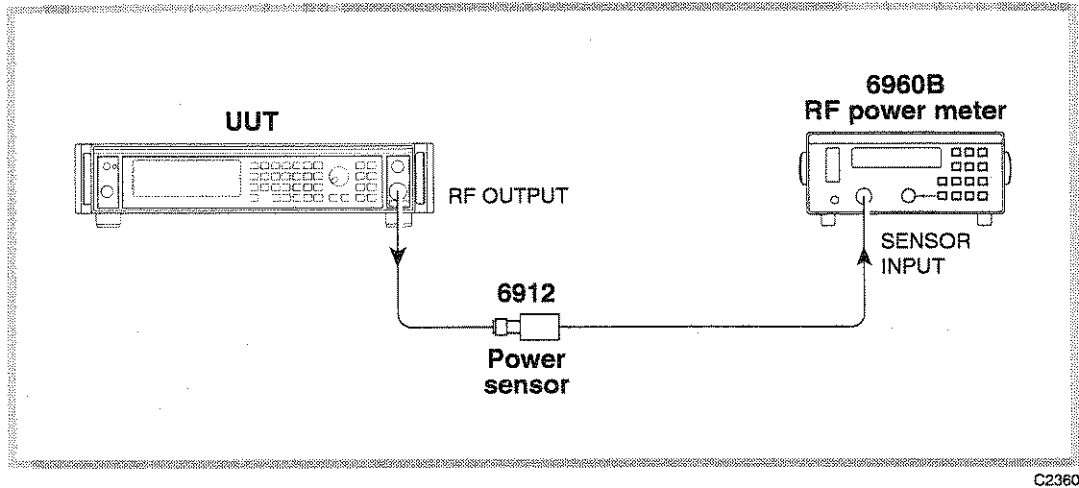

C2360

*Fig. 7-1 RF output test set-up*

- (1) Perform AUTO ZERO and AUTO CAL on the power meter.
- (2) Connect the test equipment as shown in Fig. 7-1.
- (3) On the UUT set:

[CARR FREQ]	30 [kHz]
[RF LEVEL]	0 [dB]
- (4) Record the output level measured by the power meter against each of the carrier frequencies shown in Table 7-1, checking that the results are within specification.
- (5) Set the UUT RF level to +7 dBm and repeat (4) using Table 7-2.
- (6) Set the UUT RF level to +13 dBm and repeat (4) using Table 7-3.

**ALC linearity** (not Option 3, refer to 'Test procedure for instruments fitted with Option 3' on page 7-29)

**Test procedure**

- (1) Perform AUTO ZERO and AUTO CAL on the power meter.
- (2) Connect the test equipment as shown in Fig. 7-1.
- (3) On the UUT set:

[CARR FREQ]	2.5 [MHz]
[RF LEVEL]	-4 [dB]
- (4) Record the output level measured by the power meter against each of the steps shown in Table 7-4, checking that the results are within specification.
- (5) Set the UUT carrier frequency to 500 MHz and repeat (4) using Table 7-5.
- (6) Set the UUT carrier frequency to 2050 MHz and repeat (4) using Table 7-6.
- (7) Set the UUT carrier frequency to 2510 MHz and repeat (4) using Table 7-7.

**ACCEPTANCE  
TESTING**

## Attenuator accuracy (not required for instruments with Option 1)

The following test will confirm that the attenuator performs to the published performance specification. In the event of the receiver/down-converter not being available, an alternative method to functionally test the individual pads is also suggested. (See 'Alternative attenuator functional test')

### Test procedure

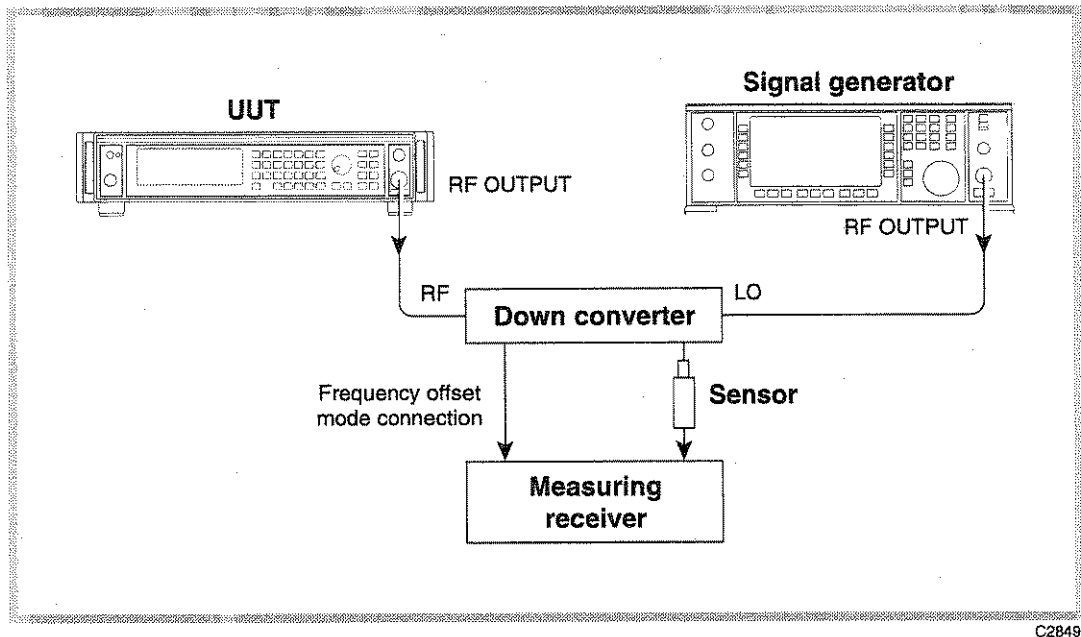

Fig. 7-2 RF output test set-up

- (1) Connect the test equipment as shown in Fig. 7-2.
- (2) On the UUT set:

[CARR FREQ]	2.6 [MHz]
[RF LEVEL]	0 [dB]
[SET Δ]	
[RF LEVEL] (to select [Levl Step])	11 [dB]
[RF LEVEL]	
- (3) Tune the receiver to 2.6 MHz and record the output level measured in Table 7-8, checking that the result is within specification.
- (4) Set the UUT RF level to -4.1 dBm. Measure the received level and record the result in Table 7-8, checking that the result is within specification.
- (5) Decrement the UUT, using the [×10 ↓] key, in 11 dB steps down to an RF level of -103.1 dBm measuring the received level at each step shown in Table 7-8, checking that the results are within specification.
- (6) Set the UUT to carrier frequency 540 MHz and repeat (2) to (5) using Table 7-9.
- (7) Set the UUT to carrier frequency 1140 MHz and repeat (2) to (5) using Table 7-10.

Note that the following test frequencies are for 2023B and 2025 only. The down converter will automatically be enabled when testing frequencies above 1300 MHz.
- (8) Set the local oscillator to +8 dBm at a carrier frequency of 62 MHz less than the test frequency (i.e. 1678 MHz).
- (9) On the receiver, enter the local oscillator frequency followed by the test frequency.
- (10) Set the UUT to carrier frequency 1740 MHz and repeat (2) to (5) using Table 7-11.
- (11) Set the UUT to carrier frequency 2050 MHz (2023B) or 2510 MHz (2025) and repeat (2) to (5) using Table 7-12.

## Alternative attenuator functional test (not required for instruments with Option 1)

- (1) Connect the test equipment as shown in Fig. 7-1.
- (2) Perform AUTO ZERO and AUTO CAL on the power meter.
- (3) On the UUT set:
 

[CARR FREQ]	10 [MHz]
[RF LEVEL]	13 [dB]*

\*For units fitted with Option 3, high power option, select 7 [dB]

[MENU] 70 [ENTER]

The UUT will enter the *Latch Access* diagnostic menu.

- (4) Use the [+10 ↑] and [×10 ↓] keys to select *RF Board Shift-Reg 1*.
- (5) Press [NEXT] and [NEXT] again to select *Data (bin)* :
- (6) Use the [+10 ↑] and [×10 ↓] to move the cursor left and right.
- (7) Set a reference on the power meter such that 0 dB is indicated.
- (8) On the UUT, move the cursor to the MSB and press 0 (01111111)  
This will enable the first 33 dB pad.
- (9) Record the relative level measured on the power meter in Table 7-13.

Note that this is a nominal value as no software correction figures are applied to the attenuator when performing this test.

- (10) On the UUT, press 1 to disable the first 33 dB pad.
- (11) Repeat (6) to (10) for the next four MSBs; the 22 dB, 33 dB, 11 dB and 33 dB pads respectively.

## Carrier frequency accuracy

This check provides a conventional method of checking the signal generator frequency locking circuitry. It will confirm correct operation of phase locked loops and dividers. Overall accuracy is determined by the instrument's internal reference standard.

### Specification

Frequency range:	9 kHz to 1.2 GHz (2023A). 9 kHz to 2.05 GHz (2023B). 9 kHz to 2.51 GHz (2025).
Resolution:	1 Hz.
Accuracy:	Equal to the frequency standard accuracy.
Phase incrementing:	The carrier phase can be advanced or retarded in steps as low as 0.09° using the rotary control.

### Test equipment

Description	Minimum specification	Example
Frequency counter	9 kHz to 2.51 GHz	IFR 2440 or EIP 535B
50 Ω load (termination)	1 W, 50 Ω nominal impedance, DC to 2.51 GHz	Lucas Weinschel M1404N

ACCEPTANCE TESTING



## Test procedure

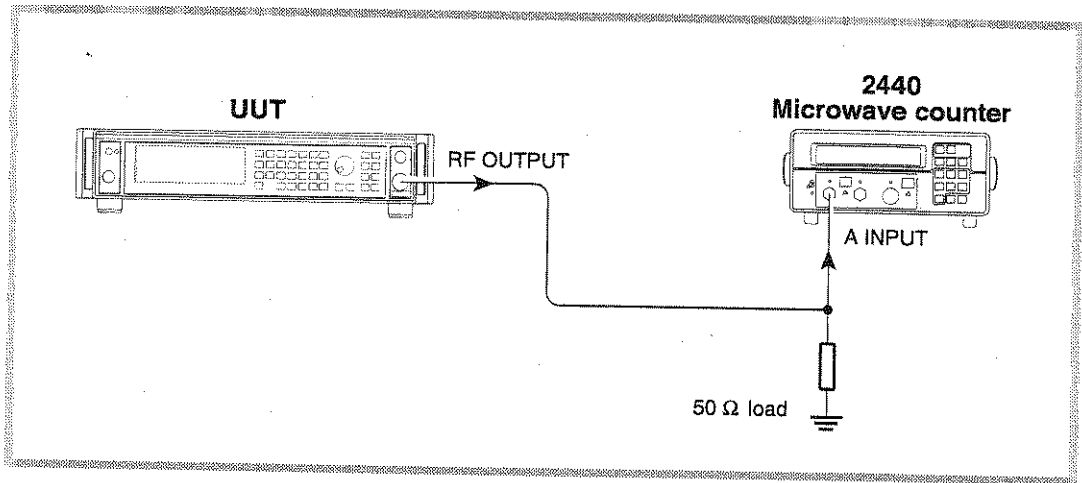

C2374

Fig. 7-3 Carrier frequency accuracy test set-up

- (1) Connect the test equipment as shown in Fig. 7-3.
- (2) Connect the internal frequency standard from the UUT to the external standard input on the counter.
- (3) On the UUT set:

[CARR FREQ]	9 [kHz]
[RF LEVEL]	0 [dB]
- (4) Record the frequency measured by the counter meter against each of the carrier frequencies shown in Table 7-14. (As the two instruments' frequencies are locked together, the limit is  $\pm 1$  digit on the counter display.)
- (5) At 1200 MHz disconnect the UUT internal frequency standard from the counter and instead apply the external reference. Check the result against the limits.

### Notes

If the instrument is fitted with Option 4, (high stability frequency standard), use the *second* 1200 MHz test limits.

The test limits quoted are for guidance and assume that the internal frequency standard has recently been adjusted. Aging and stability have to be considered when establishing the real test limits (see 'Specification' the Data Sheet (following Chapter 1).

## Spectral purity

### Specification

<b>Harmonics:</b>	Typically better than $-30$ dBc for RF levels up to $+7$ dBm Typically better than $-25$ dBc for RF levels up to $+13$ dBm
<b>Non-harmonics:</b>	Better than $-70$ dBc for carrier frequencies up to 1 GHz Better than $-64$ dBc for carrier frequencies above 1 GHz Better than $-60$ dBc for carrier frequencies above 2 GHz
<b>Residual FM:</b>	Less than 4.5 Hz RMS in a 300 Hz to 3.4 kHz bandwidth at a carrier frequency of 1 GHz
<b>SSB phase noise:</b>	Better than $-124$ dBc/Hz at 20 kHz offset from a 470 MHz carrier, typically $-121$ dBc/Hz at 20 kHz offset from a 1 GHz carrier
<b>RF leakage:</b>	Less than $0.5$ $\mu$ V at the carrier frequency into a two-turn 25 mm loop 25 mm away from the surface of the signal generator

## Test equipment

Description	Minimum specification	Example
Spectrum analyzer	DC to 7.6 GHz frequency coverage	Anritsu MS2602A or IFR 2386
Measuring receiver	0 dBm to -127 dBm; 2.5 MHz to 2.51 GHz. Capable of measuring residual FM <2 Hz and SSB phase noise <-124 dBc/Hz at 20 kHz offset from a 1 GHz carrier	HP 8902A with Option 037
Signal generator	+8 dBm from 32.5 MHz to 2.54 GHz	IFR 2041
50 $\Omega$ load	1 W, 50 $\Omega$ nominal impedance, DC to 2.51 GHz	Lucas Weinschel M1404N
2 turn loop	25 mm diameter	

## Harmonics

### Test procedure

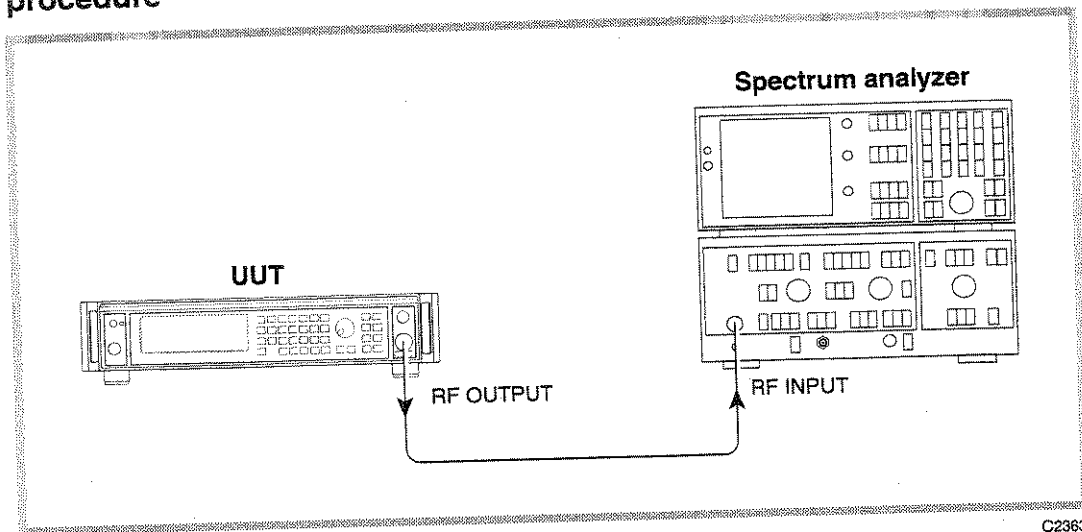

C2363

Fig. 7-4 Carrier harmonics and non-harmonics test set-up

- (1) Press CAL on the spectrum analyzer.
- (2) Connect the test equipment as shown in Fig. 7-4.
- (3) On the UUT set:
 

[CARR FREQ]	10 [kHz]
[RF LEVEL]	-4 [dB]
- (4) Measure the level of the second and third harmonics on the spectrum analyzer at each of the carrier frequencies shown in Table 7-15, checking that the results are within specification.
- (5) Set the UUT RF level to 0 dBm and repeat (4) using Table 7-16.
- (6) Set the UUT RF level to +7 dBm and repeat (4) using Table 7-17.

ACCEPTANCE TESTING

## Non-harmonics

### Test procedure

- (1) Press CAL on the spectrum analyzer.
- (2) Connect the test equipment as shown in Fig. 7-4.
- (3) On the UUT set:

[CARR FREQ]	1201 [MHz]
[RF LEVEL]	0 [dB]
- (4) Measure the level of the non-harmonics on the spectrum analyzer at each of the carrier frequencies shown in Table 7-18, checking that the results are within specification.

## Residual FM

### Test procedure

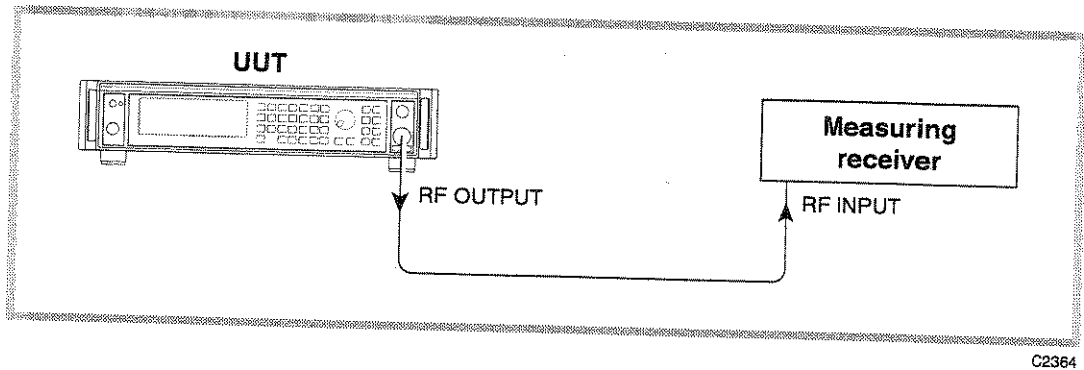

Fig. 7-5 Residual FM test set-up

- (1) Connect the test equipment as shown in Fig. 7-5.
- (2) On the UUT set:

[CARR FREQ]	1 [GHz]
[RF LEVEL]	0 [dB]
- (3) On the measuring receiver, select FM, 300 Hz high-pass filter, 3.4 kHz low-pass filter and enable averaging.
- (4) Measure the residual FM, checking that the result is within the specification shown in Table 7-19.

## SSB phase noise

### Test procedure

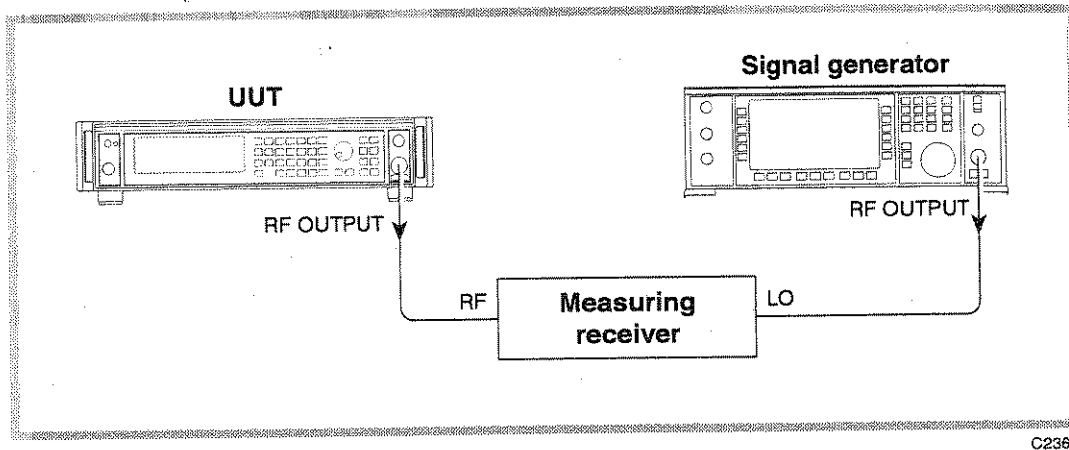

Fig. 7-6 SSB phase noise test set-up

- (1) Connect the test equipment as shown in Fig. 7-6.
- (2) On the UUT set:

[CARR FREQ]	470 [MHz]
[RF LEVEL]	0 [dB]
- (3) On the measuring receiver:  
Tune the receiver to 470 MHz.  
Select 24.0 SPCL to enter selective power measurement mode.  
Select 23.1 SPCL to set the LO to external.
- (4) Set the signal generator to a carrier frequency of 470.455 MHz, RF level 0 dBm.
- (5) On the measuring receiver:  
Select 24.5 SPCL to establish the IF reference value (in volts).  
Select 24.6 SPCL to set the reference to 0 dBm.
- (6) Fine tune the signal generator frequency until a maximum value is displayed on the measuring receiver.
- (7) Offset the signal generator by 20 kHz.
- (8) On the measuring receiver:  
Select 24.7 SPCL to normalize the measurement for a 1 Hz bandwidth.
- (9) Measure the level on the receiver (the SSB phase noise in a 1 Hz bandwidth), checking that the result is within the specification shown in Table 7-20.

## RF leakage

## Test procedure

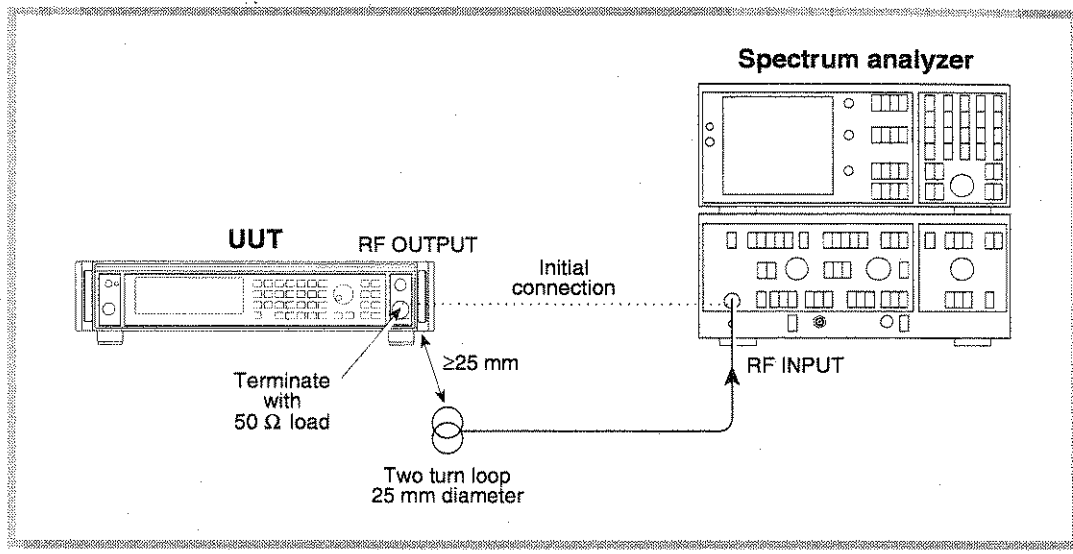

C2366

Fig. 7-7 RF leakage test set-up

- (1) Press PRESET then CAL on the spectrum analyzer.
- (2) Connect the test equipment as shown in Fig. 7-7.
- (3) On the UUT set:
 

[CARR FREQ]	469.03 [MHz]
[RF LEVEL]	-30 [dB]
- (4) On the spectrum analyzer select
 

REF FREQ	469.03 MHz
SPAN/DIV	10 Hz
PEAK FIND	
MKR 1 SETS REF FREQ	
- (5) Disconnect the cable from the UUT RF output socket and place a 25 mm two-turn loop on the end of the cable.
- (6) Connect a 50 Ω sealed load to the UUT RF OUTPUT.
- (7) On the spectrum analyzer select:
 

VOLTS/DIV	
REF LEVEL	0.1 μV
2nd FUNCT RF ATTEN ↓	(to set 0 dB input attenuation)
- (8) Hold the 2 turn loop not less than 25 mm from the UUT at various points around its case ensuring that the worst case leakage indicated on the spectrum analyzer does not exceed that shown in Table 7-21.
- (9) Repeat (1) to (8) for each of the carrier frequencies shown in Table 7-21.

# Internal FM

## Specification

<b>Deviation range:</b>	CW range (MHz)	Max. deviation (kHz)
	1200 to 2510	12800
	600 to 1200	6400
	300 to 600	3200
	150 to 300	1600
	75 to 150	800
	37.5 to 75	400
	18.75 to 37.5	200
	0.009 to 18.75	100
<b>Resolution:</b>	3 digits or 1 Hz	
<b>Bandwidth (1 dB):</b>	DC to 275 kHz (DC coupled) 10 Hz to 275 kHz (AC coupled) 20 Hz to 275 kHz (AC coupled with ALC)	
<b>Accuracy:</b>	±4% at 1 kHz modulation rate	
<b>Carrier error:</b>	Less than 1% of the set frequency deviation when DC coupled	
<b>Distortion:</b>	Less than 1% at 1 kHz rate for deviations up to 20% of max. available deviation. Typically 0.1% for deviations of 2% of max. available deviation and less than 3% at max. available deviation.	
<b>External modulation input:</b>	1 V RMS for set deviation	
<b>Modulation ALC:</b>	Levels the applied external modulation over the range 0.5 to 1.25 V RMS.	
<b>FSK:</b>	Accepts logic level inputs (1 or 2) to produce an unfiltered FSK modulated output	

## Test equipment

Description	Minimum specification	Example
Modulation meter	FM accuracy ±1% at 1 kHz modulation frequency	IFR 2305 with distortion option
DVM	DC voltage measurement	Solartron 7150+
50 Ω load (termination)	1 W, 50 Ω nominal impedance, DC to 2.51 GHz	Lucas Weinschel M1404N
Audio analyzer	Capable of measuring THD of 0.01% from 100 Hz to 20 kHz	Rhode & Schwarz UPA3
Function gen.	DC to 100 kHz sine, ±0.6 dB flatness	HP 3325B

## FM deviation and distortion

### Test procedure

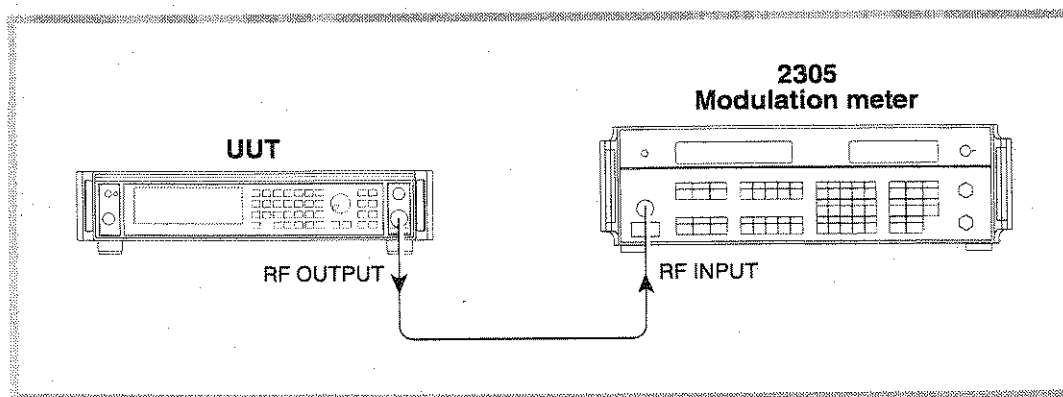

Fig. 7-8 Internal modulation and modulation distortion test set-up

C2367

ACCEPTANCE TESTING

- (1) Connect the test equipment as shown in Fig. 7-8.
- (2) On the UUT set:
 

[CARR FREQ]	10 [MHz]
[RF LEVEL]	0 [dB]
[MOD]	100 [kHz]
[SOURCE ON/OFF]	(to enable modulation source)
[MOD ON/OFF]	(to enable modulation)
- (3) On the modulation meter, select CAL, FM, 50 Hz  $\Rightarrow$  15 kHz filter.
- (4) Measure the FM accuracy and distortion at the carrier frequencies shown in Table 7-22, checking that the results are within specification.

### FM scale shape Test procedure

- (1) Connect the test equipment as shown in Fig. 7-8.
- (2) On the UUT set:
 

[CARR FREQ]	15 [MHz]
[RF LEVEL]	0 [dB]
[MOD]	100 [kHz]
[SOURCE ON/OFF]	(to enable modulation source)
[MOD ON/OFF]	(to enable modulation)
- (3) On the modulation meter, select CAL, FM, 50 Hz  $\Rightarrow$  15 kHz filter.
- (4) Measure the FM accuracy at the deviations shown in Table 7-23, checking that the results are within specification.

### Carrier error Test procedure

- (1) Connect the test equipment as shown in Fig. 7-8.
- (2) On the UUT set:
 

[CARR FREQ]	1200 [MHz]
[RF LEVEL]	0 [dB]
- (3) On the modulation meter select CARRIER ERROR. The FREQUENCY display will read 0.00 kHz.
- (4) On the UUT set:
 

[MOD]	100 [kHz]
[SOURCE ON/OFF]	(to enable modulation source)
[MOD ON/OFF]	(to enable modulation)
[MENU]	20 [ENTER]

The UUT will enter the *Modulation Mode* menu  
 Select *FM ext* using [NEXT]  
 [MENU] 30 [ENTER]

The UUT will enter the *Modulation Source* menu  
 Select *Ext* using [NEXT]  
 Select 2 to select DC coupling  
 [MENU] 23 [ENTER]

The UUT will select the *DC FM Nulling* control.

On the modulation meter, measure the carrier frequency error displayed in the FREQUENCY window, checking that the result is within the specification shown in Table 7-24.

## External FM frequency response (ALC off, DC coupled)

### Test procedure

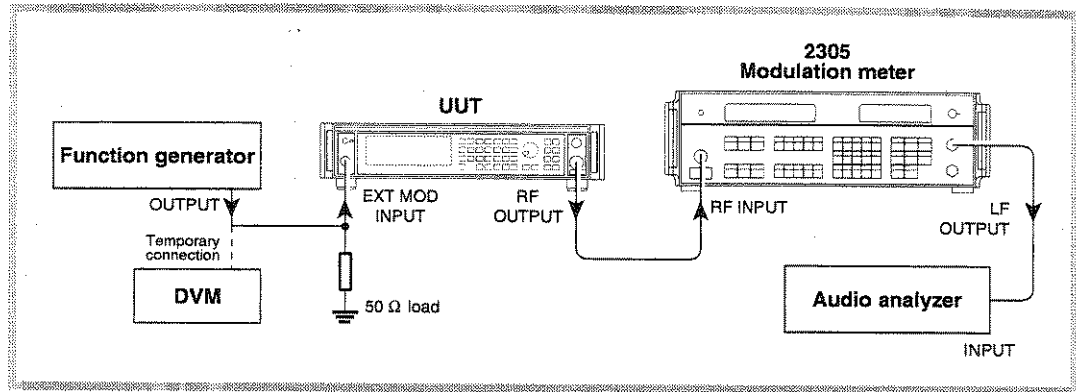

Fig. 7-9 External modulation and modulation distortion test set-up

### 30 Hz to 275 kHz

- (1) Connect the test equipment as shown in Fig. 7-9.
- (2) On the UUT set:

[CARR FREQ]	15 [MHz]
[RF LEVEL]	0 [dB]
[MOD]	50 [kHz]
[SOURCE ON/OFF]	(to enable modulation source)
[MOD ON/OFF]	(to enable modulation)
[MENU]	20 [ENTER]

The UUT will enter the *Modulation Mode* menu

Select *FM ext* using [NEXT]  
[MENU] 30 [ENTER]

The UUT will enter the *Modulation Source* menu.

Select *Ext* using [NEXT]  
Select 2 to select DC coupling

- (3) Set the function generator to give 1 V RMS (1 V peak for units with Option 10), 1 kHz sine wave.
- (4) On the modulation meter, select CAL, FM, 10 Hz  $\Rightarrow$  300 kHz filter.
- (5) On the modulation meter, check that the FM reading is between 47.5 kHz and 52.5 kHz, then set a reference using the relative function.
- (6) Set the function generator to each of the frequencies shown in Table 7-25, checking that the relative readings on the modulation meter are within specification.
- (7) At those frequencies indicated in Table 7-25, set the modulation meter LF output control to mid position and measure the AF distortion on the audio analyzer, checking that the results are within specification.

### 0 Hz (DC)

#### Note

To measure the FM deviation at DC, it will be necessary to use the DC offset facility on the function generator proceeding as follows:

ACCEPTANCE  
TESTING



- (8) Set the function generator to +1.4142 V DC (+1 V DC for units with Option 10).  
(Temporarily connect the function generator output to the DVM and set this voltage as close as possible to +1.4142 V (+1 V DC for units with Option 10).)
- (9) Press CARRIER ERROR on the modulation meter.
- (10) Set the function generator to -1.4142 V DC (-1 V DC for units with Option 10).  
(Temporarily connect the function generator output to the DVM and set this voltage as close as possible to -1.4142 V (-1 V DC for units with Option 10).)
- (11) Measure the frequency indicated on the modulation meter carrier frequency window.  
FM 1 = \_\_\_\_\_
- (12) Reset the function generator to 1V RMS, 1 kHz sine wave and measure the FM deviation.  
FM2 = \_\_\_\_\_
- (13) Using the following formula, calculate the change in response, checking that the result is within the specification shown against 0 Hz in Table 7-25.

$$20 \log_{10} \left\{ \frac{FM2}{FM1} \right\}$$

## External FM frequency response (ALC on)

### Test procedure

- (1) Connect the test equipment as shown in Fig. 7-9.
- (2) On the UUT set:
 

[CARR FREQ]	15 [MHz]
[RF LEVEL]	0 [dB]
[MOD]	10 [kHz]
[SOURCE ON/OFF] (to enable modulation source)	
[MOD ON/OFF] (to enable modulation)	
[MENU]	20 [ENTER]

The UUT will enter the *Modulation Mode* menu.

Select *FM ext* using [NEXT]  
[MENU] 30 [ENTER]

The UUT will enter the *Modulation Source* menu.

Select *Ext* using [NEXT]  
Select *1* to select ALC

- (3) Set the function generator to give 0.75 V RMS (0.75 V peak for units with Option 10), 1 kHz sine wave.
- (4) On the modulation meter, select CAL, FM, 10 Hz  $\Rightarrow$  300 kHz filter.
- (5) On the modulation meter, check that the FM reading is between 9.5 kHz and 10.5 kHz, then set a reference using the relative function.
- (6) Set the function generator to each of the frequencies shown in Table 7-26, checking that the relative readings on the modulation meter are within specification.
- (7) Set the function generator to 1.25 V RMS (1.25 V peak for units with Option 10) and repeat (4) to (6) using Table 7-27, also measuring the AF distortion on the audio analyzer at those frequencies indicated.

## Phase modulation Specification

Range:	0 to 10 radians
Resolution:	3 digits or 0.01 radians
Bandwidth (3 dB):	100 Hz to 10 kHz
Accuracy:	±4% at 1 kHz modulation rate
Distortion:	Less than 3% at 10 radians at 1 kHz modulation rate

### Test equipment

Description	Minimum specification	Example
Modulation meter	ΦM and FM accuracy ±2% at 1 kHz modulation frequency	IFR 2305 with distortion option

### Phase modulation Test procedure

- (1) Connect the test equipment as shown in Fig. 7-8.
- (2) On the UUT set:
 

[CARR FREQ]	10.5 [MHz]
[RF LEVEL]	0 [dB]
[MENU]	20 [ENTER]

The UUT will enter the *Modulation Mode* menu.

Select *ΦM int* using [NEXT]  
 [MOD] 10 [rad]  
 [SOURCE ON/OFF] (to enable modulation source)  
 [MOD ON/OFF] (to enable modulation)

- (3) On the modulation meter, select CAL, ΦM.
- (4) Measure the ΦM accuracy and distortion, checking that the results are within the specification shown in Table 7-28.

### Phase modulation flatness Test procedure

#### Note

For this test, the phase modulation figures are calculated from readings taken with the modulation meter set to FM. No allowances need to be made for the modulation source frequency accuracy since it is derived from the reference oscillator in the UUT.

- (1) Connect the test equipment as shown in Fig. 7-8.

ACCEPTANCE TESTING

- (2) On the UUT set:
- |             |            |
|-------------|------------|
| [CARR FREQ] | 15 [MHz]   |
| [RF LEVEL]  | 0 [dB]     |
| [MENU]      | 20 [ENTER] |

The UUT will enter the *Modulation Mode* menu

Select  $\Phi M$  int using [NEXT]  
 [MOD] 10 [rad]  
 [SOURCE ON/OFF] (to enable modulation source)  
 [MOD ON/OFF] (to enable modulation)

- (3) On the modulation meter, select CAL, FM, 50 Hz  $\Rightarrow$  15 kHz LF filter.  
 (4) Measure the deviation on the modulation meter and calculate the phase modulation using the formula:

$$\Phi M = \left\{ \frac{\text{FM dev (Hz)}}{\text{mod freq (Hz)}} \right\}$$

- (5) On the UUT set [MOD SOURCE] to each of the frequencies shown in Table 7-29, measure the deviation on the modulation meter and calculate the phase modulation for each step using the formula in (4).  
 (6) Using the figure recorded in (4) as a reference, calculate the change in response at each modulation frequency using the formula:

$$20 \log_{10} \left\{ \frac{\text{Figure recorded in (5)}}{\text{Figure recorded in (4)}} \right\}$$

Check that the results are within the specifications shown in Table 7-29.

## Amplitude modulation Specification

<b>Range:</b>	0 to 99.9%
<b>Resolution:</b>	0.1%
<b>Carrier frequency range:</b>	<500 MHz usable to 1.5 GHz.
<b>Bandwidth (1 dB):</b>	DC to 30 kHz (DC coupled) 10 Hz to 30 kHz (AC coupled) 20 Hz to 30 kHz (AC coupled with ALC)
<b>Accuracy:</b>	$\pm 5\%$ of set depth at 1 kHz modulation rate
<b>Distortion:</b>	For modulation depths up to 80%, less than 2.5% at 1 kHz rate, for modulation depths up to 30% less than 1.5% at 1 kHz rate.
<b><math>\Phi M</math> on AM:</b>	Typically 0.1 radians at 30% depth at 470 MHz

## Test equipment

Description	Minimum specification	Example
Modulation meter	AM accuracy $\pm 1\%$ at 1 kHz modulation frequency	IFR 2305 with distortion option
DVM	DC voltage measurement	Solartron 7150+
50 $\Omega$ load (termination)	1 W, 50 $\Omega$ nominal impedance, DC to 2.51 GHz	Lucas Weinschel M1404N
Audio analyzer	Capable of measuring THD of 0.01% from 100 Hz to 20 kHz	Rhode & Schwarz UPA3
Function generator	DC to 30 kHz sine, $\pm 0.6$ dB flatness	HP 3325B

## AM depth and distortion

### Test procedure

- (1) Connect the test equipment as shown in Fig. 7-8.
- (2) On the UUT set:
 

[CARR FREQ]	1.5 [MHz]
[RF LEVEL]	-4 [dB]
[MENU]	20 [ENTER]

The UUT will enter the *Modulation Mode* menu

Select *AM int*

[MOD]	30 [%]
[SOURCE ON/OFF]	(to enable modulation source)
[MOD ON/OFF]	(to enable modulation)

- (3) On the modulation meter, select CAL, AM, 300 Hz  $\Rightarrow$  3.4 kHz LF filter.
- (4) Measure the AM accuracy and distortion at the frequencies shown in Table 7-30, checking that the results are within specification
- (5) Set the UUT to [MOD] 80% and repeat (4).
- (6) Set the UUT to [RF LEVEL] 0 dBm and repeat (2) to (5) using Table 7-31.
- (7) Set the UUT to [RF LEVEL] +7 dBm and repeat (2) to (5) using Table 7-32.

## AM scale shape

### Test procedure

- (1) Connect the test equipment as shown in Fig. 7-8.

- (2) On the UUT set:
 

[CARR FREQ]	100 [MHz]
[RF LEVEL]	0 [dB]
[MENU]	20 [ENTER]

The UUT will enter the *Modulation Mode* menu

Select *AM int*  
 [MOD] 1 [%]  
 [SOURCE ON/OFF] (to enable modulation source)  
 [MOD ON/OFF] (to enable modulation)

- (3) On the modulation meter, select CAL, AM, 300 Hz  $\Rightarrow$  3.4 kHz LF filter.
- (4) Measure the AM accuracy at the depths shown in Table 7-33 checking that the results are within specification.

## External AM frequency response (ALC off, DC coupled)

### Test procedure

#### 100 Hz to 30 kHz

- (1) Connect the test equipment as shown in Fig. 7-9.
- (2) On the UUT set:
 

[CARR FREQ]	400 [MHz]
[RF LEVEL]	-4 [dB]
[MENU]	20 [ENTER]

The UUT will enter the *Modulation Mode* menu

Select *AM ext* using [NEXT]  
 [MOD] 80 [%]  
 [MENU] 30 [ENTER]

The UUT will enter the *Modulation Source* menu

Select *Ext* using [NEXT]  
 Select 2 to select DC coupling  
 [MOD]  
 [SOURCE ON/OFF] (to enable modulation source)  
 [MOD ON/OFF] (to enable modulation)

- (3) Set the function generator to give 1 V RMS (+1 V peak for units with Option 10), 1 kHz sine wave.
- (4) On the modulation meter, select CAL, AM, 10 Hz  $\Rightarrow$  300 kHz filter.
- (5) On the modulation meter, check that the AM reading is between 76% and 84%, then set a reference using the relative function.
- (6) Record the absolute reading for use in the formula in (16).
- (7) Set the function generator to each of the frequencies shown in Table 7-34, checking that the relative readings on the modulation meter are within specification.
- (8) Set the UUT RF level to +7 dBm and repeat (3) to (7) using Table 7-35.

## 0 Hz (DC)

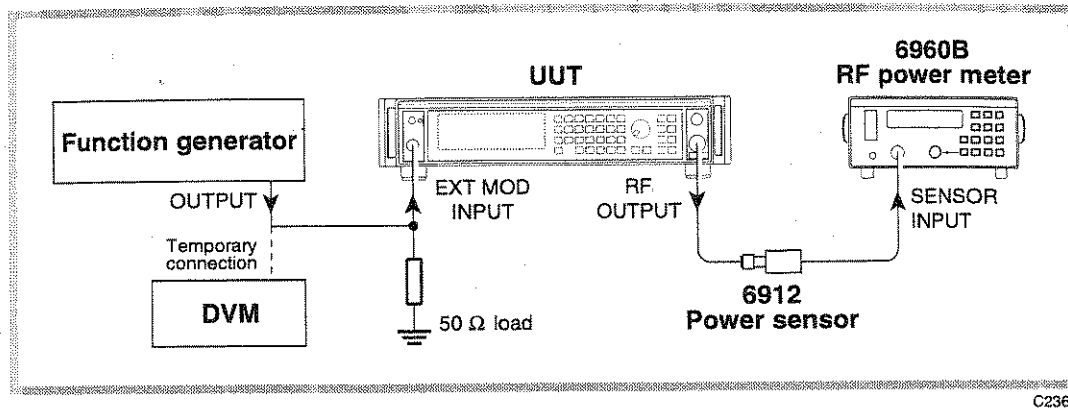

C2369

Fig. 7-10 0 Hz external AM and distortion test set-up

### Note

To measure the AM depth at DC, it will be necessary to use the DC offset facility on the function generator proceeding as follows:

- (9) Connect the test equipment as shown in Fig. 7-10.
- (10) Set the function generator to +1.4142 V DC (+1 V DC for units with Option 10).  
(Temporarily connect the function generator output to the DVM and set this voltage as close as possible to +1.4142 V (+1 V DC for units with Option 10).)
- (11) Measure the power on the power meter.

P1 = \_\_\_\_\_

- (12) Set the function generator to -1.4142 V DC (-1 V DC for units with Option 10). (Temporarily connect the function generator output to the DVM and set this voltage as close as possible to -1.4142 V (-1 V DC for units with Option 10).)
- (13) Measure the power on the power meter.

P2 = \_\_\_\_\_

- (14) Subtract P2 from P1 (= x)
- (15) Calculate the modulation depth using the formula:

$$AM = (\%) \left\{ \frac{1 - 10^{(-x/20)}}{1 + 10^{(-x/20)}} \right\}$$

- (16) Calculate the 0 Hz response relative to 1 kHz using the following formula, recording the result in Table 7-34:

$$20 \log_{10} \left\{ \frac{\text{Figure recorded in (6)}}{\text{Figure recorded in (15)}} \right\}$$

- (17) Set the UUT RF level to +7 dBm and repeat (4) to (16) using Table 7-35.

ACCEPTANCE  
TESTING

# Pulse modulation (not Option 7 or 11 – refer to Annex A or B) Specification

<b>Carrier frequency range:</b>	32 MHz to 2.51 GHz, usable to 10 MHz
<b>RF level range:</b>	Maximum guaranteed output is reduced to +8 dBm when pulse modulation is selected
<b>RF level accuracy:</b>	Maximum additional uncertainty is $\pm 0.5$ dB
<b>On/off ratio:</b>	Better than 40 dB Better than 45 dB below 1.2 GHz
<b>Rise and fall time:</b>	Less than 10 $\mu$ s

## Test equipment

Description	Minimum specification	Example
Power meter	$\pm 0.1$ dB from 9 kHz to 2.51 GHz	IFR 6960B and 6912
Spectrum analyzer	Frequency coverage 32 MHz to 2.51 GHz	Anritsu MS2602A or IFR 2386 or 2383
50 $\Omega$ load (termination)	1 W, 50 $\Omega$ nominal impedance, DC to 2.51 GHz	Lucas Weinschel M1404N
Oscilloscope	100 MHz bandwidth	Tektronix TAS 465
Function generator	DC to 10 kHz square wave	HP 3325B

## Pulse modulation RF level frequency response

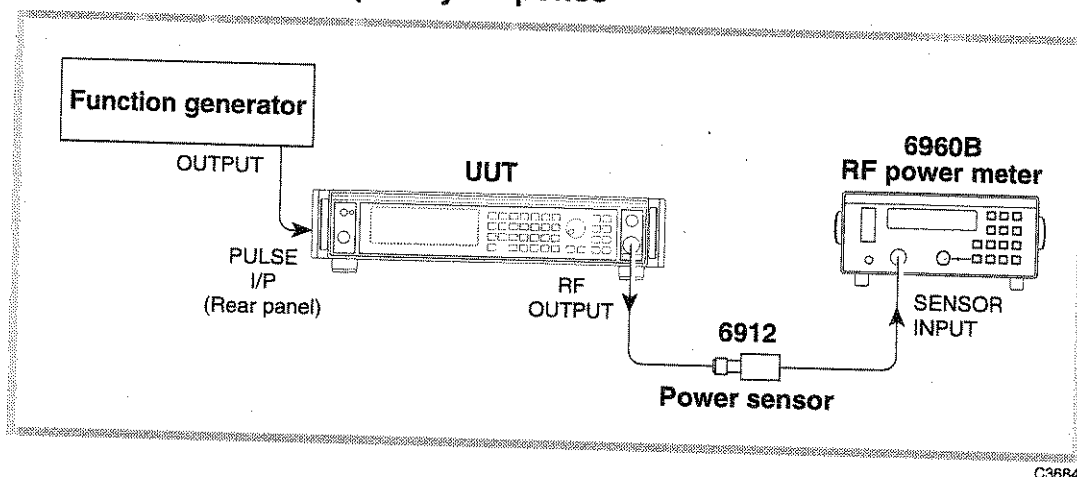

Fig. 7-11 Pulse modulation test set-up

## Test procedure

- (1) Perform AUTO ZERO and AUTO CAL on the power meter.
- (2) Connect the test equipment as shown in Fig. 7-11.
- (3) On the UUT set:
 

[CARR FREQ]	32 [MHz]
[RF LEVEL]	-7 [dB]
[MENU]	22 [ENTER]

The UUT will enter the *Pulse Modulation* menu.

Select *1* (to enable Pulse Mod.)

[MOD] then [MOD] then [MOD] again (to select *Pulse Mod*)

[SOURCE ON/OFF] (to enable modulation source)

[MOD ON/OFF] (to enable modulation)

- (4) Set the function generator to provide +5 V DC. The RF output will now be enabled.
- (5) Record the output level measured by the power meter against each of the carrier frequencies shown in Table 7-36, checking that the results are within specification.
- (6) Set the UUT RF level to +4 dBm and repeat (5) using Table 7-37.

## Pulse modulation on/off ratio

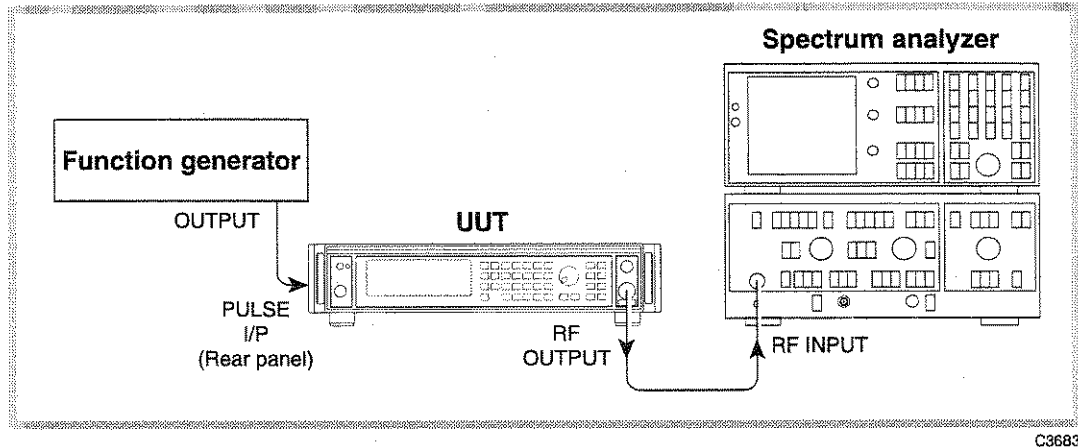

Fig. 7-12 Pulse modulation on/off ratio test set-up

## Test procedure

- (1) Press CAL on the spectrum analyzer.
- (2) Connect the test equipment as shown in Fig. 7-12.
- (3) On the UUT set:

[CARR FREQ]	32 [MHz]
[RF LEVEL]	0 [dB]
[MENU]	22 [ENTER]

The UUT will enter the *Pulse Modulation* menu

Select *1* (to enable Pulse Mod.)

[MOD] then [MOD] then [MOD] again (to select *Pulse Mod*)

[SOURCE ON/OFF] (to enable modulation source)

[MOD ON/OFF] (to enable modulation)

- (4) Set the function generator to provide +5 V DC. The RF output will now be enabled.
- (5) Tune the spectrum analyzer to the same frequency as the signal generator.
- (6) Press PEAK FIND on the spectrum analyzer and note the output level.
- (7) Switch off the function generator and apply a short circuit to the PULSE I/P socket on the rear panel.
- (8) Again note the output level measured by the spectrum analyzer.
- (9) The difference between the levels recorded in (6) and (8) is the pulse mod on/off ratio. Check that the ratio is within specification using Table 7-38.
- (10) Repeat (5) to (9) for each of the frequencies shown in Table 7-38.

ACCEPTANCE  
TESTING



## Pulse modulation rise and fall time

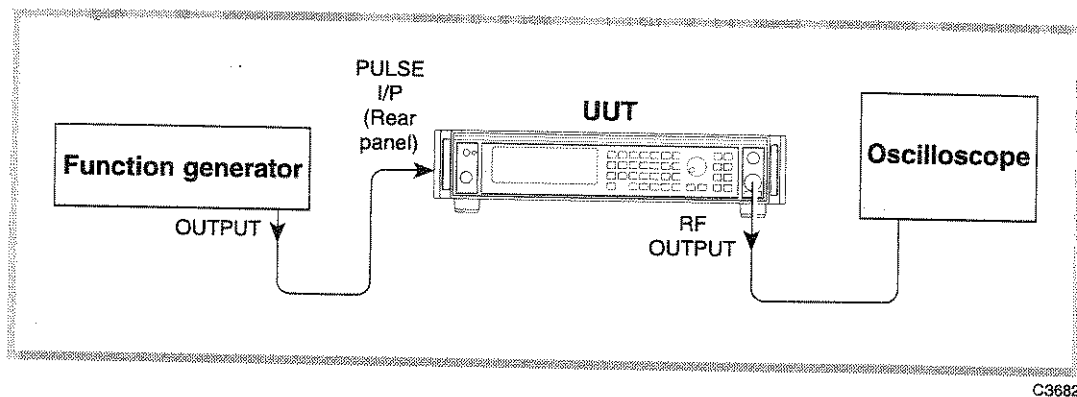

Fig. 7-13 Pulse modulation rise and fall time test set-up

### Test procedure

- (1) Connect the test equipment as shown in Fig. 7-13.
- (2) On the UUT set:
 

[CARR FREQ]	50 [MHz]
[RF LEVEL]	+7 [dB]
[MENU]	22 [ENTER]

The UUT will enter the *Pulse Modulation* menu.

Select *1* (to enable Pulse Mod)  
 [MOD] then [MOD] then [MOD] again (to select *Pulse Mod*)  
 [SOURCE ON/OFF] (to enable modulation source)  
 [MOD ON/OFF] (to enable modulation)

The RF output will now be enabled.

- (3) Set the function generator to produce 10 kHz, 0 V to +5 V square wave.
- (4) Adjust the oscilloscope controls such that the rise time of the envelope can be measured.
- (5) Measure the rise time between the 10% to 90% points, checking that it is within the specification shown in Table 7-39.
- (6) Repeat (4) to (5) for the fall time of the envelope.

## Modulation oscillator

### Specification

<b>Frequency range:</b>	0.01 Hz to 20 kHz
<b>Resolution:</b>	5 digits
<b>Distortion:</b>	Less than 0.1% at 1 kHz
<b>Waveforms:</b>	Sine (to 20 kHz), triangle or square wave (to 3 kHz) Square wave jitter <6.4 $\mu$ s on any edge
<b>Output:</b>	2 V RMS EMF from a 600 $\Omega$ source impedance

## Test equipment

Description	Minimum specification	Example
Frequency counter	9 kHz to 2.51 GHz	EIP535B or IFR 2440
50 $\Omega$ load (termination)	1 W, 50 $\Omega$ nominal impedance, DC to 2.51 GHz	Lucas Weinschel M1404N
Audio analyzer	Capable of measuring THD of 0.01% at 1 kHz	Rohde & Schwarz UPA3

## Modulation oscillator frequencies

### Test procedure

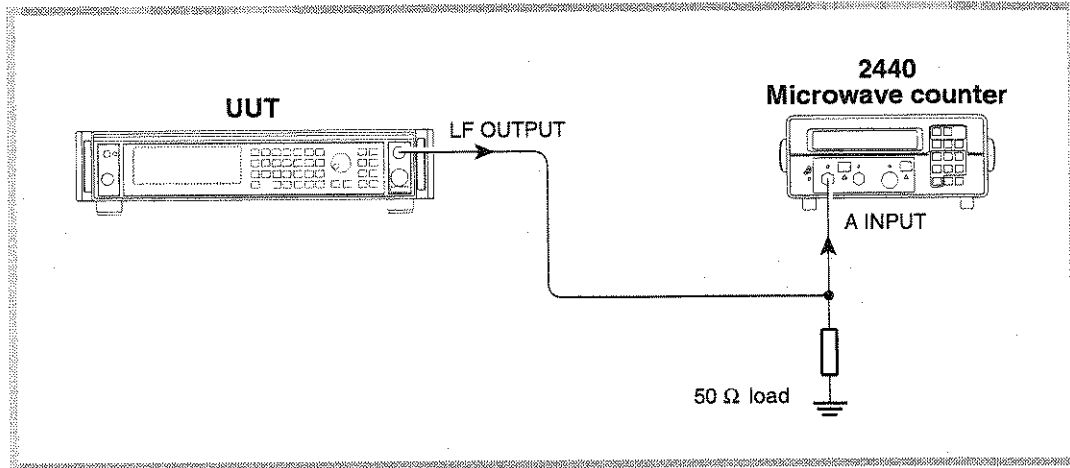

C2374

Fig. 7-14 Modulation oscillator frequency test set-up

- (1) Connect the test equipment as shown in Fig. 7-14.
- (2) On the UUT set:
  - [SOURCE ON/OFF] (to enable modulation source)
  - [MOD ON/OFF] (to enable modulation)
  - [MOD SOURCE] 10 Hz
- (3) Record the frequency measured by the counter against each of the modulation oscillator frequencies shown in Table 7-40.

## Modulation oscillator distortion and LF output flatness

### Test procedure

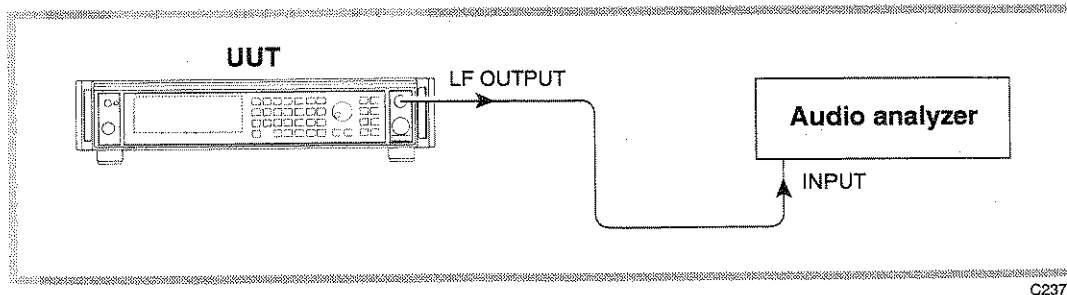

C2371

Fig. 7-15 Modulation oscillator distortion test set-up

- (1) Connect the test equipment as shown in Fig. 7-15.

ACCEPTANCE TESTING

- (2) On the UUT set:
  - [SOURCE ON/OFF] (to enable modulation source)
  - [MOD ON/OFF] (to enable modulation)
  - [MOD SOURCE] 1 kHz
- (3) Measure the distortion on the audio analyzer, checking that the result is within the specification shown in Table 7-41.
- (4) Measure the absolute level on the audio analyzer (in dBm) and record this level as a reference.
- (5) Set the UUT mod source to each of the frequencies shown in Table 7-41. Subtract the level measured on the audio analyzer at each frequency from that recorded in (4), checking that the results are within specification.

## External frequency standard input

### Specification

Input levels:	Requires an input of 220 mV RMS to 1.8 V RMS into 1 k $\Omega$
Input frequencies:	1 MHz or 10 MHz

### Test equipment

Description	Minimum specification	Example
Signal generator	220 mV to 1.8 V RMS, 1 MHz to 10 MHz	IFR 2041 or 2030

### Test procedure

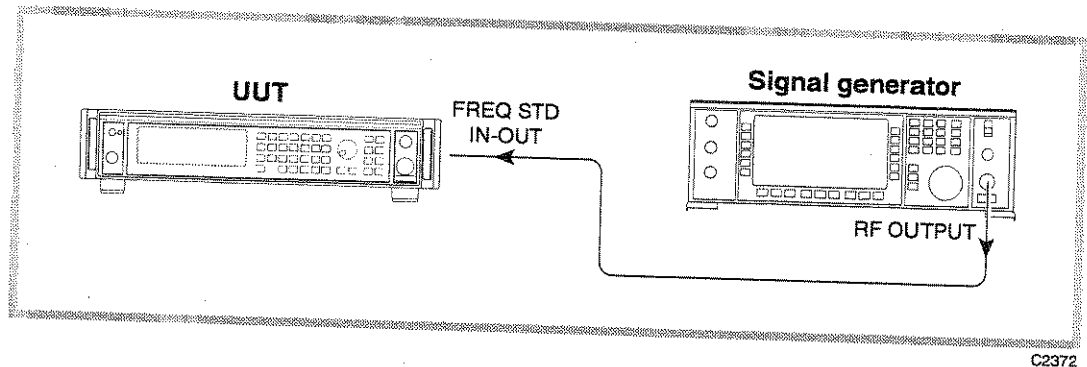

Fig. 7-16 External standard test set-up.

- (1) Connect the test equipment as shown in Fig. 7-16.
- (2) On the UUT set:
  - [MENU]
  - Select *Frequency/Sweep*
  - Using the [NEXT] key, select *Frequency Standard*
  - Select 2 (to select *Ext 1 MHz indirect*)
- (3) Set the signal generator to RF level 220 mV EMF, carrier frequency 1 MHz.
- (4) Using Table 7-42, check that no external standard error messages are displayed on the UUT.
- (5) Set the signal generator to 1.8 V EMF and repeat (4).
- (6) On the UUT select 3 (to select *Ext 10 MHz indirect*).
- (7) Set the signal generator to carrier frequency 10 MHz and repeat (4).
- (8) Set the signal generator to 220 mV and repeat (4).

# TEST PROCEDURES FOR INSTRUMENTS FITTED WITH OPTION 3

## RF output

### Specification

**Level range:** -140 dBm to +25 dBm, uncalibrated above +19 dBm for carrier frequencies from 1.2 GHz to 2.4 GHz and uncalibrated above +14 dBm for carrier frequencies above 2.4 GHz.

**Accuracy:** As per the standard instrument for output levels below +7 dBm.

For output levels above +7 dBm and over a temperature range of 17°C to 27°C:

±1 dBm to 1.2 GHz  
±2 dBm to 2.51 GHz

**Temperature coefficient**

≤±0.02 dB/°C to 1.2 GHz ,  
≤±0.03 dB/°C to 2.51 GHz

### Test equipment

Description	Minimum specification	Example
Power meter	±0.1 dB from 9 kHz to 2.51 GHz	IFR 6960B and 6932
Measuring receiver	0 dBm to -127 dBm; 2.5 MHz to 2.51 GHz	HP 8902A with 11722A sensor and 11793A down converter
Signal generator	+8 dBm from 32.5 MHz to 2.54 GHz	IFR 2041

## RF level frequency response

### Test procedure

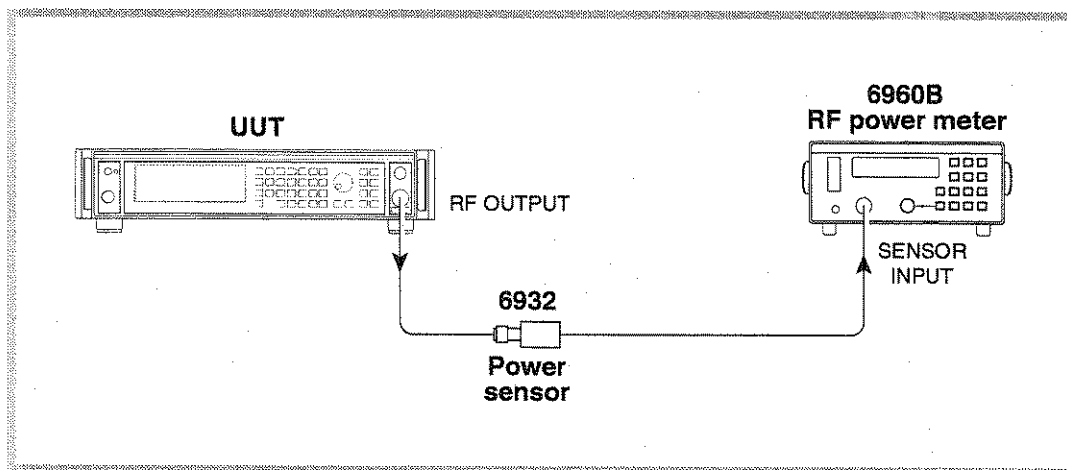

C2373

Fig. 7-17 RF output test set-up

- (1) Perform AUTO ZERO and AUTO CAL on the power meter.

ACCEPTANCE TESTING

- (2) Connect the test equipment as shown in Fig. 7-17.
- (3) On the UUT set:
 

[CARR FREQ]	30 [kHz]
[RF LEVEL]	0 [dB]
- (4) Record the output level measured by the power meter against each of the carrier frequencies shown in Table 7-43, checking that the results are within specification.
- (5) Set the UUT RF level to +7 dBm and repeat (4) using Table 7-44.
- (6) Set the UUT RF level to +13 dBm and repeat (4) using Table 7-45.
- (7) Set the UUT RF level to +25 dBm and repeat (4) using Table 7-46, decreasing the RF level to +19 dBm when testing at carrier frequencies above 1.2 GHz and further decreasing the RF level to +14 dBm when testing at carrier frequencies above 2.4 GHz.

## ALC linearity

### Test procedure

- (1) Perform AUTO ZERO and AUTO CAL on the power meter.
- (2) Connect the test equipment as shown in Fig. 7-17.
- (3) On the UUT set:
 

[CARR FREQ]	2.5 [MHz]
[RF LEVEL]	-4 [dB]
- (4) Record the output level measured by the power meter against each of the steps shown in Table 7-47, checking that the results are within specification.
- (5) Set the UUT carrier frequency to 500 MHz and repeat (4) using Table 7-48.
- (6) Set the UUT carrier frequency to 2050 MHz and repeat (4) using Table 7-49.
- (7) Set the UUT carrier frequency to 2510 MHz and repeat (4) using Table 7-50.

## Carrier harmonics

### Specification

Harmonics: Better than -25 dBc for RF levels up to 6 dB below the maximum specified output

### Test equipment

Description	Minimum specification	Example
Spectrum analyzer	DC to 7.6 GHz frequency coverage	Anritsu MS2602A IFR 2390 or 2386

## Test procedure

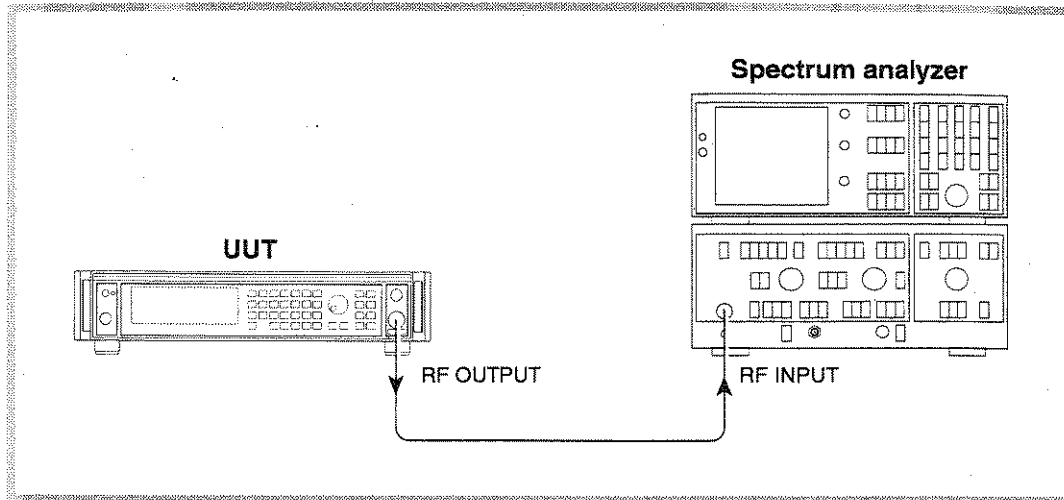

C2363

Fig. 7-18 Carrier harmonics test set-up

- (1) Press CAL on the spectrum analyzer.
- (2) Connect the test equipment as shown in Fig. 7-18.
- (3) On the UUT set:

[CARR FREQ]	10 [kHz]
[RF LEVEL]	+19 [dB]
- (4) Measure the level of the second and third harmonics on the spectrum analyzer at each of the carrier frequencies shown in Table 7-51, decreasing the RF output to +13 dBm for carrier frequencies above 1.2 GHz, checking that the results are within specification.

ACCEPTANCE  
TESTING

# TEST PROCEDURES FOR INSTRUMENTS FITTED WITH OPTION 12

## SINAD

### Specification

SINAD measurement resolution:	0.01 dB.
SINAD measurement range:	50 dB.
Filter weighting:	C-MESSAGE; CCITT P53; None.
Modulation frequency:	1.000 kHz.
Maximum input level:	3 V RMS (maximum safe input level $\pm 15$ V).
Sensitivity:	50 mV RMS (250 mV RMS for 50 dB SINAD).
Input impedance:	100 k $\Omega$ .
SINAD measurement accuracy:	$\pm 0.5$ dB.

### Test equipment – none required

### Measurement accuracy

### Test procedure

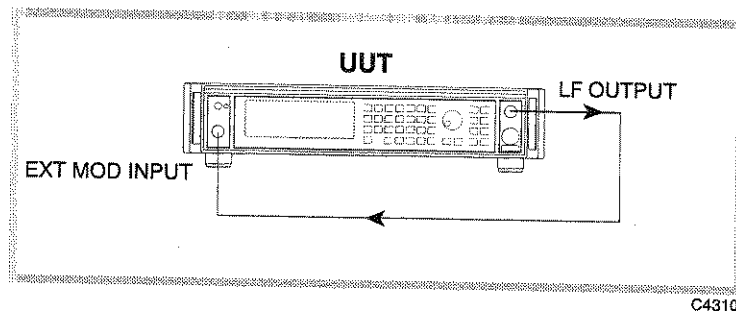

Fig. 7-19 SINAD test set-up

#### Note

The connection shown between EXT MOD INPUT and LF OUTPUT (on the standard instrument) is not required for instruments fitted with Option 7 or 11. With these options the signal is routed internally.

- (1) Connect the test equipment as shown in Fig. 7-19.
  - (2) Set FM1 Deviation as follows:  
[MOD] 10 [kHz]  
[MOD ON/OFF]  
[SOURCE ON/OFF]
- Set FM2 Deviation as follows:  
[MOD][MOD] 1.0 [kHz]  
[SOURCE ON/OFF]

Enable SINAD as follows:

[MENU]

49 [ENTER]

Select Weighting using [NEXT]

Set Unweighted by pressing 0

Select SINAD by using [NEXT]

Enable SINAD by pressing 1

[MOD][MOD]

- (3) Record the SINAD measured by the UUT in Table 7-52, checking that the result is within specification.

### Sensitivity

- (4) On the UUT set FM1 Deviation to 145 Hz as follows:

[MOD]

145 [Hz]

Turn off FM2 as follows:

[MOD][MOD]

[SOURCE ON/OFF]

Return to SINAD reading:

[MOD]

With FM2 Deviation set to 1 kHz but switched off, 145 Hz produces a 250 mV LF output.

- (5) Record the SINAD measured by the UUT in Table 7-53 checking that the result is within specification.

ACCEPTANCE  
TESTING



---

# ACCEPTANCE TEST RESULTS TABLES

For 2023A  signal generator, serial number \_\_\_\_\_ / \_\_\_\_\_  
2023B   
2025

- Option 1  no attenuator
- Option 2  DC operation
- Option 3  high power
- Option 4  high stability frequency standard
- Option 5  rear panel connectors
- Option 7  fast pulse modulation
- Option 10  1V peak mod input
- Option 11  high power and fast pulse modulator
- Option 12  SINAD



Table 7-1 RF output at 0 dBm (not Option 3)

Carrier frequency (MHz)	RF level min. (dBm)	Result (dBm)	RF level max. (dBm)
0.03	-0.8	_____	+0.8
0.33	-0.8	_____	+0.8
60	-0.8	_____	+0.8
180	-0.8	_____	+0.8
300	-0.8	_____	+0.8
420	-0.8	_____	+0.8
540	-0.8	_____	+0.8
660	-0.8	_____	+0.8
780	-0.8	_____	+0.8
900	-0.8	_____	+0.8
1020	-0.8	_____	+0.8
1140	-0.8	_____	+0.8
1200	-0.8	_____	+0.8
<b>2023B and 2025</b>			
1201	-1.2	_____	+1.2
1260	-1.2	_____	+1.2
1380	-1.2	_____	+1.2
1500	-1.2	_____	+1.2
1620	-1.2	_____	+1.2
1740	-1.2	_____	+1.2
1860	-1.2	_____	+1.2
2050	-1.2	_____	+1.2
<b>2025 only</b>			
2220	-1.6	_____	+1.6
2340	-1.6	_____	+1.6
2400	-1.6	_____	+1.6
2510	-1.6	_____	+1.6

**ACCEPTANCE TESTING**

Table 7-2 RF output at +7 dBm (not Option 3)

Carrier frequency (MHz)	RF level min. (dBm)	Result (dBm)	RF level max. (dBm)
0.03	+6.2	_____	+7.8
0.33	+6.2	_____	+7.8
60	+6.2	_____	+7.8
180	+6.2	_____	+7.8
300	+6.2	_____	+7.8
420	+6.2	_____	+7.8
540	+6.2	_____	+7.8
660	+6.2	_____	+7.8
780	+6.2	_____	+7.8
900	+6.2	_____	+7.8
1020	+6.2	_____	+7.8
1140	+6.2	_____	+7.8
1200	+6.2	_____	+7.8
<b>2023B and 2025</b>			
1201	+5.8	_____	8.2
1260	+5.8	_____	8.2
1380	+5.8	_____	8.2
1500	+5.8	_____	8.2
1620	+5.8	_____	8.2
1740	+5.8	_____	8.2
1860	+5.8	_____	8.2
2050	+5.8	_____	8.2
<b>2025 only</b>			
2220	+5.4	_____	+8.6
2340	+5.4	_____	+8.6
2400	+5.4	_____	+8.6
2510	+5.4	_____	+8.6

Table 7-3 RF output at +13 dBm (not Option 3)

Carrier frequency (MHz)	RF level min. (dBm)	Result (dBm)	RF level max. (dBm)
0.03	+12.2	_____	+13.8
0.33	+12.2	_____	+13.8
60	+12.2	_____	+13.8
180	+12.2	_____	+13.8
300	+12.2	_____	+13.8
420	+12.2	_____	+13.8
540	+12.2	_____	+13.8
660	+12.2	_____	+13.8
780	+12.2	_____	+13.8
900	+12.2	_____	+13.8
1020	+12.2	_____	+13.8
1140	+12.2	_____	+13.8
1200	+12.2	_____	+13.8
<b>2023B and 2025</b>			
1201	+11.8	_____	+14.2
1260	+11.8	_____	+14.2
1380	+11.8	_____	+14.2
1500	+11.8	_____	+14.2
1620	+11.8	_____	+14.2
1740	+11.8	_____	+14.2
1860	+11.8	_____	+14.2
2050	+11.8	_____	+14.2
<b>2025 only</b>			
2220	+11.4	_____	+14.6
2340	+11.4	_____	+14.6
2400	+11.4	_____	+14.6
2510	+11.4	_____	+14.6

**ACCEPTANCE TESTING**

Table 7-4 ALC linearity at 2.5 MHz (not Option 3)

RF level (dBm)	RF level min. (dBm)	Result (dBm)	RF level max. (dBm)
-4	-4.8	_____	-3.2
-3	-3.8	_____	-2.2
-2	-2.8	_____	-1.2
-1	-1.8	_____	-0.2
0	-0.8	_____	+0.8
1	+0.2	_____	+1.8
2	+1.2	_____	+2.8
3	+2.2	_____	+3.8
4	+3.2	_____	+4.8
5	+4.2	_____	+5.8
6	+5.2	_____	+6.8
7	+6.2	_____	+7.8
8	+7.2	_____	+8.8
9	+8.2	_____	+9.8
10	+9.2	_____	+10.8
11	+10.2	_____	+11.8
12	+11.2	_____	+12.8
12.1	+11.3	_____	+12.9
12.2	+11.4	_____	+13
12.3	+11.5	_____	+13.1
12.4	+11.6	_____	+13.2
12.5	+11.7	_____	+13.3
12.6	+11.8	_____	+13.4
12.7	+11.9	_____	+13.5
12.8	+12	_____	+13.6
12.9	+12.1	_____	+13.7
13	+12.2	_____	+13.8

Table 7-5 ALC linearity at 500 MHz (not Option 3)

RF level (dBm)	RF level min. (dBm)	Result (dBm)	RF level max. (dBm)
-4	-4.8	_____	-3.2
-3	-3.8	_____	-2.2
-2	-2.8	_____	-1.2
-1	-1.8	_____	-0.2
0	-0.8	_____	+0.8
1	+0.2	_____	+1.8
2	+1.2	_____	+2.8
3	+2.2	_____	+3.8
4	+3.2	_____	+4.8
5	+4.2	_____	+5.8
6	+5.2	_____	+6.8
7	+6.2	_____	+7.8
8	+7.2	_____	+8.8
9	+8.2	_____	+9.8
10	+9.2	_____	+10.8
11	+10.2	_____	+11.8
12	+11.2	_____	+12.8
12.1	+11.3	_____	+12.9
12.2	+11.4	_____	+13
12.3	+11.5	_____	+13.1
12.4	+11.6	_____	+13.2
12.5	+11.7	_____	+13.3
12.6	+11.8	_____	+13.4
12.7	+11.9	_____	+13.5
12.8	+12	_____	+13.6
12.9	+12.1	_____	+13.7
13	+12.2	_____	+13.8

ACCEPTANCE TESTING

Table 7-6 ALC linearity at 2050 MHz (2023B and 2025, not Option 3)

RF level (dBm)	RF level min. (dBm)	Result (dBm)	RF level max. (dBm)
-4	-5.2	_____	-2.8
-3	-4.2	_____	-1.8
-2	-3.2	_____	-0.8
-1	-2.2	_____	+0.2
0	-1.2	_____	+1.2
1	-0.2	_____	+2.2
2	+0.8	_____	+3.2
3	+1.8	_____	+4.2
4	+2.8	_____	+5.2
5	+3.8	_____	+6.2
6	+4.8	_____	+7.2
7	+5.8	_____	+8.2
8	+6.8	_____	+9.2
9	+7.8	_____	+10.2
10	+8.8	_____	+11.2
11	+9.8	_____	+12.2
12	+10.8	_____	+13.2
12.1	+10.9	_____	+13.3
12.2	+11	_____	+13.4
12.3	+11.1	_____	+13.5
12.4	+11.2	_____	+13.6
12.5	+11.3	_____	+13.7
12.6	+11.4	_____	+13.8
12.7	+11.5	_____	+13.9
12.8	+11.6	_____	+14
12.9	+11.7	_____	+14.1
13	+11.8	_____	+14.2

Table 7-7 ALC linearity at 2510 MHz (2025 only, not Option 3)

RF level (dBm)	RF Level Min. (dBm)	Result (dBm)	RF Level Max. (dBm)
-4	-5.6	_____	-2.4
-3	-4.6	_____	-1.4
-2	-3.6	_____	-0.4
-1	-2.6	_____	+0.6
0	-1.6	_____	+1.6
1	-0.6	_____	+2.6
2	+0.4	_____	+3.6
3	+1.4	_____	+4.6
4	+2.4	_____	+5.6
5	+3.4	_____	+6.6
6	+4.4	_____	+7.6
7	+5.4	_____	+8.6
8	+6.4	_____	+9.6
9	+7.4	_____	+10.6
10	+8.4	_____	+11.6
11	+9.4	_____	+12.6
12	+10.4	_____	+13.6
12.1	+10.5	_____	+13.7
12.2	+10.6	_____	+13.8
12.3	+10.7	_____	+13.9
12.4	+10.8	_____	+14
12.5	+10.9	_____	+14.1
12.6	+11	_____	+14.2
12.7	+11.1	_____	+14.3
12.8	+11.2	_____	+14.4
12.9	+11.3	_____	+14.5
13	+11.4	_____	+14.6

ACCEPTANCE TESTING



Table 7-8 Attenuator test at 2.6 MHz

RF Level (dBm)	RF level min. (dBm)	Result (dBm)	RF level max. (dBm)
0	-0.8	_____	+0.8
-4.1	-4.9	_____	-3.3
-15.1	-15.9	_____	-14.3
-26.1	-26.9	_____	-25.3
-37.1	-37.9	_____	-36.3
-48.1	-48.9	_____	-47.3
-59.1	-59.9	_____	-58.3
-70.1	-70.9	_____	-69.3
-81.1	-81.9	_____	-80.3
-92.1	-92.9	_____	-91.3
-103.1	-103.9	_____	-102.3

Table 7-9 Attenuator test at 540 MHz

RF Level (dBm)	RF level min. (dBm)	Result (dBm)	RF level max. (dBm)
0	-0.8	_____	+0.8
-4.1	-4.9	_____	-3.3
-15.1	-15.9	_____	-14.3
-26.1	-26.9	_____	-25.3
-37.1	-37.9	_____	-36.3
-48.1	-48.9	_____	-47.3
-59.1	-59.9	_____	-58.3
-70.1	-70.9	_____	-69.3
-81.1	-81.9	_____	-80.3
-92.1	-92.9	_____	-91.3
-103.1	-103.9	_____	-102.3

Table 7-10 Attenuator test at 1140 MHz

RF Level (dBm)	RF level min. (dBm)	Result (dBm)	RF level max. (dBm)
0	-0.8	_____	+0.8
-4.1	-4.9	_____	-3.3
-15.1	-15.9	_____	-14.3
-26.1	-26.9	_____	-25.3
-37.1	-37.9	_____	-36.3
-48.1	-48.9	_____	-47.3
-59.1	-59.9	_____	-58.3
-70.1	-70.9	_____	-69.3
-81.1	-81.9	_____	-80.3
-92.1	-92.9	_____	-91.3
-103.1	-103.9	_____	-102.3

Table 7-11 Attenuator test at 1740 MHz (2023B and 2025)

RF level (dBm)	RF level min. (dBm)	Result (dBm)	RF level max. (dBm)
0	-1.2	_____	+1.2
-4.1	-5.3	_____	-2.9
-15.1	-16.3	_____	-13.9
-26.1	-27.3	_____	-24.9
-37.1	-38.3	_____	-35.9
-48.1	-49.3	_____	-46.9
-59.1	-60.3	_____	-57.9
-70.1	-71.3	_____	-68.9
-81.1	-82.3	_____	-79.9
-92.1	-93.3	_____	-90.9
-103.1	-104.3	_____	-101.9

ACCEPTANCE TESTING

Table 7-12 Attenuator test at 2050 MHz (2023B) or 2510 MHz (2025)

RF level (dBm)	RF level min. (dBm)	Result (dBm)	RF level max. (dBm)
0	-1.2	_____	+1.2
-4.1	-5.3	_____	-2.9
-15.1	-16.3	_____	-13.9
-26.1	-27.3	_____	-24.9
-37.1	-38.3	_____	-35.9
-48.1	-49.3	_____	-46.9
-59.1	-60.3	_____	-57.9
-70.1	-71.3	_____	-68.9
-81.1	-82.3	_____	-79.9
-92.1	-93.3	_____	-90.9
-103.1	-104.3	_____	-101.9

Table 7-13 Alternative attenuator functional test at 10 MHz

Attenuator pad	Measured value (dB)
33 dB	_____
22 dB	_____
33 dB	_____
11 dB	_____
33 dB	_____

Table 7-14 Carrier frequency tests

Frequency (MHz)	Frequency min. (MHz)	Result (MHz)	Frequency max. (MHz)
0.009	-	_____	-
1	-	_____	-
9.999999	-	_____	-
18.75	-	_____	-
37.5	-	_____	-
75	-	_____	-
150	-	_____	-
300	-	_____	-
600	-	_____	-
1200	1199.99988	_____	1200.00012
<b>Instrument fitted with Option 4</b>			
1200	1199.99988	_____	1200.00012
<b>2023B and 2025</b>			
1200.000001	-	_____	-
1230	-	_____	-
1250	-	_____	-
1260	-	_____	-
1320	-	_____	-
1350	-	_____	-
1500	-	_____	-
1599.999999	-	_____	-
2050	-	_____	-
<b>2025 ONLY</b>			
2510	-	_____	-

**ACCEPTANCE TESTING**

Table 7-15 Carrier harmonic tests at -4 dBm (not Option 3)

Carrier frequency (MHz)	2nd harmonic max. level (dBc)	Result (dBc)	3rd harmonic max. level (dBc)	Result (dBc)
0.01	-30	_____	-30	_____
0.1	-30	_____	-30	_____
1	-30	_____	-30	_____
9.9	-30	_____	-30	_____
10	-30	_____	-30	_____
18.7	-30	_____	-30	_____
18.8	-30	_____	-30	_____
37.4	-30	_____	-30	_____
37.6	-30	_____	-30	_____
74.9	-30	_____	-30	_____
75.1	-30	_____	-30	_____
150	-30	_____	-30	_____
151	-30	_____	-30	_____
300	-30	_____	-30	_____
301	-30	_____	-30	_____
600	-30	_____	-30	_____
601	-30	_____	-30	_____
750	-30	_____	-30	_____
950	-30	_____	-30	_____
1200	-30	_____	-30	_____
<b>2023B and 2025</b>				
1201	-30	_____	-30	_____
1500	-30	_____	-30	_____
1900	-30	_____	-30	_____
<b>2025 ONLY</b>				
2510	-30	_____	-30	_____

Table 7-16 Carrier harmonic tests at 0 dBm (not Option 3)

Carrier frequency (MHz)	2nd harmonic max. level (dBc)	Result (dBc)	3rd harmonic max. level (dBc)	Result (dBc)
0.01	-30	_____	-30	_____
0.1	-30	_____	-30	_____
1	-30	_____	-30	_____
9.9	-30	_____	-30	_____
10	-30	_____	-30	_____
18.7	-30	_____	-30	_____
18.8	-30	_____	-30	_____
37.4	-30	_____	-30	_____
37.6	-30	_____	-30	_____
74.9	-30	_____	-30	_____
75.1	-30	_____	-30	_____
150	-30	_____	-30	_____
151	-30	_____	-30	_____
300	-30	_____	-30	_____
301	-30	_____	-30	_____
600	-30	_____	-30	_____
601	-30	_____	-30	_____
750	-30	_____	-30	_____
950	-30	_____	-30	_____
1200	-30	_____	-30	_____
<b>2023B and 2025</b>				
1201	-30	_____	-30	_____
1500	-30	_____	-30	_____
1900	-30	_____	-30	_____
<b>2025 ONLY</b>				
2510	-30	_____	-30	_____

**ACCEPTANCE TESTING**

Table 7-17 Carrier harmonic tests at +7 dBm (not Option 3)

Carrier frequency (MHz)	2nd harmonic max. level (dBc)	Result (dBc)	3rd harmonic max. level (dBc)	Result (dBc)
0.01	-30	_____	-30	_____
0.1	-30	_____	-30	_____
1	-30	_____	-30	_____
9.9	-30	_____	-30	_____
10	-30	_____	-30	_____
18.7	-30	_____	-30	_____
18.8	-30	_____	-30	_____
37.4	-30	_____	-30	_____
37.6	-30	_____	-30	_____
74.9	-30	_____	-30	_____
75.1	-30	_____	-30	_____
150	-30	_____	-30	_____
151	-30	_____	-30	_____
300	-30	_____	-30	_____
301	-30	_____	-30	_____
600	-30	_____	-30	_____
601	-30	_____	-30	_____
750	-30	_____	-30	_____
950	-30	_____	-30	_____
1200	-30	_____	-30	_____
<b>2023B and 2025</b>				
1201	-30	_____	-30	_____
1500	-30	_____	-30	_____
1900	-30	_____	-30	_____
<b>2025 ONLY</b>				
2510	-30	_____	-30	_____

Table 7-18 Carrier non-harmonic tests

Carrier frequency (MHz)	Sub-harmonic output			Sub-harmonic output		
	Non-harmonic frequency (MHz)	Non-harmonic level (dBc)	Result (dBc)	Non-harmonic frequency (MHz)	Non-harmonic level (dBc)	Result (dBc)
1201	800.6667	-64	_____	1601.3333	-64	_____
1201	400.3333	-64	_____	2001.6667	-64	_____
1599	1066	-64	_____	2132	-64	_____
1599	533	-64	_____	2665	-64	_____
1601	1200.75	-64	_____	2001.25	-64	_____
1601	800.5	-64	_____	2401.5	-64	_____
1999	1499.25	-64	_____	2498.75	-64	_____
1999	999.5	-64	_____	2998.5	-64	_____
2001	1600.8	-60	_____	2401.2	-60	_____
2001	1200.6	-60	_____	2801.4	-60	_____
2400	1920	-60	_____	2880	-60	_____
2400	1440	-60	_____	3360	-60	_____
9.9	100.000032	-70	_____	109.900036	-70	_____

Table 7-19 Residual FM test

Carrier frequency	Residual FM	Measured value (Hz RMS)
1 GHz	<4.5 Hz RMS	_____

Table 7-20 SSB phase noise test

Carrier frequency	SSB phase noise at 20 kHz offset	Measured value (dBc/Hz)
470 MHz	<-124 dBc/Hz	_____

**ACCEPTANCE TESTING**



Table 7-21 RF leakage test

Carrier frequency (MHz)	RF leakage	Measured value (dBm)
469	<0.5 $\mu$ V	_____
929	<0.5 $\mu$ V	_____
1349	<0.5 $\mu$ V	_____
2509	<0.5 $\mu$ V	_____

Table 7-22 Internal FM deviation and distortion tests at 100 kHz deviation

Carrier frequency (MHz)	FM deviation			Distortion	
	FM deviation min. (kHz)	Result (kHz)	FM deviation max. (kHz)	Distortion (%)	Result (%)
10	96	_____	104	<3%	_____
10.144	96	_____	104	<3%	_____
10.292	96	_____	104	<3%	_____
10.441	96	_____	104	<3%	_____
10.592	96	_____	104	<3%	_____
10.746	96	_____	104	<3%	_____
10.901	96	_____	104	<3%	_____
11.059	96	_____	104	<3%	_____
11.22	96	_____	104	<3%	_____
11.382	96	_____	104	<3%	_____
11.547	96	_____	104	<3%	_____
11.714	96	_____	104	<3%	_____
11.884	96	_____	104	<3%	_____
12.056	96	_____	104	<3%	_____
12.23	96	_____	104	<3%	_____
12.5	96	_____	104	<3%	_____
12.587	96	_____	104	<3%	_____
12.77	96	_____	104	<3%	_____
12.995	96	_____	104	<3%	_____
13.143	96	_____	104	<3%	_____
13.333	96	_____	104	<3%	_____

Table 7-23 FM scale shape tests at 15 MHz carrier

FM deviation (kHz)	FM deviation min. (kHz)	Result (kHz)	FM deviation max. (kHz)
100	96	_____	104
71	68.16	_____	73.84
56	53.76	_____	58.24
44	42.24	_____	45.76
34	32.64	_____	35.36
27	25.92	_____	28.08
21	20.16	_____	21.84
16	15.36	_____	16.64
13	12.48	_____	13.52
11	10.56	_____	11.44
10	9.6	_____	10.4
1	0.96	_____	1.04
0.1	0.096	_____	0.104

Table 7-24 Carrier error test at 1.2 GHz, FM deviation 100 kHz

Carrier error	Result (kHz)
<1 kHz	_____

Table 7-25 External FM frequency response (ALC off, DC coupled), 50 kHz deviation

Modulation frequency (kHz)	Response level min. (dB)	Result (dB)	Response level max. (dB)	Distortion (%)	Result (%)
0	-1	_____	+1	-	-
0.03	-1	_____	+1	-	-
0.1	-1	_____	+1	<3	_____
0.3	-1	_____	+1	-	-
1	-	reference	-	<3	_____
3	-1	_____	+1	-	-
5	-1	_____	+1	<3	_____
10	-1	_____	+1	-	-
20	-1	_____	+1	<3	_____
50	-1	_____	+1	-	-
100	-1	_____	+1	-	-
200	-1	_____	+1	-	-
275	-1	_____	+1	-	-

ACCEPTANCE TESTING

Table 7-26 External FM frequency response (ALC on), 10 kHz deviation, 0.75 V input

Modulation frequency (kHz)	Response level min. (dB)	Result (dB)	Response level max. (dB)
0.02	-1	_____	+1
0.1	-1	_____	+1
0.3	-1	_____	+1
1	-	reference	-
3	-1	_____	+1
10	-1	_____	+1
30	-1	_____	+1
100	-1	_____	+1
200	-1	_____	+1
275	-1	_____	+1

Table 7-27 External FM frequency response (ALC on), 10 kHz deviation, 1.25 V input

Modulation frequency (kHz)	Response level min. (dB)	Result (dB)	Response level max. (dB)	Distortion (%)	Result (%)
0.02	-1	_____	+1	-	-
0.1	-1	_____	+1	<3	_____
0.3	-1	_____	+1	-	-
1	-	reference	-	<3	_____
3	-1	_____	+1	-	-
5	-1	_____	+1	<3	_____
10	-1	_____	+1	-	-
20	-1	_____	+1	<3	_____
30	-1	_____	+1	-	-
100	-1	_____	+1	-	-
200	-1	_____	+1	-	-
275	-1	_____	+1	-	-

Table 7-28 Internal  $\Phi$ M and distortion test at 10.5 MHz carrier, 10 rad deviation

$\Phi$ M deviation			Distortion	
$\Phi$ M deviation min. (rad)	Result (rad)	$\Phi$ M deviation max. (rad)	Distortion (%)	Result (%)
9.6	_____	10.4	<3%	_____

Table 7-29 Internal FM flatness test

Modulation frequency (kHz)	Response level min. (dB)	Result (dB)	Response level max. (dB)
0.1	-3	_____	+3
0.3	-3	_____	+3
1	-	reference	-
3	-3	_____	+3
10	-3	_____	+3

Table 7-30 Internal AM depth and distortion tests at -4 dBm

Carrier frequency (MHz)	AM depth 30%			AM depth 80%			Distortion	
	min. (%)	Result (%)	max. (%)	min. (%)	Result (%)	max. (%)	Result at 30% depth (<1.5%)	Result at 80% depth (<2.5%)
1.5	28.5	_____	31.5	76	_____	84	_____	_____
5	28.5	_____	31.5	76	_____	84	_____	_____
9	28.5	_____	31.5	76	_____	84	_____	_____
11	28.5	_____	31.5	76	_____	84	_____	_____
20	28.5	_____	31.5	76	_____	84	_____	_____
50	28.5	_____	31.5	76	_____	84	_____	_____
100	28.5	_____	31.5	76	_____	84	_____	_____
200	28.5	_____	31.5	76	_____	84	_____	_____
500	28.5	_____	31.5	76	_____	84	_____	_____

Table 7-31 Internal AM depth and distortion tests at 0 dBm

Carrier frequency (MHz)	AM depth 30%			AM depth 80%			Distortion	
	min. (%)	Result (%)	max. (%)	min (%)	Result (%)	max. (%)	Result at 30% depth (<1.5%)	Result at 80% depth (<2.5%)
1.5	28.5	_____	31.5	76	_____	84	_____	_____
5	28.5	_____	31.5	76	_____	84	_____	_____
9	28.5	_____	31.5	76	_____	84	_____	_____
11	28.5	_____	31.5	76	_____	84	_____	_____
20	28.5	_____	31.5	76	_____	84	_____	_____
50	28.5	_____	31.5	76	_____	84	_____	_____
100	28.5	_____	31.5	76	_____	84	_____	_____
200	28.5	_____	31.5	76	_____	84	_____	_____
500	28.5	_____	31.5	76	_____	84	_____	_____

Table 7-32 Internal AM depth and distortion tests at +7 dBm

Carrier frequency (MHz)	AM depth 30%			AM depth 80%			Distortion	
	min. (%)	Result (%)	max. (%)	min. (%)	Result (%)	max. (%)	Result at 30% depth (<1.5%)	Result at 80% depth (<2.5%)
1.5	28.5	_____	31.5	76	_____	84	_____	_____
5	28.5	_____	31.5	76	_____	84	_____	_____
9	28.5	_____	31.5	76	_____	84	_____	_____
11	28.5	_____	31.5	76	_____	84	_____	_____
20	28.5	_____	31.5	76	_____	84	_____	_____
50	28.5	_____	31.5	76	_____	84	_____	_____
100	28.5	_____	31.5	76	_____	84	_____	_____
200	28.5	_____	31.5	76	_____	84	_____	_____
500	28.5	_____	31.5	76	_____	84	_____	_____

ACCEPTANCE TESTING

Table 7-33 AM scale shape test

AM depth (%)	AM depth min. (%)	Result (%)	AM depth max. (%)
10	9.5	_____	10.5
20	19	_____	21
30	28.5	_____	31.5
40	38	_____	42
50	47.5	_____	52.5
60	57	_____	63
70	66.5	_____	73.5
80	76	_____	84
85	80.75	_____	89.25

**Table 7-34 External AM frequency response (ALC off, DC coupled), RF level -4 dBm**

Modulation frequency (kHz)	Response level min. (dB)	Result (dB)	Response level max. (dB)
0	-1	_____	+1
0.1	-1	_____	+1
0.3	-1	_____	+1
1	-	reference	-
10	-1	_____	+1
20	-1	_____	+1
30	-1	_____	+1

**Table 7-35 External AM frequency response (ALC off, DC coupled), RF level +7 dBm**

Modulation frequency (kHz)	Response level min. (dB)	Result (dB)	Response level max. (dB)
0	-1	_____	+1
0.1	-1	_____	+1
0.3	-1	_____	+1
1	-	reference	-
10	-1	_____	+1
20	-1	_____	+1
30	-1	_____	+1

**ACCEPTANCE TESTING**



Table 7-36 Pulse modulation RF output at -7 dBm (not Option 7 or 11)

Carrier frequency (MHz)	RF level min. (dBm)	Result (dBm)	RF level max. (dBm)
30	-8.3	_____	+5.7
60	-8.3	_____	+5.7
180	-8.3	_____	+5.7
300	-8.3	_____	+5.7
420	-8.3	_____	+5.7
540	-8.3	_____	+5.7
660	-8.3	_____	+5.7
780	-8.3	_____	+5.7
900	-8.3	_____	+5.7
1020	-8.3	_____	+5.7
1140	-8.3	_____	+5.7
1200	-8.3	_____	+5.7
<b>2023B and 2025</b>			
1201	-8.7	_____	+5.3
1260	-8.7	_____	+5.3
1380	-8.7	_____	+5.3
1500	-8.7	_____	+5.3
1620	-8.7	_____	+5.3
1740	-8.7	_____	+5.3
1860	-8.7	_____	+5.3
2050	-8.7	_____	+5.3
<b>2025 only</b>			
2220	-9.1	_____	+4.9
2340	-9.1	_____	+4.9
2400	-9.1	_____	+4.9
2510	-9.1	_____	+4.9

Table 7-37 Pulse modulation RF output at +4 dBm (not Option 7 or 11)

Carrier frequency (MHz)	RF level min. (dBm)	Result (dBm)	RF level max. (dBm)
30	+2.7	_____	+5.3
60	+2.7	_____	+5.3
180	+2.7	_____	+5.3
300	+2.7	_____	+5.3
420	+2.7	_____	+5.3
540	+2.7	_____	+5.3
660	+2.7	_____	+5.3
780	+2.7	_____	+5.3
900	+2.7	_____	+5.3
1020	+2.7	_____	+5.3
1140	+2.7	_____	+5.3
1200	+2.7	_____	+5.3
<b>2023B and 2025</b>			
1201	+2.3	_____	+5.7
1260	+2.3	_____	+5.7
1380	+2.3	_____	+5.7
1500	+2.3	_____	+5.7
1620	+2.3	_____	+5.7
1740	+2.3	_____	+5.7
1860	+2.3	_____	+5.7
2050	+2.3	_____	+5.7
<b>2025 ONLY</b>			
2220	+1.9	_____	+6.1
2340	+1.9	_____	+6.1
2400	+1.9	_____	+6.1
2510	+1.9	_____	+6.1

**ACCEPTANCE TESTING**

**Table 7-38 Pulse modulation on/off ratio test (not Option 7 or 11)**

Carrier frequency (MHz)	Pulse mod. on/off ratio (dB)	Measured value (dB)
32	>45	_____
100	>45	_____
320	>45	_____
1000	>45	_____
1200	>45	_____
<b>2023B and 2025</b>		
1500	>40	_____
1800	>40	_____
<b>2025 ONLY</b>		
2100	>40	_____
2510	>40	_____

**Table 7-39 Pulse modulation rise and fall time test (not Option 7)**

		Result ( $\mu$ s)
Rise time	<10 $\mu$ s	_____
Fall time	<10 $\mu$ s	_____

**Table 7-40 Modulation oscillator frequency tests**

Frequency (Hz)	Result (Hz)
10	_____
100	_____
1000	_____
20000	_____

**Table 7-41 Modulation oscillator distortion and LF output tests**

Mod. oscillator frequency (Hz)	Response level min. (dB)	Result	Response level max. (dB)	Distortion (%)	Result (%)
10	-1	_____	+1	-	-
20	-1	_____	+1	-	-
50	-1	_____	+1	-	-
100	-1	_____	+1	-	-
200	-1	_____	+1	-	-
500	-1	_____	+1	-	-
1000	-1	reference	-	<0.1%	_____
2000	-1	_____	+1	-	-
5000	-1	_____	+1	-	-
10000	-1	_____	+1	-	-
20000	-1	_____	+1	-	-

**Table 7-42 External frequency standard tests**

External signal	Locked [✓]
1 MHz, 220 mV	[ ]
1 MHz, 1.8 V	[ ]
10 MHz, 220 mV	[ ]
10 MHz, 1.8 V	[ ]

**ACCEPTANCE TESTING**

# ACCEPTANCE TEST RESULTS TABLES OPTION 3

Table 7-43 RF output at 0 dBm

Carrier Frequency (MHz)	RF Level Min. (dBm)	Result (dBm)	RF Level Max. (dBm)
0.03	-0.8	_____	+0.8
0.33	-0.8	_____	+0.8
60	-0.8	_____	+0.8
180	-0.8	_____	+0.8
300	-0.8	_____	+0.8
420	-0.8	_____	+0.8
540	-0.8	_____	+0.8
660	-0.8	_____	+0.8
780	-0.8	_____	+0.8
900	-0.8	_____	+0.8
1020	-0.8	_____	+0.8
1140	-0.8	_____	+0.8
1200	-0.8	_____	+0.8
<b>2023B and 2025</b>			
1201	-1.2	_____	+1.2
1260	-1.2	_____	+1.2
1380	-1.2	_____	+1.2
1500	-1.2	_____	+1.2
1620	-1.2	_____	+1.2
1740	-1.2	_____	+1.2
1860	-1.2	_____	+1.2
2050	-1.2	_____	+1.2
<b>2025 ONLY</b>			
2220	-1.6	_____	+1.6
2340	-1.6	_____	+1.6
2400	-1.6	_____	+1.6
2510	-1.6	_____	+1.6

Table 7-44 RF Output at +7 dBm

Carrier Frequency (MHz)	RF Level Min. (dBm)	Result (dBm)	RF Level Max. (dBm)
0.03	+6	_____	+8
0.33	+6	_____	+8
60	+6	_____	+8
180	+6	_____	+8
300	+6	_____	+8
420	+6	_____	+8
540	+6	_____	+8
660	+6	_____	+8
780	+6	_____	+8
900	+6	_____	+8
1020	+6	_____	+8
1140	+6	_____	+8
1200	+6	_____	+8
<b>2023B and 2025</b>			
1201	+5	_____	+9
1260	+5	_____	+9
1380	+5	_____	+9
1500	+5	_____	+9
1620	+5	_____	+9
1740	+5	_____	+9
1860	+5	_____	+9
2050	+5	_____	+9
<b>2025 ONLY</b>			
2220	+5	_____	+9
2340	+5	_____	+9
2400	+5	_____	+9
2510	+5	_____	+9

**ACCEPTANCE TESTING**



Table 7-46 RF Output at +25 dBm

Carrier frequency (MHz)	RF level min. (dBm)	Result (dBm)	RF level max. (dBm)
0.03	+24	_____	+26
0.33	+24	_____	+26
60	+24	_____	+26
180	+24	_____	+26
300	+24	_____	+26
420	+24	_____	+26
540	+24	_____	+26
660	+24	_____	+26
780	+24	_____	+26
900	+24	_____	+26
1020	+24	_____	+26
1140	+24	_____	+26
1200	+24	_____	+26
<b>2023B and 2025, +19 dBm</b>			
1201	+17	_____	+21
1260	+17	_____	+21
1380	+17	_____	+21
1500	+17	_____	+21
1620	+17	_____	+21
1740	+17	_____	+21
1860	+17	_____	+21
2050	+17	_____	+21
<b>2025 ONLY, +19 dBm</b>			
2220	+17	_____	+21
2340	+17	_____	+21
2400	+17	_____	+21
<b>+14 dBm</b>			
2510	+12	_____	+16

**ACCEPTANCE TESTING**



Table 7-47 ALC linearity at 2.5 MHz

RF level (dBm)	RF Level Min. (dBm)	Result (dBm)	RF Level Max. (dBm)
-4	-4.8	_____	-3.2
-3	-3.8	_____	-2.2
-2	-2.8	_____	-1.2
-1	-1.8	_____	-0.2
0	-0.8	_____	+0.8
1	0.2	_____	+1.8
2	+1.2	_____	+2.8
3	+2.2	_____	+3.8
4	+3.2	_____	+4.8
5	+4.2	_____	+5.8
6	+5.2	_____	+6.8
7	+6	_____	+8
8	+7	_____	+9
9	+8	_____	+10
10	+9	_____	+11
11	+10	_____	+12
12	+11	_____	+13
12.1	+11.1	_____	+13.1
12.2	+11.2	_____	+13.2
12.3	+11.3	_____	+13.3
12.4	+11.4	_____	+13.4
12.5	+11.5	_____	+13.5
12.6	+11.6	_____	+13.6
12.7	+11.7	_____	+13.7
12.8	+11.8	_____	+13.8
12.9	+11.9	_____	+13.9
13	+12	_____	+14
14	+13	_____	+15
15	+14	_____	+16
16	+15	_____	+17
17	+16	_____	+18
18	+17	_____	+19
19	+18	_____	+20
20	+19	_____	+21
21	+20	_____	+22
22	+21	_____	+23
23	+22	_____	+24
24	+23	_____	+25
25	+24	_____	+26

Table 7-48 ALC linearity at 500 MHz

RF level (dBm)	RF Level Min. (dBm)	Result (dBm)	RF Level Max. (dBm)
-4	-4.8	_____	-3.2
-3	-3.8	_____	-2.2
-2	-2.8	_____	-1.2
-1	-1.8	_____	-0.2
0	-0.8	_____	+0.8
1	0.2	_____	+1.8
2	+1.2	_____	+2.8
3	+2.2	_____	+3.8
4	+3.2	_____	+4.8
5	+4.2	_____	+5.8
6	+5.2	_____	+6.8
7	+6	_____	+8
8	+7	_____	+9
9	+8	_____	+10
10	+9	_____	+11
11	+10	_____	+12
12	+11	_____	+13
12.1	+11.1	_____	+13.1
12.2	+11.2	_____	+13.2
12.3	+11.3	_____	+13.3
12.4	+11.4	_____	+13.4
12.5	+11.5	_____	+13.5
12.6	+11.6	_____	+13.6
12.7	+11.7	_____	+13.7
12.8	+11.8	_____	+13.8
12.9	+11.9	_____	+13.9
13	+12	_____	+14
14	+13	_____	+15
15	+14	_____	+16
16	+15	_____	+17
17	+16	_____	+18
18	+17	_____	+19
19	+18	_____	+20
20	+19	_____	+21
21	+20	_____	+22
22	+21	_____	+23
23	+22	_____	+24
24	+23	_____	+25
25	+24	_____	+26

ACCEPTANCE TESTING

Table 7-49 ALC linearity at 2050 MHz

RF level (dBm)	RF Level Min. (dBm)	Result (dBm)	RF Level Max. (dBm)
-4	-5.2	_____	-2.8
-3	-4.2	_____	-1.8
-2	-3.2	_____	-0.8
-1	-2.2	_____	+0.2
0	-1.2	_____	+1.2
1	-0.2	_____	+2.2
2	0.8	_____	+3.2
3	+1.8	_____	+4.2
4	+2.8	_____	+5.2
5	+3.8	_____	+6.2
6	+4.8	_____	+7.2
7	+5	_____	+9
8	+6	_____	+10
9	+7	_____	+11
10	+8	_____	+12
11	+9	_____	+13
12	+10	_____	+14
12.1	+10.1	_____	+14.1
12.2	+10.2	_____	+14.2
12.3	+10.3	_____	+14.3
12.4	+10.4	_____	+14.4
12.5	+10.5	_____	+14.5
12.6	+10.6	_____	+14.6
12.7	+10.7	_____	+14.7
12.8	+10.8	_____	+14.8
12.9	+10.9	_____	+14.9
13	+11	_____	+15
14	+12	_____	+16
15	+13	_____	+17
16	+14	_____	+18
17	+15	_____	+19
18	+16	_____	+20
19	+17	_____	+21



Table 7-50 ALC linearity at 2510 MHz

RF level (dBm)	RF Level Min. (dBm)	Result (dBm)	RF Level Max. (dBm)
-4	-5.6	_____	-2.4
-3	-4.6	_____	-1.4
-2	-3.6	_____	-0.4
-1	-2.6	_____	+0.6
0	-1.6	_____	+1.6
1	-0.6	_____	+2.6
2	0.4	_____	+3.6
3	+1.4	_____	+4.6
4	+2.4	_____	+5.6
5	+3.4	_____	+6.6
6	+4.4	_____	+7.6
7	+5	_____	+9
8	+6	_____	+10
9	+7	_____	+11
10	+8	_____	+12
11	+9	_____	+13
12	+10	_____	+14
12.1	+10.1	_____	+14.1
12.2	+10.2	_____	+14.2
12.3	+10.3	_____	+14.3
12.4	+10.4	_____	+14.4
12.5	+10.5	_____	+14.5
12.6	+10.6	_____	+14.6
12.7	+10.7	_____	+14.7
12.8	+10.8	_____	+14.8
12.9	+10.9	_____	+14.9
13	+11	_____	+15
14	+12	_____	+16
15	+13	_____	+17
16	+14	_____	+18
17	+15	_____	+19
18	+16	_____	+20
19	+17	_____	+21

ACCEPTANCE TESTING

Table 7-51 Carrier harmonic tests at +19 dBm

Carrier frequency (MHz)	2nd harmonic max. level (dBc)	Result (MHz)	3rd harmonic max. level (dBc)	Result (MHz)
0.01	-25	_____	-25	_____
0.1	-25	_____	-25	_____
1	-25	_____	-25	_____
9.9	-25	_____	-25	_____
10	-25	_____	-25	_____
18.7	-25	_____	-25	_____
18.8	-25	_____	-25	_____
37.4	-25	_____	-25	_____
37.6	-25	_____	-25	_____
74.9	-25	_____	-25	_____
75.1	-25	_____	-25	_____
150	-25	_____	-25	_____
151	-25	_____	-25	_____
300	-25	_____	-25	_____
301	-25	_____	-25	_____
600	-25	_____	-25	_____
601	-25	_____	-25	_____
750	-25	_____	-25	_____
950	-25	_____	-25	_____
1200	-25	_____	-25	_____
<b>2023B and 2025 (+13 dBm)</b>				
1201	-25	_____	-25	_____
1500	-25	_____	-25	_____
1900	-25	_____	-25	_____
<b>2025 ONLY (+13 dBm)</b>				
2510	-25	_____	-25	_____

# ACCEPTANCE TEST RESULTS TABLES

## OPTION 12

Table 7-52 SINAD measurement accuracy

SINAD (dB)	Min. (dB)	Result (dB)	Max. (dB)
20	19.5	_____	20.5

Table 7-53 SINAD sensitivity

SINAD (dB)	Result (dB)
>50	_____

ACCEPTANCE  
TESTING

---

# Annex A

## OPTION 7 FAST PULSE MODULATION

### Contents

General description .....	A-2
Performance data .....	A-2
Controls and connectors.....	A-2
Front panel connectors.....	A-2
Rear panel connectors.....	A-3
Operation .....	A-4
Pulse modulation selection .....	A-4
Remote operation.....	A-4
Brief technical description .....	A-4
Acceptance testing .....	A-6
Pulse modulation .....	A-6

### List of tables

Table A-1 Pulse mod. RF output at -4 dBm.....	A-9
Table A-2 Pulse mod. RF output at +7 dBm.....	A-10
Table A-3 Pulse modulation on/off ratio test.....	A-11
Table A-4 Pulse modulation rise and fall time test.....	A-11

### List of figures

Fig. A-1 2023B front panel showing SUPPLY switch and connectors.....	A-2
Fig. A-2 Instrument rear panel showing connectors.....	A-3
Fig. A-3 Pulse modulation menu.....	A-4
Fig. A-4 Block schematic of instrument fitted with Option 7 .....	A-5
Fig. A-5 Pulse modulation test set-up .....	A-6
Fig. A-6 Pulse modulation on/off ratio test set-up .....	A-7
Fig. A-7 Pulse modulation rise and fall time test set-up.....	A-8

## General description

Option 7 adds the ability for the instrument to internally generate a fast pulse modulated waveform from logic levels applied to the PULSE INPUT socket. The pulse modulator is suitable for generating fast pulses with high isolation for applications in radar and EMI. It may be used in conjunction with other forms of modulation to form composite signals. Familiarity with normal operation of the signal generator is assumed.

The functions of the EXT MOD INPUT and LF OUTPUT sockets for the standard instrument are combined in the MOD I/O socket. The PULSE INPUT socket replaces the standard rear panel PULSE I/P socket. This relabeling should be taken into consideration throughout the manual, especially in regard to the connections made for Acceptance Testing in Chapter 7.

## Performance data

The following specification supersedes that with the same title in Chapter 7.

### Pulse modulation

Carrier frequency range:	100 kHz to 2.51 GHz, usable to 9 kHz.
RF output range:	-140 dBm to +10 dBm (usable to +13 dBm) when pulse modulation enabled.
RF level accuracy:	Additional less than $\pm 0.01$ dB/ $^{\circ}$ C temperature coefficient when pulse modulation enabled.
Input:	An HCT logical '1' (2 to 5 V) turns the carrier on, a logical '0' (0 to 0.8 V) turns the carrier off. Maximum safe input is $\pm 10$ V.
On/off ratio:	>80 dBc below 1.2 GHz; >70 dBc up to 2.05 GHz (typically >80 dB); >65 dBc up to 2.51 GHz (typically >70 dB at 2.51 GHz).
Maximum repetition frequency:	10 MHz.
Rise and fall time:	<20 ns, typically 10 ns.

## Controls and connectors

The following sections replace those with the same titles in Chapter 4 in the main body of the manual.

### Front panel connectors

The front panel connectors are shown in Fig. A-1 below:

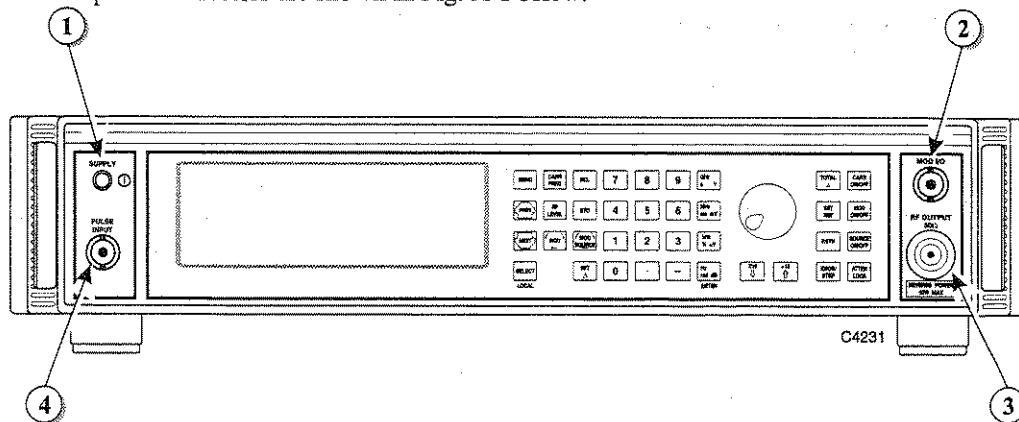

Fig. A-1 2023B front panel showing SUPPLY switch and connectors

- |                   |  |
|-------------------|--|
| (1) SUPPLY switch | Switches the supply on and off using a press on, press off action.   |
| (2) MOD I/O       | 100 k $\Omega$ BNC connector which allows an external modulating signal to be applied. Also provides a modulation oscillator output from a 600 k $\Omega$ source impedance.<br>With Option 5 this connector is fitted on the rear panel. |



- (3) RF OUTPUT 50  $\Omega$  N-type socket. Protected against the application of reverse power of up to 50 W.  
With Option 5 this socket is fitted on the rear panel.
- (4) PULSE INPUT 50  $\Omega$  BNC socket which accepts a pulsed input.  
With Option 5 this socket is fitted on the rear panel.

## Rear panel connectors

The rear panel connectors are shown in Fig. A-2 below.

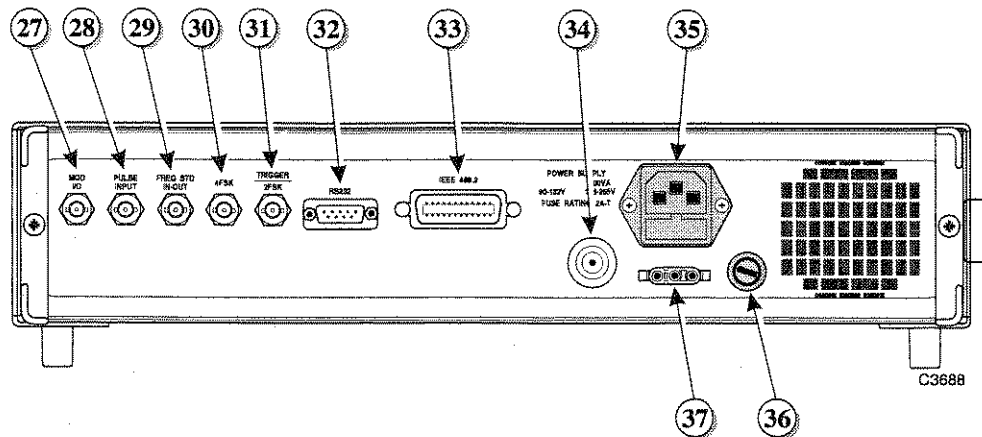

Fig. A-2 Instrument rear panel showing connectors

- (27) MOD I/O (optional) An Option 5 BNC socket which, when fitted, replaces the front-panel MOD I/O socket.
- (28) PULSE INPUT (optional) An Option 5 BNC socket which, when fitted, replaces the front-panel PULSE INPUT socket.
- (29) FREQ STD IN-OUT BNC socket for the input of external standard frequencies of either 1 MHz or 10 MHz. Can also supply a 10 MHz internal standard output.
- (30) 4FSK BNC socket used as one logic input (the other is the 2FSK input) for 4FSK modulation.
- (31) TRIGGER  
2FSK BNC socket which has three uses; in priority order these are:  
FSK logic input  
Memory sequencing  
Sweep trigger.
- (32) RS232 9-way RS-232 connector for remote control of the instrument. For contact allocation see Chapter 2.
- (33) IEEE 488.2 24-pin socket accepts the standard GPIB connector to allow remote control of the instrument. For contact allocation see Chapter 2.
- (34) RF OUTPUT (optional) An Option 5 50  $\Omega$  N-type socket. When fitted, replaces the front-panel RF OUTPUT socket.
- (35) Power supply 3-pin plug integral with fuse holder. Mates with AC supply lead socket.
- (36) DC supply fuse (optional) When Option 2 fitted, fuses the DC input socket.
- (37) DC input (optional) When Option 2 fitted, the socket allows operation from an external 11 to 32 V DC source. For contact polarity see Chapter 2.

## Operation

The following sections replace those with the same titles in Chapter 4.

### Pulse modulation selection

Pulse modulation may be selected in addition to any other normal modulation modes. The source is external only from the front-panel PULSE INPUT socket. Selection may be made as follows:

- (1) Select the *Util 22: Pulse Modulation* menu. This shows the currently selected modulation mode against *Mod Mode*: (see Fig. A-3).

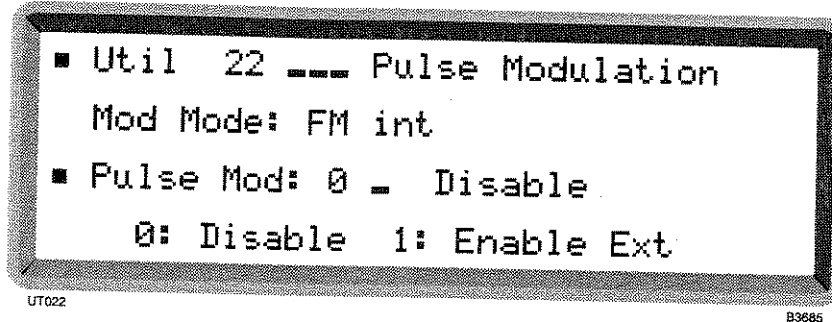

Fig. A-3 Pulse modulation menu

- (2) Enter 1 on the key pad (no terminator is required) to *Enable* the external modulation. The display changes to show the current modulation plus *Pulse* (e.g. *Mod Mode: AM int + FM ext + Pulse*). Entering 0 will disable the modulation.
- (3) Press [MOD] to return to the main screen. Repeatedly press [Mod] until *Pulse Mod* is displayed together with *EXT ON*. Note that for pulse operation pressing [Source ON/OFF] has no effect on the instrument.

When *ON* the carrier is controlled by the logic level applied to the PULSE INPUT socket. A logical '1' (a voltage between 3.5 and 5 V) allows carrier output, a logical '0' (a voltage between 0 and 1.0 V) suppresses it. Turning pulse mod *OFF* effectively applies a logical '1' allowing carrier output.

### Remote operation

The GPIB commands for pulse modulation PULSE:ON and PULSE:OFF are invalid, and PULSE? will always return PULSE:ON.

### Brief technical description

Block diagram Fig. A-4 replaces that given in Chapter 6 in the main body of the manual. This shows that for an instrument fitted with Option 7:

- The front-panel EXT MOD INPUT socket is replaced by the PULSE INPUT socket.
- The front-panel former LF OUTPUT socket performs the dual functions of MOD I/O.
- The rear-panel PULSE I/P socket is replaced by the 4FSK socket.

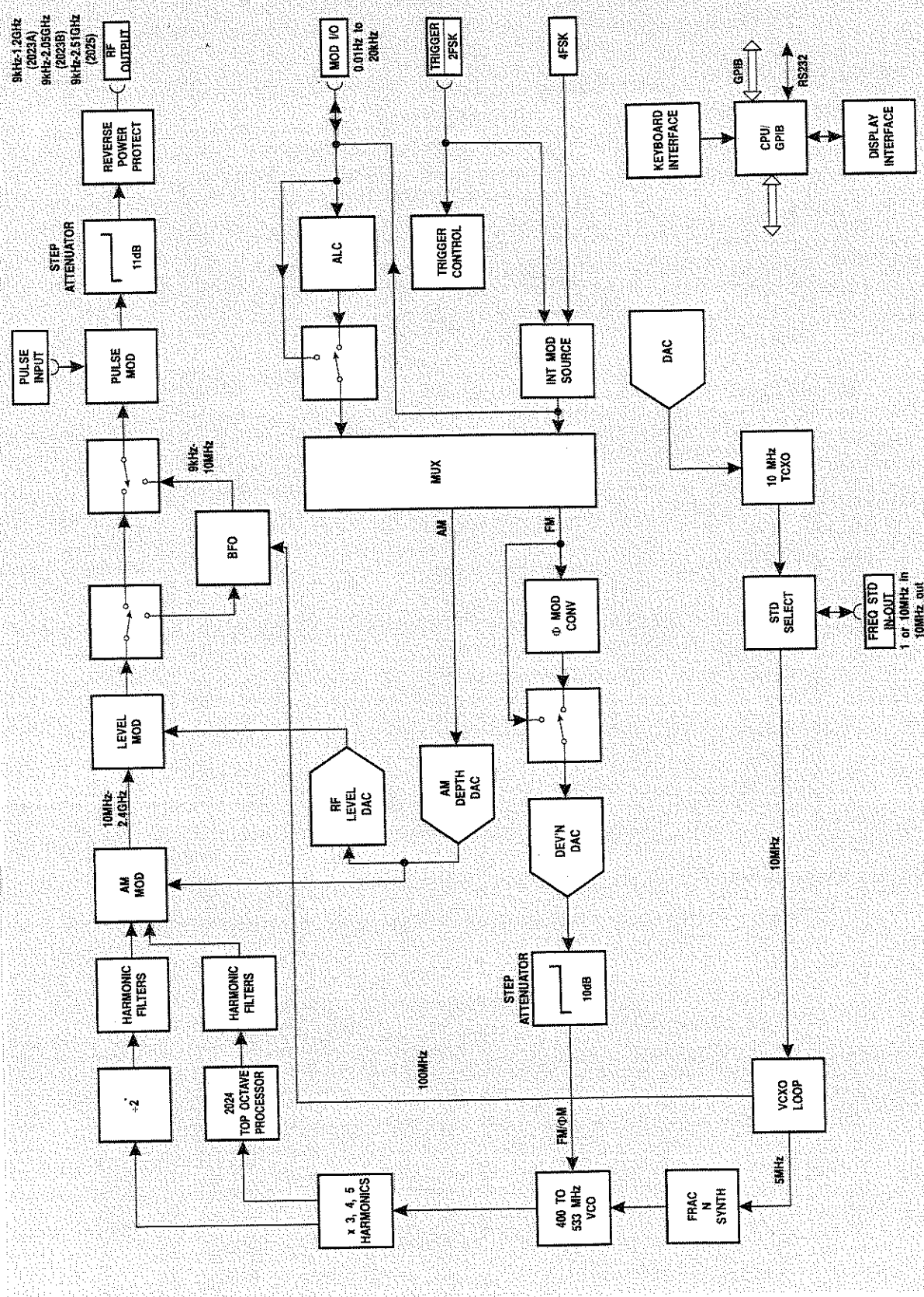

Fig. A-4 Block schematic of instrument fitted with Option 7

# Acceptance testing

The following acceptance tests supersede those given under Pulse modulation in Chapter 7.

## Pulse modulation

### Specification

Carrier frequency range:	100 kHz to 2.51 GHz (usable to 9 kHz).
RF level range:	Maximum guaranteed output is reduced to +10 dBm when pulse modulation is selected.
RF level accuracy:	Additional temperature coefficient $\pm 0.01$ dB/°C when pulse modulation is enabled.
On/off ratio:	>80 dB below 1.2 GHz, >70 dB below 2.1 GHz, >65 dB above 2.1 GHz.
Rise and fall time:	Less than 20 ns (typically 10 ns).

### Test equipment

Alternative equipment may be used providing it complies with the stated minimum performance.

Description	Minimum specification	Example
Power meter	$\pm 0.1$ dB from 9 kHz to 2.51 GHz	IFR* 6960B and 6912
Spectrum analyzer	Frequency coverage 100 kHz to 2.51 GHz	IFR* 2392, 2383 or 2386
50 $\Omega$ load (termination)	1 W, 50 $\Omega$ nominal impedance, DC to 2.51 GHz	Lucas Weinschel M1404N
Oscilloscope	100 MHz bandwidth	Tektronix TAS 465
Function generator	DC to 10 kHz square wave	HP 3325B
RF detector	100 kHz to 2 GHz	HP 8471D

\*IFR Ltd was previously known as Marconi Instruments Ltd

### Pulse modulation RF level frequency response

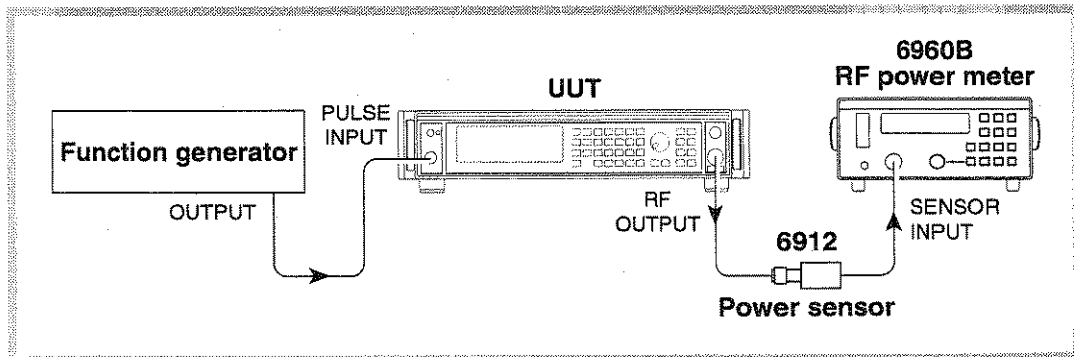

C3852

Fig. A-5 Pulse modulation test set-up

### Test procedure

- (1) Perform AUTO ZERO and AUTO CAL on the power meter.
- (2) Connect the test equipment as shown in Fig. A-5.

- (3) On the UUT set:
 

[CARR FREQ]	100 [kHz]
[RF LEVEL]	-4 [dB]
[MENU]	22 ENTER

The UUT will enter the *Pulse Modulation* menu

Select *1* (To enable Pulse Mod.)  
 [MOD] then [MOD] then [MOD] again (To select *Pulse Mod*)  
 [SOURCE ON/OFF] (To enable modulation source)  
 [MOD ON/OFF] (To enable modulation)

- (4) Set the function generator to provide +5 V DC. The RF output will now be enabled.
- (5) Record the output level measured by the power meter against each of the carrier frequencies shown in Table A-1 checking that the results are within specification.
- (6) Set the UUT RF level to +7 dBm and repeat (5) using Table A-2.

### Pulse modulation on/off ratio

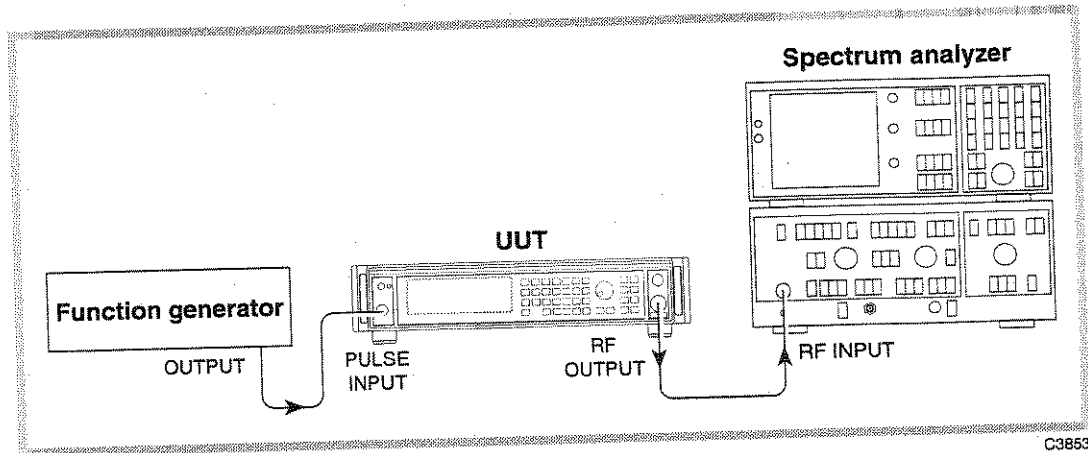

Fig. A-6 Pulse modulation on/off ratio test set-up

### Test procedure

- (1) Press CAL on the spectrum analyzer.
- (2) Connect the test equipment as shown in Fig. A-6.
- (3) On the UUT set:
 

[CARR FREQ]	100 [kHz]
[RF LEVEL]	0 [dB]
[MENU]	22 ENTER

The UUT will enter the *Pulse Modulation* menu

Select *1* (To enable Pulse Mod.)  
 [MOD] then [MOD] then [MOD] again (To select *Pulse Mod*)  
 [SOURCE ON/OFF] (To enable modulation source)  
 [MOD ON/OFF] (To enable modulation)

- (4) Set the function generator to provide +5 V DC. The RF output will now be enabled.
- (5) Tune the spectrum analyzer to the same frequency as the signal generator.
- (6) Press PEAK FIND on the spectrum analyzer and note the output level.
- (7) Apply a short circuit to the PULSE INPUT socket.
- (8) Again note the output level measured by the spectrum analyzer.

- (9) The difference between the levels recorded in (6) and (8) is the pulse mod on/off ratio. Check that the ratio is within specification using Table A-3.
- (10) Repeat (5) to (9) for each of the frequencies shown in Table A-3.

**Pulse modulation rise and fall time**

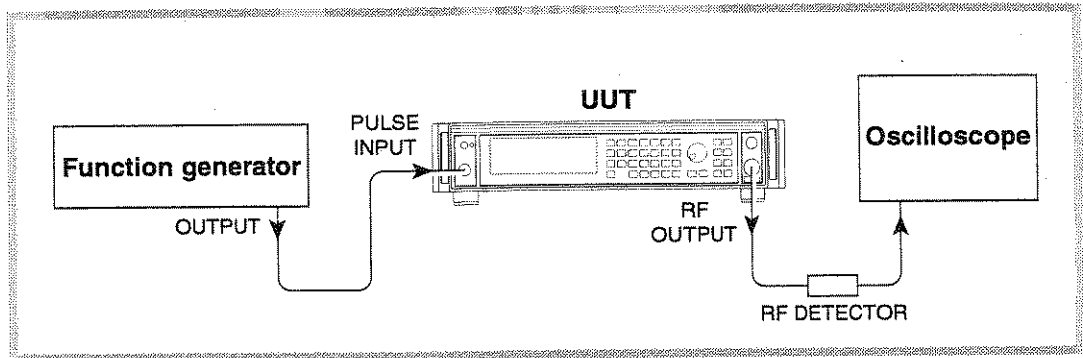

Fig. A-7 Pulse modulation rise and fall time test set-up

**Test procedure**

- (1) Connect the test equipment as shown in Fig. A-7.
- (2) On the UUT set:
 

[CARR FREQ]	1 [GHz]
[RF LEVEL]	+7 [dB]
[MENU]	22 ENTER

The UUT will enter the *Pulse Modulation* menu

- Select 1 (To enable Pulse Mod.)
- [MOD] then [MOD] then [MOD] again (To select *Pulse Mod*)
- [SOURCE ON/OFF] (To enable modulation source)
- [MOD ON/OFF] (To enable modulation)

- (3) Set the function generator to produce 100 kHz, 0 V to +5 V square wave.
- (4) Adjust the oscilloscope controls such that the rise time of the envelope can be measured.
- (5) Measure the rise time between the 10% to 90% points checking that it is within the specification shown in Table A-4.
- (6) Repeat (4) to (5) for the fall time of the envelope.

# ACCEPTANCE TEST RESULTS TABLES

## for Option 7 (fast pulse modulator)

Table A-1 Pulse mod. RF output at -4 dBm

Carrier Frequency (MHz)	RF level in. (dBm)	Result (dBm)	RF level max. (dBm)
30	-4.8	_____	-3.2
60	-4.8	_____	-3.2
180	-4.8	_____	-3.2
300	-4.8	_____	-3.2
420	-4.8	_____	-3.2
540	-4.8	_____	-3.2
660	-4.8	_____	-3.2
780	-4.8	_____	-3.2
900	-4.8	_____	-3.2
1020	-4.8	_____	-3.2
1140	-4.8	_____	-3.2
1200	-4.8	_____	-3.2
<b>2023B and 2025</b>			
1201	-5.2	_____	-2.8
1260	-5.2	_____	-2.8
1380	-5.2	_____	-2.8
1500	-5.2	_____	-2.8
1620	-5.2	_____	-2.8
1740	-5.2	_____	-2.8
1860	-5.2	_____	-2.8
2050	-5.2	_____	-2.8
<b>2025 ONLY</b>			
2220	-5.6	_____	-2.4
2340	-5.6	_____	-2.4
2400	-5.6	_____	-2.4
2510	-5.6	_____	-2.4

Table A-2 Pulse mod. RF output at +7 dBm

Carrier frequency (MHz)	RF level min. (dBm)	Result (dBm)	RF level max. (dBm)
30	+6.2	_____	+7.8
60	+6.2	_____	+7.8
180	+6.2	_____	+7.8
300	+6.2	_____	+7.8
420	+6.2	_____	+7.8
540	+6.2	_____	+7.8
660	+6.2	_____	+7.8
780	+6.2	_____	+7.8
900	+6.2	_____	+7.8
1020	+6.2	_____	+7.8
1140	+6.2	_____	+7.8
1200	+6.2	_____	+7.8
<b>2023B and 2025</b>			
1201	+5.8	_____	+8.2
1260	+5.8	_____	+8.2
1380	+5.8	_____	+8.2
1500	+5.8	_____	+8.2
1620	+5.8	_____	+8.2
1740	+5.8	_____	+8.2
1860	+5.8	_____	+8.2
2050	+5.8	_____	+8.2
<b>2023B and 2025</b>			
2220	+5.4	_____	+8.6
2340	+5.4	_____	+8.6
2400	+5.4	_____	+8.6
2510	+5.4	_____	+8.6





**Table A-3 Pulse modulation on/off ratio test**

Carrier frequency (MHz)	Pulse mod. on/off ratio (dB)	Measured value (dB)
0.1	>80	_____
32	>80	_____
100	>80	_____
320	>80	_____
1000	>80	_____
1200	>80	_____
<b>2023B and 2025</b>		
1500	>70	_____
1800	>70	_____
2050	>70	_____
<b>2025 ONLY</b>		
2100	>70	_____
2400	>65	_____
2510	>65	_____

**Table A-4 Pulse modulation rise and fall time test**

		Result (ns)
Rise time	<20 ns	_____
Fall time	<20 ns	_____

# Annex B

## OPTION 11 FAST PULSE AND HIGH POWER

### Contents

General description .....	B-2
Performance data .....	B-2
Controls and connectors .....	B-3
Front-panel connectors.....	B-3
Rear-panel connectors.....	B-4
Operation .....	B-5
Pulse modulation selection.....	B-5
Remote operation .....	B-5
Brief technical description .....	B-7
Acceptance testing .....	B-7
RF output .....	B-7
RF level frequency response .....	B-8
ALC linearity.....	B-8
Carrier harmonics.....	B-8
Pulse modulation.....	B-9

### List of tables

Table B-1 RF output at 0 dBm.....	B-13
Table B-2 RF output at +7 dBm .....	B-14
Table B-3 RF output at +13 dBm .....	B-15
Table B-4 RF output at +25 dBm .....	B-16
Table B-5 ALC linearity at 2.5 MHz .....	B-17
Table B-6 ALC linearity at 500 MHz .....	B-18
Table B-7 ALC linearity at 2050 MHz .....	B-19
Table B-8 ALC linearity at 2510 MHz .....	B-20
Table B-9 Carrier harmonic tests at +19 dBm .....	B-21
Table B-10 Pulse mod. RF output at -4 dBm .....	B-22
Table B-11 Pulse mod. RF output at +7 dBm.....	B-23
Table B-12 Pulse modulation on/off ratio test .....	B-24
Table B-13 Pulse modulation rise and fall time test .....	B-24

### List of figures

Fig. B-1 2023B front panel showing SUPPLY switch and connectors .....	B-3
Fig. B-2 Instrument rear panel showing connectors .....	B-4
Fig. B-3 Pulse modulation menu.....	B-5
Fig. B-4 Block schematic of instrument fitted with Option 7.....	B-6
Fig. B-5 RF output test set-up .....	B-7
Fig. B-6 Carrier harmonics test set-up .....	B-9
Fig. B-7 Pulse modulation test set-up .....	B-10
Fig. B-8 Pulse modulation on/off ratio test set-up.....	B-11
Fig. B-9 Pulse modulation rise and fall time test set-up.....	B-12





## Rear-panel connectors

The rear-panel connectors are shown in Fig. B-2 below.

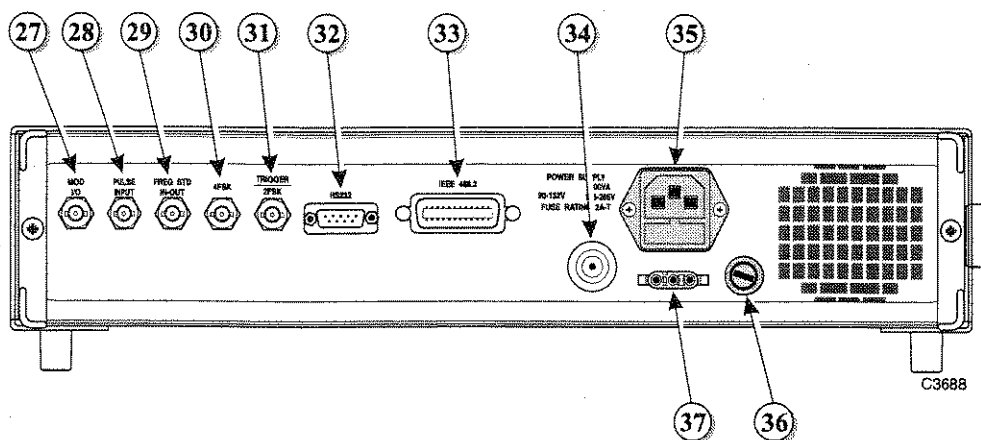

Fig. B-2 Instrument rear panel showing connectors

- |                                |   |
|--------------------------------|---|
| (27) MOD I/O (optional)        | An Option 5 BNC socket which, when fitted, replaces the front-panel MOD I/O socket.   |
| (28) PULSE INPUT (optional)    | An Option 5 BNC socket which, when fitted, replaces the front-panel PULSE INPUT socket.   |
| (29) FREQ STD IN-OUT           | BNC socket for the input of external standard frequencies of either 1 MHz or 10 MHz. Can also supply a 10 MHz internal standard output. |
| (30) 4FSK                      | BNC socket used as one logic input (the other is the 2FSK input) for 4FSK modulation.   |
| (31) <u>TRIGGER</u><br>2FSK    | BNC socket which has three uses; in priority order these are:<br>FSK logic input<br>Memory sequencing<br>Sweep trigger.                 |
| (32) RS232                     | 9-way RS-232 connector for remote control of the instrument. For contact allocation see Chapter 2.                                      |
| (33) IEEE 488.2                | 24-pin socket accepts the standard GPIB connector to allow remote control of the instrument. For contact allocation see Chapter 2.      |
| (34) RF OUTPUT (optional)      | An Option 5 50 $\Omega$ N-type socket. When fitted, replaces the front-panel RF OUTPUT socket.  |
| (35) Power supply              | 3-pin plug integral with fuse holder. Mates with AC supply lead socket.   |
| (36) DC supply fuse (optional) | When Option 2 fitted, fuses the DC input socket.  |
| (37) DC input (optional)       | When Option 2 fitted, the socket allows operation from an external 11 to 32 V DC source. For contact polarity see Chapter 2.            |

## Operation

The following sections replace those with the same titles in Chapter 4 in the main body of the manual.

### Pulse modulation selection

Pulse modulation may be selected in addition to any other normal modulation modes. The source is external only from the front-panel PULSE INPUT socket. Selection may be made as follows:

- (1) Select the *Util 22: Pulse Modulation* menu. This shows the currently selected modulation mode against *Mod Mode*: (see Fig. B-3).

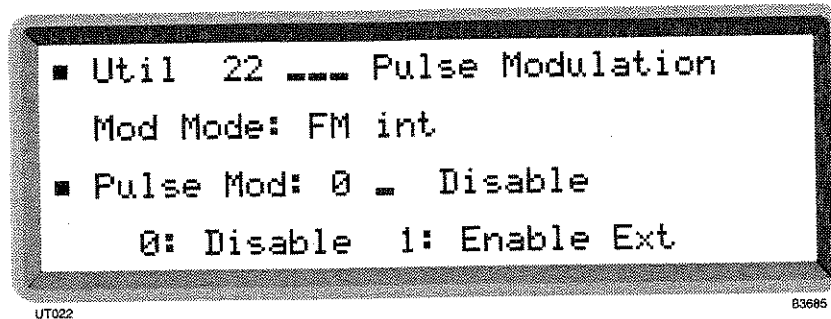

Fig. B-3 Pulse modulation menu

- (2) Enter 1 on the key pad (no terminator is required) to *Enable* the external modulation. The display changes to show the current modulation plus *Pulse* (for example, *Mod Mode: AM int + FM ext + Pulse*). Entering 0 will disable the modulation.
- (3) Press [MOD] to return to the main screen. Repeatedly press [Mod] until *Pulse Mod* is displayed together with *EXT ON*. Note that for pulse operation pressing [Source ON/OFF] has no effect on the instrument.

When *ON* the carrier is controlled by the logic level applied to the PULSE INPUT socket. A logical '1' (a voltage between 3.5 and 5 V) allows carrier output, a logical '0' (a voltage between 0 and 1.0 V) suppresses it. Turning pulse mod *OFF* effectively applies a logical '1' allowing carrier output.

### Remote operation

The GPIB commands for pulse modulation PULSE:ON and PULSE:OFF are invalid, and PULSE? will always return PULSE:ON.

### Brief technical description

Block diagram Fig. B-4 replaces that given in Chapter 6 in the main body of the manual. This shows that for an instrument fitted with Option 11:

- The front-panel EXT MOD INPUT socket is replaced by the PULSE INPUT socket.
- The front-panel former LF OUTPUT socket performs the dual functions of MOD I/O.
- The rear-panel PULSE I/P socket is replaced by the 4FSK socket.

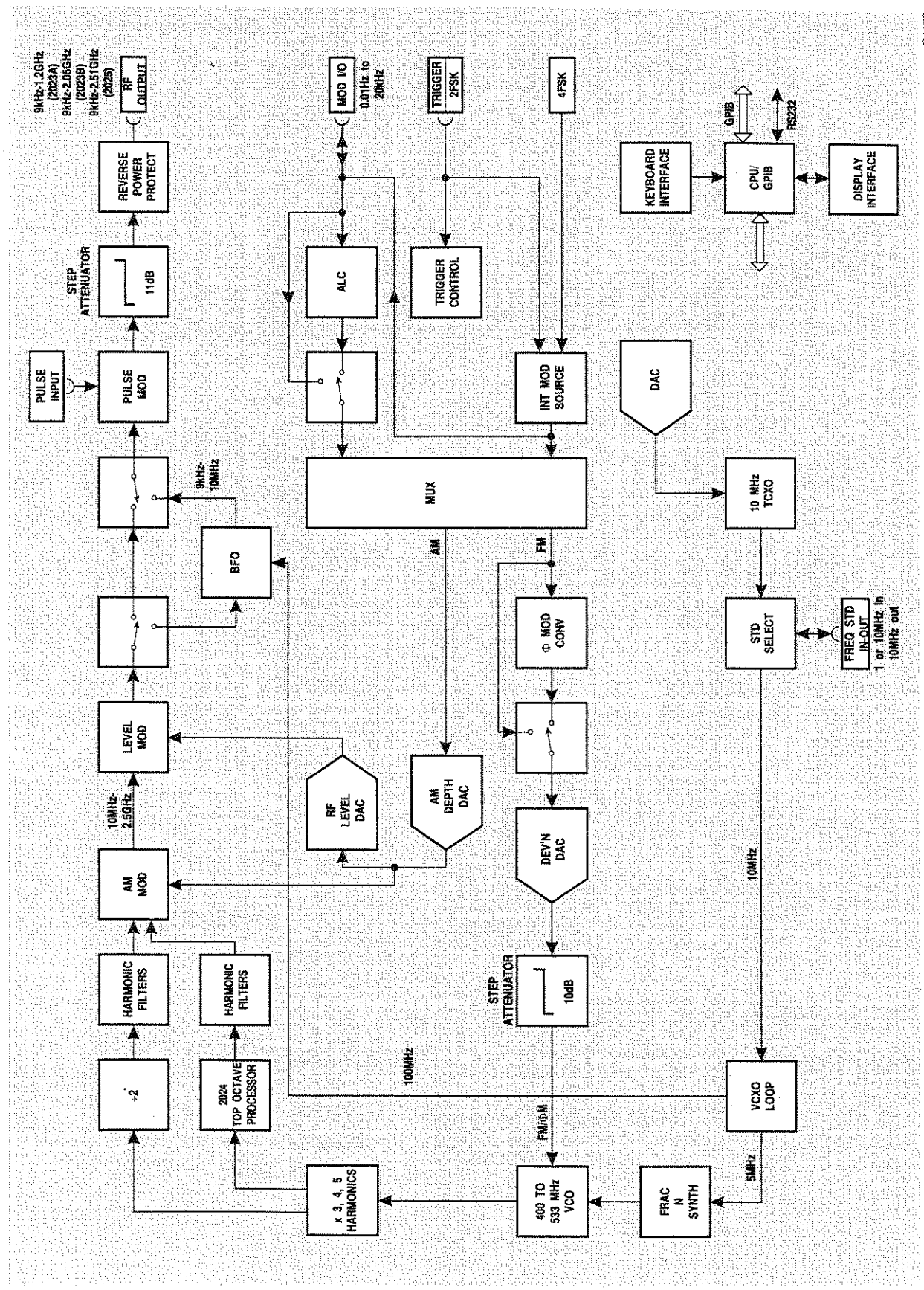

Fig. B-4 Block schematic of instrument fitted with Option 7

# Acceptance testing

The following acceptance tests supersede those given under 'RF output', 'Carrier harmonics' and 'Pulse modulation' in Chapter 7.

## RF output

### Specification

**Level range:** -140 dBm to +25 dBm, uncalibrated above +19 dBm for carrier frequencies from 1.2 GHz to 2.4 GHz and uncalibrated above +14 dBm for carrier frequencies above 2.4 GHz.

**Accuracy:** As per the standard instrument for output levels below +7 dBm.

For output levels above +7 dBm and over a temperature range of 17°C to 27°C:

- ±1 dBm to 1.2 GHz
- ±2 dBm to 2.51 GHz

Temperature coefficient:

- ≤±0.02 dB/°C to 1.2 GHz
- ≤±0.03 dB/°C to 2.51 GHz

### Test equipment

Description	Minimum specification	Example
Power meter	±0.1 dB from 9 kHz to 2.51 GHz	IFR* 6960B and 6932
Measuring receiver	0 dBm to -127 dBm; 2.51 MHz to 2.51 GHz	HP 8902A with 11722A sensor and 11793A down converter
Signal generator	+8 dBm from 32.5 MHz to 2.54 GHz	IFR* 2041

\*IFR Ltd was previously known as Marconi Instruments Ltd

## RF level frequency response

### Test procedure

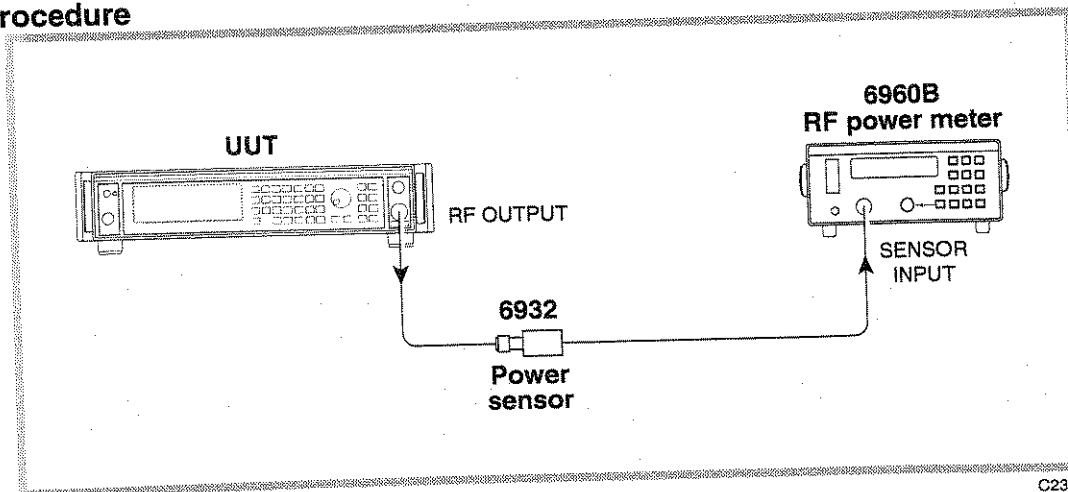

Fig. B-5 RF output test set-up



- (1) Perform AUTO ZERO and AUTO CAL on the power meter.
- (2) Connect the test equipment as shown in Fig. B-5.
- (3) On the UUT set:
 

[CARR FREQ]	30 [kHz]
[RF LEVEL]	0 [dB]
- (4) Record the output level measured by the power meter against each of the carrier frequencies shown in Table B-1, checking that the results are within specification.
- (5) Set the UUT RF level to +7 dBm and repeat (4) using Table B-2.
- (6) Set the UUT RF level to +13 dBm and repeat (4) using Table B-3.
- (7) Set the UUT RF level to +25 dBm and repeat (4) using Table B-4, decreasing the RF level to +19 dBm when testing at carrier frequencies above 1.2 GHz and further decreasing the RF level to +14 dBm when testing at carrier frequencies above 2.4 GHz.

## ALC linearity

### Test procedure

- (1) Perform AUTO ZERO and AUTO CAL on the power meter.
- (2) Connect the test equipment as shown in Fig. B-5.
- (3) On the UUT set:
 

[CARR FREQ]	2.5 [MHz]
[RF LEVEL]	-4 [dB]
- (4) Record the output level measured by the power meter against each of the steps shown in Table B-5, checking that the results are within specification.
- (5) Set the UUT carrier frequency to 500 MHz and repeat (4) using Table B-6.
- (6) Set the UUT carrier frequency to 2050 MHz and repeat (4) using Table B-7.
- (7) Set the UUT carrier frequency to 2510 and repeat (4) using Table B8.

## Carrier harmonics

### Specification

**Harmonics:** Typically better than -25 dBc for RF levels up to 6 dB below the maximum specified output

### Test equipment

Description	Minimum specification	Example
Spectrum analyzer	DC to 7.6 GHz frequency coverage	Anritsu MS2602A or IFR 2390 or 2386

## Test procedure

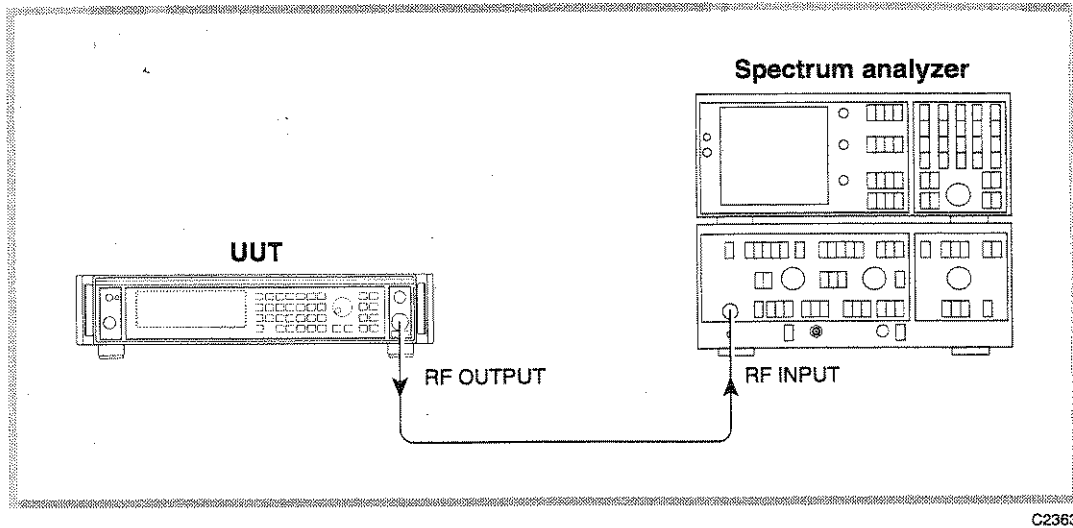

C2363

Fig. B-6 Carrier harmonics test set-up

- (1) Press CAL on the spectrum analyzer.
- (2) Connect the test equipment as shown in Fig. B-6.
- (3) On the UUT set:

[CARR FREQ]	10 [kHz]
[RF LEVEL]	+19 [dB]
- (4) Measure the level of the second and third harmonics on the spectrum analyzer at each of the carrier frequencies shown in Table B-9, decreasing the RF output to +13 dBm for carrier frequencies above 1.2 GHz, checking that the results are within specification.

## Pulse modulation

### Specification

Carrier frequency range:	100 kHz to 2.51 GHz (usable to 9 kHz).
RF level range:	Maximum guaranteed output is reduced by 3 dB when pulse modulation is selected.
RF level accuracy:	Additional temperature coefficient $\pm 0.01$ dB/ $^{\circ}$ C when pulse modulation is enabled.
On/off ratio:	>80 dB below 1.2 GHz. >70 dB below 2.1 GHz. >65 dB above 2.1 GHz.
Rise and fall time:	Less than 20 ns (typically 10 ns).

**Test equipment**

Description	Minimum specification	Example
Power meter	$\pm 0.1$ dB from 9 kHz to 2.51 GHz	IFR 6960B and 6912
Spectrum analyzer	Frequency coverage 100 kHz to 2.51 GHz	Anritsu MS2602A or IFR 2392, 2383 or 2386
50 $\Omega$ load (termination)	1 W, 50 $\Omega$ nominal impedance, DC to 2.51 GHz	Lucas Weinschel M1404N
Oscilloscope	100 MHz bandwidth	Tektronix TAS 465
Function generator	DC to 10 kHz square wave	HP 3325B
RF detector	100 kHz to 2 GHz	HP 8471D

**Pulse modulation RF level frequency response**

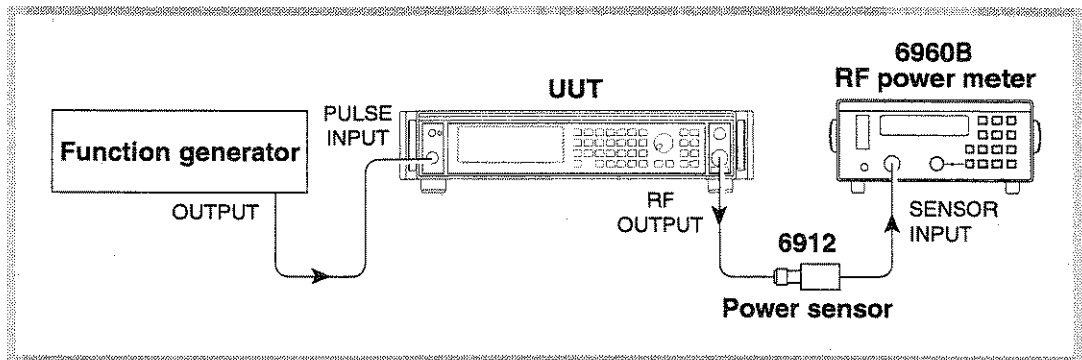

C3852

Fig. B-7 Pulse modulation test set-up

**Test procedure**

- (1) Perform AUTO ZERO and AUTO CAL on the power meter.
- (2) Connect the test equipment as shown in Fig. B-7.
- (3) On the UUT set:
 

[CARR FREQ]	100 [kHz]
[RF LEVEL]	-4 [dB]
[MENU]	22 ENTER

The UUT will enter the *Pulse Modulation* menu

- Select 1 (To enable Pulse Mod.)
- [MOD] then [MOD] then [MOD] again (To select *Pulse Mod*)
- [SOURCE ON/OFF] (To enable modulation source)
- [MOD ON/OFF] (To enable modulation)

- (4) Set the function generator to provide +5 V DC. The RF output will now be enabled.
- (5) Record the output level measured by the power meter against each of the carrier frequencies shown in Table B-10 checking that the results are within specification.
- (6) Set the UUT RF level to +7 dBm and repeat (5) using Table B-11.

## Pulse modulation on/off ratio

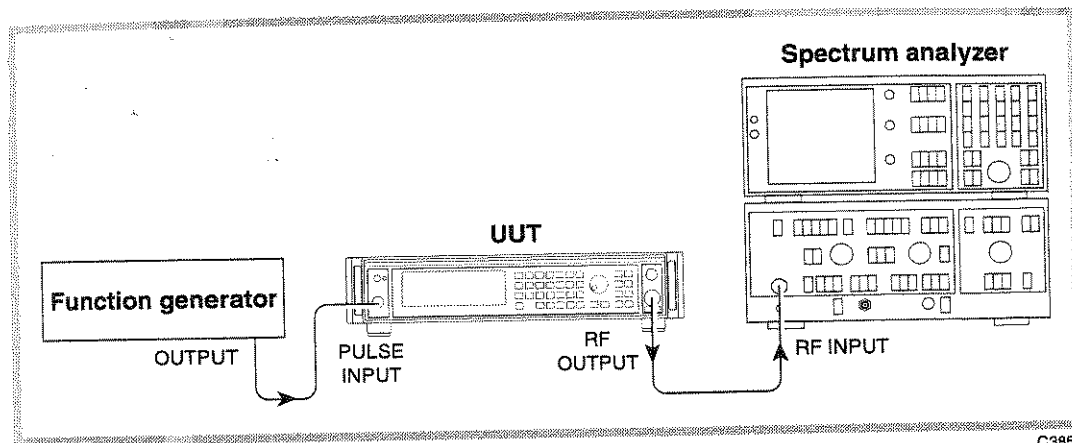

Fig. B-8 Pulse modulation on/off ratio test set-up

### Test procedure

- (1) Press CAL on the spectrum analyzer.
- (2) Connect the test equipment as shown in Fig. B-8.
- (3) On the UUT set:

[CARR FREQ]	100 [kHz]
[RF LEVEL]	0 [dB]
[MENU]	22 ENTER

The UUT will enter the *Pulse Modulation* menu

Select 1 (To enable Pulse Mod.)

[MOD] then [MOD] then [MOD] again (To select *Pulse Mod*)

[SOURCE ON/OFF] (To enable modulation source)

[MOD ON/OFF] (To enable modulation)

- (4) Set the function generator to provide +5 V DC. The RF output will now be enabled.
- (5) Tune the spectrum analyzer to the same frequency as the signal generator.
- (6) Press PEAK FIND on the spectrum analyzer and note the output level.
- (7) Apply a short circuit to the PULSE INPUT socket.
- (8) Again note the output level measured by the spectrum analyzer.
- (9) The difference between the levels recorded in (6) and (8) is the pulse mod on/off ratio. Check that the ratio is within specification using Table B-12.
- (10) Repeat (5) to (9) for each of the frequencies shown in Table B-12.

## Pulse modulation rise and fall time

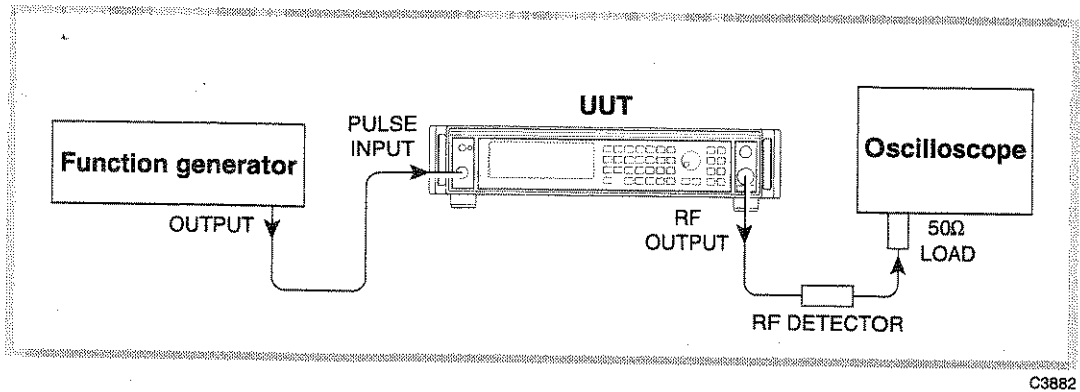

Fig. B-9 Pulse modulation rise and fall time test set-up

### Test procedure

- (1) Connect the test equipment as shown in Fig. B-9.
- (2) On the UUT set:  
[CARR FREQ] 1 [GHz]  
[RF LEVEL] +7 [dB]  
[MENU] 22 ENTER

The UUT will enter the *Pulse Modulation* menu

Select 1 (To enable Pulse Mod.)  
[MOD] then [MOD] then [MOD] again (To select *Pulse Mod*)  
[SOURCE ON/OFF] (To enable modulation source)  
[MOD ON/OFF] (To enable modulation)

- (3) Set the function generator to produce 100 kHz, 0 V to +5 V square wave.
- (4) Adjust the oscilloscope controls such that the rise time of the envelope can be measured.
- (5) Measure the rise time between the 10% to 90% points checking that it is within the specification shown in Table B-13.
- (6) Repeat (4) to (5) for the fall time of the envelope.

# ACCEPTANCE TEST RESULTS TABLES OPTION 11

Table B-1 RF output at 0 dBm

Carrier frequency (MHz)	RF level min. (dBm)	Result (dBm)	RF level max. (dBm)
0.03	-0.8	_____	+0.8
0.33	-0.8	_____	+0.8
60	-0.8	_____	+0.8
180	-0.8	_____	+0.8
300	-0.8	_____	+0.8
420	-0.8	_____	+0.8
540	-0.8	_____	+0.8
660	-0.8	_____	+0.8
780	-0.8	_____	+0.8
900	-0.8	_____	+0.8
1020	-0.8	_____	+0.8
1140	-0.8	_____	+0.8
1200	-0.8	_____	+0.8
<b>2023B and 2025</b>			
1201	-1.2	_____	+1.2
1260	-1.2	_____	+1.2
1380	-1.2	_____	+1.2
1500	-1.2	_____	+1.2
1620	-1.2	_____	+1.2
1740	-1.2	_____	+1.2
1860	-1.2	_____	+1.2
2050	-1.2	_____	+1.2
<b>2025 ONLY</b>			
2220	-1.6	_____	+1.6
2340	-1.6	_____	+1.6
2400	-1.6	_____	+1.6
2510	-1.6	_____	+1.6

Table B-2 RF output at +7 dBm

Carrier frequency (MHz)	RF level min. (dBm)	Result (dBm)	RF level max. (dBm)
0.03	+6	_____	+8
0.33	+6	_____	+8
60	+6	_____	+8
180	+6	_____	+8
300	+6	_____	+8
420	+6	_____	+8
540	+6	_____	+8
660	+6	_____	+8
780	+6	_____	+8
900	+6	_____	+8
1020	+6	_____	+8
1140	+6	_____	+8
1200	+6	_____	+8
<b>2023B and 2025</b>			
1201	+5	_____	+9
1260	+5	_____	+9
1380	+5	_____	+9
1500	+5	_____	+9
1620	+5	_____	+9
1740	+5	_____	+9
1860	+5	_____	+9
2050	+5	_____	+9
<b>2025 ONLY</b>			
2220	+5	_____	+9
2340	+5	_____	+9
2400	+5	_____	+9
2510	+5	_____	+9

**Table B-3 RF output at +13 dBm**

Carrier frequency (MHz)	RF level min. (dBm)	Result (dBm)	RF level max. (dBm)
0.03	+12	_____	+14
0.33	+12	_____	+14
60	+12	_____	+14
180	+12	_____	+14
300	+12	_____	+14
420	+12	_____	+14
540	+12	_____	+14
660	+12	_____	+14
780	+12	_____	+14
900	+12	_____	+14
1020	+12	_____	+14
1140	+12	_____	+14
1200	+12	_____	+14
<b>2023B and 2025</b>			
1201	+11	_____	+15
1260	+11	_____	+15
1380	+11	_____	+15
1500	+11	_____	+15
1620	+11	_____	+15
1740	+11	_____	+15
1860	+11	_____	+15
2050	+11	_____	+15
<b>2025 ONLY</b>			
2220	+11	_____	+15
2340	+11	_____	+15
2400	+11	_____	+15
2510	+11	_____	+15



Table B-4 RF output at +25 dBm

Carrier frequency (MHz)	RF level min. (dBm)	Result (dBm)	RF level max. (dBm)
0.03	+24	_____	+26
0.33	+24	_____	+26
60	+24	_____	+26
180	+24	_____	+26
300	+24	_____	+26
420	+24	_____	+26
540	+24	_____	+26
660	+24	_____	+26
780	+24	_____	+26
900	+24	_____	+26
1020	+24	_____	+26
1140	+24	_____	+26
1200	+24	_____	+26
<b>2023B and 2025, +19 dBm</b>			
1201	+17	_____	+21
1260	+17	_____	+21
1380	+17	_____	+21
1500	+17	_____	+21
1620	+17	_____	+21
1740	+17	_____	+21
1860	+17	_____	+21
1980	+17	_____	+21
<b>2025 ONLY, +19 dBm</b>			
2220	+17	_____	+21
2340	+17	_____	+21
2400	+17	_____	+21
<b>+14 dBm</b>			
2401	+12	_____	+16
2510	+12	_____	+16

Table B-5 ALC linearity at 2.5 MHz

RF level (dBm)	RF level min. (dBm)	Result (dBm)	RF level max. (dBm)
-4	-4.8	_____	-3.2
-3	-3.8	_____	-2.2
-2	-2.8	_____	-1.2
-1	-1.8	_____	-0.2
0	-0.8	_____	+0.8
1	+0.2	_____	+1.8
2	+1.2	_____	+2.8
3	+2.2	_____	+3.8
4	+3.2	_____	+4.8
5	+4.2	_____	+5.8
6	+5.2	_____	+6.8
7	+6	_____	+8
8	+7	_____	+9
9	+8	_____	+10
10	+9	_____	+11
11	+10	_____	+12
12	+11	_____	+13
12.1	+11.1	_____	+13.1
12.2	+11.2	_____	+13.2
12.3	+11.3	_____	+13.3
12.4	+11.4	_____	+13.4
12.5	+11.5	_____	+13.5
12.6	+11.6	_____	+13.6
12.7	+11.7	_____	+13.7
12.8	+11.8	_____	+13.8
12.9	+11.9	_____	+13.9
13	+12	_____	+14
14	+13	_____	+15
15	+14	_____	+16
16	+15	_____	+17
17	+16	_____	+18
18	+17	_____	+19
19	+18	_____	+20
20	+19	_____	+21
21	+20	_____	+22
22	+21	_____	+23
23	+22	_____	+24
24	+23	_____	+25
25	+24	_____	+26

Table B-6 ALC linearity at 500 MHz

RF level (dBm)	RF level min. (dBm)	Result (dBm)	RF level max. (dBm)
-4	-4.8	_____	-3.2
-3	-3.8	_____	-2.2
-2	-2.8	_____	-1.2
-1	-1.8	_____	-0.2
0	-0.8	_____	+0.8
1	0.2	_____	+1.8
2	+1.2	_____	+2.8
3	+2.2	_____	+3.8
4	+3.2	_____	+4.8
5	+4.2	_____	+5.8
6	+5.2	_____	+6.8
7	+6	_____	+8
8	+7	_____	+9
9	+8	_____	+10
10	+9	_____	+11
11	+10	_____	+12
12	+11	_____	+13
12.1	+11.1	_____	+13.1
12.2	+11.2	_____	+13.2
12.3	+11.3	_____	+13.3
12.4	+11.4	_____	+13.4
12.5	+11.5	_____	+13.5
12.6	+11.6	_____	+13.6
12.7	+11.7	_____	+13.7
12.8	+11.8	_____	+13.8
12.9	+11.9	_____	+13.9
13	+12	_____	+14
14	+13	_____	+15
15	+14	_____	+16
16	+15	_____	+17
17	+16	_____	+18
18	+17	_____	+19
19	+18	_____	+20
20	+19	_____	+21
21	+20	_____	+22
22	+21	_____	+23
23	+22	_____	+24
24	+23	_____	+25
25	+24	_____	+26

Table B-7 ALC linearity at 2050 MHz

RF level (dBm)	RF level min. (dBm)	Result (dBm)	RF level max. (dBm)
-4	-5.2	_____	-2.8
-3	-4.2	_____	-1.8
-2	-3.2	_____	-0.8
-1	-2.2	_____	+0.2
0	-1.2	_____	+1.2
1	-0.2	_____	+2.2
2	+0.8	_____	+3.2
3	+1.8	_____	+4.2
4	+2.8	_____	+5.2
5	+3.8	_____	+6.2
6	+4.8	_____	+7.2
7	+5	_____	+9
8	+6	_____	+10
9	+7	_____	+11
10	+8	_____	+12
11	+9	_____	+13
12	+10	_____	+14
12.1	+10.1	_____	+14.1
12.2	+10.2	_____	+14.2
12.3	+10.3	_____	+14.3
12.4	+10.4	_____	+14.4
12.5	+10.5	_____	+14.5
12.6	+10.6	_____	+14.6
12.7	+10.7	_____	+14.7
12.8	+10.8	_____	+14.8
12.9	+10.9	_____	+14.9
13	+11	_____	+15
14	+12	_____	+16
15	+13	_____	+17
16	+14	_____	+18
17	+15	_____	+19
18	+16	_____	+20
19	+17	_____	+21

Table B-8 ALC linearity at 2510 MHz

RF level (dBm)	RF level min. (dBm)	Result (dBm)	RF level max. (dBm)
-4	-5.6	_____	-2.4
-3	-4.6	_____	-1.4
-2	-3.6	_____	-0.4
-1	-2.6	_____	+0.6
0	-1.6	_____	+1.6
1	-0.6	_____	+2.6
2	+0.4	_____	+3.6
3	+1.4	_____	+4.6
4	+2.4	_____	+5.6
5	+3.4	_____	+6.6
6	+4.4	_____	+7.6
7	+5	_____	+9
8	+6	_____	+10
9	+7	_____	+11
10	+8	_____	+12
11	+9	_____	+13
12	+10	_____	+14
12.1	+10.1	_____	+14.1
12.2	+10.2	_____	+14.2
12.3	+10.3	_____	+14.3
12.4	+10.4	_____	+14.4
12.5	+10.5	_____	+14.5
12.6	+10.6	_____	+14.6
12.7	+10.7	_____	+14.7
12.8	+10.8	_____	+14.8
12.9	+10.9	_____	+14.9
13	+11	_____	+15
14	+12	_____	+16
15	+13	_____	+17
16	+14	_____	+18
17	+15	_____	+19
18	+16	_____	+20
19	+17	_____	+21

Table B-9 Carrier harmonic tests at +19 dBm

Carrier frequency (MHz)	2nd harmonic max. level (dBc)	Result (dBc)	3rd harmonic max. level (dBc)	Result (dBc)
0.01	-25	_____	-25	_____
0.1	-25	_____	-25	_____
1	-25	_____	-25	_____
9.9	-25	_____	-25	_____
10	-25	_____	-25	_____
18.7	-25	_____	-25	_____
18.8	-25	_____	-25	_____
37.4	-25	_____	-25	_____
37.6	-25	_____	-25	_____
74.9	-25	_____	-25	_____
75.1	-25	_____	-25	_____
150	-25	_____	-25	_____
151	-25	_____	-25	_____
300	-25	_____	-25	_____
301	-25	_____	-25	_____
600	-25	_____	-25	_____
601	-25	_____	-25	_____
750	-25	_____	-25	_____
950	-25	_____	-25	_____
1200	-25	_____	-25	_____
<b>2023B and 2025 (+13 dBm)</b>				
1201	-25	_____	-25	_____
1500	-25	_____	-25	_____
1900	-25	_____	-25	_____
<b>2050 ONLY (+13 dBm)</b>				
2510	-25	_____	-25	_____

Table B-10 Pulse mod. RF output at -4 dBm

Carrier frequency (MHz)	RF level min. (dBm)	Result (dBm)	RF level max. (dBm)
30	-5.0	_____	-3.0
60	-5.0	_____	-3.0
180	-5.0	_____	-3.0
300	-5.0	_____	-3.0
420	-5.0	_____	-3.0
540	-5.0	_____	-3.0
660	-5.0	_____	-3.0
780	-5.0	_____	-3.0
900	-5.0	_____	-3.0
1020	-5.0	_____	-3.0
1140	-5.0	_____	-3.0
1200	-5.0	_____	-3.0
<b>2023B and 2025</b>			
1201	-6.0	_____	-2.0
1260	-6.0	_____	-2.0
1380	-6.0	_____	-2.0
1500	-6.0	_____	-2.0
1620	-6.0	_____	-2.0
1740	-6.0	_____	-2.0
1860	-6.0	_____	-2.0
2050	-6.0	_____	-2.0
<b>2025 ONLY</b>			
2220	-6.0	_____	-2.0
2340	-6.0	_____	-2.0
2400	-6.0	_____	-2.0
2510	-6.0	_____	-2.0

Table B-11 Pulse mod. RF output at +7 dBm

Carrier frequency (MHz)	RF level min. (dBm)	Result (dBm)	RF level max. (dBm)
30	+6.0	_____	+8.0
60	+6.0	_____	+8.0
180	+6.0	_____	+8.0
300	+6.0	_____	+8.0
420	+6.0	_____	+8.0
540	+6.0	_____	+8.0
660	+6.0	_____	+8.0
780	+6.0	_____	+8.0
900	+6.0	_____	+8.0
1020	+6.0	_____	+8.0
1140	+6.0	_____	+8.0
1200	+6.0	_____	+8.0
<b>2023B and 2025</b>			
1201	+5.0	_____	+9.0
1260	+5.0	_____	+9.0
1380	+5.0	_____	+9.0
1500	+5.0	_____	+9.0
1620	+5.0	_____	+9.0
1740	+5.0	_____	+9.0
1860	+5.0	_____	+9.0
2050	+5.0	_____	+9.0
<b>2025 ONLY</b>			
2220	+5.0	_____	+9.0
2340	+5.0	_____	+9.0
2400	+5.0	_____	+9.0
2510	+5.0	_____	+9.0



**Table B-12 Pulse modulation on/off ratio test**

Carrier frequency (MHz)	Pulse mod. on/off ratio (dB)	Measured value (dB)
0.1	>80	_____
32	>80	_____
100	>80	_____
320	>80	_____
1000	>80	_____
1200	>80	_____
<b>2023B and 2025</b>		
1500	>70	_____
1800	>70	_____
2050	>70	_____
<b>2025 ONLY</b>		
2100	>70	_____
2400	>65	_____
2510	>65	_____

**Table B-13 Pulse modulation rise and fall time test**

		Result (ns)
Rise time	<20 ns	_____
Fall time	<20 ns	_____

# Index

## A

About this manual.....	ii
AC fuse.....	2-5
AC operation.....	2-5
Adjusting the display.....	4-48
ALC linearity test.....	7-7
AM depth and distortion test.....	7-21
AM scale shape test.....	7-21
Amplitude modulation selection.....	4-27
Attenuator hold.....	4-20

## B

Beryllia.....	vi
---------------	----

## C

Carrier error test.....	7-16
Carrier frequency.....	4-16
Carrier frequency accuracy test.....	7-9
Carrier phase adjustment.....	4-19
Carrier sweep.....	4-16
Changing the password.....	4-52
Cleaning the LCD window.....	2-9
Conventions for key labeling.....	ii
Coupling event registers.....	5-38

## D

Data Sheets.....	See end of Chap. 1
DC fuse.....	2-5
DC operation (Option 2).....	2-5
DC supply cable.....	2-5
DCFM nulling.....	4-43
Default settings.....	4-9, 4-32, 5-11
Disk installation/loading instructions.....	2-9
Display.....	4-10
Display blanking.....	4-46

## E

Electrical hazards.....	v
EMF or PD.....	4-21
Error messages.....	4-53
External AM frequency response test.....	7-22
External FM frequency response test.....	7-17, 7-18
External frequency standard input test.....	7-28

## F

Fire hazards.....	vi
First-time use.....	4-9
FM deviation and distortion test.....	7-15
FM scale shape test.....	7-16
Frequency modulation selection.....	4-28
Frequency standard selection.....	4-39
Front-panel controls and connectors.....	4-4, B-3
FSK selection.....	4-31
Fuses.....	2-5

## G

General purpose interface bus (GPIB).....	2-6
Goods-in checks.....	2-4
GPIB mnemonics.....	5-10
*CLS.....	5-10
*ESE.....	5-10
*ESE?.....	5-10
*ESR?.....	5-10
*IDN?.....	5-10
*OPC.....	5-10
*OPC?.....	5-10
*OPT?.....	5-10
*RST?.....	5-10
*SRE.....	5-10
*SRE?.....	5-10
*STB?.....	5-10
*TRG.....	5-10
*TST?.....	5-10
*WAI.....	5-10
AM.....	5-21
AM?.....	5-22
ATTEN.....	5-32
ATTEN?.....	5-32
BLANK.....	5-31
BLANK?.....	5-31
CCR?.....	5-43
CFRQ.....	5-12
CFRQ?.....	5-12
CONTRAST.....	5-31
CONTRAST?.....	5-31
CSE.....	5-43
CSE?.....	5-43
CSR?.....	5-43
DCFMNL.....	5-18
ELAPSED.....	5-31
ELAPSED?.....	5-31
ERASE.....	5-24
FM.....	5-17
FM?.....	5-18
FSTD.....	5-30
FSTD?.....	5-30
GPIB.....	5-30
HCR?.....	5-43
HSE.....	5-43
HSE?.....	5-43
HSR?.....	5-43
IMPEDANCE.....	5-32
IMPEDANCE?.....	5-33
KLOCK.....	5-32
KUNLOCK.....	5-32
MOD.....	5-16
MOD?.....	5-16
MODE.....	5-16
MODF?.....	5-18, 5-20, 5-22

contd./...

**G**GPIB mnemonics (*continued*)

MPROT.....	5-26
MSEQ.....	5-25
MSEQ?.....	5-25
MTRIG.....	5-26
MTRIG?.....	5-26
OPER?.....	5-31
PM.....	5-19
PM?.....	5-19
POWUP.....	5-32
POWUP?.....	5-32
PULSE.....	5-23
PULSE?.....	5-23
RCL.....	5-24
RCL?.....	5-24
RFLV.....	5-13
RFLV?.....	5-14
RPP.....	5-30
SCR?.....	5-43
SINAD.....	5-29
SINAD?.....	5-29
SSE.....	5-43
SSE?.....	5-43
SSR?.....	5-43
STO.....	5-24
SWEEP.....	5-27
SWEEP?.....	5-28

**H**

Hardware event registers.....	5-37
Hardware information.....	4-49
Harmonics test.....	7-11
Hazard symbols.....	v

**I**

IEEE to IEC conversion.....	2-6
Impedance selection.....	4-40
Initial visual inspection.....	2-2
Installation.....	2-1
Instrument event registers.....	5-39
Instrument operating position.....	2-5
Instrument options.....	4-50
Internal fuse.....	2-5

**K**

Keyboard locking.....	4-46
-----------------------	------

**L**

Linear units.....	4-21
Local lockout.....	5-3
Local operation.....	4-1
Logarithmic units.....	4-22

**M**

Main features.....	1-2
Main screen operation.....	3-2
Memory cloning.....	4-38

Memory operation.....	3-3
Memory recall.....	4-34
Memory sequencing.....	4-35
Memory state summary.....	4-37
Memory stores.....	4-33
Memory write protection.....	4-36
Menu conventions.....	4-15
Modulation enable/disable.....	4-26
Modulation modes.....	4-23
Modulation oscillator distortion and LF output flatness test.....	7-27
Modulation oscillator frequencies test.....	7-27
Modulation selection.....	4-27
Modulation source phase adjustment.....	4-26

**N**

Naming conventions.....	ii
Non-harmonics test.....	7-12

**O**

Option 1.....	<i>See Data Sheet at end of Chap. 1</i>
Option 2.....	<i>See Data Sheet at end of Chap. 1</i>
Option 3.....	<i>See Data Sheet at end of Chap. 1</i>
Option 4.....	<i>See Data Sheet at end of Chap. 1</i>
Option 5.....	<i>See Data Sheet at end of Chap. 1</i>
Option 7: Fast pulse modulation, Annex A.....	A-1
Option 10.....	<i>See Data Sheet at end of Chap. 1</i>
Option 11: Fast pulse and high power, Annex B.....	B-1
Option 12: SINAD measurement.....	4-44
Options.....	<i>See Data Sheet at end of Chap. 1</i>
Output control.....	5-15

**P**

Performance data ...	<i>See Data Sheets at end of Chap. 1</i>
Phase modulation flatness test.....	7-19
Phase modulation selection.....	4-29
Phase modulation test.....	7-19
Plug and Play driver.....	5-3
Power-up options.....	4-47
Principles of operation.....	3-1
Programming.....	5-8
Protection locking and unlocking.....	4-51
Pulse modulation.....	B-9
Pulse modulation rise and fall time test.....	7-26
Pulse modulation selection.....	4-30, B-5
Putting into storage.....	2-9

**Q**

Queue flag details.....	5-40
-------------------------	------

**R**

Rack mounting.....	2-7
Rear-panel connectors.....	4-7, B-4
Recommended test equipment.....	7-5
Remote operation.....	5-1
Remote operation selection.....	5-3
Residual FM test.....	7-12
Reverse power protection.....	4-20

RF leakage test.....	7-14
RF level .....	4-20
RF level frequency response test .....	7-7
RF level limit.....	4-41
RF level linear units.....	4-21
RF level logarithmic units.....	4-22
RF level offsets.....	4-42
Routine safety testing and inspection.....	2-8
RS-232 interface .....	2-7
RS-232 operation.....	5-4

**S**

Safety testing (routine).....	2-8
SINAD measurement (Option 12) .....	4-44
SINAD mode .....	5-29
Software information .....	4-49
Source selection.....	4-24
Specification.....	<i>See Data Sheets at end of Chap. 1</i>
Spectral purity test.....	7-10
SSB phase noise test.....	7-13

Standard event registers.....	5-36
Status byte .....	5-34, 5-41, 5-42
Status data structure.....	5-35
Sweep control.....	4-18
Sweep mode .....	4-17

**T**

Test procedures for Option 3.....	7-29, 7-32
Tilt warning.....	vi
Toxic hazards .....	vi

**U**

Utility menu operation.....	3-2
-----------------------------	-----

**V**

Ventilation.....	2-2
Version and Accessories	
	<i>See Data Sheet at end of Chap. 1</i>