AM/FM SIGNAL GENERATOR

2023 & 2024

10 kHz - 1.2 GHz 10 kHz - 2.4 GHz

Includes information on:

- Option 1: No attenuator.
- Option 2: DC operation.
- Option 3: High power.
- Option 4: High stability frequency standard.
- Option 5: Rear panel connectors.

© Marconi Instruments Ltd. 1995

No part of this book may be reproduced or transmitted in any form or by any means, electronic or mechanical, including photocopying, or recorded by any information storage or retrieval system, without permission in writing by Marconi Instruments Ltd.

Printed in the UK

Manual part no. 46882-225U

Issue 2

1 May 1995

About this manual

This manual explains how to use the 2023 and 2024 AM/FM Signal Generators.

Intended audience

Persons engaged on work relating to equipment who have a need for accurately generated signals in the VHF and UHF spectrum.

Structure

Chapter 1

Main features and performance data.

Chapter 2

Installation details.

Chapter 3

Operation for the experienced user.

Chapter 4

Detailed operation including first time usage.

Chapter 5

GPIB operation with keywords and sample programs.

Chapter 6

Brief technical description.

Chapter 7

Instructions for doing acceptance testing.

Document conventions

The following conventions apply throughout this manual:

RF OUTPUT	Titles marked on the instrument panel are shown in Capital letters
[TRIGGER]	Key titles are as shown on the key-caps in square brackets, and
<i>Disable</i>	Messages on the display are shown in Italic letters

Associated publications

There is one other publication covering specific aspects of this equipment:-

- **Service manual** (46880-068C) covers maintenance and repair of the equipment.

CUSTOMER QUESTIONNAIRE

Please spare a moment to detach, complete and return the Questionnaire on the next page. Your comments and suggestions will help us improve our products.

If you have had any problems with this product, please contact our Customer Support Help Desk on 01582-33866 at Luton if you are in the UK, or your Local Service Centre if outside the UK. The address and telephone number of your Local Service Centre is listed in this manual.

Please put the completed form in the addressed envelope provided and mail.

End User details

Name		
Company Name		
Company Address		
Country	Post Code	Fax no.
	Telephone No	Ext.

Equipment details

Part nos	Serial nos	Software Issues
Name & Address of Purchaser (if different from above)		
Delivery Date	Do you have a Maintenance Contract?	<input type="checkbox"/> Yes <input type="checkbox"/> No

Equipment Condition

Was the equipment in perfect working order when delivered?		<input type="checkbox"/> Yes <input type="checkbox"/> No
If the answer to the above question was 'no', was the problem to do with		
mechanical condition (damaged case etc.)	<input type="checkbox"/>	Severity Critical <input type="checkbox"/> Major <input type="checkbox"/> Minor <input type="checkbox"/>
suspected hardware fault	<input type="checkbox"/>	
suspected software fault	<input type="checkbox"/>	
did not meet its specification.	<input type="checkbox"/>	
Please tick the relevant item and describe below;		Repeatable? Yes <input type="checkbox"/> No <input type="checkbox"/> Occasionally <input type="checkbox"/>
<i>(continue in blank space on previous page if necessary)</i>		

Claim under Guarantee

If you have had problems,

have you already claimed under the Guarantee Yes No

or do you intend to claim under Guarantee? Yes No

Improvements

We should like to receive any suggestions for improvements or applications of this or other products that you may have. Please add them below or include them on an extra sheet.

(continue in blank space on previous page if necessary)

Marconi Instruments Action

	Initial/Date	Initial/Date	Initial/Date
Copy to Comm. Admin.		Distributor contacted	Problem established
Service Dept response		Follow through needed	Cleared

CONTENTS

Preface

Precautions

Chapter 1 GENERAL INFORMATION

Chapter 2 INSTALLATION

Chapter 3 PRINCIPLES OF OPERATION

Chapter 4 LOCAL OPERATION

Chapter 5 REMOTE OPERATION

Chapter 6 TECHNICAL DESCRIPTION

Chapter 7 ACCEPTANCE TESTING

Index

GENERAL
INFORMATION

INSTALLATION

PRINCIPLES OF
OPERATION

LOCAL
OPERATION

REMOTE
OPERATION

TECHNICAL
DESCRIPTION

ACCEPTANCE
TESTING

INDEX

Precautions

WARNING

CAUTION

Note

These terms have specific meanings in this manual:

WARNING

information to prevent personal injury.

CAUTION





information to prevent damage to the equipment.

Note

important general information.

Hazard symbols

The meaning of hazard symbols appearing on the equipment is as follows:

Symbol	Nature of hazard	Reference in manual
	Dangerous voltage	Page iv
	Static sensitive components	Page v
	Fire hazard	Page v
	Beryllia	Page v

Safety

This product has been designed and tested in accordance with IEC1010-1 (BS EN61010-1) 'Safety requirements for electrical equipment for measurement, control and laboratory use'.

WARNING

Electrical hazards

AC supply voltage

This equipment conforms with IEC Safety Class 1, meaning that it is provided with a protective grounding lead. To maintain this protection the supply lead must always be connected to the source of supply via a socket with a grounded contact.

Be aware that the supply filter contains capacitors that may remain charged after the equipment is disconnected from the supply. Although the stored energy is within the approved safety requirements, a slight shock may be felt if the plug pins are touched immediately after removal.

Fuses

Note that the internal supply fuse is in series with the live (brown) conductor of the supply lead. If connection is made to a 2-pin unpolarized supply socket, it is possible for the fuse to become transposed to the neutral conductor, in which case, parts of the equipment could remain at supply potential even after the fuse has ruptured.

Removal of covers

Disconnect the supply before removing the covers so as to avoid the risk of exposing high voltage parts. If any internal adjustment or servicing has to be carried out with the supply on, it must only be performed by a skilled person who is aware of the hazard involved.

WARNING**Fire hazard**

Make sure that only fuses of the correct rating and type are used for replacement.

If an integrally fused plug is used on the supply lead, ensure that the fuse rating is commensurate with the current requirements of this equipment. See under 'Performance Data' in Chapter 1 for power requirements.

WARNING**Toxic hazards**

Some of the components used in this equipment may include resins and other materials which give off toxic fumes if incinerated. Take appropriate precautions, therefore, in the disposal of these items.

WARNING**Beryllia**

Beryllia (beryllium oxide) is used in the construction of some of the components in this equipment. This material, if incorrectly handled, could cause a danger to health - refer to the Maintenance part of the Service Manual for safe handling precautions.

WARNING**Tilt facility**

When the instrument is in the tilt position, it is advisable, for stability reasons, not to stack other instruments on top of it.

CAUTION**Static sensitive components**

This equipment contains static sensitive components which may be damaged by handling - refer to the Maintenance part of the Service Manual for handling precautions.

Précautions

WARNING**CAUTION****Note**

Les termes suivants ont, dans ce manuel, des significations particulières:

WARNING

contient des informations pour éviter toute blessure au personnel.

CAUTION



contient des informations pour éviter les dommages aux équipements.

Note

contient d'importantes informations d'ordre général.

Symboles Signalant Un Risque

La signification des symboles liés à cet équipement est la suivante:

Symbole	Nature du risque	Référence dans le manuel
	Tension dangereuse	Page vi
	Risque lié au feu	Page vii
	Le Beryllia	Page vii

Sécurité

Ce produit a été conçu et testé conformément à la norme IEC 1010-1 (BS EN 61010-1) recommandations de sécurité des équipements électriques pour la mesure, le contrôle et l'utilisation en laboratoire.

WARNING

Sécurité Electrique

Tension d'alimentation alternative

Cet appareil est protégé conformément à la norme CEI de sécurité class 1, c'est-à-dire que sa prise secteur comporte un fil de protection à la terre. Pour maintenir cette protection, le câble d'alimentation doit toujours être branché à la source d'alimentation par l'intermédiaire d'une prise comportant une borne terre.

Notez que les filtres d'alimentation contiennent des condensateurs qui peuvent encore être chargés lorsque l'appareil est débranché. Bien que l'énergie contenue soit conforme aux exigences de sécurité, il est possible de ressentir un léger choc si l'on touche les bornes sitôt après débranchement.

Fusibles

Notez que le fusible d'alimentation interne est en série avec la phase (fil brun) du câble d'alimentation. Si la prise d'alimentation comporte deux bornes non polarisées, il est possible de connecter le fusible au neutre. Dans ce cas, certaines parties de l'appareil peuvent rester à un certain potentiel même après coupure du fusible.

Retrait des couvercles

L'appareil doit être débranché avant de retirer les couvercles afin d'éviter tout contact avec les éléments haute tension. Si toutefois un réglage interne ou une réparation nécessitent la présence de l'alimentation, ils devront être effectués par une personne qualifiée et avisée des risques encourus.

WARNING

Risque Lie Au Feu

Lors du remplacement des fusibles vérifiez l'exactitude de leur type et de leur valeur.

Si le câble d'alimentation comporte une prise avec fusible intégré, assurez vous que sa valeur est compatible avec les besoins en courant de l'appareil. Pour la consommation, reportez-vous au chapitre 1 "Spécifications".

WARNING

Danger produits toxiques

Certains composants utilisés dans cet appareil peuvent contenir des résines et d'autres matières qui dégagent des fumées toxiques lors de leur incinération. Les précautions d'usages doivent donc être prises lorsqu'on se débarrasse de ce type de composant.

WARNING

Le Beryllia

Le Beryllia (oxyde de Beryllium) entre dans la composition de certains composants de cet appareil. Cette matière peut représenter un danger pour la santé s'il elle n'est pas manipulée de façon correcte - se référer à la partie "Maintenance" du "Manuel de Maintenance" pour les précautions de manipulation.

WARNING

Position Inclinée

Lorsque l'appareil est dans une position inclinée, il est recommandé, pour des raisons des stabilité, de ne pas y empiler d'autres appareils.

Vorsichtsmaßnahmen

WARNING
CAUTION
Note

Diese Hinweise haben eine bestimmte Bedeutung in diesem Handbuch:

WARNING dienen zur Vermeidung von Verletzungsrisiken.

CAUTION dienen dem Schutz der Geräte.

Note enthalten wichtige Informationen.

Gefahrensymbole

Die Gefahrensymbole auf den Geräten sind wie folgt:

Symbol	Gefahrenart	Im Handbuch
	Gefährliche Spannung	Seite viii
	Feuergefährlich	Seite ix
	Beryllium Oxid	Seite ix

Sicherheit

Dieses Produkt wurde in Übereinstimmung mit der IEC 1010-1 Norm (BS EN 61010-1) für "Sicherheitsanforderungen an elektrische Geräte in der Meßtechnik, für Steuerungen oder im Laboreinsatz" entwickelt und geprüft.

WARNING

Elektrische Schläge

Wechselspannungsversorgung

Das Gerät entspricht IEC Sicherheitsklasse 1 mit einem Schutzleiter nach Erde. Das Netzkabel muß stets an eine Steckdose mit Erdkontakt angeschlossen werden.

Filterkondensatoren in der internen Spannungsversorgung können auch nach Unterbrechung der Spannungszuführung noch geladen sein. Obwohl die darin gespeicherte Energie innerhalb der Sicherheitsmargen liegt, kann ein leichter Spannungsschlag bei Berührung kurz nach der Unterbrechung erfolgen.

Sicherungen

Die interne Sicherung in der Spannungszuführung ist in Reihe mit der spannungsführenden Zuleitung (braun) geschaltet. Bei Verbindung mit einer zweiadrigen, nicht gepolten Steckdose kann die Sicherung in der Masseleitung liegen, so daß auch bei geschmolzener Sicherung Geräteteile immer noch auf Spannungspotential sind.

Abnahme von Abdeckungen

Die Spannungsversorgung muß vor Abnahme von Gehäuseabdeckungen unterbrochen sein, damit hochspannungsführende Teile gefahrlos zugänglich sind. Falls Abgleiche oder Servicearbeiten unter Spannung notwendig werden, dürfen solche Arbeiten nur von fachkundigem Personal durchgeführt werden, das die Gefahren kennt.

WARNING

Feuergefahr

Es dürfen nur Ersatzsicherungen vom gleichen Typ mit den korrekten Spezifikationen entsprechend der Stromaufnahme des Gerätes verwendet werden. Siehe hierzu die Leistungsdaten (Performance Data) in Kapitel 1.

WARNING

Warnung vor giftigen Substanzen

In einigen Bauelementen dieses Geräts können Epoxyharze oder andere Materialien enthalten sein, die im Brandfall giftige Gase erzeugen. Bei der Entsorgung müssen deshalb entsprechende Vorsichtsmaßnahmen getroffen werden.

WARNING

Beryllium Oxid

Beryllium Oxid wird in einigen Bauelementen verwendet.

Bei inkorrektter Handhabung kann dieses Material Gesundheitsschäden verursachen. Siehe hierzu die Hinweise zur Handhabung im Service-Handbuch.

WARNING

Schrägstellung

Bei Schrägstellung des Geräts sollten aus Stabilitätsgründen keine anderen Geräte darauf gestellt werden.

Precauzioni

WARNING**CAUTION****Note**

Questi termini vengono utilizzati in questo manuale con significati specifici:

WARNING

riportano informazioni atte ad evitare possibili pericoli alla persona.

CAUTION



riportano informazioni per evitare possibili pericoli all'apparecchiatura.

Note

riportano importanti informazioni di carattere generale.

Simboli di pericolo

Significato dei simboli di pericolo utilizzati nell'apparato:

Simbolo	Tipo di pericolo	Riferimento nel manuale
	Tensione pericolosa	Pagina x
	Pericolo d'incendio	Pagina xi
	Berillio	Pagina xi

Sicurezza

Questo prodotto è stato progettato e collaudato in accordo con le norme IEC1010-1 (BS EN61010-1) "Safety requirements for electrical equipment for measurement, control and laboratory use" (Requisiti di sicurezza per apparati elettrici di misura, controllo e di laboratorio).

WARNING

Pericoli Da Elettricità

Alimentazione c.a.

Quest' apparato è provvisto del collegamento di protezione di terra e rispetta le norme di sicurezza IEC, classe 1. Per mantenere questa protezione è necessario che il cavo, la spina e la presa d'alimentazione siano tutti provvisti di terra.

Il circuito d'alimentazione contiene dei filtri i cui condensatori possono restare carichi anche dopo aver rimosso l'alimentazione. Sebbene l'energia immagazzinata è entro i limiti di sicurezza, purtuttavia una leggera scossa può essere avvertita toccando i capi della spina subito dopo averla rimossa.

Fusibili

Notare che un fusibile è posto sul filo caldo (marrone) del cavo di alimentazione. Qualora l'alimentazione avvenga tramite due poli non polarizzati, è possibile che il fusibile vada a protezione del neutro per cui anche in caso di una sua rottura, l'apparato potrebbe restare sotto tensione.

Rimozione dei coperchi

Prima di rimuovere i coperchi occorre scollegare la spina d'alimentazione onde evitare il rischio di esposizione di parti ad alta tensione. Eventuali operazioni di manutenzione che richiedono la presenza dell'alimentazione dovranno essere eseguite solo da parte di personale specializzato ed a conoscenza dei pericoli coinvolti.

WARNING

Pericolo d'incendio

Assicurarsi che, in caso di sostituzione, vengano utilizzati solo fusibili della portata e del tipo prescritti.

Se viene usata una spina con fusibili, assicurarsi che questi siano di portata adeguata ai requisiti di alimentazione richiesti dallo strumento. Tali requisiti sono riportati nel cap. 1 "Performance data".

WARNING

Pericolo sostanze tossiche

Alcuni dei componenti usati in questo strumento possono contenere resine o altri materiali che, se bruciati, possono emettere fumi tossici. Prendere quindi le opportune precauzioni nell'uso di tali parti.

WARNING

Berillio

Berillio (ossido di berillio) è utilizzato nella costruzione di alcuni componenti di quest'apparato.

Questo materiale, se maneggiato non correttamente, può causare danni alla salute. Far riferimento ai capitoli di manutenzione del Manuale di Servizio per le precauzioni richieste.

WARNING

Posizionamento inclinato

Quando lo strumento è in posizione inclinata è raccomandato, per motivi di stabilità, non sovrapporre altri strumenti.

Precauciones

WARNING**CAUTION****Note**

Estos términos tienen significados específicos en este manual:

WARNING

contienen información referente a prevención de daños personales.

CAUTION



contienen información referente a prevención de daños en equipos.

Note

contienen información general importante.

Símbolos de peligro

Los significados de los símbolos de peligro que aparecen en los equipos son los siguientes:

Símbolo	Naturaleza del peligro	Referencia en manual
	Voltaje peligroso	Página xii
	Peligro de incendio	Página xiii
	Berilio	Página xiii

Seguridad

Este producto ha sido diseñado y comprobado de acuerdo con la norma IEC 1010-1 (BS EN61010-1) sobre "Necesidades de seguridad para equipos eléctricos de medida, control y laboratorio.

WARNING

Nivel Peligroso De Electricidad

Tensión de red

Este equipo cumple las normas IEC Seguridad Clase 1, lo que significa que va provisto de un cable de protección de masa. Para mantener esta protección, el cable de alimentación de red debe de conectarse siempre a una clavija con terminal de masa.

Tenga en cuenta que el filtro de red contiene condensadores que pueden almacenar carga una vez desconectado el equipo. Aunque la energía almacenada está dentro de los requisitos de seguridad, pudiera sentirse una ligera descarga al tocar la clavija de alimentación inmediatamente después de su desconexión de red.

Fusibles

Se hace notar que el fusible de alimentación interno está en serie con el activo (marrón) del cable de alimentación a red. Si la clavija de alimentación de red cuenta con sólo dos terminales sin polaridad, el fusible puede pasar a estar en serie con el neutro, en cuyo caso existen partes del equipo que permanecerían a tensión de red incluso después de que el fusible haya fundido.

Para retirar las tapas

Desconectar de red antes de retirar las tapas para evitar el riesgo que supone tener accesibles aquellas partes del equipo expuestas a alta tensión. Aquellas operaciones que requieran tener alimentación con las tapas abiertas para mantenimiento o ajuste deben de ser realizadas por personal cualificado, que esté al tanto de los riesgos implicados.

WARNING

Peligro de Incendio

Asegúrese de utilizar sólo fusibles del tipo y valores especificados como recuento.

Si se utiliza una clavija con fusible incorporado, asegúrese de que los valores del fusible corresponden a los requeridos por el equipo. Ver sección de especificaciones del capítulo 1 para comprobar los requisitos de alimentación.

WARNING

Aviso de toxicidad

Alguno de los componentes utilizados en este equipo pudieran incluir resinas u otro tipo de materiales que al arder produjeran sustancias tóxicas, Por tanto, tome las debidas precauciones en la manipulación de esas piezas.

WARNING

Berilio

Berilio (óxido de berilio) Este material es utilizado en la fabricación de alguno de los componentes de este equipo.

Si se manipulase incorrectamente podría causar daños a la salud - En la sección de mantenimiento y reparación encontrará normas de manejo de seguridad.

WARNING

Tener En Cuenta Con El Equipo Inclinado

Si utiliza el equipo en posición inclinada, se recomienda, por razones de estabilidad, no apilar otros equipos encima de él.

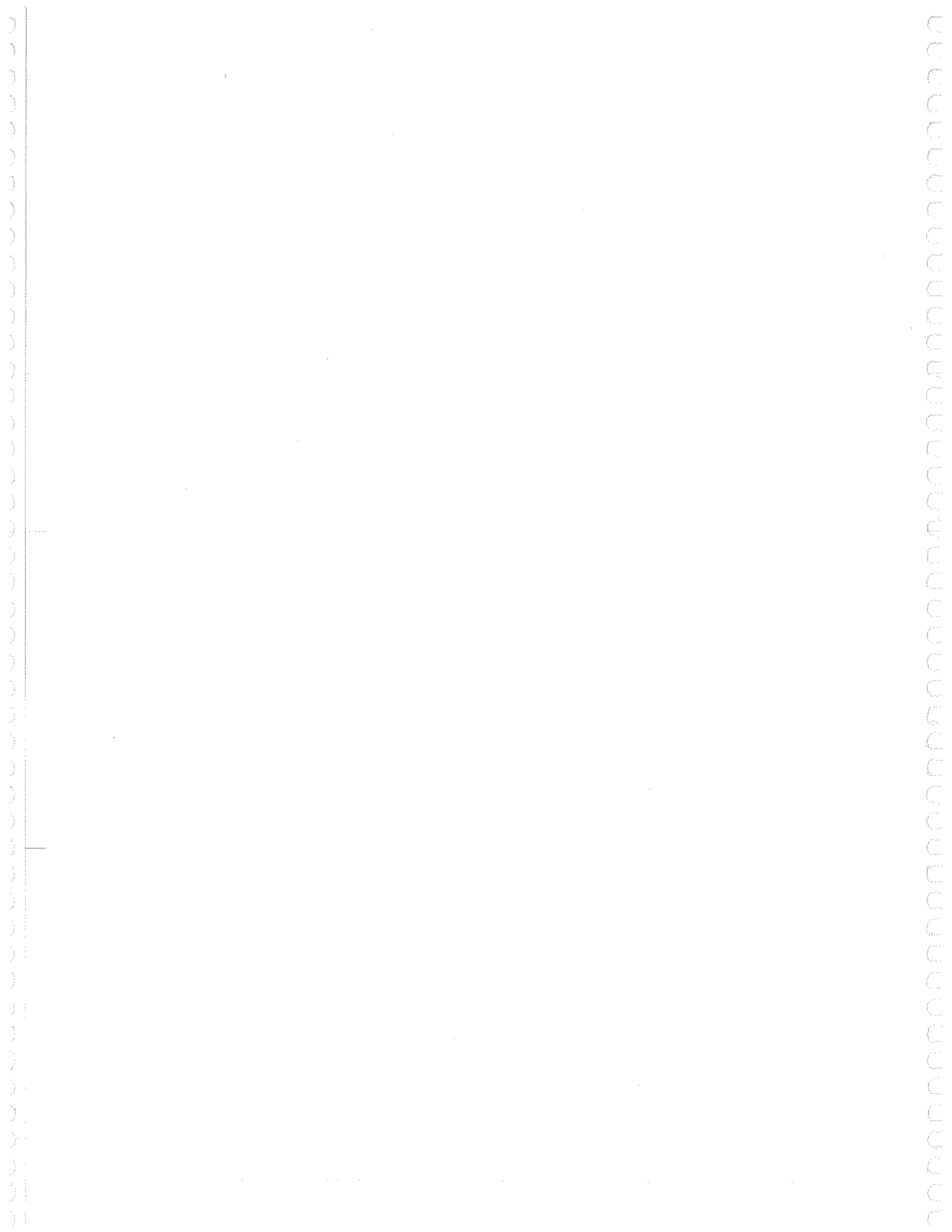

Chapter 1

GENERAL INFORMATION

Contents

Introduction	1-2
Main features	1-2
Operation	1-2
Display	1-2
Frequency selection	1-2
Output	1-2
Modulation	1-2
Incrementing	1-3
Frequency sweep	1-3
Memory	1-3
Programming	1-3
Software protection	1-4
Calibration data	1-4
Spectral purity	1-4
Calibration	1-4
Performance data	1-5
Versions, options and accessories	1-9

Introduction

The 2023 and 2024 are portable and lightweight synthesized signal generators covering the frequency range 10 kHz to 1.2 GHz (2023) and 10 kHz to 2.4 GHz (2024). A dot matrix display with a comprehensive set of utility menus allow flexibility of operation and ease of use. The RF output can be amplitude, frequency, phase or pulse modulated. An internal programmable AF source is capable of generating simultaneous two-tone modulation.

All parameters can be entered from a front panel keyboard and a rotary control can be used to adjust most settings. Microprocessor control ensures that the instruments are flexible and easy to use and allows programming by either the General Purpose Interface Bus (GPIB) or by RS-232. The GPIB is designed to IEEE Standard 488.2. The interfaces allow remote control of all functions except the supply switch, and allow the instruments to be used either manually or as part of a fully automated test system.

Main features

Operation

Selection of parameters on the screen may involve one or more of the numeric, hard or menu selection keys or the rotary control knob. Parameters may be set to specific values by numeric key entry, while values may be varied in steps of any size using the DOWN/UP keys or altered by moving the control knob, set to a particular sensitivity.

Display

The display is a dot matrix liquid crystal panel, with backlighting. Display contrast may be varied to accommodate differing lighting conditions and the setting saved in memory. A graphical display test is available to the user.

Frequency selection

Carrier frequency is either selected directly via the keyboard or remotely via the interfaces. Frequency resolution is 1 Hz across the band. A series of carrier frequencies can be stored in non-volatile memory for recall when required.

Output

RF output up to +13 dBm can be set by direct keyboard entry with a resolution of 0.1 dB over the entire range. For instruments fitted with the high power option, RF output is increased to +25 dBm (+19 dBm above 1.2 GHz). A carrier ON/OFF key is provided to completely disable the output.

A choice of level units is available to the user and provision is made for the conversion of units (for example, dBm to μV) by a simple keypress.

An electronic trip protects the generator output against reverse power of up to 50 W. This prevents damage to output circuits when RF or DC power is accidentally applied to the RF OUTPUT connector.

To facilitate testing of receiver squelch systems, an attenuator hold function allows control of the RF output without introducing RF level drop-outs from the step attenuator.

Modulation

Comprehensive amplitude, frequency and phase modulations are available. Pulse modulation can be applied to the carrier from an external pulse source. The instrument also accepts one or two logic level inputs to produce a 2-level or 4-level FSK modulated output. An internal modulation oscillator is provided, having a frequency range of 0.01 Hz to 20 kHz. The oscillator is capable of generating one or two modulation tones simultaneously in one modulation channel. An independent BNC input on the front panel allows external modulation signals to be combined

with the internal signal(s). These sources can be combined to give a number of modulation modes. The pulse modulation can be used in combination with the other forms of modulation.

The frequency modulation range provides a 1 dB bandwidth of typically 100 kHz and provides FM deviation up to a maximum of 100 kHz. AC or DC coupled FM can be selected. Phase modulation is also available with a 10 kHz bandwidth up to a maximum of 10 radians.

Amplitude modulation with a 1 dB bandwidth of typically 30 kHz and with modulation depths of up to 99.9% is available with a resolution of 0.1%. Pulse modulation is available as standard with typical rise and fall times of less than 10 μ s and 40 dB on/off ratio.

The external input voltage required for 100% modulation is 1 V RMS (1.414 V peak). To accommodate other signal levels, Automatic Level Control (ALC) can be selected which provides correctly calibrated modulation for inputs between 0.75 and 1.25 V RMS.

A MOD ON/OFF key simplifies the testing of signal to noise ratio.

Incrementing

All major parameters can be incremented or decremented in step sizes entered via keyboard entry or remotely. If no step size is entered for a parameter, the steps are preset to 1 kHz for carrier frequency, 1 kHz for modulation oscillator, 1 kHz for FM deviation, 0.1% for AM depth, 0.01 rad for Φ M and 1 dB for output level.

In addition, the rotary control knob can be used to vary the parameter with the sensitivity of the knob being changed by means of the $\times 10$ and $\div 10$ keys.

Frequency sweep

The sweep capability of the instrument allows comprehensive testing of systems. Four parameters are used to specify sweep; start, stop, step size and time per step, all of which may be specified by the user. The sweep can be paused at any time. During the sweep the RF level can be altered using the rotary control. Sweep triggering can be single shot or continuous and can be initiated directly or on the detection of a trigger. The triggering signal may either be programmed or from a TTL signal applied to the rear panel TRIGGER input.

Memory

The instrument provides both non-volatile and volatile memory for storing instrument settings. The non-volatile memory provides 100 instrument settings and 100 settings of carrier frequency only. The volatile memory (RAM) also provides 100 instrument settings. Any one of the non-volatile instrument settings can be selected as the power-up setting for the instrument.

Memory cloning

The stored settings in one instrument can be easily transferred (without the use of a controller) to another instrument using the RS-232 interface, or to several other instruments using the GPIB interface.

Memory sequencing

A software facility allows sequences of stored instrument settings to be defined. The incrementing facilities can then be used to cycle through the settings in manually operated test systems.

Programming

A GPIB interface is fitted so that all functions are controllable via the interface bus which is designed to the IEEE Standard 488.2. The instrument can function both as talker and listener. The instrument also has an RS-232 interface which uses the common GPIB command set. The interfaces enable the instrument to be remotely controlled as well as being used to transfer settings (cloning) from one instrument to another.

Software protection

To prevent accidental interference with the contents of internal memories, internal data is protected.

Calibration data

All alignment data is digitally derived. Realignment can be undertaken, without removing covers, by protected front panel functions or via the GPIB interface.

Spectral purity

With an SSB phase noise performance of typically -121 dBc/Hz at 20 kHz offset from a 1 GHz carrier, these instruments can be used for both in-channel and adjacent channel receiver measurements. Harmonically related signals and non-harmonics are typically better than -25 dBc and -60 dBc respectively.

Calibration

This instrument has a recommended two year calibration interval after which it should be returned for recalibration (for addresses refer to 'Addresses' section at end of manual).

Performance data

Carrier frequency

- Range: 10 kHz to 1.2 GHz (2023).
10 kHz to 2.4 GHz (2024).
- Resolution: 1 Hz.
- Accuracy: Equal to the frequency standard accuracy.

RF output

- Range: -137 dBm to +13 dBm.
When AM is selected the maximum RF output level decreases linearly with increasing AM depth to +7 dBm at 99.9% depth.
- Resolution: 0.1 dB.
- Accuracy: For output levels above -127 dBm and over a temperature range of 17 to 27°C:
±0.8 dB to 1.2 GHz;
±1.6 dB to 2.4 GHz.
Temperature coefficient <±0.02 dB/°C to 1.2 GHz, and <±0.04 dB/°C to 2.4 GHz.
- Attenuator hold: Inhibits operation of the step attenuator from the level at which the key is enabled. Usable for a level reduction of at least 10 dB. Typical accuracy ±3 dB.
- Output impedance: 50 Ω, type-N connector to MIL 390123D. For output levels less than -5 dBm output VSWR is less than 1.3:1 for carrier frequencies up to 1.2 GHz and less than 1.5:1 for carrier frequencies up to 2.4 GHz.
- Reverse power: Protected against the application of reverse power to the output connector for levels up to 50 W from 50 Ω or 25 W from a source VSWR of 5:1. Protection circuit can be reset from the front panel or via the GPIB/RS-232 interfaces.
- 75 Ω calibration: The output level can be entered as the value after a 50/75 Ω external adapter.

Spectral purity

- Harmonics: Typically better than -30 dBc for levels up to +7 dBm.
Typically better than -25 dBc for RF levels up to +13 dBm.
- Non-harmonics: Better than -70 dBc for carrier frequencies up to 1 GHz.
Better than -64 dBc for carrier frequencies above 1 GHz.
Better than -60 dBc for carrier frequencies above 2 GHz.
- Residual FM: Less than 4.5 Hz RMS in a 300 Hz to 3.4 kHz bandwidth at a carrier frequency of 1 GHz.

Residual FM (typical)
< 1 HZ at 249 MHz
< 2 HZ at 501 MHz
< 3 HZ at 1001 MHz
< 6 HZ at 2001 MHz
- SSB phase noise: Better than -121 dB/Hz at 20 kHz offset from a 470 MHz carrier.
Typically -121 dB/Hz at 20 kHz offset from a 1 GHz carrier.
- RF leakage: Less than 0.5 μV at the carrier frequency into a two-turn 25 mm diameter loop 25 mm from the surface of the signal generator.

Modulation

FM, AM or phase modulation can be applied to the carrier from an internal or external modulation source. The internal modulation source is capable of generating two simultaneous signals into any one of the modulation channels. Internal and external modulation can be simultaneously enabled to produce combined amplitude and frequency (or phase) modulation. Pulse modulation can be applied to the carrier from an external pulse source. The pulse modulation can be used in combination with the other forms of modulation. 2 level or 4 level FSK modulation can be applied to the carrier using data from an external source.

Frequency modulation

- Deviation range: 0 to 100 kHz.
- Resolution: 3 digits or 1 Hz.
- Bandwidth (1 dB): DC to 100 kHz (DC coupled),
10 Hz to 100 kHz (AC coupled),
20 Hz to 100 kHz (AC coupled with ALC).
- Accuracy: ±5% at 1 kHz modulation rate.

Carrier error:	Less than 1% of the set frequency deviation when DC coupled.
Distortion:	Less than 3% at 1 kHz rate for deviations up to 100 kHz. Typically 0.5% at 1 kHz rate for deviations up to 10 kHz.
Group delay:	Less than 5 μ s to 100 kHz.

FSK

Modes:	2 level or 4 level FSK.
Data source:	External data connected to TRIGGER connector (2 level) or TRIGGER and PULSE connectors (4 level).
Frequency shift:	Settable up to \pm 100 kHz.
Accuracy:	As FM deviation accuracy.
Timing jitter:	\pm 3.2 μ s
Filter:	8 th order Bessel, -3 dB at 20 kHz.

Phase modulation

Range:	0 to 10 radians.
Resolution:	3 digits or 0.01 radians.
Bandwidth (3 dB):	100 Hz to 10 kHz.
Accuracy:	\pm 5% at 1 kHz modulation rate.
Distortion:	Less than 3% at 10 radians at 1 kHz. Typically 0.5% for deviations up to 1 radian at 1 kHz.

Amplitude modulation (for carrier frequencies <1 GHz, usable to 2 GHz)

Range:	0 to 99.9%.
Bandwidth (1 dB):	DC to 30 kHz (DC coupled), 10 Hz to 30 kHz (AC coupled), 20 Hz to 30 kHz (AC coupled with ALC).
Resolution:	0.1%.
Accuracy:	\pm 5% of set depth at 1 kHz rate at +17°C to 27°C ambient temperature. Temperature coefficient <0.02% per °C.
Distortion:	Less than 3% at 1 kHz rate for modulation depths up to 80%.
Φ M on AM:	Typically 0.1 radians at 30% depth at 470 MHz.

Pulse modulation

Carrier frequency range:	32 MHz to 2.4 GHz, usable to 10 MHz.
RF level range:	Maximum guaranteed output is reduced to +8 dBm (+20 dBm or +14 dBm with high power option) when pulse modulation is selected.
RF level accuracy:	Maximum additional uncertainty is \pm 0.5 dB.
Input:	Rear panel BNC connector with an input impedance of 10 k Ω nominal. A logical '1' (3.5 to 5 V) turns the carrier on, a logical '0' (0 to 1 V) turns the carrier off. Maximum safe input is \pm 15 V.
On-off ratio:	Better than 40 dB, better than 45 dB below 1.2 GHz.
Rise and fall time:	Less than 10 μ s.

Modulation oscillator

	The internal modulation oscillator is capable of generating one or two modulation tones simultaneously in one modulation channel.
Frequency range:	0.01 Hz to 20 kHz.
Resolution:	0.01 Hz to 100 Hz, 0.1 Hz to 1 kHz, 1 Hz to 20 kHz.
Distortion:	Less than 0.1% at 1 kHz.
Sine wave frequency response:	Typically 1 dB DC to 20 kHz.
Waveforms:	Sine (to 20 kHz), triangle or square wave (to 3 kHz). Square wave jitter <6.4 μ s on any edge.

Output:	The modulation oscillator signal is available on a front panel BNC connector at a level of 2 V RMS EMF from a 600 Ω source impedance.												
External modulation input	A front panel external modulation input is provided.												
Input level:	1 V RMS (1.414 V peak) sine wave for set deviation. Maximum safe input is ±15 V.												
Input impedance:	100 kΩ nominal.												
Modulation ALC:	Levels the applied external modulation over the range 0.75 to 1.25 V RMS. High and low indicators in display indicate when the input is outside levelling range.												
Sweep mode	A carrier frequency sweep mode is provided. The sweep is defined by entry of the start, stop and frequency step size. The step time can be set from 20 ms to 10 s per step. A trigger input on the rear panel may be used to trigger a step or the complete sweep. Sweep can be set to continuous.												
Frequency standard	The carrier frequency and internal modulation frequency are synthesized from either an internal reference oscillator or an external reference.												
Internal standard													
Type:	10 MHz TCXO.												
Aging rate:	Less than ±1 in 10 ⁶ per year.												
Temperature stability:	Better than ±5 in 10 ⁷ over the temperature range 0 to 55°C.												
External standard:	Input: Requires an input of 220 mV RMS to 1.8 V RMS into 1 kΩ on rear panel BNC connector. Input frequency can be 1 MHz or 10 MHz. Output: Rear panel BNC socket provides an output of 10 MHz at a nominal level of 2 V pk-pk into 50 Ω.												
Calibration interval	Recommended 2 years. Realignment can be accomplished by GPIB control or from the front panel. There are no mechanical adjustments required for realignment.												
Remote control													
GPIB:	All functions except the supply switch are remotely programmable.												
Capabilities:	Complies with the following subsets as defined in IEEE Std 488.1: SH1, AH1, T6, TE0, L4, LE0, SR1, PP0, DC1, DT1, C0, E2.												
RS-232:	All functions except the supply switch are remotely programmable.												
Connector:	9-way male D-type												
Baud rate:	300 to 9600 bit/s.												
Handshake:	Hardware: DTR, RTS, CTS and DSR Software: XON and XOFF												
Electrical:	Interface to EIA-232-D.												
Electromagnetic compatibility	Conforms to the protection requirements of Council Directive 89/336/EEC. Complies with the limits specified in the following standards: EN55011 Class B CISPR 11 EN50082-1 IEC 801-2,3,4 EN60555-2 IEC 555-2												
Safety	This instrument is designed to comply with the requirements of EN61010-1/IEC1010-1, for Class 1 portable equipment and is for use in a pollution degree 2 environment. The equipment is designed to operate from an installation category 1 and 2 supply.												
Rated range of use	Specification is met over the temperature range 0 to +55°C, humidity up to 93% at 40°C and elevation up to 3050 m (10,000 ft).												
Conditions of storage and transport	The instrument can be stored at temperatures from -40°C to +71°C, elevations up to 4600 m and humidities up to 95% at 40°C.												
Power requirements	47 to 63 Hz at 90 to 132 V, or 188 to 264 V at 175 VA maximum.												
Dimensions and weight	<table border="0" style="width: 100%;"> <thead> <tr> <th style="text-align: left;">Height</th> <th style="text-align: left;">Width</th> <th style="text-align: left;">Depth</th> <th style="text-align: left;">Weight</th> </tr> </thead> <tbody> <tr> <td>107 mm</td> <td>419 mm</td> <td>440 mm</td> <td><8 kg</td> </tr> <tr> <td>4.2 in</td> <td>16.5 in</td> <td>17.3 in</td> <td><17.6 lb</td> </tr> </tbody> </table>	Height	Width	Depth	Weight	107 mm	419 mm	440 mm	<8 kg	4.2 in	16.5 in	17.3 in	<17.6 lb
Height	Width	Depth	Weight										
107 mm	419 mm	440 mm	<8 kg										
4.2 in	16.5 in	17.3 in	<17.6 lb										

Options

Option 1: No attenuator

Omits the internal step attenuator. Not available with Option 3. Specification as standard instrument with the following exceptions:

RF output range:	-2 dBm to +15 dBm. When AM is selected the maximum output level reduces linearly with AM depth to +9 dBm at maximum AM depth.
RF level accuracy:	As standard instrument for levels between -2 dBm and +15 dBm.
Pulse modulation:	Not available.
Reverse power protection:	Reverse power protection is not provided.

Option 2: DC operation

Allows for operation from an external DC power source in addition to an AC power source. Specification as standard instrument with the following additions:

DC supply range:	11 to 32 V.
DC consumption:	70 W with Option 3 not fitted.
AC supply frequency	47 to 440 Hz at 90 to 132 V, 47 to 63 Hz at 188 to 264 V at 200 VA maximum.

Option 3: High power

Increases maximum output from the normal +13 dBm. Not available with Option 1. Specification as standard instrument with the following exceptions:

RF output range:	-137 dBm to +25 dBm for carrier frequencies up to 1.2 GHz. -137 dBm to +19 dBm for carrier frequencies above 1.2 GHz. Maximum output is reduced by 5 dB when pulse modulation is selected and/or by up to 6 dB dependant upon set AM depth.
RF level accuracy:	Over a temperature range 17°C to 27°C: ±1 dB up to 1.2 GHz, ±2 dB up to 2.4 GHz. Temperature coefficient <±0.02 dB/°C to 1.2 GHz, and <±0.04 dB/°C to 2.4 GHz.
Harmonics:	Typically better than -25 dBc for levels 6 dB below the maximum specified output.

Option 4: High stability frequency standard

Replaces the internal TCXO with a high stability OCXO. Specification as standard instrument with the following exceptions:

Aging rate:	±2.5 in 10^7 per year, ±5 in 10^9 per day after 2 months continuous use.
Stability:	Better than ±5 in 10^8 over the temperature range 0 to 50°C.
Warm-up time:	Within 2 in 10^7 of final frequency 10 minutes after switch on at a temperature of 20°C.

Option 5: Rear panel connectors

The front panel connectors RF OUTPUT, LF OUTPUT and EXT MOD INPUT are relocated on the rear panel for rack mounted operation.

Versions, options and accessories

When ordering please quote the full ordering number information.

Ordering numbers

2023
2024

Versions

10 kHz to 1.2 GHz Signal Generator.
10 kHz to 2.4 GHz Signal Generator.

Options

Option 1	No attenuator (not available with Option 3).
Option 2	DC operation.
Option 3	High power (not available with Option 1).
Option 4	High stability frequency standard.
Option 5	Rear panel connectors.

Supplied accessories

43129-003W	AC power supply lead.
46882-225U	Operating manual (this manual).
43130-119U	DC supply lead (supplied with Option 2 only).

Optional accessories

54311-208Z	50/75 Ω adapter.
46880-068C	Service manual.
46884-792D	Rack mounting kit.
46662-601J	Transit case.
46662-602F	Carrying case.
46884-650F	RS-232 cable, 9-way female to 9-way female, 1.5 m.
46883-408K	IEEE/IEC adapter block for GPIB socket.
43129-189U	GPIB lead assembly.
59999-524N	TEM cell.

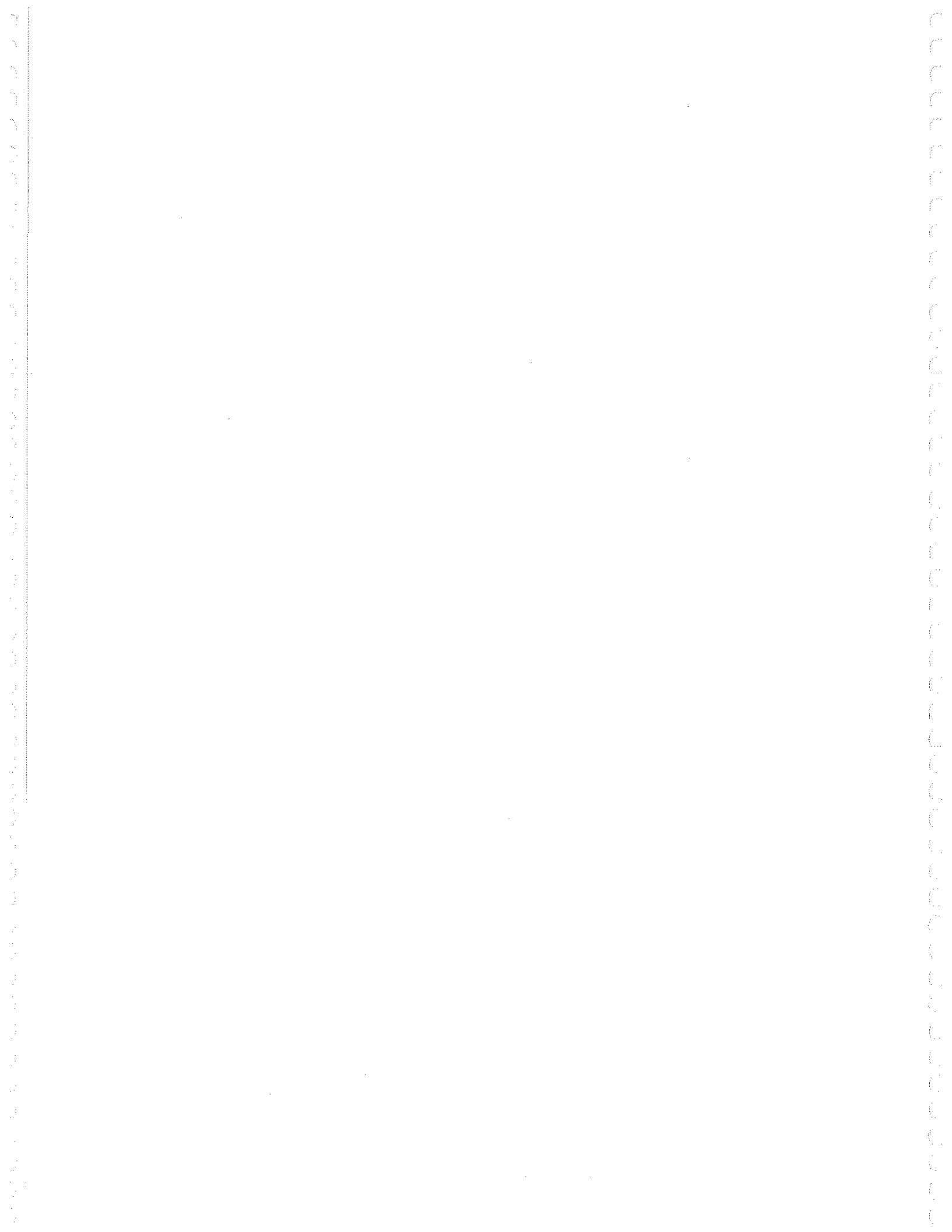

Chapter 2

INSTALLATION

Contents

Initial visual inspection.....	2-2
Ventilation.....	2-2
Goods-in checks.....	2-2
Instrument operating position	2-2
AC operation	2-2
Connecting to supply	2-2
AC fuse.....	2-2
Internal fuse.....	2-3
Supply cable.....	2-3
DC operation (Option 2).....	2-3
Connecting to supply	2-3
DC fuse.....	2-3
Supply cable.....	2-3
General purpose interface bus (GPIB)	2-3
GPIB cable connection.....	2-4
GPIB connector contact assignments.....	2-4
IEEE to IEC conversion.....	2-4
Interface bus connection.....	2-5
RS-232 interface	2-5
RS-232 connector.....	2-5
Cleaning the LCD window.....	2-5
Rack mounting	2-5
Routine safety testing and inspection	2-6
1. Visual inspection	2-6
2. Earth bonding tests (Class I Equipment only).....	2-6
3. Insulation tests.....	2-7
Putting into storage.....	2-7

List of figures

Fig. 2-1 DC INPUT socket showing connector polarity (viewed from rear of instrument).....	2-3
Fig. 2-2 GPIB connector contact assignments (viewed from rear of instrument).....	2-4
Fig. 2-3 IEEE to IEC conversion.....	2-4
Fig. 2-4 RS-232 connector contact assignments (viewed from rear of instrument).....	2-5

Initial visual inspection

Immediately after unpacking, thoroughly inspect the instrument for signs of physical damage that may have occurred during shipping. If any damage is found, or if the instrument fails the Goods-in checks (see below), return the instrument to the following address:

Marconi Instruments Ltd
The Airport
LUTON
Bedfordshire LU2 9NS

Attach a label indicating the service required, type or model number, serial number and your return address. Use the container and packing materials that were used to ship the instrument.

Ventilation

If the instrument is fitted with a plastic cover it should be removed before the instrument is connected to the AC mains supply. The instrument is air-cooled with fan assistance, via air intakes. Air is ducted over the heat producing elements and is expelled via a rear panel fan. Neither the fan exhaust nor the air intakes must be obstructed whilst the instrument is in use.

Goods-in checks

The following goods-in check verifies that the instrument is functioning correctly, but does not verify conformance to the listed specification. To verify that the instrument conforms to the specification given in Chapter 1, refer to Chapter 7, 'Acceptance testing'.

- (1) Ensure that the correct fuse is fitted (accessible from the rear panel) and connect the instrument to the supply.
- (2) Switch on and check that a display is present.
- (3) If the instrument appears to be completely dead, carry out the following:

Check that the mains power supply line is providing power to the instrument.

Check that the mains fuses have not blown.

Instrument operating position

For reasons of stability and ventilation the instrument must only be operated on its underside feet (with or without the tilt stands).

AC operation

Connecting to supply

Ensure that the AC supply is correctly connected to the POWER SUPPLY socket. For supplies in the range 90 - 132 V and 188 - 264 V the PSU automatically selects the appropriate range. There is no manual voltage range selection provided.

AC fuse

For the AC voltage range of 90 to 264 V the fuse rating is 2 A-T (time lag). The AC fuse is a cartridge type measuring 20 mm x 5 mm.

The fuse-holder is integral with the rear panel 3-pin supply plug. For access to change the fuse, use a screwdriver to lever out the holder.

Internal fuse

Note that there is an additional, non-operator replaceable internal, fuse fitted in the switched mode power supply (not applicable to instruments fitted with Option 2, which have a different power supply).

AC supply cable

The AC supply cable is fitted at one end with a socket which mates with the AC connector on the rear panel. When fitting a supply plug, ensure that connections are made as follows:

Ground (Earth)	-	Green/Yellow
Neutral	-	Blue
Live	-	Brown

When attaching the supply lead to a non-soldered plug, it is recommended that the tinned ends of the lead are cut off to avoid intermittent connections resulting from cold flow.

DC operation (Option 2)

Connecting to supply

Before connecting the instrument to a DC supply, for an instrument fitted with Option 2, check that the DC supply is within the following range:

11 to 32 V

If, however, the DC supply is to provide a back-up for the AC supply, the following DC supply range must be used:

18 to 32 V

DC fuse

For the DC voltage range of 11 to 32 V the fuse rating is 10 A-T (time lag). Fuses are cartridge type measuring 20 mm × 5 mm.

DC supply cable

Connection is made to a 3-pin polarized plug on the instrument (see Fig. 2-1). Note that the negative (-) connector is internally connected to the chassis of the instrument. A suitable lead is available as a supplied accessory (see Chap. 1 'Versions, options and accessories').

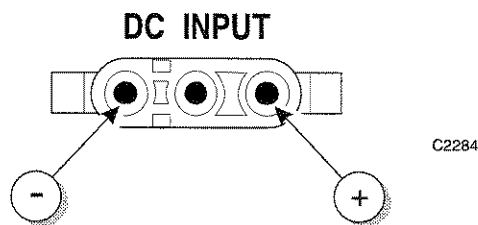

Fig. 2-1 DC INPUT socket showing connector polarity (viewed from rear of instrument)

General purpose interface bus (GPIB)

The GPIB interface built into the instrument enables the signal generator to be remotely controlled to form part of an automatic measuring system, as well as being used to dump memory (cloning) from one instrument to another.

GPIB cable connection

Connection to other equipment which has a 24-way connector to IEEE Standard 488 is made using the rear panel IEEE 488-2 socket. For this purpose the GPIB cable assembly, available as an optional accessory (see Chap. 1 'Accessories'), may be used.

GPIB connector contact assignments

The contact assignments of the GPIB cable connector are as given in the table below and shown in Fig. 2-2.

Contact	Function	Contact	Function
1	Data I/O 1	13	Data/O 5
2	Data I/O 2	14	Data/O 6
3	Data I/O 3	15	Data/O 7
4	Data I/O 4	16	Data/O 8
5	EOI	17	REN
6	DAV	18	Pair with 6
7	NRFD	19	Pair with 7
8	NDAC	20	Pair with 8
9	IFC	21	Pair with 9
10	SRQ	22	Pair with 10
11	ATN	23	Pair with 11
12	Ground shield	24	Logic ground

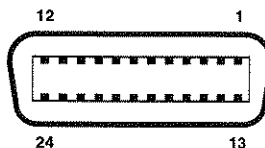
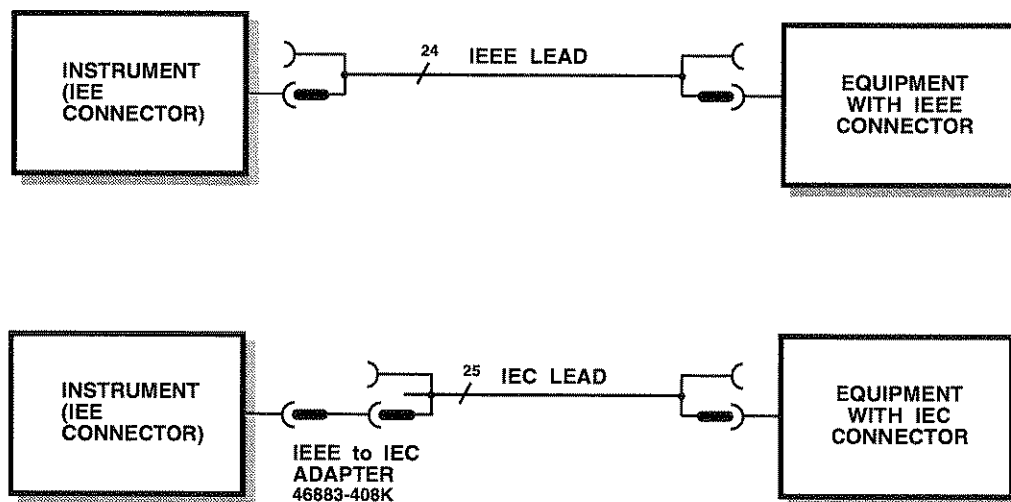

Fig. 2-2 GPIB connector contact assignments (viewed from rear of instrument)

IEEE to IEC conversion

An optional IEEE to IEC adapter is also available (see Chap. 1 'Versions, options and accessories') for interfacing with systems using a 25-way bus connector to IEC Recommendation 625. The method of use is shown in Fig. 2-3.



C0032

Fig. 2-3 IEEE to IEC conversion

Interface bus connection

The cables for the interface bus use special male-female connectors at both ends. This allows several connectors to be stacked one on top of another permitting several cables to be connected to the same source and secured by a lockscrew mechanism. Too large a stack, however, may form a cantilevered structure which might cause damage and should be avoided. The piggyback arrangement permits star or linear interconnection between the devices with the restriction that the total cable length for the system must be:-

- (1) No greater than 20 m (65 ft).
- (2) No greater than 2 m (6 ft) times the total number of devices (including the controller) connected to the bus.

RS-232 interface

The RS-232 interface built into the instrument enables the signal generator to be remotely controlled as well as being used to dump memory (cloning) from one instrument to another.

RS-232 connector

The rear panel male D-type RS-232 connector is shown in Fig. 2-4.

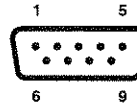

Fig. 2-4 RS-232 connector contact assignments (viewed from rear of instrument)

The pin-outs for the 9-way RS-232 connector are shown below:

Contact		Signal
1	DCD	Data carrier detect
2	RXD	Receive data
3	TXD	Transmit data
4	DTR	Data terminal ready
5	SG	Signal ground
6	DSR	Data set ready
7	RTS	Request to send
8	CTS	Clear to send
9	RI	Ring indicator

The RS-232 interface can be connected to a personal computer's AT connector using a null-modem cable. A suitable cable is available from Marconi Instruments - see 'Versions, options and accessories' in Chap. 1.

Cleaning the LCD window

To prevent damage to the LCD window, care should be taken not to scratch the surface during use and also when cleaning. The LCD window should be cleaned by wiping a slightly damp, soft, lint-free cloth gently over the surface

Rack mounting

The instrument, which is normally supplied for bench mounting, may be mounted in a standard 19 inch rack (see Chap. 1 'Versions, options and accessories').

Routine safety testing and inspection

In the UK the 'Electricity at Work Regulations' (1989) section 4(2) places a requirement on the users of equipment to maintain it in a safe condition. The explanatory notes call for regular inspections and tests together with a need to keep records.

The following electrical tests and inspection information is provided for guidance purposes and involves the use of voltages and currents that can cause injury. It is important that these tests are only performed by competent personnel.

Prior to carrying out any inspection and tests the instruments must be disconnected from the mains supply and all external signal connections removed. All tests should include the instrument's own supply lead, all covers must be fitted and the supply switch must be in the 'ON' position.

The recommended inspection and tests fall into three categories and should be carried out in the following sequence:

1. Visual inspection
2. Earth bonding test (Class I equipment only)
3. Insulation resistance test.

1. Visual inspection

A visual inspection should be carried out on a periodic basis. This interval is dependant on the operating environment, maintenance and use, and should be assessed in accordance with guidelines issued by the Health and Safety Executive (HSE). As a guide, this instrument when used indoors in a relatively clean environment would be classified as 'low risk' equipment and hence should be subject to safety inspections on an annual basis. If the use of the equipment is contrary to the conditions specified, you should review the safety re-test interval.

As a guide, the visual inspection should include the following where appropriate:

Check that the equipment has been installed in accordance with the instructions provided (e.g. that ventilation is adequate, supply isolators are accessible, supply wiring is adequate and properly routed).

The condition of the mains supply lead and supply connector(s).

Check that the mains supply switch isolates the instrument from the supply.

The correct rating and type of supply fuses.

Security and condition of covers and handles.

Check the supply indicator functions (if fitted).

Check the presence and condition of all warning labels and markings and supplied safety information.

Check the wiring in re-wireable plugs and appliance connectors.

If any defect is noted this should be rectified before proceeding with the following electrical tests.

2. Earth bonding tests (Class I Equipment only)

Earth bonding tests should be carried out using a 25A (12V maximum open circuit voltage) DC source. Tests should be limited to a maximum duration of 5 seconds and have a pass limit of 0.1Ω after allowing for the resistance of the supply lead. Exceeding the test duration can cause damage to the equipment. The tests should be carried out between the supply earth and exposed case metalwork, no attempt should be made to perform the tests on functional earths (e.g. signal carrying connector shells or screen connections) as this will result in damage to the equipment.

3. Insulation tests

A 500 VDC test should be applied between the protective earth connection and combined live and neutral supply connections with the equipment supply switch in the 'on' position. It is advisable to make the live/neutral link on the appliance tester or its connector to avoid the possibility of returning the instrument to the user with the live and neutral poles linked with an ad-hoc strap. The test voltage should be applied for 5 seconds before taking the measurement. Marconi Instruments products employ reinforced insulation in their construction and hence a minimum pass limit of 7 M Ω should be achieved during this test.

Where a DC power adapter is provided with the instrument the adapter must pass the 7 M Ω test limit.

We do not recommend dielectric flash testing during routine safety tests. Most portable appliance testers use AC for the dielectric strength test which can cause damage to the supply input filter capacitors.

It is recommended that the results from the above tests are recorded and checked during each repeat test. Significant differences between the previous readings and measured values should be investigated.

If any failure is detected during the above visual inspection or tests, the instrument should be disabled and the fault should be rectified by an experienced Service Engineer who is familiar with the hazards involved in carrying out such repairs.

Safety critical components should only be replaced with equivalent parts, using techniques and procedures recommended by Marconi Instruments Ltd.

The above information is provided for guidance only. Marconi Instruments products are designed and constructed in accordance with International Safety Standards such that in normal use they represent no hazard to the operator. Marconi Instruments Ltd reserve the right to amend the above information in the course of continuing its commitment to product safety.

Putting into storage

If the instrument is to be put into storage, ensure that the following conditions are maintained:

Temperature range:	-40 to +70°C
Humidity:	Less than 93% at 40°C

Chapter 3

PRINCIPLES OF OPERATION

Contents

Introduction	3-2
Main screen operation.....	3-2
Utility menu operation	3-2
Menu grouping	3-3
Family tree.....	3-3
Memory operation.....	3-3

List of figures

Fig. 3-1 Utility menu operation summary showing a modulation selection example	3-3
Fig. 3-2 Utility menu family tree.....	3-5

Introduction

This chapter is specifically for use by the experienced signal generator user and therefore the operation of the instrument is not explained in detail. Since the instrument has been designed to be easy to use, the experienced user may need only to refer to this chapter to efficiently use the instrument.

The operation of the instrument is based on using the main screen and using the menus. The main screen is used in association with six function keys while menu operation is entered using the [MENU] key. Four of the function keys [CARR FREQ], [RF LEVEL], [MOD] and [MOD SOURCE] enable you to set the basic parameters of a signal. The remaining two function keys [STO] and [RCL] control memory store and recall operations. The blue [MENU] key enables you to select utility menu operation which provides access to a wide range of utilities.

Main screen operation

The main screen is displayed at switch-on and after one of the dark grey function keys has been pressed. Pressing a function key highlights the area of the screen appropriate to that key and the instrument awaits either parameter entry or menu operation.

Both the [MOD] and [MOD SOURCE] function keys operate in a cyclic fashion as shown by the arrows marked on the keys. Repeated pressing of the [MOD] key steps through each modulation of the currently selected modulation mode, together with full source information for that mode.

As each modulation mode is displayed, the signal source for that modulation can be selected. For internal sources, repeated pressing of the [MOD SOURCE] key steps through and selects each of the available waveforms. If the displayed modulation mode is external, repeated pressing of the key displays and selects each of the external types of coupling.

Utility menu operation

The instrument provides a range of utilities for such applications as setting the GPIB address, adjusting the LCD contrast, poking the latches and selecting the modulation mode. Utility menu operation is summarized in Fig. 3-1 which uses a modulation selection example.

The function keys are closely connected with the utility menus for greater efficiency of operation. This means that when you press a function key followed by the [MENU] key, those utilities associated with that function are called up for immediate use. Thus pressing [MOD][MENU] takes you to the modulation group of menus.

Within the menus, pressing [SELECT] will take you down the menu chain, pressing [MENU] will take you back up.

Moving between items on a menu is done by means of the [NEXT] and [PREV] keys.

Once you are familiar with the use of the utility menus, you can immediately call up commonly used menus by using the sequence:

[MENU] Utility number [ENTER]

To return to the main screen, press any one of the function keys.

With the main screen displayed, pressing [SELECT] will either display your last selected utility or, if you have just switched on, display the software status of the instrument.

Menu grouping

To save you having to memorize specific utility numbers the utilities are split into the ten groups listed below:

Utility number	Utility group
01 - 09	FREQUENCY/SWEEP
10 - 19	RF LEVEL
20 - 29	MODULATION (Normal and FSK)
30 - 39	MODULATION SOURCE
40 - 49	MEMORY
50 - 59	SETUP
60 - 69	INFORMATION
70 - 79	DIAGNOSTICS
80 - 89	LOCK/UNLOCK
100 onwards	CALIBRATION

Family tree

Menu operation is graphically presented in Fig. 3-2.

Memory operation

During operation, either the current carrier frequency or the current instrument settings can be saved by means the memory store [STO] key and recalled when required by means of the recall [RCL] key. The type of store is determined by the location number selected:

Carrier store		0 - 99
Full store	non-volatile	100 - 199
Full store	volatile	200 - 299

Note that the instrument factory settings can be recalled from memory location 999.

Main screen

```

Carr Freq 2 400.000 000 Mhz
RF Level -137.0 dBm ON Mod Disable FM2 ~ OFF
FM1 Devn 0 Hz ModF ~ 1.0000 kHz
  
```

Modulation selected as current on main screen

Pressing

SELECT

displays the LAST selected utility or the DEFAULT

MENU

```

Utility Group menu      Util 1
┌───────────┬───────────┐
│ Frequency/Sweep │ Setup          │
│ RF Level       │ Information   │
│ Modulation     │ Diagnostics  │
│ Modulation Source │ Lock/Unlock  │
│ Memory        │ Calibration  │
└───────────┴───────────┘
  
```

Utility number entered terminated with [ENTER]

Modulation highlighted

MENU

SELECT

```

Modulation Source Menu Util 1
RF Level Menu Util 1
Frequency/Sweep Menu Util 1
Modulation Menu Util 1
┌───────────┬───────────┐
│ 20 Modulation Mode (Normal) │
│ 21 Modulation Mode (Special) │
│ 22 Pulse Modulation         │
│ 23 DCFM Nulling            │
└───────────┴───────────┘
  
```

Modulation Mode highlighted

MENU

SELECT

```

Util 1
Util 1
Util 1 23 DCFM Nulling
Util 1 22 Pulse Modulation
Util 1 21 Modulation Mode (Special)
Util 1 20 Modulation Mode (Normal)
Util 20 Modulation Mode (Normal)
Mod Mode: FM int
┌───────────┬───────────┐
│ AM int    │ AM ext    │
│ FM int    │ FM ext    │
│ QM int    │ QM ext    │
│           │ None...   │
└───────────┴───────────┘
  
```

```

CARR FREQ  RCL
RF LEVEL   STO
MOD SOURCE
  
```

Any FUNCTION key

C2350

Fig. 3-1 Utility menu operation summary showing a modulation selection example





Chapter 4

LOCAL OPERATION

Contents

Introduction	4-4
Front panel controls and connectors	4-4
Connectors	4-4
Keyboard	4-4
Rear panel connectors	4-7
FIRST TIME USE	4-9
Switching on	4-9
Display	4-10
Selecting functions and keyboard entry	4-12
Carrier frequency	4-12
RF level	4-12
Modulation	4-12
Using [NEXT] and [PREV] to select a function	4-12
Using the [$\uparrow+10$] and [$\downarrow\times 10$] keys	4-12
With the control knob	4-13
With steps	4-13
Using the utility menus	4-14
Menu conventions	4-15
DETAILED OPERATION	4-16
Selecting carrier frequency	4-16
Carrier on/off	4-16
Carrier sweep operation	4-16
Sweep parameters	4-16
Sweep mode	4-17
Sweep control	4-18
Carrier phase adjustment	4-19
Selecting RF level	4-20
Choice of units	4-20
Attenuator hold	4-20
Reverse power protection	4-20
RF level linear units	4-21
RF level logarithmic units	4-22
Modulation modes	4-23
Mode selection	4-23
Source selection - internal	4-24
Source selection - external	4-25
Modulation enable/disable	4-26
Modulation source phase adjustment	4-26
Modulation selection	4-27
Amplitude modulation selection	4-27
Frequency modulation selection	4-28
Phase modulation selection	4-29
Pulse modulation selection	4-30
FSK selection	4-31
Default settings	4-32
MEMORY	4-33
Memory stores	4-33
Memory recall	4-34
Recalling data	4-34
Recalling default settings	4-34
Memory sequencing	4-35
Memory write protection	4-36

LOCAL
OPERATION

Memory state summary	4-37
Memory cloning	4-38
GENERAL.....	4-39
Frequency standard selection.....	4-39
50 Ω /75 Ω impedance selection.....	4-40
DCFM nulling.....	4-41
Keyboard locking and display blanking	4-42
Power-up options.....	4-43
Adjusting the display.....	4-44
Software information.....	4-45
Hardware information	4-45
Instrument options	4-46
Protection locking and unlocking.	4-47
Changing the password	4-48
ERROR MESSAGES	4-49
Error handling	4-49
Background errors:.....	4-49
Foreground errors:.....	4-49
Error message priority:.....	4-49
GPIB errors	4-49

List of tables

Table 4-1 Instrument default settings.....	4-32
Table 4-2 Background errors (500 - 599) in priority order	4-50
Table 4-3 Foreground errors (0 - 399)	4-51
Table 4-4 GPIB errors (400 - 499).....	4-52

List of figures

Fig. 4-1 2024 front panel showing SUPPLY switch and connectors	4-4
Fig. 4-2 Instrument front panel showing keyboard.....	4-5
Fig. 4-3 Instrument rear panel showing connectors.....	4-7
Fig. 4-4 2023 main screen in normal operation showing default display	4-9
Fig. 4-5 2024 main screen in normal operation showing default display	4-9
Fig. 4-6 Division of the display into fields	4-11
Fig. 4-7 Step setting display showing default settings	4-14
Fig. 4-8 Utility group menu	4-14
Fig. 4-9 Frequency/sweep menu.....	4-14
Fig. 4-10 Frequency standard menu.....	4-15
Fig. 4-11 Carrier sweep parameters menu.....	4-16
Fig. 4-12 Carrier sweep mode select menu.....	4-17
Fig. 4-13 Carrier sweep control menu.....	4-18
Fig. 4-14 Carrier phase adjust menu	4-19
Fig. 4-15 RPP tripped display	4-20
Fig. 4-16 RF level linear units menu.....	4-21
Fig. 4-17 RF level logarithmic units menu.....	4-22
Fig. 4-18 Modulation mode menu - first page	4-23
Fig. 4-19 Modulation mode menu - second page.....	4-23
Fig. 4-20 Modulation source menu	4-24
Fig. 4-21 Modulation source menu - shown with an external source selected	4-25
Fig. 4-22 Modulation source phase menu	4-26
Fig. 4-23 Pulse modulation menu	4-30
Fig. 4-24 Modulation mode (special) menu.....	4-31
Fig. 4-25 Memory sequencing menu.....	4-35
Fig. 4-26 Memory write protection menu (showing stores 0 to 100 protected).....	4-36
Fig. 4-27 Memory state summary (showing carrier stores 0 to 20 protected).....	4-37

Fig. 4-28	Memory cloning menu (showing instrument ready to receive via the GPIB).....	4-38
Fig. 4-29	Frequency standard menu	4-39
Fig. 4-30	50 Ω /75 Ω calibration menu	4-40
Fig. 4-31	DCFM nulling display	4-41
Fig. 4-32	Key lock/display blanking menu	4-42
Fig. 4-33	Power-up settings menu	4-43
Fig. 4-34	LCD adjustment menu (with the setting saved for automatic recall at switch-on) ..	4-44
Fig. 4-35	Software status.....	4-45
Fig. 4-36	Hardware status	4-45
Fig. 4-37	Instrument options display	4-46
Fig. 4-38	Protection locking and unlocking.....	4-47
Fig. 4-39	Password selection menu	4-48
Fig. 4-40	Background errors display	4-49

Introduction

All operations of the signal generator are carried out from the front panel keyboard which is colour-coded. An extensive suite of utility menus make this a very versatile instrument. The built-in GPIB and RS-232 interfaces enable the instrument to be remotely operated.

Front panel controls and connectors

Parameters are selected by means of keys which have their functions printed on them, a numerical key pad and a rotary control knob. The numerical keys are used to set parameters to specific values which can also be varied in steps of any size by using the [$\uparrow+10$] and [$\downarrow\times 10$] keys or the rotary control knob.

Connectors

The front panel connectors are shown in Fig. 4-1 below:

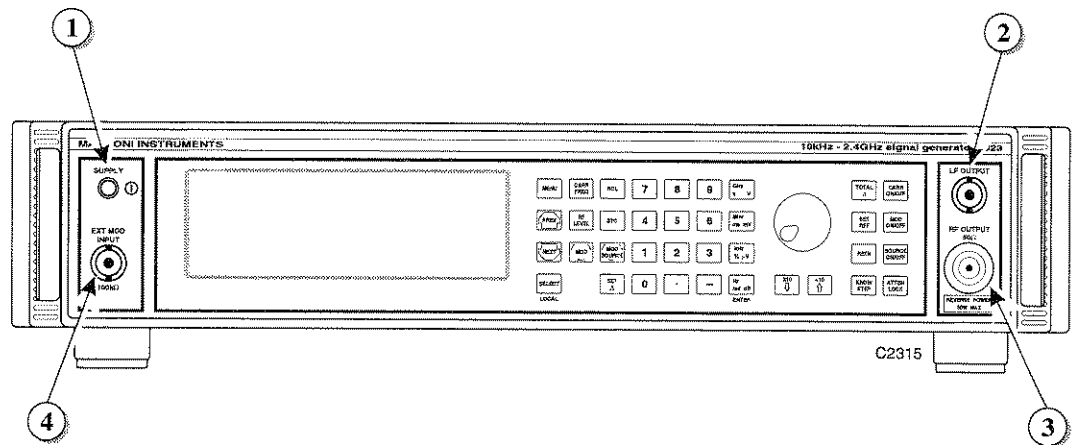

Fig. 4-1 2024 front panel showing SUPPLY switch and connectors

- | | |
|-------------------|---|
| (1) SUPPLY switch | Switches the supply on and off using a press on, press off action. |
| (2) LF OUTPUT | 600 Ω BNC socket which monitors the modulation oscillator.
With Option 5 this socket is fitted on the rear panel. |
| (3) RF OUTPUT | 50 Ω N-type socket. Protected against the application of reverse power of up to 50 W.
With Option 5 this socket is fitted on the rear panel. |
| (4) EXT MOD INPUT | 100 k Ω BNC socket. An independent input which allows an external modulating signal to be applied.
With Option 5 this socket is fitted on the rear panel. |

Keyboard

The keyboard is functionally colour-coded. The keys for the primary functions of carrier frequency, level and modulation are dark grey. Secondary functions such as unit selection and on/off keys are medium grey. Menu selection, which plays such a prominent part in this instrument, has keys which are coloured blue.

The front panel keyboard is shown in Fig. 4-2 below:

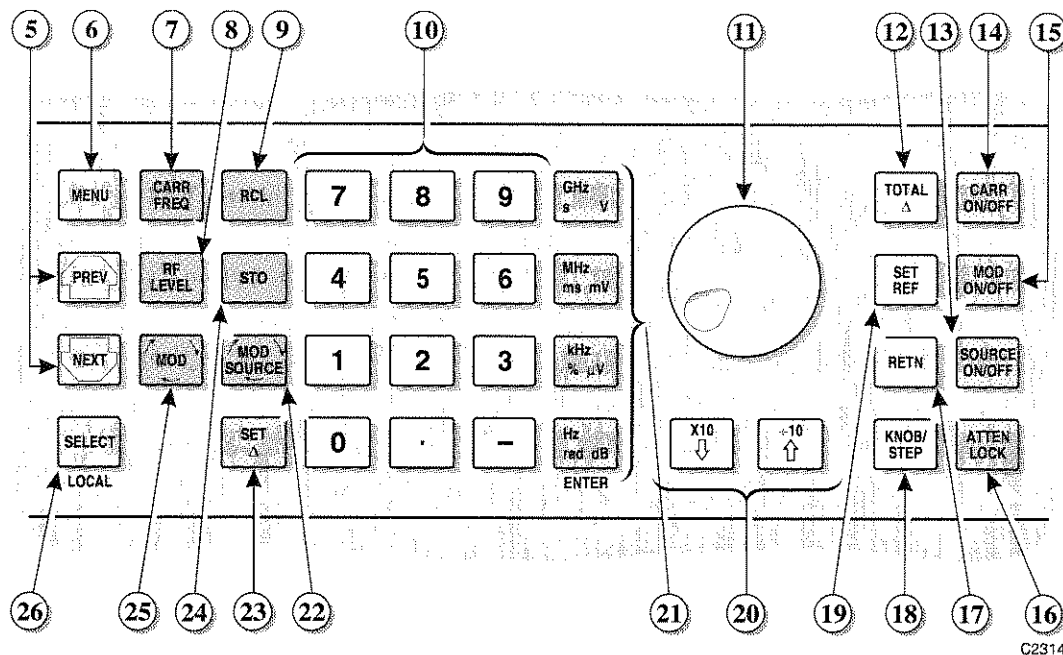

Fig. 4-2 Instrument front panel showing keyboard

- (5) [PREV] A key used to scrolls backwards through a menu list or the function list.
- [NEXT] A menu key used to scroll forwards through a menu list or the function list.
- (6) [MENU] Selects the main utility menu, or within utility menus steps back up through the menus.
- (7) [CARR FREQ] Selects carrier frequency as the current function and causes the main screen to be displayed.
- (8) [RF LEVEL] Selects RF level as the current function and causes the main screen to be displayed.
- (9) [RCL] Used to recall a previously stored instrument setting from memory.
- (10) Numerical key pad For entering the value of a selected parameter. Minus sign and decimal point are included.
- (11) Control knob When enabled by the [KNOB/STEP] key, adjusts the value of the selected parameter.
- (12) [TOTAL Δ] While the key is held down, displays the total shift from the keyed-in value.
- (13) [SOURCE ON/OFF] Switches the current modulation source on and off.
- (14) [CARR ON/OFF] Switches the carrier output on and off.
- (15) [MOD ON/OFF] Switches ALL modulation on and off.
- (16) [ATTEN LOCK] Holds the attenuator at the current setting with *Atten Lock* displayed. Allows the RF level to be decreased by a further 10 dBm without the step attenuator operating.
- (17) [RETN] After using the [\uparrow +10] or [\downarrow ×10] keys or the control knob returns the setting of the function to the last keyed-in value.
- (18) [KNOB/STEP] Switches between enabling the control knob and enabling the step operation.

LOCAL OPERATION

(19)	[SET REF]	Transfers the current value as the keyed-in setting.
(20)	[↑÷10]	When KNOB is enabled, increases the knob resolution by a factor of 10. When STEP is enabled, increments the current function by one step.
	[↓×10]	When KNOB is enabled, decreases the knob resolution by a factor of 10. When STEP is enabled, decrements the current function by one step.
(21)	[ENTER]/Units keys	Determine the units of the set parameters and also used to terminate a numerical entry.
(22)	[MOD SOURCE]	Selects modulation source as the current function and causes the main screen to be displayed. For internal modulation repetitive pressing of this key cycles through the currently selected modulation sources while displaying the appropriate wave shape on the screen. For external modulation it cycles through the currently selected external coupling modes.
(23)	[SET Δ]	Press to obtain the step setting display. To change the step size, press the relevant function key.
(24)	[STO]	Used to store the current instrument settings in memory.
(25)	[MOD]	Selects modulation as the current function and causes the main screen to be displayed. Repetitive pressing of this key cycles through each of the modulations of the current mode together with their source values.
(26)	[SELECT]	Selects an item highlighted on a utility menu. With the main screen displayed selects the last utility accessed. After power-up causes the software status to be displayed.
	[LOCAL]	Transfers control from the GPIB to the front panel (providing LLO not asserted).

Rear panel connectors

The rear panel connectors are shown in Fig. 4-3 below.

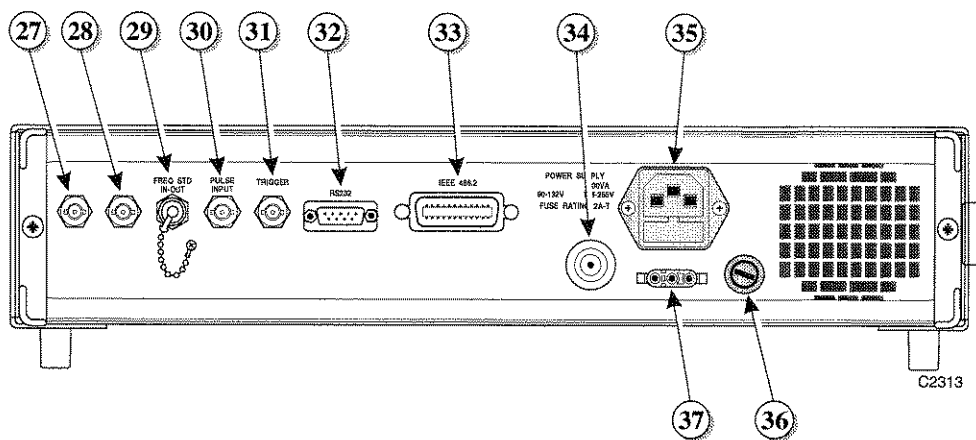

Fig. 4-3 Instrument rear panel showing connectors

- | | |
|--------------------------------|---|
| (27) EXT MOD INPUT (optional) | An Option 5 BNC socket which allows an external modulating signal to be applied. When fitted, replaces the front panel socket. |
| (28) LF OUTPUT (optional) | An Option 5 BNC socket which monitors the modulation oscillator. When fitted, replaces the front panel socket. |
| (29) FREQ STD IN-OUT | BNC socket for the input of external standard frequencies of either 1 MHz or 10 MHz. Can also supply a 10 MHz internal standard output. |
| (30) PULSE INPUT | 10 kΩ BNC socket which accepts a pulsed input. Also used as one logic input (the other is the TRIGGER input) for 4FSK modulation. |
| (31) TRIGGER | BNC socket which has three uses; in priority order these are:
FSK logic input
Memory recall
Sweep trigger |
| (32) RS232 | 9-way RS-232 connector for remote control of the instrument. For contact allocation see Chap. 2. |
| (33) IEEE 488.2 | 24-pin socket accepts the standard GPIB connector to allow remote control of the instrument. For contact allocation see Chap. 2. |
| (34) RF OUTPUT (optional) | An Option 5 50 Ω N-type socket. When fitted, replaces the front panel socket. |
| (35) POWER SUPPLY | 3-pin plug integral with fuse holder. Mates with AC supply lead socket. |
| (36) DC SUPPLY FUSE (optional) | When Option 2 fitted, fuses the DC INPUT socket. |
| (37) DC INPUT (optional) | When Option 2 fitted, the socket allows operation from an external 11 to 32 V DC source. For contact polarity see Chap. 2. |

LOCAL OPERATION

FIRST TIME USE

First time users can quickly become familiar with the principles of control and display by carrying out the following exercise, which demonstrates how to set up a typical basic signal having the following parameters:

Carrier frequency:	100 MHz,
Output level:	10 dBm,
Frequency modulation:	100 kHz deviation at 500 Hz mod.

Switching on

Before switching the instrument on, check that the power supply is connected and ensure that no external signal sources are connected.

Switch on by means of the SUPPLY switch and check that the display is similar to that shown in Fig. 4-4 or Fig. 4-5. This shows the main screen as it appears during normal operation.

If the default display shown in Fig. 4-4 or Fig. 4-5 is not obtained, a previous user may have set the instrument to switch on with one of the user memories recalled, rather than using the default factory settings.

To reset to the factory settings press the [RCL] hard key. RCL appears highlighted at the top right of the screen with the cursor blinking awaiting your entry. Enter 999 on the keyboard and press [ENTER]. (Note that any one of the units keys can be used to perform the [ENTER] function.) The *RESET* annunciator is shown and the factory settings are now recalled from memory location 999 and displayed on the screen.

LOCAL
OPERATION

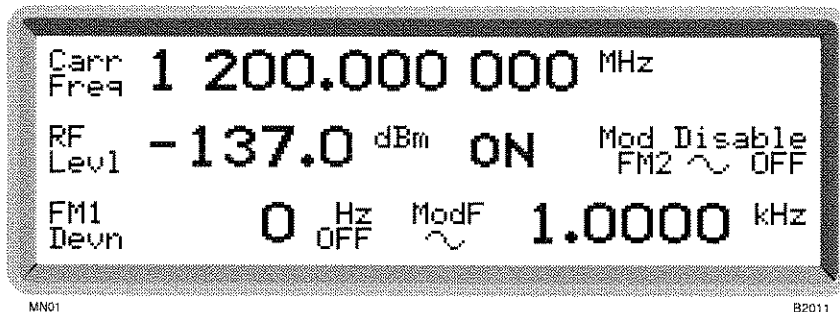

Fig. 4-4 2023 main screen in normal operation showing default display

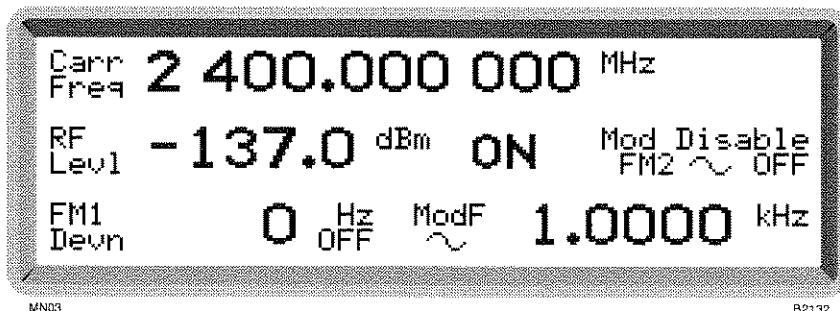

Fig. 4-5 2024 main screen in normal operation showing default display

Display

Before entering any parameters it will be found useful to look at the effect that pressing various keys has on the display. The display is divided into a number of fields as shown in Fig. 4-6.

Carrier frequency field

When you press [CARR FREQ] it causes *Carr Freq* to be highlighted and your data entry is recognised as a frequency setting. *Ext* is displayed when the instrument is locked to an external standard.

Memory field

When you press the [STO] or [RCL] key it causes *STO* or *RCL* to be highlighted respectively. Your data entry is recognized as a memory location number. The type of recall, *FREQ*, *FULL* or *RAM* (or sequence number for memory sequencing) is additionally shown.

Error message field

Error messages are displayed when, for example, you exceed a parameter limit. A list of error messages is given at the end of this Chapter.

RF level field

When you press [RF LEVEL] it causes *RF Level* to be highlighted and your data entry is recognized as a level setting. Units and unit type are displayed together with the carrier *ON* or *OFF* state. *Atten Lock* is displayed whenever you have activated this.

Modulation field

When you press [MOD] it causes the currently selected type of modulation to be highlighted and your data entry is recognized as a modulation depth or deviation setting. Modulation *ON* or *OFF* is also shown.

Modulation source field

When you press [MOD SOURCE] it causes the currently selected internal modulation source or external coupling to be highlighted. For an internal source a sine, triangle or square wave symbol is shown. Your data entry is recognized as a modulating frequency. For an external source *AC*, *DC* or *ALC* coupling is shown.

When the instrument is operating under remote control *REM* is displayed.

Modulation summary field

In this field are shown your other selected modulation sources. All your settings: types of modulation, waveforms, current *ON* or *OFF* states as well as modulation enabled or disabled are shown.

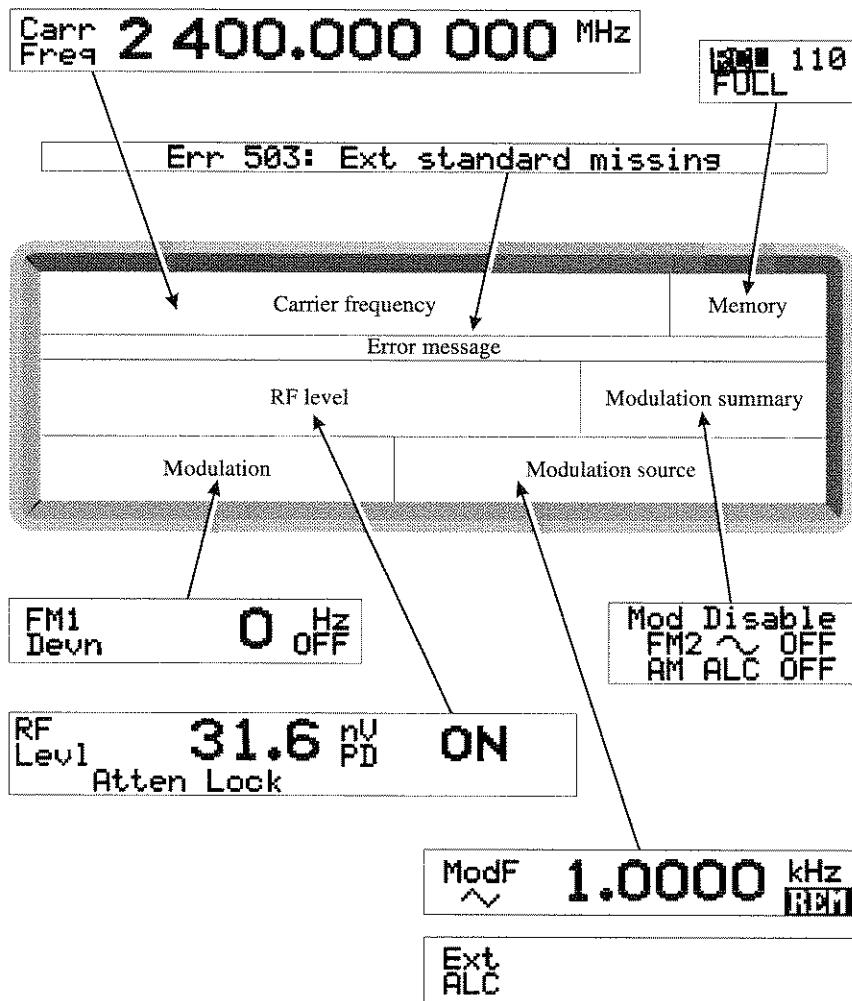

LOCAL OPERATION

Fig. 4-6 Division of the display into fields

Selecting functions and keyboard entry

Whenever one of the main functions - carrier frequency, RF level, modulation, modulation source - is highlighted on the main screen, making any terminated numerical entry will be accepted as being a changed parameter for that function. This enables you to enter, for example, a sequence of carrier frequencies without having to re-press the [CARR FREQ] function key for each entry.

Carrier frequency

- (1) Press [CARR FREQ] to select carrier frequency as the current function. *Carr Freq:* is highlighted on the screen.
- (2) Using the numerical key pad, enter 100 MHz by entering 100 on the key pad and terminate with [MHz]. Observe that the *Carr Freq:* display changes to *100.000 000 MHz*.

If you make an error when keying in, press the function key again and key in the correct value. If this causes an error message (e.g. *Err 100: Carrier limit*) to be displayed, it can be cancelled by a correct entry (e.g. by entering a value which is within limits).

RF level

- (3) Press [RF LEVEL] to select RF level as the current function. *RF Levl:* is now highlighted on the screen.
- (4) Using the numerical key pad, enter 10 dBm by entering 10 on the key pad and terminate with [dB]. Observe that the *RF Levl:* display changes to *+10.0 dBm*.
- (5) Press [CARR ON/OFF]. Repeated pressing toggles between the on and off states as shown by *ON* and *OFF* at the centre of the screen. Select *ON*. A 100 MHz, 10 dBm carrier is now being generated from the RF OUTPUT socket.

Modulation

- (6) Press [MOD] which highlights *FM Devn*. Repeated pressing of the key alternates between FM1 and FM2. Select *FM1 Devn*. Enter 100 on the key pad and terminate with [kHz]. *100 kHz* is displayed.
- (7) Press [MOD ON/OFF]. Repeated pressing toggles between the off state (when *Mod Disable* is displayed) and the on state. Select on. A 100 MHz, 10 dBm carrier is now being generated at a 100 kHz deviation rate from the RF OUTPUT socket.
- (8) Press [MOD SOURCE] which highlights *ModF* with a waveform displayed. Repeated pressing of the key cycles through sine, triangle and square waveforms. Select sine wave. Enter 500 on the key pad and terminate with Hz. *500.00 Hz* is displayed.
- (9) Press [SOURCE ON/OFF]. Repeated pressing toggles between the on and off states. Select *ON*. A 100 MHz, 10 dBm carrier is now being generated at a 100 kHz deviation rate, modulated at 500 Hz, from the RF OUTPUT socket.

Using [NEXT] and [PREV] to select a function

The operating example above was carried out by pressing the four function keys in turn in order to enter the parameter values. Another method is to repeatedly press either the [NEXT] or [PREV] key. This enables you to access each of the four functions CARR FREQ, RF LEVEL, MOD, MOD SOURCE in either forward or reverse rotation.

Using the [$\uparrow \div 10$] and [$\downarrow \times 10$] keys

When you have entered a parameter value using the numerical key pad, you can adjust its value either in single steps or continuous steps.

As an example of its use we will adjust the carrier frequency using the knob for continuous adjustment as well as in selected increments/decrements using single steps.

- (1) Press [CARR FREQ] to select carrier frequency as the current function. Note that the frequency is displayed as *100.000 000 MHz*. The number of digits behind the decimal point shows the maximum resolution and indicates that the frequency can be changed in 1 Hz steps.

With the control knob

- (2) Select the control knob for adjustment by toggling the [KNOB/STEP] key so that the carrier frequency is displayed underlined by a bracket. With the bracket displayed the control knob is enabled and its sensitivity can be set.
- (3) Adjust the control knob sensitivity by pressing either the [$\uparrow+10$] key or the [$\downarrow\times 10$] key. Pressing the [$\uparrow+10$] key increases the bracket length by one decimal place. Pressing the [$\downarrow\times 10$] key shortens the bracket length by one decimal place. In this way the sensitivity of the control knob is respectively increased or decreased by a factor of ten.
- (4) Move the control knob in either direction and note how the displayed carrier frequency changes by the desired amount.
- (5) To check the current amount of offset from the reference carrier frequency press and hold [TOTAL Δ]. For the duration of the key press the offset is displayed as either a negative or positive value.
- (6) You can return at any time to the reference carrier frequency by pressing [RETN]. *100.000 000 MHz* is displayed.
- (7) Alternatively, you can make the currently displayed frequency the reference carrier frequency by pressing [SET REF]. Subsequently pressing [RETN] will then return you to this frequency.

With steps

- (8) Press [KNOB/STEP] to disable the control knob (as indicated by the bracket no longer being displayed).
- (9) Press [SET Δ]. The screen changes to display the default step settings for frequency, level and modulation as shown in Fig. 4-7.
- (10) Press [CARR FREQ]. *Freq Step* is highlighted. Enter the step value on the key pad and terminate with the [MHz], [kHz] or [Hz] key.
- (11) Press [CARR FREQ] again to return to the main screen.
Note that pressing one of the function keys at any time will at once return you to the main screen.
- (12) Now repeatedly press the [$\uparrow+10$] and [$\downarrow\times 10$] keys and note how the displayed carrier frequency changes in steps of the desired amount. Holding either of these keys pressed provides continuous stepping.
- (13) As for control knob operation, you can check the current amount of offset from the reference carrier frequency by pressing and holding [TOTAL Δ].
- (14) As for control knob operation, pressing [RETN] returns you to the reference carrier frequency; pressing [SET REF] selects the currently displayed frequency as the reference frequency.

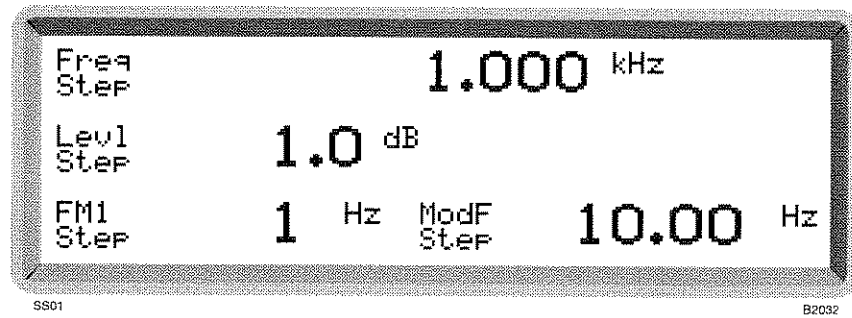

Fig. 4-7 Step setting display showing default settings

Using the utility menus

As an exercise in the use of the utility menus we will perform the operation of selecting an alternative frequency standard.

- (1) Press [CARR FREQ] followed by [MENU] to display the *Utility Group Menu* shown in Fig. 4-8. This is the top level menu of a 3-tier menu chain. Since the [CARR FREQ] function key preceded the [MENU] key, the required *Frequency/Sweep* group is already highlighted on the menu.

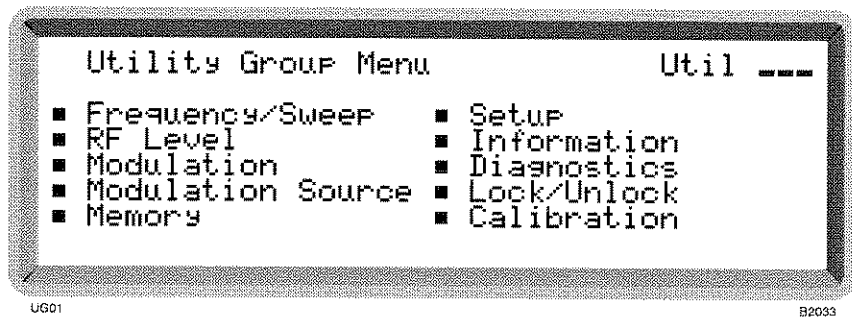

Fig. 4-8 Utility group menu

- (2) Use the [NEXT] and [PREV] keys to move around the menu.
- (3) Highlight *Frequency/Sweep* again and press [SELECT]. This causes the 2nd level *Frequency/Sweep Menu* shown in Fig. 4-9 to be displayed.

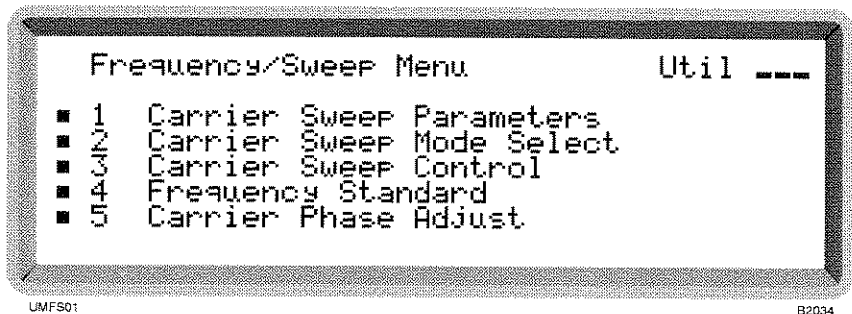

Fig. 4-9 Frequency/sweep menu

- (4) Highlight utility 4 *Frequency Standard* and press [SELECT]. This displays the 3rd level menu used for internal and external standard selection shown in Fig. 4-10. A flashing cursor awaiting entry is shown against the current selection.

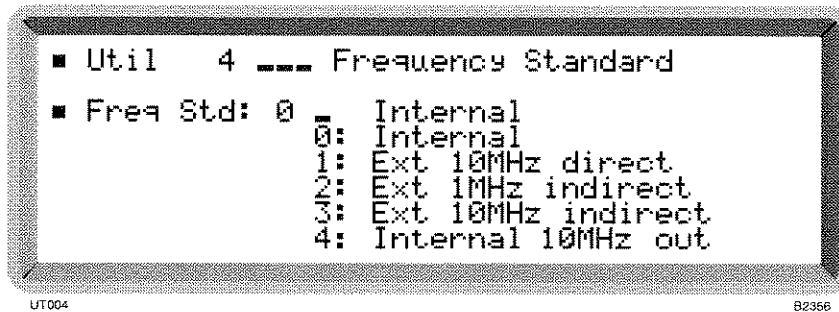

Fig. 4-10 Frequency standard menu

- (5) Step through the selections using the [$\uparrow+10$] and [$\downarrow\times 10$] keys or by direct entry on the key pad. Each time, the highlighted selection becomes the current selection (no terminator is required).

Since no external standard is connected, the message *Err 503: Ext standard missing* is displayed every time you select an external standard.

- (6) Enter *0: Internal* to restore the instrument to normal operation. *Internal* is displayed as the current selection.
- (7) Press any function key which returns you again to the main display. Pressing [SELECT] at any time from now on will always return you to your last selected utility menu.

Short cut

Note that for the top and 2nd level menus *Util* is shown each time at the top right. This allows you to use a short cut. Since you now know the utility number for the *Frequency Standard* utility, enter 4 on the key pad for this menu followed by [ENTER] which takes you straight to the requested menu.

Moving within the menus

When you are using the menus, pressing [SELECT] will take you down the menu chain, pressing [MENU] will take you back up.

Looking through the list of menus

To see what utilities are available to you, display the top level menu then press [SELECT] to display the numbered list of menus. Now you can use the [NEXT] and [PREV] keys to browse through the complete list.

Menu operation is summarized graphically in Chap. 3.

Menu conventions

The following simple conventions apply to the menus:

- A filled-in square indicates an unprotected function.
- An open, unfilled, square indicates a protected function.
- An ellipsis (...) indicates a continuation to another screen.

Additionally, the following are used for memory operation:

- A dash (-) indicates an unprotected memory store.
- A lower-case **p** indicates a protected memory store.

DETAILED OPERATION

Selecting carrier frequency

Carrier frequency can be entered in the range 10 kHz to 1.2 GHz (2023) or 10 kHz to 2.4 GHz (2024) to a resolution of 1 Hz.

- (1) Press [CARR FREQ] to select carrier frequency as the current function. *Carr Freq:* is highlighted on the screen.
- (2) Enter the required value using the numerical key pad. Terminate using the [Hz], [kHz], [MHz] or [GHz] key.
- (3) The frequency can then be adjusted either in steps or by using the control knob for continuous adjustment. The default increment/decrement is 1 kHz.
- (4) You can check the current amount of offset from the reference carrier frequency by pressing and holding [TOTAL Δ].
- (5) Pressing [RETN] returns you to the reference carrier frequency; pressing [SET REF] selects the currently displayed frequency as the reference frequency.

Carrier on/off

The carrier may be switched *ON* or *OFF* at any time via the [CARR ON/OFF] key. This effectively switches the output on and off, retaining the 50 Ω output impedance.

Carrier sweep operation

The sweep capability allows the comprehensive testing of systems, since measurements at single points will not necessarily give an overall indication of the performance. Sweep operation is carried out in this instrument by means of three utility menus.

Sweep parameters

Carrier start and stop frequencies together with step size and time are set as follows:

- (1) Select the *Util 1: Carrier Sweep Parameters* menu. This shows the currently selected parameter values (see Fig. 4-11) as well as the currently selected mode.
- (2) Enter the sweep start and stop frequencies.
- (3) Enter the step size and step time. Enter step time in the range 20 ms to 10 s.

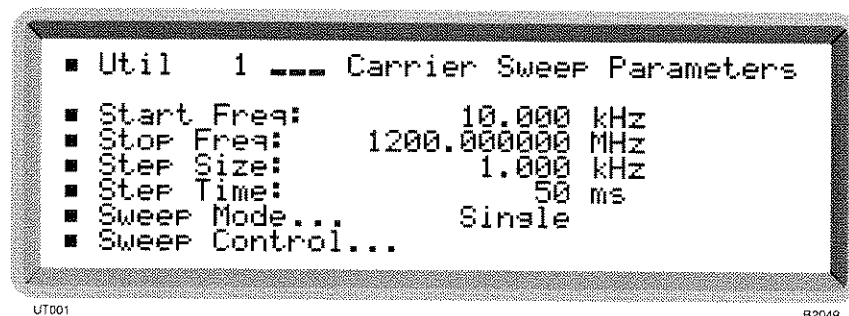

Fig. 4-11 Carrier sweep parameters menu

- (4) To change the mode of sweeping, highlight *Sweep Mode...* and press [SELECT]. This gives you immediate access to the *Util 2: Carrier Sweep Mode Select* menu shown below.
- (5) To carry out the sweeping operation, highlight *Sweep Control...* and press [SELECT]. This gives you immediate access to the *Util 3: Carrier Sweep Control* menu shown below.

Sweep mode

The following menu allows you to set the carrier sweep mode to either single shot or continuous sweep and to select the mode of external triggering. For external operation, connect a TTL trigger signal to the rear panel TRIGGER connector. Ensure however, that this socket is not disabled by higher priority mode having been selected. The order of priority is as follows:

FSK logic input
Memory recall
Sweep trigger

All three modes of operation may be enabled at the same time, but only one mode will be active, the one with the highest priority. Therefore ensure that FSK and memory recall are not enabled, otherwise selecting sweep triggering will have no effect. Sweep mode selection is as follows:

- (1) Select the *Util 2: Carrier Sweep Mode Select* menu. This shows the currently selected sweep mode (See Fig. 4-12).

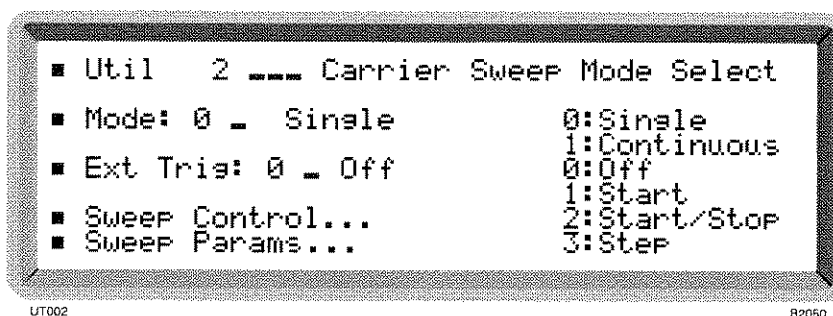

Fig. 4-12 Carrier sweep mode select menu

- (2) Select the required sweep mode by setting *Mode* to either *1* for continuous sweep or *0* for single shot.
- (3) For external triggering set *Ext Trig* to *0* to inhibit the external trigger, or to *1*, *2*, or *3* to select one of the following triggering modes:

Start: The first trigger input causes the carrier sweep to commence sweeping. Any other trigger inputs whilst sweeping are ignored. Only at the end of each sweep is the trigger latch reset ready for the next input.

Start/Stop: The first trigger input starts the carrier sweep and the following trigger input pauses it, so that the user can investigate a particular point of interest. The next trigger input continues the sweep from where it was paused. At the start of each sweep the trigger latch is reset ready for the next input.

Step: Each trigger input steps the sweep on by one frequency step. The trigger latch is reset after each step ready for the next step.

- (4) To carry out the sweeping operation highlight *Sweep Control...* and press [SELECT] to access the *Util 3: Carrier Sweep Control* menu.
- (5) To return to the *Carrier Sweep Parameters* menu, highlight *Set Params...* and press [SELECT].

Sweep control

Control of the sweep: start, stop, reset and continue is performed as follows:-

- (1) Select the *Util 3: Carrier Sweep Control* menu. Initially this shows *Start Sweep* and the start *Carr Freq:* value together with the currently selected *Freq Mode:* (see Fig. 4-13).

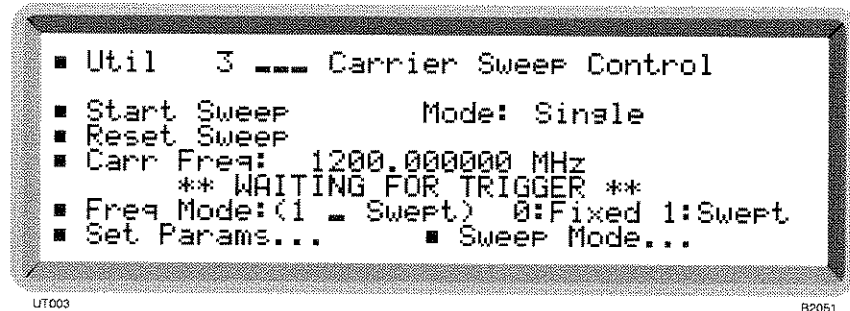

Fig. 4-13 Carrier sweep control menu

- (2) Enable the sweep operation by setting *Freq Mode:* to 1 (no terminator is necessary). **** WAITING FOR TRIGGER **** is displayed.
- (3) To start the sweep, select *Start Sweep*. The selection changes to *Stop Sweep*, the frequency is shown changing and **** SWEEPING **** is displayed.
- (4) During the sweep, *Reset Sweep* may be selected to discontinue the sweep and reset it to the start frequency. Note that during the sweep all of the function keys are still accessible.
- (5) Selecting *Stop Sweep* causes the selection to change to *Continue Sweep* and **** PAUSED **** is displayed.
- (6) Selecting *Continue Sweep* allows the sweep to continue. At the end of a single sweep, the stop frequency is shown and the selection changes to *Restart Sweep* with **** COMPLETE **** displayed. For continuous sweep, the sweep automatically recommences from the start frequency.
- (7) To change the sweep parameters, highlight *Set Parameters...* and press [SELECT] to return to the *Carrier Sweep Parameters* menu.
- (8) To change the sweep mode, highlight *Sweep Mode...* and press [SELECT] to return to the *Carrier Sweep Mode Select* menu.

Carrier phase adjustment

The phase offset of the carrier can be adjusted in degrees as follows:

- (1) Select the *Util 5: Carrier Phase Adjust* menu. This shows the currently selected phase shift setting (see Fig. 4-14).

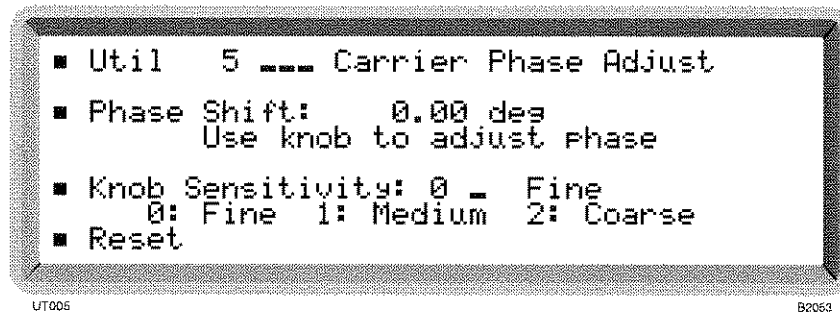

Fig. 4-14 Carrier phase adjust menu

- (2) Select the required control knob sensitivity between *Fine* (0.09°), *Medium* (0.9°) and *Coarse* (2.7°).
- (3) Highlight *Phase Difference* and adjust the phase using the control knob. Adjustment is in the range -359.91° to $+359.91^\circ$ (fine sensitivity). Note that if you have set the carrier phase and subsequently adjusted the carrier frequency, the menu *Phase Shift* value will be blanked. This is because the value will then be indeterminate due to the adjustment.
- (4) When required the phase can be reset to 0° by simply highlighting *Reset* and pressing [SELECT].

Selecting RF level

RF level can be entered in the range -137 to +13 dBm (or to +25 dBm for the High Power Option).

- (1) Select the RF level from the main screen by pressing [RF LEVEL]. *RF Lev:* is highlighted on the screen.
- (2) Enter the required value using the numerical key pad.
- (3) For voltage terminate using the [μ V], [mV] or [V] key. For dBm terminate using the [dB] key. RF levels in linear (PD or EMF) and logarithmic units are selected from the utilities.
- (4) The level can then be adjusted either in steps or by using the control knob for continuous adjustment. The default increment/decrement is 1 dB.
- (5) You can check the current amount of offset from the reference level by pressing and holding [TOTAL Δ].
- (6) Pressing [RETN] returns you to the reference level; pressing [SET REF] selects the currently displayed level as the reference level.
- (7) The RF output level may be toggled on and off by means of the [CARR ON/OFF] key.

Choice of units

Conversion can be made between dB and V by pressing the appropriate units key. Selection of linear and logarithmic units is made using Util 10 and Util 11 respectively (see below).

Attenuator hold

Pressing the [ATTEN LOCK] key inhibits operation of the step attenuator from the level at which the key is enabled. Usable for a level reduction of at least 10 dB. Whilst in operation the display shows *Atten Lock*.

Reverse power protection

Accidental application of power to the RF OUTPUT socket trips the reverse power protection (RPP) circuit (unless Option 1: No Attenuator is fitted, which has no protection) and causes Fig. 4-15 to be displayed.

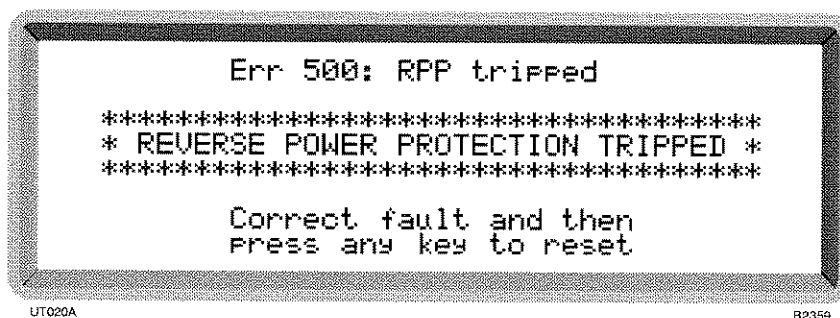

Fig. 4-15 RPP tripped display

The protection circuit can be reset by pressing any key after having removed the power source. The display then returns to the menu in use at the time that the RPP was tripped.

RF level linear units

You can set the RF level in linear units of volts PD or volts EMF as follows:

- (1) Select the *Util 10: RF Level Linear Unit* menu. This shows the currently selected linear unit (see Fig. 4-16).

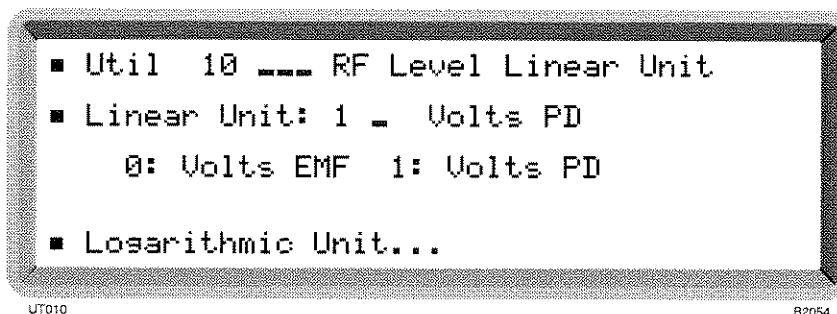

Fig. 4-16 RF level linear units menu

- (2) Enter *1* for *Volts PD* or *0* for *Volts EMF* (no terminator is necessary).
- (3) To select a logarithmic unit, highlight *Logarithmic Unit...* and press [SELECT]. This gives you immediate access to the *Util 11: RF Level Logarithmic Unit* menu shown below.

LOCAL
OPERATION

RF level logarithmic units

You can set the RF level in logarithmic units as follows:

- (1) Select the *Util 11: RF Level Logarithmic Unit* menu. This shows the currently selected logarithmic unit (see Fig. 4-17).

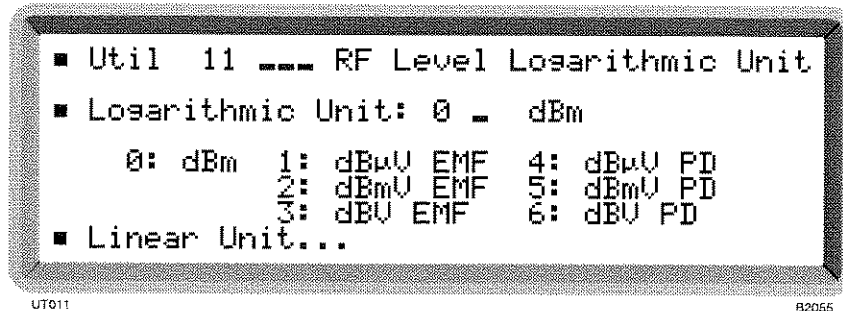

UT011

B2055

Fig. 4-17 RF level logarithmic units menu

- (2) Enter a number in the range 0 to 6 (no terminator is necessary) to select between volts (dBV), millivolts (dBmV), microvolts (dB μ V) - in EMF or PD - and 1 milliwatt into 50 Ω (dBm).
- (3) To select a linear unit, highlight *Linear Unit...* and press [SELECT]. This gives you immediate access to the *Util 10: RF Level Linear Unit* menu shown above.

Modulation modes

The EXT MOD INPUT socket allows an external modulation signal to be summed with the signals from the internal oscillator. This allows up to 3 modulations to be available e.g. external FM with a combined internal AM1 and AM2.

Modulation source can be internal or external. If internal, the modulation can be the sum of two signals i.e. AM1 + AM2, FM1 + FM2 or Φ M1 + Φ M2, each of which can have its own depth/deviation and modulation frequency.

The common carrier wave can be modulated by two different types of modulation, where one uses an internal source and the other an external source. The internal source may be composed of two signals. Allowed combinations are:

internal AM + external FM ; internal FM + external AM
 internal AM + external Φ M ; internal Φ M + external AM

Note that pulse modulation may be selected in addition to any normal modulation combination.

Mode selection

Modulation mode may be selected as follows:-

- (1) Select the *Util 20: Modulation Mode (Normal)* menu. This shows the currently selected modulation mode against *Mod Mode:*. If pulse modulation is enabled this will additionally be displayed.
- (2) From the menu select the desired modulation mode by highlighting the item and then pressing [SELECT]. The current modulation mode changes accordingly. Select single on the first menu page (shown in Fig. 4-18) or dual on the second (shown in Fig. 4-19).

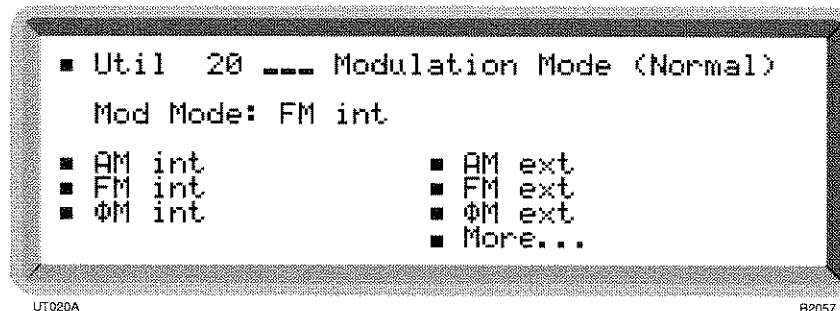

UT020A

B2057

Fig. 4-18 Modulation mode menu - first page

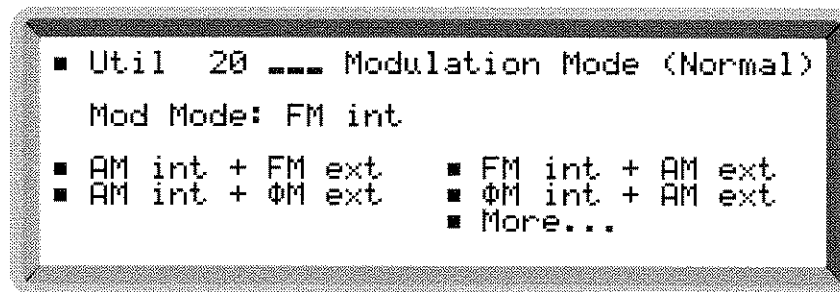

UT020B

B2058

Fig. 4-19 Modulation mode menu - second page

- (3) Press [MOD] to return to the main screen. Repeatedly pressing [MOD] will now step through each modulation of your selected modulation mode.

LOCAL OPERATION

Source selection - internal

Having previously selected internal modulation from the *Util 20: Modulation Mode* menu, select the waveform and modulating frequency as follows:-

- (1) Press [MOD SOURCE] to highlight the current modulation source selection.
- (2) Repeatedly press [MOD SOURCE] to cycle through and select a sine, square or triangular waveform.
- (3) Enter the required modulating frequency on the keypad and terminate with the [Hz] or [kHz] key. If the modulation requested exceeds 20 kHz the modulation is set to the maximum value.

The output waveform can be switched in a different sequence to that allowed by the [MOD SOURCE] key. For instance it may be required to switch from sine to square wave without the necessity of switching via the triangular wave. For this requirement, use the *Util 30: Modulation Source* menu shown in Fig. 4-20.

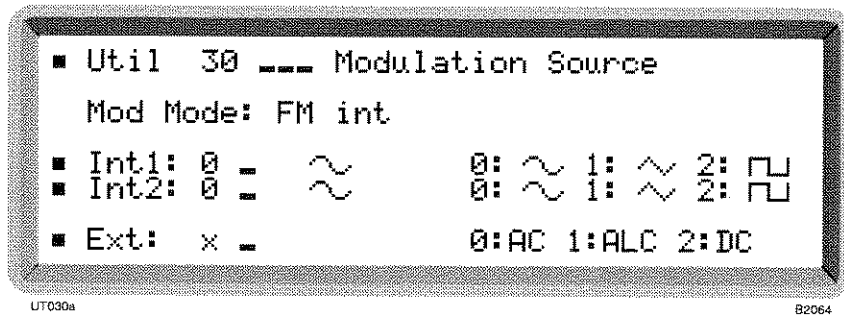

Fig. 4-20 Modulation source menu

Source selection - external

AC or DC coupling or automatic levelling control (ALC) can be used in conjunction with an external source. Having previously selected external modulation from the *Util 20 Modulation Mode* menu continue as follows:-

- (1) Press [MOD SOURCE] for modulation source selection.
- (2) Repeatedly press [MOD SOURCE] to cycle through the selections *Ext DC*, *Ext AC* and *Ext ALC*.
- (3) Apply a signal to the EXT MOD INPUT socket. Note that on switch-on this socket is disabled.
- (4) If *EXT ALC* has been selected and the error message *Err 511: ALC too high* or *Err 512: ALC too low* is displayed the signal input is outside the 0.75 to 1.25 V RMS ALC range of the instrument.
- (5) If *EXT DC* has been selected, note that a DCFM nulling facility is available (refer to 'DCFM nulling' in the 'General' section below).

External source selection may also be made by means of the *Util 30: Modulation Source* menu shown in Fig. 4-21.

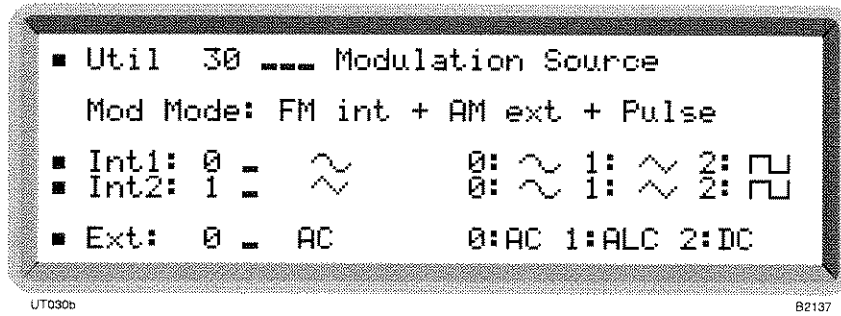

Fig. 4-21 Modulation source menu - shown with an external source selected

LOCAL OPERATION

Modulation enable/disable

[SOURCE ON/OFF] switches the current modulation channel on or off. To switch all modulation on or off press [MOD ON/OFF]; this function is mainly used when more than one modulation source is enabled. Switching all modulation off causes *Mod Disable* to appear on the main screen.

Modulation source phase adjustment

The phase offset of the modulation oscillator relative to the current phase can be adjusted in degrees as follows:

- (1) Select the *Util 31: Modulation Source Phase* menu. This shows the currently selected phase difference setting (see Fig. 4-22).

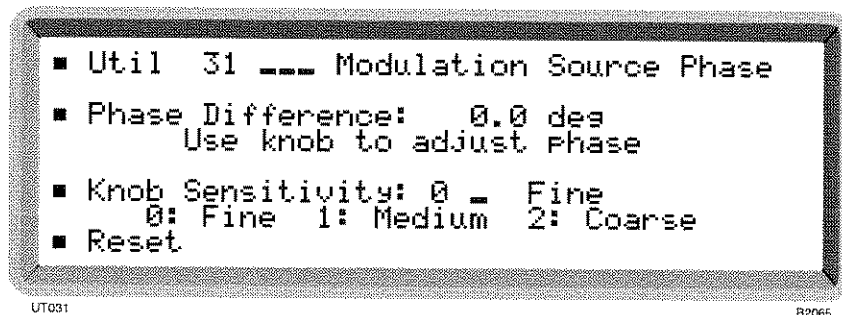

Fig. 4-22 Modulation source phase menu

- (2) Select the required control knob sensitivity between *Fine* (0.1°), *Medium* (1°) and *Coarse* (3°).
- (3) Highlight *Phase Difference* and adjust the phase using the control knob. Adjustment is in the range -359.9° to +359.9° (fine sensitivity). Note that if you have set the source phase and subsequently adjusted the source frequency or changed the waveform, the menu *Phase Difference* value will be blanked. This is because the value will then be indeterminate due to the adjustment or changed waveform.
- (4) When required the phase can be reset to 0° by simply highlighting *Reset* and pressing [SELECT].

Modulation selection

The carrier can be frequency, amplitude or phase modulated from an internal or external source. Additionally pulse modulation is available from an external source. The internal modulation oscillator is capable of generating two tones simultaneously in one modulation channel and has a frequency range of 0.01 Hz to 20 kHz.

Amplitude modulation selection

Having previously selected the modulation mode (see 'Mode selection' above) select amplitude modulation as follows:-

- (1) Press [MOD] to display the main screen with *AM1 Depth* highlighted.
- (2) Enter the required internal modulation depth via the numerical key pad and terminate with the [%] key. If you exceed the 99.9% modulation depth it is reset by default to the maximum value.
- (3) If the internal modulation is to be the sum of two signals (selected from the *Util 30* menu), press the [MOD] key again to highlight *AM2 Depth*. Enter the required modulation depth for the second signal. If you exceed the (99.9% - AM1) modulation depth limit it is reset by default to the maximum allowed value.

Frequency modulation selection

Having previously selected the modulation mode (see 'Mode selection' above) select frequency modulation as follows:-

- (1) Press [MOD] to display the main screen with *FM1 Devn* highlighted.
- (2) Enter the required internal FM deviation via the numerical key pad and terminate with the [Hz] or [kHz] key. If you exceed the 100 kHz deviation limit it is reset by default to the maximum value.
- (3) If the internal modulation is to be the sum of two signals (selected from the *Util 30* menu), press the [MOD] key again to highlight *FM2 Devn*. Enter the required deviation for the second signal. If you exceed the (100 kHz - FM1) deviation limit it is reset by default to the maximum allowed value.

Phase modulation selection

Having previously selected the modulation mode (see 'Mode selection' above) select phase modulation as follows:-

- (1) Press [MOD] to display the main screen with $\Phi M1$ Devn highlighted.
- (2) Enter the required internal ΦM deviation via the numerical key pad and terminate with the [rad] key. If you exceed the 10 radians deviation limit it is reset by default to the maximum value.
- (3) If the internal modulation is to be the sum of two signals, press the [MOD] key again to highlight $\Phi M2$ Devn. Enter the required deviation for the second signal. If you exceed the (10 rad - $\Phi M1$) deviation limit it is reset by default to the maximum allowed value.

Pulse modulation selection

Pulse modulation may be selected in addition to any other normal modulation modes. The source is external only from the rear panel PULSE INPUT socket. (Note that using this socket prevents 4FSK operation). Selection may be made as follows:

- (1) Select the *Util 22: Pulse Modulation* menu. This shows the currently selected modulation mode against *Mod Mode*: (see Fig. 4-23).

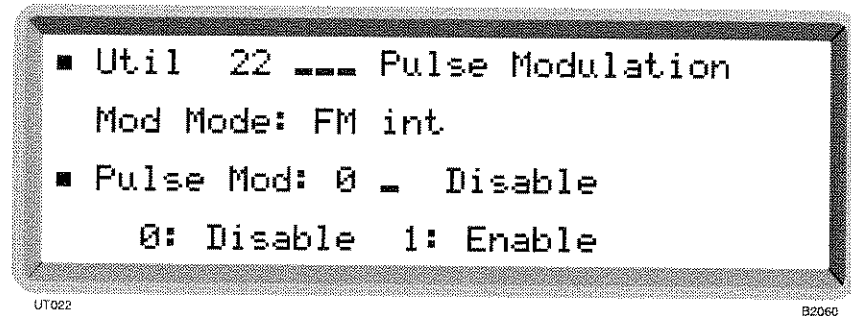

Fig. 4-23 Pulse modulation menu

- (2) Enter 1 on the key pad (no terminator is required) to *Enable* the external modulation. The display changes to show the current modulation plus *Pulse* (e.g. *Mod Mode: AM int + FM ext + Pulse*).
- (3) Press [MOD] to return to the main screen with *Pulse* displayed together with its *ON* or *OFF* state.

When *ON* the carrier is controlled by the logic level applied to the PULSE INPUT socket. A logical '1' (a voltage between 3.5 and 5 V) allows carrier output, a logical '0' (a voltage between 0 and 1.0 V) suppresses it. Turning pulse mod *OFF* effectively applies a logical '1' allowing carrier output.

FSK selection

The instrument accepts one or two logic level inputs to produce an FSK modulated output signal. The input data is sampled at 156 kHz and produces a 2 or 4 level shift waveform which is filtered by a 20 kHz Bessel filter and applied to the carrier. Frequency shift keying is selected as follows:

- (1) Select the *Util 21: Modulation Mode (Special)* menu. This shows the currently selected modulation mode against *Mod Mode*: (see Fig. 4-24).

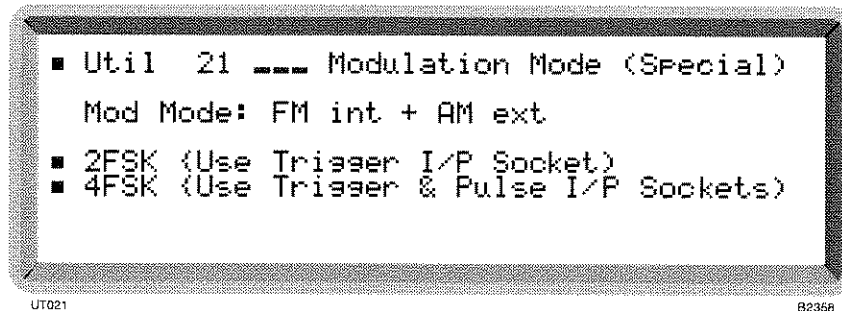

Fig. 4-24 Modulation mode (special) menu

- (2) Select between *2FSK* and *4FSK*.
- (3) For *2FSK* apply a TTL signal to the TRIGGER socket. For *4FSK* apply the signals to the TRIGGER and PULSE INPUT sockets. (Note that this prevents pulse operation.)
- (4) Press [MOD] to return to the main screen with *FM Devn* displayed. Enter the required deviation via the numerical key pad and terminate with the [Hz] or [kHz] key. If you exceed the 100 kHz deviation limit it is reset by default to the maximum value.
- (5) Either *2FSK Ext* or *4FSK Ext* is shown in the modulation source field. Note that for FSK operation pressing [MOD SOURCE] has no effect on the instrument.
- (6) If FSK is turned *OFF* no frequency shift is applied to the carrier.

The frequency shifts produced by the applied data are as follows:

2FSK		4FSK		
TRIGGER	SHIFT	TRIGGER	PULSE	SHIFT
1	+D	1	0	+D
0	-D	1	1	+D/3
		0	1	-D/3
		0	0	-D

Where D is the set deviation value.

LOCAL
OPERATION

Default settings

The instrument is reset to the factory default settings in the following cases:

- (1) At power-up.
- (2) Following execution of the RCL 999 command.
- (3) Following execution of the *RST command.

The default settings are shown in Table 4-1 .

Table 4-1 Instrument default settings

Carrier frequency	:	(Maximum available) 1.2 GHz/2.4 GHz
Step	:	1 kHz
RF level	:	-137 dBm (or -2 dBm with the No Attenuator option)
Step	:	1 dB Status: ON
Modulation mode	:	Internal FM, modulation disabled
Modulations	:	FM1 : Deviation: 0 Hz, OFF : Internal source, frequency: 1 kHz, sine
	:	FM2 : Deviation: 0 Hz, OFF : Internal source, frequency: 400 Hz, sine
	:	Φ M1 : Deviation: 0 rad, OFF : Internal source, frequency: 1 kHz, sine
	:	Φ M2 : Deviation: 0 rad, OFF : Internal source, frequency: 400 Hz, sine
	:	AM1 : Deviation: 0%, OFF : Internal source, frequency: 1 kHz, sine
	:	AM1 : Deviation: 0%, OFF : Internal source, frequency: 400 Hz, sine
	:	Pulse : OFF :
Modulation steps	:	Δ FM 1 kHz, $\Delta\Phi$ M 0.1 rad, Δ AM1%
Mod frequency steps	:	10 Hz
Carrier sweep:		
Mode	:	Single sweep
Trigger	:	Internal
Start	:	10 kHz Stop: (maximum available), step size: 1 kHz
	:	Time 50 ms

MEMORY

Memory stores

There are three types of store: carrier, full and RAM. Both carrier and full stores are non-volatile. The contents of the RAM store are lost when the instrument is switched off.

Carrier store

The non-volatile carrier frequency store has 100 locations numbered 0 to 99 for the storage of carrier frequency only. This store can be used to apply a set of test conditions to a range of frequencies. For example, if you wish to use the same modulation at a variety of frequencies you can use the carrier store to set the instrument to each of the frequencies in turn. When a carrier store is used it will only replace the current carrier frequency - all the other settings will remain unchanged.

Full store

The non-volatile full store has 100 locations numbered 100 to 199 for the storage of instrument settings. This store is used to store those parameters which currently affect the RF output; carrier frequency, RF level, modulations in use, on/off and source information and the two modulation oscillator frequencies in use.

A full store contains the following information:

- Carrier frequency setting
- Carrier frequency step size
- RF level setting
- RF level step size
- All modulation settings
- All modulation step sizes
- Modulation mode and status
- The active modulation frequencies
- The modulation frequency step size
- All sweep settings

RAM store

The volatile RAM store has locations numbered from 200 to 299 for the full storage of instrument settings. The parameters stored are the same as those for the full store. However, the RAM store has no long term wear-out mechanism and is therefore recommended for use in ATE programs where all the settings to be used in a test sequence are initially declared and then recalled. This results in a reduction of the GPIB/RS-232 overhead.

Storing data

To store data, press the [STO] key and enter the location number on the key pad then press [ENTER]. According to which location range the number falls in, so the display shows *FREQ* (for carrier store), *FULL* or *RAM*. If you make a mistake, and have not yet pressed [ENTER], press [STO] again and re-enter the location number.

Memory recall

There are three types of recall: carrier, full and RAM. Both carrier and full stores are non-volatile. The contents of the RAM store are lost when the instrument is switched off.

Carrier recall

The non-volatile carrier frequency store has 100 locations numbered 0 to 99 for carrier frequency only. These can be recalled and used in conjunction with full recall to apply a set of test conditions to a range of frequencies.

Full recall

The non-volatile full store has 100 locations numbered 100 to 199 for the storage of instrument settings. These stores may be recalled and used to reset the instrument's parameters to those which affect the RF output; carrier frequency, RF level, modulations in use, on/off and source information and the two modulation oscillator frequencies in use.

RAM recall

The volatile RAM store has locations numbered 200 onwards for the full storage of instrument settings. The parameters that are recalled are the same as those for full recall.

Recalling data

To recall data, press the [RCL] key and enter the location number on the key pad then press [ENTER]. According to which location range the number falls in, so the display shows *FREQ* (for carrier store), *FULL* or *RAM*. The [\uparrow +10] and [\downarrow ×10] keys as well as the control knob can be used to recall the next and previous locations.

Recalling default settings

To recall the factory default settings, press the [RCL] key and enter 999 on the keypad then press [ENTER]. The *RESET* annunciator is shown and the instrument is reset to the settings shown in Table 4-1.

Memory sequencing

You can step the memory up in a sequence from a start location using a TTL input connected to the rear panel TRIGGER socket. Note that the triggering order of priority is as follows:

FSK logic input
Memory recall
Sweep trigger

Therefore ensure that FSK is not enabled, otherwise selecting memory recall triggering will have no effect. The memory sequencing operation is as follows:

- (1) Select *Util 40: Memory Sequencing* to display the menu shown in Fig. 4-25.

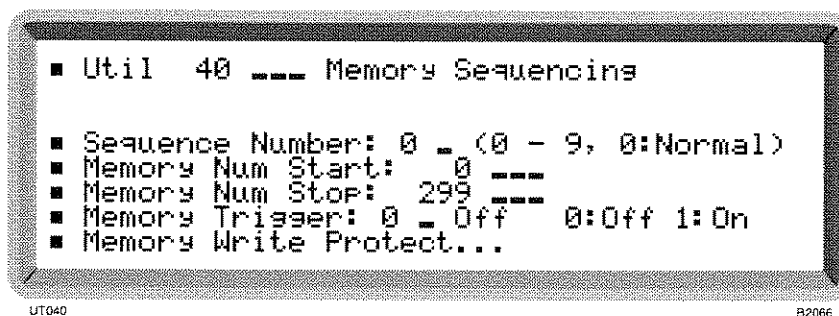

Fig. 4-25 Memory sequencing menu

- (2) Select one of up to 9 sequences by entering a number in the range 1 to 9. Select 0 to turn sequence off (normal mode).
- (3) Enter the *Memory Num Start* and *Mem Num Stop* store numbers for the selected sequence within the ranges:

0 - 99	Carrier store
100 - 199	Full store
200 - 299	RAM store
- (4) To enable memory recall sequencing set *Memory Trigger* to 1. Each trigger will then recall the next memory store. When the end of the sequence is reached the carrier and full stores will wrap around to the start.
- (5) To protect your selected memory sequence against accidental overwriting, highlight *Memory Write Protect...* and press [SELECT]. This gives immediate access to the *Util 41: Memory Write Protect* menu shown below.

Memory write protection

To use the memory protection utility first ensure that the instrument is unlocked to Level 1 using *Util 80: Protection Lock/Unlock*. Then you can either write protect a block of stores (or a single store) to prevent accidental overwriting or unprotect it as follows:

- (1) Select *Util 41: Memory Write Protect* to display the menu shown in Fig. 4-26.

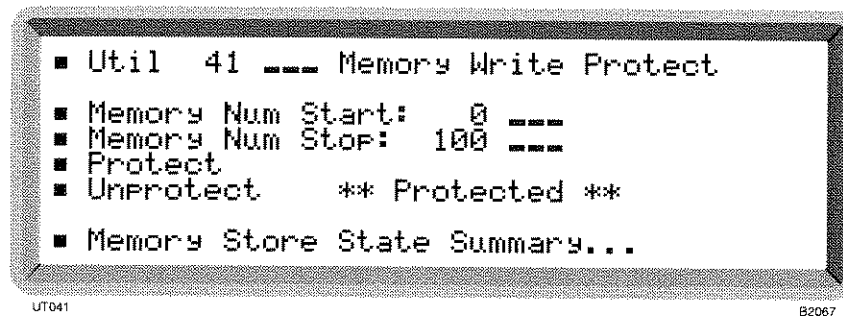

Fig. 4-26 Memory write protection menu (showing stores 0 to 100 protected)

- (2) For a memory block enter the *Memory Num Start* and *Memory Num Stop* store numbers. For a single store make both numbers the same.
- (3) Select *Protect* or *Unprotect* as required. This action is acknowledged by the message **** Protected **** or **** Unprotected **** appearing respectively.
- (4) You can see which areas of the memory are protected by highlighting *Memory Store State Summary...* and pressing [SELECT]. This gives immediate access to the *Util 42: Memory State Summary* shown below.

Note that at power-on the volatile RAM stores are unprotected to allow immediate use.

Memory state summary

The memory state summary enables you to look at blocks of 100 stores at a time to see their protection states as follows:

- (1) Select *Util 42: Memory State Summary* to display the summary shown in Fig. 4-27.

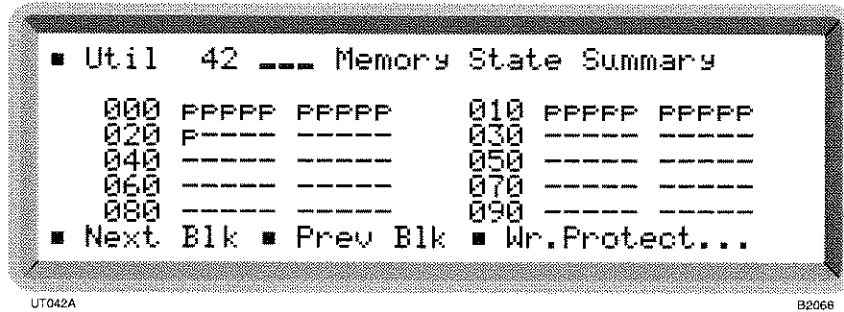

Fig. 4-27 Memory state summary (showing carrier stores 0 to 20 protected)

- (2) Choose which of the three blocks you require by selecting *Next Blk* or *Prev Blk*.
- (3) An unprotected store is indicated by a dash, a protected store is indicated by a letter *p*. To change the protection status select *Wr. Protect...* This gives immediate access to the *Util 41: Memory Write Protect* menu above.

Memory cloning

You can transfer the stored settings from one signal generator to another by using either the GPIB or the RS-232 interface. These stored settings are the full and carrier stores together with their currently protected states. This means that after cloning has been performed all of the non-protected memory stores on the receiving instrument will have been overwritten. For GPIB operation the transmitting instrument is automatically configured as a talker sending to one or more automatically configured listeners. It does not matter which addresses the instruments are set to. For RS-232 operation the transmitting instrument can only send to one receiving instrument. The settings of the serial ports of the two instruments do not matter except that data transfer will be at the higher baud rate. To use this utility first of all ensure that the instrument is unlocked to Level 1 using *Util 80: Protection Lock/Unlock*. Then proceed as follows:

- (1) Ensure that the correct mode of operation, either GPIB or RS-232, has been selected for both instruments using *Util 50: Remote Operation Select*.
- (2) Select *Util 43: Memory Cloning* on transmitting and receiving instruments to display the menu shown in Fig. 4-28. Check that all instruments show the same remote mode - either *GPIB* or *RS232*.

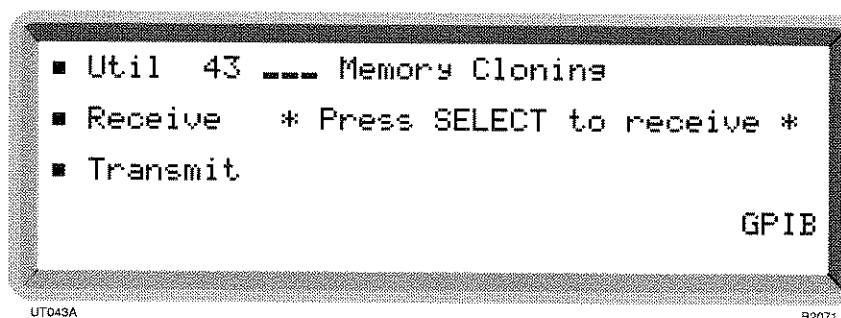

Fig. 4-28 Memory cloning menu (showing instrument ready to receive via the GPIB)

- (3) On the receiving instrument highlight *Receive* and press [SELECT]. The message ** Press SELECT to receive ** changes to ** Ready to receive ** and the instrument enters the remote mode (displays *REM*).
- (4) On the transmitting instrument highlight *Transmit* and press [SELECT]. The message ** Press SELECT ** changes to ** Transmitting **, *REM* is displayed and data transfer takes place. Cloning times via GPIB and RS-232 are approximately 4s and 14s respectively.
- (5) At the end of the data transfer process ** Transfer complete ** is displayed by all participating instruments.

GENERAL

Frequency standard selection

This utility enables you to select a 10 MHz output to provide a standard for use with associated equipment. It also enables you to select a standard (either external or internal) for use by the instrument. When an external standard is selected, the internal TCXO is locked to the external standard using a phase locked loop. In this case, the menu allows you to select between *direct* and *indirect*. When *direct* is selected the internal standard for the RF tray is provided directly from the external standard. When *indirect* is selected this standard is provided from the TCXO locked to the external standard. Frequency standard selection is as follows:

- (1) Select the *Util 4: Frequency Standard* menu shown in Fig. 4-29.

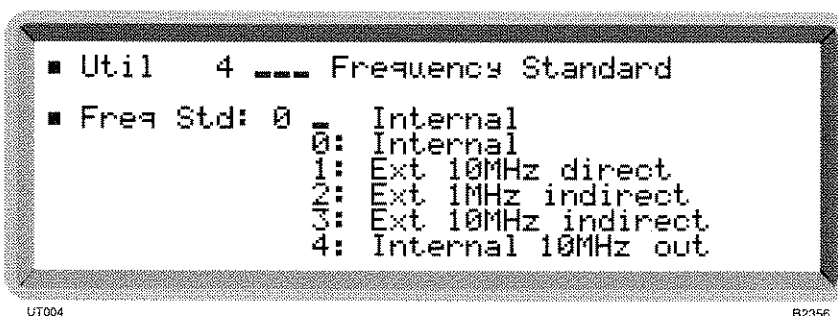

Fig. 4-29 Frequency standard menu

- (2) To select the standard for the instrument, choose between *Internal* or one of the three external standard selections. When an external standard is selected, *Ext* is displayed on the main screen.
- (3) To obtain an internally generated 10 MHz standard from the instrument's FREQ STD IN-OUT socket, select *Internal 10MHz out*.
- (4) To provide an externally generated 1 or 10 MHz standard for the instrument, connect the signal to the rear panel FREQ STD IN-OUT socket. Then with an external standard selected, you can choose between *direct* and *indirect*. You should select *direct* if your provided standard is better than that fitted in the instrument.

50 Ω /75 Ω impedance selection

The performance specification of the instrument assumes operation into 50 Ω loads. By means of this menu in association with a 75 Ω adapter (see 'Versions, options and accessories' in Chap. 1) you can select operation into 75 Ω loads whilst maintaining correct voltage calibration. It also enables the reverse power protection circuit to function correctly. But note that in the event of an overload the RPP will function but the adapter will NOT be protected. Proceed as follows:

- (1) First of all connect the 50 Ω /75 Ω adapter to the front panel RF OUTPUT socket.
- (2) Select the *Util 12: 50 Ohm/75 Ohm Calibration* menu. This shows the currently selected impedance (see Fig. 4-30).

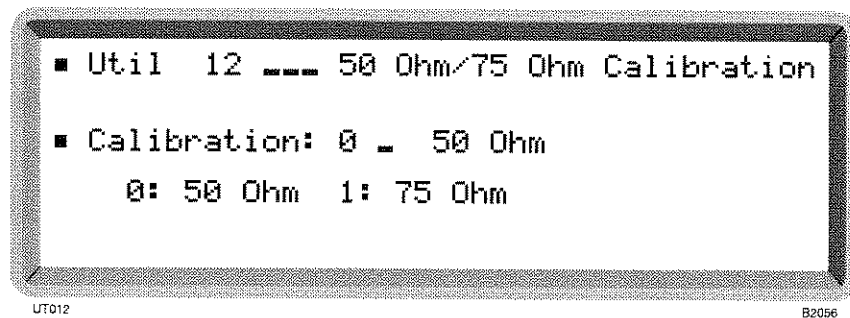

Fig. 4-30 50 Ω /75 Ω calibration menu

- (3) Select *1* for 75 Ω or *0* for 50 Ω (no terminator is necessary).

DCFM nulling

For a DC-coupled external FM signal, small frequency offsets can be reduced by using the DCFM nulling facility. Operation is as follows:

- (1) First of all select external FM from *Util 20: Modulation Mode (Normal)*. Then select DC-coupling from *Util 30: Modulation Source*.
- (2) Select the *Util 23: DCFM Nulling* utility shown in Fig. 4-31 below.

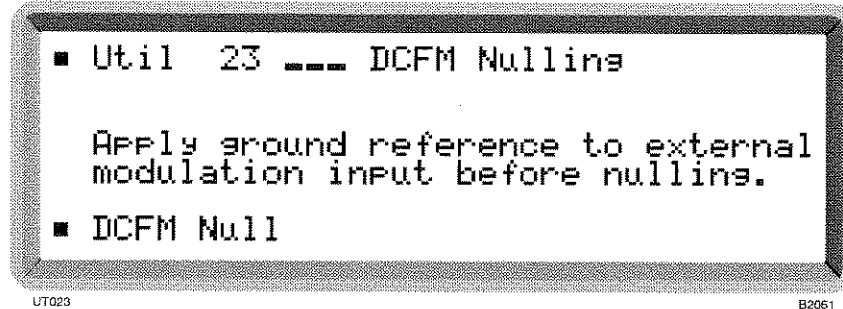

Fig. 4-31 DCFM nulling display

- (3) Follow the on-screen directions by connecting your ground reference to the EXT MOD INPUT socket.
- (4) With *DCFM Null* highlighted press [SELECT]. * *DCFM Nulling* * appears during the nulling process and when it disappears the process is completed.

Keyboard locking and display blanking

You may lock the keyboard to prevent unauthorised use of the instrument. Additionally you may blank the display to prevent sensitive data from being displayed. Selection is made as follows:

- (1) Unlock the protection by selecting *Util 80: Protection Lock/Unlock* and entering the 4-digit password for Level 1 using the keypad and pressing [ENTER].
- (2) Select the *Util 53: Key Lock/Display Blanking* menu shown in Fig. 4-32.

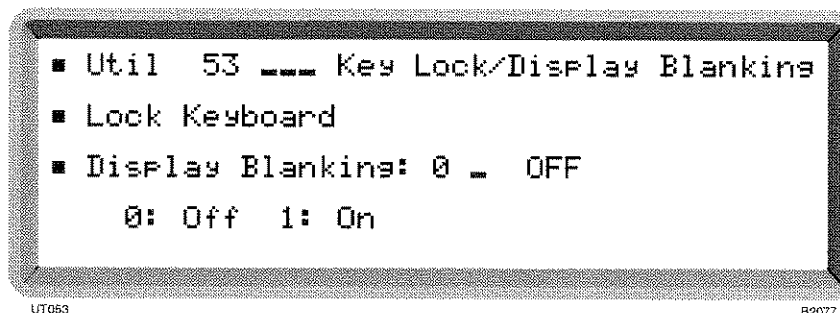

Fig. 4-32 Key lock/display blanking menu

Keyboard locking/unlocking

- (3) To lock the keyboard highlight *Lock Keyboard* and press [SELECT]. The instrument automatically returns to the main screen which indicates the locked status by displaying a key-shaped icon at the top right of the display. Now the keyboard is locked, although the instrument still responds to GPIB or RS-232 commands.
- (4) To unlock the keyboard enter the 4-digit password for Level 1 using the keypad and pressing [ENTER].

Display blanking

- (5) To blank the display highlight *Display Blanking* and press 1 [ENTER]. Press any function key to return to the main screen. Here it can be seen that the main parameters are blanked and replaced by dashes. This also applies to *Util 1: Carrier Sweep Parameters* where the start and stop frequencies are blanked, and to *Util 3: Carrier Sweep Control* where the carrier frequency is blanked.
- (6) To unblank the display re-enter *Util 53* and press 0 [ENTER].
- (7) You may lock the display in the blank state by using *Util 80* to enter an incorrect password.

Power-up options

The instrument can power-up in one of two states; with the factory settings or with the settings of your choice stored in one of the full memory locations. Selection is made as follows:

- (1) Select the *Util 54: Power Up Settings* menu. This shows the currently selected power-up choice (see Fig. 4-33).

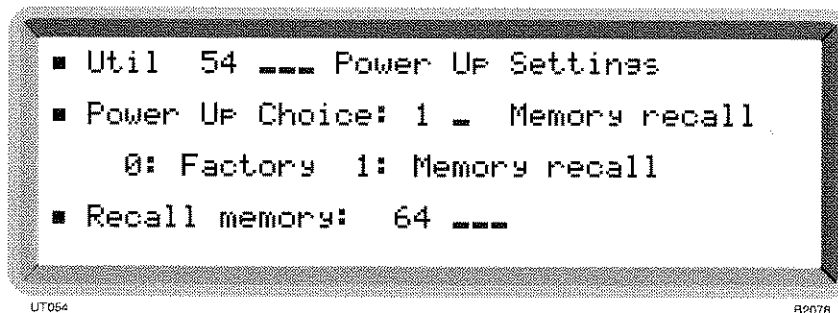

Fig. 4-33 Power-up settings menu

- (2) Enter 1 for *Memory Recall* or 0 for *Factory* (no terminator is necessary).
- (3) The current recall memory location is shown. To change, highlight *Recall Memory* and enter the required location number (in the range 0 to 199) and terminate with [ENTER].

Adjusting the display

Display contrast may be set to suit different lighting conditions and the setting saved in memory as follows:

- (1) Select the *Util 55: LCD Adjustment* menu. This shows the currently selected contrast setting (see Fig. 4-34).

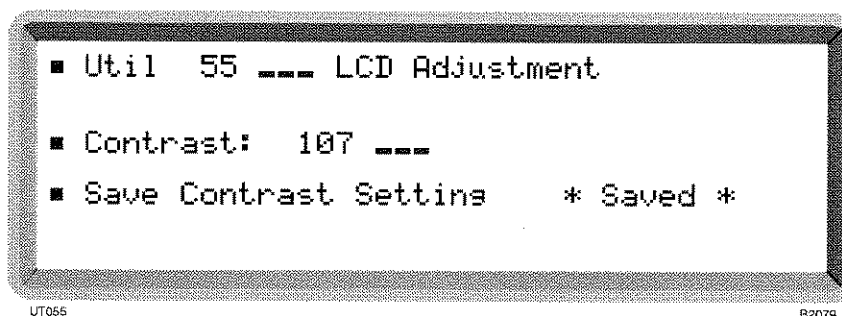

Fig. 4-34 LCD adjustment menu (with the setting saved for automatic recall at switch-on)

- (2) Enter a number in the low- to high-contrast range 0 - 255 (the default setting is 127). The setting can be adjusted by use of the [\uparrow +] and [\downarrow ×] keys or the control knob.
- (3) If required, you can save the setting by selecting *Save Contrast Setting*. The instrument responds with **** SAVED **** and from now on whenever the instrument is switched on, the contrast will be at your individual setting.

Software information

You can obtain a description of the instrument's software by selecting *Util 60: Software Status*. This causes the software version and date as well as the programmed EPROM part number to be displayed (see Fig. 4-35).

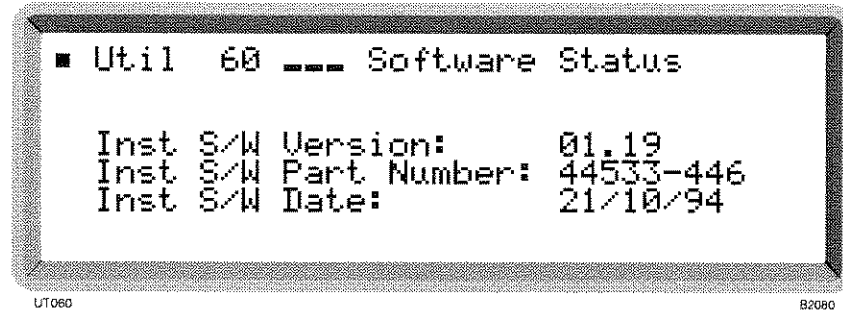

Fig. 4-35 Software status

Hardware information

You can obtain a description of the instrument's hardware by selecting *Util 61*. This causes the instrument type and serial number to be displayed (see Fig. 4-36).

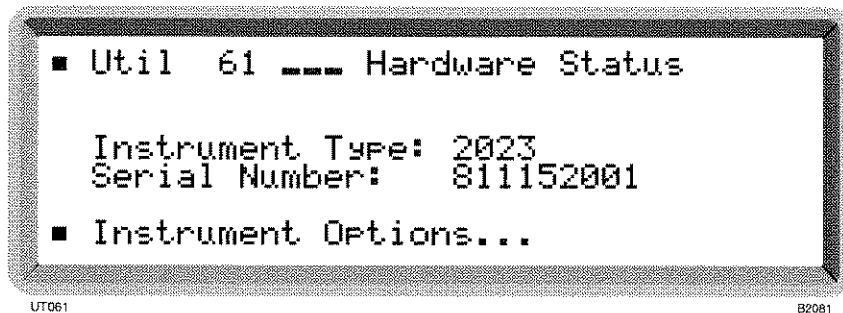

Fig. 4-36 Hardware status

- (1) Highlight *Instrument Options...* and press [SELECT]. This give you immediate access to the *Util 62: Instrument Options* display shown below.

Instrument options

You can obtain a list of the options fitted in the instrument by selecting *Util 62: Instrument Options* (see Fig. 4-37). For available options refer to 'Options' in Chapter 1.

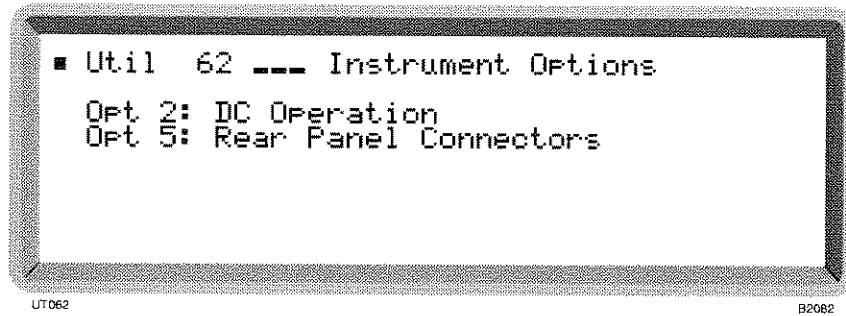

Fig. 4-37 Instrument options display

Note that if no attenuator is fitted reverse power protection is not provided.

Protection locking and unlocking.

To prevent accidental interference with the contents of internal memories, internal data is protected by secure key sequences. There are two levels of protection. The most secure, Level 2, used for servicing, is reserved for features such as altering the calibration data of the instrument. Level 1 protection is used for locking the keyboard, blanking the display and for memory protection. A filled-in square indicates an unprotected function. An open, unfilled square indicates a protected function.

To lock or unlock the protection select the *Util 80: Protection Lock/Unlock* menu shown in Fig. 4-38.



Fig. 4-38 Protection locking and unlocking

- (1) Highlight *Level 1:* and enter the 4-figure password on the keypad and press [ENTER]. *Locked* changes to *Unlocked*. The default password is 1234.
- (2) Highlight *Level 2:* and enter the 6-figure password on the keypad and press [ENTER]. *Locked* changes to *Unlocked*.
- (3) If the entered password is not recognised by the instrument the password will have been changed by operating personnel.
- (4) To lock the instrument, highlight either *Level 1:* or *Level 2:* and enter an incorrect password. Both levels will then become locked.

Changing the password

To change the password first ensure that the instrument is unlocked to Level 2 using *Util 80: Protection Lock/Unlock*. Then select the *Util 81: Password* menu shown in Fig. 4-39 and proceed as follows:

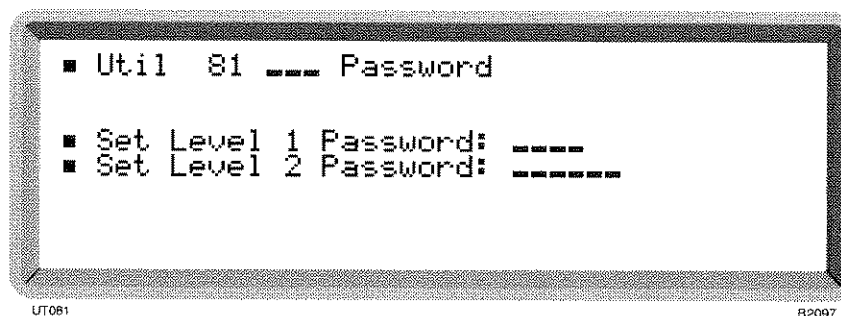

Fig. 4-39 Password selection menu

- (1) Highlight *Set Level 1 Password:* and enter a 4-figure password on the keypad then press [ENTER].
- (2) Highlight *Set Level 2 Password:* and enter a 6-figure password on the keypad and press [ENTER].

Keep a copy of your passwords in a safe place and remember to update the copy whenever the passwords are changed. In the event that you have forgotten your password(s) get in touch with your local Service Centre (for address refer to the end of this manual).

ERROR MESSAGES

Error handling

Error messages are divided into four groups:

- (1) Background errors - represent a condition of the instrument.
- (2) Foreground errors - generally caused by the user.
- (3) GPIB errors - generated by incorrect programming.
- (4) Fatal errors - caused by failure associated with the main RAM or the PROM. These errors may or may not be displayed according to the severity of the failure or corruption.

Background errors:

These are generated due to an incorrect operating condition within the instrument. These errors are generated automatically to warn the operator. For example if the reverse power protection circuit should trip the message: *Err 500: RPP tripped* will be displayed on the main screen. Background errors are listed in Table 4-2. Only one error will be displayed, that with the highest priority. To obtain a full list of errors occurring on your instrument in priority order, select *Util 75: Background Errors* (see Fig. 4-40).

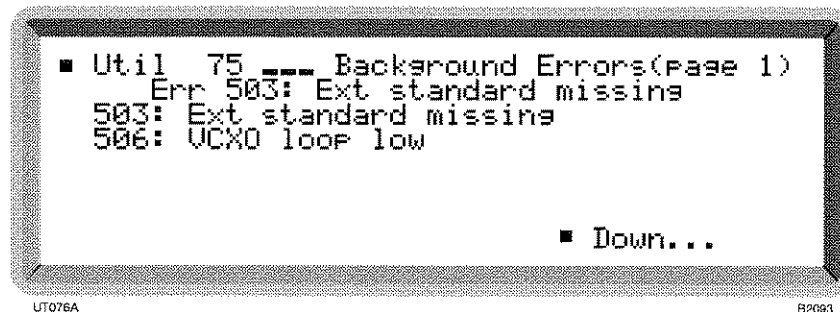

Fig. 4-40 Background errors display

Foreground errors:

These are typically generated when an entered parameter value is outside the valid range or for some other invalid operation. For example trying to set the carrier frequency above or below the specified range will display the following message *Err 100: Carrier limit* on the screen. The foreground errors are cleared upon function selection or by re-entering the parameter correctly. Foreground errors are listed in Table 4-3.

Error message priority:

A background error has a priority bit set which is used to determine which message needs to be displayed. A foreground error will temporarily overwrite the background error if currently displayed, but will return to displaying that error once the foreground error has been cleared.

GPIB errors

When an error occurs the error number is put into the error queue and the error message is displayed. Clearing the error message from the screen does not clear the error queue, which is only cleared by the GPIB command *ERROR?* query, which returns the error at the head of the queue, or by the **CLS* command which clears the whole error queue. GPIB errors are listed in Table 4-4.

The queue holds a maximum of 64 error message error numbers. If an error occurs while the queue is full the last error number is replaced with 399 to indicate that the queue is full. The ERROR? query returns a value of 399 for queue full and 0 for queue empty.

When an error number is written into the queue, a bit (<erb>) in the status byte register is set, and an appropriate bit in the standard event register is also set (one of <cme>, <exe>, <dde> or <qye>). These errors will also generate SRQ if the relevant bit in the status register is set. Many background errors are also reported in the Hardware and Coupling Status Registers.

Table 4-2 Background errors (500 - 599) in priority order

-	-	-	591	ftl	Main PROM faulty
590	ftl	Main RAM faulty	-	-	-
-	-	-	-	-	-
-	-	-	-	-	-
-	-	-	-	-	-
500	dde	RPP tripped	501	dde	Fractional-N loop low
502	dde	Fractional-N loop high	503	dde	Ext standard missing
504	dde	External std frequency low	505	dde	External std frequency high
506	dde	VCXO loop low	507	dde	VCXO loop high
508	dde	Amplitude modulator unlevelled	509	dde	Output unlevelled
510	dde	High power amplifier failed	511	dde	ALC too high
512	dde	ALC too low	513	dde	DSP not responding
-	-	-	-	-	-
-	-	-	-	-	-
-	-	-	-	-	-
550	exe	RF level limited by AM	551	exe	AM2 limited by AM1
552	exe	FM2 limited by FM1	553	exe	ΦM2 limited by ΦM1

Table 4-3 Foreground errors (0 - 399)

0	dde	No error	1	dde	EEPROM checksum
2	dde	Pad cal checksum	3	dde	RF cal checksum
4	dde	Freq std checksum	5	dde	Synthesizer cal checksum
6	dde	Mod ref checksum	7	dde	Mod offset checksum
8	dde	Mod amp checksum	9	dde	ALC cal checksum
10	dde	FM cal factor checksum	11	dde	FM tracking checksum
12	dde	Φ M cal factor checksum	13	dde	System cal checksum
14	dde	AM cal checksum	15	dde	Store checksum
16	dde	Image checksum	-	-	-
-	-	-	-	-	-
-	-	-	51	dde	Keyboard buffer overflow
52	dde	Display buffer overflow	53	dde	Display missing
-	-	-	-	-	-
100	exe	Carrier limit	101	exe	Carrier step limit
102	exe	RF level limit	103	exe	RF level step limit
104	exe	Invalid modulation mode	105	exe	AM limit
106	exe	AM2 limit	107	exe	AM step limit
108	exe	AM2 step limit	109	exe	FM limit
110	exe	FM2 limit	111	exe	FM step limit
112	exe	FM2 step limit	113	exe	Φ M limit
114	exe	Φ M2 limit	115	exe	Φ M step limit
116	exe	Φ M2 step limit	117	exe	Memory limit
118	exe	AM mod freq limit	119	exe	AM mod step limit
120	exe	AM2 mod freq limit	121	exe	AM2 mod step limit
122	exe	FM mod freq limit	123	exe	FM mod step limit
124	exe	FM2 mod freq limit	125	exe	FM2 mod step limit
126	exe	Φ M mod freq limit	127	exe	Φ M mod step limit
128	exe	Φ M2 mod freq limit	129	exe	Φ M2 mod step limit
130	exe	Return/Transfer not allowed	131	exe	Util limit
132	exe	Start freq limit	133	exe	Stop freq limit
134	exe	Sweep time limit	135	exe	Sweep mode disabled
136	exe	Carrier phase limit	137	exe	AM phase limit
138	exe	FM phase limit	139	exe	Φ M phase limit
140	exe	Memory store limit	141	exe	Memory recall limit
142	exe	Display blanking limit	143	exe	GPIB address limit
144	exe	Latch address limit	145	exe	Latch data limit
146	exe	Freq std carrier limit	147	exe	Freq std course adj limit
148	exe	Freq std fine adj limit	149	exe	Mod ref adj limit
170	exe	Util not available	171	exe	Entry outside limits
172	exe	Data out of range	173	exe	Units not valid
174	exe	Unlev fact limited by FM fact	175	exe	Invalid baud rate
176	exe	Data overrun	177	exe	Data parity
178	exe	Data framing	179	exe	Break in data
180	exe	Transmit buffer full	181	exe	Receiver not enabled
182	exe	Protected utility - Level 1	183	exe	Protected utility - Level 2
184	-	-	185	exe	This store is Read Only
186	-	-	187	-	-
188	exe	Pulse unavailable in 4FSK mode	189	exe	Pulse has been disabled
190	exe	No attenuator fitted	191	exe	No high power amp fitted
192	-	-	193	exe	Ext DCFM mod mode required
398	-	-	399	exe	Error queue full

LOCAL
OPERATION

Table 4-4 GPIB errors (400 - 499)

400	cme	Syntax error	401	cme	Unrecognised mnemonic
402	cme	Numeric syntax	403	cme	Data expected
404	cme	Illegal data	405	cme	Too much data
406	cme	Incorrect data type	407	cme	Unrecognised character data
408	cme	Character data not unique	409	cme	Block definition
410	cme	Block size	411	cme	Missing quote
412	cme	Terminator expected	413	cme	Invalid unit
414	cme	Unit not expected	415	cme	No header match found
416	cme	Header not unique	417	cme	Illegal star command
418	cme	Sub-command not allowed	419	cme	Action not allowed with header
420	cme	Query not allowed with header	421	cme	Parser decode
-	-	-	-	-	-
-	-	-	-	-	-
-	-	-	-	-	-
-	-	-	-	-	-
450	qye	Query INTERRUPTED	451	qye	Query UNTERMINATED
452	qye	Query DEADLOCK	453	qye	Query lost after arbitrary char
-	-	-	-	-	-
-	-	-	-	-	-
-	-	-	-	-	-

Chapter 5

REMOTE OPERATION

Contents

Preparing the instrument for remote operation	5-3
Introduction	5-3
Local lockout	5-3
Remote operation selection	5-3
RS-232 operation	5-3
RS-232 control port.....	5-3
Handshaking.....	5-4
Software only	5-4
Hardware only.....	5-4
Hardware and software.....	5-4
Control characters.....	5-4
Setting RS-232 parameters.....	5-4
GPIB operation.....	5-5
GPIB control port.....	5-5
Setting GPIB address	5-5
GPIB functions	5-6
Device listening elements	5-7
Device talking elements	5-7
Programming.....	5-8
Program messages.....	5-8
Compound headers	5-8
Program data	5-9
Message exchange protocol.....	5-9
Remote/local operation.....	5-9
Common commands and queries (IEEE 488.2)	5-10
Device dependent commands	5-11
Default settings.....	5-11
Carrier frequency	5-12
RF level	5-13
Modulation mode.....	5-14
Modulation control	5-14
Frequency modulation (and FSK)	5-15
Phase modulation.....	5-17
Amplitude modulation	5-19
Pulse modulation	5-21
Memory - store	5-22
Memory - recall	5-22
Memory - erase	5-22
Memory - sequencing.....	5-23
Memory - triggering	5-24
Memory - protection	5-24
Sweep operation.....	5-25
Sweep mode.....	5-25
Sweep control	5-26
Miscellaneous commands	5-27
Status byte	5-30
Status data structure - register model	5-31
Standard event registers.....	5-32
Hardware event registers.....	5-33
Coupling event registers	5-34
Instrument event registers	5-35
Queue flag details	5-36

REMOTE
OPERATION

Status byte when read by *STB?..... 5-37
Status byte when read by serial poll 5-38
Summary of status reporting commands and queries..... 5-39

List of figures

Fig. 5-1 Remote operation select menu 5-3
Fig. 5-2 RS-232 setup menu 5-4
Fig. 5-3 GPIB Address menu..... 5-5

Preparing the instrument for remote operation

Introduction

The 2023 and 2024 Signal Generators can be controlled remotely using either the RS-232 interface or the GPIB (General Purpose Interface Bus) interface. The command set used is designed to comply with IEEE 488.2. In RS-232 mode some IEEE 488.2 features are not implemented due to the restrictions of the interface.

Programs to control the instrument remotely over the two interfaces have much in common, the main difference being the way in which characters are transmitted.

Local lockout

In the remote mode the controller can set the instrument into Local Lockout state. When Local Lockout is set the front panel is disabled and the [LOCAL] key is made ineffective. This state is often used when the instrument is part of an automatic test system and left unattended. In this state the instrument cannot be affected by operation of the front panel. The keyboard can only be re-enabled by releasing Local Lockout over the remote interface or by switching the supply off and on again.

Remote operation selection

Remote operation can be selected between RS-232 and GPIB as follows:

- (1) Select the *Util 50: Remote Operation Select* menu. This shows the currently selected remote mode of operation (see Fig. 5-1).

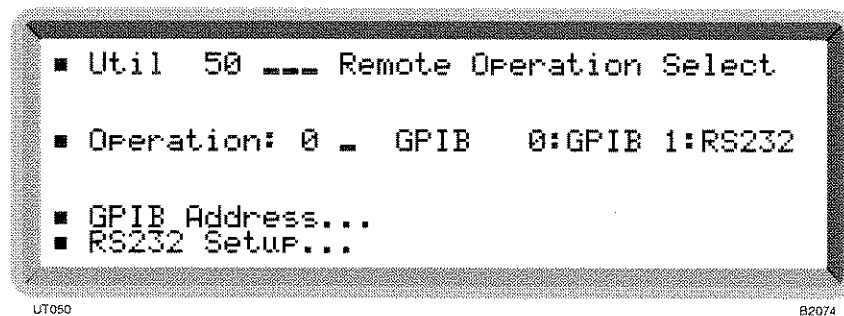

Fig. 5-1 Remote operation select menu

- (2) Select between *RS232* and *GPIB* remote operation.
- (3) To set the RS-232 parameters highlight *RS232 Setup...* and press [SELECT]. This causes the *Util 52: RS232 Setup* menu shown in Fig. 5-2 to be displayed.
- (4) To set the GPIB address highlight *GPIB Address...* and press [SELECT]. This causes the *Util 51: GPIB Address* menu shown in Fig. 5-3 to be displayed.

RS-232 operation

RS-232 control port

The connections required between the RS-232 serial port and the controlling device are described in Chapter 2 under 'RS-232 interface'.

Handshaking

Software only

Flow control is achieved by XON/XOFF.

Note

All control lines are normally in the OFF state and are ignored.

Hardware only

Flow control is achieved DSR or CTS to suspend transmission from the instrument and using DTR to suspend transmission from the controller.

Note

The instrument will try to stop the controller from transmitting when the instrument's input buffer is nearly full and will allow further transmission when the buffer has enough room for new data.

The instrument will continue to transmit for a few characters after receiving the command to stop transmission, the controller must have enough buffer space to cope with this extra data.

Hardware and software

Normally used in conjunction with a modem. The flow control between the instrument and modem is achieved with the control lines, and the flow control to the remote control is achieved by XON/XOFF.

Control characters

The following list shows the control characters that are used over the RS-232 system to simulate certain features of the IEEE 488 interface:

^A (control A 01H) - connect or go to remote

^D (control D 04H) - disconnect or go to local

^R (control R 12H) - local lockout

^P (control P 10H) - release local lockout

^Q (control Q 11H) - XON char for software handshake

^S (control S 13H) - XOFF char for software handshake

Note that power on (PON) also clears the local lockout states.

Setting RS-232 parameters

The RS-232 settings can be changed as follows:

- (1) First of all ensure that *RS233 Setup* has been selected from the *Util 50: Remote Operation Select* menu.
- (2) Select the *Util 52: RS232 Setup* menu. This shows the current RS-232 settings (see Fig. 5-2).

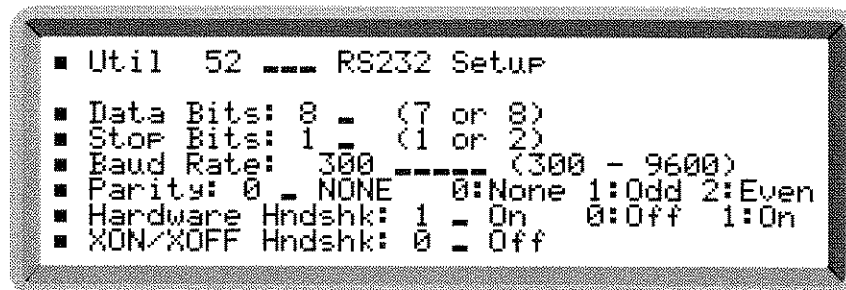

UT052

B2076

Fig. 5-2 RS-232 setup menu

- (3) Set the *Data Bits* to either 7 or 8.
- (4) Set the *Stop Bits* to either 1 or 2.
- (5) Set the *Baud Rate* in the range 300 to 9600 bit/s. But note that if the entered value is not one of the following standard settings, the next higher value will be selected by default:

300
600
1200
2400
4800
9600

- (6) Set *Parity* between *None*, *Odd* and *Even*.
- (7) Set the *Hardware Hndshk* and the *XON/XOFF Hndshk* as required to any handshake combination from both off to both on.

GPIB operation

The instrument can be operated remotely from a personal computer fitted with a GPIB interface card or a dedicated GPIB controller. All functions can be controlled by coded messages sent over the interface bus via the 24-way socket on the rear panel of the instrument. IEEE Standard 488.2 (1987) is implemented, which defines the protocols and syntax of commands.

The instrument can function either as a talker or a listener. In the listen mode, it will respond to IEEE 488.2 common commands and queries and device-specific commands and queries. These allow various device functions to be controlled and operating parameters to be set. In the talk mode, device status information and parameter settings can be read from the instrument.

For full information on the IEEE protocols and syntax the IEEE 488.2 standard should be consulted.

GPIB control port

The connections required between the GPIB interface port and the controlling device are described in Chapter 2 under 'General Purpose Interface Bus (GPIB)'.

Setting GPIB address

The instrument must be given an address code before it can be used by remote control over the GPIB. This address is selected as follows:

- (1) Select the *Util 51: GPIB Address* menu. This shows the current GPIB address (see Fig. 5-3).

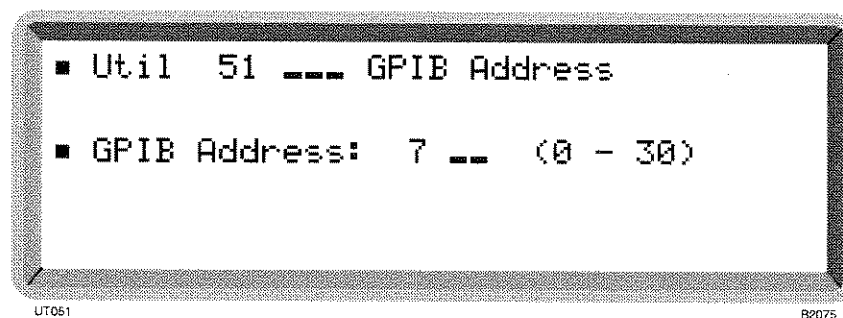

Fig. 5-3 GPIB Address menu

- (2) Enter the address which must be unique on the system to the instrument and within the range 0 to 30.

GPIB functions

The IEEE 488.1 interface functions offered by the 2023 and 2024 Signal Generators are as follows:

Source handshake (SH1)	complete capability.
Acceptor handshake (AH1)	complete capability.
Talker (T6)	basic talker, serial poll, unaddress if MLA.
Listener (L4)	basic listener, unaddress if MTA.
Service Request (SR1)	complete capability.
Remote/Local (RL1)	complete capability.
Device clear (DC1)	complete capability.
Device trigger (DT1)	complete capability.
Parallel Poll (PP0)	no capability.
Controller (C0)	no capability.
Tri-state drivers (E2)	as opposed to open collector drivers.

Device listening elements

The following is a list of the device listening elements (as defined in the IEEE 488.2 standard) which are used in the instrument:

- <PROGRAM MESSAGE>
- <PROGRAM MESSAGE TERMINATOR>
- <PROGRAM MESSAGE UNIT>
- <PROGRAM MESSAGE UNIT SEPARATOR>
- <COMMAND MESSAGE UNIT>
- <QUERY MESSAGE UNIT>
- <COMPOUND COMMAND PROGRAM HEADER>
- <COMPOUND QUERY PROGRAM HEADER>
- <PROGRAM HEADER SEPARATOR>
- <PROGRAM DATA>
- <PROGRAM DATA SEPARATOR>
- <DECIMAL NUMERIC PROGRAM DATA>
- <CHARACTER PROGRAM DATA>
- <SUFFIX PROGRAM DATA>
- <STRING PROGRAM DATA>
- <ARBITRARY BLOCK PROGRAM DATA>

Device talking elements

The following is a list of the device talking elements (as defined in the IEEE 488.2 standard) which are used in the instrument:

- <RESPONSE MESSAGE>
- <RESPONSE MESSAGE TERMINATOR>
- <RESPONSE MESSAGE UNIT>
- <RESPONSE MESSAGE UNIT SEPARATOR>
- <COMPOUND RESPONSE HEADER>
- <RESPONSE HEADER SEPARATOR>
- <RESPONSE DATA>
- <RESPONSE DATA SEPARATOR>
- <NR1 NUMERIC RESPONSE DATA>
- <NR2 NUMERIC RESPONSE DATA>
- <ARBITRARY ASCII RESPONSE DATA>
- <CHARACTER RESPONSE DATA>
- <STRING RESPONSE DATA>
- <DEFINITE LENGTH ARBITRARY BLOCK RESPONSE DATA>

Programming

Program messages

A message consists of one or more message units. Message units are separated by a semi-colon (;). The whole message is ended by the Program Message Terminator (or End Of Message) defined as one of the following:

- (1) <newline> (ASCII 10 - often known as 'line feed') or
- (2) <newline> + END (the EOI line is asserted as well) or
- (3) + END (EOI is asserted in the last data byte of the message)

Note

A response message is always terminated by <EOM> consisting of <newline> + END.

A message unit consists of a mnemonic header which may be followed by data. If data follows, it must be separated from its header by at least one space:

<header><SPACE><data>

e.g. RFLV:INC 6.0 dB

Spaces may be freely inserted in a message to improve readability, except within a header or within data.

A header may be a command or a query. A query has a '?' as its final character and causes the generation of a response message which will be read by the controller. Common commands and queries (defined in IEEE 488.2) begin with a '*'.

Upper and lower case characters are considered equivalent (i.e. FM fm Fm fM are all interpreted by the instrument in the same way).

Compound headers

The instrument implements compound headers which allows a complex set of commands to be built up from a small set of basic elements in a 'tree and branch' structure. The elements of a compound header are separated by a colon (:). Spaces are not allowed within a header.

Special rules apply when more than one compound header is used in one message. When the separator ';' is encountered, all headers except the trailing element of the previous header in the message are assumed to precede the following header, for example:

AM:DEPTH 30PCT;ON

is equivalent to the two commands:

AM:DEPTH 30PCT

and AM:ON

This does not apply to common commands (*RST etc.). The rule may be overridden by preceding a header with a colon, for example:

AM:ON;:FM:ON

Most main functions have a short form of header which may be used for clarity and brevity in simple messages, for example:

CFRQ 1.25GHZ is the same as CFRQ:VALUE 1.25GHZ

Program data

Data can take many forms, as follows:

Decimal Numeric Data is a flexible numeric format which encompasses integer, fixed point and floating point (mantissa and exponent) representations. Data is rounded to a resolution appropriate to the function. Decimal data can, in most cases, be followed by the appropriate units. If no units are present, the specified default units are assumed.

Character Data is an alphanumeric word.

String Data consists of a number of 7-bit ASCII characters enclosed in quotes, either a pair of single ('ASCII 39') or double ("ASCII 34") quotes may be used.

Some commands can accept Multiple Data items which are separated by commas, for example MODE FM,AM.

Message exchange protocol

The controller should not attempt to read a response until it has sent the entire query message (terminated by EOM). Also, it should not start to send a new message until it has read the entire response (terminated by EOM). The query message may contain more than one query message unit, but only one response message (containing several response message units) is generated.

Failure to follow the protocol will generate a query error:

INTERRUPTED (error 450) occurs when the controller starts to send a new message before having read the response to a preceding query.

UNTERMINATED (error 451) occurs when the controller attempts to read a response without having sent a query.

DEADLOCK (error 452) can only occur if the input and output buffers are both filled by the controller having sent an extra long message containing several query message units.

These instruments have an input buffer of 256 characters and an output buffer of 256 characters.

Remote/local operation

When the instrument is addressed by the controller it will enter its remote mode and the screen will display the *[REM]* annunciator at the lower right corner. Only one key, *[SELECT]*, will have any effect. Pressing this key returns the unit to normal manual operation, unless Local Lockout has been asserted by the controller.

Common commands and queries (IEEE 488.2)

The IEEE 488.2 standard defines a set of common commands and queries which implement common system functions.

Common command and query mnemonics are preceded by an asterisk (*) to distinguish them from device dependent data such as instrument programming strings. The following common commands and queries are implemented in the instrument:

Mnemonic	Name and Description
*IDN?	<p>Identification Query. Returns an arbitrary ASCII response comprising four data fields in the format:</p> <p><manufacturer>,<model>,<serial number>,<software part number and issue number>.</p> <p>where: <manufacturer> is MARCONI INSTRUMENTS, <model> is the instrument model number, which is one of 2023 or 2024. <serial number> is the instrument serial number in the form nnnnn/nnn, where n is an ASCII digit in the range 0 to 9. <software part number and issue number> is in the form nnnnn/nnn/n.nn, where n is an ASCII digit in the range 0 to 9.</p> <p>Example: MARCONI INSTRUMENTS,2024,811152/011,44533/446/01.00<EOM></p>
*OPT?	<p>Option Identification Query. Returns an arbitrary ASCII response containing a data field for each fitted option in the format:</p> <p><option a>,<option b>, ... ,<option n><EOM></p> <p>Example: HIGH POWER,NO ATTENUATOR <EOM></p> <p>If no options are fitted, ASCII '0' is returned.</p>

Note

Because an Arbitrary ASCII Response ends with the Response Message Terminator (<EOM>) either *IDN? or *OPT? must be the last Query Message Unit in a Program Message.

*RST	Reset Command. Sets the instrument functions to the factory default power up state.
*TST?	Self Test Query. Returns a '0' when the GPIB interface and processor are operating.
*OPC	Operation Complete Command. Sets the Operation Complete bit in the Standard Event Status Register when execution of the preceding operation is complete.
*OPC?	Operation Complete Query. Returns a '1' when the preceding operation has been completed.
*WAI	Wait to Continue Command. Inhibits execution of an overlapped command until the execution of the preceding operation has been completed.
*TRG	Trigger Command. Equivalent to Group Execute Trigger.
*STB?	Read Status Byte Query. Returns the value of the Status Byte as an nr1 number (0-255).
*SRE <nrf>	Service Request Enable Command. Sets the Service Request Enable Register.
*SRE?	Service Request Enable Query. Returns the value of the Service Request Enable Register as nr1.
*ESR?	Standard Event Status Register Query. Returns the value of the Status Event Status Register as nr1.
*ESE <nrf>	Standard Event Status Enable Command. Sets the Standard Event Enable Register.
*ESE?	Standard Event Status Enable Query. Returns the value of the Standard Event Status Enable Register as nr1.
*CLS	Clear Status Command. Clears all the Status Event registers and clears the Error Queue. Does not affect the Enable Registers.

Device dependent commands

The following list describes the features of the device dependent mnemonics for the instrument together with simple examples of their use within each major section (Carrier frequency, RF level, etc.) The root mnemonic is listed first followed by the lower level mnemonics. Each group is followed by a list of requirements for data type and suffix.

In addition to the normal listen commands the instrument accepts query commands which cause it to prepare a message which will be sent to the controller when the instrument is next addressed to talk. For each query an example of a response is given. Where responses are similar for a group of queries not all are listed. Some queries can produce more than one type of response - an example of each is usually given.

In the list which follows, the abbreviations <char>, <nrf> and <str> have the following meanings:

<char>	=	Character Program Data
<nrf>	=	Decimal Numeric Program Data
<str>	=	String Program Data

Where the data format is Decimal Numeric Program Data, the value may be expressed as a signed or unsigned number in any of the following formats:

nr1:	Decimal integer, e.g. 1234 or -567
nr2:	Floating point number, e.g. 1.234 or -56.789
nr3:	Floating point number with exponent, e.g. 1.2345E5 or -12.47E-8

Default settings

These are the settings assigned to instrument functions in the following cases:

- (i) Power-up to factory default settings.
- (ii) Execution of *RST command.
- (iii) Recall Store 999.

Carrier frequency

CFRQ	Set Carrier Frequency (short form)
:VALUE	Set Carrier Frequency
:INC	Set Carrier Frequency step
	Data type : Decimal Numeric Program Data
	Allowed suffices : Any one of: GHZ, MHZ, KHZ or HZ
	Default suffix : HZ
:UP	Go UP one step
:DN	Go DOWN one step
:RETN	Return to original setting
:XFER	Transfer current value to be the new setting
	Data type : None
	Allowed suffices : None
	Default suffix : None
:MODE	Selects the mode of carrier frequency operation. SWEPT enables swept carrier frequency operation, while FIXED disables it
	Data type : Character Program Data (FIXED - non swept mode, SWEPT - swept mode).
	Allowed suffices : None
	Default suffix : None
:START	Set Start Frequency for use in sweep
:STOP	Set Stop Frequency for use in sweep
	Data type : Decimal Numeric Program Data
	Allowed suffices : Any one of: GHZ, MHZ, KHZ or HZ
	Default suffix : HZ
:TIME	Set time per sweep step
	Data type : Decimal Numeric Program Data
	Allowed suffices : MS or S
	Default suffix : MS
:PHASE	Adjust Phase Offset of Carrier in degrees
	Data type : Decimal Numeric Program Data
	Allowed suffices : DEG
	Default suffix : DEG

Examples: CFRQ:VALUE 2.54MHZ;INC 10KHZ
 CFRQ:UP;XFER
 CFRQ:START 1MHZ;STOP 10MHZ;TIME 100MS
 CFRQ:MODE SWEPT

CFRQ? Prepares message containing information on Carrier Frequency setting in the following format:
 :CFRQ:VALUE <nr2>;INC <nr2>;MODE<mode>
 where: <mode> is character program data indicating whether carrier frequency operation is swept or fixed

Example: :CFRQ:VALUE 1000000000.0;INC 25000.0;MODE FIXED

RF level

RFLV	Set RF Output Level (short form)
:VALUE	Set RF Output Level
	Data type : Decimal Numeric Program Data
	Allowed suffices : Any one of: DBM, DBV, DBMV, DBUV, V, MV or UV
	Default suffix : DBM unless changed by UNITS command
:INC	Set RF Level step (dB)
	Data type : Decimal Numeric Program Data
	Allowed suffices : DB only
	Default suffix : DB
:UP	Go UP one step
:DN	Go DOWN one step
:RETN	Return to original setting
:XFER	Transfer current value to be the new setting
:ON	Turn RF Output ON
:OFF	Turn RF Output OFF
	Data type : None
	Allowed suffices : None
	Default suffix : None
:TYPE	Selects EMF or PD for voltage related units
	Data type : Character Program Data (EMF or PD)
	Allowed suffices : None
	Default suffix : None
:UNITS	Select default RF level units.
	Data type : Character Program Data (DBM, DBV, DBMV, DBUV, V, MV or UV)
	Allowed suffices : None
	Default suffix : None
	Examples: RFLV:VALUE -27.3DBM;ON RFLV:TYPE PD;VALUE 1.23UV
RFLV?	Prepares message containing information on RF Level setting in the following format: :RFLV:UNITS <unit>;TYPE <type>;VALUE <nr2>;INC <nr2>;<status>
	where: <unit> is character program data defining the default RF level units (DBM, DBV, DBMV, DBUV, V, MV or UV), <type> is character program data indicating EMF or PD and <status> is a program mnemonic indicating whether the RF output is ON or OFF
	Examples: :RFLV:UNITS DBM;TYPE PD;VALUE -103.5;INC 2.0;ON :RFLV:UNITS DBV;TYPE EMF;VALUE -83.2;INC 0.5;ON

REMOTE
OPERATION

Modulation mode

MODE

Set modulation mode

Data type : Character Program Data (valid combinations of AM, FM, PM, FSK2L, FSK4L or PULSE. See table below.)

Allowed suffices : None

Default suffix : None

Examples: MODE AM, FM
MODE FM, PULSE

VALID MODE COMBINATIONS TABLE

AM [,PULSE]
FM [,PULSE]
PM [,PULSE]
AM,FM [,PULSE]
AM,PM [,PULSE]
FSK2L [,PULSE]
FSK4L

Note...

Order is not important, for example AM,FM is equivalent to FM,AM. Pulse modulation can be used with any of the AM,FM,PM and FSK2L modes, but not with FSK4L

FSK2L and FSK4L parameters are controlled using the FM commands

MODE?

Prepares message containing information on Modulation Mode in the following format:

:MODE <mode>

where: <mode> is character program data indicating the modulation mode settings

Example: :MODE AM, FM

Modulation control

MOD

[not used alone]

:ON

Turn modulation globally ON

:OFF

Turn modulation globally OFF

Examples: MOD : ON
MOD : OFF

MOD?

Prepares message containing information on Modulation Control in the following format:

:MOD:<status>

where: <status> is a program mnemonic indicating whether the Modulation is globally ON or OFF

Example: :MOD : ON

Frequency modulation (and FSK)

FM or FM1 or FM2

Set FM Deviation (short form)

:DEVN Set FM Deviation

:INC Set FM step size

Data type : Decimal Numeric Program Data

Allowed suffices : Any one of: GHZ, MHZ, KHZ or HZ

Default suffix : HZ

:<src> Select modulation source where <src> is any one of: INT, EXTAC, EXTALC, or EXTDC

:ON Turn FM ON (locally)

:OFF Turn FM OFF (locally)

:UP Go UP one step

:DN Go DOWN one step

:RETN Return to original setting

:XFER Transfer current value to be the new setting

Data type : None

Allowed suffices : None

Default suffix : None

Examples: FM:DEVN 25KHZ;INT;ON
FM1:DEVN 15KHZ;INC 1KHZ;EXTDC

:MODF Set FM modulation oscillator frequency (short form)

:VALUE Set FM modulation oscillator frequency

:INC Set FM modulation oscillator frequency step size

Data type : Decimal Numeric Program Data

Allowed suffices : Any one of: GHZ, MHZ, KHZ or HZ

Default suffix : HZ

:UP Go UP one step

:DN Go DOWN one step

:RETN Return to original setting

:XFER Transfer current value to be the new setting

:SIN Select sinusoidal waveform

:TRI Select triangle waveform

:SQR Select square waveform

Data type : None

Allowed suffices : None

Default suffix : None

:PHASE Set phase offset of modulation oscillator relative to current phase

Data type : Decimal Numeric Program Data

Allowed suffices : DEG

Default suffix : DEG

Examples: FM2:MODF:VALUE 1.5KHZ;SIN
FM:MODF:PHASE 1.2DEG

DCFMNL

Perform DC FM null operation

Data type : None
Allowed suffices : None
Default suffix : None

Example: DCFMNL

FM? or FM1? or FM2?

Prepares message containing information on FM setting in one of the following formats:

:FM:DEVN <nr2>;<src>;<status>;INC <nr2>
:FM1:DEVN <nr2>;<src>;<status>;INC <nr2>
:FM2:DEVN <nr2>;<src>;<status>;INC <nr2>

where: <src> is a program mnemonic representing the source of the modulation signal and <status> is a program mnemonic indicating whether the frequency modulation is locally ON or OFF

Example: :FM1:DEVN 25000.0;INT;ON;INC 1000.0

**FM:MODF? or FM1:MODF?
or FM2:MODF?**

Prepares message containing information on FM modulation oscillator setting in one of the following formats:

:FM:MODF:VALUE <nr2>;<shape>;INC <nr2>
:FM1:MODF:VALUE <nr2>;<shape>;INC <nr2>
:FM2:MODF:VALUE <nr2>;<shape>;INC <nr2>

where: <shape> is a program mnemonic representing the waveform shape

Example: :FM1:MODF:VALUE 5750.00;SIN;INC 1000.00

Phase modulation

PM or PM1 or PM2

	Set Phase Modulation Deviation (short form)
:DEVN	Set Phase Modulation Deviation
:INC	Set Phase Modulation step size
	Data type : Decimal Numeric Program Data
	Allowed suffices : RAD
	Default suffix : RAD
:<src>	Select modulation source where <src> is any one of: INT, EXTAC, EXTALC, or EXTDC
:ON	Turn PM ON (locally)
:OFF	Turn PM OFF (locally)
:UP	Go UP one step
:DN	Go DOWN one step
:RETN	Return to original setting
:XFER	Transfer current value to be the new setting

Data type : None
 Allowed suffices : None
 Default suffix : None

Examples: PM:DEVN 2.38RAD;INT;ON
 PM1:DEVN 1.5RAD;INC 0.1RAD;EXTAC

:MODF	Set PM modulation oscillator frequency (short form)
:VALUE	Set PM modulation oscillator frequency
:INC	Set PM modulation oscillator frequency step size

Data type : Decimal Numeric Program Data
 Allowed suffices : Any one of: GHZ, MHZ, KHZ or HZ
 Default suffix : HZ

:UP	Go UP one step
:DN	Go DOWN one step
:RETN	Return to original setting
:XFER	Transfer current value to be the new setting
:SIN	Select sinusoidal waveform
:TRI	Select triangle waveform
:SQR	Select square waveform

Data type : None
 Allowed suffices : None
 Default suffix : None

:PHASE	Set phase offset of modulation oscillator relative to current phase
--------	---

Examples: PM1:MODF:VALUE 10.5KHZ;SQR
 PM2:MODF:PHASE 2.0DEG

PM? or PM1? or PM2?

Prepares message containing information on Phase Modulation setting in one of the following formats:

```
:PM:DEVN <nr2>;<src>;<status>;INC <nr2>
:PM1:DEVN <nr2>;<src>;<status>;INC <nr2>
:PM2:DEVN <nr2>;<src>;<status>;INC <nr2>
```

where <src> is a program mnemonic representing the source of the modulation signal and <status> is a program mnemonic indicating whether the phase modulation is locally ON or OFF

Example: :PM2:DEVN 2.30;INT;OFF;INC 0.05

REMOTE
OPERATION

**PM:MODF? or PM1:MODF?
or PM2:MODF?**

Prepares message containing information on PM modulation oscillator setting in one of the following formats:

:PM:MODF:VALUE <nr2>;<shape>;INC <nr2>

:PM1:MODF:VALUE <nr2>;<shape>;INC <nr2>

:PM2:MODF:VALUE <nr2>;<shape>;INC <nr2>

where: <shape> is a program mnemonic representing the waveform shape

Example: :PM2:MODF:VALUE 2500.00;TRI;INC 500.00

Amplitude modulation

AM or AM1 or AM2

	Set AM Depth (short form)
:DEPTH	Set AM Depth
:INC	Set AM step size
	Data type : Decimal Numeric Program Data
	Allowed suffices : PCT
	Default suffix : PCT
:<src>	Select modulation source where <src> is any one of: INT, EXTAC, EXTALC, or EXTDC
:ON	Turn AM ON (locally)
:OFF	Turn AM OFF (locally)
:UP	Go UP one step
:DN	Go DOWN one step
:RETN	Return to original setting
:XFER	Transfer current value to be the new setting

Data type : None
 Allowed suffices : None
 Default suffix : None

Examples: AM:DEPTH 30.5PCT;EXTAC;ON
 AM1:DEPTH 40PCT;INT;OFF

:MODF

	Set AM modulation oscillator frequency (short form)
:VALUE	Set AM modulation oscillator frequency
:INC	Set AM modulation oscillator frequency step size

Data type : Decimal Numeric Program Data
 Allowed suffices : Any one of: GHZ, MHZ, KHZ or HZ
 Default suffix : HZ

:UP	Go UP one step
:DN	Go DOWN one step
:RETN	Return to original setting
:XFER	Transfer current value to be the new setting
:SIN	Select sinusoidal waveform
:TRI	Select triangle waveform
:SQR	Select square waveform

Data type : None
 Allowed suffices : None
 Default suffix : None

:PHASE	Set phase offset of modulation oscillator relative to current phase
--------	---

Examples: AM2:MODF:VALUE 15.5KHZ;TRI;INC 500HZ
 AM:MODF:PHASE 5DEG

REMOTE
OPERATION

AM? or AM1? or AM2?

Prepares message containing information on Amplitude Modulation setting in one of the following formats:

:AM:DEPTH <nr2>;<src>;<status>;INC <nr2>
 :AM1:DEPTH <nr2>;<src>;<status>;INC <nr2>
 :AM2:DEPTH <nr2>;<src>;<status>;INC <nr2>

where <src> is a program mnemonic representing the source of the modulation signal and <status> is a program mnemonic indicating whether the amplitude modulation is locally ON or OFF

Example: :AM1:DEPTH 56.6;INT;ON;INC 5.0

**AM:MODF? or AM1:MODF?
 or AM2:MODF?**

Prepares message containing information on AM modulation oscillator setting in one of the following formats:

:AM:MODF:VALUE <nr2>;<shape>;INC <nr2>
 :AM1:MODF:VALUE <nr2>;<shape>;INC <nr2>
 :AM2:MODF:VALUE <nr2>;<shape>;INC <nr2>

where: <shape> is a program mnemonic representing the waveform shape

Example: :AM:MODF:VALUE 5000.00;TRI;INC 1000.00

Pulse modulation

PULSE

[not used alone]

:ON

Turn Pulse modulation ON

:OFF

Turn Pulse modulation OFF

Data type : None
Allowed suffices : None
Default suffix : None

Examples: PULSE:ON
PULSE:OFF

PULSE?

Prepares message containing information on Pulse Modulation setting in the following format:

:PULSE:<status>

where: <status> is a program mnemonic indicating whether the pulse modulation is ON or OFF

Examples: :PULSE:ON
:PULSE:OFF

Memory - store

STO Store 0-299 (short form)
 :MEM Store 0-299
 :CFRQ Carrier Freq Store 0-99
 :FULL Full Store 100-199
 :RAM RAM Store 200-299

Data type : Decimal Numeric Program Data
 Allowed suffices : None
 Default suffix : None

Examples: STO:FULL 112
 STO:CFRQ 83

Memory - recall

RCL Recall Store 0-299 (short form)
 :MEM Recall Store 0-299
 :CFRQ Recall Carrier Freq Store 0-99
 :FULL Recall Full Store 100-199
 :RAM Recall RAM Store 200-299

Data type : Decimal Numeric Program Data
 Allowed suffices : None
 Default suffix : None

:UP Step up through stores. Use this command for memory sequencing
 :DN Step down through stores. Use this command for memory sequencing

Data type : None
 Allowed suffices : None
 Default suffix : None

Examples: RCL:FULL 125
 RCL:UP

RCL? Prepares message containing information on last memory store that was recalled in the following format:
 :RCL:MEM <nr1>

Examples: :RCL:MEM 126

Memory - erase

ERASE [not used alone]
 :CFRQ Erase all Carrier Freq Stores (0-99)
 :FULL Erase all Full Stores (100-199)
 :RAM Erase all RAM Stores (200-299)
 :ALL Erase all Stores (0-299)

Data type : None
 Allowed suffices : None
 Default suffix : None

Examples: ERASE:FULL
 ERASE:ALL

Memory - sequencing

MSEQ

[not used alone]

:MODE

Select sequencing mode of operation. When a sequence is selected, the user can step through the sequence using the RCL:UP and RCL:DN commands. The sequence modes are SEQ1 to SEQ9, and the sequencing can be disabled with the OFF parameter.

Data type : Character Program Data
 Allowed suffices : None
 Default suffix : None

Examples: MSEQ:MODE OFF
 MSEQ:MODE SEQ2

:SEQ1...:SEQ9

:START

:STOP

Set the memory store for the start of the sequencing loop

Set the memory store for the end of the sequencing loop

Data type : Decimal Numeric Program Data
 Allowed suffices : None
 Default suffix : None

Example: MSEQ:SEQ2:START 50;STOP 70

MSEQ?

Prepares message containing information on the current memory sequencing mode in the following format:

:MSEQ:MODE <mode>

where: <mseq> is character program data indicating the sequence mode selection

Examples: :MSEQ:MODE SEQ4
 :MSEQ:MODE OFF

MSEQ:SEQ1?

.....

MSEQ:SEQ9?

Prepares message containing information on the start and stop settings of the given memory sequence in the following format:

:MSEQ:SEQn:START <nr1>;STOP <nr1>

where n is between 1 and 9 inclusive

Example: :MSEQ:SEQ4:START 120;STOP 155

Memory - triggering

MTRIG

:ON

Enables memory recall triggering to be activated by *TRG command or by external triggering. The triggering order of priority is as follows:

FSK logic input

Memory recall

Sweep trigger

Therefore ensure that FSK is not enabled, otherwise selecting memory recall triggering will have no effect.

:OFF

Disable memory recall triggering

Data type : None
 Allowed suffices : None
 Default suffix : None

Examples: MTRIG : ON
 MTRIG : OFF

MTRIG?

:OFF

Prepares message containing information on memory triggering state in the following format:

:MTRIG:<status>

where: <status> is a program mnemonic indicating whether the memory recall triggering is enabled (:ON) or disabled (:OFF)

Example: :MTRIG : ON

Memory - protection

MPROT

:START

[not used alone]

Set the start of the memory block which is to be protected/unprotected

:STOP

Set the end of the memory block which is to be protected/unprotected

Data type : Decimal Numeric Program Data
 Allowed suffices : None
 Default suffix : None

:ON

Set memory protection ON for the selected memory block

:OFF

Set memory protection OFF (i.e. unprotected) for the selected memory block

Data type : None
 Allowed suffices : None
 Default suffix : None

Examples: MPROT : START 100 ; STOP 150
 MPROT : ON

Sweep operation

To make these commands operational they must first be enabled by the CFRQ:MODE SWEPT command.

SWEEP [not used alone]

:CFRQ Optional command (may be omitted)

:START Set Start Frequency

:STOP Set Stop Frequency

:INC Set Carrier Frequency sweep step size

Data type : Decimal Numeric Program Data
 Allowed suffices : Any one of: GHZ, MHZ, KHZ or HZ
 Default suffix : HZ

:TIME Select time per sweep step

Data type : Decimal Numeric Program Data
 Allowed suffices : MS, S
 Default suffix : MS

Example: SWEEP:CFRQ:START 100KHZ;STOP 500KHZ;INC 100HZ;TIME 60MS

SWEEP:CFRQ? Prepares message containing information on Carrier Frequency Sweep settings in the following format:

:SWEEP:CFRQ:START <nr2>;STOP <nr2>;INC <nr2>;TIME <nr2>

Example: :SWEEP:CFRQ:START 1230000.0;STOP 1330000.0;INC 100.0;TIME 20.0

Sweep mode

To make these commands operational they must first be enabled by the CFRQ:MODE SWEPT command. Note that for triggering the order of priority is as follows:

- FSK logic input
- Memory recall
- Sweep trigger

Therefore ensure that FSK is not enabled, otherwise selecting sweep triggering will have no effect.

SWEEP [not used alone]

:MODE Select Mode of operation for Sweep generator (single or continuous)

Data type : Character Program Data (either SNGL or CONT)
 Allowed suffices : None
 Default suffix : None

Example: SWEEP:MODE SNGL

:TRIG

Data type : Character Program Data (any one of OFF, START, STARTSTOP, STEP)
 Allowed suffices : None
 Default suffix : None

Example: SWEEP:TRIG STARTSTOP

REMOTE OPERATION

SWEEP?

Prepares message containing information on Sweep Mode and trigger in the following format:

:SWEEP:MODE <mode>;TRIG <trig>

where: <mode> is character program data indicating the sweep mode selected, and <trig> is character program data indicating the trigger type selected

Example: :SWEEP:MODE CONT;TRIG STEP

Sweep control

SWEEP

	[not used alone]
:GO	Commence Sweep
:HALT	Pause Sweep
:CONT	Continue Sweep
:RESET	Reset sweep to Start Value
:RETN	Return to original setting
:XFER	Transfer current value as the new setting
:UP	Go UP one sweep step while paused
:DN	Go DOWN one sweep step while paused

Data type : None

Allowed suffices : None

Default suffix : None

Examples: SWEEP:GO
SWEEP:RESET

Miscellaneous commands

ERROR?	Prepares message relating to the next error in the error queue in the following format: <nr1>, <string> Where <string> is a descriptive error message. The numeric value returned is that of the next error number, or 0 if the queue is empty, or 399 if the queue is full
	Example: 100, "Carrier Limit"
GPIB	Set the GPIB Address (between 0 and 30 inclusive)
	Data type : Decimal Numeric Program Data
	Allowed suffices : None
	Default suffix : None
	Example: GPIB 7
RPP	Reset reverse power protection trip (short form)
:RESET	Reset RPP trip
	Data type : None
	Allowed suffices : None
	Default suffix : None
	Example: RPP:RESET
RPP:TRIPPED?	Prepares message containing information on whether the RPP Circuitry is currently tripped in the following format: <nr1> (0 = not tripped, 1 = tripped)
	Example: 1
RPP:COUNT?	Prepares message containing information on the number of times the RPP Circuitry has tripped in the following format: <nr1>
	Example: 3
FSTD	Select internal or external frequency standard
	Data type : Character program data (any one of INT, EXT10DIR, EXT11ND, EXT10IND or INT10OUT)
	Allowed suffices : None
	Default suffix : None
	Examples: FSTD INT FSTD EXT10IND
FSTD?	Prepares message containing information on frequency standard selection in the format: :FSTD <char>
	Example: :FSTD EXT10IND
BLANK	Blank or unblank display parameters: Carrier Frequency, RF Level, Modulation Depth and Deviations, and Modulation Frequency
	Data type : None
	Allowed suffices : None
	Default suffix : None
	Examples: BLANK:ON BLANK:OFF

BLANK?

Prepares message containing information on the display blanking setting in the following format:

:BLANK:<state>

where: <state> is program mnemonic indicating whether the blanking is ON or OFF

Examples: BLANK : OFF

CONTRAST

Sets the LCD contrast, over a scale of 0 to 255

Data type : Decimal Numeric Program Data
 Allowed suffices : none
 Default suffix : none

Examples: CONTRAST 120

CONTRAST?

Prepares message containing information on LCD contrast setting in the following format:

:CONTRAST <nr1>

Example: :CONTRAST 78

ELAPSED

:RESET

Reset elapsed operating hours to zero

Data type : None
 Allowed suffices : None
 Default suffix : None

Example: ELAPSED : RESET

ELAPSED?

Prepares message containing information on elapsed operating hours since last reset. Fractional part is in 15 minute intervals (0.25, 0.50, 0.75). Format is as follows:

<nr2>

Example: 454 . 50

OPER?

Prepares message containing information on total operating hours. Fractional part is in 15 minute intervals (0.25, 0.50, 0.75). Format is as follows::

<nr2>

Example: 1453 . 00

KLOCK

Disables keyboard entry except RPP Reset and Go to Local

Data type : None
 Allowed suffices : None
 Default suffix : None

KUNLOCK

Enables keyboard entry

Data type : None
 Allowed suffices : None
 Default suffix : None

POWUP

[not used alone]

:MODE

Select the power up mode. The instrument can power up in either the factory preset mode or from a selected memory

Data type : Character program data (FACTORY or MEMORY)
 Allowed suffices : None
 Default suffix : None

:MEM

Set the memory location for a memory power up

Data type : Decimal Numeric Program Data
 Allowed suffices : None
 Default suffix : None

Examples: POWUP:MODE MEMORY
 POWUP:MEM 172

POWUP?

Prepares message containing information on the instrument power up selection in the following format:

Example: :POWUP:MODE MEMORY;MEM 135

ATTEN

[not used alone]

:LOCK

Lock the Attenuators

:UNLOCK

Unlock the Attenuators

Data type : None
 Allowed suffices : None
 Default suffix : None

Example: ATTEN:LOCK

ATTEN?

Prepares message containing information on whether the Attenuators are locked or unlocked in the following format:

:ATTEN:<status>

where <status> is a program mnemonic indicating whether the attenuators are locked or unlocked

Example: :ATTEN:LOCK

IMPEDANCE

Set 50 Ω or 75 Ω adapter mode

Data type : Character program data (Z50R or Z75R)
 Allowed suffices : None
 Default suffix : None

Example: IMPEDANCE Z75R

IMPEDANCE?

Prepares message containing information on which adapter mode is selected in the following format:

:IMPEDANCE <char>

Example: :IMPEDANCE Z75R

REMOTE
OPERATION

Status byte

The Status Byte provides information about events and conditions within the instrument. It may be read by a conventional Serial Poll or its value obtained as a response to the *STB? query. Bits 0 to 5 and bit 7 are each single bit Summary Messages which may be of two types (or not used at all).

- (i) Queue Status - a '1' indicates that an associated Queue is non-empty and has data available to be read.
- (ii) Status Register Summary - reports the occurrence of an enabled event monitored by a Status Register Structure.

The Service Request Enable Register determines which of the bits can generate an SRQ. This register may be set by *SRE or read by *SRE?. If the bitwise -AND of the Status Byte and the Enable Register is non-zero the Flag Master Summary Status (<mss>) is True. Bit 6 of the Status Byte value read by *STB? holds <mss>. However bit 6 of the Status Byte when Serial Polled is the Request For Service bit used to determine which device on the Bus has asserted SRQ, and is cleared by a Serial Poll.

The IEEE 488.2 Standard defines bit 4 as Message Available (<mav>), the Queue Summary for the Output Buffer, indicating whether any part of a Response Messages is available to be read. Bit 5 is the Event Summary Bit (<esb>), the Summary Message from the Standard Event Status Register.

With this instrument, bit 7 is a Queue Summary for the Error Queue. Bits 1, 2, and 3 are Status summaries for the Instrument Status, Coupling Status and Hardware Status Registers. Bit 0 is unused.

Status data structure - register model

Below is a generalised model of the Register Set which funnels the monitored data into a single summary bit to set the appropriate bit in the Status Byte.

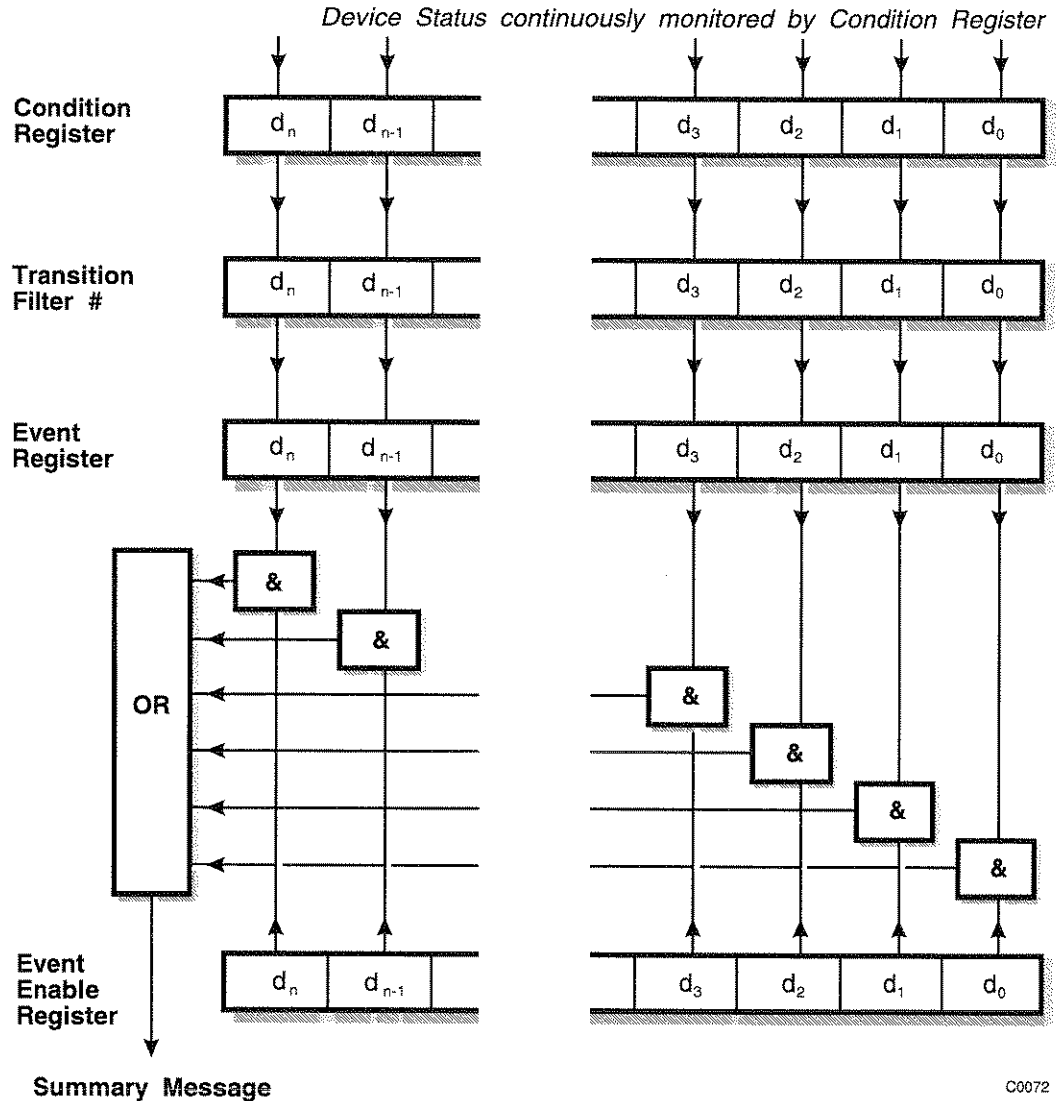

Notes

The Device Status is continuously monitored by the Condition Register. If a Query to read a Condition Register is provided, the Response represents the Status of the instrument at the moment the Response is generated. A Condition Register cannot be written to.

The Transition Filter determines which transition of the Condition Register data bits will set the corresponding bit in the Event Register. Either positive-going, negative-going or both transitions can set bits in an Event Register. But with this instrument the Transition Filters are pre-set as either Positive or Negative, as described in the following pages.

The bits in an Event Register are "latched". Once set they remain set, regardless of subsequent changes in the associated condition bit until the Event Register is cleared by being read or by the *CLS common command. Once cleared, an Event Register bit will only be set again if the appropriate change in the Condition bit occurs.

The Event Enable Register may be both written to and read from. It is bitwise AND-ed with the Event Register and if the result is non-zero the Summary Message is true, otherwise the Summary Message is false. Enable Registers are not affected by *CLS but are however clear at power-on.

Standard event registers

This register is defined by IEEE 488.2 and each bit has the meaning shown below:-

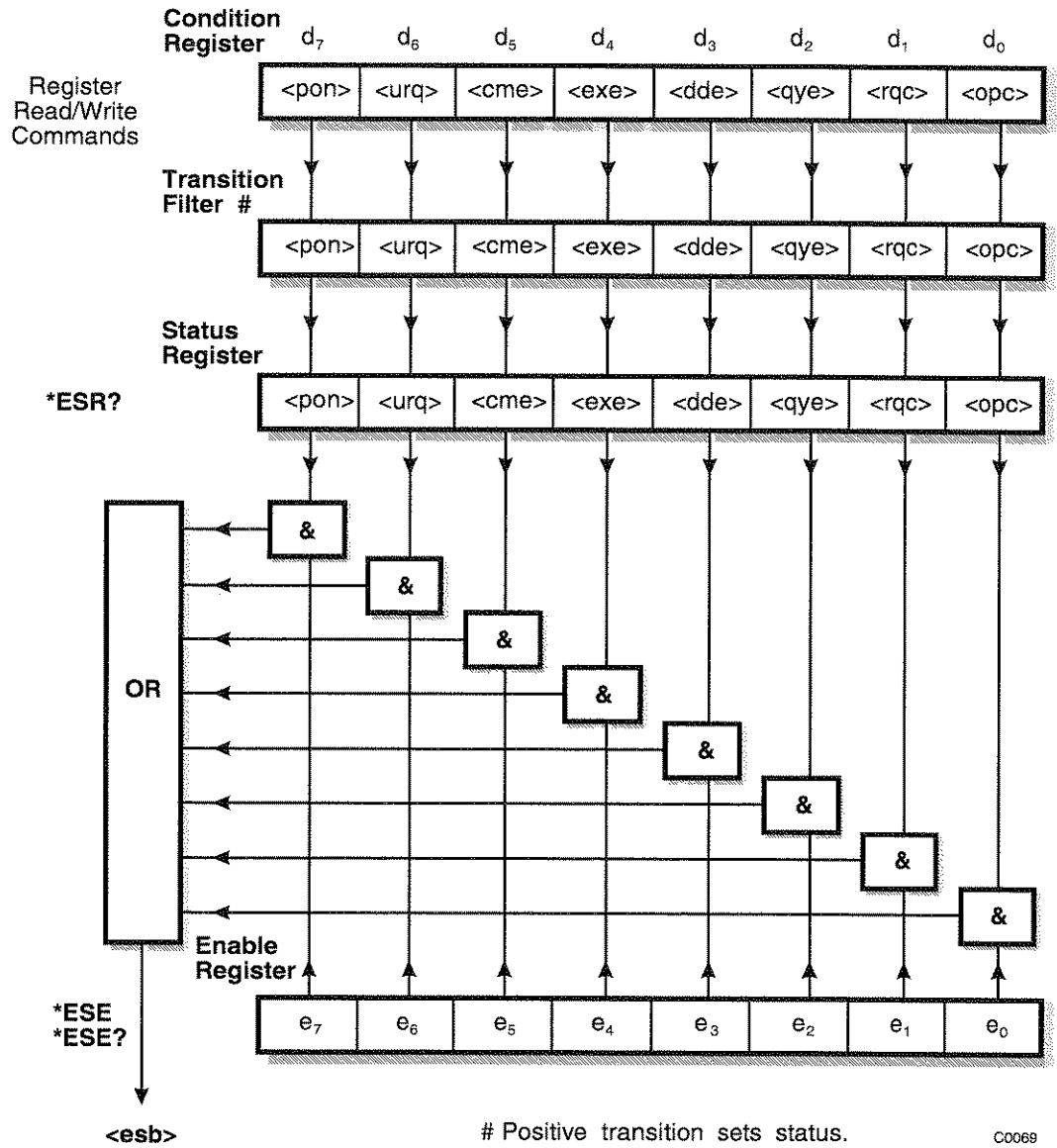

- <pon> power on
- <urq> user request - not implemented in this product
- <cme> command error
- <exe> execution error
- <dde> device dependent error
- <qye> query error
- <rqc> request control - not implemented in this product
- <opc> operation complete - set in response to the *OPC command for synchronisation.

- <esb> standard event register summary bit

Hardware event registers

This is a device dependent register and the bits have meanings as shown in the list at the bottom of the page.

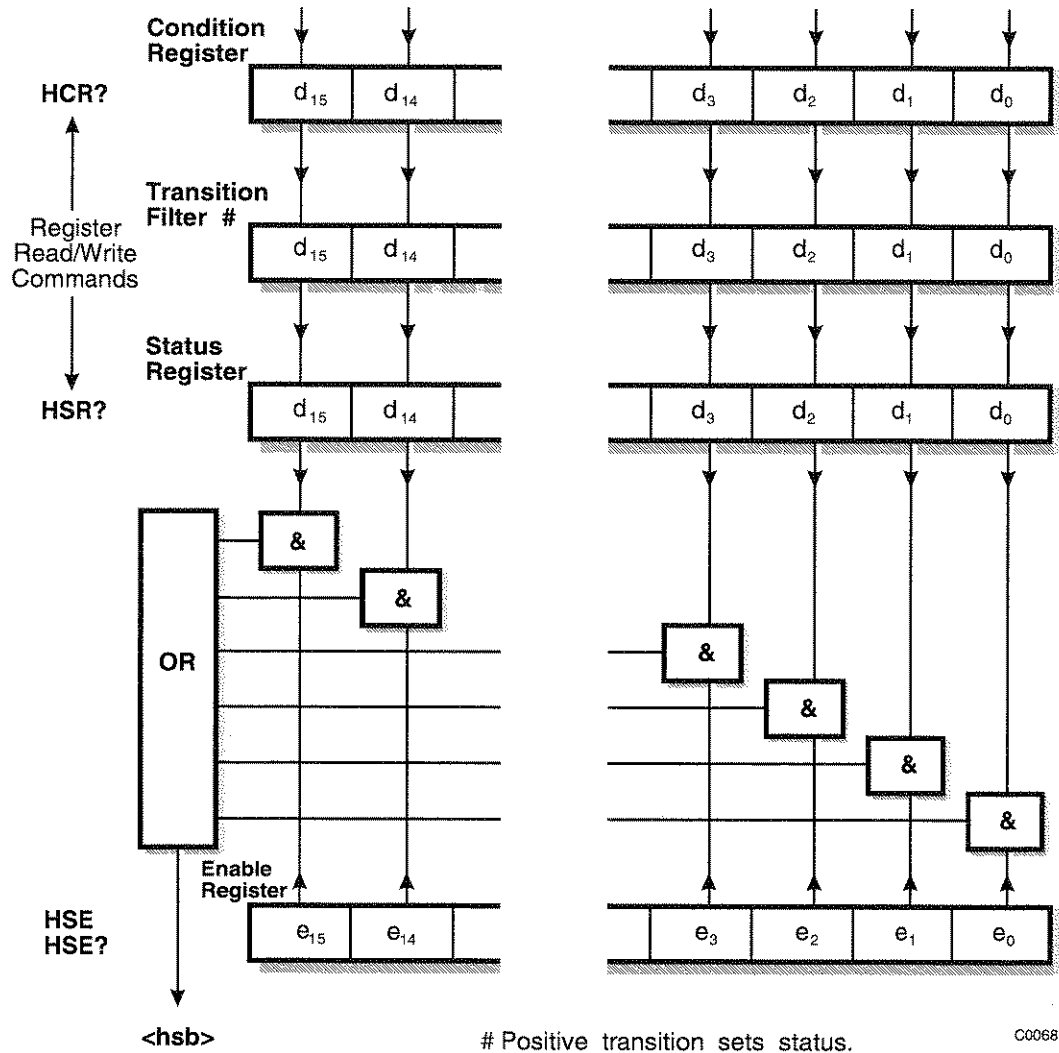

- | | | | |
|----|--------------------------------------|-----|-----------------------------|
| d0 | reverse power protection tripped | d8 | filter unlevelled |
| d1 | fractional-n loop low | d9 | output unlevelled |
| d2 | fractional-n loop high | d10 | high power amplifier failed |
| d3 | external standard missing | d11 | ALC too high |
| d4 | external standard frequency too low | d12 | ALC too low |
| d5 | external standard frequency too high | d13 | DSP not responding |
| d6 | VCXO loop low | d14 | not used |
| d7 | VCXO loop high | d15 | not used |

<hsb> hardware event register summary bit

REMOTE OPERATION

Coupling event registers

This is a device dependent register and the bits have meanings as shown in the list at the bottom of the page.

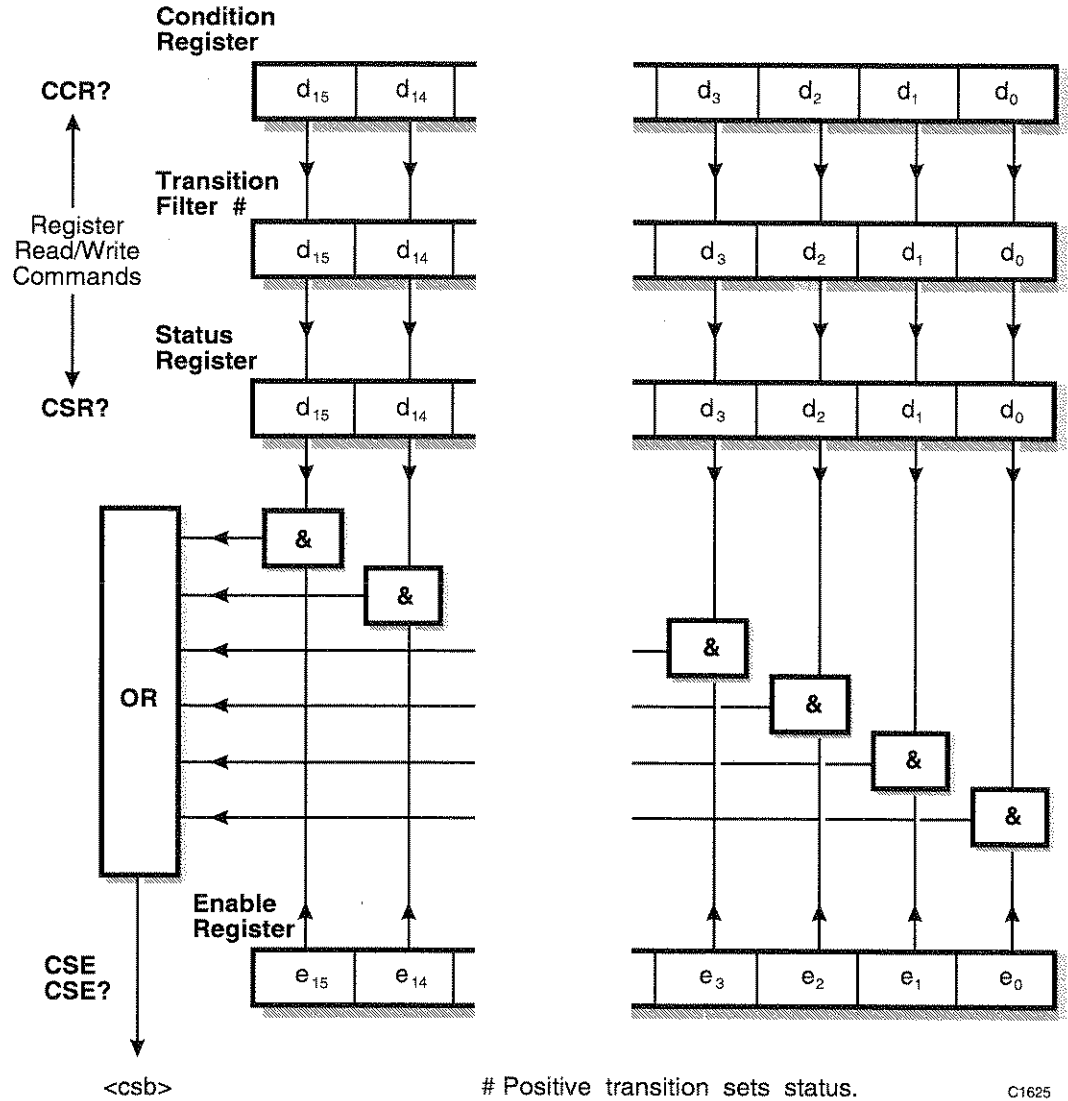

- d₀ RF level restricted by requested AM depth
- d₁ not used
- d₂ not used
- d₃ AM2 depth restricted by requested AM1 depth
- d₄ FM2 deviation restricted by requested FM1 deviation
- d₅ ΦM2 deviation restricted by requested ΦM1 deviation
- d₆ number of sweep steps restricted by other parameters
- d₇ - d₁₅ not used

- <csb> coupling event register summary bit

Instrument event registers

This is a device dependent register and the bits have meanings as shown in the list at the bottom of the page.

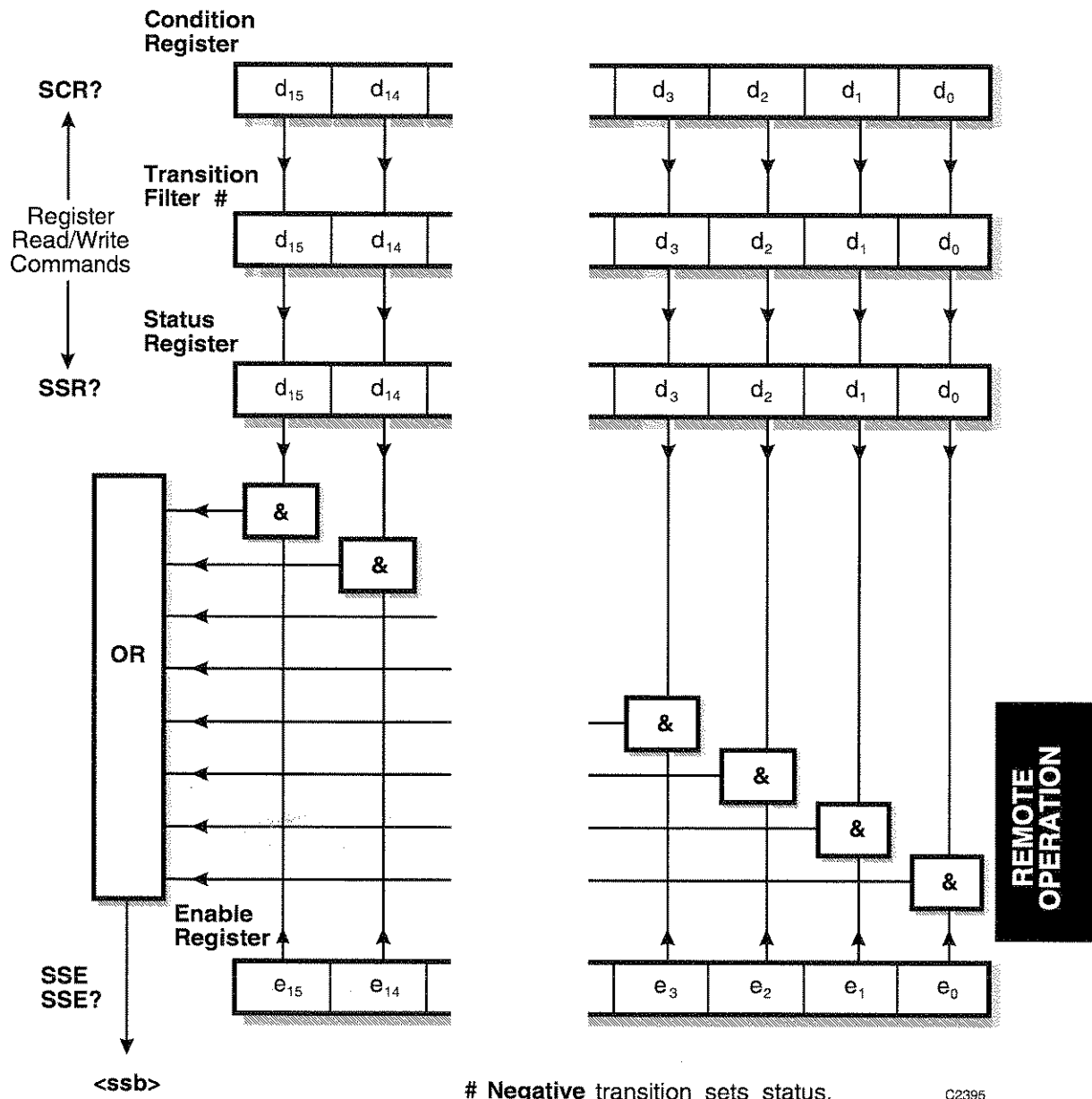

Negative transition sets status.

C2395

	Condition (SCR?)	Event Status (SSR?)
d ₀	sweep in progress	end of sweep
d ₁	not used	not used
d ₂	selfcal in progress	selfcal completed
d ₃	DC FM null in progress	DC FM null completed
d ₄ - d ₁₅	not used	not used
<ssb>	instrument event register summary bit	

Queue flag details

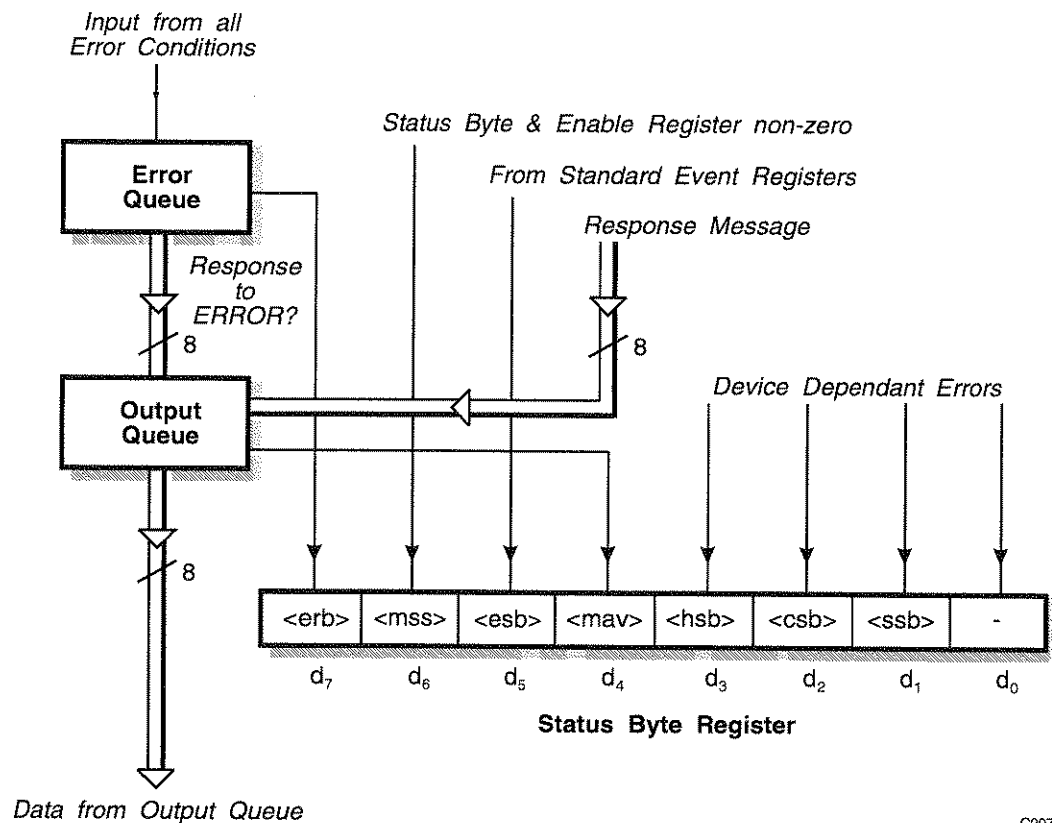

C0075

The <mav> status bit is set when one or more bytes are available to be read from the Output Queue.

The <erb> status bit is set when one or more errors are present in the Error Queue. The ERROR? query will place a nr1 and string response message in the Output Queue representing the error at the head of the queue. If the queue is empty this message will be 0, "No error".

Status byte when read by *STB?

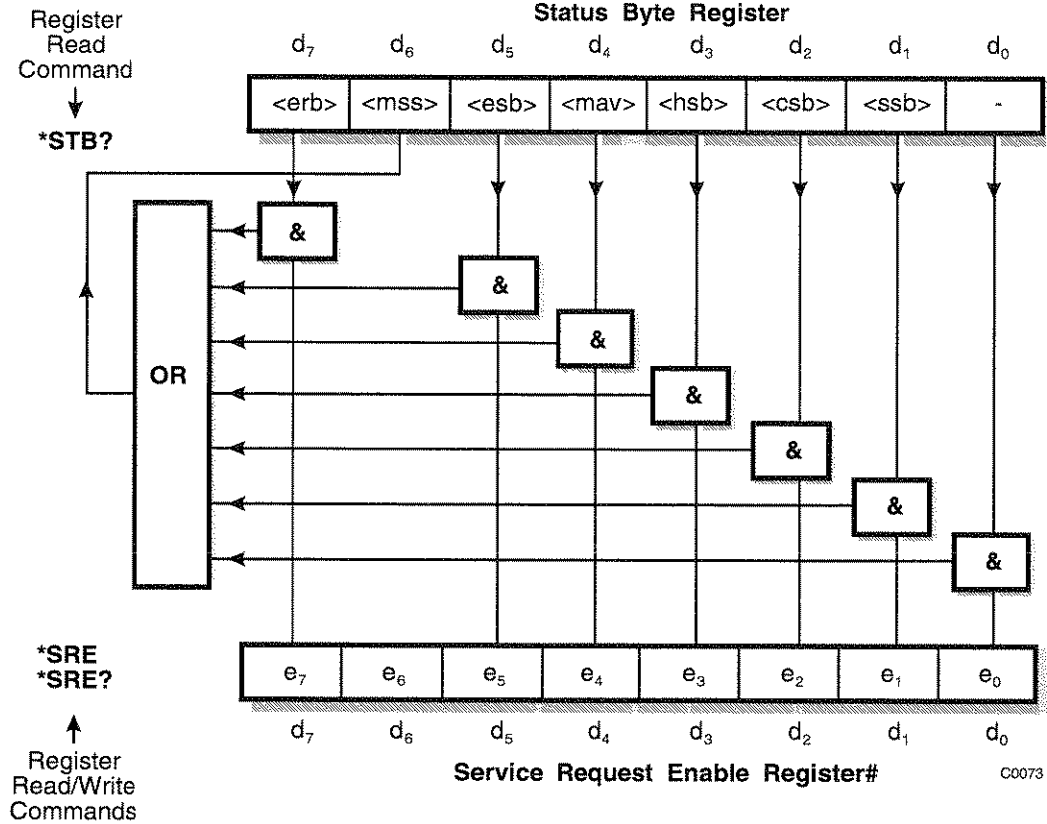

Bit 6 in this register ignores data sent by *SRE and always returns 0 in response to *SRE?

<rqs>, <esb> and <mav> are defined in IEEE 488.2

- <erb> is a device defined queue summary bit indicating that the error queue is non-empty.
- <mss> is true when (Status Byte) AND (Enable register) > 0.
- <esb> is the standard event register summary bit.
- <mav> is 'message available' indicating that the output queue is non-empty.
- <hsb> is 'hardware status' summary bit
- <csb> is 'coupling status' summary bit
- <ssb> is 'instrument status' summary bit

Note The Status Byte Register is Not cleared by the *STB? query.

REMOTE OPERATION

Status byte when read by serial poll

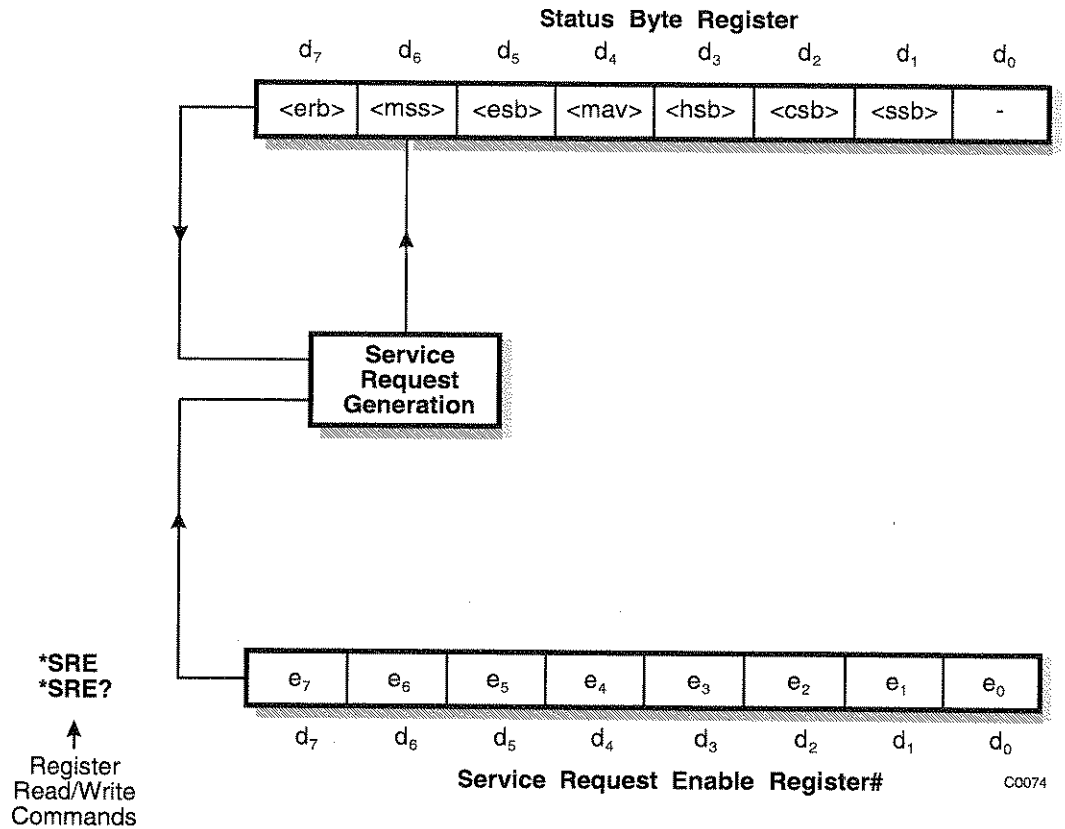

Bit 6 in this register ignores data sent by *SRE and always returns 0 in response to *SRE?

- $\langle erb \rangle$ is a device defined queue summary bit indicating that the error queue is non-empty.
- $\langle rqs \rangle$ is set by a request for service and is cleared by the poll.
- $\langle esb \rangle$ is the standard event register summary bit.
- $\langle mav \rangle$ is 'message available' indicating that the output queue is non-empty.
- $\langle hsb \rangle$ is 'hardware status' summary bit
- $\langle csb \rangle$ is 'coupling status' summary bit
- $\langle ssb \rangle$ is 'instrument status' summary bit

$\langle rqs \rangle$, $\langle esb \rangle$ and $\langle mav \rangle$ are defined in IEEE 488.2

$\langle rqs \rangle$ (request for service) will produce an SRQ at the controller. It is set by a change to either the Status Byte or the Service Enable Register that results in a New Reason for Service. It is cleared when $\langle mss \rangle$ goes FALSE (i.e. no reason for service) or by Serial Poll.

Chapter 6

BRIEF TECHNICAL DESCRIPTION

Contents

Introduction.....	6-1
Modulation.....	6-1
Frequency generation.....	6-1
Display.....	6-1
Control.....	6-1

List of figures

Fig. 6-1 Block schematic diagram.....	6-2
---------------------------------------	-----

Introduction

The 2023 and 2024 Signal Generators cover the wide range of frequencies from 10 kHz to 1.2 GHz (2023) and to 2.4 GHz (2024). Output levels range from -137 dBm to +13 dBm (+25 dBm (2023) or +19 dBm (2024) with option 3 fitted). A block schematic for the instrument is shown in Fig. 6-1.

Modulation

The carrier frequency can be frequency, phase or amplitude modulated from internal or external sources. The internal source can be the sum of two signals and used in combination with an external source connected to the front panel EXT MOD INPUT connector.

Frequency generation

A voltage controlled oscillator (VCO) covering the frequency range 400 to 533 MHz is phase locked to a 10 MHz temperature compensated crystal oscillator using a fractional-N synthesizer system. Additional frequency coverage is achieved by means of frequency division or multiplication. Low frequencies are generated by a beat frequency oscillator (BFO) system.

Display

The display is a high definition dot matrix liquid crystal panel with backlighting to cater for variations in ambient light conditions. The display contrast can be adjusted.

Control

The instrument uses function keys for setting the main parameters of a generated signal in conjunction with an extensive set of utility menus. Internal control of the instrument is achieved by a microprocessor which receives data from the various controls and sends instructions via an internal 8-bit data bus to the signal processing circuits.

The instruments can also be controlled by the built-in General Purpose Interface Bus (GPIB) or the RS-232 interface. The interfaces enable the instrument to be used both as a manually operated bench mounted instrument and as part of a fully automated test system.

TECHNICAL
DESCRIPTION

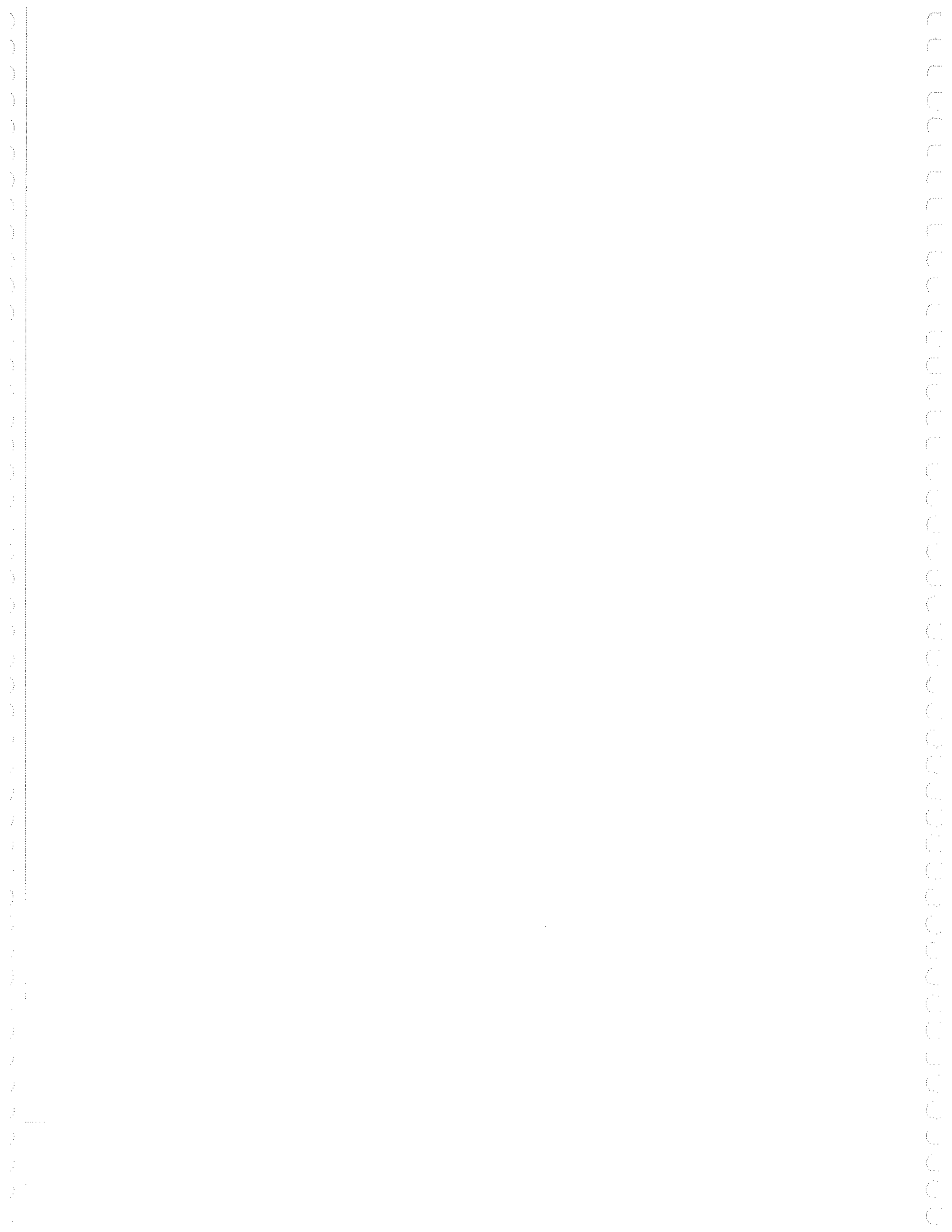

Chapter 7

ACCEPTANCE TESTING

Contents

Introduction	7-4
Test precautions	7-4
Recommended test equipment	7-5
TEST PROCEDURES	7-6
RF output.....	7-6
RF level frequency response	7-7
ALC linearity	7-7
Attenuator accuracy	7-8
Carrier frequency accuracy	7-9
Spectral purity	7-10
Harmonics	7-11
Non-harmonics	7-12
Residual FM	7-12
SSB phase noise.....	7-13
RF leakage.....	7-14
Internal FM	7-15
FM deviation and distortion	7-15
FM scale shape	7-16
Carrier error	7-16
External FM frequency response (ALC off, DC coupled).....	7-17
External FM frequency response (ALC on)	7-18
Phase modulation.....	7-19
Phase modulation.....	7-19
Phase modulation flatness	7-19
Amplitude modulation	7-20
AM depth and distortion	7-21
AM scale shape.....	7-21
External AM frequency response (ALC off, DC coupled)	7-22
Pulse modulation	7-24
Pulse modulation RF level frequency response	7-24
Pulse modulation on/off ratio	7-25
Pulse modulation rise and fall time	7-25
Modulation oscillator.....	7-26
Modulation oscillator frequencies.....	7-27
Modulation oscillator distortion and LF output flatness	7-27
External frequency standard input.....	7-28
TEST PROCEDURES FOR INSTRUMENTS FITTED WITH OPTION 3	7-29
RF output.....	7-29
RF level frequency response	7-29
ALC linearity.....	7-30
Attenuator accuracy	7-30
Carrier harmonics.....	7-31
ACCEPTANCE TEST RESULTS TABLES OPTION 3.....	7-58

List of tables

Table 7-1	RF output at 0 dBm (not option 3).....	7-32
Table 7-2	RF output at +7 dBm (not option 3)	7-33
Table 7-3	RF output at +13 dBm (not option 3)	7-34
Table 7-4	ALC linearity at 2.5 MHz (not option 3)	7-35
Table 7-5	ALC linearity at 500 MHz (not option 3)	7-36
Table 7-6	ALC linearity at 2400 MHz (not option 3)	7-37
Table 7-7	Attenuator test at 2.6 MHz (not option 3).....	7-38
Table 7-8	Attenuator test at 540 MHz (not option 3).....	7-38
Table 7-9	Attenuator test at 1140 MHz (not option 3).....	7-39
Table 7-10	Attenuator test at 1740 MHz (2024 only, not option 3).....	7-39
Table 7-11	Attenuator test at 2400 MHz (2024 only, not option 3).....	7-40
Table 7-12	Alternative attenuator functional test at 10 MHz	7-40
Table 7-13	Carrier frequency tests	7-41
Table 7-14	Carrier harmonic tests at -4 dBm (not option 3)	7-42
Table 7-15	Carrier harmonic tests at 0 dBm (not option 3)	7-43
Table 7-16	Carrier harmonic tests at +7 dBm (not option 3)	7-44
Table 7-17	Carrier non-harmonic tests	7-45
Table 7-18	Residual FM test.....	7-45
Table 7-19	SSB phase noise test	7-45
Table 7-20	RF leakage test.....	7-46
Table 7-21	Internal FM deviation and distortion tests at 100 kHz deviation	7-46
Table 7-22	FM scale shape tests at 15 MHz carrier.....	7-47
Table 7-23	Carrier error test at 1.2 GHz, FM deviation 100 kHz.....	7-47
Table 7-24	External FM frequency response (ALC off, DC coupled), 50 kHz deviation	7-47
Table 7-25	External FM frequency response (ALC on), 10 kHz deviation, 0.75 V input	7-48
Table 7-26	External FM frequency response (ALC on), 10 kHz deviation, 1.25 V input	7-48
Table 7-27	Internal Φ M and distortion test at 10.5 MHz carrier, 10 rad deviation	7-48
Table 7-28	Internal Φ M flatness test	7-49
Table 7-29	Internal AM depth and distortion tests at -4 dBm.....	7-49
Table 7-30	Internal AM depth and distortion tests at 0 dBm.....	7-50
Table 7-31	Internal AM depth and distortion tests at +7 dBm.....	7-51
Table 7-32	AM scale shape test	7-52
Table 7-33	External AM frequency response (ALC off, DC coupled), RF level -4 dBm.....	7-53
Table 7-34	External AM frequency response (ALC off, DC coupled), RF level +7 dBm.....	7-53
Table 7-35	Pulse modulation RF output at -7 dBm.....	7-54
Table 7-36	Pulse modulation RF output at +4 dBm.....	7-55
Table 7-37	Pulse modulation on/off ratio test.....	7-56
Table 7-38	Pulse modulation rise and fall time test.....	7-56
Table 7-39	Modulation oscillator frequency tests	7-56
Table 7-40	Modulation oscillator distortion and LF output tests.....	7-57
Table 7-41	External frequency standard tests.....	7-57
Table 7-42	RF output at 0 dBm.....	7-58
Table 7-43	RF output at +7 dBm	7-59
Table 7-44	RF output at +13 dBm.....	7-60
Table 7-45	RF output at +25 dBm.....	7-61
Table 7-46	ALC linearity at 2.5 MHz	7-62
Table 7-47	ALC linearity at 500 MHz	7-63
Table 7-48	ALC linearity at 2400 MHz	7-64
Table 7-49	Attenuator test at 2.6 MHz.....	7-65
Table 7-50	Attenuator test at 540 MHz.....	7-65
Table 7-51	Attenuator test at 1140 MHz	7-66
Table 7-52	Attenuator test at 1740 MHz (2024 Only)	7-66
Table 7-53	Attenuator test at 2400 MHz (2024 only)	7-67
Table 7-54	Carrier harmonic tests at +19 dBm	7-68

List of figures

Fig. 7-1	RF output test set-up	7-7
Fig. 7-2	RF output test set-up	7-8
Fig. 7-3	Carrier frequency accuracy test set-up.....	7-10
Fig. 7-4	Carrier harmonics and non-harmonics test set-up	7-11
Fig. 7-5	Residual FM test set-up.....	7-12
Fig. 7-6	SSB phase noise test set-up	7-13
Fig. 7-7	RF leakage test set-up	7-14
Fig. 7-8	Internal modulation and modulation distortion test set-up.....	7-15
Fig. 7-9	External modulation and modulation distortion test set-up.....	7-17
Fig. 7-10	0 Hz external AM and distortion test set-up	7-23
Fig. 7-11	Pulse modulation rise and fall time test set-up.....	7-25
Fig. 7-12	Modulation oscillator frequency test set-up	7-27
Fig. 7-13	Modulation oscillator distortion test set-up.....	7-27
Fig. 7-14	External standard test set-up.....	7-28
Fig. 7-15	RF output test set-up	7-29
Fig. 7-16	Carrier harmonics test set-up	7-31

Introduction

The test procedures in this chapter enable you to verify that the electrical performance of the signal generator complies with the Performance Data given in Chapter 1. For convenience, the test equipment and specification for each test are summarised before the test procedure.

Apart from the UUT, (Unit Under Test), no specific set-up procedures will be included for the test equipment unless the measurement is dependant on specific instrument settings or special measurement techniques.

Test precautions

To ensure minimum errors and uncertainties when making measurements, it is important to observe the following precautions:-

- (1) Always use recently calibrated test equipment, with any correction figures taken into account, so as to establish a known traceable limit of performance uncertainty. This uncertainty must be allowed for in determining the accuracy of measurements.
- (2) A common external frequency standard, with an accuracy of ± 1 part in 10^9 should be used for any frequency controlled test equipment.
- (3) Use the shortest possible connecting leads.
- (4) Some areas of the specification which are labelled *typical* rather than having clearly defined limits are *not* tested.

Recommended test equipment

The test equipment recommended for acceptance testing is shown below. Alternative equipment may be used provided it complies with the stated minimum specification.

Recommended test equipment

Description	Minimum specification	Example
Power meter	± 0.1 dB from 10 kHz to 2.4 GHz	Marconi 6960B with 6912 and 6932 sensors #
Measuring receiver	0 dBm to -127 dBm; 2.5 MHz to 2.4 GHz. Capable of measuring residual FM <2 Hz and SSB phase noise <-124 dBc/Hz at 20 kHz offset from a 1 GHz carrier	HP 8902A with option 037 * and 11722A sensor and 11793A down converter ##
Signal generator	+8 dBm from 32.5 MHz to 2.43 GHz	Marconi 2041
Frequency counter	10 Hz to 2.4 GHz	Marconi 2440
Audio analyser	Capable of measuring THD of 0.01% from 100 Hz to 20 kHz	Rhode & Schwarz UPA3
Spectrum analyser	DC to 7.2 GHz, 3 Hz resolution bandwidth	Marconi 2386
Modulation meter	AM, FM and Φ M 50 kHz to 2.4 GHz, accuracy $\pm 1\%$ at 1 kHz modulation frequency.	Marconi 2305 plus distortion option **
Function generator	DC to 100 kHz sine, ± 0.6 dB flatness, 100 kHz square wave	HP 3325B
Digital voltmeter	DC voltage measurement	Solartron 7150+
50 Ω load (termination)	1 W, 50 Ω nominal impedance, DC to 2.4 GHz	Lucas Weinschel M1404N
2 turn loop	25 mm diameter	
Oscilloscope	100 MHz bandwidth	Tektronix TAS 465

The 6932 sensor is only required when testing instruments fitted with option 3 (high power).

* Option 037 is necessary to measure SSB phase noise.

If the receiver and down converter are not available, an alternative procedure to ensure attenuator pad accuracy using a power meter is given.

** The distortion option of the 2305 modulation meter allows modulation distortion tests to be carried out with greater ease. If a 2305 with the distortion option is not available, the audio analyzer may be connected to the modulation meter LF output and set to measure distortion.

TEST PROCEDURES

Each test procedure relies on the UUT being set to its power-up conditions. To avoid switching the instrument off and back on, reset the UUT by selecting:

[RCL] 999 [ENTER]

At the end of this chapter are a set of results Table 7-s which give all the test points for each of the tests. These Table 7-s should be photocopied and used to record the results of all the measurements taken.

Tests for the options, where necessary, are included with the tests for the standard instrument, with the exception of Option 3 (high power option) which has a dedicated chapter at the end of the procedures for RF level accuracy and carrier harmonics.

RF output

Specification

Level range:	-137 dBm to +13 dBm
Accuracy:	For output levels above -127 dBm and over a temperature range of 17°C to 27°C: <ul style="list-style-type: none"> ±0.8 dBm to 1.2 GHz ±1.6 dBm to 2.4 GHz (2024) Temperature coefficient <±0.02 dB/°C to 1.2 GHz , <±0.04 dB/°C to 2.4 GHz
Output impedance:	50 ohms <ul style="list-style-type: none"> VSWR <1.3:1 to 1.2 GHz <1.5:1 to 2.4 GHz (2024)

Test equipment

Description	Minimum specification	Example
Power meter	±0.1 dB from 10 kHz to 2.4 GHz	Marconi 6960B and 6912
Measuring receiver	0 dBm to -127 dBm; 2.5 MHz to 2.4 GHz	HP 8902A with 11722A sensor and 11793A down converter
Signal generator	+8 dBm from 32.5 MHz to 2.43 GHz	Marconi 2041

RF level frequency response (not option 3, refer to 'Test procedure for instruments fitted with option 3')

Test procedure

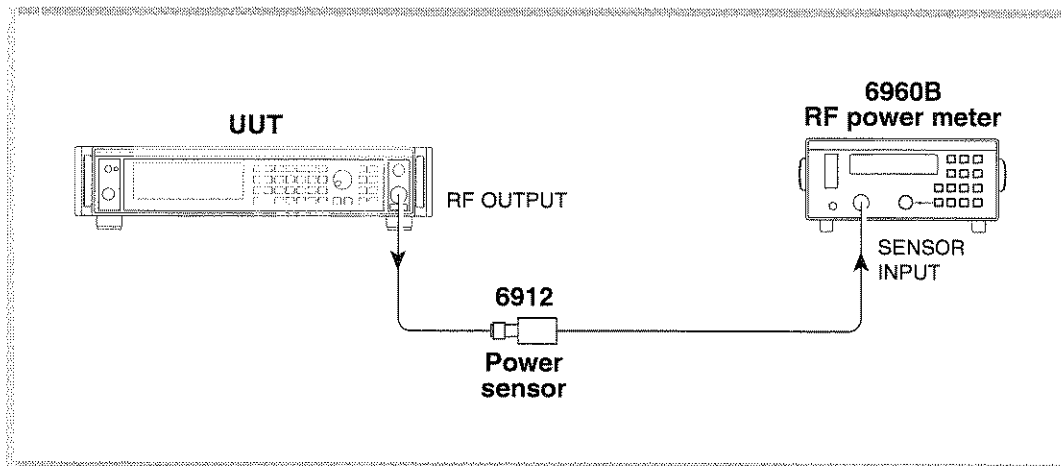

C2360

Fig. 7-1 RF output test set-up

- (1) Perform AUTO ZERO and AUTO CAL on the power meter.
- (2) Connect the test equipment as shown in Fig. 7-1.
- (3) On the UUT set:

[CARR FREQ]	30 [kHz]
[RF LEVEL]	0 [dB]
- (4) Record the output level measured by the power meter against each of the carrier frequencies shown in Table 7-1, checking that the results are within specification.
- (5) Set the UUT RF level to +7 dBm and repeat (4) using Table 7-2.
- (6) Set the UUT RF level to +13 dBm and repeat (4) using Table 7-3.

ALC linearity (not option 3, refer to 'Test procedure for instruments fitted with option 3')

Test procedure

- (1) Perform AUTO ZERO and AUTO CAL on the power meter.
- (2) Connect the test equipment as shown in Fig. 7-1.
- (3) On the UUT set:

[CARR FREQ]	2.5 [MHz]
[RF LEVEL]	-4 [dB]
- (4) Record the output level measured by the power meter against each of the steps shown in Table 7-1, checking that the results are within specification.
- (5) Set the UUT carrier frequency to 500 MHz and repeat (4) using Table 7-5.
- (6) Set the UUT carrier frequency to 2400 MHz and repeat (4) using Table 7-6.

**Attenuator accuracy (not option 3, refer to 'Test procedure for instruments fitted with option 3')
(not required for instruments with option 1)**

The following test will confirm that the attenuator performs to the published performance specification. In the event of the receiver/down-converter not being available, an alternative method to functionally test the individual pads is also suggested (see 'Alternative attenuator functional test' below).

Test procedure

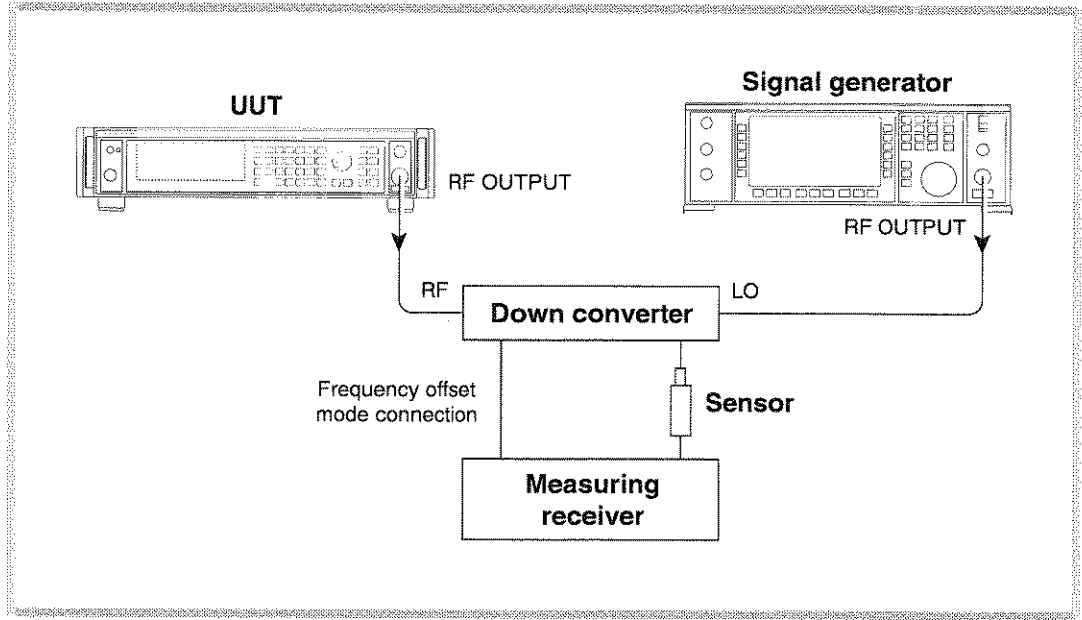

C2361

Fig. 7-2 RF output test set-up

- (1) Connect the test equipment as shown in Fig. 7-2.
- (2) On the UUT set:

[CARR FREQ]	2.6 [MHz]
[RF LEVEL]	0 [dB]
[SET Δ]	
[RF LEVEL] (to select [Levl Step])	11 [dB]
[RF LEVEL]	
- (3) Tune the receiver to 2.6 MHz and record the output level measured in Table 7-7, checking that the result is within specification.
- (4) Set the UUT RF level to -4.1 dBm. Measure the received level and record the result in Table 7-7, checking that the result is within specification.
- (5) Decrement the UUT, using the [×10 ↓] key, in 11 dB steps down to an RF level of -103.1 dBm measuring the received level at each step shown in Table 7-7, checking that the results are within specification.
- (6) Set the UUT to carrier frequency 540 MHz and repeat (2) to (5) using Table 7-8.
- (7) Set the UUT to carrier frequency 1140 MHz and repeat (2) to (5) using Table 7-9.
 Note that the following test frequencies are for 2024 only. The down converter will automatically be enabled when testing frequencies above 1300 MHz.
- (8) Set the local oscillator to +8 dBm at a carrier frequency of 62 MHz less than the test frequency (i.e. 1678 MHz).

- (9) On the receiver, enter the local oscillator frequency followed by the test frequency.
- (10) Set the UUT to carrier frequency 1740 MHz and repeat (2) to (5) using Table 7-10.
- (11) Set the UUT to carrier frequency 2400 MHz and repeat (2) to (5) using Table 7-11.

Alternative attenuator functional test (not required for instruments with option 1)

- (1) Connect the test equipment as shown in Fig. 7-1.
- (2) Perform AUTO ZERO and AUTO CAL on the power meter.
- (3) On the UUT set:

[CARR FREQ]	10 [MHz]
[RF LEVEL]	13 [dB]
[MENU]	70 [ENTER]

The UUT will enter the *Latch Access* diagnostic menu.

- (4) Use the [+10 ↑] and [×10 ↓] keys to select *RF Board Shift-Reg 1*.
- (5) Press [NEXT] and [NEXT] again to select *Data (bin)* :
- (6) Use the [+10 ↑] and [×10 ↓] to move the cursor left and right.
- (7) Set a reference on the power meter such that 0 dB is indicated.
- (8) On the UUT, move the cursor to the MSB and press 0 (01111111)
This will enable the first 33 dB pad.
- (9) Record the relative level measured on the power meter in Table 7-12.

Note that this is a nominal value as no software correction figures are applied to the attenuator when performing this test.

- (10) On the UUT, press 1 to disable the first 33 dB pad.
- (11) Repeat (6) to (10) for the next four MSBs; the 22 dB, 33 dB, 11 dB and 33 dB pads respectively.

Carrier frequency accuracy

This check provides a conventional method of checking the signal generator frequency locking circuitry. It will confirm correct operation of phase locked loops and dividers. Overall accuracy is determined by the instrument's internal reference standard.

Specification

Frequency range:	10 kHz to 1.2 GHz (2023) 10 kHz to 2.4 GHz (2024)
Accuracy:	Determined by the frequency standard accuracy
Resolution:	1 Hz

Test equipment

Description	Minimum specification	Example
Frequency counter	10 kHz to 2.4 GHz	Marconi 2440
50 Ω load (termination)	1 W, 50 Ω nominal impedance, DC to 2.4 GHz	Lucas Weinschel M1404N

Test procedure

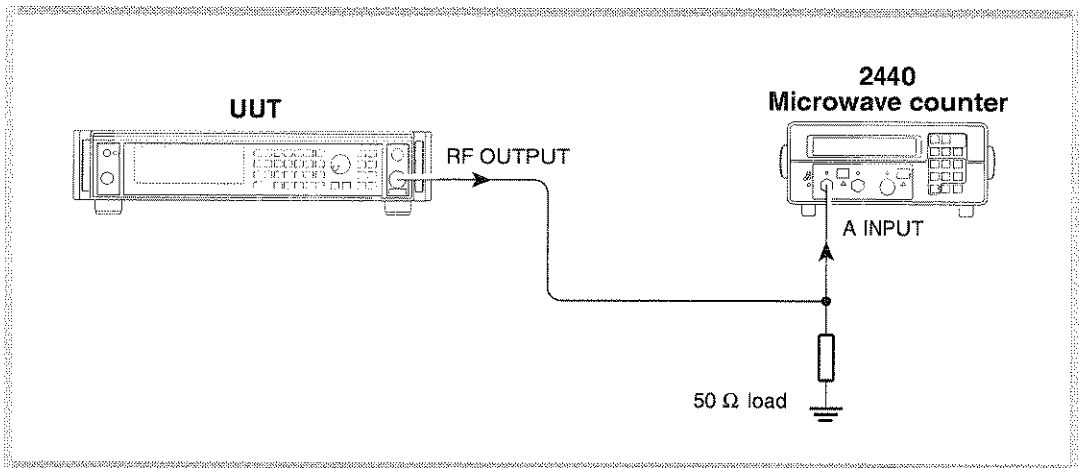

C2374

Fig. 7-3 Carrier frequency accuracy test set-up

- (1) Connect the test equipment as shown in Fig. 7-3.
- (2) Connect the internal frequency standard from the UUT to the external standard input on the counter.
- (3) On the UUT set:

[CARR FREQ]	10 [kHz]
[RF LEVEL]	0 [dB]
- (4) Record the frequency measured by the counter meter against each of the carrier frequencies shown in Table 7-13. (As the two instruments' frequencies are locked together, the limit is ± 1 digit on the counter display.)
- (5) At 1200 MHz disconnect the UUT internal frequency standard from the counter and instead apply the external reference. Check the result against the limits.

Notes

If the instrument is fitted with Option 4, (high stability frequency standard), use the *second* 1200 MHz test limits.

The test limits quoted are for guidance and assume that the internal frequency standard has recently been adjusted. Ageing and stability have to be considered when establishing the real test limits (see Performance data' in Chapter 1).

It will be necessary to disconnect the 50 Ω load and reconnect the UUT RF OUTPUT to the B input and C input where necessary.

Spectral purity

Specification

Harmonics:	Typically better than -30 dBc for RF levels up to +7 dBm Typically better than -25 dBc for RF levels up to +13 dBm
Non-harmonics:	Better than -70 dBc for carrier frequencies up to 1 GHz Better than -64 dBc for carrier frequencies above 1 GHz Better than -60 dBc for carrier frequencies above 2 GHz
Residual FM:	Less than 4.5 Hz RMS in a 300 Hz to 3.4 kHz bandwidth at a carrier frequency of 1 GHz
SSB phase noise:	Better than -121 dBc/Hz at 20 kHz offset from a 470 MHz carrier, Typically -121 dBc/Hz at 20 kHz offset from a 1 GHz carrier
RF leakage:	Less than 0.5 μ V at the carrier frequency into a two turn 25 mm loop 25 mm away from the surface of the signal generator

Test equipment

Description	Minimum specification	Example
Spectrum analyzer	DC to 7.2 GHz frequency coverage	Marconi 2386
Measuring receiver	0 dBm to -127 dBm; 2.5 MHz to 2.4 GHz. Capable of measuring residual FM <2 Hz and SSB phase noise <-124 dBc/Hz at 20 kHz offset from a 1 GHz carrier	HP 8902A with option 037
Signal generator	+8 dBm from 32.5 MHz to 2.43 GHz	Marconi 2041
50 Ω load	1 W, 50 Ω nominal impedance, DC to 2.4 GHz	Lucas Weinschel M1404N
2 turn loop	25 mm diameter	

Harmonics

Test procedure

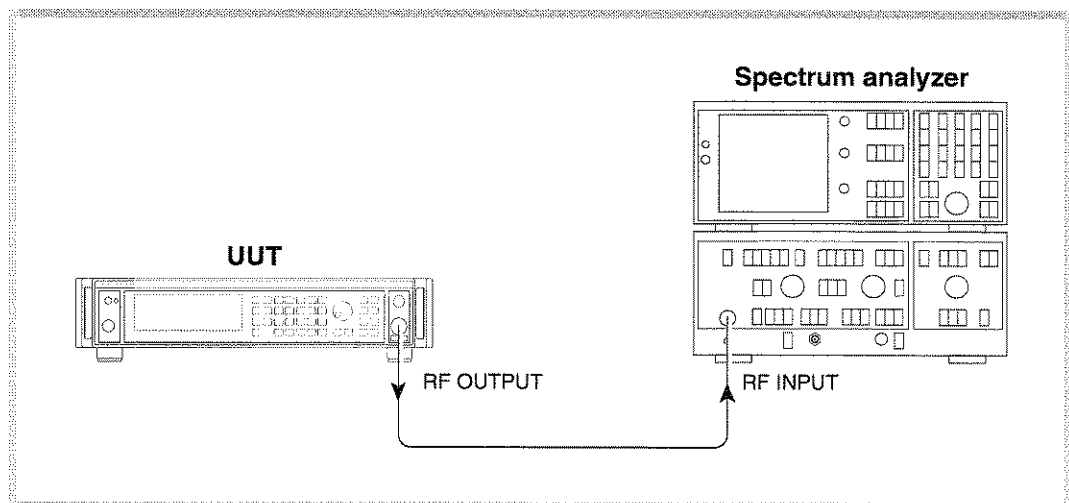

C2363

Fig. 7-4 Carrier harmonics and non-harmonics test set-up

- (1) Press CAL on the spectrum analyzer.
- (2) Connect the test equipment as shown in Fig. 7-4.
- (3) On the UUT set:

[CARR FREQ]	10 [kHz]
[RF LEVEL]	-4 [dB]
- (4) Measure the level of the second and third harmonics on the spectrum analyzer at each of the carrier frequencies shown in Table 7-14, checking that the results are within specification.
- (5) Set the UUT RF level to 0 dBm and repeat (4) using Table 7-15.
- (6) Set the UUT RF level to +7 dBm and repeat (4) using Table 7-16.

Non-harmonics

Test procedure

- (1) Press CAL on the spectrum analyzer.
- (2) Connect the test equipment as shown in Fig. 7-4.
- (3) On the UUT set:

[CARR FREQ]	1201 [MHz]
[RF LEVEL]	0 [dB]
- (4) Measure the level of the non-harmonics on the spectrum analyzer at each of the carrier frequencies shown in Table 7-17, checking that the results are within specification.

Residual FM

Test procedure

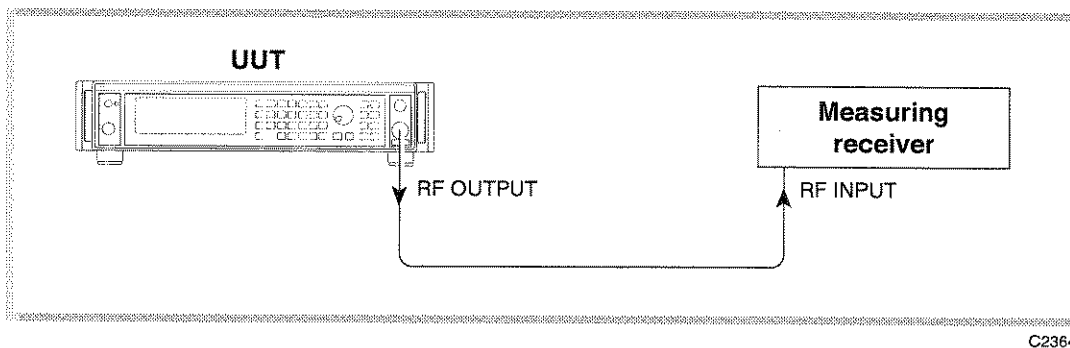

C2364

Fig. 7-5 Residual FM test set-up

- (1) Connect the test equipment as shown in Fig. 7-5.
- (2) On the UUT set:

[CARR FREQ]	1 [GHz]
[RF LEVEL]	0 [dB]
- (3) On the measuring receiver, select FM, 300 Hz high-pass filter, 3.4 kHz low-pass filter and enable averaging.
- (4) Measure the residual FM, checking that the result is within the specification shown in Table 7-18.

SSB phase noise

Test procedure

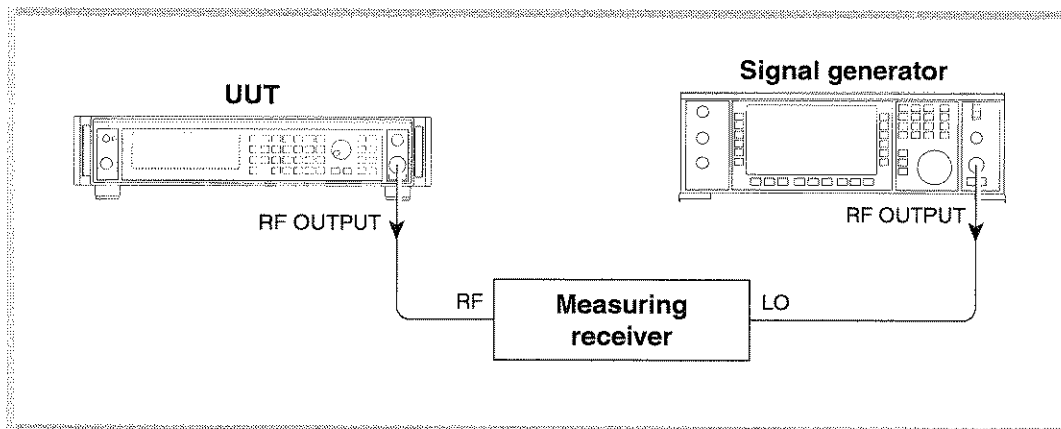

C2365

Fig. 7-6 SSB phase noise test set-up

- (1) Connect the test equipment as shown in Fig. 7-6.
- (2) On the UUT set:

[CARR FREQ]	470 [MHz]
[RF LEVEL]	0 [dB]
- (3) On the measuring receiver:
 - Tune the receiver to 470 MHz.
 - Select 24.0 SPCL to enter selective power measurement mode.
 - Select 23.1 SPCL to set the LO to external.
- (4) Set the signal generator to a carrier frequency of 470.455 MHz, RF level 0 dBm.
- (5) On the measuring receiver:
 - Select 24.5 SPCL to establish the IF reference value (in volts).
 - Select 24.6 SPCL to set the reference to 0 dBm.
- (6) Fine tune the signal generator frequency until a maximum value is displayed on the measuring receiver.
- (7) On the measuring receiver:
 - Reselect 24.5 SPCL to establish the IF reference value (in volts).
 - Reselect 24.6 SPCL to set the reference to 0 dBm.
 - Select 24.7 SPCL to normalize the measurement for a 1 Hz bandwidth.
- (8) Offset the signal generator by 20 kHz.
- (9) Measure the level on the receiver (the SSB phase noise in a 1 Hz bandwidth), checking that the result is within the specification shown in Table 7-19.

RF leakage

Test procedure

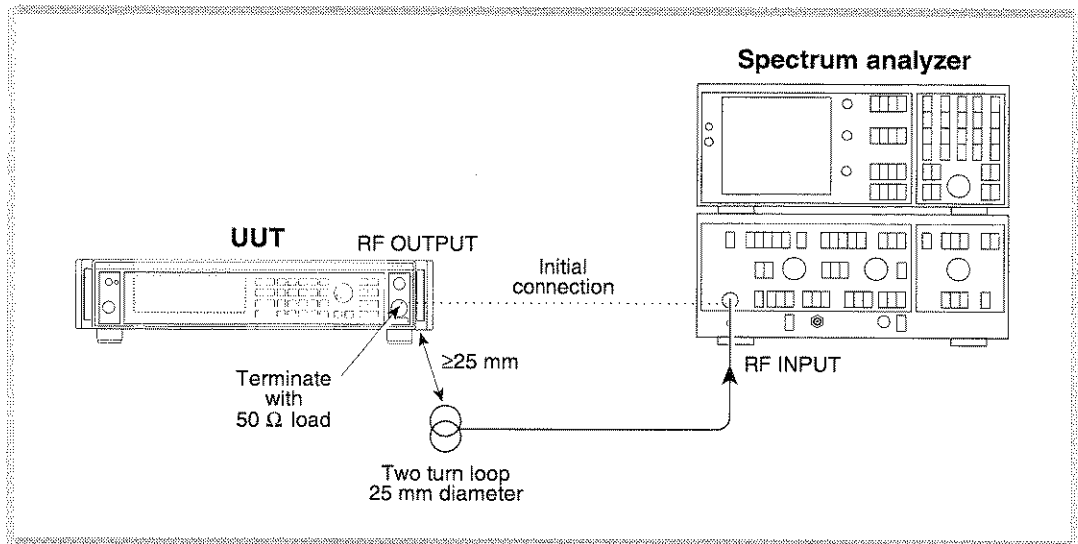

C2366

Fig. 7-7 RF leakage test set-up

- (1) Press PRESET then CAL on the spectrum analyzer.
- (2) Connect the test equipment as shown in Fig. 7-7.
- (3) On the UUT set:

[CARR FREQ]	469.03 [MHz]
[RF LEVEL]	-30 [dB]
- (4) On the spectrum analyzer select

REF FREQ	469.03 MHz
SPAN/DIV	10 Hz
PEAK FIND	
MKR 1 SETS REF FREQ	
- (5) Disconnect the cable from the UUT RF output socket and place a 25 mm 2 turn loop on the end of the cable.
- (6) Connect a 50 Ω sealed load to the UUT RF OUTPUT.
- (7) On the spectrum analyzer select:

VOLTS/DIV	
REF LEVEL	0.1 μ V
2nd FUNCT RF ATTEN \Downarrow	(to set 0 dB input attenuation)
- (8) Hold the 2 turn loop not less than 25 mm from the UUT at various points around its case ensuring that the worst case leakage indicated on the spectrum analyzer does not exceed that shown in Table 7-20.
- (9) Repeat (1) to (8) for each of the carrier frequencies shown in Table 7-20.

Internal FM

Specification

Deviation range:	0 to 100 kHz
Resolution:	3 digits or 1 Hz
Bandwidth (1 dB):	DC to 100 kHz (DC coupled) 10 Hz to 100 kHz (AC coupled) 20 Hz to 100 kHz (AC coupled with ALC)
Accuracy:	±5% at 1 kHz modulation rate
Carrier error:	Less than 1% of the set frequency deviation when DC coupled
Distortion:	Less than 3% at 1 kHz rate for deviations up to 100 kHz. Typically 0.5% at 1 kHz rate for deviations up to 10 kHz
External modulation input:	1 V RMS for set deviation
Modulation ALC:	Levels the applied external modulation over the range 0.75 to 1.25 V RMS.
FSK:	Accepts logic level inputs (1 or 2) to produce an unfiltered FSK modulated output

Test equipment

Description	Minimum specification	Example
Modulation meter	FM accuracy ±1% at 1 kHz modulation frequency	Marconi 2305 with distortion option
DVM	DC voltage measurement	Solartron 7150+
50 Ω load (termination)	1 W, 50 Ω nominal impedance, DC to 2.4 GHz	Lucas Weinschel M1404N
Audio analyser	Capable of measuring THD of 0.01% from 100 Hz to 20 kHz	Rhode & Schwarz UPA3
Function generator	DC to 100 kHz sine, ±0.6 dB flatness	HP 3325B

FM deviation and distortion

Test procedure

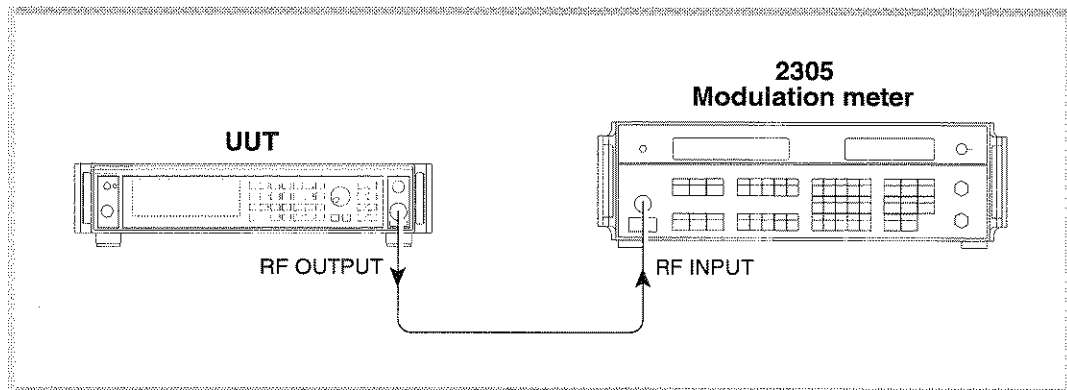

C2367

Fig. 7-8 Internal modulation and modulation distortion test set-up

- (1) Connect the test equipment as shown in Fig. 7-8.
- (2) On the UUT set:

[CARR FREQ]	10 [MHz]
[RF LEVEL]	0 [dB]
[MOD]	100 [kHz]
[SOURCE ON/OFF]	(to enable modulation source)
[MOD ON/OFF]	(to enable modulation)
- (3) On the modulation meter, select CAL, FM, 300 Hz \Rightarrow 3.4 kHz filter.
- (4) Measure the FM accuracy and distortion at the carrier frequencies shown in Table 7-21, checking that the results are within specification.

FM scale shape Test procedure

- (1) Connect the test equipment as shown in Fig. 7-8.
- (2) On the UUT set:

[CARR FREQ]	15 [MHz]
[RF LEVEL]	0 [dB]
[MOD]	100 [kHz]
[SOURCE ON/OFF]	(to enable modulation source)
[MOD ON/OFF]	(to enable modulation)
- (3) On the modulation meter, select CAL, FM, 300 Hz \Rightarrow 3.4 kHz filter.
- (4) Measure the FM accuracy at the deviations shown in Table 7-22, checking that the results are within specification.

Carrier error Test procedure

- (1) Connect the test equipment as shown in Fig. 7-8.
- (2) On the UUT set:

[CARR FREQ]	1200 [MHz]
[RF LEVEL]	0 [dB]
- (3) On the modulation meter select CARRIER ERROR. The FREQUENCY display will read 0.00 kHz.
- (4) On the UUT set:

[MOD]	100 [kHz]
[SOURCE ON/OFF]	(to enable modulation source)
[MOD ON/OFF]	(to enable modulation)
[MENU]	20 [ENTER]

The UUT will enter the *Modulation Mode* menu

Select *FM ext* using [NEXT]

[MENU] 30 [ENTER]

The UUT will enter the *Modulation Source* menu

Select *Ext* using [NEXT]

Select 2 to select DC coupling

[MENU] 23 [ENTER]

The UUT will select the *DC FM Nulling* control.

On the modulation meter, measure the carrier frequency error displayed in the FREQUENCY window, checking that the result is within the specification shown in Table 7-23.

External FM frequency response (ALC off, DC coupled)

Test procedure

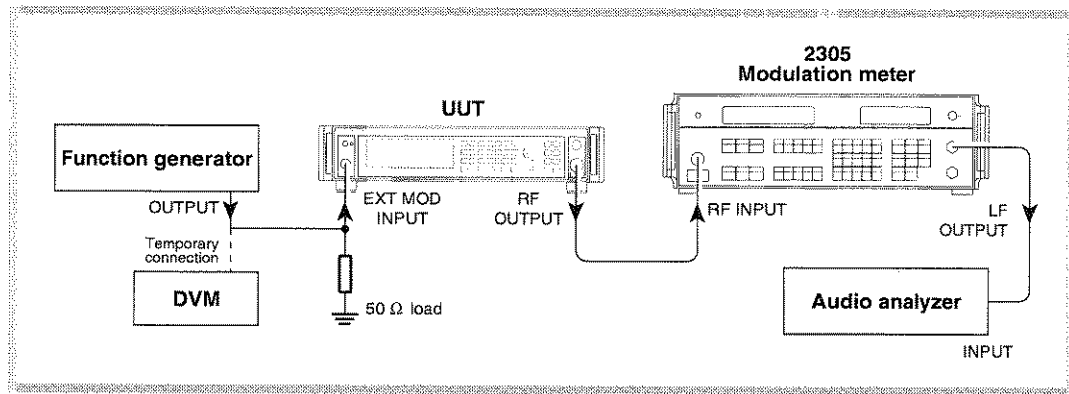

Fig. 7-9 External modulation and modulation distortion test set-up

30 Hz to 100 kHz

- (1) Connect the test equipment as shown in Fig. 7-9.
- (2) On the UUT set:

[CARR FREQ]	15 [MHz]
[RF LEVEL]	0 [dB]
[MOD]	50 [kHz]
[SOURCE ON/OFF]	(to enable modulation source)
[MOD ON/OFF]	(to enable modulation)
[MENU]	20 [ENTER]

The UUT will enter the *Modulation Mode* menu

Select *FM ext* using [NEXT]
[MENU] 30 [ENTER]

The UUT will enter the *Modulation Source* menu.

Select *Ext* using [NEXT]
Select 2 to select DC coupling

- (3) Set the function generator to give 1V RMS, 1 kHz sine wave.
- (4) On the modulation meter, select CAL, FM, 10 Hz ⇒ 300 kHz filter.
- (5) On the modulation meter, check that the FM reading is between 47.5 kHz and 52.5 kHz, then set a reference using the relative function.
- (6) Set the function generator to each of the frequencies shown in Table 7-24, checking that the relative readings on the modulation meter are within specification.
- (7) At those frequencies indicated in Table 7-24, set the modulation meter LF output control to mid position and measure the AF distortion on the audio analyzer, checking that the results are within specification.

0 Hz (DC)

Note

To measure the FM deviation at DC, it will be necessary to use the DC offset facility on the function generator proceeding as follows:

- (8) Set the function generator to +1.4142 V DC (temporarily connect the function generator output to the DVM and set this voltage as close as possible to +1.4142 V).
- (9) Press CARRIER ERROR on the modulation meter.
- (10) Set the function generator to -1.4142 V DC (temporarily connect the function generator output to the DVM and set this voltage as close as possible to -1.4142 V).
- (11) Measure the frequency indicated on the modulation meter carrier frequency window.
FM 1= _____
- (12) Reset the function generator to 1V RMS, 1 kHz sine wave and measure the FM deviation.
FM2 = _____
- (13) Using the following formula, calculate the change in response, checking that the result is within the specification shown against 0 Hz in Table 7-24.

$$20 \log_{10} \left\{ \frac{FM2}{FM1} \right\}$$

External FM frequency response (ALC on)

Test procedure

- (1) Connect the test equipment as shown in Fig. 7-9.
- (2) On the UUT set:

[CARR FREQ]	15 [MHz]
[RF LEVEL]	0 [dB]
[MOD]	10 [kHz]
[SOURCE ON/OFF]	(to enable modulation source)
[MOD ON/OFF]	(to enable modulation)
[MENU]	20 [ENTER]

The UUT will enter the *Modulation Mode* menu.

Select <i>FM ext</i> using [NEXT]
[MENU] 30 [ENTER]

The UUT will enter the *Modulation Source* menu.

Select <i>Ext</i> using [NEXT]
Select <i>1</i> to select ALC

- (3) Set the function generator to give 0.75 V RMS, 1 kHz sine wave.
- (4) On the modulation meter, select CAL, FM, 10 Hz \Rightarrow 300 kHz filter.
- (5) On the modulation meter, check that the FM reading is between 9.5 kHz and 10.5 kHz, then set a reference using the relative function.
- (6) Set the function generator to each of the frequencies shown in Table 7-25, checking that the relative readings on the modulation meter are within specification.
- (7) Set the function generator to 1.25 V RMS and repeat (4) to (6) using Table 7-26, also measuring the AF distortion on the audio analyzer at those frequencies indicated.

Phase modulation Specification

Range:	0 to 10 radians
Resolution:	3 digits or 0.01 radians
Bandwidth (3 dB):	10 Hz to 10 kHz
Accuracy:	±5% at 1 kHz modulation rate
Distortion:	Less than 3% at 10 radians at 1 kHz modulation rate

Test equipment

Description	Minimum specification	Example
Modulation meter	ΦM and FM accuracy ±2% at 1 kHz modulation frequency	Marconi 2305 with distortion option

Phase modulation Test procedure

- (1) Connect the test equipment as shown in Fig. 7-8.
- (2) On the UUT set:

[CARR FREQ]	10.5 [MHz]
[RF LEVEL]	0 [dB]
[MENU]	20 [ENTER]

The UUT will enter the *Modulation Mode* menu.

Select *ΦM int* using [NEXT]
 [MOD] 10 [rad]
 [SOURCE ON/OFF] (to enable modulation source)
 [MOD ON/OFF] (to enable modulation)

- (3) On the modulation meter, select CAL, ΦM.
- (4) Measure the ΦM accuracy and distortion, checking that the results are within the specification shown in Table 7-27.

Phase modulation flatness Test procedure

Note

For this test, the phase modulation figures are calculated from readings taken with the modulation meter set to FM. No allowances need to be made for the modulation source frequency accuracy since it is derived from the reference oscillator in the UUT.

- (1) Connect the test equipment as shown in Fig. 7-8.

- (2) On the UUT set:
- | | |
|-------------|------------|
| [CARR FREQ] | 15 [MHz] |
| [RF LEVEL] | 0 [dB] |
| [MENU] | 20 [ENTER] |

The UUT will enter the *Modulation Mode* menu

Select ΦM *int* using [NEXT]
 [MOD] 10 [rad]
 [SOURCE ON/OFF] (to enable modulation source)
 [MOD ON/OFF] (to enable modulation)

- (3) On the modulation meter, select CAL, FM, 50 Hz \Rightarrow 15 kHz LF filter.
 (4) Measure the deviation on the modulation meter and calculate the phase modulation using the formula:

$$\Phi M = \left\{ \frac{\text{FM dev (Hz)}}{\text{mod freq (Hz)}} \right\}$$

- (5) On the UUT set [MOD SOURCE] to each of the frequencies shown in Table 7-28, measure the deviation on the modulation meter and calculate the phase modulation for each step using the formula in (4).
 (6) Using the figure recorded in (4) as a reference, calculate the change in response at each modulation frequency using the formula:

$$20 \log_{10} \left\{ \frac{\text{Figure recorded in (5)}}{\text{Figure recorded in (4)}} \right\}$$

Check that the results are within the specifications shown in Table 7-28.

Amplitude modulation Specification

Range:	0 to 99.9%
Resolution:	0.1%
Carrier frequency range:	<1 GHz usable to 2 GHz.
Bandwidth (1 dB):	DC to 30 kHz (DC coupled) 10 Hz to 30 kHz (AC coupled) 20 Hz to 30 kHz (AC coupled with ALC)
Accuracy:	$\pm 5\%$ of set depth at 1 kHz modulation rate
Distortion:	For modulation depths up to 80%: less than 3% at 1 kHz rate less than 5% at rates up to 30 kHz
ΦM on AM:	Typically 0.1 radians at 80% depth

Test equipment

Description	Minimum specification	Example
Modulation meter	AM accuracy $\pm 1\%$ at 1 kHz modulation frequency	Marconi 2305 with distortion option
DVM	DC voltage measurement	Solartron 7150+
50 Ω load (termination)	1 W, 50 Ω nominal impedance, DC to 2.4 GHz	Lucas Weinschel M1404N
Audio analyser	Capable of measuring THD of 0.01% from 100 Hz to 20 kHz	Rhode & Schwarz UPA3
Function generator	DC to 30 kHz sine, ± 0.6 dB flatness	HP 3325B

AM depth and distortion

Test procedure

- (1) Connect the test equipment as shown in Fig. 7-8.
- (2) On the UUT set:

[CARR FREQ]	1.5 [MHz]
[RF LEVEL]	-4 [dB]
[MENU]	20 [ENTER]

The UUT will enter the *Modulation Mode* menu

Select *AM int*

[MOD]	30 [%]
[SOURCE ON/OFF]	(to enable modulation source)
[MOD ON/OFF]	(to enable modulation)

- (3) On the modulation meter, select CAL, AM, 300 Hz \Rightarrow 3.4 kHz LF filter.
- (4) Measure the AM accuracy and distortion at the frequencies shown in Table 7-29, checking that the results are within specification
- (5) Set the UUT to [MOD] 80% and repeat (4).
- (6) Set the UUT to [RF LEVEL] 0 dBm and repeat (2) to (5) using Table 7-30.
- (7) Set the UUT to [RF LEVEL] +7 dBm and repeat (2) to (5) using Table 7-31.

AM scale shape

Test procedure

- (1) Connect the test equipment as shown in Fig. 7-8.

- (2) On the UUT set:
- | | |
|-------------|------------|
| [CARR FREQ] | 100 [MHz] |
| [RF LEVEL] | 0 [dB] |
| [MENU] | 20 [ENTER] |

The UUT will enter the *Modulation Mode* menu

Select *AM int*

- | | |
|-----------------|-------------------------------|
| [MOD] | 1 [%] |
| [SOURCE ON/OFF] | (to enable modulation source) |
| [MOD ON/OFF] | (to enable modulation) |

- (3) On the modulation meter, select CAL, AM, 300 Hz \Rightarrow 3.4 kHz LF filter.
- (4) Measure the AM accuracy at the depths shown in Table 7-7 checking that the results are within specification.

External AM frequency response (ALC off, DC coupled)

Test procedure

100 Hz to 30 kHz

- (1) Connect the test equipment as shown in Fig. 7-9.
- (2) On the UUT set:
- | | |
|-------------|------------|
| [CARR FREQ] | 400 [MHz] |
| [RF LEVEL] | -4 [dB] |
| [MENU] | 20 [ENTER] |

The UUT will enter the *Modulation Mode* menu

Select *AM ext* using [NEXT]

- | | |
|--------|------------|
| [MOD] | 80 [%] |
| [MENU] | 30 [ENTER] |

The UUT will enter the *Modulation Source* menu

Select *Ext* using [NEXT]

Select 2 to select DC coupling

- | | |
|-----------------|-------------------------------|
| [MOD] | |
| [SOURCE ON/OFF] | (to enable modulation source) |
| [MOD ON/OFF] | (to enable modulation) |

- (3) Set the function generator to give 1 V RMS, 1 kHz sine wave.
- (4) On the modulation meter, select CAL, AM, 10 Hz \Rightarrow 300 kHz filter.
- (5) On the modulation meter, check that the AM reading is between 76% and 84%, then set a reference using the relative function.
- (6) Record the absolute reading for use in the formula in (16).
- (7) Set the function generator to each of the frequencies shown in Table 7-33, checking that the relative readings on the modulation meter are within specification.
- (8) Set the UUT RF level to +7 dBm and repeat (3) to (7) using Table 7-34.

0 Hz (DC)

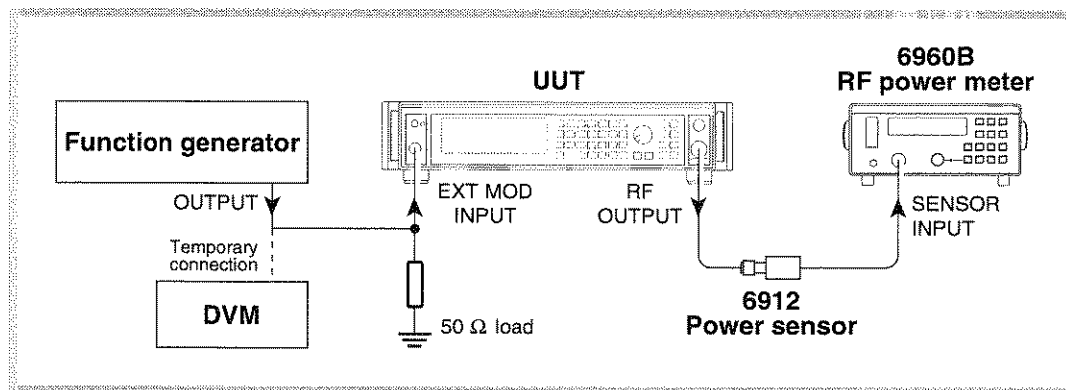

C2369

Fig. 7-10 0 Hz external AM and distortion test set-up

Note

To measure the AM depth at DC, it will be necessary to use the DC offset facility on the function generator proceeding as follows:

- (9) Connect the test equipment as shown in Fig. 7-10.
- (10) Set the function generator to +1.4142 V DC (temporarily connect the function generator output to the DVM and set this voltage as close as possible to +1.4142 V).
- (11) Measure the power on the power meter.

$$P1 = \underline{\hspace{2cm}}$$

- (12) Set the function generator to -1.4142 V DC (temporarily connect the function generator output to the DVM and set this voltage as close as possible to -1.4142 V).
- (13) Measure the power on the power meter.

$$P2 = \underline{\hspace{2cm}}$$

- (14) Subtract P2 from P1 (= x)
- (15) Calculate the modulation depth using the formula:

$$AM(\%) = \left\{ \frac{1 + 10^{(-x/20)}}{1 + 10^{(-x/20)}} \right\}$$

- (16) Calculate the 0 Hz response relative to 1 kHz using the following formula, recording the result in Table 7-33:

$$20 \log_{10} \left\{ \frac{\text{Figure recorded in (6)}}{\text{Figure recorded in (15)}} \right\}$$

- (17) Set the UUT RF level to +7 dBm and repeat (4) to (16) using Table 7-34.

Pulse modulation

Specification

Carrier frequency range:	32 MHz to 2.4 GHz, usable to 10 MHz
RF level range:	Maximum guaranteed output is reduced to +8 dBm when pulse modulation is selected
RF level accuracy:	Maximum additional uncertainty is ± 0.5 dB
On/off ratio:	Better than 40 dB Better than 45 dB below 1.2 GHz
Rise and fall time:	Less than 10 μ s

Test equipment

Description	Minimum specification	Example
Power meter	± 0.1 dB from 10 kHz to 2.4 GHz	Marconi 6960B and 6912
Spectrum analyser	Frequency coverage 32 MHz to 2.4 GHz	Marconi 2386 or 2383
50 Ω load (termination)	1 W, 50 Ω nominal impedance, DC to 2.4 GHz	Lucas Weinschel M1404N
Oscilloscope	100 MHz bandwidth	Tektronix TAS 465
Function generator	DC to 10 kHz square wave	HP 3325B

Pulse modulation RF level frequency response

Test procedure

- Perform AUTO ZERO and AUTO CAL on the power meter.
- Connect the test equipment as shown in Fig. 7-1.
- On the UUT set:

[CARR FREQ]	32 [MHz]
[RF LEVEL]	-7 [dB]
[MENU]	22 [ENTER]

The UUT will enter the *Pulse Modulation* menu.

Select *1* (to enable Pulse Mod.)
 [MOD] then [MOD] then [MOD] again (to select *Pulse Mod*)
 [SOURCE ON/OFF] (to enable modulation source)
 [MOD ON/OFF] (to enable modulation)

The RF output will now be enabled.

- Record the output level measured by the power meter against each of the carrier frequencies shown in Table 7-35, checking that the results are within specification.
- Set the UUT RF level to +4 dBm and repeat (4) using Table 7-36.

Pulse modulation on/off ratio

Test procedure

- (1) Press CAL on the spectrum analyzer.
- (2) Connect the test equipment as shown in Fig. 7-4.
- (3) On the UUT set:

[CARR FREQ]	32 [MHz]
[RF LEVEL]	0 [dB]
[MENU]	22 [ENTER]

The UUT will enter the *Pulse Modulation* menu

Select *I* (to enable Pulse Mod.)
 [MOD] then [MOD] then [MOD] again (to select *Pulse Mod*)
 [SOURCE ON/OFF] (to enable modulation source)
 [MOD ON/OFF] (to enable modulation)

The RF output will now be enabled.

- (4) Tune the spectrum analyzer to the same frequency as the signal generator.
- (5) Press PEAK FIND on the spectrum analyzer and note the output level.
- (6) Apply a short circuit to the PULSE INPUT socket on the rear panel.
- (7) Again note the output level measured by the spectrum analyzer.
- (8) The difference between the levels recorded in (5) and (7) is the pulse mod on/off ratio. Check that the ratio is within specification using Table 7-37.
- (9) Repeat (4) to (8) for each of the frequencies shown in Table 7-37.

Pulse modulation rise and fall time

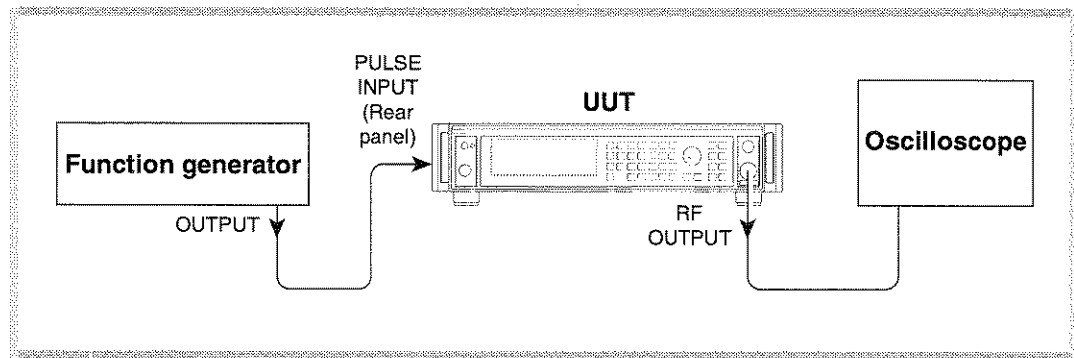

C2370

Fig. 7-11 Pulse modulation rise and fall time test set-up

Test procedure

- (1) Connect the test equipment as shown in Fig. 7-11.

- (2) On the UUT set:
- | | |
|-------------|------------|
| [CARR FREQ] | 50 [MHz] |
| [RF LEVEL] | +7 [dB] |
| [MENU] | 22 [ENTER] |

The UUT will enter the *Pulse Modulation* menu.

Select *1* (to enable Pulse Mod)
 [MOD] then [MOD] then [MOD] again (to select *Pulse Mod*)
 [SOURCE ON/OFF] (to enable modulation source)
 [MOD ON/OFF] (to enable modulation)

The RF output will now be enabled.

- (3) Set the function generator to produce 10 kHz, 0 V to +5 V square wave.
 (4) Adjust the oscilloscope controls such that the rise time of the envelope can be measured.
 (5) Measure the rise time between the 10% to 90% points, checking that it is within the specification shown in Table 7-38.
 (6) Repeat (4) to (5) for the fall time of the envelope.

Modulation oscillator

Specification

Frequency range:	0.01 Hz to 20 kHz
Resolution:	0.01 Hz to 100 Hz 0.1 Hz to 1 kHz 1 Hz to 20 kHz
Distortion:	Less than 0.1% at 1 kHz
Sine wave frequency response:	Typically 1 dB, DC to 20 kHz
Waveforms:	Sine (to 20 kHz), triangle or square wave (to 3 kHz) Square wave jitter <6.4 μ s on any edge
Output:	2 V RMS EMF from a 600 Ω source impedance

Test equipment

Description	Minimum specification	Example
Frequency counter	10 kHz to 2.4 GHz	Marconi 2440
50 Ω load (termination)	1 W, 50 Ω nominal impedance, DC to 2.4 GHz	Lucas Weinschel M1404N
Audio analyzer	Capable of measuring THD of 0.01% at 1 kHz	Rohde & Schwarz UPA3

Modulation oscillator frequencies

Test procedure

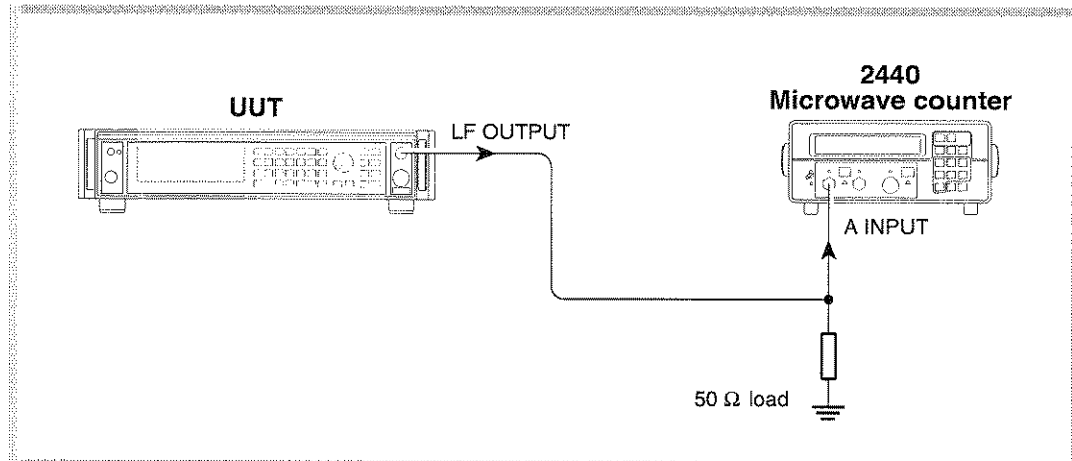

C2374

Fig. 7-12 Modulation oscillator frequency test set-up

- (1) Connect the test equipment as shown in Fig. 7-12.
- (2) On the UUT set:
 - [SOURCE ON/OFF] (to enable modulation source)
 - [MOD ON/OFF] (to enable modulation)
 - [MOD SOURCE] 10 Hz
- (3) Record the frequency measured by the counter against each of the modulation oscillator frequencies shown in Table 7-39.

Modulation oscillator distortion and LF output flatness

Test procedure

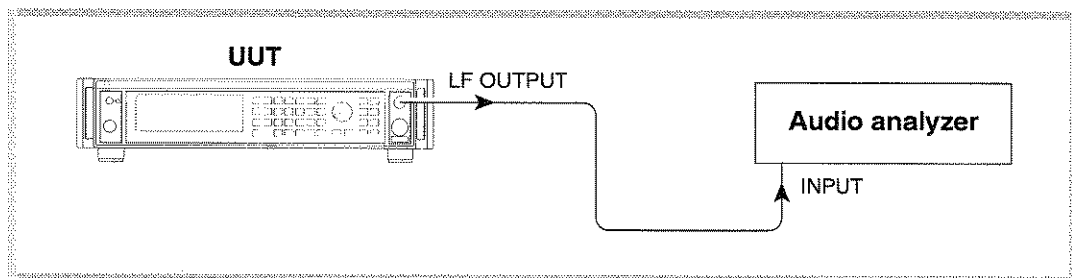

C2371

Fig. 7-13 Modulation oscillator distortion test set-up

- (1) Connect the test equipment as shown in Fig. 7-13.
- (2) On the UUT set:
 - [SOURCE ON/OFF] (to enable modulation source)
 - [MOD ON/OFF] (to enable modulation)
 - [MOD SOURCE] 1 kHz
- (3) Measure the distortion on the audio analyzer, checking that the result is within the specification shown in Table 7-40.
- (4) Measure the absolute level on the audio analyzer (in dBm) and record this level as a reference.

- (5) Set the UUT mod source to each of the frequencies shown in Table 7-40. Subtract the level measured on the audio analyzer at each frequency from that recorded in (4), checking that the results are within specification.

External frequency standard input

Specification

Input levels:	Requires an input of 220 mV RMS to 1.8 V RMS into 1 k Ω
Input frequencies:	1 MHz or 10 MHz

Test equipment

Description	Minimum specification	Example
Signal generator	220 mV to 1.8 V RMS, 1 MHz to 10 MHz	MI 2041 or 2030

Test procedure

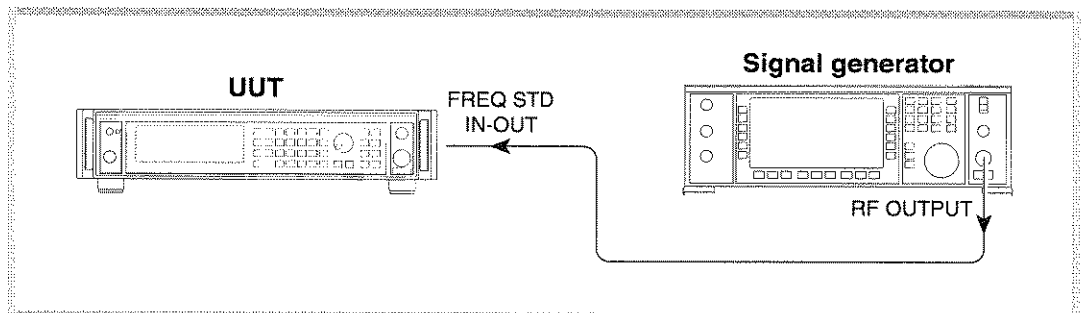

C2372

Fig. 7-14 External standard test set-up.

- (1) Connect the test equipment as shown in Fig. 7-14.
- (2) On the UUT set:
 [MENU]
 Select *Frequency/Sweep*
 Using the [NEXT] key, select *Frequency Standard*
 Select 2 (to select *Ext 1 MHz indirect*)
- (3) Set the signal generator to RF level 220 mV EMF, carrier frequency 1 MHz.
- (4) Using Table 7-41, check that no external standard error messages are displayed on the UUT.
- (5) Set the signal generator to 1.8 V EMF and repeat (4).
- (6) On the UUT select 3 (to select *Ext 10 MHz indirect*).
- (7) Set the signal generator to carrier frequency 10 MHz and repeat (4).
- (8) Set the signal generator to 220 mV and repeat (4).

TEST PROCEDURES FOR INSTRUMENTS FITTED WITH OPTION 3

RF output

Specification

Level range:	-137 dBm to +25 dBm for carrier frequencies up to 1.2 GHz -137 dBm to +19 dBm for carrier frequencies above 1.2 GHz
Accuracy:	For output levels above -127 dBm and over a temperature range of 17°C to 27°C: ± 1 dBm to 1.2 GHz ± 2 dBm to 2.4 GHz (2024) Temperature coefficient $< \pm 0.02$ dB/°C to 1.2 GHz , $< \pm 0.04$ dB/°C to 2.4 GHz

Test equipment

Description	Minimum specification	Example
Power meter	± 0.1 dB from 10 kHz to 2.4 GHz	Marconi 6960B and 6932
Measuring receiver	0 dBm to -127 dBm; 2.5 MHz to 2.4 GHz	HP 8902A with 11722A sensor and 11793A down converter
Signal generator	+8 dBm from 32.5 MHz to 2.43 GHz	Marconi 2041

RF level frequency response

Test procedure

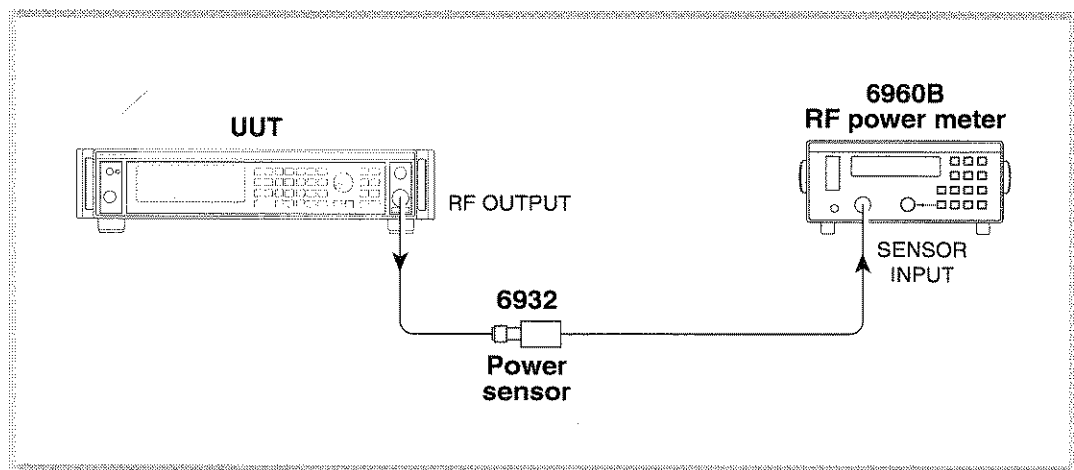

C2373

Fig. 7-15 RF output test set-up

- (1) Perform AUTO ZERO and AUTO CAL on the power meter.
- (2) Connect the test equipment as shown in Fig. 7-15.

- (3) On the UUT set:

[CARR FREQ]	30 [kHz]
[RF LEVEL]	0 [dB]
- (4) Record the output level measured by the power meter against each of the carrier frequencies shown in Table 7-42, checking that the results are within specification.
- (5) Set the UUT RF level to +7 dBm and repeat (4) using Table 7-43.
- (6) Set the UUT RF level to +13 dBm and repeat (4) using Table 7-44.
- (7) Set the UUT RF level to +25 dBm and repeat (4) using Table 7-45, decreasing the RF level to +19 dBm when testing at carrier frequencies above 1.2 GHz.

ALC linearity

Test procedure

- (1) Perform AUTO ZERO and AUTO CAL on the power meter.
- (2) Connect the test equipment as shown in Fig. 7-15.
- (3) On the UUT set:

[CARR FREQ]	2.5 [MHz]
[RF LEVEL]	-4 [dB]
- (4) Record the output level measured by the power meter against each of the steps shown in Table 7-46, checking that the results are within specification.
- (5) Set the UUT carrier frequency to 500 MHz and repeat (4) using Table 7-47.
- (6) Set the UUT carrier frequency to 2400 MHz and repeat (4) using Table 7-48.

Attenuator accuracy

The following test will confirm that the attenuator performs to the published performance specification. In the event of the receiver/down-converter not being available, an alternative method to functionally test the individual pads is also suggested. (See 'Alternative attenuator functional test under 'ALC linearity' at the start of this Chapter).

Test procedure

- (1) Connect the test equipment as shown in Fig. 7-2.
- (2) On the UUT set:

[CARR FREQ]	2.6 [MHz]
[RF LEVEL]	0 [dB]
[SET Δ]	
[RF LEVEL] (to select [Levl Step])	11 [ENTER]
[RF LEVEL]	
- (3) Tune the receiver to 2.6 MHz and record the output level measured in Table 7-49, checking that the result is within specification.
- (4) Set the UUT RF level to -4.1 dBm. Measure the received level and record the result in Table 7-49, checking that the result is within specification.
- (5) Decrement the UUT, using the [×10 ↓] key, in 11 dB steps down to an RF level of -103.1 dBm, measuring the received level at each step shown in Table 7-49, checking that the results are within specification.
- (6) Set the UUT to carrier frequency 540 MHz and repeat (2) to (5) using Table 7-50.
- (7) Set the UUT to carrier frequency 1140 MHz and repeat (2) to (5) using Table 7-51.

The following test frequencies are for 2024 only. The down converter will automatically be enabled when testing frequencies above 1300 MHz.

- (8) Set the local oscillator to +8 dBm at a carrier frequency of 62 MHz less than the test frequency (i.e. 1678 MHz).
- (9) On the receiver, enter the local oscillator frequency followed by the test frequency.
- (10) Set the UUT to carrier frequency 1740 MHz and repeat (2) to (5) using Table 7-52.
- (11) Set the UUT to carrier frequency 2400 MHz and repeat (2) to (5) using Table 7-53.

Carrier harmonics

Specification

Harmonics: Better than -25 dBc for RF levels up to 6 dB below the maximum specified output

Test equipment

Description	Minimum specification	Example
Spectrum analyzer	DC to 7.2 GHz frequency coverage	Marconi 2386

Test procedure

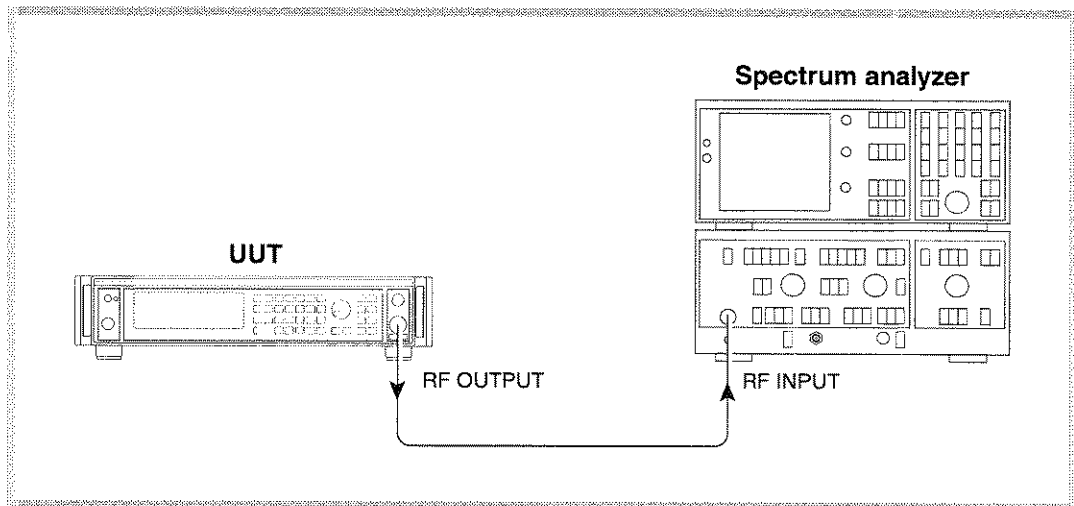

C2363

Fig. 7-16 Carrier harmonics test set-up

- (1) Press CAL on the spectrum analyzer.
- (2) Connect the test equipment as shown in Fig. 7-16.
- (3) On the UUT set:

[CARR FREQ]	10 [kHz]
[RF LEVEL]	+19 [dB]
- (4) Measure the level of the second and third harmonics on the spectrum analyzer at each of the carrier frequencies shown in Table 7-54, decreasing the RF output to +13 dBm for carrier frequencies above 1.2 GHz, checking that the results are within specification.

ACCEPTANCE TEST RESULTS TABLES

For 2023 signal generator, serial number _____ / _____
 2024

Option 1 no attenuator
 Option 2 DC operation
 Option 3 high power
 Option 4 high stability frequency standard

Table 7-1 RF output at 0 dBm (not option 3)

Carrier frequency (MHz)	RF level min. (dBm)	Result (dBm)	RF level max. (dBm)
0.03	-0.8	_____	+0.8
0.33	-0.8	_____	+0.8
60	-0.8	_____	+0.8
180	-0.8	_____	+0.8
300	-0.8	_____	+0.8
420	-0.8	_____	+0.8
540	-0.8	_____	+0.8
660	-0.8	_____	+0.8
780	-0.8	_____	+0.8
900	-0.8	_____	+0.8
1020	-0.8	_____	+0.8
1140	-0.8	_____	+0.8
1200	-0.8	_____	+0.8
2024 ONLY			
1201	-1.6	_____	+1.6
1260	-1.6	_____	+1.6
1380	-1.6	_____	+1.6
1500	-1.6	_____	+1.6
1620	-1.6	_____	+1.6
1740	-1.6	_____	+1.6
1860	-1.6	_____	+1.6
1980	-1.6	_____	+1.6
2220	-1.6	_____	+1.6
2340	-1.6	_____	+1.6
2400	-1.6	_____	+1.6

Table 7-2 RF output at +7 dBm (not option 3)

Carrier frequency (MHz)	RF level min. (dBm)	Result (dBm)	RF level max. (dBm)
0.03	+6.2	_____	+7.8
0.33	+6.2	_____	+7.8
60	+6.2	_____	+7.8
180	+6.2	_____	+7.8
300	+6.2	_____	+7.8
420	+6.2	_____	+7.8
540	+6.2	_____	+7.8
660	+6.2	_____	+7.8
780	+6.2	_____	+7.8
900	+6.2	_____	+7.8
1020	+6.2	_____	+7.8
1140	+6.2	_____	+7.8
1200	+6.2	_____	+7.8
2024 ONLY			
1201	+5.4	_____	+8.6
1260	+5.4	_____	+8.6
1380	+5.4	_____	+8.6
1500	+5.4	_____	+8.6
1620	+5.4	_____	+8.6
1740	+5.4	_____	+8.6
1860	+5.4	_____	+8.6
1980	+5.4	_____	+8.6
2220	+5.4	_____	+8.6
2340	+5.4	_____	+8.6
2400	+5.4	_____	+8.6

Table 7-3 RF output at +13 dBm (not option 3)

Carrier frequency (MHz)	RF level min. (dBm)	Result (dBm)	RF level max. (dBm)
0.03	+12.2	_____	+13.8
0.33	+12.2	_____	+13.8
60	+12.2	_____	+13.8
180	+12.2	_____	+13.8
300	+12.2	_____	+13.8
420	+12.2	_____	+13.8
540	+12.2	_____	+13.8
660	+12.2	_____	+13.8
780	+12.2	_____	+13.8
900	+12.2	_____	+13.8
1020	+12.2	_____	+13.8
1140	+12.2	_____	+13.8
1200	+12.2	_____	+13.8
2024 ONLY			
1201	+11.4	_____	+14.6
1260	+11.4	_____	+14.6
1380	+11.4	_____	+14.6
1500	+11.4	_____	+14.6
1620	+11.4	_____	+14.6
1740	+11.4	_____	+14.6
1860	+11.4	_____	+14.6
1980	+11.4	_____	+14.6
2220	+11.4	_____	+14.6
2340	+11.4	_____	+14.6
2400	+11.4	_____	+14.6

Table 7-4 ALC linearity at 2.5 MHz (not option 3)

RF level (dBm)	RF level min. (dBm)	Result (dBm)	RF level max. (dBm)
-4	-4.8	_____	-3.2
-3	-3.8	_____	-2.2
-2	-2.8	_____	-1.2
-1	-1.8	_____	-0.2
0	-0.8	_____	+0.8
1	+0.2	_____	+1.8
2	+1.2	_____	+2.8
3	+2.2	_____	+3.8
4	+3.2	_____	+4.8
5	+4.2	_____	+5.8
6	+5.2	_____	+6.8
7	+6.2	_____	+7.8
8	+7.2	_____	+8.8
9	+8.2	_____	+9.8
10	+9.2	_____	+10.8
11	+10.2	_____	+11.8
12	+11.2	_____	+12.8
12.1	+11.3	_____	+12.9
12.2	+11.4	_____	+13
12.3	+11.5	_____	+13.1
12.4	+11.6	_____	+13.2
12.5	+11.7	_____	+13.3
12.6	+11.8	_____	+13.4
12.7	+11.9	_____	+13.5
12.8	+12	_____	+13.6
12.9	+12.1	_____	+13.7
13	+12.2	_____	+13.8

Table 7-5 ALC linearity at 500 MHz (not option 3)

RF level (dBm)	RF level min. (dBm)	Result (dBm)	RF level max. (dBm)
-4	-4.8	_____	-3.2
-3	-3.8	_____	-2.2
-2	-2.8	_____	-1.2
-1	-1.8	_____	-0.2
0	-0.8	_____	+0.8
1	+0.2	_____	+1.8
2	+1.2	_____	+2.8
3	+2.2	_____	+3.8
4	+3.2	_____	+4.8
5	+4.2	_____	+5.8
6	+5.2	_____	+6.8
7	+6.2	_____	+7.8
8	+7.2	_____	+8.8
9	+8.2	_____	+9.8
10	+9.2	_____	+10.8
11	+10.2	_____	+11.8
12	+11.2	_____	+12.8
12.1	+11.3	_____	+12.9
12.2	+11.4	_____	+13
12.3	+11.5	_____	+13.1
12.4	+11.6	_____	+13.2
12.5	+11.7	_____	+13.3
12.6	+11.8	_____	+13.4
12.7	+11.9	_____	+13.5
12.8	+12	_____	+13.6
12.9	+12.1	_____	+13.7
13	+12.2	_____	+13.8

Table 7-6 ALC linearity at 2400 MHz (not option 3)

RF level (dBm)	RF level min. (dBm)	Result (dBm)	RF level max. (dBm)
-4	-5.6	_____	-2.4
-3	-4.6	_____	-1.4
-2	-3.6	_____	-0.4
-1	-2.6	_____	+0.6
0	-1.6	_____	+1.6
1	-0.6	_____	+2.6
2	+0.4	_____	+3.6
3	+1.4	_____	+4.6
4	+2.4	_____	+5.6
5	+3.4	_____	+6.6
6	+4.4	_____	+7.6
7	+5.4	_____	+8.6
8	+6.4	_____	+9.6
9	+7.4	_____	+10.6
10	+8.4	_____	+11.6
11	+9.4	_____	+12.6
12	+10.4	_____	+13.6
12.1	+10.5	_____	+13.7
12.2	+10.6	_____	+13.8
12.3	+10.7	_____	+13.9
12.4	+10.8	_____	+14
12.5	+10.9	_____	+14.1
12.6	+11	_____	+14.2
12.7	+11.1	_____	+14.3
12.8	+11.2	_____	+14.4
12.9	+11.3	_____	+14.5
13	+11.4	_____	+14.6

Table 7-7 Attenuator test at 2.6 MHz (not option 3)

RF Level (dBm)	RF level min. (dBm)	Result (dBm)	RF level max. (dBm)
0	-0.8	_____	+0.8
-4.1	-4.9	_____	-3.3
-15.1	-15.9	_____	-14.3
-26.1	-26.9	_____	-25.3
-37.1	-37.9	_____	-36.3
-48.1	-48.9	_____	-47.3
-59.1	-59.9	_____	-58.3
-70.1	-70.9	_____	-69.3
-81.1	-81.9	_____	-80.3
-92.1	-92.9	_____	-91.3
-103.1	-103.9	_____	-102.3

Table 7-8 Attenuator test at 540 MHz (not option 3)

RF Level (dBm)	RF level min. (dBm)	Result (dBm)	RF level max. (dBm)
0	-0.8	_____	+0.8
-4.1	-4.9	_____	-3.3
-15.1	-15.9	_____	-14.3
-26.1	-26.9	_____	-25.3
-37.1	-37.9	_____	-36.3
-48.1	-48.9	_____	-47.3
-59.1	-59.9	_____	-58.3
-70.1	-70.9	_____	-69.3
-81.1	-81.9	_____	-80.3
-92.1	-92.9	_____	-91.3
-103.1	-103.9	_____	-102.3

Table 7-9 Attenuator test at 1140 MHz (not option 3)

RF Level (dBm)	RF level min. (dBm)	Result (dBm)	RF level max. (dBm)
0	-0.8	_____	+0.8
-4.1	-4.9	_____	-3.3
-15.1	-15.9	_____	-14.3
-26.1	-26.9	_____	-25.3
-37.1	-37.9	_____	-36.3
-48.1	-48.9	_____	-47.3
-59.1	-59.9	_____	-58.3
-70.1	-70.9	_____	-69.3
-81.1	-81.9	_____	-80.3
-92.1	-92.9	_____	-91.3
-103.1	-103.9	_____	-102.3

Table 7-10 Attenuator test at 1740 MHz (2024 only, not option 3)

RF level (dBm)	RF level min. (dBm)	Result (dBm)	RF level max. (dBm)
0	-1.6	_____	+1.6
-4.1	-5.7	_____	-2.5
-15.1	-16.7	_____	-13.5
-26.1	-27.7	_____	-24.5
-37.1	-38.7	_____	-35.5
-48.1	-49.7	_____	-46.5
-59.1	-60.7	_____	-57.5
-70.1	-71.7	_____	-68.5
-81.1	-82.7	_____	-79.5
-92.1	-93.7	_____	-90.5
-103.1	-104.7	_____	-101.5

Table 7-11 Attenuator test at 2400 MHz (2024 only, not option 3)

RF level (dBm)	RF level min. (dBm)	Result (dBm)	RF level max. (dBm)
0	-1.6	_____	+1.6
-4.1	-5.7	_____	-2.5
-15.1	-16.7	_____	-13.5
-26.1	-27.7	_____	-24.5
-37.1	-38.7	_____	-35.5
-48.1	-49.7	_____	-46.5
-59.1	-60.7	_____	-57.5
-70.1	-71.7	_____	-68.5
-81.1	-82.7	_____	-79.5
-92.1	-93.7	_____	-90.5
-103.1	-104.7	_____	-101.5

Table 7-12 Alternative attenuator functional test at 10 MHz

Attenuator pad	Measured value (dB)
33 dB	_____
22 dB	_____
33 dB	_____
11 dB	_____
33 dB	_____

Table 7-13 Carrier frequency tests

Frequency (MHz)	Frequency min. (MHz)	Result (MHz)	Frequency max. (MHz)
0.01	-	_____	-
1	-	_____	-
9.999999	-	_____	-
18.75	-	_____	-
37.5	-	_____	-
75	-	_____	-
150	-	_____	-
300	-	_____	-
600	-	_____	-
1200	1199.99988	_____	1200.00012
Instrument fitted with option 4			
1200	1199.999988	_____	1200.000012
2024 ONLY			
1200.000001	-	_____	-
1230	-	_____	-
1250	-	_____	-
1260	-	_____	-
1320	-	_____	-
1350	-	_____	-
1500	-	_____	-
1599.999999	-	_____	-
2400	-	_____	-

Table 7-14 Carrier harmonic tests at -4 dBm (not option 3)

Carrier frequency (MHz)	2nd harmonic max. level (dBc)	Result (MHz)	3rd harmonic max. level (dBc)	Result (MHz)
0.01	-30	_____	-30	_____
0.1	-30	_____	-30	_____
1	-30	_____	-30	_____
9.9	-30	_____	-30	_____
10	-30	_____	-30	_____
18.7	-30	_____	-30	_____
18.8	-30	_____	-30	_____
37.4	-30	_____	-30	_____
37.6	-30	_____	-30	_____
74.9	-30	_____	-30	_____
75.1	-30	_____	-30	_____
150	-30	_____	-30	_____
151	-30	_____	-30	_____
300	-30	_____	-30	_____
301	-30	_____	-30	_____
600	-30	_____	-30	_____
601	-30	_____	-30	_____
750	-30	_____	-30	_____
950	-30	_____	-30	_____
1200	-30	_____	-30	_____
2024 ONLY				
1201	-30	_____	-30	_____
1500	-30	_____	-30	_____
1900	-30	_____	-30	_____
2400	-30	_____	-30	_____

Table 7-15 Carrier harmonic tests at 0 dBm (not option 3)

Carrier frequency (MHz)	2nd harmonic max. level (dBc)	Result (MHz)	3rd harmonic max. level (dBc)	Result (MHz)
0.01	-30	_____	-30	_____
0.1	-30	_____	-30	_____
1	-30	_____	-30	_____
9.9	-30	_____	-30	_____
10	-30	_____	-30	_____
18.7	-30	_____	-30	_____
18.8	-30	_____	-30	_____
37.4	-30	_____	-30	_____
37.6	-30	_____	-30	_____
74.9	-30	_____	-30	_____
75.1	-30	_____	-30	_____
150	-30	_____	-30	_____
151	-30	_____	-30	_____
300	-30	_____	-30	_____
301	-30	_____	-30	_____
600	-30	_____	-30	_____
601	-30	_____	-30	_____
750	-30	_____	-30	_____
950	-30	_____	-30	_____
1200	-30	_____	-30	_____
2024 ONLY				
1201	-30	_____	-30	_____
1500	-30	_____	-30	_____
1900	-30	_____	-30	_____
2400	-30	_____	-30	_____

Table 7-16 Carrier harmonic tests at +7 dBm (not option 3)

Carrier frequency (MHz)	2nd harmonic max. level (dBc)	Result (MHz)	3rd harmonic max. level (dBc)	Result (MHz)
0.01	-30	_____	-30	_____
0.1	-30	_____	-30	_____
1	-30	_____	-30	_____
9.9	-30	_____	-30	_____
10	-30	_____	-30	_____
18.7	-30	_____	-30	_____
18.8	-30	_____	-30	_____
37.4	-30	_____	-30	_____
37.6	-30	_____	-30	_____
74.9	-30	_____	-30	_____
75.1	-30	_____	-30	_____
150	-30	_____	-30	_____
151	-30	_____	-30	_____
300	-30	_____	-30	_____
301	-30	_____	-30	_____
600	-30	_____	-30	_____
601	-30	_____	-30	_____
750	-30	_____	-30	_____
950	-30	_____	-30	_____
1200	-30	_____	-30	_____
2024 ONLY				
1201	-30	_____	-30	_____
1500	-30	_____	-30	_____
1900	-30	_____	-30	_____
2400	-30	_____	-30	_____

Table 7-17 Carrier non-harmonic tests

Carrier frequency (MHz)	Sub-harmonic output			Sub-harmonic output		
	Non-harmonic frequency (MHz)	Non-harmonic level (dBc)	Result (dBc)	Non-harmonic frequency (MHz)	Non-harmonic level (dBc)	Result (dBc)
1201	800.6667	-64	_____	1601.3333	-64	_____
1201	400.3333	-64	_____	2001.6667	-64	_____
1599	1066	-64	_____	2132	-64	_____
1599	533	-64	_____	2665	-64	_____
1601	1200.75	-64	_____	2001.25	-64	_____
1601	800.5	-64	_____	2401.5	-64	_____
1999	1499.25	-64	_____	2498.75	-64	_____
1999	999.5	-64	_____	2998.5	-64	_____
2001	1600.8	-60	_____	2401.2	-60	_____
2001	1200.6	-60	_____	2801.4	-60	_____
2400	1920	-60	_____	2880	-60	_____
2400	1440	-60	_____	3360	-60	_____
9.9	100.000032	-70	_____	109.900036	-70	_____

Table 7-18 Residual FM test

Carrier frequency	Residual FM	Measured value (Hz RMS)
1 GHz	<4.5 Hz RMS	_____

Table 7-19 SSB phase noise test

Carrier frequency	SSB phase noise at 20 kHz offset	Measured value (dBc/Hz)
470 MHz	<-121 dBc/Hz	_____

Table 7-20 RF leakage test

Carrier frequency (MHz)	RF leakage	Measured value (dBm)
469	<0.5 μ V	_____
929	<0.5 μ V	_____
1349	<0.5 μ V	_____
2399	<0.5 μ V	_____

Table 7-21 Internal FM deviation and distortion tests at 100 kHz deviation

Carrier frequency (MHz)	FM Deviation			Distortion	
	FM deviation min. (kHz)	Result (kHz)	FM deviation max. (kHz)	Distortion (%)	Result (%)
10	95	_____	105	<3%	_____
10.144	95	_____	105	<3%	_____
10.292	95	_____	105	<3%	_____
10.441	95	_____	105	<3%	_____
10.592	95	_____	105	<3%	_____
10.746	95	_____	105	<3%	_____
10.901	95	_____	105	<3%	_____
11.059	95	_____	105	<3%	_____
11.22	95	_____	105	<3%	_____
11.382	95	_____	105	<3%	_____
11.547	95	_____	105	<3%	_____
11.714	95	_____	105	<3%	_____
11.884	95	_____	105	<3%	_____
12.056	95	_____	105	<3%	_____
12.23	95	_____	105	<3%	_____
12.5	95	_____	105	<3%	_____
12.587	95	_____	105	<3%	_____
12.77	95	_____	105	<3%	_____
12.995	95	_____	105	<3%	_____
13.143	95	_____	105	<3%	_____
13.333	95	_____	105	<3%	_____

Table 7-22 FM scale shape tests at 15 MHz carrier

FM deviation (kHz)	FM deviation min. (kHz)	Result (kHz)	FM deviation max. (kHz)
100	95	_____	105
71	67.45	_____	74.55
56	53.2	_____	58.8
44	41.8	_____	46.2
34	32.3	_____	35.7
27	25.65	_____	28.35
21	19.95	_____	22.05
16	15.2	_____	16.8
13	12.35	_____	13.65
11	10.45	_____	11.55
10	9.5	_____	10.5
1	0.95	_____	1.05
0.1	0.095	_____	0.105

Table 7-23 Carrier error test at 1.2 GHz, FM deviation 100 kHz

Carrier error	Result (kHz)
<1 kHz	_____

Table 7-24 External FM frequency response (ALC off, DC coupled), 50 kHz deviation

Modulation frequency (kHz)	Response level min. (dB)	Result (dB)	Response level max. (dB)	Distortion (%)	Result (%)
0	-1	_____	+1	-	-
0.03	-1	_____	+1	-	-
0.1	-1	_____	+1	<3	_____
0.3	-1	_____	+1	-	-
1	-	reference	-	<3	_____
3	-1	_____	+1	-	-
5	-1	_____	+1	<3	_____
10	-1	_____	+1	-	-
20	-1	_____	+1	<3	_____
50	-1	_____	+1	-	-
100	-1	_____	+1	-	-

Table 7-25 External FM frequency response (ALC on), 10 kHz deviation, 0.75 V input

Modulation frequency (kHz)	Response level min. (dB)	Result (dB)	Response level max. (dB)
0.02	-1	_____	+1
0.1	-1	_____	+1
0.3	-1	_____	+1
1	-	reference	-
3	-1	_____	+1
10	-1	_____	+1
30	-1	_____	+1
100	-1	_____	+1

Table 7-26 External FM frequency response (ALC on), 10 kHz deviation, 1.25 V input

Modulation frequency (kHz)	Response level min. (dB)	Result (dB)	Response level max. (dB)	Distortion (%)	Result (%)
0.02	-1	_____	+1	-	-
0.1	-1	_____	+1	<3	_____
0.3	-1	_____	+1	-	-
1	-	reference	-	<3	_____
3	-1	_____	+1	-	-
5	-1	_____	+1	<3	_____
10	-1	_____	+1	-	-
20	-1	_____	+1	<3	_____
30	-1	_____	+1	-	-
100	-1	_____	+1	-	-

Table 7-27 Internal Φ M and distortion test at 10.5 MHz carrier, 10 rad deviation

Φ M deviation			Distortion	
Φ M deviation min. (rad)	Result (rad)	Φ M deviation max. (rad)	Distortion (%)	Result (%)
9.5	_____	10.5	<3%	_____

Table 7-28 Internal Φ M flatness test

Modulation frequency (kHz)	Response level min. (dB)	Result (dB)	Response level max. (dB)
0.1	-3	_____	+3
0.3	-3	_____	+3
1	-	reference	-
3	-3	_____	+3
10	-3	_____	+3

Table 7-29 Internal AM depth and distortion tests at -4 dBm

Carrier frequency (MHz)	AM depth 30%			AM depth 80%			Distortion (%)	Result at 30% depth	Result at 80% depth
	min. (%)	Result (%)	max. (%)	min. (%)	Result (%)	max. (%)			
1.5	28.5	_____	31.5	76	_____	84	<3	_____	_____
5	28.5	_____	31.5	76	_____	84	<3	_____	_____
9	28.5	_____	31.5	76	_____	84	<3	_____	_____
11	28.5	_____	31.5	76	_____	84	<3	_____	_____
20	28.5	_____	31.5	76	_____	84	<3	_____	_____
50	28.5	_____	31.5	76	_____	84	<3	_____	_____
100	28.5	_____	31.5	76	_____	84	<3	_____	_____
200	28.5	_____	31.5	76	_____	84	<3	_____	_____
500	28.5	_____	31.5	76	_____	84	<3	_____	_____
1000	28.5	_____	31.5	76	_____	84	<3	_____	_____

Table 7-30 Internal AM depth and distortion tests at 0 dBm

Carrier frequency (MHz)	AM depth 30%			AM depth 80%			Distortion (%)	Result at 30% depth	Result at 80% depth
	min. (%)	Result (%)	max. (%)	min (%)	Result (%)	max. (%)			
1.5	28.5	_____	31.5	76	_____	84	<3	_____	_____
5	28.5	_____	31.5	76	_____	84	<3	_____	_____
9	28.5	_____	31.5	76	_____	84	<3	_____	_____
11	28.5	_____	31.5	76	_____	84	<3	_____	_____
20	28.5	_____	31.5	76	_____	84	<3	_____	_____
50	28.5	_____	31.5	76	_____	84	<3	_____	_____
100	28.5	_____	31.5	76	_____	84	<3	_____	_____
200	28.5	_____	31.5	76	_____	84	<3	_____	_____
500	28.5	_____	31.5	76	_____	84	<3	_____	_____
1000	28.5	_____	31.5	76	_____	84	<3	_____	_____

Table 7-31 Internal AM depth and distortion tests at +7 dBm

Carrier frequency (MHz)	AM depth 30%			AM depth 80%			Distortion (%)	Result at 30% depth	Result at 80% depth
	min. (%)	Result (%)	max. (%)	min. (%)	Result (%)	max. (%)			
1.5	28.5	_____	31.5	76	_____	84	<3	_____	_____
5	28.5	_____	31.5	76	_____	84	<3	_____	_____
9	28.5	_____	31.5	76	_____	84	<3	_____	_____
11	28.5	_____	31.5	76	_____	84	<3	_____	_____
20	28.5	_____	31.5	76	_____	84	<3	_____	_____
50	28.5	_____	31.5	76	_____	84	<3	_____	_____
100	28.5	_____	31.5	76	_____	84	<3	_____	_____
200	28.5	_____	31.5	76	_____	84	<3	_____	_____
500	28.5	_____	31.5	76	_____	84	<3	_____	_____
1000	28.5	_____	31.5	76	_____	84	<3	_____	_____

Table 7-32 AM scale shape test

AM depth (%)	AM depth min. (%)	Result (%)	AM depth max. (%)
10	9.5	_____	10.5
20	19	_____	21
30	28.5	_____	31.5
40	38	_____	42
50	47.5	_____	52.5
60	57	_____	63
70	66.5	_____	73.5
80	76	_____	84
85	80.75	_____	89.25

Table 7-36 Pulse modulation RF output at +4 dBm

Carrier frequency (MHz)	RF level min. (dBm)	Result (dBm)	RF level max. (dBm)
30	+2.7	_____	+5.3
60	+2.7	_____	+5.3
180	+2.7	_____	+5.3
300	+2.7	_____	+5.3
420	+2.7	_____	+5.3
540	+2.7	_____	+5.3
660	+2.7	_____	+5.3
780	+2.7	_____	+5.3
900	+2.7	_____	+5.3
1020	+2.7	_____	+5.3
1140	+2.7	_____	+5.3
1200	+2.7	_____	+5.3
2024 ONLY			
1201	+1.9	_____	+6.1
1260	+1.9	_____	+6.1
1380	+1.9	_____	+6.1
1500	+1.9	_____	+6.1
1620	+1.9	_____	+6.1
1740	+1.9	_____	+6.1
1860	+1.9	_____	+6.1
1980	+1.9	_____	+6.1
2220	+1.9	_____	+6.1
2340	+1.9	_____	+6.1
2400	+1.9	_____	+6.1

Table 7-37 Pulse modulation on/off ratio test

Carrier frequency (MHz)	Pulse mod. on/off ratio (dB)	Measured value (dB)
32	>45	_____
100	>45	_____
320	>45	_____
1000	>45	_____
1200	>45	_____
2024 ONLY		
1500	>40	_____
1800	>40	_____
2100	>40	_____
2400	>40	_____

Table 7-38 Pulse modulation rise and fall time test

		Result (μ S)
Rise time	<10 μ s	_____
Fall time	<10 μ s	_____

Table 7-39 Modulation oscillator frequency tests

Frequency (Hz)	Result (Hz)
10	_____
100	_____
1000	_____
20000	_____

Table 7-40 Modulation oscillator distortion and LF output tests

Mod. oscillator frequency (Hz)	Response level min. (dB)	Result	Response level max. (dB)	Distortion (%)	Result (%)
10	-1	_____	+1	-	-
20	-1	_____	+1	-	-
50	-1	_____	+1	-	-
100	-1	_____	+1	-	-
200	-1	_____	+1	-	-
500	-1	_____	+1	-	-
1000	-1	reference	-	<0.1%	_____
2000	-1	_____	+1	-	-
5000	-1	_____	+1	-	-
10000	-1	_____	+1	-	-
20000	-1	_____	+1	-	-

Table 7-41 External frequency standard tests

External signal	Locked [<input type="checkbox"/>]
1 MHz, 220 mV	[<input type="checkbox"/>]
1 MHz, 1.8 V	[<input type="checkbox"/>]
10 MHz, 220 mV	[<input type="checkbox"/>]
10 MHz, 1.8 V	[<input type="checkbox"/>]

ACCEPTANCE TEST RESULTS

TABLES OPTION 3

Table 7-42 RF output at 0 dBm

Carrier frequency (MHz)	RF level min. (dBm)	Result (dBm)	RF level max. (dBm)
0.03	-1	_____	+1
0.33	-1	_____	+1
60	-1	_____	+1
180	-1	_____	+1
300	-1	_____	+1
420	-1	_____	+1
540	-1	_____	+1
660	-1	_____	+1
780	-1	_____	+1
900	-1	_____	+1
1020	-1	_____	+1
1140	-1	_____	+1
1200	-1	_____	+1
2024 ONLY			
1201	-2	_____	+2
1260	-2	_____	+2
1380	-2	_____	+2
1500	-2	_____	+2
1620	-2	_____	+2
1740	-2	_____	+2
1860	-2	_____	+2
1980	-2	_____	+2
2220	-2	_____	+2
2340	-2	_____	+2
2400	-2	_____	+2

Table 7-43 RF output at +7 dBm

Carrier frequency (MHz)	RF level min. (dBm)	Result (dBm)	RF level max. (dBm)
0.03	+6	_____	+8
0.33	+6	_____	+8
60	+6	_____	+8
180	+6	_____	+8
300	+6	_____	+8
420	+6	_____	+8
540	+6	_____	+8
660	+6	_____	+8
780	+6	_____	+8
900	+6	_____	+8
1020	+6	_____	+8
1140	+6	_____	+8
1200	+6	_____	+8
2024 ONLY			
1201	+5	_____	+9
1260	+5	_____	+9
1380	+5	_____	+9
1500	+5	_____	+9
1620	+5	_____	+9
1740	+5	_____	+9
1860	+5	_____	+9
1980	+5	_____	+9
2220	+5	_____	+9
2340	+5	_____	+9
2400	+5	_____	+9

Table 7-44 RF output at +13 dBm

Carrier frequency (MHz)	RF level min. (dBm)	Result (dBm)	RF level max. (dBm)
0.03	+12	_____	+14
0.33	+12	_____	+14
60	+12	_____	+14
180	+12	_____	+14
300	+12	_____	+14
420	+12	_____	+14
540	+12	_____	+14
660	+12	_____	+14
780	+12	_____	+14
900	+12	_____	+14
1020	+12	_____	+14
1140	+12	_____	+14
1200	+12	_____	+14
2024 ONLY			
1201	+11	_____	+15
1260	+11	_____	+15
1380	+11	_____	+15
1500	+11	_____	+15
1620	+11	_____	+15
1740	+11	_____	+15
1860	+11	_____	+15
1980	+11	_____	+15
2220	+11	_____	+15
2340	+11	_____	+15
2400	+11	_____	+15

Table 7-45 RF output at +25 dBm

Carrier frequency (MHz)	RF level min. (dBm)	Result (dBm)	RF level max. (dBm)
0.03	+24	_____	+26
0.33	+24	_____	+26
60	+24	_____	+26
180	+24	_____	+26
300	+24	_____	+26
420	+24	_____	+26
540	+24	_____	+26
660	+24	_____	+26
780	+24	_____	+26
900	+24	_____	+26
1020	+24	_____	+26
1140	+24	_____	+26
1200	+24	_____	+26
2024 ONLY, +19 dBm			
1201	+17	_____	+21
1260	+17	_____	+21
1380	+17	_____	+21
1500	+17	_____	+21
1620	+17	_____	+21
1740	+17	_____	+21
1860	+17	_____	+21
1980	+17	_____	+21
2220	+17	_____	+21
2340	+17	_____	+21
2400	+17	_____	+21

Table 7-46 ALC linearity at 2.5 MHz

RF level (dBm)	RF level min. (dBm)	Result (dBm)	RF level max. (dBm)
-4	-5	_____	-3
-3	-4	_____	-2
-2	-3	_____	-1
-1	-2	_____	0
0	-1	_____	+1
1	0	_____	+2
2	+1	_____	+3
3	+2	_____	+4
4	+3	_____	+5
5	+4	_____	+6
6	+5	_____	+7
7	+6	_____	+8
8	+7	_____	+9
9	+8	_____	+10
10	+9	_____	+11
11	+10	_____	+12
12	+11	_____	+13
12.1	+11.1	_____	+13.1
12.2	+11.2	_____	+13.2
12.3	+11.3	_____	+13.3
12.4	+11.4	_____	+13.4
12.5	+11.5	_____	+13.5
12.6	+11.6	_____	+13.6
12.7	+11.7	_____	+13.7
12.8	+11.8	_____	+13.8
12.9	+11.9	_____	+13.9
13	+12	_____	+14
14	+13	_____	+15
15	+14	_____	+16
16	+15	_____	+17
17	+16	_____	+18
18	+17	_____	+19
19	+18	_____	+20
20	+19	_____	+21
21	+20	_____	+22
22	+21	_____	+23
23	+22	_____	+24
24	+23	_____	+25
25	+24	_____	+26

Table 7-47 ALC linearity at 500 MHz

RF level (dBm)	RF level min. (dBm)	Result (dBm)	RF level max. (dBm)
-4	-5	_____	-3
-3	-4	_____	-2
-2	-3	_____	-1
-1	-2	_____	0
0	-1	_____	+1
1	0	_____	+2
2	+1	_____	+3
3	+2	_____	+4
4	+3	_____	+5
5	+4	_____	+6
6	+5	_____	+7
7	+6	_____	+8
8	+7	_____	+9
9	+8	_____	+10
10	+9	_____	+11
11	+10	_____	+12
12	+11	_____	+13
12.1	+11.1	_____	+13.1
12.2	+11.2	_____	+13.2
12.3	+11.3	_____	+13.3
12.4	+11.4	_____	+13.4
12.5	+11.5	_____	+13.5
12.6	+11.6	_____	+13.6
12.7	+11.7	_____	+13.7
12.8	+11.8	_____	+13.8
12.9	+11.9	_____	+13.9
13	+12	_____	+14
14	+13	_____	+15
15	+14	_____	+16
16	+15	_____	+17
17	+16	_____	+18
18	+17	_____	+19
19	+18	_____	+20
20	+19	_____	+21
21	+20	_____	+22
22	+21	_____	+23
23	+22	_____	+24
24	+23	_____	+25
25	+24	_____	+26

Table 7-51 Attenuator test at 1140 MHz

RF level (dBm)	RF level min. (dBm)	Result (dBm)	RF level max. (dBm)
0	-1	_____	+1
-4.1	-5.1	_____	-3.1
-15.1	-16.1	_____	-14.1
-26.1	-27.1	_____	-25.1
-37.1	-38.1	_____	-36.1
-48.1	-49.1	_____	-47.1
-59.1	-60.1	_____	-58.1
-70.1	-71.1	_____	-69.1
-81.1	-82.1	_____	-80.1
-92.1	-93.1	_____	-91.1
-103.1	-104.1	_____	-102.1

Table 7-52 Attenuator test at 1740 MHz (2024 Only)

RF level (dBm)	RF level min. (dBm)	Result (dBm)	RF level max. (dBm)
0	-2	_____	+2
-4.1	-6.1	_____	-2.1
-15.1	-17.1	_____	-13.1
-26.1	-28.1	_____	-24.1
-37.1	-39.1	_____	-35.1
-48.1	-50.1	_____	-46.1
-59.1	-61.1	_____	-57.1
-70.1	-72.1	_____	-68.1
-81.1	-83.1	_____	-79.1
-92.1	-94.1	_____	-90.1
-103.1	-105.1	_____	-101.1

Table 7-53 Attenuator test at 2400 MHz (2024 only)

RF level (dBm)	RF level min. (dBm)	Result (dBm)	RF level max. (dBm)
0	-2	_____	+2
-4.1	-6.1	_____	-2.1
-15.1	-17.1	_____	-13.1
-26.1	-28.1	_____	-24.1
-37.1	-39.1	_____	-35.1
-48.1	-50.1	_____	-46.1
-59.1	-61.1	_____	-57.1
-70.1	-72.1	_____	-68.1
-81.1	-83.1	_____	-79.1
-92.1	-94.1	_____	-90.1
-103.1	-105.1	_____	-101.1

Table 7-54 Carrier harmonic tests at +19 dBm

Carrier frequency (MHz)	2nd harmonic max. level (dBc)	Result (MHz)	3rd harmonic max. level (dBc)	Result (MHz)
0.01	-25	_____	-25	_____
0.1	-25	_____	-25	_____
1	-25	_____	-25	_____
9.9	-25	_____	-25	_____
10	-25	_____	-25	_____
18.7	-25	_____	-25	_____
18.8	-25	_____	-25	_____
37.4	-25	_____	-25	_____
37.6	-25	_____	-25	_____
74.9	-25	_____	-25	_____
75.1	-25	_____	-25	_____
150	-25	_____	-25	_____
151	-25	_____	-25	_____
300	-25	_____	-25	_____
301	-25	_____	-25	_____
600	-25	_____	-25	_____
601	-25	_____	-25	_____
750	-25	_____	-25	_____
950	-25	_____	-25	_____
1200	-25	_____	-25	_____
2024 ONLY (+13 dBm)				
1201	-25	_____	-25	_____
1500	-25	_____	-25	_____
1900	-25	_____	-25	_____
2400	-25	_____	-25	_____

Index

A

About this manual.....	ii
AC fuse.....	2-2
AC operation.....	2-2
AC supply cable.....	2-3
AC supply voltage.....	iv
Adjusting the display.....	4-44
ALC linearity test.....	7-7
AM depth and distortion test.....	7-21
AM scale shape test.....	7-21
Amplitude modulation selection.....	4-27
Attenuator accuracy test.....	7-8
Attenuator hold.....	4-20

B

Beryllia.....	v
---------------	---

C

Carrier error test.....	7-16
Carrier frequency.....	4-16
Carrier frequency accuracy test.....	7-9
Carrier phase adjustment.....	4-19
Carrier sweep.....	4-16
Changing the password.....	4-48
Cleaning the LCD window.....	2-5
Conventions for key labelling.....	ii
Coupling event registers.....	5-34

D

DC fuse.....	2-3
DC operation (Option 2).....	2-3
DC supply cable.....	2-3
DCFM nulling.....	4-41
Default settings.....	4-32
Display.....	4-10
Display blanking.....	4-42

E

Electrical hazards.....	iv
Error messages.....	4-49
External AM frequency response test.....	7-22
External FM frequency response test.....	7-17, 7-18
External frequency standard input test.....	7-28

F

Fire hazards.....	v
First time use.....	4-9
FM deviation and distortion test.....	7-15
FM scale shape test.....	7-16
Frequency modulation selection.....	4-28

Frequency standard selection.....	4-39
Front panel controls and connectors.....	4-4
FSK selection.....	4-31
Fuses.....	iv, 2-2, 2-3

G

General purpose interface bus (GPIB).....	2-3
Goods-in checks.....	2-2
GPIB mnemonics.....	
AM.....	5-19
AM?.....	5-20
ATTEN.....	5-29
ATTEN?.....	5-29
BLANK.....	5-27
BLANK?.....	5-28
CCR?.....	5-39
CFRQ.....	5-12
CFRQ?.....	5-12
*CLS.....	5-10
CONTRAST.....	5-28
CONTRAST?.....	5-28
CSE.....	5-39
CSE?.....	5-39
CSR?.....	5-39
DCFMNL.....	5-16
ELAPSED.....	5-28
ELAPSED?.....	5-28
ERASE.....	5-22
*ESE.....	5-10
*ESE?.....	5-10
*ESR?.....	5-10
FM.....	5-15
FM?.....	5-16
FSTD.....	5-27
FSTD?.....	5-27
GPIB.....	5-27
HCR?.....	5-39
HSE.....	5-39
HSE?.....	5-39
HSR?.....	5-39
*IDN?.....	5-10
IMPEDANCE.....	5-29
IMPEDANCE?.....	5-29
KLOCK.....	5-28
KUNLOCK.....	5-28
MOD.....	5-14
MOD?.....	5-14
MODE.....	5-14
MODF?.....	5-16, 5-18, 5-20
MPROT.....	5-24
MSEQ.....	5-23
MSEQ?.....	5-23
MTRIG.....	5-24

GPIB mnemonics (*continued.*)

MTRIG?	5-24
*OPC	5-10
*OPC?	5-10
OPER?	5-28
*OPT?	5-10
PM	5-17
PM?	5-17
POWUP	5-29
POWUP?	5-29
PULSE	5-21
PULSE?	5-21
RCL	5-22
RCL?	5-22
RFLV	5-13
RFLV?	5-13
RPP	5-27
*RST	5-10
SCR?	5-39
*SRE	5-10
*SRE?	5-10
SSE	5-39
SSE?	5-39
SSR?	5-39
*STB?	5-10
STO	5-22
SWEEP	5-25
SWEEP?	5-26
*TRG	5-10
*TST?	5-10
*WAI	5-10

H

Hardware event registers	5-33
Hardware information	4-45
Harmonics test	7-11
Hazard symbols	iv

I

IEEE to IEC conversion	2-4
Impedance selection	4-40
Initial visual inspection	2-2
Installation	2-1
Instrument event registers	5-35
Instrument operating position	2-2
Instrument options	4-46
Internal fuse	2-3

K

Keyboard locking	4-42
------------------	------

L

Local lockout	5-3
Local operation	4-1

M

Main features	1-2
Main screen operation	3-2
Memory cloning	4-38
Memory operation	0-3
Memory recall	4-34
Memory sequencing	4-35
Memory state summary	4-37
Memory stores	4-33
Memory write protection	4-36
Menu conventions	4-15
Modulation enable/disable	4-26
Modulation modes	4-23
Modulation oscillator distortion and LF output flatness test	7-27
Modulation oscillator frequencies test	7-27
Modulation selection	4-27
Modulation source phase adjustment	4-26

N

Naming conventions	ii
Non-harmonics test	7-12

O

Option 1: No attenuator	1-8
Option 2: DC operation	1-8
Option 3: High power	1-8
Option 5: Rear panel connectors	1-8

P

Performance data	1-5
Phase modulation flatness test	7-19
Phase modulation selection	4-29
Phase modulation test	7-19
Power-up options	4-43
Principles of operation	3-1
Programming	5-8
Protection locking and unlocking	4-47
Pulse modulation on/off ratio test	7-25
Pulse modulation RF level frequency response test	7-24
Pulse modulation rise and fall time test	7-25
Pulse modulation selection	4-30
Putting into storage	2-7

Q

Queue flag details	5-36
--------------------	------

R

Rack mounting	2-5
Rear panel connectors	4-7
Recommended test equipment	7-5
Remote operation	5-1
Remote operation selection	5-3

Remote/local operation.....	5-9
Removal of covers	iv
Residual FM test	7-12
Reverse power protection	4-20
RF leakage test.....	7-14
RF level	4-20
RF level frequency response test.....	7-7
RF level linear units	4-21
RF level logarithmic units	4-22
Routine safety testing and inspection.....	2-6
RS-232 interface	2-5
RS-232 operation	5-3

S

Safety.....	iv
Safety testing (routine)	2-6
Software information	4-45
Source selection	4-24

SSB phase noise test.....	7-13
Standard event registers	5-32
Status byte.....	5-30, 5-37, 5-38
Status data structure	5-31

T

Test procedures for option 3	7-29
Tilt warning	v
Toxic hazards.....	v

U

Utility menu operation.....	3-2
-----------------------------	-----

V

Ventilation	2-2
Versions, options and accessories	1-9

FRANCE

Marconi Instruments SA
18 Rue du Plessis-Briard
"Le Canal"
Courcouronnes
91023 EVRY CEDEX
France
Telephone: [+33] (1) 60 77 90 66
Fax: [+33] (1) 60 77 69 22
Telex: 604482 F

GERMANY

Marconi Messtechnik GmbH
Landsberger Strasse 65
D-82110 GERMERING
Germany
Telephone: [+49] (89) 84 9360
Fax: [+49] (89) 84 19142
Telex: 5212642 MMMC D

GREECE

Telecom Hellas Ltd
116 El Venizelou Avenue
GR 176 76 Kallithea
ATHENS
Greece
Telephone: [+30] (1) 959 7166
Fax: [+30] (1) 957 1994

HONG KONG

GEC Hong Kong Ltd
CC Wu Building
302-308 Hennessy Road
WANCHAI
Hong Kong
Telephone: [+852] 2919 8282
Fax: [+852] 2834 5773

HUNGARY

MTA-MMSZ Ltd
59-61 Etele ut
H-1119 BUDAPEST
Hungary
Telephone: [+36] (1) 2034350
Fax: [+36] (1) 2034353
Telex: 225114 MTAMM H

ICELAND

Amundason HF
Langholtsvegur 109
P. O. Box 4207
124 REYKJAVIK
Iceland
Telephone: [+354] 5687820
Fax: [+354] 5889318
Telex: 2108 AMCO IS

INDIA

Blue Star Limited
Head Office
Sahas, 414/2 Veer Savarkar Marg
Prabhadevi
BOMBAY 100 025
India
Telephone: [+91] (22) 4306 155 or
[+91] (22) 4306 185
Fax: [+91] (22) 4307 078

INDIA

Blue Star Limited
13 Community Centre
New Friends Colony
NEW DEHLI 110 065
India
Telephone: [+91] (11) 6911 660 or
[+91] (11) 6834 262
Fax: [+91] (11) 6841 845

INDIA

Blue Star Limited
Blue Star House
11 Magarath Road
BANGALORE 560 025
India
Telephone: [+91] (80) 5584 727 or
[+91] (80) 5584 729
Fax: [+91] (80) 5584 599

INDIA

Blue Star Limited
2-2-47, 47/1108,
Bolarum Road
SECUNDERABAD 580 009
India
Telephone: [+91] (40) 842 057 or
[+91] (40) 841 278
Fax: [+91] (40) 841 445

INDONESIA

P.T. Centronix
28 Jalan Matraman Raya
JAKARTA 13150
Indonesia
Telephone: [+62] (21) 8509870
Fax: [+62] (21) 8580555
Telex: 48216 CENT JKT

IRAN

Zaeim Electronic Ind. Co. Ltd
PO Box 14155-1434
Niloo Street
No 21 Zaeim Building
Vanak Square
TEHRAN
Iran
Telephone: [+98] (21) 226 1214/15
Fax: [+98] (21) 226 6455
Telex: 212997 ZEIM IR

IRELAND

Neltronic Ltd
John F. Kennedy Road
Naas Road
DUBLIN 12
Eire
Telephone: [+353] (1) 503560
Fax: [+353] (1) 552789
Telex: 93556 NELT EI

ISRAEL

IES Electronics Agencies (1986) Ltd
50 Betzael Street
RAMAT GAN 52521
Israel
Telephone: [+972] (3) 752 6333
Fax: [+972] (3) 751 0927
Telex: 361396 IES IL

ITALY

Marconi SpA
Via Palmanova, 185
20132 MILANO
Italy
Telephone: [+39] (2) 256 3141
Fax: [+39] (2) 256 7745
Telex: 311467 MARCON I

ITALY

Marconi SpA
Via Campo Nell'Elba 3/5
00199 ROME
Italy
Telephone: [+39] (6) 886 931
Fax: [+39] (6) 886 3963
Telex: 626189 MARCON I

JAPAN

Kikusui Electronics Corp.
Nisso dai 15th Bldg. 8F
No.2-17-19, Shin-Yokohama
Kohoku-ku, Yokohama City
KANAGAWA PREF., 222
Japan
Telephone: [+81] (45) 475 1112
Fax: [+81] (45) 475 1115
Telex: J36475 KECJPN

KENYA

GPT Kenya Ltd
Uhuru Highway
P.O. Box 40743
NAIROBI
Kenya
Telephone: [+254] (2) 555011
Fax: [+254] (2) 541556
Telex: 24053

KOREA, SOUTH

Zino International
Youngsung Bldg.
108-4 Samsung-dong
Kangnam-ku
SEOUL 135 091
Republic of Korea
Telephone: [+82] (2) 545 7334
Fax: [+82] (2) 545 7335

KUWAIT

Al Nawasi Trading & Contracting Co.
PO Box 3204
13033 SAFAT
Kuwait
Telephone: [+965] 244 7243
Fax: [+965] 241 0473
Telex: 22131 AAA KT

LEBANON

Mabek
P.O. Box 13-5657
BEIRUT
Lebanon
Telephone: [+961] (1) 864479
Fax: [+961] (1) 603129
Telex: 22889 MABEK LE

LIECHTENSTEIN

Isatel Emitec AG
Hinterbergstrasse 9
6330 CHAM
Switzerland
Telephone: [+41] (42) 41 80 41
Fax: [+41] (42) 41 80 43

International Service Centres

All Marconi Instruments products are supported by the following network of Service Centres. Details of these establishments may change from time to time. If you experience difficulties, please contact our Customer Support Group at the UK Service Division at the address on the previous page.

ARGENTINA

V.R. Marine Electronics
(RF Instrumentos)
Tacuman 858 - 6 TO Piso L
(1049) BUENOS AIRES
Republic of Argentina
Telephone: [+54] (1) 311 0424/7432
Fax: [+54] (1) 312 2799
Telex: 21833 JUDD AR

AUSTRALIA

Marconi Instruments (Pty) Ltd
Unit 1
38 South Street
Rydalmere,
NEW SOUTH WALES, 2116
Australia
Telephone: [+61] (2) 638 0800
Fax: [+61] (2) 638 3131

AUSTRIA

LB-Electronics GmbH
Doblinger Hauptstrasse 95
A-1190 WIEN
Austria
Telephone: [+43] (1) 367660
Fax: [+43] (1) 3698443

BAHRAIN

Airwave Electric WLL
PO Box 22506
MANAMA
Bahrain
Telephone: [+973] 295200
Fax: [+973] 295363

BANGLADESH

AEI-EE of Bangladesh Ltd
Magnet House 71-72
Dilkusha Commercial Area
DHAKA 1000
Bangladesh
Telephone: [+880] (2) 46031-46037
Fax: [+880] (2) 863278
Telex: 642818 BDI BJ

BELGIUM

Marconi Instrumenten
Van Limburg Stirumlaan 4
5037 SK TILBURG
Postbus 645
5000 AP TILBURG
Netherlands
Telephone: [+31] (13) 639540
Fax: [+31] (13) 639663

BRAZIL

ATP Hi-Tek Eletronica Ltda
Alameda Amazonas
422-Alphaville
06400 BARUERI SP
Brazil
Telephone: [+55] (11) 421 5477
Fax: [+55] (11) 421 5032
Telex: 1171413 HITK BR

BRUNEI

Marconi Instruments
ASEAN Regional Centre
GEC Building, 3 Tai Seng Drive
SINGAPORE 535216
Telephone: [+65] 381 1470
Fax: [+65] 281 0113

BULGARIA

GOPE Electronics
45 "Popova Shapka" Str
1505 SOFIA
Bulgaria
Telephone: [+359] (02) 708357
Fax: [+359] (02) 2388256

CANADA

Canadian Marconi Company
600 Dr Frederik Philips Boulevard
Ville St Laurent
QUEBEC H4M 2S9
Canada
Telephone: [+1] (514) 748 3000
Fax: [+1] (514) 748 3100

CANADA

Canadian Marconi Company
415 Leggett Drive
PO Box 13330
Kanata
ONTARIO K2K 2B2
Canada
Telephone: [+1] (613) 592 6500
Fax: [+1] (613) 592 7427

CHILE

Morgan & Cia
Miguel Claro 070
Dpto 807 Torre B de Tajamar
PO Box 1 T Providencia
SANTIAGO
Chile
Telephone: [+56] (2) 236 1278
Fax: [+56] (2) 235 7552

CHINA

Marconi Instruments Service Centre
Department of Electronic Engineering
Beijing Institute of Technology
7 Baishi Qiao Road
BEIJING 100081
Peoples Republic of China
Telephone: [+86] (1) 842 7954
Fax: [+86] (1) 842 7954
Telex: 22011 BIT CN

CHINA

Marconi Instruments Service Centre
88 Jiang An Road
SHANGHAI 200233
Peoples Republic of China
Telephone: [+86] (21) 64821947
Fax: [+86] (21) 64821947

COLOMBIA

Telectrónica Limitada
Carrera 13,
Nr 48-47 Piso 80
SANTAFE DE BOGOTÁ, DC
Colombia
Telephone: [+57] (1) 2325886,
[+57] (1) 2327816 or
[+57] (1) 2876136
Fax: [+57] (1) 2878589

CZECH REPUBLIC

EMPOS s.r.o.
Rostislavova 13
140 00 PRAHA 4
Czech Republic
Telephone: [+42] (2) 692 50 80
Fax: [+42] (2) 692 50 84

DENMARK

Stantronic Ormhøjgårdvej 16
DK 8700 HORSSENS
Denmark
Telephone: [+45] 75 643366
Fax: [+45] 75 644080

EGYPT

Multi-Systems Engineering
21 El Obour Building
Salah Salem, Floor 18
CAIRO
Egypt
Telephone: [+20] (2) 2632771
Fax: [+20] (2) 4028057

FIJI

AWA Compac Communication Pacific
Ltd
37 Freeston Road
Walu Bay
Suva P.O. Box 858
SUVA
Fiji
Telephone: [+679] 312744
Fax: [+679] 300379
Telex: 2347 AWA FIJI FS

FINLAND

Kaukomarkkinat Oy
Kutojantie 4
P. O. Box 40
SF-02630 ESPOO 63
Finland
Telephone: [+358] (0) 5211
Fax: [+358] (0) 521 5290
Telex: 124469 KAUKO SF

SOUTH AFRICA

Measuretest cc
 P. O. Box 6301
 DUNSWART 1508
 Transvaal
 Republic of South Africa
 Telephone: [+27] (11) 894 7721
 Fax: [+27] (11) 894 6414
 Telex: 747651 MTEST SA

SOUTH AMERICA

Marconi Instruments
 Latin American Division
 24703 US Hwy. 19N
 Suite 215
 CLEARWATER
 Florida 34623, USA
 Telephone: [+1] (813) 726 1401
 Fax: [+1] (813) 726 1344

SPAIN

Marconi Instrumentos S.A.
 Europa Empresarial
 C/Rozabella, No. 6
 Edif. Paris, Planta Baja, Oficina 1
 28230 LAS ROZAS
 Madrid, Spain
 Telephone: [+34] (1) 640 11 34
 Fax: [+34] (1) 640 06 40
 Telex: 57481 MIES E

SWEDEN

Pronesto AB
 Box 6014
 164 06 KISTA
 Sweden
 Telephone: [+46] (8) 632 65 70
 Fax: [+46] (8) 751 41 11
 Telex: 19270 PROS

SWITZERLAND

Isatel Emitec AG
 Hinterbergstrasse 9
 6330 CHAM
 Switzerland
 Telephone: [+41] (42) 41 80 41
 Fax: [+41] (42) 41 80 43

TAIWAN

HWA Jeat Corp.
 6F-3, No. 181 Fu-Hsing N. Road
 TAIPEI 10441
 Taiwan
 Republic of China
 Telephone: [+886] (2) 719 3216
 Fax: [+886] (2) 719 2886

THAILAND

Yip in Tsoi & Jacks Ltd
 523 Mahaputharam Road
 P.O. Box 2611
 BANGKOK 10501
 Thailand
 Telephone: [+66] (2) 236 5730
 Fax: [+66] (2) 236 5693
 Telex: 82929 YIPJACKS TH.

TURKEY

Orko Mumessillik
 Tunus Caddesi 85/9
 06680 Kavaklidere
 ANKARA
 Turkey
 Telephone: [+90] (312) 426 6047
 Fax: [+90] (312) 426 6180
 Telex: 44498 OKAS TR

UAE ABU DHABI

Business Communications UAE (Pte)
 Ltd
 P.O. Box 2534
 ABU DHABI
 United Arab Emirate
 Telephone: [+971] (2) 720646
 Fax: [+971] (2) 782702
 Telex: 22457 BCLAH EM

UAE DUBAI

Business Communications UAE (Pte)
 Ltd
 P.O. Box 233
 DUBAI
 United Arab Emirate
 Telephone: [+971] (4) 225135/6/7 or
 [+971] (4) 220186/7/8
 Fax: [+971] (4) 236193
 Telex: 47631 DUTEN EM

UNITED KINGDOM

Marconi Instruments Ltd
 The Airport
 LUTON
 Bedfordshire LU2 9NS
 United Kingdom
 Telephone: [+44] (1582) 33866
 Fax: [+44] (1582) 417573

URUGUAY

Pellmar S.A.
 Casilla Corres 6125
 Piedras 676
 MONTEVIDEO
 Uruguay
 Telephone: [+598] (2) 962017
 Fax: [+598] (2) 961991
 Telex: 26685 PELMA UY

USA

Marconi Instruments Inc.
 3 Pearl Court
 Allendale
 NEW JERSEY 07401
 USA
 Telephone: [+1] (201) 934 9050
 Toll Free: 1 800 233 2955
 Fax: [+1] (201) 934 9229
 Telex: 910 710 991 9752

VENEZUELA

Marcoms De Venezuela C.A.
 Edif Exagon Piso 5 OFC 57
 Av Romulo Gallegos El Marques
 Apartado 76702
 CARACAS 1070A
 Venezuela
 Telephone: [+58] (2) 242 1110 or
 [+58] (2) 242 1590
 Fax: [+58] (2) 238 0068 or
 [+58] (2) 242 0241
 Telex: 23049 DHMAR VC

VIETNAM

East Asiatic Company Ltd A/S,
 Ho Chi Minh City Representative
 Office
 17 Ton Duc Thang Street, 2nd Floor
 HO CHI MINH CITY
 Vietnam
 Telephone: [+84] (1) 290499
 Fax: [+84] (1) 230014

ZIMBABWE

KDB Holdings (Pvt) Ltd
 Elecombe House
 P. O. Box 2500
 HARARE
 Zimbabwe
 Telephone: [+263] (4) 758921
 Fax: [+263] (4) 758928
 Telex: 26069 KDB ZW

