

To buy, sell, rent or trade-in this product please click on the link below:
<http://www.avionteq.com/IFR-Aeroflex-8800-Radio-Test-Set.aspx>

AvionTEq

□ □ □ □ □ □ □ □
Test with full trust

www.avionteq.com

**AEROFLEX**

Digital Radio Test System 8800 Series Operation Manual

Issue-4

EXPORT CONTROL WARNING: This document contains controlled technical data under the jurisdiction of the Export Administration Regulations (EAR), 15 CFR 730-774. It cannot be transferred to any foreign third party without the specific prior approval of the U.S. Department of Commerce, Bureau of Industry and Security (BIS). Violations of these regulations are punishable by fine, imprisonment, or both.

OPERATION MANUAL

DIGITAL RADIO TEST SYSTEM

8800 SERIES

PUBLISHED BY
Aeroflex

COPYRIGHT © Aeroflex 2016

All rights reserved. No part of this publication may be reproduced, stored in a retrieval system, or transmitted in any form or by any means, electronic, mechanical, photocopying, recording or otherwise without the prior permission of the publisher.

Original Printing	Mar 2015
Issue-2	May 2015
Issue-3	Aug 2015
Issue-4	Jan 2016

10200 West York / Wichita, Kansas 67215 U.S.A. / (316) 522-4981 / FAX (316) 524-2623

Subject to Export Control, see Cover Page for details.

Electromagnetic Compatibility:

For continued EMC compliance, all external cables must be shielded and three meters or less in length.

Nomenclature Statements:

In this manual, 8800 refers to the 8800 Digital Radio Test System.

In this manual, 8800S refers to the 8800S Digital Radio Test System.

In this manual, 8800SX refers to the 8800SX Digital Radio Test System.

In this manual, 8800 Series refers to the 8800 Series Digital Radio Test System.

In this manual, Test Set, Digital Radio Test System or Unit refers to the 8800 Series Digital Radio Test System.

Product Warranty:

Refer to <http://ats.aeroflex.com/about-us/quality/standard-hardware-warranty> for the Product Warranty information.

THIS PAGE INTENTIONALLY LEFT BLANK.

SAFETY FIRST: TO ALL OPERATIONS PERSONNEL

REFER ALL SERVICING OF UNIT TO QUALIFIED TECHNICAL PERSONNEL. THIS UNIT CONTAINS NO OPERATOR SERVICEABLE PARTS.

WARNING: USING THIS EQUIPMENT IN A MANNER NOT SPECIFIED BY THE ACCOMPANYING DOCUMENTATION MAY IMPAIR THE SAFETY PROTECTION PROVIDED BY THE EQUIPMENT.

CASE, COVER OR PANEL REMOVAL

Opening the Case Assembly exposes the operator to electrical hazards that can result in electrical shock or equipment damage. Do not operate this Unit with the Case Assembly open.

SAFETY IDENTIFICATION IN TECHNICAL MANUAL

This manual uses the following terms to draw attention to possible safety hazards, that may exist when operating or servicing this equipment.

CAUTION: THIS TERM IDENTIFIES CONDITIONS OR ACTIVITIES THAT, IF IGNORED, CAN RESULT IN EQUIPMENT OR PROPERTY DAMAGE (E.G., FIRE).

WARNING: THIS TERM IDENTIFIES CONDITIONS OR ACTIVITIES THAT, IF IGNORED, CAN RESULT IN PERSONAL INJURY OR DEATH.

SAFETY SYMBOLS IN MANUALS AND ON UNITS



CAUTION: Refer to accompanying documents. (This symbol refers to specific CAUTIONS represented on the unit and clarified in the text.)



AC OR DC TERMINAL: Terminal that may supply or be supplied with AC or DC voltage.



DC TERMINAL: Terminal that may supply or be supplied with DC voltage.



AC TERMINAL: Terminal that may supply or be supplied with AC or alternating voltage.



HOT SURFACE: This surface may be hot to the touch.

EQUIPMENT GROUNDING PRECAUTION

Improper grounding of equipment can result in electrical shock.

USE OF PROBES

Check the specifications for the maximum voltage, current and power ratings of any connector on the Unit before connecting it with a probe from a terminal device. Be sure the terminal device performs within these specifications before using it for measurement, to prevent electrical shock or damage to the equipment.

POWER CORDS

Power cords must not be frayed, broken nor expose bare wiring when operating this equipment.

USE RECOMMENDED FUSES ONLY

Use only fuses specifically recommended for the equipment at the specified current and voltage ratings.

INTENDED USE

This Unit is intended for indoor use only and should not be subjected to conditions which cause water or other liquids to collect on the Touch Screen Display.

INTERNAL BATTERY

This Unit contains a Lithium Ion Battery, serviceable only by a qualified technician.

CAUTION: SIGNAL GENERATORS CAN BE A SOURCE OF ELECTROMAGNETIC INTERFERENCE (EMI) TO COMMUNICATION RECEIVERS. SOME TRANSMITTED SIGNALS CAN CAUSE DISRUPTION AND INTERFERENCE TO COMMUNICATION SERVICES OUT TO A DISTANCE OF SEVERAL MILES. USERS OF THIS EQUIPMENT SHOULD SCRUTINIZE ANY OPERATION THAT RESULTS IN RADIATION OF A SIGNAL (DIRECTLY OR INDIRECTLY) AND SHOULD TAKE NECESSARY PRECAUTIONS TO AVOID POTENTIAL COMMUNICATION INTERFERENCE PROBLEMS.

THIS PAGE INTENTIONALLY LEFT BLANK.

DECLARATION OF CONFORMITY

The Declaration of Conformity Certificate included with the Unit should remain with the Unit.

Aeroflex recommends the operator reproduce a copy of the Declaration of Conformity Certificate to be stored with the Operation Manual for future reference.

THIS PAGE INTENTIONALLY LEFT BLANK.

RoHs Product Information for People's Republic of China

Toxic or Hazardous Substance Content Table

The table provided below lists information as required by People's Republic of China Electronic Industry Standard SJ/T11364-2006, Marking for Control of Pollution Caused by Electronic Information Products. The table lists toxic or hazardous substances contained in Aeroflex products that exceed limits in SJ/T11363-2006

Table 1. Toxic or Hazardous Substances in Product

部件名称 Parts	Toxic or Hazardous Substances 有毒有害物质或元素					
	Lead (Pb)	Mercury (Hg)	Cadmium (Cd)	Hexavalent Chromium (Cr6+)	Polybrominated Biphenyls (PBB)	Polybrominated Diphenyl Ethers (PBDE)
	铅	汞	镉	六价铬	多溴联苯	多溴二苯醚
印刷板组件 Printed Board Assemblies	X	O	O	O	O	O
机箱子组件 Chassis subassembly	X	O	O	O	O	O
电源 Power Supply	X	O	O	O	O	O
电缆及电缆组件 Cables & Cable Assemblies	X	O	O	O	O	O
<p>O: Indicates that the toxic or hazardous substance contained in all of the homogenous materials for this component is below the limit requirement in SJ/T11363-2006</p> <p>O: 表示该有毒有害物质在该部件所有均质材料中的含量均在 SJ/T 11363-2006 标准规定的限量要求以下</p> <p>X: Indicates that the toxic or hazardous substance contained in at least one of the homogeneous materials for this component is above the limit requirement in SJ/T11363-2006.</p> <p>X: 表示该有毒有害物质至少在该部件的某一均质材料中的含量超出 SJ/T 11363-2006 标准规定的限量要求</p>						

RoHs Product Information for People's Republic of China (cont)

Pollution Control Marking

The following marking is located on all Aeroflex products sold in China. The number in the center indicates the Environmental Protection Use Period. This indicates the period in years during which the hazardous substances described in Table 1 will not leak or mutate under normal operating conditions so that the use of the product will not result in any severe environmental problem, any bodily injury, or damage to assets. The Environmental Protection Use period is valid only when the product is operated under the conditions defined in the product manual.



PREFACE

SCOPE

This Manual contains Instructions for operating the Digital Radio Test System. It is strongly recommended that the Operator be thoroughly familiar with this manual before attempting to operate the equipment.

ORGANIZATION

The Manual is composed of the following Chapters:

CHAPTER 1 - INTRODUCTION

Provides an Introduction and a Brief Overview of Functions and Features. Principles of Operation are also included.

CHAPTER 2 - OPERATING INSTRUCTIONS

Identifies and functionally describes all Controls, Indicators and Connectors.

Provides UI interaction.

Provides a Turn-On Procedure and Initial Adjustments.

Provides Operation Procedures.

Provides Applications.

CHAPTER 3 - OPERATOR MAINTENANCE

Identifies and explains Routine Service, Maintenance and Storage Procedures.

TABLE OF CONTENTS

PARAGRAPH PAGE

CHAPTER 1 - INTRODUCTION

1-1	General Information	1-1
1-1A	Scope	1-1
1-1B	Nomenclature Cross-Reference List.....	1-1
1-2	Equipment Capabilities and Features	1-2
1-2A	Capabilities	1-2
1-2B	Features.....	1-3
1-3	Equipment Data.....	1-9
1-4	Principles of Operation.....	1-25

CHAPTER 2 - OPERATING INSTRUCTIONS

2-1	Operator's Controls, Indicators and Connectors	2-1
2-2	Functions and Tiles	2-5
2-2-1	System Icons	2-8
2-2-2	Touch Screen.....	2-12
2-2-3	User Interface (UI) Components	2-13
2-2-3A	Launch Bar	2-13
2-2-3B	Function Icons	2-14
2-2-3C	Tile Windows	2-15
2-2-3D	Defining Parameters	2-18
2-2-3E	Dropdown Menus	2-22
2-2-3F	Message Windows	2-24
2-2-4	System Menu	2-25
2-2-5	Suspend (Sleep) Mode	2-26
2-2-6	Multi-Language Support	2-28
2-3	Preventive Maintenance Checks and Services.....	2-30
2-3-1	General	2-30
2-3-2	Preventive Maintenance Procedures	2-30
2-3-2A	Tools, Materials and Equipment Required	2-30
2-3-2B	Routine Checks	2-30
2-3-2C	Schedule of Checks	2-30
2-4	Operation Under Usual Conditions	2-31
2-4-1	Turn-On Procedure	2-31
2-4-2	Install/Remove License	2-32
2-4-3	Install Software	2-36
2-4-4	Save/Recall Function Windows.....	2-38
2-4-5	Snapshot	2-39
2-4-6	Clone Unit	2-42
2-4-7	Digital Multimeter (DMM)	2-43
2-4-8	Configuration Modes	2-44
2-4-9	Time Base Reference Modes.....	2-46
2-5	Basic LMR Configuration Setups	2-47
2-5-1	Analog Demod.....	2-47
2-5-2	Analog SINAD	2-48
2-5-3	Digital DMR	2-49
2-6	Advanced Digital Configuration Setups.....	2-50
2-6-1	P25 Phase 2	2-50
2-6-2	DMR Repeater.....	2-51

CHAPTER 3 - MAINTENANCE

3-1	Preliminary Servicing and Adjustment of Equipment.....	3-1
3-2	Self Test.....	3-2
3-3	Maintenance Procedures	3-3
3-3-1	Battery Recharging	3-3
3-3-2	Battery Replacement.....	3-4
3-3-3	Fuse Replacement	3-5
3-3-4	DMM Fuse Replacement	3-6
3-3-5	Feet Replacement.....	3-7
3-4	Preparation for Storage or Shipment.....	3-8
3-4A	Packaging	3-8
3-4B	Environment.....	3-8

APPENDICES

A	Connector Pin-Out Tables.....	A-1
A-1	I/O Connectors	A-1
A-2	MIC Connector Pin-Out Table.....	A-3
A-3	REMOTE Connector Pin-Out Table	A-4
A-4	ETHERNET Connector Pin-Out Table	A-5
A-5	USB Connector Pin-Out Table	A-6
B	Abbreviations	B-1

LIST OF ILLUSTRATIONS / TABLES

LIST OF TABLES

<u>TITLE</u>	<u>PAGE</u>
I/O Connectors (Front Panel)	A-1
I/O Connectors (Rear Panel)	A-2
MIC Connector Pin-Out Table	A-3
REMOTE Connector Pin-Out Table	A-4
ETHERNET Connector Pin-Out Table	A-5
USB Connector Pin-Out Table	A-6

SERVICE UPON RECEIPT OF MATERIAL

Unpacking

Special-design packing material inside the shipping container provides maximum protection for the Digital Radio Test System. Avoid damaging the shipping container and packing material during equipment unpacking.

Use the following steps for unpacking the Digital Radio Test System.

- Cut and remove the sealing tape on top of the shipping container and open the shipping container.
- Remove the top packing mold.
- Remove the Digital Radio Test System and packing material from the bottom packing mold.
- Remove the protective plastic bag from the Digital Radio Test System and inspect the contents.
- Place the protective plastic bag and packing material inside the shipping container.
- Store the shipping container for future use should the Digital Radio Test System need to be returned/shipped.

Checking Unpacked Equipment

Check the equipment for damage incurred during shipment. If the equipment has been damaged or if items seem to be absent from the shipment, report the damage and/or discrepancies to Aeroflex Customer Service.

CONTACT: Aeroflex

Telephone: (800) 835-2350 (U.S. only)
(316) 522-4981

FAX: (316) 524-2623

E-Mail: americas.service@aeroflex.com

Checking Unpacked Equipment (cont)

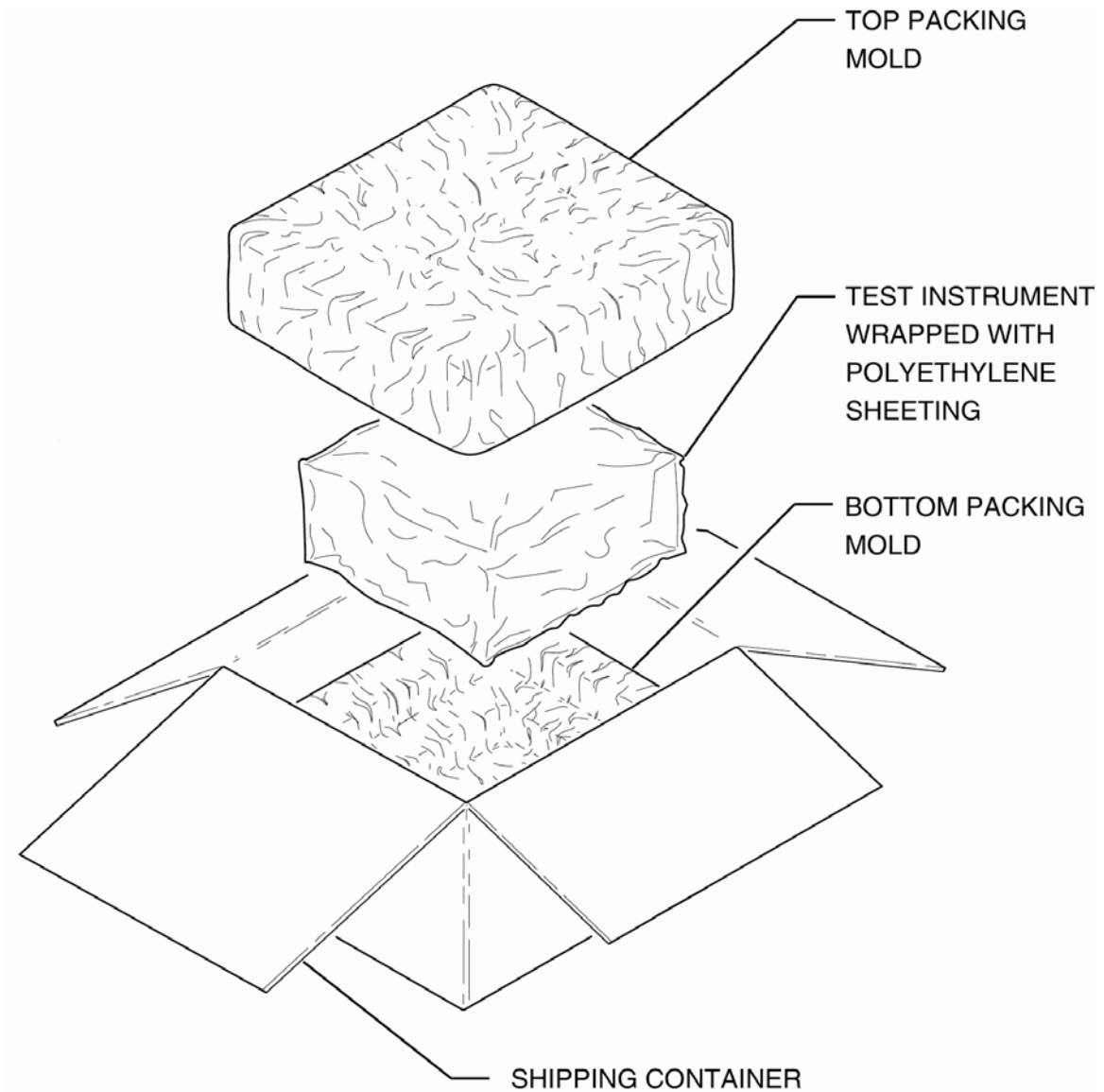

Checking Unpacked Equipment (cont)

STANDARD ITEMS

DESCRIPTION	PART NUMBER	QTY
8800 Series Digital Radio Test System: 8800 8800S 8800SX	112581 138803 139942	1
Battery, Spare	67076	1
External DC Power Supply	67374	1
Front Cover	138167	1
Fuse, Spare (5 A, 32 Vdc, Type F)	56080	2
Manual, Getting Started (Paper)	139254	1
Manual, Operation (CD)	139274	1
Power Cable (AC) (China)	91803	1
Power Cable (AC) (Continental Europe)	27480	1
Power Cable (AC) (North America)	27478	1
Power Cable (AC) (UK)	27477	1

Checking Unpacked Equipment (cont)

STANDARD ITEMS



8800 / 8800S / 8800SX
112581 / 138803 / 139942



Battery, Spare
67076



External DC Power Supply
67374



Front Cover
138167



Fuse, Spare (5 A, 32 Vdc, Mini-Blade)
56080

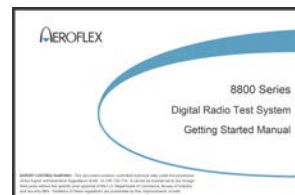

Manual, Getting Started (Paper)
139254



Manual, Operation (CD)
139274



Power Cable (AC) (China)
91803

Checking Unpacked Equipment (cont)

STANDARD ITEMS



Power Cable (AC) (Continental Europe)
27480



Power Cable (AC) (North America)
27478



Power Cable (AC) (UK)
27477

Checking Unpacked Equipment (cont)

OPTIONAL ITEMS

(These optional items may be included if ordered)

DESCRIPTION	PART NUMBER
Antenna Kit	114475
Attenuator (20 dB / 150 W)	82560
Battery Charger, External	114479
Battery, Spare	67076
Case, Soft-Sided Carrying Case	114478
Case, Transit	114477
DMM Test Leads	63936
Handset (Microphone)	112861
Manual, Maintenance (CD)	113614
Power Cable (DC Cigarette Lighter)	62404
Power Sensor (Bird 5017B)	113309
Precision DTF / VSWR Accessory Kit	114348
Rackmount Kit	114312

Checking Unpacked Equipment (cont)

OPTIONAL ITEMS

(These optional items may be included if ordered)

DESCRIPTION	PART NUMBER
Software Options	
DMR	8800 Series Opt01
dPMR	8800 Series Opt02
NXDN	8800 Series Opt03
P25	8800 Series Opt04
P25 Phase 2	8800 Series Opt05
ARIB-T98	8800 Series Opt09
Tracking Generator	8800 Series Opt10
Occupied Bandwidth	8800 Series Opt11
Internal Precision Power Meter	8800 Series Opt12
Precision Thru-Line Meter	8800 Series Opt13
PTC	8800 Series Opt14
AAR Channel Plan	8800 Series Opt15
R&S NRT-Z Power Sensor Support	8800 Series Opt20
Simplified Chinese	8800 Series Opt300
Traditional Chinese	8800 Series Opt301
Spanish	8800 Series Opt302
Portuguese	8800 Series Opt303
Malay / Indonesian	8800 Series Opt304
Korean	8800 Series Opt305
Arabic	8800 Series Opt306
Polish	8800 Series Opt307
Russian	8800 Series Opt308
Japanese	8800 Series Opt309
German	8800 Series Opt310
French	8800 Series Opt311
Italian	8800 Series Opt312

Checking Unpacked Equipment (cont)

OPTIONAL ITEMS

(These optional items may be included if ordered)



Antenna Kit
114475



Attenuator (20 dB / 150 W)
38242



Battery Charger, External
114479



Battery, Spare
67076



Case, Soft-Sided Carrying Case
114478



Case, Transit
114477



DMM Test Leads
63936



Handset (Microphone)
112861

Checking Unpacked Equipment (cont)

OPTIONAL ITEMS

(These optional items may be included if ordered)



Manual, Maintenance (CD)
113614



Power Cable (DC Cigarette Lighter)
62404

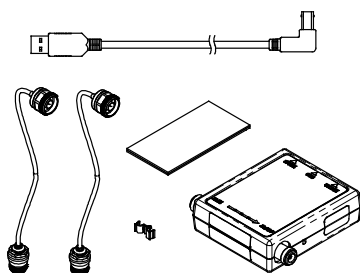

Power Sensor (Bird 5017B)
113309



Precision DTF / VSWR Accessory Kit
114348

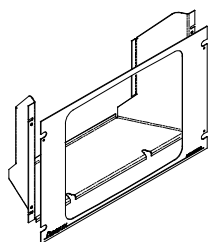

Rackmount Kit
114312

THIS PAGE INTENTIONALLY LEFT BLANK.

CHAPTER 1 - INTRODUCTION

1-1. GENERAL INFORMATION

A. Scope

Type of Manual: Operation Manual
Equipment Name and Model Number: 8800 Series Digital Radio Test System
Purpose of Equipment: The 8800 Series Digital Radio Test System is used for testing radios and related equipment.

B. Nomenclature Cross-Reference List

<u>COMMON NAME</u>	<u>OFFICIAL NOMENCLATURE</u>
8800	8800 Digital Radio Test System
8800S	8800S Digital Radio Test System
8800SX	8800SX Digital Radio Test System
8800 Series	8800 Series Digital Radio Test System
Test Set, Digital Radio Test System or Unit	8800 Series Digital Radio Test System

1-2. EQUIPMENT CAPABILITIES AND FEATURES

The 8800 Series Digital Radio Test System, used for Radio installation testing, designed for ease of use, portability, reliability and long service life, is capable of measuring high power, up to 50 W, as well as fault finding for antennas, power amplifiers and interconnects, meeting the needs of a variety of vehicular radios as well as commercial radio applications.

Power is derived from an optional internal battery. When using as a portable Test Set, the DC IN Connector is provided for battery charging, bench operation or servicing.

A. Capabilities

Capabilities

- RF Receiver Testing - Up to 1 GHz bandwidth; AM, FM, frequency and level measurements.
- RF Transmitter Testing - Up to 1 GHz bandwidth; AM, FM, 1 kHz / 150 Hz and external modulation sources.
- RF Power Meter - Up to 50 W continuous; 200 W with an external attenuator.
- VSWR measurements.
- Simple operation with few key strokes and textual displays.
- Large Touch Screen Display with user adjustable Backlight Brightness.
- Self Test for internal validation and testing.
- Optional Battery allows 2.5 hours typical continuous use before recharge.
- Automatic power shutdown after approximately 5 to 20 minutes (selectable) of non-use when AC power is not connected.
- Compact and lightweight enough to allow for one person operation.

B. Features

Functions and Tiles - LMR

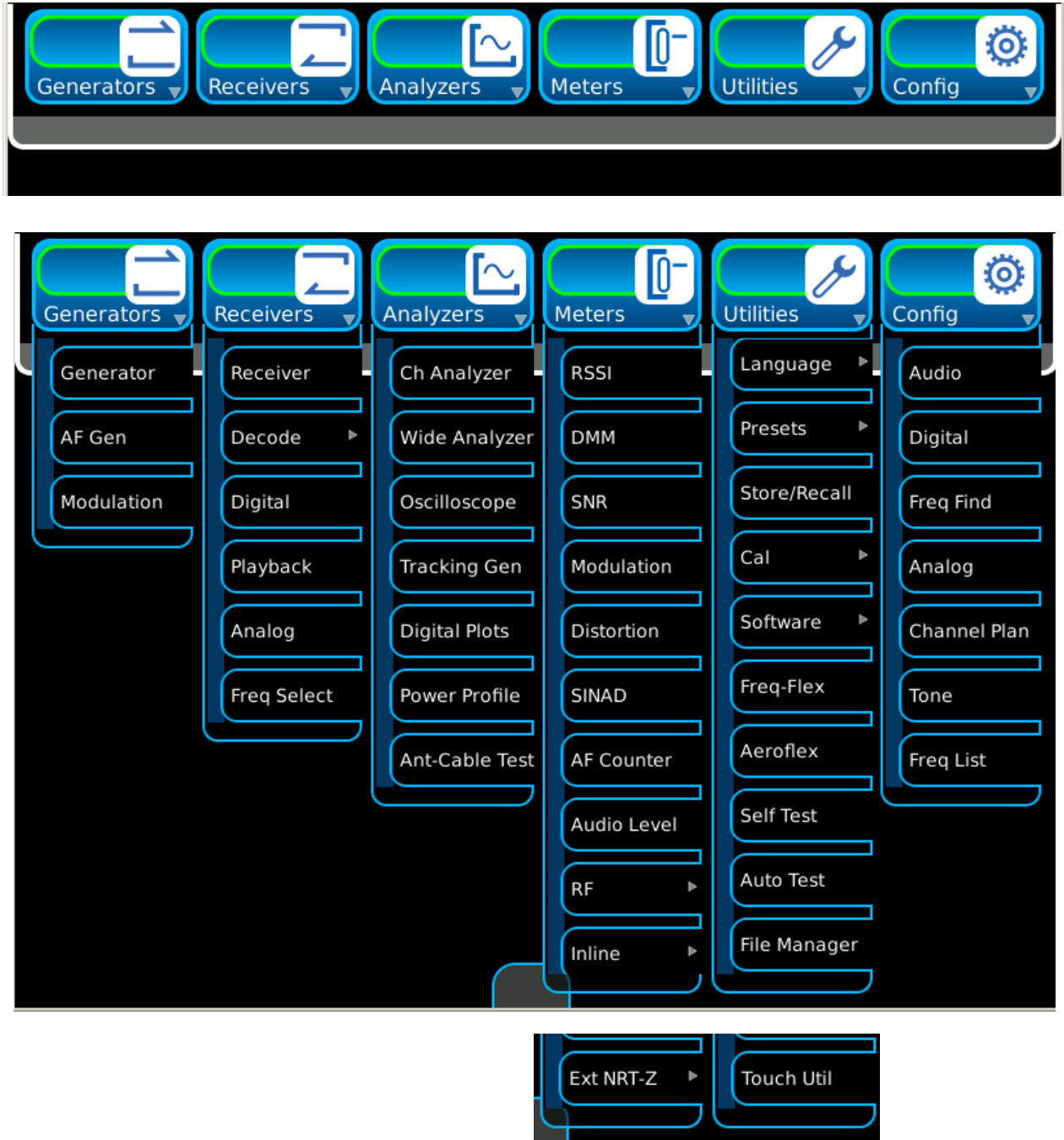

(Optional Functions are shown for display purposes only.)

B. Features (cont)

Functions and Tiles - Extended - LMR

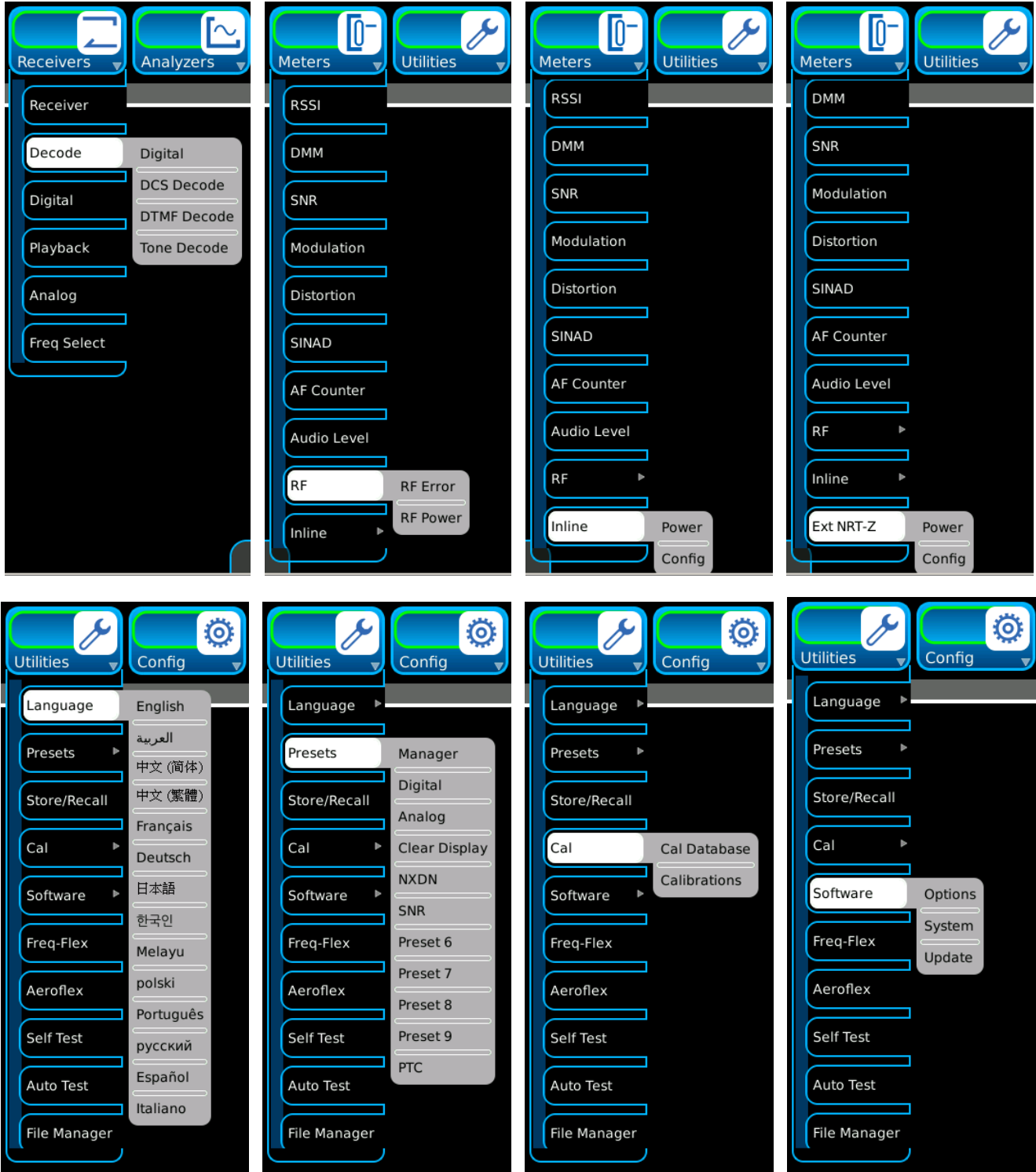

(Optional Functions are shown for display purposes only.)

B. Features (cont)

Functions and Tiles - PTC

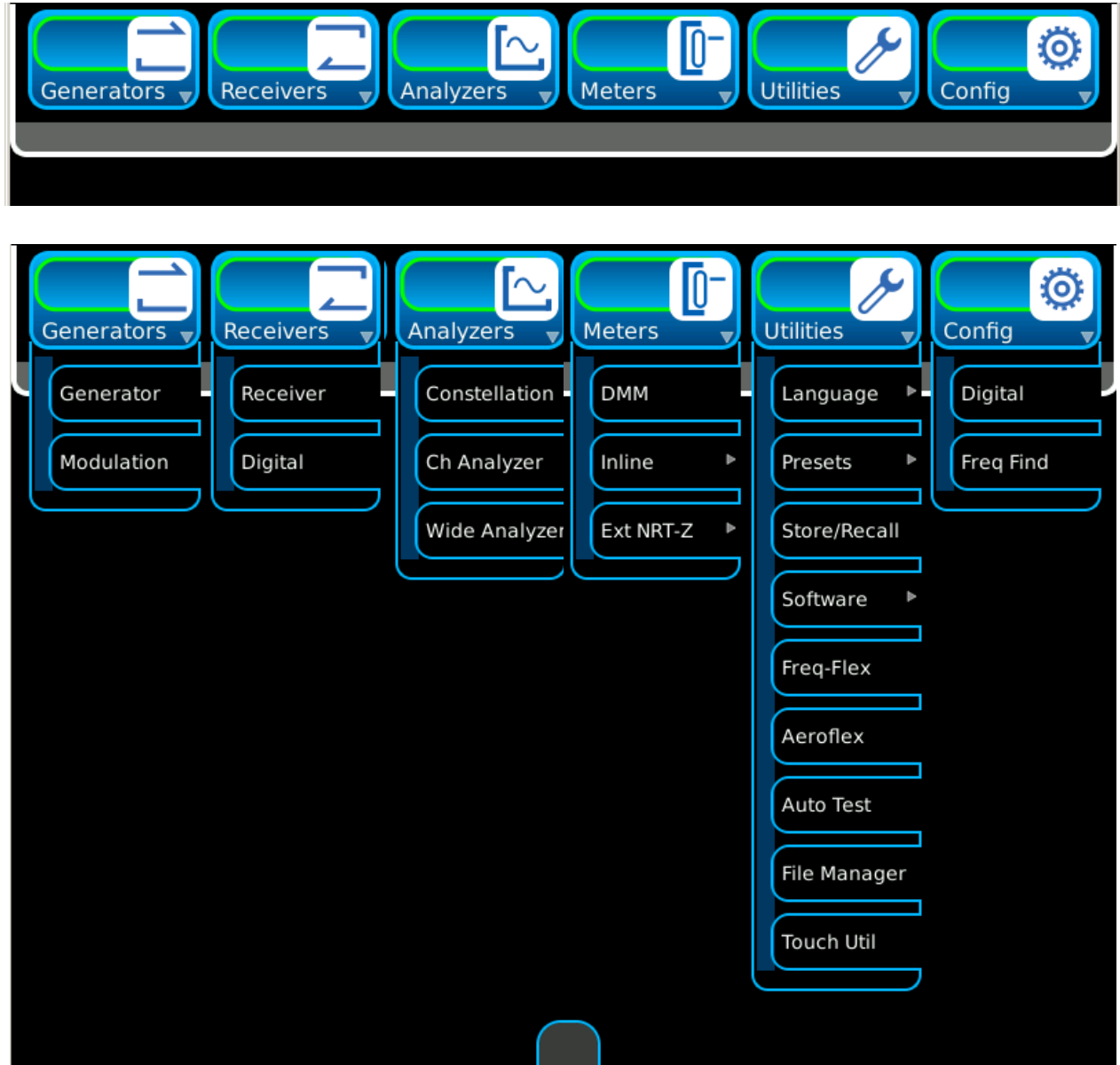

(Optional Functions are shown for display purposes only.)

B. Features (cont)

Functions and Tiles - Extended - PTC



(Optional Functions are shown for display purposes only.)

B. Features (cont)

Functions and Tiles - Advanced Digital

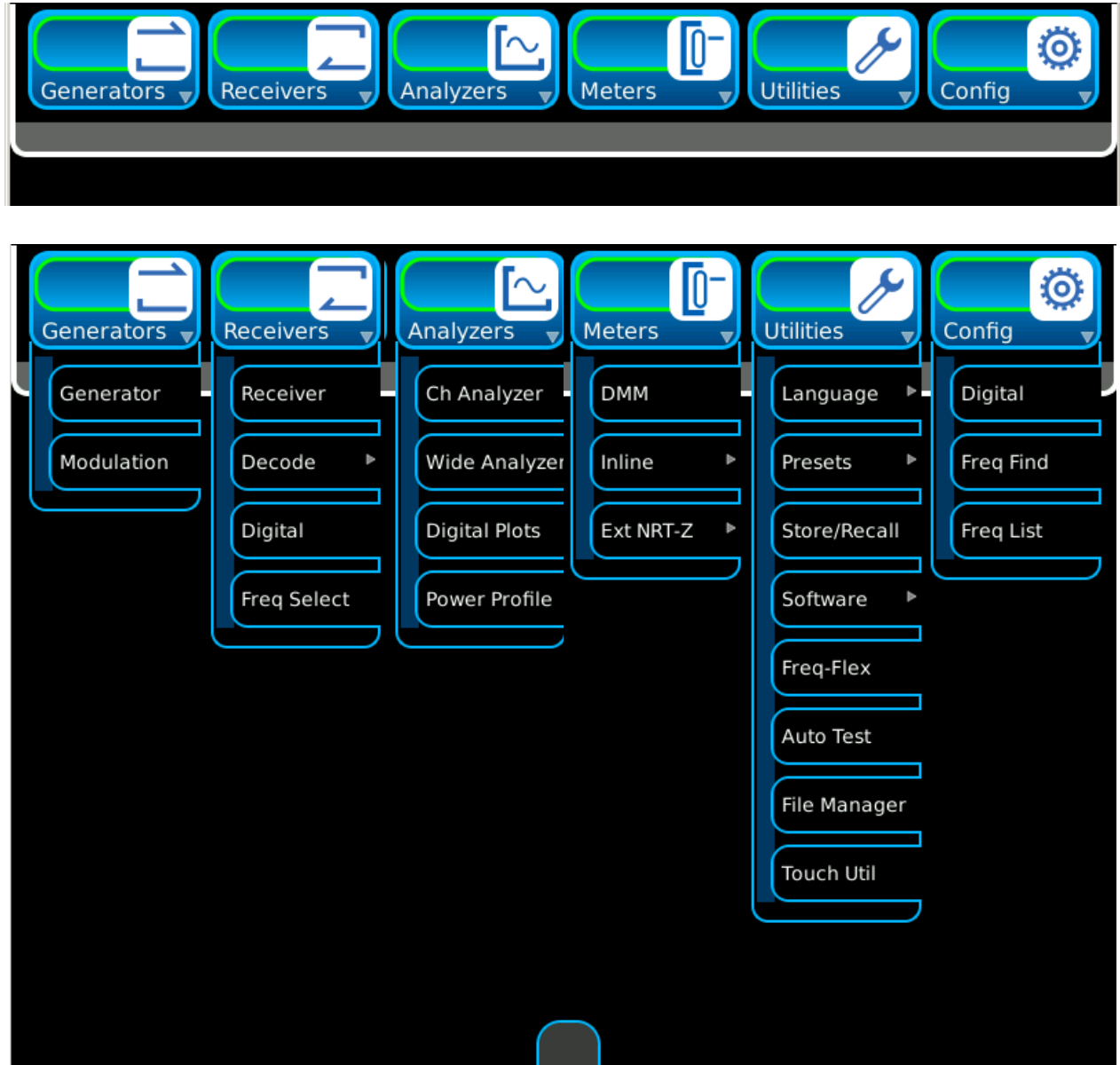

(Optional Functions are shown for display purposes only.)

B. Features (cont)

Functions and Tiles - Extended - Advanced Digital



(Optional Functions are shown for display purposes only.)

1-3. EQUIPMENT DATA

NOTE

- Where specified resolution exceeds specified accuracy, the specified resolution takes precedence.
- Accuracy and resolution stated in percentages are referenced to the measured or selected value.
- All RF characteristics are referenced to 50 Ω .
- Allow warm-up period of at least 10 minutes.
- Received (input) signal modulation bandwidth does not exceed selected receiver IF bandwidth.
- ANT and GEN Connector's VSWR specification only applies when the connector is selected.
- Specifications are subject to change without notice.

RF GENERATOR

PORT INPUT PROTECTION

ANT Port:	+20 dBm (Input Power Alarm Typical)
T/R Port (8800):	+49 dBm CW (Input Power Alarm Typical) >+90°C (Temperature Alarm Typical)
T/R Port (8800S / 8800SX):	+52 dBm CW (Input Power Alarm Typical) >+90°C (Temperature Alarm Typical)

FREQUENCY

Range:	2 to 1000 MHz
Usable Range:	100 kHz to 2 MHz
Accuracy:	Same as Timebase
Resolution:	1 Hz

OUTPUT LEVEL RANGE

T/R Connector:	-50 to -125 dBm
ANT Connector:	-30 to -90 dBm
GEN Connector:	-5 to -65 dBm
Level Accuracy:	± 2 dB ± 3 dB (<-100 dBm) ± 3 dB (<-110 dBm Hold Atten Mode)

NOTE

ANT Connector Generator output level only applies when Receiver port is selected to ANT.

Generator ANT Port level accuracy is valid >0°C.

Level Resolution:	1 dB
Level Resolution (Hold Atten Mode):	0.1 dB (0 to -6 dB)

NOTE

Level Accuracy is not specified over Temperature in "Hold Atten Mode."

1-3. EQUIPMENT DATA (cont)

RF GENERATOR (cont)

External: MIC, Audio In

MIC FM:

Microphone Input:

Alternate Microphone Configurations	MIC Connector Pins
Range 1: 2 to 15 mVrms (8 mVrms Typical)	Pin 2-OPEN, Pin 6-GND
Range 2: 35 to 350 mVrms (100 mVrms Typical)	Pin 2-GND, Pin 6-OPEN
Range 3: 2 to 32 mVrms (20 mVrms Typical)	Pin 2-OPEN, Pin 6-OPEN

NOTE

Range 2 turns ON a nominal 3 Vdc bias voltage.

FM Frequency Range: 300 Hz to 3 kHz

FM Level: Off, 0 Hz to 80 kHz

FM Modulation Accuracy: $\pm 20\%$ (300 Hz to 1.2 kHz)
 $\pm 30\%$ (>1.2 kHz)

FM Input Slope: Positive voltage yields positive deviation

AUD IN:

Input Range: 3 V, 30 V

Switchable Loads:

3 V Range: 150 Ω , 600 Ω , 1 k Ω , High Z

30 V Range: High Z

Input Levels:

3 V Range: 0.05 to 3.2 Vrms

30 V Range: 3 to 30 Vrms

FM Input Frequency Range: 300 Hz to 5 kHz

FM Input Level Sensitivity:

3 V Range: 1 kHz / 35 mVrms Typical

30 V Range: 1 kHz / 350 mVrms Typical

FM Input Slope: Positive voltage yields positive deviation

MODULATION - AM

Internal: Gen 1, Gen 2

Frequency Rate:

Range: 10 Hz to 20 kHz

Resolution: 0.1 Hz

Accuracy: Timebase ± 2 Hz

Range: OFF, 0% to 100% (GEN1 and GEN2 selectable)

Resolution: 0.1%

1-3. EQUIPMENT DATA (cont)

RF GENERATOR (cont)

Frequency Accuracy: Timebase ± 2 Hz
Output Level:
Audio Out Load Impedance: $< 1 \Omega$
Audio Level Out: 0 to 1.57 Vrms
Resolution: 0.001 Vrms
Accuracy: $\pm 10\%$, > 100 Vrms, 30 Hz to 5 kHz
Distortion: $< 3\%$ (1 kHz rate, sine 300 Hz to 3 kHz)

1-3. EQUIPMENT DATA (cont)

RECEIVER METERS

RF ERROR METER

Units:Hz, PPM
Range:..... ± 200 kHz / ± 1000 ppm
Resolution:..... 1 Hz
Accuracy:..... Timebase ± 1 Hz

RSSI METER (RF Power within Receiver IF BW)

Units:dBm, Watts, microWatts
Range (3 Connectors):..... -120 to +60 dBm
Useable RF Level Range:
ANT Connector (Preamp OFF): -90 to +10 dBm
ANT Connector (Preamp ON):..... -110 to -10 dBm
T/R Connector: -50 to +47 dBm
Resolution:..... 0.01 dBm
Accuracy:..... ± 3 dB, ± 1.5 dB Typical (Normalize function completed)
Ext Attenuation: 0 to 30 dB, 0.01 dB resolution

RF POWER METER (CW Only) (Broadband RF Power into T/R Connector)

Range:..... +20 to +53 dBm
Meter Floor:0.10 W / +20 dBm
Maximum T/R Port Input Level (8800):..... 50 W continuous, +25°C, +10°C
Maximum T/R Port Input Level (8800S / 8800SX):..... 125 W, +25°C, +10°C
50 W continuous
Max ON of 30 sec and Min OFF of 90 sec for power levels >50 W
Averaging Range:..... 1 to 99
Display Units:dBm, Watts
Resolution:..... 0.01 W, 0.1 dBm
Accuracy:..... 10% of reading (6% Typical)
Zero function completed
Receiver set to desired Frequency
Ext Attenuation: 0 to 50 dB, 0.01 dB resolution

1-3. EQUIPMENT DATA (cont)

AUDIO METERS

SINAD METER

Measurement Sources: AUD IN, DEMOD
DEMOD:
FM:>2 kHz Deviation (IF BW set appropriately for received modulation BW)
AM:>25% Modulation (IF BW set appropriately for received modulation BW)
AUD IN:
Frequency Range:..... 300 Hz to 10 kHz
Input Level:
3 V (Audio Config Setup):0.9 Vp-p to 8 Vp-p
30 V (Audio Config Setup):9 Vp-p to 80 Vp-p
Audio Frequency Notch:..... 1 to 1.8 kHz (Useable to 5 kHz.)
Reading Range: 0 to 60 dB
Resolution:..... 0.001 dB
Accuracy: ± 1.5 dB, reading >8 dB, <40 dB

SNR Meter

Weighting:.....User defined from C-WT BP, CCITT BP, NONE, 15 kHz LP,
..... 0.3 kHz LP, 0.3 kHz HP, 5 kHz LP, 300 Hz to 5 kHz BP,
..... 300 Hz to 3 kHz BP, 0.3 kHz to 20 kHz BP, 3 kHz LP
Display Range: 0 to 100 dB
Accuracy: ± 1 dB, reading >8 dB, <50 dB

DISTORTION METER

Measurement Sources: AUD IN, DEMOD
DEMOD:
FM:>2 kHz Deviation (IF BW set appropriately for received modulation BW)
AM:>25% Modulation (IF BW set appropriately for received modulation BW)
AUD IN:
Frequency Range:..... 300 Hz to 10 kHz
Input Level:
3 V (Audio Config Setup):0.9 Vp-p to 9 Vp-p
30 V (Audio Config Setup):9 Vp-p to 90 Vp-p
Audio Frequency Notch:..... 1 to 1.8 kHz (Useable to 5 kHz.)
Reading Range: 0% to 100%
Resolution:..... 0.001%
Accuracy: $\pm 10\%$ of reading + 0.1% Distortion, >1% to <20%

1-3. EQUIPMENT DATA (cont)

AUDIO METERS (cont)

AF COUNTER

Measurement Sources: AUD IN, DEMOD

DEMOD:

FM:15 Hz to 20 kHz Rate (IF BW set appropriately for received modulation BW)

AM: 100 Hz to 10 kHz Rate (IF BW set appropriately for received modulation BW)

AUD IN:

Frequency Range:..... 300 Hz to 20 kHz

Input Level:

3 V (Audio Config Setup): 28 mVp-p to 9 Vp-p

30 V (Audio Config Setup):280 mVp-p to 90 Vp-p

Frequency Range: 15 Hz to 20 kHz

Resolution:.....0.1 Hz

Accuracy:±1 Hz

AUDIO FREQUENCY LEVEL METER

Measurement Sources: AUD IN, SCOPE

Input Ranges:

AUD IN:3 V, 30 V

SCOPE: 2 Vdc, 40 Vdc

Frequency Range: 200 Hz to <5 kHz

Load Selection:

AUD IN:

3 V Input Range:..... High Z, 150 Ω, 600 Ω, 1 kΩ

30 V Input Range: 10 kΩ

SCOPE: High Z

Input Level:

AUD IN Connector:

3 V Range:..... 10 mVrms to 3 Vrms

30 V Range: 1 to 30 Vrms

SCOPE Connector:

2.0 Vdc Range:..... 10 mVrms to 1 Vrms

40 Vdc Range:..... 1 to 28.28 Vrms

Display Unit Resolution:.....0.001 V, 0.001 mV, 0.001 dBμV, 0.001 dBm, 0.001 W

Accuracy:±5% (AUD IN Connector)

1-3. EQUIPMENT DATA (cont)

OPTIONS

SWR

Frequency: 2 to 1000 MHz (Calibration and Sweep Bandwidth)

Resolution: 0.1 MHz

SWR Reading:

Range: 1.00 to 20.00

Resolution: 0.01

Accuracy: $\pm 20\%$ of SWR readings (Calibrate) <300 MHz (Typical)
..... $\pm 30\%$ of SWR readings (Calibrate) >300 MHz (Typical)

DTF READING

Test Range: 3 to 328 ft (1 to 100 m)

Display Range: 40 to 400 ft
(Range is function of Frequency Span and Cable Velocity and Cable Loss.)

Accuracy: ± 3 ft

DIGITAL MULTIMETER (DMM)

AC / DC Voltmeter

Full Scale Ranges: 200 mV, 2 V, 20 V, 200 V, 2000 V, Auto
(150 VAC RMS or VDC MAX input, Category II)

Resolution: 3.5 Digits (2000 Counts)

Accuracy:

AC: $\pm 5\%$ FS, ± 1 Count + 25mV

DC: $\pm 1\%$ FS, ± 1 Count

AC / DC Ammeter

Full Scale Ranges: 200 mA, 2 A, 20 A, Auto
(20 A Range uses Optional Shunt connected to Voltmeter)

Maximum Open Circuit Input Voltage: 30 Vrms
(referenced to COMMON or EARTH GROUND, Category I)

Resolution: 3.5 Digits (2000 Counts)

Accuracy:

AC: $\pm 5\%$ FS, ± 1 Count

DC: $\pm 5\%$ FS, ± 1 Count

AC Volts Frequency Range: 50 Hz to 10 kHz

Ohmmeter

Full Scale Ranges: 200 Ω , 2 k Ω , 20 k Ω , 200 k Ω , 2 M Ω , 20 M Ω , Auto

Resolution: 3.5 Digits (2000 Counts)

Accuracy: $\pm 5\%$ FS, ± 1 Count

1-3. EQUIPMENT DATA (cont)

OPTIONS (cont)

IN-LINE POWER METER

RF Measurement Type: Average Power, Peak, Burst, Crest, CCDF
Frequency Range: 25 MHz to 1.0 GHz
Power Range: 500 mW to 500 W Average, 13.3 to 1300 W peak
Insertion VSWR: <1.05
Insertion Loss: <0.05 dB
Directivity: 29 dB up to 50 MHz
30 dB from 51 to 1000 MHz
Accuracy: +25°C ($\pm 10^\circ\text{C}$), Internal Temperature of In_Line Power Meter
Receiver set to desired Frequency

Average Power

Average Forward Power Range: 500 mW to 500 W Avg
Peak/Average Ratio Maximum: 12 dB
Accuracy, Average Forward Power: $\pm 4\%$ of reading + 166 mW
Return Loss: 0 to 23 dB
VSWR: 1.15 to 99.9

Burst Average Power

Burst Average Power Range: 13.5 to 500 W Average
Burst Width: 1 μs to 5 ms
Repetitions Rate Min: 200 Hz
Duty Cycle (D): 0.001 to 1.0 (D = Burst Width / Period)
Accuracy, Burst Average Power: $\pm 6\%$ of reading + 0.166/D mW

Peak Envelope Power

Peak Envelope Power Range: 13.3 to 1300 W
Peak Envelope Power Accuracy
Burst Width > 200 μs : $\pm 7\%$ of reading, + 0.70 W
1 μs < Burst Width < 200 μs : $\pm 10\%$ of reading, + 1.40 W
0.5 μs < Burst Width < 1 μs : $\pm 15\%$ of reading, + 1.40 W
Burst Width < 0.5 μs : $\pm 20\%$ of reading, + 1.40 W

Crest Factor

Measurement Range: 500 mW to 300 W, 13.3 W Minimum peak
Accuracy, Crest Factor: Linear Sum of Peak and Average Power Accuracies

1-3. EQUIPMENT DATA (cont)

OPTIONS (cont)

Complementary Cululative Distribution Function (CCDF)

CCDF Measurement Range: 0.1% to 100%

Threshold Measurement Range:..... 13.5 to 500 W

Measurement Uncertainty:..... ±0.2%

Level Set Accuracy:As Peak Envelope, Power Accuracy + 2.0%

SPEAKER OUTPUT

Speaker:On or Off

Output: 75 dBa minimum at 0.5 m, 600 to 1800 Hz, maximum volume

VOLUME CONTROL

Level Range: Scale 0 to 100

TIMEBASE

Frequency Stability: 0.15 ppm at -20°C to 70°C

Aging:0.02 ppm / day
1.0 ppm/ year

NOTE

Frequency Stability is observed with a temperature variable speed of <2°C/minute.

Aging applies after 1 hr of operation.

External Reference (10 MHz IN) (8800SX only):

Input Frequency Range:..... 10 MHz (±150 Hz)

Input Level:..... -10 to +10 dBm

Maximum Input Level:..... +15 dBm

FREQ-FLEX (EXTERNALLY REFERENCED TIMEBASE CALIBRATION)

Input Frequency Range:..... 2 to 1000 MHz

Reference Input Connector:..... >-20 dBm (T/R)
>-40 dBm (ANT)

Freq-Flex Accuracy: <0.5 Hz from External Source Applied + Stability + Aging
(Example: 10 MHz External input after Freq Flex = ±0.5 Hz to External input.
10 MHz ±0.5 Hz = 0.05ppm + Stability + Aging)

1-3. EQUIPMENT DATA (cont)

ENVIRONMENTAL / PHYSICAL

OVERALL DIMENSIONS: 343 mm (13.50 in) (W), 293 mm (11.54 in) (L), 146 mm (5.75 in) (D)

WEIGHT: 17 lbs. (7.71 kg) (8800 / 8800S Only)

TEMPERATURE

Storage: -40°C to +71°C (MIL-PRF-28800F, Class 3)

NOTE

Battery must not be subjected to temperatures below -20°C, nor above +60°C.

Operation:

AC/DC Power Supply: 0°C to +40°C

Battery Power: -20°C to +50°C

NOTE

Battery operation over temperature is based on the actual temperature rise of the Battery and instrument usage.

Battery must not be subjected to temperatures below -20°C, nor above +60°C.

RELATIVE HUMIDITY: 5% to 95% (MIL-PRF-28800F, Class 3)

ALTITUDE:

DC Operation: 4600 M (MIL-PRF-28800F, Class 3)

AC Operation: 3048 M

SHOCK (FUNCTIONAL): 30 G (MIL-PRF-28800F, Class 3)

VIBRATION: 5 to 500 Hz Random Vibrations (MIL-PRF-28800F, Class 3)

BENCH HANDLING: MIL-PRF-28800F, Class 3

COMPLIANCE/SAFETY

EMC Emissions and Immunity: MIL-PRF-28800F, Class 3
EN61326-1 Class A
EN61000-3-2
EN61000-3-3

Safety: UL 6101-1
UL 61010-1
CSA C22.2 No. 61010-1

1-3. EQUIPMENT DATA (cont)

AC INPUT POWER (AC to DC Converter / Charger)

Voltage Range: 100 to 250 VAC, 3 A maximum, 47 to 63 Hz
Voltage Fluctuation: <10% of the nominal input voltage
Transient Overvoltage: According to Installation Category II
Usage Environment: Indoor Use
80% Maximum Relative Humidity for temperatures up
to 31°C decreasing linearly to 50% RH at +40°C
Installation Category II
Pollution Degree 2
Operating Temperature: 0°C to +40°C
Storage Temperature: -20°C to +85°C
EMI: EN55022 Class B
EN61000-3-2 Class D
Safety: UL 1950
CSA 22.2 No. 234 and No.950
IEC 950/EN 60950

DC INPUT POWER

Voltage Range: 11 to 24 Vdc
Maximum Power: 55 W, 65 W charging with Optional Battery
Typical Power: 30 W
DC Fuse: Mini-Blade, 5 A, 32 Vdc, Type F

BATTERY

Battery Type: Lithium Ion (Li Ion) Battery Pack

NOTE

Battery must not be subjected to temperatures below -20°C, nor above +60°C.

Operation Time:

Minimum Backlight (Still Viewable): 3 hours Typical

100% Backlight: 2.5 hours Typical

Charge Time: 4 hours (Unit OFF) Typical
4 hours (Unit ON) Typical

NOTE

Battery does not charge when Battery temperature is <0°C and >+45°C.

Dead Battery (<10% capacity) is to be charged for 20 minutes before operation
on External DC Power.

1-4. PRINCIPLES OF OPERATION

The Digital Radio Test System contains the following assemblies:

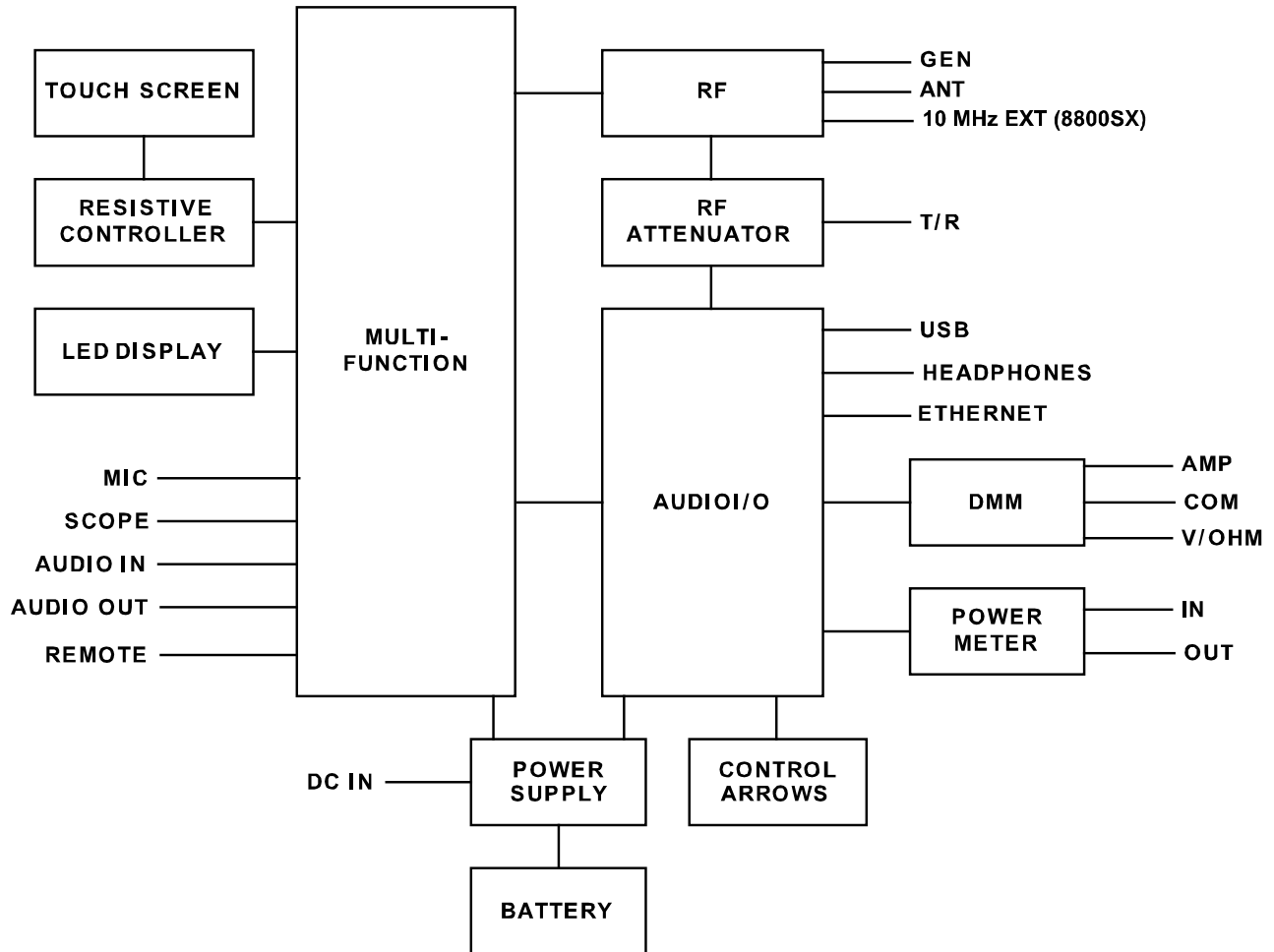

THIS PAGE INTENTIONALLY LEFT BLANK.

CHAPTER 2 - OPERATING INSTRUCTIONS

2-1. OPERATOR'S CONTROLS, INDICATORS AND CONNECTORS

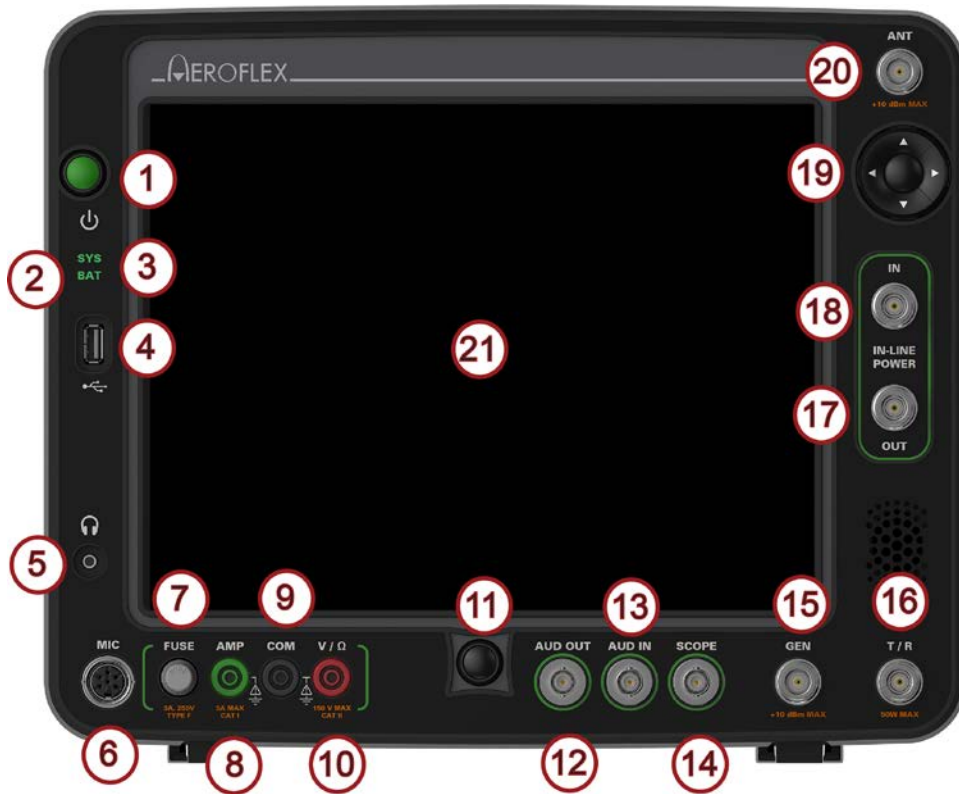

(Front Panel)

2-1. OPERATOR'S CONTROLS, INDICATORS AND CONNECTORS (cont)

ITEM	DESCRIPTION
1	POWER Key Used for powering the Unit ON and OFF.
2	BATT Indicator Used to indicate the charging state of the Battery (if installed): GREEN Battery at Full Charge AMBER Battery is Charging
3	SYS Indicator Illuminates when external DC power is applied. WHITE Unit is in "awake/ON" mode. FLASHING RED/GREEN Battery temperature is >60°C. Warning message is displayed. BLUE Unit is in "sleep" mode. RED Unit is shutting down.
4	USB Connector Allows allows connection of USB 2.0 devices (e.g. USB memory stick).
5	Head Phones Connector Used for connection to Head Phones.
6	MIC Connector Used for connection to a Handset (Microphone).
7	DMM Fuse 3 A, 250 V, Type F
8	AMP Connector Digital Multimeter External Input for AC and DC current meter input.
9	COM Connector Digital Multimeter External Input for DMM functions.
10	V / Ω Connector Digital Multimeter External Input for DMM AC or DC Voltmeter and Ohmmeter.
11	HOME Key Provides access to a screen for the selection of User controls and settings.
12	AUD OUT Connector Used to receive external modulation input, and as input for the SINAD and Distortion Meters and AF Counter.
13	AUD IN Connector Used as output for Demod and Function Generators and for Audio In signal output.
14	SCOPE Connector Provides DC coupled input for the Audio Level Meter and the Oscilloscope.
15	GEN Connector Provides the maximum RF output level from the RF Generator.

2-1. OPERATOR'S CONTROLS, INDICATORS AND CONNECTORS (cont)

ITEM		DESCRIPTION
16	T/R Connector	Used for high power direct connection to radio equipment.
17	IN LINE POWER OUT Connector	Used with optional hardware for connection to the Radio Transmitter for measuring in-line power.
18	IN LINE POWER IN Connector	Used with optional hardware for connection to the load (i.e., Antenna) for measuring in-line power.
19	Arrow Keys	Used for manual edit of numeric values.
20	ANT Connector	Used for over-the-air tests.
21	Touch Screen Display	Used for viewing menus and screens and for providing manual input for data and settings.

2-1. OPERATOR'S CONTROLS, INDICATORS AND CONNECTORS (cont)



**8800 / 8800S
(Rear Panel)**



**8800SX
(Rear Panel)**

ITEM	DESCRIPTION	
1	ETHERNET Connector	Used for software upgrades and/or Remote Operation.
2	USB Connector	Allows connection of USB 2.0 devices (e.g. USB memory stick).
3	Ground Connector	Used as a chassis ground point for an optional ground connection.
4	DC IN Connector	Used for External DC operation of the Unit or battery charging.
5	REMOTE Connector	Used for communicating with external equipment.
6	10 MHz IN Connector	Used to connect the Unit to an external frequency standard.

2-2. FUNCTIONS AND TILES

Functions and Tiles - LMR

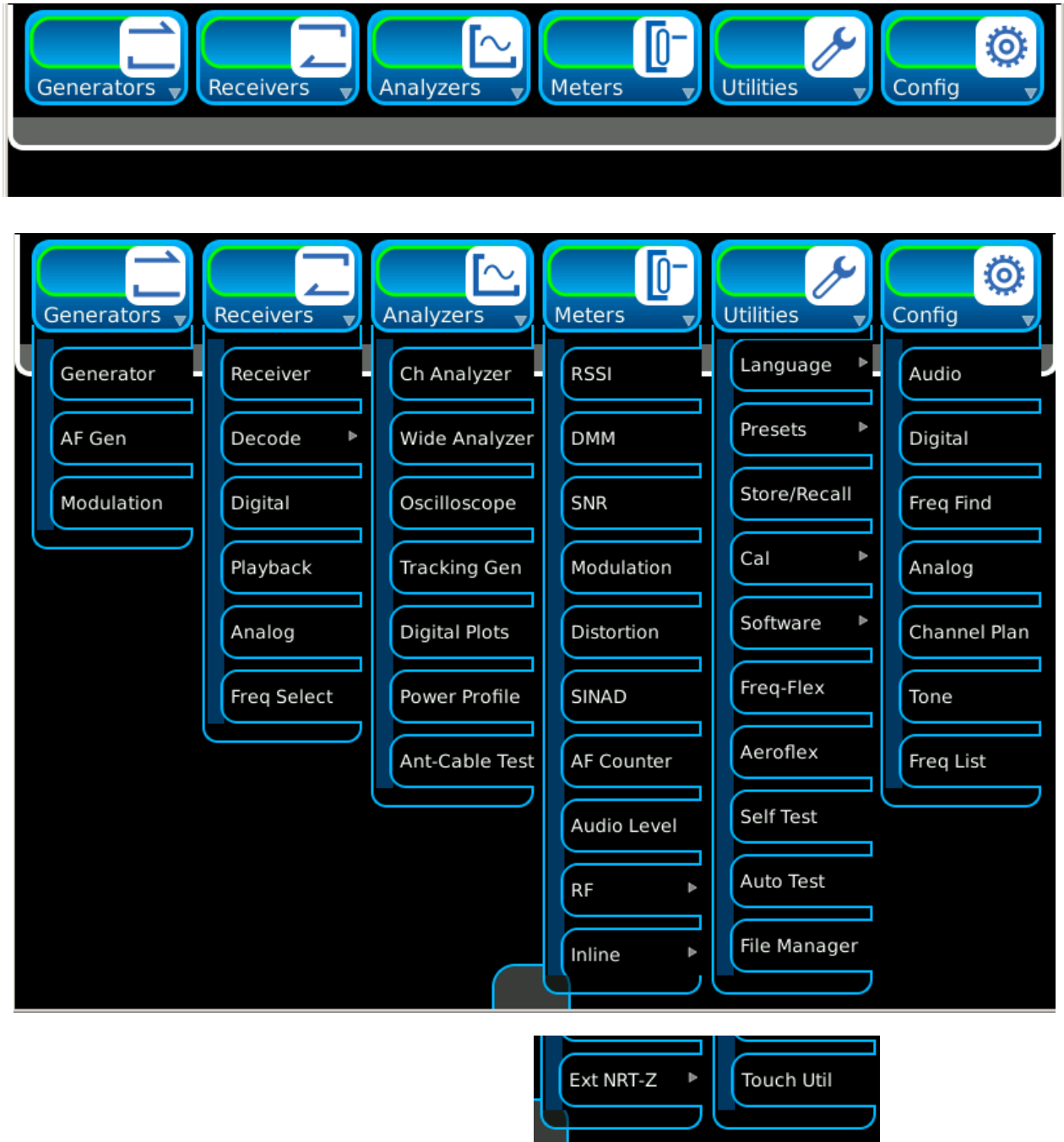

(Optional Functions are shown for display purposes only.)

2-2. FUNCTIONS AND TILES (cont)

Functions and Tiles - PTC

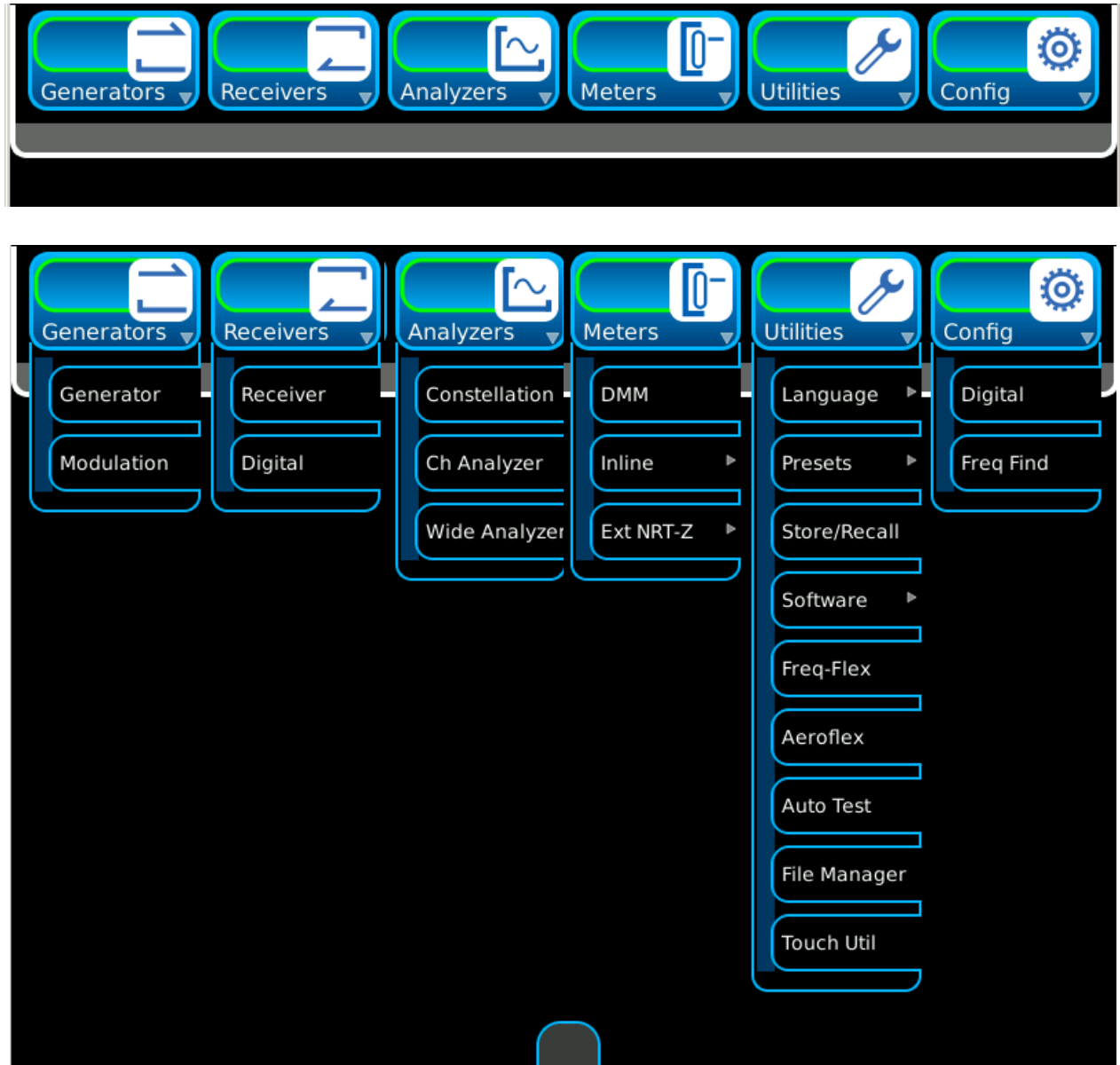

(Optional Functions are shown for display purposes only.)

2-2. FUNCTIONS AND TILES (cont)

Functions and Tiles - Advanced Digital



(Optional Functions are shown for display purposes only.)

2-2-1. SYSTEM ICONS

The System icons are displayed in three modes at the bottom of the screen.



When the System icons are set to minimize mode (default setting), select the System icon tab to display the System icons.

NOTE: If the gray icon is not visible, the “Hide Icons” button on the System Menu has been selected.













Press the Open/Close icon to display the System icons with status window.



Press the Open/Close icon again to display the System icons in minimize mode.







2-2-1. SYSTEM ICONS (cont)

ICON	FUNCTION
	Opens and closes the Status Bar.
	Applies the external reference (Freq-Flex) Calibration value (if calibrated).
	Switches between Internal or External 10 MHz reference.
	Opens the Snapshot Tile Window.
	Indicates touch screen functions are locked or unlocked.
	Captures (freezes) the readings/traces on the screen.
	Indicates the Unit is controlled remotely.
	Indicates Warnings and Error Messages.
	Displays the level of charge remaining in the Battery.
	Status window.

2-2-1. SYSTEM ICONS (cont)

The Function Window icons are displayed at the bottom right of the Function Windows.

ICON	FUNCTION
	Switches between numeric entry pad and slider bar.
	Sends Tile Windows to back of other Tile Windows on the screen.
	Closes the Tile Window.
	Alternates between the different views (if applicable) of the Tile Window.
	Alternates between the different views (if applicable) of the Tile Window.

2-2-1. SYSTEM ICONS (cont)

The Marker icons are displayed on the Tile Windows.

ICON	FUNCTION
	Enables marker delta measurements for the first two enabled markers.
	Adds a Marker to the graph.
	Deletes an active marker from the Markers Window.
	Moves the selected marker to the highest point on signal.
	Moves the selected marker to the lowest point on signal.
	Moves the selected marker left to the next peak. Supports press and hold functionality.
	Moves the selected marker right to the next peak. Supports press and hold functionality.
	Moves the selected marker left to the next data point. Supports press and hold functionality.
	Moves the selected marker right to the next data point. Supports press and hold functionality.
	Moves the selected marker to the left side of the plot field.
	Moves the selected marker to the right side of the plot field.

2-2-2. TOUCH SCREEN

The Digital Radio Test System contains a resistive Touch Screen that is responsive to the touch of a human finger. Gloves can be worn when utilizing the Touch Screen or a writing instrument (e.g. stylus) can be used on the Touch Screen.

The Digital Radio Test System UI is navigated locally using the Front Panel Touch Screen.

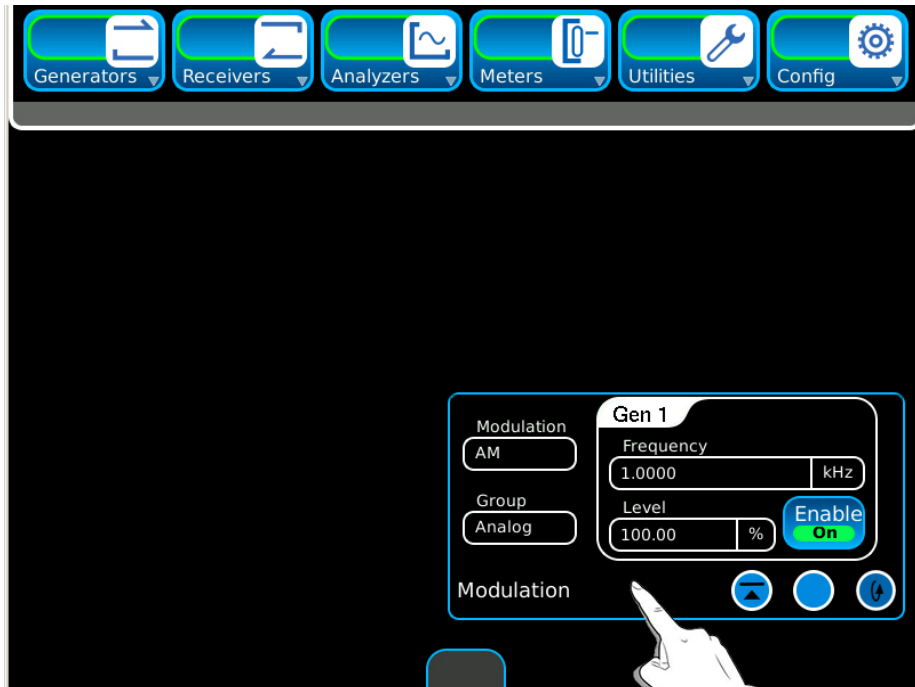
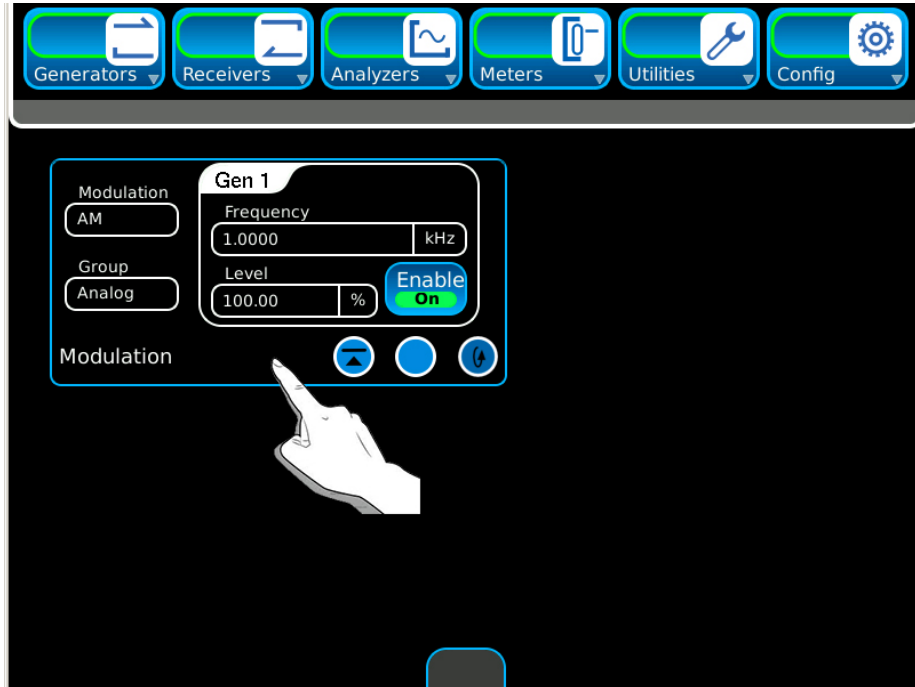

2-2-3. USER INTERFACE (UI) COMPONENTS

A. Launch Bar

The Digital Radio Test System UI is a touch screen control panel that provides a flexible working environment for all users. The UI is designed to allow users to open and close, drag and drop, and maximize/minimize screen components to create custom display configurations.

The Launch Bar is located at the top of the UI. The Launch Bar provides access to the Function Icons.

The Launch Bar is opened (from minimize mode) by clicking on the gray icon at the top of the screen.

NOTE: If the gray icon is not visible, the “Hide Menu” button on the System Menu has been selected.

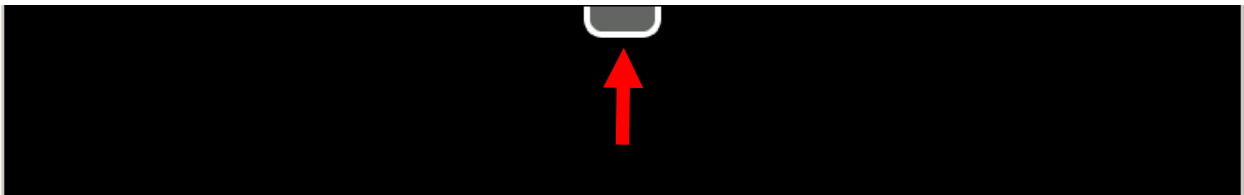

The Launch Bar is minimized by clicking on the gray bar at the bottom of the Launch Bar.

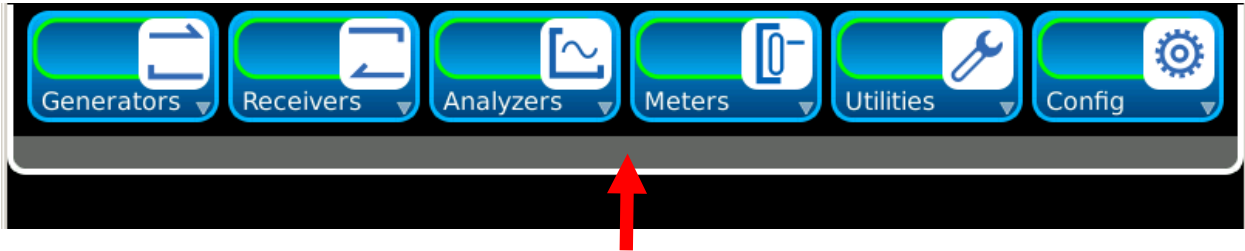

2-2-3. USER INTERFACE (UI) COMPONENTS (cont)

B. Function Icons

The Launch Bar consists of Function Icons that identify functions installed in the Digital Radio Test System. The Tiles displayed in the Function Dropdown Menus depend on the Options installed in the Digital Radio Test System.

When the Launch Bar is set to minimize mode (default setting), select the gray icon at the top of the screen to display the Launch Bar.

NOTE: If the gray icon is not visible, the “Hide Menu” button on the System Menu has been selected.

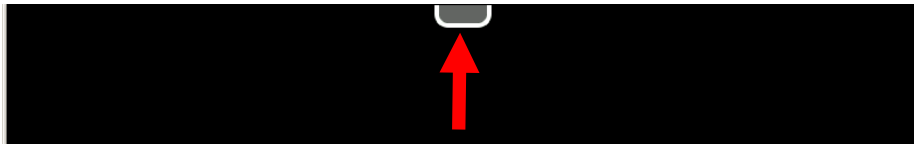

Press a Function Icon to display the Dropdown Menu for the Function.

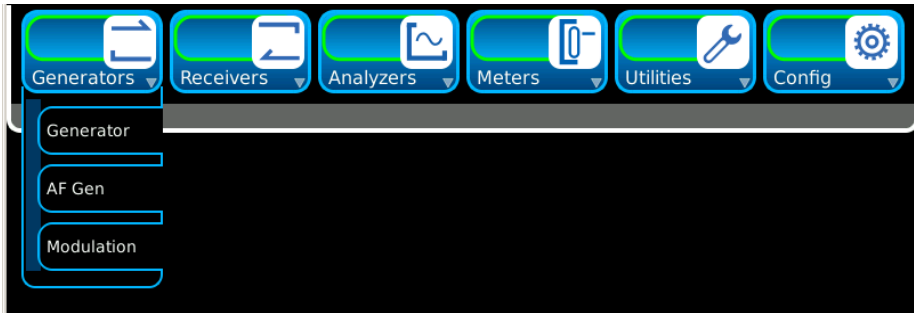
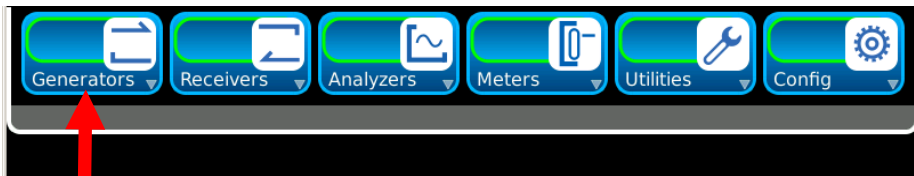

Press the gray bar at the bottom of the Launch Bar to return to minimize mode.

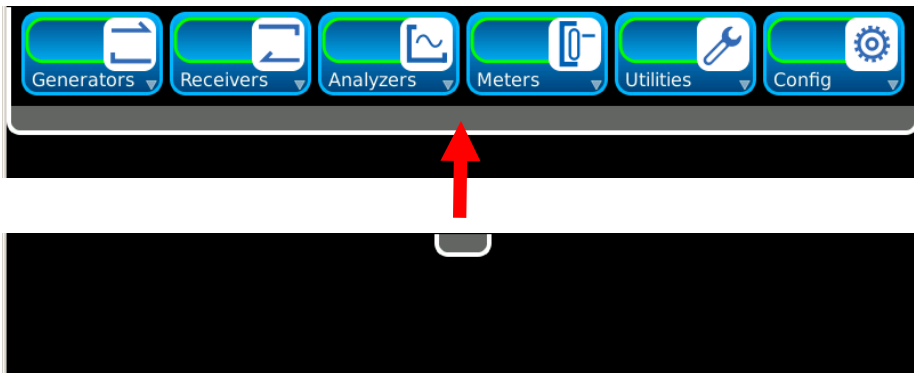

2-2-3. USER INTERFACE (UI) COMPONENTS (cont)

C. Tile Windows

Tile Windows provide visual access to the Digital Radio Test System's operating parameters and measurement data.

Tile Windows are opened by selecting the Tile from the Function Dropdown Menu.



Tile Windows are closed by selecting the minimize icon at the bottom of the Tile Window.

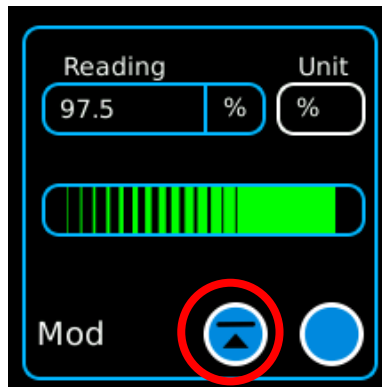

2-2-3. USER INTERFACE (UI) COMPONENTS (cont)

C. Tile Windows (cont)

Tile Windows can be displayed in multiple shapes (when applicable). Press the view icon to change the Tile Window shape.



When a Tile Window is maximized, the Tile Window occupies the full display area and provides access to Tile parameters which may not be visible when the Tile Window is in other views.

Tile Windows can be moved anywhere on the display area (except Full Screen view). To move a Tile Window, touch or click on the Tile Window's title block or background and drag the Tile Window to a new location on the display.

Tile Windows can be minimized to the Launch Bar where the Tile Window remains active but is not visible on the screen.

2-2-3. USER INTERFACE (UI) COMPONENTS (cont)

C. Tile Windows (cont)

Multiple Tile Windows can be displayed on the display area at any one time.

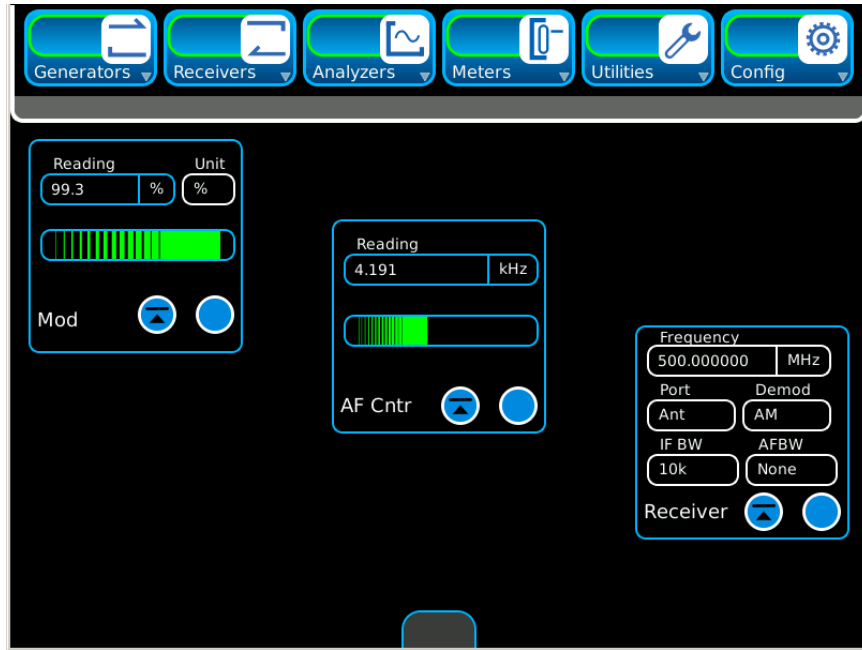

When an active Tile Window is closed and reopened, the Digital Radio Test System positions the Tile Window in the last active state and position on the screen.

When multiple Tile windows are active on the screen, the Tile windows can be switched back and forth using the switch icon.

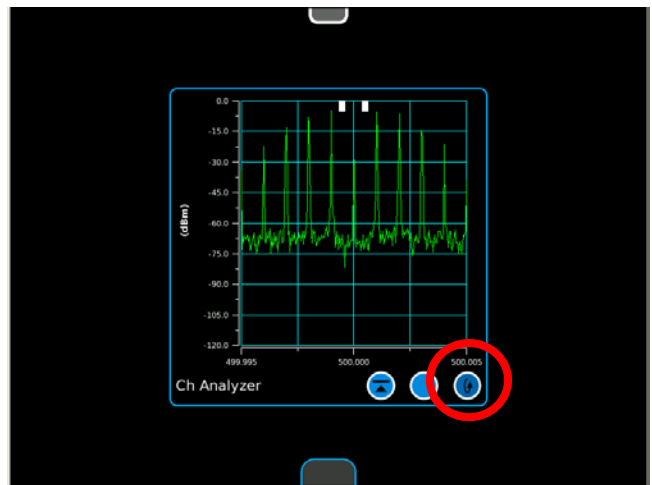
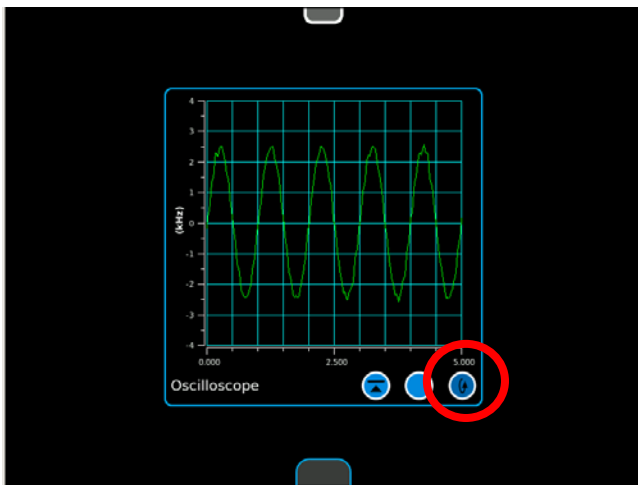

2-2-3. USER INTERFACE (UI) COMPONENTS (cont)

D. Defining Parameters

Numeric Keypad

When Numeric Data Fields are edited, the Numeric Keypad is displayed. The Numeric Keypad allows the user to enter a specific numeric value. A value is entered by pressing the numbers on the keypad. The value is then enabled by pressing the unit of measurement or the Enter Button on the Numeric Keypad. Press Cancel to void any un-entered changes and close the Numeric Entry Window. Pressing Cancel does not restore a changed value that has already been enabled (entered). Press Clear to reset a numeric value to zero. To reset an un-entered value to the previously defined value press Cancel. Press Backspace to delete the last number (to the right) in the numeric value.

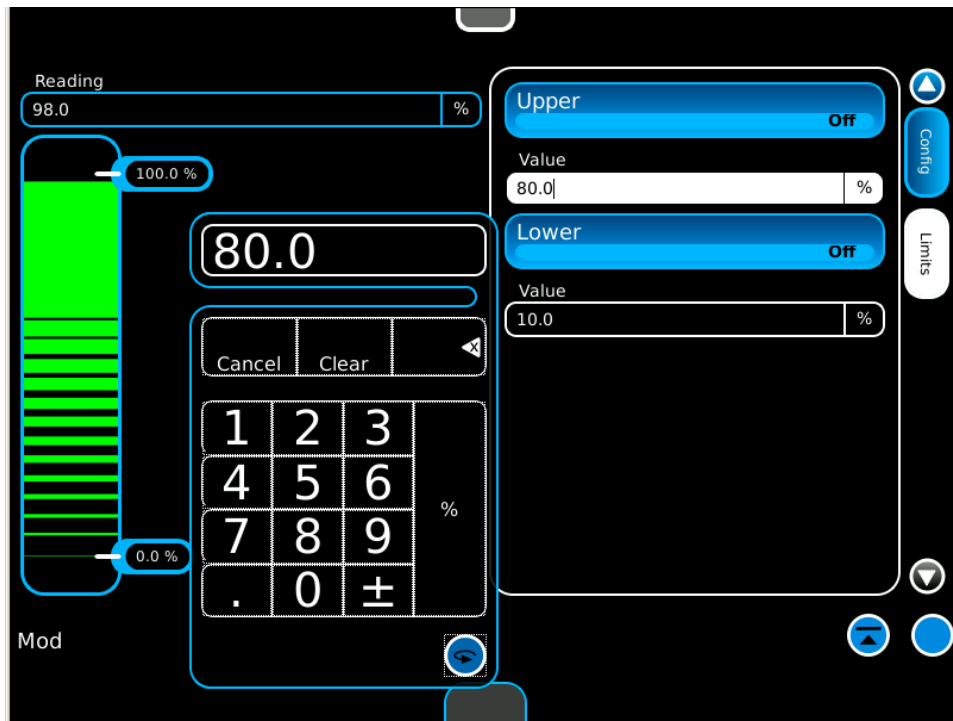

2-2-3. USER INTERFACE (UI) COMPONENTS (cont)

D. Defining Parameters (cont)

Slider Bar

The Slider Bar allows the user to select and change a defined range of values. The values to be changed are indicated by a bounding box (box with a white background). The position of the bounding box is controlled using the /10 and x10 keys to adjust the precision setting. Once the digit range is selected the value is increased or decreased using the Slider Bar or the Up and Down arrows. The Up (increase) and Down (decrease) arrows are used to adjust the last value selected in the bounding box. Values are active at the time the values are edited ("live" edits). Press Cancel to void any un-entered changes and close the Slider Bar. Pressing Cancel does not restore a changed value that is already enabled (entered). Press the Enter or Cancel Button to close the Slider Bar.



2-2-3. USER INTERFACE (UI) COMPONENTS (cont)

D. Defining Parameters (cont)

Arrow Keys

The Arrow Keys allow the user to edit numeric values. The selected values are changed by using the left/right arrows or by using the up/down arrows.



After a numeric value is changed, press the ENTER button (middle round button).
The Numeric Keypad automatically closes when using the Arrow Keys.

2-2-3. USER INTERFACE (UI) COMPONENTS (cont)

D. Defining Parameters (cont)

Keyboard

The Keyboard is displayed when a Text Data Field is selected for editing. The Keyboard functions similar to an external keyboard.

The Keyboard allows the user to enter alpha-numeric content.

Data is enabled by pressing the Enter Key.



2-2-3. USER INTERFACE (UI) COMPONENTS (cont)

E. Dropdown Menus

Function Icons

Dropdown Menus are used to select pre-defined Function icons. If an opened Dropdown Menu extends off of the UI, the Dropdown Menu can be moved up or down on the UI to access Dropdown Menu Function icons.

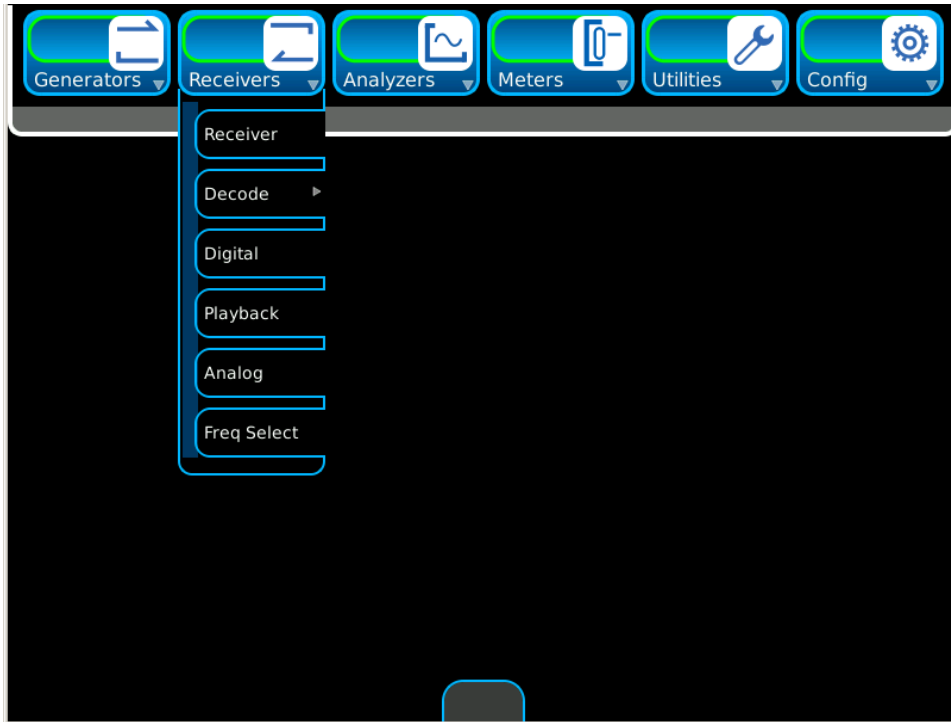

If a Dropdown Menu contains expanded Function icons, a gray arrow appears on the right side of the icon. Select the Function icon to display the expanded Function icons.

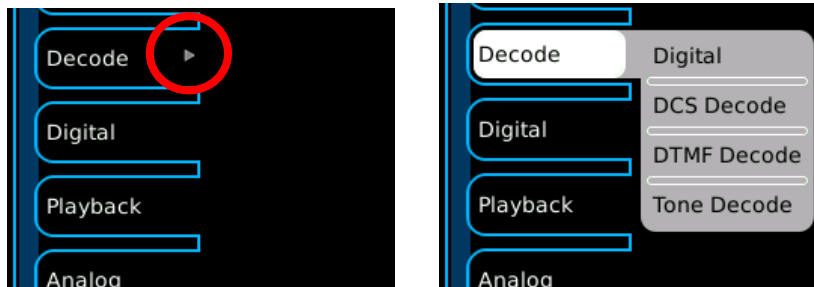

2-2-3. USER INTERFACE (UI) COMPONENTS (cont)

E. Dropdown Menus (cont)

Field Selections

Dropdown Menus are used to select pre-defined Field selections. If an opened Dropdown Menu extends off of the UI, the Dropdown Menu can be moved up or down on the UI to access Dropdown Menu Field selections.



2-2-3. USER INTERFACE (UI) COMPONENTS (cont)

F. Message Windows

Operator Interaction.

Message windows are displayed with information or to request user interaction.

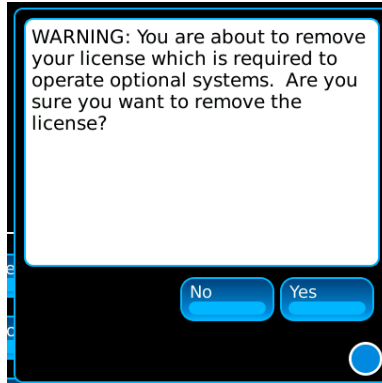

Locked Fields

An editable field updates to the Locked state when the Digital Radio Test System experiences a condition which makes the field un-editable.

A locked field cannot be edited until the lock-out condition is resolved.

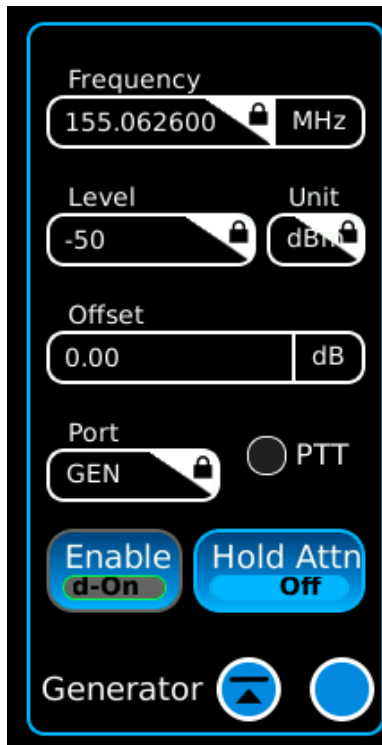

2-2-4. SYSTEM MENU

The System Menu contains field selections for the overall operation of the Digital Radio Test System. Press the HOME Key to display the System Menu.

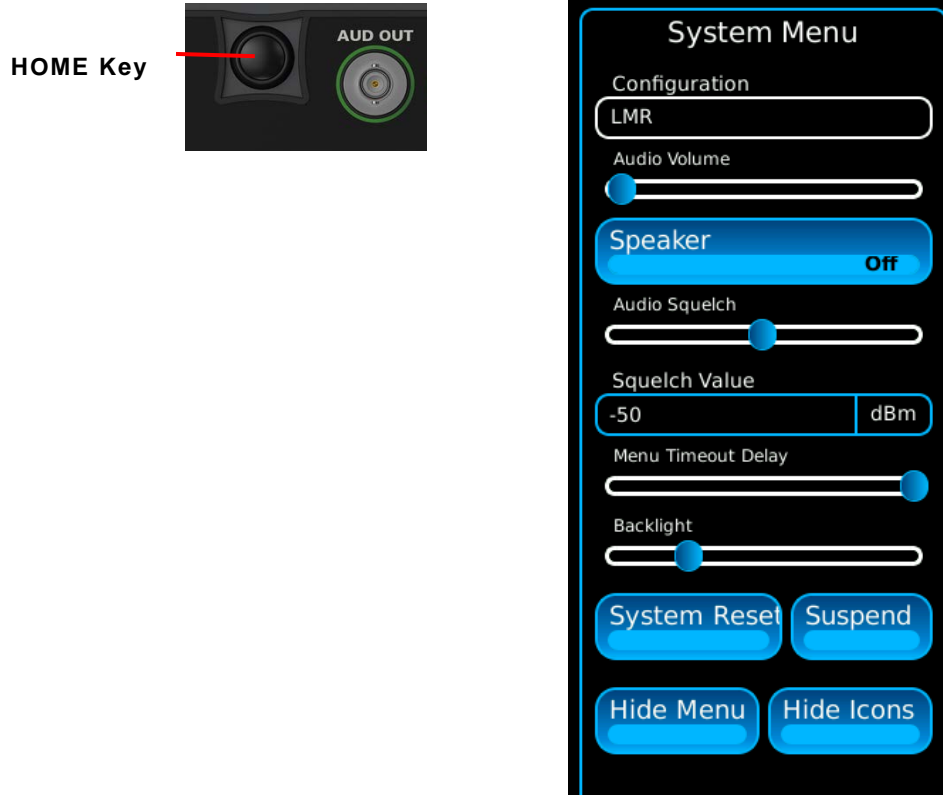

FIELD	DESCRIPTION
Configuration	Selects different systems.
Audio Volume	Volume control for speaker and headphones.
Speaker	Sets speaker to ON or OFF.
Audio Squelch	Adjusts Audio Squelch level.
Squelch Value	Selects Audio Squelch level display.
Menu Timeout Delay	Adjust for timeout on Launch Bar for Menu to remain displayed.
Backlight	Adjust for Backlight brightness.
System Reset	Resets Digital Radio Test System to factory settings.
Suspend	Select to place Digital Radio Test System in Suspend (Sleep) Mode.
Hide Menu	Launch Bar is not displayed on top of Touch Screen.
Hide Icons	Icons are not displayed on bottom of Touch Screen.

2-2-5. SUSPEND (SLEEP) MODE

The Digital Radio Test System can be placed in “suspend (sleep)” mode which decreases battery usage and increases the amount of time the Unit can operate on battery power.

Follow these instructions to place the Digital Radio Test System into “suspend (sleep)” mode:

1. With the Unit running in “active (awake)” mode (SYS Indicator is White), press the HOME Key to display the System Menu.



SYS Indicator

HOME Key

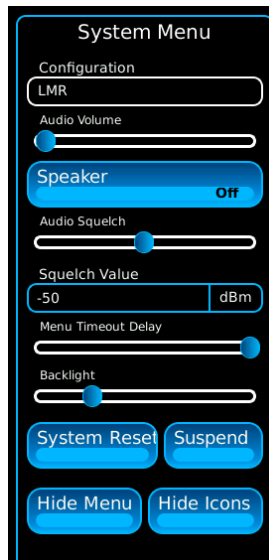
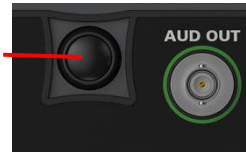

2-2-5. SUSPEND (SLEEP) MODE (cont)

2. Press the Suspend Button on the System Menu to place the Digital Radio Test System into “suspend (sleep)” mode.

The Touch Screen Display is blank and the internal RF hardware systems are shut OFF.

NOTE: The Digital Hardware systems retain active status and no information or screen settings are lost in “suspend (sleep)” mode.

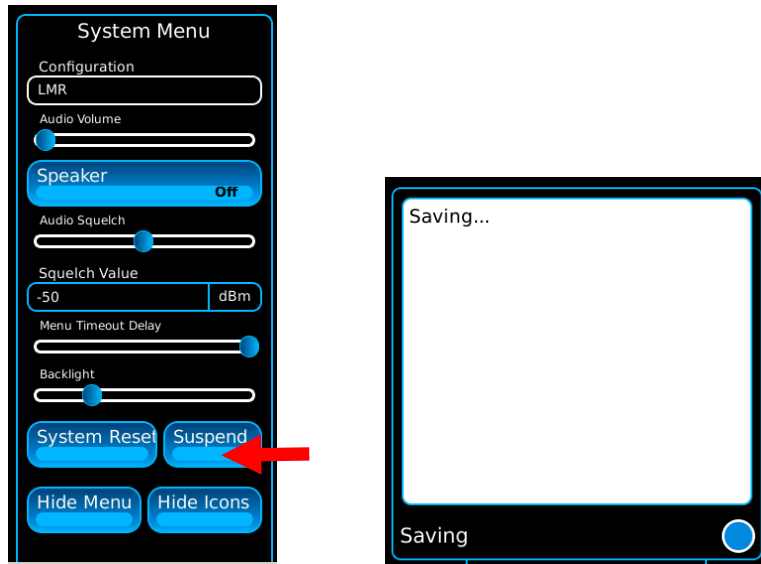

3. When the Unit is in “suspend (sleep)” mode, press the HOME Key once to display the current time and battery life remaining. Press the HOME Key a second time to restore the system to “active (awake)” mode.

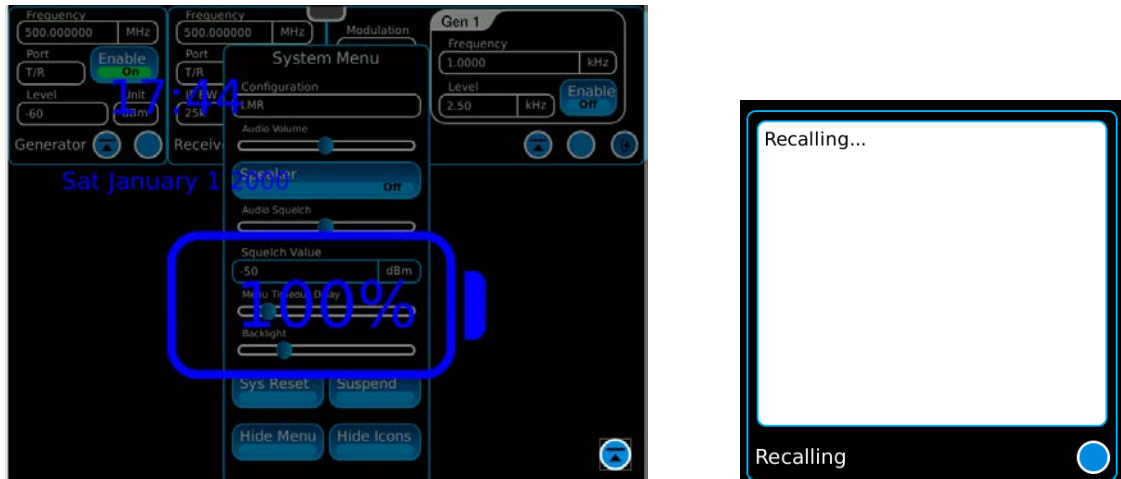

2-2-6. MULTI-LANGUAGE SUPPORT

The Digital Radio Test System can be configured to display the function tiles, tabs and windows in several different languages. The languages available are:

ةيبرعلا
简体中文
繁体中文
English
Français
Deutsch
日本語
한국의
Melayu
Polski
Português
русский
Español
Italiano

To change the Unit to a different language, select the Utilities function tab. Select the Language drop down item to display the Language Extended Icons. Choose the desired language tab.

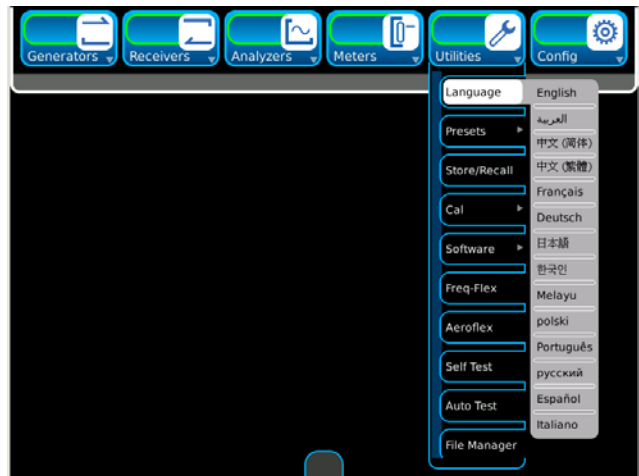
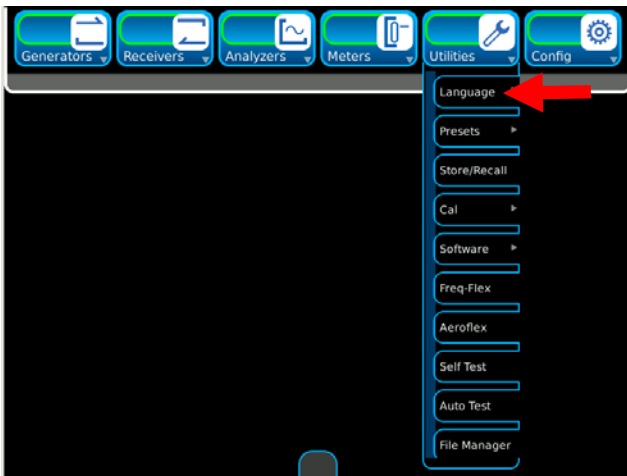

(Optional Languages are shown
for display purposes only.)

2-2-6. MULTI-LANGUAGE SUPPORT (cont)

EXAMPLE

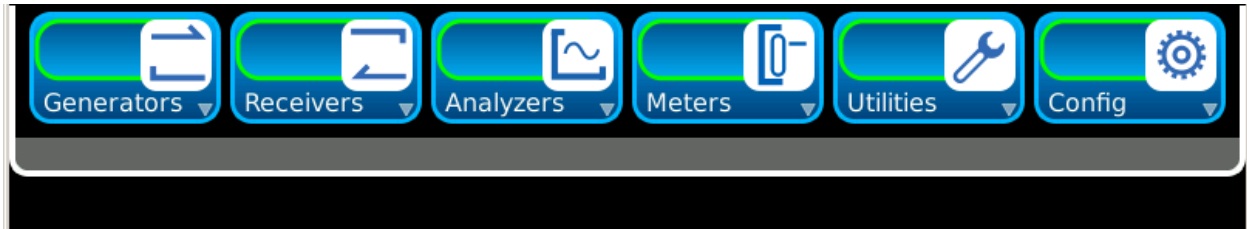

English Language



Chinese (Simplified) Language

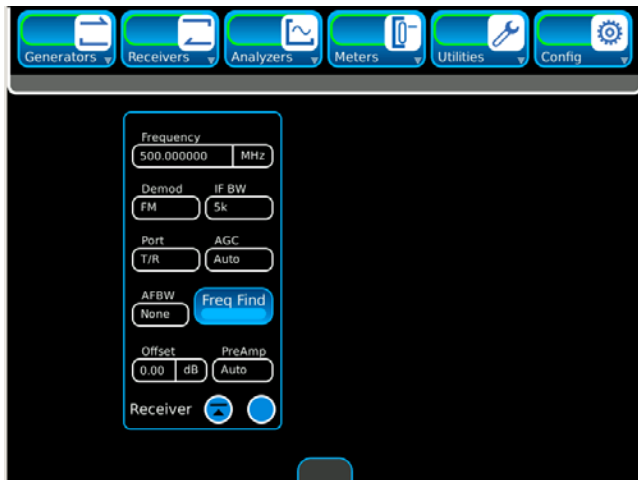

English Language



Chinese (Simplified) Language

2-3. PREVENTIVE MAINTENANCE CHECKS AND SERVICES

2-3-1. GENERAL

When doing any Preventive Maintenance or routine checks, keep in mind the WARNINGS and CAUTIONS about electrical shock and bodily harm.

2-3-2. PREVENTIVE MAINTENANCE PROCEDURES

A. Tools, Materials and Equipment Required

No tools or equipment are required for operator preventive maintenance. Cleaning materials required are a lint free cloth and mild liquid detergent.

B. Routine Checks

Preventive Maintenance is limited to routine checks such as shown below:

- Cleaning
- Dusting
- Wiping
- Checking for frayed cables
- Storing items not in use
- Covering unused receptacles
- Checking for loose nuts, bolts or screws

C. Schedule of Checks

Perform routine checks whenever required.

2-4. OPERATION UNDER USUAL CONDITIONS

2-4-1. TURN-ON PROCEDURE

Follow these instructions to initialize the Digital Radio Test System:

1. Press the POWER Key to initialize the Unit and verify the SYS Indicator illuminates.



2. The Opening Screen is displayed. The operator can now choose the desired screen.

NOTE: The Unit displays the last screen(s) accessed when the Unit was powered down.



2-4-2. INSTALL/REMOVE LICENSE

A License can be installed or removed from the Digital Radio Test System. The Options Function Window displays the Options installed in the Unit associated with the License.

Install License

Follow these instructions to install a License in the Unit:

1. Select the Utilities Function Icon to display the Utilities Dropdown Menu. Select the Software icon to display the Software extended icons. Select the Options icon to display the Options Tile Window.



(Options are shown for display purposes only.)

2-4-2. INSTALL/REMOVE LICENSE (cont)

Install License (cont)

2. Verify the Unit displays a Serial Number. If the Serial Number field is blank, contact Aeroflex Customer Service. This procedure can only be completed with a Serial Number installed in the Unit.

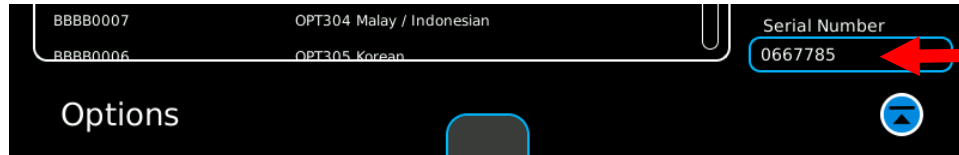

3. Unzip the License file to the PC then copy the License file (options.new) to the following directory on a USB Flash Drive: Aeroflex\License.
4. Install the USB Flash Drive in the USB Connector and wait for the Unit to recognize the USB Flash Drive (approximately 15 seconds).
5. Select Copy from USB Button and verify the Status Field displays "Copying from USB Drive." When the copy process is completed, the Status Field displays "Copying from USB Done."
6. Select Install License Button. When License file installation is complete the Status File displays "Installing License Done."
7. The Unit prompts to cycle power.

2-4-2. INSTALL/REMOVE LICENSE (cont)

Remove License

Follow these instructions to remove the License from the Unit:

1. Select the Utilities Function Icon to display the Utilities Dropdown Menu. Select the Software icon to display the Software extended icons. Select the Options icon to display the Options Tile Window.

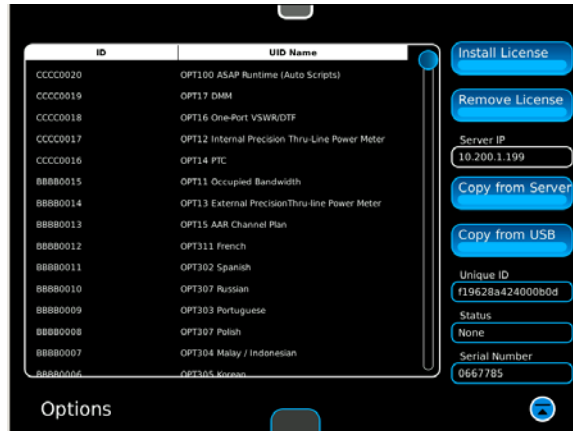

(Options are shown for display purposes only.)

2-4-2. INSTALL/REMOVE LICENSE (cont)

Remove License (cont)

2. Select the Remove License button. The following prompt is displayed:

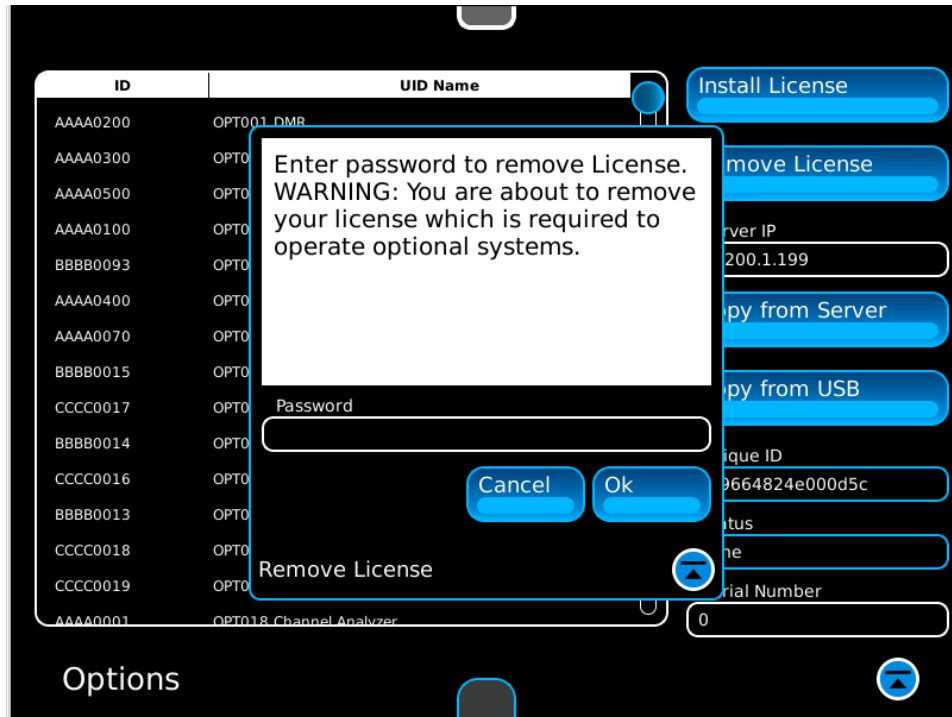

3. Enter the password and select the OK Button to remove the License. Select the Cancel Button to cancel the License removal.

2-4-3. INSTALL SOFTWARE

System Software can be installed in the Digital Radio Test System. The System Update Function Window displays the System Software version installed in the Unit.

NOTE: When loading Software into the Unit, the Calibration Values are not affected.

Follow these instructions to install System Software in the Unit:

1. Select the Utilities Function Icon to display the Utilities Dropdown Menu. Select the Software icon to display the Software extended icons. Select the Update icon to display the Update Tile Window.



2. Using a PC, access the following website: aeroflex.com/8800. Download the zip file containing the System Software to the PC.
3. After removing all files from a USB Flash Drive, unzip the System Software files to the root directory of the USB Flash Drive.
4. Confirm the "Aeroflex" folder is created in the root directory of the USB Flash Drive and the system rpm files are located under the "Aeroflex/Common" directory on the USB Flash Drive.
5. Plug in the USB Flash Drive in the USB Connector and wait for the Unit to recognize the USB Flash Drive (approximately 15 seconds).

2-4-3. INSTALL SOFTWARE (cont)

6. Select Copy from USB Button and verify Status Field displays “Copying Software” then “Refreshing List.” Items are displayed on the RPM List.



7. When the Status Field displays “Files are ready to install” select the Install Software Button. Select the OK Button to continue. Press the Cancel Button to abort the Software Load.
8. When the Software load is completed, the Unit prompts to cycle power.
NOTE: Progress Bars are displayed showing the software installation progress.

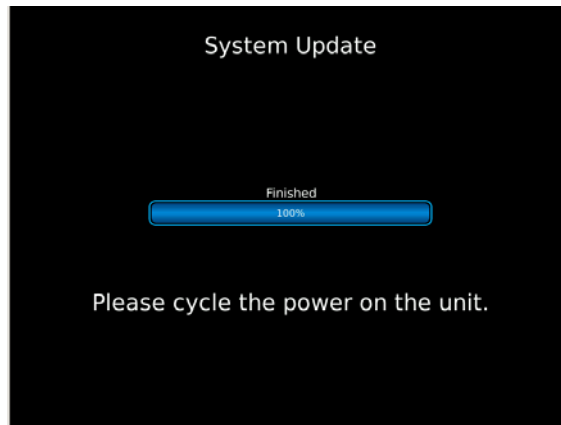

9. Cycle power and repeat Steps 6 to 8 until all displayed items have been installed in the Unit.

2-4-4. SAVE/RECALL FUNCTION WINDOWS

Save Function Window

Follow these instructions to save a Function Window in the Unit:

1. Select the Utilities Function Tab to display the Utilities Dropdown selections. Select "Store/Recall" to display the Store/Recall Tile Window.

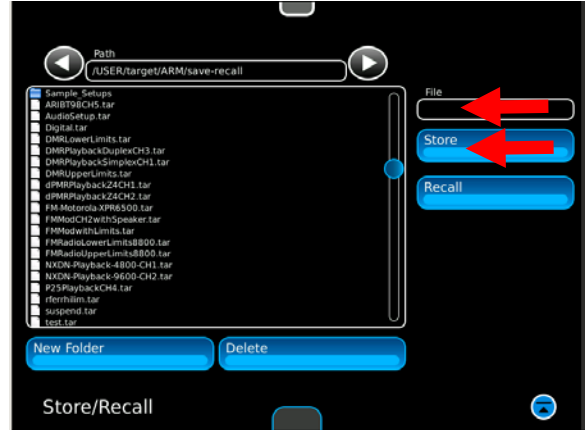
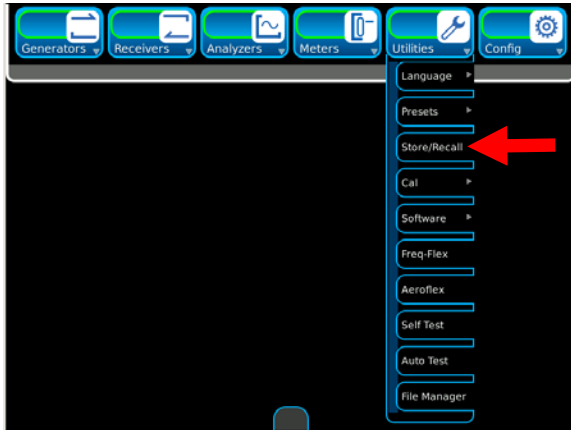

2. Select the File Name field, use the Keyboard to select the file name and press Enter.
3. Select the Store button.

NOTE: Up to 100 setups can be saved.

Recall Function Window

Follow these instructions to save a Function Window in the Unit:

1. Select the Utilities Function Tab to display the Utilities Dropdown selections. Select "Store/Recall" to display the Store/Recall Tile Window.

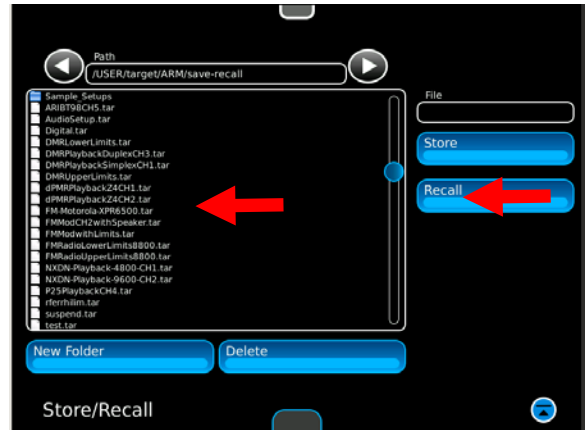
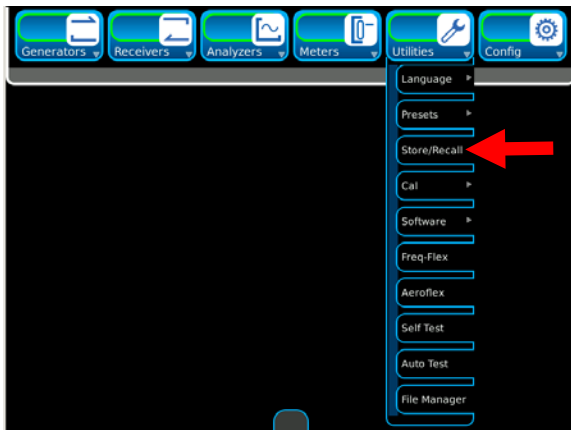

2. Highlight the file name in the displayed list and select the Recall Button.

2-4-5. SNAPSHOT

Select the Snapshot icon to display the Snapshot Tile Window.

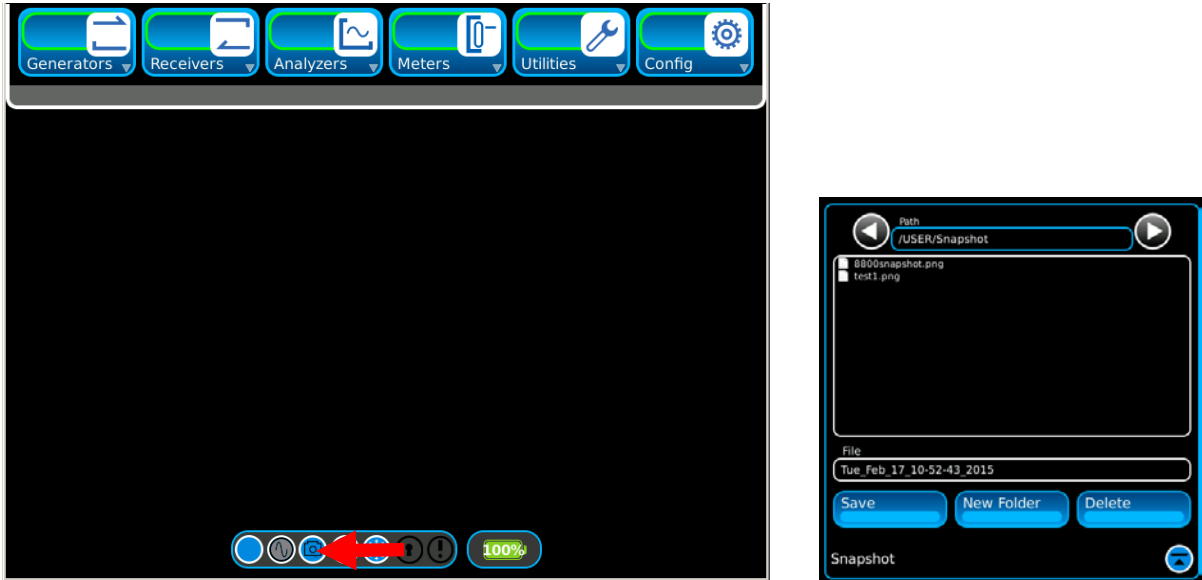

(File Names are shown for display purposes only.)

Save Snapshot

Select the Save button to save the Snapshot with the file name shown in the File field.

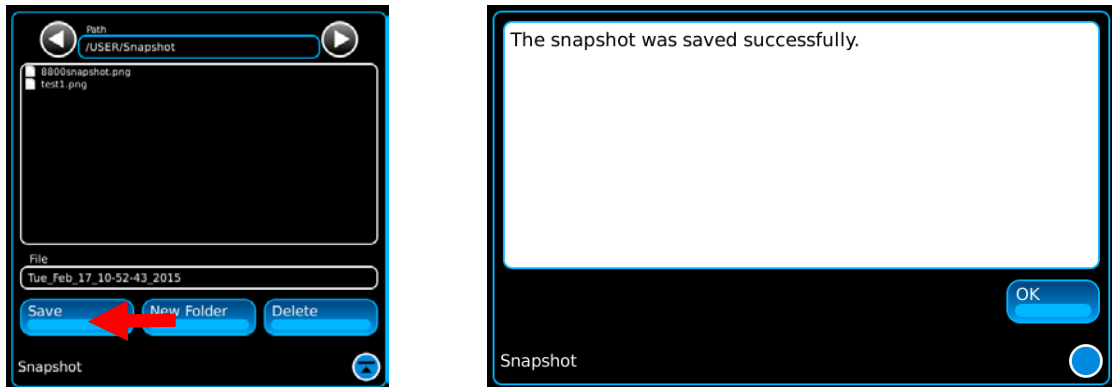

(File Names are shown for display purposes only.)

Press the OK button to save the file name.

2-4-5. SNAPSHOT (cont)

Create New Folder

To create a new folder, select the New Folder button.

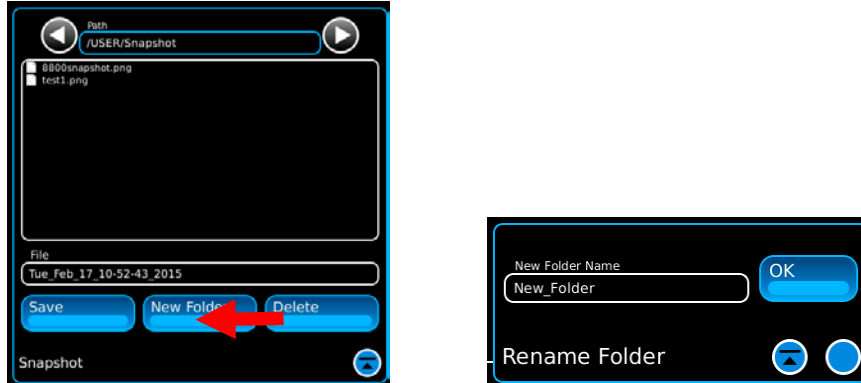

(File Names are shown for display purposes only.)

Select the New Folder Name field and use the Keyboard to select the folder name. Press the OK button to save the folder name.

Create New File

To create a new file name, select the File Name field, use the Keyboard to select the file name and press Enter.

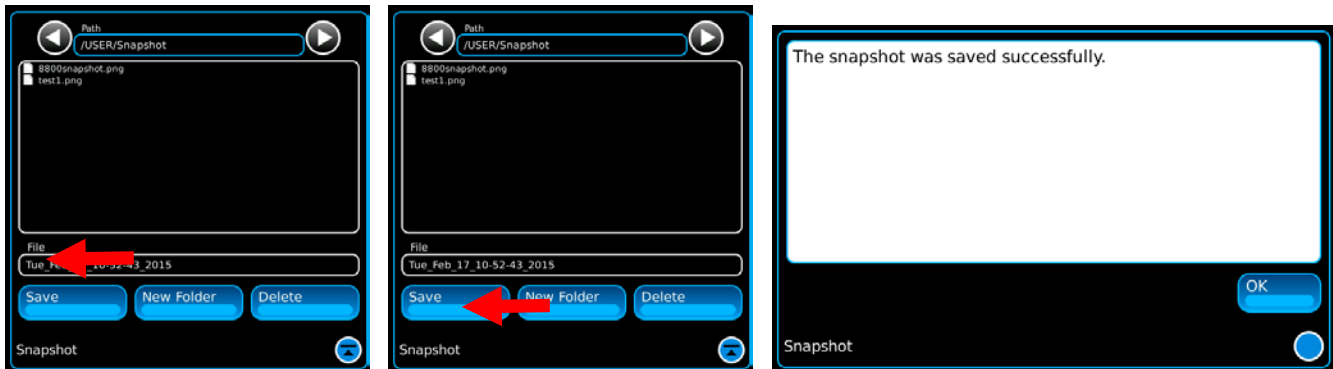

(File Names are shown for display purposes only.)

Select the Save button and press the OK button to save the file name.

2-4-5. SNAPSHOT (cont)

Delete File

To delete a file, use the Delete button.

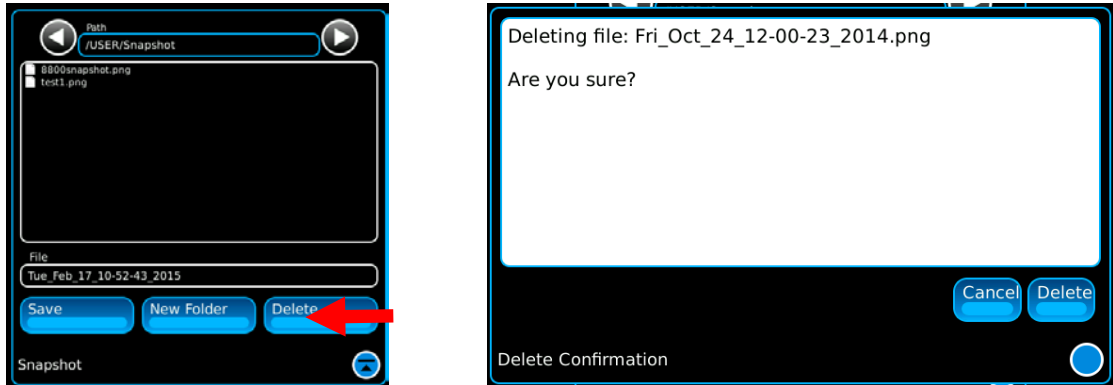

(File Names are shown for display purposes only.)

Select the file to be deleted (file name shown in the File field). Press the Delete button to display the Delete Confirmation Window. Press the Delete button to delete the file or the Cancel button to escape from the Delete action.

2-4-6. CLONE UNIT

Follow these instructions to clone a Unit:

1. Connect Units to Network.
2. Select the Utilities Function Tab to display the Utilities Dropdown selections. Select the Software icon to display the Software extended icons. Select the System icon to display the System Tile Window. Select the Clone Me icon.

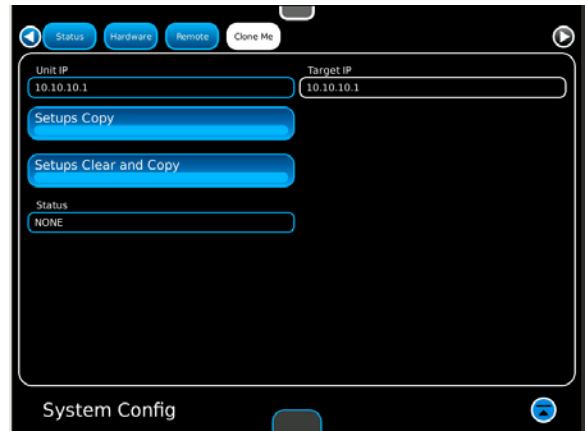
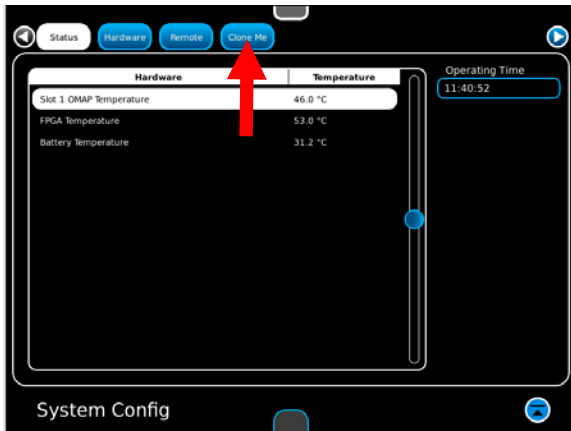
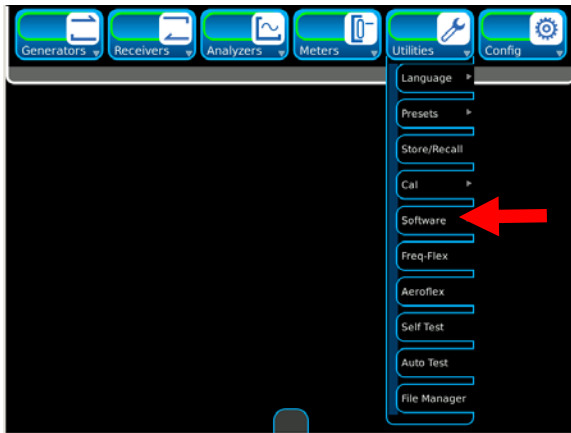

3. Enter the IP Address of the Base Unit into the Unit IP Field.
4. Enter the IP Address of the Target Unit into the Target IP Field.
5. Select the Screen Settings Clear and Copy Button to clear all saved screens in the Target Unit and copy the saved screens from the Base Unit to the Target Unit.
6. Select the Screen Settings Copy Button to copy the saved screens from the Base Unit to the Target Unit.
7. Select the Scripts Clear and Copy Button to clear all Scripts in the Target Unit and copy the Scripts from the Base Unit to the Target Unit.
8. Select the Scripts Copy Button to copy the Scripts from the Base Unit to the Target Unit.

2-4-7. DIGITAL MULTIMETER (DMM)

The DMM (Digital Multimeter) displays the results of resistance, AC current, DC current and voltage measurements. Additional parameters are available on the Configuration Window.

DMM Measurement Modes

- AC/DC Volts** When Volts AC or Volts DC Mode is selected the DMM Meter functions as a Voltage Meter and displays the measurement of the voltage in the circuit being tested.
- AC/DC AMPS** When AMPS AC or AMPS DC Mode is selected the DMM Meter functions as an Ampere (AMP) Meter and displays measurement of electric current in the circuit being tested.
- Ohms** When Ohms Mode is selected the DMM functions as a Resistance (Ohm) Meter and displays the measurement of resistance found in the circuit being tested.

DMM Configuration Window

The DMM Configuration Window contains parameters for defining DMM measurements.



FIELD	DESCRIPTION
Reading	Displays meter measurement. The type of measurement being displayed (Live, Average, Maximum or Minimum) is selected from the Reading Type Drop-down Menu.
Range	Defines the vertical scale of the meter bar graph. Range and unit of measurement vary according to the selected Mode.
Type	Selects type of reading being displayed in the Reading field.
Average	Defines the number of signal traces used to calculate average measurements.
Peak Hold	Sets peak and average measurements.
Peak Hold Clear	Clears peak and average measurements.
Peak Hold Value	Displays the Peak Hold measurement.
Enable (On/Off)	Enables or disables the DMM measurement.

2-4-8 CONFIGURATION MODES

The Digital Radio Test System offers three configuration modes depending on the options purchased with the system. These modes include:

- LMR
- Advanced Digital
- PTC

LMR Configuration

The LMR configuration is the standard mode and offers access to analog, digital, Auto-Test and cable/antenna sweep testing. Analog tests include CW, AM, FM, DTFM, DCS, Two Tone Sequential, Tone Remote and Tone Sequential. Digital tests include P25 Phase 1, DMR, NXDN, dPMR, ARIB-T98 and PDR-C.

Advanced Digital Configuration

The Advanced Digital configuration provides access to advanced digital test modes. These modes include: P25 Phase 2 (HCPM and HDQPSK) and DMR Repeater (Sync). For simplicity, the Advanced Digital configuration also contains P25 Phase 1 and DMR test parameters, which allows users to provide complete P25 (Phase 1 and Phase 2) tests and DMR (mobile and repeater) tests from a single location.

PTC Configuration

PTC (Positive Train Control) testing is located under the PTC configuration.

Verifying Configuration

Press the Home Key to display the System Menu. The Configuration field displays the current configuration mode of the Unit.

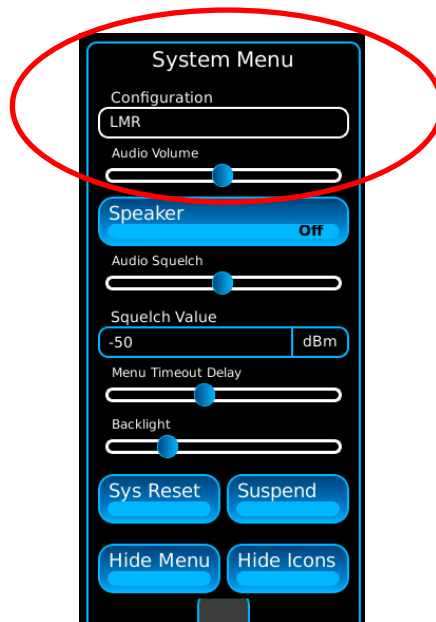

2-4-8 CONFIGURATION MODES (cont)

Selecting Configuration Modes

Press the Home Key to display the System Menu. Select the Configuration field to display a selection menu of configuration modes (LMR, PTC or Advanced Digital). Select the desired configuration mode to change the configuration mode of the Unit.

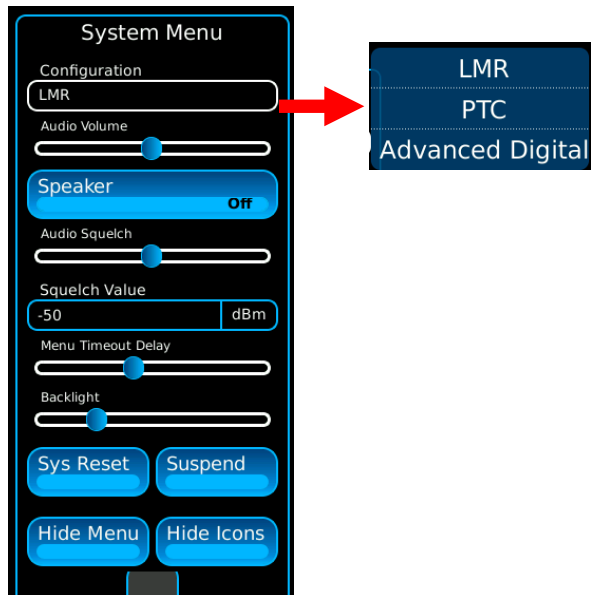

2-4-9 TIME BASE REFERENCE MODES

The Digital Radio Test System offers different time base reference mode selections depending on the base model number of the system: 8800, 8800S or 8800SX. These mode selections include:

- Internal Reference
- External Reference
- Frequency Flex (Freq Flex)

Definitions

The "Internal" reference selection refers to the standard internal time base within the Digital Radio Test System. The "External" reference refers to an external time base connected to the 10 MHz IN Connector (8800SX only). The Freq Flex reference allows the user to calibrate the Digital Radio Test System to a clean external frequency reference and store that calibration reference within the Unit.

8800 / 8800S

The 8800 / 8800S offers the Internal reference and Freq Flex selections.

8800SX

The 8800SX offers the Internal reference, External reference and Freq Flex selections.

Selecting the Reference Mode (8800SX)

Contact the Aeroflex Customer Service Dept.

2-5. BASIC LMR CONFIGURATION SETUPS

2-5-1. ANALOG DEMOD

1. Select the Generators icon to display the Generators Dropdown Menu. Select the Generator Function icon to display the Generator Tile Window.
2. Select the Receivers icon to display the Receivers Dropdown Menu. Select the Receiver Function icon to display the Receiver Tile Window.
3. Select the Generators icon to display the Generators Dropdown Menu. Select the Modulation Function icon to display the Modulation Tile Window.
4. Select the Receivers icon to display the Receivers Dropdown Menu. Select the Analog Function icon to display the Analog Demod Tile Window.
5. Select the Analyzers icon to display the Analyzers Dropdown Menu. Select the Oscilloscope Function icon to display the Oscilloscope Tile Window.
6. Select the Config icon to display the Config Dropdown Menu. Select the Audio Function icon to display the Audio Config Tile Window.
7. The Oscilloscope Tile Window and the Audio Config Tile Window can be alternately moved to the front of the screen using the switch icon.

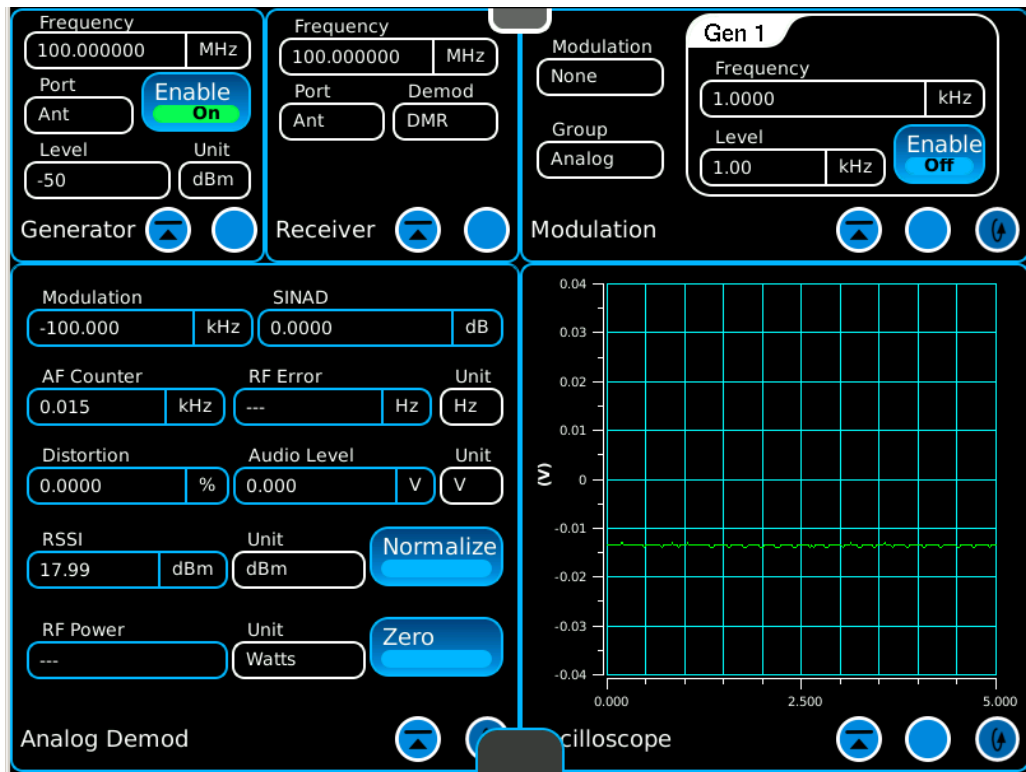

2-5-2. ANALOG SINAD

1. Select the Generators icon to display the Generators Dropdown Menu. Select the Generator Function icon to display the Generator Tile Window.
2. Select the Receivers icon to display the Receivers Dropdown Menu. Select the Receiver Function icon to display the Receiver Tile Window.
3. Select the Generators icon to display the Generators Dropdown Menu. Select the Modulation Function icon to display the Modulation Tile Window.
4. Select the View icon to expand the Modulation Tile Window.
5. Select the Receivers icon to display the Receivers Dropdown Menu. Select the Analog Function icon to display the Analog Demod Tile Window.
6. Select the Analyzers icon to display the Analyzers Dropdown Menu. Select the Oscilloscope Function icon to display the Oscilloscope Tile Window.
7. The Oscilloscope Tile Window and the Analog Demod Tile Window can be alternately moved to the front of the screen using the switch icon.
8. Select the Config icon to display the Config Dropdown Menu. Select the Audio Function icon to display the Audio Config Tile Window.

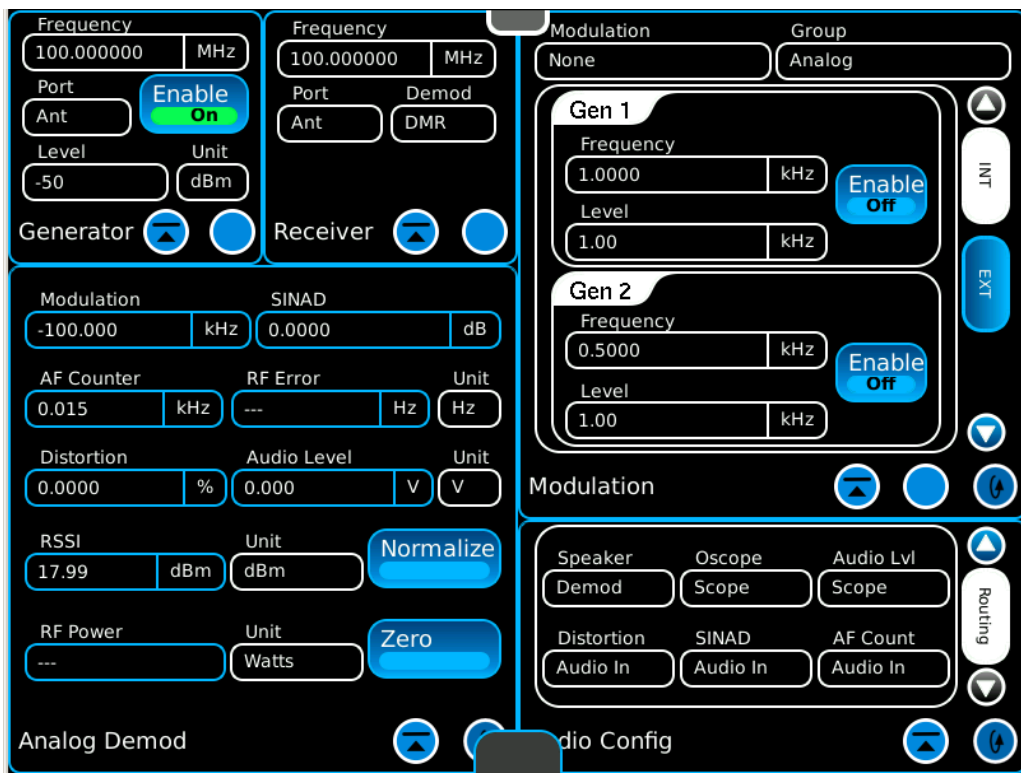

2-5-3. DIGITAL DMR

1. Select the Generators icon to display the Generators Dropdown Menu. Select the Generator Function icon to display the Generator Tile Window.
2. Select the Receivers icon to display the Receivers Dropdown Menu. Select the Receiver Function icon to display the Receiver Tile Window.
3. Select the Generators icon to display the Generators Dropdown Menu. Select the Modulation Function icon to display the Modulation Tile Window.
4. Select the Receivers icon to display the Receivers Dropdown Menu. Select the Digital Function icon to display the Digital Demod Tile Window.
5. Select the Analyzers icon to display the Analyzers Dropdown Menu. Select the Digital Plots Function icon to display the Digital Plots Tile Window.
6. Select the Analyzers icon to display the Analyzers Dropdown Menu. Select the Power Profile Function icon to display the Power Profile Tile Window.
7. The Digital Plots Tile Window and the Power Profile Tile Window can be alternately moved to the front of the screen using the switch icon.

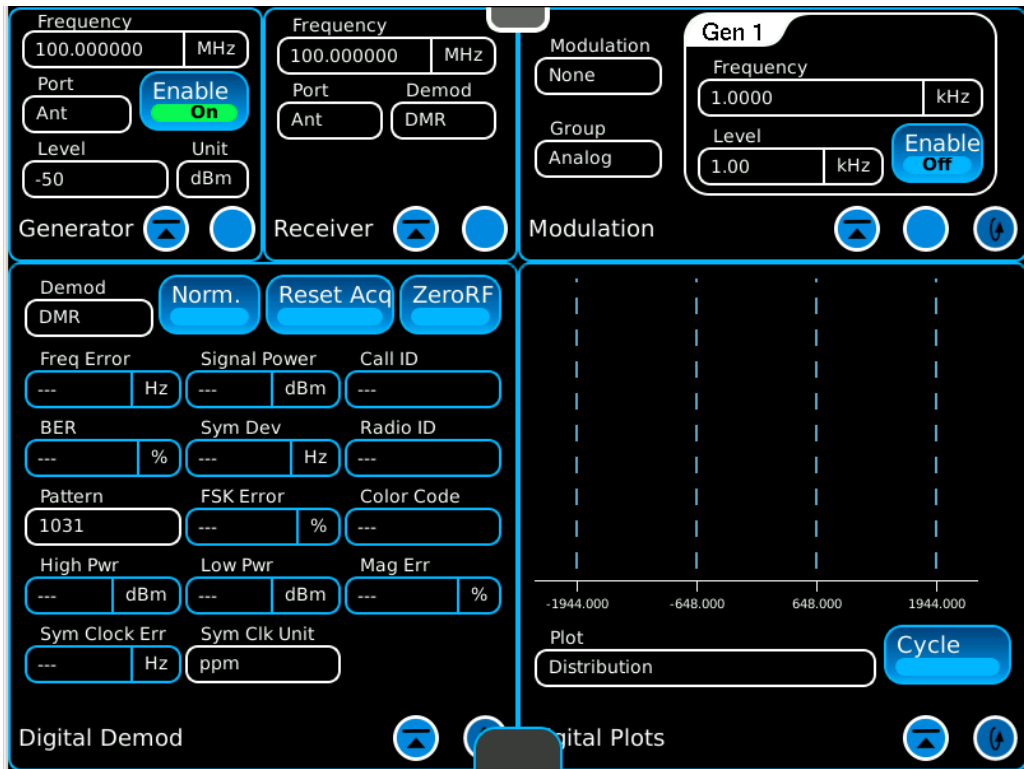

2-6. ADVANCED DIGITAL CONFIGURATION SETUPS

2-6-1. P25 PHASE 2

The screenshot displays the advanced digital configuration interface for P25 Phase 2, organized into several functional panels:

- Generator Panel:** Shows Frequency set to 810.000000 MHz, Port Ant, Level -114 dBm, and an **Enable On** indicator.
- Receiver Panel:** Shows Frequency set to 855.000000 MHz, Port T/R, and Demod HDQPSK.
- Modulation Panel:** Shows Modulation HCPM and Group Digital.
- P25-HCPM Panel:** Shows Pattern 1031, Mode Sync, and Channel 0.
- Demod Panel:** Shows Demod HDQPSK, buttons for Norm., Reset Acq, and ZeroRF, and various performance metrics including Freq Error, Signal Power, RF Power Avg, BER, Sym Dev, RF Power Units, Pattern 1031, Mod Fidelity, Sym Clock Err, and Sym Clk Unit.
- Digital Demod Panel:** Includes navigation arrows and a refresh icon.
- Digital Plots Panel:** Features a spectrum plot with a green signal trace, a Plot Distribution dropdown menu, and a Cycle button.

2-6-2. DMR REPEATER

The screenshot displays a control interface for a DMR Repeater, organized into several functional sections:

- Top Left:** Frequency 465.000000 MHz, Port Ant, Level -60 dBm, and an **Enable On** button.
- Top Middle:** Frequency 470.000000 MHz, Port T/R, and Demod DMR.
- Top Right:** Modulation DMR, Group Digital, and a DMR configuration box with Pattern 1031, Mode Sync, Color 13, and Slot Slot1.
- Middle Left:** Demod DMR, buttons for Norm., Reset Acq, and ZeroRF, and various error and power metrics (Freq Error, BER, High Pwr, Low Pwr, RF Power Avg, etc.).
- Middle Right:** A digital plot area with a horizontal axis ranging from -1944.000 to 1944.000 and a **Cycle** button.
- Bottom Left:** Digital Demod controls.
- Bottom Right:** Digital Plots controls.

THIS PAGE INTENTIONALLY LEFT BLANK.

CHAPTER 3 - OPERATOR MAINTENANCE

3-1. PRELIMINARY SERVICING AND ADJUSTMENT OF EQUIPMENT

Place the Digital Radio Test System on a work bench or table and perform the Turn-On Procedure (para 2-4-1).

BATTERY PRECAUTIONS

The Digital Radio Test System is powered by an internal Lithium Ion battery pack. The Digital Radio Test System is supplied with an External DC Power Supply which allows the operator to recharge the battery using AC power. The Unit can operate continuously on AC power via the External DC Power Supply, for servicing and/or bench tests.

The internal battery is equipped to power the Unit for 2.5 hours of continuous use, after which time, the Unit battery needs recharging. When the BAT Indicator is GREEN, the battery is at 100% full charge. When the BAT Indicator is AMBER, the battery is charging.

If the battery level, shown in the BAT Icon, is $\leq 5\%$, a "Low Battery" warning message is displayed.

The battery charger operates whenever the supplied External DC Power Supply or a suitable (11 to 24 Vdc) DC Power source is applied to the Unit. When charging, the battery reaches a 100% charge in approximately four hours. The internal battery charger allows the battery to charge between the temperature range of 0° to 45°C. Allow 20 minutes for the battery to charge when turning the Unit ON from a dead battery condition.

The battery should be charged every three months (minimum) or disconnected for long term inactive storage periods of more than six months. The Battery must be removed when conditions surrounding the Unit are $< -20^{\circ}\text{C}$ and $> 60^{\circ}\text{C}$.

3-2. SELF TEST

The Digital Radio Test System is equipped with a Self Test for quick performance evaluation. Test results are shown next to the tests in the Pass/Fail Counters.

1. Select the Utilities icon to display the Utilities Dropdown Menu. Select the Self Test Function icon to display the Self Test Tile Window.

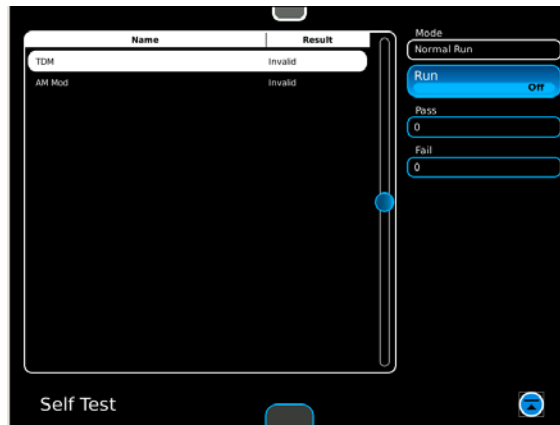

2. Select the Run button to initiate the Self Test.

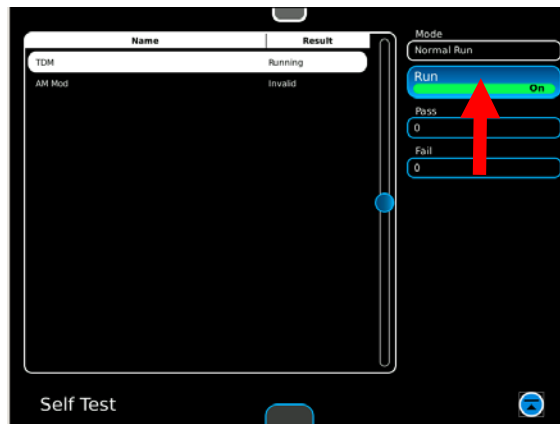

3-3. MAINTENANCE PROCEDURES

3-3-1. BATTERY RECHARGING

The battery charger operates whenever the supplied External DC Power Supply or a suitable (11 to 24 Vdc) DC Power source is applied to the Unit. When charging, the battery reaches a 100% charge in approximately four hours. The internal battery charger allows the battery to charge between the temperature range of 0° to 45°C. Allow 20 minutes for the battery to charge when turning the Unit ON from a dead battery condition.

The battery should be charged every three months (minimum) or disconnected for long term inactive storage periods of more than six months. The Battery must be removed when conditions surrounding the Unit are <-20°C and >60°C).

DESCRIPTION

This procedure is used to recharge the Battery in the Unit with an External DC Power Supply.

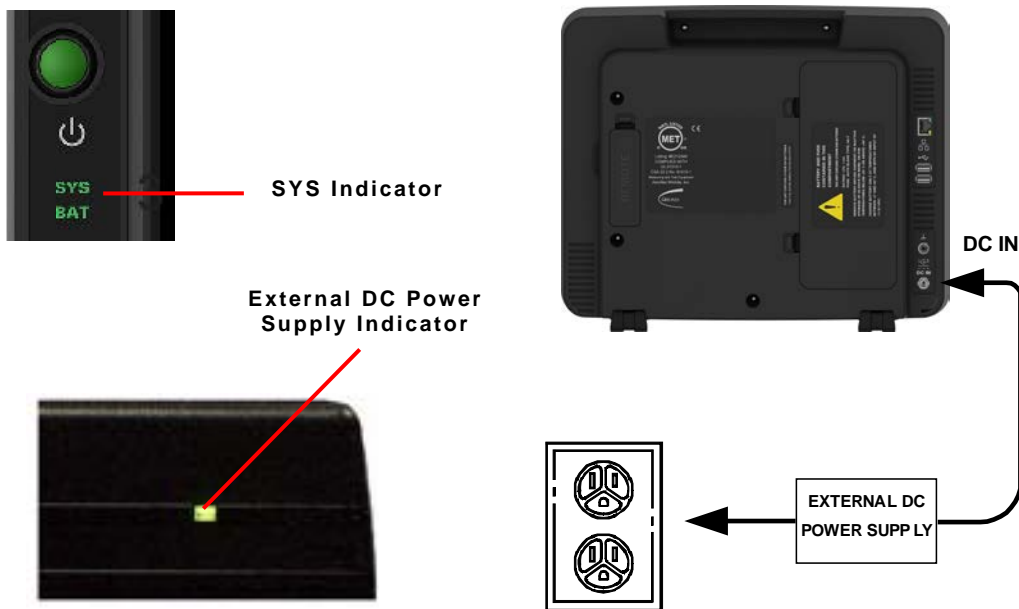

1. Connect the External DC Power Supply to the DC IN Connector on the Unit.
2. Connect the AC Power Cable to the AC PWR Connector on the External DC Power Supply and an appropriate AC power source.
3. Verify the Indicator on the External DC Power Supply is GREEN.
4. Allow four hours (Typical) for Battery charge or until the BAT Indicator is GREEN.

If the BAT Indicator is AMBER and/or the Battery fails to accept a charge and the Unit does not operate on Battery power, the battery requires replacement.

3-3-2. BATTERY REPLACEMENT

DESCRIPTION

This procedure is used to replace the Battery in the Unit.

CAUTION

REPLACE ONLY WITH THE BATTERY SPECIFIED. DO NOT ATTEMPT TO INSTALL A NON-RECHARGEABLE BATTERY.

WARNING

- **DISPOSE OF THE LITHIUM ION BATTERY PACK ACCORDING TO LOCAL STANDARD SAFETY PROCEDURES. DO NOT CRUSH, INCINERATE OR DISPOSE OF THE LITHIUM ION BATTERY PACK IN NORMAL WASTE.**
- **DO NOT SHORT CIRCUIT OR FORCE DISCHARGE OF THE LITHIUM ION BATTERY PACK AS THIS MIGHT CAUSE THE LITHIUM ION BATTERY PACK TO VENT, OVERHEAT OR EXPLODE.**

REMOVE

1. Verify the Unit is OFF and is not connected to AC power.
2. Unlatch the Battery Cover to expose the Battery.
3. Disconnect the Battery Wire Harness (connecting the Battery to the Unit) and remove the Battery.

INSTALL

1. Install the Battery in the Unit and connect the Battery Wire Harness.
2. Relatch the Battery Cover on the Unit.

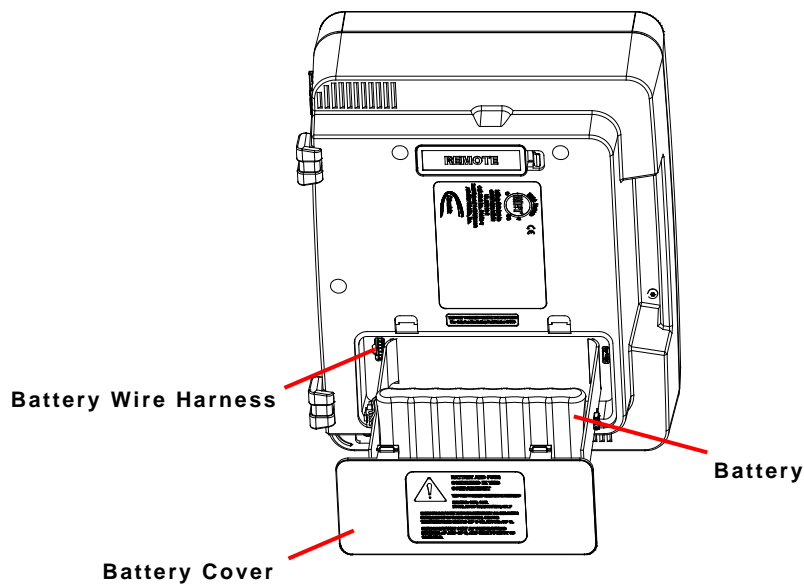

3-3-3. FUSE REPLACEMENT

DESCRIPTION

This procedure is used to replace the internal fuse in the Unit.

CAUTION

FOR CONTINUOUS PROTECTION AGAINST FIRE, REPLACE ONLY WITH FUSES OF THE SPECIFIED VOLTAGE AND CURRENT RATINGS. (5 A, 32 VDC, MINI-BLADE FUSE)

REMOVE

1. Verify the Unit is OFF and is not connected to AC power.
2. Unlatch the Battery Cover to expose the Fuse.
3. Locate and remove the Fuse.

INSTALL

1. Install the Fuse.
2. Relatch the Battery Cover on the Unit.

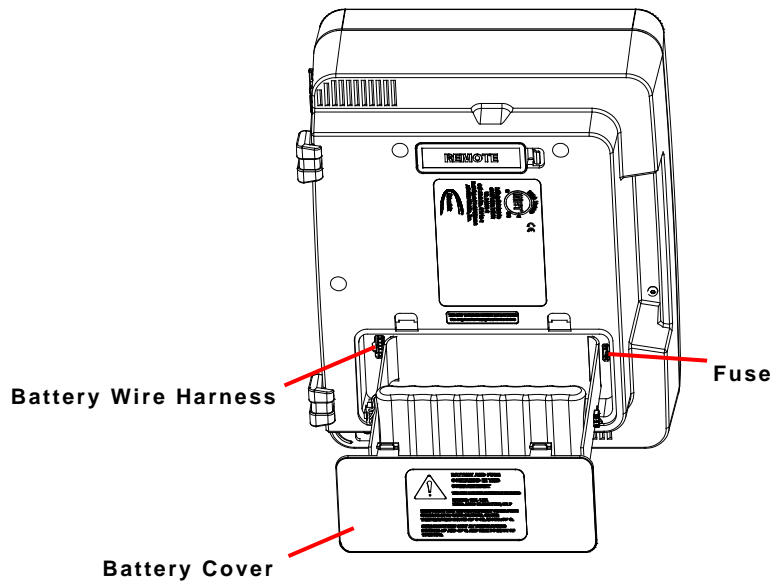

3-3-4. DMM FUSE REPLACEMENT

DESCRIPTION

This procedure is used to replace the DMM fuse in the Unit.

CAUTION

FOR CONTINUOUS PROTECTION AGAINST FIRE, REPLACE ONLY WITH FUSES OF THE SPECIFIED VOLTAGE AND CURRENT RATINGS. (3 A, 250 V, TYPE F FUSE)

REMOVE

Remove the DMM fuse cover and DMM fuse from the Unit and replace the DMM fuse.

INSTALL

Install the DMM fuse and fuse cover in the Unit.

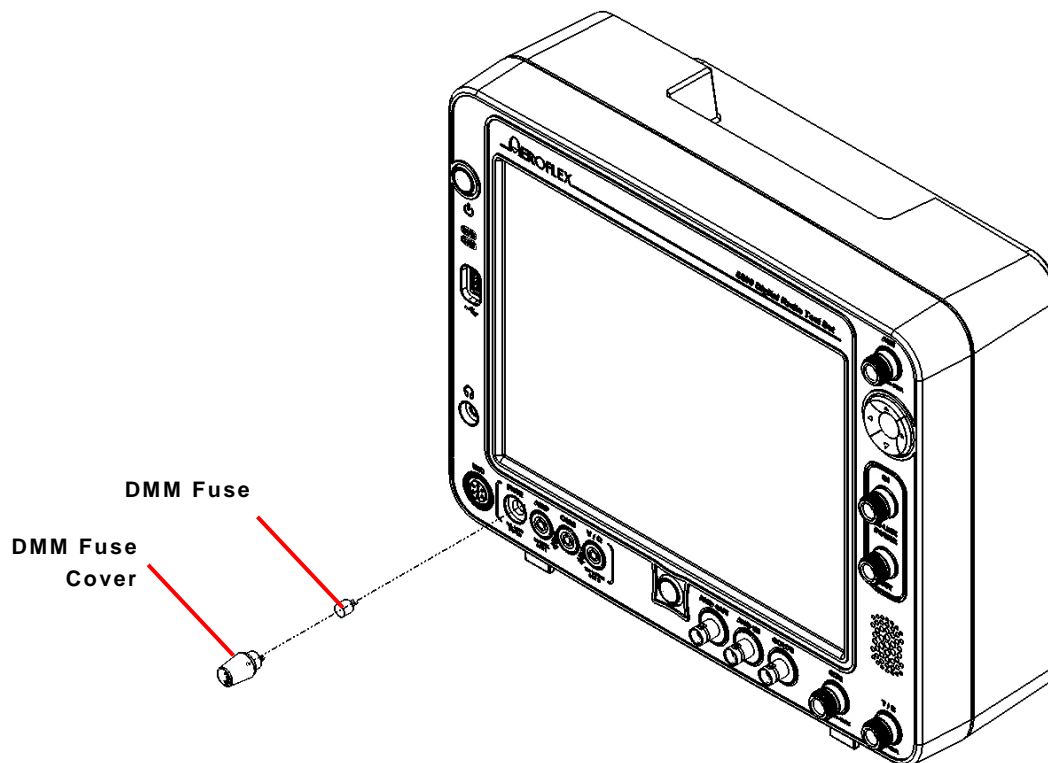

3-3-5. FEET REPLACEMENT

DESCRIPTION

This procedure is used to replace the feet on the Unit.

REMOVE

Remove screw from the Unit. Remove front foot and flip foot from the Unit.

Lift Tab on Rear Foot and remove Rear Foot from the Unit.

INSTALL

Install the flip foot and front foot on the Unit. Install the screw in the Unit and tighten to 6 in/lbs.

Install Rear Foot in the Unit.

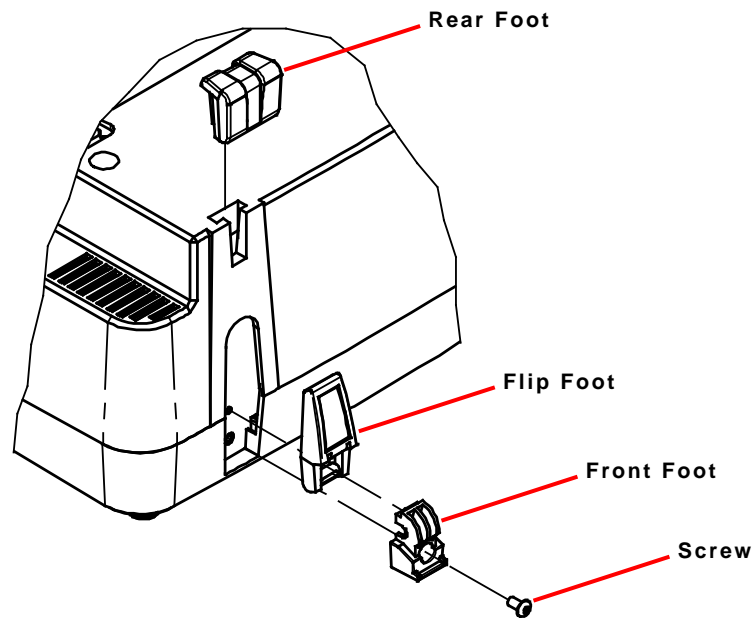

3-4. PREPARATION FOR STORAGE OR SHIPMENT

A. Packaging

Package the Unit in the original shipping container. When using packing materials other than the original, use the following guidelines:

- Wrap the Unit in plastic packing material.
- Use a double-wall cardboard shipping container.
- Protect all sides with shock-absorbing material to prevent Unit movement within the container.
- Seal the shipping container with approved sealing tape.
- Mark "FRAGILE" on the top, bottom and all sides of the shipping container.

B. Environment

The Unit should be stored in a clean, dry environment. In high humidity environments, protect the Unit from temperature variations that could cause internal condensation. The following environmental conditions apply to both shipping and storage:

Temperature:..... -30°C to +71°C*
Relative Humidity:..... 0% to 95%
Altitude:..... 0 to 4600 m
Vibration:..... <2 g
Shock: <30 g

* The Battery must not be subjected to temperatures <-20°C or >+60°C.

APPENDIX A - CONNECTOR PIN-OUT TABLES

A-1. I/O CONNECTORS



(Front Panel)

CONNECTOR	TYPE	INPUT/OUTPUT
AMP	DMM Banana Plug Female	INPUT
ANT	N Female	INPUT/OUTPUT
AUD IN	BNC Female	INPUT
AUD OUT	BNC Female	OUTPUT
COM	DMM Banana Plug Female	INPUT
GEN	N Female	OUTPUT
HEAD PHONES	2.5 mm CIRCULAR	OUTPUT
IN LINE POWER IN	N Female	INPUT
IN LINE POWER OUT	N Female	OUTPUT
MIC	6 Pin CIRCULAR Female	INPUT/OUTPUT
	Refer to Table A-3 for MIC Connector description.	
SCOPE	BNC Female	INPUT
T/R	N Female	INPUT/OUTPUT
USB	USB 2.0	INPUT/OUTPUT
	Refer to Table A-6 for USB Connector description.	
V / Ω	DMM Banana Plug Female	INPUT

Table A-1. I/O Connectors (Front Panel)

A-1. I/O CONNECTORS (cont)



8800 / 8800S
(Rear Panel)



8800SX
(Rear Panel)

CONNECTOR	TYPE	INPUT/OUTPUT
DC IN	2.5 mm CIRCULAR	INPUT
ETHERNET	RJ45	INPUT/OUTPUT
	Refer to Table A-5 for ETHERNET Connector description.	
GROUND	2.5 mm CIRCULAR	INPUT/OUTPUT
REMOTE	44-Pin D-SUB Female	INPUT/OUTPUT
	Refer to Table A-4 for REMOTE Connector description.	
USB	USB 2.0	INPUT/OUTPUT
	Refer to Table A-6 for USB Connector description.	
10 MHz IN	BNC Female	INPUT

Table A-2. I/O Connectors (Rear Panel)

A-2. MIC CONNECTOR PIN-OUT TABLE

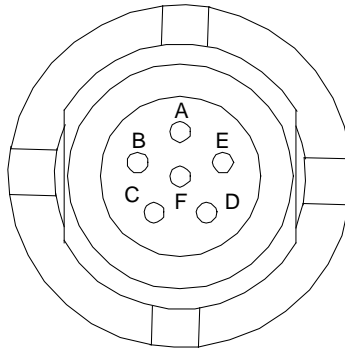

PIN NO.	SIGNAL NAME
A	GND
B	SPEAKER+
C	PTT
D	MIC
E	MICSEL1
F	MICSEL2

Table A-3. MIC Connector Pin-Out Table

A-3. REMOTE CONNECTOR PIN-OUT TABLE

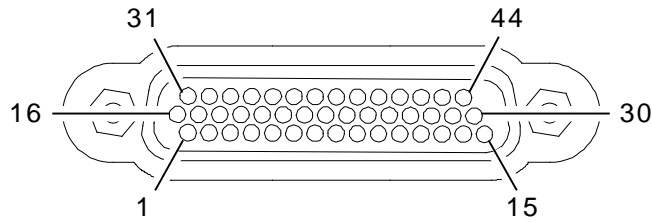

PIN NO.	SIGNAL NAME	PIN NO.	SIGNAL NAME
1	USB3_VBUS	23	GND
2	USB3_GND	24	PPC_ETX_P
3	+5V_ACC	25	GND
4	PPCDEBUG_TXD	26	PPCUSR_CTS
5	GND	27	PPCUSR_TXD
6	OMAPRCI_RTS	28	REM_GPIO(5)
7	GND	29	REM_GPIO(1)
8	PPC_ERX_N	30	REM_GPIO(3)
9	PPC_ETX_N	31	USB3_VBUS
10	GND	32	USB3_GND
11	PPCUSR_RTS	33	+5V_ACC
12	PPCUSR_RXD	34	PPCDEBUG_RXD
13	REM_GPIO(7)	35	GND
14	REM_GPIO(6)	36	OMAPRCI_RXD
15	REM_GPIO(2)	37	GND
16	USB3_FD_N	38	PPC_ERX_P
17	USB3_FD_P	39	GND
18	OMAPCON_TXD	40	REM_GPIO(4)
19	OMAPCON_RXD	41	REM_GPIO(0)
20	GND	42	OMAPCON_RTS
21	OMAPRCI_TXD	43	OMAPCON_CTS
22	OMAPRCI_CTS	44	BKBOX#

Table A-4. REMOTE Connector Pin-Out Table

A-4. ETHERNET CONNECTOR PIN-OUT TABLE

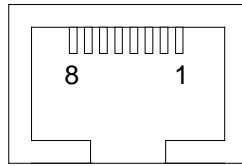

PIN NO.	SIGNAL NAME
1	TX+
2	TX-
3	RX+
4	NOT USED
5	NOT USED
6	RX-
7	NOT USED
8	NOT USED

Table A-5. ETHERNET Connector Pin-Out Table

A-5. USB CONNECTOR PIN-OUT TABLE

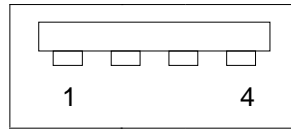

PIN NO.	SIGNAL NAME
1	VCC
2	D-
3	D+
4	GND

Table A-6. USB Connector Pin-Out Table

APPENDIX B - ABBREVIATIONS

A			
A	Amperes	Gen	Generate / Generator
AC	Alternating Current	GHz	Gigahertz (10 ⁹ Hertz)
AF	Audio Frequency		
AFBW	Audio Frequency Bandwidth		
AM	Amplitude Modulation		
ANT	Antenna	H	Hour
Assy	Assembly	HI	High
ATTN	Attenuation	HP	High-Pass
Aud	Audio	Hr	Hour
		HW	Hardware
		Hz	Hertz
B			
Bat	Battery		
Batt	Battery		
BER	Bit Error Rate		
BNC	Bayonet Neill-Concelman	ID	Identification
BP	Bandpass	i.e.,	That is ...
BW	Bandwidth	IF	Intermediate Frequency
		IN	Input or Inch
		In/lbs.	Inch/Pounds
		I/O	Input/Output
C			
C	Celsius or Centigrade		
CAL	Calibrate/Calibration		
CD	Compact Disk (CD-ROM)	kHz	Kilohertz (10 ³ Hertz)
CFM	Coldfire Firmware		
CH	Channel		
Config	Configure/Configuration	LCD	Liquid Crystal Display
CPLD	Complex Processing Logic Device	LO	Low
CW	Continuous Wave	LP	Low-Pass
		Lvl	Level
D			
D	Day	M, m	Month, Meters, Minutes or Male
dB	Decibel	MFIO	Multi-Function I/O
dBc	Decibels below Carrier	MHz	Megahertz (10 ⁶ Hertz)
dBm	Decibels above one Milliwatt	MIC	Microphone
DC	Direct Current	MIN, min	Minimum or Minutes
DCS	Digitally Coded Squelch	mm	Millimeter (10 ⁻³ Meters)
Demod	Demodulation	MOD	Modulation
DEV	Deviation		
DIST	Distortion		
DTF	Distance to Fault		
DVM	Digital Voltmeter	N/A	Not Applicable
		NORM	Normal or Normalize
E			
e.g.	For Example ...		
EMC	Electromagnetic Compatibility	OUT	Output
EMI	Electromagnetic Interference	Ovr	Overload
Err	Error		
ESC	Escape		
Est	Estimated		
F			
F	Female	para	Paragraph
FH	Frequency Hop	PC	Printed Circuit
Fgen	Function Generator	PCB	Printed Circuit Board
FM	Frequency Modulation	PPC	PowerPC
FPGA	Field Programmable Gate Array	ppm	Parts per Million
FREQ	Frequency	PTT	Push to Talk
		Pwr	Power
		G	
		H	
		I	
		K	
		L	
		M	
		N	
		O	
		P	

R

REC Receive
RF Radio Frequency
RSSI Received Signal Strength
Indication
RX Receive

S

SWR Standing Wave Ratio
SYS System

T

TDM Time-Division Multiplexing
Tem Temperature
Temp Temperature
TNC Threaded Neill-Concelman
T/R Transmit/Receive
TX Transmit

U

UHF Ultra High Frequency
UI User Interface
USB Universal Serial Bus
UUT Unit Under Test

V

V Volt
VAC Volts, Alternating Current
Vdc Volts, Direct Current
VHF Very High Frequency
Vol Volume
Vp Volta Peak
Vrms Volts Root Mean Square
VSWR Voltage Standing Wave Ratio

W

W Watt

Y

Y Year

As we are always seeking to improve our products, the information in this document gives only a general indication of the product capacity, performance and suitability, none of which shall form part of any contract. We reserve the right to make design changes without notice.



Go to <http://ats.aeroflex.com/contact/sales-distribution> for Sales and Service contact information.



EXPORT CONTROL WARNING: This document contains controlled technical data under the jurisdiction of the Export Administration Regulations (EAR), 15 CFR 730-774. It cannot be transferred to any foreign third party without the specific prior approval of the U.S. Department of Commerce, Bureau of Industry and Security (BIS). Violations of these regulations are punishable by fine, imprisonment, or both.



Our passion for performance is defined by three attributes represented by these three icons: solution-minded, performance-driven, customer-focused.